

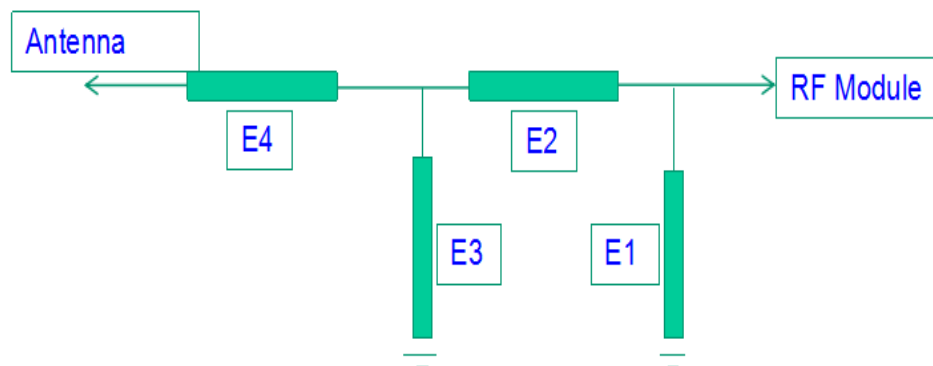

Antenna test report

1, Matching circuit: not modified



Main antenna		Diversity antenna		IFI/Bluetooth
Element	Value	Element	Value	Element
E1 (0402)		E1 (0402)		E1 (0402)
E2 (0402)		E2 (0402)		E2 (0402)
E3 (0402)		E3 (0402)		E3 (0402)
E4 (0402)		E4 (0402)		E4 (0402)

WIFI

Frequency(MHZ)	2400	2420	2440	2460	2500
Efficiency	39.5	40.4	41.3	42.1	40.7
Gain (DBI)	1.51	1.53	1.65	1.73	1.56

2400M

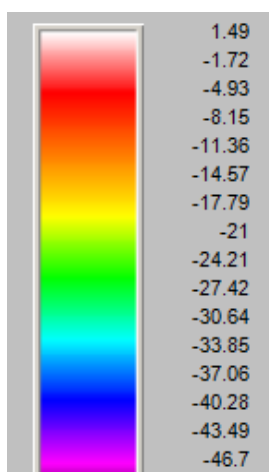
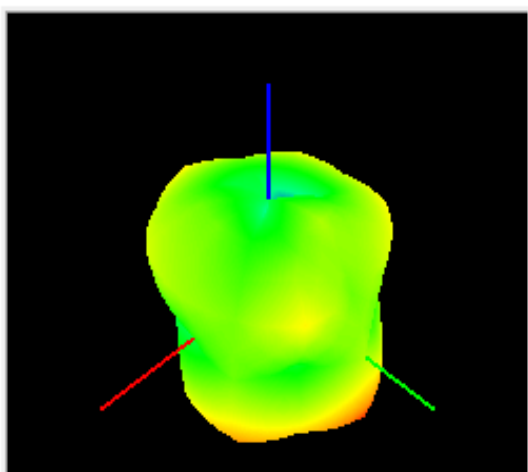

X Axis
Y Axis
Z Axis



2450M

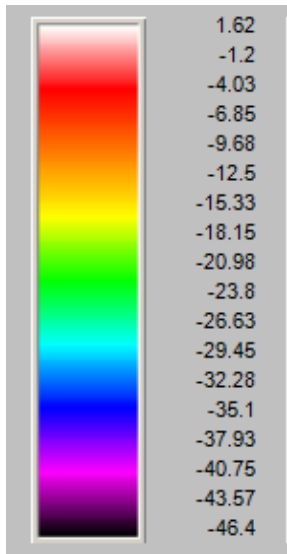
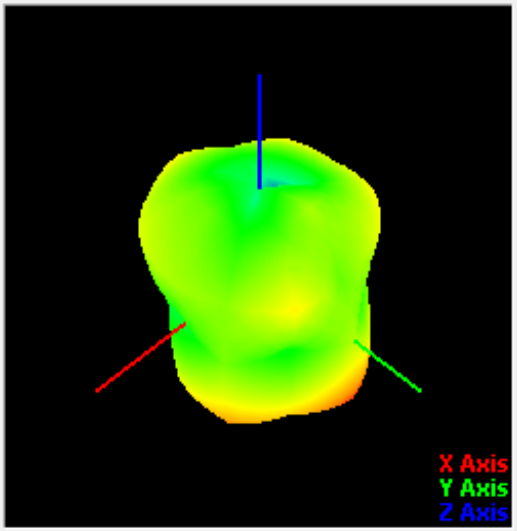

2500M

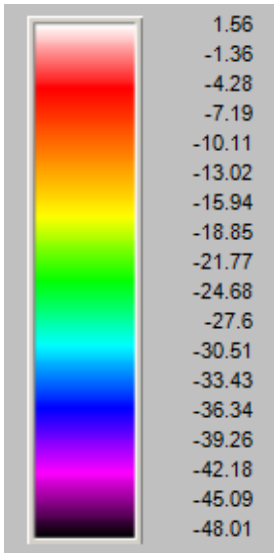
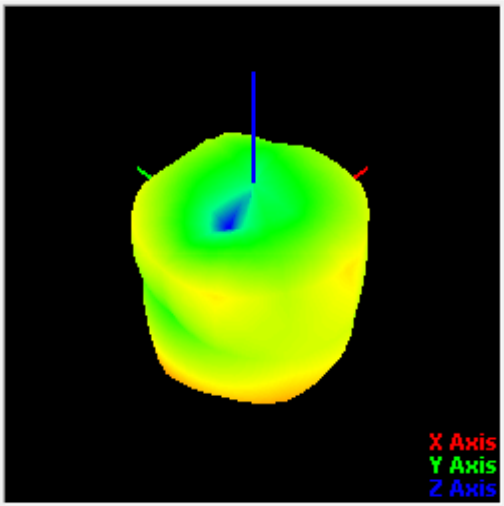

Antenna Photo



JINHONG COMMUNICATIONS TECHNOLOGY (SHENZHEN) CO.,LTD
Room 301, Building B1, Weiye Innovation 18 Industrial Zone, Nanchang Baoyuan
Road, Nanchang Community, Xixiang Street, Bao'an District, Shenzhen, China

Phone: +86-13927408317
Email: sale@szjhw.com
Website: www.szjhw.com