

IC RF Test Report

APPLICANT : Texas Instruments Incorporated
EQUIPMENT : WiFi and Bluetooth Module
BRAND NAME : Texas Instruments
MODEL NAME : WL18MODGB
IC : 4511-WL18SBMOD
STANDARD : IC RSS-210 issue 8

The product was received on Nov. 27, 2013 and testing was completed on Dec. 27, 2013. We, SPORTON INTERNATIONAL INC., would like to declare that the tested sample has been evaluated in accordance with the procedures and shown to be compliant with the applicable technical standards.

The test results in this report apply exclusively to the tested model / sample. Without written approval of SPORTON INTERNATIONAL INC., the test report shall not be reproduced except in full.



Reviewed by: Joseph Lin / Supervisor



Approved by: Jones Tsai / Manager



SPORTON INTERNATIONAL INC.

No. 52, Hwa Ya 1st Rd., Hwa Ya Technology Park, Kwei-Shan Hsiang, Tao Yuan Hsien, Taiwan, R.O.C.

SPORTON INTERNATIONAL INC.

TEL : 886-3-327-3456

FAX : 886-3-328-4978

IC : 4511-WL18SBMOD

Page Number : 1 of 46

Report Issued Date : Jan. 27, 2014

Report Version : Rev. 01



TABLE OF CONTENTS

REVISION HISTORY 3

SUMMARY OF TEST RESULT 4

1 GENERAL DESCRIPTION..... 5

 1.1 Applicant 5

 1.2 Manufacturer..... 5

 1.3 Feature of Equipment Under Test 5

 1.4 Product Specification of Equipment Under Test..... 5

 1.5 Modification of EUT 6

 1.6 Testing Site..... 6

 1.7 Applied Standards 6

2 TEST CONFIGURATION OF EQUIPMENT UNDER TEST..... 7

 2.1 Descriptions of Test Mode 7

 2.2 Test Mode..... 7

 2.3 Connection Diagram of Test System..... 8

 2.4 Support Unit used in test configuration and system 9

 2.5 EUT Operation Test Setup 9

 2.6 Measurement Results Explanation Example..... 9

3 TEST RESULT 10

 3.1 6dB and 99% Bandwidth Measurement 10

 3.2 Peak Output Power Measurement 15

 3.3 Power Spectral Density Measurement 17

 3.4 Conducted Band Edges and Spurious Emission Measurement 22

 3.5 Radiated Band Edges and Spurious Emission Measurement 31

 3.6 AC Conducted Emission Measurement..... 40

 3.7 Antenna Requirements 44

4 LIST OF MEASURING EQUIPMENT..... 45

5 UNCERTAINTY OF EVALUATION..... 46

APPENDIX A. SETUP PHOTOGRAPHS

SUMMARY OF TEST RESULT

Report Section	FCC Rule	IC Rule	Description	Limit	Result	Remark
3.1	15.247(a)(2)	RSS-210 A8.2(a)	6dB Bandwidth	$\geq 0.5\text{MHz}$	Pass	-
3.1	-	RSS-Gen 4.6.1	99% Bandwidth	-	Pass	-
3.2	15.247(b)(1)	RSS-210 A8.1(b)	Peak Output Power	$\leq 30\text{dBm}$	Pass	-
3.3	15.247(e)	RSS-210 A8.2(b)	Power Spectral Density	$\leq 8\text{dBm}$	Pass	-
3.4	15.247(d)	RSS-210 A8.5	Conducted Band Edges and Spurious Emission	$\leq 20\text{dBc}$	Pass	-
3.5	15.247(d)	RSS-210 A8.5	Radiated Band Edges and Spurious Emission	15.209(a) & 15.247(d)	Pass	Under limit 0.06 dB at 4806.000 MHz
3.6	15.207	RSS-Gen 7.2.4	AC Conducted Emission	15.207(a)	Pass	Under limit 8.50 dB at 0.350 MHz
3.7	15.203 & 15.247(b)	RSS-210 A8.4	Antenna Requirement	N/A	Pass	-

1 General Description

1.1 Applicant

Texas Instruments Incorporated
12500 TI Boulevard, M/S 8751, Dallas, TX 75243, USA

1.2 Manufacturer

Jorjin Technologies Inc.
17F., No. 239, Sec. 1, Datong Rd., Xizhi Dist. New Taipei City 221, Taiwan. R.O.C.

1.3 Feature of Equipment Under Test

Product Feature	
Equipment	WiFi and Bluetooth Module
Brand Name	Texas Instruments
Model Name	WL18MODGB
IC	451I-WL18SBMOD
EUT supports Radios application	WLAN 11b/g/n HT20/HT40 Bluetooth v3.0 + EDR Bluetooth v4.0 + LE
EUT Stage	Production Unit

Remark: The above EUT's information was declared by manufacturer. Please refer to the specifications or user's manual for more detailed description.

1.4 Product Specification of Equipment Under Test

Product Specification subjective to this standard	
Tx/Rx Frequency Range	2402 MHz ~ 2480 MHz
Number of Channels	40
Carrier Frequency of Each Channel	40 Channel(37 hopping + 3 advertising channel)
Maximum Output Power to Antenna	9.99 dBm (0.010 W)
99% Occupied Bandwidth	1.012MHz
Antenna Type	Chip Antenna type with gain -0.36 dBi
Type of Modulation	Bluetooth 4.0 - LE : GFSK



1.5 Modification of EUT

No modifications are made to the EUT during all test items.

1.6 Testing Site

Test Site	SPORTON INTERNATIONAL INC.			
Test Site Location	No. 52, Hwa Ya 1 st Rd., Hwa Ya Technology Park, Kwei-Shan Hsiang, Tao Yuan Hsien, Taiwan, R.O.C. TEL: +886-3-3273456 / FAX: +886-3-3284978			
Test Site No.	Sporton Site No.			FCC/IC Registration No.
	TH02-HY	CO05-HY	03CH07-HY	722060/4086B-1

Note: The test site complies with ANSI C63.4 2003 requirement.

1.7 Applied Standards

According to the specifications of the manufacturer, the EUT must comply with the requirements of the following standards:

- FCC Part 15 Subpart C §15.247
- FCC KDB Publication No. 558074 D01 DTS Meas. Guidance v03r01
- ANSI C63.4-2003
- IC RSS-210 Issue 8
- IC RSS-Gen Issue 3
- NOTICE 2012-DRS0126

Remark:

1. All test items were verified and recorded according to the standards and without any deviation during the test.
2. This EUT has also been tested and complied with the requirements of ICES-003, recorded in a separate test report.
3. Per the section 2.2.3 of Notice of 2012-DRS0126, “ Receivers Excluded from Industry Canada Requirements”, only radiocommunication receivers operating in stand-alone mode within the band 30-960 MHz and scanner receivers are subject to Industry Canada requirements.

2 Test Configuration of Equipment Under Test

2.1 Descriptions of Test Mode

The RF output power was recorded in the following table:

Channel	Frequency	Bluetooth 4.0 – LE RF Output Power	
		Data Rate / Modulation	
		GFSK	
		1Mbps	
Ch00	2402MHz	9.99 dBm	
Ch19	2440MHz	9.59 dBm	
Ch39	2480MHz	9.06 dBm	

- a. The EUT has been associated with peripherals and configuration operated in a manner tended to maximize its emission characteristics in a typical application. Frequency range investigated: conduction (150 kHz to 30 MHz), radiation (9 kHz to the 10th harmonic of the highest fundamental frequency or to 40 GHz, whichever is lower).
- b. AC power line Conducted Emission was tested under maximum output power.

2.2 Test Mode

The following summary table is showing all test modes to demonstrate in compliance with the standard.

Summary table of Test Cases	
Test Item	Data Rate / Modulation
	Bluetooth 4.0 – LE / GFSK
Conducted TCs	Mode 1: Bluetooth Tx CH00_2402 MHz_1Mbps Mode 2: Bluetooth Tx CH19_2440 MHz_1Mbps Mode 3: Bluetooth Tx CH39_2480 MHz_1Mbps
Radiated TCs	Mode 1: Bluetooth Tx CH00_2402 MHz_1Mbps Mode 2: Bluetooth Tx CH19_2440 MHz_1Mbps Mode 3: Bluetooth Tx CH39_2480 MHz_1Mbps
AC Conducted Emission	Mode 1: WLAN Link + Bluetooth Link + Adapter

2.3 Connection Diagram of Test System

<Bluetooth 4.0 – LE Tx Mode>

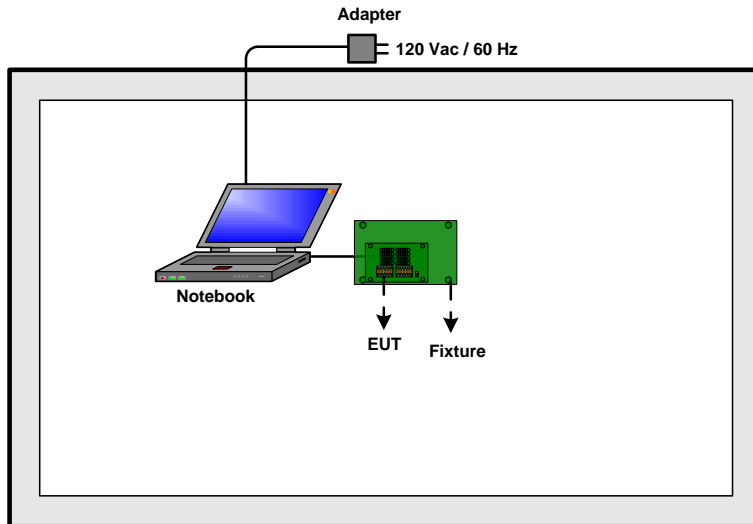

<AC Conducted Emission Mode>

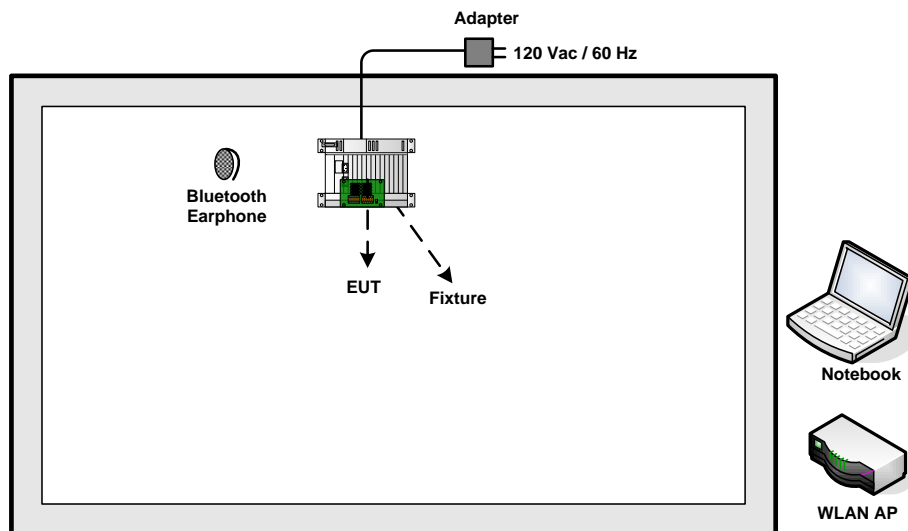

2.4 Support Unit used in test configuration and system

Item	Equipment	Trade Name	Model Name	FCC ID	Data Cable	Power Cord
1.	Bluetooth Earphone	SonyEricsson	MW600	PY700A2029	N/A	N/A
2.	WLAN AP	D-Link	DIR-628	KA2DIR628A2	N/A	Unshielded, 1.8 m
3.	Notebook	DELL	Vostro 1320	FCC DoC	N/A	AC I/P: Unshielded, 1.2 m DC O/P: Shielded, 1.8 m
4.	Notebook	DELL	Latitude E6320	FCC DoC	N/A	AC I/P: Unshielded, 1.2 m DC O/P: Shielded, 1.8 m
5.	Fixture	N/A	WG7XXXT01	N/A	N/A	N/A
6.	Adapter	Aviv Energy	HK-IP15-A05	N/A	N/A	Unshielded, 1.8 m

2.5 EUT Operation Test Setup

For Bluetooth function, programmed RF utility, "HCT tester" installed in the notebook make the EUT provides functions like channel selection and power level for continuous transmitting and receiving signals.

2.6 Measurement Results Explanation Example

For all conducted test items:

The offset level is set in the spectrum analyzer to compensate the RF cable loss and attenuator factor between EUT conducted output port and spectrum analyzer. With the offset compensation, the spectrum analyzer reading level is exactly the EUT RF output level.

Example :

The spectrum analyzer offset is derived from RF cable loss and attenuator factor.

Offset = RF cable loss + attenuator factor.

Following shows an offset computation example with cable loss 4.2 dB and 10dB attenuator.

$$\begin{aligned}
 \text{Offset(dB)} &= \text{RF cable loss(dB)} + \text{attenuator factor(dB)}. \\
 &= 4.2 + 10 = 14.2 \text{ (dB)}
 \end{aligned}$$

3 Test Result

3.1 6dB and 99% Bandwidth Measurement

3.1.1 Limit of 6dB and 99% Bandwidth

The minimum 6 dB bandwidth shall be at least 500 kHz.

3.1.2 Measuring Instruments

The section 4.0 of List of Measuring Equipment of this test report is used for test.

3.1.3 Test Procedures

1. The testing follows FCC KDB Publication No. 558074 D01 DTS Meas. Guidance v03r01.
2. The RF output of EUT was connected to the spectrum analyzer by RF cable and attenuator. The path loss was compensated to the results for each measurement.
3. Set to the maximum power setting and enable the EUT transmit continuously.
4. Make the measurement with the spectrum analyzer's resolution bandwidth (RBW) = 100 kHz. Set the Video bandwidth (VBW) = 300 kHz. In order to make an accurate measurement. The 6 dB bandwidth must be greater than 500 kHz.
5. For 99% Bandwidth Measurement, the spectrum analyzer's resolution bandwidth (RBW) is set 30kHz and set the Video bandwidth (VBW) = 100kHz.
6. Measure and record the results in the test report.

3.1.4 Test Setup

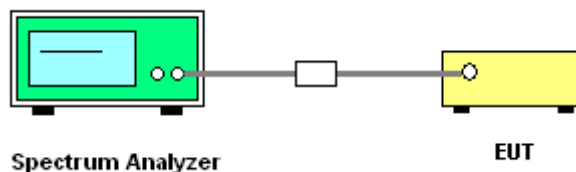



3.1.5 Test Result of 6dB Bandwidth

Test Mode :	Bluetooth 4.0 - LE	Temperature :	22~25°C
Test Engineer :	Book Lin	Relative Humidity :	51~55%

Channel	Frequency (MHz)	6dB Bandwidth (MHz)	6dB Bandwidth Min. Limit (MHz)	Pass/Fail
00	2402	0.656	0.5	Pass
19	2440	0.656	0.5	Pass
39	2480	0.660	0.5	Pass

6 dB Bandwidth Plot on Channel 00

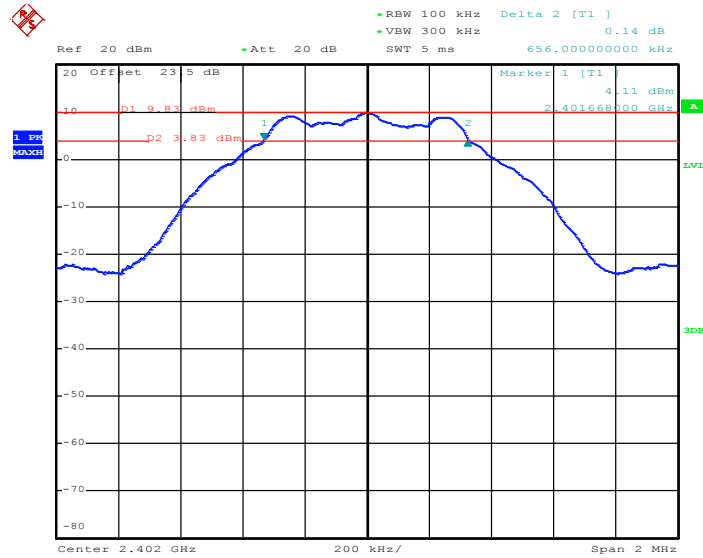

Date: 19.DEC.2013 09:34:13



6 dB Bandwidth Plot on Channel 19

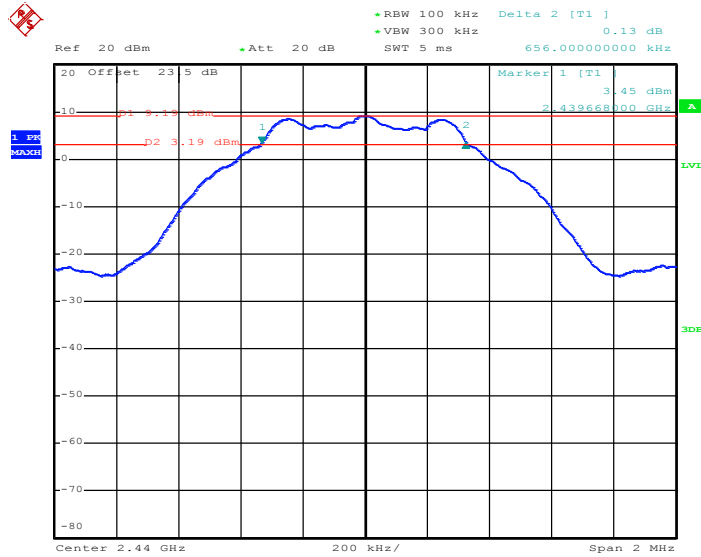

Date: 19.DEC.2013 09:45:19

6 dB Bandwidth Plot on Channel 39

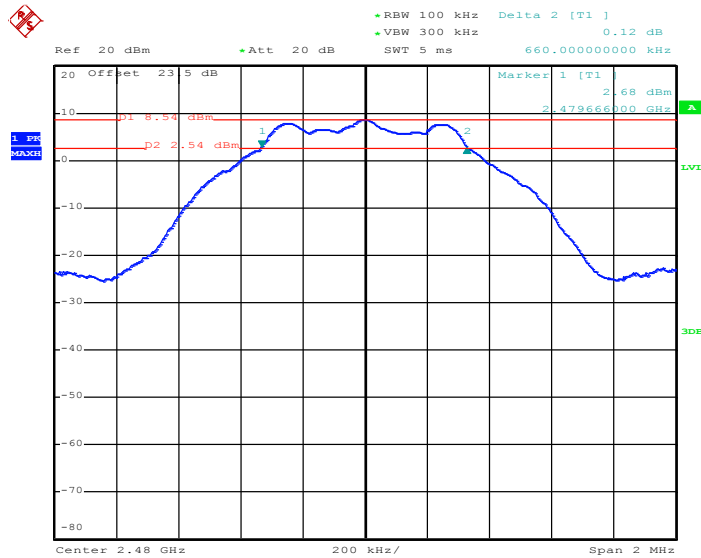

Date: 19.DEC.2013 09:50:03

3.1.6 Test Result of 99% Occupied Bandwidth

Test Mode :	Bluetooth 4.0 - LE	Temperature :	22~25°C
Test Engineer :	Book Lin	Relative Humidity :	51~55%

Channel	Frequency (MHz)	99% Occupied Bandwidth (MHz)
00	2402	1.006
19	2440	1.012
39	2480	1.012

99% Bandwidth Plot on Channel 00

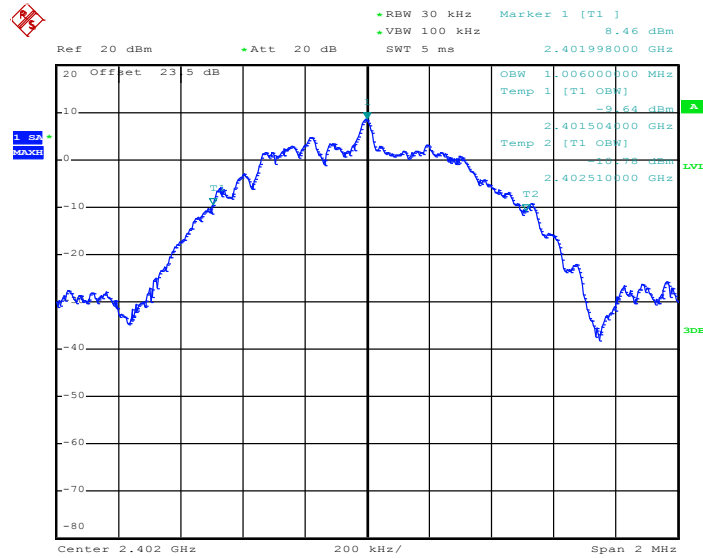

Date: 19.DEC.2013 09:39:13



99% Occupied Bandwidth Plot on Channel 19

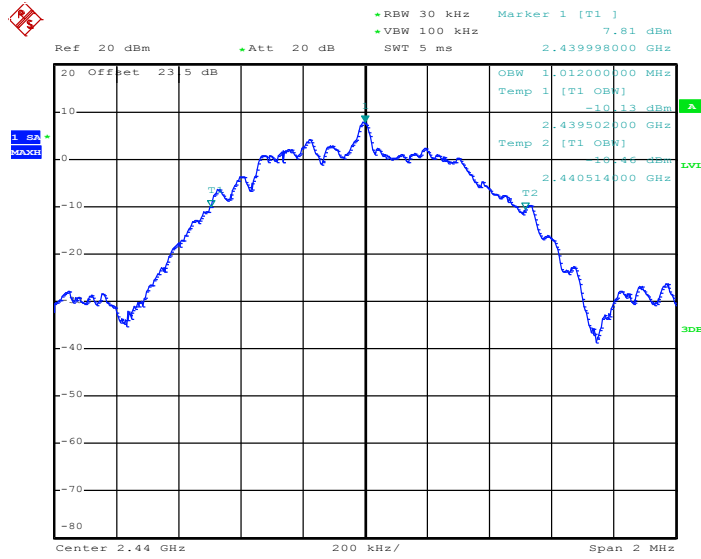

Date: 19.DEC.2013 09:46:56

99% Occupied Bandwidth Plot on Channel 39

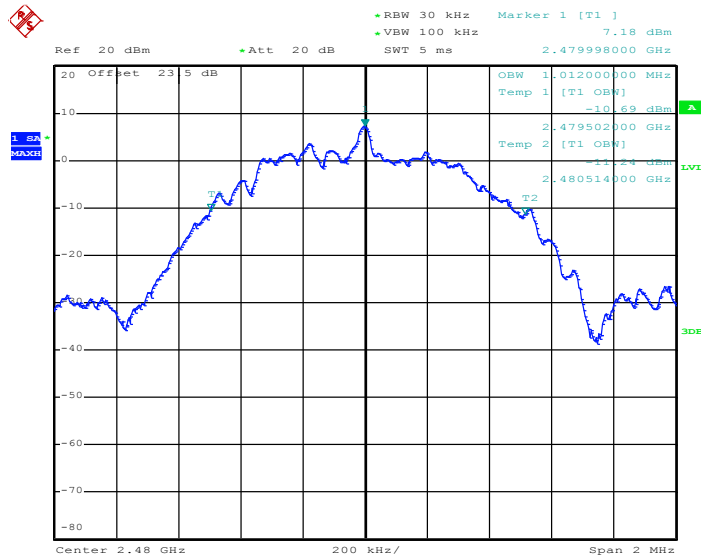

Date: 19.DEC.2013 09:51:56

3.2 Peak Output Power Measurement

3.2.1 Limit of Peak Output Power

For systems using digital modulation in the 2400-2483.5MHz, the limit for peak output power is 30dBm. If transmitting antenna of directional gain greater than 6dBi is used, the peak output power from the intentional radiator shall be reduced below the above stated value by the amount in dB that the directional gain of the antenna exceeds 6 dBi. In case of point-to-point operation, the limit has to be reduced by 1dB for every 3dB that the directional gain of the antenna exceeds 6dBi.

3.2.2 Measuring Instruments

The section 4.0 of List of Measuring Equipment of this test report is used for test.

3.2.3 Test Procedures

1. The testing follows the Measurement Procedure of FCC KDB No. 558074 DTS D01 Meas. Guidance v03r01.
2. The RF output of EUT was connected to the power meter by RF cable and attenuator. The path loss was compensated to the results for each measurement.
3. Set to the maximum power setting and enable the EUT transmit continuously.
4. Measure the conducted output power and record the results in the test report.

3.2.4 Test Setup

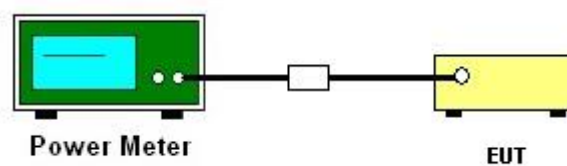



3.2.5 Test Result of Peak Output Power

Test Mode :	Bluetooth 4.0 - LE	Temperature :	22~25°C
Test Engineer :	Book Lin	Relative Humidity :	51~55%

Channel	Frequency (MHz)	RF Power (dBm)		
		GFSK	Max. Limits (dBm)	Pass/Fail
		1 Mbps		
00	2402	9.99	30.00	Pass
19	2440	9.59	30.00	Pass
39	2480	9.06	30.00	Pass

3.3 Power Spectral Density Measurement

3.3.1 Limit of Power Spectral Density

The peak power spectral density shall not be greater than 8dBm in any 3kHz band at any time interval of continuous transmission.

3.3.2 Measuring Instruments

The section 4.0 of List of Measuring Equipment of this test report is used for test.

3.3.3 Test Procedures

1. The testing follows Measurement Procedure 10.2 Method PKPSD of FCC KDB Publication No. 558074 D01 DTS Meas. Guidance v03r01
2. The RF output of EUT was connected to the spectrum analyzer by RF cable and attenuator. The path loss was compensated to the results for each measurement.
3. Set to the maximum power setting and enable the EUT transmit continuously.
4. Make the measurement with the spectrum analyzer's resolution bandwidth (RBW) = 3 kHz. Video bandwidth VBW = 10 kHz In order to make an accurate measurement, set the span to 1.5 times DTS Channel Bandwidth. (6dB BW)
5. Detector = peak, Sweep time = auto couple, Trace mode = max hold, Allow trace to fully stabilize. Use the peak marker function to determine the maximum power level.
6. Measure and record the results in the test report.
7. The Measured power density (dBm)/ 100kHz is a reference level and used as 20dBc down limit line for Conducted Band Edges and Conducted Spurious Emission.

3.3.4 Test Setup

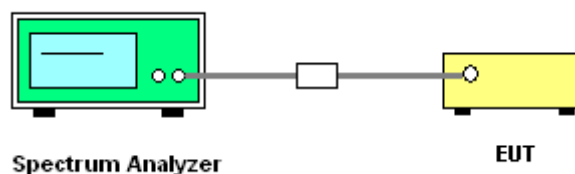

3.3.5 Test Result of Power Spectral Density

Test Mode :	Bluetooth 4.0 - LE	Temperature :	22~25°C
Test Engineer :	Book Lin	Relative Humidity :	51~55%

Channel	Frequency (MHz)	Power Density		Max. Limits (dBm/3kHz)	Pass/Fail
		PSD/100kHz (dBm)	PSD/3kHz (dBm)		
00	2402	9.78	-5.77	8	Pass
19	2440	9.15	-6.45	8	Pass
39	2480	8.53	-6.94	8	Pass

Note:

1. Measured power density (dBm) has offset with cable loss.
2. The Measured power density (dBm)/ 100kHz is reference level and used as 20dBc down for Conducted Band Edges and Conducted Spurious Emission limit line.

3.3.6 Test Result of Power Spectral Density Plots (100kHz)

PSD 100kHz Plot on Channel 00

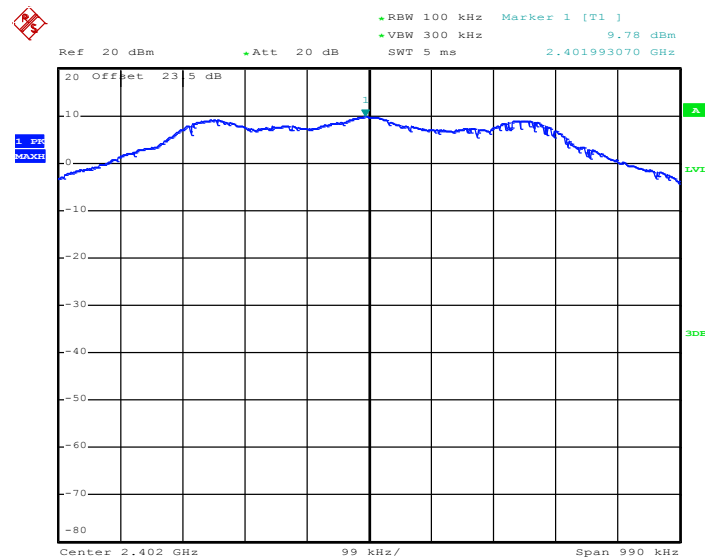

Date: 19.DEC.2013 09:38:05

PSD 100kHz Plot on Channel 19

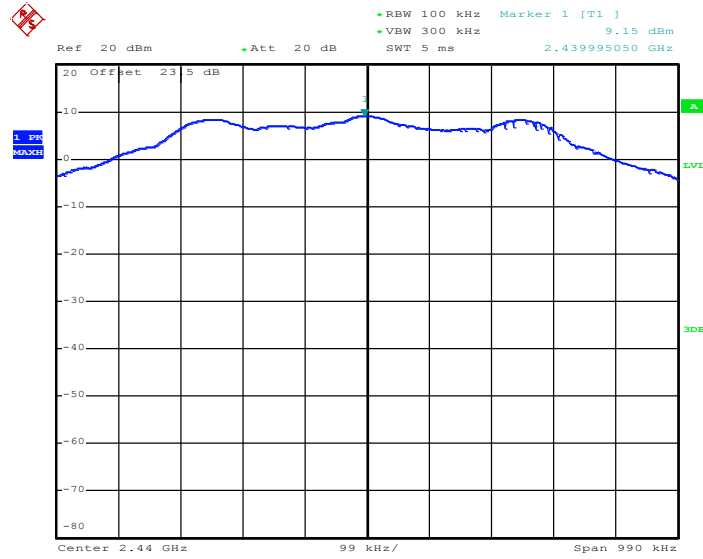

Date: 19.DEC.2013 09:46:01

PSD 100kHz Plot on Channel 39

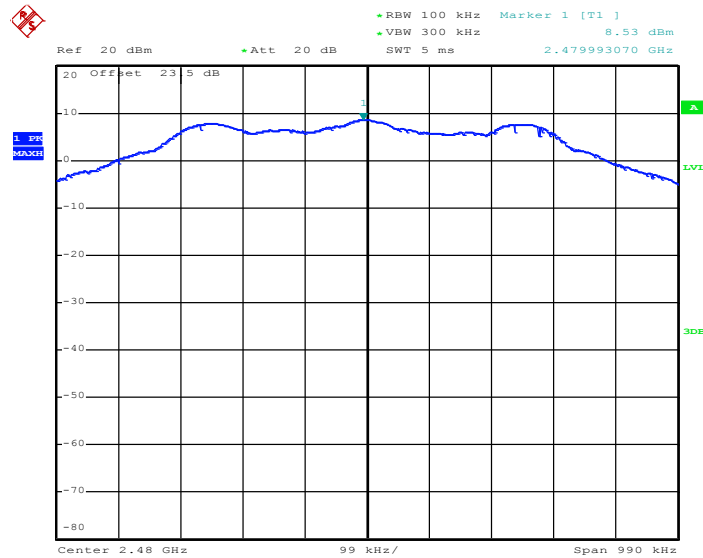

Date: 19.DEC.2013 09:50:35

3.3.7 Test Result of Power Spectral Density Plots (3kHz)

PSD 3kHz Plot on Channel 00

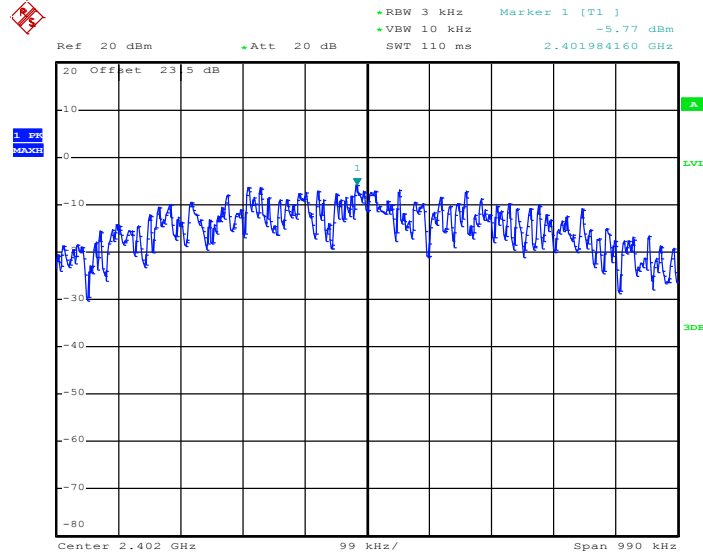

Date: 19.DEC.2013 09:37:54

PSD 3kHz Plot on Channel 19

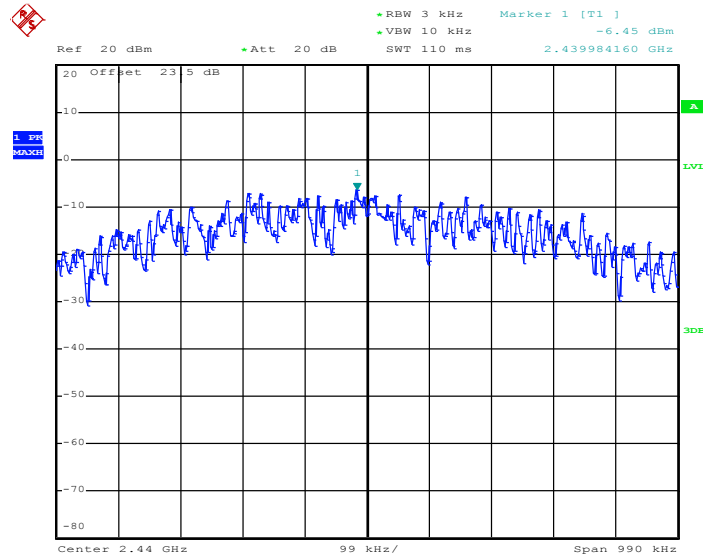

Date: 19.DEC.2013 09:45:39



PSD 3kHz Plot on Channel 39

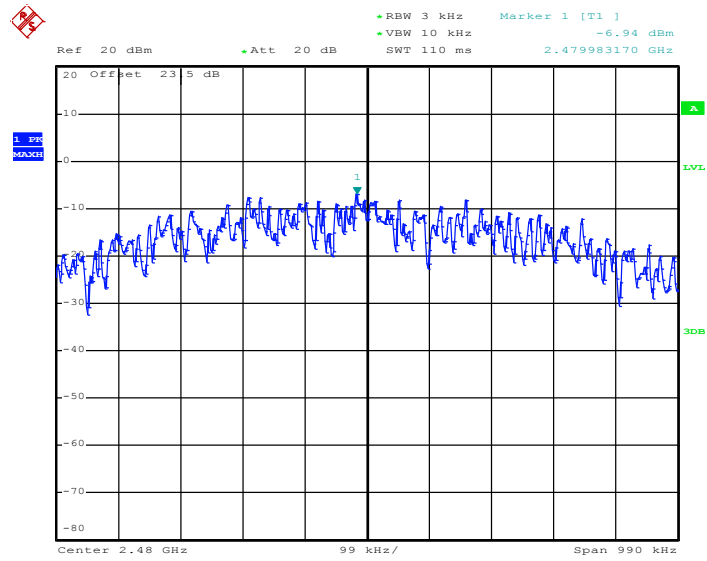

Date: 19.DEC.2013 09:50:23

3.4 Conducted Band Edges and Spurious Emission Measurement

3.4.1 Limit of Conducted Band Edges and Spurious Emission

All harmonics/spurious must be at least 20 dB down from the highest emission level within the authorized band.

3.4.2 Measuring Instruments

The section 4.0 of List of Measuring Equipment of this test report is used for test.

3.4.3 Test Procedure

1. The testing follows FCC KDB Publication No. 558074 D01 DTS Meas. Guidance v03r01.
2. The RF output of EUT was connected to the spectrum analyzer by RF cable and attenuator. The path loss was compensated to the results for each measurement.
3. Set to the maximum power setting and enable the EUT transmit continuously.
4. Set RBW = 100 kHz, VBW=300 kHz, Peak Detector. Unwanted Emissions measured in any 100 kHz bandwidth outside of the authorized frequency band shall be attenuated by at least 20 dB relative to the maximum in-band peak PSD level in 100 kHz when maximum peak conducted output power procedure is used. If the transmitter complies with the conducted power limits based on the use of RMS averaging over a time interval, the attenuation required under this paragraph shall be 30 dB instead of 20 dB per 15.247(d).
5. Measure and record the results in the test report.
6. The RF fundamental frequency should be excluded against the limit line in the operating frequency band.

3.4.4 Test Setup

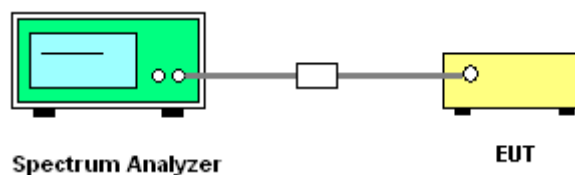

3.4.5 Test Result of Conducted Band Edges

Test Mode :	Bluetooth 4.0 - LE	Temperature :	22~25°C
Test Channel :	00 and 39	Relative Humidity :	51~55%
		Test Engineer :	Book Lin

Low Band Edge Plot on Channel 00

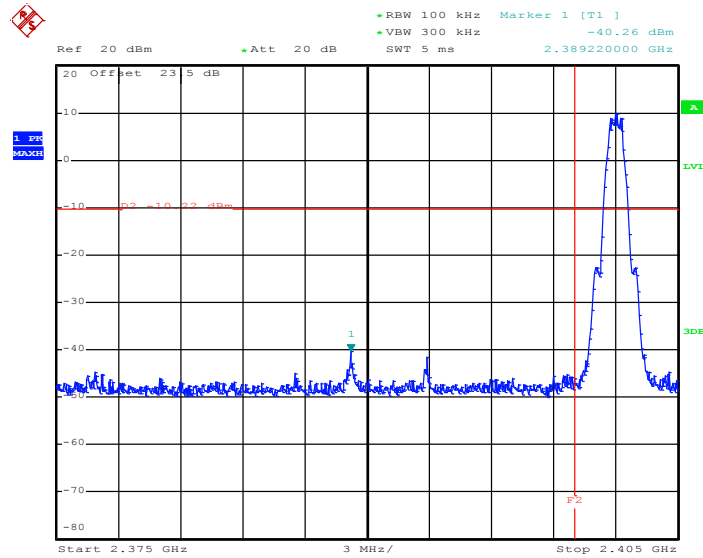

Date: 19.DEC.2013 09:38:21



High Band Edge Plot on Channel 39

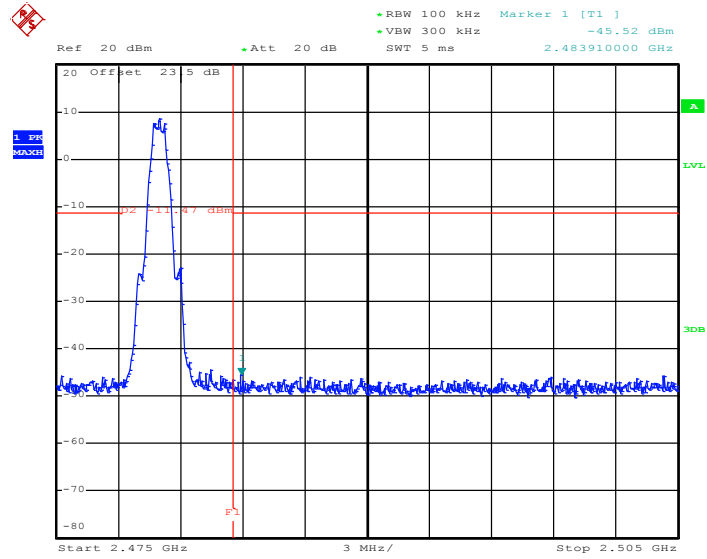

Date: 19.DEC.2013 09:51:02

3.4.6 Test Result of Conducted Spurious Emission

Test Mode :	Bluetooth 4.0 - LE	Temperature :	22~25°C
Test Channel :	00	Relative Humidity :	51~55%
		Test Engineer :	Book Lin

Conducted Spurious Emission Plot on Bluetooth LE 1Mbps
GFSK Channel 00

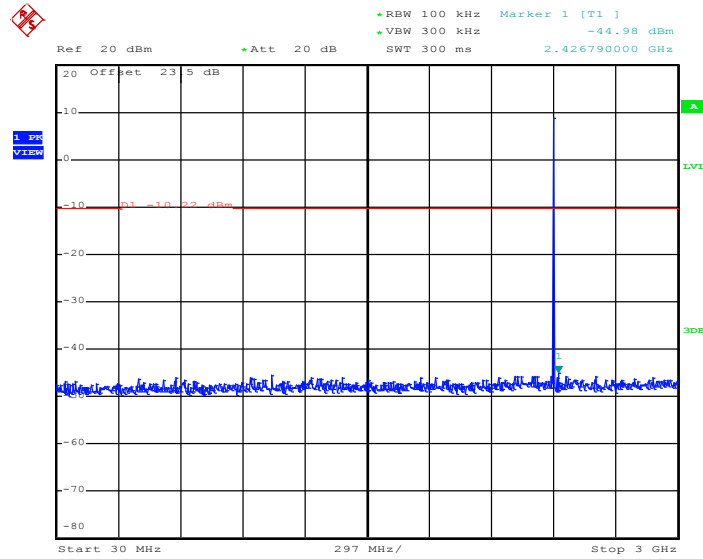

Date: 19.DEC.2013 09:58:21



Conducted Spurious Emission Plot on Bluetooth LE 1Mbps
GFSK Channel 00

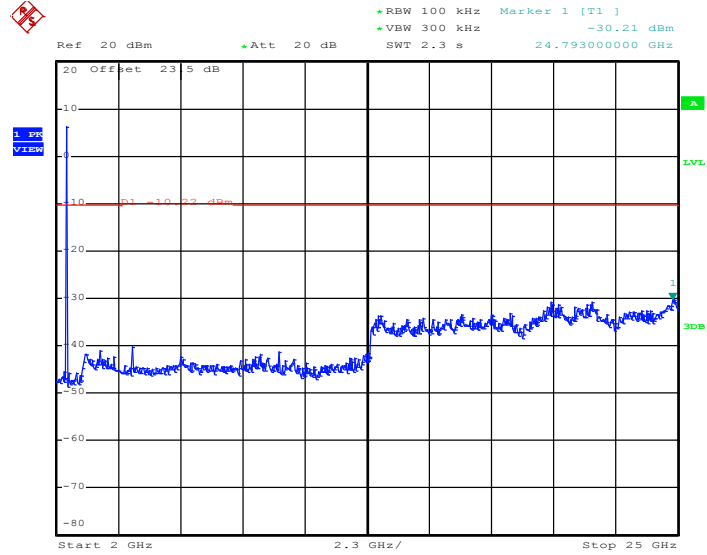

Date: 19.DEC.2013 09:58:40



Test Mode :	Bluetooth 4.0 - LE	Temperature :	22~25°C
Test Channel :	19	Relative Humidity :	51~55%
		Test Engineer :	Book Lin

Conducted Spurious Emission Plot on Bluetooth LE 1Mbps
GFSK Channel 19

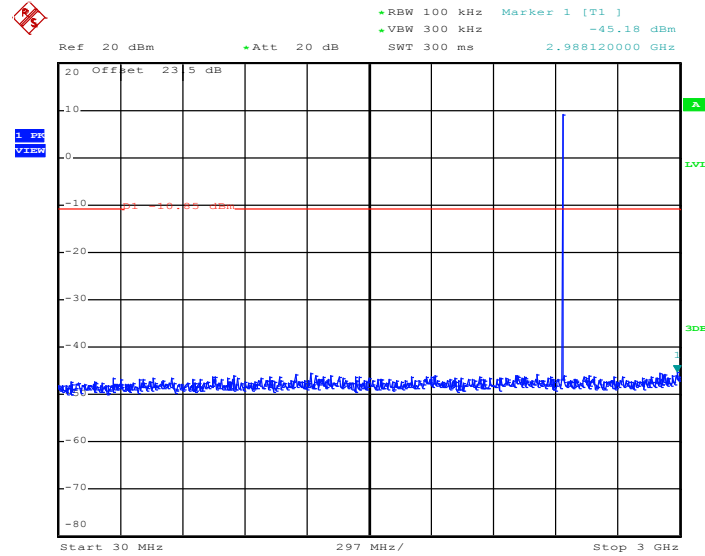

Date: 19.DEC.2013 09:46:24



Conducted Spurious Emission Plot on Bluetooth LE 1Mbps
GFSK Channel 19

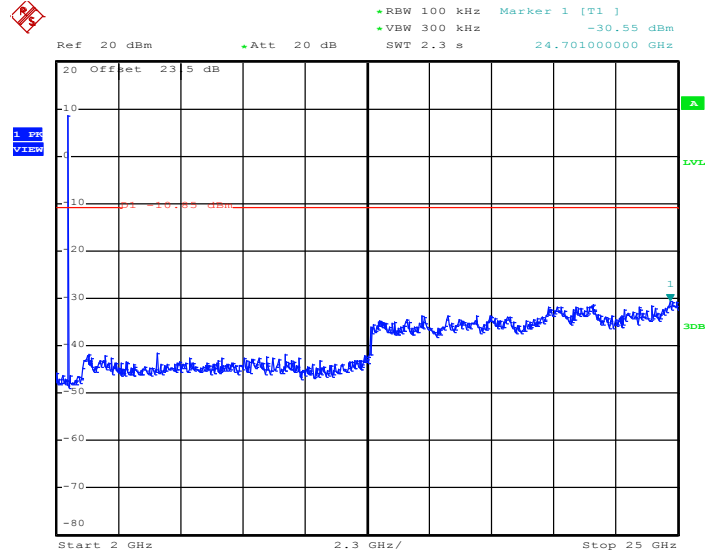

Date: 19.DEC.2013 09:46:43



Test Mode :	Bluetooth 4.0 - LE	Temperature :	22~25°C
Test Channel :	39	Relative Humidity :	51~55%
		Test Engineer :	Book Lin

Conducted Spurious Emission Plot on Bluetooth LE 1Mbps
GFSK Channel 39

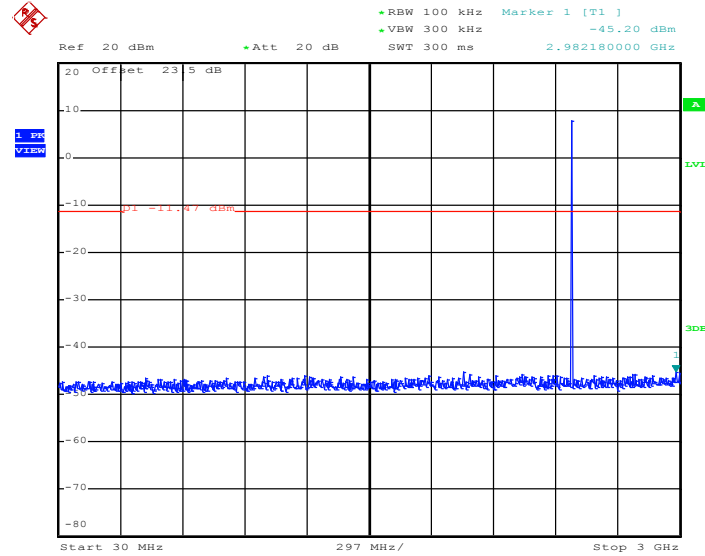

Date: 19.DEC.2013 09:51:25



Conducted Spurious Emission Plot on Bluetooth LE 1Mbps
GFSK Channel 39

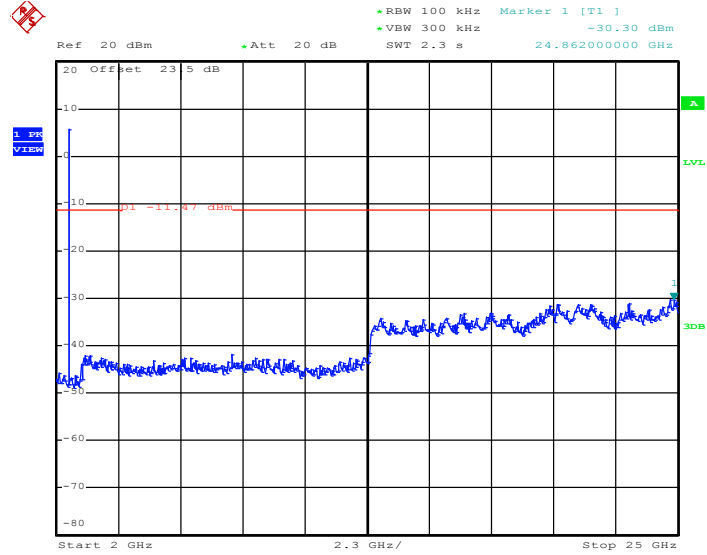

Date: 19.DEC.2013 09:51:43

3.5 Radiated Band Edges and Spurious Emission Measurement

3.5.1 Limit of Radiated Band Edges and Spurious Emission

In any 100 kHz bandwidth outside the intentional radiator frequency band, all harmonics/spurious must be at least 20 dB below the highest emission level within the authorized band. If the output power of this device was measured by spectrum analyzer, the attenuation under this paragraph shall be 30 dB instead of 20 dB. In addition, radiated emissions which fall in the restricted bands must also comply with the FCC section 15.209 limits as below.

Frequency (MHz)	Field Strength (microvolts/meter)	Measurement Distance (meters)
0.009 – 0.490	2400/F(kHz)	300
0.490 – 1.705	24000/F(kHz)	30
1.705 – 30.0	30	30
30 – 88	100	3
88 – 216	150	3
216 - 960	200	3
Above 960	500	3

3.5.2 Measuring Instruments

The section 4.0 of List of Measuring Equipment of this test report is used for test.

3.5.3 Test Procedures

1. The testing follows FCC KDB Publication No. 558074 D01 DTS Meas. Guidance v03r01.
2. The EUT was arranged to its worst case and then tune the antenna tower (from 1 m to 4 m) and turntable (from 0 degree to 360 degrees) to find the maximum reading. A pre-amp and a high pass filter are used for the test in order to get better signal level.
3. The EUT was placed on a turntable with 0.8 meter above ground.
4. The EUT was set 3 meters from the interference receiving antenna, which was mounted on the top of a variable height antenna tower.
5. Corrected Reading: Antenna Factor + Cable Loss + Read Level - Preamp Factor = Level
6. For measurement below 1GHz, If the emission level of the EUT measured by the peak detector is 3 dB lower than the applicable limit, the peak emission level will be reported. Otherwise, the emission measurement will be repeated using the quasi-peak detector and reported.
7. Use the following spectrum analyzer settings:
 - (1) Span shall wide enough to fully capture the emission being measured;
 - (2) Set RBW=100 kHz for $f < 1$ GHz; $VBW \geq RBW$; Sweep = auto; Detector function = peak; Trace = max hold;
 - (3) Set RBW = 1 MHz, VBW= 3MHz for $f \geq 1$ GHz, detector = Peak for peak measurement.
Set RBW = 1 MHz, VBW= 3MHz for $f \geq 1$ GHz detector = RMS for average measurement.
Trace averaging with linear voltage averaging mode is used and the correction factor $20\log(1/x)$ is added to the test results, where x is the duty cycle.

Band	x = Duty Cycle(%)	1/x	20log(1/x)
Bluetooth 4.0 - LE	51.59	1.938	5.85

3.5.4 Test Setup

For radiated emissions below 30MHz

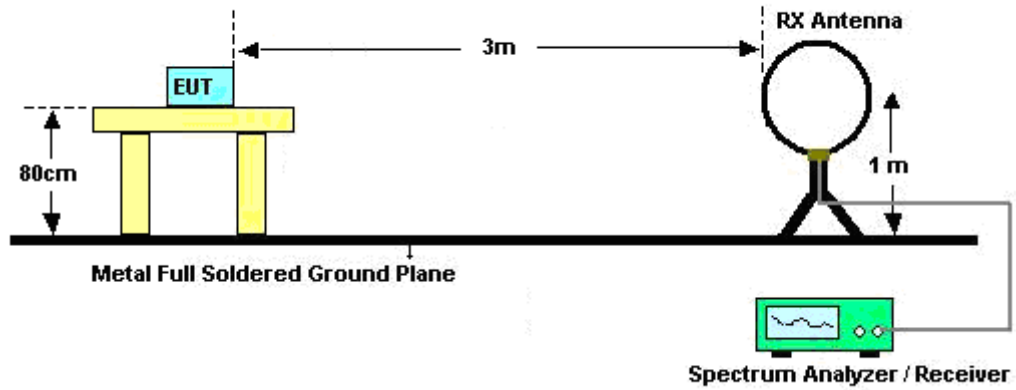

For radiated emissions from 30MHz to 1GHz

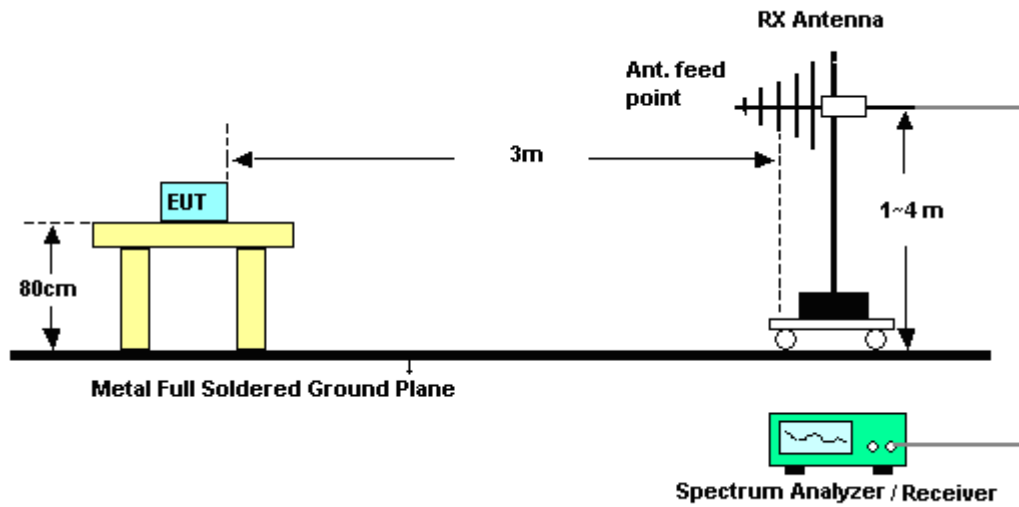

For radiated emissions above 1GHz

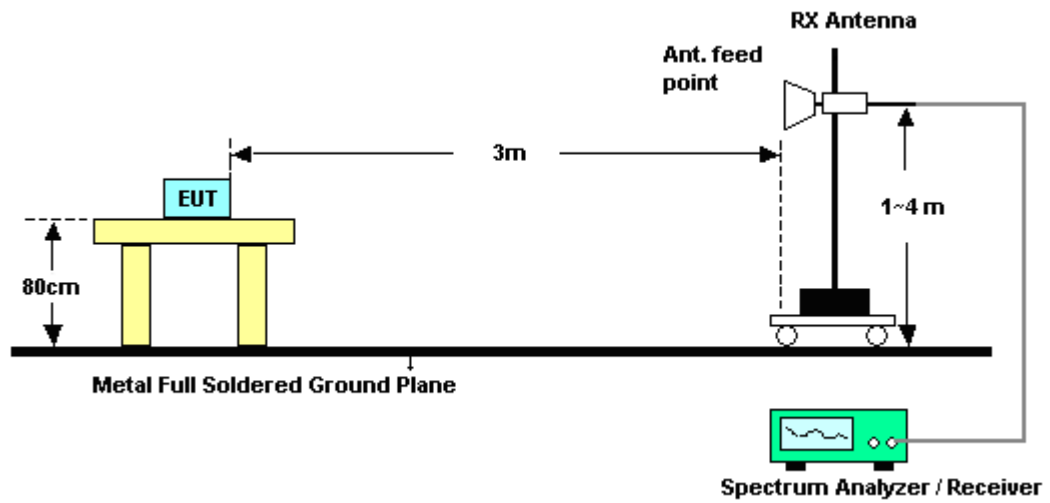

3.5.5 Test Results of Radiated Spurious Emissions (9 kHz ~ 30 MHz)

The low frequency, which started from 9 kHz to 30MHz, was pre-scanned and the result which was 20dB lower than the limit line per 15.31(o) was not reported.



3.5.6 Test Result of Radiated Spurious at Band Edges

Test Mode :	Mode 1	Temperature :	20~22°C
Test Channel :	00	Relative Humidity :	51~56%
		Test Engineer :	Stan Hsieh

ANTENNA POLARITY : HORIZONTAL										
Frequency (MHz)	Level (dB μ V /m)	Over Limit (dB)	Limit Line (dB μ V /m)	Read Level (dB μ V)	Antenna Factor (dB)	Cable Loss (dB)	Preamp Factor (dB)	Ant Pos (cm)	Table Pos (deg)	Remark
2389.7	47.21	-26.79	74	42.27	32.3	6.91	34.27	169	139	Peak
2389.7	41.61	-12.39	54	36.67	32.3	6.91	34.27	169	139	Average

ANTENNA POLARITY : VERTICAL										
Frequency (MHz)	Level (dB μ V /m)	Over Limit (dB)	Limit Line (dB μ V /m)	Read Level (dB μ V)	Antenna Factor (dB)	Cable Loss (dB)	Preamp Factor (dB)	Ant Pos (cm)	Table Pos (deg)	Remark
2389.9	48.21	-25.79	74	43.3	32.3	6.91	34.3	158	114	Peak
2389.9	41.51	-12.49	54	36.6	32.3	6.91	34.3	158	114	Average

Test Mode :	Mode 3	Temperature :	20~22°C
Test Channel :	39	Relative Humidity :	51~56%
		Test Engineer :	Stan Hsieh

ANTENNA POLARITY : HORIZONTAL										
Frequency (MHz)	Level (dB μ V /m)	Over Limit (dB)	Limit Line (dB μ V /m)	Read Level (dB μ V)	Antenna Factor (dB)	Cable Loss (dB)	Preamp Factor (dB)	Ant Pos (cm)	Table Pos (deg)	Remark
2491.51	49.52	-24.48	74	44.49	32.4	7.06	34.43	132	140	Peak
2491.51	41.46	-12.54	54	36.43	32.4	7.06	34.43	132	140	Average

ANTENNA POLARITY : VERTICAL										
Frequency (MHz)	Level (dB μ V /m)	Over Limit (dB)	Limit Line (dB μ V /m)	Read Level (dB μ V)	Antenna Factor (dB)	Cable Loss (dB)	Preamp Factor (dB)	Ant Pos (cm)	Table Pos (deg)	Remark
2486.83	47.01	-26.99	74	42	32.38	7.06	34.43	124	88	Peak
2486.83	41.39	-12.61	54	36.38	32.38	7.06	34.43	124	88	Average

3.5.7 Test Result of Radiated Spurious Emission (30MHz ~ 10th Harmonic)

Note: Pre-scanned all test modes and only choose the worst case mode recorded in the test report for radiated spurious emission below 1GHz.

Test Mode :	Mode 1	Temperature :	20~22°C
Test Channel :	00	Relative Humidity :	51~56%
Test Engineer :	Stan Hsieh	Polarization :	Horizontal
Remark :	2402 MHz is fundamental signal which can be ignored.		

Frequency (MHz)	Level (dB μ V/m)	Over Limit (dB)	Limit Line (dB μ V/m)	Read Level (dB μ V)	Antenna Factor (dB)	Cable Loss (dB)	Preamp Factor (dB)	Ant Pos (cm)	Table Pos (deg)	Remark
66.72	36.5	-3.5	40	60.76	6.16	0.82	31.24	-	-	Peak
126.93	39.61	-3.89	43.5	57.82	11.76	1.13	31.1	-	-	Peak
288.93	42.6	-3.4	46	58.92	13.07	1.69	31.08	159	37	Peak
324.5	41.72	-4.28	46	57.29	13.6	1.83	31	-	-	Peak
745.9	39	-7	46	44.21	22.14	3.05	30.4	-	-	Peak
797	39.17	-6.83	46	44.37	21.97	3.14	30.31	-	-	Peak
2402	88.79	-	-	83.88	32.3	6.91	34.3	169	139	Average
2402	89.21	-	-	84.3	32.3	6.91	34.3	169	139	Peak
4803	52.5	-1.5	54	68.73	33.98	8.75	58.96	123	351	Average
4803	56.17	-17.83	74	72.4	33.98	8.75	58.96	123	351	Peak

Note: Other harmonics are lower than background noise.



Test Mode :	Mode 1	Temperature :	20~22°C
Test Channel :	00	Relative Humidity :	51~56%
Test Engineer :	Stan Hsieh	Polarization :	Vertical
Remark :	2402 MHz is fundamental signal which can be ignored.		

Frequency (MHz)	Level (dBμV/m)	Over Limit (dB)	Limit Line (dBμV/m)	Read Level (dBμV)	Antenna Factor (dB)	Cable Loss (dB)	Preamp Factor (dB)	Ant Pos (cm)	Table Pos (deg)	Remark
65.37	35.81	-4.19	40	60.21	6	0.8	31.2	145	173	Peak
126.66	32.37	-11.13	43.5	50.58	11.76	1.13	31.1	-	-	Peak
215.22	30.99	-12.51	43.5	51.4	9.25	1.39	31.05	-	-	Peak
396.6	33.07	-12.93	46	46.08	15.78	2.13	30.92	-	-	Peak
565.3	33.06	-12.94	46	41.37	19.84	2.59	30.74	-	-	Peak
797.7	35.2	-10.8	46	40.39	21.97	3.14	30.3	-	-	Peak
2402	82.18	-	-	77.27	32.3	6.91	34.3	158	114	Average
2402	83.46	-	-	78.55	32.3	6.91	34.3	158	114	Peak
4806	53.94	-0.06	54	70.15	33.98	8.77	58.96	157	93	Average
4806	59.28	-14.72	74	75.49	33.98	8.77	58.96	157	93	Peak

Note: Other harmonics are lower than background noise.



Test Mode :	Mode 2	Temperature :	20~22°C
Test Channel :	19	Relative Humidity :	51~56%
Test Engineer :	Stan Hsieh	Polarization :	Horizontal
Remark :	2440 MHz is fundamental signal which can be ignored.		

Frequency (MHz)	Level (dBμV/m)	Over Limit (dB)	Limit Line (dBμV/m)	Read Level (dBμV)	Antenna Factor (dB)	Cable Loss (dB)	Preamp Factor (dB)	Ant Pos (cm)	Table Pos (deg)	Remark
2440	91.83	-	-	86.84	32.35	6.99	34.35	106	142	Average
2440	92.84	-	-	87.89	32.35	6.99	34.39	106	142	Peak
4881	52.29	-1.71	54	68.32	33.95	8.85	58.83	131	228	Average
4881	54.6	-19.4	74	70.63	33.95	8.85	58.83	131	228	Peak
7320	49.4	-4.6	54	60.7	35.53	10.91	57.74	126	118	Average
7320	55.19	-18.81	74	66.49	35.53	10.91	57.74	126	118	Peak

Note: Other harmonics are lower than background noise.

Test Mode :	Mode 2	Temperature :	20~22°C
Test Channel :	19	Relative Humidity :	51~56%
Test Engineer :	Stan Hsieh	Polarization :	Vertical
Remark :	2440 MHz is fundamental signal which can be ignored.		

Frequency (MHz)	Level (dBμV/m)	Over Limit (dB)	Limit Line (dBμV/m)	Read Level (dBμV)	Antenna Factor (dB)	Cable Loss (dB)	Preamp Factor (dB)	Ant Pos (cm)	Table Pos (deg)	Remark
2440	86.73	-	-	81.74	32.35	6.99	34.35	188	86	Average
2440	87.94	-	-	82.99	32.35	6.99	34.39	188	86	Peak
4881	53.9	-0.1	54	69.93	33.95	8.85	58.83	150	194	Average
4881	56.45	-17.55	74	72.48	33.95	8.85	58.83	150	194	Peak
7320	48.67	-5.33	54	59.97	35.53	10.91	57.74	130	207	Average
7320	52.58	-21.42	74	63.88	35.53	10.91	57.74	130	207	Peak

Note: Other harmonics are lower than background noise.



Test Mode :	Mode 3	Temperature :	20~22°C
Test Channel :	39	Relative Humidity :	51~56%
Test Engineer :	Stan Hsieh	Polarization :	Horizontal
Remark :	2480 MHz is fundamental signal which can be ignored.		

Frequency (MHz)	Level (dBμV/m)	Over Limit (dB)	Limit Line (dBμV/m)	Read Level (dBμV)	Antenna Factor (dB)	Cable Loss (dB)	Preamp Factor (dB)	Ant Pos (cm)	Table Pos (deg)	Remark
2480	95.15	-	-	90.14	32.38	7.06	34.43	132	140	Average
2480	95.6	-	-	90.59	32.38	7.06	34.43	132	140	Peak
4962	51.66	-2.34	54	67.49	33.91	8.92	58.66	126	227	Average
4962	53.11	-20.89	74	68.94	33.91	8.92	58.66	126	227	Peak
7440	52.92	-1.08	54	64.22	35.51	11.04	57.85	136	127	Average
7440	55.05	-18.95	74	66.35	35.51	11.04	57.85	136	127	Peak

Note: Other harmonics are lower than background noise.

Test Mode :	Mode 3	Temperature :	20~22°C
Test Channel :	39	Relative Humidity :	51~56%
Test Engineer :	Stan Hsieh	Polarization :	Vertical
Remark :	2480 MHz is fundamental signal which can be ignored.		

Frequency (MHz)	Level (dBμV/m)	Over Limit (dB)	Limit Line (dBμV/m)	Read Level (dBμV)	Antenna Factor (dB)	Cable Loss (dB)	Preamp Factor (dB)	Ant Pos (cm)	Table Pos (deg)	Remark
2480	89.13	-	-	84.12	32.38	7.06	34.43	124	88	Average
2480	89.68	-	-	84.67	32.38	7.06	34.43	124	88	Peak
4959	53.11	-0.89	54	68.94	33.91	8.92	58.66	108	186	Average
4959	55.03	-18.97	74	70.86	33.91	8.92	58.66	108	186	Peak
7440	50.32	-3.68	54	61.62	35.51	11.04	57.85	121	156	Average
7440	52.94	-21.06	74	64.24	35.51	11.04	57.85	121	156	Peak

Note: Other harmonics are lower than background noise.

3.6 AC Conducted Emission Measurement

3.6.1 Limit of AC Conducted Emission

For equipment that is designed to be connected to the public utility (AC) power line, the radio frequency voltage that is conducted back onto the AC power line on any frequency or frequencies within the band 150 kHz to 30 MHz shall not exceed the limits in the following table.

Frequency of emission (MHz)	Conducted limit (dB μ V)	
	Quasi-peak	Average
0.15-0.5	66 to 56*	56 to 46*
0.5-5	56	46
5-30	60	50

*Decreases with the logarithm of the frequency.

3.6.2 Measuring Instruments

The section 4.0 of List of Measuring Equipment of this test report is used for test.

3.6.3 Test Procedures

1. The EUT was placed 0.4 meter from the conducting wall of the shielding room was kept at least 80 centimeters from any other grounded conducting surface.
2. Connect EUT to the power mains through a line impedance stabilization network (LISN).
3. All the support units are connecting to the other LISN.
4. The LISN provides 50 ohm coupling impedance for the measuring instrument.
5. The FCC states that a 50 ohm, 50 microhenry LISN should be used.
6. Both sides of AC line were checked for maximum conducted interference.
7. The frequency range from 150 kHz to 30 MHz was searched.
8. Set the test-receiver system to Peak Detect Function and specified bandwidth with Maximum Hold Mode.

3.6.4 Test Setup

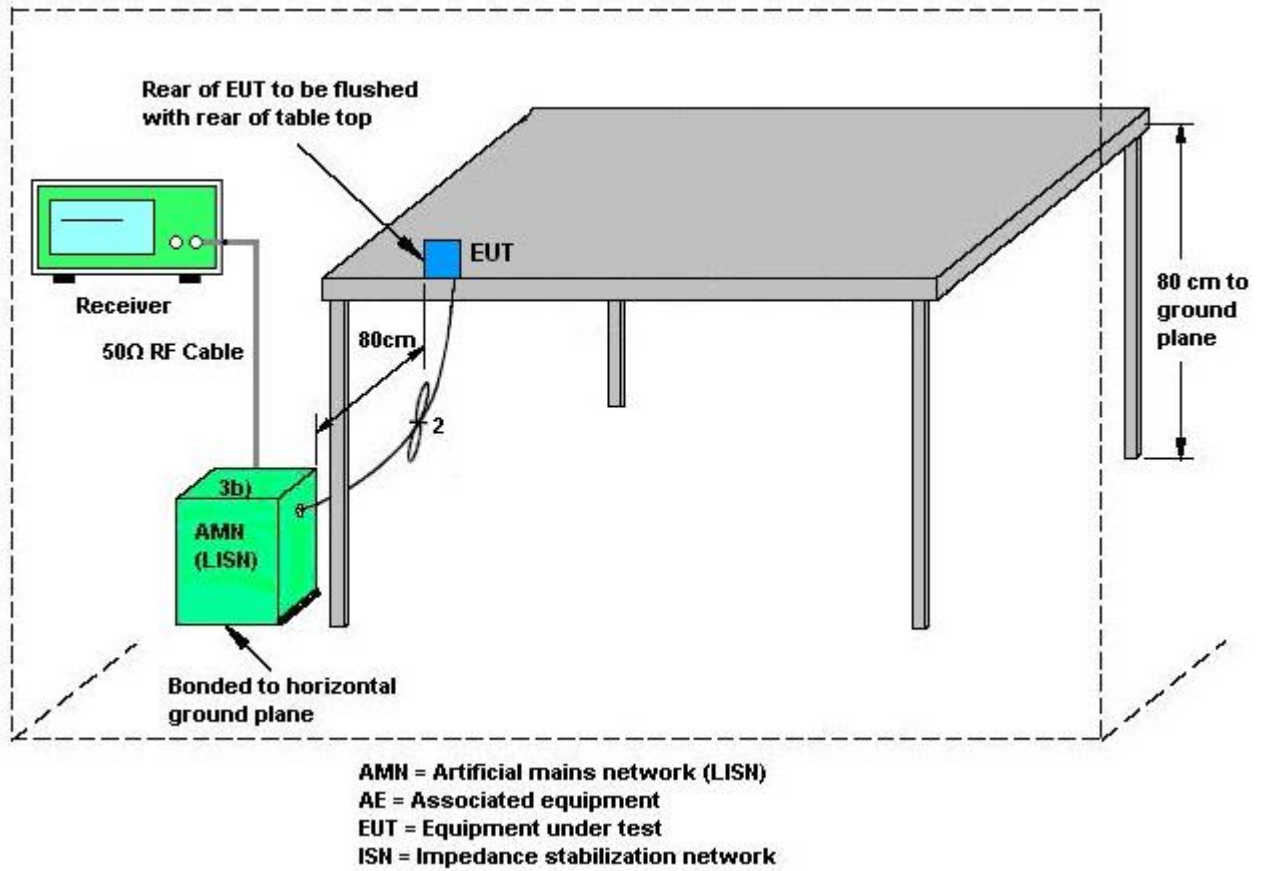

3.6.5 Test Result of AC Conducted Emission

Test Mode :	Mode 1	Temperature :	20~22°C
Test Engineer :	Cosmo Xu	Relative Humidity :	45~47%
Test Voltage :	120Vac / 60Hz	Phase :	Line
Function Type :	WLAN Link + Bluetooth Link + Adapter		

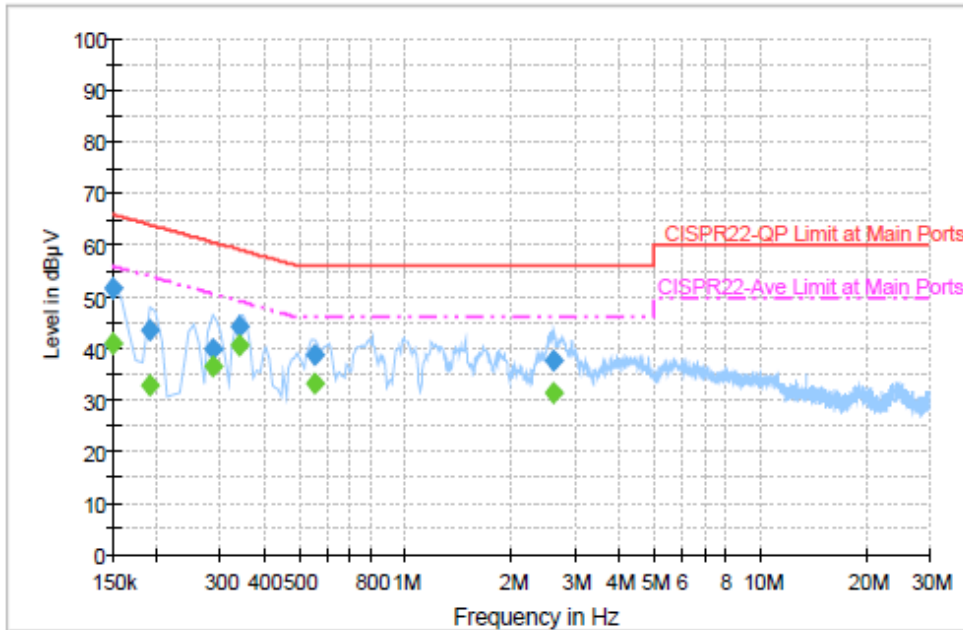

Final Result : Quasi-Peak

Frequency (MHz)	Quasi-Peak (dBµV)	Filter	Line	Corr. (dB)	Margin (dB)	Limit (dBµV)
0.150000	51.8	Off	L1	19.4	14.2	66.0
0.190000	43.4	Off	L1	19.4	20.6	64.0
0.286000	40.0	Off	L1	19.4	20.6	60.6
0.342000	44.2	Off	L1	19.4	15.0	59.2
0.558000	38.7	Off	L1	19.4	17.3	56.0
2.630000	37.5	Off	L1	19.6	18.5	56.0

Final Result : Average

Frequency (MHz)	Average (dBµV)	Filter	Line	Corr. (dB)	Margin (dB)	Limit (dBµV)
0.150000	41.1	Off	L1	19.4	14.9	56.0
0.190000	32.8	Off	L1	19.4	21.2	54.0
0.286000	36.5	Off	L1	19.4	14.1	50.6
0.342000	40.5	Off	L1	19.4	8.7	49.2
0.558000	33.2	Off	L1	19.4	12.8	46.0
2.630000	31.4	Off	L1	19.6	14.6	46.0

Test Mode :	Mode 1	Temperature :	20~22°C
Test Engineer :	Cosmo Xu	Relative Humidity :	45~47%
Test Voltage :	120Vac / 60Hz	Phase :	Neutral
Function Type :	WLAN Link + Bluetooth Link + Adapter		

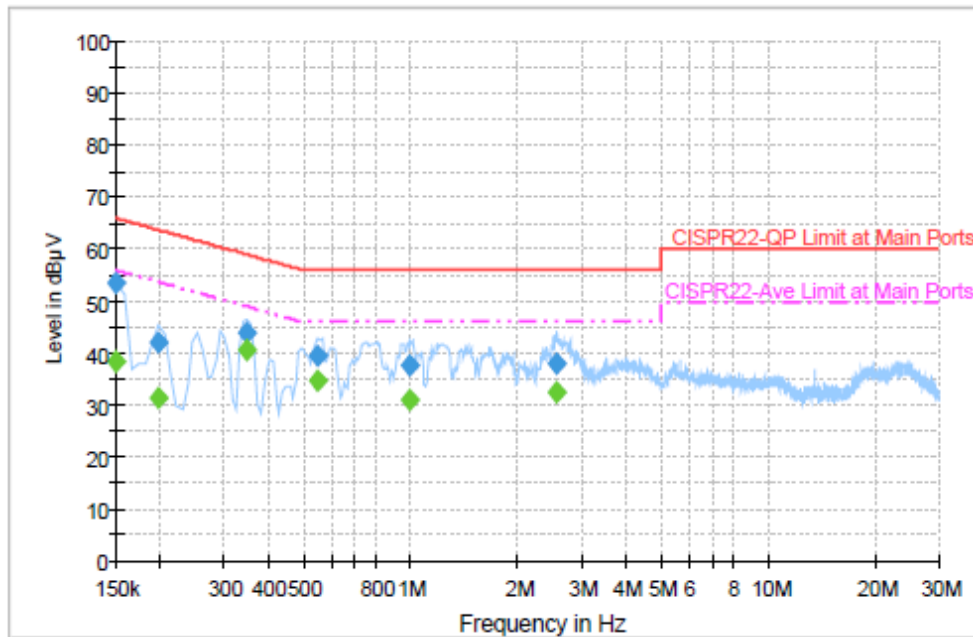

Final Result : Quasi-Peak

Frequency (MHz)	Quasi-Peak (dBµV)	Filter	Line	Corr. (dB)	Margin (dB)	Limit (dBµV)
0.150000	53.5	Off	N	19.4	12.5	66.0
0.198000	42.2	Off	N	19.3	21.5	63.7
0.350000	43.8	Off	N	19.4	15.2	59.0
0.550000	39.7	Off	N	19.4	16.3	56.0
0.990000	37.8	Off	N	19.4	18.2	56.0
2.574000	38.2	Off	N	19.6	17.8	56.0

Final Result : Average

Frequency (MHz)	Average (dBµV)	Filter	Line	Corr. (dB)	Margin (dB)	Limit (dBµV)
0.150000	38.4	Off	N	19.4	17.6	56.0
0.198000	31.5	Off	N	19.3	22.2	53.7
0.350000	40.5	Off	N	19.4	8.5	49.0
0.550000	34.9	Off	N	19.4	11.1	46.0
0.990000	30.9	Off	N	19.4	15.1	46.0
2.574000	32.6	Off	N	19.6	13.4	46.0



3.7 Antenna Requirements

3.7.1 Standard Applicable

If directional gain of transmitting antennas is greater than 6dBi, the power shall be reduced by the same level in dB comparing to gain minus 6dBi. The use of a permanently attached antenna or of an antenna that uses a unique coupling to the intentional radiator shall be considered sufficient to comply with the FCC rule.

3.7.2 Antenna Anti-Replacement Construction

Non-standard antenna connector is used.

3.7.3 Antenna Gain

The antenna peak gain of EUT is less than 6 dBi. Therefore, it is not necessary to reduce maximum peak output power limit.



4 List of Measuring Equipment

Instrument	Manufacturer	Model No.	Serial No.	Characteristics	Calibration Date	Test Date	Due Date	Remark
Spectrum Analyzer	Rohde & Schwarz	FSP40	100055	9kHz~40GHz	Jun. 07, 2013	Dec. 19, 2013	Jun. 06, 2014	Conducted (TH02-HY)
Power Meter	Agilent	E4416A	GB412923 44	300MHz~40GHz	Feb. 05, 2013	Dec. 19, 2013	Feb. 04, 2014	Conducted (TH02-HY)
Power Sensor	Agilent	E9327A	US404415 48	300MHz~40GHz	Feb. 05, 2013	Dec. 19, 2013	Feb. 04, 2014	Conducted (TH02-HY)
EMI Test Receiver	Rohde & Schwarz	ESCI 7	100724	9kHz~7 GHz	Sep. 06, 2013	Dec. 26, 2013~ Dec. 27, 2013	Sep. 05, 2014	Radiation (03CH07-HY)
Spectrum Analyzer	Rohde & Schwarz	FSP30	101067	9kHz ~ 30 GHz	Nov. 20, 2013	Dec. 26, 2013~ Dec. 27, 2013	Nov. 19, 2014	Radiation (03CH07-HY)
Loop Antenna	Rohde & Schwarz	HFH2-Z2	860004/00 01	9kHz~30 Mhz	Jul. 03, 2012	Dec. 26, 2013~ Dec. 27, 2013	Jul. 03, 2014	Radiation (03CH07-HY)
Bilog Antenna	Schaffner	CBL6111C	2726	30 MHz ~ 1 GHz	Oct. 10, 2013	Dec. 26, 2013~ Dec. 27, 2013	Oct. 09, 2014	Radiation (03CH07-HY)
Double Ridge Horn Antenna	ESCO	3117	75962	1 GHz~18 GHz	Aug. 22, 2013	Dec. 26, 2013~ Dec. 27, 2013	Aug. 21, 2014	Radiation (03CH07-HY)
SHF-EHF Horn Antenna	SCHWARZBECK	BBHA 9170	BBHA917 0251	15 GHz- 40 GHz	Oct. 03, 2013	Dec. 26, 2013~ Dec. 27, 2013	Oct. 02, 2014	Radiation (03CH07-HY)
Preamplifier	COM-POWER	PA-103A	161241	30 MHz~1 GHz	Feb. 26, 2013	Dec. 26, 2013~ Dec. 27, 2013	Feb. 25, 2014	Radiation (03CH07-HY)
Preamplifier	Agilent	8449B	3008A019 17	1 GHz~26.5 GHz	Aug. 12, 2013	Dec. 26, 2013~ Dec. 27, 2013	Aug. 11, 2014	Radiation (03CH07-HY)
Preamplifier	MITEQ	AMF-7D-0010 1800-30-10P	159088	DC~18 G High Gain	Feb. 27, 2013	Dec. 26, 2013~ Dec. 27, 2013	Feb. 26, 2014	Radiation (03CH07-HY)
Turn Table	ChainTek	ChainTek 3000	N/A	0 ~ 360 degree	N/A	Dec. 26, 2013~ Dec. 27, 2013	N/A	Radiation (03CH07-HY)
Antenna Mast	ChainTek	ChainTek 3000	N/A	N/A	N/A	Dec. 26, 2013~ Dec. 27, 2013	N/A	Radiation (03CH07-HY)
EMI Test Receiver	Rohde & Schwarz	ESCS 30	100356	9kHz ~ 2.75GHz	Nov. 15, 2013	Dec. 10, 2013	Nov. 14, 2014	Conduction (CO05-HY)
Two-LISN (for auxiliary equipment)	Rohde & Schwarz	ENV216	100081	9kHz ~ 30MHz	Dec. 12, 2013	Dec. 10, 2013	Dec. 11, 2014	Conduction (CO05-HY)
Two-LISN	Rohde & Schwarz	ENV216	100080	9kHz ~ 30MHz	Dec. 04, 2013	Dec. 10, 2013	Dec. 03, 2014	Conduction (CO05-HY)
AC Power Source	APC	APC-1000W	N/A	N/A	N/A	Dec. 10, 2013	N/A	Conduction (CO05-HY)



5 Uncertainty of Evaluation

Uncertainty of Conducted Emission Measurement (150 kHz ~ 30 MHz)

Measuring Uncertainty for a Level of Confidence of 95% ($U = 2Uc(y)$)	2.26
---	------

Uncertainty of Radiated Emission Measurement (30 MHz ~ 1000 MHz)

Measuring Uncertainty for a Level of Confidence of 95% ($U = 2Uc(y)$)	4.50
---	------

Appendix A. Setup Photographs

<Conducted Emission>



<Radiated Emission>

LF

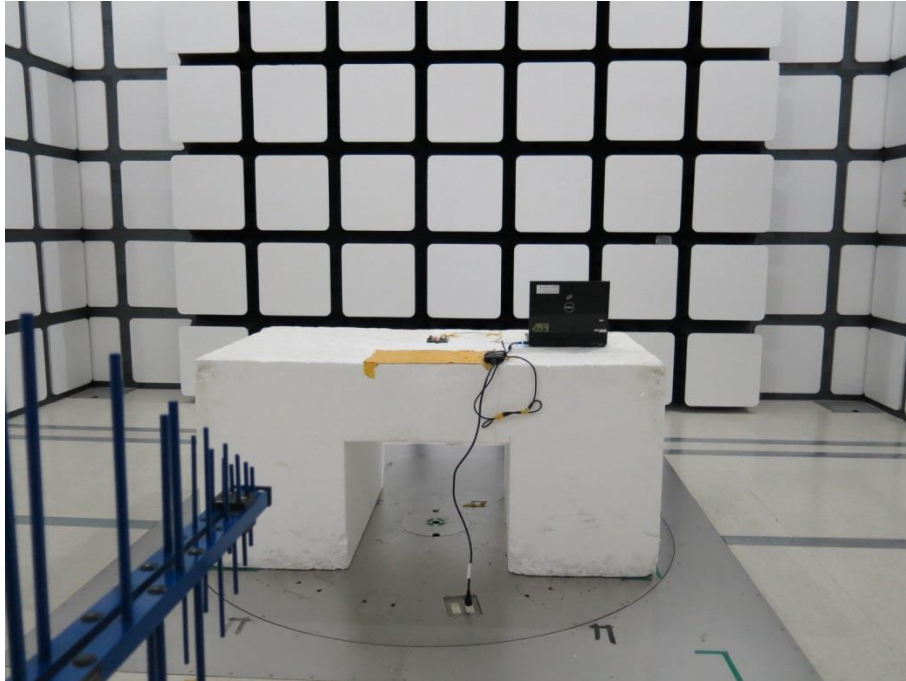

HF

