



Vehicle Blackbox DVR
USER MANUAL

Disclaimer

1. Please follow the set-up and usage instructions in the print material that came with this Dashboard Camera product.
2. You should not set/install this dash cam at a place that would obstruct or reduce a driver's view. Make sure your usage comply with pertinent vehicle codes of your state, province, territory or country.
3. You should post the required notices of recordation to occupants inside the vehicle, if voices or other information/signal pertaining to in-vehicle activities will be recorded.
4. You should not change the dash cam's setting or mode of operation when the vehicle is in motion.
5. You should not leave the dash cam in a visible spot when no one is inside the vehicle, to avoid attracting break-ins to steal the unit, or other property.
6. You should avoid extended exposure of the dash cam to direct sunlight or

extreme temperatures (either high or low temperature) which tend to degrade or damage the unit and its normal functionality.

7. You should examine, check and verify the dash cam at least every 6 months, including the memory card, to ensure the video reception and recording are working properly. For each use, you should verify that the dash cam unit, the visible lights and the audible sounds are working normally. If there are signs of non-operation or malfunction, you should immediately seek to replace the product and check to see if the product is covered under any applicable warranty.

8. The dash cam unit may have additional functionality, such as transmission and recordation of audible or GPS signal or other identification information. If you have privacy concerns about these functions, make sure you follow the instruction to disable these functions.

9. You should use the dash cam unit in the way it is intended. You should not

use the dash cam unit in a way that would be illegal or that tends to physically damage the unit, or tend to cause danger to the safe operation of the vehicle or the occupants.

10. THIS DEVICE SHOULD NOT BE ADJUSTED BY THE DRIVER WHILE DRIVING. IN THE EVENT OF AN ACCIDENT, DEVICE MAY DISLODGE AND BECOME UNSAFE FOR PASSENGERS.

Note

●This user manual will detail how to use, operation, technical specifications and precautions. Before use, please read this manual thoroughly and fully understand, Please keep this manual, we hope our products can meet your needs and long-term service to you!

Using this product, enjoying the real high quality life.

●This manual in the printing process, the machine because of the appearance, software or hardware repair process leads to the same part of the manual operation of non-conformance, the Company has maintained the final interpretation!

●Do not put the machine into the damp working condition, this machine have no waterproof function, so please make the machine no pour water or exposed to rain water.

●Do not try open the shell or try repair by yourself, if the accessories for this

machine have any problem, please do to the professional maintenance station to repair.

●Do not use the thrill chemical substance, clean solvent or cleaner to clean this machine, please use the moist soft cloth to clean.

●Do not use this machine under the condition that the dust and high density, to avoid affecting the video.

●Please protect the environment, don't discard this machine randomly; do not throw this machine into fire, otherwise will have an explosion.

●Please pay attention to clean the lens surface, use the moist soft cloth clean the lens then use, to avoid the video is not so good.

Tips:

1. Outdoor use Please avoid high temperature and direct sun exposure.
2. Please use original accessories.
3. Please do not disassemble the product.

Content Guide

Introduction.....	7
Inserting Memory Card.....	10
Installing Your DashCam.....	11
Connecting To Power.....	13
Downloading LuckyCam App.....	14
Using Your DashCam.....	17
System setup.....	18
Specifications.....	21
FAQ	22
Notice.....	23

Introduction

Features

Continuous Loop recording

Full HD camera (1080p@30fps)

2.45"IPS screen

170°wide angle lens

Motion detection

Max supports 64GB Micro SD

Built-in Wi-Fi

Built-in G-Sensor

Auto-record and auto-power off

Interface supports USB/AV out

Supports multi language

What's Include

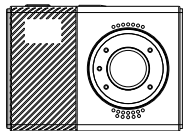

Dashcam

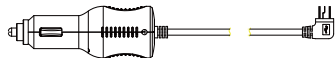

Car charger with Cable

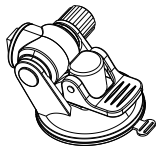

Suction Mount

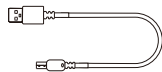

Usb Cable



User Manual

At a Glance

Product Structure

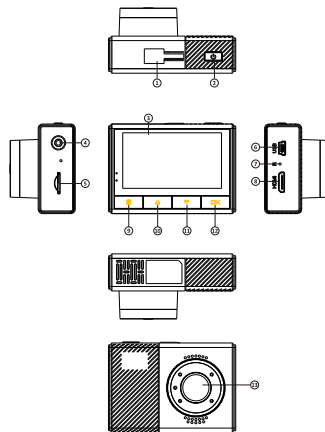

- 1 Holder
- 2 Power
- 3 Screen
- 4 AV-OUT
- 5 TF card slot
- 6 USB
- 7 Reset
- 8 HDMI
- 9 Menu

- 10 Up
- 11 Down
- 12 Ok
- 13 Lens

Inserting Memory Card

⚠ Do not remove or insert microSD card when this product is powered on which may damage the card.

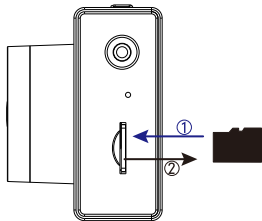

- ① Insert a microSD card with the gold contacts facing the screen side of the dashcam. Push the card until it clicks into place.
- ② To remove the microSD card, gently push its top edge inward until it clicks, and then pull it out of the slot.

Installing Your DashCam

Never install this product while driving.

Install this product near the rear-view mirror to obtain the best open-field view. Do not install in a location that will obstruct your required driving view.

Make sure that the lens is within the wiping range of the windshield wiper to ensure a clear view even when it rains.

Do not touch the lens with your fingers. Finger grease may be left on the lens and will result in unclear videos.

The mount is adhesive and may be destroyed if it is removed from the windshield.

- ① Attach the dashcam onto the mount.

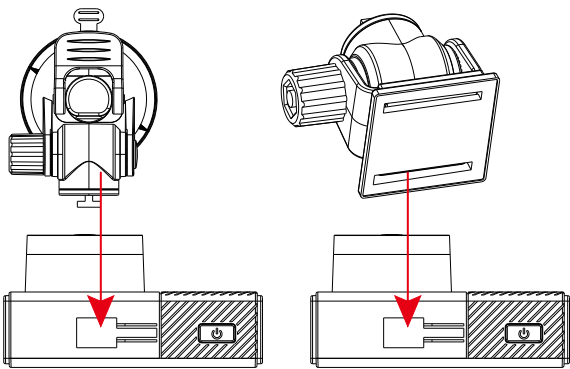

- ① Select a location (A or B) on the windshield rear of the rearview mirror.
- ② Install the suction mount or remove 3M adhesive sticker and firmly affix the mount onto the windshield.

- ③ Hide cable into the seams around the edge of the dashboard.
- ④ Adjust the lens viewing angle to ensure that it is aligned with the road ahead.

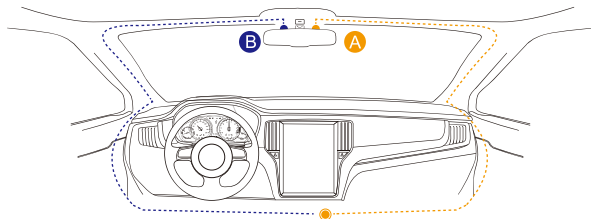

Connecting To Power

- ① Connect the car charger and DashCam by using the charging cable.
- ② Plug the other end of the car charger to your vehicle's cigarette lighter socket.