

EUT	AP351	Date of Test	2021-05-22
Factor	BBHA 9120D & BBHA 9170	Temp. / Humidity	25°C /66%
Polarity	Horizontal	Site / Test Engineer	AC1 / Jay
Test Mode	802.11n-20MHz_TX_CH 11_SCAN ANT 0	Test Voltage	By PoE

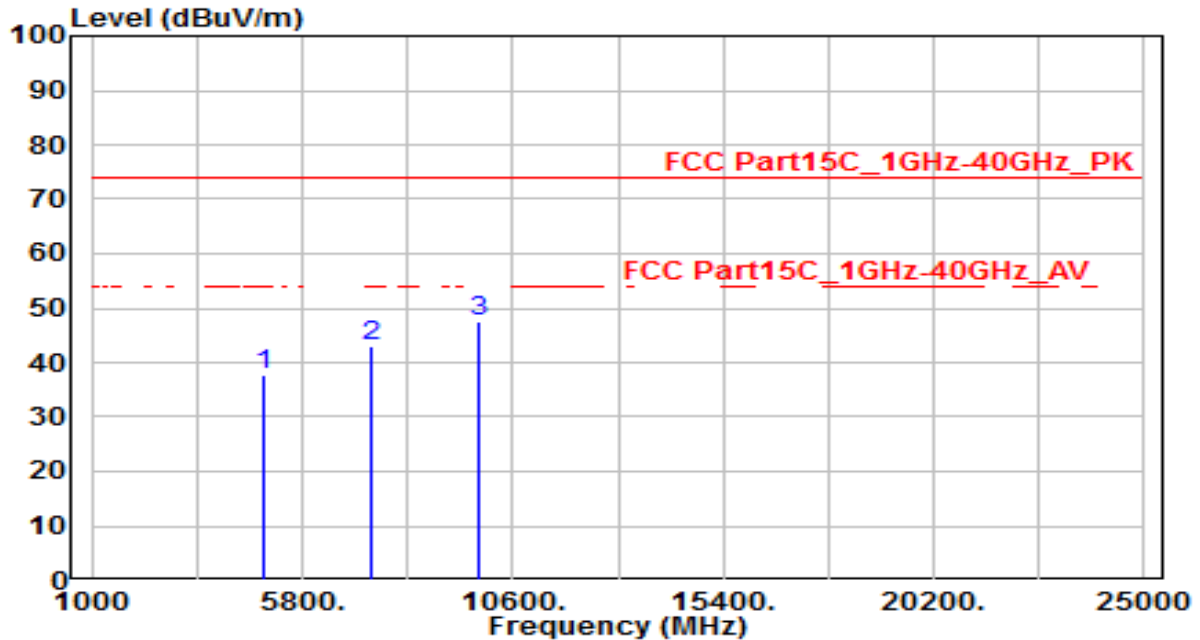

No	Frequency (MHz)	Reading (dBuV)	C.F (dB)	Measurement (dBuV/m)	Margin (dB)	Limit (dBuV/m)	Height (cm)	Angle (deg)	Remark (QP/PK/AV)
1	4924.000	33.82	3.81	37.63	-36.37	74.00	150	0	Peak
2	7386.000	30.39	12.51	42.90	-31.10	74.00	150	0	Peak
3	* 9848.000	31.11	16.30	47.42	-26.58	74.00	150	0	Peak

Note:

- "*", means this data is the worst emission level.
- C.F (Correction Factor) = Antenna Factor (dB/m)+ Cable Loss (dB) – Preamplifier(dB).
- Measurement (dBuV/m) = Reading(dBuV) + C.F (Correction Factor).
- The emission levels of other frequencies are very lower than the limit and not show in test report.

EUT	AP351	Date of Test	2021-05-22
Factor	BBHA 9120D & BBHA 9170	Temp. / Humidity	25°C /66%
Polarity	Vertical	Site / Test Engineer	AC1 / Jay
Test Mode	802.11n-20MHz_TX_CH 11_SCAN ANT 0	Test Voltage	By PoE

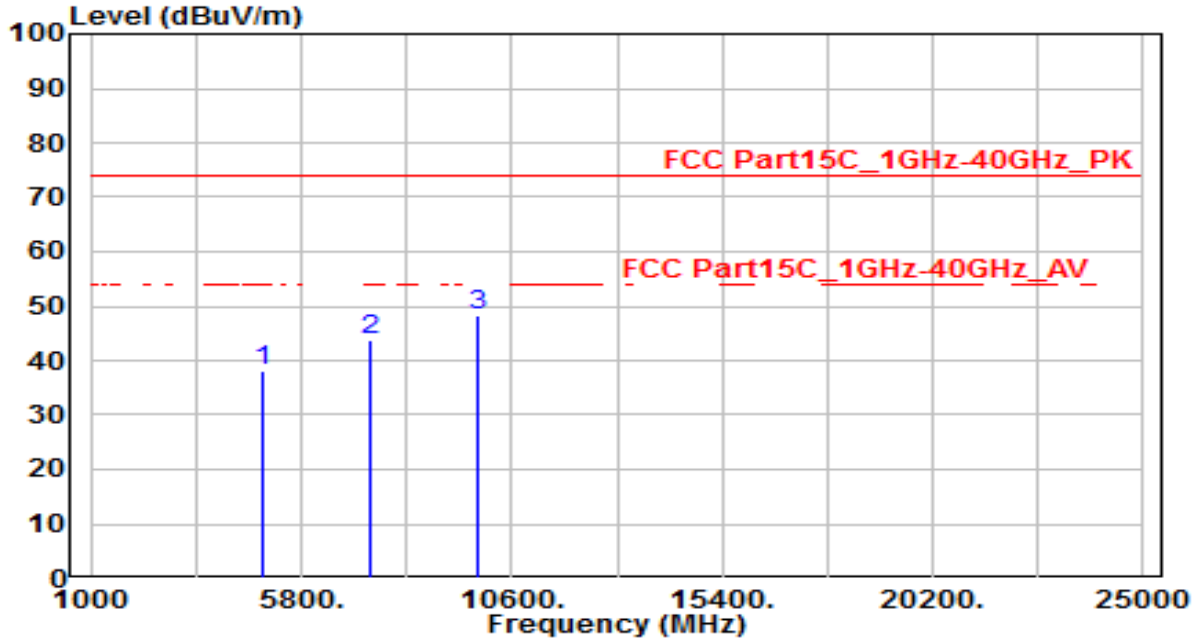

No	Frequency (MHz)	Reading (dBuV)	C.F (dB)	Measurement (dBuV/m)	Margin (dB)	Limit (dBuV/m)	Height (cm)	Angle (deg)	Remark (QP/PK/AV)
1	4924.000	34.21	3.81	38.02	-35.98	74.00	150	0	Peak
2	7386.000	31.20	12.51	43.71	-30.29	74.00	150	0	Peak
3	* 9848.000	32.17	16.30	48.48	-25.52	74.00	150	0	Peak

Note:

1. " *", means this data is the worst emission level.
2. C.F (Correction Factor) = Antenna Factor (dB/m)+ Cable Loss (dB) – Preamplifier(dB).
3. Measurement (dBuV/m) = Reading(dBuV) + C.F (Correction Factor).
4. The emission levels of other frequencies are very lower than the limit and not show in test report.

EUT	AP351	Date of Test	2021-05-22
Factor	BBHA 9120D & BBHA 9170	Temp. / Humidity	25°C /66%
Polarity	Horizontal	Site / Test Engineer	AC1 / Jay
Test Mode	802.11n-40MHz_TX_CH 3_SCAN ANT 0	Test Voltage	By PoE

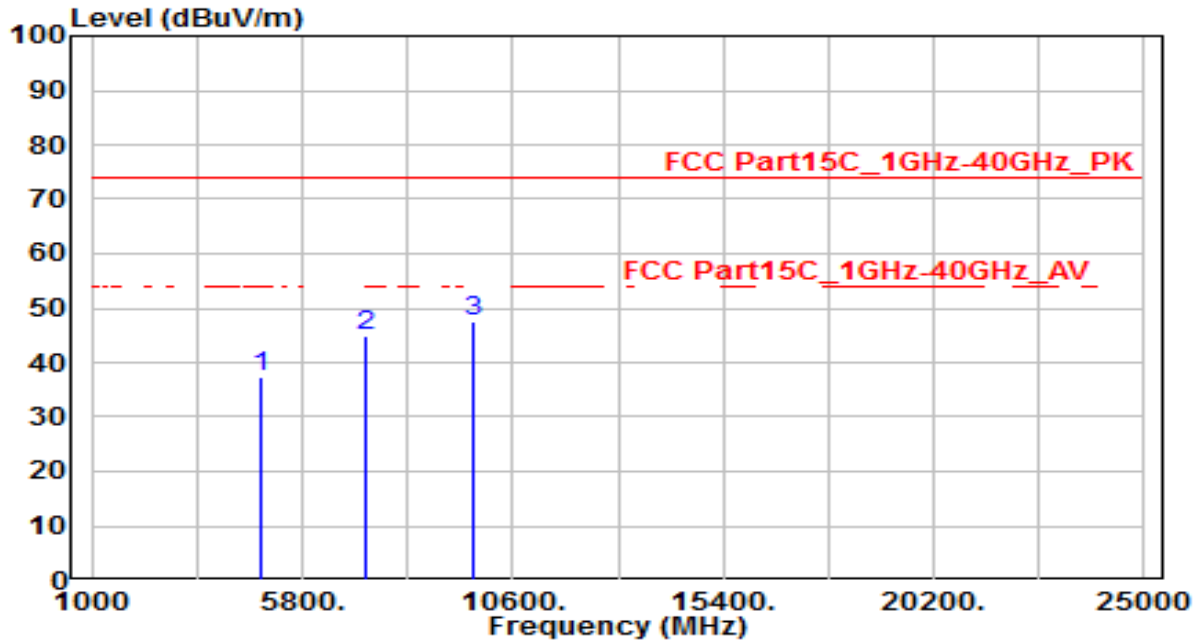

No	Frequency (MHz)	Reading (dBuV)	C.F (dB)	Measurement (dBuV/m)	Margin (dB)	Limit (dBuV/m)	Height (cm)	Angle (deg)	Remark (QP/PK/AV)
1	4844.000	33.84	3.67	37.50	-36.50	74.00	150	0	Peak
2	7266.000	32.78	11.98	44.76	-29.24	74.00	150	0	Peak
3	* 9688.000	31.37	16.04	47.40	-26.60	74.00	150	0	Peak

Note:

1. " *", means this data is the worst emission level.
2. C.F (Correction Factor) = Antenna Factor (dB/m)+ Cable Loss (dB) – Preamplifier(dB).
3. Measurement (dBuV/m) = Reading(dBuV) + C.F (Correction Factor).
4. The emission levels of other frequencies are very lower than the limit and not show in test report.

EUT	AP351	Date of Test	2021-05-22
Factor	BBHA 9120D & BBHA 9170	Temp. / Humidity	25°C /66%
Polarity	Vertical	Site / Test Engineer	AC1 / Jay
Test Mode	802.11n-40MHz_TX_CH 3_SCAN ANT 0	Test Voltage	By PoE

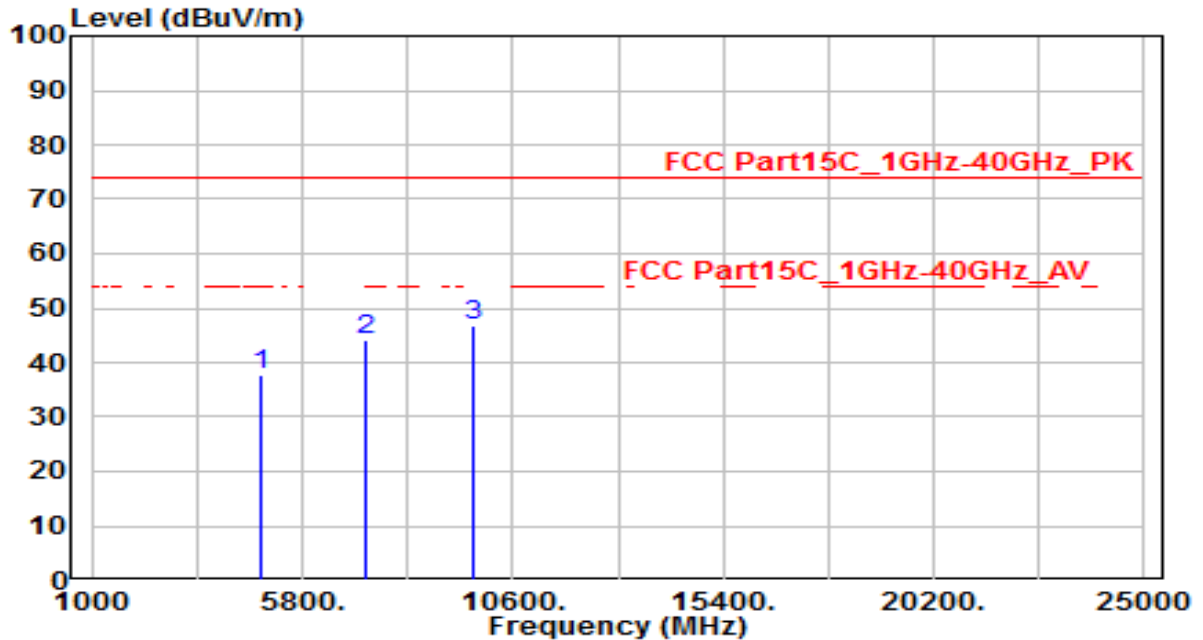

No	Frequency (MHz)	Reading (dBUV)	C.F (dB)	Measurement (dBUV/m)	Margin (dB)	Limit (dBUV/m)	Height (cm)	Angle (deg)	Remark (QP/PK/AV)
1	4844.000	33.91	3.67	37.58	-36.42	74.00	150	0	Peak
2	7266.000	32.14	11.98	44.12	-29.88	74.00	150	0	Peak
3	* 9688.000	30.59	16.04	46.63	-27.37	74.00	150	0	Peak

Note:

1. " *", means this data is the worst emission level.
2. C.F (Correction Factor) = Antenna Factor (dB/m)+ Cable Loss (dB) – Preamplifier(dB).
3. Measurement (dBUV/m) = Reading(dBUV) + C.F (Correction Factor).
4. The emission levels of other frequencies are very lower than the limit and not show in test report.

EUT	AP351	Date of Test	2021-05-22
Factor	BBHA 9120D & BBHA 9170	Temp. / Humidity	25°C /66%
Polarity	Horizontal	Site / Test Engineer	AC1 / Jay
Test Mode	802.11n-40MHz_TX_CH 6_SCAN ANT 0	Test Voltage	By PoE

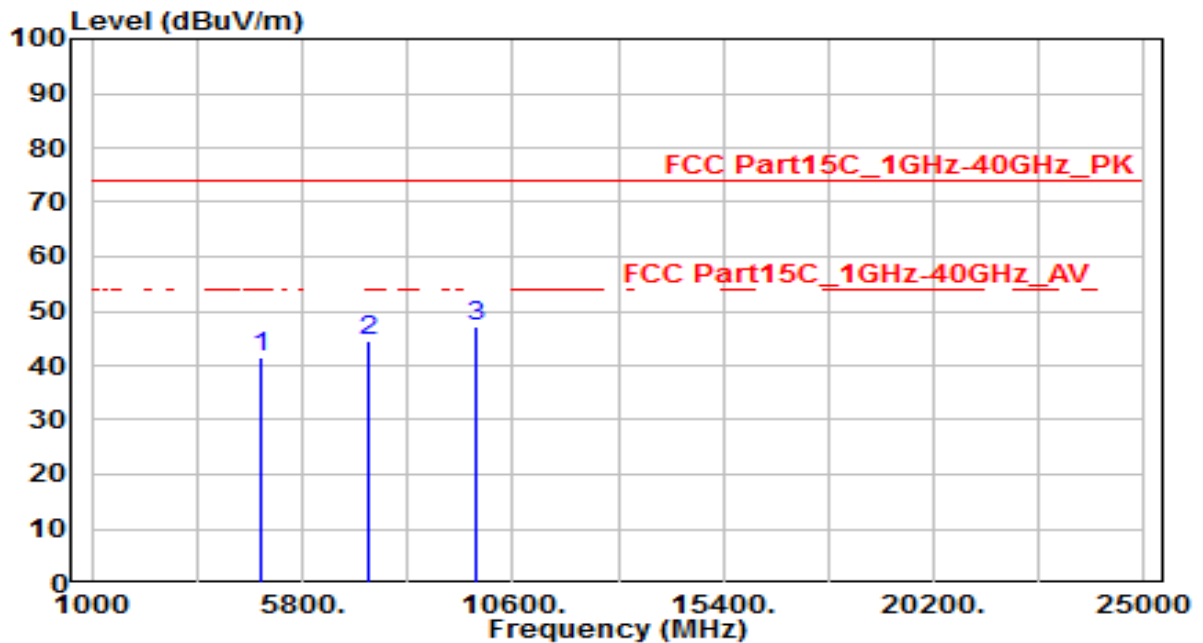

No	Frequency (MHz)	Reading (dBuV)	C.F (dB)	Measurement (dBuV/m)	Margin (dB)	Limit (dBuV/m)	Height (cm)	Angle (deg)	Remark (QP/PK/AV)
1	4874.000	37.79	3.72	41.51	-32.49	74.00	150	0	Peak
2	7311.000	32.34	12.18	44.51	-29.49	74.00	150	0	Peak
3	* 9748.000	31.04	16.14	47.18	-26.82	74.00	150	0	Peak

Note:

- "*", means this data is the worst emission level.
- C.F (Correction Factor) = Antenna Factor (dB/m)+ Cable Loss (dB) – Pre-amplifier(dB).
- Measurement (dBuV/m) = Reading(dBuV) + C.F (Correction Factor).
- The emission levels of other frequencies are very lower than the limit and not show in test report.

EUT	AP351	Date of Test	2021-05-22
Factor	BBHA 9120D & BBHA 9170	Temp. / Humidity	25°C /66%
Polarity	Vertical	Site / Test Engineer	AC1 / Jay
Test Mode	802.11n-40MHz_TX_CH 6_SCAN ANT 0	Test Voltage	By PoE

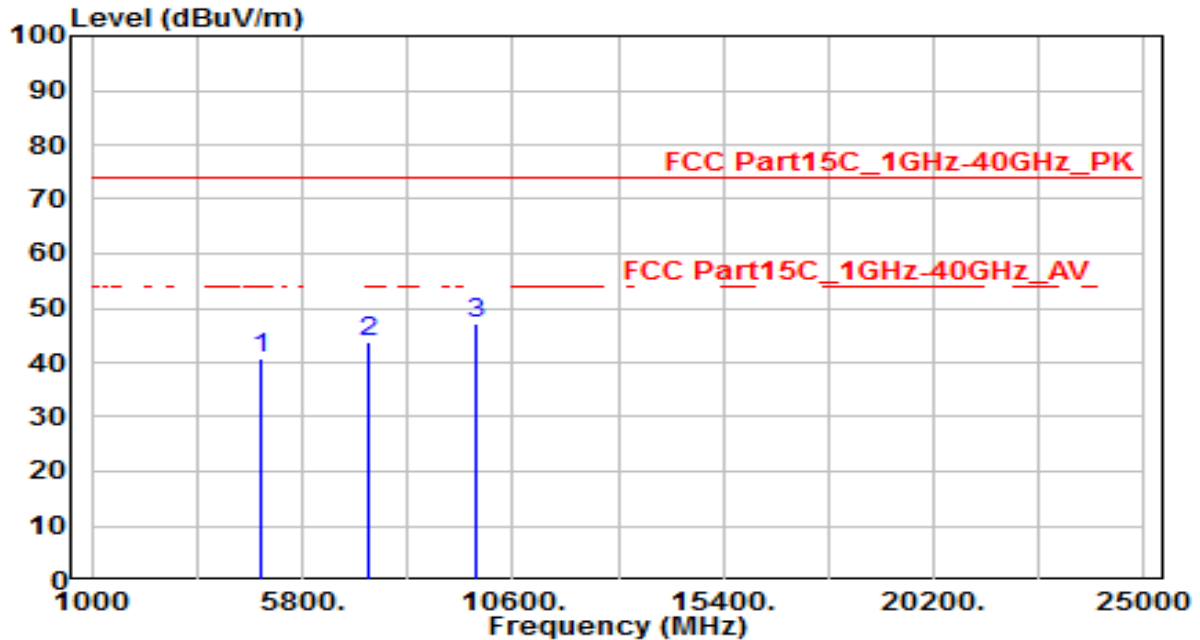

No	Frequency (MHz)	Reading (dBuV)	C.F (dB)	Measurement (dBuV/m)	Margin (dB)	Limit (dBuV/m)	Height (cm)	Angle (deg)	Remark (QP/PK/AV)
1	4874.000	37.20	3.72	40.93	-33.07	74.00	150	0	Peak
2	7311.000	31.75	12.18	43.93	-30.07	74.00	150	0	Peak
3	* 9748.000	31.17	16.14	47.31	-26.69	74.00	150	0	Peak

Note:

- "*", means this data is the worst emission level.
- C.F (Correction Factor) = Antenna Factor (dB/m)+ Cable Loss (dB) – Preamplifier(dB).
- Measurement (dBuV/m) = Reading(dBuV) + C.F (Correction Factor).
- The emission levels of other frequencies are very lower than the limit and not show in test report.

EUT	AP351	Date of Test	2021-05-22
Factor	BBHA 9120D & BBHA 9170	Temp. / Humidity	25°C /66%
Polarity	Horizontal	Site / Test Engineer	AC1 / Jay
Test Mode	802.11n-40MHz_TX_CH 9_SCAN ANT 0	Test Voltage	By PoE

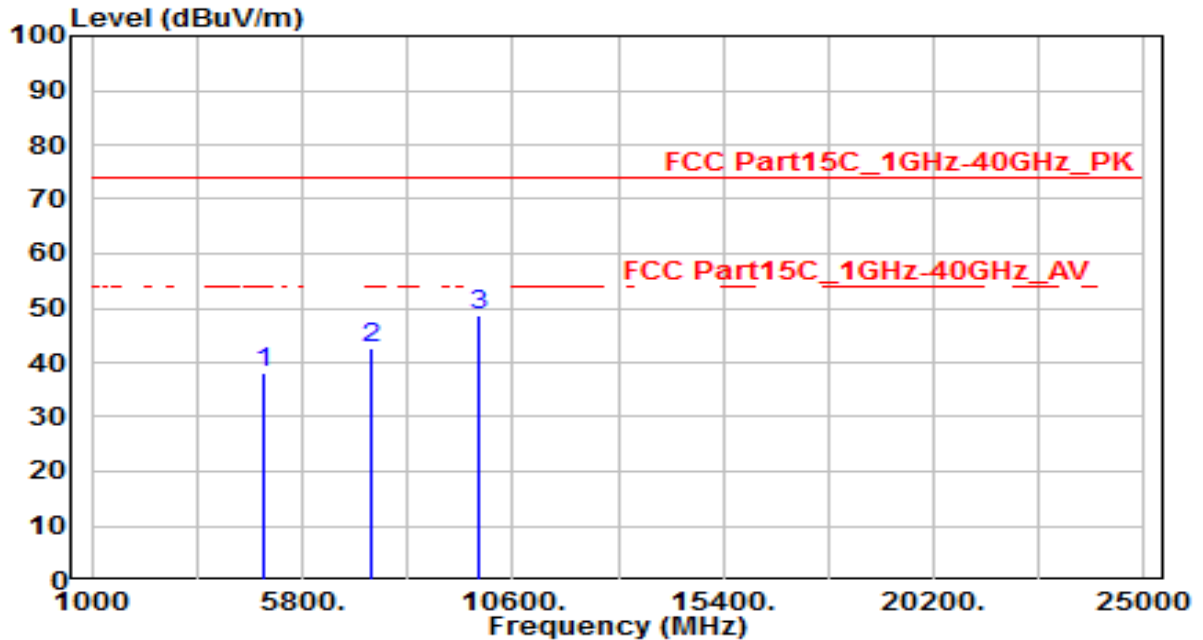

No	Frequency (MHz)	Reading (dBUV)	C.F (dB)	Measurement (dBUV/m)	Margin (dB)	Limit (dBUV/m)	Height (cm)	Angle (deg)	Remark (QP/PK/AV)
1	4904.000	34.15	3.78	37.93	-36.07	74.00	150	0	Peak
2	7356.000	30.34	12.38	42.72	-31.28	74.00	150	0	Peak
3	* 9808.000	32.51	16.24	48.74	-25.26	74.00	150	0	Peak

Note:

1. " *", means this data is the worst emission level.
2. C.F (Correction Factor) = Antenna Factor (dB/m)+ Cable Loss (dB) – Preamplifier(dB).
3. Measurement (dBUV/m) = Reading(dBUV) + C.F (Correction Factor).
4. The emission levels of other frequencies are very lower than the limit and not show in test report.

EUT	AP351	Date of Test	2021-05-22
Factor	BBHA 9120D & BBHA 9170	Temp. / Humidity	25°C /66%
Polarity	Vertical	Site / Test Engineer	AC1 / Jay
Test Mode	802.11n-40MHz_TX_CH 9_SCAN ANT 0	Test Voltage	By PoE

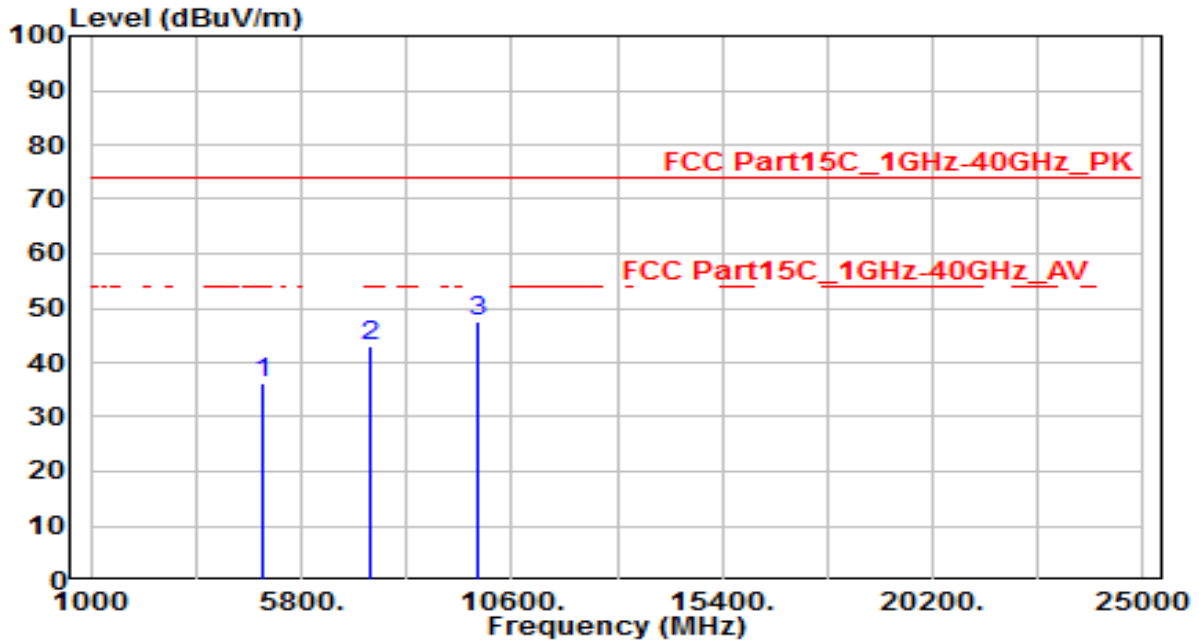

No	Frequency (MHz)	Reading (dBuV)	C.F (dB)	Measurement (dBuV/m)	Margin (dB)	Limit (dBuV/m)	Height (cm)	Angle (deg)	Remark (QP/PK/AV)
1	4904.000	32.51	3.78	36.29	-37.71	74.00	150	0	Peak
2	7356.000	30.46	12.38	42.84	-31.16	74.00	150	0	Peak
3	* 9808.000	31.40	16.24	47.63	-26.37	74.00	150	0	Peak

Note:

- "*", means this data is the worst emission level.
- C.F (Correction Factor) = Antenna Factor (dB/m)+ Cable Loss (dB) – Pre-amplifier(dB).
- Measurement (dBuV/m) = Reading(dBuV) + C.F (Correction Factor).
- The emission levels of other frequencies are very lower than the limit and not show in test report.

6.7. Radiated Restricted Band Edge Measurement

6.7.1. Test Limit

For 15.205 requirement:

Radiated emissions which fall in the restricted bands, as defined in Section 15.205(a) of FCC part 15, must also comply with the radiated emission limits specified in Section 15.209(a).

Frequency (MHz)	Frequency (MHz)	Frequency (MHz)	Frequency (GHz)
0.090 - 0.110	16.42 - 16.423	399.9 - 410	4.5 - 5.15
¹ 0.495 - 0.505	16.69475 - 16.69525	608 - 614	5.35 - 5.46
2.1735 - 2.1905	16.80425 - 16.80475	960 - 1240	7.25 - 7.75
4.125 - 4.128	25.5 - 25.67	1300 - 1427	8.025 - 8.5
4.17725 - 4.17775	37.5 - 38.25	1435 - 1626.5	9.0 - 9.2
4.20725 - 4.20775	73 - 74.6	1645.5 - 1646.5	9.3 - 9.5
6.215 - 6.218	74.8 - 75.2	1660 - 1710	10.6 - 12.7
6.26775 - 6.26825	108 - 121.94	1718.8 - 1722.2	13.25 - 13.4
6.31175 - 6.31225	123 - 138	2200 - 2300	14.47 - 14.5
8.291 - 8.294	149.9 - 150.05	2310 - 2390	15.35 - 16.2
8.362 - 8.366	156.52475 - 156.52525	2483.5 - 2500	17.7 - 21.4
8.37625 - 8.38675	156.7 - 156.9	2690 - 2900	22.01 - 23.12
8.41425 - 8.41475	162.0125 - 167.17	3260 - 3267	23.6 - 24.0
12.29 - 12.293	167.72 - 173.2	3332 - 3339	31.2 - 31.8
12.51975 - 12.52025	240 - 285	3345.8 - 3358	36.43 - 36.5
12.57675 - 12.57725	322 - 335.4	3600 - 4400	(²)
13.36 - 13.41	--	--	--

All out of band emissions appearing in a restricted band as specified in Section 15.205 of the Title 47CFR must not exceed the limits shown in Table per Section 15.209.

FCC Part 15 Subpart C Paragraph 15.209		
Frequency [MHz]	Field Strength [uV/m]	Measured Distance [Meters]
0.009 - 0.490	2400/F (kHz)	300
0.490 - 1.705	24000/F (kHz)	30
1.705 - 30	30	30
30 - 88	100	3
88 - 216	150	3
216 - 960	200	3
Above 960	500	3

6.7.2. Test Procedure Used

ANSI C63.10-2013 Section 6.3

ANSI C63.10-2013 Section 6.6

ANSI C63.10-2013 Section 11.13

6.7.3. Test Setting

Peak Field Strength Measurements

1. Analyzer center frequency was set to the frequency of the radiated spurious emission of interest
2. RBW = 1MHz
3. VBW = 3MHz
4. Detector = peak
5. Sweep time = auto couple
6. Trace mode = max hold
7. Trace was allowed to stabilize

Average Field Strength Measurements

1. Analyzer center frequency was set to the frequency of the radiated spurious emission of interest
2. RBW = 1MHz
3. VBW $\geq 1/T$
4. As an alternative, the instrument may be set to linear detector mode. Ensure that video filtering is applied in linear voltage domain (rather than in a log or dB domain). Some instruments require linear display mode in order to accomplish this. Others have a setting for Average-VBW Type, which can be set to "Voltage" regardless of the display mode
5. Detector = Peak
6. Sweep time = auto
7. Trace mode = max hold
8. Allow max hold to run for at least 50 times (1/duty cycle) traces

6.7.4. Test Setup

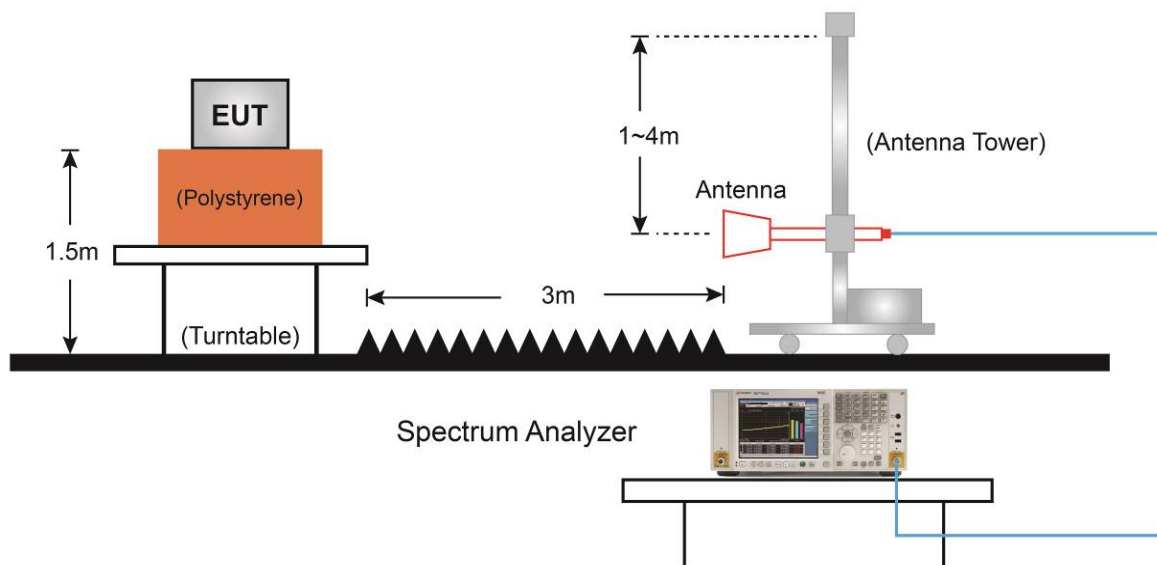

6.7.5. Test Result

EUT	AP351	Date of Test	2021-05-15
Factor	BBHA 9120D	Temp. / Humidity	25°C /66%
Polarity	Horizontal	Site / Test Engineer	AC1 / Kaunaz
Test Mode	802.11b_TX_CH 1_ANT 0+1+2+3	Test Voltage	By PoE

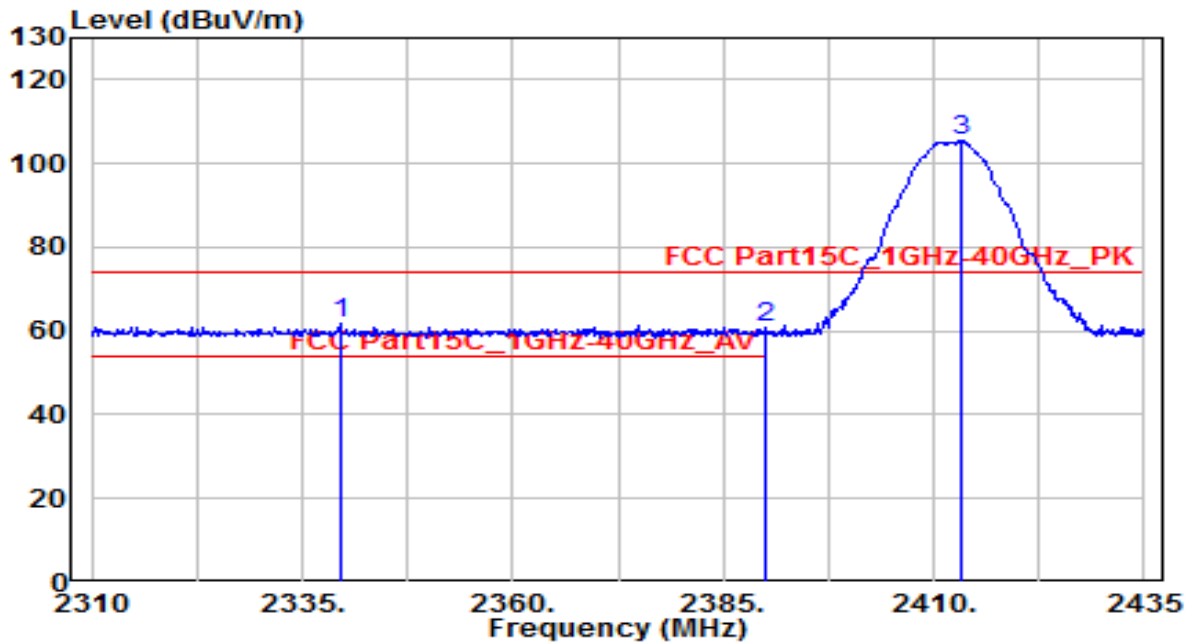

No	Frequency (MHz)	Reading (dBuV)	C.F (dB)	Measurement (dBuV/m)	Margin (dB)	Limit (dBuV/m)	Height (cm)	Angle (deg)	Remark (QP/PK/AV)
1	* 2339.500	29.57	32.01	61.58	-12.42	74.00	170	100	Peak
2	2390.000	28.65	32.22	60.87	-13.13	74.00	170	100	Peak
3	2413.250	73.03	32.32	105.35	N/A	N/A	170	100	Peak

Note:

1. " *", means this data is the worst emission level.
2. C.F (Correction Factor) = Antenna Factor (dB/m)+ Cable Loss (dB).
3. Measurement (dBuV/m) = Reading(dBuV) + C.F (Correction Factor).
4. The emission levels of other frequencies are very lower than the limit and not show in test report.

EUT	AP351	Date of Test	2021-05-15
Factor	BBHA 9120D	Temp. / Humidity	25°C /66%
Polarity	Horizontal	Site / Test Engineer	AC1 / Kaunaz
Test Mode	802.11b_TX_CH 1_ANT 0+1+2+3	Test Voltage	By PoE

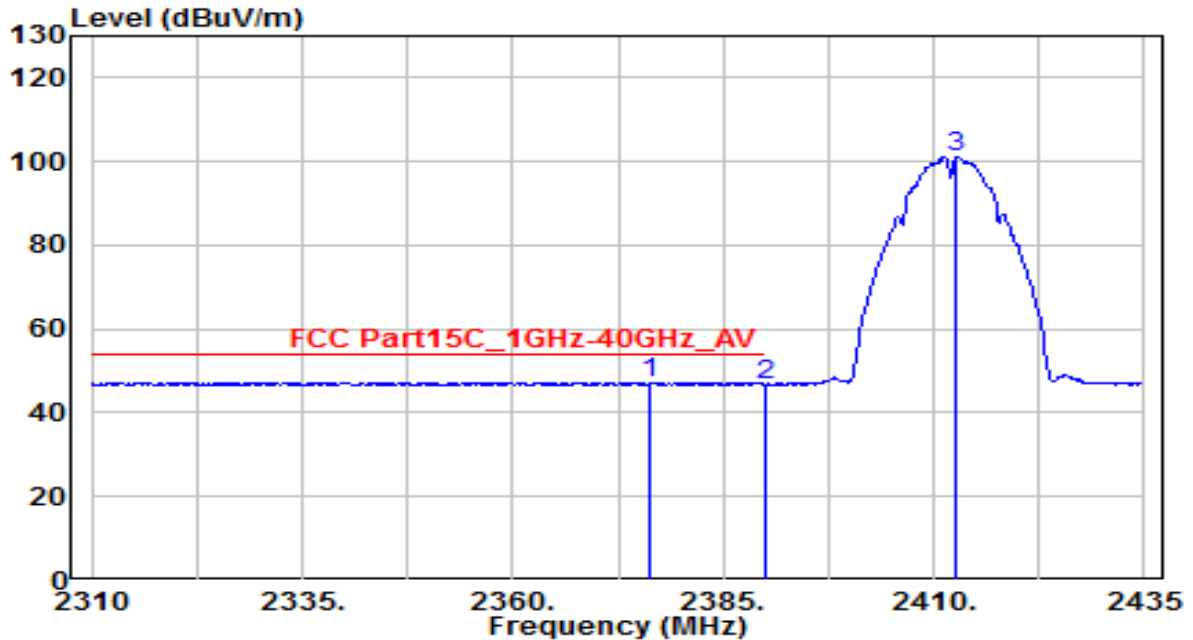

No	Frequency (MHz)	Reading (dBuV)	C.F (dB)	Measurement (dBuV/m)	Margin (dB)	Limit (dBuV/m)	Height (cm)	Angle (deg)	Remark (QP/PK/AV)
1	* 2376.375	15.16	32.16	47.32	-6.68	54.00	170	100	Average
2	2390.000	14.58	32.22	46.80	-7.20	54.00	170	100	Average
3	2412.750	68.96	32.31	101.28	N/A	N/A	170	100	Average

Note:

1. " *", means this data is the worst emission level.
2. C.F (Correction Factor) = Antenna Factor (dB/m)+ Cable Loss (dB).
3. Measurement (dBuV/m) = Reading(dBuV) + C.F (Correction Factor).
4. The emission levels of other frequencies are very lower than the limit and not show in test report.

EUT	AP351	Date of Test	2021-05-15
Factor	BBHA 9120D	Temp. / Humidity	25°C /66%
Polarity	Vertical	Site / Test Engineer	AC1 / Kaunaz
Test Mode	802.11b_TX_CH 1_ANT 0+1+2+3	Test Voltage	By PoE

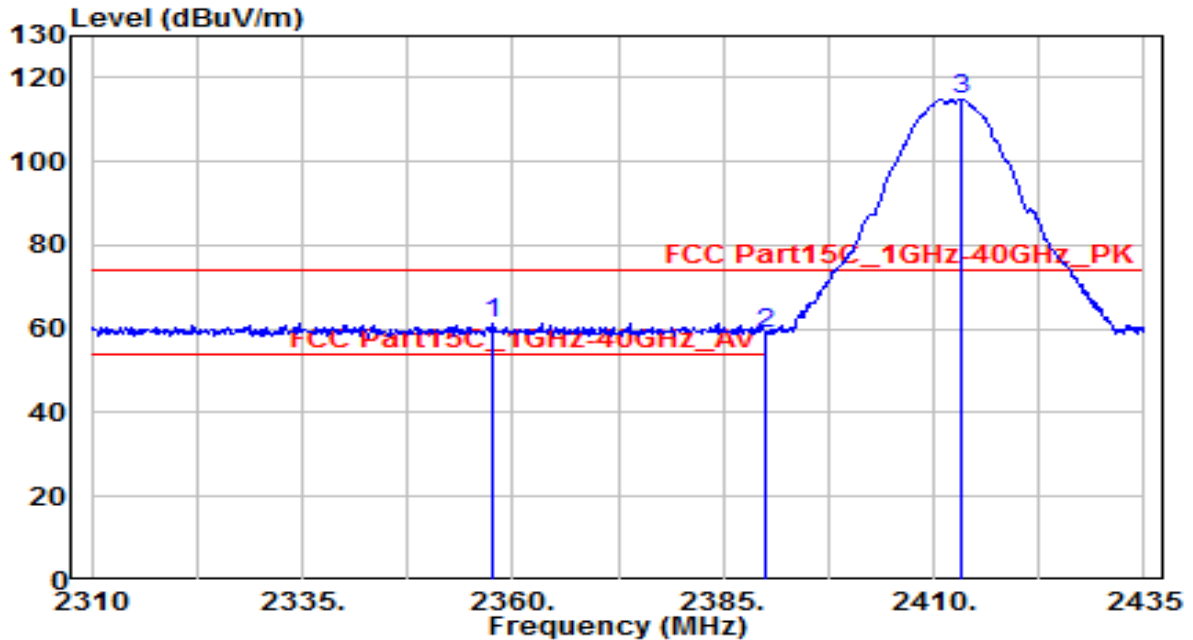

No	Frequency (MHz)	Reading (dBUV)	C.F (dB)	Measurement (dBUV/m)	Margin (dB)	Limit (dBUV/m)	Height (cm)	Angle (deg)	Remark (QP/PK/AV)
1	* 2357.625	29.19	32.08	61.28	-12.72	74.00	260	85	Peak
2	2390.000	26.88	32.22	59.10	-14.90	74.00	260	85	Peak
3	2413.125	82.57	32.32	114.88	N/A	N/A	260	85	Peak

Note:

1. " *", means this data is the worst emission level.
2. C.F (Correction Factor) = Antenna Factor (dB/m)+ Cable Loss (dB).
3. Measurement (dBUV/m) = Reading(dBUV) + C.F (Correction Factor).
4. The emission levels of other frequencies are very lower than the limit and not show in test report.

EUT	AP351	Date of Test	2021-05-15
Factor	BBHA 9120D	Temp. / Humidity	25°C /66%
Polarity	Vertical	Site / Test Engineer	AC1 / Kaunaz
Test Mode	802.11b_TX_CH 1_ANT 0+1+2+3	Test Voltage	By PoE

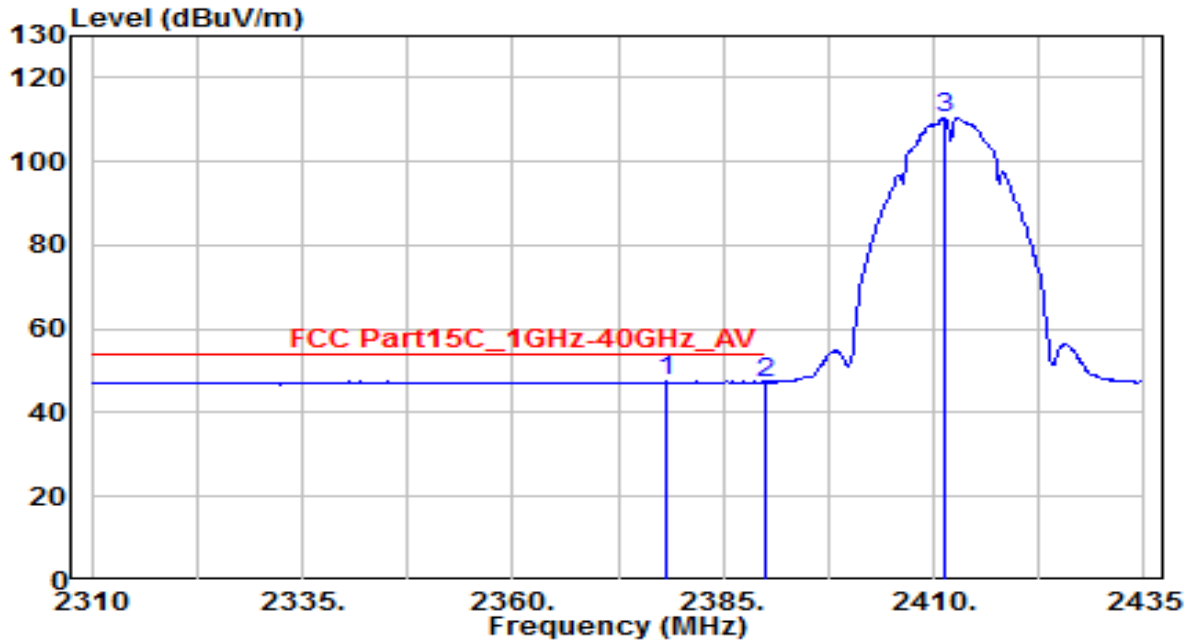

No	Frequency (MHz)	Reading (dBuV)	C.F (dB)	Measurement (dBuV/m)	Margin (dB)	Limit (dBuV/m)	Height (cm)	Angle (deg)	Remark (QP/PK/AV)
1	* 2378.250	15.22	32.17	47.39	-6.61	54.00	260	85	Average
2	2390.000	15.03	32.22	47.24	-6.76	54.00	260	85	Average
3	2411.250	78.28	32.31	110.58	N/A	N/A	260	85	Average

Note:

1. " *", means this data is the worst emission level.
2. C.F (Correction Factor) = Antenna Factor (dB/m)+ Cable Loss (dB).
3. Measurement (dBuV/m) = Reading(dBuV) + C.F (Correction Factor).
4. The emission levels of other frequencies are very lower than the limit and not show in test report.

EUT	AP351	Date of Test	2021-05-15
Factor	BBHA 9120D	Temp. / Humidity	25°C /66%
Polarity	Horizontal	Site / Test Engineer	AC1 / Kaunaz
Test Mode	802.11b_TX_CH 11_ANT 0+1+2+3	Test Voltage	By PoE

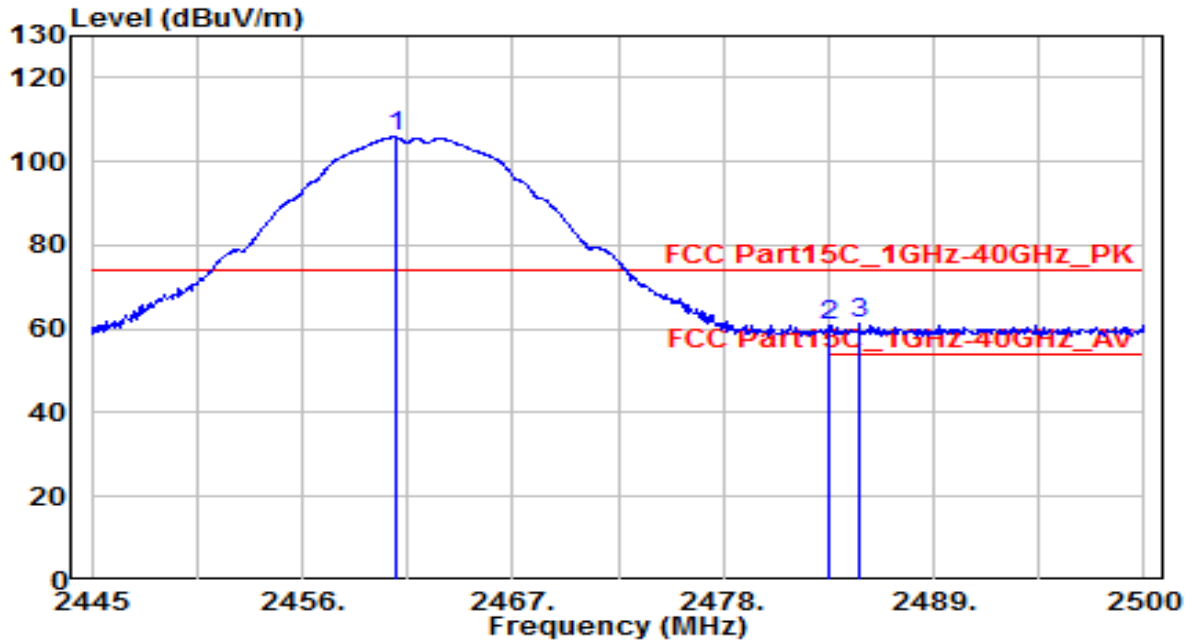

No	Frequency (MHz)	Reading (dBUV)	C.F (dB)	Measurement (dBUV/m)	Margin (dB)	Limit (dBUV/m)	Height (cm)	Angle (deg)	Remark (QP/PK/AV)
1	2460.840	73.22	32.52	105.74	N/A	N/A	170	95	Peak
2	2483.500	28.08	32.61	60.69	-13.31	74.00	170	95	Peak
3	* 2485.095	28.50	32.62	61.11	-12.89	74.00	170	95	Peak

Note:

1. " *", means this data is the worst emission level.
2. C.F (Correction Factor) = Antenna Factor (dB/m)+ Cable Loss (dB).
3. Measurement (dBUV/m) = Reading(dBUV) + C.F (Correction Factor).
4. The emission levels of other frequencies are very lower than the limit and not show in test report.

EUT	AP351	Date of Test	2021-05-15
Factor	BBHA 9120D	Temp. / Humidity	25°C /66%
Polarity	Horizontal	Site / Test Engineer	AC1 / Kaunaz
Test Mode	802.11b_TX_CH 11_ANT 0+1+2+3	Test Voltage	By PoE

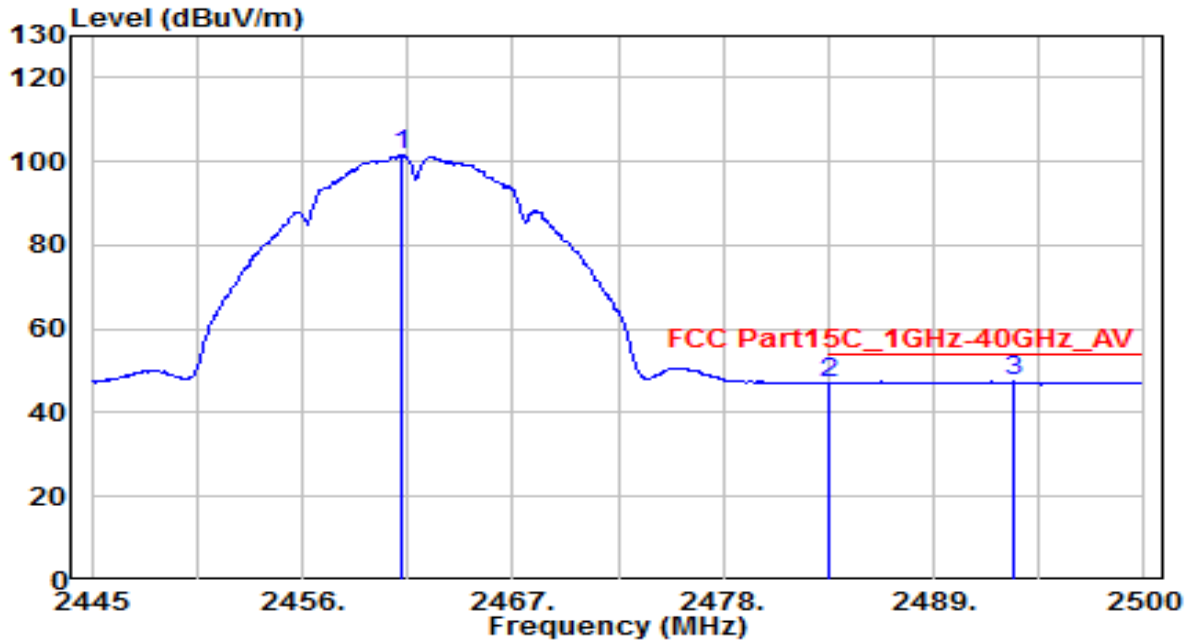

No	Frequency (MHz)	Reading (dBuV)	C.F (dB)	Measurement (dBuV/m)	Margin (dB)	Limit (dBuV/m)	Height (cm)	Angle (deg)	Remark (QP/PK/AV)
1	2461.170	69.02	32.52	101.54	N/A	N/A	170	95	Average
2	2483.500	14.51	32.61	47.12	-6.88	54.00	170	95	Average
3	* 2493.180	14.71	32.65	47.36	-6.64	54.00	170	95	Average

Note:

1. " *", means this data is the worst emission level.
2. C.F (Correction Factor) = Antenna Factor (dB/m)+ Cable Loss (dB).
3. Measurement (dBuV/m) = Reading(dBuV) + C.F (Correction Factor).
4. The emission levels of other frequencies are very lower than the limit and not show in test report.

EUT	AP351	Date of Test	2021-05-15
Factor	BBHA 9120D	Temp. / Humidity	25°C /66%
Polarity	Vertical	Site / Test Engineer	AC1 / Kaunaz
Test Mode	802.11b_TX_CH 11_ANT 0+1+2+3	Test Voltage	By PoE

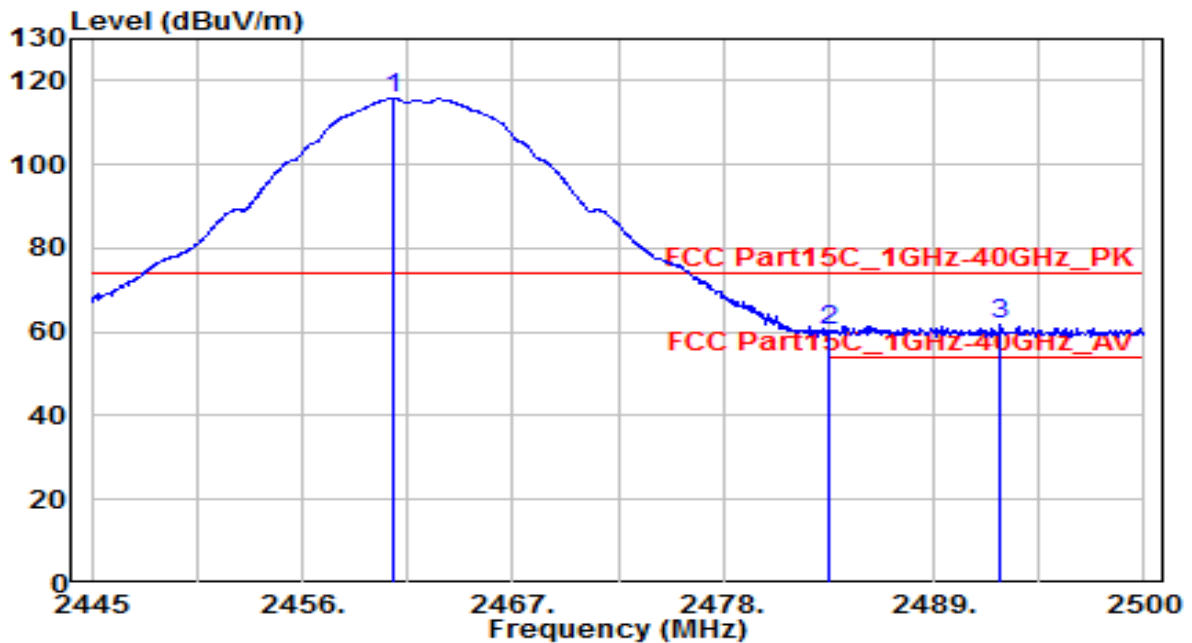

No	Frequency (MHz)	Reading (dBuV)	C.F (dB)	Measurement (dBuV/m)	Margin (dB)	Limit (dBuV/m)	Height (cm)	Angle (deg)	Remark (QP/PK/AV)
1	2460.785	83.24	32.52	115.76	N/A	N/A	230	80	Peak
2	2483.500	27.66	32.61	60.27	-13.73	74.00	230	80	Peak
3	* 2492.465	29.12	32.65	61.77	-12.23	74.00	230	80	Peak

Note:

1. " *", means this data is the worst emission level.
2. C.F (Correction Factor) = Antenna Factor (dB/m)+ Cable Loss (dB).
3. Measurement (dBuV/m) = Reading(dBuV) + C.F (Correction Factor).
4. The emission levels of other frequencies are very lower than the limit and not show in test report.

EUT	AP351	Date of Test	2021-05-15
Factor	BBHA 9120D	Temp. / Humidity	25°C /66%
Polarity	Vertical	Site / Test Engineer	AC1 / Kaunaz
Test Mode	802.11b_TX_CH 11_ANT 0+1+2+3	Test Voltage	By PoE

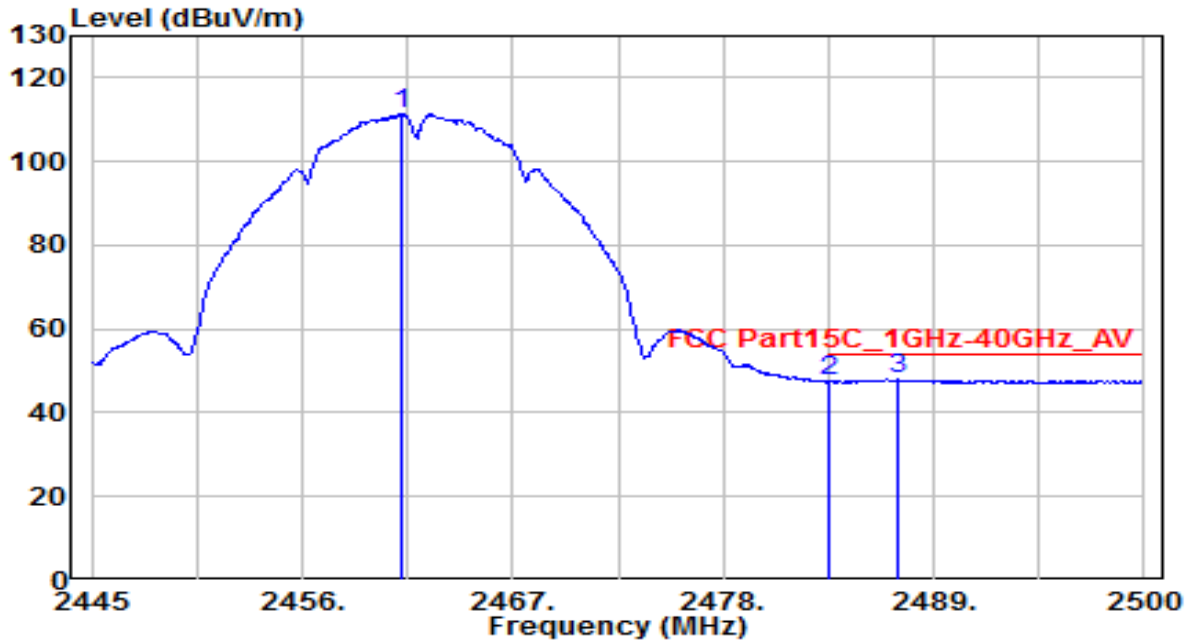

No	Frequency (MHz)	Reading (dBUV)	C.F (dB)	Measurement (dBUV/m)	Margin (dB)	Limit (dBUV/m)	Height (cm)	Angle (deg)	Remark (QP/PK/AV)
1	2461.225	78.95	32.52	111.47	N/A	N/A	230	80	Average
2	2483.500	14.75	32.61	47.36	-6.64	54.00	230	80	Average
3	* 2487.185	15.40	32.63	48.03	-5.97	54.00	230	80	Average

Note:

1. " *", means this data is the worst emission level.
2. C.F (Correction Factor) = Antenna Factor (dB/m)+ Cable Loss (dB).
3. Measurement (dBUV/m) = Reading(dBUV) + C.F (Correction Factor).
4. The emission levels of other frequencies are very lower than the limit and not show in test report.

EUT	AP351	Date of Test	2021-05-18
Factor	BBHA 9120D	Temp. / Humidity	25°C /66%
Polarity	Horizontal	Site / Test Engineer	AC1 / Kaunaz
Test Mode	802.11g_TX_CH 1_ANT 0+1+2+3	Test Voltage	By PoE

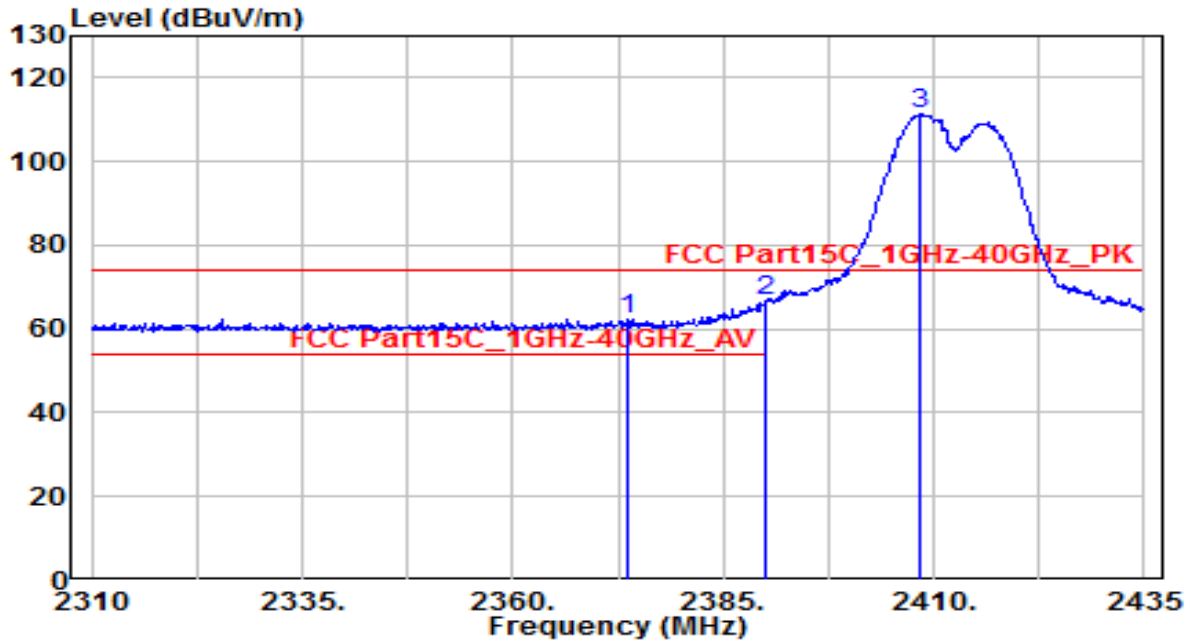

No	Frequency (MHz)	Reading (dBuV)	C.F (dB)	Measurement (dBuV/m)	Margin (dB)	Limit (dBuV/m)	Height (cm)	Angle (deg)	Remark (QP/PK/AV)
1	2373.500	30.30	32.15	62.45	-11.55	74.00	175	205	Peak
2	* 2390.000	34.61	32.22	66.83	-7.17	74.00	175	205	Peak
3	2408.500	79.00	32.30	111.29	N/A	N/A	175	205	Peak

Note:

1. " *", means this data is the worst emission level.
2. C.F (Correction Factor) = Antenna Factor (dB/m)+ Cable Loss (dB).
3. Measurement (dBuV/m) = Reading(dBuV) + C.F (Correction Factor).
4. The emission levels of other frequencies are very lower than the limit and not show in test report.

EUT	AP351	Date of Test	2021-05-18
Factor	BBHA 9120D	Temp. / Humidity	25°C /66%
Polarity	Horizontal	Site / Test Engineer	AC1 / Kaunaz
Test Mode	802.11g_TX_CH 1_ANT 0+1+2+3	Test Voltage	By PoE

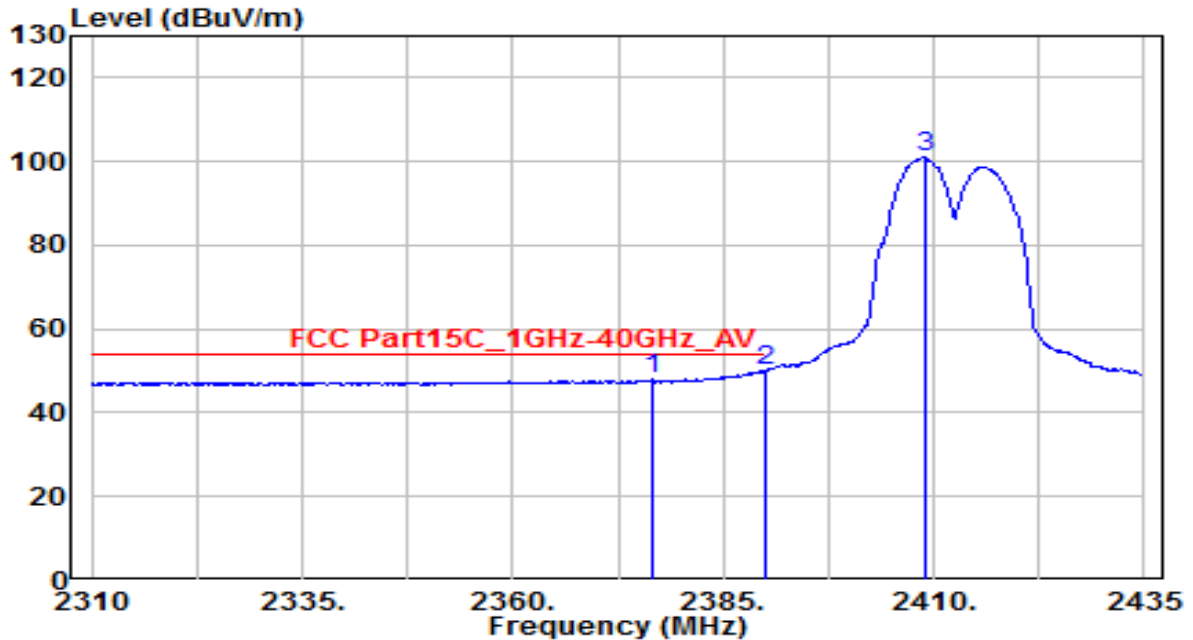

No	Frequency (MHz)	Reading (dBuV)	C.F (dB)	Measurement (dBuV/m)	Margin (dB)	Limit (dBuV/m)	Height (cm)	Angle (deg)	Remark (QP/PK/AV)
1	2376.500	15.67	32.16	47.83	-6.17	54.00	175	205	Average
2	* 2390.000	17.86	32.22	50.08	-3.92	54.00	175	205	Average
3	2408.875	68.71	32.30	101.00	N/A	N/A	175	205	Average

Note:

1. " *", means this data is the worst emission level.
2. C.F (Correction Factor) = Antenna Factor (dB/m)+ Cable Loss (dB).
3. Measurement (dBuV/m) = Reading(dBuV) + C.F (Correction Factor).
4. The emission levels of other frequencies are very lower than the limit and not show in test report.

EUT	AP351	Date of Test	2021-05-18
Factor	BBHA 9120D	Temp. / Humidity	25°C /66%
Polarity	Vertical	Site / Test Engineer	AC1 / Kaunaz
Test Mode	802.11g_TX_CH 1_ANT 0+1+2+3	Test Voltage	By PoE

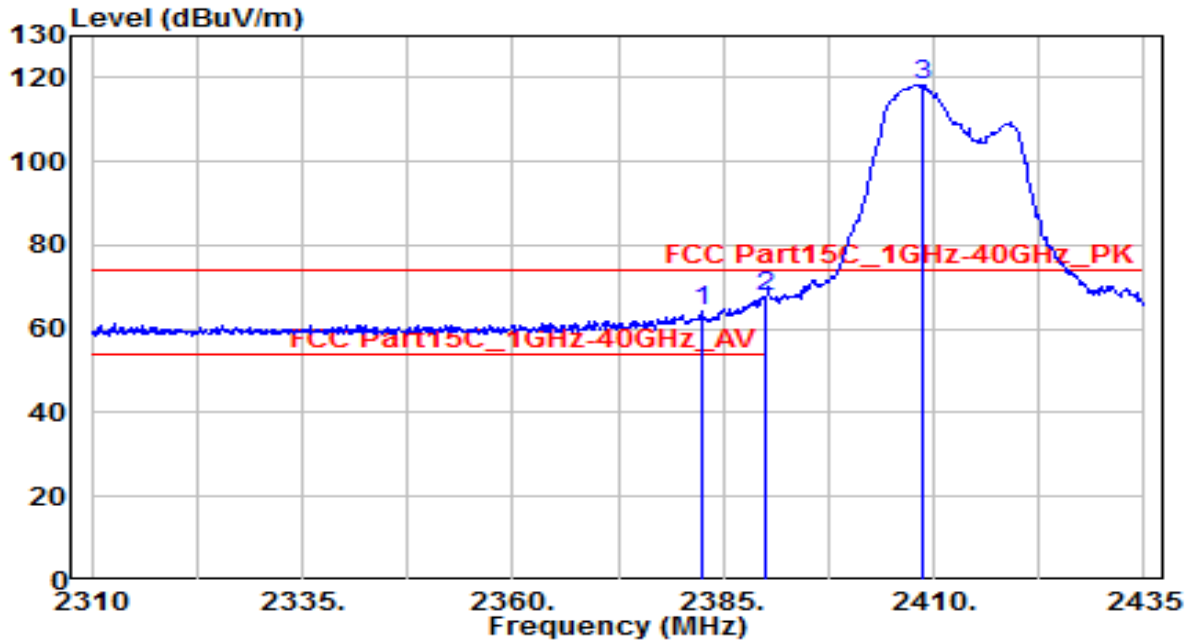

No	Frequency (MHz)	Reading (dBuV)	C.F (dB)	Measurement (dBuV/m)	Margin (dB)	Limit (dBuV/m)	Height (cm)	Angle (deg)	Remark (QP/PK/AV)
1	2382.375	32.22	32.19	64.41	-9.59	74.00	235	275	Peak
2	* 2390.000	35.50	32.22	67.72	-6.28	74.00	235	275	Peak
3	2408.625	86.11	32.30	118.41	N/A	N/A	235	275	Peak

Note:

1. " *", means this data is the worst emission level.
2. C.F (Correction Factor) = Antenna Factor (dB/m)+ Cable Loss (dB).
3. Measurement (dBuV/m) = Reading(dBuV) + C.F (Correction Factor).
4. The emission levels of other frequencies are very lower than the limit and not show in test report.

EUT	AP351	Date of Test	2021-05-18
Factor	BBHA 9120D	Temp. / Humidity	25°C /66%
Polarity	Vertical	Site / Test Engineer	AC1 / Kaunaz
Test Mode	802.11g_TX_CH 1_ANT 0+1+2+3	Test Voltage	By PoE

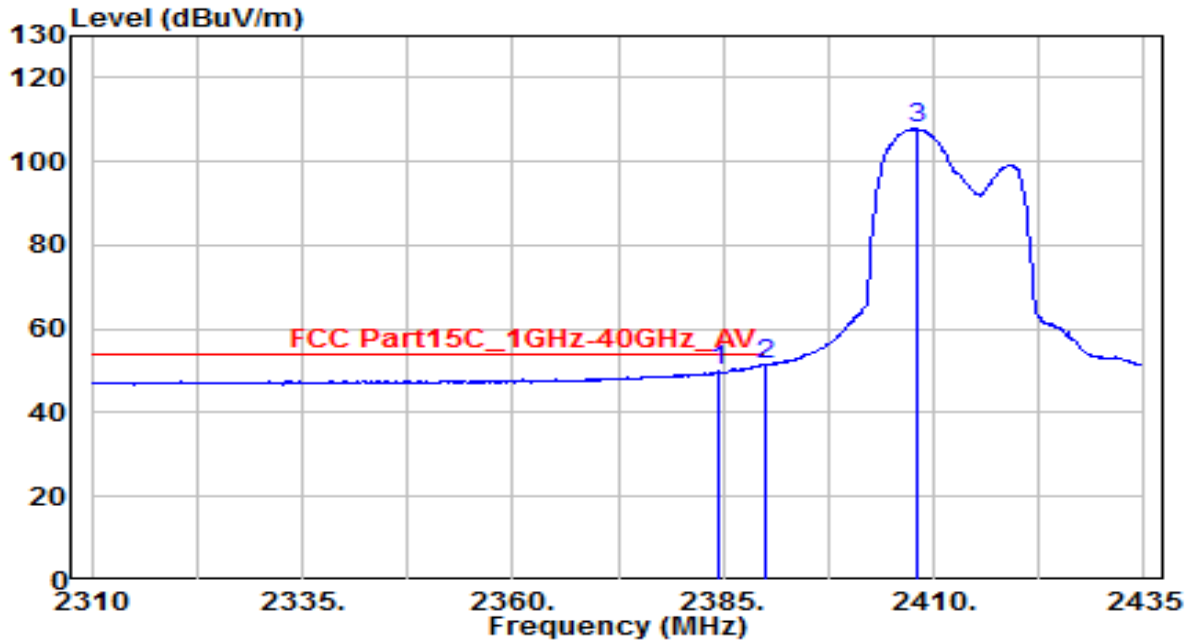

No	Frequency (MHz)	Reading (dBuV)	C.F (dB)	Measurement (dBuV/m)	Margin (dB)	Limit (dBuV/m)	Height (cm)	Angle (deg)	Remark (QP/PK/AV)
1	2384.375	17.64	32.19	49.84	-4.16	54.00	235	275	Average
2	* 2390.000	19.06	32.22	51.28	-2.72	54.00	235	275	Average
3	2408.125	75.46	32.29	107.76	N/A	N/A	235	275	Average

Note:

1. " *", means this data is the worst emission level.
2. C.F (Correction Factor) = Antenna Factor (dB/m)+ Cable Loss (dB).
3. Measurement (dBuV/m) = Reading(dBuV) + C.F (Correction Factor).
4. The emission levels of other frequencies are very lower than the limit and not show in test report.

EUT	AP351	Date of Test	2021-05-18
Factor	BBHA 9120D	Temp. / Humidity	25°C /66%
Polarity	Horizontal	Site / Test Engineer	AC1 / Kaunaz
Test Mode	802.11g_TX_CH 11_ANT 0+1+2+3	Test Voltage	By PoE

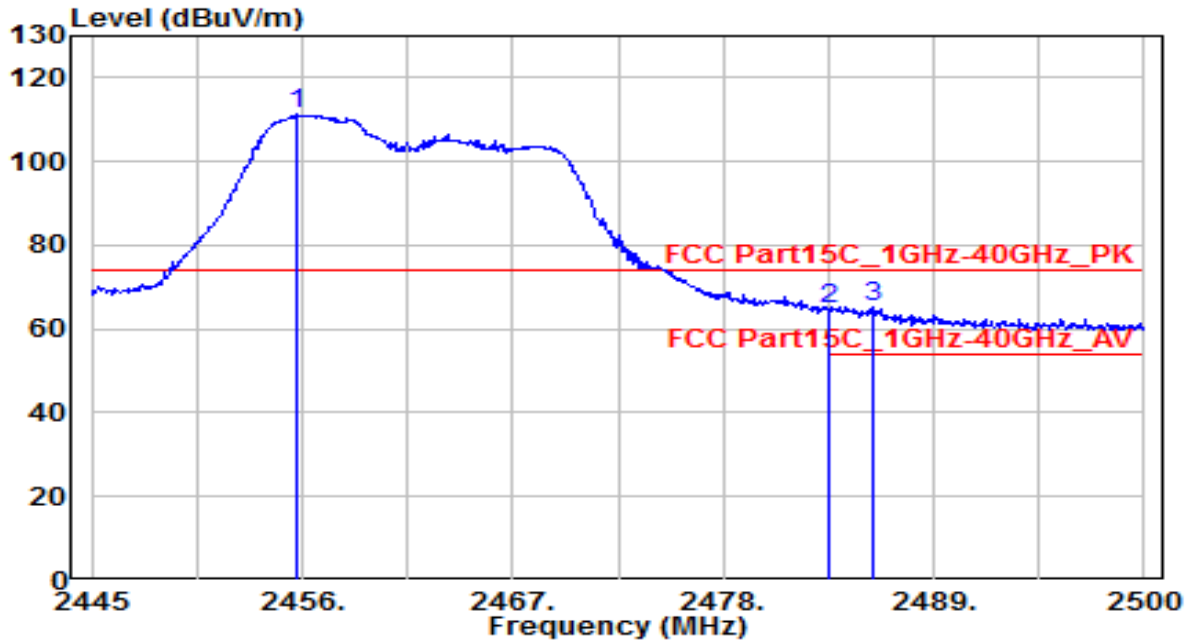

No	Frequency (MHz)	Reading (dBuV)	C.F (dB)	Measurement (dBuV/m)	Margin (dB)	Limit (dBuV/m)	Height (cm)	Angle (deg)	Remark (QP/PK/AV)
1	2455.780	78.73	32.49	111.23	N/A	N/A	150	330	Peak
2	2483.500	32.21	32.61	64.82	-9.18	74.00	150	330	Peak
3	* 2485.865	32.41	32.62	65.03	-8.97	74.00	150	330	Peak

Note:

1. " *", means this data is the worst emission level.
2. C.F (Correction Factor) = Antenna Factor (dB/m)+ Cable Loss (dB).
3. Measurement (dBuV/m) = Reading(dBuV) + C.F (Correction Factor).
4. The emission levels of other frequencies are very lower than the limit and not show in test report.

EUT	AP351	Date of Test	2021-05-18
Factor	BBHA 9120D	Temp. / Humidity	25°C /66%
Polarity	Horizontal	Site / Test Engineer	AC1 / Kaunaz
Test Mode	802.11g_TX_CH 11_ANT 0+1+2+3	Test Voltage	By PoE

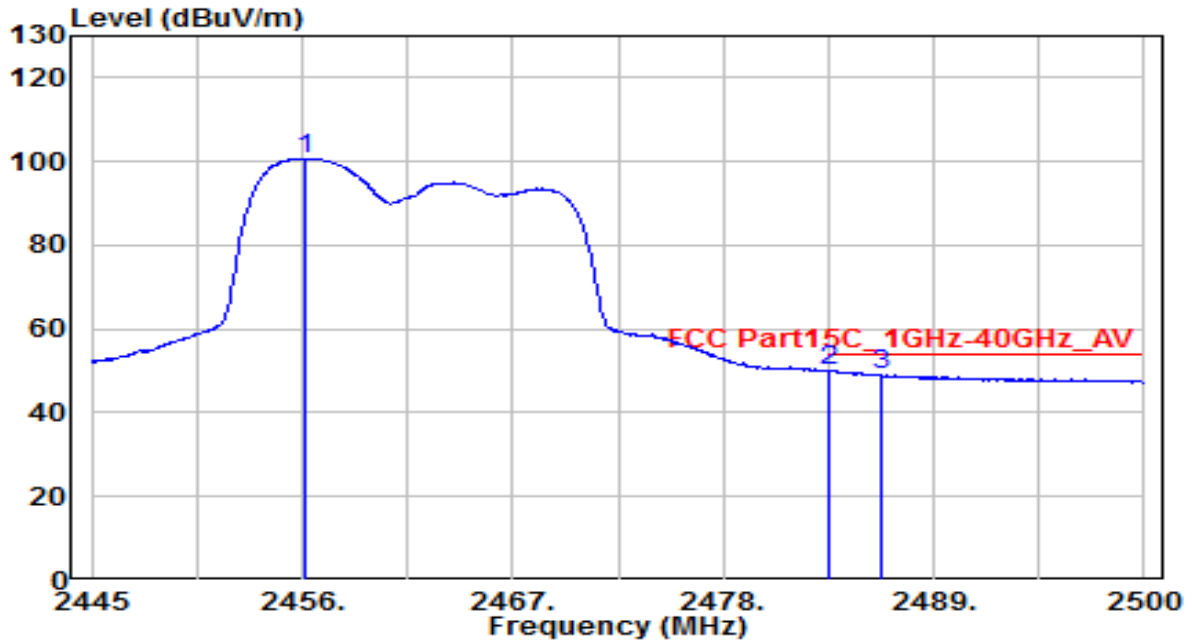

No	Frequency (MHz)	Reading (dBUV)	C.F (dB)	Measurement (dBUV/m)	Margin (dB)	Limit (dBUV/m)	Height (cm)	Angle (deg)	Remark (QP/PK/AV)
1	2456.165	68.27	32.50	100.77	N/A	N/A	150	330	Average
2	* 2483.500	17.27	32.61	49.88	-4.12	54.00	150	330	Average
3	2486.250	16.31	32.62	48.94	-5.06	54.00	150	330	Average

Note:

1. " *", means this data is the worst emission level.
2. C.F (Correction Factor) = Antenna Factor (dB/m)+ Cable Loss (dB).
3. Measurement (dBUV/m) = Reading(dBUV) + C.F (Correction Factor).
4. The emission levels of other frequencies are very lower than the limit and not show in test report.

EUT	AP351	Date of Test	2021-05-18
Factor	BBHA 9120D	Temp. / Humidity	25°C /66%
Polarity	Vertical	Site / Test Engineer	AC1 / Kaunaz
Test Mode	802.11g_TX_CH 11_ANT 0+1+2+3	Test Voltage	By PoE

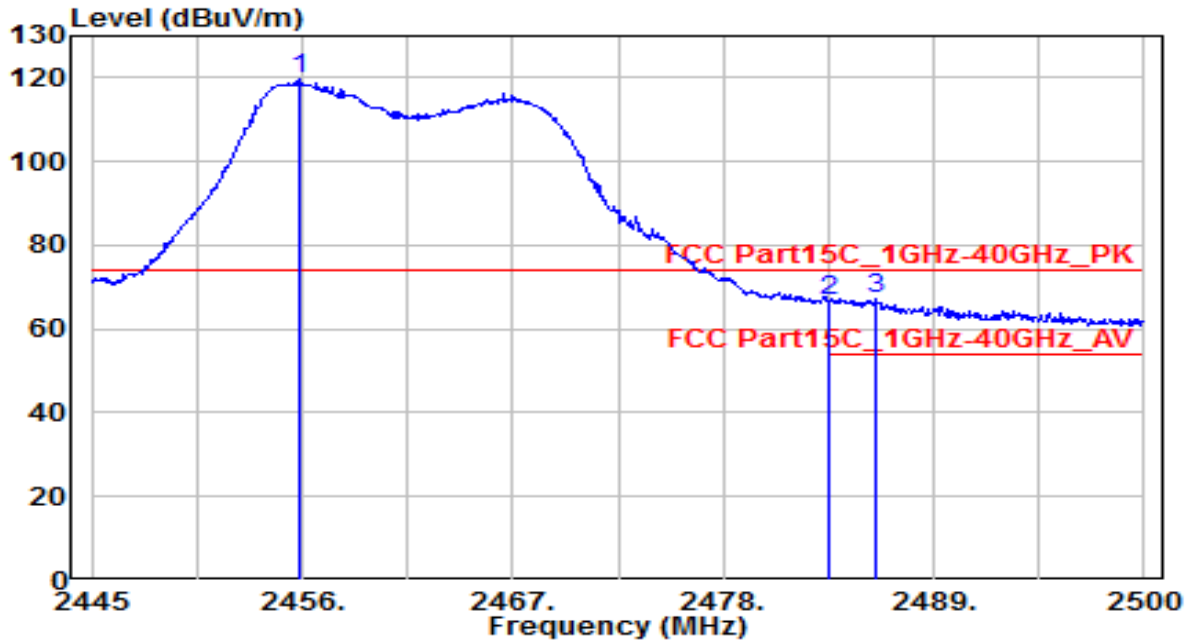

No	Frequency (MHz)	Reading (dBuV)	C.F (dB)	Measurement (dBuV/m)	Margin (dB)	Limit (dBuV/m)	Height (cm)	Angle (deg)	Remark (QP/PK/AV)
1	2455.835	87.29	32.49	119.78	N/A	N/A	260	265	Peak
2	2483.500	34.30	32.61	66.91	-7.09	74.00	260	265	Peak
3	* 2485.920	34.68	32.62	67.30	-6.70	74.00	260	265	Peak

Note:

1. " *", means this data is the worst emission level.
2. C.F (Correction Factor) = Antenna Factor (dB/m)+ Cable Loss (dB).
3. Measurement (dBuV/m) = Reading(dBuV) + C.F (Correction Factor).
4. The emission levels of other frequencies are very lower than the limit and not show in test report.

EUT	AP351	Date of Test	2021-05-18
Factor	BBHA 9120D	Temp. / Humidity	25°C /66%
Polarity	Vertical	Site / Test Engineer	AC1 / Kaunaz
Test Mode	802.11g_TX_CH 11_ANT 0+1+2+3	Test Voltage	By PoE

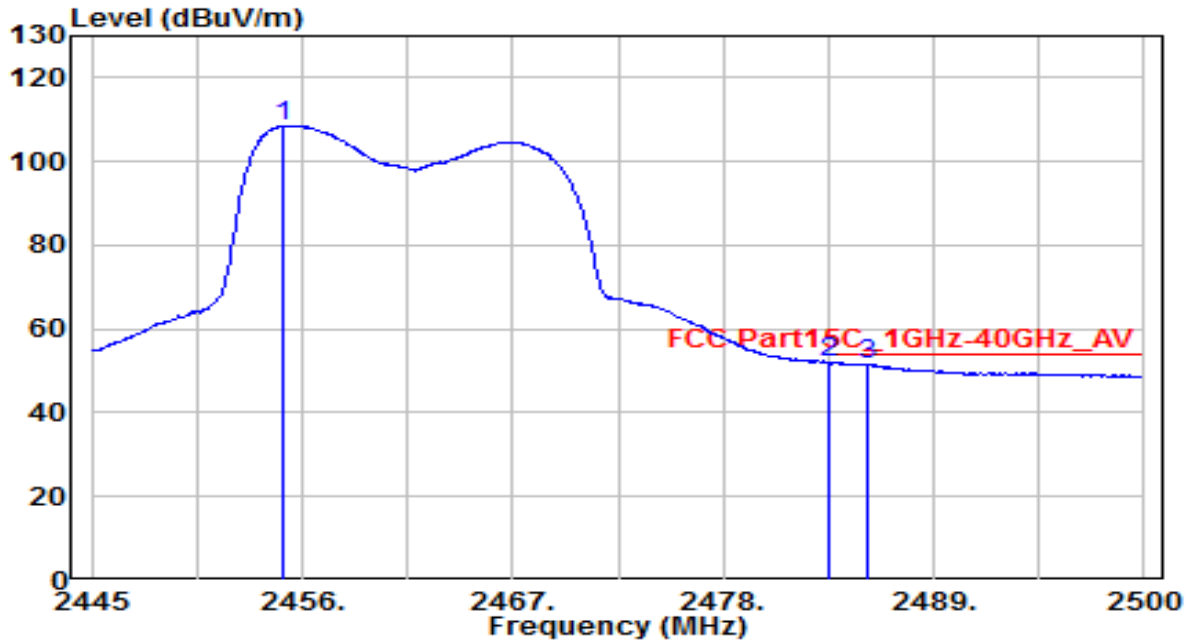

No	Frequency (MHz)	Reading (dBuV)	C.F (dB)	Measurement (dBuV/m)	Margin (dB)	Limit (dBuV/m)	Height (cm)	Angle (deg)	Remark (QP/PK/AV)
1	2455.010	76.10	32.49	108.59	N/A	N/A	260	265	Average
2	* 2483.500	19.52	32.61	52.13	-1.87	54.00	260	265	Average
3	2485.535	18.93	32.62	51.55	-2.45	54.00	260	265	Average

Note:

1. " *", means this data is the worst emission level.
2. C.F (Correction Factor) = Antenna Factor (dB/m)+ Cable Loss (dB).
3. Measurement (dBuV/m) = Reading(dBuV) + C.F (Correction Factor).
4. The emission levels of other frequencies are very lower than the limit and not show in test report.

EUT	AP351	Date of Test	2021-05-15
Factor	BBHA 9120D	Temp. / Humidity	25°C /66%
Polarity	Horizontal	Site / Test Engineer	AC1 / Kaunaz
Test Mode	802.11n-20MHz_TX_CH 1_ANT 0+1+2+3	Test Voltage	By PoE

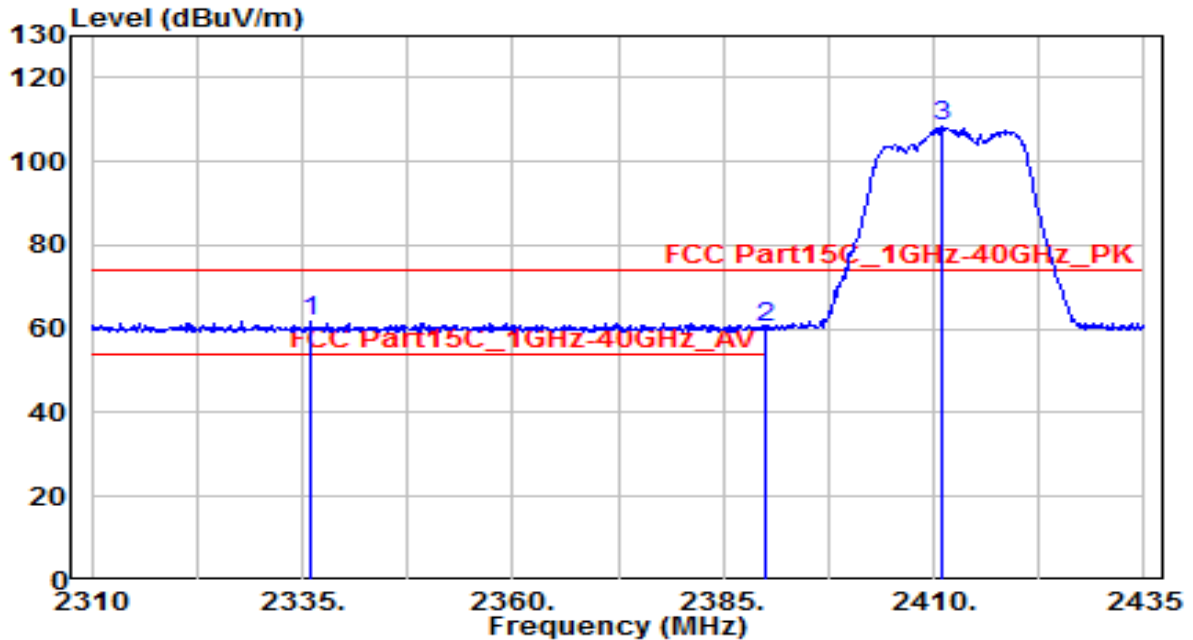

No	Frequency (MHz)	Reading (dBUV)	C.F (dB)	Measurement (dBUV/m)	Margin (dB)	Limit (dBUV/m)	Height (cm)	Angle (deg)	Remark (QP/PK/AV)
1	* 2336.000	29.84	31.99	61.83	-12.17	74.00	170	100	Peak
2	2390.000	28.28	32.22	60.50	-13.50	74.00	170	100	Peak
3	2411.125	75.91	32.31	108.22	N/A	N/A	170	100	Peak

Note:

1. " *", means this data is the worst emission level.
2. C.F (Correction Factor) = Antenna Factor (dB/m)+ Cable Loss (dB).
3. Measurement (dBUV/m) = Reading(dBUV) + C.F (Correction Factor).
4. The emission levels of other frequencies are very lower than the limit and not show in test report.

EUT	AP351	Date of Test	2021-05-15
Factor	BBHA 9120D	Temp. / Humidity	25°C /66%
Polarity	Horizontal	Site / Test Engineer	AC1 / Kaunaz
Test Mode	802.11n-20MHz_TX_CH 1_ANT 0+1+2+3	Test Voltage	By PoE

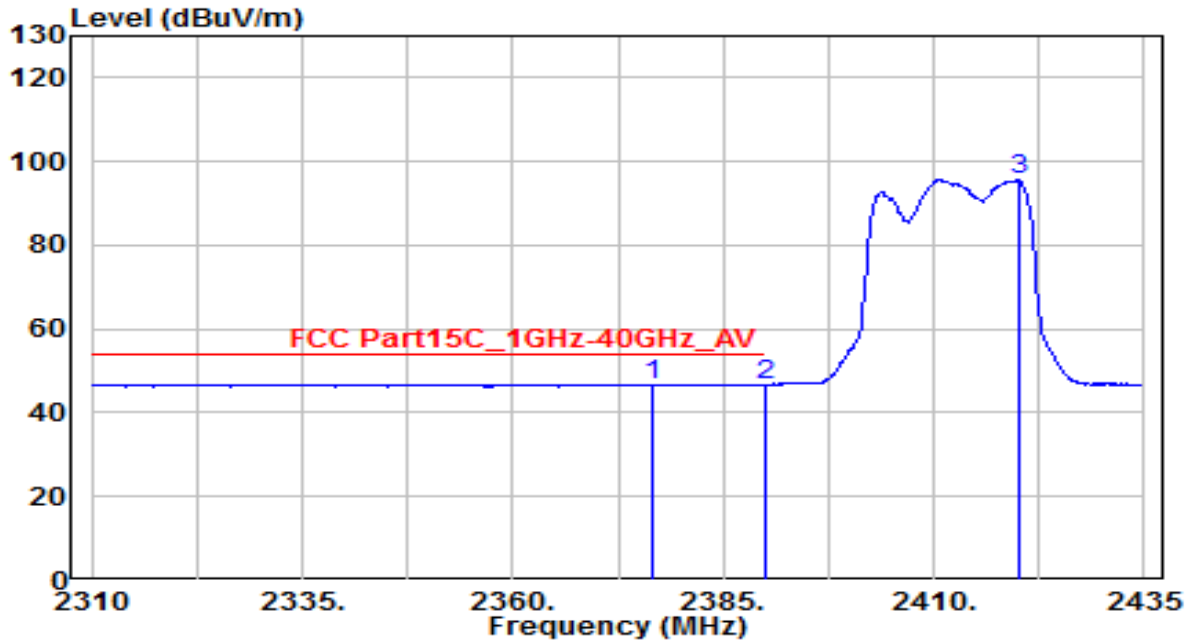

No	Frequency (MHz)	Reading (dBuV)	C.F (dB)	Measurement (dBuV/m)	Margin (dB)	Limit (dBuV/m)	Height (cm)	Angle (deg)	Remark (QP/PK/AV)
1	2376.750	14.55	32.16	46.71	-7.29	54.00	170	100	Average
2	* 2390.000	14.56	32.22	46.77	-7.23	54.00	170	100	Average
3	2420.000	63.27	32.34	95.61	N/A	N/A	170	100	Average

Note:

1. " *", means this data is the worst emission level.
2. C.F (Correction Factor) = Antenna Factor (dB/m)+ Cable Loss (dB).
3. Measurement (dBuV/m) = Reading(dBuV) + C.F (Correction Factor).
4. The emission levels of other frequencies are very lower than the limit and not show in test report.

EUT	AP351	Date of Test	2021-05-15
Factor	BBHA 9120D	Temp. / Humidity	25°C /66%
Polarity	Vertical	Site / Test Engineer	AC1 / Kaunaz
Test Mode	802.11n-20MHz_TX_CH 1_ANT 0+1+2+3	Test Voltage	By PoE

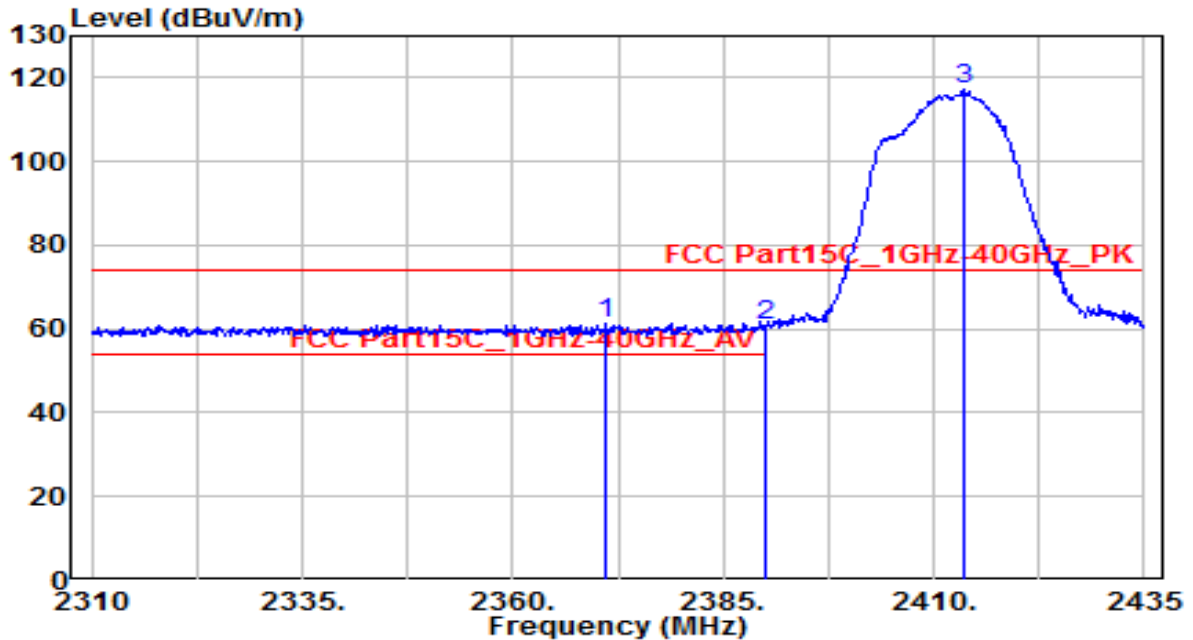

No	Frequency (MHz)	Reading (dBUV)	C.F (dB)	Measurement (dBUV/m)	Margin (dB)	Limit (dBUV/m)	Height (cm)	Angle (deg)	Remark (QP/PK/AV)
1	* 2371.125	29.31	32.14	61.45	-12.55	74.00	260	85	Peak
2	2390.000	28.43	32.22	60.65	-13.35	74.00	260	85	Peak
3	2413.625	84.77	32.32	117.09	N/A	N/A	260	85	Peak

Note:

1. " *", means this data is the worst emission level.
2. C.F (Correction Factor) = Antenna Factor (dB/m)+ Cable Loss (dB).
3. Measurement (dBUV/m) = Reading(dBUV) + C.F (Correction Factor).
4. The emission levels of other frequencies are very lower than the limit and not show in test report.

EUT	AP351	Date of Test	2021-05-15
Factor	BBHA 9120D	Temp. / Humidity	25°C /66%
Polarity	Vertical	Site / Test Engineer	AC1 / Kaunaz
Test Mode	802.11n-20MHz_TX_CH 1_ANT 0+1+2+3	Test Voltage	By PoE

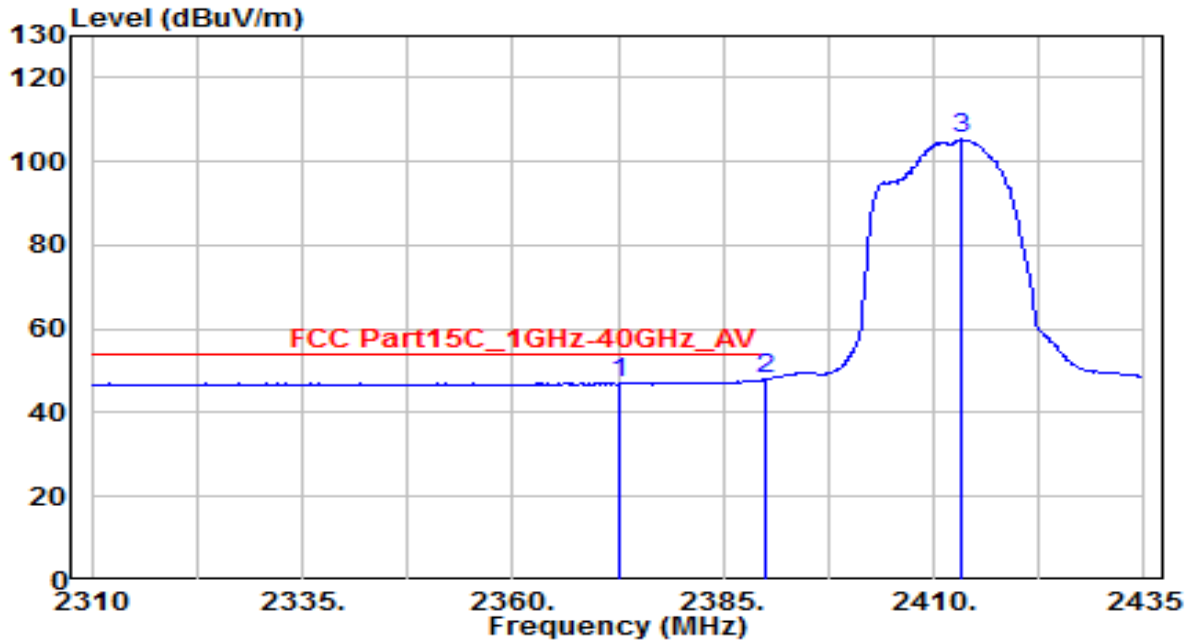

No	Frequency (MHz)	Reading (dBuV)	C.F (dB)	Measurement (dBuV/m)	Margin (dB)	Limit (dBuV/m)	Height (cm)	Angle (deg)	Remark (QP/PK/AV)
1	2372.625	14.96	32.15	47.10	-6.90	54.00	260	85	Average
2	* 2390.000	15.75	32.22	47.96	-6.04	54.00	260	85	Average
3	2413.250	72.94	32.32	105.26	N/A	N/A	260	85	Average

Note:

1. " *", means this data is the worst emission level.
2. C.F (Correction Factor) = Antenna Factor (dB/m)+ Cable Loss (dB).
3. Measurement (dBuV/m) = Reading(dBuV) + C.F (Correction Factor).
4. The emission levels of other frequencies are very lower than the limit and not show in test report.

EUT	AP351	Date of Test	2021-05-15
Factor	BBHA 9120D	Temp. / Humidity	25°C /66%
Polarity	Horizontal	Site / Test Engineer	AC1 / Kaunaz
Test Mode	802.11n-20MHz_TX_CH 11_ANT 0+1+2+3	Test Voltage	By PoE

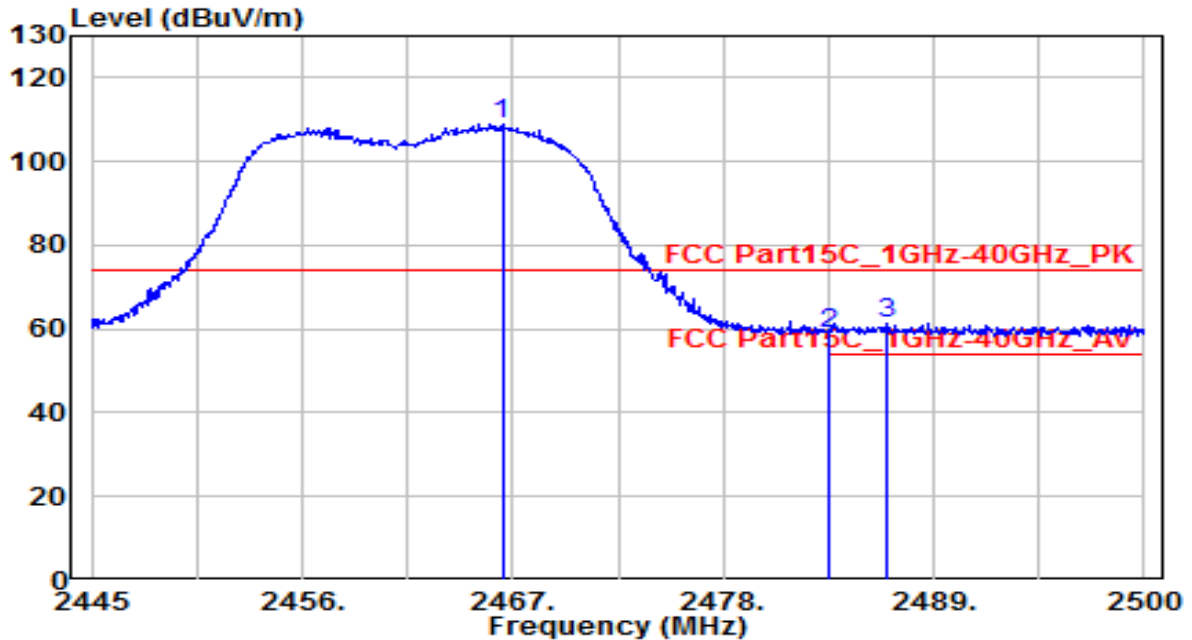

No	Frequency (MHz)	Reading (dBuV)	C.F (dB)	Measurement (dBuV/m)	Margin (dB)	Limit (dBuV/m)	Height (cm)	Angle (deg)	Remark (QP/PK/AV)
1	2466.450	76.52	32.54	109.06	N/A	N/A	170	95	Peak
2	2483.500	26.30	32.61	58.91	-15.09	74.00	170	95	Peak
3	* 2486.525	28.76	32.62	61.38	-12.62	74.00	170	95	Peak

Note:

1. " *", means this data is the worst emission level.
2. C.F (Correction Factor) = Antenna Factor (dB/m)+ Cable Loss (dB).
3. Measurement (dBuV/m) = Reading(dBuV) + C.F (Correction Factor).
4. The emission levels of other frequencies are very lower than the limit and not show in test report.

EUT	AP351	Date of Test	2021-05-15
Factor	BBHA 9120D	Temp. / Humidity	25°C /66%
Polarity	Horizontal	Site / Test Engineer	AC1 / Kaunaz
Test Mode	802.11n-20MHz_TX_CH 11_ANT 0+1+2+3	Test Voltage	By PoE

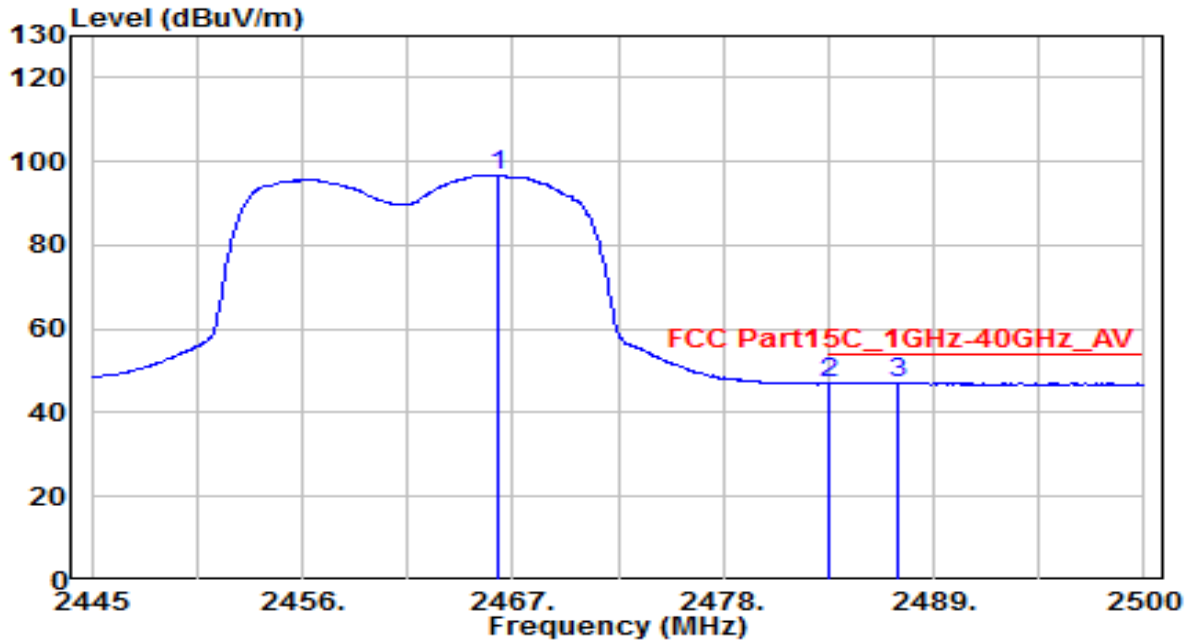

No	Frequency (MHz)	Reading (dBuV)	C.F (dB)	Measurement (dBuV/m)	Margin (dB)	Limit (dBuV/m)	Height (cm)	Angle (deg)	Remark (QP/PK/AV)
1	2466.175	64.32	32.54	96.85	N/A	N/A	170	95	Average
2	2483.500	14.32	32.61	46.93	-7.07	54.00	170	95	Average
3	* 2487.075	14.61	32.63	47.23	-6.77	54.00	170	95	Average

Note:

1. " *", means this data is the worst emission level.
2. C.F (Correction Factor) = Antenna Factor (dB/m)+ Cable Loss (dB).
3. Measurement (dBuV/m) = Reading(dBuV) + C.F (Correction Factor).
4. The emission levels of other frequencies are very lower than the limit and not show in test report.

EUT	AP351	Date of Test	2021-05-15
Factor	BBHA 9120D	Temp. / Humidity	25°C /66%
Polarity	Vertical	Site / Test Engineer	AC1 / Kaunaz
Test Mode	802.11n-20MHz_TX_CH 11_ANT 0+1+2+3	Test Voltage	By PoE

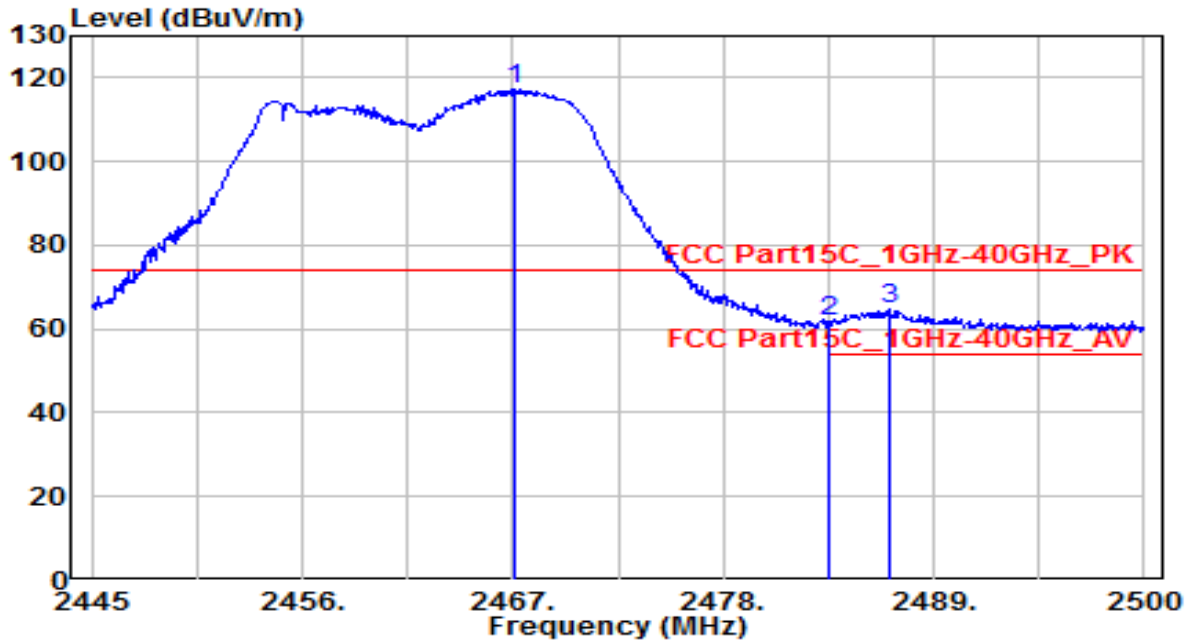

No	Frequency (MHz)	Reading (dBuV)	C.F (dB)	Measurement (dBuV/m)	Margin (dB)	Limit (dBuV/m)	Height (cm)	Angle (deg)	Remark (QP/PK/AV)
1	2467.055	84.90	32.54	117.44	N/A	N/A	230	80	Peak
2	2483.500	29.21	32.61	61.82	-12.18	74.00	230	80	Peak
3	* 2486.635	31.97	32.62	64.59	-9.41	74.00	230	80	Peak

Note:

1. " *", means this data is the worst emission level.
2. C.F (Correction Factor) = Antenna Factor (dB/m)+ Cable Loss (dB).
3. Measurement (dBuV/m) = Reading(dBuV) + C.F (Correction Factor).
4. The emission levels of other frequencies are very lower than the limit and not show in test report.

EUT	AP351	Date of Test	2021-05-15
Factor	BBHA 9120D	Temp. / Humidity	25°C /66%
Polarity	Vertical	Site / Test Engineer	AC1 / Kaunaz
Test Mode	802.11n-20MHz_TX_CH 11_ANT 0+1+2+3	Test Voltage	By PoE

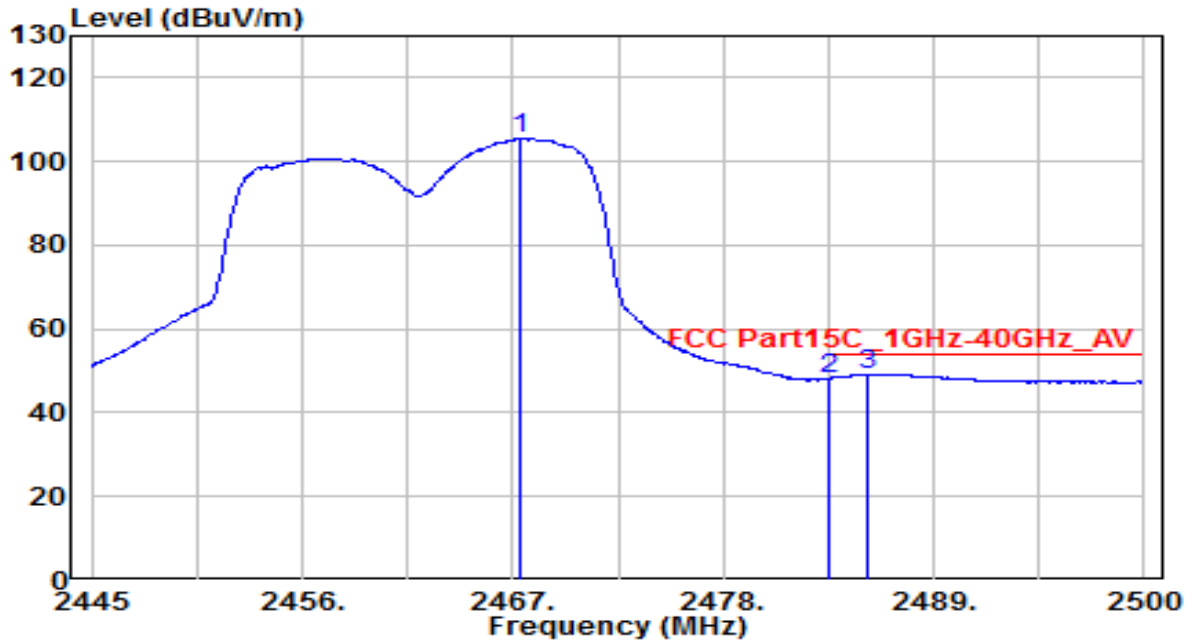

No	Frequency (MHz)	Reading (dBuV)	C.F (dB)	Measurement (dBuV/m)	Margin (dB)	Limit (dBuV/m)	Height (cm)	Angle (deg)	Remark (QP/PK/AV)
1	2467.330	73.04	32.54	105.59	N/A	N/A	230	80	Average
2	2483.500	15.58	32.61	48.19	-5.81	54.00	230	80	Average
3	* 2485.480	16.58	32.62	49.20	-4.80	54.00	230	80	Average

Note:

1. " *", means this data is the worst emission level.
2. C.F (Correction Factor) = Antenna Factor (dB/m)+ Cable Loss (dB).
3. Measurement (dBuV/m) = Reading(dBuV) + C.F (Correction Factor).
4. The emission levels of other frequencies are very lower than the limit and not show in test report.

EUT	AP351	Date of Test	2021-05-15
Factor	BBHA 9120D	Temp. / Humidity	25°C /66%
Polarity	Horizontal	Site / Test Engineer	AC1 / Kaunaz
Test Mode	802.11n-40MHz_TX_CH 3_ANT 0+1+2+3	Test Voltage	By PoE

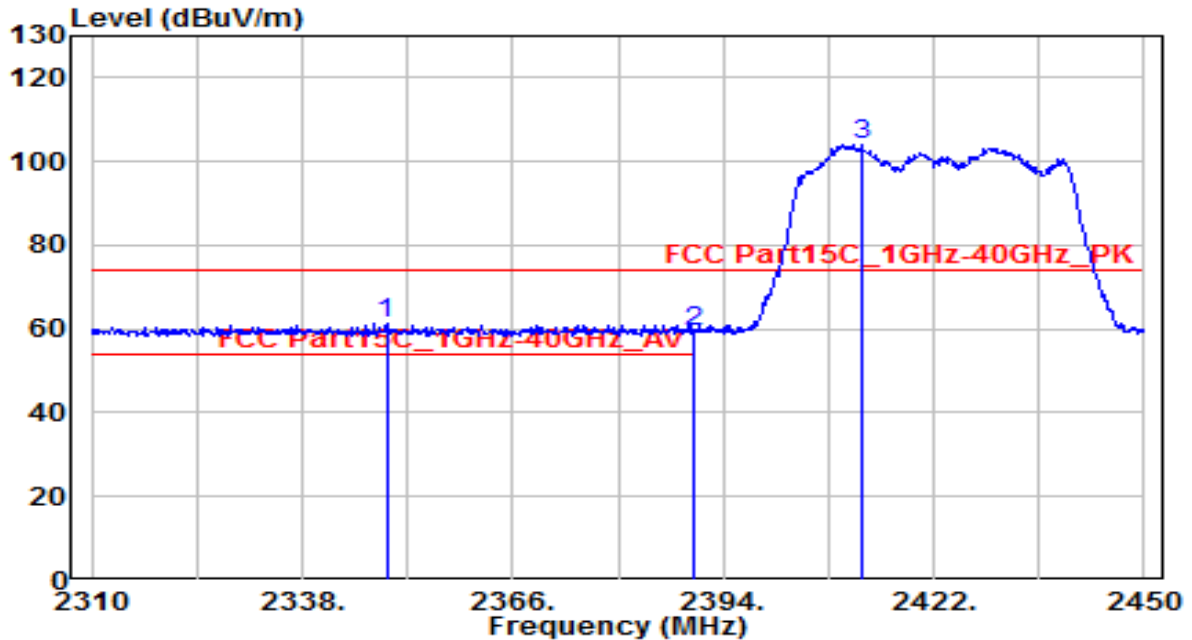

No	Frequency (MHz)	Reading (dBuV)	C.F (dB)	Measurement (dBuV/m)	Margin (dB)	Limit (dBuV/m)	Height (cm)	Angle (deg)	Remark (QP/PK/AV)
1	* 2349.200	29.11	32.05	61.15	-12.85	74.00	170	100	Peak
2	2390.000	27.18	32.22	59.40	-14.60	74.00	170	100	Peak
3	2412.480	71.81	32.31	104.12	N/A	N/A	170	100	Peak

Note:

1. " *", means this data is the worst emission level.
2. C.F (Correction Factor) = Antenna Factor (dB/m)+ Cable Loss (dB).
3. Measurement (dBuV/m) = Reading(dBuV) + C.F (Correction Factor).
4. The emission levels of other frequencies are very lower than the limit and not show in test report.

EUT	AP351	Date of Test	2021-05-15
Factor	BBHA 9120D	Temp. / Humidity	25°C /66%
Polarity	Horizontal	Site / Test Engineer	AC1 / Kaunaz
Test Mode	802.11n-40MHz_TX_CH 3_ANT 0+1+2+3	Test Voltage	By PoE

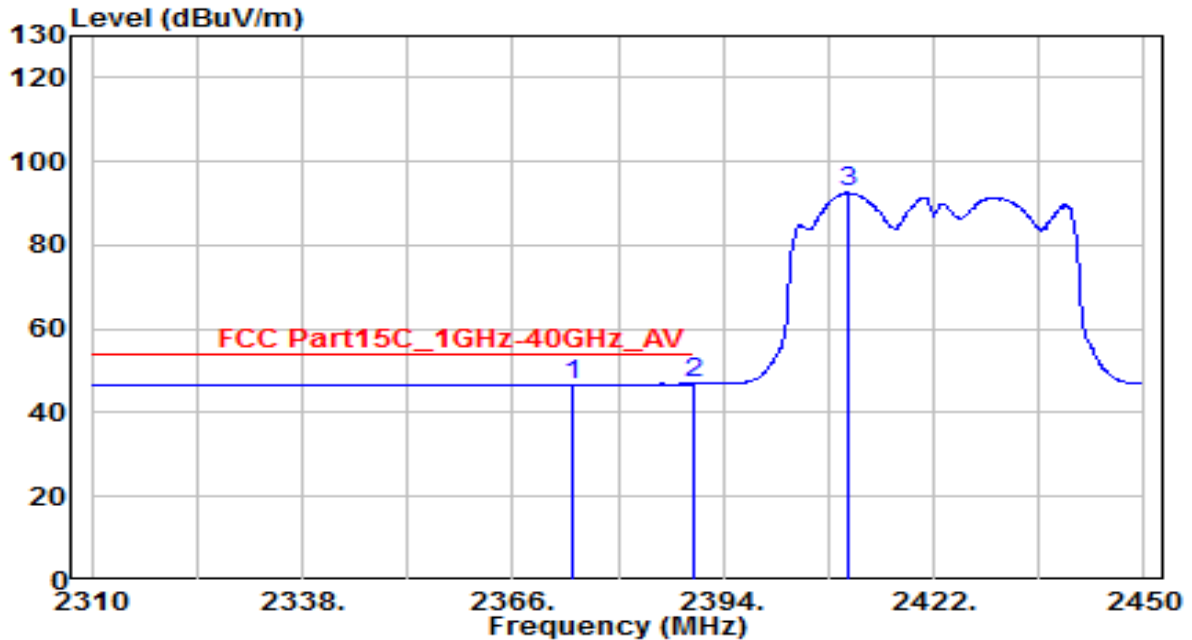

No	Frequency (MHz)	Reading (dBuV)	C.F (dB)	Measurement (dBuV/m)	Margin (dB)	Limit (dBuV/m)	Height (cm)	Angle (deg)	Remark (QP/PK/AV)
1	2373.980	14.58	32.15	46.73	-7.27	54.00	170	100	Average
2	* 2390.000	14.76	32.22	46.98	-7.02	54.00	170	100	Average
3	2410.520	60.25	32.30	92.55	N/A	N/A	170	100	Average

Note:

1. " *", means this data is the worst emission level.
2. C.F (Correction Factor) = Antenna Factor (dB/m)+ Cable Loss (dB).
3. Measurement (dBuV/m) = Reading(dBuV) + C.F (Correction Factor).
4. The emission levels of other frequencies are very lower than the limit and not show in test report.

EUT	AP351	Date of Test	2021-05-15
Factor	BBHA 9120D	Temp. / Humidity	25°C /66%
Polarity	Vertical	Site / Test Engineer	AC1 / Kaunaz
Test Mode	802.11n-40MHz_TX_CH 3_ANT 0+1+2+3	Test Voltage	By PoE

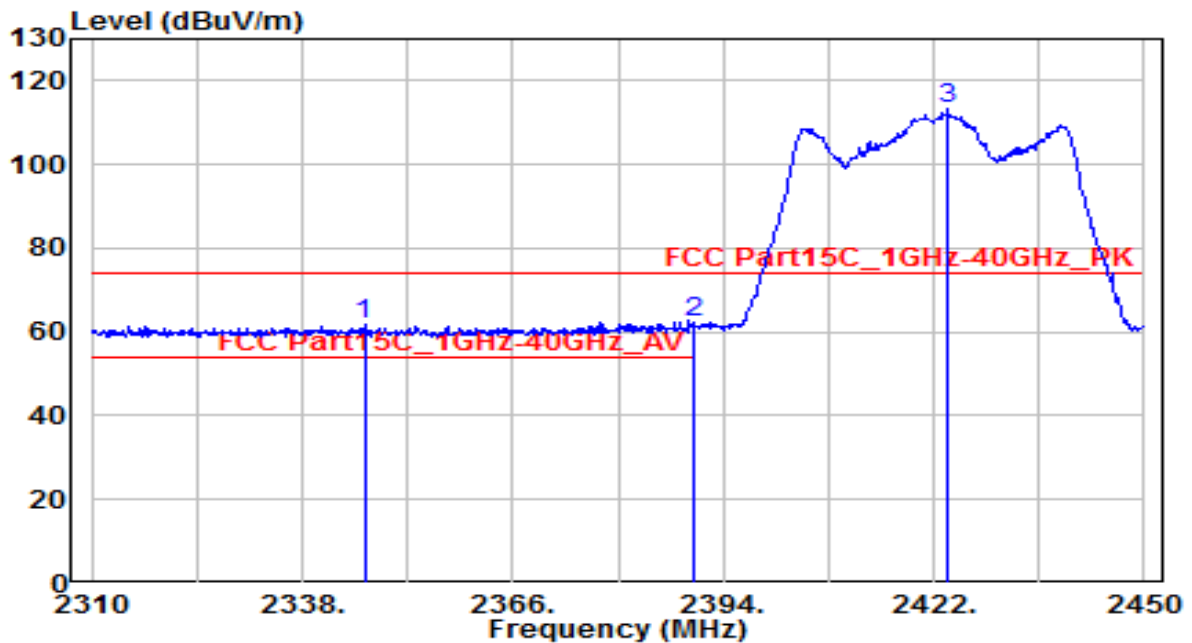

No	Frequency (MHz)	Reading (dBuV)	C.F (dB)	Measurement (dBuV/m)	Margin (dB)	Limit (dBuV/m)	Height (cm)	Angle (deg)	Remark (QP/PK/AV)
1	2346.260	29.83	32.03	61.86	-12.14	74.00	260	85	Peak
2	* 2390.000	29.88	32.22	62.10	-11.90	74.00	260	85	Peak
3	2423.820	81.16	32.36	113.52	N/A	N/A	260	85	Peak

Note:

1. " *", means this data is the worst emission level.
2. C.F (Correction Factor) = Antenna Factor (dB/m)+ Cable Loss (dB).
3. Measurement (dBuV/m) = Reading(dBuV) + C.F (Correction Factor).
4. The emission levels of other frequencies are very lower than the limit and not show in test report.

EUT	AP351	Date of Test	2021-05-15
Factor	BBHA 9120D	Temp. / Humidity	25°C /66%
Polarity	Vertical	Site / Test Engineer	AC1 / Kaunaz
Test Mode	802.11n-40MHz_TX_CH 3_ANT 0+1+2+3	Test Voltage	By PoE

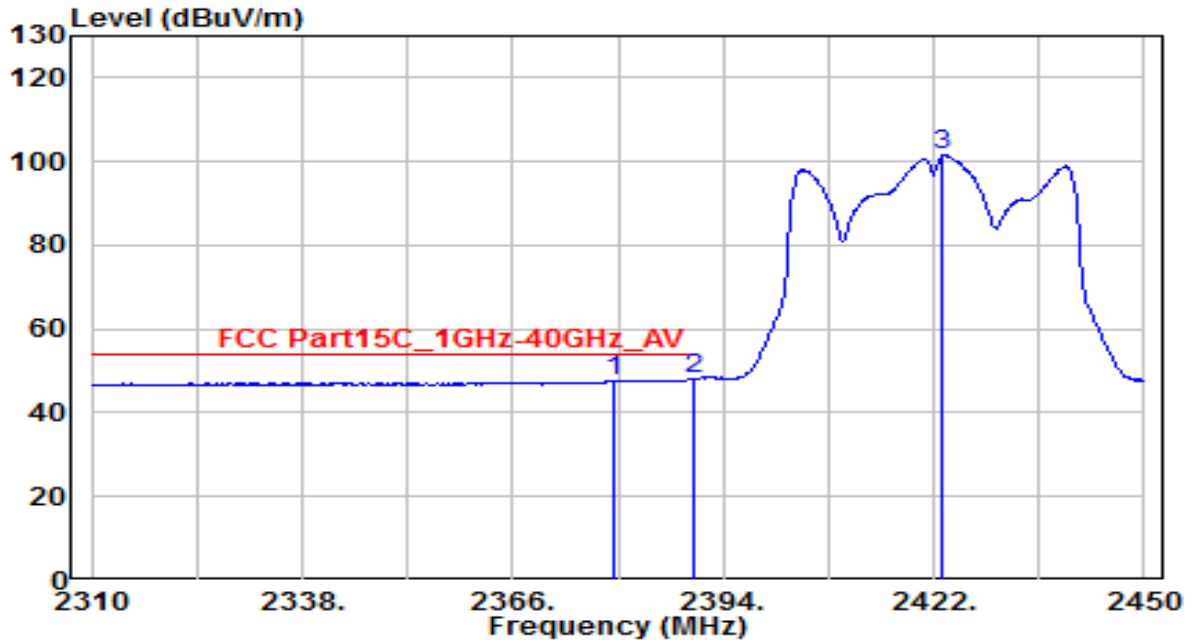

No	Frequency (MHz)	Reading (dBuV)	C.F (dB)	Measurement (dBuV/m)	Margin (dB)	Limit (dBuV/m)	Height (cm)	Angle (deg)	Remark (QP/PK/AV)
1	2379.580	15.43	32.17	47.60	-6.40	54.00	260	85	Average
2	* 2390.000	15.86	32.22	48.08	-5.92	54.00	260	85	Average
3	2423.260	69.07	32.36	101.43	N/A	N/A	260	85	Average

Note:

1. " *", means this data is the worst emission level.
2. C.F (Correction Factor) = Antenna Factor (dB/m)+ Cable Loss (dB).
3. Measurement (dBuV/m) = Reading(dBuV) + C.F (Correction Factor).
4. The emission levels of other frequencies are very lower than the limit and not show in test report.

EUT	AP351	Date of Test	2021-05-15
Factor	BBHA 9120D	Temp. / Humidity	25°C /66%
Polarity	Horizontal	Site / Test Engineer	AC1 / Kaunaz
Test Mode	802.11n-40MHz_TX_CH 9_ANT 0+1+2+3	Test Voltage	By PoE

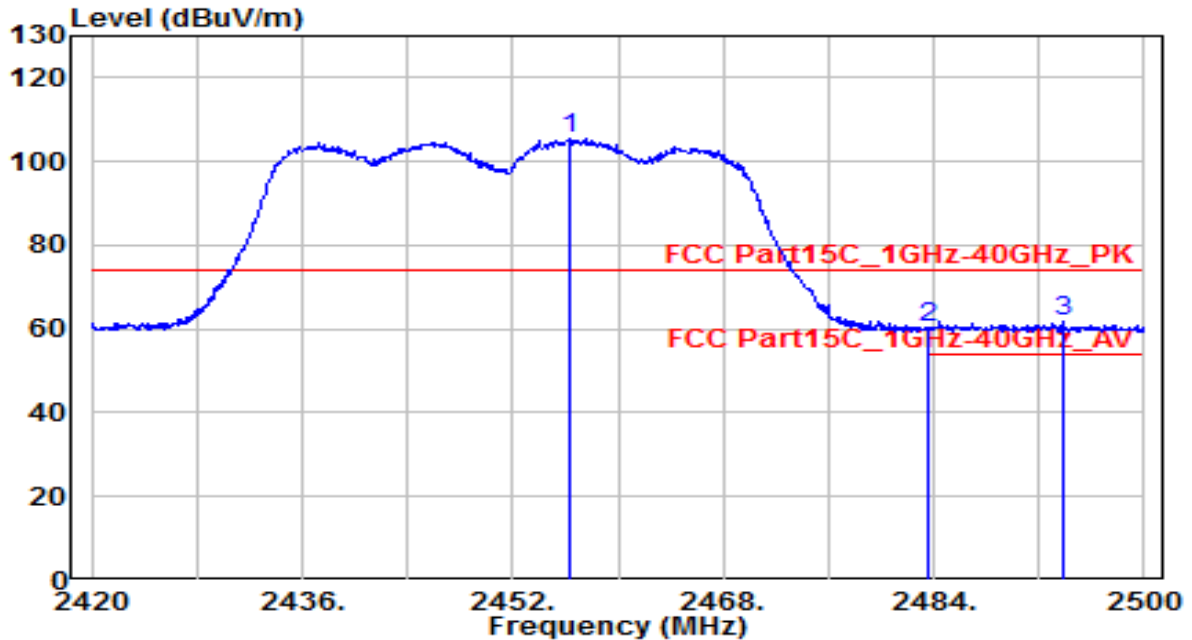

No	Frequency (MHz)	Reading (dBUV)	C.F (dB)	Measurement (dBUV/m)	Margin (dB)	Limit (dBUV/m)	Height (cm)	Angle (deg)	Remark (QP/PK/AV)
1	2456.240	72.79	32.50	105.29	N/A	N/A	170	95	Peak
2	2483.500	27.53	32.61	60.14	-13.86	74.00	170	95	Peak
3	* 2493.760	29.18	32.65	61.83	-12.17	74.00	170	95	Peak

Note:

1. " *", means this data is the worst emission level.
2. C.F (Correction Factor) = Antenna Factor (dB/m)+ Cable Loss (dB).
3. Measurement (dBUV/m) = Reading(dBUV) + C.F (Correction Factor).
4. The emission levels of other frequencies are very lower than the limit and not show in test report.

EUT	AP351	Date of Test	2021-05-15
Factor	BBHA 9120D	Temp. / Humidity	25°C /66%
Polarity	Horizontal	Site / Test Engineer	AC1 / Kaunaz
Test Mode	802.11n-40MHz_TX_CH 9_ANT 0+1+2+3	Test Voltage	By PoE

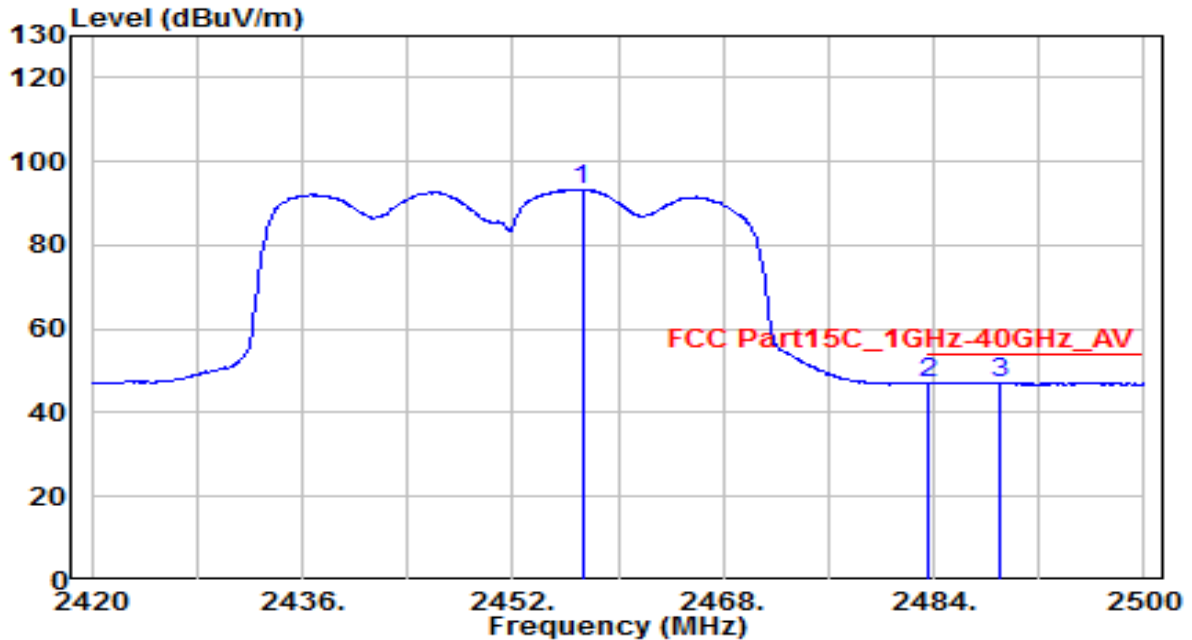

No	Frequency (MHz)	Reading (dBuV)	C.F (dB)	Measurement (dBuV/m)	Margin (dB)	Limit (dBuV/m)	Height (cm)	Angle (deg)	Remark (QP/PK/AV)
1	2457.280	60.95	32.50	93.45	N/A	N/A	170	95	Average
2	2483.500	14.46	32.61	47.07	-6.93	54.00	170	95	Average
3	* 2489.040	14.49	32.63	47.13	-6.87	54.00	170	95	Average

Note:

1. " *", means this data is the worst emission level.
2. C.F (Correction Factor) = Antenna Factor (dB/m)+ Cable Loss (dB).
3. Measurement (dBuV/m) = Reading(dBuV) + C.F (Correction Factor).
4. The emission levels of other frequencies are very lower than the limit and not show in test report.

EUT	AP351	Date of Test	2021-05-15
Factor	BBHA 9120D	Temp. / Humidity	25°C /66%
Polarity	Vertical	Site / Test Engineer	AC1 / Kaunaz
Test Mode	802.11n-40MHz_TX_CH 9_ANT 0+1+2+3	Test Voltage	By PoE

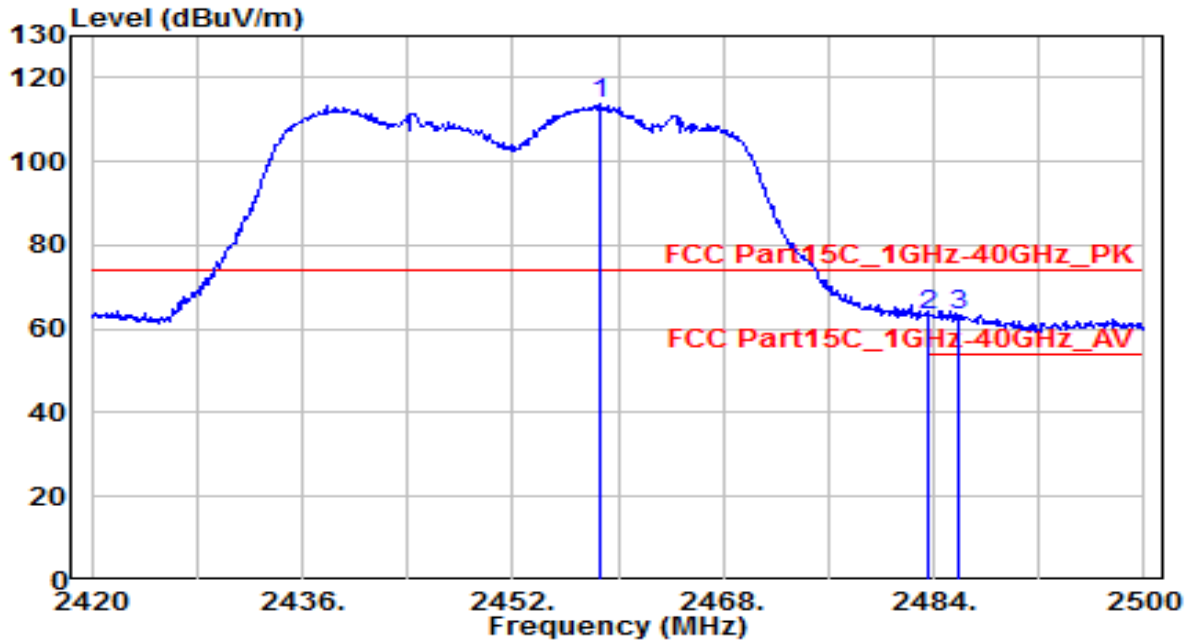

No	Frequency (MHz)	Reading (dBuV)	C.F (dB)	Measurement (dBuV/m)	Margin (dB)	Limit (dBuV/m)	Height (cm)	Angle (deg)	Remark (QP/PK/AV)
1	2458.560	81.24	32.51	113.74	N/A	N/A	230	80	Peak
2	2483.500	30.49	32.61	63.10	-10.90	74.00	230	80	Peak
3	* 2485.920	30.87	32.62	63.50	-10.50	74.00	230	80	Peak

Note:

1. " *", means this data is the worst emission level.
2. C.F (Correction Factor) = Antenna Factor (dB/m)+ Cable Loss (dB).
3. Measurement (dBuV/m) = Reading(dBuV) + C.F (Correction Factor).
4. The emission levels of other frequencies are very lower than the limit and not show in test report.

EUT	AP351	Date of Test	2021-05-15
Factor	BBHA 9120D	Temp. / Humidity	25°C /66%
Polarity	Vertical	Site / Test Engineer	AC1 / Kaunaz
Test Mode	802.11n-40MHz_TX_CH 9_ANT 0+1+2+3	Test Voltage	By PoE

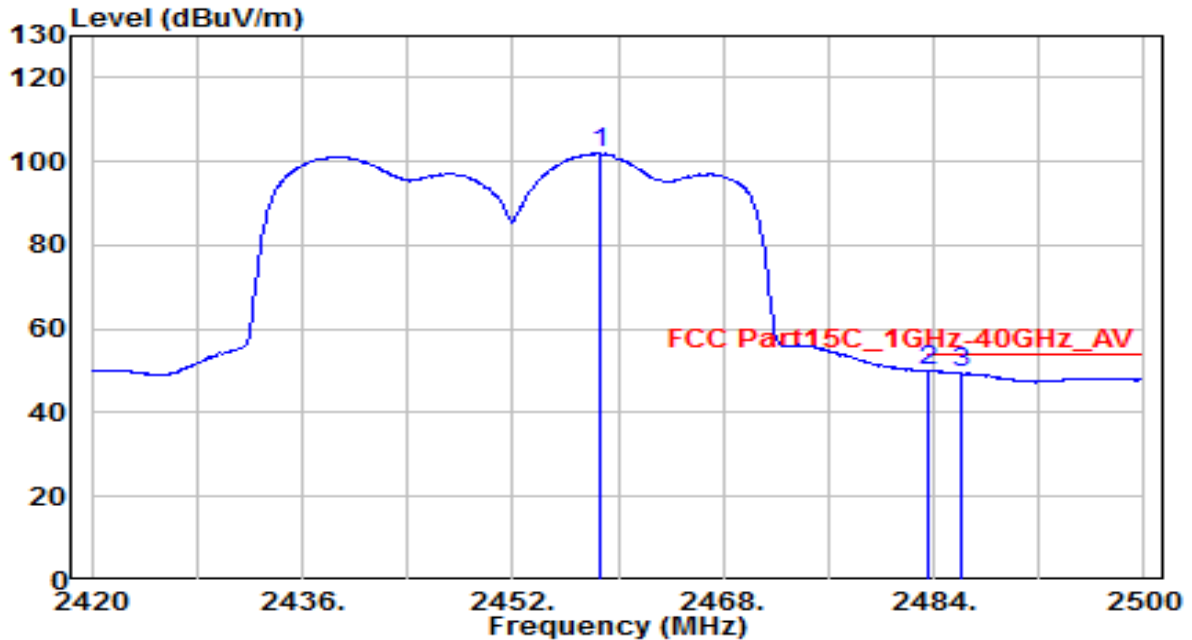

No	Frequency (MHz)	Reading (dBuV)	C.F (dB)	Measurement (dBuV/m)	Margin (dB)	Limit (dBuV/m)	Height (cm)	Angle (deg)	Remark (QP/PK/AV)
1	2458.560	69.42	32.51	101.92	N/A	N/A	230	80	Average
2	* 2483.500	17.41	32.61	50.02	-3.98	54.00	230	80	Average
3	2486.080	16.97	32.62	49.59	-4.41	54.00	230	80	Average

Note:

1. " *", means this data is the worst emission level.
2. C.F (Correction Factor) = Antenna Factor (dB/m)+ Cable Loss (dB).
3. Measurement (dBuV/m) = Reading(dBuV) + C.F (Correction Factor).
4. The emission levels of other frequencies are very lower than the limit and not show in test report.

EUT	AP351	Date of Test	2021-05-15
Factor	BBHA 9120D	Temp. / Humidity	25°C /66%
Polarity	Horizontal	Site / Test Engineer	AC1 / Kaunaz
Test Mode	802.11ax-20MHz_TX_CH 1_ANT 0+1+2+3	Test Voltage	By PoE

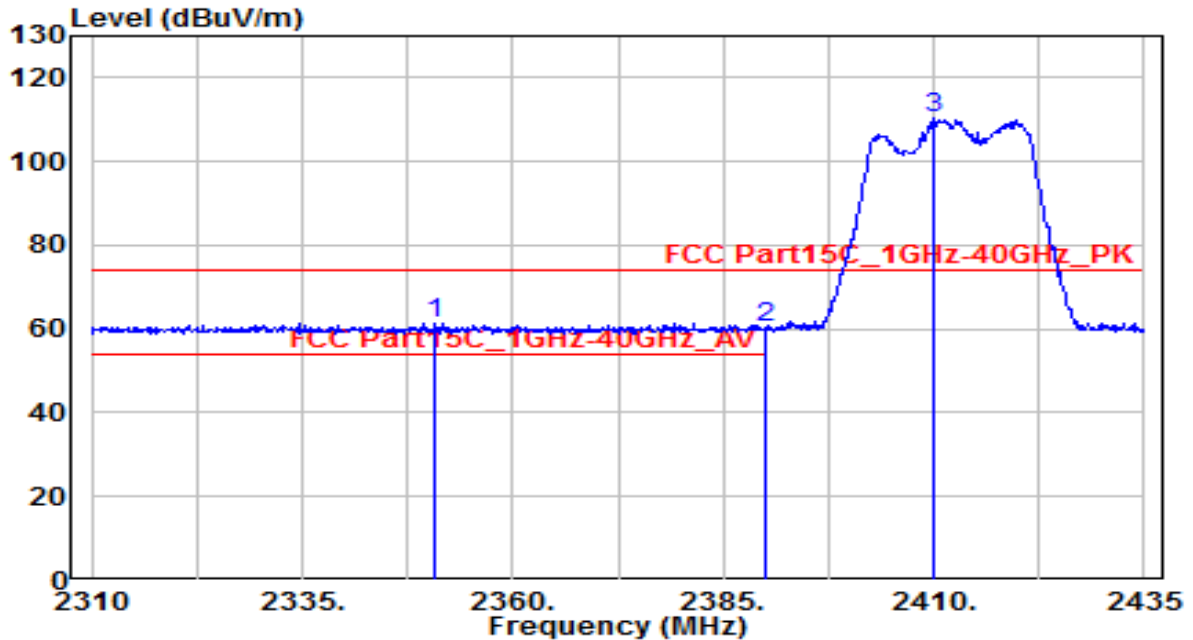

No	Frequency (MHz)	Reading (dBUV)	C.F (dB)	Measurement (dBUV/m)	Margin (dB)	Limit (dBUV/m)	Height (cm)	Angle (deg)	Remark (QP/PK/AV)
1	* 2350.875	29.20	32.05	61.25	-12.75	74.00	170	100	Peak
2	2390.000	27.95	32.22	60.17	-13.83	74.00	170	100	Peak
3	2410.125	77.98	32.30	110.28	N/A	N/A	170	100	Peak

Note:

1. " *", means this data is the worst emission level.
2. C.F (Correction Factor) = Antenna Factor (dB/m)+ Cable Loss (dB).
3. Measurement (dBUV/m) = Reading(dBUV) + C.F (Correction Factor).
4. The emission levels of other frequencies are very lower than the limit and not show in test report.

EUT	AP351	Date of Test	2021-05-15
Factor	BBHA 9120D	Temp. / Humidity	25°C /66%
Polarity	Horizontal	Site / Test Engineer	AC1 / Kaunaz
Test Mode	802.11ax-20MHz_TX_CH 1_ANT 0+1+2+3	Test Voltage	By PoE

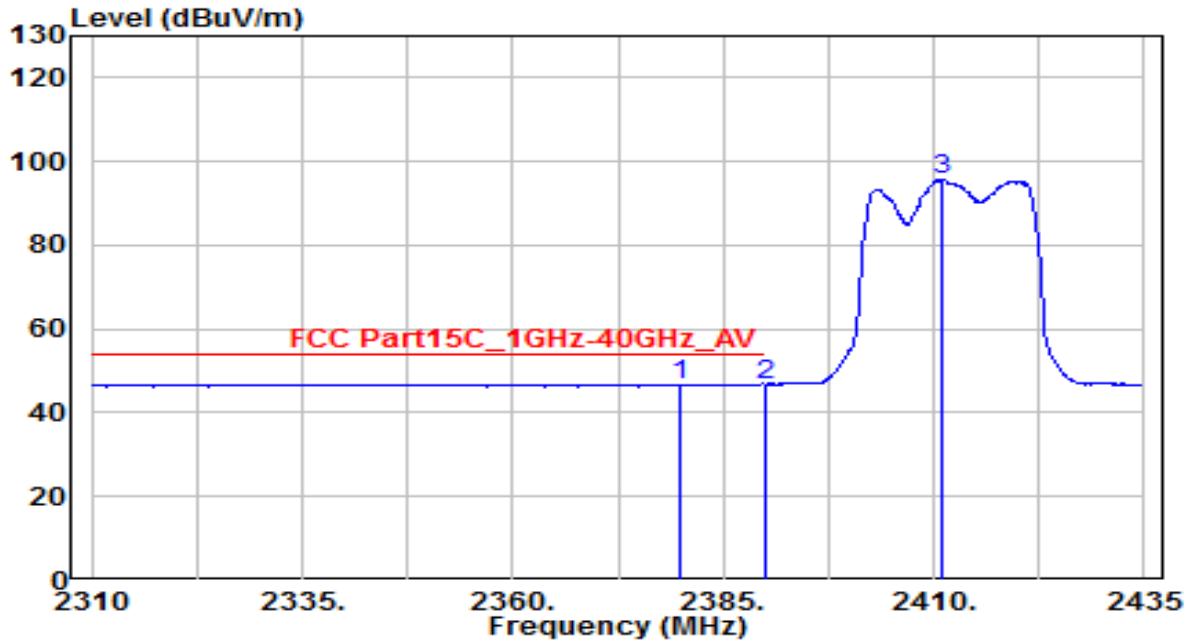

No	Frequency (MHz)	Reading (dBuV)	C.F (dB)	Measurement (dBuV/m)	Margin (dB)	Limit (dBuV/m)	Height (cm)	Angle (deg)	Remark (QP/PK/AV)
1	2379.750	14.52	32.17	46.69	-7.31	54.00	170	100	Average
2	* 2390.000	14.61	32.22	46.83	-7.17	54.00	170	100	Average
3	2410.875	63.39	32.31	95.70	N/A	N/A	170	100	Average

Note:

1. " *", means this data is the worst emission level.
2. C.F (Correction Factor) = Antenna Factor (dB/m)+ Cable Loss (dB).
3. Measurement (dBuV/m) = Reading(dBuV) + C.F (Correction Factor).
4. The emission levels of other frequencies are very lower than the limit and not show in test report.

EUT	AP351	Date of Test	2021-05-15
Factor	BBHA 9120D	Temp. / Humidity	25°C /66%
Polarity	Vertical	Site / Test Engineer	AC1 / Kaunaz
Test Mode	802.11ax-20MHz_TX_CH 1_ANT 0+1+2+3	Test Voltage	By PoE

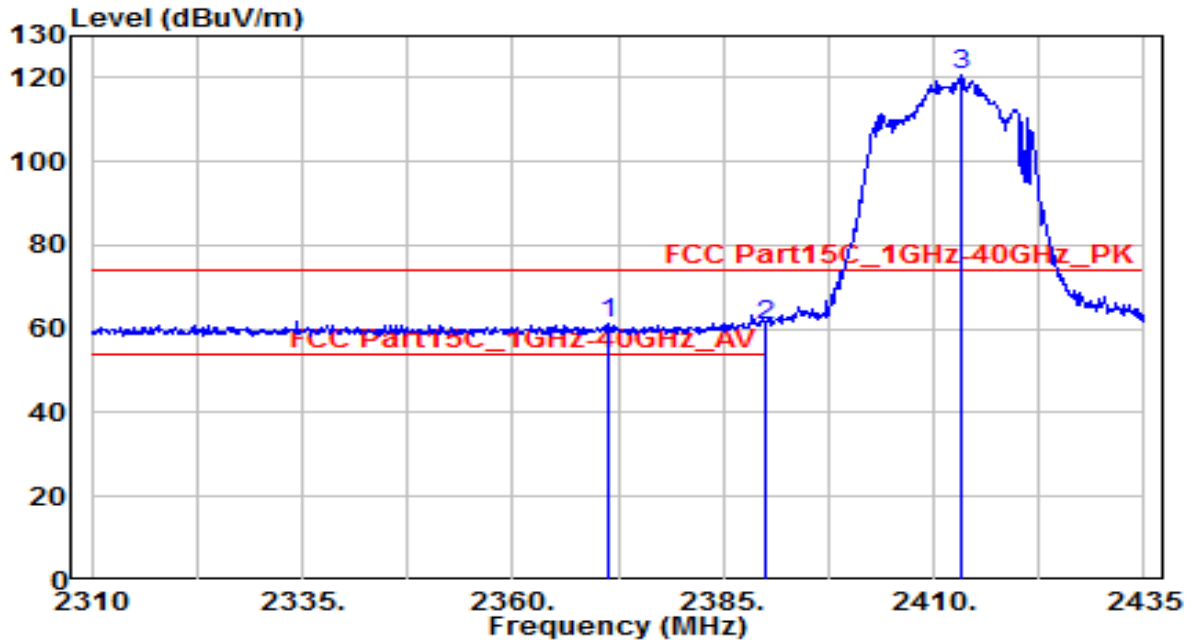

No	Frequency (MHz)	Reading (dBuV)	C.F (dB)	Measurement (dBuV/m)	Margin (dB)	Limit (dBuV/m)	Height (cm)	Angle (deg)	Remark (QP/PK/AV)
1	* 2371.375	28.96	32.14	61.10	-12.90	74.00	260	85	Peak
2	2390.000	28.64	32.22	60.86	-13.14	74.00	260	85	Peak
3	2413.125	88.20	32.32	120.52	N/A	N/A	260	85	Peak

Note:

1. " *", means this data is the worst emission level.
2. C.F (Correction Factor) = Antenna Factor (dB/m)+ Cable Loss (dB).
3. Measurement (dBuV/m) = Reading(dBuV) + C.F (Correction Factor).
4. The emission levels of other frequencies are very lower than the limit and not show in test report.

EUT	AP351	Date of Test	2021-05-15
Factor	BBHA 9120D	Temp. / Humidity	25°C /66%
Polarity	Vertical	Site / Test Engineer	AC1 / Kaunaz
Test Mode	802.11ax-20MHz_TX_CH 1_ANT 0+1+2+3	Test Voltage	By PoE

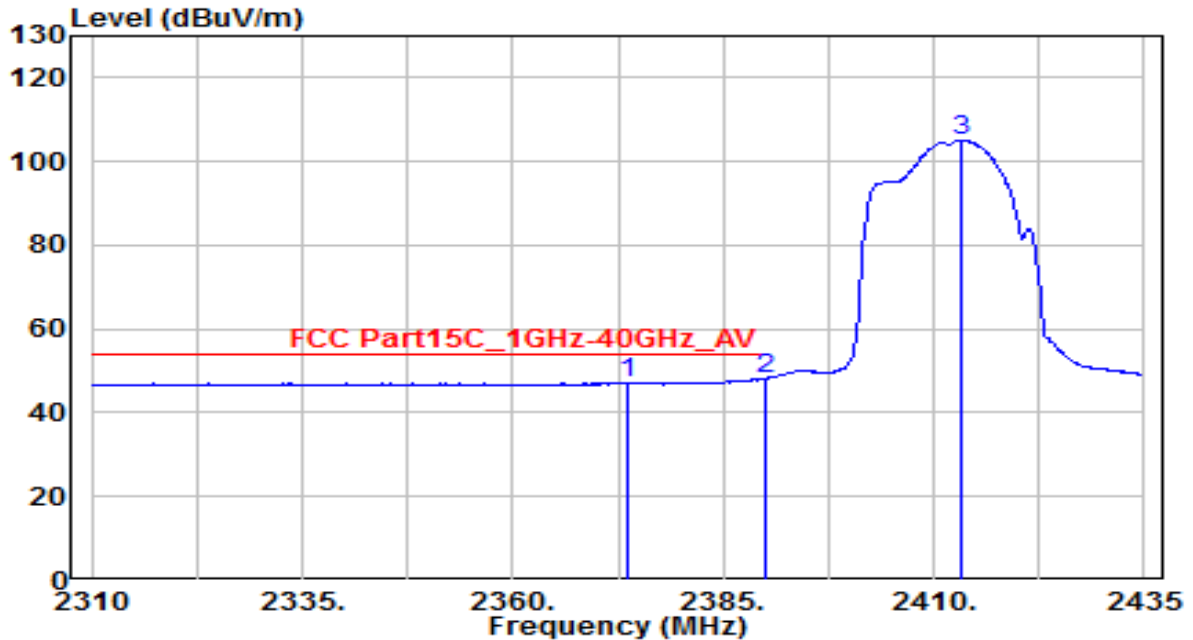

No	Frequency (MHz)	Reading (dBuV)	C.F (dB)	Measurement (dBuV/m)	Margin (dB)	Limit (dBuV/m)	Height (cm)	Angle (deg)	Remark (QP/PK/AV)
1	2373.500	15.04	32.15	47.19	-6.81	54.00	260	85	Average
2	* 2390.000	15.96	32.22	48.18	-5.82	54.00	260	85	Average
3	2413.250	72.89	32.32	105.21	N/A	N/A	260	85	Average

Note:

1. " *", means this data is the worst emission level.
2. C.F (Correction Factor) = Antenna Factor (dB/m)+ Cable Loss (dB).
3. Measurement (dBuV/m) = Reading(dBuV) + C.F (Correction Factor).
4. The emission levels of other frequencies are very lower than the limit and not show in test report.

EUT	AP351	Date of Test	2021-05-15
Factor	BBHA 9120D	Temp. / Humidity	25°C /66%
Polarity	Horizontal	Site / Test Engineer	AC1 / Kaunaz
Test Mode	802.11ax-20MHz_TX_CH 11_ANT 0+1+2+3	Test Voltage	By PoE

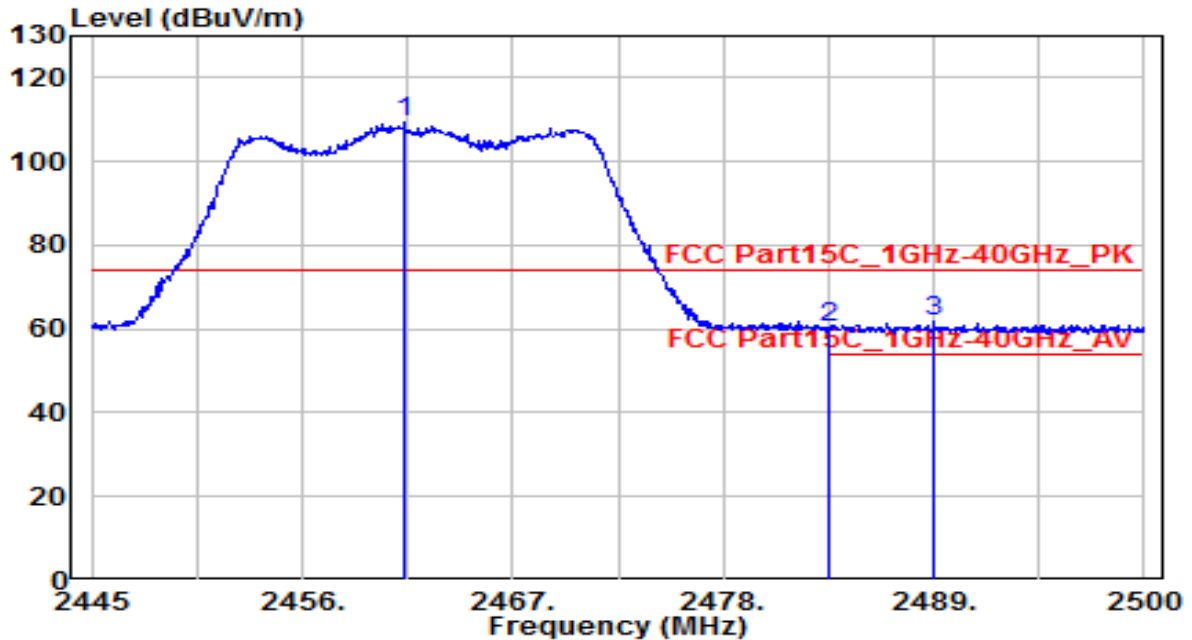

No	Frequency (MHz)	Reading (dBuV)	C.F (dB)	Measurement (dBuV/m)	Margin (dB)	Limit (dBuV/m)	Height (cm)	Angle (deg)	Remark (QP/PK/AV)
1	2461.335	76.67	32.52	109.19	N/A	N/A	170	95	Peak
2	2483.500	27.61	32.61	60.22	-13.78	74.00	170	95	Peak
3	* 2489.055	29.11	32.63	61.74	-12.26	74.00	170	95	Peak

Note:

1. " *", means this data is the worst emission level.
2. C.F (Correction Factor) = Antenna Factor (dB/m)+ Cable Loss (dB).
3. Measurement (dBuV/m) = Reading(dBuV) + C.F (Correction Factor).
4. The emission levels of other frequencies are very lower than the limit and not show in test report.

EUT	AP351	Date of Test	2021-05-15
Factor	BBHA 9120D	Temp. / Humidity	25°C /66%
Polarity	Horizontal	Site / Test Engineer	AC1 / Kaunaz
Test Mode	802.11ax-20MHz_TX_CH 11_ANT 0+1+2+3	Test Voltage	By PoE

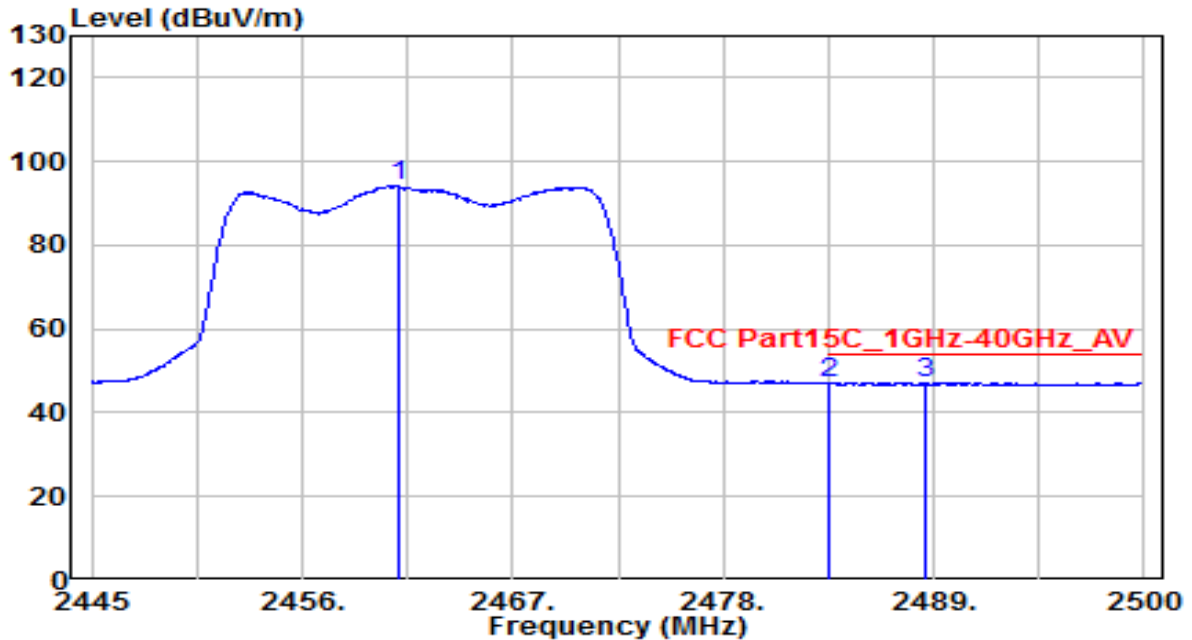

No	Frequency (MHz)	Reading (dBuV)	C.F (dB)	Measurement (dBuV/m)	Margin (dB)	Limit (dBuV/m)	Height (cm)	Angle (deg)	Remark (QP/PK/AV)
1	2461.005	61.71	32.52	94.22	N/A	N/A	170	95	Average
2	2483.500	14.40	32.61	47.01	-6.99	54.00	170	95	Average
3	* 2488.505	14.40	32.63	47.03	-6.97	54.00	170	95	Average

Note:

1. " *", means this data is the worst emission level.
2. C.F (Correction Factor) = Antenna Factor (dB/m)+ Cable Loss (dB).
3. Measurement (dBuV/m) = Reading(dBuV) + C.F (Correction Factor).
4. The emission levels of other frequencies are very lower than the limit and not show in test report.

EUT	AP351	Date of Test	2021-05-15
Factor	BBHA 9120D	Temp. / Humidity	25°C /66%
Polarity	Vertical	Site / Test Engineer	AC1 / Kaunaz
Test Mode	802.11ax-20MHz_TX_CH 11_ANT 0+1+2+3	Test Voltage	By PoE

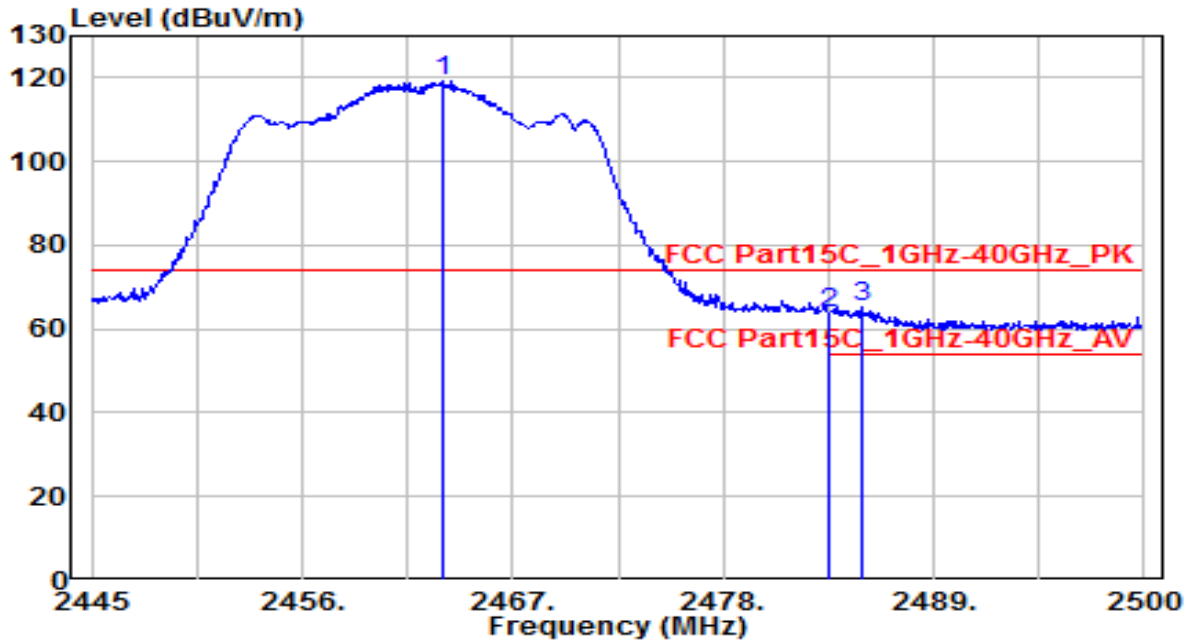

No	Frequency (MHz)	Reading (dBuV)	C.F (dB)	Measurement (dBuV/m)	Margin (dB)	Limit (dBuV/m)	Height (cm)	Angle (deg)	Remark (QP/PK/AV)
1	2463.315	86.74	32.53	119.27	N/A	N/A	230	80	Peak
2	2483.500	31.38	32.61	63.99	-10.01	74.00	230	80	Peak
3	* 2485.205	32.48	32.62	65.10	-8.90	74.00	230	80	Peak

Note:

1. " *", means this data is the worst emission level.
2. C.F (Correction Factor) = Antenna Factor (dB/m)+ Cable Loss (dB).
3. Measurement (dBuV/m) = Reading(dBuV) + C.F (Correction Factor).
4. The emission levels of other frequencies are very lower than the limit and not show in test report.

EUT	AP351	Date of Test	2021-05-15
Factor	BBHA 9120D	Temp. / Humidity	25°C /66%
Polarity	Vertical	Site / Test Engineer	AC1 / Kaunaz
Test Mode	802.11ax-20MHz_TX_CH 11_ANT 0+1+2+3	Test Voltage	By PoE

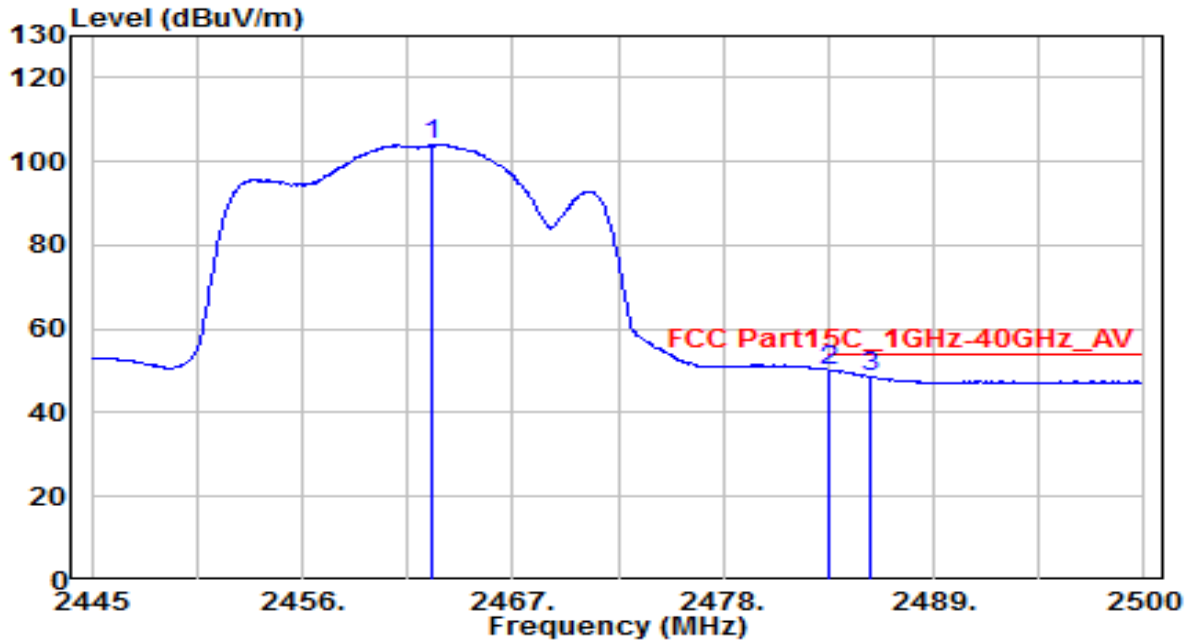

No	Frequency (MHz)	Reading (dBUV)	C.F (dB)	Measurement (dBUV/m)	Margin (dB)	Limit (dBUV/m)	Height (cm)	Angle (deg)	Remark (QP/PK/AV)
1	2462.765	71.48	32.52	104.00	N/A	N/A	230	80	Average
2	* 2483.500	17.58	32.61	50.19	-3.81	54.00	230	80	Average
3	2485.755	15.97	32.62	48.59	-5.41	54.00	230	80	Average

Note:

1. " *", means this data is the worst emission level.
2. C.F (Correction Factor) = Antenna Factor (dB/m)+ Cable Loss (dB).
3. Measurement (dBUV/m) = Reading(dBUV) + C.F (Correction Factor).
4. The emission levels of other frequencies are very lower than the limit and not show in test report.

EUT	AP351	Date of Test	2021-05-15
Factor	BBHA 9120D	Temp. / Humidity	25°C /66%
Polarity	Horizontal	Site / Test Engineer	AC1 / Kaunaz
Test Mode	802.11ax-40MHz_TX_CH 3_ANT 0+1+2+3	Test Voltage	By PoE

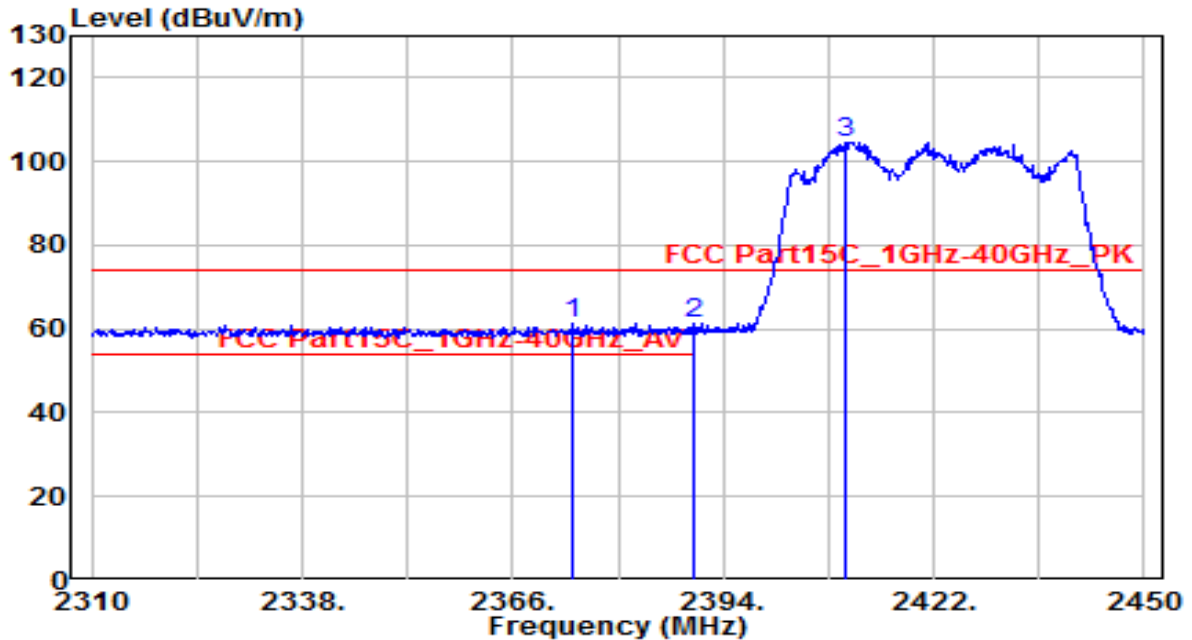

No	Frequency (MHz)	Reading (dBUV)	C.F (dB)	Measurement (dBUV/m)	Margin (dB)	Limit (dBUV/m)	Height (cm)	Angle (deg)	Remark (QP/PK/AV)
1	2374.120	28.96	32.15	61.11	-12.89	74.00	170	100	Peak
2	* 2390.000	28.98	32.22	61.20	-12.80	74.00	170	100	Peak
3	2410.240	72.33	32.30	104.63	N/A	N/A	170	100	Peak

Note:

1. " *", means this data is the worst emission level.
2. C.F (Correction Factor) = Antenna Factor (dB/m)+ Cable Loss (dB).
3. Measurement (dBUV/m) = Reading(dBUV) + C.F (Correction Factor).
4. The emission levels of other frequencies are very lower than the limit and not show in test report.

EUT	AP351	Date of Test	2021-05-15
Factor	BBHA 9120D	Temp. / Humidity	25°C /66%
Polarity	Horizontal	Site / Test Engineer	AC1 / Kaunaz
Test Mode	802.11ax-40MHz_TX_CH 3_ANT 0+1+2+3	Test Voltage	By PoE

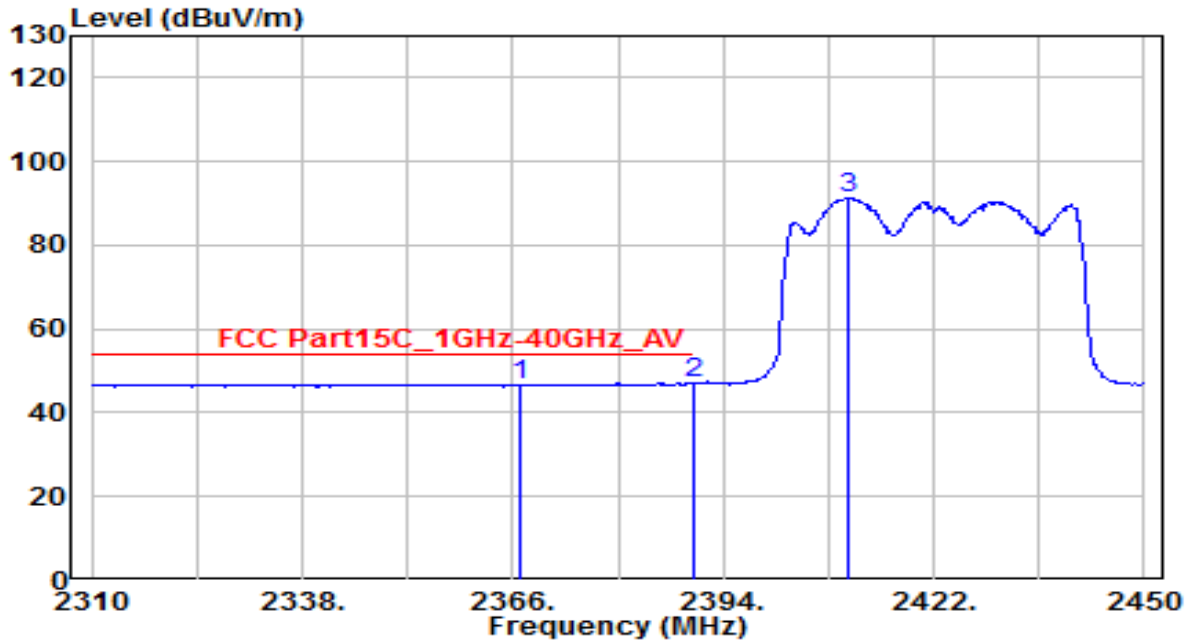

No	Frequency (MHz)	Reading (dBuV)	C.F (dB)	Measurement (dBuV/m)	Margin (dB)	Limit (dBuV/m)	Height (cm)	Angle (deg)	Remark (QP/PK/AV)
1	2366.980	14.56	32.12	46.68	-7.32	54.00	170	100	Average
2	* 2390.000	14.75	32.22	46.97	-7.03	54.00	170	100	Average
3	2410.520	59.02	32.30	91.32	N/A	N/A	170	100	Average

Note:

1. " *", means this data is the worst emission level.
2. C.F (Correction Factor) = Antenna Factor (dB/m)+ Cable Loss (dB).
3. Measurement (dBuV/m) = Reading(dBuV) + C.F (Correction Factor).
4. The emission levels of other frequencies are very lower than the limit and not show in test report.

EUT	AP351	Date of Test	2021-05-15
Factor	BBHA 9120D	Temp. / Humidity	25°C /66%
Polarity	Vertical	Site / Test Engineer	AC1 / Kaunaz
Test Mode	802.11ax-40MHz_TX_CH 3_ANT 0+1+2+3	Test Voltage	By PoE

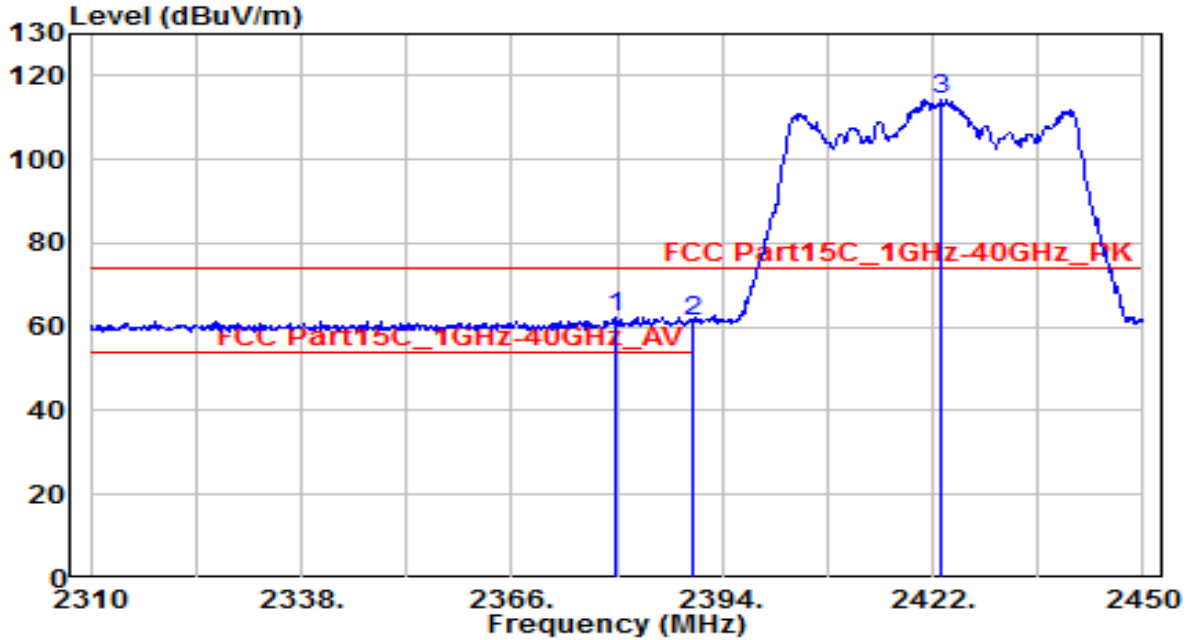

No	Frequency (MHz)	Reading (dBuV)	C.F (dB)	Measurement (dBuV/m)	Margin (dB)	Limit (dBuV/m)	Height (cm)	Angle (deg)	Remark (QP/PK/AV)
1	* 2379.720	30.18	32.17	62.35	-11.65	74.00	260	85	Peak
2	2390.000	29.03	32.22	61.25	-12.75	74.00	260	85	Peak
3	2423.120	82.07	32.36	114.43	N/A	N/A	260	85	Peak

Note:

1. " *", means this data is the worst emission level.
2. C.F (Correction Factor) = Antenna Factor (dB/m)+ Cable Loss (dB).
3. Measurement (dBuV/m) = Reading(dBuV) + C.F (Correction Factor).
4. The emission levels of other frequencies are very lower than the limit and not show in test report.

EUT	AP351	Date of Test	2021-05-15
Factor	BBHA 9120D	Temp. / Humidity	25°C /66%
Polarity	Vertical	Site / Test Engineer	AC1 / Kaunaz
Test Mode	802.11ax-40MHz_TX_CH 3_ANT 0+1+2+3	Test Voltage	By PoE

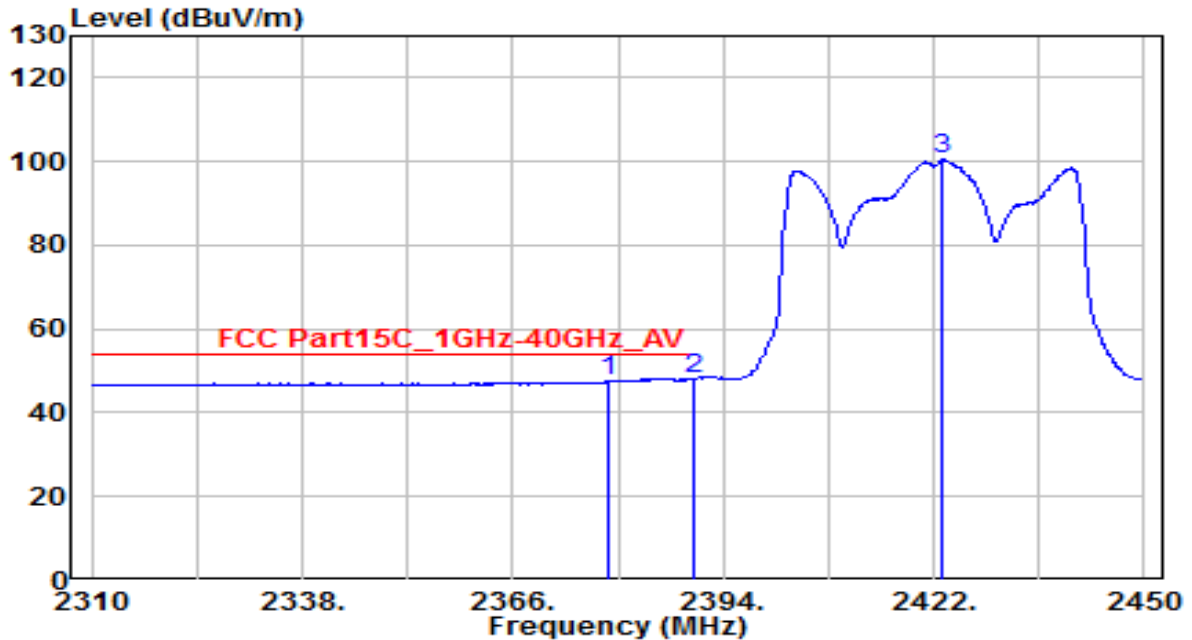

No	Frequency (MHz)	Reading (dBuV)	C.F (dB)	Measurement (dBuV/m)	Margin (dB)	Limit (dBuV/m)	Height (cm)	Angle (deg)	Remark (QP/PK/AV)
1	2378.600	15.34	32.17	47.51	-6.49	54.00	260	85	Average
2	* 2390.000	15.95	32.22	48.16	-5.84	54.00	260	85	Average
3	2423.260	68.07	32.36	100.42	N/A	N/A	260	85	Average

Note:

1. " *", means this data is the worst emission level.
2. C.F (Correction Factor) = Antenna Factor (dB/m)+ Cable Loss (dB).
3. Measurement (dBuV/m) = Reading(dBuV) + C.F (Correction Factor).
4. The emission levels of other frequencies are very lower than the limit and not show in test report.

EUT	AP351	Date of Test	2021-05-15
Factor	BBHA 9120D	Temp. / Humidity	25°C /66%
Polarity	Horizontal	Site / Test Engineer	AC1 / Kaunaz
Test Mode	802.11ax-40MHz_TX_CH 9_ANT 0+1+2+3	Test Voltage	By PoE

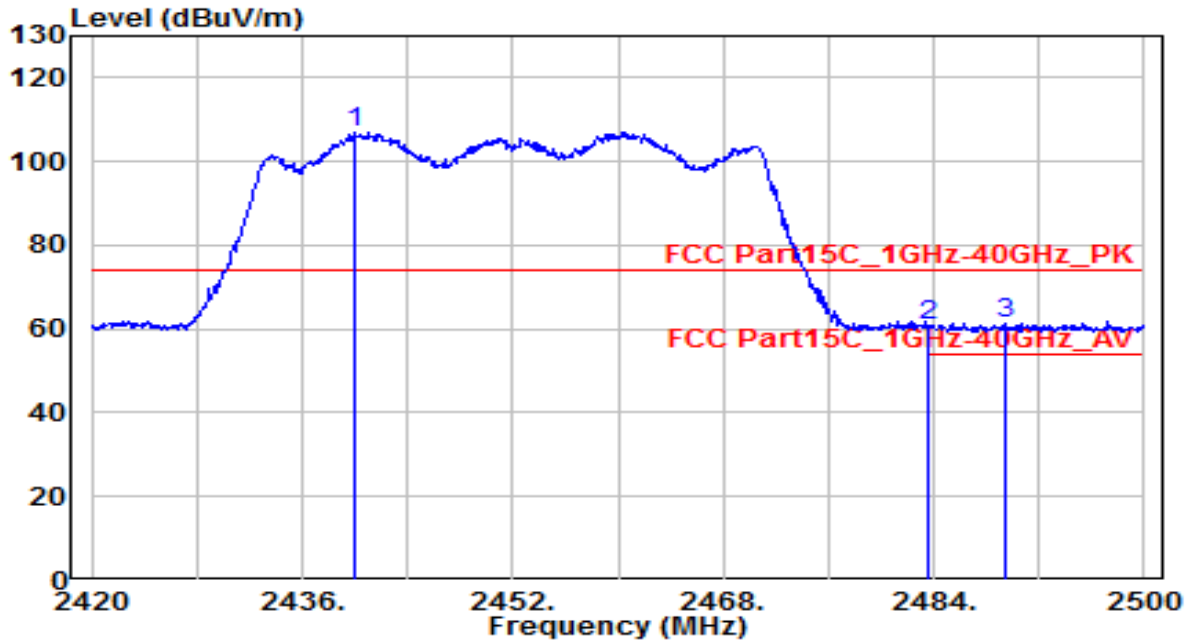

No	Frequency (MHz)	Reading (dBuV)	C.F (dB)	Measurement (dBuV/m)	Margin (dB)	Limit (dBuV/m)	Height (cm)	Angle (deg)	Remark (QP/PK/AV)
1	2440.000	74.47	32.43	106.90	N/A	N/A	170	95	Peak
2	2483.500	28.03	32.61	60.64	-13.36	74.00	170	95	Peak
3	* 2489.440	28.60	32.64	61.24	-12.76	74.00	170	95	Peak

Note:

1. " *", means this data is the worst emission level.
2. C.F (Correction Factor) = Antenna Factor (dB/m)+ Cable Loss (dB).
3. Measurement (dBuV/m) = Reading(dBuV) + C.F (Correction Factor).
4. The emission levels of other frequencies are very lower than the limit and not show in test report.

EUT	AP351	Date of Test	2021-05-15
Factor	BBHA 9120D	Temp. / Humidity	25°C /66%
Polarity	Horizontal	Site / Test Engineer	AC1 / Kaunaz
Test Mode	802.11ax-40MHz_TX_CH 9_ANT 0+1+2+3	Test Voltage	By PoE

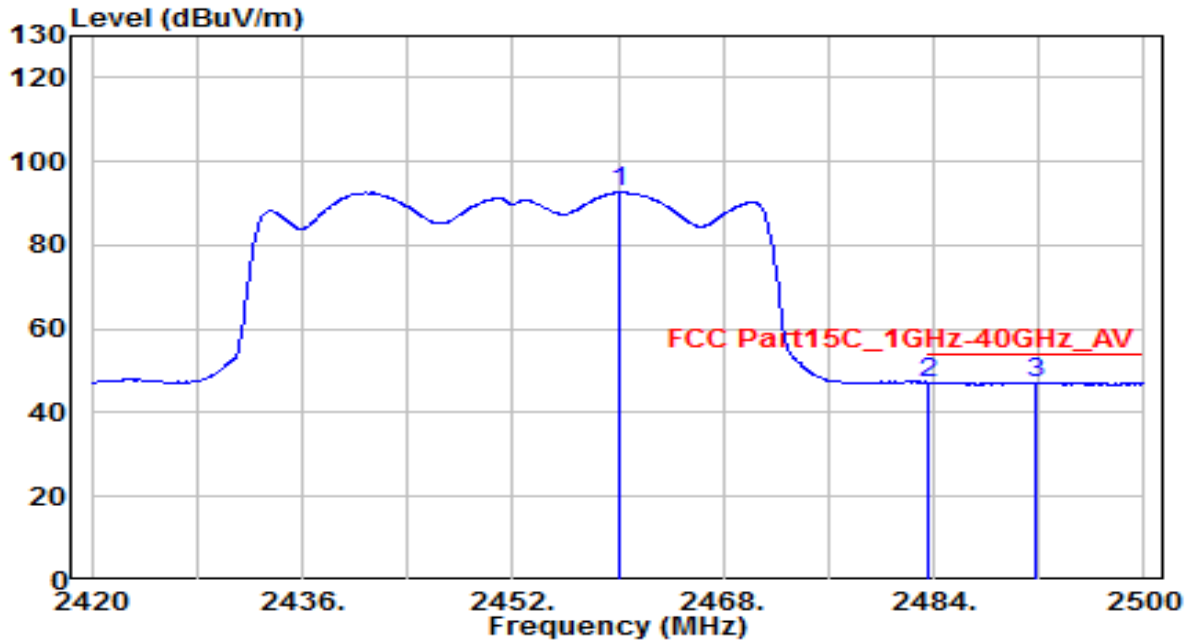

No	Frequency (MHz)	Reading (dBuV)	C.F (dB)	Measurement (dBuV/m)	Margin (dB)	Limit (dBuV/m)	Height (cm)	Angle (deg)	Remark (QP/PK/AV)
1	2460.160	60.15	32.51	92.66	N/A	N/A	170	95	Average
2	* 2483.500	14.71	32.61	47.32	-6.68	54.00	170	95	Average
3	2491.680	14.47	32.65	47.11	-6.89	54.00	170	95	Average

Note:

1. " *", means this data is the worst emission level.
2. C.F (Correction Factor) = Antenna Factor (dB/m)+ Cable Loss (dB).
3. Measurement (dBuV/m) = Reading(dBuV) + C.F (Correction Factor).
4. The emission levels of other frequencies are very lower than the limit and not show in test report.

EUT	AP351	Date of Test	2021-05-15
Factor	BBHA 9120D	Temp. / Humidity	25°C /66%
Polarity	Vertical	Site / Test Engineer	AC1 / Kaunaz
Test Mode	802.11ax-40MHz_TX_CH 9_ANT 0+1+2+3	Test Voltage	By PoE

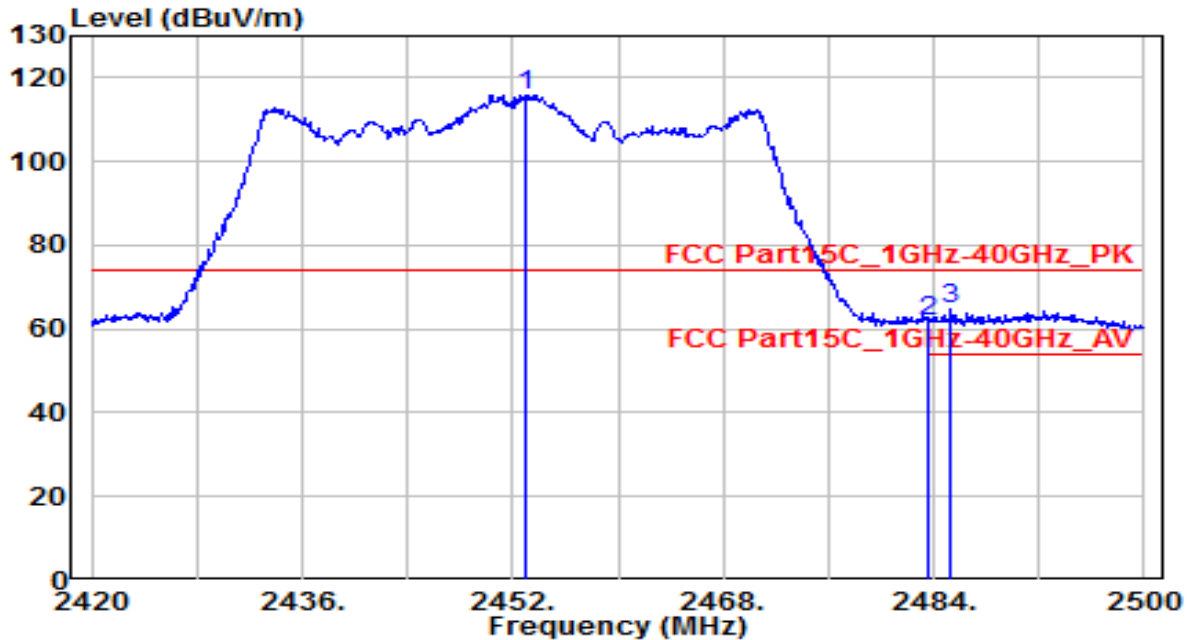

No	Frequency (MHz)	Reading (dBuV)	C.F (dB)	Measurement (dBuV/m)	Margin (dB)	Limit (dBuV/m)	Height (cm)	Angle (deg)	Remark (QP/PK/AV)
1	2452.960	83.47	32.48	115.95	N/A	N/A	230	80	Peak
2	2483.500	29.31	32.61	61.92	-12.08	74.00	230	80	Peak
3	* 2485.280	32.16	32.62	64.78	-9.22	74.00	230	80	Peak

Note:

1. " *", means this data is the worst emission level.
2. C.F (Correction Factor) = Antenna Factor (dB/m)+ Cable Loss (dB).
3. Measurement (dBuV/m) = Reading(dBuV) + C.F (Correction Factor).
4. The emission levels of other frequencies are very lower than the limit and not show in test report.

EUT	AP351	Date of Test	2021-05-15
Factor	BBHA 9120D	Temp. / Humidity	25°C /66%
Polarity	Vertical	Site / Test Engineer	AC1 / Kaunaz
Test Mode	802.11ax-40MHz_TX_CH 9_ANT 0+1+2+3	Test Voltage	By PoE

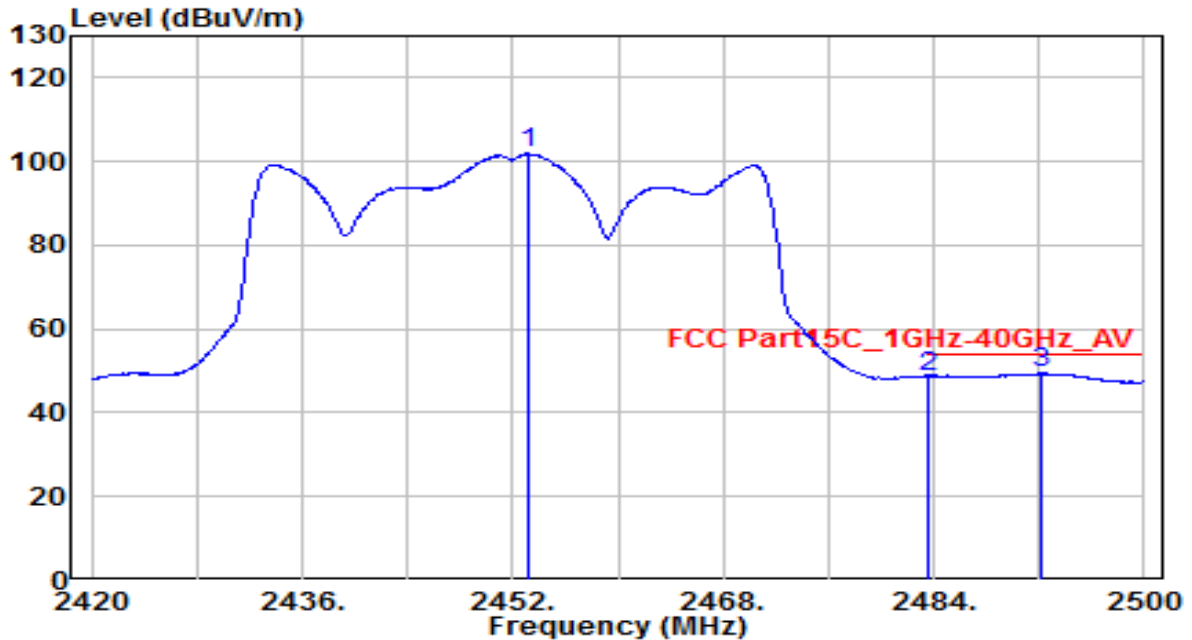

No	Frequency (MHz)	Reading (dBuV)	C.F (dB)	Measurement (dBuV/m)	Margin (dB)	Limit (dBuV/m)	Height (cm)	Angle (deg)	Remark (QP/PK/AV)
1	2453.280	69.37	32.48	101.85	N/A	N/A	230	80	Average
2	2483.500	16.15	32.61	48.76	-5.24	54.00	230	80	Average
3	* 2492.080	16.79	32.65	49.43	-4.57	54.00	230	80	Average

Note:

1. " *", means this data is the worst emission level.
2. C.F (Correction Factor) = Antenna Factor (dB/m)+ Cable Loss (dB).
3. Measurement (dBuV/m) = Reading(dBuV) + C.F (Correction Factor).
4. The emission levels of other frequencies are very lower than the limit and not show in test report.

EUT	AP351	Date of Test	2021-05-22
Factor	BBHA 9120D	Temp. / Humidity	25°C /66%
Polarity	Horizontal	Site / Test Engineer	AC1 / Jay
Test Mode	802.11b_TX_CH 1_SCAN ANT 0	Test Voltage	By PoE

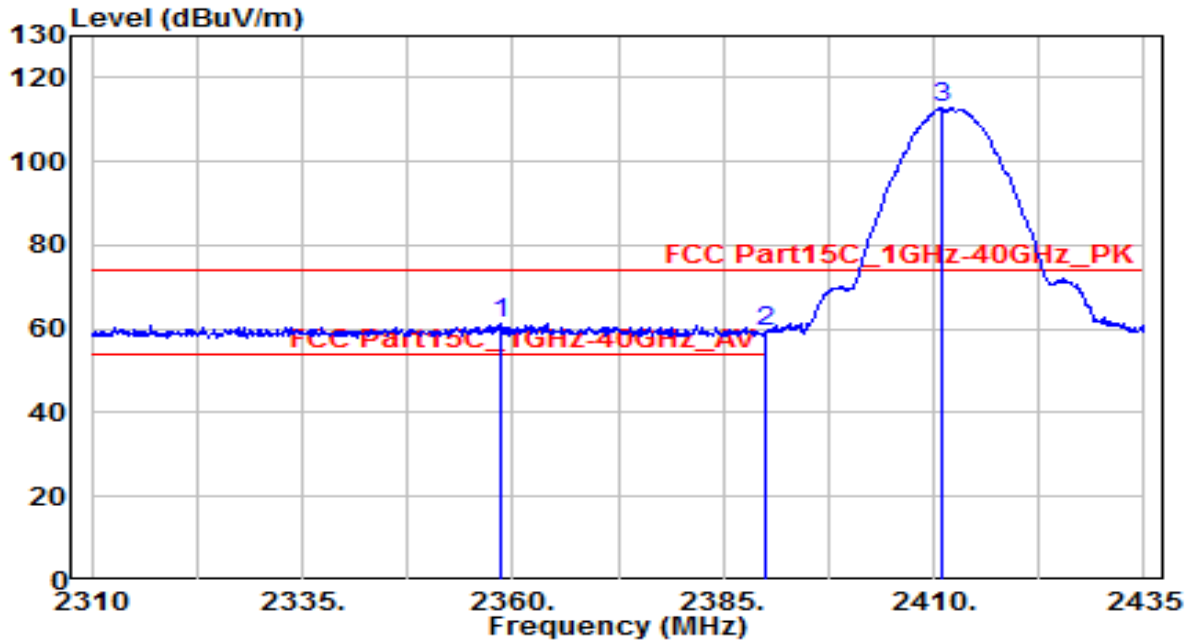

No	Frequency (MHz)	Reading (dBuV)	C.F (dB)	Measurement (dBuV/m)	Margin (dB)	Limit (dBuV/m)	Height (cm)	Angle (deg)	Remark (QP/PK/AV)
1	* 2358.500	29.41	32.09	61.50	-12.50	74.00	140	105	Peak
2	2390.000	27.24	32.22	59.46	-14.54	74.00	140	105	Peak
3	2410.875	80.41	32.31	112.71	N/A	N/A	140	105	Peak

Note:

1. " *", means this data is the worst emission level.
2. C.F (Correction Factor) = Antenna Factor (dB/m)+ Cable Loss (dB).
3. Measurement (dBuV/m) = Reading(dBuV) + C.F (Correction Factor).
4. The emission levels of other frequencies are very lower than the limit and not show in test report.

EUT	AP351	Date of Test	2021-05-22
Factor	BBHA 9120D	Temp. / Humidity	25°C /66%
Polarity	Horizontal	Site / Test Engineer	AC1 / Jay
Test Mode	802.11b_TX_CH 1_SCAN ANT 0	Test Voltage	By PoE

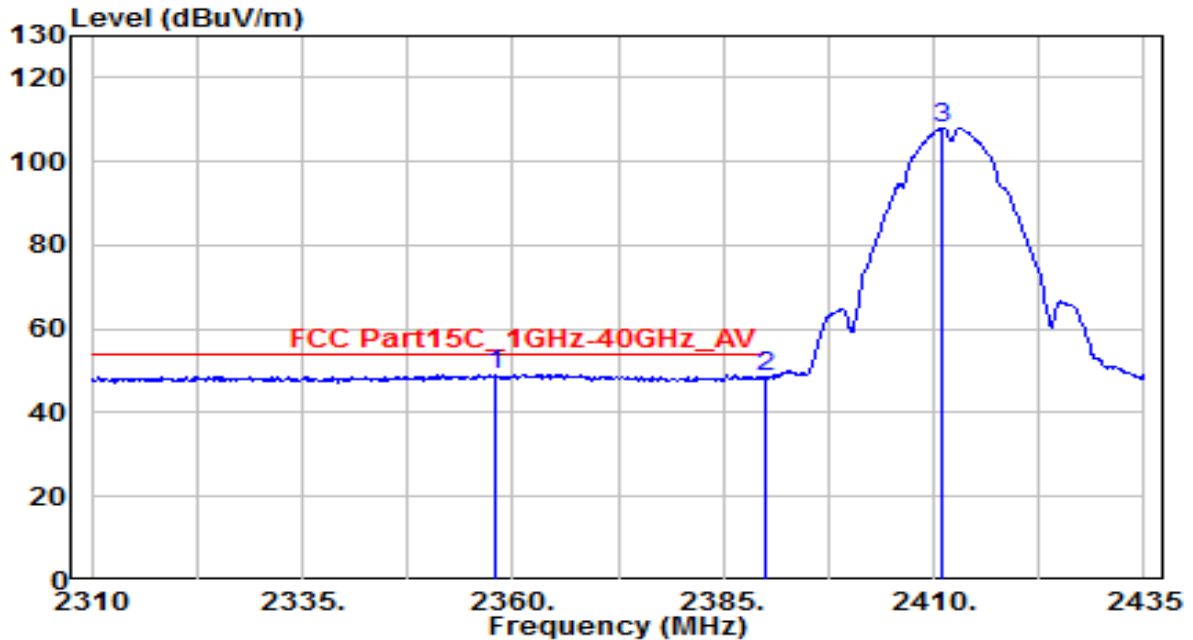

No	Frequency (MHz)	Reading (dBuV)	C.F (dB)	Measurement (dBuV/m)	Margin (dB)	Limit (dBuV/m)	Height (cm)	Angle (deg)	Remark (QP/PK/AV)
1	* 2358.000	17.11	32.08	49.19	-4.81	54.00	140	105	Average
2	2390.000	16.26	32.22	48.47	-5.53	54.00	140	105	Average
3	2411.125	75.82	32.31	108.13	N/A	N/A	140	105	Average

Note:

1. " *", means this data is the worst emission level.
2. C.F (Correction Factor) = Antenna Factor (dB/m)+ Cable Loss (dB).
3. Measurement (dBuV/m) = Reading(dBuV) + C.F (Correction Factor).
4. The emission levels of other frequencies are very lower than the limit and not show in test report.

EUT	AP351	Date of Test	2021-05-22
Factor	BBHA 9120D	Temp. / Humidity	25°C /66%
Polarity	Vertical	Site / Test Engineer	AC1 / Jay
Test Mode	802.11b_TX_CH 1_SCAN ANT 0	Test Voltage	By PoE

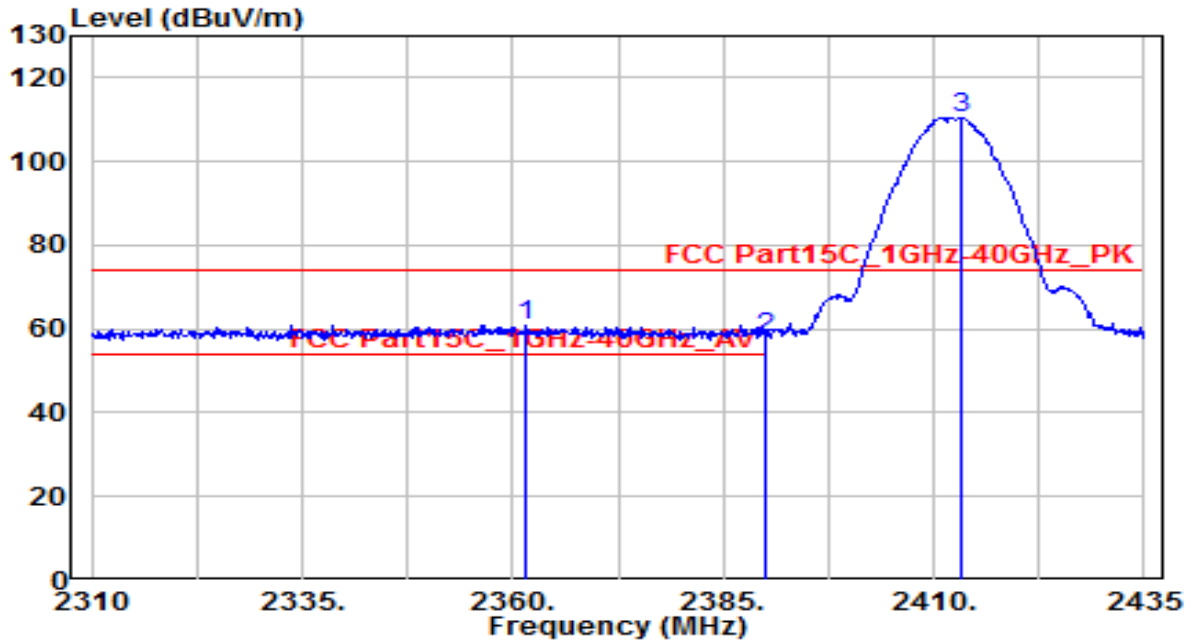

No	Frequency (MHz)	Reading (dBUV)	C.F (dB)	Measurement (dBUV/m)	Margin (dB)	Limit (dBUV/m)	Height (cm)	Angle (deg)	Remark (QP/PK/AV)
1	* 2361.500	28.95	32.10	61.05	-12.95	74.00	150	160	Peak
2	2390.000	25.81	32.22	58.03	-15.97	74.00	150	160	Peak
3	2413.125	78.29	32.32	110.61	N/A	N/A	150	160	Peak

Note:

1. " *", means this data is the worst emission level.
2. C.F (Correction Factor) = Antenna Factor (dB/m)+ Cable Loss (dB).
3. Measurement (dBUV/m) = Reading(dBUV) + C.F (Correction Factor).
4. The emission levels of other frequencies are very lower than the limit and not show in test report.

EUT	AP351	Date of Test	2021-05-22
Factor	BBHA 9120D	Temp. / Humidity	25°C /66%
Polarity	Vertical	Site / Test Engineer	AC1 / Jay
Test Mode	802.11b_TX_CH 1_SCAN ANT 0	Test Voltage	By PoE

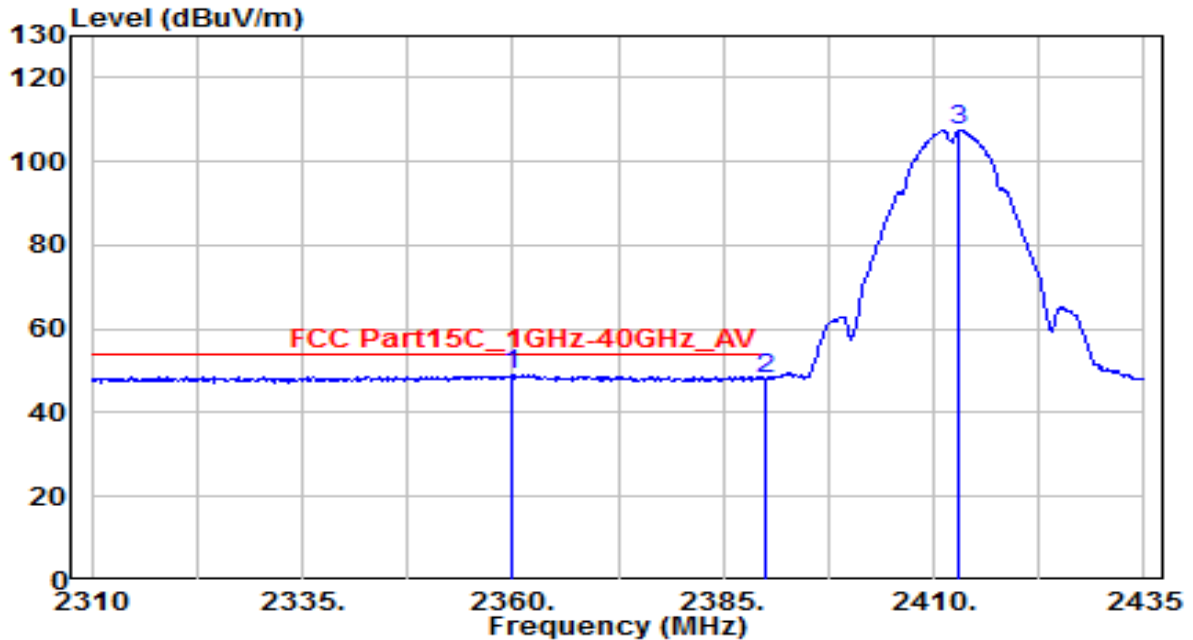

No	Frequency (MHz)	Reading (dBuV)	C.F (dB)	Measurement (dBuV/m)	Margin (dB)	Limit (dBuV/m)	Height (cm)	Angle (deg)	Remark (QP/PK/AV)
1	* 2359.750	16.97	32.09	49.06	-4.94	54.00	150	160	Average
2	2390.000	16.00	32.22	48.22	-5.78	54.00	150	160	Average
3	2413.000	75.23	32.31	107.55	N/A	N/A	150	160	Average

Note:

1. " *", means this data is the worst emission level.
2. C.F (Correction Factor) = Antenna Factor (dB/m)+ Cable Loss (dB).
3. Measurement (dBuV/m) = Reading(dBuV) + C.F (Correction Factor).
4. The emission levels of other frequencies are very lower than the limit and not show in test report.

EUT	AP351	Date of Test	2021-05-22
Factor	BBHA 9120D	Temp. / Humidity	25°C /66%
Polarity	Horizontal	Site / Test Engineer	AC1 / Jay
Test Mode	802.11b_TX_CH 11_SCAN ANT 0	Test Voltage	By PoE

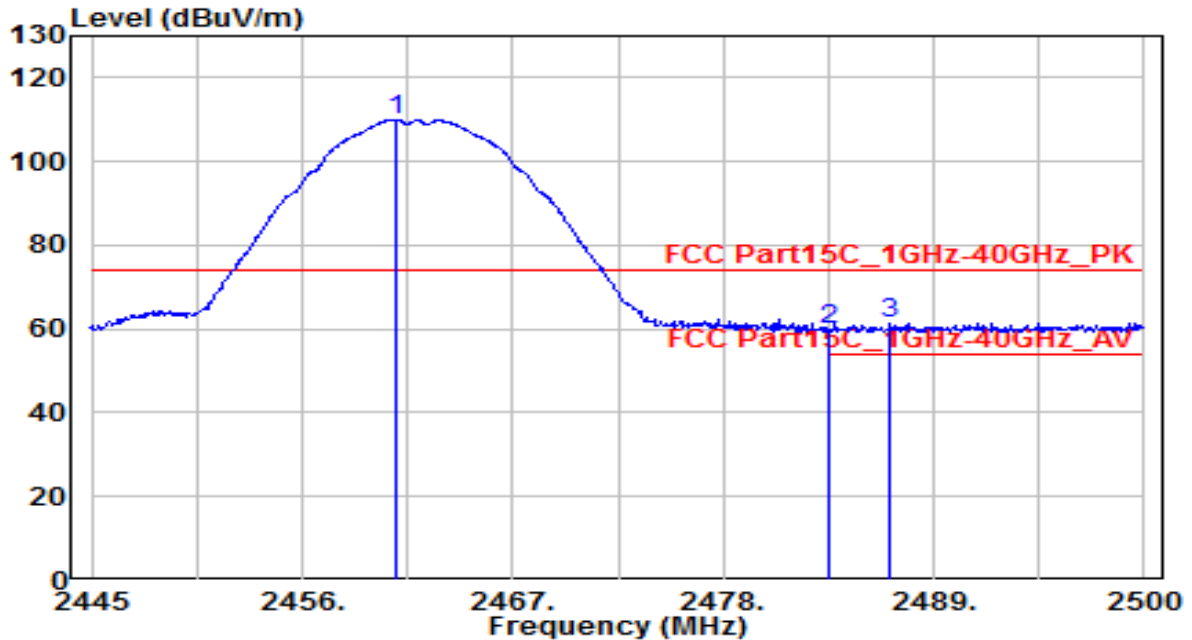

No	Frequency (MHz)	Reading (dBuV)	C.F (dB)	Measurement (dBuV/m)	Margin (dB)	Limit (dBuV/m)	Height (cm)	Angle (deg)	Remark (QP/PK/AV)
1	2466.880	77.49	32.52	110.01	N/A	N/A	160	120	Peak
2	2483.500	27.37	32.61	59.98	-14.02	74.00	160	120	Peak
3	* 2486.740	28.89	32.62	61.51	-12.49	74.00	160	120	Peak

Note:

1. " *", means this data is the worst emission level.
2. C.F (Correction Factor) = Antenna Factor (dB/m)+ Cable Loss (dB).
3. Measurement (dBuV/m) = Reading(dBuV) + C.F (Correction Factor).
4. The emission levels of other frequencies are very lower than the limit and not show in test report.

EUT	AP351	Date of Test	2021-05-22
Factor	BBHA 9120D	Temp. / Humidity	25°C /66%
Polarity	Horizontal	Site / Test Engineer	AC1 / Jay
Test Mode	802.11b_TX_CH 11_SCAN ANT 0	Test Voltage	By PoE

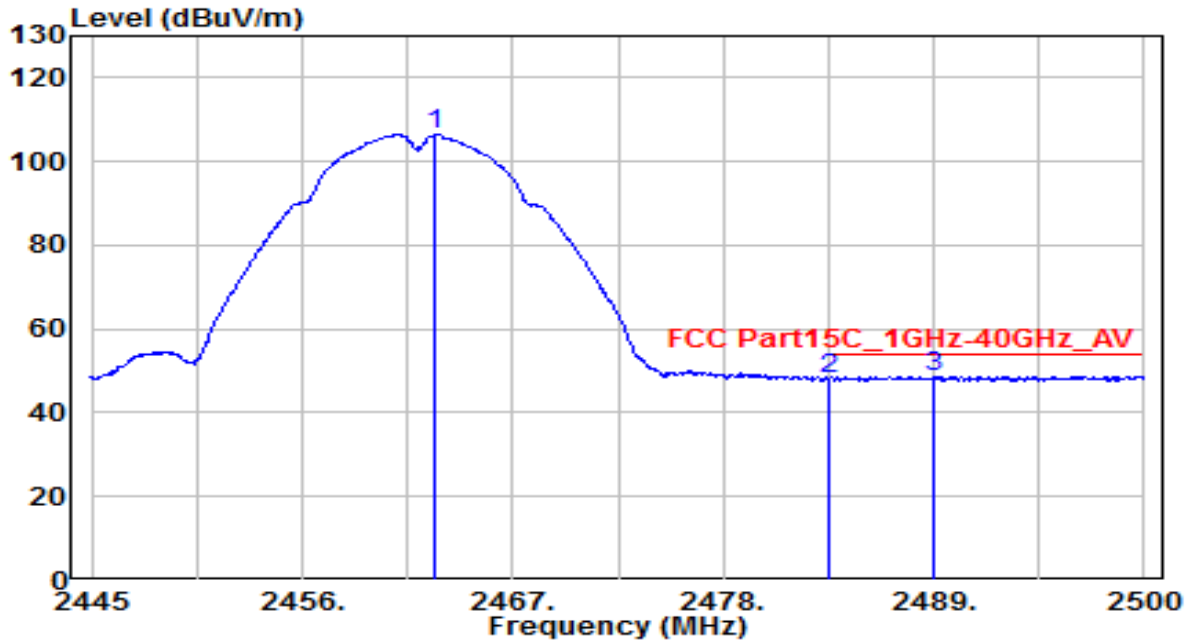

No	Frequency (MHz)	Reading (dBUV)	C.F (dB)	Measurement (dBUV/m)	Margin (dB)	Limit (dBUV/m)	Height (cm)	Angle (deg)	Remark (QP/PK/AV)
1	2462.920	73.84	32.52	106.37	N/A	N/A	160	120	Average
2	2483.500	15.55	32.61	48.16	-5.84	54.00	160	120	Average
3	* 2488.960	16.01	32.63	48.64	-5.36	54.00	160	120	Average

Note:

1. " *", means this data is the worst emission level.
2. C.F (Correction Factor) = Antenna Factor (dB/m)+ Cable Loss (dB).
3. Measurement (dBUV/m) = Reading(dBUV) + C.F (Correction Factor).
4. The emission levels of other frequencies are very lower than the limit and not show in test report.

EUT	AP351	Date of Test	2021-05-22
Factor	BBHA 9120D	Temp. / Humidity	25°C /66%
Polarity	Vertical	Site / Test Engineer	AC1 / Jay
Test Mode	802.11b_TX_CH 11_SCAN ANT 0	Test Voltage	By PoE

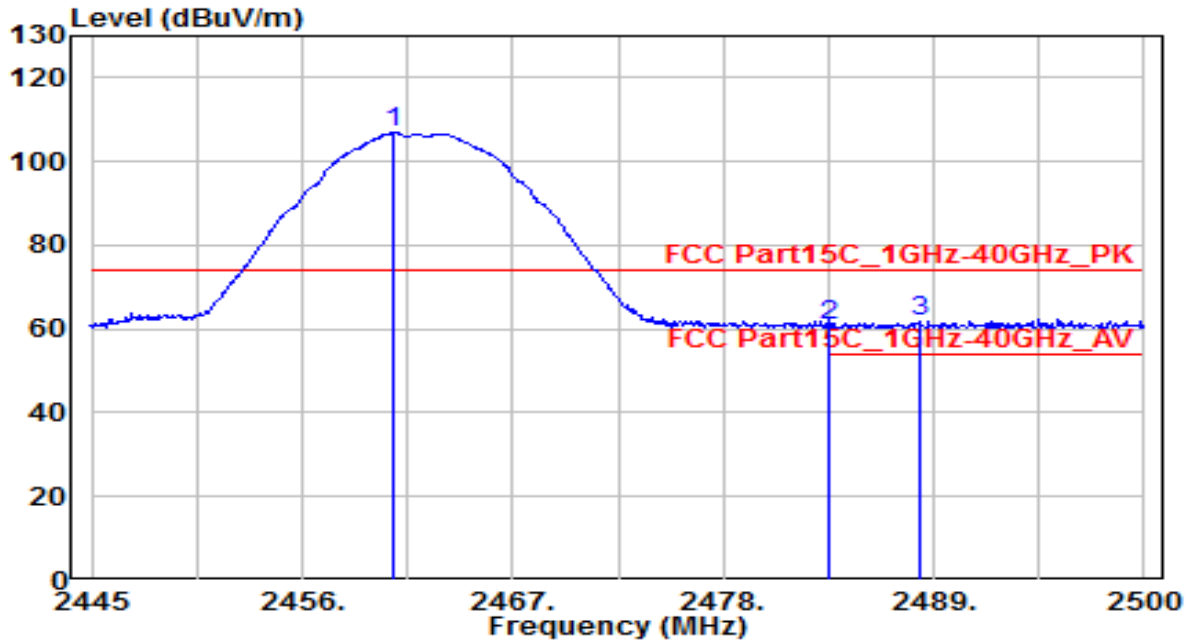

No	Frequency (MHz)	Reading (dBuV)	C.F (dB)	Measurement (dBuV/m)	Margin (dB)	Limit (dBuV/m)	Height (cm)	Angle (deg)	Remark (QP/PK/AV)
1	2460.820	74.27	32.52	106.79	N/A	N/A	140	155	Peak
2	2483.500	28.27	32.61	60.88	-13.12	74.00	140	155	Peak
3	* 2488.240	29.22	32.63	61.85	-12.15	74.00	140	155	Peak

Note:

1. " *", means this data is the worst emission level.
2. C.F (Correction Factor) = Antenna Factor (dB/m)+ Cable Loss (dB).
3. Measurement (dBuV/m) = Reading(dBuV) + C.F (Correction Factor).
4. The emission levels of other frequencies are very lower than the limit and not show in test report.

EUT	AP351	Date of Test	2021-05-22
Factor	BBHA 9120D	Temp. / Humidity	25°C /66%
Polarity	Vertical	Site / Test Engineer	AC1 / Jay
Test Mode	802.11b_TX_CH 11_SCAN ANT 0	Test Voltage	By PoE

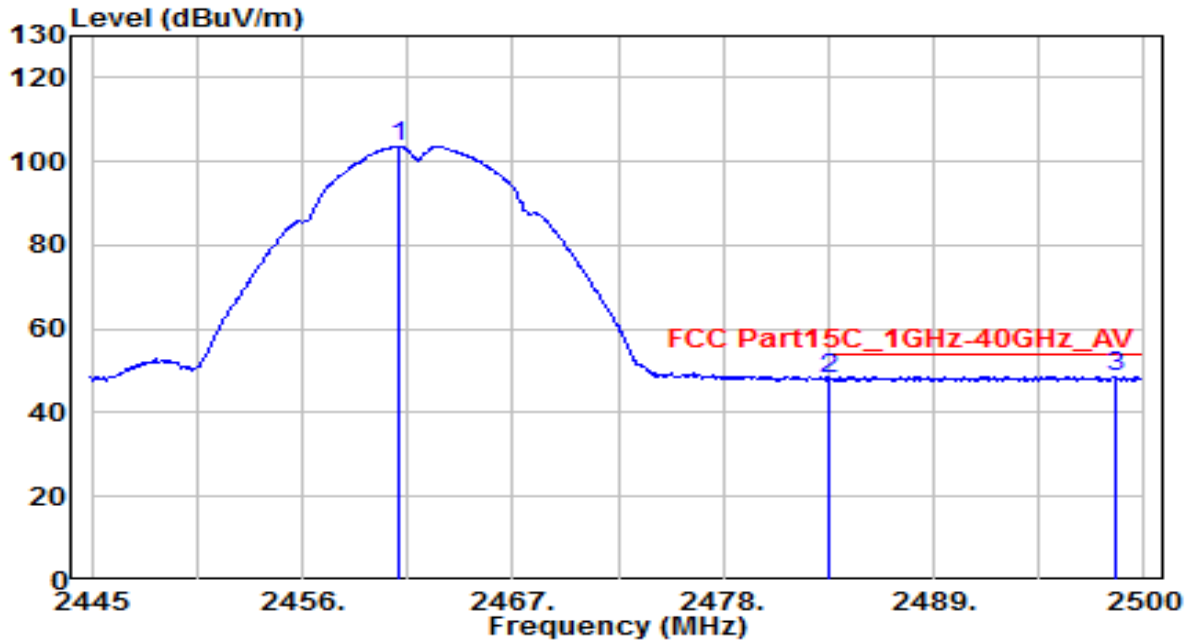

No	Frequency (MHz)	Reading (dBuV)	C.F (dB)	Measurement (dBuV/m)	Margin (dB)	Limit (dBuV/m)	Height (cm)	Angle (deg)	Remark (QP/PK/AV)
1	2461.000	71.11	32.52	103.62	N/A	N/A	140	155	Average
2	2483.500	15.28	32.61	47.89	-6.11	54.00	140	155	Average
3	* 2498.560	16.11	32.67	48.79	-5.21	54.00	140	155	Average

Note:

1. " *", means this data is the worst emission level.
2. C.F (Correction Factor) = Antenna Factor (dB/m)+ Cable Loss (dB).
3. Measurement (dBuV/m) = Reading(dBuV) + C.F (Correction Factor).
4. The emission levels of other frequencies are very lower than the limit and not show in test report.

EUT	AP351	Date of Test	2021-05-22
Factor	BBHA 9120D	Temp. / Humidity	25°C /66%
Polarity	Horizontal	Site / Test Engineer	AC1 / Jay
Test Mode	802.11g_TX_CH 1_SCAN ANT 0	Test Voltage	By PoE

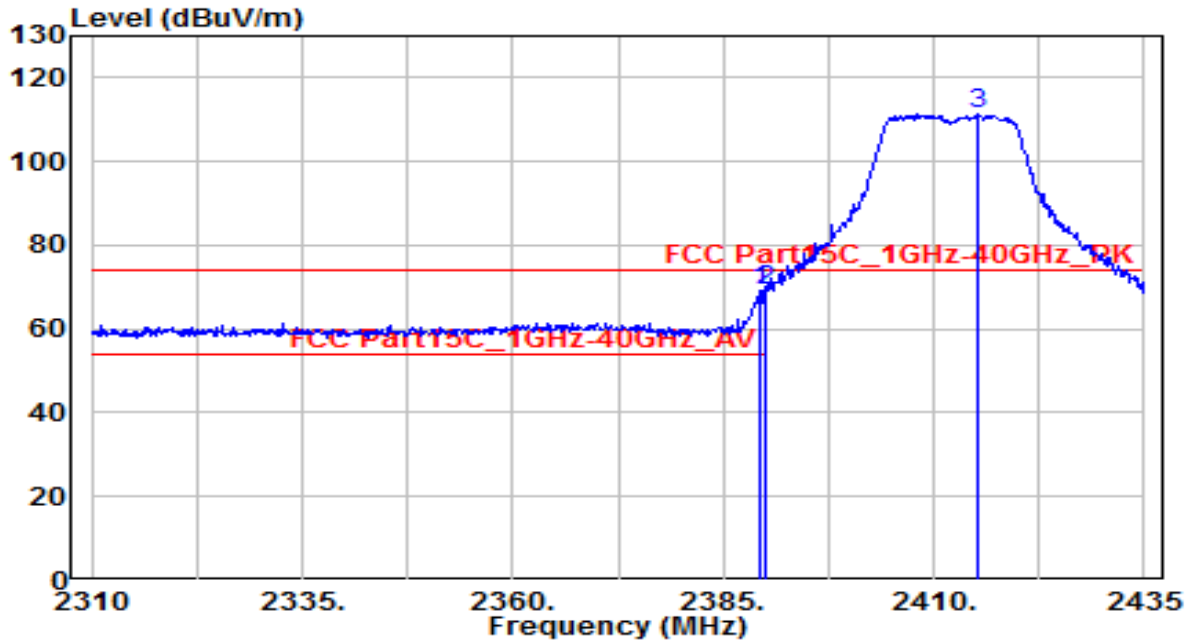

No	Frequency (MHz)	Reading (dBuV)	C.F (dB)	Measurement (dBuV/m)	Margin (dB)	Limit (dBuV/m)	Height (cm)	Angle (deg)	Remark (QP/PK/AV)	
1	*	2389.250	36.92	32.21	69.14	-4.86	74.00	140	105	Peak
2		2390.000	36.87	32.22	69.09	-4.91	74.00	140	105	Peak
3		2415.250	78.96	32.32	111.28	N/A	N/A	140	105	Peak

Note:

1. " *", means this data is the worst emission level.
2. C.F (Correction Factor) = Antenna Factor (dB/m)+ Cable Loss (dB) – Preamplifier(dB).
3. Measurement (dBuV/m) = Reading(dBuV) + C.F (Correction Factor).
4. The emission levels of other frequencies are very lower than the limit and not show in test report.

EUT	AP351	Date of Test	2021-05-22
Factor	BBHA 9120D	Temp. / Humidity	25°C /66%
Polarity	Horizontal	Site / Test Engineer	AC1 / Jay
Test Mode	802.11g_TX_CH 1_SCAN ANT 0	Test Voltage	By PoE

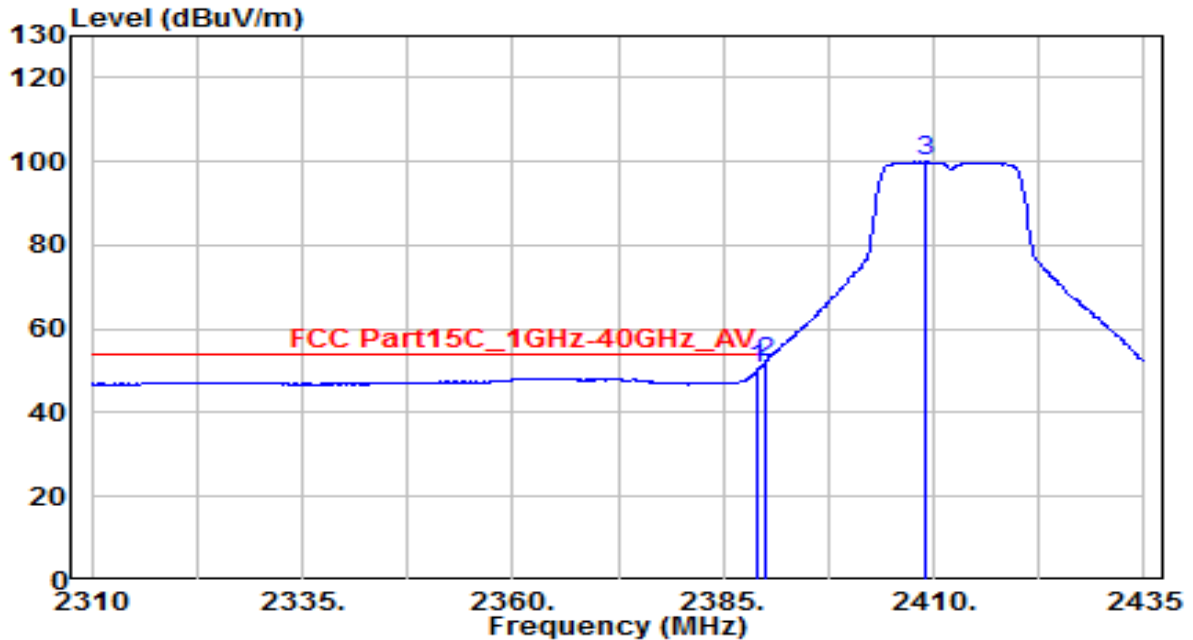

No	Frequency (MHz)	Reading (dBuV)	C.F (dB)	Measurement (dBuV/m)	Margin (dB)	Limit (dBuV/m)	Height (cm)	Angle (deg)	Remark (QP/PK/AV)
1	2389.125	18.29	32.21	50.51	-3.49	54.00	140	105	Average
2	* 2390.000	19.64	32.22	51.86	-2.14	54.00	140	105	Average
3	2408.875	67.62	32.30	99.92	N/A	N/A	140	105	Average

Note:

1. " *", means this data is the worst emission level.
2. C.F (Correction Factor) = Antenna Factor (dB/m)+ Cable Loss (dB) – Preamplifier(dB).
3. Measurement (dBuV/m) = Reading(dBuV) + C.F (Correction Factor).
4. The emission levels of other frequencies are very lower than the limit and not show in test report.

EUT	AP351	Date of Test	2021-05-22
Factor	BBHA 9120D	Temp. / Humidity	25°C /66%
Polarity	Vertical	Site / Test Engineer	AC1 / Jay
Test Mode	802.11g_TX_CH 1_SCAN ANT 0	Test Voltage	By PoE

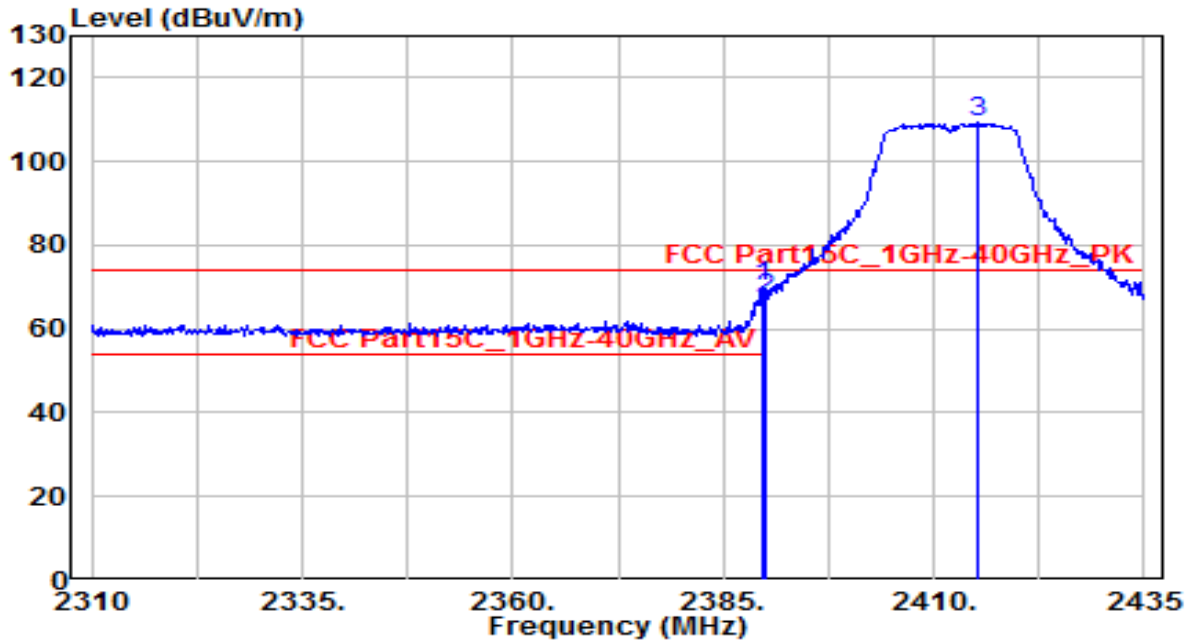

No	Frequency (MHz)	Reading (dBUV)	C.F (dB)	Measurement (dBUV/m)	Margin (dB)	Limit (dBUV/m)	Height (cm)	Angle (deg)	Remark (QP/PK/AV)
1	* 2389.625	37.96	32.22	70.17	-3.83	74.00	150	160	Peak
2	2390.000	35.00	32.22	67.22	-6.78	74.00	150	160	Peak
3	2415.250	77.04	32.32	109.36	N/A	N/A	150	160	Peak

Note:

1. " *", means this data is the worst emission level.
2. C.F (Correction Factor) = Antenna Factor (dB/m)+ Cable Loss (dB) – Pre-amplifier(dB).
3. Measurement (dBUV/m) = Reading(dBUV) + C.F (Correction Factor).
4. The emission levels of other frequencies are very lower than the limit and not show in test report.

EUT	AP351	Date of Test	2021-05-22
Factor	BBHA 9120D	Temp. / Humidity	25°C /66%
Polarity	Vertical	Site / Test Engineer	AC1 / Jay
Test Mode	802.11g_TX_CH 1_SCAN ANT 0	Test Voltage	By PoE

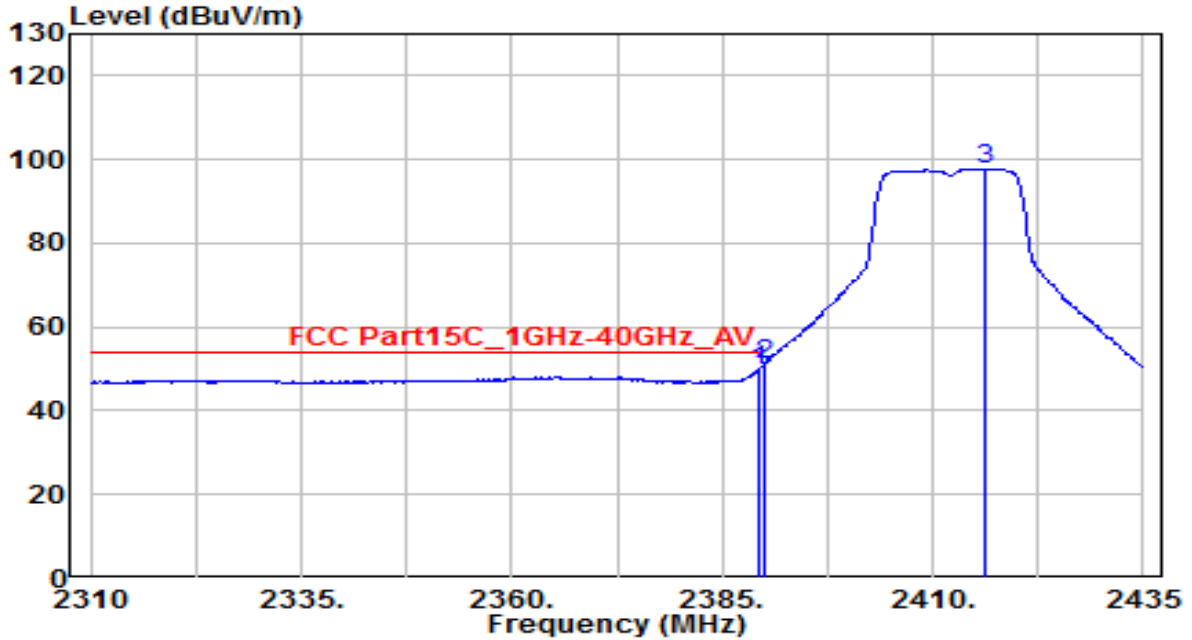

No	Frequency (MHz)	Reading (dBuV)	C.F (dB)	Measurement (dBuV/m)	Margin (dB)	Limit (dBuV/m)	Height (cm)	Angle (deg)	Remark (QP/PK/AV)
1	2389.250	17.43	32.21	49.64	-4.36	54.00	150	160	Average
2	* 2390.000	18.82	32.22	51.04	-2.96	54.00	150	160	Average
3	2416.125	65.47	32.33	97.80	N/A	N/A	150	160	Average

Note:

1. " *", means this data is the worst emission level.
2. C.F (Correction Factor) = Antenna Factor (dB/m)+ Cable Loss (dB) – Preamplifier(dB).
3. Measurement (dBuV/m) = Reading(dBuV) + C.F (Correction Factor).
4. The emission levels of other frequencies are very lower than the limit and not show in test report.

EUT	AP351	Date of Test	2021-05-22
Factor	BBHA 9120D	Temp. / Humidity	25°C /66%
Polarity	Horizontal	Site / Test Engineer	AC1 / Jay
Test Mode	802.11g_TX_CH 11_SCAN ANT 0	Test Voltage	By PoE

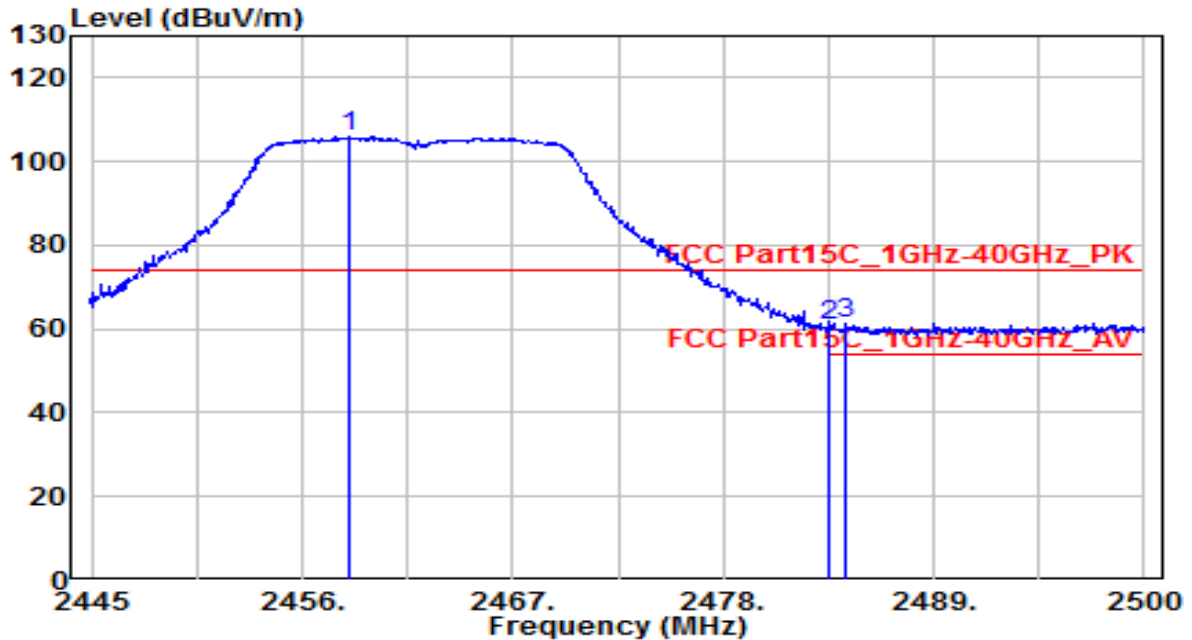

No	Frequency (MHz)	Reading (dBuV)	C.F (dB)	Measurement (dBuV/m)	Margin (dB)	Limit (dBuV/m)	Height (cm)	Angle (deg)	Remark (QP/PK/AV)
1	2458.420	73.70	32.51	106.21	N/A	N/A	160	120	Peak
2	2483.500	28.19	32.61	60.80	-13.20	74.00	160	120	Peak
3	* 2484.400	28.69	32.61	61.30	-12.70	74.00	160	120	Peak

Note:

1. " *", means this data is the worst emission level.
2. C.F (Correction Factor) = Antenna Factor (dB/m)+ Cable Loss (dB) – Preamplifier(dB).
3. Measurement (dBuV/m) = Reading(dBuV) + C.F (Correction Factor).
4. The emission levels of other frequencies are very lower than the limit and not show in test report.

EUT	AP351	Date of Test	2021-05-22
Factor	BBHA 9120D	Temp. / Humidity	25°C /66%
Polarity	Horizontal	Site / Test Engineer	AC1 / Jay
Test Mode	802.11g_TX_CH 11_SCAN ANT 0	Test Voltage	By PoE

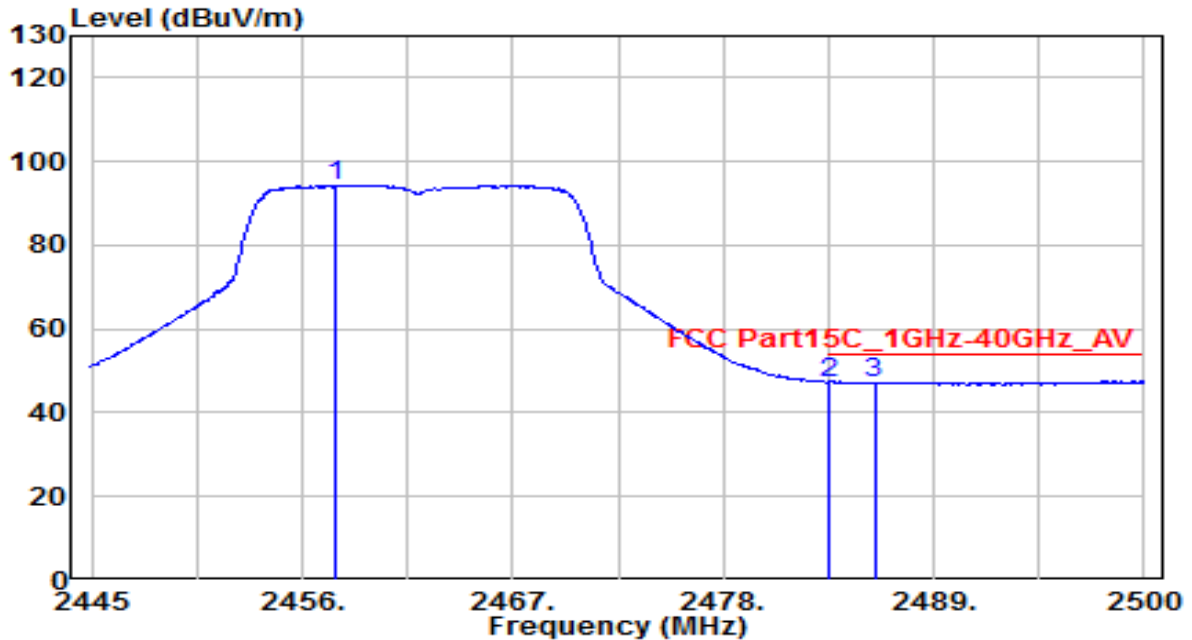

No	Frequency (MHz)	Reading (dBuV)	C.F (dB)	Measurement (dBuV/m)	Margin (dB)	Limit (dBuV/m)	Height (cm)	Angle (deg)	Remark (QP/PK/AV)
1	2457.760	61.82	32.50	94.32	N/A	N/A	160	120	Average
2	* 2483.500	14.70	32.61	47.31	-6.69	54.00	160	120	Average
3	2485.900	14.55	32.62	47.18	-6.82	54.00	160	120	Average

Note:

1. " *", means this data is the worst emission level.
2. C.F (Correction Factor) = Antenna Factor (dB/m)+ Cable Loss (dB) – Preamplifier(dB).
3. Measurement (dBuV/m) = Reading(dBuV) + C.F (Correction Factor).
4. The emission levels of other frequencies are very lower than the limit and not show in test report.

EUT	AP351	Date of Test	2021-05-22
Factor	BBHA 9120D	Temp. / Humidity	25°C /66%
Polarity	Vertical	Site / Test Engineer	AC1 / Jay
Test Mode	802.11g_TX_CH 11_SCAN ANT 0	Test Voltage	By PoE

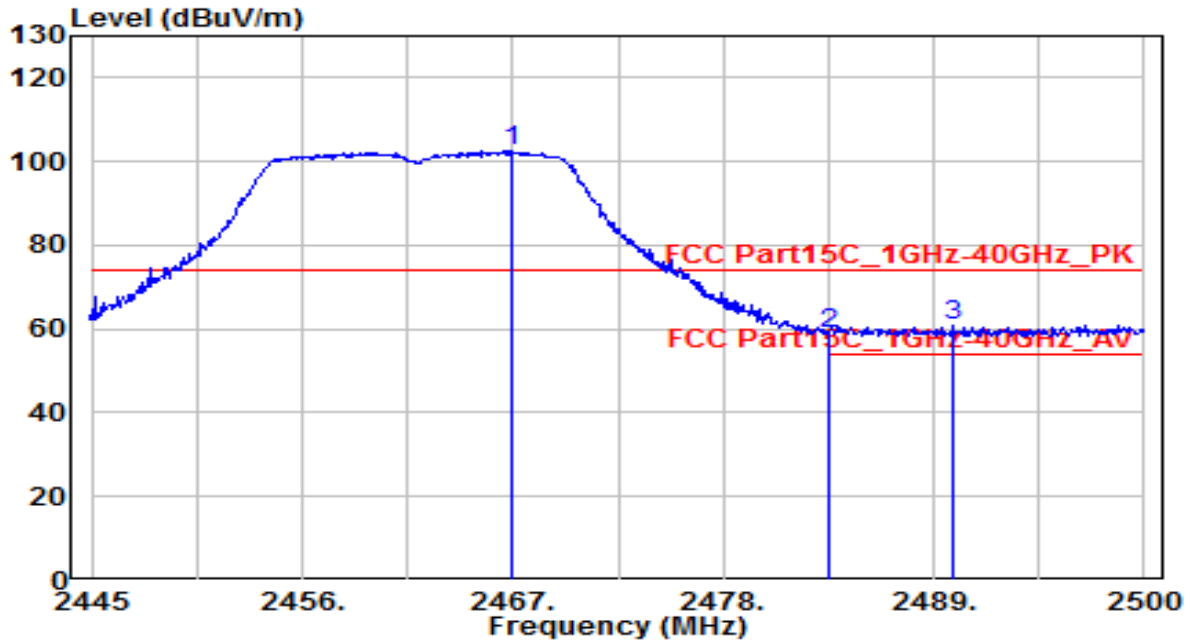

No	Frequency (MHz)	Reading (dBuV)	C.F (dB)	Measurement (dBuV/m)	Margin (dB)	Limit (dBuV/m)	Height (cm)	Angle (deg)	Remark (QP/PK/AV)
1	2467.000	69.97	32.54	102.51	N/A	N/A	140	155	Peak
2	2483.500	26.42	32.61	59.03	-14.97	74.00	140	155	Peak
3	* 2490.040	28.10	32.64	60.74	-13.26	74.00	140	155	Peak

Note:

1. " *", means this data is the worst emission level.
2. C.F (Correction Factor) = Antenna Factor (dB/m)+ Cable Loss (dB) – Preamplifier(dB).
3. Measurement (dBuV/m) = Reading(dBuV) + C.F (Correction Factor).
4. The emission levels of other frequencies are very lower than the limit and not show in test report.

EUT	AP351	Date of Test	2021-05-22
Factor	BBHA 9120D	Temp. / Humidity	25°C /66%
Polarity	Vertical	Site / Test Engineer	AC1 / Jay
Test Mode	802.11g_TX_CH 11_SCAN ANT 0	Test Voltage	By PoE

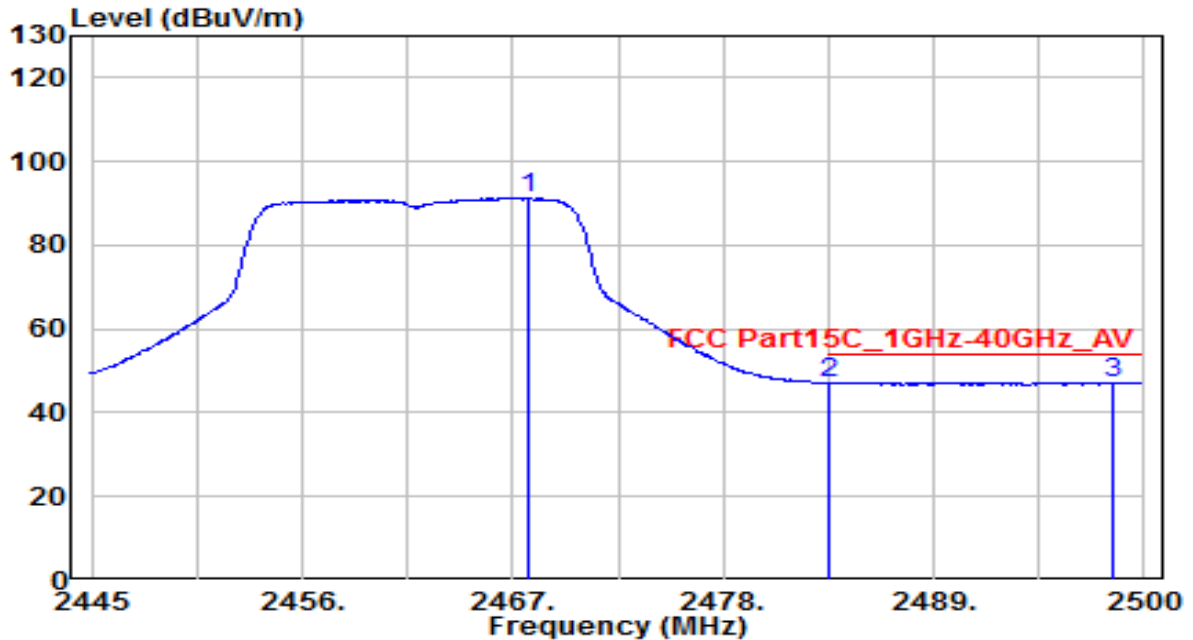

No	Frequency (MHz)	Reading (dBuV)	C.F (dB)	Measurement (dBuV/m)	Margin (dB)	Limit (dBuV/m)	Height (cm)	Angle (deg)	Remark (QP/PK/AV)
1	2467.840	58.70	32.54	91.24	N/A	N/A	140	155	Average
2	2483.500	14.51	32.61	47.12	-6.88	54.00	140	155	Average
3	* 2498.380	14.63	32.67	47.30	-6.70	54.00	140	155	Average

Note:

1. "*" , means this data is the worst emission level.
2. C.F (Correction Factor) = Antenna Factor (dB/m)+ Cable Loss (dB) – Preamplifier(dB).
3. Measurement (dBuV/m) = Reading(dBuV) + C.F (Correction Factor).
4. The emission levels of other frequencies are very lower than the limit and not show in test report.

EUT	AP351	Date of Test	2021-05-22
Factor	BBHA 9120D	Temp. / Humidity	25°C /66%
Polarity	Horizontal	Site / Test Engineer	AC1 / Jay
Test Mode	802.11n-20MHz_TX_CH 1_SCAN ANT 0	Test Voltage	By PoE

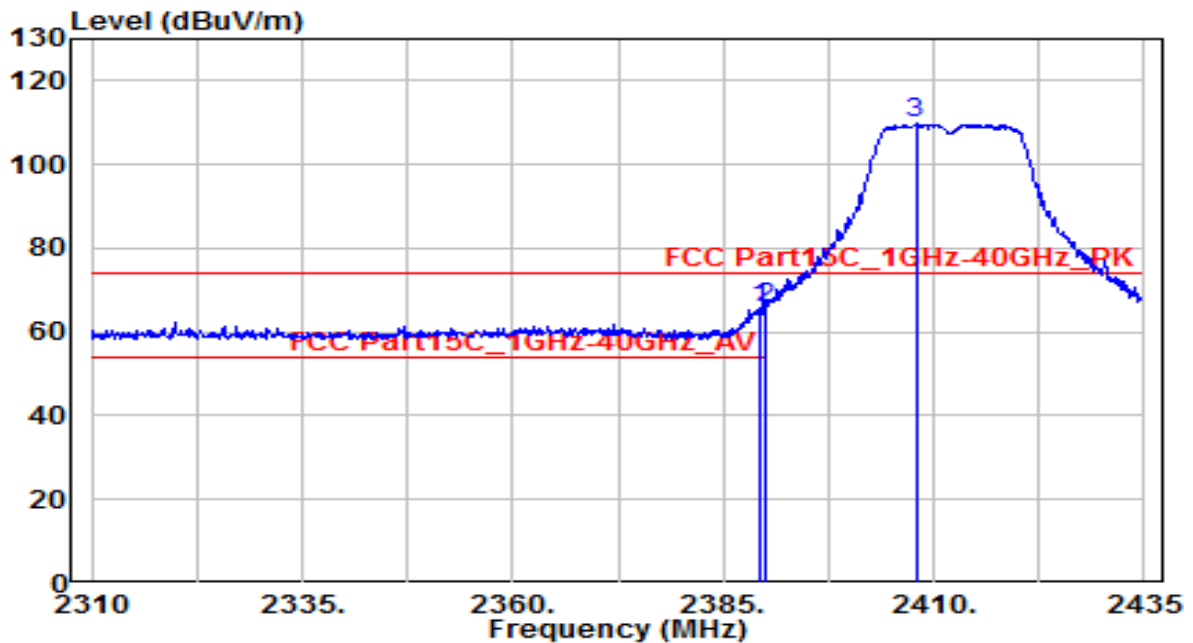

No	Frequency (MHz)	Reading (dBuV)	C.F (dB)	Measurement (dBuV/m)	Margin (dB)	Limit (dBuV/m)	Height (cm)	Angle (deg)	Remark (QP/PK/AV)
1	2389.250	33.41	32.21	65.62	-8.38	74.00	140	105	Peak
2	* 2390.000	33.67	32.22	65.89	-8.11	74.00	140	105	Peak
3	2407.875	77.41	32.29	109.71	N/A	N/A	140	105	Peak

Note:

1. " *", means this data is the worst emission level.
2. C.F (Correction Factor) = Antenna Factor (dB/m)+ Cable Loss (dB).
3. Measurement (dBuV/m) = Reading(dBuV) + C.F (Correction Factor).
4. The emission levels of other frequencies are very lower than the limit and not show in test report.

EUT	AP351	Date of Test	2021-05-22
Factor	BBHA 9120D	Temp. / Humidity	25°C /66%
Polarity	Horizontal	Site / Test Engineer	AC1 / Jay
Test Mode	802.11n-20MHz_TX_CH 1_SCAN ANT 0	Test Voltage	By PoE

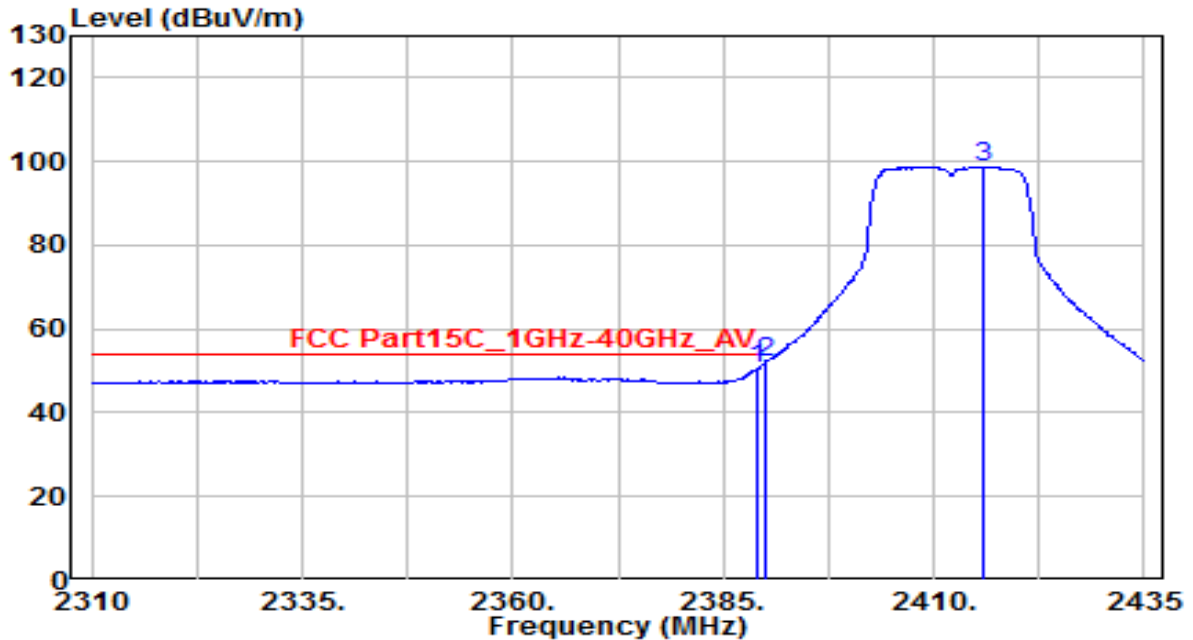

No	Frequency (MHz)	Reading (dBuV)	C.F (dB)	Measurement (dBuV/m)	Margin (dB)	Limit (dBuV/m)	Height (cm)	Angle (deg)	Remark (QP/PK/AV)
1	2389.125	18.45	32.21	50.66	-3.34	54.00	140	105	Average
2	* 2390.000	19.60	32.22	51.82	-2.18	54.00	140	105	Average
3	2415.750	66.44	32.33	98.77	N/A	N/A	140	105	Average

Note:

1. " *", means this data is the worst emission level.
2. C.F (Correction Factor) = Antenna Factor (dB/m)+ Cable Loss (dB).
3. Measurement (dBuV/m) = Reading(dBuV) + C.F (Correction Factor).
4. The emission levels of other frequencies are very lower than the limit and not show in test report.

EUT	AP351	Date of Test	2021-05-22
Factor	BBHA 9120D	Temp. / Humidity	25°C /66%
Polarity	Vertical	Site / Test Engineer	AC1 / Jay
Test Mode	802.11n-20MHz_TX_CH 1_SCAN ANT 0	Test Voltage	By PoE

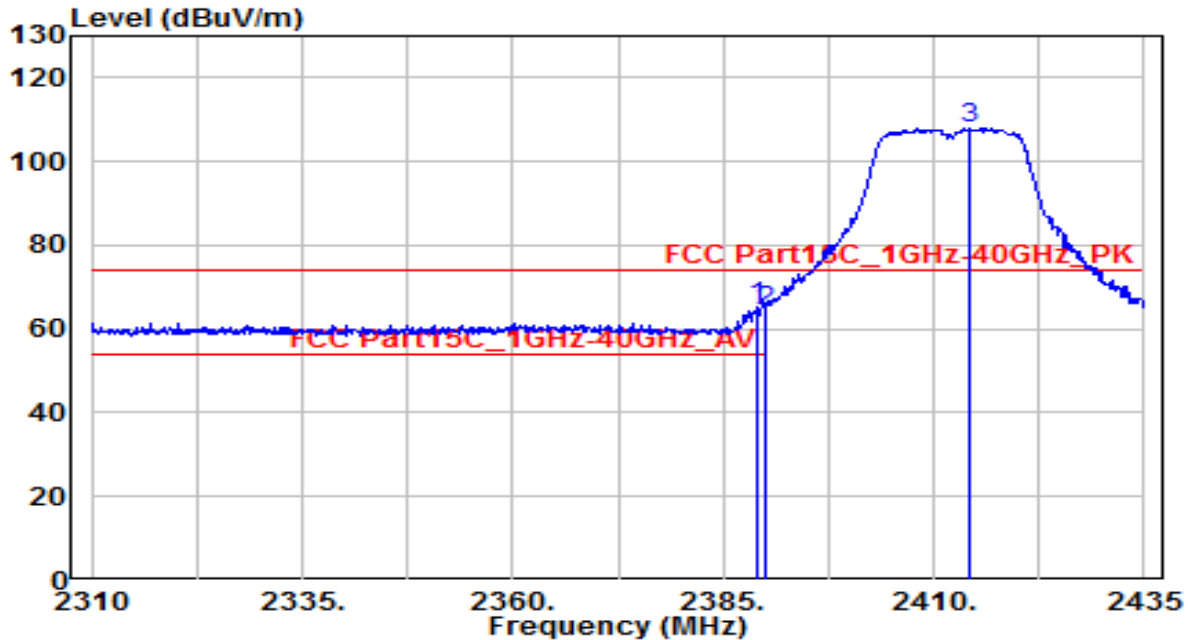

No	Frequency (MHz)	Reading (dBuV)	C.F (dB)	Measurement (dBuV/m)	Margin (dB)	Limit (dBuV/m)	Height (cm)	Angle (deg)	Remark (QP/PK/AV)
1	* 2389.000	32.87	32.21	65.09	-8.91	74.00	150	160	Peak
2	2390.000	32.29	32.22	64.50	-9.50	74.00	150	160	Peak
3	2414.125	75.63	32.32	107.95	N/A	N/A	150	160	Peak

Note:

1. " *", means this data is the worst emission level.
2. C.F (Correction Factor) = Antenna Factor (dB/m)+ Cable Loss (dB).
3. Measurement (dBuV/m) = Reading(dBuV) + C.F (Correction Factor).
4. The emission levels of other frequencies are very lower than the limit and not show in test report.

EUT	AP351	Date of Test	2021-05-22
Factor	BBHA 9120D	Temp. / Humidity	25°C /66%
Polarity	Vertical	Site / Test Engineer	AC1 / Jay
Test Mode	802.11n-20MHz_TX_CH 1_SCAN ANT 0	Test Voltage	By PoE

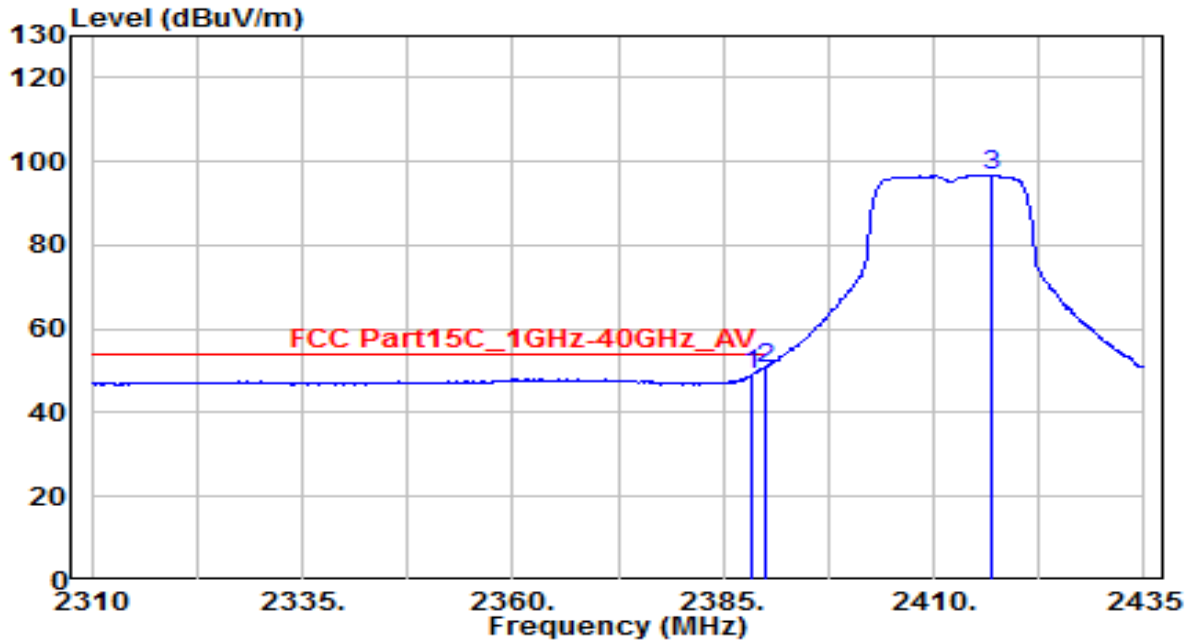

No	Frequency (MHz)	Reading (dBuV)	C.F (dB)	Measurement (dBuV/m)	Margin (dB)	Limit (dBuV/m)	Height (cm)	Angle (deg)	Remark (QP/PK/AV)
1	2388.375	16.73	32.21	48.94	-5.06	54.00	150	160	Average
2	* 2390.000	18.47	32.22	50.69	-3.31	54.00	150	160	Average
3	2417.000	64.52	32.33	96.85	N/A	N/A	150	160	Average

Note:

1. " *", means this data is the worst emission level.
2. C.F (Correction Factor) = Antenna Factor (dB/m)+ Cable Loss (dB).
3. Measurement (dBuV/m) = Reading(dBuV) + C.F (Correction Factor).
4. The emission levels of other frequencies are very lower than the limit and not show in test report.

EUT	AP351	Date of Test	2021-05-22
Factor	BBHA 9120D	Temp. / Humidity	25°C /66%
Polarity	Horizontal	Site / Test Engineer	AC1 / Jay
Test Mode	802.11n-20MHz_TX_CH 11_SCAN ANT 0	Test Voltage	By PoE

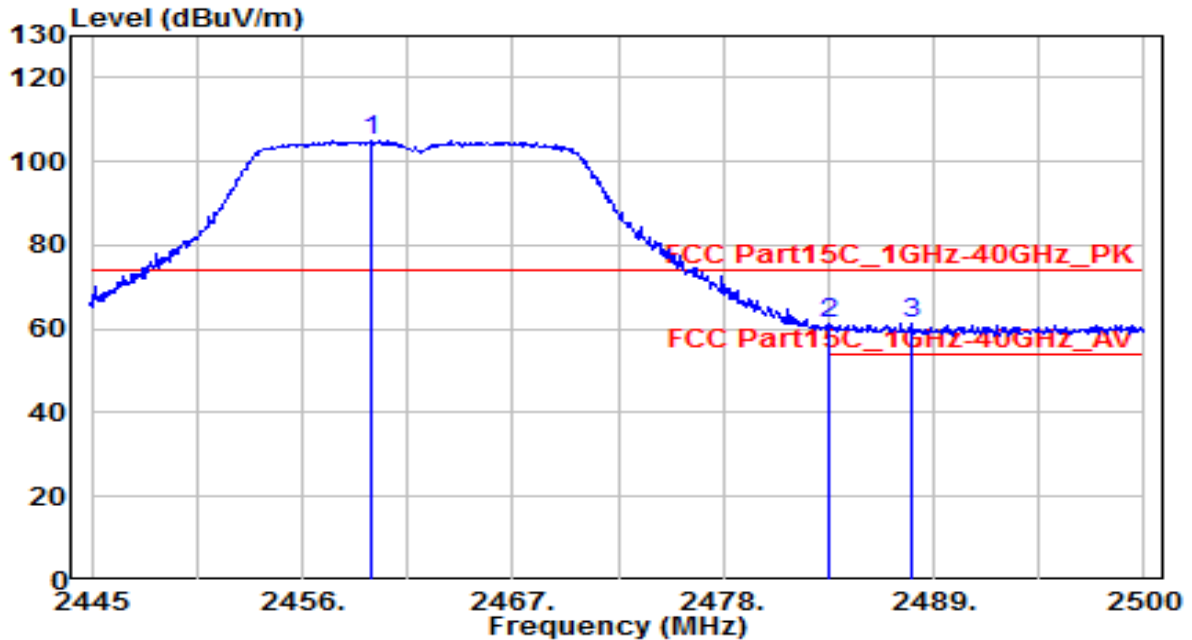

No	Frequency (MHz)	Reading (dBuV)	C.F (dB)	Measurement (dBuV/m)	Margin (dB)	Limit (dBuV/m)	Height (cm)	Angle (deg)	Remark (QP/PK/AV)
1	2459.620	72.38	32.51	104.89	N/A	N/A	160	120	Peak
2	* 2483.500	28.62	32.61	61.23	-12.77	74.00	160	120	Peak
3	2487.820	28.49	32.63	61.12	-12.88	74.00	160	120	Peak

Note:

1. " *", means this data is the worst emission level.
2. C.F (Correction Factor) = Antenna Factor (dB/m)+ Cable Loss (dB).
3. Measurement (dBuV/m) = Reading(dBuV) + C.F (Correction Factor).
4. The emission levels of other frequencies are very lower than the limit and not show in test report.

EUT	AP351	Date of Test	2021-05-22
Factor	BBHA 9120D	Temp. / Humidity	25°C /66%
Polarity	Horizontal	Site / Test Engineer	AC1 / Jay
Test Mode	802.11n-20MHz_TX_CH 11_SCAN ANT 0	Test Voltage	By PoE

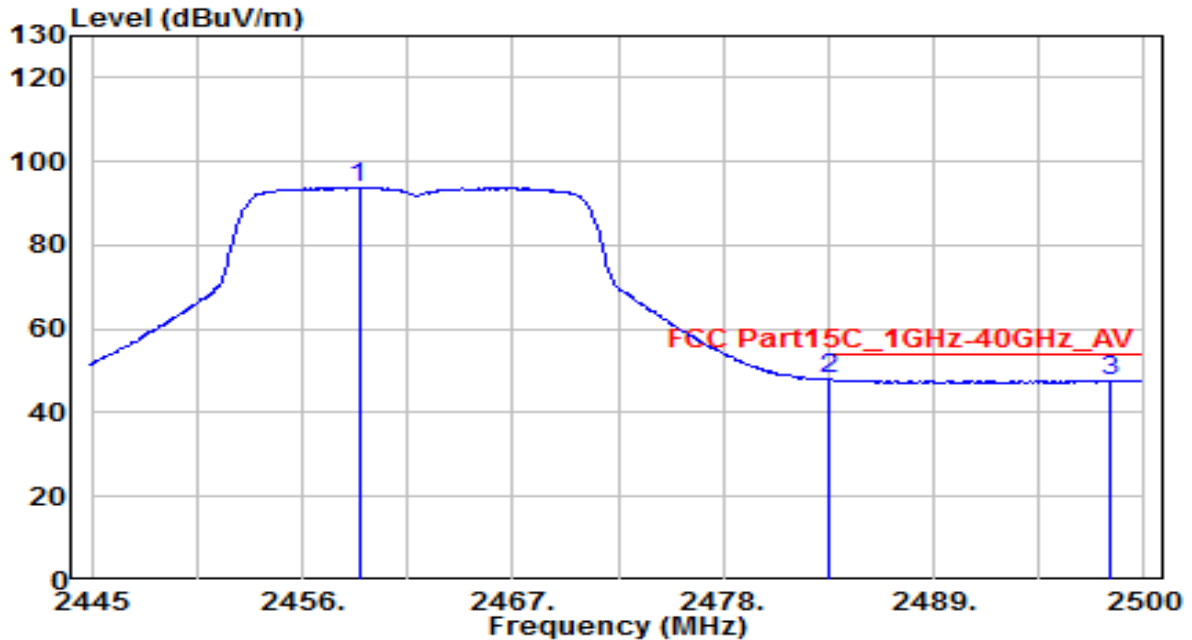

No	Frequency (MHz)	Reading (dBuV)	C.F (dB)	Measurement (dBuV/m)	Margin (dB)	Limit (dBuV/m)	Height (cm)	Angle (deg)	Remark (QP/PK/AV)
1	2458.960	61.34	32.51	93.84	N/A	N/A	160	120	Average
2	* 2483.500	15.27	32.61	47.88	-6.12	54.00	160	120	Average
3	2498.200	15.14	32.67	47.81	-6.19	54.00	160	120	Average

Note:

1. " *", means this data is the worst emission level.
2. C.F (Correction Factor) = Antenna Factor (dB/m)+ Cable Loss (dB).
3. Measurement (dBuV/m) = Reading(dBuV) + C.F (Correction Factor).
4. The emission levels of other frequencies are very lower than the limit and not show in test report.

EUT	AP351	Date of Test	2021-05-22
Factor	BBHA 9120D	Temp. / Humidity	25°C /66%
Polarity	Vertical	Site / Test Engineer	AC1 / Jay
Test Mode	802.11n-20MHz_TX_CH 11_SCAN ANT 0	Test Voltage	By PoE

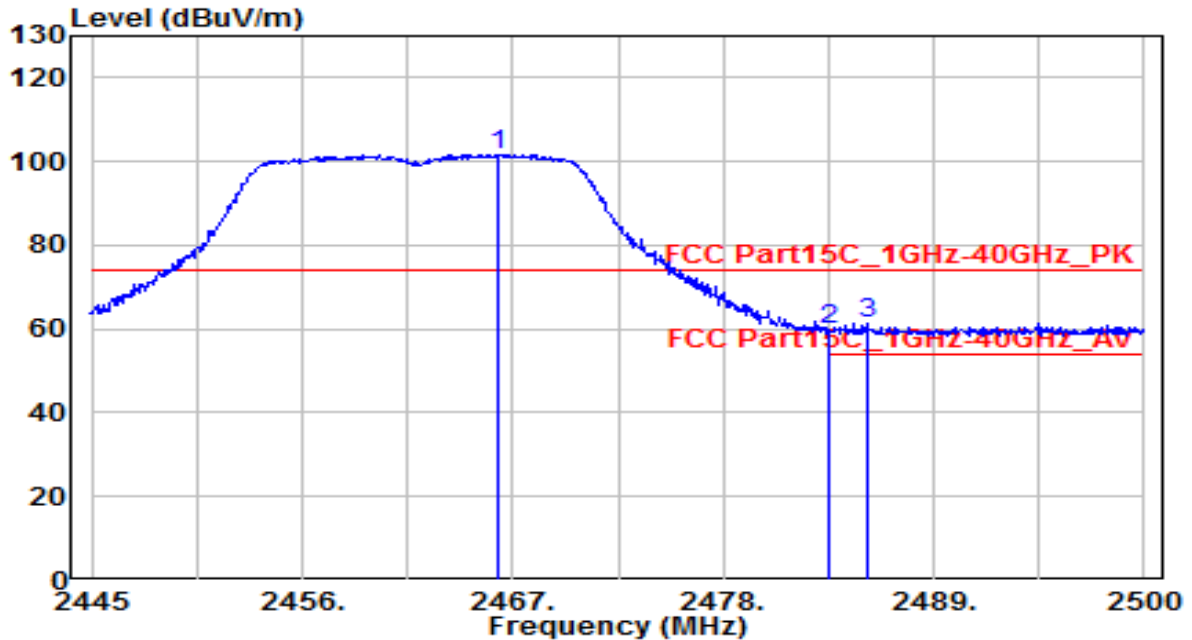

No	Frequency (MHz)	Reading (dBuV)	C.F (dB)	Measurement (dBuV/m)	Margin (dB)	Limit (dBuV/m)	Height (cm)	Angle (deg)	Remark (QP/PK/AV)
1	2466.220	69.09	32.54	101.63	N/A	N/A	140	155	Peak
2	2483.500	27.34	32.61	59.95	-14.05	74.00	140	155	Peak
3	* 2485.480	28.56	32.62	61.18	-12.82	74.00	140	155	Peak

Note:

1. " *", means this data is the worst emission level.
2. C.F (Correction Factor) = Antenna Factor (dB/m)+ Cable Loss (dB).
3. Measurement (dBuV/m) = Reading(dBuV) + C.F (Correction Factor).
4. The emission levels of other frequencies are very lower than the limit and not show in test report.

EUT	AP351	Date of Test	2021-05-22
Factor	BBHA 9120D	Temp. / Humidity	25°C /66%
Polarity	Vertical	Site / Test Engineer	AC1 / Jay
Test Mode	802.11n-20MHz_TX_CH 11_SCAN ANT 0	Test Voltage	By PoE

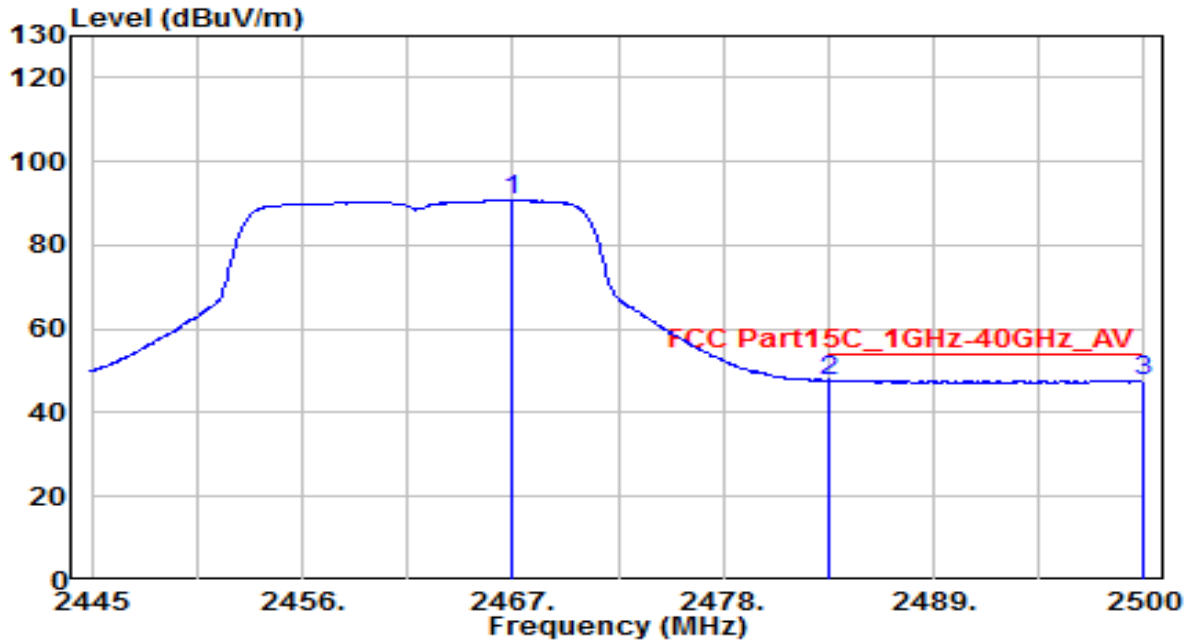

No	Frequency (MHz)	Reading (dBuV)	C.F (dB)	Measurement (dBuV/m)	Margin (dB)	Limit (dBuV/m)	Height (cm)	Angle (deg)	Remark (QP/PK/AV)
1	2466.940	58.21	32.54	90.75	N/A	N/A	140	155	Average
2	2483.500	14.97	32.61	47.58	-6.42	54.00	140	155	Average
3	* 2499.940	15.05	32.68	47.73	-6.27	54.00	140	155	Average

Note:

1. " *", means this data is the worst emission level.
2. C.F (Correction Factor) = Antenna Factor (dB/m)+ Cable Loss (dB).
3. Measurement (dBuV/m) = Reading(dBuV) + C.F (Correction Factor).
4. The emission levels of other frequencies are very lower than the limit and not show in test report.

EUT	AP351	Date of Test	2021-05-22
Factor	BBHA 9120D	Temp. / Humidity	25°C /66%
Polarity	Horizontal	Site / Test Engineer	AC1 / Jay
Test Mode	802.11n-40MHz_TX_CH 3_SCAN ANT 0	Test Voltage	By PoE

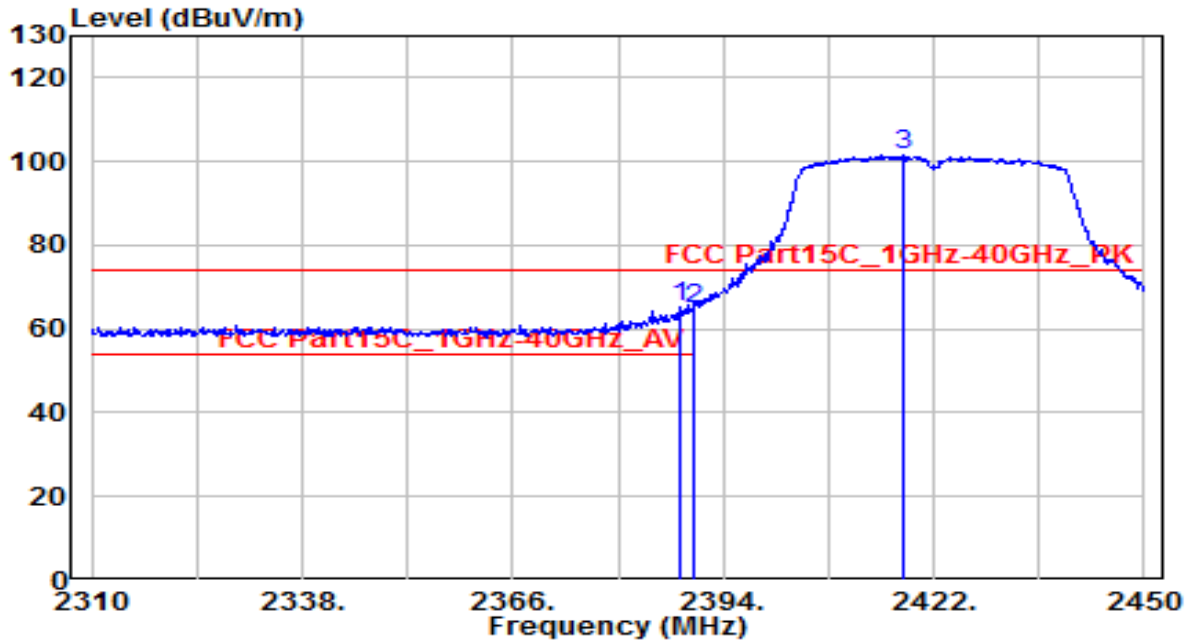

No	Frequency (MHz)	Reading (dBuV)	C.F (dB)	Measurement (dBuV/m)	Margin (dB)	Limit (dBuV/m)	Height (cm)	Angle (deg)	Remark (QP/PK/AV)
1	* 2388.120	33.02	32.21	65.23	-8.77	74.00	135	110	Peak
2	2390.000	32.70	32.22	64.92	-9.08	74.00	135	110	Peak
3	2417.940	69.14	32.34	101.48	N/A	N/A	135	110	Peak

Note:

- "*", means this data is the worst emission level.
- C.F (Correction Factor) = Antenna Factor (dB/m)+ Cable Loss (dB).
- Measurement (dBuV/m) = Reading(dBuV) + C.F (Correction Factor).
- The emission levels of other frequencies are very lower than the limit and not show in test report.

EUT	AP351	Date of Test	2021-05-22
Factor	BBHA 9120D	Temp. / Humidity	25°C /66%
Polarity	Horizontal	Site / Test Engineer	AC1 / Jay
Test Mode	802.11n-40MHz_TX_CH 3_SCAN ANT 0	Test Voltage	By PoE

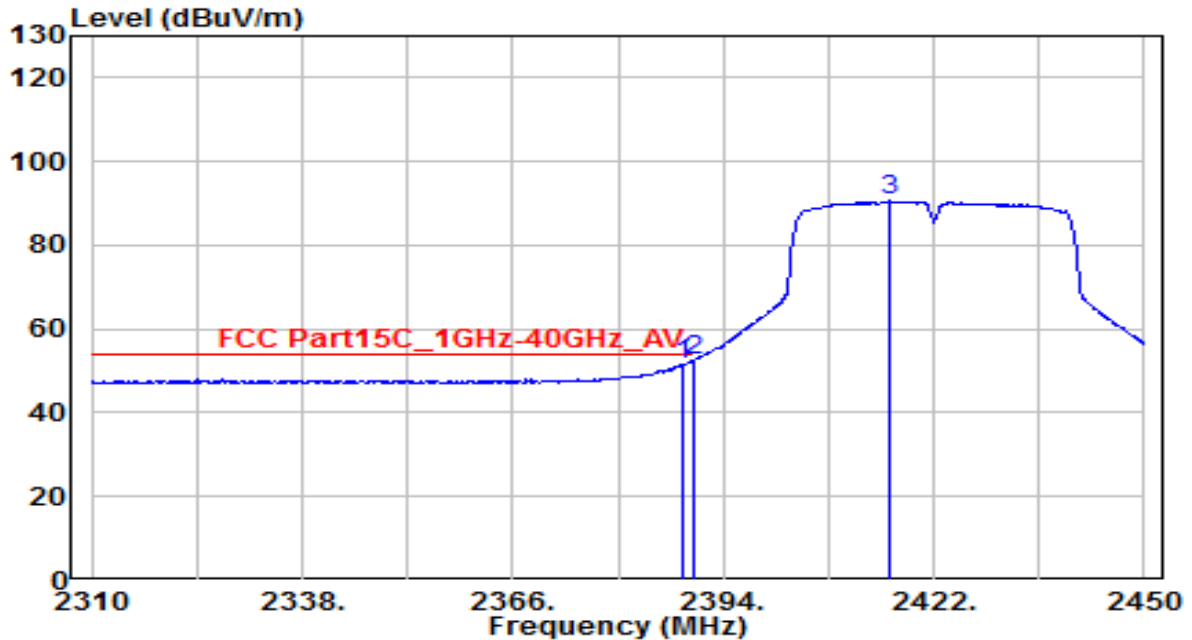

No	Frequency (MHz)	Reading (dBuV)	C.F (dB)	Measurement (dBuV/m)	Margin (dB)	Limit (dBuV/m)	Height (cm)	Angle (deg)	Remark (QP/PK/AV)
1	2388.540	19.24	32.21	51.45	-2.55	54.00	135	110	Average
2	* 2390.000	20.30	32.22	52.51	-1.49	54.00	135	110	Average
3	2416.260	58.27	32.33	90.59	N/A	N/A	135	110	Average

Note:

1. " *", means this data is the worst emission level.
2. C.F (Correction Factor) = Antenna Factor (dB/m)+ Cable Loss (dB).
3. Measurement (dBuV/m) = Reading(dBuV) + C.F (Correction Factor).
4. The emission levels of other frequencies are very lower than the limit and not show in test report.

EUT	AP351	Date of Test	2021-05-22
Factor	BBHA 9120D	Temp. / Humidity	25°C /66%
Polarity	Vertical	Site / Test Engineer	AC1 / Jay
Test Mode	802.11n-40MHz_TX_CH 3_SCAN ANT 0	Test Voltage	By PoE

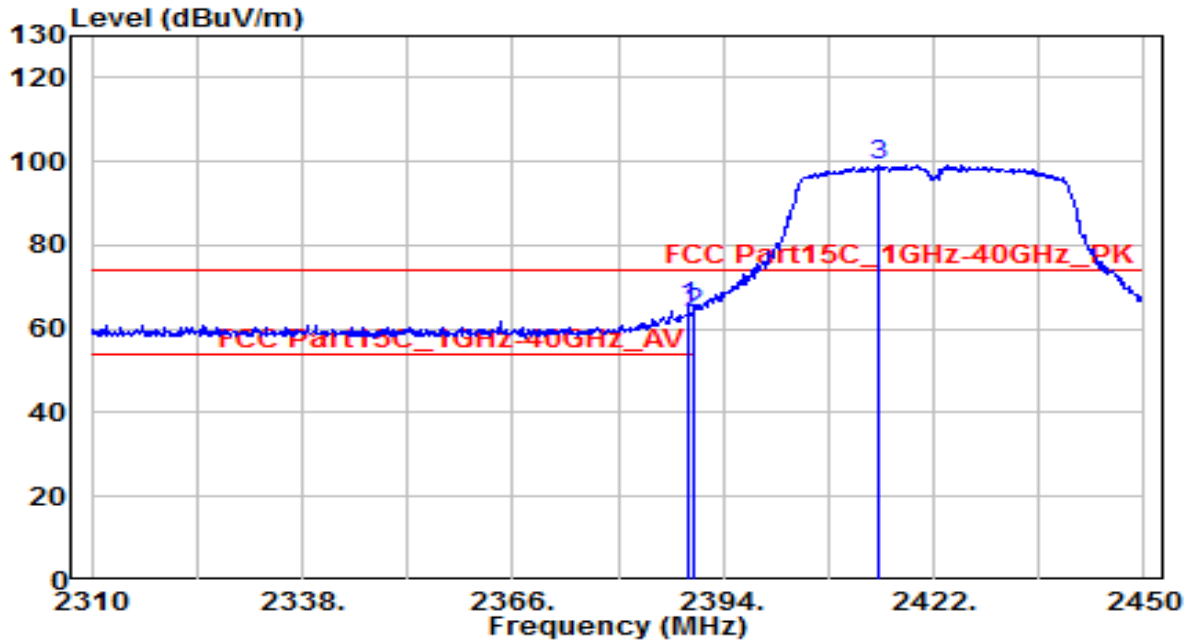

No	Frequency (MHz)	Reading (dBuV)	C.F (dB)	Measurement (dBuV/m)	Margin (dB)	Limit (dBuV/m)	Height (cm)	Angle (deg)	Remark (QP/PK/AV)
1	* 2389.380	33.23	32.22	65.45	-8.55	74.00	140	160	Peak
2	2390.000	31.45	32.22	63.67	-10.33	74.00	140	160	Peak
3	2414.720	66.75	32.32	99.07	N/A	N/A	140	160	Peak

Note:

1. " *", means this data is the worst emission level.
2. C.F (Correction Factor) = Antenna Factor (dB/m)+ Cable Loss (dB).
3. Measurement (dBuV/m) = Reading(dBuV) + C.F (Correction Factor).
4. The emission levels of other frequencies are very lower than the limit and not show in test report.

EUT	AP351	Date of Test	2021-05-22
Factor	BBHA 9120D	Temp. / Humidity	25°C /66%
Polarity	Vertical	Site / Test Engineer	AC1 / Jay
Test Mode	802.11n-40MHz_TX_CH 3_SCAN ANT 0	Test Voltage	By PoE

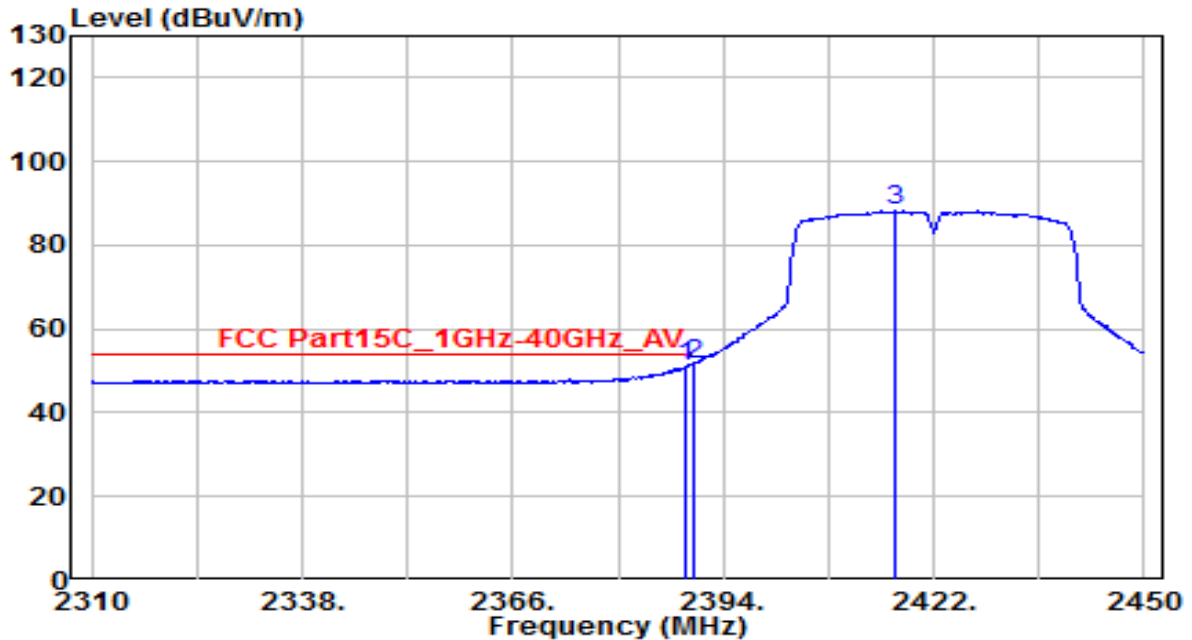

No	Frequency (MHz)	Reading (dBuV)	C.F (dB)	Measurement (dBuV/m)	Margin (dB)	Limit (dBuV/m)	Height (cm)	Angle (deg)	Remark (QP/PK/AV)
1	2388.820	18.59	32.21	50.80	-3.20	54.00	140	160	Average
2	* 2390.000	19.33	32.22	51.54	-2.46	54.00	140	160	Average
3	2416.820	55.95	32.33	88.29	N/A	N/A	140	160	Average

Note:

1. " *", means this data is the worst emission level.
2. C.F (Correction Factor) = Antenna Factor (dB/m)+ Cable Loss (dB).
3. Measurement (dBuV/m) = Reading(dBuV) + C.F (Correction Factor).
4. The emission levels of other frequencies are very lower than the limit and not show in test report.

EUT	AP351	Date of Test	2021-05-22
Factor	BBHA 9120D	Temp. / Humidity	25°C /66%
Polarity	Horizontal	Site / Test Engineer	AC1 / Jay
Test Mode	802.11n-40MHz_TX_CH 9_SCAN ANT 0	Test Voltage	By PoE

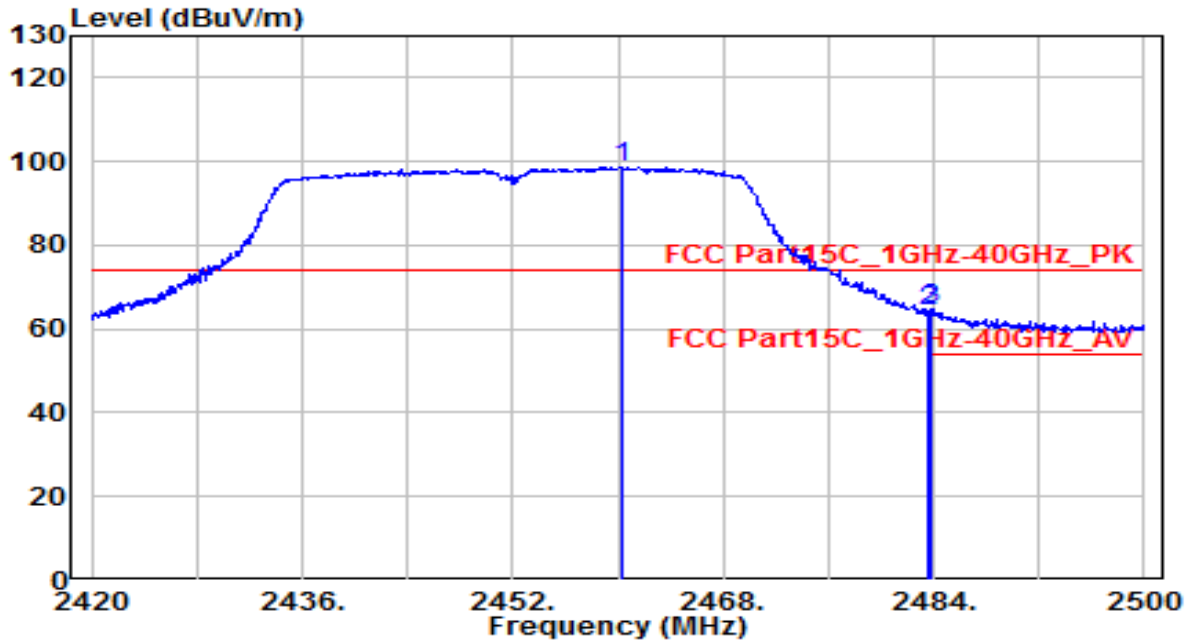

No	Frequency (MHz)	Reading (dBUV)	C.F (dB)	Measurement (dBUV/m)	Margin (dB)	Limit (dBUV/m)	Height (cm)	Angle (deg)	Remark (QP/PK/AV)
1	2460.240	66.29	32.51	98.81	N/A	N/A	150	130	Peak
2	2483.500	31.44	32.61	64.05	-9.95	74.00	150	130	Peak
3	* 2483.840	32.18	32.61	64.79	-9.21	74.00	150	130	Peak

Note:

1. " *", means this data is the worst emission level.
2. C.F (Correction Factor) = Antenna Factor (dB/m)+ Cable Loss (dB).
3. Measurement (dBUV/m) = Reading(dBUV) + C.F (Correction Factor).
4. The emission levels of other frequencies are very lower than the limit and not show in test report.

EUT	AP351	Date of Test	2021-05-22
Factor	BBHA 9120D	Temp. / Humidity	25°C /66%
Polarity	Horizontal	Site / Test Engineer	AC1 / Jay
Test Mode	802.11n-40MHz_TX_CH 9_SCAN ANT 0	Test Voltage	By PoE

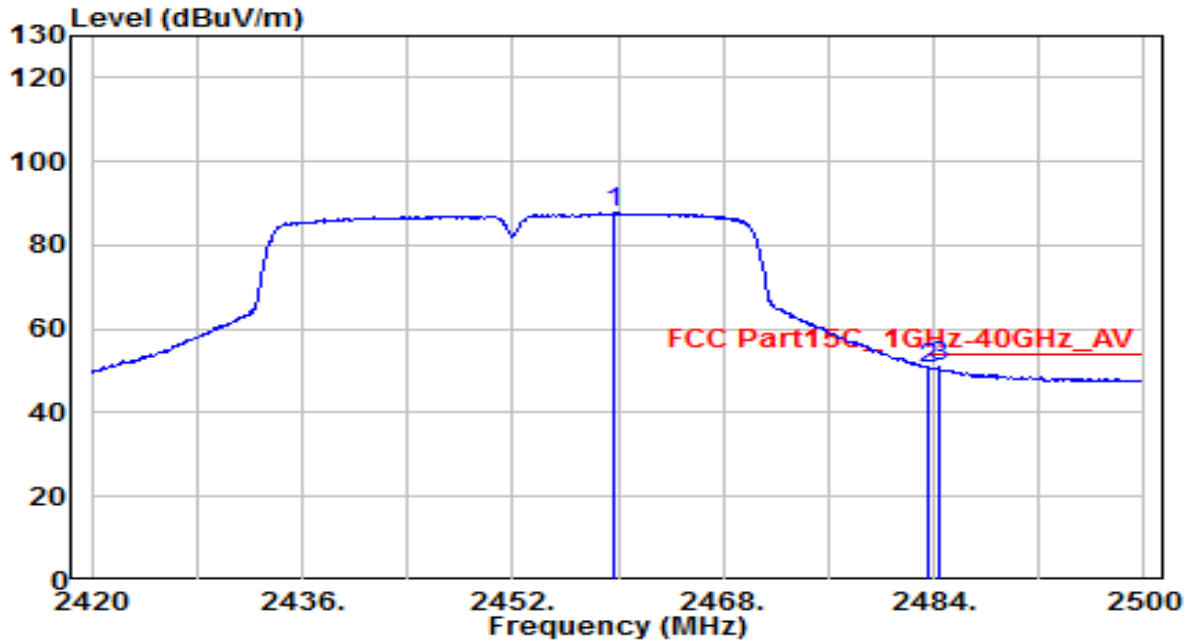

No	Frequency (MHz)	Reading (dBuV)	C.F (dB)	Measurement (dBuV/m)	Margin (dB)	Limit (dBuV/m)	Height (cm)	Angle (deg)	Remark (QP/PK/AV)
1	2459.760	55.17	32.51	87.69	N/A	N/A	150	130	Average
2	2483.500	18.03	32.61	50.64	-3.36	54.00	150	130	Average
3	* 2484.400	18.23	32.61	50.85	-3.15	54.00	150	130	Average

Note:

1. " *", means this data is the worst emission level.
2. C.F (Correction Factor) = Antenna Factor (dB/m)+ Cable Loss (dB).
3. Measurement (dBuV/m) = Reading(dBuV) + C.F (Correction Factor).
4. The emission levels of other frequencies are very lower than the limit and not show in test report.

EUT	AP351	Date of Test	2021-05-22
Factor	BBHA 9120D	Temp. / Humidity	25°C /66%
Polarity	Vertical	Site / Test Engineer	AC1 / Jay
Test Mode	802.11n-40MHz_TX_CH 9_SCAN ANT 0	Test Voltage	By PoE

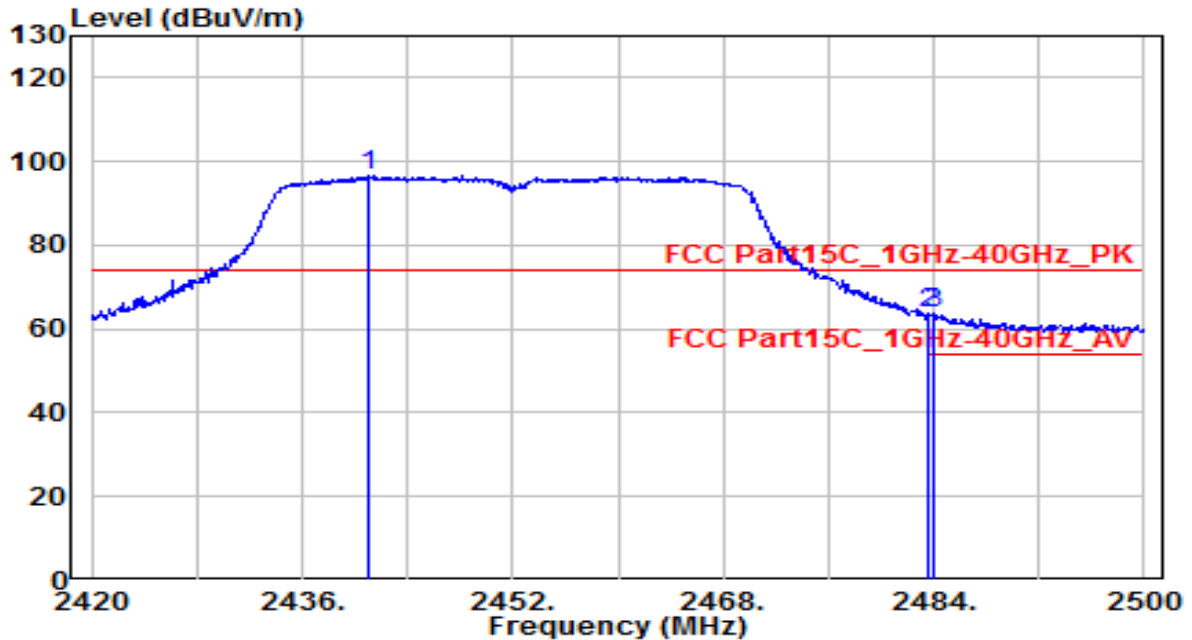

No	Frequency (MHz)	Reading (dBuV)	C.F (dB)	Measurement (dBuV/m)	Margin (dB)	Limit (dBuV/m)	Height (cm)	Angle (deg)	Remark (QP/PK/AV)
1	2440.960	63.97	32.43	96.40	N/A	N/A	120	155	Peak
2	2483.500	30.93	32.61	63.54	-10.46	74.00	120	155	Peak
3	* 2484.000	31.28	32.61	63.89	-10.11	74.00	120	155	Peak

Note:

1. " *", means this data is the worst emission level.
2. C.F (Correction Factor) = Antenna Factor (dB/m)+ Cable Loss (dB).
3. Measurement (dBuV/m) = Reading(dBuV) + C.F (Correction Factor).
4. The emission levels of other frequencies are very lower than the limit and not show in test report.

EUT	AP351	Date of Test	2021-05-22
Factor	BBHA 9120D	Temp. / Humidity	25°C /66%
Polarity	Vertical	Site / Test Engineer	AC1 / Jay
Test Mode	802.11n-40MHz_TX_CH 9_SCAN ANT 0	Test Voltage	By PoE

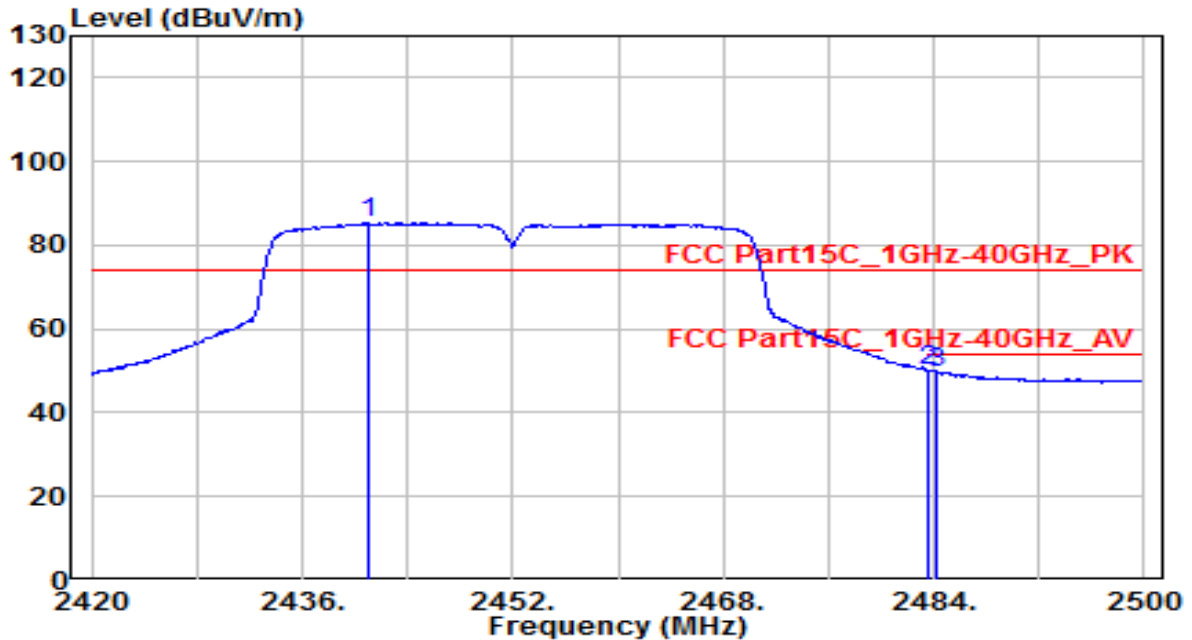

No	Frequency (MHz)	Reading (dBUV)	C.F (dB)	Measurement (dBUV/m)	Margin (dB)	Limit (dBUV/m)	Height (cm)	Angle (deg)	Remark (QP/PK/AV)
1	2441.120	52.86	32.43	85.29	N/A	N/A	120	155	Peak
2	* 2483.500	17.54	32.61	50.15	-23.85	74.00	120	155	Peak
3	2484.240	17.11	32.61	49.72	-24.28	74.00	120	155	Peak

Note:

1. " *", means this data is the worst emission level.
2. C.F (Correction Factor) = Antenna Factor (dB/m)+ Cable Loss (dB).
3. Measurement (dBUV/m) = Reading(dBUV) + C.F (Correction Factor).
4. The emission levels of other frequencies are very lower than the limit and not show in test report.

6.8. AC Conducted Emissions Measurement

6.8.1. Test Limit

FCC Part 15 Subpart C Paragraph 15.207 Limits		
Frequency (MHz)	QP (dBuV)	AV (dBuV)
0.15 - 0.50	66 - 56	56 - 46
0.50 - 5.0	56	46
5.0 - 30	60	50

Note 1: The lower limit shall apply at the transition frequencies.

Note 2: The limit decreases linearly with the logarithm of the frequency in the range 0.15MHz to 0.5MHz.

6.8.2. Test Setup

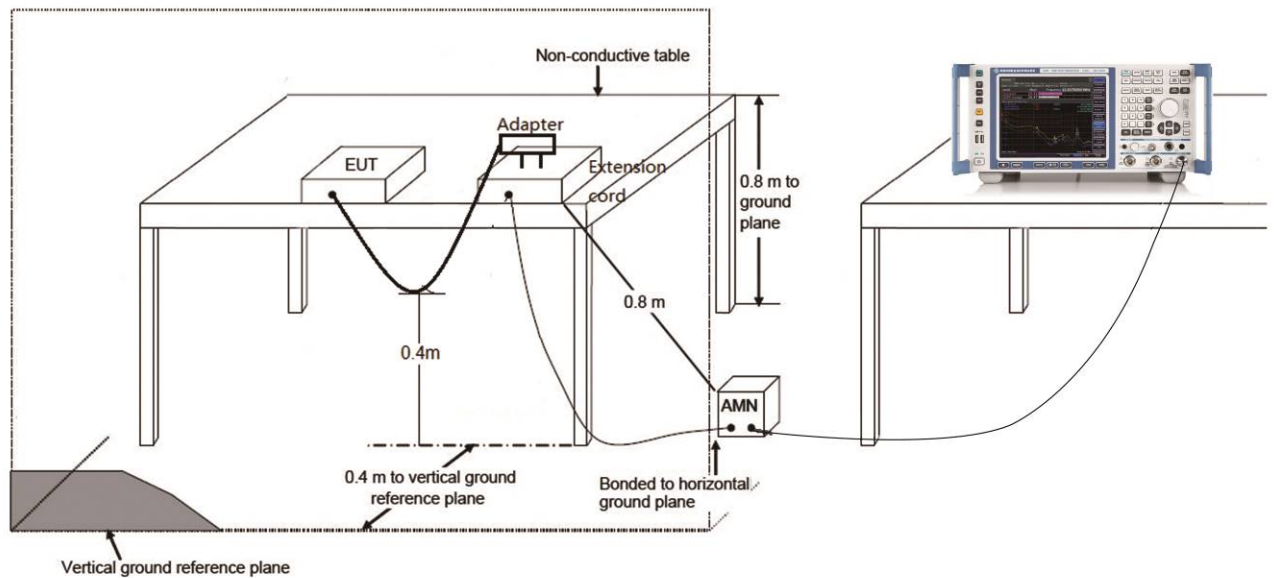

6.8.3. Test Result

EUT	AP351	Date of Test	2021-06-12
Factor	CE_ENV216-L1 (Filter ON)_2020	Temp. / Humidity	21.9°C /58.4%
Polarity	Line1	Site / Test Engineer	SR2 / Peter
Test Mode	802.11n-40MHz_TX_CH 9	Test Voltage	120V/60Hz

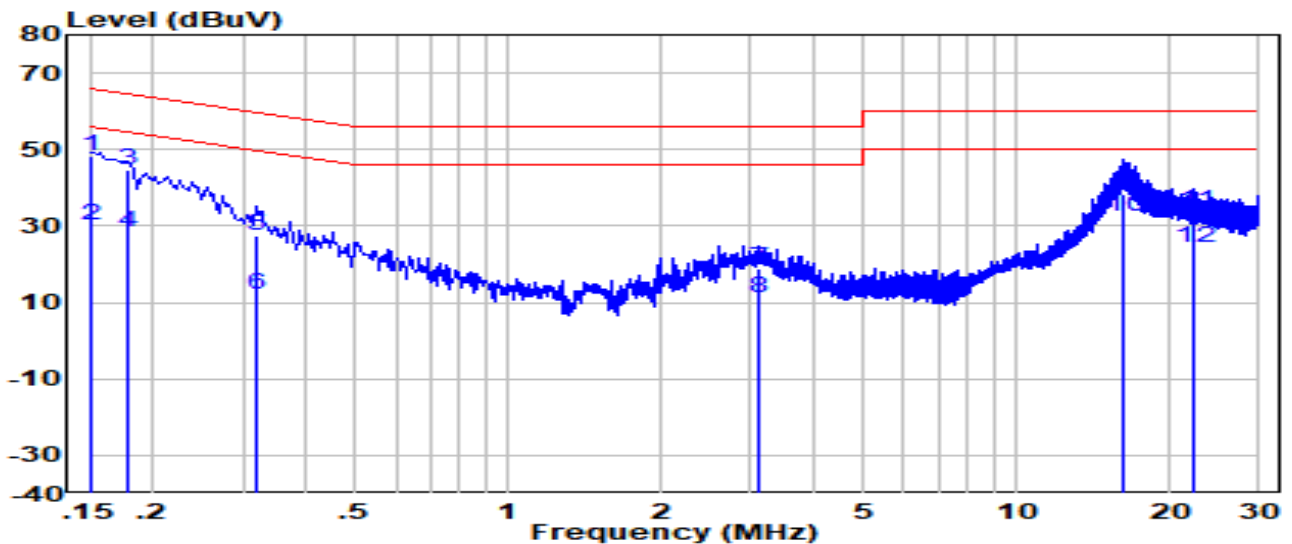

No	Frequency (MHz)	Reading (dBuV)	C.F (dB)	Measurement (dBuV/m)	Margin (dB)	Limit (dBuV/m)	Remark (QP/PK/AV)
1	*	38.50	9.61	48.11	-17.89	66.00	QP
2		20.80	9.61	30.41	-35.59	66.00	Average
3		34.92	9.61	44.53	-20.05	64.58	QP
4		18.92	9.61	28.53	-36.05	64.58	Average
5		17.94	9.62	27.56	-32.20	59.76	QP
6		2.34	9.62	11.96	-47.80	59.76	Average
7		9.29	9.71	19.00	-37.00	56.00	QP
8		1.39	9.71	11.10	-44.90	56.00	Average
9		28.59	9.94	38.53	-21.47	60.00	QP
10		22.39	9.94	32.33	-27.67	60.00	Average
11		23.98	10.01	34.00	-26.00	60.00	QP
12		14.28	10.01	24.30	-35.70	60.00	Average

Note:

1. " *", means this data is the worst emission level.
2. C.F (Correction Factor) = LISN Factor (dB)+ Cable Loss (dB).
3. Measurement(dBuV/m) = Reading(dBuV) + C.F (Correction Factor).

EUT	AP351	Date of Test	2021-06-12
Factor	CE_ENV216-N (Filter ON)_2020	Temp. / Humidity	21.9°C /58.4%
Polarity	Neutral	Site / Test Engineer	SR2 / Peter
Test Mode	802.11n-40MHz_TX_CH 9	Test Voltage	120V/60Hz

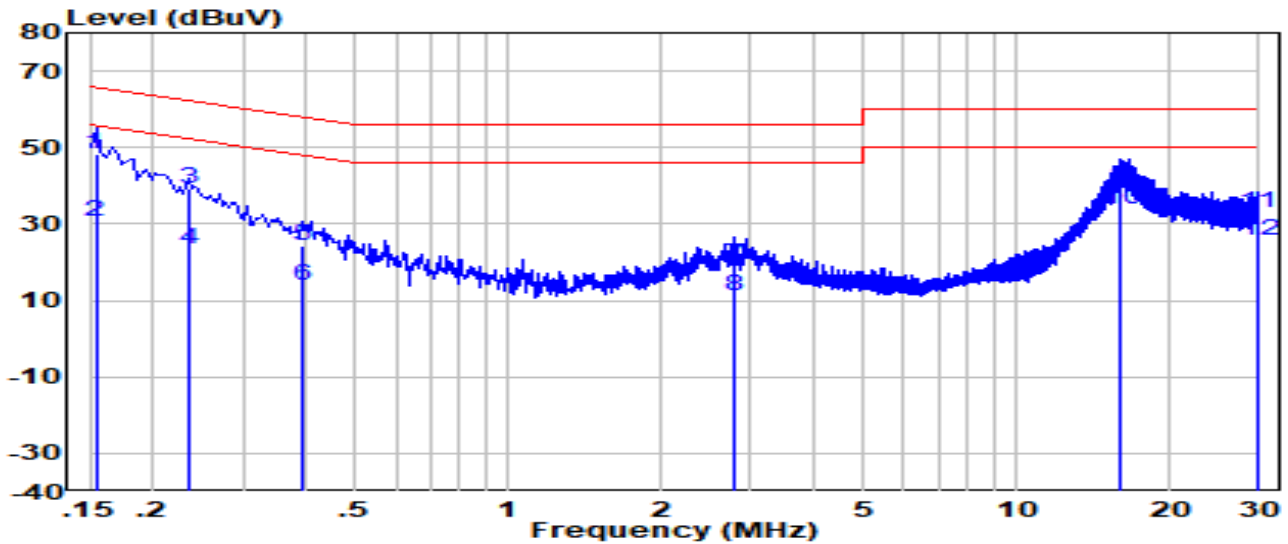

No	Frequency (MHz)	Reading (dBUV)	C.F (dB)	Measurement (dBUV/m)	Margin (dB)	Limit (dBUV/m)	Remark (QP/PK/AV)
1	* 0.154	38.58	9.62	48.20	-17.58	65.78	QP
2	0.154	21.18	9.62	30.80	-34.98	65.78	Average
3	0.234	29.61	9.62	39.23	-23.08	62.31	QP
4	0.234	13.61	9.62	23.23	-39.08	62.31	Average
5	0.394	14.54	9.63	24.17	-33.81	57.98	QP
6	0.394	4.34	9.63	13.97	-44.01	57.98	Average
7	2.800	9.58	9.71	19.29	-36.71	56.00	QP
8	2.800	1.68	9.71	11.39	-44.61	56.00	Average
9	16.080	29.71	10.00	39.71	-20.29	60.00	QP
10	16.080	23.81	10.00	33.81	-26.19	60.00	Average
11	29.680	22.85	10.23	33.09	-26.91	60.00	QP
12	29.680	15.55	10.23	25.79	-34.21	60.00	Average

Note:

1. "*" , means this data is the worst emission level.
2. C.F (Correction Factor) = LISN Factor (dB)+ Cable Loss (dB).
3. Measurement(dBUV/m) = Reading(dBUV) + C.F (Correction Factor).

7. CONCLUSION

The data collected relate only the item(s) tested and show that the device is compliance with Part 15C of the FCC rules.

The End

Appendix A - Test Setup Photograph

Refer to "2107TW0105-UT" file.

Appendix B - EUT Photograph

Refer to "2107TW0105-UE" file.