



## MEASUREMENT REPORT

### FCC PART 15C

#### (WLAN 802.11b/g/n/ax)

---

**FCC ID** : 2ALJ3AP35X  
**APPLICANT** : HAN Networks Co., Ltd.  
**Product** : HAN Access Point  
**Model No.** : AP351  
**Brand Name** : HANNETWORKS, HAN NETWORKS  
**FCC Classification** : Digital Transmission System (DTS)  
**FCC Rule Part(s)** : Part 15 Subpart C (Section 15.247)  
**Test Procedure(s)** : ANSI C63.10-2013  
**Result** : Complies  
**Received Date** : March 17,2021  
**Test Date** : April 12~ June 12,2021

**Tested By** : *Fran Chen*  
( Fran Chen )  
**Reviewed By** : *Paddy Chen*  
( Paddy Chen )  
**Approved By** : *Chenz Ker*  
( Chenz Ker )



The test results relate only to the samples tested.

This equipment has been shown to be capable of compliance with the applicable technical standards as indicated in the measurement report and was tested in accordance with the measurement procedures specified in ANSI C63.10-2013. Test results reported herein relate only to the item(s) tested.

The test report shall not be reproduced except in full without the written approval of MRT Technology (Taiwan) Co., Ltd.

## Revision History

Report No.	Version	Description	Issue Date	Note
2107TW0105-U1	1.0	Original Report	2021-08-01	Valid

Note: This is a copy report based on MRT original report (report No.: 2105TW0102-U1). It only changed the information of the applicant and the product. The hardware and software of the product are the same.

---

## CONTENTS

Description	Page
<b>1. General Information .....</b>	<b>5</b>
1.1. Applicant .....	5
1.2. Manufacturer .....	5
1.3. Testing Facility .....	5
<b>2. PRODUCT INFORMATION .....</b>	<b>6</b>
2.1. Equipment Description .....	6
2.2. Product Specification Subjective to this Report .....	6
2.3. Working Frequencies for this report .....	7
2.4. Description of Available Antennas .....	7
2.5. Test Mode .....	9
2.6. Configuration of Test System .....	9
2.7. Test System Details .....	10
2.8. Description of Test Software .....	10
2.9. Duty Cycle .....	11
2.10. EMI Suppression Device(s)/Modifications .....	13
2.11. Test Environment Condition .....	13
<b>3. ANTENNA REQUIREMENTS .....</b>	<b>14</b>
<b>4. TEST EQUIPMENT CALIBRATION DATE .....</b>	<b>15</b>
<b>5. MEASUREMENT UNCERTAINTY .....</b>	<b>16</b>
<b>6. TEST RESULT .....</b>	<b>17</b>
6.1. Summary .....	17
6.2. 6dB Bandwidth Measurement .....	18
6.2.1. Test Limit .....	18
6.2.2. Test Procedure used .....	18
6.2.3. Test Setting .....	18
6.2.4. Test Setup .....	18
6.2.5. Test Result .....	19
6.3. Output Power Measurement .....	31
6.3.1. Test Limit .....	31
6.3.2. Test Procedure Used .....	31
6.3.3. Test Setting .....	31
6.3.4. Test Setup .....	31
6.3.5. Test Result .....	32
6.4. Power Spectral Density Measurement .....	34

---

6.4.1.	Test Limit.....	34
6.4.2.	Test Procedure Used .....	34
6.4.3.	Test Setting .....	34
6.4.4.	Test Setup .....	35
6.4.5.	Test Result .....	36
6.5.	Conducted Band Edge and Out-of-Band Emissions.....	66
6.5.1.	Test Limit.....	66
6.5.2.	Test Procedure Used .....	66
6.5.3.	Test Settintg .....	66
6.5.4.	Test Setup .....	67
6.5.5.	Test Result .....	68
6.6.	Radiated Spurious Emission Measurement.....	126
6.6.1.	Test Limit.....	126
6.6.2.	Test Procedure Used .....	126
6.6.3.	Test Setting .....	126
6.6.4.	Test Setup .....	128
6.6.5.	Test Result .....	129
6.7.	Radiated Restricted Band Edge Measurement .....	193
6.7.1.	Test Limit.....	193
6.7.2.	Test Procedure Used .....	194
6.7.3.	Test Setting .....	194
6.7.4.	Test Setup .....	195
6.7.5.	Test Result .....	196
6.8.	AC Conducted Emissions Measurement .....	276
6.8.1.	Test Limit.....	276
6.8.2.	Test Setup .....	276
6.8.3.	Test Result .....	277
<b>7.</b>	<b>CONCLUSION .....</b>	<b>279</b>
	<b>Appendix A - Test Setup Photograph .....</b>	<b>280</b>
	<b>Appendix B - EUT Photograph .....</b>	<b>281</b>

## 1. General Information

### 1.1. Applicant

HAN Networks Co., Ltd.

101-A16, 1st Floor, Building 3, No.9 compound, Yongfeng Road, Haidian District, Beijing, P.R. China

### 1.2. Manufacturer

HAN Networks Co., Ltd.

101-A16, 1st Floor, Building 3, No.9 compound, Yongfeng Road, Haidian District, Beijing, P.R. China

### 1.3. Testing Facility

<input type="checkbox"/>	<b>Test Site - MRT Suzhou Laboratory</b>
	<b>Laboratory Location (Suzhou - Wuzhong)</b> D8 Building, No.2 Tian'edang Rd., Wuzhong Economic Development Zone, Suzhou, China
	<b>Laboratory Location (Suzhou - SIP)</b> 4b Building, Liando U Valley, No.200 Xingpu Rd., Shengpu Town, Suzhou Industrial Park, China
	<b>Laboratory Accreditations</b>
	A2LA: 3628.01 FCC: CN1166 VCCI: R-20025, G-20034, C-20020, T-20020
	CNAS: L10551 ISED: CN0001
<input type="checkbox"/>	<b>Test Site - MRT Shenzhen Laboratory</b>
	<b>Laboratory Location (Shenzhen)</b> 1G, Building A, Junxiangda Building, Zhongshanyuan Road West, Nanshan District, Shenzhen, China
	<b>Laboratory Accreditations</b>
	A2LA: 3628.02 FCC: CN1284
	CNAS: L10551 ISED: CN0105
<input checked="" type="checkbox"/>	<b>Test Site - MRT Taiwan Laboratory</b>
	<b>Laboratory Location (Taiwan)</b> No. 38, Fuxing 2nd Rd., Guishan Dist., Taoyuan City 333, Taiwan (R.O.C.)
	<b>Laboratory Accreditations</b>
	TAF: L3261-190725 FCC: 291082, TW3261
	ISED: TW3261

## 2. PRODUCT INFORMATION

### 2.1. Equipment Description

Product Name	HAN Access Point
Model No.	AP351
Brand Name	HANNETWORKS, HAN NETWORKS
Operating Temperature	0 ~ 45 °C
Wi-Fi Specification	802.11a/b/g/n/ac/ax
Accessories	
AC/DC Adapter	Model: ADP-50GR B Input: 100-240V ~ 50/60Hz, 1.3A Output: 48.0V, 1.042A, 50.1W MAX
PoE Injector	Model: POE60U-1BT-X Input: 100-240V ~ 1.5A, 50/60Hz Output: 56.0V, 0.535A, (Pin 3,6+ to pin 1,2 Return); 56V dc, 0.535A(pin 4,5+ to Pin 7,8 Return)

Note: The AC/DC adapter and PoE Injector are not sold with product.

### 2.2. Product Specification Subjective to this Report

Frequency Range	802.11b/g/n-HT20/ax-HE20: 2412 ~ 2462MHz 802.11n-HT40/ax-HE40: 2422 ~ 2452MHz
Channel Number	802.11b/g/n-HT20/ax-HE20: 11 802.11n-HT40/ax-HE40: 7
Type of Modulation	802.11b: DSSS 802.11g/n: OFDM 802.11ax: OFDMA
Data Rate	802.11b: 1/2/5.5/11Mbps 802.11g: 6/9/12/18/24/36/48/54Mbps 802.11n: up to 600Mbps 802.11ax: up to 1147.2Mbps
Scan Antenna	
Frequency Range:	802.11b/g/n-HT20:2412 ~ 2462 MHz 802.11n-HT40: 2422 ~ 2452MHz
Type of Modulation:	802.11b: DSSS; 802.11g/n: OFDM
Data Rate:	802.11b: 1/2/5.5/11Mbps; 802.11g: 6/9/12/18/24/36/48/54Mbps 802.11n: up to 150Mbps

Note

1. For other features of this EUT, test report will be issued separately.

2.The information of EUT was provided by the manufacturer, and the accuracy of the information shall be the responsibility of the manufacturer.

### 2.3. Working Frequencies for this report

802.11b/g/n-HT20/ax-HE20

Channel	Frequency	Channel	Frequency	Channel	Frequency
01	2412 MHz	02	2417 MHz	03	2422 MHz
04	2427 MHz	05	2432 MHz	06	2437 MHz
07	2442 MHz	08	2447 MHz	09	2452 MHz
10	2457 MHz	11	2462 MHz	--	--

802.11n-HT40/ax-HE40

Channel	Frequency	Channel	Frequency	Channel	Frequency
03	2422 MHz	04	2427 MHz	05	2432 MHz
06	2437 MHz	07	2442 MHz	08	2447 MHz
09	2452 MHz	--	--	--	--

### 2.4. Description of Available Antennas

Antenna Type	Frequency Band (MHz)	Tx Paths	Max Antenna Gain (dBi)	Directional Gain (dBi)		Beamforming Directional Gain (dBi)
				For Power	For PSD	
PIFA Antenna	2400 ~ 2483.5	4	3.9	3.9	9.92	9.92
Dipole Antenna	5150 ~ 5350	4	3.8	3.8	9.82	9.82
PIFA & Dipole Antenna	5470 ~ 5850	8	3.9	BW $\geq$ 40M, 3.9 BW=20M, 6.9	12.93	12.93
<b>Scanning</b>						
Dipole Antenna	2400 ~ 2483.5	1	3.5	3.5	3.5	--
Dipole Antenna	5150 ~ 5250 & 5725 ~5850	1	3.9	3.9	3.9	--
<b>Bluetooth</b>						
Dipole	2400 ~ 2483.5	1	3.5	3.5	3.5	--

Antenna						
<p>Remark:</p> <ol style="list-style-type: none"><li>1. The EUT supports Cyclic Delay Diversity (CDD) mode and beamforming mode.</li><li>2. All antenna information (Antenna type and Peak Gain) is provided by the manufacturer.</li><li>3. High gain antenna power setting will be reduced according to difference value of antenna gain declared by applicant.</li></ol>						



## 2.5. Test Mode

Test Mode	Mode 1: Transmit by 802.11b (1Mbps)
	Mode 2: Transmit by 802.11g (6Mbps)
	Mode 3: Transmit by 802.11n-HT20 (MCS0)
	Mode 4: Transmit by 802.11n-HT40 (MCS0)
	Mode 5: Transmit by 802.11ax-HE20 (MCS0)
	Mode 6: Transmit by 802.11ax-HE40 (MCS0)
	Mode 7: Transmit by 802.11b (1Mbps) - Scan Antenna
	Mode 8: Transmit by 802.11g (6Mbps) - Scan Antenna
	Mode 9: Transmit by 802.11n-HT20 (MCS0) - Scan Antenna
	Mode 10: Transmit by 802.11n-HT40 (MCS0) - Scan Antenna

Note: The EUT can't operate in the same frequency band at the same time.

## 2.6. Configuration of Test System

The device was tested per the guidance ANSI C63.10-2013 was used to reference the appropriate EUT setup for radiated emissions testing and AC line conducted testing.

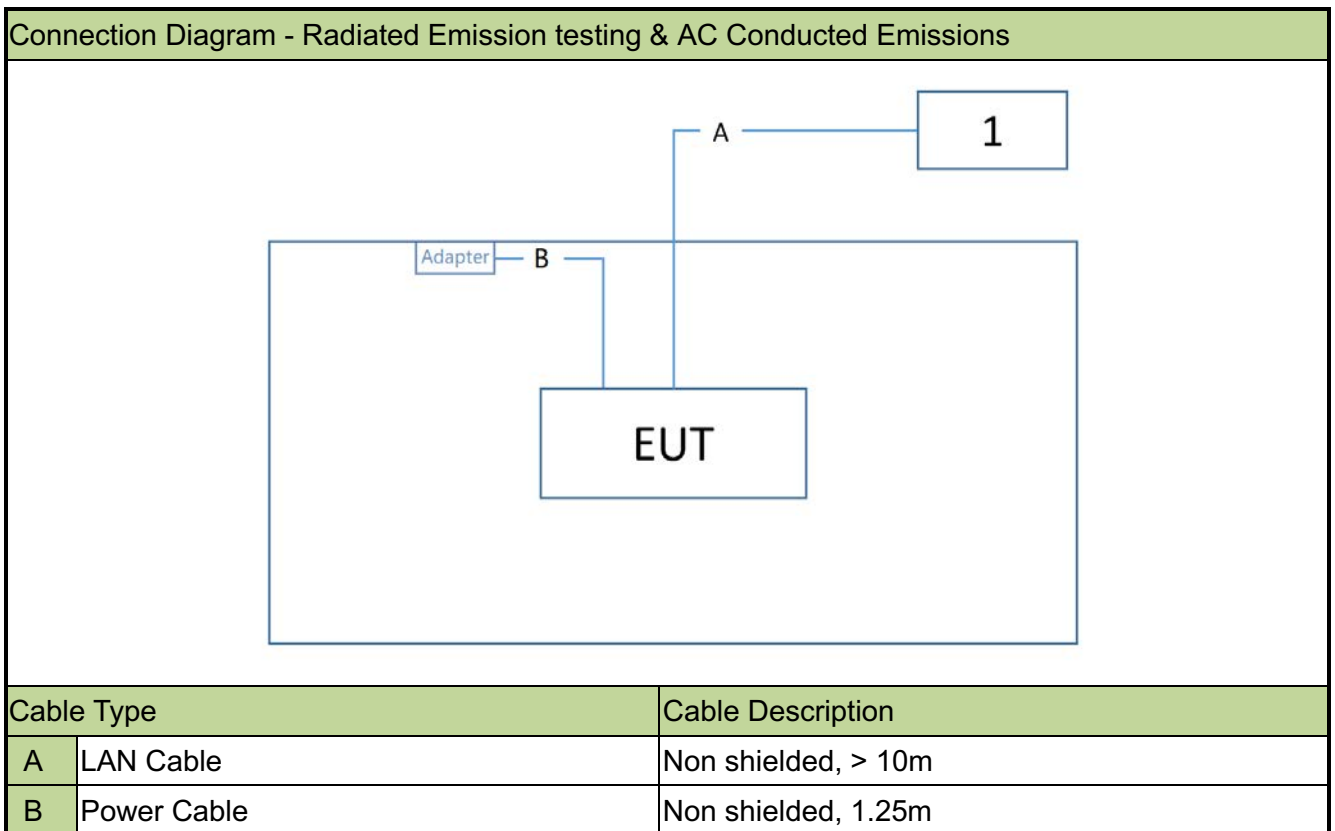

## 2.7. Test System Details

Product		Manufacturer	Model No.
1	Notebook	Dell	P62G

## 2.8. Description of Test Software

The test utility software used during testing was “QSPR”, and the version was 5.0-00099.

Note: Final power setting please refer to operational description.

## 2.9. Duty Cycle

The maximum achievable duty cycles for all modes were determined based on measurements performed on a spectrum analyzer in zero-span mode with RBW = 8MHz, VBW = 50MHz. The RBW and VBW were both greater than 50/T, where T is the minimum transmission duration, and the number of sweep points across T was greater than 100. The duty cycles are as follows:

Test Mode	Duty Cycle	Test Mode – Scan Antenna	Duty Cycle
802.11b	65.47%	802.11b	99.51%
802.11g	94.55%	802.11g	96.11%
802.11n-HT20	95.37%	802.11n-HT20	95.83%
802.11n-HT40	93.55%	802.11n-HT40	92.52%
802.11ax-HE20	95.56%	--	--
802.11ax-HE40	95.38%	--	--

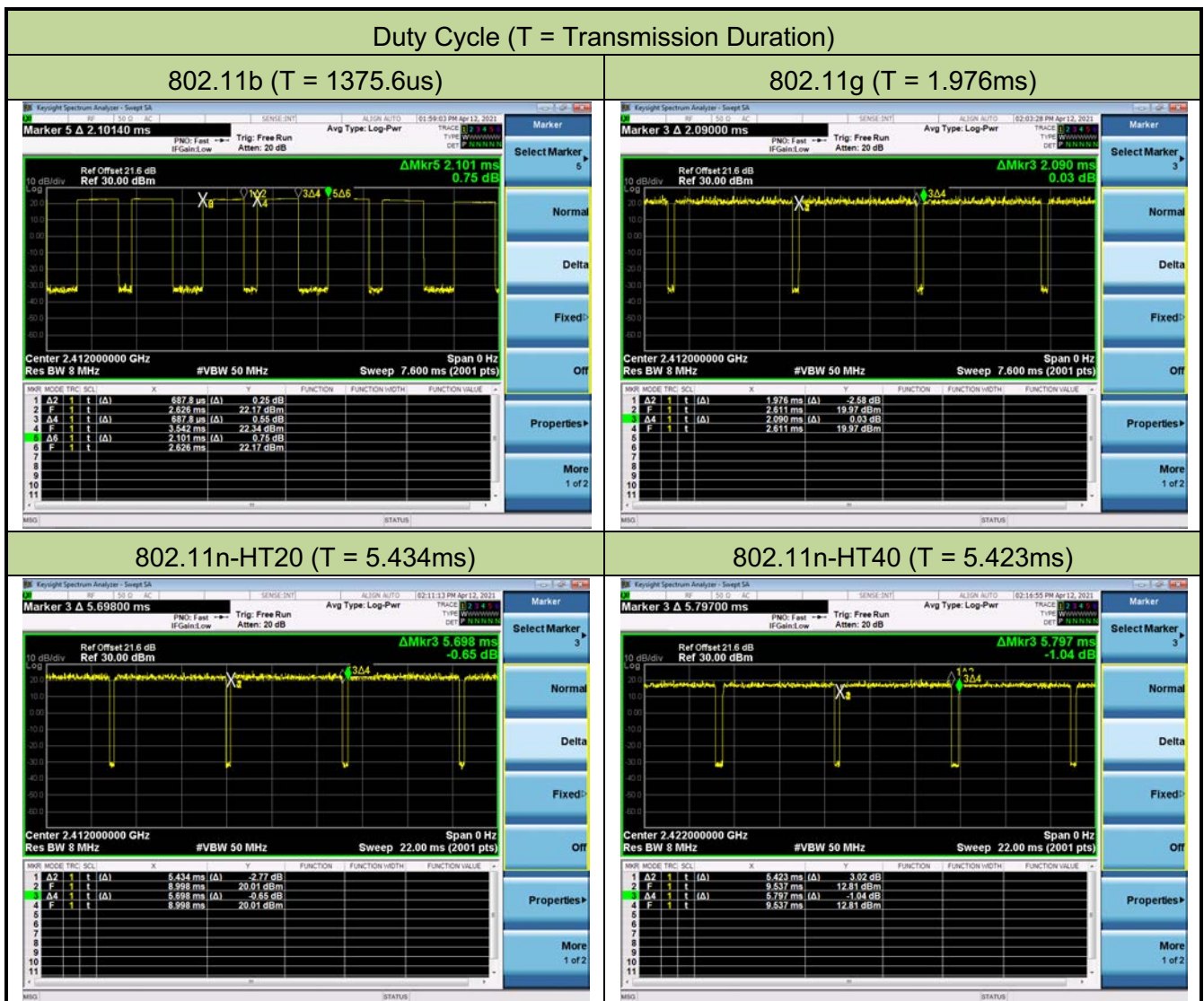

Duty Cycle (T = Transmission Duration)

802.11ax-HE20 (T = 5.445ms)

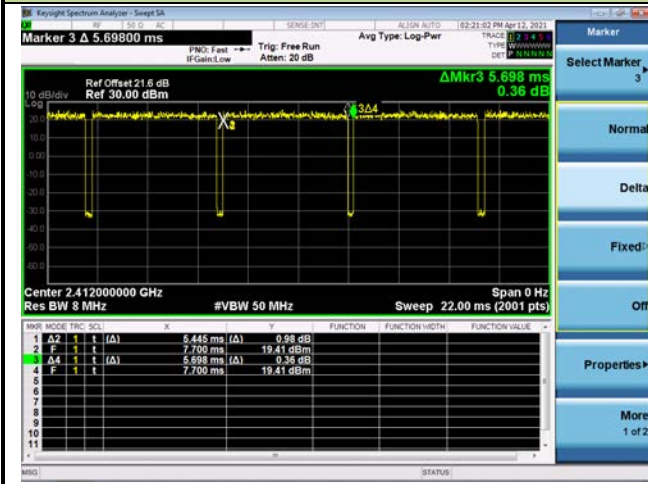

802.11ax-HE40 (T = 5.445us)

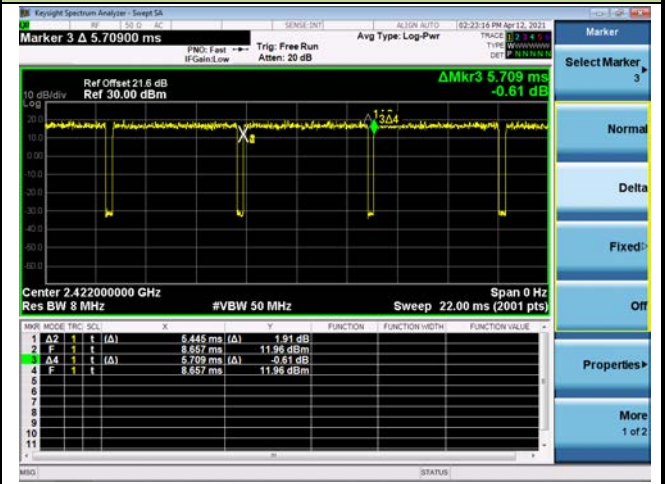

Duty Cycle (T = Transmission Duration) – Scan Antenna

802.11b (T = 12.22ms)



802.11g (T = 2.028ms)

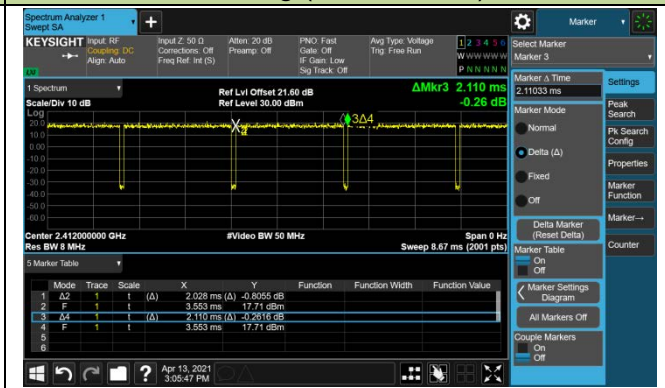

802.11n-HT20 (T = 1.885ms)

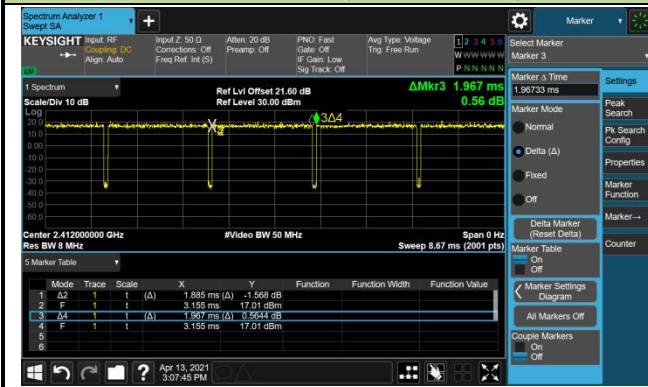

802.11n-HT40 (T = 928.0us)

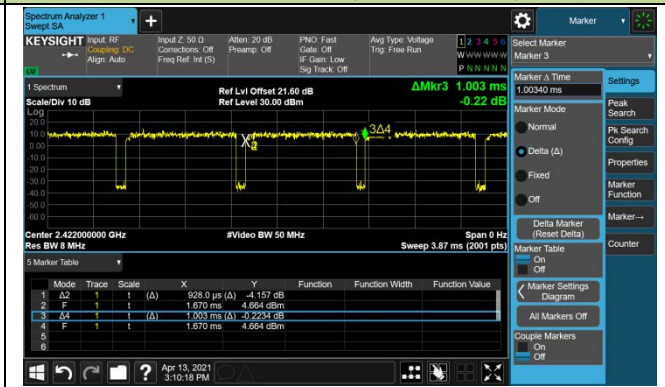

**2.10. EMI Suppression Device(s)/Modifications**

No EMI suppression device(s) were added and/or no modifications were made during testing.

**2.11. Test Environment Condition**

Ambient Temp.	15 ~ 35°C
Relative Humidity	20 ~ 75%RH

### 3. ANTENNA REQUIREMENTS

**Excerpt from §15.203 of the FCC Rules/Regulations:**

“An intentional radiator antenna shall be designed to ensure that no antenna other than that furnished by the responsible party can be used with the device. The use of a permanently attached antenna or of an antenna that uses a unique coupling to the intentional radiator shall be considered sufficient to comply with the provisions of this section.”

- The antenna of the device is **permanently attached**.
- There are no provisions for connection to an external antenna.

**Conclusion:**

The unit complies with the requirement of §15.203.

#### 4. TEST EQUIPMENT CALIBRATION DATE

##### Conducted Emissions – SR2

Instrument	Manufacturer	Type No.	Asset No.	Cali. Interval	Cali. Due Date
Two-Line V-Network	R&S	ENV216	MRTTWA00019	1 year	2022/3/23
Cable	Rosnol	N1C50-RG400-B 1C50-500CM	MRTTWE00013	1 year	2022/6/20
EMI Test Receiver	R&S	ESR3	MRTTWA00009	1 year	2022/3/24

##### Radiated Emissions – AC1

Instrument	Manufacturer	Type No.	Asset No.	Cali. Interval	Cali. Due Date
Broadband TRILOG Antenna	Schwarzbeck	VULB 9162	MRTTWA00001	1 year	2021/10/5
EMI Test Receiver	R&S	ESR3	MRTTWA00009	1 year	2022/3/24
Active Loop Antenna	Schwarzbeck	FMZB 1519B	MRTTWA00002	1 year	2022/5/6
Broadband Horn antenna	Schwarzbeck	BBHA 9120D	MRTTWA00003	1 year	2022/4/21
Breitband Hornantenna	Schwarzbeck	BBHA 9170	MRTTWA00004	1 year	2022/4/28
Broadband Amplifier	Schwarzbeck	BBV 9721	MRTTWA00006	1 year	2022/4/26
Broadband Preamplifier	Schwarzbeck	BBV 9718	MRTTWA00005	1 year	2022/4/21
Cable	HUBERSUHNER	SF106	MRTTWE00010	1 year	2022/6/15
Cable	Rosnol	K1K50-UP0264- K1K50-4M	MRTTWE00012	1 year	2022/6/20

##### Conducted Test Equipment – SR2

Instrument	Manufacturer	Type No.	Asset No.	Cali. Interval	Cali. Due Date
EXA Signal Analyzer	KEYSIGHT	N9010A	MRTTWA00012	1 year	2021/10/14
EXA Signal Analyzer	KEYSIGHT	N9010B	MRTTWA00074	1 year	2021/7/14
USB Wideband Power Sensor	KEYSIGHT	U2021XA	MRTTWA00015	1 year	2022/3/24

##### Test Software

Software	Version	Function
e3	9.160520a	EMI Test Software
EMI	V3	EMI Test Software

## 5. MEASUREMENT UNCERTAINTY

Where relevant, the following test uncertainty levels have been estimated for tests performed on the EUT as specified in CISPR 16-4-2. This uncertainty represents an expanded uncertainty expressed at approximately the 95% confidence level using a coverage factor of  $k = 2$ .

<b>Conducted Emission- Power Line</b>
Measuring Uncertainty for a Level of Confidence of 95% ( $U=2Uc(y)$ ): 0.15MHz~30MHz: $\pm 2.53\text{dB}$
<b>Radiated Spurious Emission</b>
Measuring Uncertainty for a Level of Confidence of 95% ( $U=2Uc(y)$ ): 9kHz~30MHz: $\pm 3.92\text{dB}$ 30MHz~1GHz: $\pm 4.25\text{dB}$ 1GHz~18GHz: $\pm 4.40\text{dB}$ 18GHz~40GHz: $\pm 4.45\text{dB}$
<b>Frequency Error</b>
Measuring Uncertainty for a Level of Confidence of 95% ( $U=2Uc(y)$ ): $\pm 78.4\text{Hz}$
<b>Conducted Power</b>
Measuring Uncertainty for a Level of Confidence of 95% ( $U=2Uc(y)$ ): $\pm 0.84\text{dB}$
<b>Conducted Spurious Emission</b>
Measuring Uncertainty for a Level of Confidence of 95% ( $U=2Uc(y)$ ): $\pm 2.65\text{ dB}$
<b>Occupied Bandwidth</b>
Measuring Uncertainty for a Level of Confidence of 95% ( $U=2Uc(y)$ ): 3.3%
<b>Temp. / Humidity</b>
Measuring Uncertainty for a Level of Confidence of 95% ( $U=2Uc(y)$ ): $\pm 0.82^\circ\text{C}/ \pm 3\%$
<b>DC Voltage</b>
Measuring Uncertainty for a Level of Confidence of 95% ( $U=2Uc(y)$ ): $\pm 0.3\%$



## 6. TEST RESULT

### 6.1. Summary

FCC Section(s)	Test Description	Test Limit	Test Condition	Test Result	Reference
15.247(a)(2)	6dB Bandwidth	$\geq 500\text{kHz}$	Conducted	Pass	Section 6.2
15.247(b)(3)	Output Power	$\leq 30\text{dBm}$		Pass	Section 6.3
15.247(e)	Power Spectral Density	$\leq 8\text{dBm}/3\text{kHz}$		Pass	Section 6.4
15.247(d)	Band Edge / Out-of-Band Emissions	$\geq 30\text{dBc}$ (Average)		Pass	Section 6.5
15.205 15.209	General Field Strength (Restricted Bands and Radiated Emission)	Emissions in restricted bands must meet the radiated limits detailed in 15.209	Radiated	Pass	Section 6.6 & 6.7
15.207	AC Conducted Emissions 150kHz - 30MHz	< FCC 15.207 limits	Line Conducted	Pass	Section 6.8

#### Notes:

- 1) The analyzer plots shown in this section were all taken with a correction table loaded into the analyzer. The correction table was used to account for the losses of the cables and attenuators used as part of the system to connect the EUT to the analyzer at all frequencies of interest.
- 2) Output power test was verified over all data rates of each mode (data refers to operational description), and then choose the maximum power output (low data rate) for the final test of each channel.
- 3) Test Items "6dB Bandwidth" showed the worst test data in this report.
- 4) 802.11 ax Support Full RB mode.

## 6.2. 6dB Bandwidth Measurement

### 6.2.1. Test Limit

The minimum 6dB bandwidth shall be at least 500 kHz.

### 6.2.2. Test Procedure used

ANSI C63.10 - 2013 - Section 11.8

### 6.2.3. Test Setting

1. The Spectrum's automatic bandwidth measurement capability was used to perform the 6dB bandwidth measurement. The "X" dB bandwidth parameter was set to  $X = 6$ . The bandwidth measurement was not influenced by any intermediate power nulls in the fundamental emission.
2. Set RBW = 100 kHz
3.  $VBW \geq 3 \times RBW$
4. Detector = Peak
5. Trace mode = Max hold
6. Sweep = Auto couple
7. Allow the trace to stabilize

### 6.2.4. Test Setup

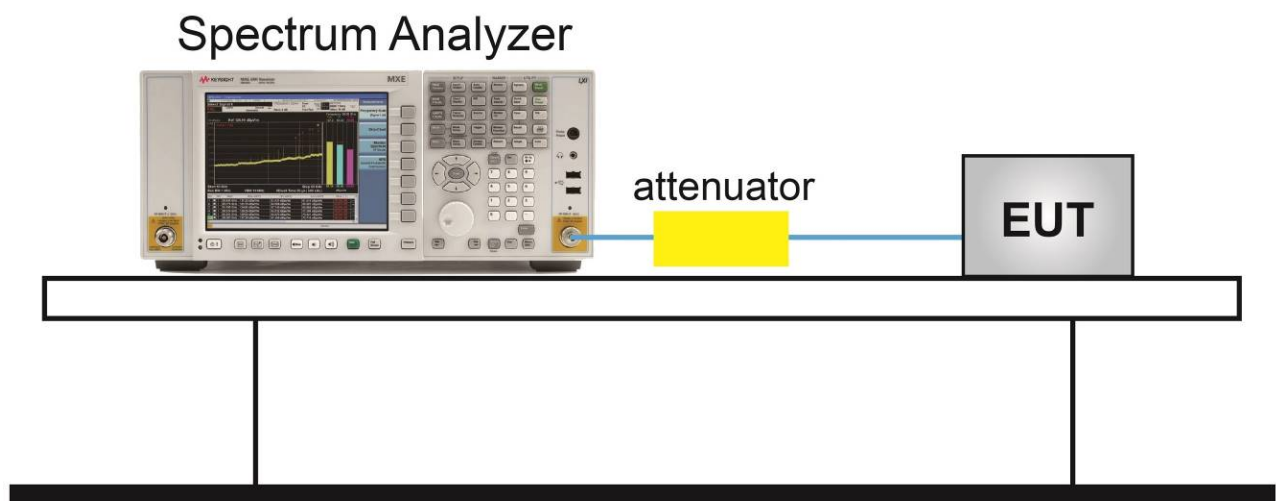

### 6.2.5. Test Result

Test Site	SR2	Test Engineer	Peter
Test Date	2021/04/12		

Test Mode	Data Rate / MCS	Channel No.	Frequency (MHz)	6dB Bandwidth (MHz)	Limit (MHz)	Result
802.11b	1Mbps	01	2412	8.064	≥ 0.5	Pass
802.11b	1Mbps	06	2437	8.055	≥ 0.5	Pass
802.11b	1Mbps	11	2462	8.061	≥ 0.5	Pass
802.11g	6Mbps	01	2412	16.32	≥ 0.5	Pass
802.11g	6Mbps	06	2437	16.31	≥ 0.5	Pass
802.11g	6Mbps	11	2462	16.06	≥ 0.5	Pass
802.11n-HT20	MCS0	01	2412	17.55	≥ 0.5	Pass
802.11n-HT20	MCS0	06	2437	17.20	≥ 0.5	Pass
802.11n-HT20	MCS0	11	2462	17.20	≥ 0.5	Pass
802.11n-HT40	MCS0	03	2422	35.93	≥ 0.5	Pass
802.11n-HT40	MCS0	06	2437	35.94	≥ 0.5	Pass
802.11n-HT40	MCS0	09	2452	36.32	≥ 0.5	Pass
802.11ax-HE20	MCS0	01	2412	18.71	≥ 0.5	Pass
802.11ax-HE20	MCS0	06	2437	18.81	≥ 0.5	Pass
802.11ax-HE20	MCS0	11	2462	18.77	≥ 0.5	Pass
802.11ax-HE40	MCS0	03	2422	37.97	≥ 0.5	Pass
802.11ax-HE40	MCS0	06	2437	37.96	≥ 0.5	Pass
802.11ax-HE40	MCS0	09	2452	37.85	≥ 0.5	Pass

Test Site	SR2	Test Engineer	Peter
Test Mode	Scan Antenna	Test Date	2021/04/13

Test Mode	Data Rate / MCS	Channel No.	Frequency (MHz)	6dB Bandwidth (MHz)	Limit (MHz)	Result
802.11b	1Mbps	01	2412	7.101	≥ 0.5	Pass
802.11b	1Mbps	06	2437	7.107	≥ 0.5	Pass
802.11b	1Mbps	11	2462	7.105	≥ 0.5	Pass
802.11g	6Mbps	01	2412	16.33	≥ 0.5	Pass
802.11g	6Mbps	06	2437	16.33	≥ 0.5	Pass
802.11g	6Mbps	11	2462	16.34	≥ 0.5	Pass
802.11n-HT20	MCS0	01	2412	16.94	≥ 0.5	Pass
802.11n-HT20	MCS0	06	2437	17.31	≥ 0.5	Pass
802.11n-HT20	MCS0	11	2462	17.04	≥ 0.5	Pass
802.11n-HT40	MCS0	03	2422	35.46	≥ 0.5	Pass
802.11n-HT40	MCS0	06	2437	35.40	≥ 0.5	Pass
802.11n-HT40	MCS0	09	2452	35.36	≥ 0.5	Pass

802.11b 6dB Bandwidth

Channel 01 (2412MHz)

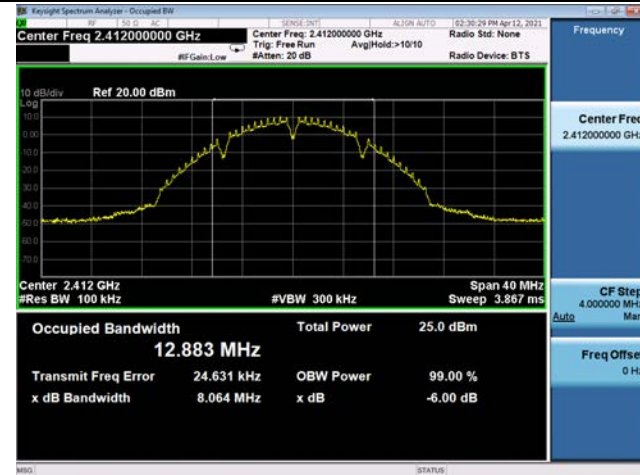

Channel 06 (2437MHz)



Channel 11 (2462MHz)



802.11g 6dB Bandwidth

Channel 01 (2412MHz)

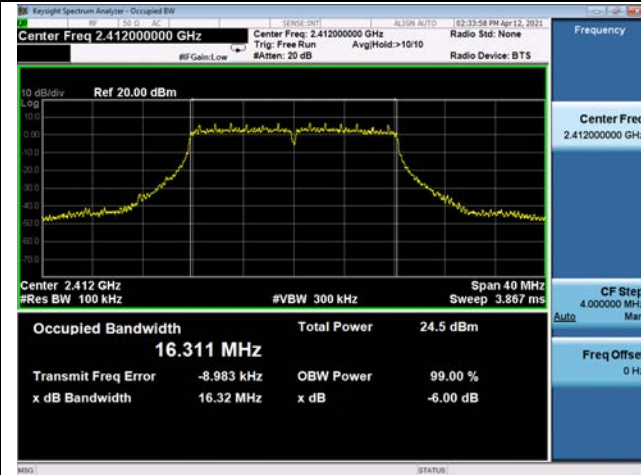

Channel 06 (2437MHz)

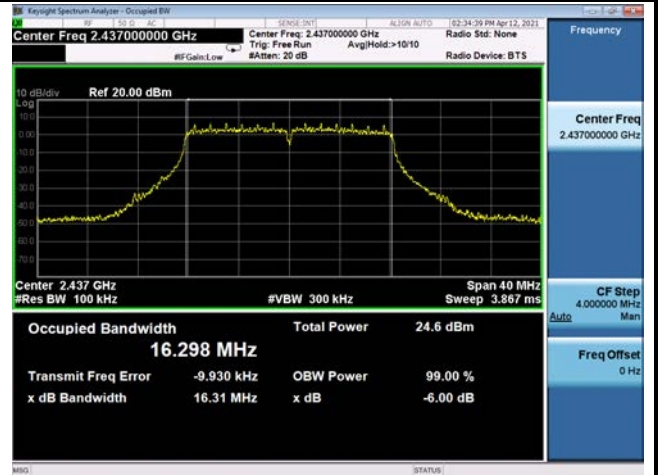

Channel 11 (2462MHz)

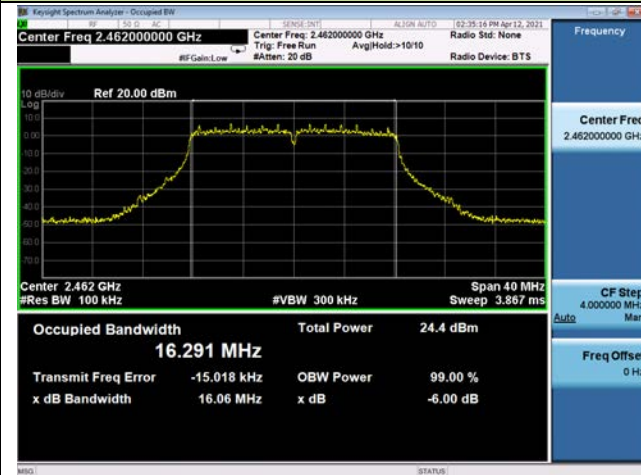

802.11n-HT20 6dB Bandwidth

Channel 01 (2412MHz)



Channel 06 (2437MHz)

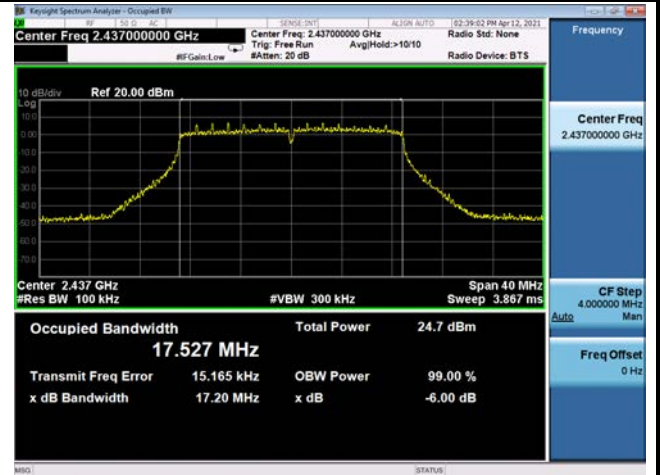

Channel 11 (2462MHz)

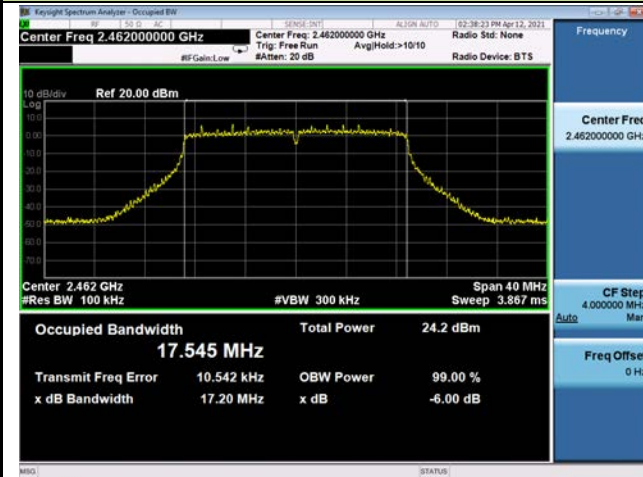

802.11n-HT40 6dB Bandwidth

Channel 03 (2422MHz)

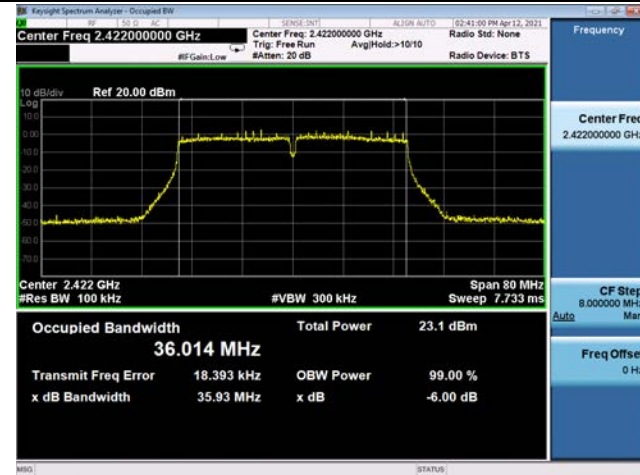

Channel 06 (2437MHz)

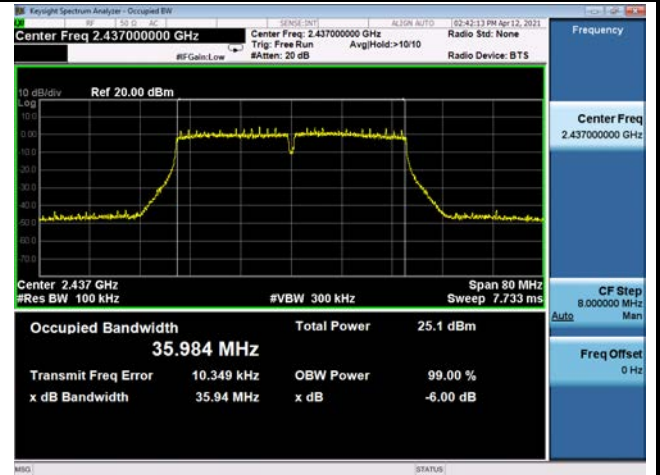

Channel 09 (2452MHz)

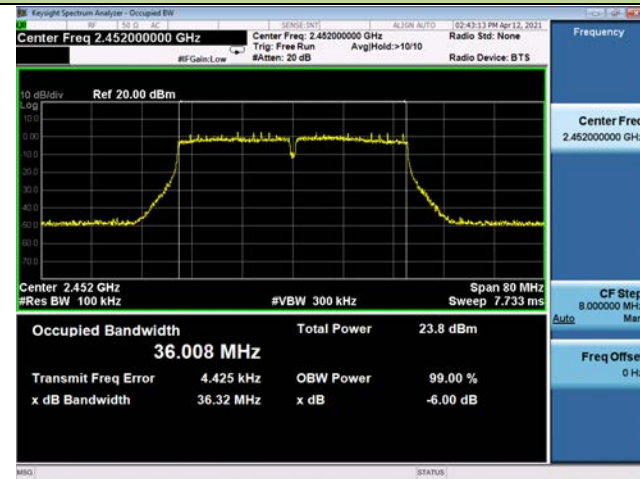



802.11ax-HE20 6dB Bandwidth

Channel 01 (2412MHz)

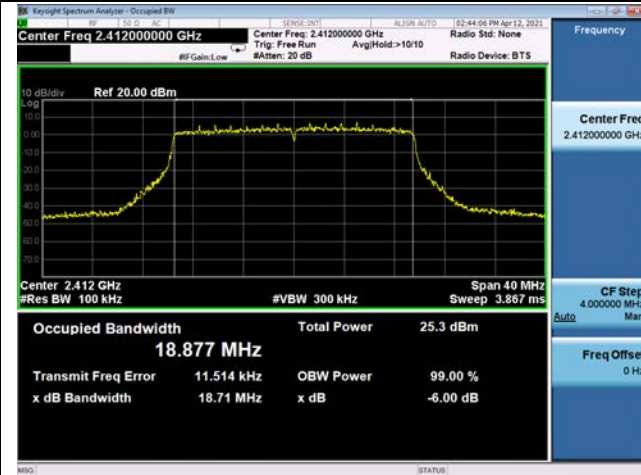

Channel 06 (2437MHz)

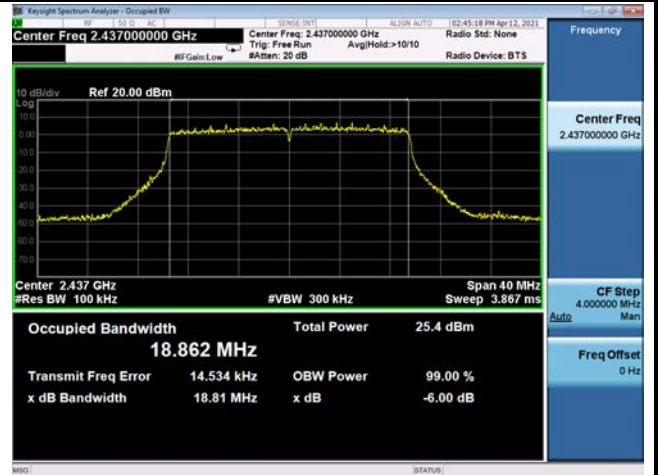

Channel 11 (2462MHz)



802.11ax-HE40 6dB Bandwidth

Channel 03 (2422MHz)

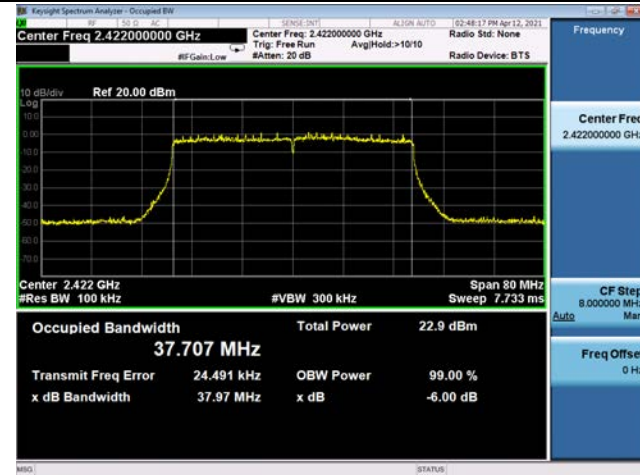

Channel 06 (2437MHz)

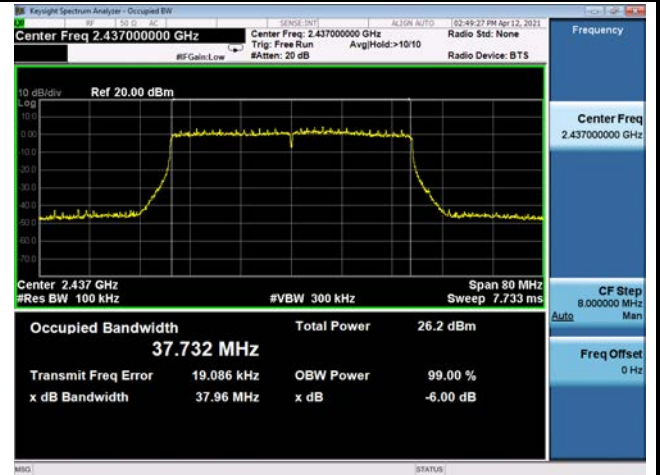

Channel 09 (2452MHz)

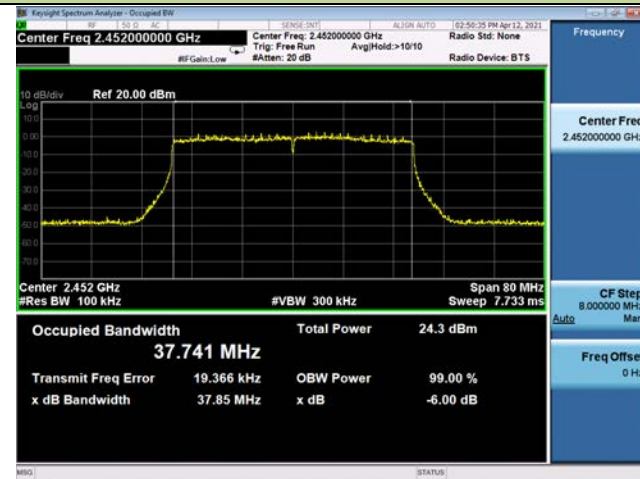

802.11b 6dB Bandwidth - Scan Antenna

Channel 01 (2412MHz)



Channel 06 (2437MHz)



Channel 11 (2462MHz)



802.11g 6dB Bandwidth - Scan Antenna

Channel 01 (2412MHz)

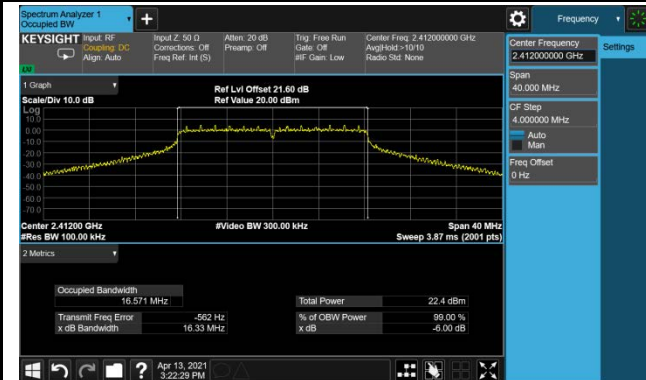

Channel 06 (2437MHz)



Channel 11 (2462MHz)



802.11n-HT20 6dB Bandwidth - Scan Antenna

Channel 01 (2412MHz)



Channel 06 (2437MHz)



Channel 11 (2462MHz)



802.11n-HT40 6dB Bandwidth - Scan Antenna

Channel 03 (2422MHz)



Channel 06 (2437MHz)



Channel 09 (2452MHz)

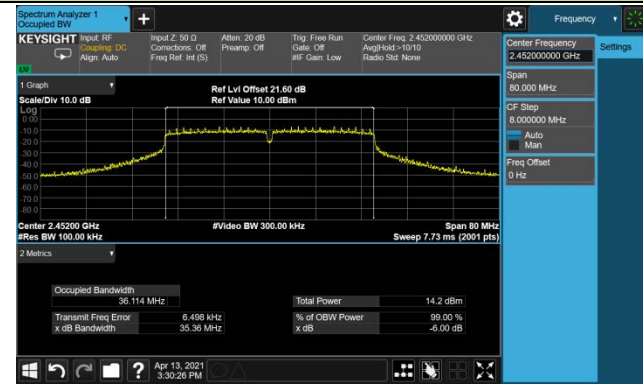

### 6.3. Output Power Measurement

#### 6.3.1. Test Limit

The maximum output power shall be less 1 Watt (30dBm).

The conducted output power limit specified in paragraph FCC Part 15.247(b) of this section is based on the use of antennas with directional gains that do not exceed 6 dBi. If transmitting antennas of directional gain greater than 6 dBi are used, the conducted output power from the intentional radiator shall be reduced below the stated values in paragraphs FCC Part 15.247(b)(3) of this section, as appropriate, by the amount in dB that the directional gain of the antenna exceeds 6 dBi.

#### 6.3.2. Test Procedure Used

ANSI C63.10 - 2013 - Section 11.9.2.3.2

#### 6.3.3. Test Setting

##### Average Power Measurement

Average power measurements were performed only when the EUT was transmitting at its maximum power control level using a broadband power meter with a pulse sensor. The power meter implemented triggering and gating capabilities which were set up such that power measurements were recorded only during the ON time of the transmitter.

#### 6.3.4. Test Setup

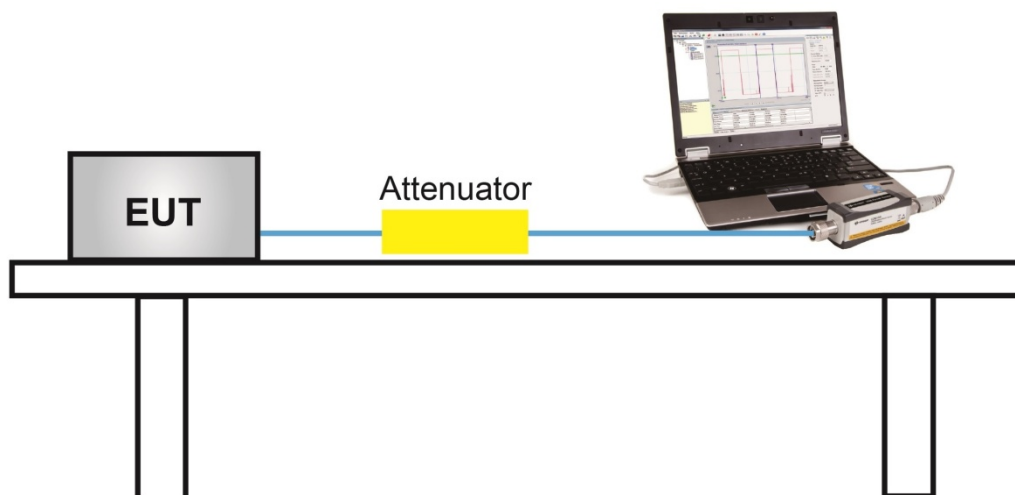

**6.3.5. Test Result**

Test Site	SR2	Test Engineer	Peter
Test Date	2021/04/22		

Test Mode	Data Rate/ MCS	Channel No.	Freq. (MHz)	Average Power (dBm)				Total Average Power (dBm)	Limit (dBm)	Result
				Ant 0	Ant 1	Ant 2	Ant 3			
802.11b	1Mbps	01	2412	17.60	17.90	17.85	17.41	23.72	≤ 30.00	Pass
802.11b	1Mbps	06	2437	17.70	18.00	17.94	17.40	23.79	≤ 30.00	Pass
802.11b	1Mbps	11	2462	17.89	18.02	17.99	17.33	23.84	≤ 30.00	Pass
802.11g	1Mbps	01	2412	17.64	17.88	17.81	17.34	23.69	≤ 30.00	Pass
802.11g	1Mbps	06	2437	17.53	17.92	17.76	17.33	23.66	≤ 30.00	Pass
802.11g	1Mbps	11	2462	17.69	18.03	17.82	17.40	23.76	≤ 30.00	Pass
802.11n-HT20	1Mbps	01	2412	17.63	17.88	17.67	17.35	23.66	≤ 30.00	Pass
802.11n-HT20	1Mbps	06	2437	17.53	17.83	17.70	17.31	23.62	≤ 30.00	Pass
802.11n-HT20	1Mbps	11	2462	17.84	17.69	17.69	17.30	23.66	≤ 30.00	Pass
802.11n-HT40	1Mbps	03	2422	16.20	16.37	16.31	15.84	22.21	≤ 30.00	Pass
802.11n-HT40	1Mbps	06	2437	17.76	17.90	17.78	17.36	23.73	≤ 30.00	Pass
802.11n-HT40	1Mbps	09	2452	16.83	17.00	16.79	16.50	22.80	≤ 30.00	Pass
802.11ax-HE20	1Mbps	01	2412	17.77	17.96	18.01	17.55	23.85	≤ 30.00	Pass
802.11ax-HE20	1Mbps	06	2437	17.70	18.02	17.95	17.57	23.83	≤ 30.00	Pass
802.11ax-HE20	1Mbps	11	2462	16.45	16.68	16.35	16.10	22.42	≤ 30.00	Pass
802.11ax-HE40	1Mbps	03	2422	15.36	15.44	15.54	15.01	21.36	≤ 30.00	Pass
802.11ax-HE40	1Mbps	06	2437	17.81	18.05	17.91	17.52	23.85	≤ 30.00	Pass
802.11ax-HE40	1Mbps	09	2452	16.44	16.69	16.41	16.15	22.45	≤ 30.00	Pass

Note: Total Average Power (dBm) =  $10 \cdot \log \{ 10^{(\text{Ant 0 Average Power} / 10)} + 10^{(\text{Ant 1 Average Power} / 10)} + 10^{(\text{Ant 2 Average Power} / 10)} + 10^{(\text{Ant 3 Average Power} / 10)} \}$  (dBm).



Test Site	SR2	Test Engineer	Peter
Test Mode	Scan Antenna	Test Date	2021/04/22

Test Mode	Data Rate/ MCS	Channel No.	Freq. (MHz)	Peak Power (dBm)	Average Power (dBm)	Limit (dBm)	Result
802.11b	1Mbps	01	2412	20.88	18.04	≤ 30.00	Pass
802.11b	1Mbps	06	2437	19.05	16.15	≤ 30.00	Pass
802.11b	1Mbps	11	2462	19.11	16.21	≤ 30.00	Pass
802.11g	1Mbps	01	2412	19.22	14.95	≤ 30.00	Pass
802.11g	1Mbps	06	2437	21.52	17.63	≤ 30.00	Pass
802.11g	1Mbps	11	2462	14.47	9.79	≤ 30.00	Pass
802.11n-HT20	1Mbps	01	2412	18.66	14.18	≤ 30.00	Pass
802.11n-HT20	1Mbps	06	2437	22.01	18.05	≤ 30.00	Pass
802.11n-HT20	1Mbps	11	2462	13.98	9.15	≤ 30.00	Pass
802.11n-HT40	1Mbps	03	2422	15.31	10.11	≤ 30.00	Pass
802.11n-HT40	1Mbps	06	2437	22.18	18.05	≤ 30.00	Pass
802.11n-HT40	1Mbps	09	2452	11.94	6.87	≤ 30.00	Pass

## **6.4. Power Spectral Density Measurement**

### **6.4.1. Test Limit**

The maximum permissible power spectral density is 8dBm in any 3 kHz band.

The same method of determining the conducted output power shall be used to determine the power spectral density.

### **6.4.2. Test Procedure Used**

ANSI C63.10 - 2013 - Section 11.10.5

### **6.4.3. Test Setting**

1. Measure the duty cycle (x) of the transmitter output signal.
2. Set instrument center frequency to DTS channel center frequency.
3. Set span to at least 1.5 times the OBW.
4. RBW = 10 kHz.
5. VBW = 30 kHz.
6. Detector = RMS.
7. Ensure that the number of measurement points in the sweep  $\geq 2 \times \text{span}/\text{RBW}$ .
8. Sweep time = auto couple.
9. Don't use sweep triggering. Allow sweep to "free run".
10. Employ trace averaging (RMS) mode over a minimum of 100 traces.
11. Use the peak marker function to determine the maximum amplitude level.
12. Add  $10 \log (1/x)$ , where x is the duty cycle measured in step (a), to the measured PSD to compute the average PSD during the actual transmission time. If measured value exceeds requirement specified by regulatory agency, then reduce RBW (but no less than 3 kHz) and repeat (note that this may require zooming in on the emission of interest and reducing the span to meet the minimum measurement point requirement as the RBW is reduced).

### 6.4.4. Test Setup

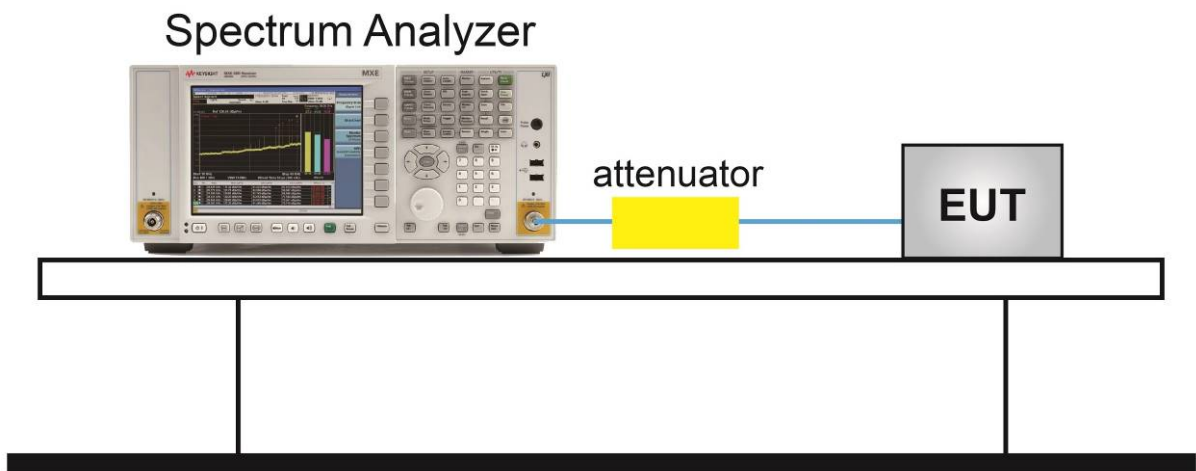

### 6.4.5. Test Result

Test Site	SR2	Test Engineer	Peter
Test Date	2021/04/12		

Test Mode	Data Rate/ MCS	Channel No.	Freq. (MHz)	PSD (dBm/ 10kHz)				Duty Cycle (%)	Total PSD (dBm/ 10kHz)	Limit (dBm/ 3kHz)	Result
				Ant 0	Ant 1	Ant 2	Ant 3				
802.11b	1Mbps	01	2412	-9.06	-8.73	-8.31	-8.97	65.47	-0.90	≤ 4.08	Pass
802.11b	1Mbps	06	2437	-9.00	-8.60	-8.62	-9.29	65.47	-1.01	≤ 4.08	Pass
802.11b	1Mbps	11	2462	-8.30	-8.52	-8.34	-9.04	65.47	-0.68	≤ 4.08	Pass
802.11g	6Mbps	01	2412	-11.37	-10.95	-10.66	-11.26	94.55	-4.79	≤ 4.08	Pass
802.11g	6Mbps	06	2437	-11.22	-11.34	-10.98	-11.56	94.55	-5.01	≤ 4.08	Pass
802.11g	6Mbps	11	2462	-11.06	-10.76	-10.48	-11.05	94.55	-4.57	≤ 4.08	Pass
802.11n-HT20	MCS0	01	2412	-11.88	-11.24	-11.48	-11.93	95.37	-5.39	≤ 4.08	Pass
802.11n-HT20	MCS0	06	2437	-11.76	-11.20	-11.52	-11.74	95.37	-5.32	≤ 4.08	Pass
802.11n-HT20	MCS0	11	2462	-11.56	-10.81	-11.36	-11.56	95.37	-5.08	≤ 4.08	Pass
802.11n-HT40	MCS0	03	2422	-16.11	-15.78	-15.47	-16.27	93.55	-9.58	≤ 4.08	Pass
802.11n-HT40	MCS0	06	2437	-14.57	-14.13	-14.28	-14.66	93.55	-8.10	≤ 4.08	Pass
802.11n-HT40	MCS0	09	2452	-15.33	-14.89	-14.81	-15.94	93.55	-8.91	≤ 4.08	Pass
802.11ax-HE20	MCS0	01	2412	-12.71	-12.51	-12.52	-12.61	95.56	-6.37	≤ 4.08	Pass
802.11ax-HE20	MCS0	06	2437	-12.87	-12.52	-12.62	-13.02	95.56	-6.54	≤ 4.08	Pass
802.11ax-HE20	MCS0	11	2462	-13.80	-13.74	-14.04	-14.46	95.56	-7.78	≤ 4.08	Pass
802.11ax-HE40	MCS0	03	2422	-18.02	-17.68	-17.63	-18.07	95.38	-11.62	≤ 4.08	Pass
802.11ax-HE40	MCS0	06	2437	-15.40	-15.25	-15.42	-16.09	95.38	-9.30	≤ 4.08	Pass
802.11ax-HE40	MCS0	09	2452	-16.60	-16.61	-16.34	-16.97	95.38	-10.40	≤ 4.08	Pass

Note:

- When EUT duty cycle ≤ 98%, Total AVGPSSD =  $10 \cdot \log \{ 10^{(\text{Ant 0 AVGPSSD}/10)} + 10^{(\text{Ant 1 AVGPSSD}/10)} + 10^{(\text{Ant 2 AVGPSSD}/10)} + 10^{(\text{Ant 3 AVGPSSD}/10)} \} + 10 \cdot \log (1/\text{Duty Cycle})$ .
- Total AVGPSSD (dBm / 10kHz) << Limit (dBm / 3kHz), so there is no necessary to conversion unit.

Test Site	SR2	Test Engineer	Peter
Test Date	2021/04/13		

## Scan Antenna

Test Mode	Data Rate/ MCS	Channel No.	Freq. (MHz)	PK PSD (dBm/10kHz)	Total PSD (dBm/10kHz)	Limit (dBm/3kHz)	Result
802.11b	1Mbps	01	2412	-3.03	-3.03	≤ 8	Pass
802.11b	1Mbps	06	2437	-4.15	-4.15	≤ 8	Pass
802.11b	1Mbps	11	2462	-4.26	-4.26	≤ 8	Pass
802.11g	6Mbps	01	2412	-9.12	-9.12	≤ 8	Pass
802.11g	6Mbps	06	2437	-6.22	-6.22	≤ 8	Pass
802.11g	6Mbps	11	2462	-14.20	-14.20	≤ 8	Pass
802.11n-HT20	MCS0	01	2412	-10.70	-10.70	≤ 8	Pass
802.11n-HT20	MCS0	06	2437	-6.67	-6.67	≤ 8	Pass
802.11n-HT20	MCS0	11	2462	-15.37	-15.37	≤ 8	Pass
802.11n-HT40	MCS0	03	2422	-17.20	-17.20	≤ 8	Pass
802.11n-HT40	MCS0	06	2437	-8.17	-8.17	≤ 8	Pass
802.11n-HT40	MCS0	09	2452	-20.49	-20.49	≤ 8	Pass

Note: Total PKPSD (dBm / 10kHz) << Limit (dBm / 3kHz), so there is no necessary to conversion unit.

802.11b AVGPST -Ant 0/ Ant 0+1+2+3

Channel 01 (2412MHz)



Channel 06 (2437MHz)

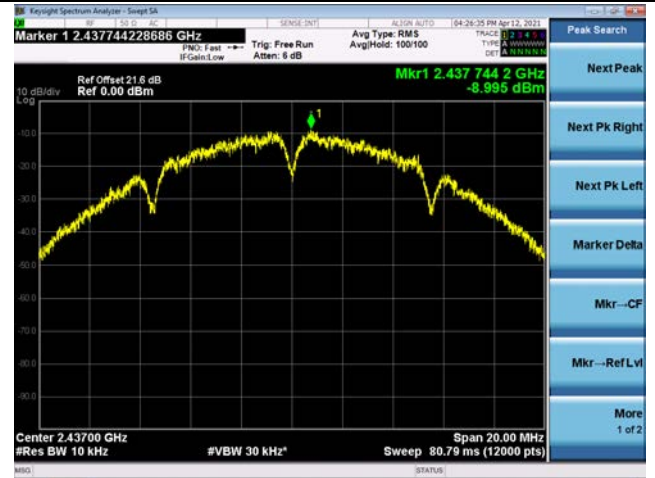

Channel 11 (2462MHz)



802.11g - AVGPSD -Ant 0/ Ant 0+1+2+3

Channel 01 (2412MHz)

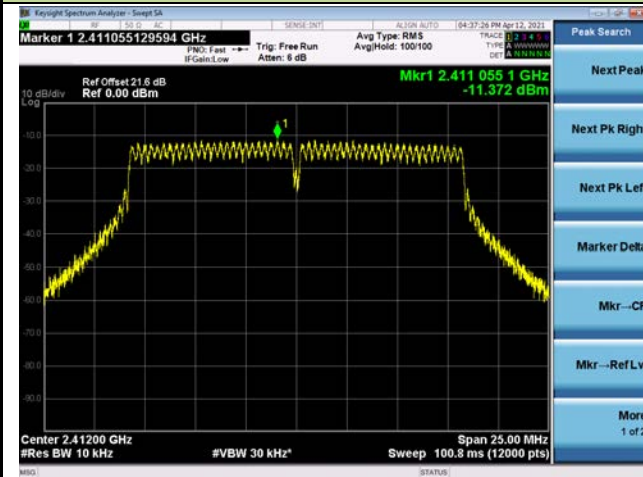

Channel 06 (2437MHz)

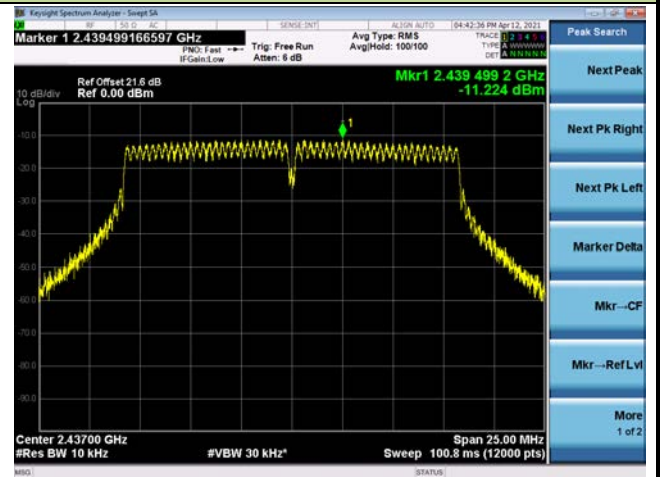

Channel 11 (2462MHz)

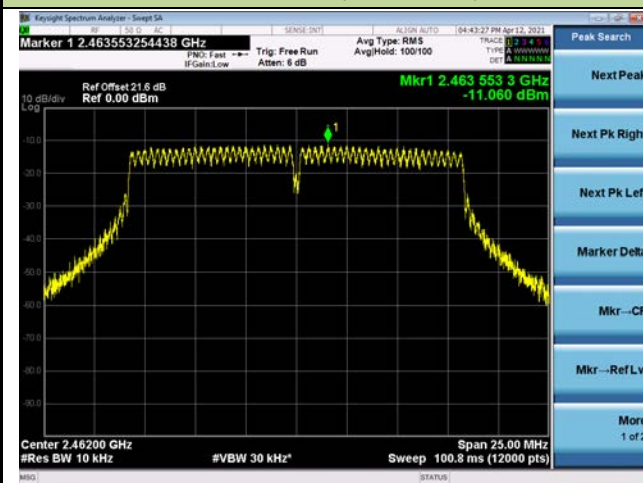

802.11n-HT20 - AVGPSD -Ant 0/ Ant 0+1+2+3

Channel 01 (2412MHz)

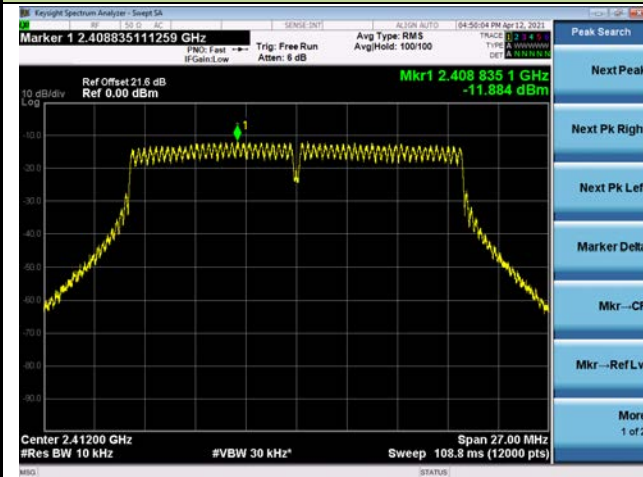

Channel 06 (2437MHz)

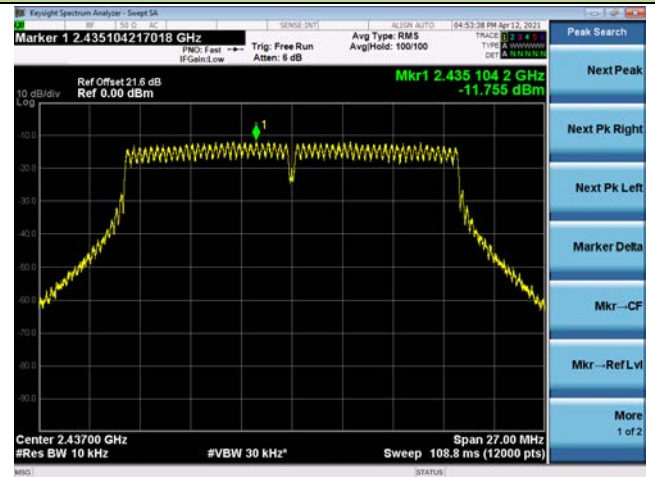

Channel 11 (2462MHz)

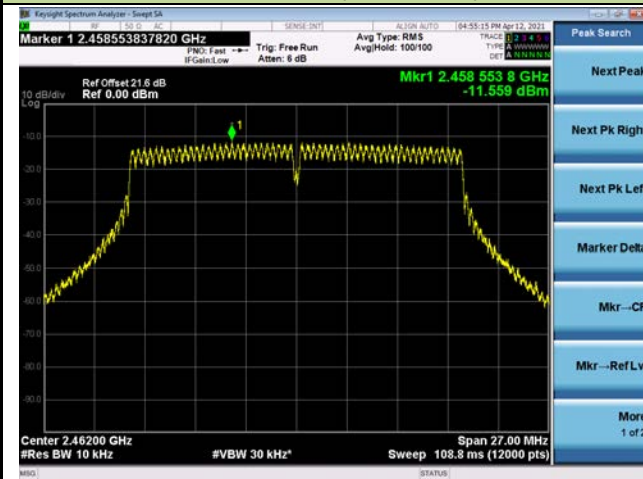



802.11n-HT40 - AVGPSD -Ant 0/ Ant 0+1+2+3

Channel 03 (2422MHz)

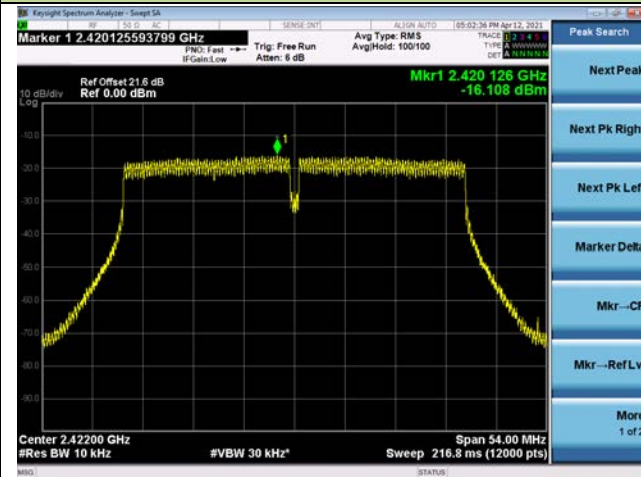

Channel 06 (2437MHz)

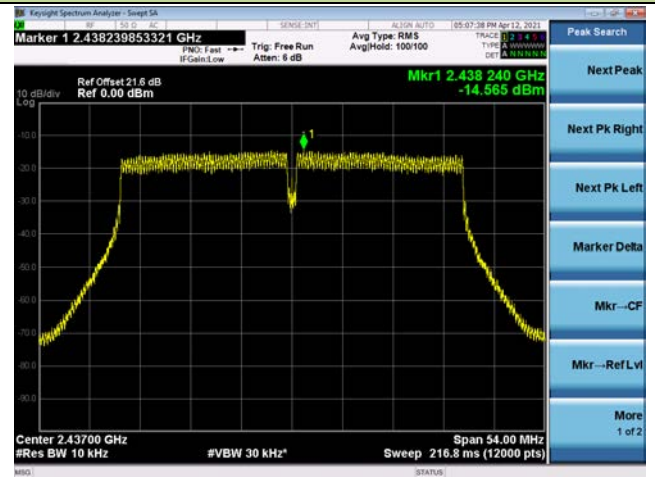

Channel 09 (2452MHz)

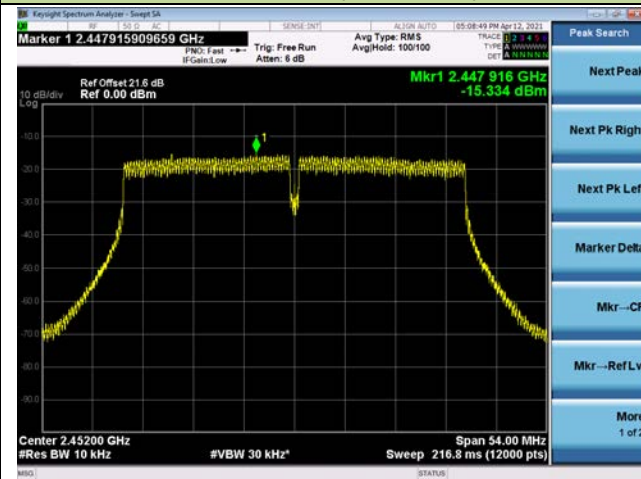

802.11ax-HE20 - AVGPSD -Ant 0/ Ant 0+1+2+3

Channel 01 (2412MHz)

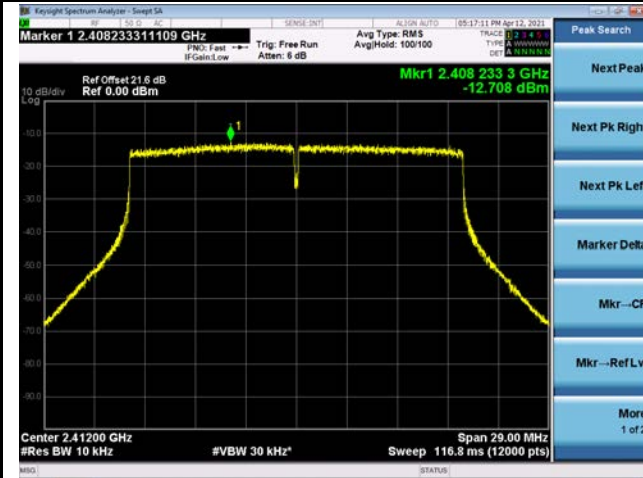

Channel 06 (2437MHz)



Channel 11 (2462MHz)

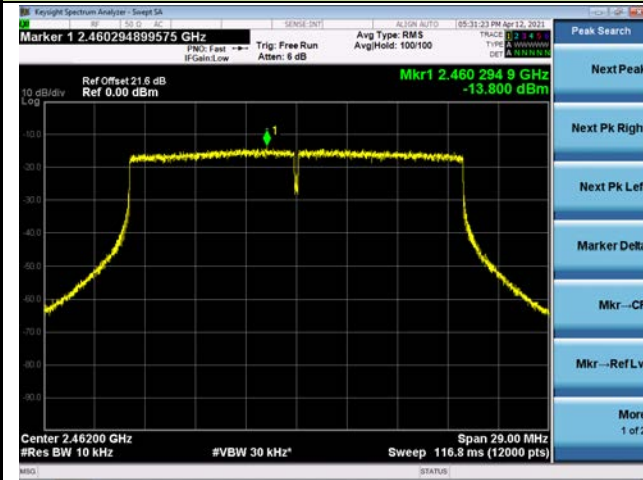

802.11ax-HE40 - AVGPSD -Ant 0/ Ant 0+1+2+3

Channel 03 (2422MHz)

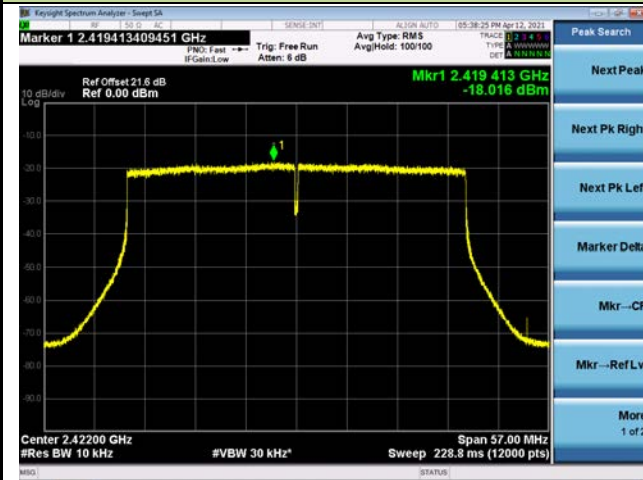

Channel 06 (2437MHz)

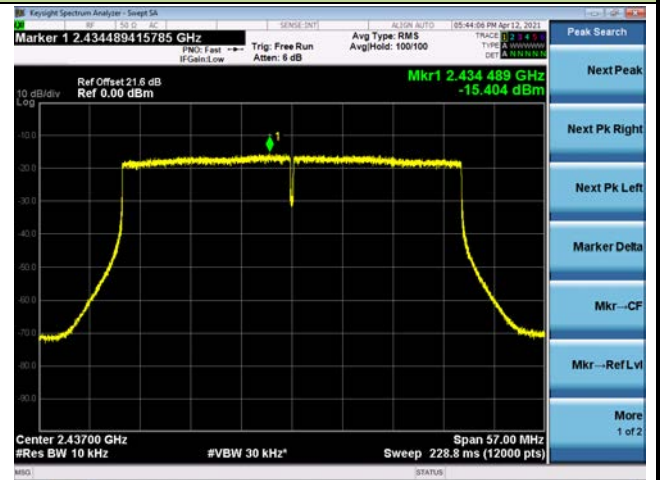

Channel 09 (2452MHz)

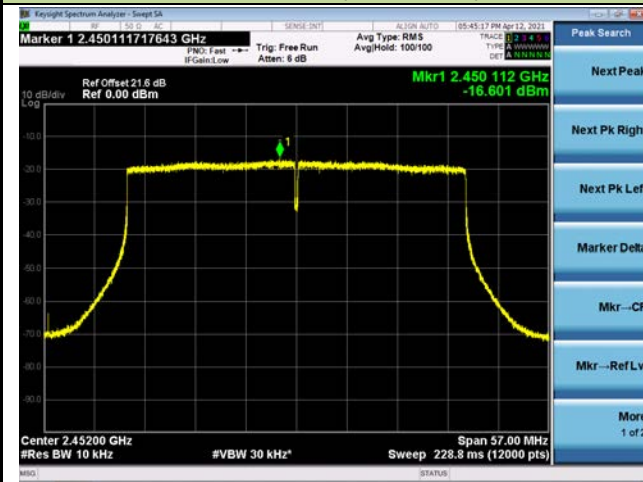

802.11b AVGPSD -Ant 1/ Ant 0+1+2+3

Channel 01 (2412MHz)



Channel 06 (2437MHz)



Channel 11 (2462MHz)



802.11g - AVGPSD -Ant 1/ Ant 0+1+2+3

Channel 01 (2412MHz)

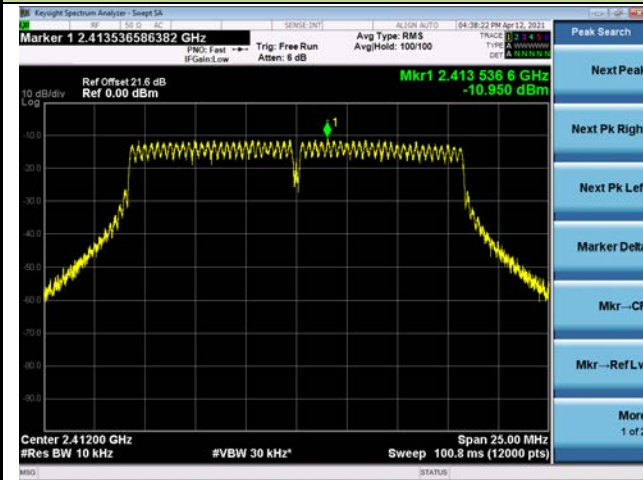

Channel 06 (2437MHz)

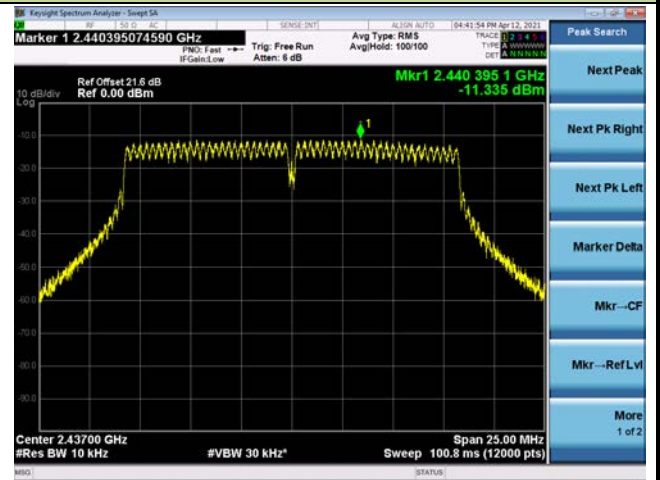

Channel 11 (2462MHz)

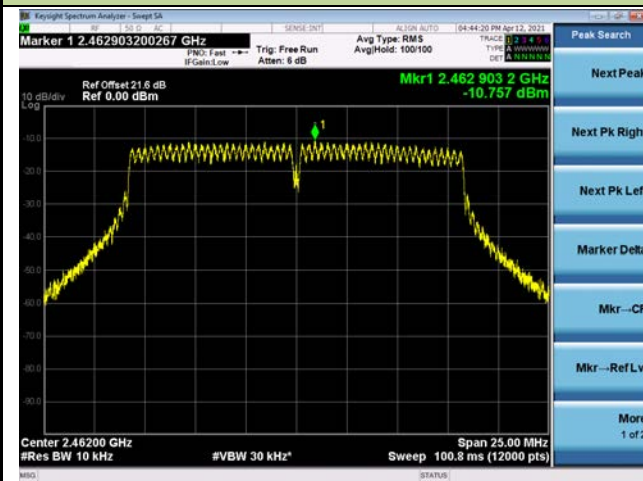

802.11n-HT20 - AVGPSD -Ant 1/ Ant 0+1+2+3

Channel 01 (2412MHz)

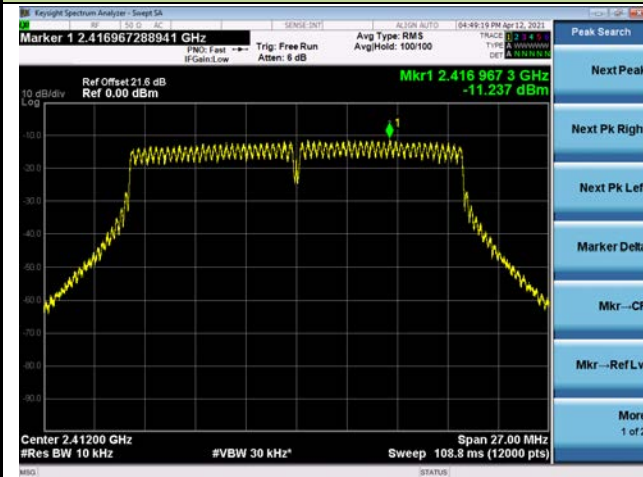

Channel 06 (2437MHz)

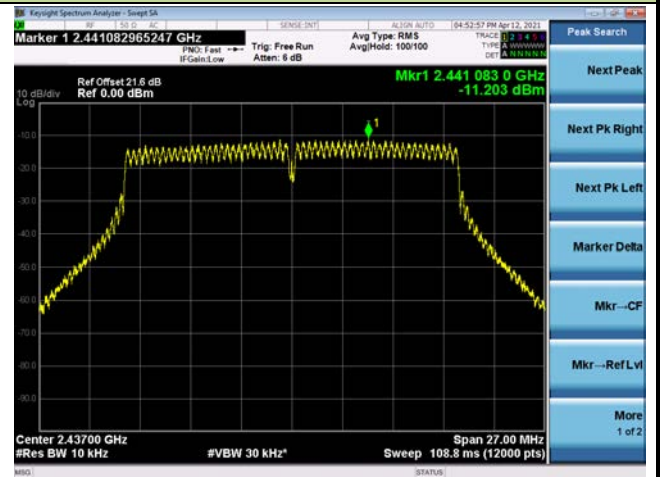

Channel 11 (2462MHz)

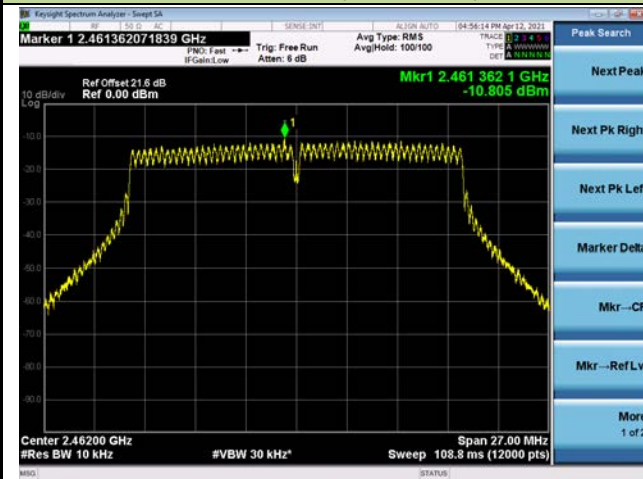

802.11n-HT40 - AVGPSD -Ant 1/ Ant 0+1+2+3

Channel 03 (2422MHz)

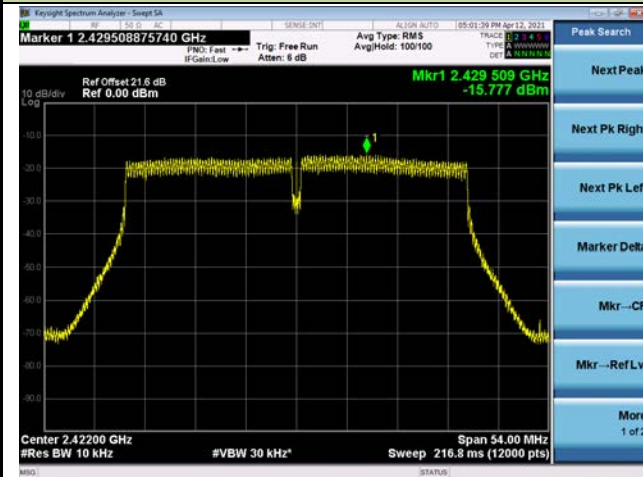

Channel 06 (2437MHz)

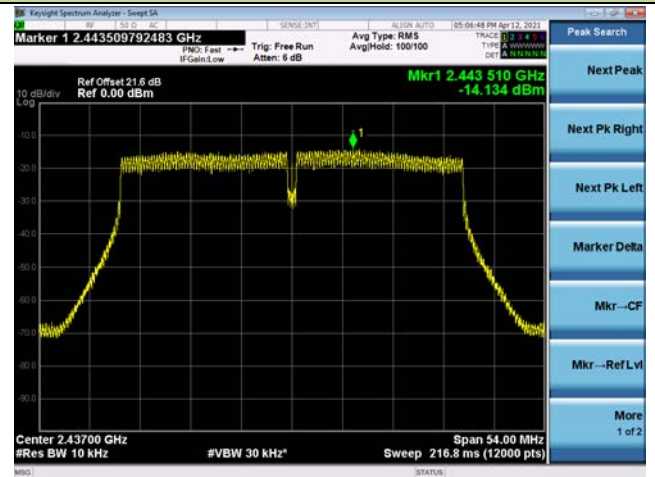

Channel 09 (2452MHz)

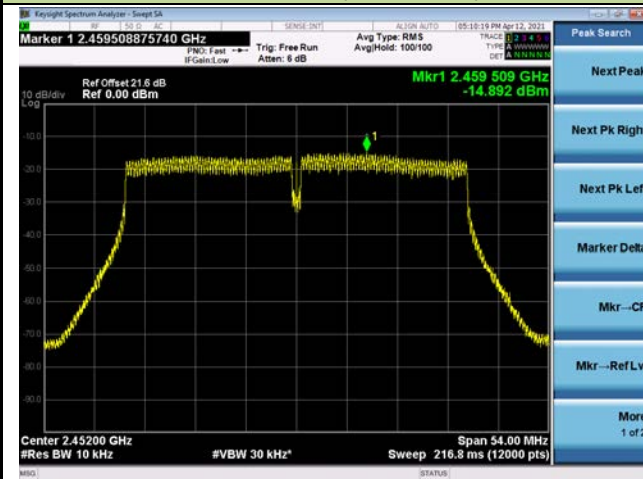

802.11ax-HE20 - AVGPSD -Ant 1/Ant 0+1+2+3

Channel 01 (2412MHz)

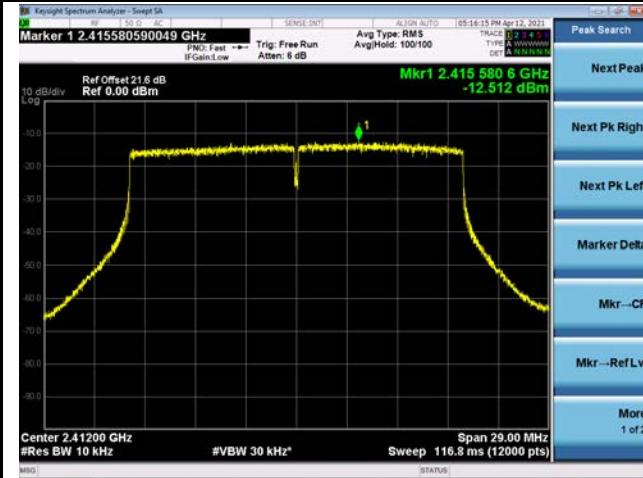

Channel 06 (2437MHz)

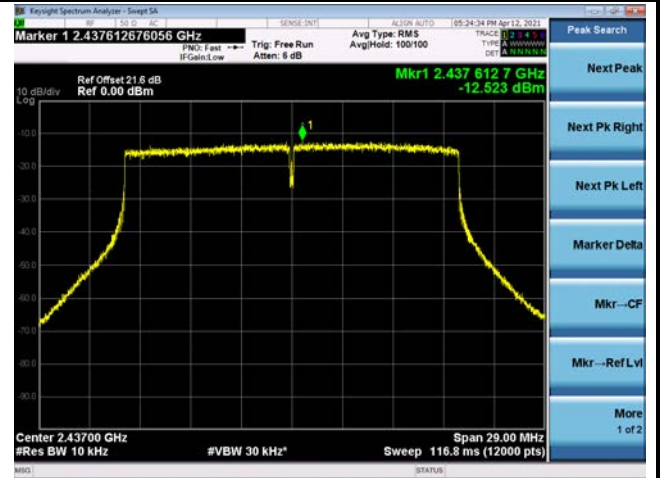

Channel 11 (2462MHz)

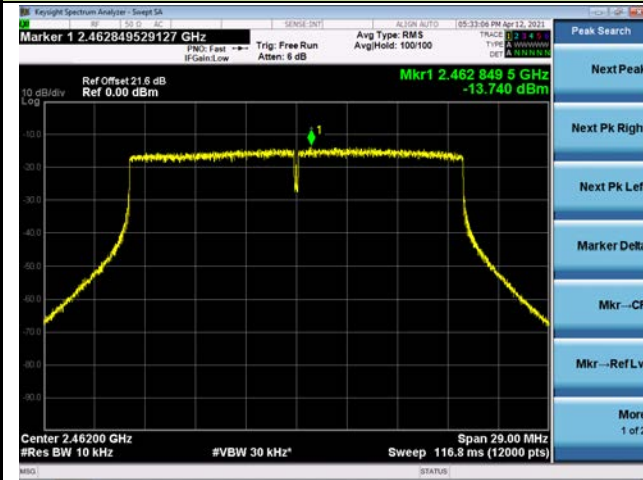



802.11ax-HE40 - AVGPSD -Ant 1/ Ant 0+1+2+3

Channel 03 (2422MHz)

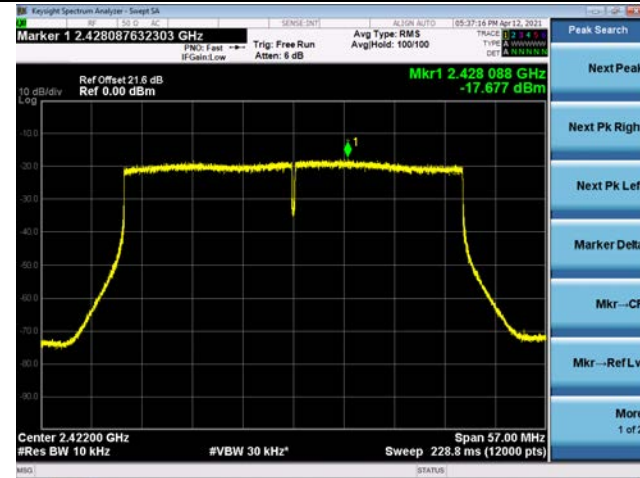

Channel 06 (2437MHz)

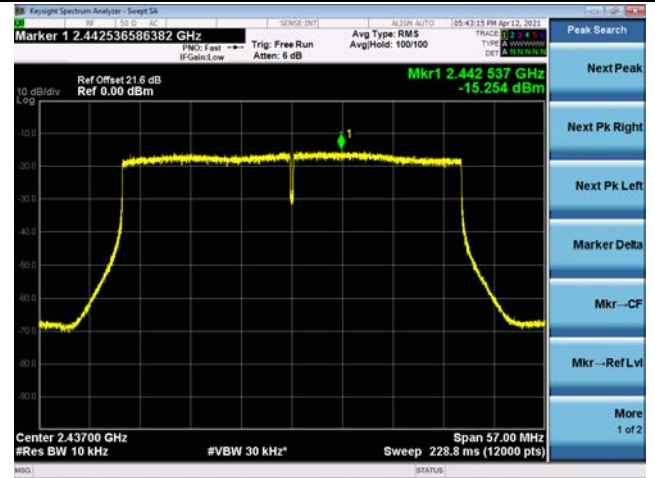

Channel 09 (2452MHz)

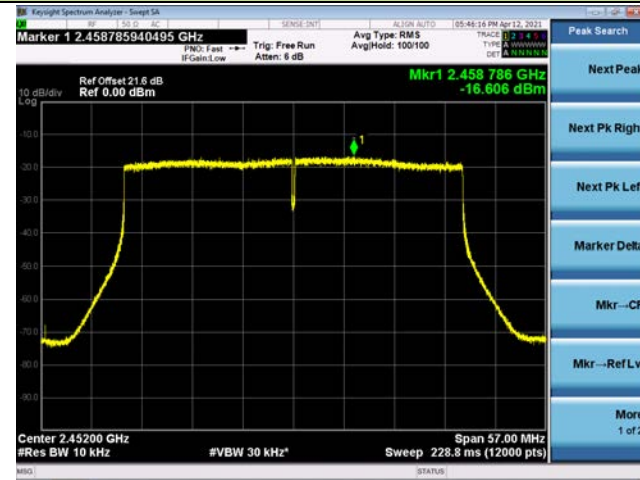

802.11b AVGPST -Ant 2/ Ant 0+1+2+3

Channel 01 (2412MHz)



Channel 06 (2437MHz)



Channel 11 (2462MHz)



802.11g - AVGPSD -Ant 2/ Ant 0+1+2+3

Channel 01 (2412MHz)

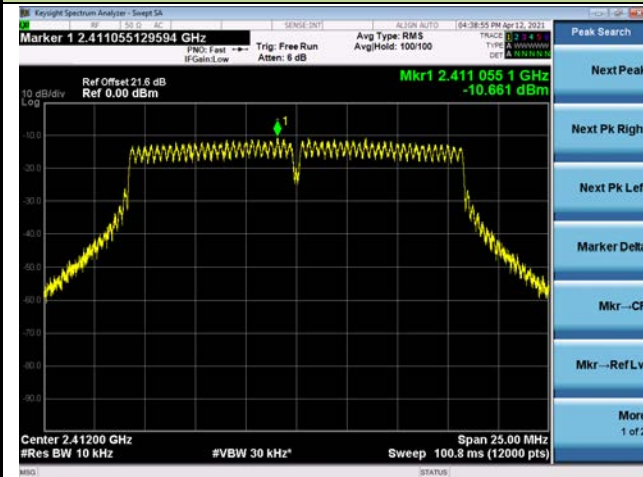

Channel 06 (2437MHz)

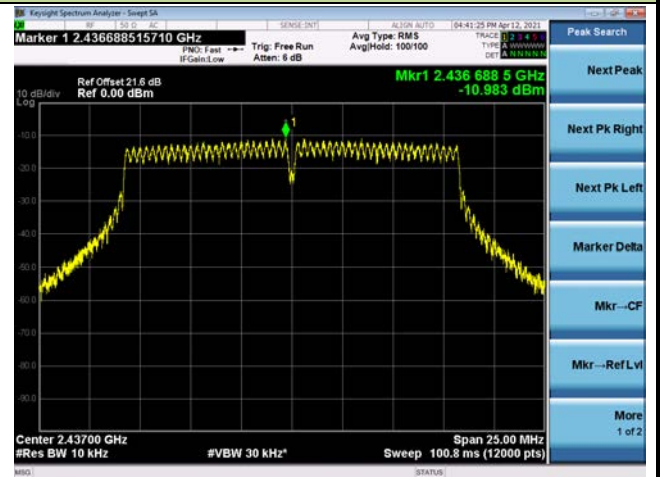

Channel 11 (2462MHz)

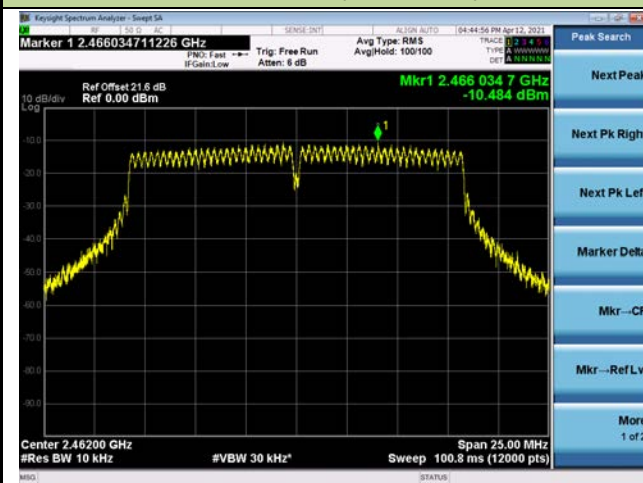

802.11n-HT20 - AVGPSD -Ant 2/ Ant 0+1+2+3

Channel 01 (2412MHz)

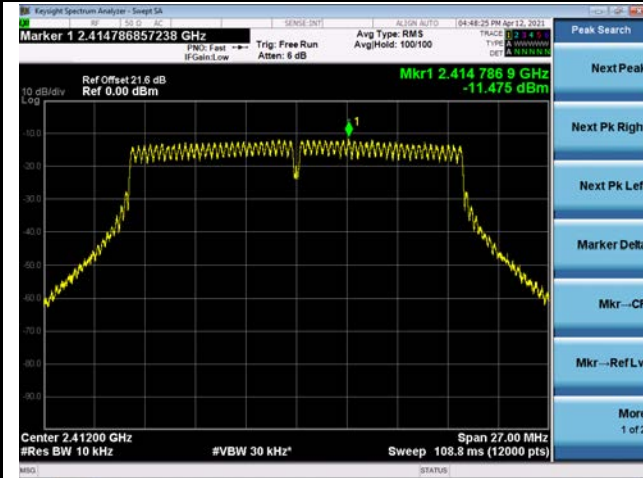

Channel 06 (2437MHz)

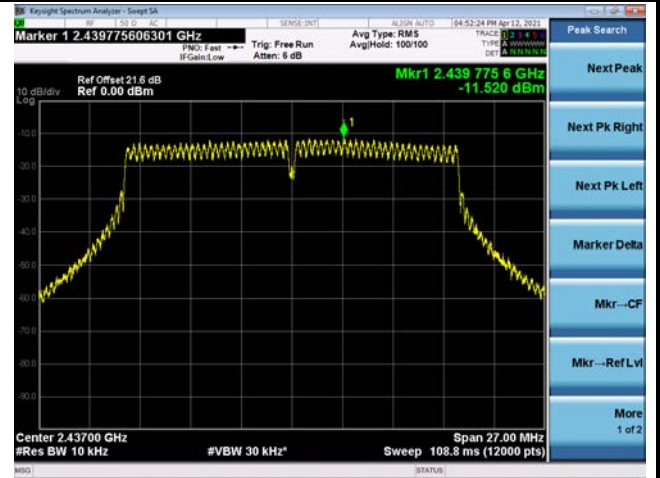

Channel 11 (2462MHz)

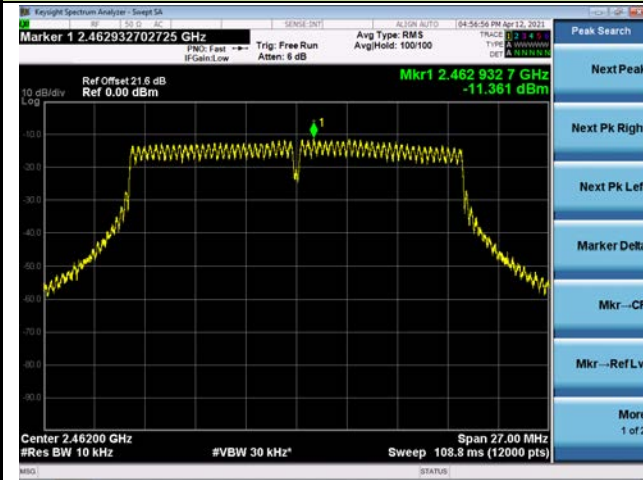

802.11n-HT40 - AVGPSD -Ant 2/ Ant 0+1+2+3

Channel 03 (2422MHz)

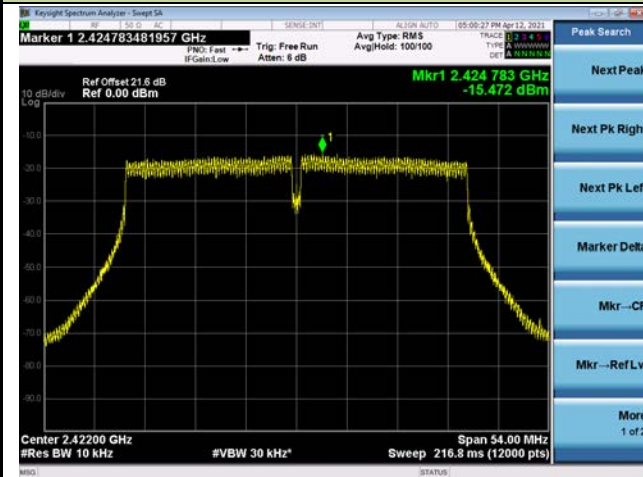

Channel 06 (2437MHz)

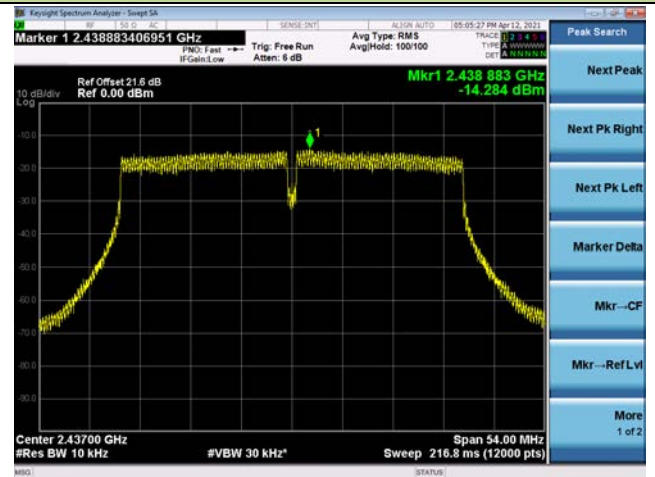

Channel 09 (2452MHz)

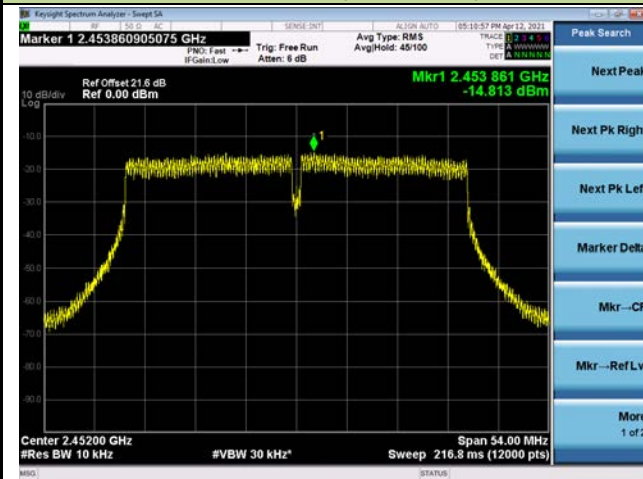

802.11ax-HE20 - AVGPSD -Ant 2/ Ant 0+1+2+3

Channel 01 (2412MHz)

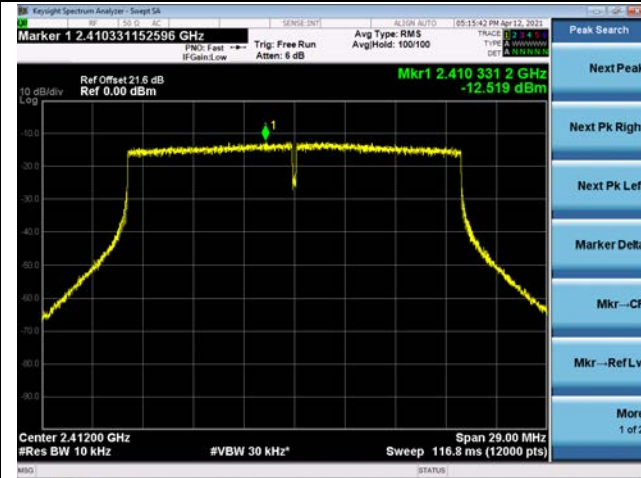

Channel 06 (2437MHz)

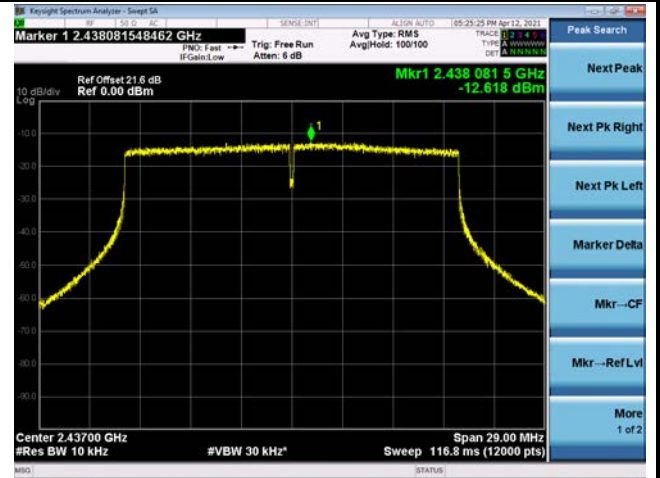

Channel 11 (2462MHz)

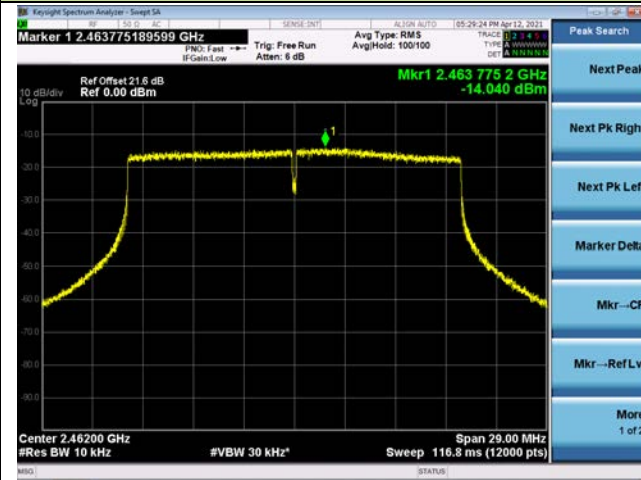

802.11ax-HE40 - AVGPSD -Ant 2/ Ant 0+1+2+3

Channel 03 (2422MHz)

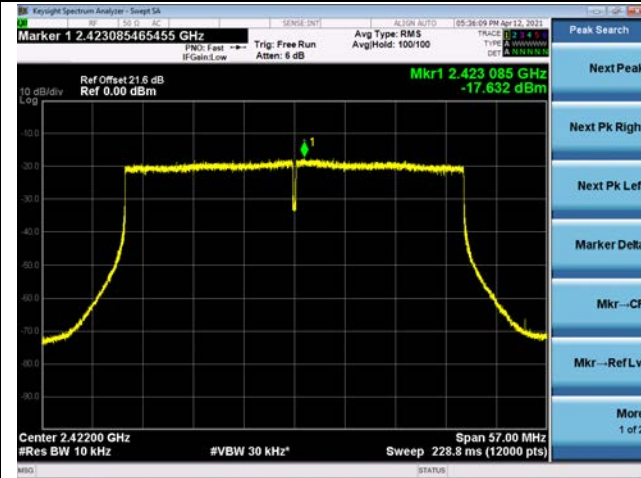

Channel 06 (2437MHz)

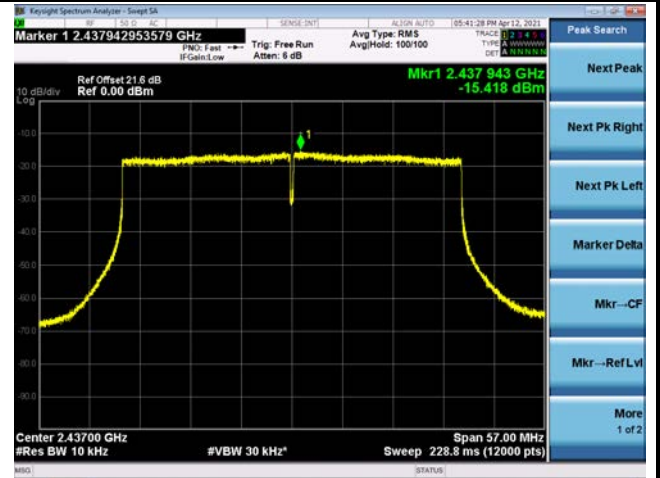

Channel 09 (2452MHz)

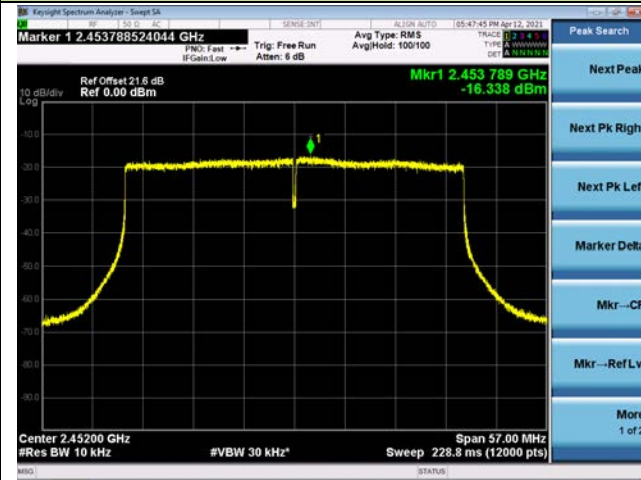

802.11b AVGPSD -Ant 3/ Ant 0+1+2+3

Channel 01 (2412MHz)



Channel 06 (2437MHz)



Channel 11 (2462MHz)





802.11g - AVGPSD -Ant 3/ Ant 0+1+2+3

Channel 01 (2412MHz)

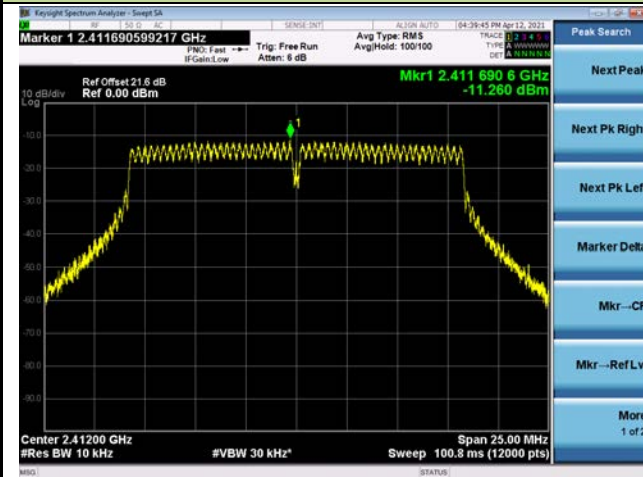

Channel 06 (2437MHz)

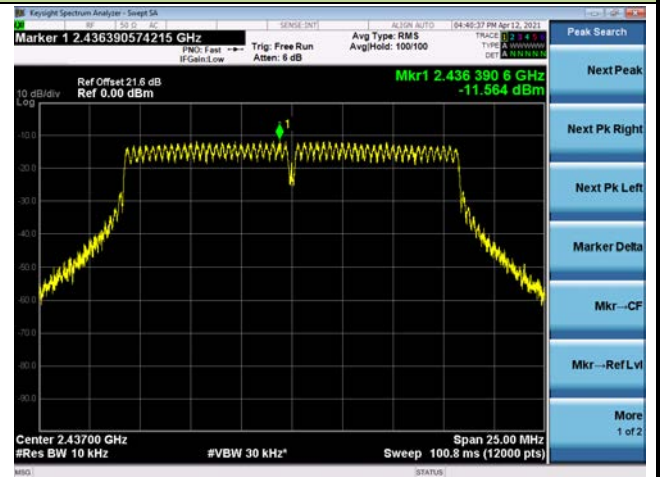

Channel 11 (2462MHz)

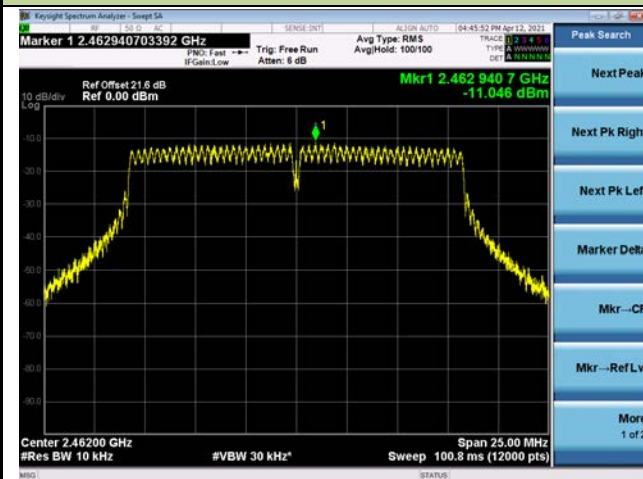

802.11n-HT20 - AVGPSD -Ant 3/ Ant 0+1+2+3

Channel 01 (2412MHz)

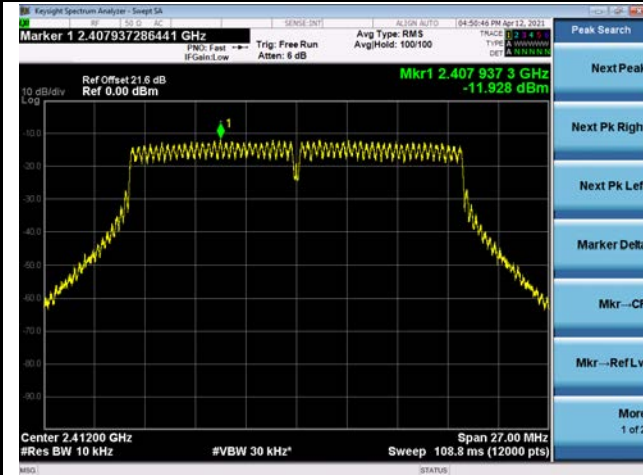

Channel 06 (2437MHz)

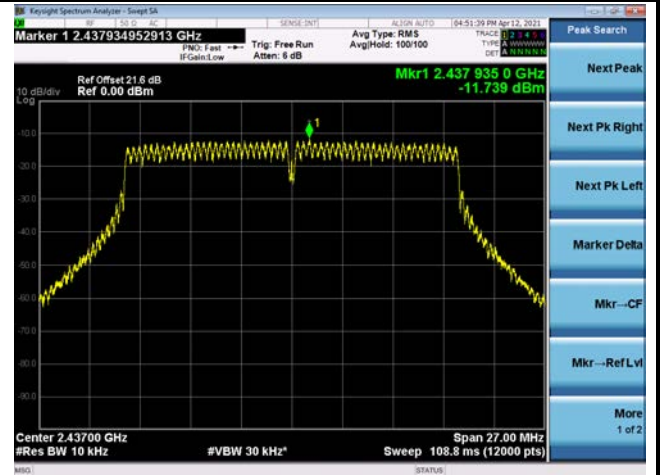

Channel 11 (2462MHz)

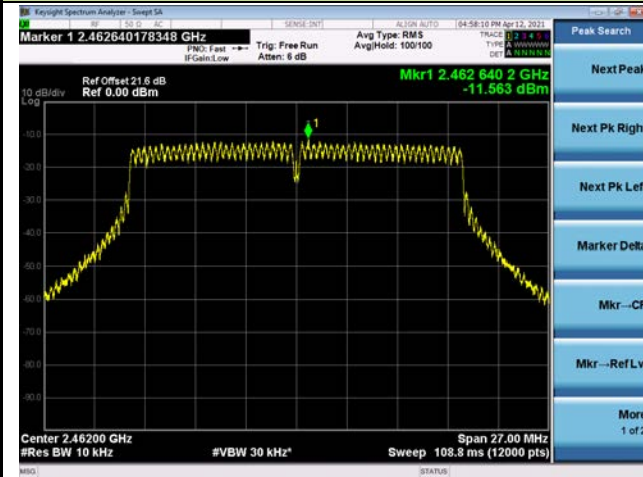

802.11n-HT40 - AVGPSD -Ant 3/ Ant 0+1+2+3

Channel 03 (2422MHz)

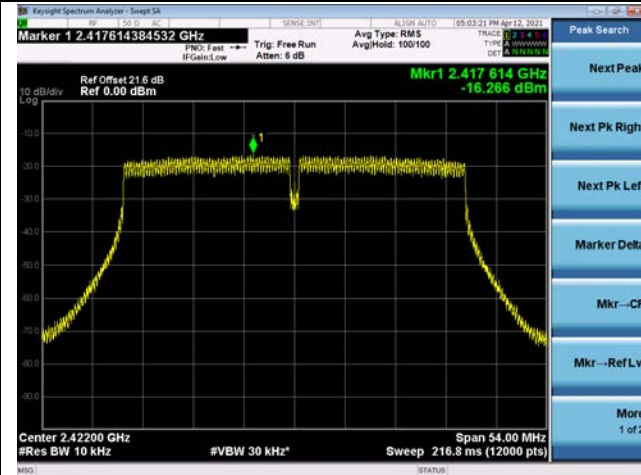

Channel 06 (2437MHz)

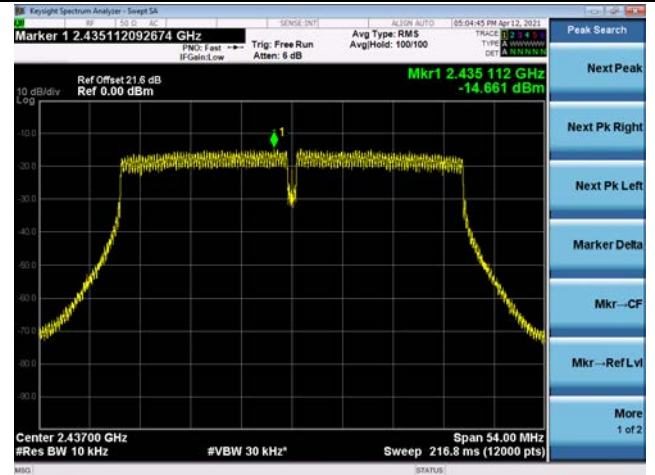

Channel 09 (2452MHz)

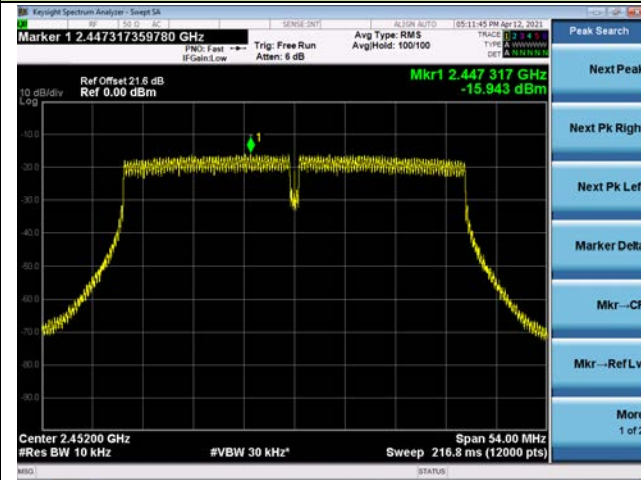

802.11ax-HE20 - AVGPSD -Ant 3/ Ant 0+1+2+3

Channel 01 (2412MHz)

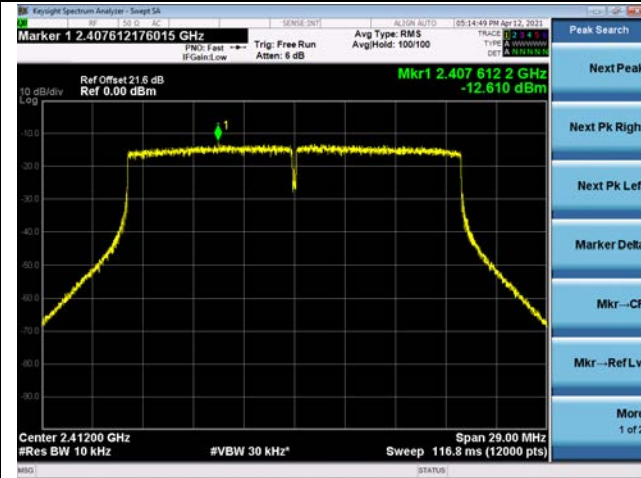

Channel 06 (2437MHz)

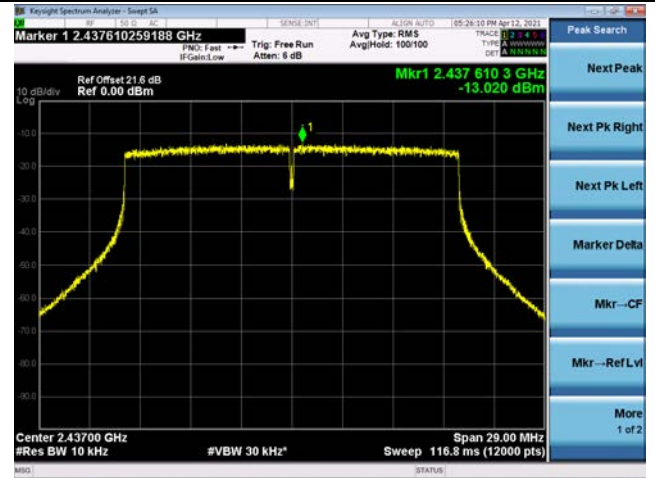

Channel 11 (2462MHz)

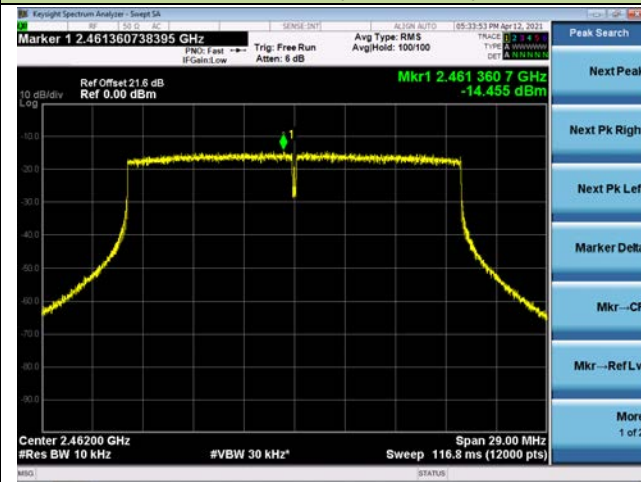

802.11ax-HE40 - AVGPSD -Ant 3/ Ant 0+1+2+3

Channel 03 (2422MHz)

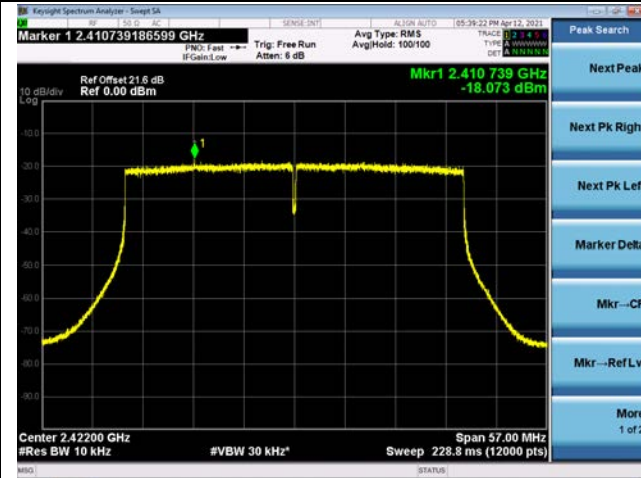

Channel 06 (2437MHz)

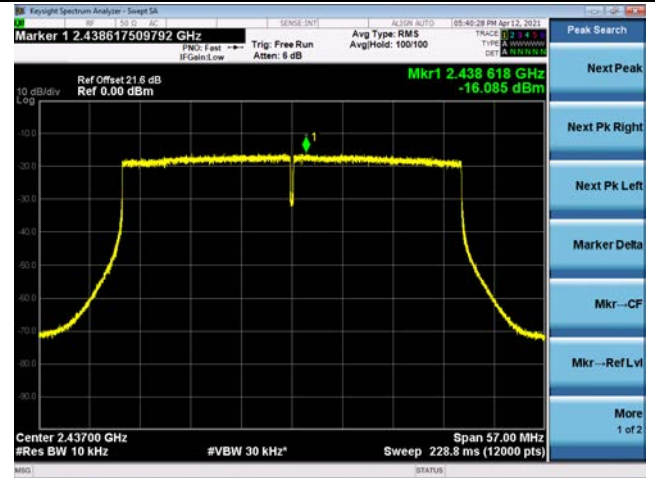

Channel 09 (2452MHz)

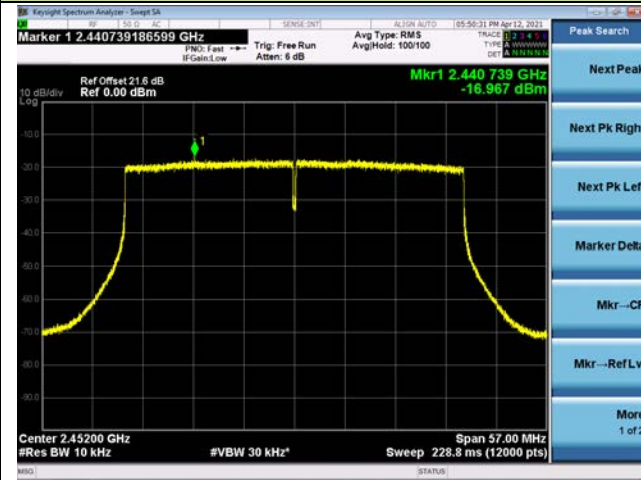

802.11b PK PSD -Scan Antenna

Channel 01 (2412MHz)

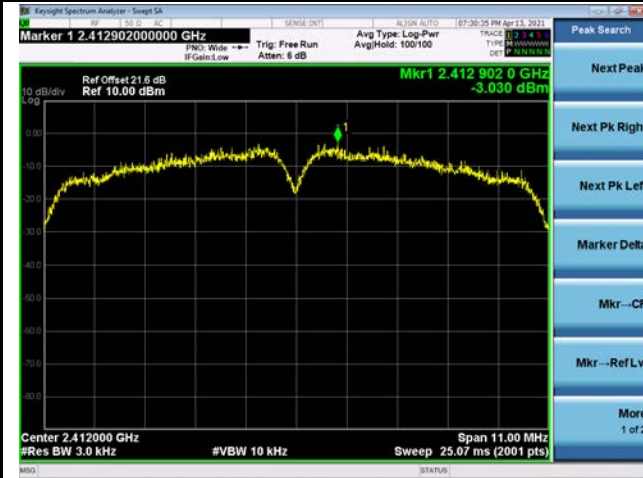

Channel 06 (2437MHz)



Channel 11 (2462MHz)



802.11g – PK PSD -Scan Antenna

Channel 01 (2412MHz)

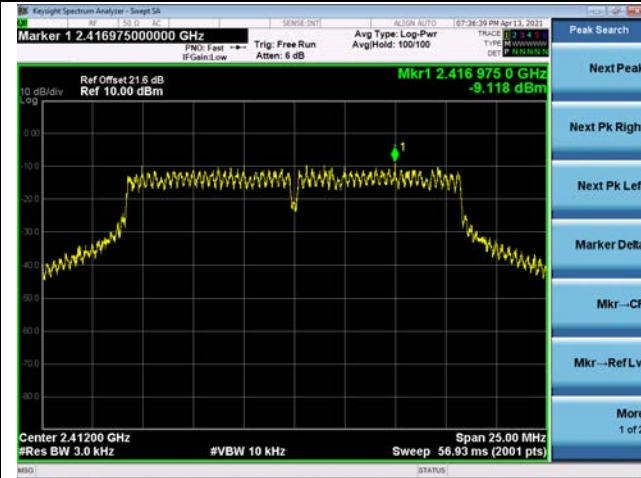

Channel 06 (2437MHz)

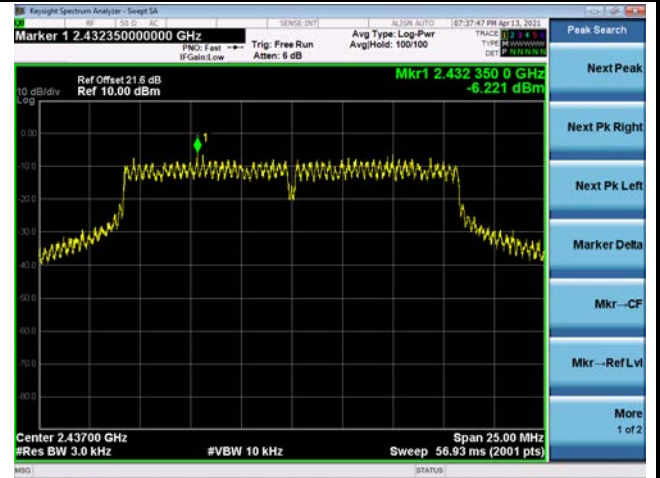

Channel 11 (2462MHz)

