

EUT	HAN Access Point	Date of Test	2021-11-13
Factor	BBHA 9120D (1GHz~18GHz)	Temp. / Humidity	23°C/53%
Polarity	Horizontal	Site / Test Engineer	AC1 / Tim
Test Mode	Transmit at 5610+5530MHz by 802.11ac-VHT80+80	Test Voltage	AC 120V/60Hz

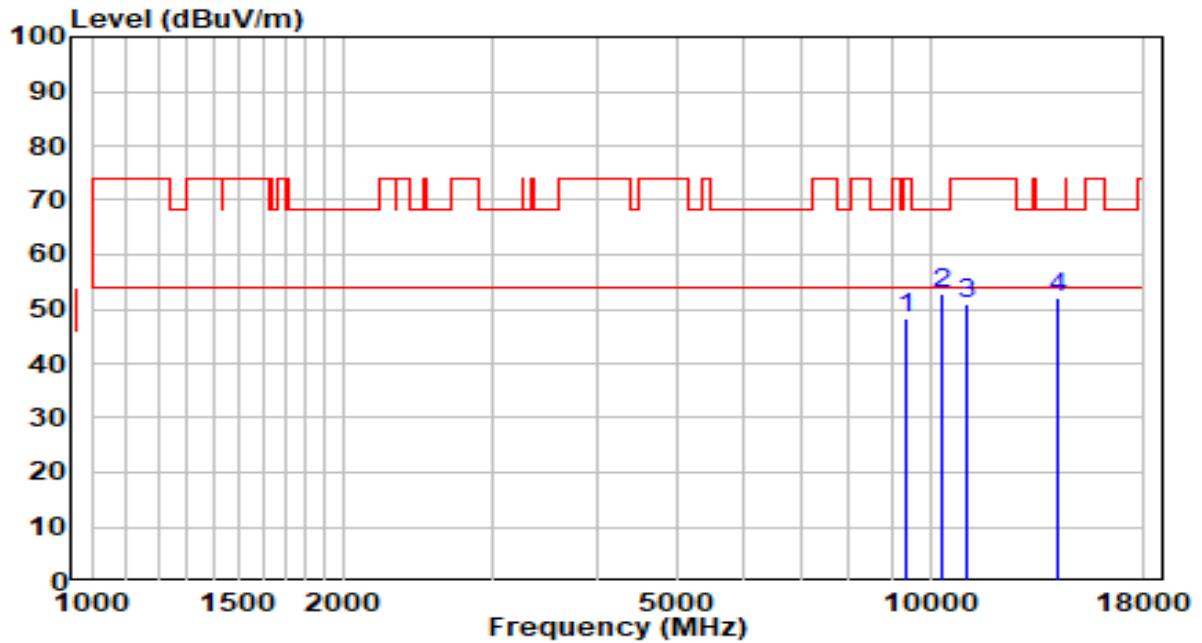

No	Frequency (MHz)	Reading (dB $\mu$ V)	C.F (dB/m)	Measurement (dB $\mu$ V/m)	Margin (dB)	Limit (dB $\mu$ V/m)	Remark (QP/PK/AV)
1	9364.000	32.67	15.49	48.16	-25.84	74.00	Peak
2	* 10316.000	35.06	17.83	52.89	-15.31	68.20	Peak
3	11064.000	31.74	19.38	51.12	-22.88	74.00	Peak
4	14166.500	29.71	22.43	52.15	-16.05	68.20	Peak

Note:

1. " \*", means this data is the worst emission level.
2. C.F (Correction Factor) = Antenna Factor (dB/m)+ Cable Loss (dB)– Preamplifier(dB).
3. Measurement(dB $\mu$ V/m) = Reading(dB $\mu$ V) + C.F (Correction Factor).

EUT	HAN Access Point	Date of Test	2021-11-13
Factor	BBHA 9120D (1GHz~18GHz)	Temp. / Humidity	23°C/53%
Polarity	Vertical	Site / Test Engineer	AC1 / Tim
Test Mode	Transmit at 5610+5530MHz by 802.11ac-VHT80+80	Test Voltage	AC 120V/60Hz

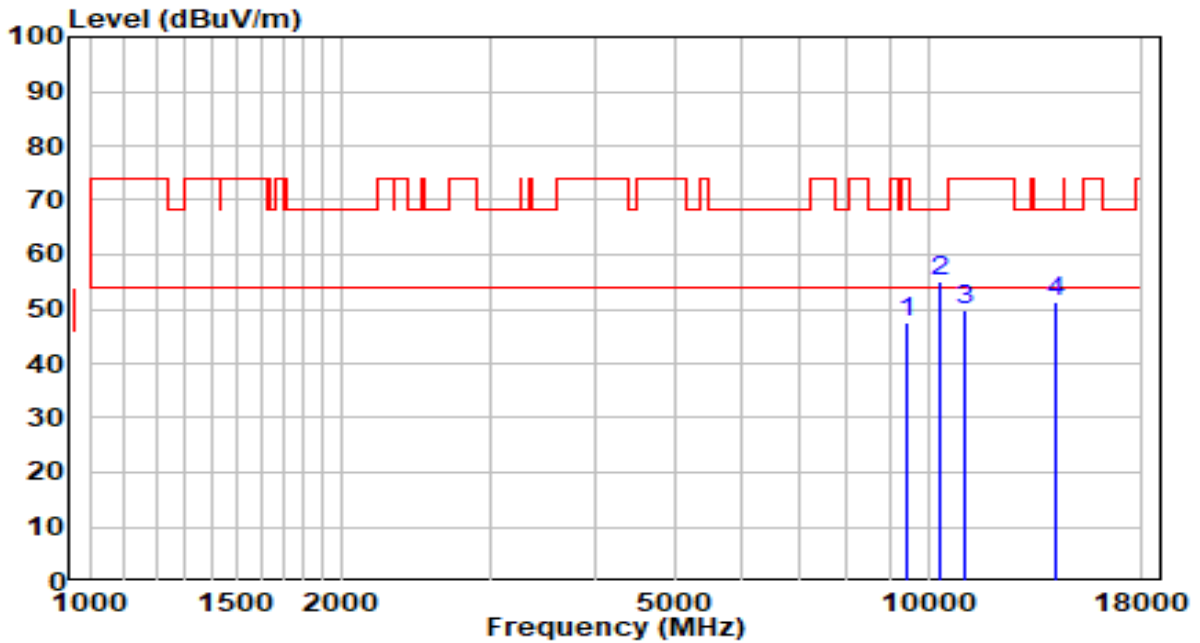

No	Frequency (MHz)	Reading (dBμV)	C.F (dB/m)	Measurement (dBμV/m)	Margin (dB)	Limit (dBμV/m)	Remark (QP/PK/AV)
1	9432.000	31.93	15.61	47.54	-26.46	74.00	Peak
2	* 10316.000	37.34	17.83	55.18	-13.02	68.20	Peak
3	11064.000	30.42	19.38	49.80	-24.20	74.00	Peak
4	14149.500	29.04	22.43	51.47	-16.73	68.20	Peak

Note:

1. " \*", means this data is the worst emission level.
2. C.F (Correction Factor) = Antenna Factor (dB/m)+ Cable Loss (dB)– Preamplifier(dB).
3. Measurement(dBμV/m) = Reading(dBμV) + C.F (Correction Factor).

EUT	HAN Access Point	Date of Test	2021-11-13
Factor	BBHA 9120D (1GHz~18GHz)	Temp. / Humidity	23°C/53%
Polarity	Horizontal	Site / Test Engineer	AC1 / Tim
Test Mode	Transmit at 5180MHz by 802.11ax-HE20	Test Voltage	AC 120V/60Hz

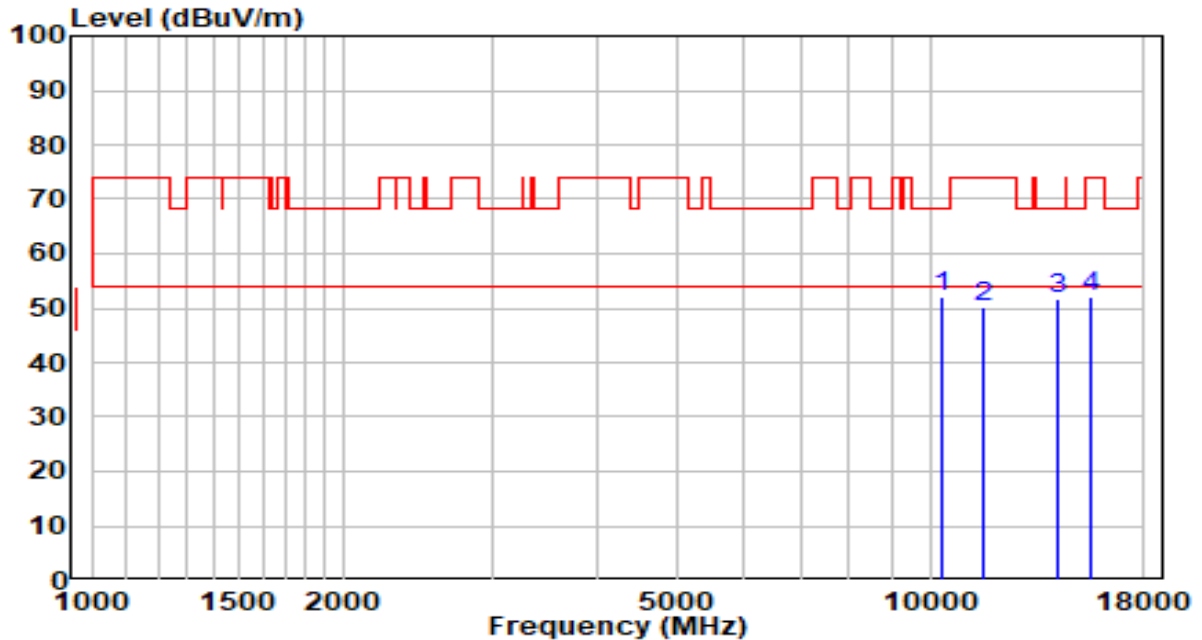

No		Frequency (MHz)	Reading (dB $\mu$ V)	C.F (dB/m)	Measurement (dB $\mu$ V/m)	Margin (dB)	Limit (dB $\mu$ V/m)	Remark (QP/PK/AV)
1	*	10316.000	34.13	17.83	51.96	-16.24	68.20	Peak
2		11531.500	30.21	19.98	50.19	-23.81	74.00	Peak
3		14166.500	29.11	22.43	51.55	-16.65	68.20	Peak
4	*	15543.500	30.93	21.24	52.17	-21.83	74.00	Peak

Note:

1. " \*", means this data is the worst emission level.
2. C.F (Correction Factor) = Antenna Factor (dB/m)+ Cable Loss (dB)– Preamplifier(dB).
3. Measurement(dB $\mu$ V/m) = Reading(dB $\mu$ V) + C.F (Correction Factor).

EUT	HAN Access Point	Date of Test	2021-11-13
Factor	BBHA 9120D (1GHz~18GHz)	Temp. / Humidity	23°C/53%
Polarity	Vertical	Site / Test Engineer	AC1 / Tim
Test Mode	Transmit at 5180MHz by 802.11ax-HE20	Test Voltage	AC 120V/60Hz

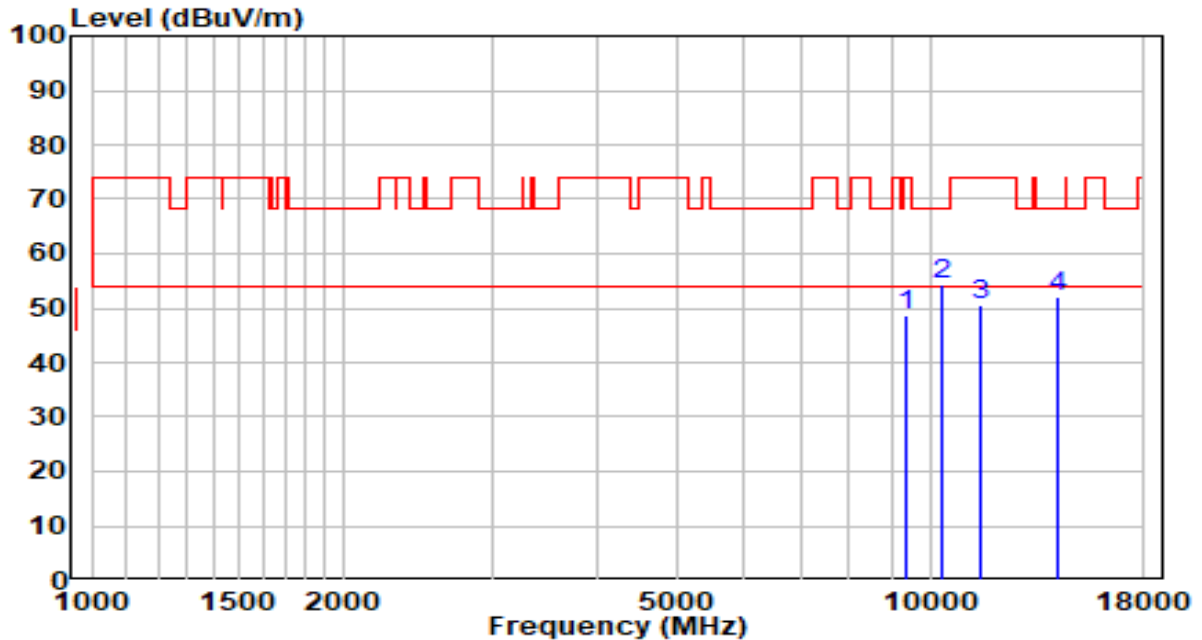

No	Frequency (MHz)	Reading (dB $\mu$ V)	C.F (dB/m)	Measurement (dB $\mu$ V/m)	Margin (dB)	Limit (dB $\mu$ V/m)	Remark (QP/PK/AV)
1	9355.500	33.08	15.48	48.56	-25.44	74.00	Peak
2	* 10316.000	36.45	17.83	54.28	-13.92	68.20	Peak
3	11472.000	30.44	20.01	50.45	-23.55	74.00	Peak
4	14243.000	29.56	22.44	52.00	-16.20	68.20	Peak

Note:

1. " \*", means this data is the worst emission level.
2. C.F (Correction Factor) = Antenna Factor (dB/m)+ Cable Loss (dB)– Preamplifier(dB).
3. Measurement(dB $\mu$ V/m) = Reading(dB $\mu$ V) + C.F (Correction Factor).

EUT	HAN Access Point	Date of Test	2021-11-13
Factor	BBHA 9120D (1GHz~18GHz)	Temp. / Humidity	23°C/53%
Polarity	Horizontal	Site / Test Engineer	AC1 / Tim
Test Mode	Transmit at 5220MHz by 802.11ax-HE20	Test Voltage	AC 120V/60Hz

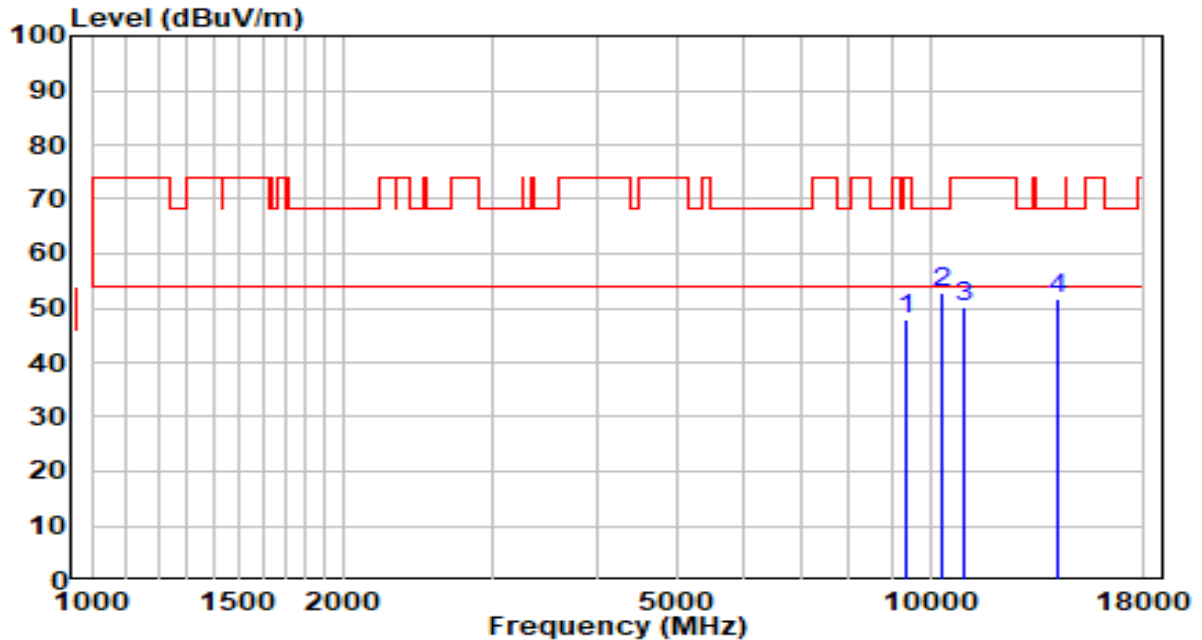

No	Frequency (MHz)	Reading (dB $\mu$ V)	C.F (dB/m)	Measurement (dB $\mu$ V/m)	Margin (dB)	Limit (dB $\mu$ V/m)	Remark (QP/PK/AV)
1	9338.500	32.37	15.45	47.82	-26.18	74.00	Peak
2	* 10316.000	34.97	17.83	52.80	-15.40	68.20	Peak
3	10953.500	30.89	19.21	50.11	-23.89	74.00	Peak
4	14149.500	29.20	22.43	51.63	-16.57	68.20	Peak

Note:

1. " \*", means this data is the worst emission level.
2. C.F (Correction Factor) = Antenna Factor (dB/m)+ Cable Loss (dB)– Preamplifier(dB).
3. Measurement(dB $\mu$ V/m) = Reading(dB $\mu$ V) + C.F (Correction Factor).

EUT	HAN Access Point	Date of Test	2021-11-13
Factor	BBHA 9120D (1GHz~18GHz)	Temp. / Humidity	23°C/53%
Polarity	Vertical	Site / Test Engineer	AC1 / Tim
Test Mode	Transmit at 5220MHz by 802.11ax-HE20	Test Voltage	AC 120V/60Hz

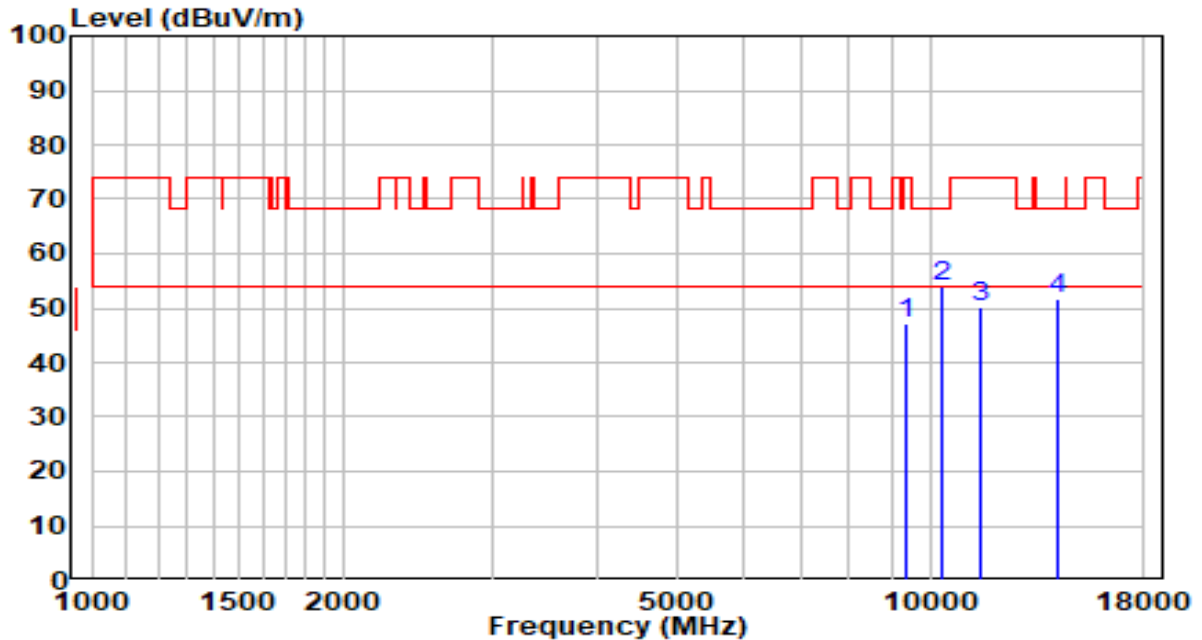

No	Frequency (MHz)	Reading (dB $\mu$ V)	C.F (dB/m)	Measurement (dB $\mu$ V/m)	Margin (dB)	Limit (dB $\mu$ V/m)	Remark (QP/PK/AV)
1	9338.500	31.55	15.45	47.00	-27.00	74.00	Peak
2	* 10316.000	36.31	17.83	54.14	-14.06	68.20	Peak
3	11489.000	30.16	20.03	50.19	-23.81	74.00	Peak
4	14175.000	29.15	22.43	51.59	-16.61	68.20	Peak

Note:

1. " \*", means this data is the worst emission level.
2. C.F (Correction Factor) = Antenna Factor (dB/m)+ Cable Loss (dB)– Preamplifier(dB).
3. Measurement(dB $\mu$ V/m) = Reading(dB $\mu$ V) + C.F (Correction Factor).

EUT	HAN Access Point	Date of Test	2021-11-13
Factor	BBHA 9120D (1GHz~18GHz)	Temp. / Humidity	23°C/53%
Polarity	Horizontal	Site / Test Engineer	AC1 / Tim
Test Mode	Transmit at 5240MHz by 802.11ax-HE20	Test Voltage	AC 120V/60Hz

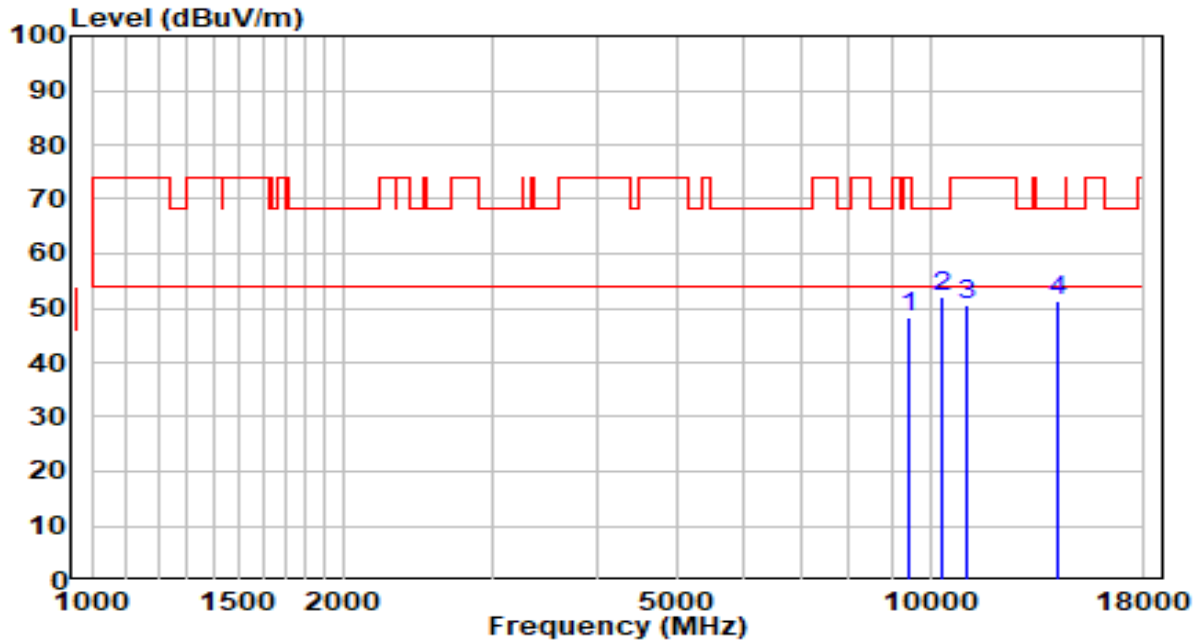

No	Frequency (MHz)	Reading (dB $\mu$ V)	C.F (dB/m)	Measurement (dB $\mu$ V/m)	Margin (dB)	Limit (dB $\mu$ V/m)	Remark (QP/PK/AV)
1	9415.000	32.64	15.58	48.21	-25.79	74.00	Peak
2	* 10316.000	34.12	17.83	51.95	-16.25	68.20	Peak
3	11038.500	31.35	19.34	50.69	-23.31	74.00	Peak
4	14149.500	29.03	22.43	51.46	-16.74	68.20	Peak

Note:

1. " \*", means this data is the worst emission level.
2. C.F (Correction Factor) = Antenna Factor (dB/m)+ Cable Loss (dB)– Preamplifier(dB).
3. Measurement(dB $\mu$ V/m) = Reading(dB $\mu$ V) + C.F (Correction Factor).

EUT	HAN Access Point	Date of Test	2021-11-13
Factor	BBHA 9120D (1GHz~18GHz)	Temp. / Humidity	23°C/53%
Polarity	Vertical	Site / Test Engineer	AC1 / Tim
Test Mode	Transmit at 5240MHz by 802.11ax-HE20	Test Voltage	AC 120V/60Hz

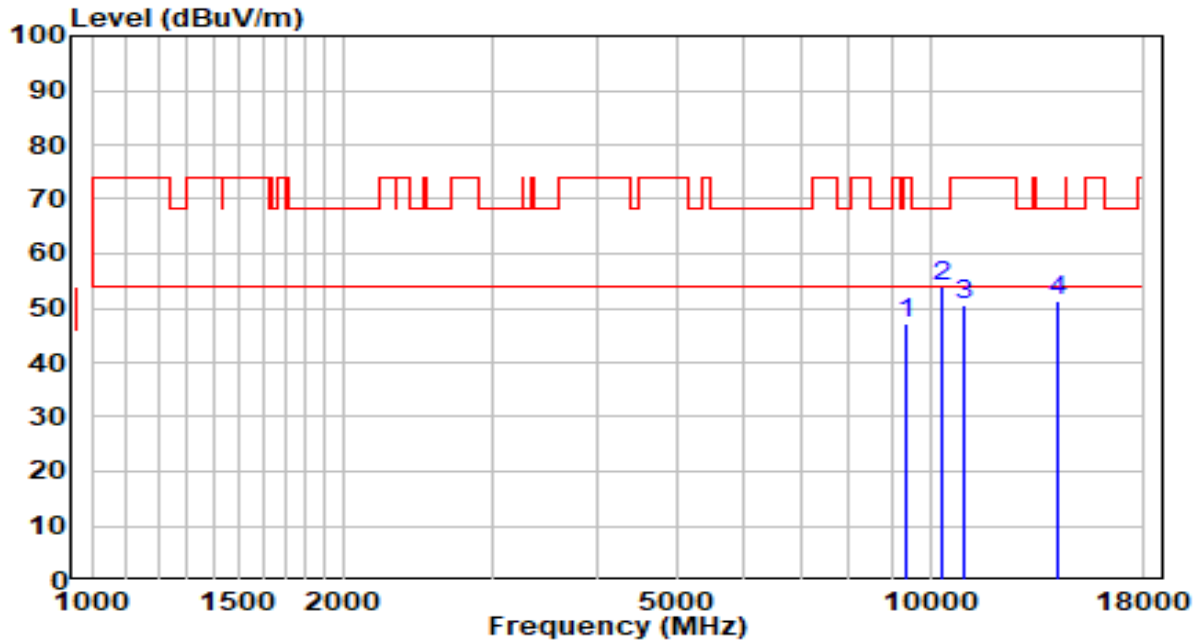

No	Frequency (MHz)	Reading (dB $\mu$ V)	C.F (dB/m)	Measurement (dB $\mu$ V/m)	Margin (dB)	Limit (dB $\mu$ V/m)	Remark (QP/PK/AV)
1	9389.500	31.72	15.53	47.25	-26.75	74.00	Peak
2	* 10316.000	36.11	17.83	53.94	-14.26	68.20	Peak
3	10936.500	31.19	19.19	50.38	-23.62	74.00	Peak
4	14158.000	28.91	22.43	51.34	-16.86	68.20	Peak

Note:

1. " \*", means this data is the worst emission level.
2. C.F (Correction Factor) = Antenna Factor (dB/m)+ Cable Loss (dB)– Preamplifier(dB).
3. Measurement(dB $\mu$ V/m) = Reading(dB $\mu$ V) + C.F (Correction Factor).



EUT	HAN Access Point	Date of Test	2021-11-13
Factor	BBHA 9120D (1GHz~18GHz)	Temp. / Humidity	23°C/53%
Polarity	Horizontal	Site / Test Engineer	AC1 / Tim
Test Mode	Transmit at 5260MHz by 802.11ax-HE20	Test Voltage	AC 120V/60Hz

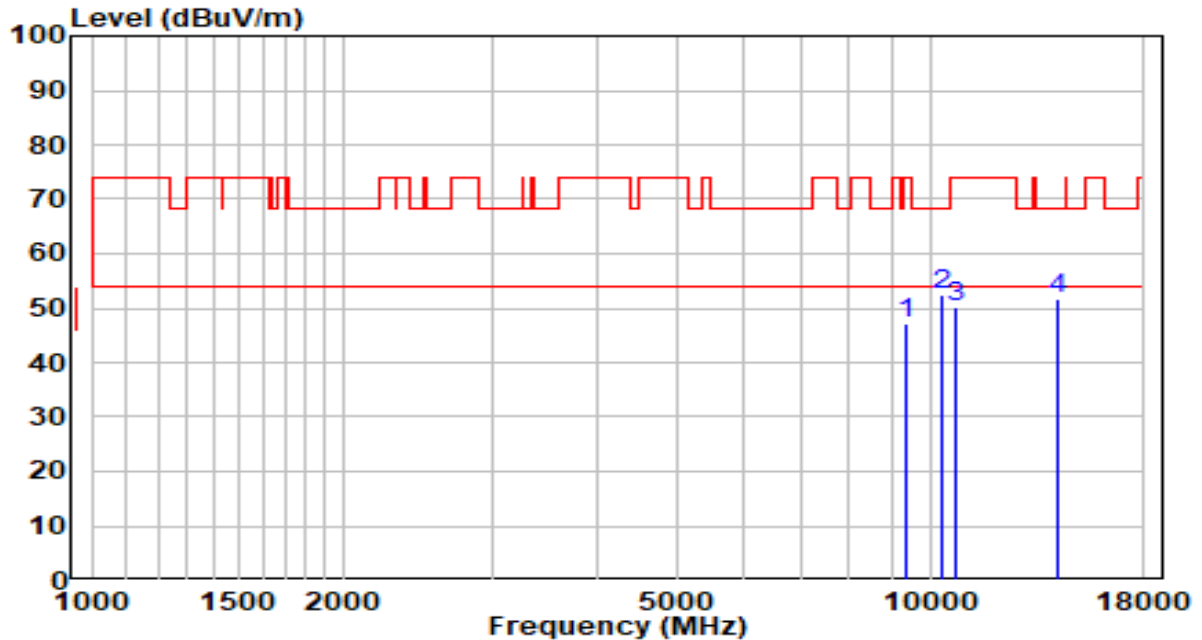

No	Frequency (MHz)	Reading (dB $\mu$ V)	C.F (dB/m)	Measurement (dB $\mu$ V/m)	Margin (dB)	Limit (dB $\mu$ V/m)	Remark (QP/PK/AV)
1	9355.500	31.75	15.48	47.23	-26.77	74.00	Peak
2	* 10316.000	34.57	17.83	52.40	-15.80	68.20	Peak
3	10758.000	31.38	18.94	50.32	-23.68	74.00	Peak
4	14166.500	29.30	22.43	51.73	-16.47	68.20	Peak

Note:

1. " \*", means this data is the worst emission level.
2. C.F (Correction Factor) = Antenna Factor (dB/m)+ Cable Loss (dB)– Preamplifier(dB).
3. Measurement(dB $\mu$ V/m) = Reading(dB $\mu$ V) + C.F (Correction Factor).

EUT	HAN Access Point	Date of Test	2021-11-13
Factor	BBHA 9120D (1GHz~18GHz)	Temp. / Humidity	23°C/53%
Polarity	Vertical	Site / Test Engineer	AC1 / Tim
Test Mode	Transmit at 5260MHz by 802.11ax-HE20	Test Voltage	AC 120V/60Hz

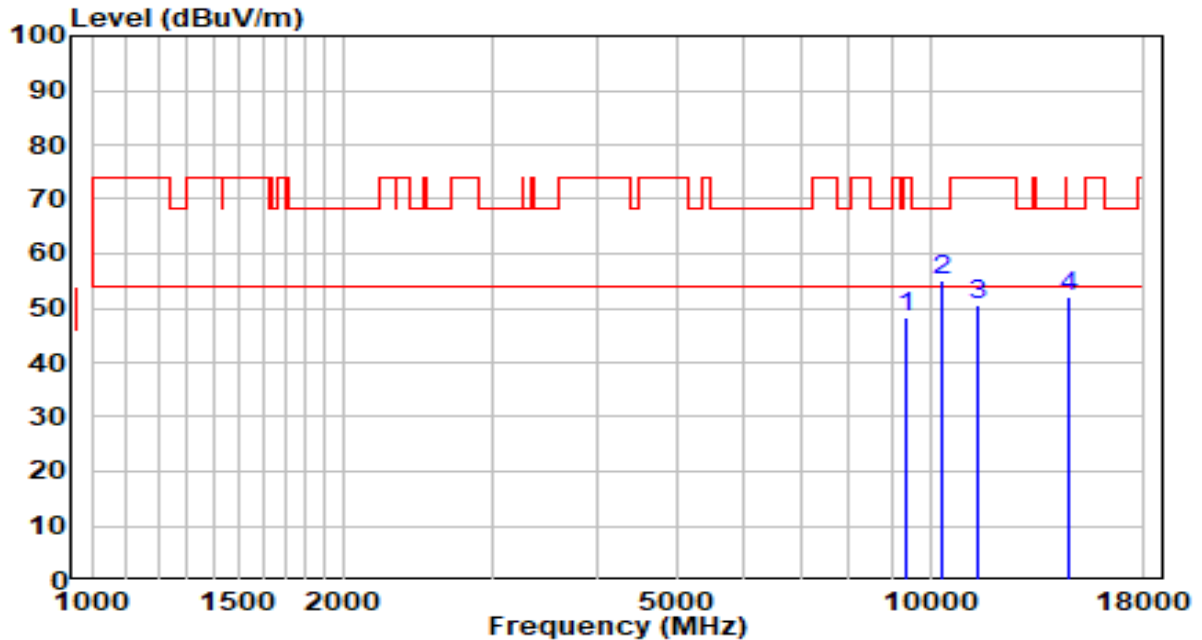

No	Frequency (MHz)	Reading (dB $\mu$ V)	C.F (dB/m)	Measurement (dB $\mu$ V/m)	Margin (dB)	Limit (dB $\mu$ V/m)	Remark (QP/PK/AV)
1	9355.500	32.96	15.48	48.44	-25.56	74.00	Peak
2	* 10316.000	37.08	17.83	54.91	-13.29	68.20	Peak
3	11395.500	30.53	19.89	50.42	-23.58	74.00	Peak
4	14600.000	29.64	22.38	52.03	-16.17	68.20	Peak

Note:

1. " \*", means this data is the worst emission level.
2. C.F (Correction Factor) = Antenna Factor (dB/m)+ Cable Loss (dB)– Preamplifier(dB).
3. Measurement(dB $\mu$ V/m) = Reading(dB $\mu$ V) + C.F (Correction Factor).

EUT	HAN Access Point	Date of Test	2021-11-13
Factor	BBHA 9120D (1GHz~18GHz)	Temp. / Humidity	23°C/53%
Polarity	Horizontal	Site / Test Engineer	AC1 / Tim
Test Mode	Transmit at 5300MHz by 802.11ax-HE20	Test Voltage	AC 120V/60Hz

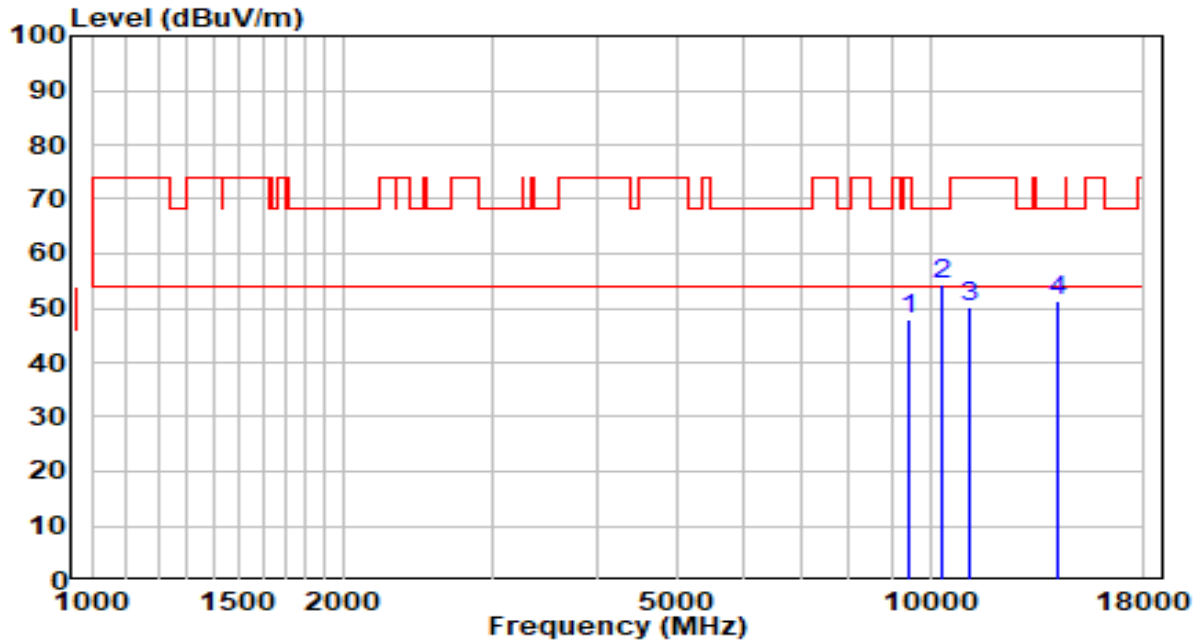

No	Frequency (MHz)	Reading (dB $\mu$ V)	C.F (dB/m)	Measurement (dB $\mu$ V/m)	Margin (dB)	Limit (dB $\mu$ V/m)	Remark (QP/PK/AV)
1	9406.500	32.53	15.56	48.09	-25.91	74.00	Peak
2	* 10316.000	36.65	17.83	54.48	-13.72	68.20	Peak
3	11115.000	30.65	19.46	50.11	-23.89	74.00	Peak
4	14158.000	28.83	22.43	51.26	-16.94	68.20	Peak

Note:

1. " \*", means this data is the worst emission level.
2. C.F (Correction Factor) = Antenna Factor (dB/m)+ Cable Loss (dB)– Preamplifier(dB).
3. Measurement(dB $\mu$ V/m) = Reading(dB $\mu$ V) + C.F (Correction Factor).

EUT	HAN Access Point	Date of Test	2021-11-13
Factor	BBHA 9120D (1GHz~18GHz)	Temp. / Humidity	23°C/53%
Polarity	Vertical	Site / Test Engineer	AC1 / Tim
Test Mode	Transmit at 5300MHz by 802.11ax-HE20	Test Voltage	AC 120V/60Hz

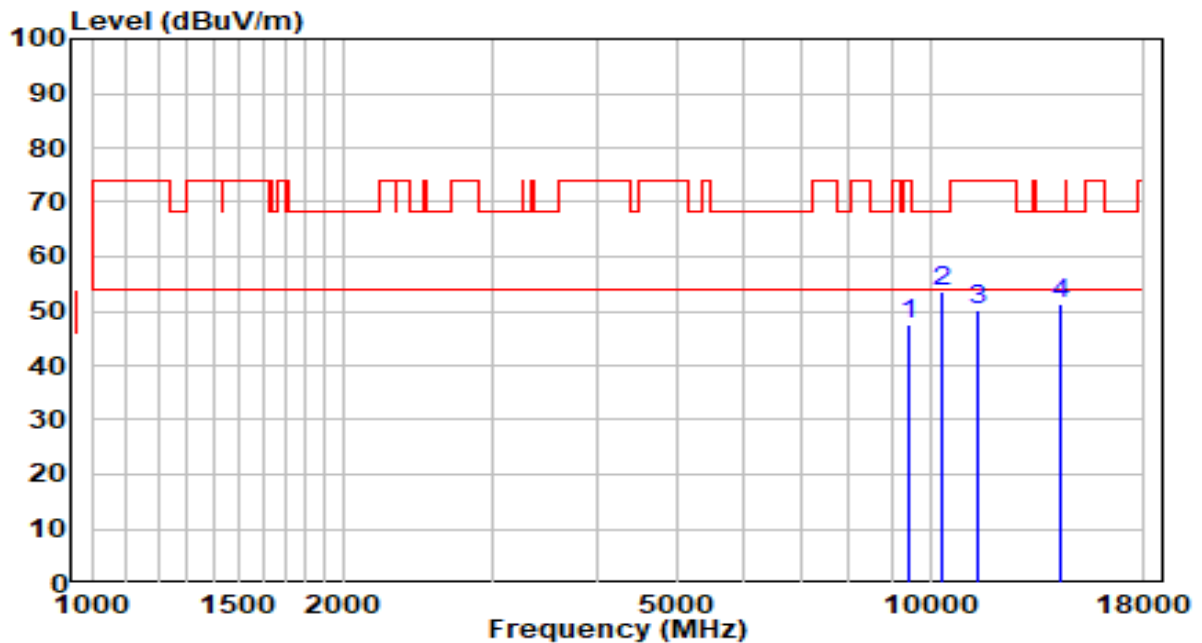

No	Frequency (MHz)	Reading (dB $\mu$ V)	C.F (dB/m)	Measurement (dB $\mu$ V/m)	Margin (dB)	Limit (dB $\mu$ V/m)	Remark (QP/PK/AV)
1	9440.500	32.10	15.62	47.72	-26.28	74.00	Peak
2	* 10316.000	35.73	17.83	53.56	-14.64	68.20	Peak
3	11412.500	30.35	19.92	50.27	-23.73	74.00	Peak
4	14260.000	29.04	22.44	51.48	-16.72	68.20	Peak

Note:

1. " \*", means this data is the worst emission level.
2. C.F (Correction Factor) = Antenna Factor (dB/m)+ Cable Loss (dB)– Preamplifier(dB).
3. Measurement(dB $\mu$ V/m) = Reading(dB $\mu$ V) + C.F (Correction Factor).

EUT	HAN Access Point	Date of Test	2021-11-13
Factor	BBHA 9120D (1GHz~18GHz)	Temp. / Humidity	23°C/53%
Polarity	Horizontal	Site / Test Engineer	AC1 / Tim
Test Mode	Transmit at 5320MHz by 802.11ax-HE20	Test Voltage	AC 120V/60Hz

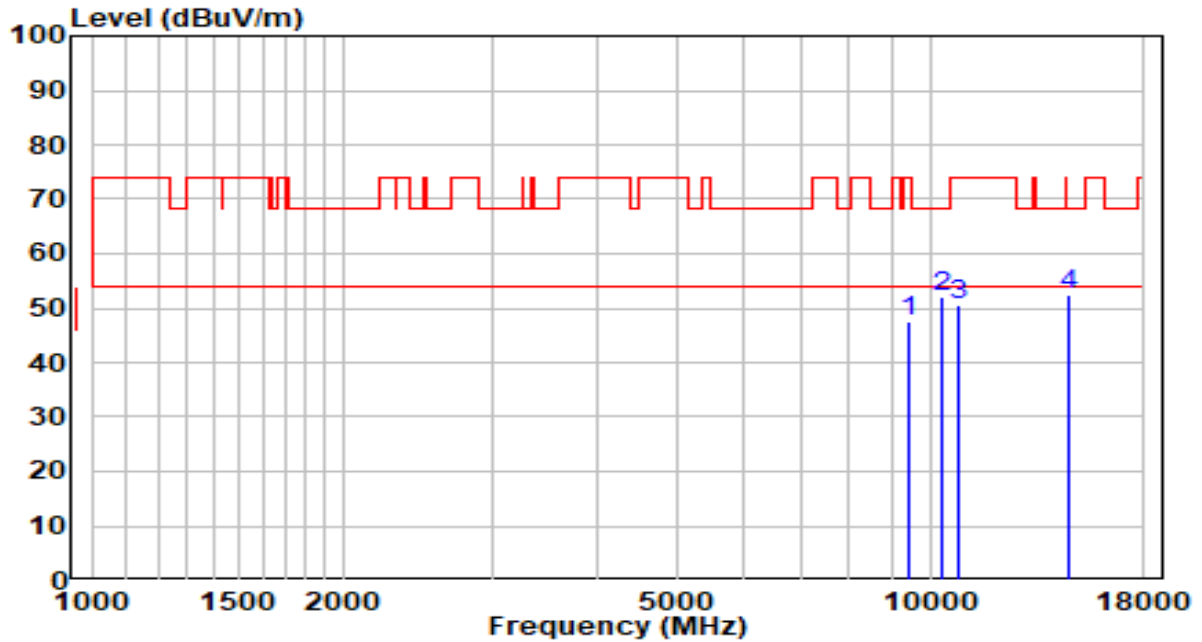

No	Frequency (MHz)	Reading (dB $\mu$ V)	C.F (dB/m)	Measurement (dB $\mu$ V/m)	Margin (dB)	Limit (dB $\mu$ V/m)	Remark (QP/PK/AV)
1	9423.500	32.11	15.59	47.70	-26.30	74.00	Peak
2	10316.000	34.31	17.83	52.14	-16.06	68.20	Peak
3	10817.500	31.52	19.02	50.54	-23.46	74.00	Peak
4	* 14617.000	29.94	22.37	52.30	-15.90	68.20	Peak

Note:

1. " \*", means this data is the worst emission level.
2. C.F (Correction Factor) = Antenna Factor (dB/m)+ Cable Loss (dB)– Preamplifier(dB).
3. Measurement(dB $\mu$ V/m) = Reading(dB $\mu$ V) + C.F (Correction Factor).

EUT	HAN Access Point	Date of Test	2021-11-13
Factor	BBHA 9120D (1GHz~18GHz)	Temp. / Humidity	23°C/53%
Polarity	Vertical	Site / Test Engineer	AC1 / Tim
Test Mode	Transmit at 5320MHz by 802.11ax-HE20	Test Voltage	AC 120V/60Hz

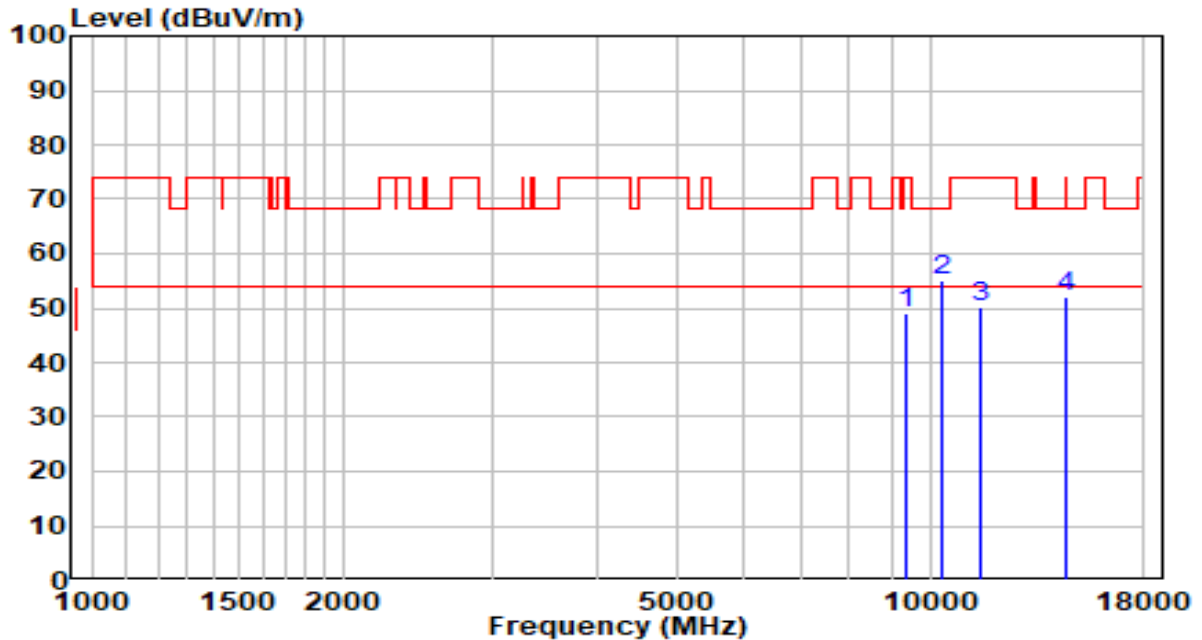

No	Frequency (MHz)	Reading (dB $\mu$ V)	C.F (dB/m)	Measurement (dB $\mu$ V/m)	Margin (dB)	Limit (dB $\mu$ V/m)	Remark (QP/PK/AV)
1	9372.500	33.44	15.51	48.94	-25.06	74.00	Peak
2	* 10316.000	37.37	17.83	55.20	-13.00	68.20	Peak
3	11455.000	30.09	19.98	50.07	-23.93	74.00	Peak
4	14532.000	29.50	22.43	51.93	-16.27	68.20	Peak

Note:

1. " \*", means this data is the worst emission level.
2. C.F (Correction Factor) = Antenna Factor (dB/m)+ Cable Loss (dB)– Preamplifier(dB).
3. Measurement(dB $\mu$ V/m) = Reading(dB $\mu$ V) + C.F (Correction Factor).

EUT	HAN Access Point	Date of Test	2021-11-13
Factor	BBHA 9120D (1GHz~18GHz)	Temp. / Humidity	23°C/53%
Polarity	Horizontal	Site / Test Engineer	AC1 / Tim
Test Mode	Transmit at 5500MHz by 802.11ax-HE20	Test Voltage	AC 120V/60Hz

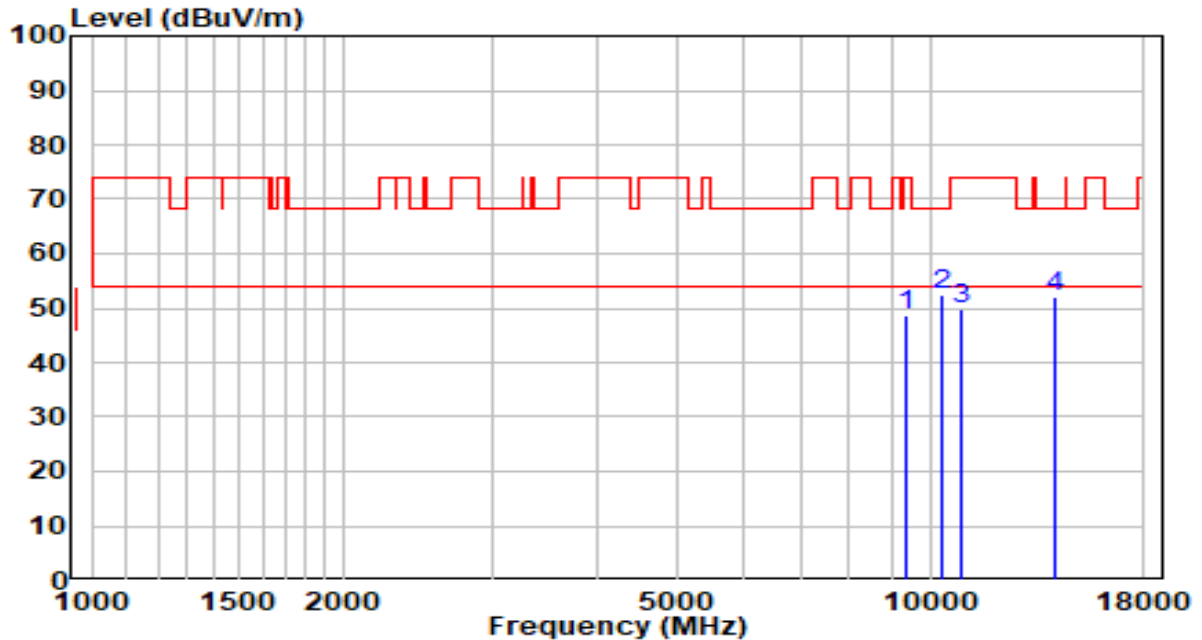

No	Frequency (MHz)	Reading (dB $\mu$ V)	C.F (dB/m)	Measurement (dB $\mu$ V/m)	Margin (dB)	Limit (dB $\mu$ V/m)	Remark (QP/PK/AV)
1	9372.500	33.23	15.51	48.73	-25.27	74.00	Peak
2	* 10316.000	34.59	17.83	52.42	-15.78	68.20	Peak
3	10894.000	30.54	19.13	49.67	-24.33	74.00	Peak
4	14132.500	29.47	22.43	51.90	-16.30	68.20	Peak

Note:

1. " \*", means this data is the worst emission level.
2. C.F (Correction Factor) = Antenna Factor (dB/m)+ Cable Loss (dB)– Preamplifier(dB).
3. Measurement(dB $\mu$ V/m) = Reading(dB $\mu$ V) + C.F (Correction Factor).

EUT	HAN Access Point	Date of Test	2021-11-13
Factor	BBHA 9120D (1GHz~18GHz)	Temp. / Humidity	23°C/53%
Polarity	Vertical	Site / Test Engineer	AC1 / Tim
Test Mode	Transmit at 5500MHz by 802.11ax-HE20	Test Voltage	AC 120V/60Hz

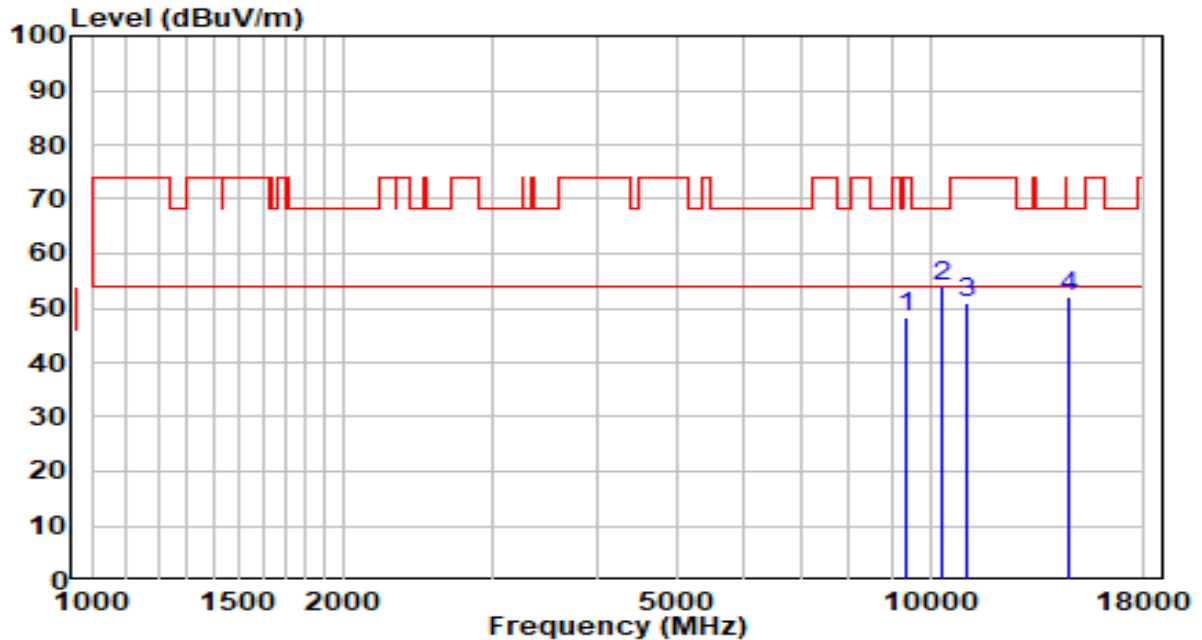

No	Frequency (MHz)	Reading (dB $\mu$ V)	C.F (dB/m)	Measurement (dB $\mu$ V/m)	Margin (dB)	Limit (dB $\mu$ V/m)	Remark (QP/PK/AV)
1	9355.500	32.83	15.48	48.31	-25.69	74.00	Peak
2	* 10316.000	36.24	17.83	54.07	-14.13	68.20	Peak
3	11038.500	31.69	19.34	51.03	-22.97	74.00	Peak
4	14600.000	29.56	22.38	51.94	-16.26	68.20	Peak

Note:

1. " \*", means this data is the worst emission level.
2. C.F (Correction Factor) = Antenna Factor (dB/m)+ Cable Loss (dB)– Preamplifier(dB).
3. Measurement(dB $\mu$ V/m) = Reading(dB $\mu$ V) + C.F (Correction Factor).



EUT	HAN Access Point	Date of Test	2021-11-13
Factor	BBHA 9120D (1GHz~18GHz)	Temp. / Humidity	23°C/53%
Polarity	Horizontal	Site / Test Engineer	AC1 / Tim
Test Mode	Transmit at 5580MHz by 802.11ax-HE20	Test Voltage	AC 120V/60Hz

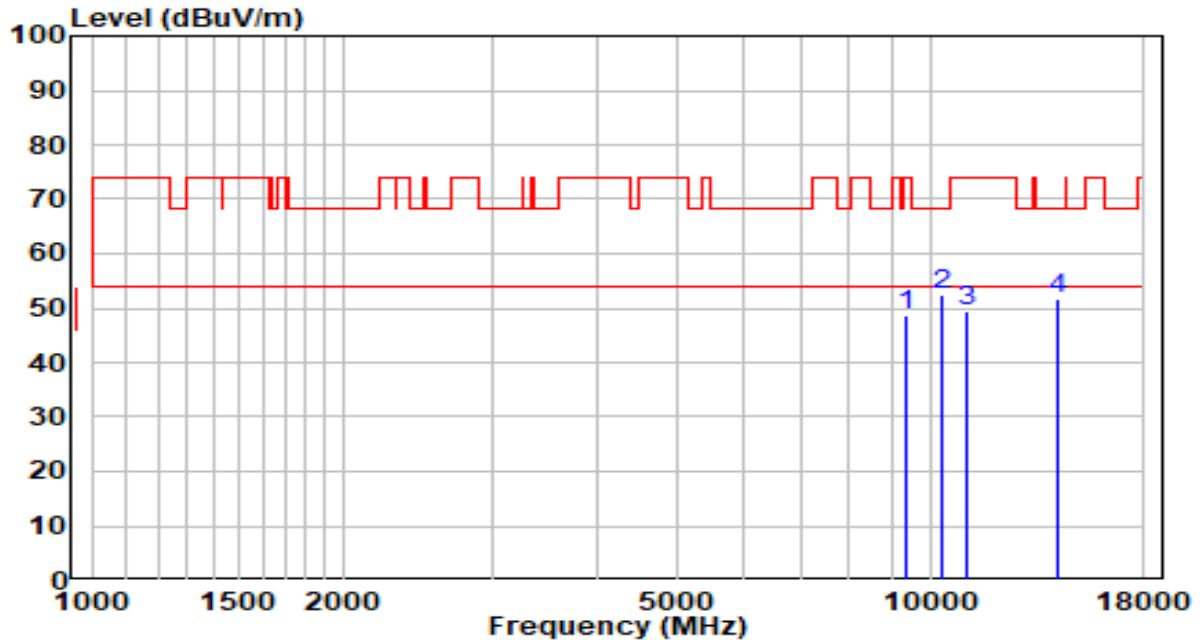

No	Frequency (MHz)	Reading (dB $\mu$ V)	C.F (dB/m)	Measurement (dB $\mu$ V/m)	Margin (dB)	Limit (dB $\mu$ V/m)	Remark (QP/PK/AV)
1	9364.000	33.16	15.49	48.66	-25.34	74.00	Peak
2	* 10316.000	34.63	17.83	52.46	-15.74	68.20	Peak
3	11055.500	30.18	19.37	49.55	-24.45	74.00	Peak
4	14158.000	29.24	22.43	51.67	-16.53	68.20	Peak

Note:

1. " \*", means this data is the worst emission level.
2. C.F (Correction Factor) = Antenna Factor (dB/m)+ Cable Loss (dB)– Preamplifier(dB).
3. Measurement(dB $\mu$ V/m) = Reading(dB $\mu$ V) + C.F (Correction Factor).

EUT	HAN Access Point	Date of Test	2021-11-13
Factor	BBHA 9120D (1GHz~18GHz)	Temp. / Humidity	23°C/53%
Polarity	Vertical	Site / Test Engineer	AC1 / Tim
Test Mode	Transmit at 5580MHz by 802.11ax-HE20	Test Voltage	AC 120V/60Hz

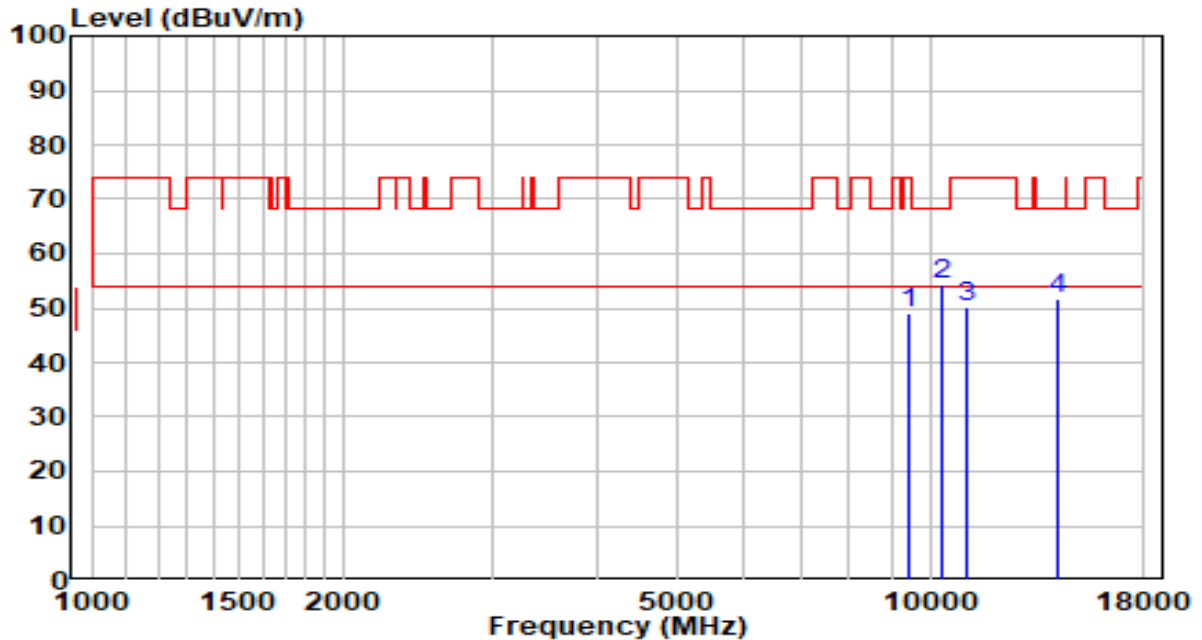

No	Frequency (MHz)	Reading (dB $\mu$ V)	C.F (dB/m)	Measurement (dB $\mu$ V/m)	Margin (dB)	Limit (dB $\mu$ V/m)	Remark (QP/PK/AV)
1	9406.500	33.59	15.56	49.15	-24.85	74.00	Peak
2	* 10316.000	36.43	17.83	54.26	-13.94	68.20	Peak
3	11072.500	30.84	19.39	50.23	-23.77	74.00	Peak
4	14149.500	29.11	22.43	51.55	-16.65	68.20	Peak

Note:

1. " \*", means this data is the worst emission level.
2. C.F (Correction Factor) = Antenna Factor (dB/m)+ Cable Loss (dB)– Preamplifier(dB).
3. Measurement(dB $\mu$ V/m) = Reading(dB $\mu$ V) + C.F (Correction Factor).

EUT	HAN Access Point	Date of Test	2021-11-13
Factor	BBHA 9120D (1GHz~18GHz)	Temp. / Humidity	23°C/53%
Polarity	Horizontal	Site / Test Engineer	AC1 / Tim
Test Mode	Transmit at 5700MHz by 802.11ax-HE20	Test Voltage	AC 120V/60Hz

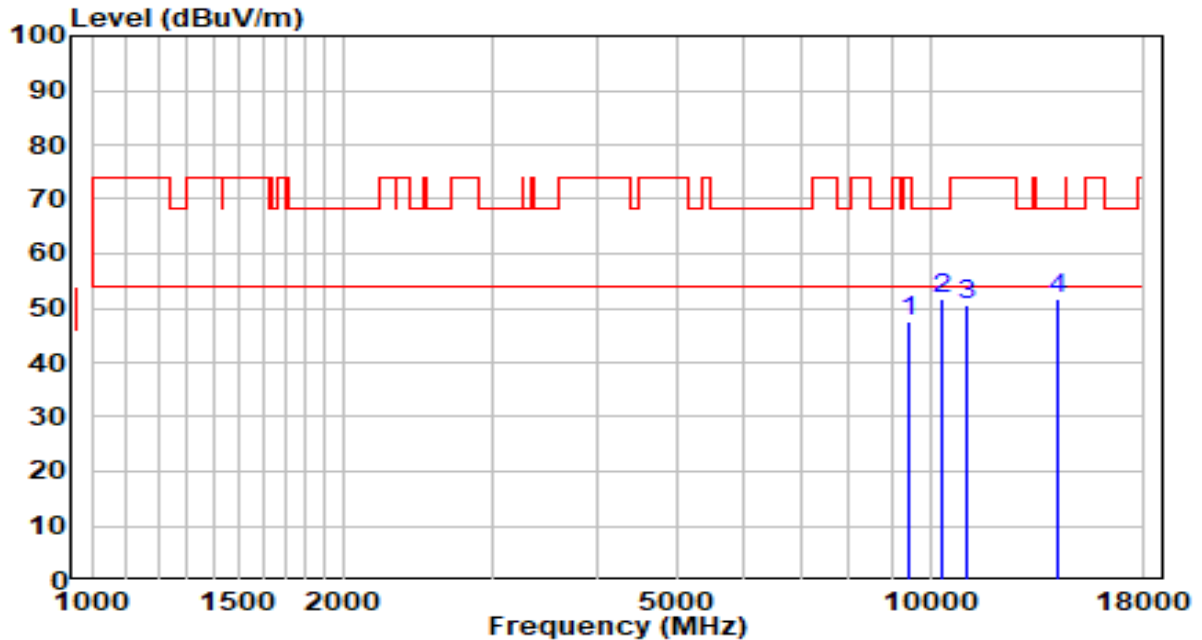

No	Frequency (MHz)	Reading (dB $\mu$ V)	C.F (dB/m)	Measurement (dB $\mu$ V/m)	Margin (dB)	Limit (dB $\mu$ V/m)	Remark (QP/PK/AV)
1	9406.500	31.90	15.56	47.47	-26.53	74.00	Peak
2	10316.000	33.90	17.83	51.73	-16.47	68.20	Peak
3	11021.500	31.12	19.31	50.43	-23.57	74.00	Peak
4	* 14158.000	29.39	22.43	51.82	-16.38	68.20	Peak

Note:

1. " \*", means this data is the worst emission level.
2. C.F (Correction Factor) = Antenna Factor (dB/m)+ Cable Loss (dB)– Preamplifier(dB).
3. Measurement(dB $\mu$ V/m) = Reading(dB $\mu$ V) + C.F (Correction Factor).

EUT	HAN Access Point	Date of Test	2021-11-13
Factor	BBHA 9120D (1GHz~18GHz)	Temp. / Humidity	23°C/53%
Polarity	Vertical	Site / Test Engineer	AC1 / Tim
Test Mode	Transmit at 5700MHz by 802.11ax-HE20	Test Voltage	AC 120V/60Hz

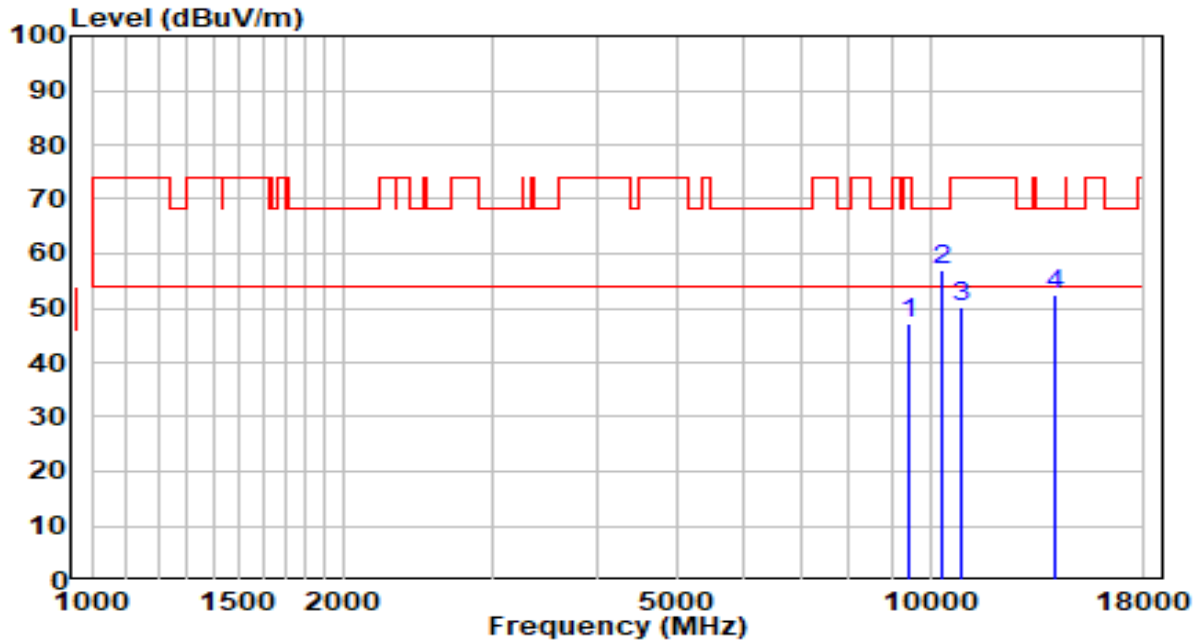

No	Frequency (MHz)	Reading (dB $\mu$ V)	C.F (dB/m)	Measurement (dB $\mu$ V/m)	Margin (dB)	Limit (dB $\mu$ V/m)	Remark (QP/PK/AV)
1	9415.000	31.48	15.58	47.05	-26.95	74.00	Peak
2	* 10316.000	39.21	17.83	57.04	-11.16	68.20	Peak
3	10885.500	31.23	19.12	50.35	-23.65	74.00	Peak
4	14141.000	30.01	22.43	52.44	-15.76	68.20	Peak

Note:

1. " \*", means this data is the worst emission level.
2. C.F (Correction Factor) = Antenna Factor (dB/m)+ Cable Loss (dB)– Preamplifier(dB).
3. Measurement(dB $\mu$ V/m) = Reading(dB $\mu$ V) + C.F (Correction Factor).

EUT	HAN Access Point	Date of Test	2021-11-13
Factor	BBHA 9120D (1GHz~18GHz)	Temp. / Humidity	23°C/53%
Polarity	Horizontal	Site / Test Engineer	AC1 / Tim
Test Mode	Transmit at 5720MHz by 802.11ax-HE20	Test Voltage	AC 120V/60Hz

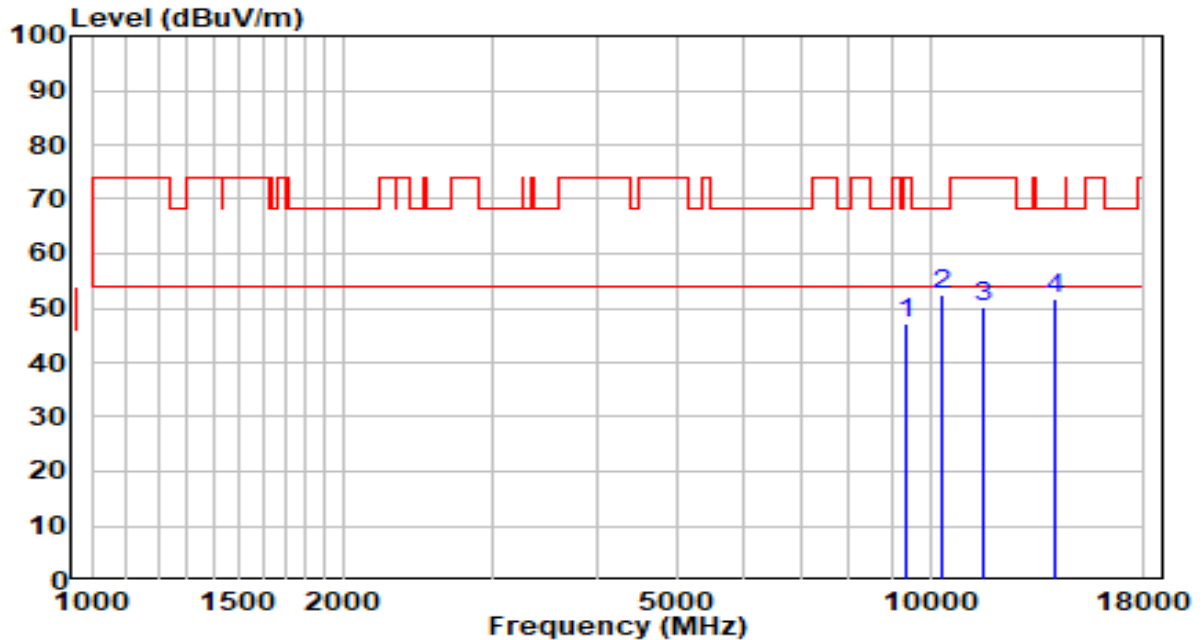

No	Frequency (MHz)	Reading (dB $\mu$ V)	C.F (dB/m)	Measurement (dB $\mu$ V/m)	Margin (dB)	Limit (dB $\mu$ V/m)	Remark (QP/PK/AV)
1	9381.000	31.61	15.52	47.13	-26.87	74.00	Peak
2	* 10316.000	34.73	17.83	52.56	-15.64	68.20	Peak
3	11565.500	30.38	19.90	50.28	-23.72	74.00	Peak
4	14056.000	29.10	22.42	51.52	-16.68	68.20	Peak

Note:

1. " \*", means this data is the worst emission level.
2. C.F (Correction Factor) = Antenna Factor (dB/m)+ Cable Loss (dB)– Preamplifier(dB).
3. Measurement(dB $\mu$ V/m) = Reading(dB $\mu$ V) + C.F (Correction Factor).

EUT	HAN Access Point	Date of Test	2021-11-13
Factor	BBHA 9120D (1GHz~18GHz)	Temp. / Humidity	23°C/53%
Polarity	Vertical	Site / Test Engineer	AC1 / Tim
Test Mode	Transmit at 5720MHz by 802.11ax-HE20	Test Voltage	AC 120V/60Hz

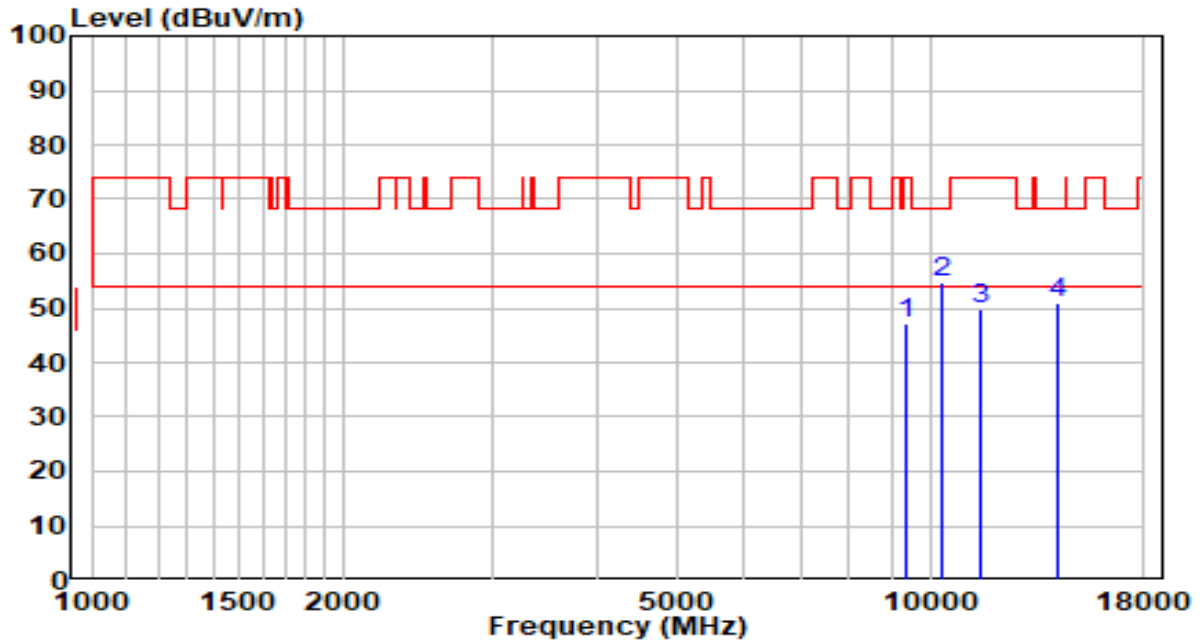

No	Frequency (MHz)	Reading (dB $\mu$ V)	C.F (dB/m)	Measurement (dB $\mu$ V/m)	Margin (dB)	Limit (dB $\mu$ V/m)	Remark (QP/PK/AV)
1	9355.500	31.82	15.48	47.30	-26.70	74.00	Peak
2	* 10316.000	36.88	17.83	54.71	-13.49	68.20	Peak
3	11489.000	29.76	20.03	49.79	-24.21	74.00	Peak
4	14183.500	28.62	22.43	51.06	-17.14	68.20	Peak

Note:

1. " \*", means this data is the worst emission level.
2. C.F (Correction Factor) = Antenna Factor (dB/m)+ Cable Loss (dB)– Preamplifier(dB).
3. Measurement(dB $\mu$ V/m) = Reading(dB $\mu$ V) + C.F (Correction Factor).

EUT	HAN Access Point	Date of Test	2021-11-13
Factor	BBHA 9120D (1GHz~18GHz)	Temp. / Humidity	23°C/53%
Polarity	Horizontal	Site / Test Engineer	AC1 / Tim
Test Mode	Transmit at 5745MHz by 802.11ax-HE20	Test Voltage	AC 120V/60Hz

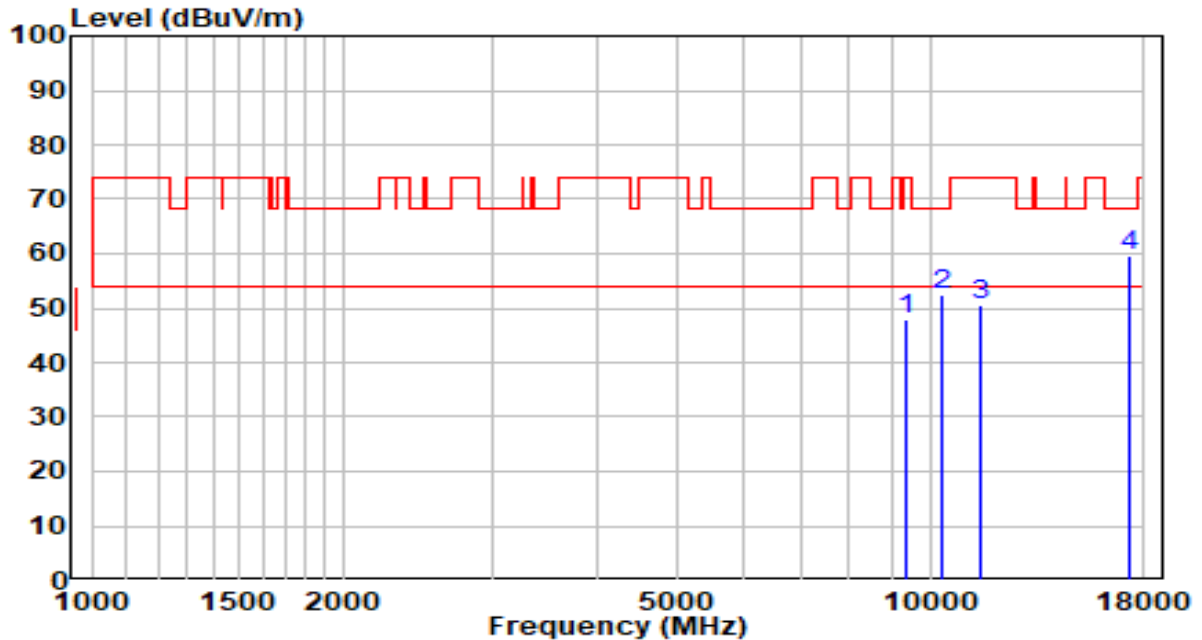

No	Frequency (MHz)	Reading (dB $\mu$ V)	C.F (dB/m)	Measurement (dB $\mu$ V/m)	Margin (dB)	Limit (dB $\mu$ V/m)	Remark (QP/PK/AV)
1	9355.500	32.40	15.48	47.87	-26.13	74.00	Peak
2	10316.000	34.71	17.83	52.54	-15.66	68.20	Peak
3	11489.000	30.53	20.03	50.56	-23.44	74.00	Peak
4	* 17243.500	33.38	26.13	59.51	-8.69	68.20	Peak

Note:

1. " \*", means this data is the worst emission level.
2. C.F (Correction Factor) = Antenna Factor (dB/m)+ Cable Loss (dB)– Preamplifier(dB).
3. Measurement(dB $\mu$ V/m) = Reading(dB $\mu$ V) + C.F (Correction Factor).

EUT	HAN Access Point	Date of Test	2021-11-13
Factor	BBHA 9120D (1GHz~18GHz)	Temp. / Humidity	23°C/53%
Polarity	Vertical	Site / Test Engineer	AC1 / Tim
Test Mode	Transmit at 5745MHz by 802.11ax-HE20	Test Voltage	AC 120V/60Hz

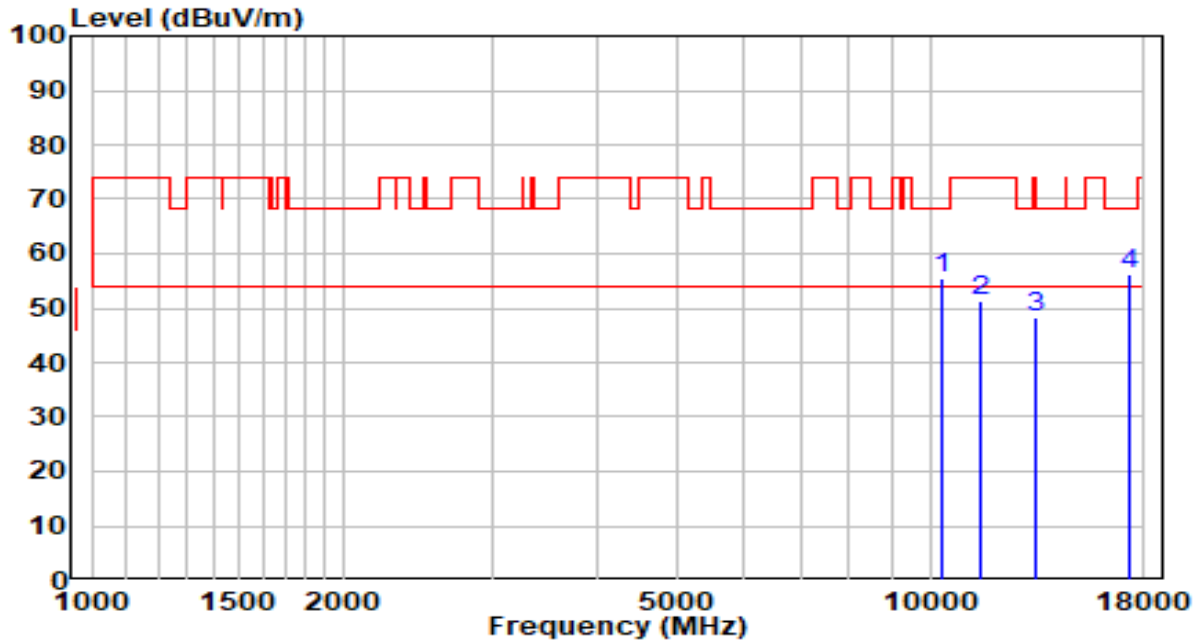

No	Frequency (MHz)	Reading (dB $\mu$ V)	C.F (dB/m)	Measurement (dB $\mu$ V/m)	Margin (dB)	Limit (dB $\mu$ V/m)	Remark (QP/PK/AV)
1	10316.000	37.46	17.83	55.29	-12.91	68.20	Peak
2	11489.000	31.47	20.03	51.50	-22.50	74.00	Peak
3	13333.500	27.04	21.20	48.24	-25.76	74.00	Peak
4	* 17243.500	30.02	26.13	56.15	-12.05	68.20	Peak

Note:

1. " \*", means this data is the worst emission level.
2. C.F (Correction Factor) = Antenna Factor (dB/m)+ Cable Loss (dB)– Preamplifier(dB).
3. Measurement(dB $\mu$ V/m) = Reading(dB $\mu$ V) + C.F (Correction Factor).



EUT	HAN Access Point	Date of Test	2021-11-13
Factor	BBHA 9120D (1GHz~18GHz)	Temp. / Humidity	23°C/53%
Polarity	Horizontal	Site / Test Engineer	AC1 / Tim
Test Mode	Transmit at 5785MHz by 802.11ax-HE20	Test Voltage	AC 120V/60Hz

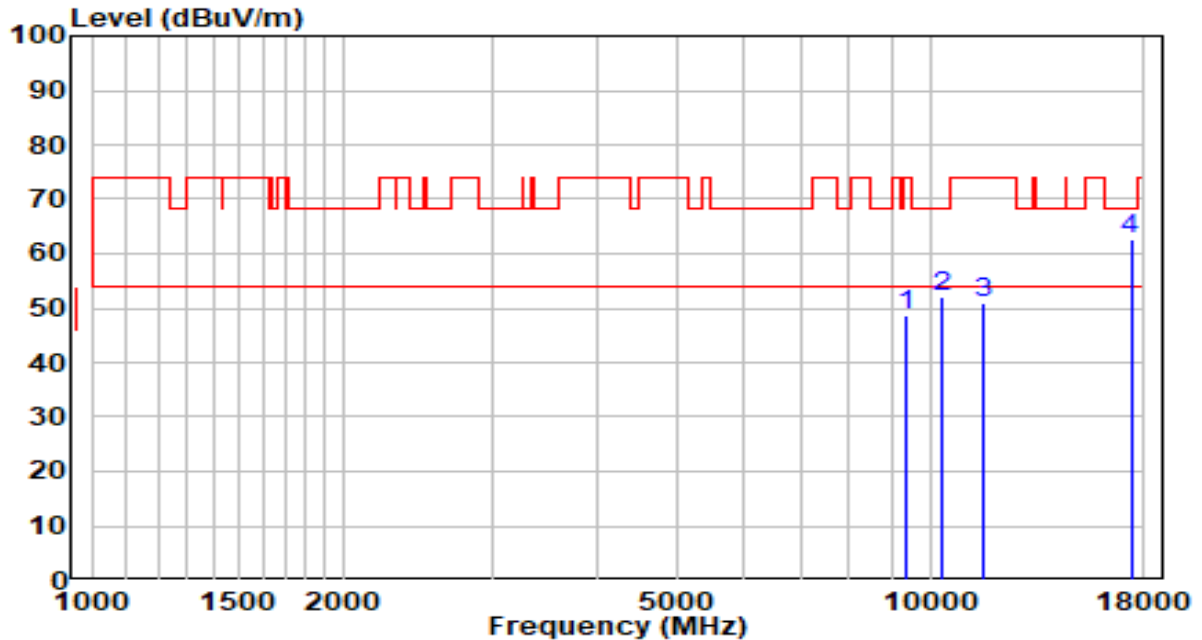

No	Frequency (MHz)	Reading (dB $\mu$ V)	C.F (dB/m)	Measurement (dB $\mu$ V/m)	Margin (dB)	Limit (dB $\mu$ V/m)	Remark (QP/PK/AV)
1	9355.500	33.13	15.48	48.60	-25.40	74.00	Peak
2	10316.000	34.12	17.83	51.95	-16.25	68.20	Peak
3	11574.000	30.98	19.88	50.86	-23.14	74.00	Peak
4	* 17354.000	35.70	26.87	62.57	-5.63	68.20	Peak

Note:

1. " \*", means this data is the worst emission level.
2. C.F (Correction Factor) = Antenna Factor (dB/m)+ Cable Loss (dB)– Preamplifier(dB).
3. Measurement(dB $\mu$ V/m) = Reading(dB $\mu$ V) + C.F (Correction Factor).

EUT	HAN Access Point	Date of Test	2021-11-13
Factor	BBHA 9120D (1GHz~18GHz)	Temp. / Humidity	23°C/53%
Polarity	Vertical	Site / Test Engineer	AC1 / Tim
Test Mode	Transmit at 5785MHz by 802.11ax-HE20	Test Voltage	AC 120V/60Hz

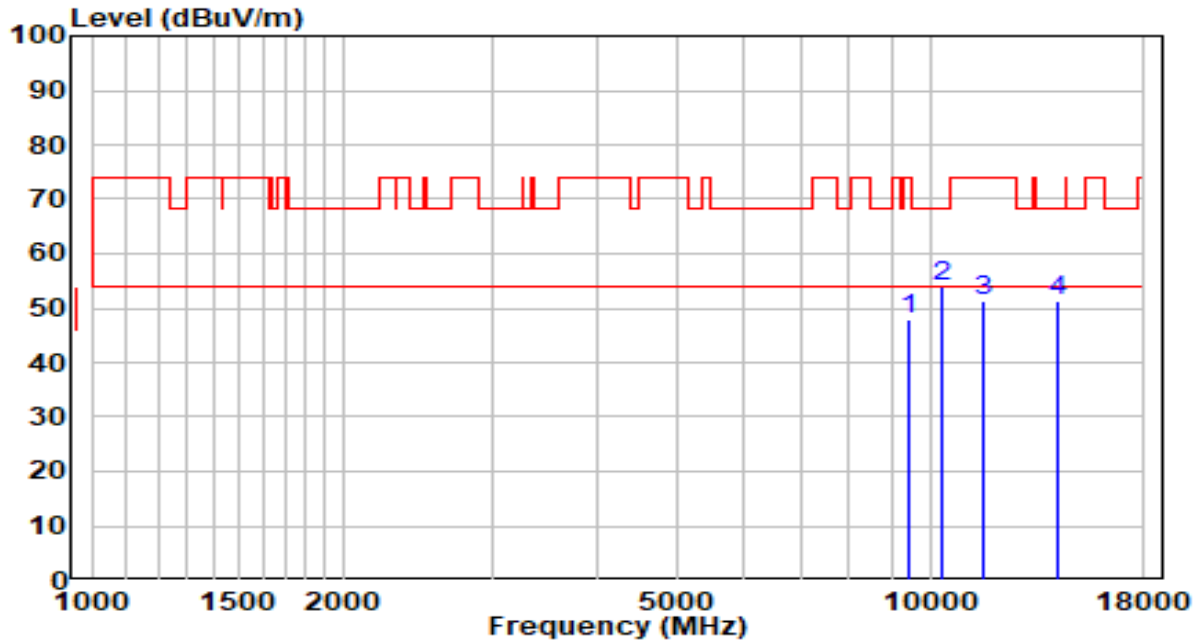

No	Frequency (MHz)	Reading (dB $\mu$ V)	C.F (dB/m)	Measurement (dB $\mu$ V/m)	Margin (dB)	Limit (dB $\mu$ V/m)	Remark (QP/PK/AV)
1	9432.000	32.27	15.61	47.87	-26.13	74.00	Peak
2	* 10316.000	36.22	17.83	54.05	-14.15	68.20	Peak
3	11565.500	31.39	19.90	51.29	-22.71	74.00	Peak
4	14149.500	28.75	22.43	51.19	-17.01	68.20	Peak

Note:

1. " \*", means this data is the worst emission level.
2. C.F (Correction Factor) = Antenna Factor (dB/m)+ Cable Loss (dB)– Preamplifier(dB).
3. Measurement(dB $\mu$ V/m) = Reading(dB $\mu$ V) + C.F (Correction Factor).

EUT	HAN Access Point	Date of Test	2021-11-13
Factor	BBHA 9120D (1GHz~18GHz)	Temp. / Humidity	23°C/53%
Polarity	Horizontal	Site / Test Engineer	AC1 / Tim
Test Mode	Transmit at 5785MHz by 802.11ax-HE20	Test Voltage	AC 120V/60Hz

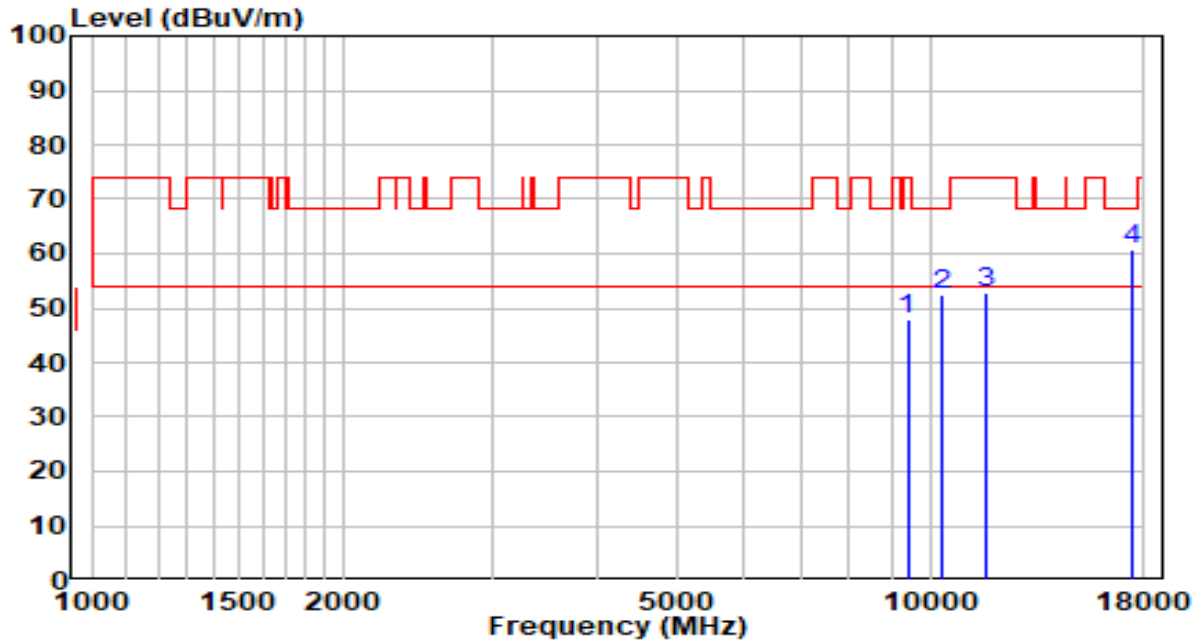

No	Frequency (MHz)	Reading (dB $\mu$ V)	C.F (dB/m)	Measurement (dB $\mu$ V/m)	Margin (dB)	Limit (dB $\mu$ V/m)	Remark (QP/PK/AV)
1	9398.000	32.22	15.55	47.76	-26.24	74.00	Peak
2	10316.000	34.67	17.83	52.50	-15.70	68.20	Peak
3	11642.000	33.13	19.73	52.86	-21.14	74.00	Peak
4	* 17464.500	33.02	27.60	60.62	-7.58	68.20	Peak

Note:

1. " \*", means this data is the worst emission level.
2. C.F (Correction Factor) = Antenna Factor (dB/m)+ Cable Loss (dB)– Preamplifier(dB).
3. Measurement(dB $\mu$ V/m) = Reading(dB $\mu$ V) + C.F (Correction Factor).

EUT	HAN Access Point	Date of Test	2021-11-13
Factor	BBHA 9120D (1GHz~18GHz)	Temp. / Humidity	23°C/53%
Polarity	Vertical	Site / Test Engineer	AC1 / Tim
Test Mode	Transmit at 5785MHz by 802.11ax-HE20	Test Voltage	AC 120V/60Hz

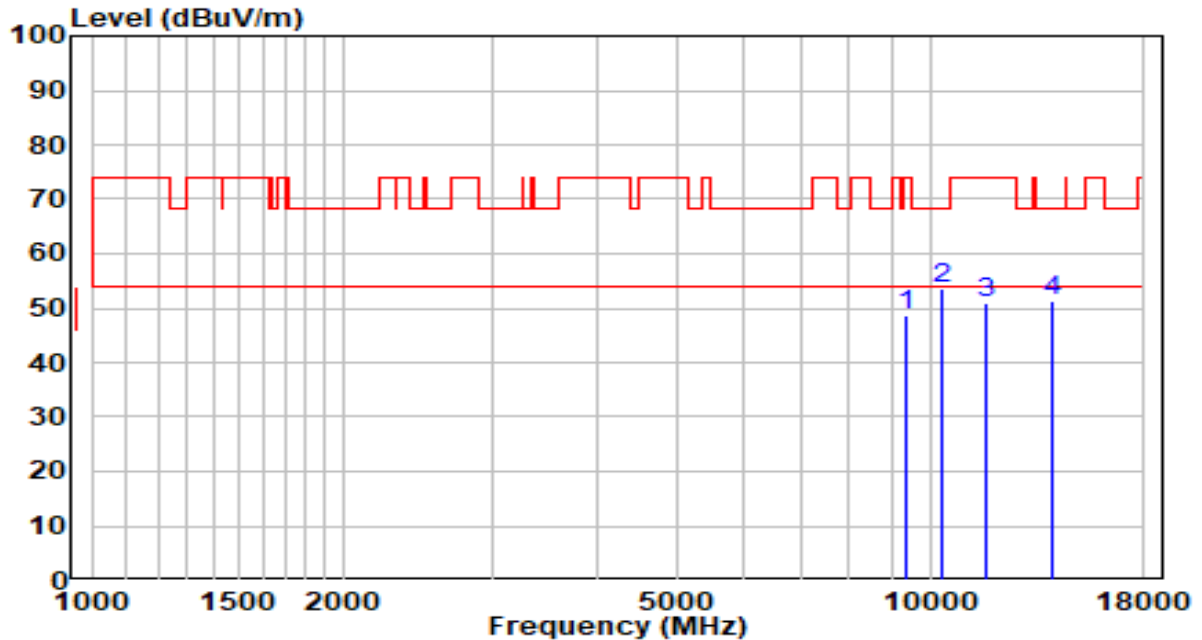

No	Frequency (MHz)	Reading (dB $\mu$ V)	C.F (dB/m)	Measurement (dB $\mu$ V/m)	Margin (dB)	Limit (dB $\mu$ V/m)	Remark (QP/PK/AV)
1	9355.500	33.11	15.48	48.58	-25.42	74.00	Peak
2	* 10316.000	35.75	17.83	53.58	-14.62	68.20	Peak
3	11642.000	31.13	19.73	50.86	-23.14	74.00	Peak
4	14022.000	28.74	22.42	51.16	-17.04	68.20	Peak

Note:

1. " \*", means this data is the worst emission level.
2. C.F (Correction Factor) = Antenna Factor (dB/m)+ Cable Loss (dB)– Preamplifier(dB).
3. Measurement(dB $\mu$ V/m) = Reading(dB $\mu$ V) + C.F (Correction Factor).

EUT	HAN Access Point	Date of Test	2021-11-13
Factor	BBHA 9120D (1GHz~18GHz)	Temp. / Humidity	23°C/53%
Polarity	Horizontal	Site / Test Engineer	AC1 / Tim
Test Mode	Transmit at 5190MHz by 802.11ax-HE40	Test Voltage	AC 120V/60Hz

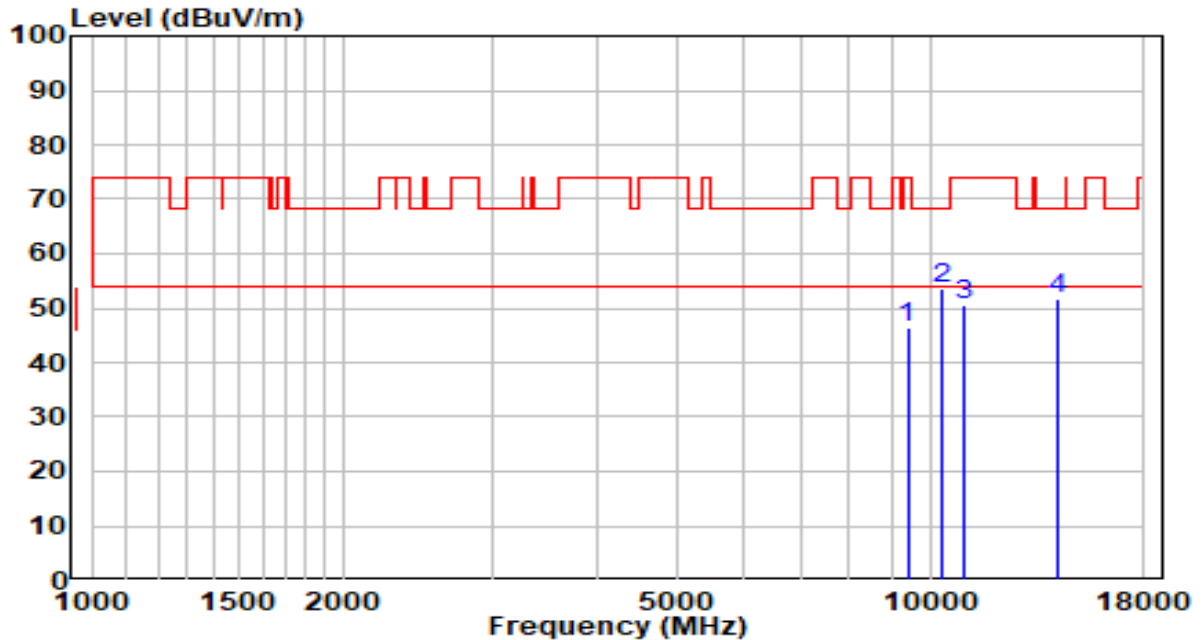

No	Frequency (MHz)	Reading (dB $\mu$ V)	C.F (dB/m)	Measurement (dB $\mu$ V/m)	Margin (dB)	Limit (dB $\mu$ V/m)	Remark (QP/PK/AV)
1	9398.000	31.04	15.55	46.59	-27.41	74.00	Peak
2	* 10316.000	35.67	17.83	53.50	-14.70	68.20	Peak
3	11013.000	31.45	19.30	50.75	-23.25	74.00	Peak
4	14149.500	29.35	22.43	51.78	-16.42	68.20	Peak

Note:

1. " \*", means this data is the worst emission level.
2. C.F (Correction Factor) = Antenna Factor (dB/m)+ Cable Loss (dB)– Preamplifier(dB).
3. Measurement(dB $\mu$ V/m) = Reading(dB $\mu$ V) + C.F (Correction Factor).

EUT	HAN Access Point	Date of Test	2021-11-13
Factor	BBHA 9120D (1GHz~18GHz)	Temp. / Humidity	23°C/53%
Polarity	Vertical	Site / Test Engineer	AC1 / Tim
Test Mode	Transmit at 5190MHz by 802.11ax-HE40	Test Voltage	AC 120V/60Hz

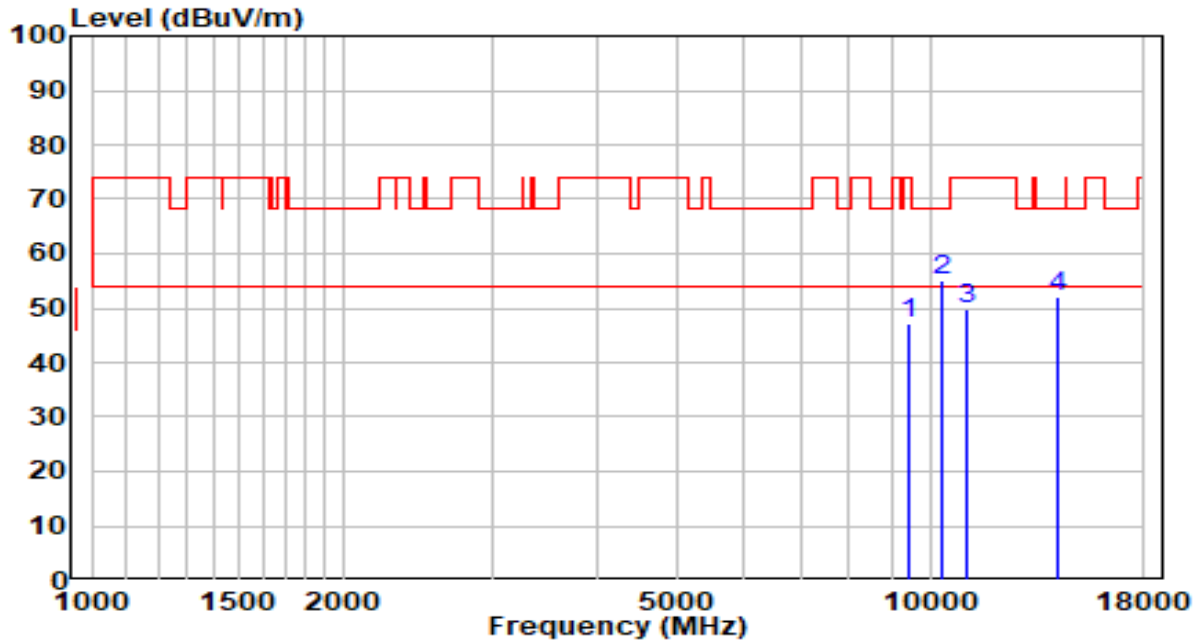

No	Frequency (MHz)	Reading (dB $\mu$ V)	C.F (dB/m)	Measurement (dB $\mu$ V/m)	Margin (dB)	Limit (dB $\mu$ V/m)	Remark (QP/PK/AV)
1	9440.500	31.68	15.62	47.30	-26.70	74.00	Peak
2	* 10316.000	37.14	17.83	54.97	-13.23	68.20	Peak
3	11047.000	30.46	19.35	49.81	-24.19	74.00	Peak
4	14209.000	29.62	22.43	52.06	-16.14	68.20	Peak

Note:

1. " \*", means this data is the worst emission level.
2. C.F (Correction Factor) = Antenna Factor (dB/m)+ Cable Loss (dB)– Preamplifier(dB).
3. Measurement(dB $\mu$ V/m) = Reading(dB $\mu$ V) + C.F (Correction Factor).

EUT	HAN Access Point	Date of Test	2021-11-13
Factor	BBHA 9120D (1GHz~18GHz)	Temp. / Humidity	23°C/53%
Polarity	Horizontal	Site / Test Engineer	AC1 / Tim
Test Mode	Transmit at 5230MHz by 802.11ax-HE40	Test Voltage	AC 120V/60Hz

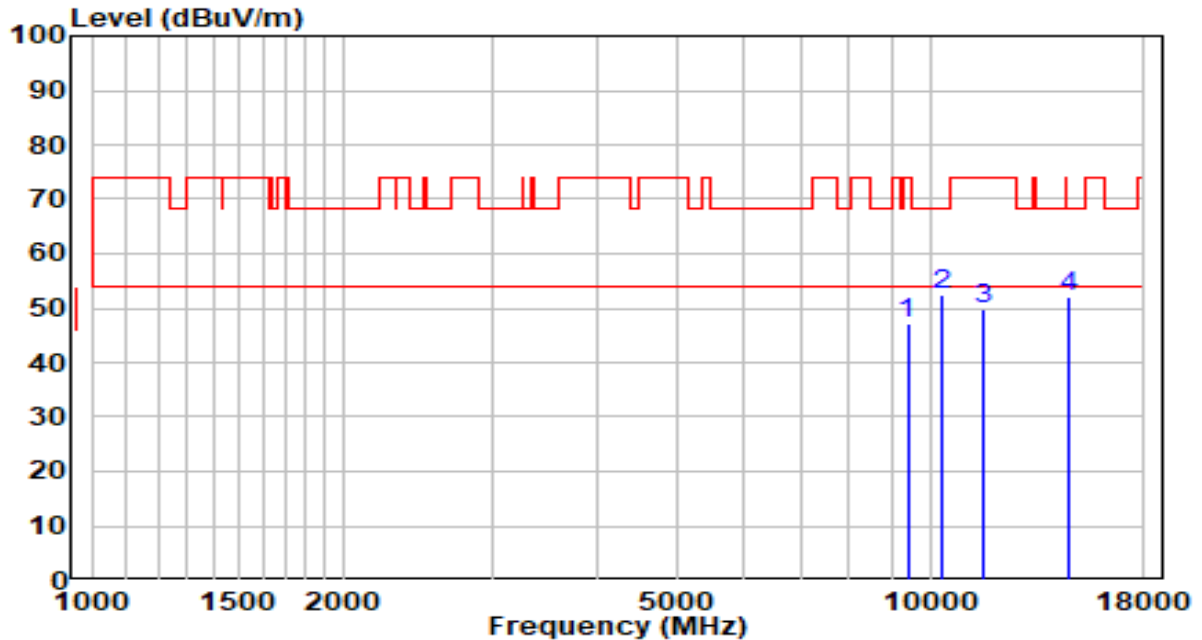

No	Frequency (MHz)	Reading (dB $\mu$ V)	C.F (dB/m)	Measurement (dB $\mu$ V/m)	Margin (dB)	Limit (dB $\mu$ V/m)	Remark (QP/PK/AV)
1	9398.000	31.63	15.55	47.18	-26.82	74.00	Peak
2	* 10316.000	34.71	17.83	52.54	-15.66	68.20	Peak
3	11608.000	30.12	19.81	49.93	-24.07	74.00	Peak
4	14642.500	29.70	22.35	52.05	-16.15	68.20	Peak

Note:

1. " \*", means this data is the worst emission level.
2. C.F (Correction Factor) = Antenna Factor (dB/m)+ Cable Loss (dB)– Preamplifier(dB).
3. Measurement(dB $\mu$ V/m) = Reading(dB $\mu$ V) + C.F (Correction Factor).

EUT	HAN Access Point	Date of Test	2021-11-13
Factor	BBHA 9120D (1GHz~18GHz)	Temp. / Humidity	23°C/53%
Polarity	Vertical	Site / Test Engineer	AC1 / Tim
Test Mode	Transmit at 5230MHz by 802.11ax-HE40	Test Voltage	AC 120V/60Hz

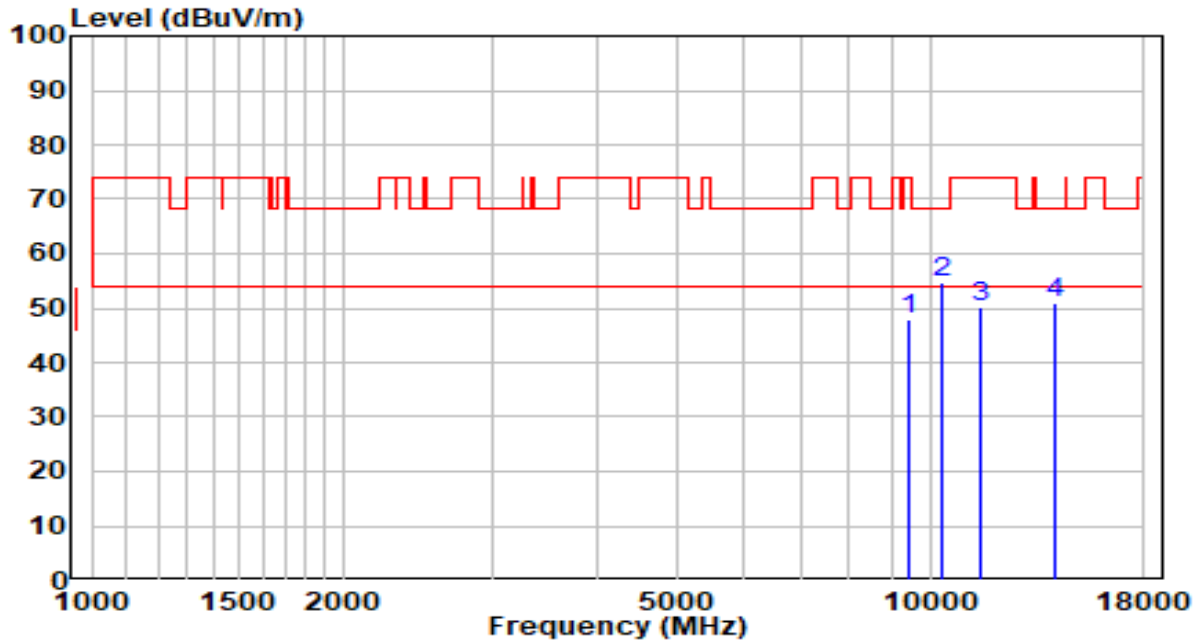

No	Frequency (MHz)	Reading (dB $\mu$ V)	C.F (dB/m)	Measurement (dB $\mu$ V/m)	Margin (dB)	Limit (dB $\mu$ V/m)	Remark (QP/PK/AV)
1	9415.000	32.24	15.58	47.81	-26.19	74.00	Peak
2	* 10316.000	36.79	17.83	54.62	-13.58	68.20	Peak
3	11497.500	29.96	20.05	50.01	-23.99	74.00	Peak
4	14132.500	28.63	22.43	51.06	-17.14	68.20	Peak

Note:

1. " \*", means this data is the worst emission level.
2. C.F (Correction Factor) = Antenna Factor (dB/m)+ Cable Loss (dB)– Preamplifier(dB).
3. Measurement(dB $\mu$ V/m) = Reading(dB $\mu$ V) + C.F (Correction Factor).



EUT	HAN Access Point	Date of Test	2021-11-13
Factor	BBHA 9120D (1GHz~18GHz)	Temp. / Humidity	23°C/53%
Polarity	Horizontal	Site / Test Engineer	AC1 / Tim
Test Mode	Transmit at 5270MHz by 802.11ax-HE40	Test Voltage	AC 120V/60Hz

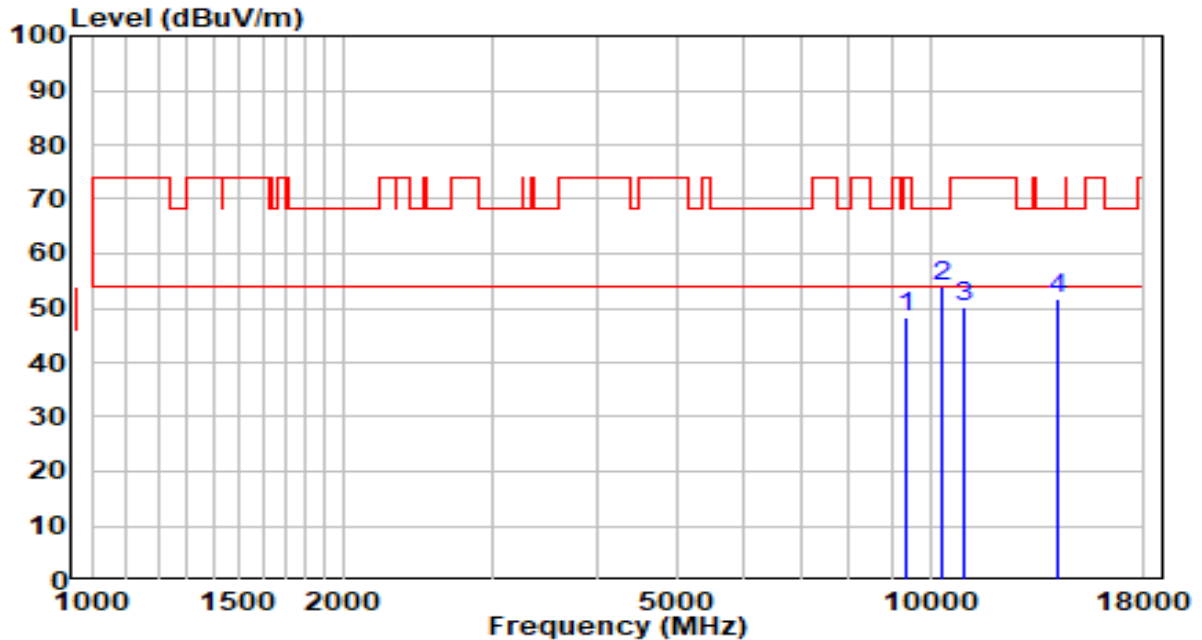

No	Frequency (MHz)	Reading (dB $\mu$ V)	C.F (dB/m)	Measurement (dB $\mu$ V/m)	Margin (dB)	Limit (dB $\mu$ V/m)	Remark (QP/PK/AV)
1	9381.000	32.83	15.52	48.35	-25.65	74.00	Peak
2	* 10316.000	36.15	17.83	53.98	-14.22	68.20	Peak
3	10945.000	30.83	19.20	50.03	-23.97	74.00	Peak
4	14149.500	29.28	22.43	51.71	-16.49	68.20	Peak

Note:

1. " \*", means this data is the worst emission level.
2. C.F (Correction Factor) = Antenna Factor (dB/m)+ Cable Loss (dB)– Preamplifier(dB).
3. Measurement(dB $\mu$ V/m) = Reading(dB $\mu$ V) + C.F (Correction Factor).

EUT	HAN Access Point	Date of Test	2021-11-13
Factor	BBHA 9120D (1GHz~18GHz)	Temp. / Humidity	23°C/53%
Polarity	Vertical	Site / Test Engineer	AC1 / Tim
Test Mode	Transmit at 5270MHz by 802.11ax-HE40	Test Voltage	AC 120V/60Hz

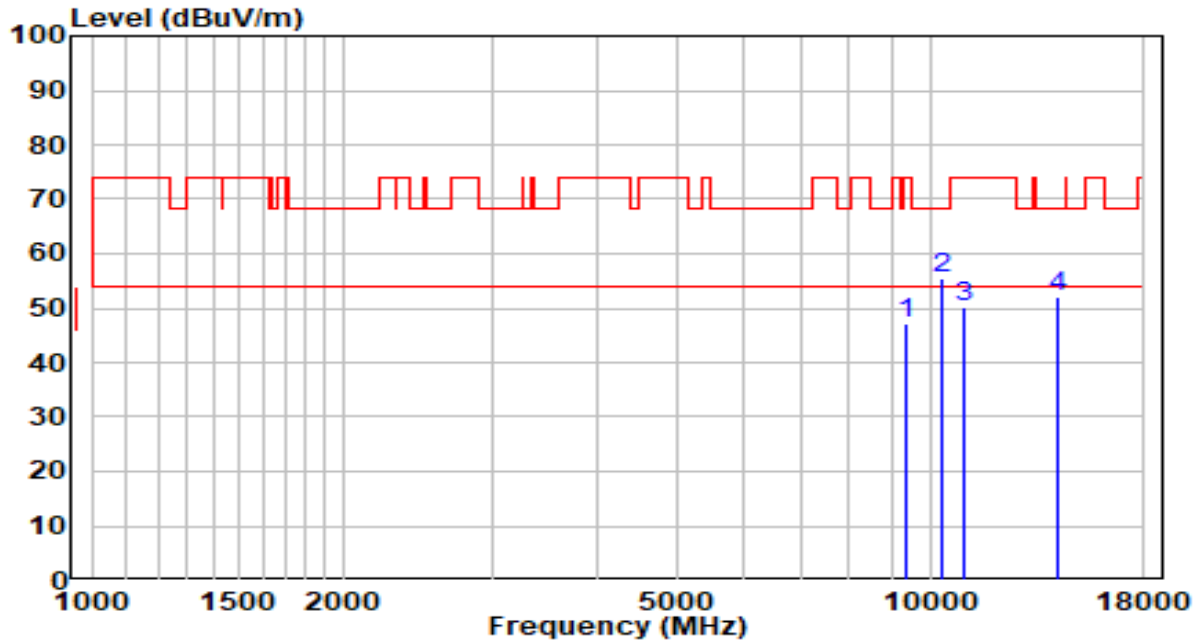

No	Frequency (MHz)	Reading (dB $\mu$ V)	C.F (dB/m)	Measurement (dB $\mu$ V/m)	Margin (dB)	Limit (dB $\mu$ V/m)	Remark (QP/PK/AV)
1	9355.500	31.78	15.48	47.26	-26.74	74.00	Peak
2	* 10316.000	37.53	17.83	55.36	-12.84	68.20	Peak
3	11013.000	30.80	19.30	50.10	-23.90	74.00	Peak
4	14149.500	29.69	22.43	52.12	-16.08	68.20	Peak

Note:

1. " \*", means this data is the worst emission level.
2. C.F (Correction Factor) = Antenna Factor (dB/m)+ Cable Loss (dB)– Preamplifier(dB).
3. Measurement(dB $\mu$ V/m) = Reading(dB $\mu$ V) + C.F (Correction Factor).

EUT	HAN Access Point	Date of Test	2021-11-13
Factor	BBHA 9120D (1GHz~18GHz)	Temp. / Humidity	23°C/53%
Polarity	Horizontal	Site / Test Engineer	AC1 / Tim
Test Mode	Transmit at 5310MHz by 802.11ax-HE40	Test Voltage	AC 120V/60Hz

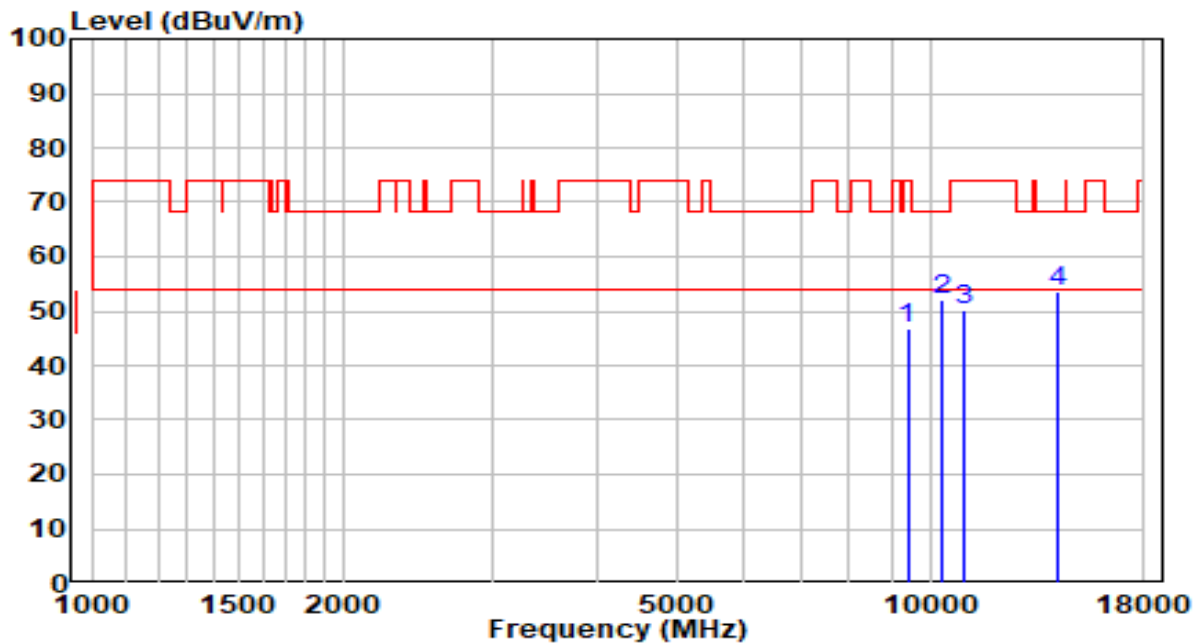

No	Frequency (MHz)	Reading (dB $\mu$ V)	C.F (dB/m)	Measurement (dB $\mu$ V/m)	Margin (dB)	Limit (dB $\mu$ V/m)	Remark (QP/PK/AV)
1	9398.000	31.26	15.55	46.81	-27.19	74.00	Peak
2	10316.000	34.35	17.83	52.18	-16.02	68.20	Peak
3	10953.500	31.15	19.21	50.36	-23.64	74.00	Peak
4	* 14149.500	31.03	22.43	53.46	-14.74	68.20	Peak

Note:

1. " \*", means this data is the worst emission level.
2. C.F (Correction Factor) = Antenna Factor (dB/m)+ Cable Loss (dB)– Preamplifier(dB).
3. Measurement(dB $\mu$ V/m) = Reading(dB $\mu$ V) + C.F (Correction Factor).

EUT	HAN Access Point	Date of Test	2021-11-13
Factor	BBHA 9120D (1GHz~18GHz)	Temp. / Humidity	23°C/53%
Polarity	Vertical	Site / Test Engineer	AC1 / Tim
Test Mode	Transmit at 5310MHz by 802.11ax-HE40	Test Voltage	AC 120V/60Hz

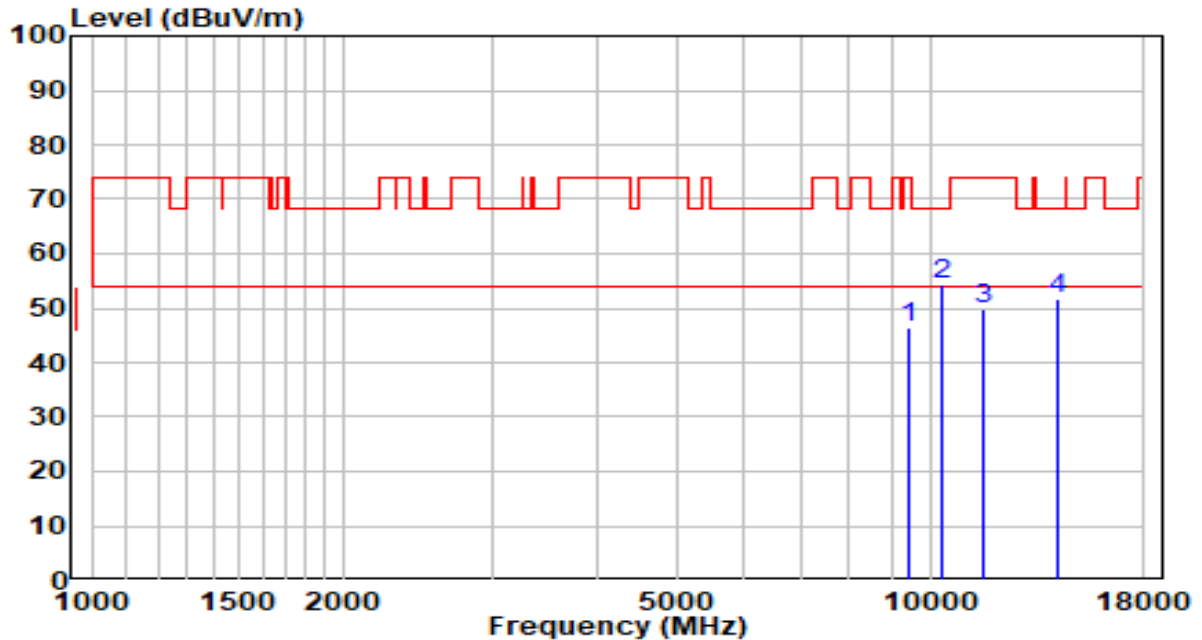

No	Frequency (MHz)	Reading (dB $\mu$ V)	C.F (dB/m)	Measurement (dB $\mu$ V/m)	Margin (dB)	Limit (dB $\mu$ V/m)	Remark (QP/PK/AV)
1	9415.000	30.80	15.58	46.38	-27.62	74.00	Peak
2	* 10316.000	36.62	17.83	54.45	-13.75	68.20	Peak
3	11574.000	29.94	19.88	49.82	-24.18	74.00	Peak
4	14217.500	29.08	22.44	51.52	-16.68	68.20	Peak

Note:

1. " \*", means this data is the worst emission level.
2. C.F (Correction Factor) = Antenna Factor (dB/m)+ Cable Loss (dB)– Preamplifier(dB).
3. Measurement(dB $\mu$ V/m) = Reading(dB $\mu$ V) + C.F (Correction Factor).

EUT	HAN Access Point	Date of Test	2021-11-13
Factor	BBHA 9120D (1GHz~18GHz)	Temp. / Humidity	23°C/53%
Polarity	Horizontal	Site / Test Engineer	AC1 / Tim
Test Mode	Transmit at 5510MHz by 802.11ax-HE40	Test Voltage	AC 120V/60Hz

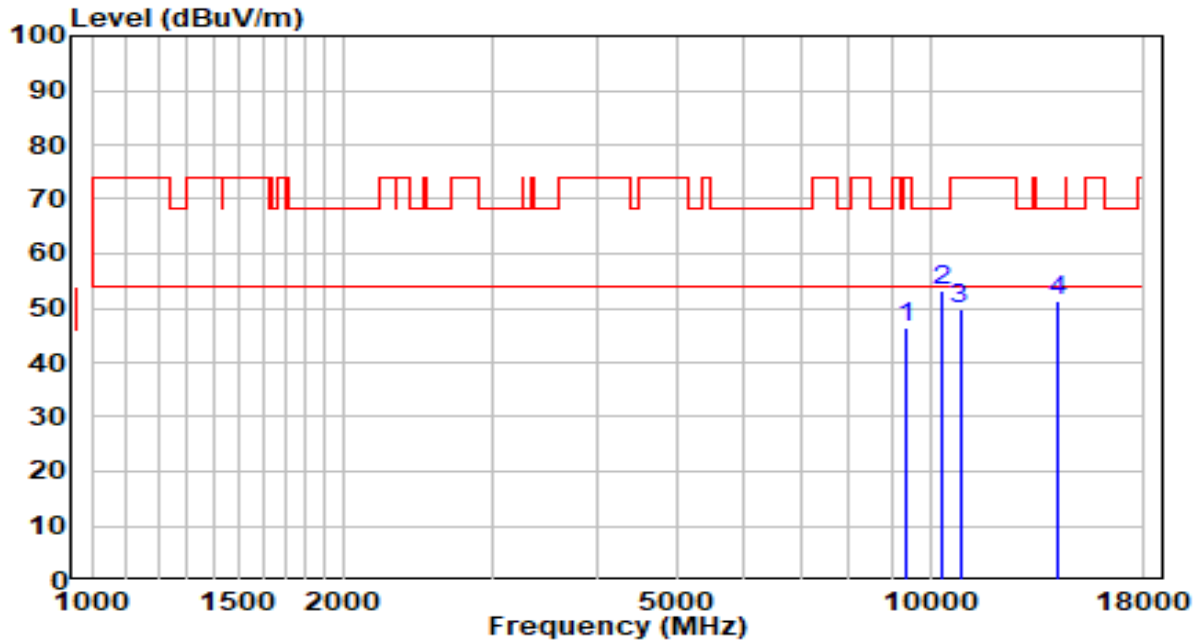

No	Frequency (MHz)	Reading (dB $\mu$ V)	C.F (dB/m)	Measurement (dB $\mu$ V/m)	Margin (dB)	Limit (dB $\mu$ V/m)	Remark (QP/PK/AV)
1	9381.000	30.76	15.52	46.28	-27.72	74.00	Peak
2	* 10316.000	35.37	17.83	53.20	-15.00	68.20	Peak
3	10851.500	30.77	19.07	49.84	-24.16	74.00	Peak
4	14175.000	29.05	22.43	51.48	-16.72	68.20	Peak

Note:

1. " \*", means this data is the worst emission level.
2. C.F (Correction Factor) = Antenna Factor (dB/m)+ Cable Loss (dB)– Preamplifier(dB).
3. Measurement(dB $\mu$ V/m) = Reading(dB $\mu$ V) + C.F (Correction Factor).

EUT	HAN Access Point	Date of Test	2021-11-13
Factor	BBHA 9120D (1GHz~18GHz)	Temp. / Humidity	23°C/53%
Polarity	Vertical	Site / Test Engineer	AC1 / Tim
Test Mode	Transmit at 5510MHz by 802.11ax-HE40	Test Voltage	AC 120V/60Hz

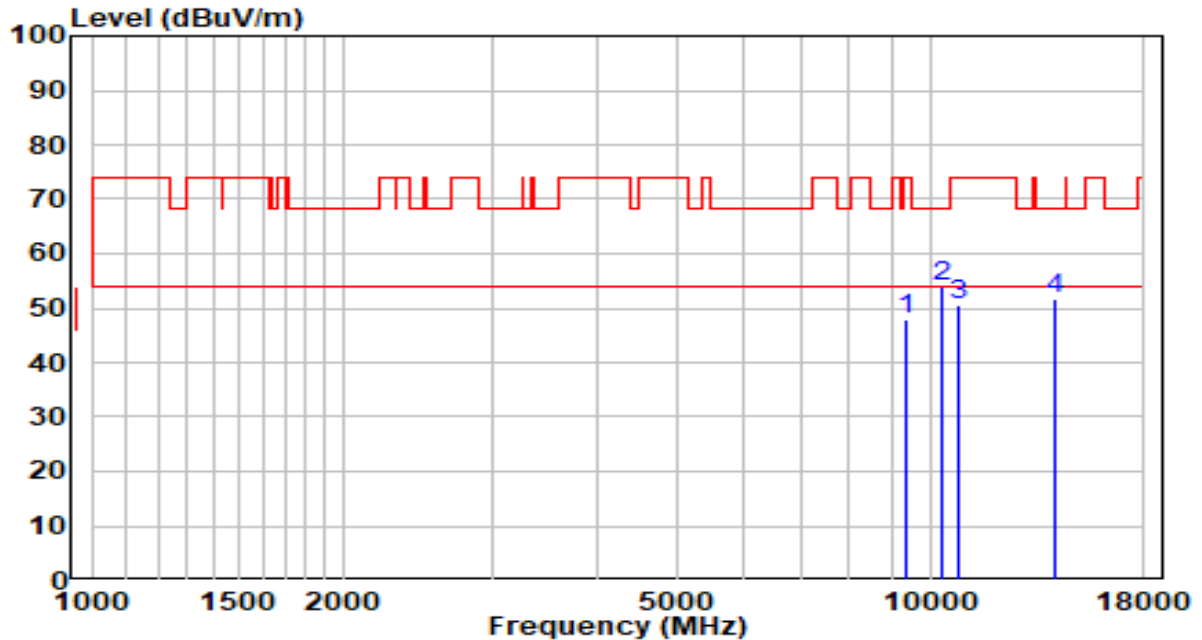

No	Frequency (MHz)	Reading (dB $\mu$ V)	C.F (dB/m)	Measurement (dB $\mu$ V/m)	Margin (dB)	Limit (dB $\mu$ V/m)	Remark (QP/PK/AV)
1	9355.500	32.50	15.48	47.98	-26.02	74.00	Peak
2	* 10316.000	36.01	17.83	53.84	-14.36	68.20	Peak
3	10826.000	31.36	19.03	50.39	-23.61	74.00	Peak
4	14141.000	29.21	22.43	51.64	-16.56	68.20	Peak

Note:

1. " \*", means this data is the worst emission level.
2. C.F (Correction Factor) = Antenna Factor (dB/m)+ Cable Loss (dB)– Preamplifier(dB).
3. Measurement(dB $\mu$ V/m) = Reading(dB $\mu$ V) + C.F (Correction Factor).

EUT	HAN Access Point	Date of Test	2021-11-13
Factor	BBHA 9120D (1GHz~18GHz)	Temp. / Humidity	23°C/53%
Polarity	Horizontal	Site / Test Engineer	AC1 / Tim
Test Mode	Transmit at 5550MHz by 802.11ax-HE40	Test Voltage	AC 120V/60Hz

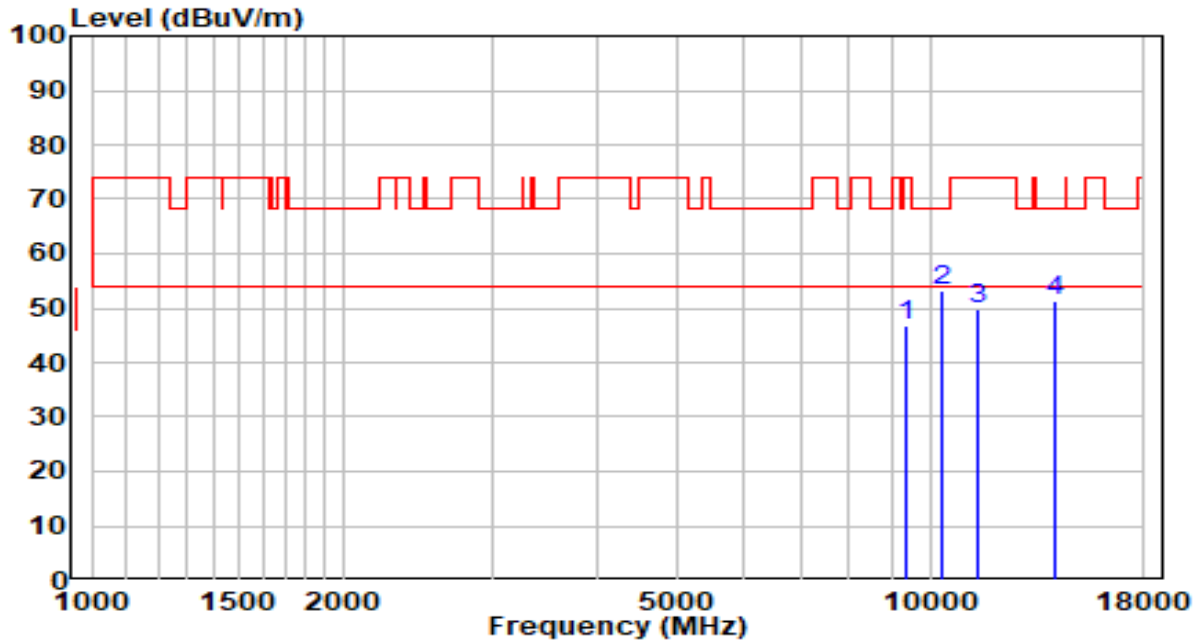

No	Frequency (MHz)	Reading (dB $\mu$ V)	C.F (dB/m)	Measurement (dB $\mu$ V/m)	Margin (dB)	Limit (dB $\mu$ V/m)	Remark (QP/PK/AV)
1	9381.000	31.12	15.52	46.64	-27.36	74.00	Peak
2	* 10316.000	35.25	17.83	53.08	-15.12	68.20	Peak
3	11412.500	29.99	19.92	49.90	-24.10	74.00	Peak
4	14064.500	29.07	22.42	51.49	-16.71	68.20	Peak

Note:

1. " \*", means this data is the worst emission level.
2. C.F (Correction Factor) = Antenna Factor (dB/m)+ Cable Loss (dB)– Preamplifier(dB).
3. Measurement(dB $\mu$ V/m) = Reading(dB $\mu$ V) + C.F (Correction Factor).

EUT	HAN Access Point	Date of Test	2021-11-13
Factor	BBHA 9120D (1GHz~18GHz)	Temp. / Humidity	23°C/53%
Polarity	Vertical	Site / Test Engineer	AC1 / Tim
Test Mode	Transmit at 5550MHz by 802.11ax-HE40	Test Voltage	AC 120V/60Hz

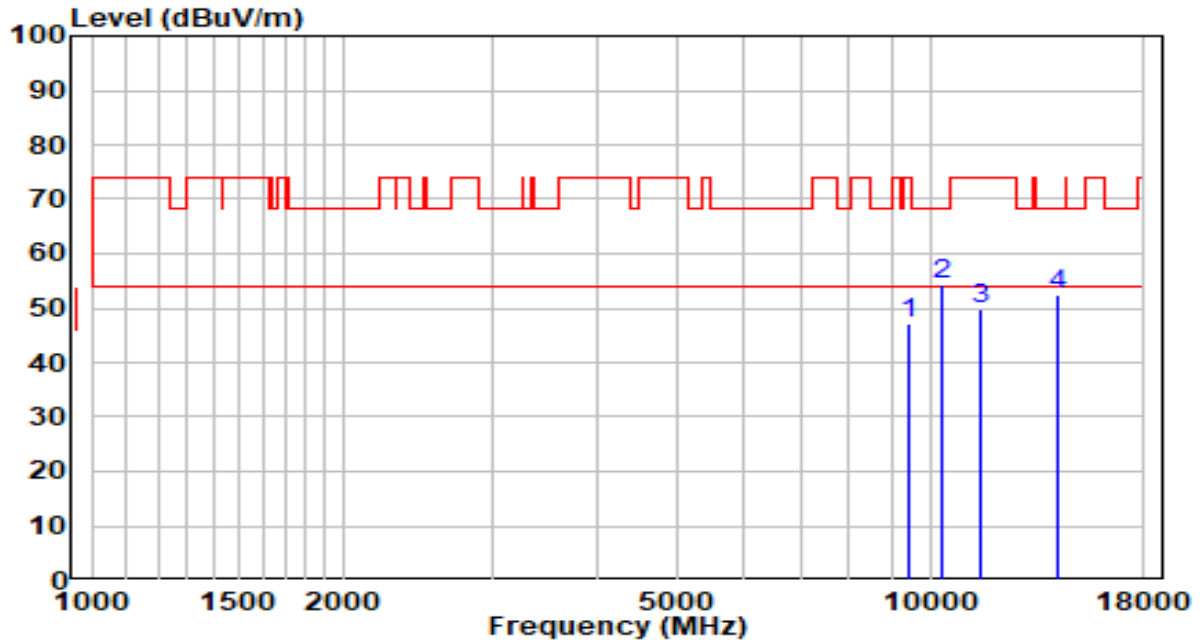

No	Frequency (MHz)	Reading (dB $\mu$ V)	C.F (dB/m)	Measurement (dB $\mu$ V/m)	Margin (dB)	Limit (dB $\mu$ V/m)	Remark (QP/PK/AV)
1	9415.000	31.45	15.58	47.03	-26.97	74.00	Peak
2	* 10316.000	36.42	17.83	54.25	-13.95	68.20	Peak
3	11523.000	29.71	20.00	49.70	-24.30	74.00	Peak
4	14149.500	29.92	22.43	52.35	-15.85	68.20	Peak

Note:

1. " \*", means this data is the worst emission level.
2. C.F (Correction Factor) = Antenna Factor (dB/m)+ Cable Loss (dB)– Preamplifier(dB).
3. Measurement(dB $\mu$ V/m) = Reading(dB $\mu$ V) + C.F (Correction Factor).



EUT	HAN Access Point	Date of Test	2021-11-13
Factor	BBHA 9120D (1GHz~18GHz)	Temp. / Humidity	23°C/53%
Polarity	Horizontal	Site / Test Engineer	AC1 / Tim
Test Mode	Transmit at 5670MHz by 802.11ax-HE40	Test Voltage	AC 120V/60Hz

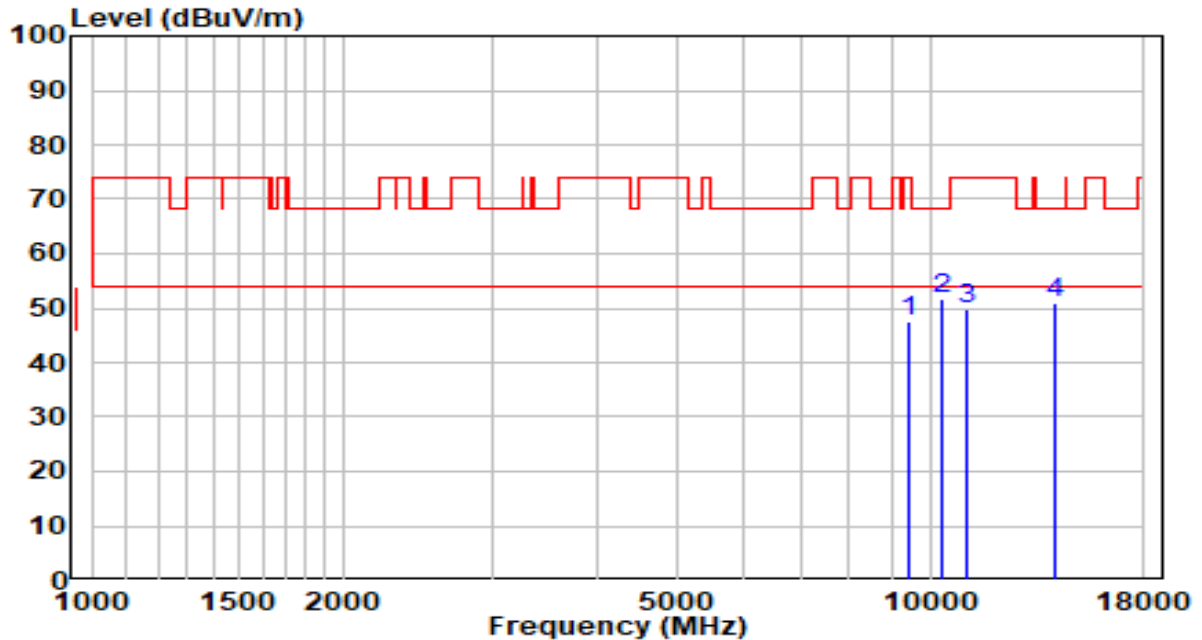

No	Frequency (MHz)	Reading (dB $\mu$ V)	C.F (dB/m)	Measurement (dB $\mu$ V/m)	Margin (dB)	Limit (dB $\mu$ V/m)	Remark (QP/PK/AV)
1	9440.500	31.76	15.62	47.38	-26.62	74.00	Peak
2	* 10316.000	34.03	17.83	51.86	-16.34	68.20	Peak
3	11047.000	30.45	19.35	49.80	-24.20	74.00	Peak
4	14132.500	28.48	22.43	50.91	-17.29	68.20	Peak

Note:

1. " \*", means this data is the worst emission level.
2. C.F (Correction Factor) = Antenna Factor (dB/m)+ Cable Loss (dB)– Preamplifier(dB).
3. Measurement(dB $\mu$ V/m) = Reading(dB $\mu$ V) + C.F (Correction Factor).

EUT	HAN Access Point	Date of Test	2021-11-13
Factor	BBHA 9120D (1GHz~18GHz)	Temp. / Humidity	23°C/53%
Polarity	Vertical	Site / Test Engineer	AC1 / Tim
Test Mode	Transmit at 5670MHz by 802.11ax-HE40	Test Voltage	AC 120V/60Hz

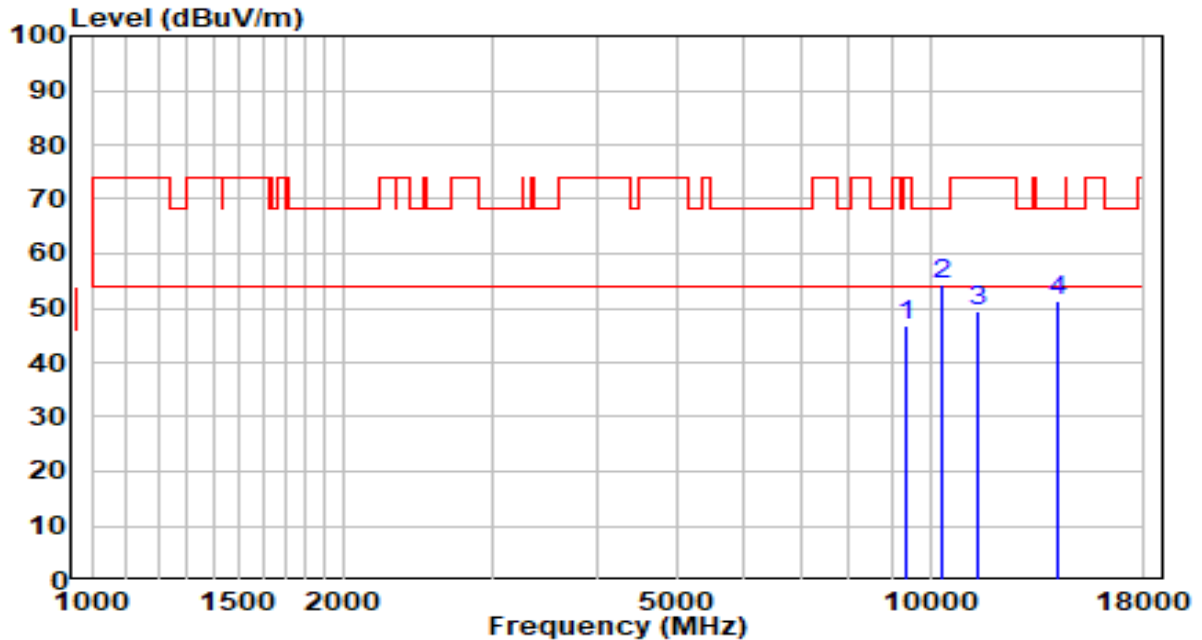

No	Frequency (MHz)	Reading (dB $\mu$ V)	C.F (dB/m)	Measurement (dB $\mu$ V/m)	Margin (dB)	Limit (dB $\mu$ V/m)	Remark (QP/PK/AV)
1	9381.000	31.19	15.52	46.71	-27.29	74.00	Peak
2	* 10316.000	36.62	17.83	54.45	-13.75	68.20	Peak
3	11421.000	29.65	19.93	49.57	-24.43	74.00	Peak
4	14166.500	28.91	22.43	51.34	-16.86	68.20	Peak

Note:

1. " \*", means this data is the worst emission level.
2. C.F (Correction Factor) = Antenna Factor (dB/m)+ Cable Loss (dB)– Preamplifier(dB).
3. Measurement(dB $\mu$ V/m) = Reading(dB $\mu$ V) + C.F (Correction Factor).

EUT	HAN Access Point	Date of Test	2021-11-13
Factor	BBHA 9120D (1GHz~18GHz)	Temp. / Humidity	23°C/53%
Polarity	Horizontal	Site / Test Engineer	AC1 / Tim
Test Mode	Transmit at 5710MHz by 802.11ax-HE40	Test Voltage	AC 120V/60Hz

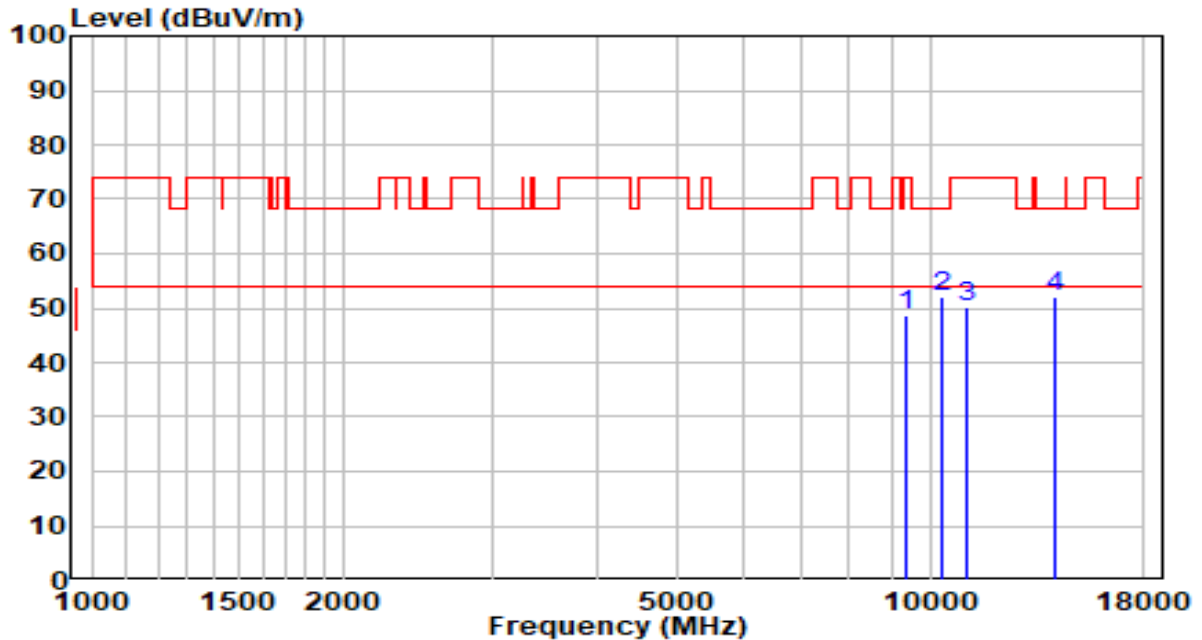

No	Frequency (MHz)	Reading (dB $\mu$ V)	C.F (dB/m)	Measurement (dB $\mu$ V/m)	Margin (dB)	Limit (dB $\mu$ V/m)	Remark (QP/PK/AV)
1	9381.000	33.28	15.52	48.80	-25.20	74.00	Peak
2	* 10316.000	34.27	17.83	52.10	-16.10	68.20	Peak
3	11064.000	30.82	19.38	50.20	-23.80	74.00	Peak
4	14141.000	29.54	22.43	51.97	-16.23	68.20	Peak

Note:

1. " \*", means this data is the worst emission level.
2. C.F (Correction Factor) = Antenna Factor (dB/m)+ Cable Loss (dB)– Preamplifier(dB).
3. Measurement(dB $\mu$ V/m) = Reading(dB $\mu$ V) + C.F (Correction Factor).

EUT	HAN Access Point	Date of Test	2021-11-13
Factor	BBHA 9120D (1GHz~18GHz)	Temp. / Humidity	23°C/53%
Polarity	Vertical	Site / Test Engineer	AC1 / Tim
Test Mode	Transmit at 5710MHz by 802.11ax-HE40	Test Voltage	AC 120V/60Hz

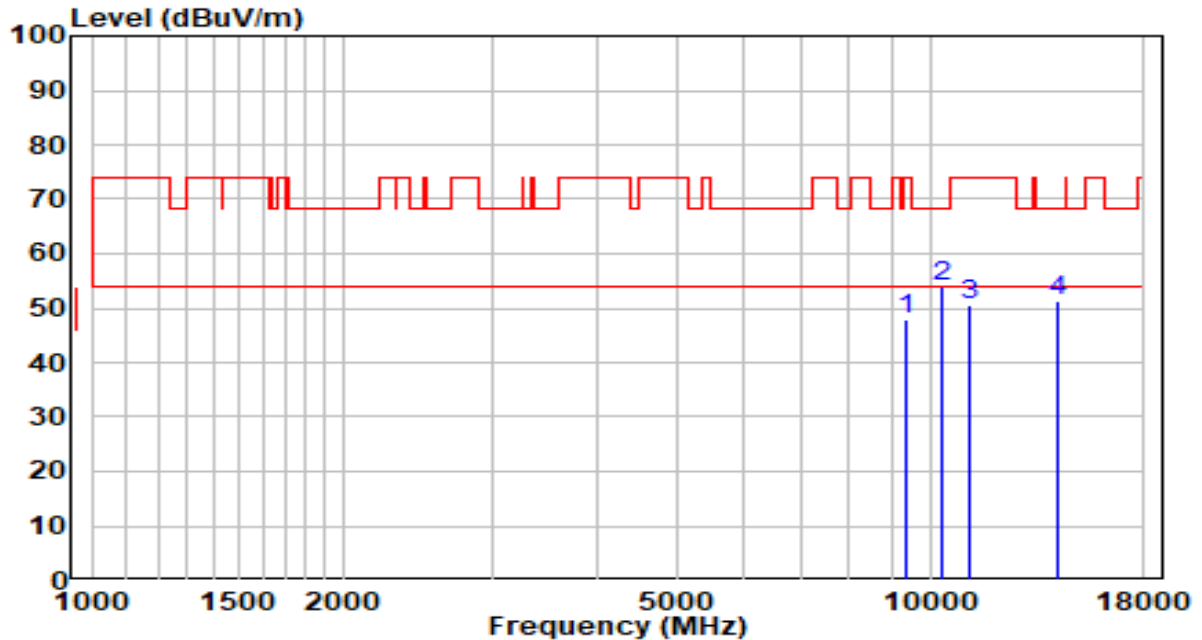

No	Frequency (MHz)	Reading (dB $\mu$ V)	C.F (dB/m)	Measurement (dB $\mu$ V/m)	Margin (dB)	Limit (dB $\mu$ V/m)	Remark (QP/PK/AV)
1	9381.000	32.39	15.52	47.91	-26.09	74.00	Peak
2	* 10316.000	36.28	17.83	54.11	-14.09	68.20	Peak
3	11123.500	31.20	19.47	50.67	-23.33	74.00	Peak
4	14234.500	28.86	22.44	51.30	-16.90	68.20	Peak

Note:

1. " \*", means this data is the worst emission level.
2. C.F (Correction Factor) = Antenna Factor (dB/m)+ Cable Loss (dB)– Preamplifier(dB).
3. Measurement(dB $\mu$ V/m) = Reading(dB $\mu$ V) + C.F (Correction Factor).

EUT	HAN Access Point	Date of Test	2021-11-13
Factor	BBHA 9120D (1GHz~18GHz)	Temp. / Humidity	23°C/53%
Polarity	Horizontal	Site / Test Engineer	AC1 / Tim
Test Mode	Transmit at 5755MHz by 802.11ax-HE40	Test Voltage	AC 120V/60Hz

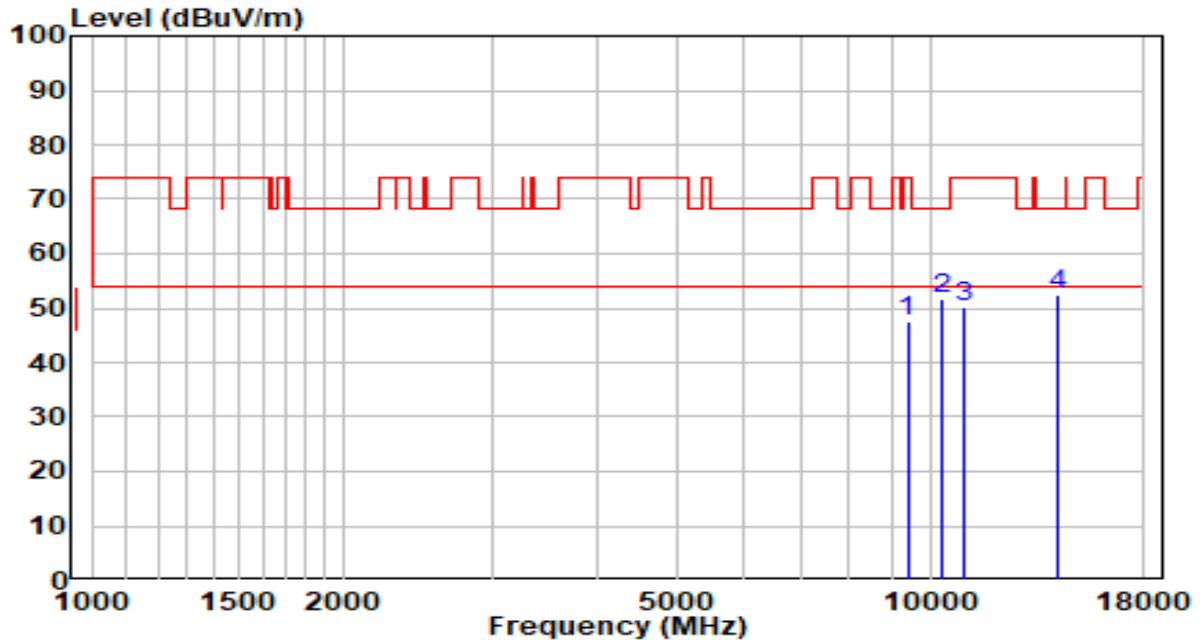

No	Frequency (MHz)	Reading (dB $\mu$ V)	C.F (dB/m)	Measurement (dB $\mu$ V/m)	Margin (dB)	Limit (dB $\mu$ V/m)	Remark (QP/PK/AV)
1	9398.000	32.10	15.55	47.65	-26.35	74.00	Peak
2	10316.000	33.99	17.83	51.82	-16.38	68.20	Peak
3	10962.000	30.78	19.23	50.01	-23.99	74.00	Peak
4	* 14149.500	29.85	22.43	52.28	-15.92	68.20	Peak

Note:

1. " \*", means this data is the worst emission level.
2. C.F (Correction Factor) = Antenna Factor (dB/m)+ Cable Loss (dB)– Preamplifier(dB).
3. Measurement(dB $\mu$ V/m) = Reading(dB $\mu$ V) + C.F (Correction Factor).

EUT	HAN Access Point	Date of Test	2021-11-13
Factor	BBHA 9120D (1GHz~18GHz)	Temp. / Humidity	23°C/53%
Polarity	Vertical	Site / Test Engineer	AC1 / Tim
Test Mode	Transmit at 5755MHz by 802.11ax-HE40	Test Voltage	AC 120V/60Hz

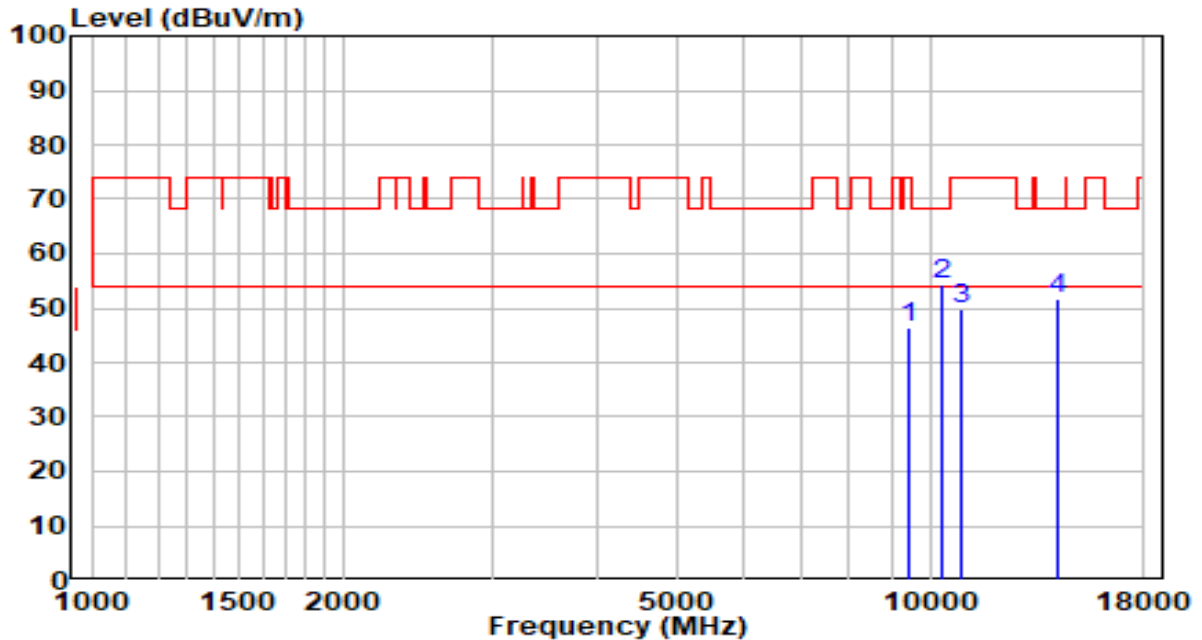

No	Frequency (MHz)	Reading (dB $\mu$ V)	C.F (dB/m)	Measurement (dB $\mu$ V/m)	Margin (dB)	Limit (dB $\mu$ V/m)	Remark (QP/PK/AV)
1	9440.500	30.62	15.62	46.24	-27.76	74.00	Peak
2	* 10316.000	36.58	17.83	54.41	-13.79	68.20	Peak
3	10885.500	30.88	19.12	49.99	-24.01	74.00	Peak
4	14175.000	29.31	22.43	51.74	-16.46	68.20	Peak

Note:

1. " \*", means this data is the worst emission level.
2. C.F (Correction Factor) = Antenna Factor (dB/m)+ Cable Loss (dB)– Preamplifier(dB).
3. Measurement(dB $\mu$ V/m) = Reading(dB $\mu$ V) + C.F (Correction Factor).

EUT	HAN Access Point	Date of Test	2021-11-13
Factor	BBHA 9120D (1GHz~18GHz)	Temp. / Humidity	23°C/53%
Polarity	Horizontal	Site / Test Engineer	AC1 / Tim
Test Mode	Transmit at 5795MHz by 802.11ax-HE40	Test Voltage	AC 120V/60Hz

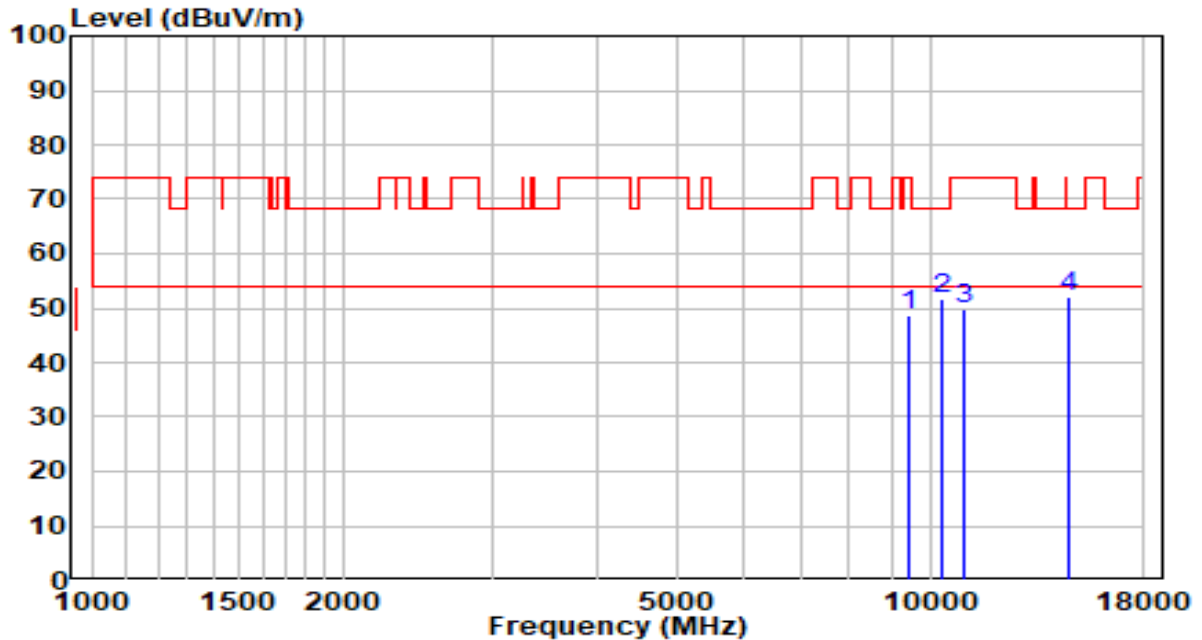

No	Frequency (MHz)	Reading (dB $\mu$ V)	C.F (dB/m)	Measurement (dB $\mu$ V/m)	Margin (dB)	Limit (dB $\mu$ V/m)	Remark (QP/PK/AV)
1	9415.000	33.02	15.58	48.60	-25.40	74.00	Peak
2	10316.000	33.85	17.83	51.68	-16.52	68.20	Peak
3	11004.500	30.52	19.29	49.81	-24.19	74.00	Peak
4	* 14625.500	29.56	22.36	51.92	-16.28	68.20	Peak

Note:

1. " \*", means this data is the worst emission level.
2. C.F (Correction Factor) = Antenna Factor (dB/m)+ Cable Loss (dB)– Preamplifier(dB).
3. Measurement(dB $\mu$ V/m) = Reading(dB $\mu$ V) + C.F (Correction Factor).

EUT	HAN Access Point	Date of Test	2021-11-13
Factor	BBHA 9120D (1GHz~18GHz)	Temp. / Humidity	23°C/53%
Polarity	Vertical	Site / Test Engineer	AC1 / Tim
Test Mode	Transmit at 5795MHz by 802.11ax-HE40	Test Voltage	AC 120V/60Hz

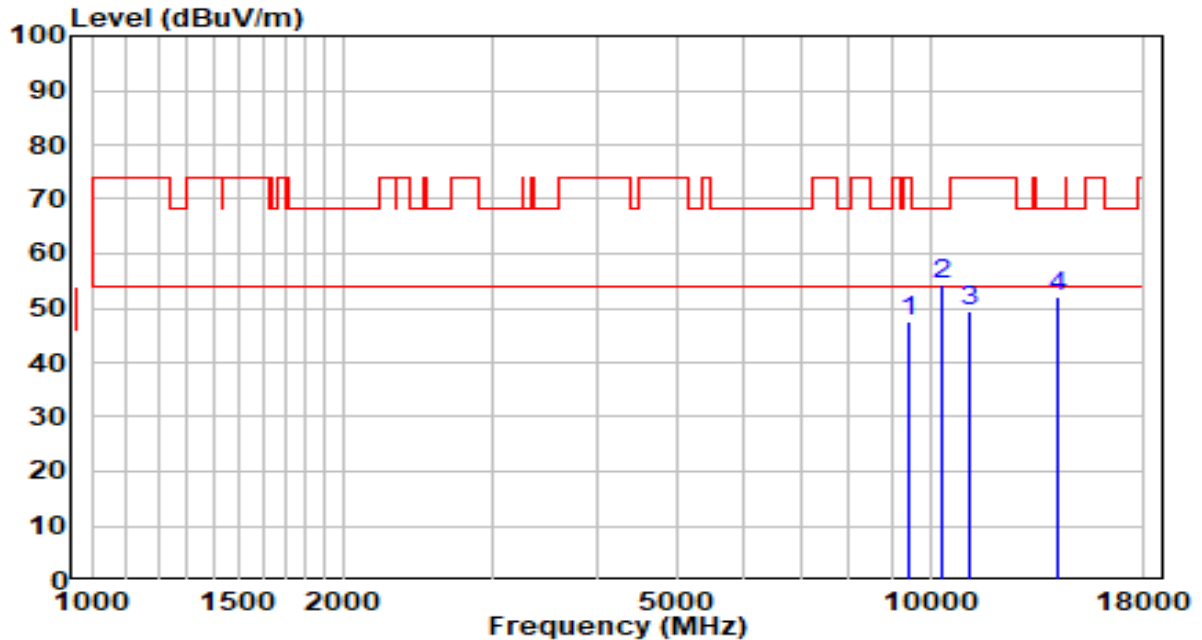

No	Frequency (MHz)	Reading (dB $\mu$ V)	C.F (dB/m)	Measurement (dB $\mu$ V/m)	Margin (dB)	Limit (dB $\mu$ V/m)	Remark (QP/PK/AV)
1	9440.500	31.76	15.62	47.38	-26.62	74.00	Peak
2	* 10316.000	36.52	17.83	54.35	-13.85	68.20	Peak
3	11115.000	30.07	19.46	49.53	-24.47	74.00	Peak
4	14175.000	29.53	22.43	51.96	-16.24	68.20	Peak

Note:

1. " \*", means this data is the worst emission level.
2. C.F (Correction Factor) = Antenna Factor (dB/m)+ Cable Loss (dB)– Preamplifier(dB).
3. Measurement(dB $\mu$ V/m) = Reading(dB $\mu$ V) + C.F (Correction Factor).



EUT	HAN Access Point	Date of Test	2021-11-13
Factor	BBHA 9120D (1GHz~18GHz)	Temp. / Humidity	23°C/53%
Polarity	Horizontal	Site / Test Engineer	AC1 / Tim
Test Mode	Transmit at 5210MHz by 802.11ax-HE80	Test Voltage	AC 120V/60Hz

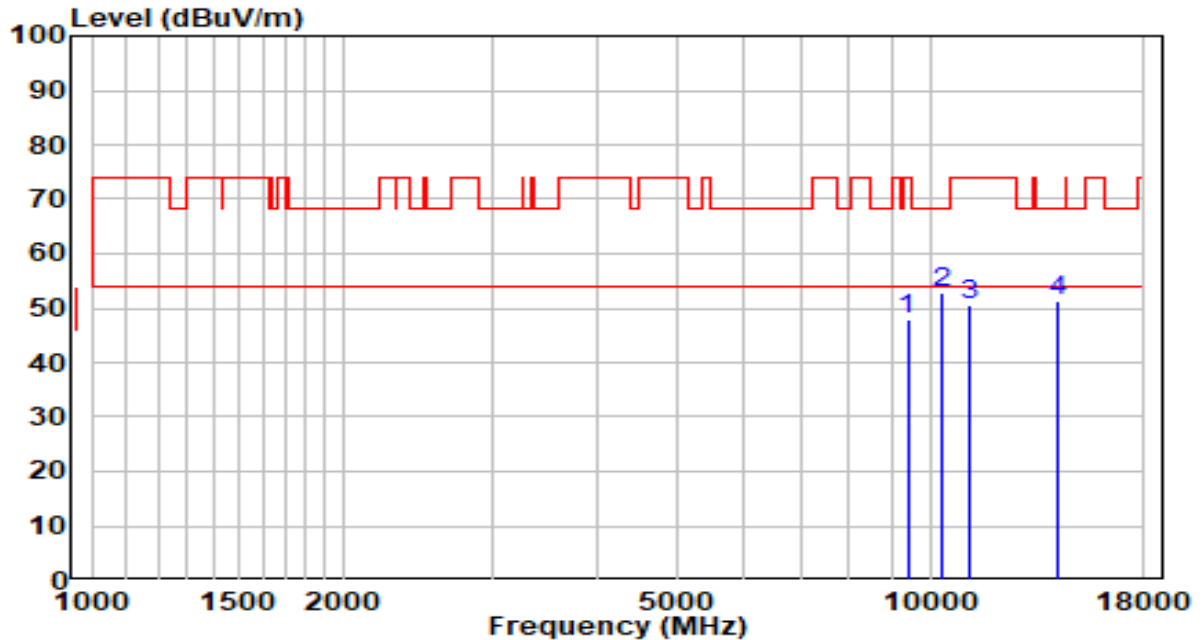

No	Frequency (MHz)	Reading (dB $\mu$ V)	C.F (dB/m)	Measurement (dB $\mu$ V/m)	Margin (dB)	Limit (dB $\mu$ V/m)	Remark (QP/PK/AV)
1	9398.000	32.35	15.55	47.90	-26.10	74.00	Peak
2	* 10316.000	34.84	17.83	52.67	-15.53	68.20	Peak
3	11115.000	31.02	19.46	50.48	-23.52	74.00	Peak
4	14175.000	29.00	22.43	51.43	-16.77	68.20	Peak

Note:

1. " \*", means this data is the worst emission level.
2. C.F (Correction Factor) = Antenna Factor (dB/m)+ Cable Loss (dB)– Preamplifier(dB).
3. Measurement(dB $\mu$ V/m) = Reading(dB $\mu$ V) + C.F (Correction Factor).

EUT	HAN Access Point	Date of Test	2021-11-13
Factor	BBHA 9120D (1GHz~18GHz)	Temp. / Humidity	23°C/53%
Polarity	Vertical	Site / Test Engineer	AC1 / Tim
Test Mode	Transmit at 5210MHz by 802.11ax-HE80	Test Voltage	AC 120V/60Hz

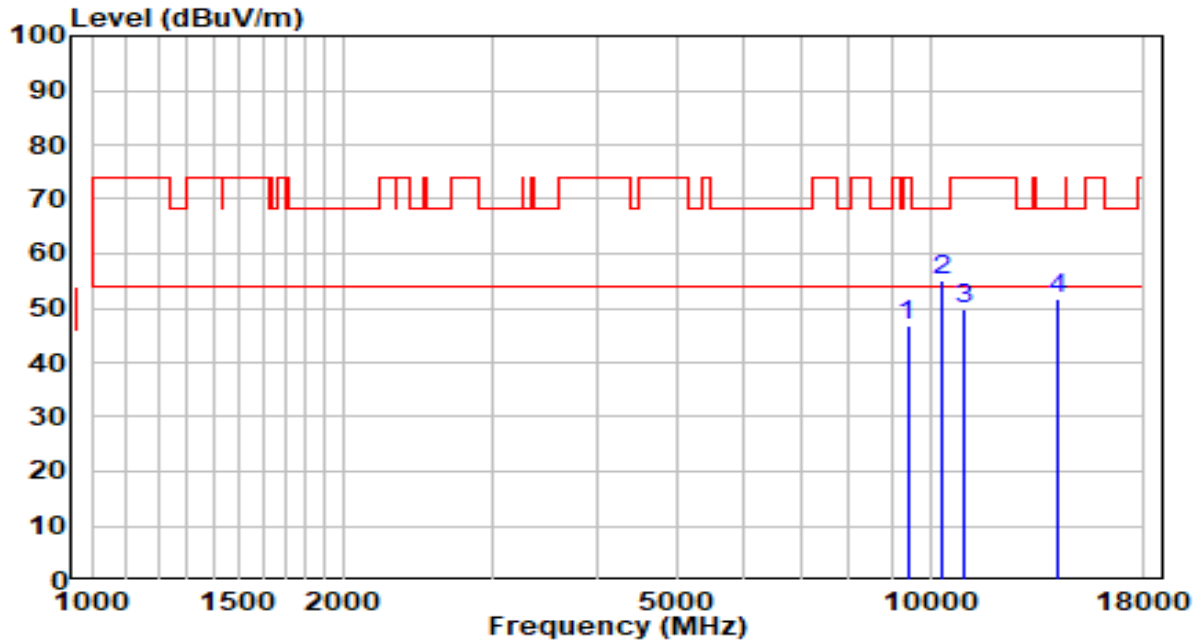

No	Frequency (MHz)	Reading (dB $\mu$ V)	C.F (dB/m)	Measurement (dB $\mu$ V/m)	Margin (dB)	Limit (dB $\mu$ V/m)	Remark (QP/PK/AV)
1	9398.000	31.16	15.55	46.71	-27.29	74.00	Peak
2	* 10316.000	37.11	17.83	54.94	-13.26	68.20	Peak
3	10996.000	30.43	19.27	49.70	-24.30	74.00	Peak
4	14226.000	29.44	22.44	51.88	-16.32	68.20	Peak

Note:

1. " \*", means this data is the worst emission level.
2. C.F (Correction Factor) = Antenna Factor (dB/m)+ Cable Loss (dB)– Preamplifier(dB).
3. Measurement(dB $\mu$ V/m) = Reading(dB $\mu$ V) + C.F (Correction Factor).

EUT	HAN Access Point	Date of Test	2021-11-13
Factor	BBHA 9120D (1GHz~18GHz)	Temp. / Humidity	23°C/53%
Polarity	Horizontal	Site / Test Engineer	AC1 / Tim
Test Mode	Transmit at 5290MHz by 802.11ax-HE80	Test Voltage	AC 120V/60Hz

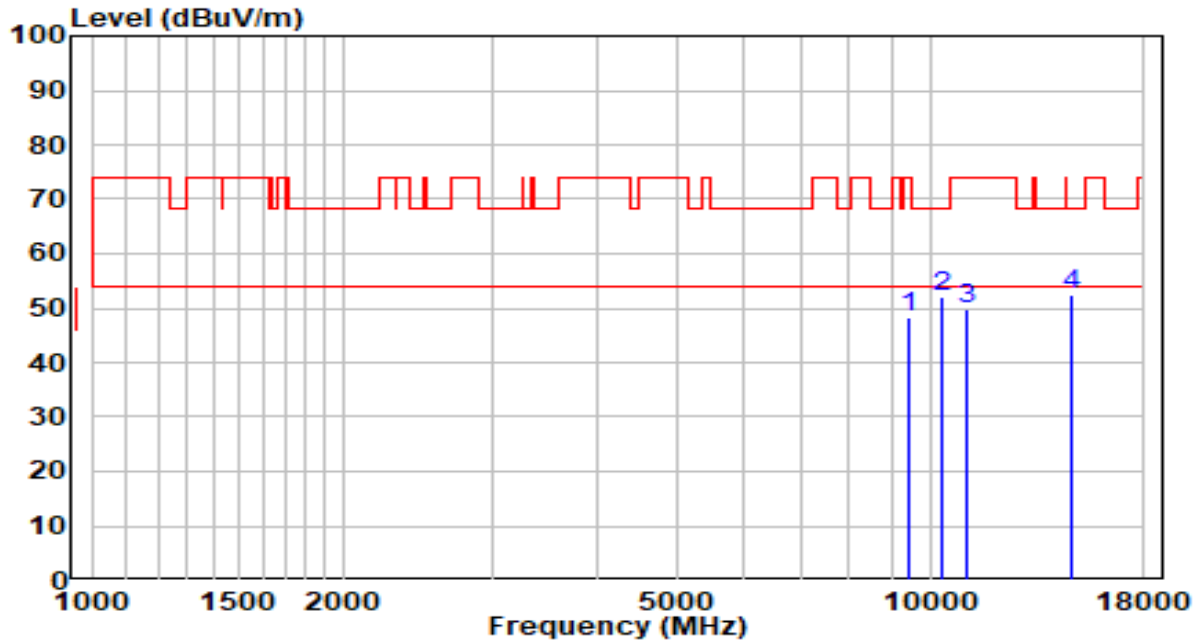

No	Frequency (MHz)	Reading (dB $\mu$ V)	C.F (dB/m)	Measurement (dB $\mu$ V/m)	Margin (dB)	Limit (dB $\mu$ V/m)	Remark (QP/PK/AV)
1	9440.500	32.62	15.62	48.24	-25.76	74.00	Peak
2	10316.000	34.21	17.83	52.04	-16.16	68.20	Peak
3	11081.000	30.27	19.40	49.67	-24.33	74.00	Peak
4	* 14710.500	30.15	22.30	52.45	-15.75	68.20	Peak

Note:

1. " \*", means this data is the worst emission level.
2. C.F (Correction Factor) = Antenna Factor (dB/m)+ Cable Loss (dB)– Preamplifier(dB).
3. Measurement(dB $\mu$ V/m) = Reading(dB $\mu$ V) + C.F (Correction Factor).

EUT	HAN Access Point	Date of Test	2021-11-13
Factor	BBHA 9120D (1GHz~18GHz)	Temp. / Humidity	23°C/53%
Polarity	Vertical	Site / Test Engineer	AC1 / Tim
Test Mode	Transmit at 5290MHz by 802.11ax-HE80	Test Voltage	AC 120V/60Hz

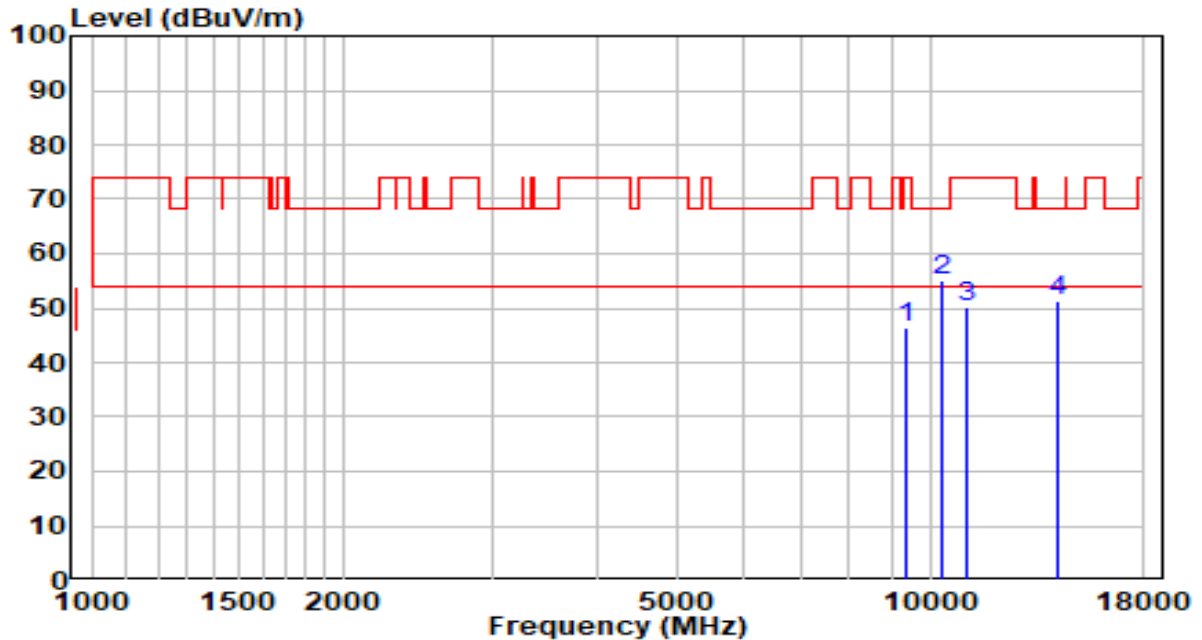

No	Frequency (MHz)	Reading (dB $\mu$ V)	C.F (dB/m)	Measurement (dB $\mu$ V/m)	Margin (dB)	Limit (dB $\mu$ V/m)	Remark (QP/PK/AV)
1	9381.000	30.94	15.52	46.46	-27.54	74.00	Peak
2	* 10316.000	37.15	17.83	54.98	-13.22	68.20	Peak
3	11038.500	30.92	19.34	50.26	-23.74	74.00	Peak
4	14149.500	28.75	22.43	51.18	-17.02	68.20	Peak

Note:

1. " \*", means this data is the worst emission level.
2. C.F (Correction Factor) = Antenna Factor (dB/m)+ Cable Loss (dB)– Preamplifier(dB).
3. Measurement(dB $\mu$ V/m) = Reading(dB $\mu$ V) + C.F (Correction Factor).

EUT	HAN Access Point	Date of Test	2021-11-13
Factor	BBHA 9120D (1GHz~18GHz)	Temp. / Humidity	23°C/53%
Polarity	Horizontal	Site / Test Engineer	AC1 / Tim
Test Mode	Transmit at 5530MHz by 802.11ax-HE80	Test Voltage	AC 120V/60Hz

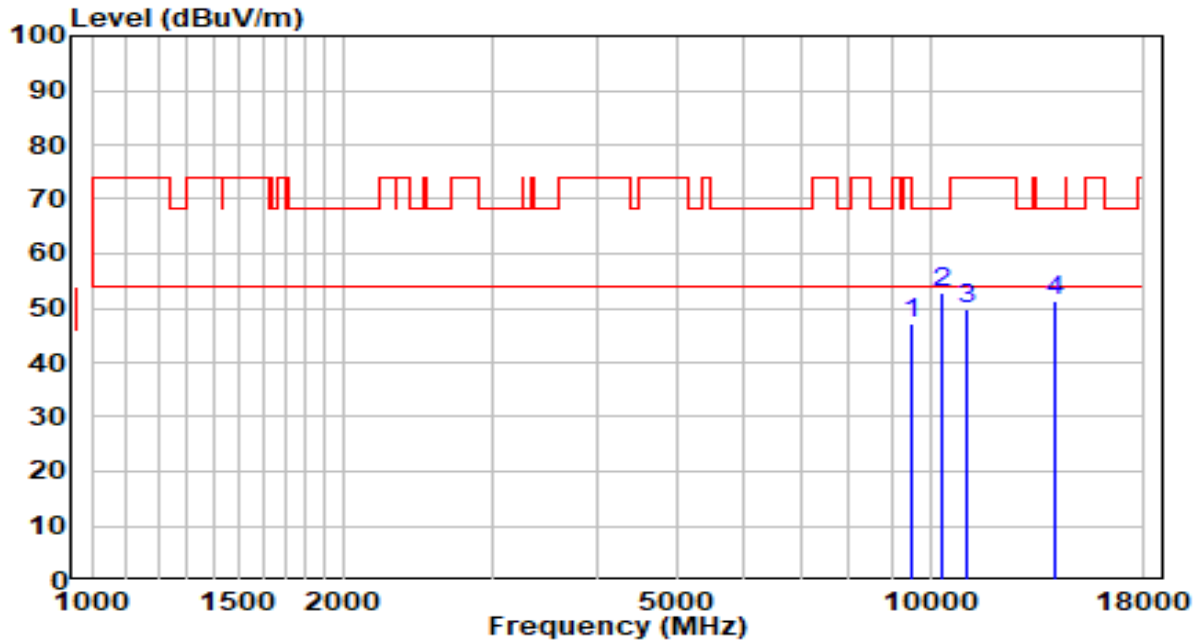

No	Frequency (MHz)	Reading (dBμV)	C.F (dB/m)	Measurement (dBμV/m)	Margin (dB)	Limit (dBμV/m)	Remark (QP/PK/AV)
1	9474.500	31.60	15.68	47.28	-26.72	74.00	Peak
2	* 10316.000	34.90	17.83	52.73	-15.47	68.20	Peak
3	11038.500	30.60	19.34	49.94	-24.06	74.00	Peak
4	14141.000	29.06	22.43	51.49	-16.71	68.20	Peak

Note:

1. " \*", means this data is the worst emission level.
2. C.F (Correction Factor) = Antenna Factor (dB/m)+ Cable Loss (dB)– Preamplifier(dB).
3. Measurement(dBμV/m) = Reading(dBμV) + C.F (Correction Factor).

EUT	HAN Access Point	Date of Test	2021-11-13
Factor	BBHA 9120D (1GHz~18GHz)	Temp. / Humidity	23°C/53%
Polarity	Vertical	Site / Test Engineer	AC1 / Tim
Test Mode	Transmit at 5530MHz by 802.11ax-HE80	Test Voltage	AC 120V/60Hz

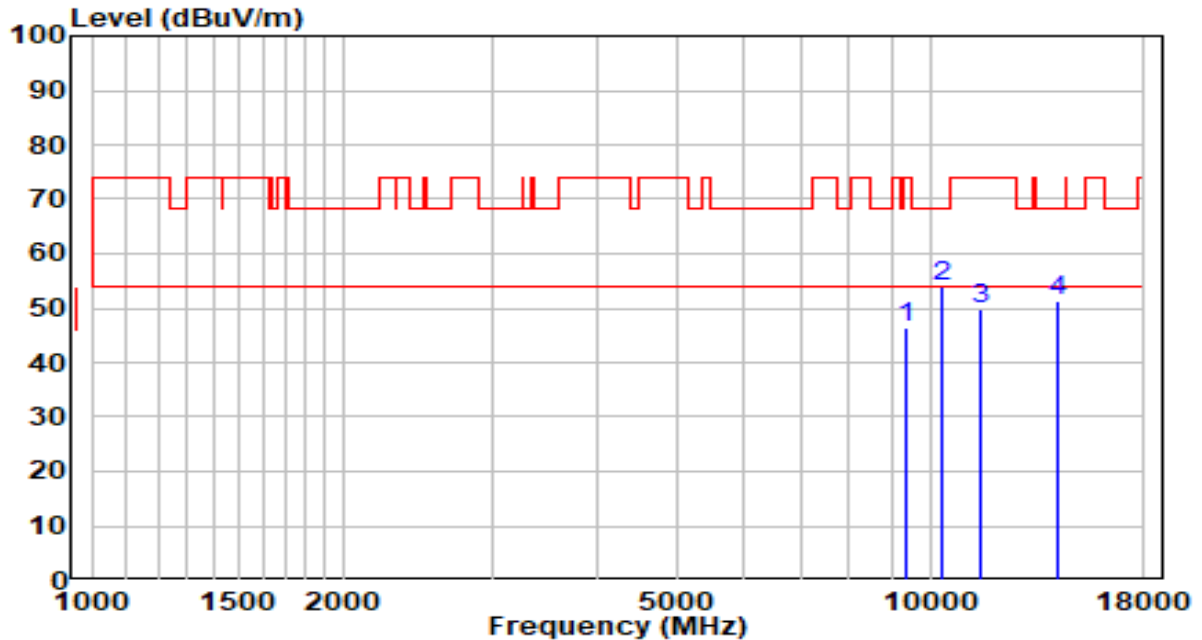

No	Frequency (MHz)	Reading (dB $\mu$ V)	C.F (dB/m)	Measurement (dB $\mu$ V/m)	Margin (dB)	Limit (dB $\mu$ V/m)	Remark (QP/PK/AV)
1	9381.000	30.83	15.52	46.36	-27.64	74.00	Peak
2	* 10316.000	36.18	17.83	54.01	-14.19	68.20	Peak
3	11497.500	29.84	20.05	49.89	-24.11	74.00	Peak
4	14217.500	28.88	22.44	51.31	-16.89	68.20	Peak

Note:

1. " \*", means this data is the worst emission level.
2. C.F (Correction Factor) = Antenna Factor (dB/m)+ Cable Loss (dB)– Preamplifier(dB).
3. Measurement(dB $\mu$ V/m) = Reading(dB $\mu$ V) + C.F (Correction Factor).

EUT	HAN Access Point	Date of Test	2021-11-13
Factor	BBHA 9120D (1GHz~18GHz)	Temp. / Humidity	23°C/53%
Polarity	Horizontal	Site / Test Engineer	AC1 / Tim
Test Mode	Transmit at 5610MHz by 802.11ax-HE80	Test Voltage	AC 120V/60Hz

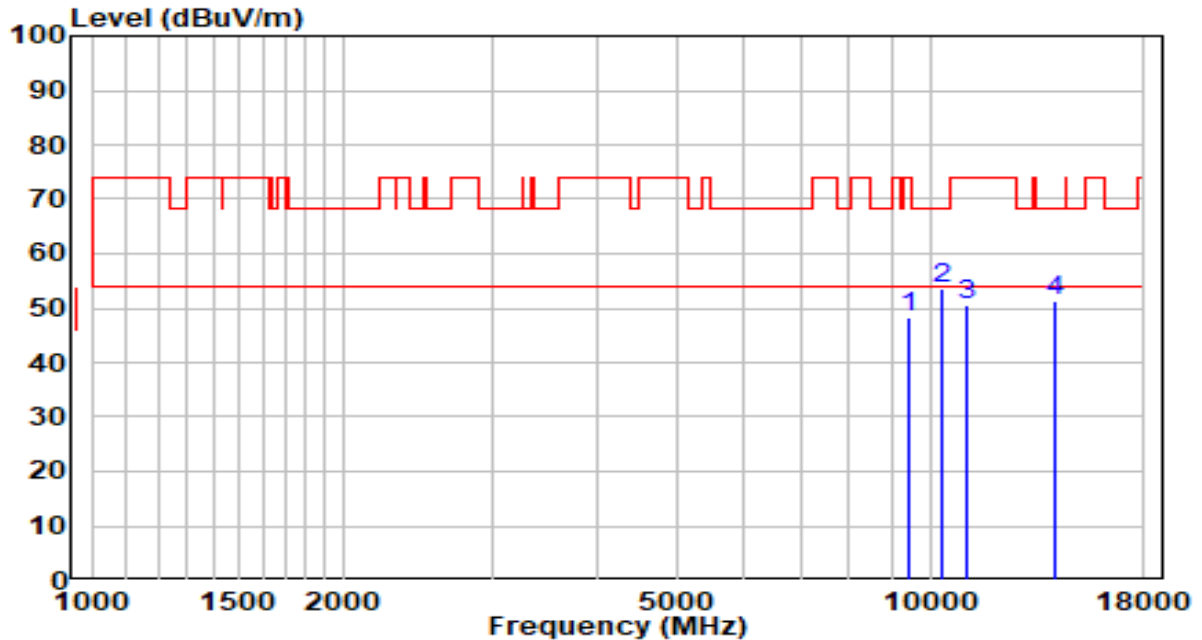

No	Frequency (MHz)	Reading (dB $\mu$ V)	C.F (dB/m)	Measurement (dB $\mu$ V/m)	Margin (dB)	Limit (dB $\mu$ V/m)	Remark (QP/PK/AV)
1	9457.500	32.66	15.65	48.31	-25.69	74.00	Peak
2	* 10316.000	35.62	17.83	53.45	-14.75	68.20	Peak
3	11038.500	31.08	19.34	50.42	-23.58	74.00	Peak
4	14141.000	28.75	22.43	51.18	-17.02	68.20	Peak

Note:

1. " \*", means this data is the worst emission level.
2. C.F (Correction Factor) = Antenna Factor (dB/m)+ Cable Loss (dB)– Preamplifier(dB).
3. Measurement(dB $\mu$ V/m) = Reading(dB $\mu$ V) + C.F (Correction Factor).

EUT	HAN Access Point	Date of Test	2021-11-13
Factor	BBHA 9120D (1GHz~18GHz)	Temp. / Humidity	23°C/53%
Polarity	Vertical	Site / Test Engineer	AC1 / Tim
Test Mode	Transmit at 5610MHz by 802.11ax-HE80	Test Voltage	AC 120V/60Hz

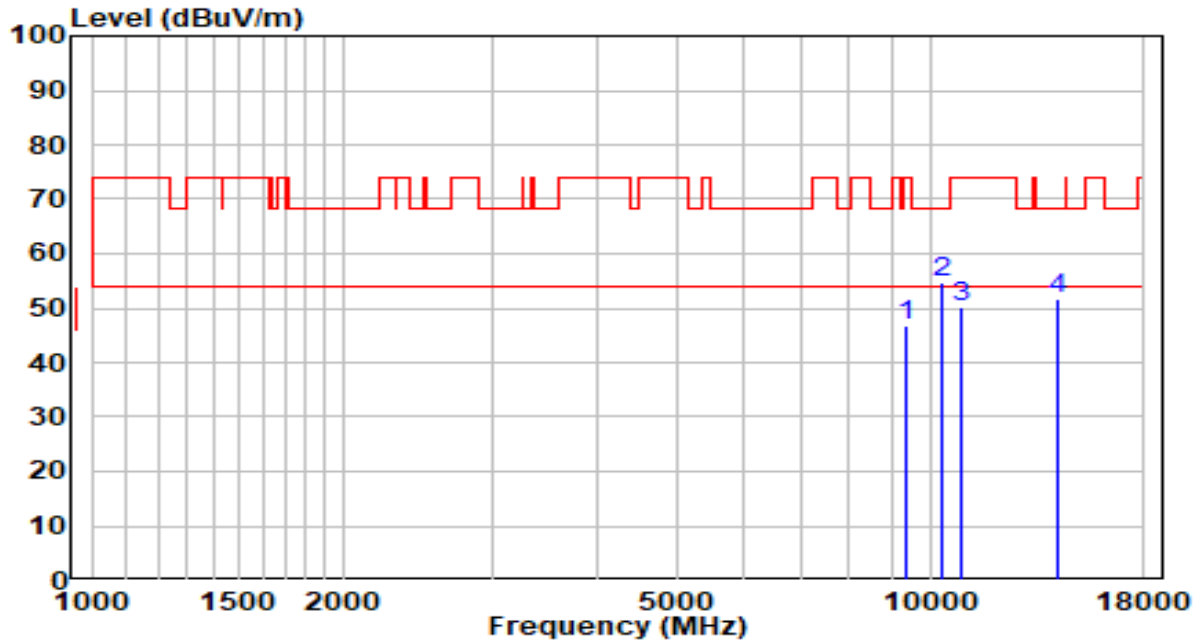

No	Frequency (MHz)	Reading (dB $\mu$ V)	C.F (dB/m)	Measurement (dB $\mu$ V/m)	Margin (dB)	Limit (dB $\mu$ V/m)	Remark (QP/PK/AV)
1	9355.500	31.20	15.48	46.68	-27.32	74.00	Peak
2	* 10316.000	36.76	17.83	54.59	-13.61	68.20	Peak
3	10860.000	31.21	19.08	50.29	-23.71	74.00	Peak
4	14175.000	29.42	22.43	51.85	-16.35	68.20	Peak

Note:

1. " \*", means this data is the worst emission level.
2. C.F (Correction Factor) = Antenna Factor (dB/m)+ Cable Loss (dB)– Preamplifier(dB).
3. Measurement(dB $\mu$ V/m) = Reading(dB $\mu$ V) + C.F (Correction Factor).



EUT	HAN Access Point	Date of Test	2021-11-13
Factor	BBHA 9120D (1GHz~18GHz)	Temp. / Humidity	23°C/53%
Polarity	Horizontal	Site / Test Engineer	AC1 / Tim
Test Mode	Transmit at 5690MHz by 802.11ax-HE80	Test Voltage	AC 120V/60Hz

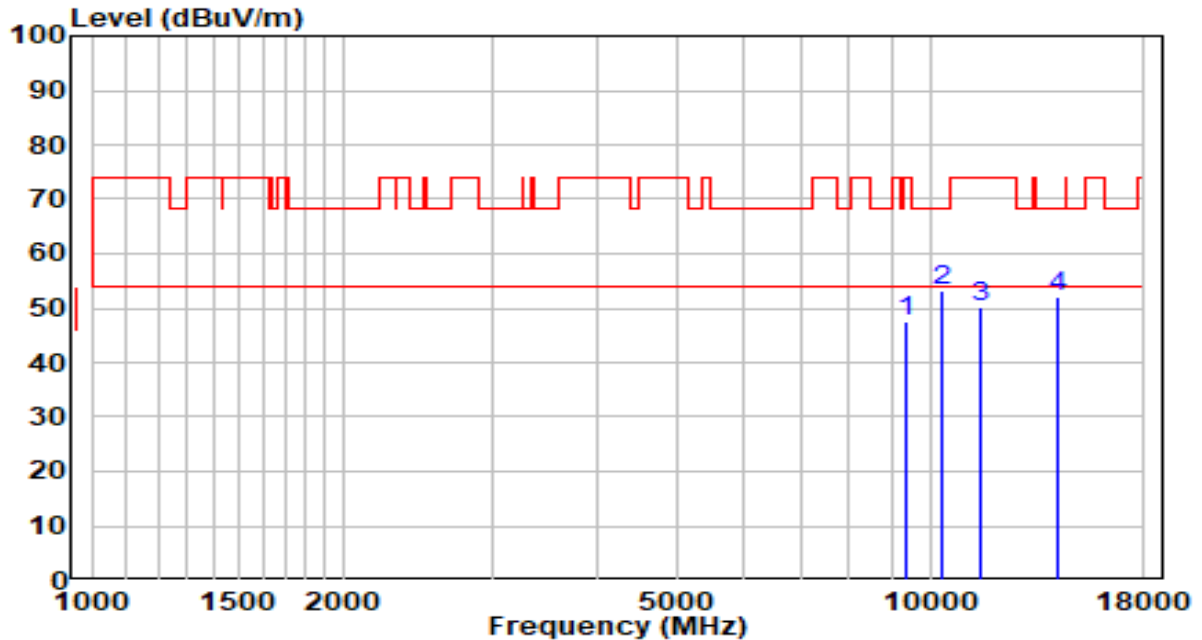

No	Frequency (MHz)	Reading (dB $\mu$ V)	C.F (dB/m)	Measurement (dB $\mu$ V/m)	Margin (dB)	Limit (dB $\mu$ V/m)	Remark (QP/PK/AV)
1	9355.500	31.98	15.48	47.46	-26.54	74.00	Peak
2	* 10316.000	35.32	17.83	53.15	-15.05	68.20	Peak
3	11523.000	30.37	20.00	50.37	-23.63	74.00	Peak
4	14158.000	29.64	22.43	52.07	-16.13	68.20	Peak

Note:

1. " \*", means this data is the worst emission level.
2. C.F (Correction Factor) = Antenna Factor (dB/m)+ Cable Loss (dB)– Preamplifier(dB).
3. Measurement(dB $\mu$ V/m) = Reading(dB $\mu$ V) + C.F (Correction Factor).

EUT	HAN Access Point	Date of Test	2021-11-13
Factor	BBHA 9120D (1GHz~18GHz)	Temp. / Humidity	23°C/53%
Polarity	Vertical	Site / Test Engineer	AC1 / Tim
Test Mode	Transmit at 5690MHz by 802.11ax-HE80	Test Voltage	AC 120V/60Hz

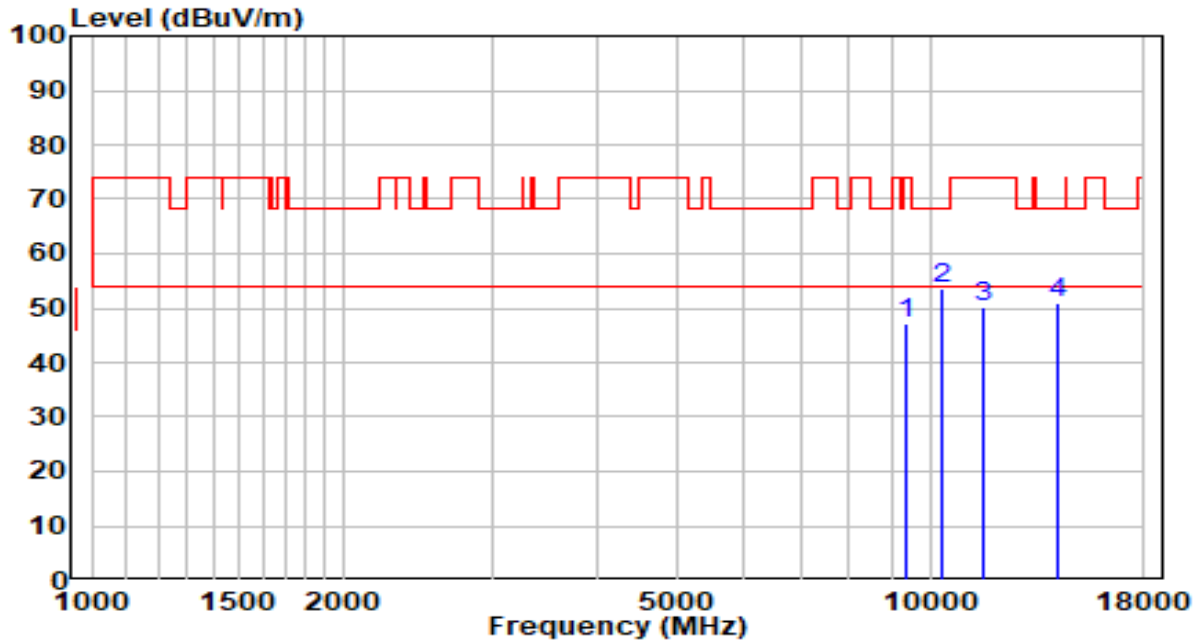

No	Frequency (MHz)	Reading (dB $\mu$ V)	C.F (dB/m)	Measurement (dB $\mu$ V/m)	Margin (dB)	Limit (dB $\mu$ V/m)	Remark (QP/PK/AV)
1	9355.500	31.74	15.48	47.22	-26.78	74.00	Peak
2	* 10316.000	35.88	17.83	53.71	-14.49	68.20	Peak
3	11531.500	30.15	19.98	50.13	-23.87	74.00	Peak
4	14158.000	28.66	22.43	51.09	-17.11	68.20	Peak

Note:

1. " \*", means this data is the worst emission level.
2. C.F (Correction Factor) = Antenna Factor (dB/m)+ Cable Loss (dB)– Preamplifier(dB).
3. Measurement(dB $\mu$ V/m) = Reading(dB $\mu$ V) + C.F (Correction Factor).

EUT	HAN Access Point	Date of Test	2021-11-13
Factor	BBHA 9120D (1GHz~18GHz)	Temp. / Humidity	23°C/53%
Polarity	Horizontal	Site / Test Engineer	AC1 / Tim
Test Mode	Transmit at 5775MHz by 802.11ax-HE80	Test Voltage	AC 120V/60Hz

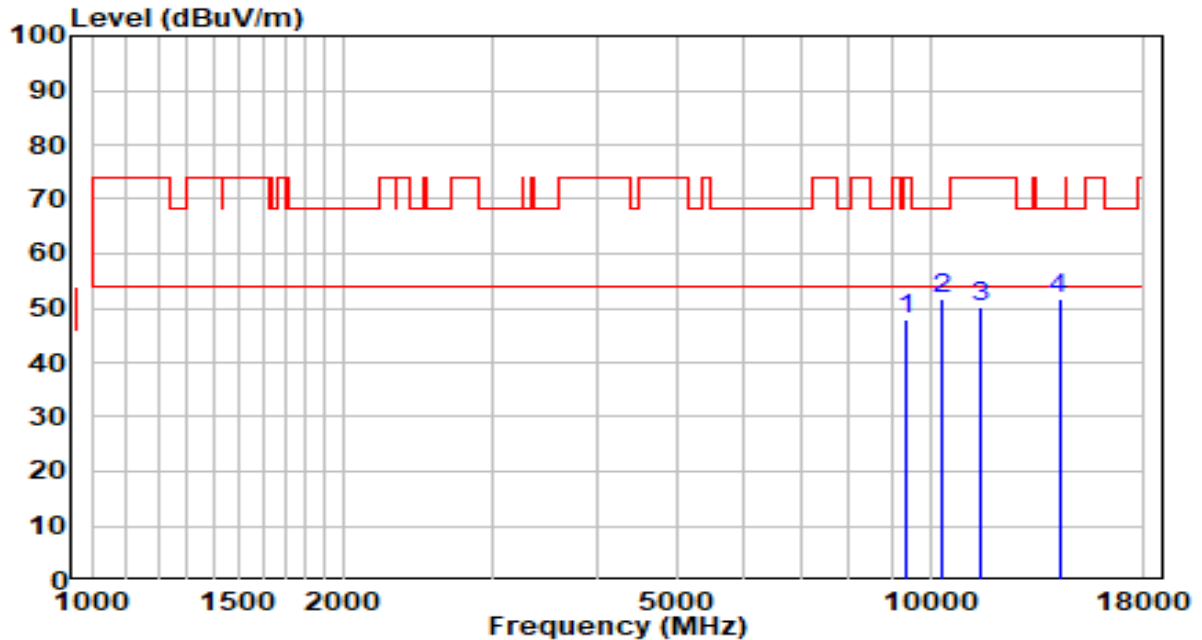

No	Frequency (MHz)	Reading (dB $\mu$ V)	C.F (dB/m)	Measurement (dB $\mu$ V/m)	Margin (dB)	Limit (dB $\mu$ V/m)	Remark (QP/PK/AV)
1	9381.000	32.29	15.52	47.81	-26.19	74.00	Peak
2	* 10316.000	34.04	17.83	51.87	-16.33	68.20	Peak
3	11523.000	30.27	20.00	50.27	-23.73	74.00	Peak
4	14251.500	29.33	22.44	51.76	-16.44	68.20	Peak

Note:

1. " \*", means this data is the worst emission level.
2. C.F (Correction Factor) = Antenna Factor (dB/m)+ Cable Loss (dB)– Preamplifier(dB).
3. Measurement(dB $\mu$ V/m) = Reading(dB $\mu$ V) + C.F (Correction Factor).

EUT	HAN Access Point	Date of Test	2021-11-13
Factor	BBHA 9120D (1GHz~18GHz)	Temp. / Humidity	23°C/53%
Polarity	Vertical	Site / Test Engineer	AC1 / Tim
Test Mode	Transmit at 5775MHz by 802.11ax-HE80	Test Voltage	AC 120V/60Hz

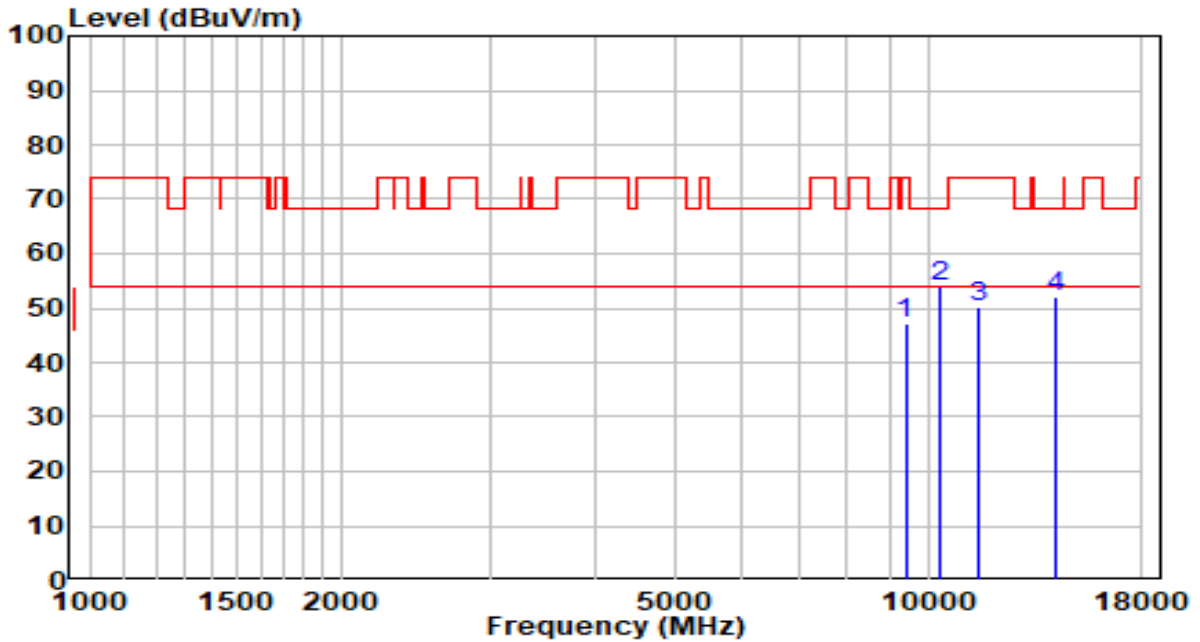

No	Frequency (MHz)	Reading (dBμV)	C.F (dB/m)	Measurement (dBμV/m)	Margin (dB)	Limit (dBμV/m)	Remark (QP/PK/AV)
1	9398.000	31.45	15.55	47.00	-27.00	74.00	Peak
2	* 10316.000	36.26	17.83	54.10	-14.10	68.20	Peak
3	11523.000	30.07	20.00	50.07	-23.93	74.00	Peak
4	14158.000	29.49	22.43	51.92	-16.28	68.20	Peak

Note:

1. " \*", means this data is the worst emission level.
2. C.F (Correction Factor) = Antenna Factor (dB/m)+ Cable Loss (dB)– Preamplifier(dB).
3. Measurement(dBμV/m) = Reading(dBμV) + C.F (Correction Factor).

EUT	HAN Access Point	Date of Test	2021-11-13
Factor	BBHA 9120D (1GHz~18GHz)	Temp. / Humidity	23°C/53%
Polarity	Horizontal	Site / Test Engineer	AC1 / Tim
Test Mode	Transmit at 5210+5290MHz by 802.11ax-HE80+80	Test Voltage	AC 120V/60Hz

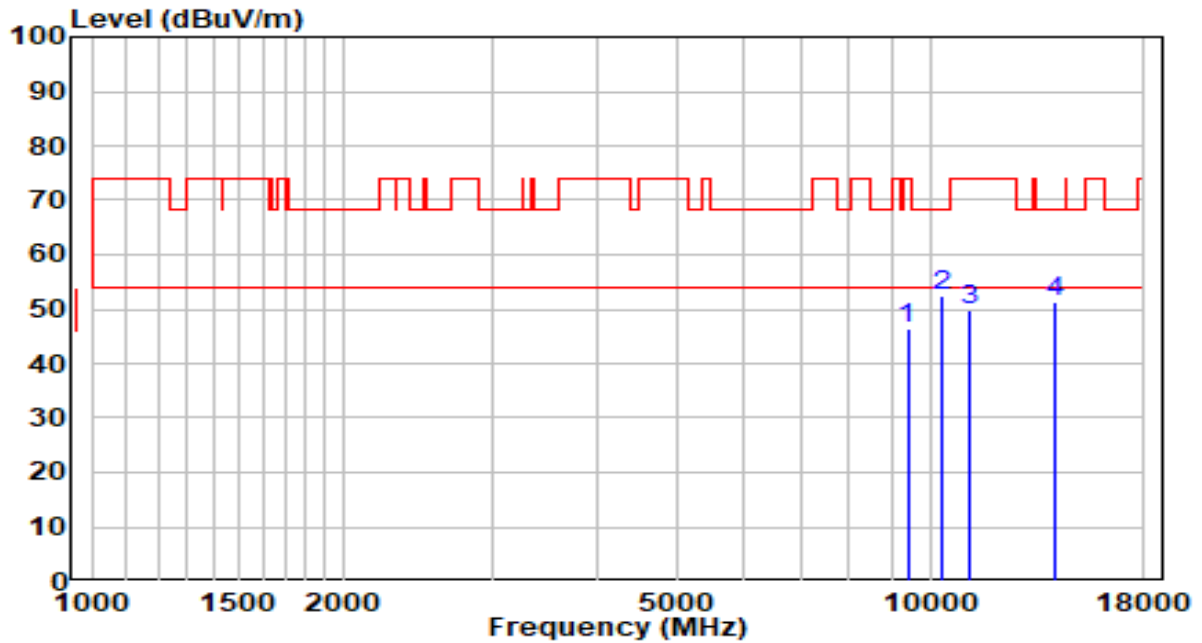

No	Frequency (MHz)	Reading (dB $\mu$ V)	C.F (dB/m)	Measurement (dB $\mu$ V/m)	Margin (dB)	Limit (dB $\mu$ V/m)	Remark (QP/PK/AV)
1	9398.000	30.76	15.55	46.31	-27.69	74.00	Peak
2	* 10316.000	34.47	17.83	52.30	-15.90	68.20	Peak
3	11115.000	30.26	19.46	49.72	-24.28	74.00	Peak
4	14141.000	28.86	22.43	51.29	-16.91	68.20	Peak

Note:

- "\*", means this data is the worst emission level.
- C.F (Correction Factor) = Antenna Factor (dB/m)+ Cable Loss (dB)– Preamplifier(dB).
- Measurement(dB $\mu$ V/m) = Reading(dB $\mu$ V) + C.F (Correction Factor).

EUT	HAN Access Point	Date of Test	2021-11-13
Factor	BBHA 9120D (1GHz~18GHz)	Temp. / Humidity	23°C/53%
Polarity	Vertical	Site / Test Engineer	AC1 / Tim
Test Mode	Transmit at 5210+5290MHz by 802.11ax-HE80+80	Test Voltage	AC 120V/60Hz

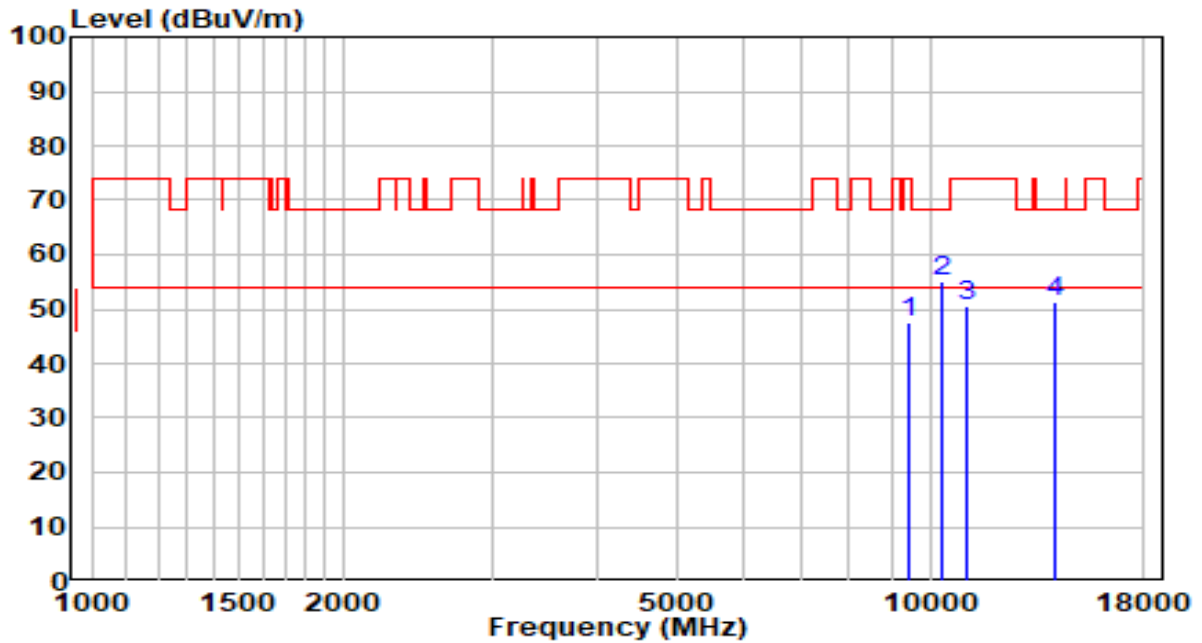

No	Frequency (MHz)	Reading (dB $\mu$ V)	C.F (dB/m)	Measurement (dB $\mu$ V/m)	Margin (dB)	Limit (dB $\mu$ V/m)	Remark (QP/PK/AV)
1	9440.500	31.75	15.62	47.37	-26.63	74.00	Peak
2	* 10316.000	37.24	17.83	55.07	-13.13	68.20	Peak
3	11030.000	31.42	19.33	50.74	-23.26	74.00	Peak
4	14132.500	28.95	22.43	51.38	-16.82	68.20	Peak

Note:

- "\*", means this data is the worst emission level.
- C.F (Correction Factor) = Antenna Factor (dB/m)+ Cable Loss (dB)– Preamplifier(dB).
- Measurement(dB $\mu$ V/m) = Reading(dB $\mu$ V) + C.F (Correction Factor).

EUT	HAN Access Point	Date of Test	2021-11-13
Factor	BBHA 9120D (1GHz~18GHz)	Temp. / Humidity	23°C/53%
Polarity	Horizontal	Site / Test Engineer	AC1 / Tim
Test Mode	Transmit at 5290+5210MHz by 802.11ax-HE80+80	Test Voltage	AC 120V/60Hz

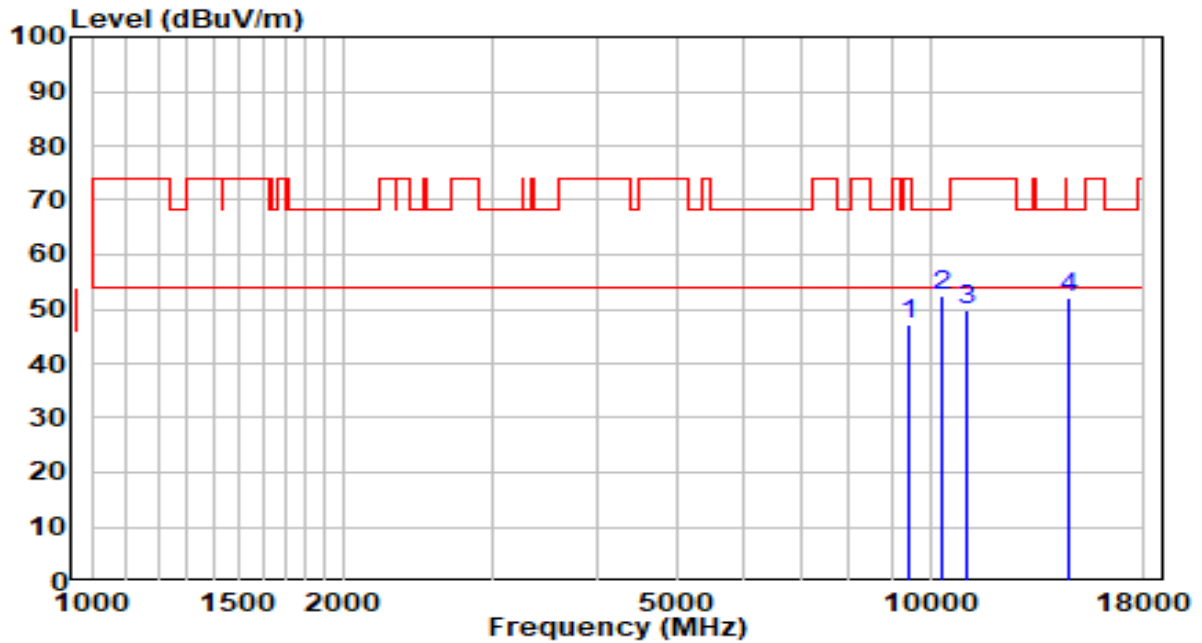

No	Frequency (MHz)	Reading (dB $\mu$ V)	C.F (dB/m)	Measurement (dB $\mu$ V/m)	Margin (dB)	Limit (dB $\mu$ V/m)	Remark (QP/PK/AV)
1	9440.500	31.56	15.62	47.18	-26.82	74.00	Peak
2	* 10316.000	34.55	17.83	52.39	-15.81	68.20	Peak
3	11038.500	30.51	19.34	49.85	-24.15	74.00	Peak
4	14685.000	29.88	22.32	52.20	-16.00	68.20	Peak

Note:

- "\*", means this data is the worst emission level.
- C.F (Correction Factor) = Antenna Factor (dB/m)+ Cable Loss (dB)– Preamplifier(dB).
- Measurement(dB $\mu$ V/m) = Reading(dB $\mu$ V) + C.F (Correction Factor).

EUT	HAN Access Point	Date of Test	2021-11-13
Factor	BBHA 9120D (1GHz~18GHz)	Temp. / Humidity	23°C/53%
Polarity	Vertical	Site / Test Engineer	AC1 / Tim
Test Mode	Transmit at 5290+5210MHz by 802.11ax-HE80+80	Test Voltage	AC 120V/60Hz

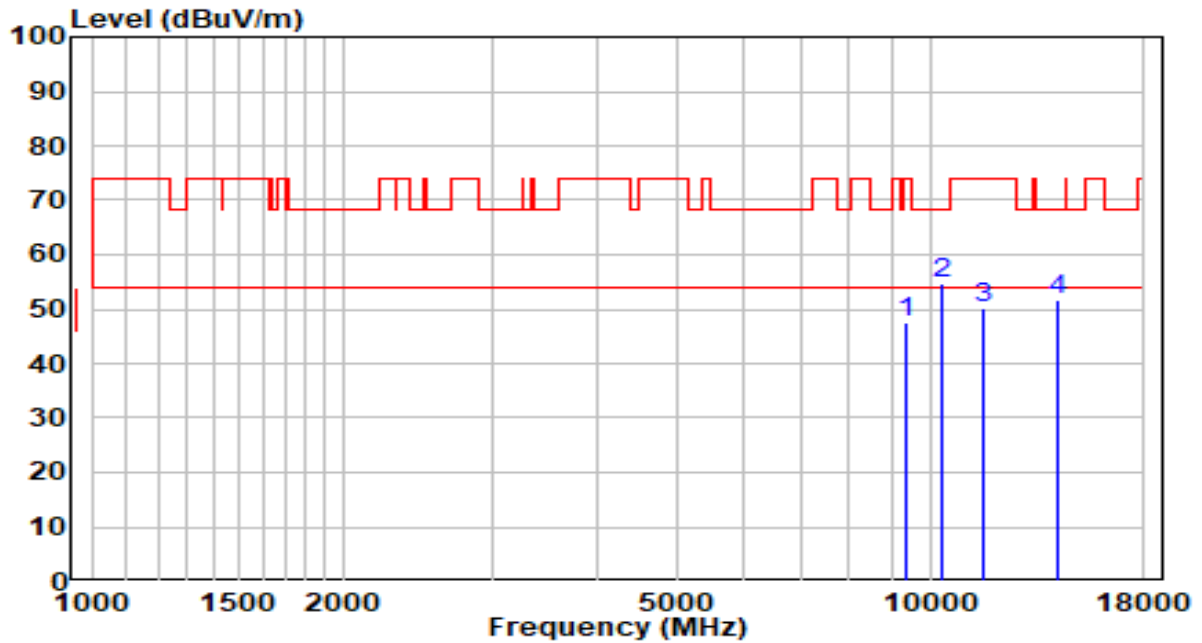

No	Frequency (MHz)	Reading (dB $\mu$ V)	C.F (dB/m)	Measurement (dB $\mu$ V/m)	Margin (dB)	Limit (dB $\mu$ V/m)	Remark (QP/PK/AV)
1	9338.500	32.04	15.45	47.49	-26.51	74.00	Peak
2	* 10316.000	36.84	17.83	54.67	-13.53	68.20	Peak
3	11574.000	30.42	19.88	50.31	-23.69	74.00	Peak
4	14192.000	29.21	22.43	51.64	-16.56	68.20	Peak

Note:

1. " \*", means this data is the worst emission level.
2. C.F (Correction Factor) = Antenna Factor (dB/m)+ Cable Loss (dB)– Preamplifier(dB).
3. Measurement(dB $\mu$ V/m) = Reading(dB $\mu$ V) + C.F (Correction Factor).



EUT	HAN Access Point	Date of Test	2021-11-13
Factor	BBHA 9120D (1GHz~18GHz)	Temp. / Humidity	23°C/53%
Polarity	Horizontal	Site / Test Engineer	AC1 / Tim
Test Mode	Transmit at 5530+5610MHz by 802.11ax-HE80+80	Test Voltage	AC 120V/60Hz

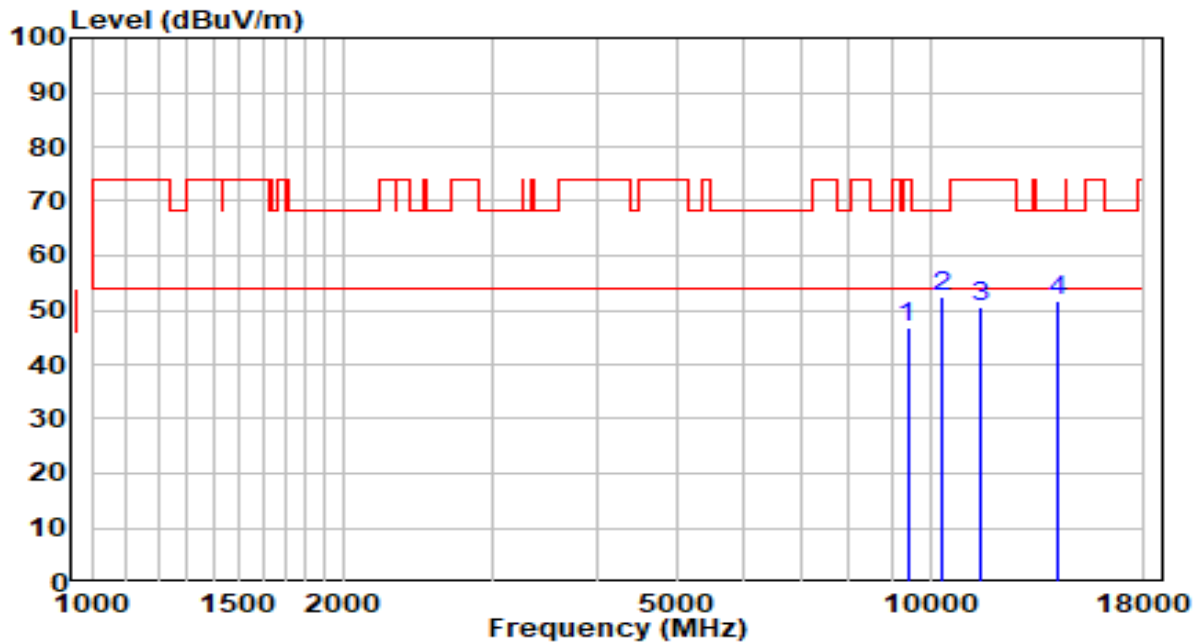

No	Frequency (MHz)	Reading (dB $\mu$ V)	C.F (dB/m)	Measurement (dB $\mu$ V/m)	Margin (dB)	Limit (dB $\mu$ V/m)	Remark (QP/PK/AV)
1	9398.000	31.42	15.55	46.97	-27.03	74.00	Peak
2	* 10316.000	34.64	17.83	52.47	-15.73	68.20	Peak
3	11497.500	30.58	20.05	50.62	-23.38	74.00	Peak
4	14149.500	29.14	22.43	51.57	-16.63	68.20	Peak

Note:

1. " \*", means this data is the worst emission level.
2. C.F (Correction Factor) = Antenna Factor (dB/m)+ Cable Loss (dB)– Preamplifier(dB).
3. Measurement(dB $\mu$ V/m) = Reading(dB $\mu$ V) + C.F (Correction Factor).

EUT	HAN Access Point	Date of Test	2021-11-13
Factor	BBHA 9120D (1GHz~18GHz)	Temp. / Humidity	23°C/53%
Polarity	Vertical	Site / Test Engineer	AC1 / Tim
Test Mode	Transmit at 5530+5610MHz by 802.11ax-HE80+80	Test Voltage	AC 120V/60Hz

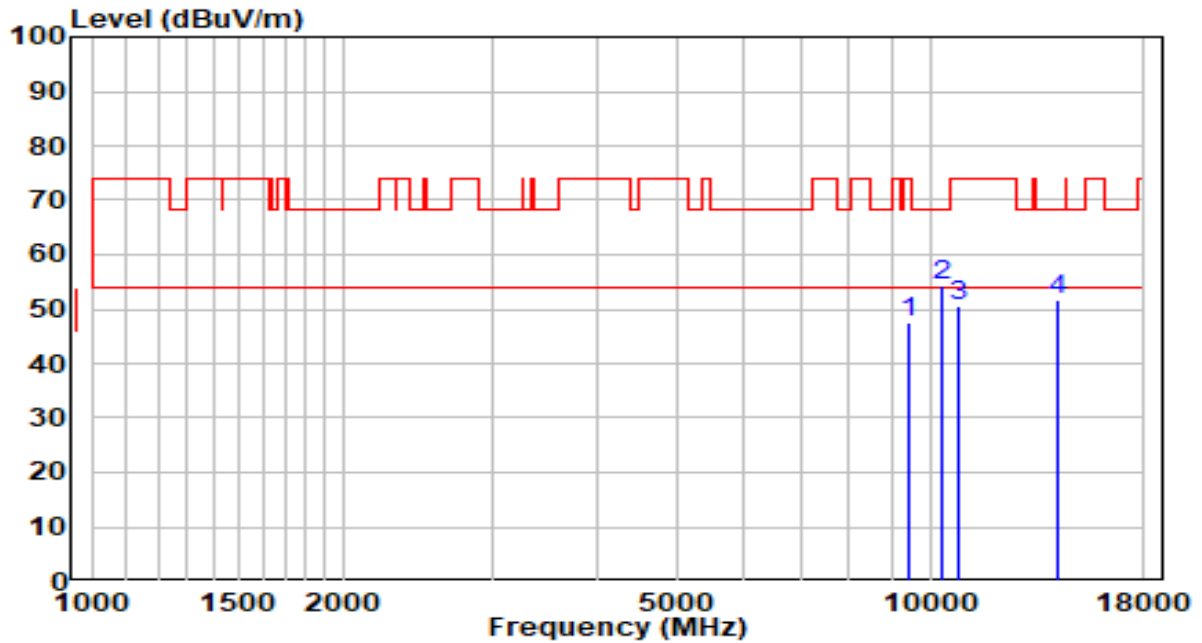

No	Frequency (MHz)	Reading (dB $\mu$ V)	C.F (dB/m)	Measurement (dB $\mu$ V/m)	Margin (dB)	Limit (dB $\mu$ V/m)	Remark (QP/PK/AV)
1	9440.500	31.84	15.62	47.46	-26.54	74.00	Peak
2	* 10316.000	36.53	17.83	54.36	-13.84	68.20	Peak
3	10834.500	31.56	19.04	50.60	-23.40	74.00	Peak
4	14149.500	29.33	22.43	51.76	-16.44	68.20	Peak

Note:

1. " \*", means this data is the worst emission level.
2. C.F (Correction Factor) = Antenna Factor (dB/m)+ Cable Loss (dB)– Preamplifier(dB).
3. Measurement(dB $\mu$ V/m) = Reading(dB $\mu$ V) + C.F (Correction Factor).

EUT	HAN Access Point	Date of Test	2021-11-13
Factor	BBHA 9120D (1GHz~18GHz)	Temp. / Humidity	23°C/53%
Polarity	Horizontal	Site / Test Engineer	AC1 / Tim
Test Mode	Transmit at 5610+5530MHz by 802.11ax-HE80+80	Test Voltage	AC 120V/60Hz

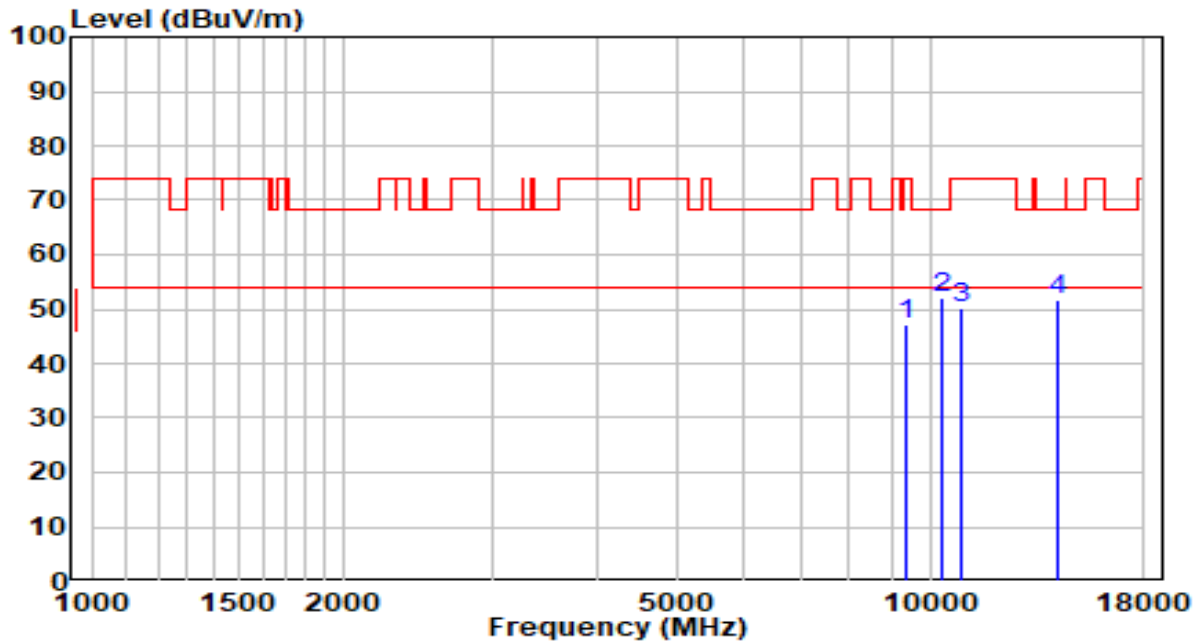

No	Frequency (MHz)	Reading (dB $\mu$ V)	C.F (dB/m)	Measurement (dB $\mu$ V/m)	Margin (dB)	Limit (dB $\mu$ V/m)	Remark (QP/PK/AV)
1	9355.500	31.56	15.48	47.04	-26.96	74.00	Peak
2	* 10316.000	34.09	17.83	51.92	-16.28	68.20	Peak
3	10919.500	30.95	19.17	50.11	-23.89	74.00	Peak
4	14209.000	29.44	22.43	51.87	-16.33	68.20	Peak

Note:

- "\*", means this data is the worst emission level.
- C.F (Correction Factor) = Antenna Factor (dB/m)+ Cable Loss (dB)– Preamplifier(dB).
- Measurement(dB $\mu$ V/m) = Reading(dB $\mu$ V) + C.F (Correction Factor).

EUT	HAN Access Point	Date of Test	2021-11-13
Factor	BBHA 9120D (1GHz~18GHz)	Temp. / Humidity	23°C/53%
Polarity	Vertical	Site / Test Engineer	AC1 / Tim
Test Mode	Transmit at 5610+5530MHz by 802.11ax-HE80+80	Test Voltage	AC 120V/60Hz

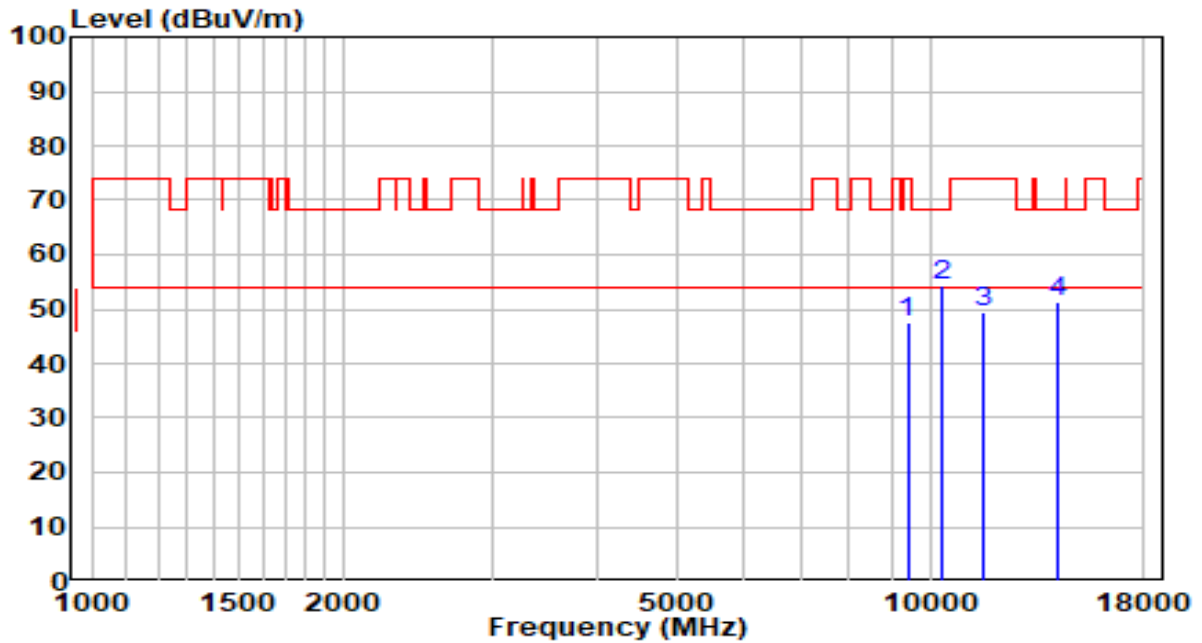

No	Frequency (MHz)	Reading (dB $\mu$ V)	C.F (dB/m)	Measurement (dB $\mu$ V/m)	Margin (dB)	Limit (dB $\mu$ V/m)	Remark (QP/PK/AV)
1	9398.000	31.93	15.55	47.48	-26.52	74.00	Peak
2	* 10316.000	36.50	17.83	54.33	-13.87	68.20	Peak
3	11574.000	29.68	19.88	49.56	-24.44	74.00	Peak
4	14192.000	29.06	22.43	51.49	-16.71	68.20	Peak

Note:

- "\*", means this data is the worst emission level.
- C.F (Correction Factor) = Antenna Factor (dB/m)+ Cable Loss (dB)– Preamplifier(dB).
- Measurement(dB $\mu$ V/m) = Reading(dB $\mu$ V) + C.F (Correction Factor).

**Scan Mode:**

EUT	HAN Access Point	Date of Test	2021-11-13
Factor	BBHA 9120D (1GHz~18GHz)	Temp. / Humidity	23°C/53%
Polarity	Horizontal	Site / Test Engineer	AC1 / Tim
Test Mode	Transmit at 5180MHz by 802.11a	Test Voltage	AC 120V/60Hz

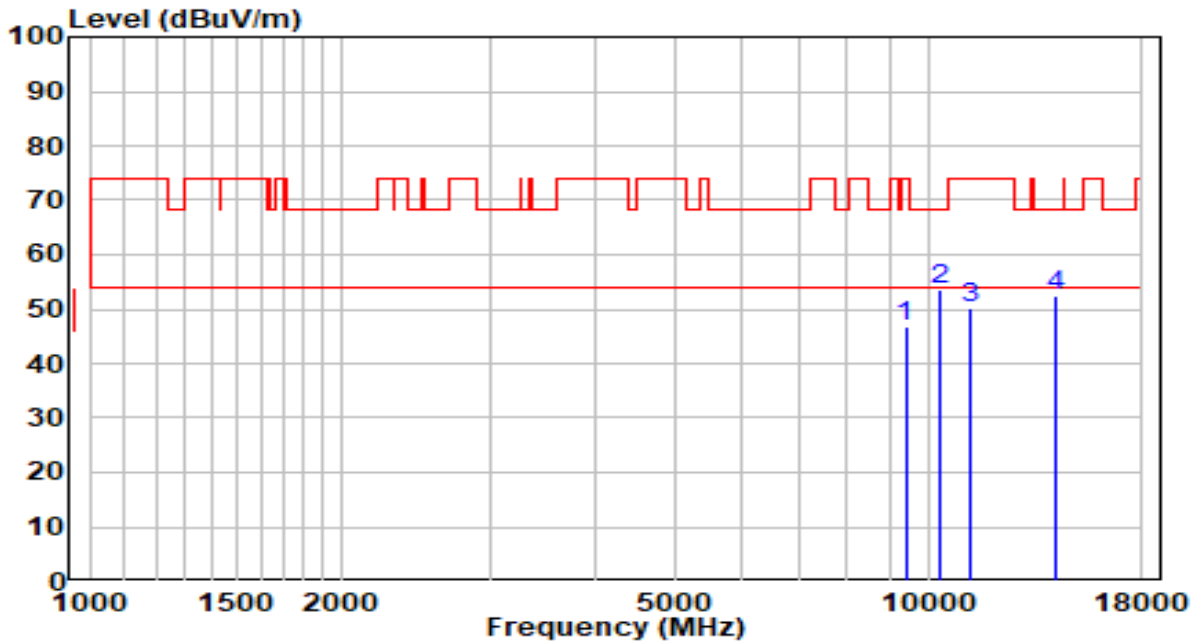

No	Frequency (MHz)	Reading (dB $\mu$ V)	C.F (dB/m)	Measurement (dB $\mu$ V/m)	Margin (dB)	Limit (dB $\mu$ V/m)	Remark (QP/PK/AV)
1	9398.000	31.26	15.55	46.80	-27.20	74.00	Peak
2	* 10316.000	35.60	17.83	53.43	-14.77	68.20	Peak
3	11191.500	30.60	19.57	50.18	-23.82	74.00	Peak
4	14149.500	29.91	22.43	52.34	-15.86	68.20	Peak

**Note:**

- "\*", means this data is the worst emission level.
- C.F (Correction Factor) = Antenna Factor (dB/m)+ Cable Loss (dB)– Preamplifier(dB).
- Measurement(dB $\mu$ V/m) = Reading(dB $\mu$ V) + C.F (Correction Factor).

EUT	HAN Access Point	Date of Test	2021-11-13
Factor	BBHA 9120D (1GHz~18GHz)	Temp. / Humidity	23°C/53%
Polarity	Vertical	Site / Test Engineer	AC1 / Tim
Test Mode	Transmit at 5180MHz by 802.11a	Test Voltage	AC 120V/60Hz

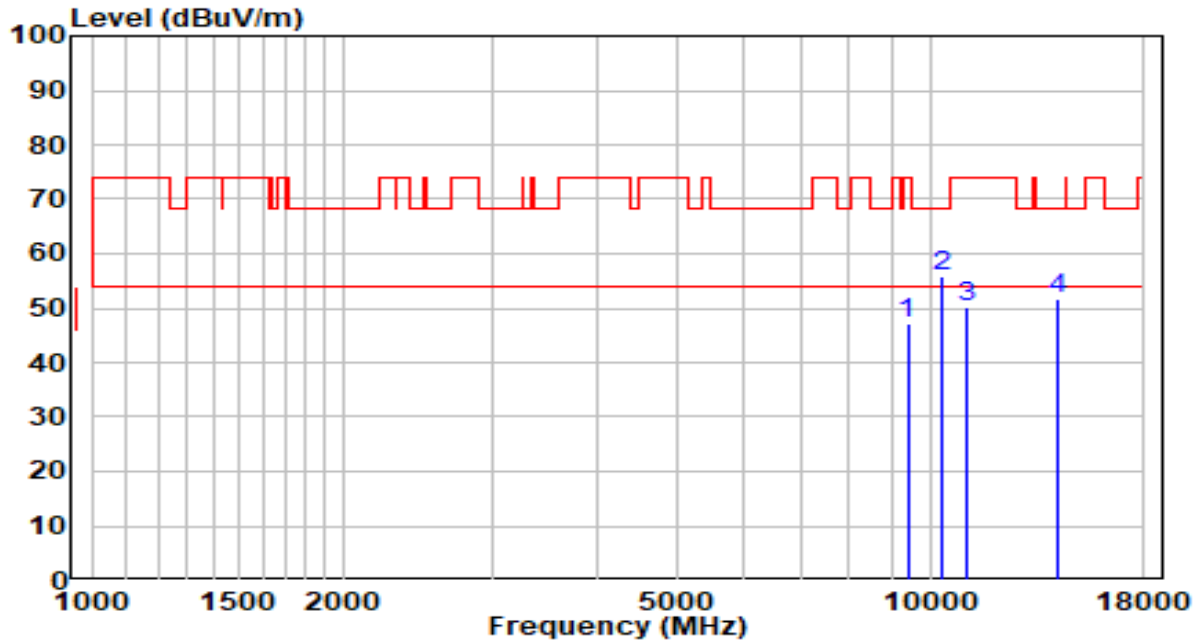

No	Frequency (MHz)	Reading (dB $\mu$ V)	C.F (dB/m)	Measurement (dB $\mu$ V/m)	Margin (dB)	Limit (dB $\mu$ V/m)	Remark (QP/PK/AV)
1	9398.000	31.48	15.55	47.03	-26.97	74.00	Peak
2	* 10316.000	38.00	17.83	55.83	-12.37	68.20	Peak
3	11047.000	30.94	19.35	50.30	-23.70	74.00	Peak
4	14192.000	29.33	22.43	51.76	-16.44	68.20	Peak

Note:

1. " \*", means this data is the worst emission level.
2. C.F (Correction Factor) = Antenna Factor (dB/m)+ Cable Loss (dB)– Preamplifier(dB).
3. Measurement(dB $\mu$ V/m) = Reading(dB $\mu$ V) + C.F (Correction Factor).

EUT	HAN Access Point	Date of Test	2021-11-13
Factor	BBHA 9120D (1GHz~18GHz)	Temp. / Humidity	23°C/53%
Polarity	Horizontal	Site / Test Engineer	AC1 / Tim
Test Mode	Transmit at 5220MHz by 802.11a	Test Voltage	AC 120V/60Hz

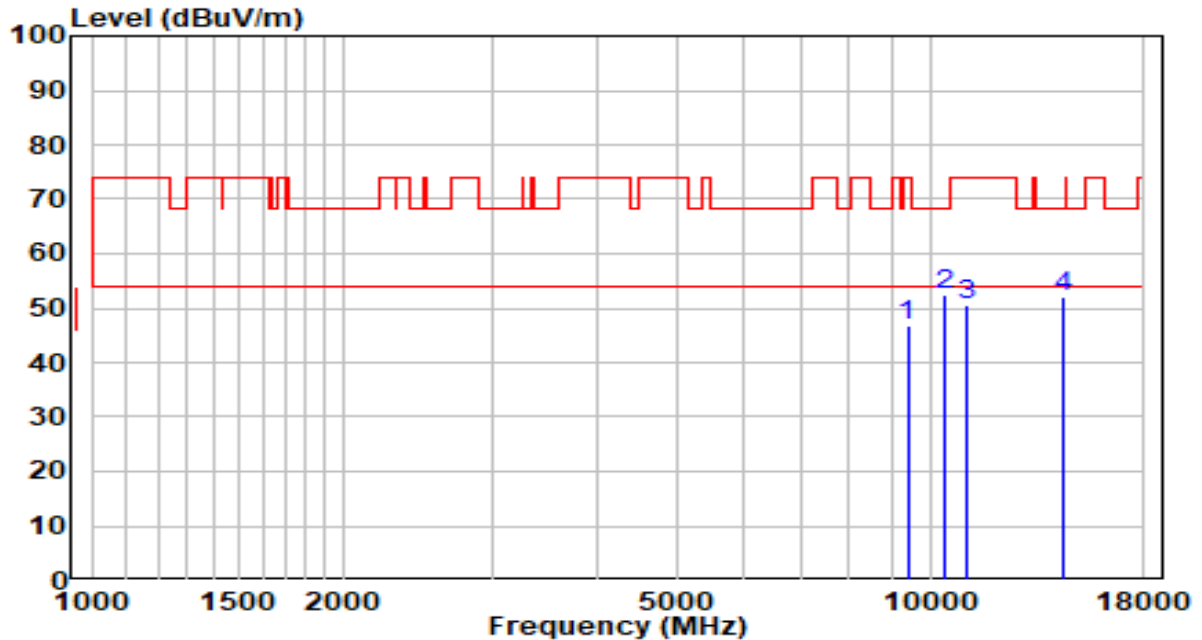

No	Frequency (MHz)	Reading (dB $\mu$ V)	C.F (dB/m)	Measurement (dB $\mu$ V/m)	Margin (dB)	Limit (dB $\mu$ V/m)	Remark (QP/PK/AV)
1	9398.000	31.15	15.55	46.70	-27.30	74.00	Peak
2	* 10435.000	34.32	18.31	52.62	-15.58	68.20	Peak
3	11055.500	31.38	19.37	50.75	-23.25	74.00	Peak
4	14421.500	29.46	22.45	51.91	-16.29	68.20	Peak

Note:

1. " \*", means this data is the worst emission level.
2. C.F (Correction Factor) = Antenna Factor (dB/m)+ Cable Loss (dB)– Preamplifier(dB).
3. Measurement(dB $\mu$ V/m) = Reading(dB $\mu$ V) + C.F (Correction Factor).

EUT	HAN Access Point	Date of Test	2021-11-13
Factor	BBHA 9120D (1GHz~18GHz)	Temp. / Humidity	23°C/53%
Polarity	Vertical	Site / Test Engineer	AC1 / Tim
Test Mode	Transmit at 5220MHz by 802.11a	Test Voltage	AC 120V/60Hz

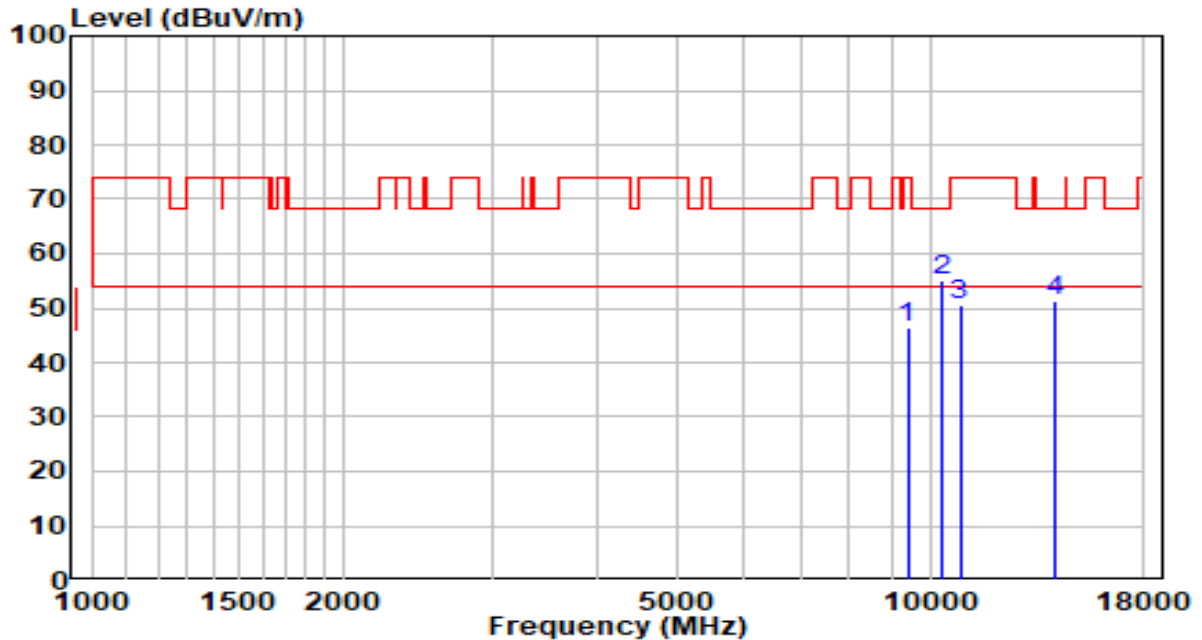

No	Frequency (MHz)	Reading (dB $\mu$ V)	C.F (dB/m)	Measurement (dB $\mu$ V/m)	Margin (dB)	Limit (dB $\mu$ V/m)	Remark (QP/PK/AV)
1	9398.000	31.01	15.55	46.56	-27.44	74.00	Peak
2	* 10316.000	37.15	17.83	54.98	-13.22	68.20	Peak
3	10851.500	31.60	19.07	50.67	-23.33	74.00	Peak
4	14141.000	28.80	22.43	51.23	-16.97	68.20	Peak

Note:

1. " \*", means this data is the worst emission level.
2. C.F (Correction Factor) = Antenna Factor (dB/m)+ Cable Loss (dB)– Preamplifier(dB).
3. Measurement(dB $\mu$ V/m) = Reading(dB $\mu$ V) + C.F (Correction Factor).



EUT	HAN Access Point	Date of Test	2021-11-13
Factor	BBHA 9120D (1GHz~18GHz)	Temp. / Humidity	23°C/53%
Polarity	Horizontal	Site / Test Engineer	AC1 / Tim
Test Mode	Transmit at 5240MHz by 802.11a	Test Voltage	AC 120V/60Hz

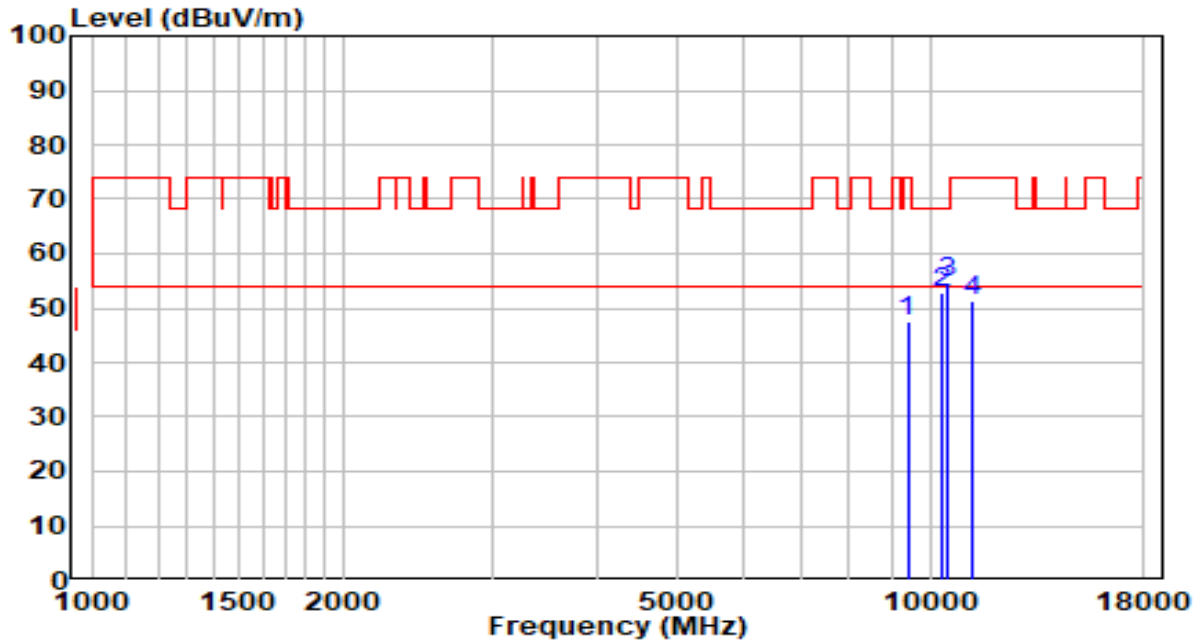

No	Frequency (MHz)	Reading (dB $\mu$ V)	C.F (dB/m)	Measurement (dB $\mu$ V/m)	Margin (dB)	Limit (dB $\mu$ V/m)	Remark (QP/PK/AV)
1	9398.000	31.96	15.55	47.51	-26.49	74.00	Peak
2	10316.000	35.00	17.83	52.83	-15.37	68.20	Peak
3	* 10477.500	36.22	18.48	54.70	-13.50	68.20	Peak
4	11217.000	31.83	19.61	51.45	-22.55	74.00	Peak

Note:

1. " \*", means this data is the worst emission level.
2. C.F (Correction Factor) = Antenna Factor (dB/m)+ Cable Loss (dB)– Preamplifier(dB).
3. Measurement(dB $\mu$ V/m) = Reading(dB $\mu$ V) + C.F (Correction Factor).

EUT	HAN Access Point	Date of Test	2021-11-13
Factor	BBHA 9120D (1GHz~18GHz)	Temp. / Humidity	23°C/53%
Polarity	Vertical	Site / Test Engineer	AC1 / Tim
Test Mode	Transmit at 5240MHz by 802.11a	Test Voltage	AC 120V/60Hz

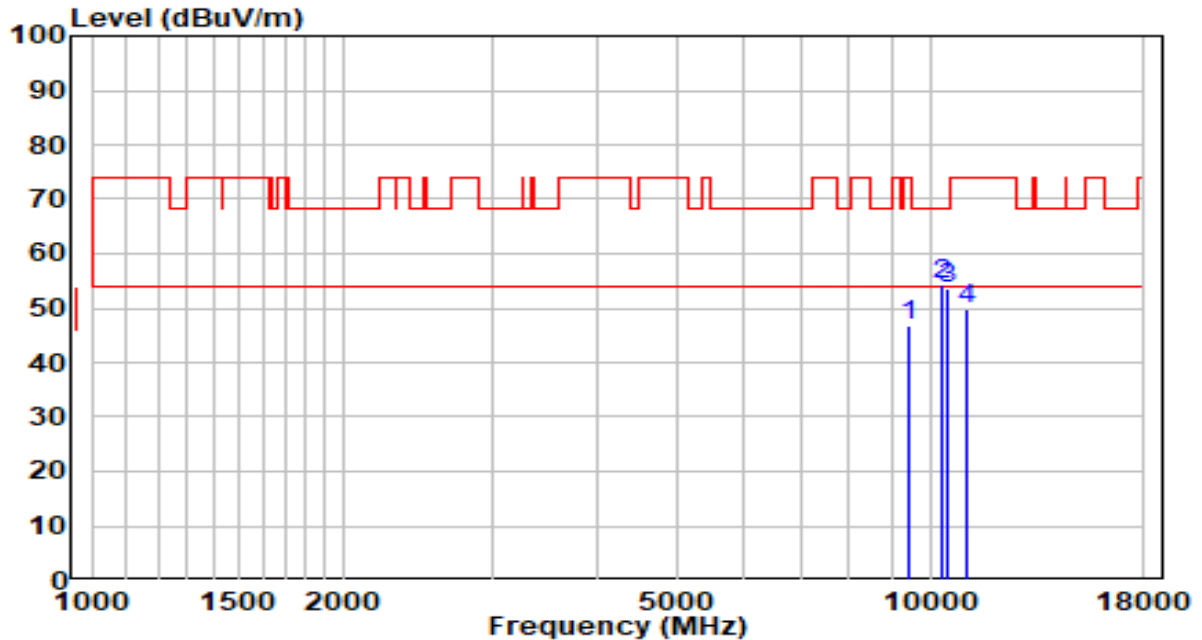

No	Frequency (MHz)	Reading (dB $\mu$ V)	C.F (dB/m)	Measurement (dB $\mu$ V/m)	Margin (dB)	Limit (dB $\mu$ V/m)	Remark (QP/PK/AV)
1	9415.000	31.27	15.58	46.85	-27.15	74.00	Peak
2	* 10316.000	36.43	17.83	54.26	-13.94	68.20	Peak
3	10477.500	35.06	18.48	53.54	-14.66	68.20	Peak
4	11047.000	30.48	19.35	49.83	-24.17	74.00	Peak

Note:

1. " \*", means this data is the worst emission level.
2. C.F (Correction Factor) = Antenna Factor (dB/m)+ Cable Loss (dB)– Preamplifier(dB).
3. Measurement(dB $\mu$ V/m) = Reading(dB $\mu$ V) + C.F (Correction Factor).

EUT	HAN Access Point	Date of Test	2021-11-13
Factor	BBHA 9120D (1GHz~18GHz)	Temp. / Humidity	23°C/53%
Polarity	Horizontal	Site / Test Engineer	AC1 / Tim
Test Mode	Transmit at 5745MHz by 802.11a	Test Voltage	AC 120V/60Hz

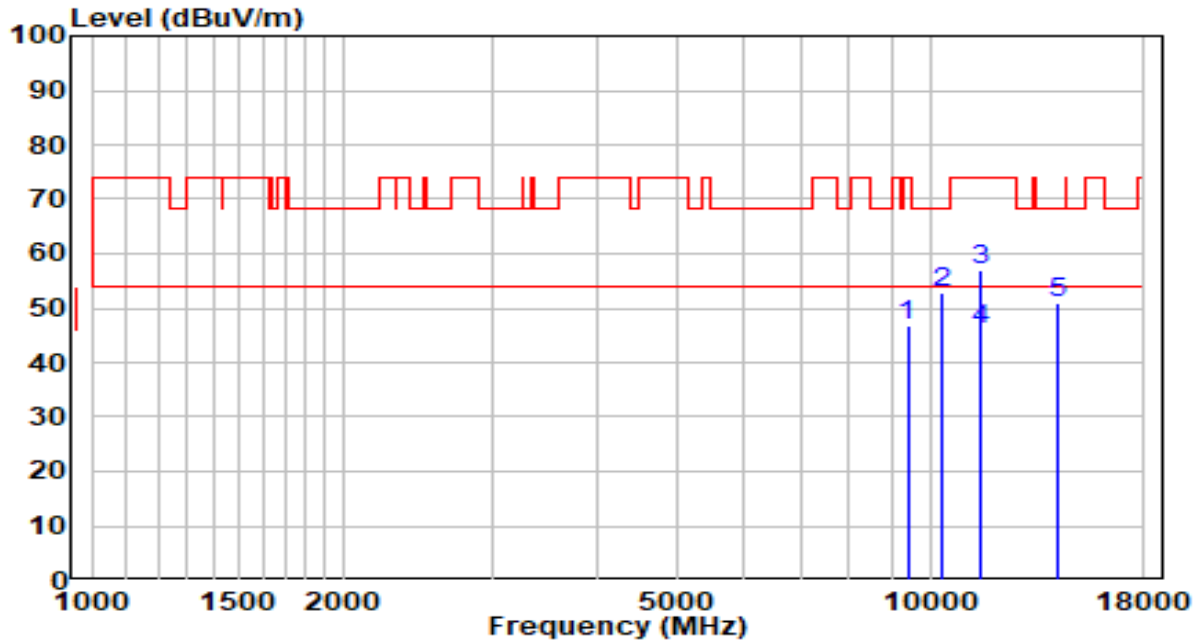

No	Frequency (MHz)	Reading (dB $\mu$ V)	C.F (dB/m)	Measurement (dB $\mu$ V/m)	Margin (dB)	Limit (dB $\mu$ V/m)	Remark (QP/PK/AV)
1	9398.000	31.09	15.55	46.64	-27.36	74.00	Peak
2	10316.000	34.92	17.83	52.75	-15.45	68.20	Peak
3	11489.000	36.82	20.03	56.85	-17.15	74.00	Peak
4	* 11489.000	25.94	20.03	45.98	-8.02	54.00	Average
5	14243.000	28.61	22.44	51.04	-17.16	68.20	Peak

Note:

1. " \*", means this data is the worst emission level.
2. C.F (Correction Factor) = Antenna Factor (dB/m)+ Cable Loss (dB)– Preamplifier(dB).
3. Measurement(dB $\mu$ V/m) = Reading(dB $\mu$ V) + C.F (Correction Factor).

EUT	HAN Access Point	Date of Test	2021-11-13
Factor	BBHA 9120D (1GHz~18GHz)	Temp. / Humidity	23°C/53%
Polarity	Vertical	Site / Test Engineer	AC1 / Tim
Test Mode	Transmit at 5745MHz by 802.11a	Test Voltage	AC 120V/60Hz

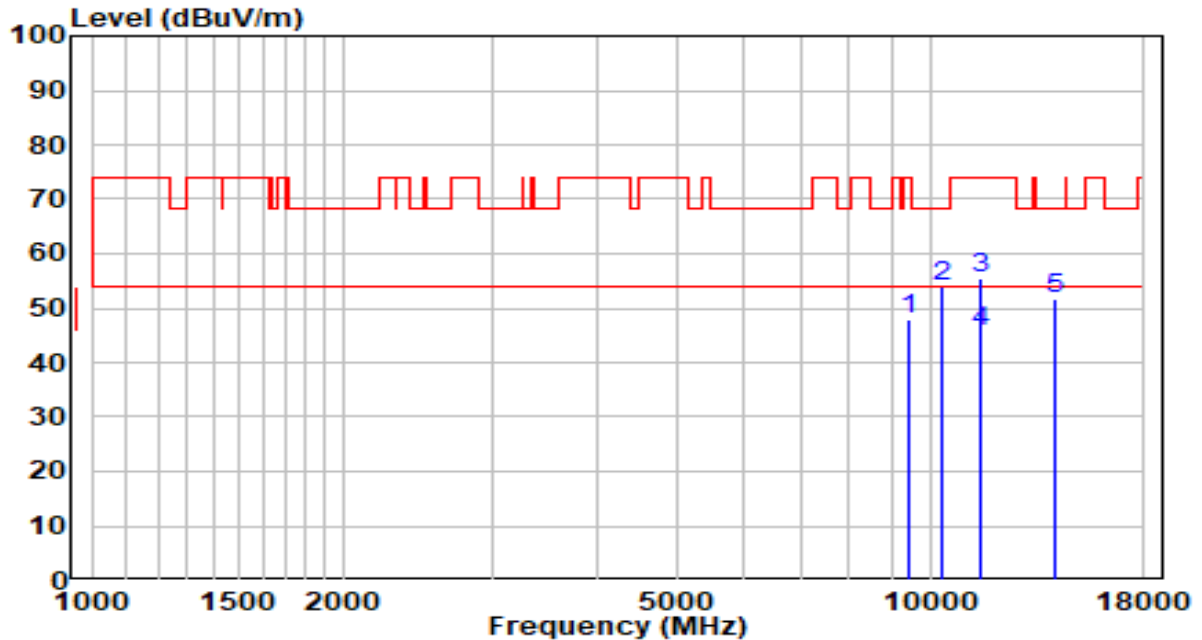

No	Frequency (MHz)	Reading (dB $\mu$ V)	C.F (dB/m)	Measurement (dB $\mu$ V/m)	Margin (dB)	Limit (dB $\mu$ V/m)	Remark (QP/PK/AV)
1	9440.500	32.35	15.62	47.97	-26.03	74.00	Peak
2	10316.000	35.96	17.83	53.79	-14.41	68.20	Peak
3	11497.500	35.39	20.05	55.44	-18.56	74.00	Peak
4	* 11497.500	25.45	20.05	45.50	-8.51	54.00	Average
5	14141.000	29.27	22.43	51.70	-16.50	68.20	Peak

Note:

1. " \*", means this data is the worst emission level.
2. C.F (Correction Factor) = Antenna Factor (dB/m)+ Cable Loss (dB)– Preamplifier(dB).
3. Measurement(dB $\mu$ V/m) = Reading(dB $\mu$ V) + C.F (Correction Factor).

EUT	HAN Access Point	Date of Test	2021-11-13
Factor	BBHA 9120D (1GHz~18GHz)	Temp. / Humidity	23°C/53%
Polarity	Horizontal	Site / Test Engineer	AC1 / Tim
Test Mode	Transmit at 5785MHz by 802.11a	Test Voltage	AC 120V/60Hz

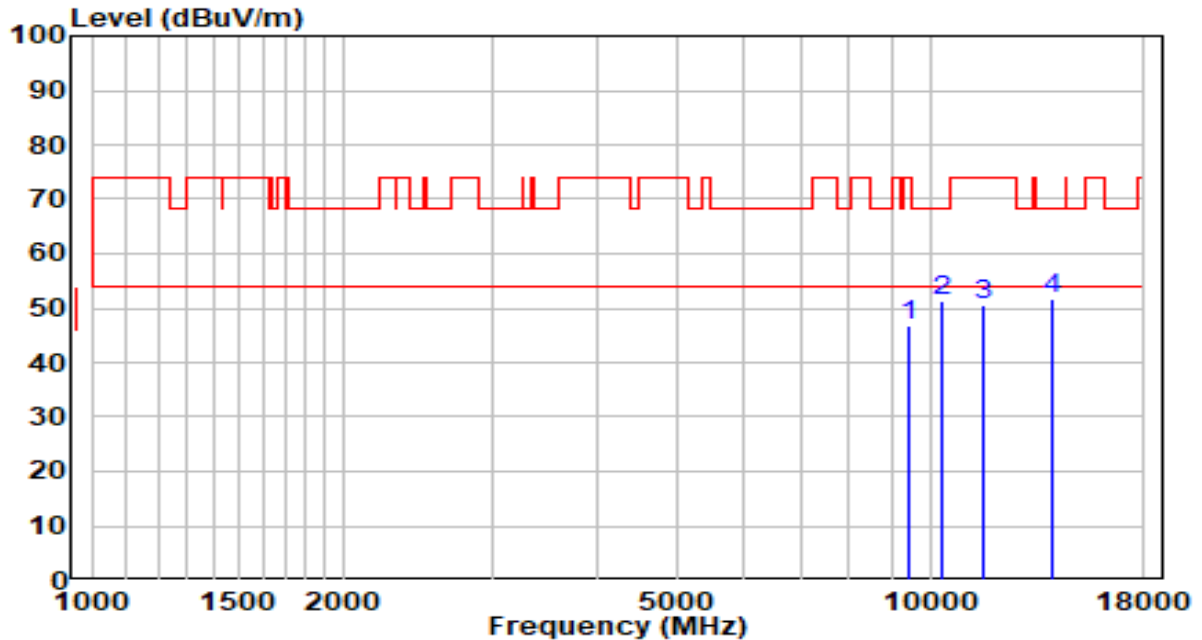

No	Frequency (MHz)	Reading (dB $\mu$ V)	C.F (dB/m)	Measurement (dB $\mu$ V/m)	Margin (dB)	Limit (dB $\mu$ V/m)	Remark (QP/PK/AV)
1	9440.500	31.20	15.62	46.82	-27.18	74.00	Peak
2	10316.000	33.44	17.83	51.27	-16.93	68.20	Peak
3	11565.500	30.71	19.90	50.61	-23.39	74.00	Peak
4	* 13971.000	29.37	22.39	51.76	-16.44	68.20	Peak

Note:

1. " \*", means this data is the worst emission level.
2. C.F (Correction Factor) = Antenna Factor (dB/m)+ Cable Loss (dB)– Preamplifier(dB).
3. Measurement(dB $\mu$ V/m) = Reading(dB $\mu$ V) + C.F (Correction Factor).

EUT	HAN Access Point	Date of Test	2021-11-13
Factor	BBHA 9120D (1GHz~18GHz)	Temp. / Humidity	23°C/53%
Polarity	Vertical	Site / Test Engineer	AC1 / Tim
Test Mode	Transmit at 5785MHz by 802.11a	Test Voltage	AC 120V/60Hz

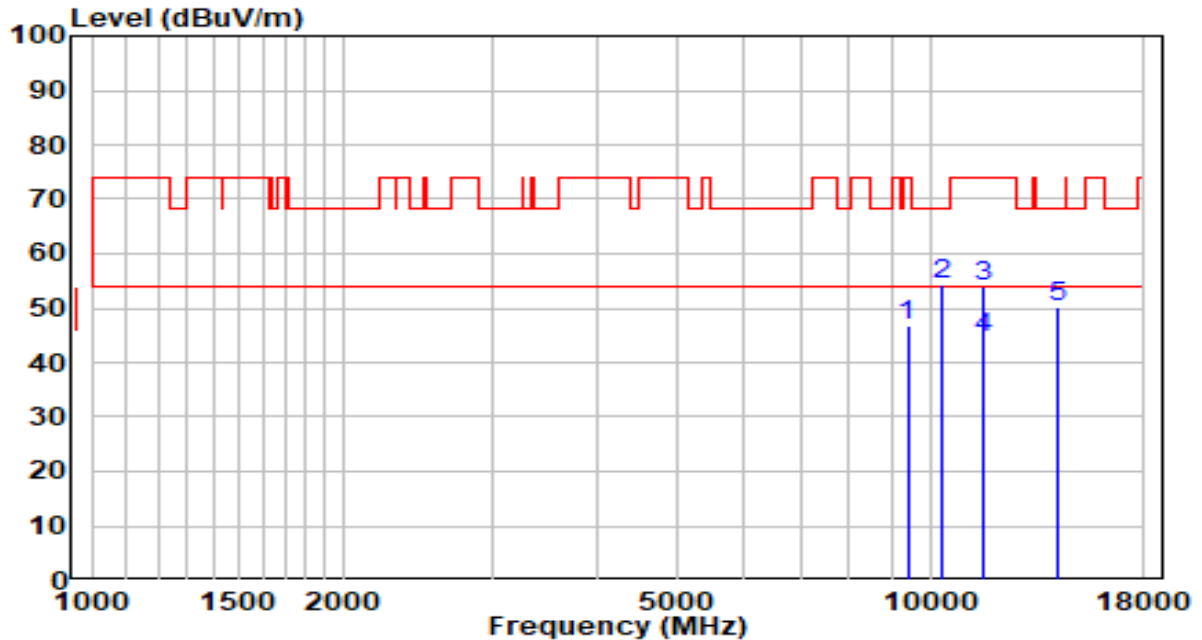

No	Frequency (MHz)	Reading (dB $\mu$ V)	C.F (dB/m)	Measurement (dB $\mu$ V/m)	Margin (dB)	Limit (dB $\mu$ V/m)	Remark (QP/PK/AV)
1	9398.000	31.43	15.55	46.98	-27.02	74.00	Peak
2	10316.000	36.59	17.83	54.42	-13.78	68.20	Peak
3	11565.500	33.94	19.90	53.84	-20.16	74.00	Peak
4	* 11565.500	24.62	19.90	44.52	-9.48	54.00	Average
5	14217.500	27.88	22.44	50.32	-17.88	68.20	Peak

Note:

1. " \*", means this data is the worst emission level.
2. C.F (Correction Factor) = Antenna Factor (dB/m)+ Cable Loss (dB)– Preamplifier(dB).
3. Measurement(dB $\mu$ V/m) = Reading(dB $\mu$ V) + C.F (Correction Factor).

EUT	HAN Access Point	Date of Test	2021-11-13
Factor	BBHA 9120D (1GHz~18GHz)	Temp. / Humidity	23°C/53%
Polarity	Horizontal	Site / Test Engineer	AC1 / Tim
Test Mode	Transmit at 5825MHz by 802.11a	Test Voltage	AC 120V/60Hz

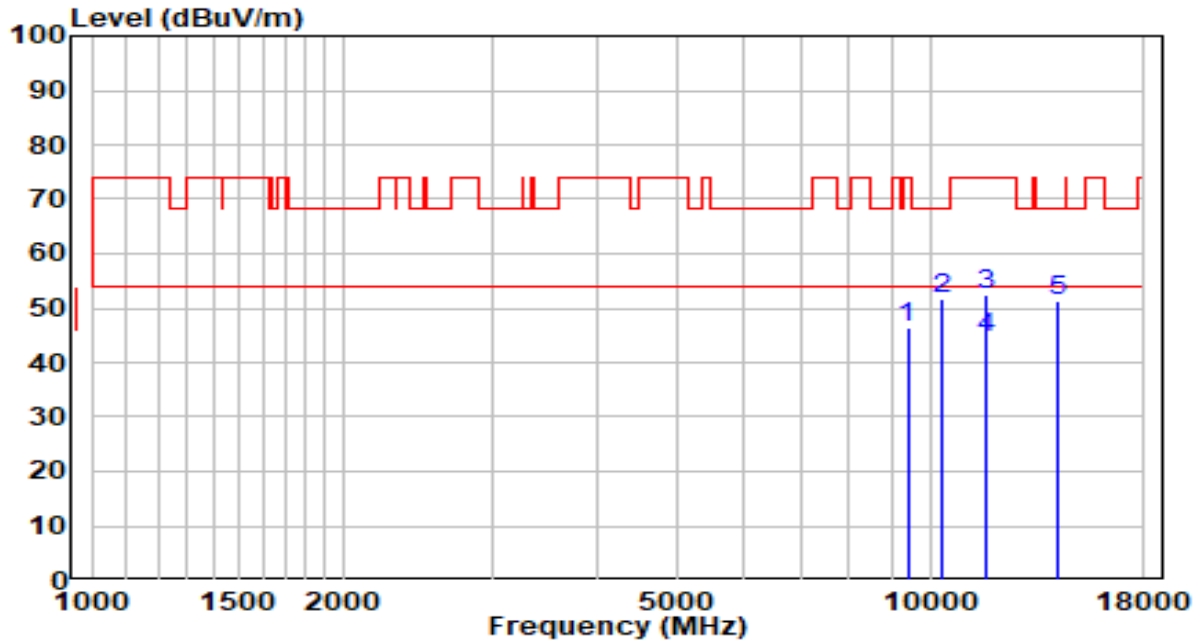

No	Frequency (MHz)	Reading (dB $\mu$ V)	C.F (dB/m)	Measurement (dB $\mu$ V/m)	Margin (dB)	Limit (dB $\mu$ V/m)	Remark (QP/PK/AV)
1	9398.000	31.00	15.55	46.55	-27.45	74.00	Peak
2	10316.000	34.02	17.83	51.85	-16.35	68.20	Peak
3	11650.500	32.62	19.71	52.33	-21.67	74.00	Peak
4	* 11650.500	24.63	19.71	44.34	-9.66	54.00	Average
5	14175.000	28.97	22.43	51.40	-16.80	68.20	Peak

Note:

1. " \*", means this data is the worst emission level.
2. C.F (Correction Factor) = Antenna Factor (dB/m)+ Cable Loss (dB)– Preamplifier(dB).
3. Measurement(dB $\mu$ V/m) = Reading(dB $\mu$ V) + C.F (Correction Factor).

EUT	HAN Access Point	Date of Test	2021-11-13
Factor	BBHA 9120D (1GHz~18GHz)	Temp. / Humidity	23°C/53%
Polarity	Vertical	Site / Test Engineer	AC1 / Tim
Test Mode	Transmit at 5825MHz by 802.11a	Test Voltage	AC 120V/60Hz

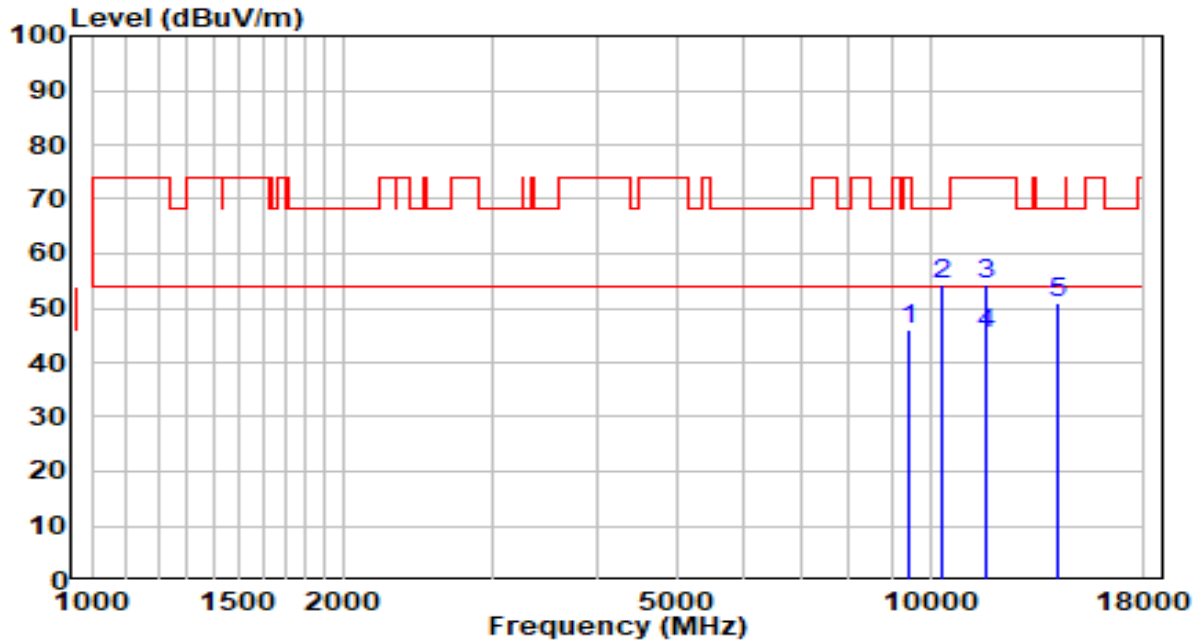

No	Frequency (MHz)	Reading (dB $\mu$ V)	C.F (dB/m)	Measurement (dB $\mu$ V/m)	Margin (dB)	Limit (dB $\mu$ V/m)	Remark (QP/PK/AV)
1	9415.000	30.64	15.58	46.21	-27.79	74.00	Peak
2	10316.000	36.50	17.83	54.33	-13.87	68.20	Peak
3	11642.000	34.45	19.73	54.18	-19.82	74.00	Peak
4	* 11642.000	25.70	19.73	45.43	-8.57	54.00	Average
5	14158.000	28.61	22.43	51.04	-17.16	68.20	Peak

Note:

1. " \*", means this data is the worst emission level.
2. C.F (Correction Factor) = Antenna Factor (dB/m)+ Cable Loss (dB)– Preamplifier(dB).
3. Measurement(dB $\mu$ V/m) = Reading(dB $\mu$ V) + C.F (Correction Factor).



EUT	HAN Access Point	Date of Test	2021-11-13
Factor	BBHA 9120D (1GHz~18GHz)	Temp. / Humidity	23°C/53%
Polarity	Horizontal	Site / Test Engineer	AC1 / Tim
Test Mode	Transmit at 5180MHz by 802.11ac-VHT20	Test Voltage	AC 120V/60Hz

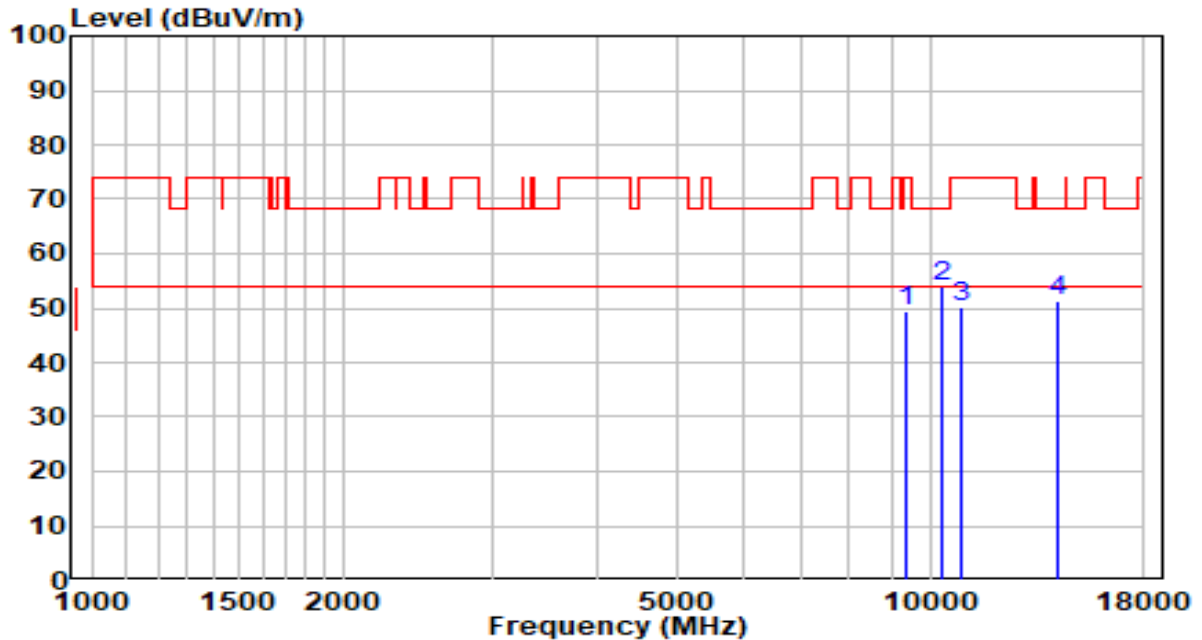

No	Frequency (MHz)	Reading (dB $\mu$ V)	C.F (dB/m)	Measurement (dB $\mu$ V/m)	Margin (dB)	Limit (dB $\mu$ V/m)	Remark (QP/PK/AV)
1	9364.000	33.81	15.49	49.30	-24.70	74.00	Peak
2	* 10316.000	36.05	17.83	53.88	-14.32	68.20	Peak
3	10919.500	31.02	19.17	50.19	-23.81	74.00	Peak
4	14149.500	29.01	22.43	51.44	-16.76	68.20	Peak

Note:

1. " \*", means this data is the worst emission level.
2. C.F (Correction Factor) = Antenna Factor (dB/m)+ Cable Loss (dB)– Preamplifier(dB).
3. Measurement(dB $\mu$ V/m) = Reading(dB $\mu$ V) + C.F (Correction Factor).

EUT	HAN Access Point	Date of Test	2021-11-13
Factor	BBHA 9120D (1GHz~18GHz)	Temp. / Humidity	23°C/53%
Polarity	Vertical	Site / Test Engineer	AC1 / Tim
Test Mode	Transmit at 5180MHz by 802.11ac-VHT20	Test Voltage	AC 120V/60Hz

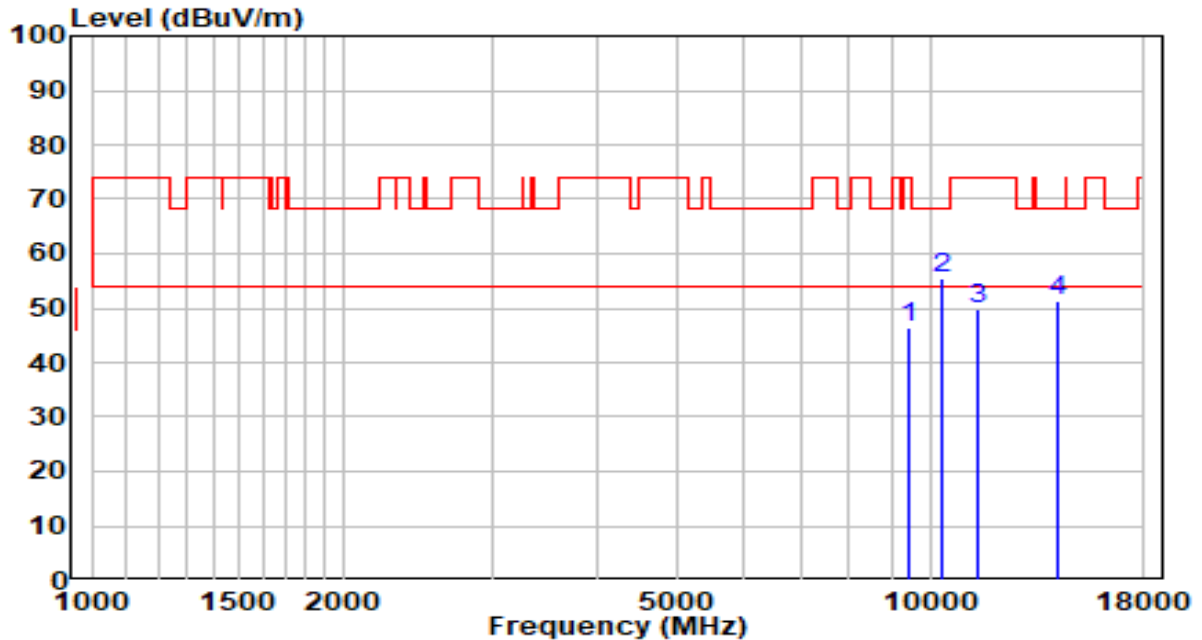

No	Frequency (MHz)	Reading (dB $\mu$ V)	C.F (dB/m)	Measurement (dB $\mu$ V/m)	Margin (dB)	Limit (dB $\mu$ V/m)	Remark (QP/PK/AV)
1	9440.500	30.66	15.62	46.28	-27.72	74.00	Peak
2	* 10316.000	37.47	17.83	55.30	-12.90	68.20	Peak
3	11421.000	29.76	19.93	49.68	-24.32	74.00	Peak
4	14166.500	28.74	22.43	51.17	-17.03	68.20	Peak

Note:

1. " \*", means this data is the worst emission level.
2. C.F (Correction Factor) = Antenna Factor (dB/m)+ Cable Loss (dB)– Preamplifier(dB).
3. Measurement(dB $\mu$ V/m) = Reading(dB $\mu$ V) + C.F (Correction Factor).

EUT	HAN Access Point	Date of Test	2021-11-13
Factor	BBHA 9120D (1GHz~18GHz)	Temp. / Humidity	23°C/53%
Polarity	Horizontal	Site / Test Engineer	AC1 / Tim
Test Mode	Transmit at 5220MHz by 802.11ac-VHT20	Test Voltage	AC 120V/60Hz

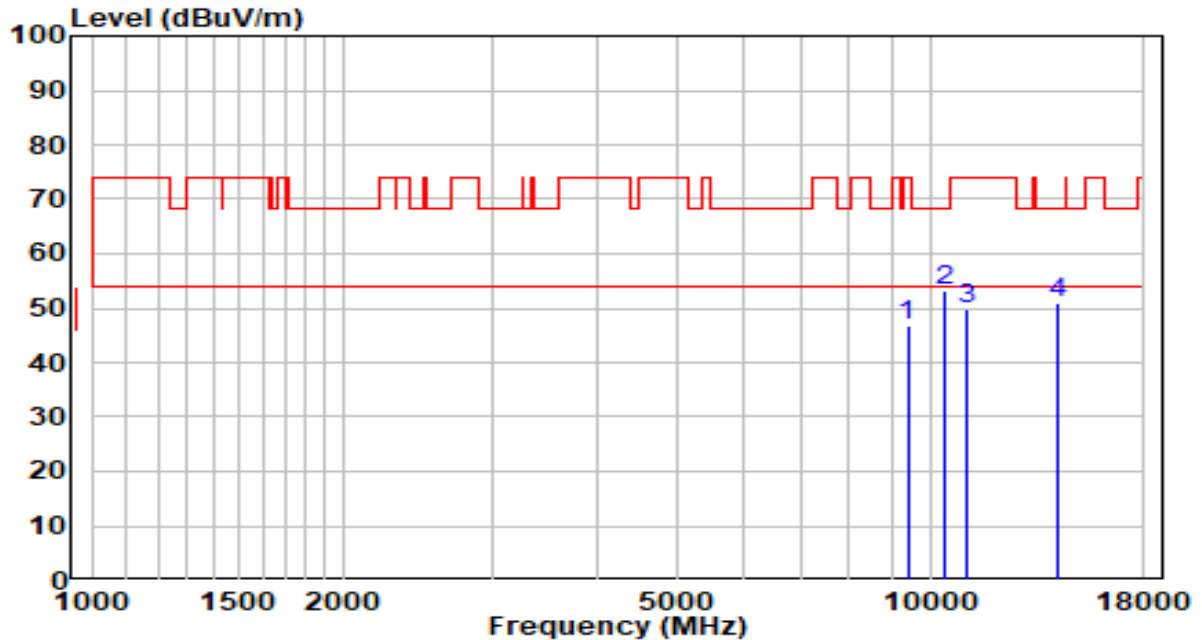

No	Frequency (MHz)	Reading (dB $\mu$ V)	C.F (dB/m)	Measurement (dB $\mu$ V/m)	Margin (dB)	Limit (dB $\mu$ V/m)	Remark (QP/PK/AV)
1	9398.000	31.11	15.55	46.66	-27.34	74.00	Peak
2	* 10443.500	34.71	18.34	53.06	-15.14	68.20	Peak
3	11055.500	30.59	19.37	49.95	-24.05	74.00	Peak
4	14149.500	28.62	22.43	51.05	-17.15	68.20	Peak

Note:

1. " \*", means this data is the worst emission level.
2. C.F (Correction Factor) = Antenna Factor (dB/m)+ Cable Loss (dB)– Preamplifier(dB).
3. Measurement(dB $\mu$ V/m) = Reading(dB $\mu$ V) + C.F (Correction Factor).

EUT	HAN Access Point	Date of Test	2021-11-13
Factor	BBHA 9120D (1GHz~18GHz)	Temp. / Humidity	23°C/53%
Polarity	Vertical	Site / Test Engineer	AC1 / Tim
Test Mode	Transmit at 5220MHz by 802.11ac-VHT20	Test Voltage	AC 120V/60Hz

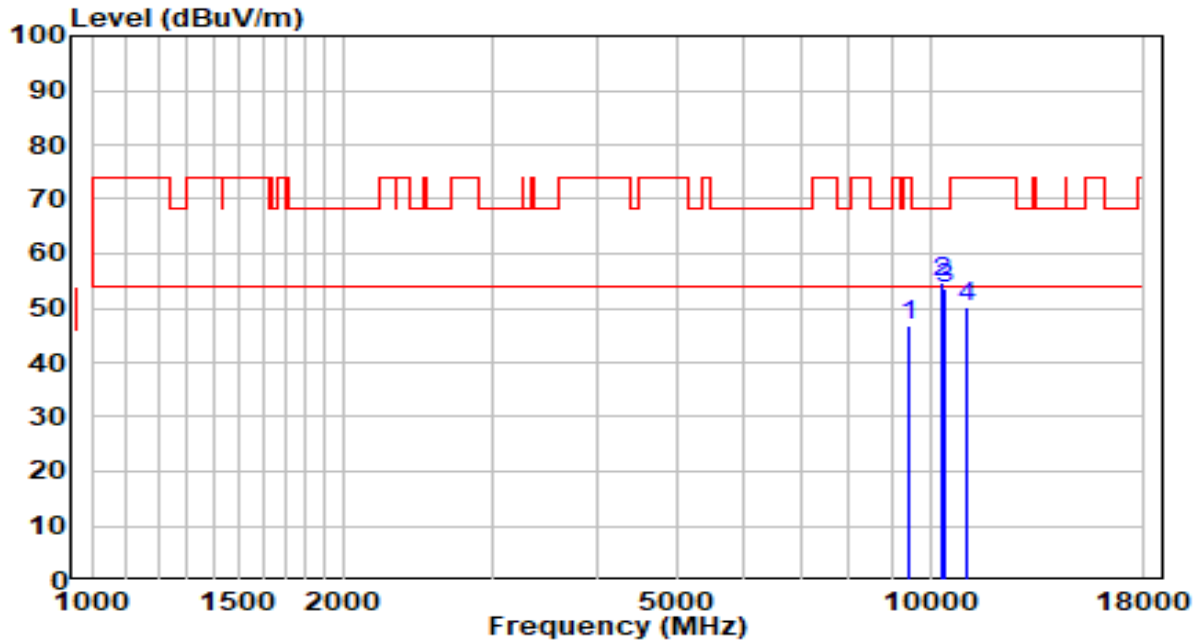

No	Frequency (MHz)	Reading (dB $\mu$ V)	C.F (dB/m)	Measurement (dB $\mu$ V/m)	Margin (dB)	Limit (dB $\mu$ V/m)	Remark (QP/PK/AV)
1	9415.000	31.03	15.58	46.61	-27.39	74.00	Peak
2	* 10316.000	36.94	17.83	54.77	-13.43	68.20	Peak
3	10443.500	35.23	18.34	53.57	-14.63	68.20	Peak
4	11030.000	31.01	19.33	50.33	-23.67	74.00	Peak

Note:

1. " \*", means this data is the worst emission level.
2. C.F (Correction Factor) = Antenna Factor (dB/m)+ Cable Loss (dB)– Preamplifier(dB).
3. Measurement(dB $\mu$ V/m) = Reading(dB $\mu$ V) + C.F (Correction Factor).

EUT	HAN Access Point	Date of Test	2021-11-13
Factor	BBHA 9120D (1GHz~18GHz)	Temp. / Humidity	23°C/53%
Polarity	Horizontal	Site / Test Engineer	AC1 / Tim
Test Mode	Transmit at 5240MHz by 802.11ac-VHT20	Test Voltage	AC 120V/60Hz

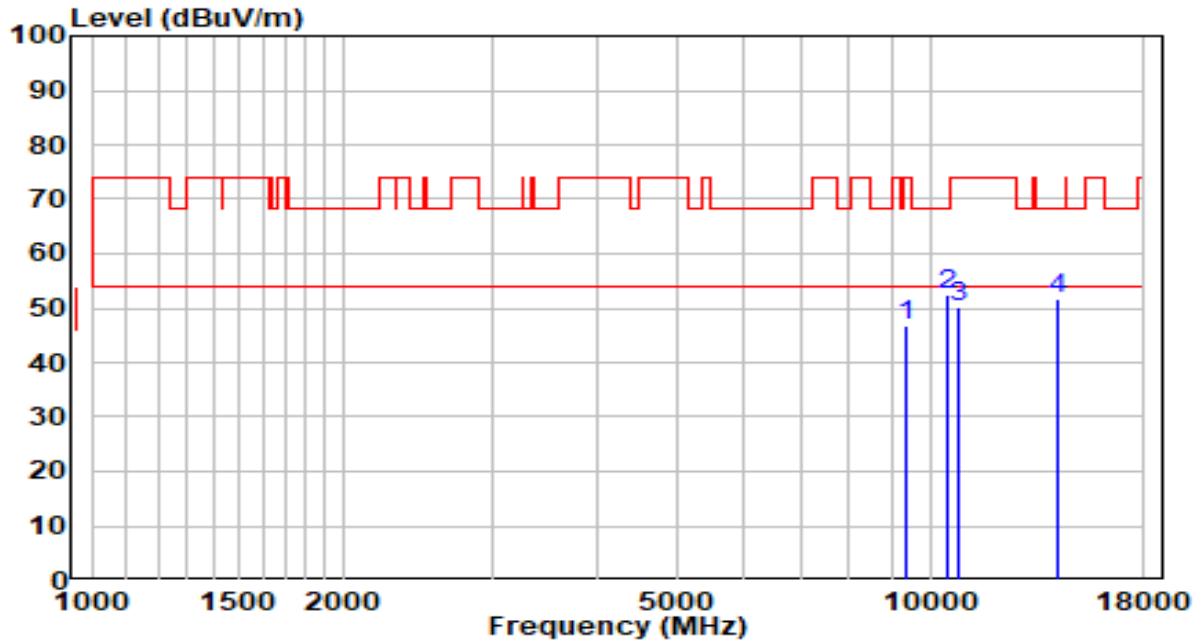

No	Frequency (MHz)	Reading (dB $\mu$ V)	C.F (dB/m)	Measurement (dB $\mu$ V/m)	Margin (dB)	Limit (dB $\mu$ V/m)	Remark (QP/PK/AV)
1	9381.000	31.41	15.52	46.93	-27.07	74.00	Peak
2	* 10477.500	33.80	18.48	52.28	-15.92	68.20	Peak
3	10826.000	30.98	19.03	50.01	-23.99	74.00	Peak
4	14217.500	29.23	22.44	51.66	-16.54	68.20	Peak

Note:

1. " \*", means this data is the worst emission level.
2. C.F (Correction Factor) = Antenna Factor (dB/m)+ Cable Loss (dB)– Preamplifier(dB).
3. Measurement(dB $\mu$ V/m) = Reading(dB $\mu$ V) + C.F (Correction Factor).

EUT	HAN Access Point	Date of Test	2021-11-13
Factor	BBHA 9120D (1GHz~18GHz)	Temp. / Humidity	23°C/53%
Polarity	Vertical	Site / Test Engineer	AC1 / Tim
Test Mode	Transmit at 5240MHz by 802.11ac-VHT20	Test Voltage	AC 120V/60Hz

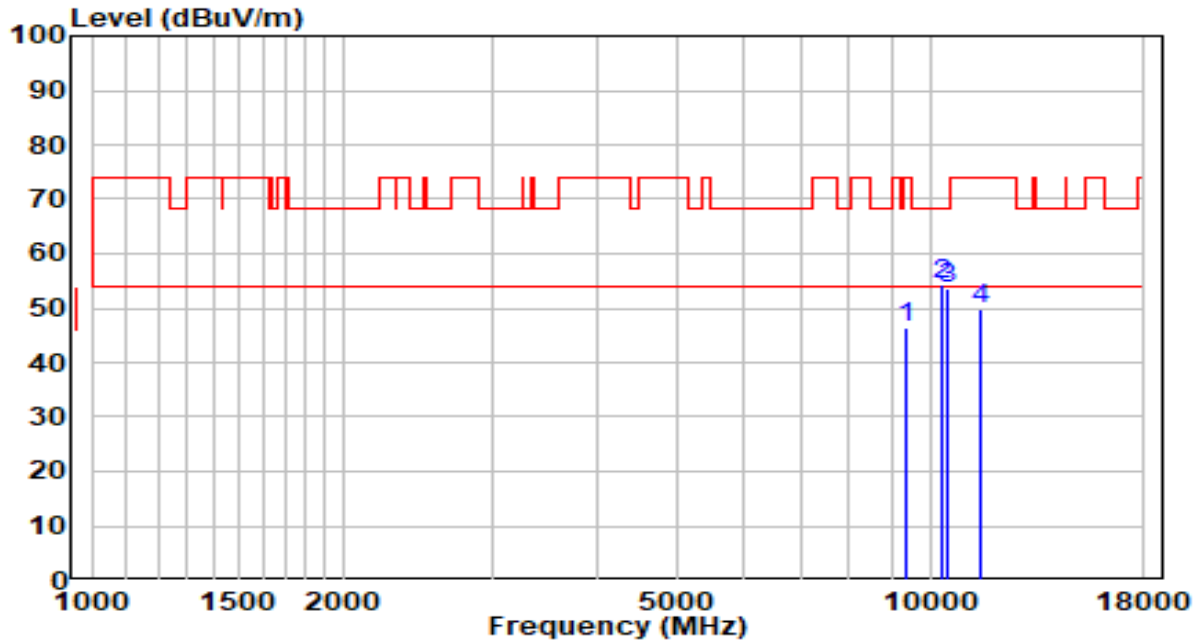

No	Frequency (MHz)	Reading (dB $\mu$ V)	C.F (dB/m)	Measurement (dB $\mu$ V/m)	Margin (dB)	Limit (dB $\mu$ V/m)	Remark (QP/PK/AV)
1	9381.000	31.01	15.52	46.53	-27.47	74.00	Peak
2	* 10316.000	36.60	17.83	54.43	-13.77	68.20	Peak
3	10477.500	35.06	18.48	53.54	-14.66	68.20	Peak
4	11523.000	29.82	20.00	49.82	-24.18	74.00	Peak

Note:

1. " \*", means this data is the worst emission level.
2. C.F (Correction Factor) = Antenna Factor (dB/m)+ Cable Loss (dB)– Preamplifier(dB).
3. Measurement(dB $\mu$ V/m) = Reading(dB $\mu$ V) + C.F (Correction Factor).

EUT	HAN Access Point	Date of Test	2021-11-13
Factor	BBHA 9120D (1GHz~18GHz)	Temp. / Humidity	23°C/53%
Polarity	Horizontal	Site / Test Engineer	AC1 / Tim
Test Mode	Transmit at 5745MHz by 802.11ac-VHT20	Test Voltage	AC 120V/60Hz

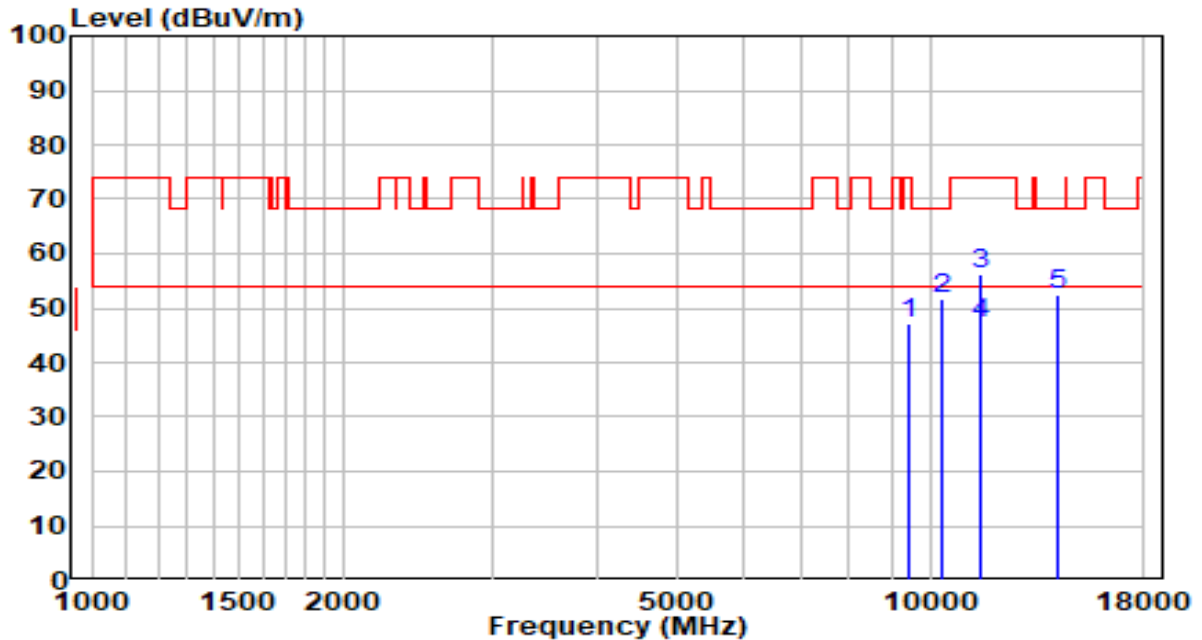

No	Frequency (MHz)	Reading (dB $\mu$ V)	C.F (dB/m)	Measurement (dB $\mu$ V/m)	Margin (dB)	Limit (dB $\mu$ V/m)	Remark (QP/PK/AV)
1	9415.000	31.61	15.58	47.19	-26.81	74.00	Peak
2	10316.000	33.86	17.83	51.69	-16.51	68.20	Peak
3	11489.000	36.25	20.03	56.28	-17.72	74.00	Peak
4	* 11489.000	27.02	20.03	47.06	-6.94	54.00	Average
5	14183.500	29.90	22.43	52.33	-15.87	68.20	Peak

Note:

1. " \*", means this data is the worst emission level.
2. C.F (Correction Factor) = Antenna Factor (dB/m)+ Cable Loss (dB)– Preamplifier(dB).
3. Measurement(dB $\mu$ V/m) = Reading(dB $\mu$ V) + C.F (Correction Factor).

EUT	HAN Access Point	Date of Test	2021-11-13
Factor	BBHA 9120D (1GHz~18GHz)	Temp. / Humidity	23°C/53%
Polarity	Vertical	Site / Test Engineer	AC1 / Tim
Test Mode	Transmit at 5745MHz by 802.11ac-VHT20	Test Voltage	AC 120V/60Hz

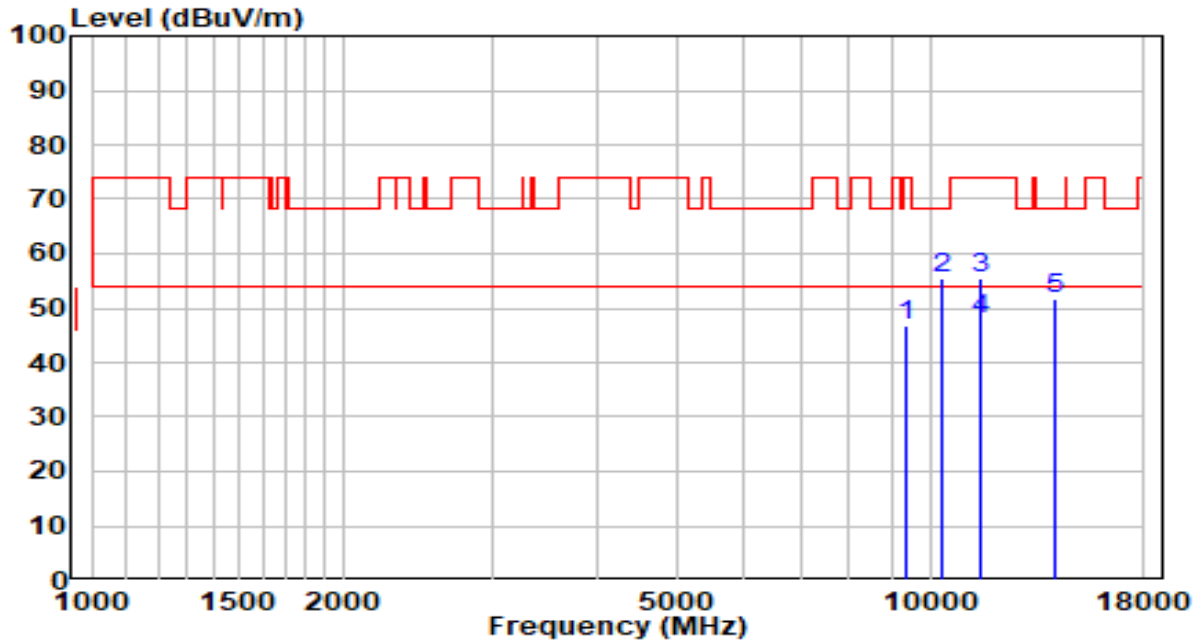

No	Frequency (MHz)	Reading (dB $\mu$ V)	C.F (dB/m)	Measurement (dB $\mu$ V/m)	Margin (dB)	Limit (dB $\mu$ V/m)	Remark (QP/PK/AV)
1	9381.000	31.19	15.52	46.71	-27.29	74.00	Peak
2	10316.000	37.73	17.83	55.57	-12.63	68.20	Peak
3	11489.000	35.47	20.03	55.51	-18.49	74.00	Peak
4	* 11489.000	27.72	20.03	47.76	-6.24	54.00	Average
5	14132.500	29.10	22.43	51.53	-16.67	68.20	Peak

Note:

1. " \*", means this data is the worst emission level.
2. C.F (Correction Factor) = Antenna Factor (dB/m)+ Cable Loss (dB)– Preamplifier(dB).
3. Measurement(dB $\mu$ V/m) = Reading(dB $\mu$ V) + C.F (Correction Factor).



EUT	HAN Access Point	Date of Test	2021-11-13
Factor	BBHA 9120D (1GHz~18GHz)	Temp. / Humidity	23°C/53%
Polarity	Horizontal	Site / Test Engineer	AC1 / Tim
Test Mode	Transmit at 5785MHz by 802.11ac-VHT20	Test Voltage	AC 120V/60Hz

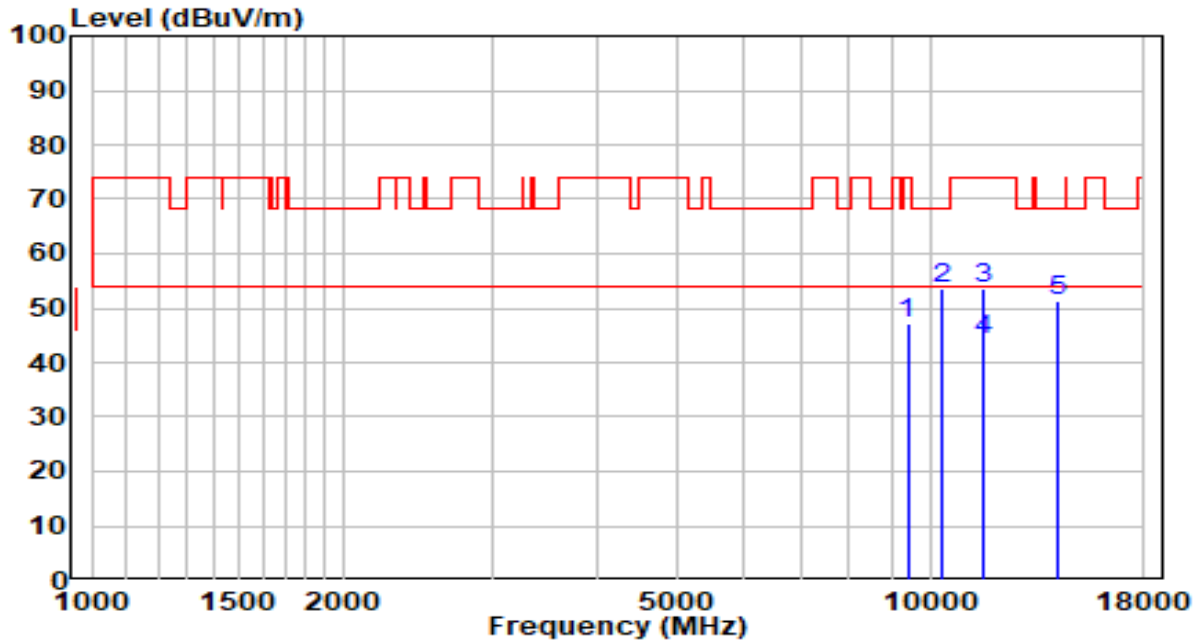

No	Frequency (MHz)	Reading (dB $\mu$ V)	C.F (dB/m)	Measurement (dB $\mu$ V/m)	Margin (dB)	Limit (dB $\mu$ V/m)	Remark (QP/PK/AV)
1	9398.000	31.77	15.55	47.32	-26.68	74.00	Peak
2	10316.000	35.75	17.83	53.58	-14.62	68.20	Peak
3	11574.000	33.84	19.88	53.72	-20.28	74.00	Peak
4	* 11574.000	24.32	19.88	44.20	-9.80	54.00	Average
5	14166.500	28.85	22.43	51.28	-16.92	68.20	Peak

Note:

1. " \*", means this data is the worst emission level.
2. C.F (Correction Factor) = Antenna Factor (dB/m)+ Cable Loss (dB)– Preamplifier(dB).
3. Measurement(dB $\mu$ V/m) = Reading(dB $\mu$ V) + C.F (Correction Factor).

EUT	HAN Access Point	Date of Test	2021-11-13
Factor	BBHA 9120D (1GHz~18GHz)	Temp. / Humidity	23°C/53%
Polarity	Vertical	Site / Test Engineer	AC1 / Tim
Test Mode	Transmit at 5785MHz by 802.11ac-VHT20	Test Voltage	AC 120V/60Hz

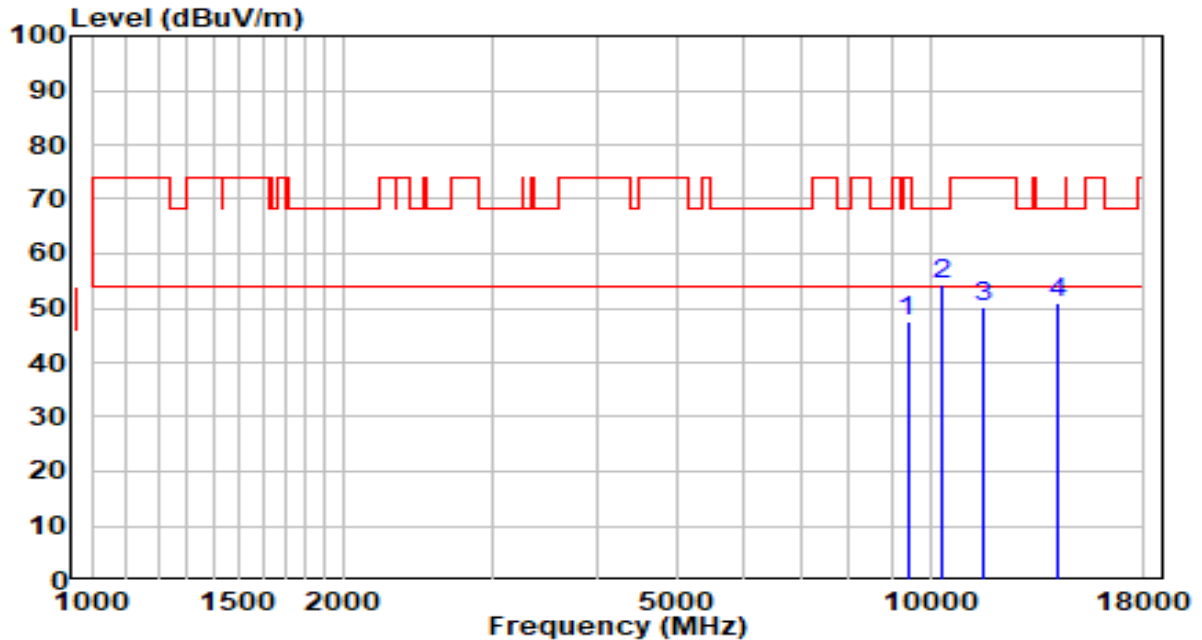

No	Frequency (MHz)	Reading (dBμV)	C.F (dB/m)	Measurement (dBμV/m)	Margin (dB)	Limit (dBμV/m)	Remark (QP/PK/AV)
1	9398.000	31.84	15.55	47.39	-26.61	74.00	Peak
2	* 10316.000	36.60	17.83	54.43	-13.77	68.20	Peak
3	11574.000	30.37	19.88	50.26	-23.74	74.00	Peak
4	14175.000	28.45	22.43	50.88	-17.32	68.20	Peak

Note:

1. " \*", means this data is the worst emission level.
2. C.F (Correction Factor) = Antenna Factor (dB/m)+ Cable Loss (dB)– Preamplifier(dB).
3. Measurement(dBμV/m) = Reading(dBμV) + C.F (Correction Factor).

EUT	HAN Access Point	Date of Test	2021-11-13
Factor	BBHA 9120D (1GHz~18GHz)	Temp. / Humidity	23°C/53%
Polarity	Horizontal	Site / Test Engineer	AC1 / Tim
Test Mode	Transmit at 5825MHz by 802.11ac-VHT20	Test Voltage	AC 120V/60Hz

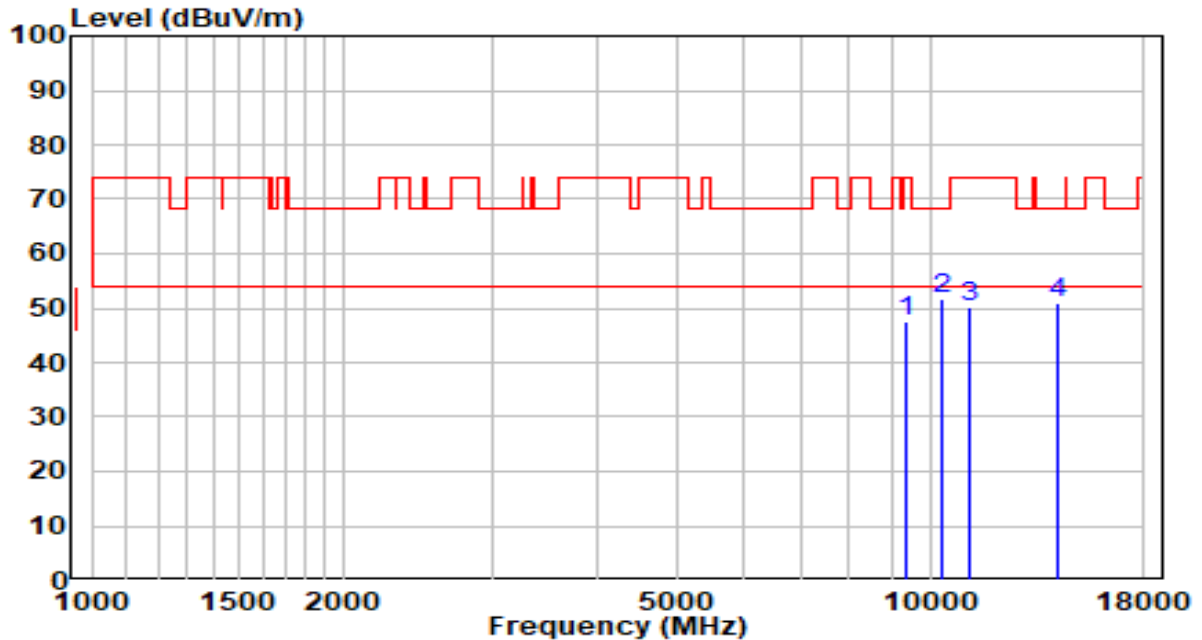

No	Frequency (MHz)	Reading (dBμV)	C.F (dB/m)	Measurement (dBμV/m)	Margin (dB)	Limit (dBμV/m)	Remark (QP/PK/AV)
1	9381.000	31.96	15.52	47.48	-26.52	74.00	Peak
2	* 10316.000	33.73	17.83	51.56	-16.64	68.20	Peak
3	11149.000	30.75	19.51	50.26	-23.74	74.00	Peak
4	14158.000	28.69	22.43	51.12	-17.08	68.20	Peak

Note:

1. " \*", means this data is the worst emission level.
2. C.F (Correction Factor) = Antenna Factor (dB/m)+ Cable Loss (dB)– Preamplifier(dB).
3. Measurement(dBμV/m) = Reading(dBμV) + C.F (Correction Factor).

EUT	HAN Access Point	Date of Test	2021-11-13
Factor	BBHA 9120D (1GHz~18GHz)	Temp. / Humidity	23°C/53%
Polarity	Vertical	Site / Test Engineer	AC1 / Tim
Test Mode	Transmit at 5825MHz by 802.11ac-VHT20	Test Voltage	AC 120V/60Hz

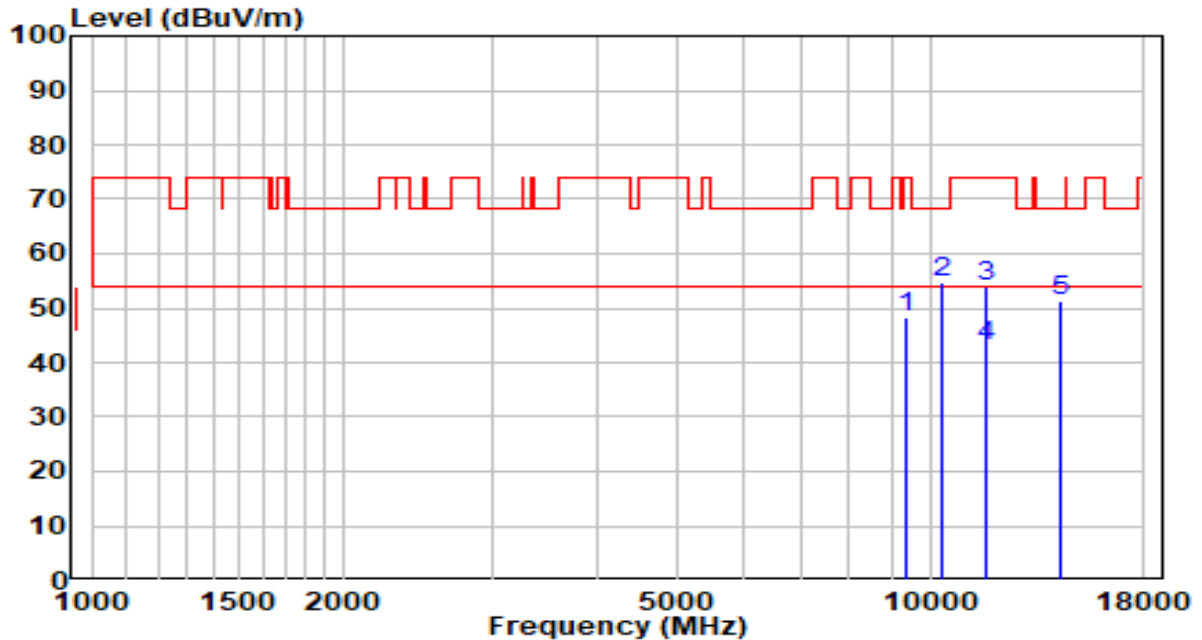

No	Frequency (MHz)	Reading (dB $\mu$ V)	C.F (dB/m)	Measurement (dB $\mu$ V/m)	Margin (dB)	Limit (dB $\mu$ V/m)	Remark (QP/PK/AV)
1	9355.500	32.81	15.48	48.28	-25.72	74.00	Peak
2	10316.000	36.91	17.83	54.74	-13.46	68.20	Peak
3	11650.500	34.07	19.71	53.78	-20.22	74.00	Peak
4	* 11650.500	23.27	19.71	42.98	-11.02	54.00	Average
5	14336.500	28.85	22.44	51.29	-16.91	68.20	Peak

Note:

1. " \*", means this data is the worst emission level.
2. C.F (Correction Factor) = Antenna Factor (dB/m)+ Cable Loss (dB)– Preamplifier(dB).
3. Measurement(dB $\mu$ V/m) = Reading(dB $\mu$ V) + C.F (Correction Factor).

EUT	HAN Access Point	Date of Test	2021-11-13
Factor	BBHA 9120D (1GHz~18GHz)	Temp. / Humidity	23°C/53%
Polarity	Horizontal	Site / Test Engineer	AC1 / Tim
Test Mode	Transmit at 5190MHz by 802.11ac-VHT40	Test Voltage	AC 120V/60Hz

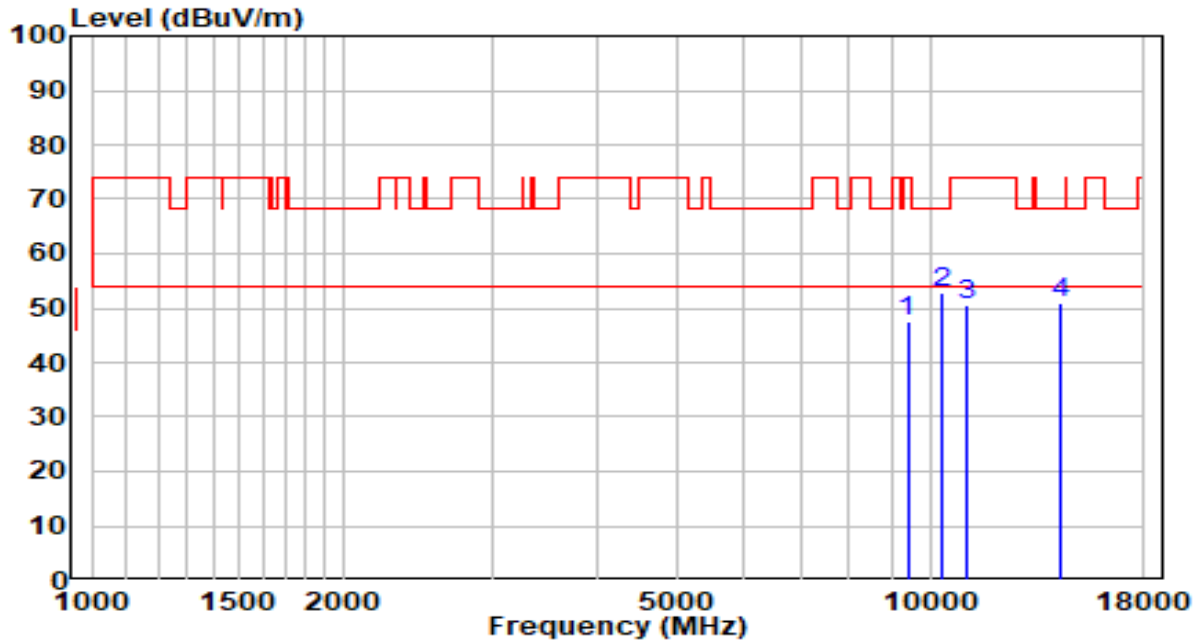

No	Frequency (MHz)	Reading (dB $\mu$ V)	C.F (dB/m)	Measurement (dB $\mu$ V/m)	Margin (dB)	Limit (dB $\mu$ V/m)	Remark (QP/PK/AV)
1	9398.000	32.18	15.55	47.73	-26.27	74.00	Peak
2	* 10316.000	34.81	17.83	52.64	-15.56	68.20	Peak
3	11064.000	31.10	19.38	50.48	-23.52	74.00	Peak
4	14260.000	28.62	22.44	51.06	-17.14	68.20	Peak

Note:

1. " \*", means this data is the worst emission level.
2. C.F (Correction Factor) = Antenna Factor (dB/m)+ Cable Loss (dB)– Preamplifier(dB).
3. Measurement(dB $\mu$ V/m) = Reading(dB $\mu$ V) + C.F (Correction Factor).

EUT	HAN Access Point	Date of Test	2021-11-13
Factor	BBHA 9120D (1GHz~18GHz)	Temp. / Humidity	23°C/53%
Polarity	Vertical	Site / Test Engineer	AC1 / Tim
Test Mode	Transmit at 5190MHz by 802.11ac-VHT40	Test Voltage	AC 120V/60Hz

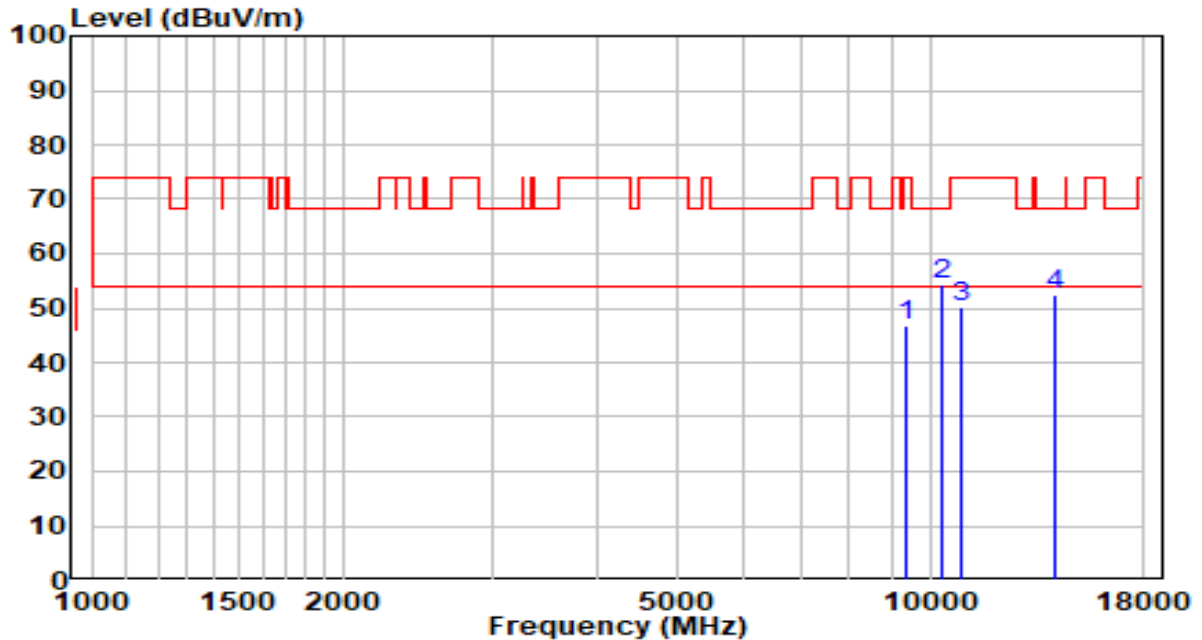

No	Frequency (MHz)	Reading (dB $\mu$ V)	C.F (dB/m)	Measurement (dB $\mu$ V/m)	Margin (dB)	Limit (dB $\mu$ V/m)	Remark (QP/PK/AV)
1	9381.000	31.18	15.52	46.70	-27.30	74.00	Peak
2	* 10316.000	36.49	17.83	54.32	-13.88	68.20	Peak
3	10928.000	30.83	19.18	50.01	-23.99	74.00	Peak
4	14132.500	30.20	22.43	52.63	-15.57	68.20	Peak

Note:

1. " \*", means this data is the worst emission level.
2. C.F (Correction Factor) = Antenna Factor (dB/m)+ Cable Loss (dB)– Preamplifier(dB).
3. Measurement(dB $\mu$ V/m) = Reading(dB $\mu$ V) + C.F (Correction Factor).

EUT	HAN Access Point	Date of Test	2021-11-13
Factor	BBHA 9120D (1GHz~18GHz)	Temp. / Humidity	23°C/53%
Polarity	Horizontal	Site / Test Engineer	AC1 / Tim
Test Mode	Transmit at 5230MHz by 802.11ac-VHT40	Test Voltage	AC 120V/60Hz

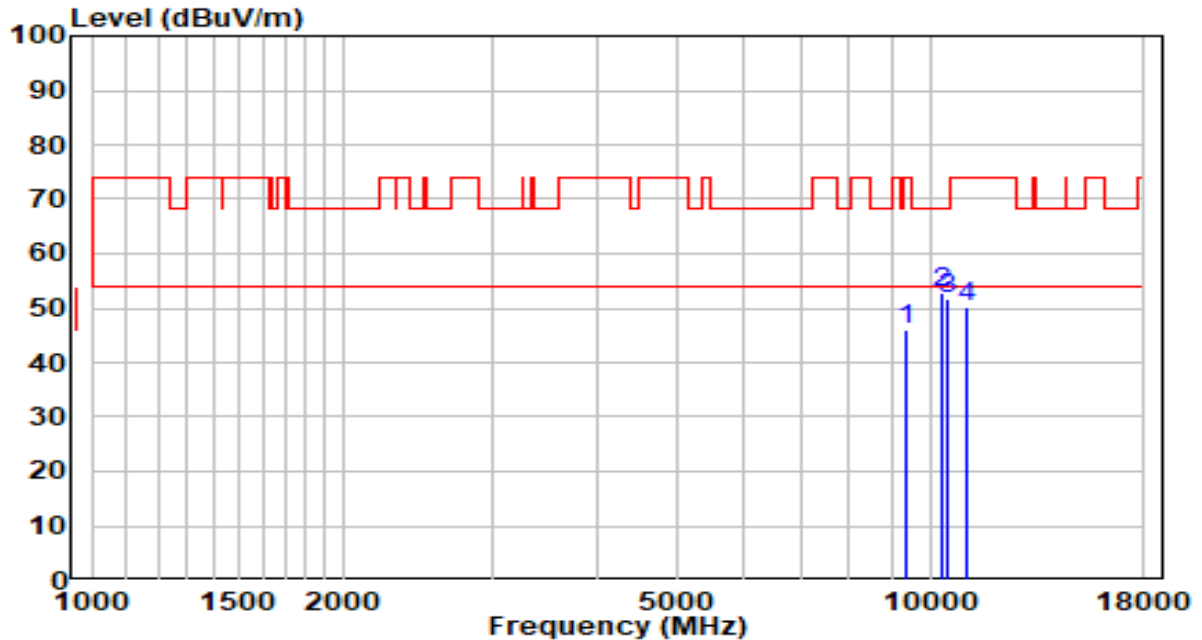

No	Frequency (MHz)	Reading (dB $\mu$ V)	C.F (dB/m)	Measurement (dB $\mu$ V/m)	Margin (dB)	Limit (dB $\mu$ V/m)	Remark (QP/PK/AV)
1	9381.000	30.55	15.52	46.07	-27.93	74.00	Peak
2	* 10316.000	34.84	17.83	52.67	-15.53	68.20	Peak
3	10460.500	33.22	18.41	51.64	-16.56	68.20	Peak
4	11055.500	30.76	19.37	50.12	-23.88	74.00	Peak

Note:

1. " \*", means this data is the worst emission level.
2. C.F (Correction Factor) = Antenna Factor (dB/m)+ Cable Loss (dB)– Preamplifier(dB).
3. Measurement(dB $\mu$ V/m) = Reading(dB $\mu$ V) + C.F (Correction Factor).

EUT	HAN Access Point	Date of Test	2021-11-13
Factor	BBHA 9120D (1GHz~18GHz)	Temp. / Humidity	23°C/53%
Polarity	Vertical	Site / Test Engineer	AC1 / Tim
Test Mode	Transmit at 5230MHz by 802.11ac-VHT40	Test Voltage	AC 120V/60Hz

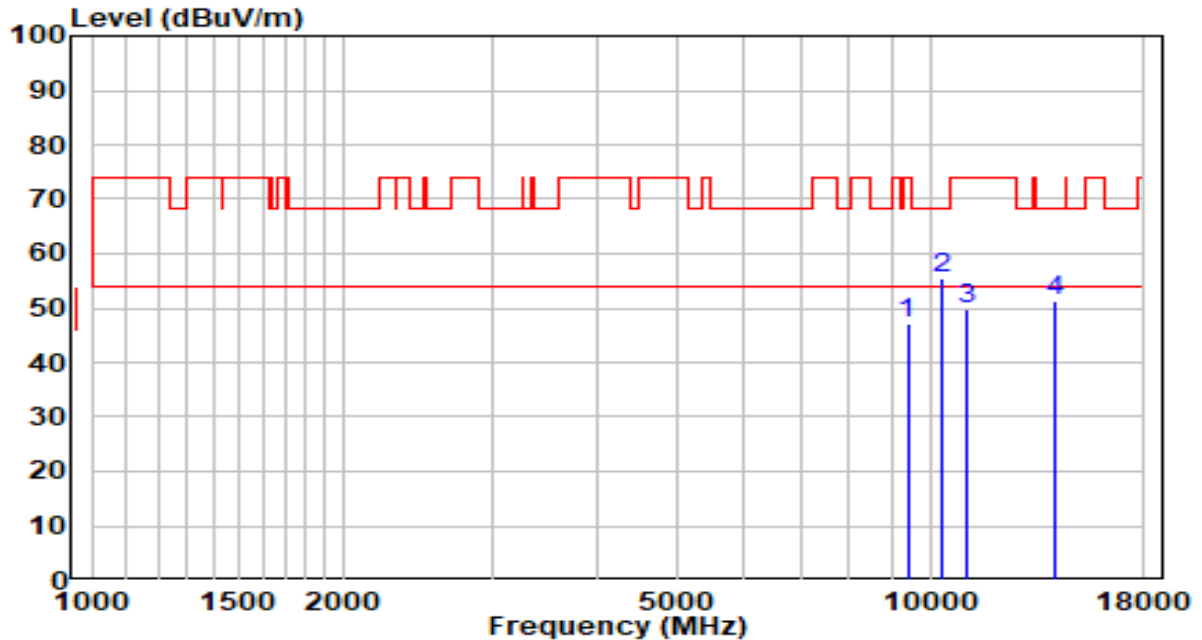

No	Frequency (MHz)	Reading (dB $\mu$ V)	C.F (dB/m)	Measurement (dB $\mu$ V/m)	Margin (dB)	Limit (dB $\mu$ V/m)	Remark (QP/PK/AV)
1	9398.000	31.58	15.55	47.13	-26.87	74.00	Peak
2	* 10316.000	37.82	17.83	55.65	-12.55	68.20	Peak
3	11038.500	30.53	19.34	49.87	-24.13	74.00	Peak
4	14064.500	28.80	22.42	51.22	-16.98	68.20	Peak

Note:

1. " \*", means this data is the worst emission level.
2. C.F (Correction Factor) = Antenna Factor (dB/m)+ Cable Loss (dB)– Preamplifier(dB).
3. Measurement(dB $\mu$ V/m) = Reading(dB $\mu$ V) + C.F (Correction Factor).



EUT	HAN Access Point	Date of Test	2021-11-13
Factor	BBHA 9120D (1GHz~18GHz)	Temp. / Humidity	23°C/53%
Polarity	Horizontal	Site / Test Engineer	AC1 / Tim
Test Mode	Transmit at 5755MHz by 802.11ac-VHT40	Test Voltage	AC 120V/60Hz

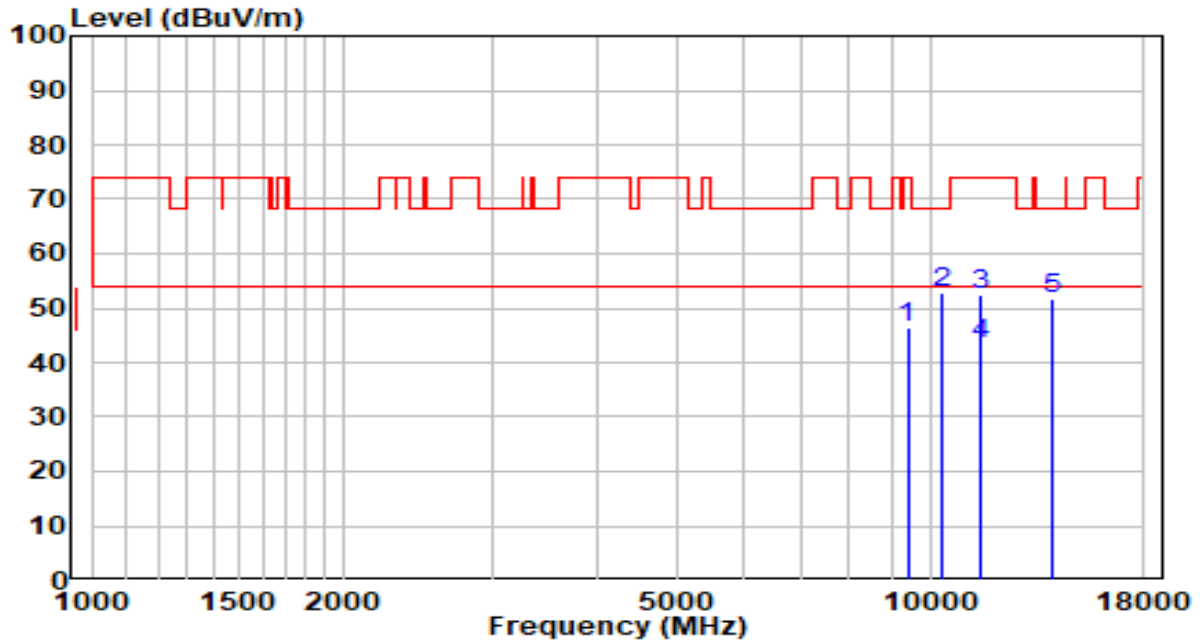

No	Frequency (MHz)	Reading (dB $\mu$ V)	C.F (dB/m)	Measurement (dB $\mu$ V/m)	Margin (dB)	Limit (dB $\mu$ V/m)	Remark (QP/PK/AV)
1	9398.000	31.03	15.55	46.58	-27.42	74.00	Peak
2	10316.000	35.09	17.83	52.92	-15.28	68.20	Peak
3	11506.000	32.51	20.04	52.54	-21.46	74.00	Peak
4	* 11506.000	23.32	20.04	43.36	-10.64	54.00	Average
5	14005.000	29.21	22.42	51.63	-16.57	68.20	Peak

Note:

1. " \*", means this data is the worst emission level.
2. C.F (Correction Factor) = Antenna Factor (dB/m)+ Cable Loss (dB)– Preamplifier(dB).
3. Measurement(dB $\mu$ V/m) = Reading(dB $\mu$ V) + C.F (Correction Factor).

EUT	HAN Access Point	Date of Test	2021-11-13
Factor	BBHA 9120D (1GHz~18GHz)	Temp. / Humidity	23°C/53%
Polarity	Vertical	Site / Test Engineer	AC1 / Tim
Test Mode	Transmit at 5755MHz by 802.11ac-VHT40	Test Voltage	AC 120V/60Hz

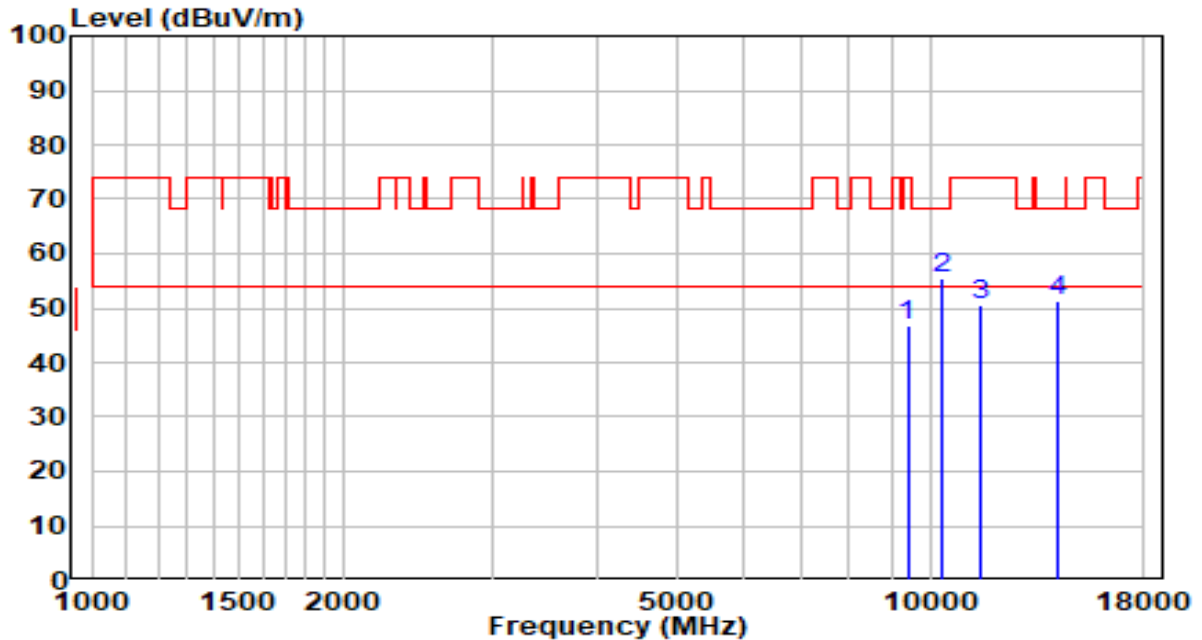

No	Frequency (MHz)	Reading (dB $\mu$ V)	C.F (dB/m)	Measurement (dB $\mu$ V/m)	Margin (dB)	Limit (dB $\mu$ V/m)	Remark (QP/PK/AV)
1	9398.000	31.39	15.55	46.94	-27.06	74.00	Peak
2	* 10316.000	37.73	17.83	55.56	-12.64	68.20	Peak
3	11506.000	30.71	20.04	50.75	-23.25	74.00	Peak
4	14175.000	29.05	22.43	51.49	-16.71	68.20	Peak

Note:

1. " \*", means this data is the worst emission level.
2. C.F (Correction Factor) = Antenna Factor (dB/m)+ Cable Loss (dB)– Preamplifier(dB).
3. Measurement(dB $\mu$ V/m) = Reading(dB $\mu$ V) + C.F (Correction Factor).

EUT	HAN Access Point	Date of Test	2021-11-13
Factor	BBHA 9120D (1GHz~18GHz)	Temp. / Humidity	23°C/53%
Polarity	Horizontal	Site / Test Engineer	AC1 / Tim
Test Mode	Transmit at 5795MHz by 802.11ac-VHT40	Test Voltage	AC 120V/60Hz

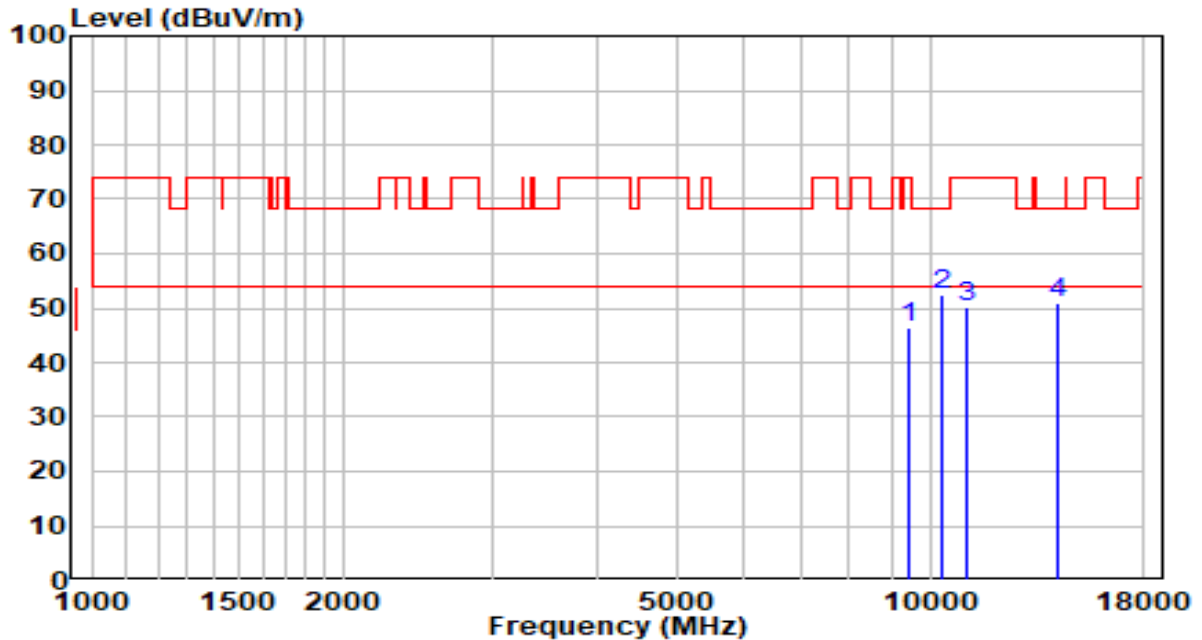

No	Frequency (MHz)	Reading (dB $\mu$ V)	C.F (dB/m)	Measurement (dB $\mu$ V/m)	Margin (dB)	Limit (dB $\mu$ V/m)	Remark (QP/PK/AV)
1	9415.000	30.80	15.58	46.38	-27.62	74.00	Peak
2	* 10316.000	34.58	17.83	52.41	-15.79	68.20	Peak
3	11047.000	30.85	19.35	50.20	-23.80	74.00	Peak
4	14226.000	28.54	22.44	50.98	-17.22	68.20	Peak

Note:

1. " \*", means this data is the worst emission level.
2. C.F (Correction Factor) = Antenna Factor (dB/m)+ Cable Loss (dB)– Preamplifier(dB).
3. Measurement(dB $\mu$ V/m) = Reading(dB $\mu$ V) + C.F (Correction Factor).

EUT	HAN Access Point	Date of Test	2021-11-13
Factor	BBHA 9120D (1GHz~18GHz)	Temp. / Humidity	23°C/53%
Polarity	Vertical	Site / Test Engineer	AC1 / Tim
Test Mode	Transmit at 5795MHz by 802.11ac-VHT40	Test Voltage	AC 120V/60Hz

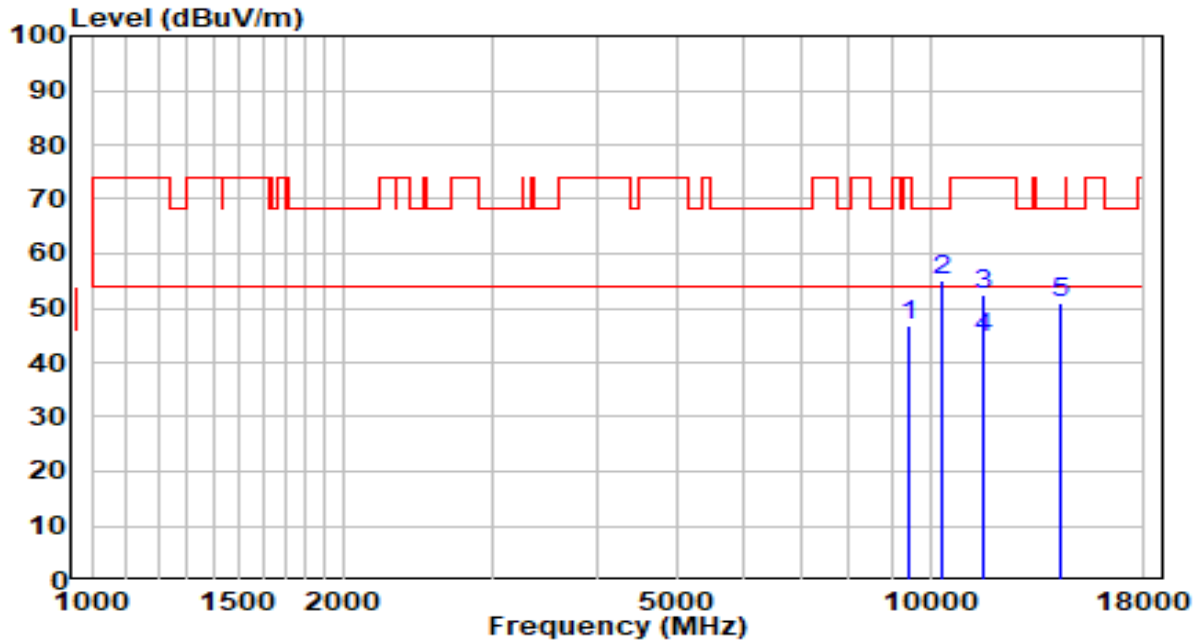

No	Frequency (MHz)	Reading (dB $\mu$ V)	C.F (dB/m)	Measurement (dB $\mu$ V/m)	Margin (dB)	Limit (dB $\mu$ V/m)	Remark (QP/PK/AV)
1	9415.000	31.21	15.58	46.79	-27.21	74.00	Peak
2	10316.000	37.13	17.83	54.96	-13.24	68.20	Peak
3	11591.000	32.75	19.84	52.59	-21.41	74.00	Peak
4	* 11591.000	24.71	19.84	44.55	-9.45	54.00	Average
5	14260.000	28.58	22.44	51.02	-17.18	68.20	Peak

Note:

1. " \*", means this data is the worst emission level.
2. C.F (Correction Factor) = Antenna Factor (dB/m)+ Cable Loss (dB)– Preamplifier(dB).
3. Measurement(dB $\mu$ V/m) = Reading(dB $\mu$ V) + C.F (Correction Factor).

EUT	HAN Access Point	Date of Test	2021-11-13
Factor	BBHA 9120D (1GHz~18GHz)	Temp. / Humidity	23°C/53%
Polarity	Horizontal	Site / Test Engineer	AC1 / Tim
Test Mode	Transmit at 5210MHz by 802.11ac-VHT80	Test Voltage	AC 120V/60Hz

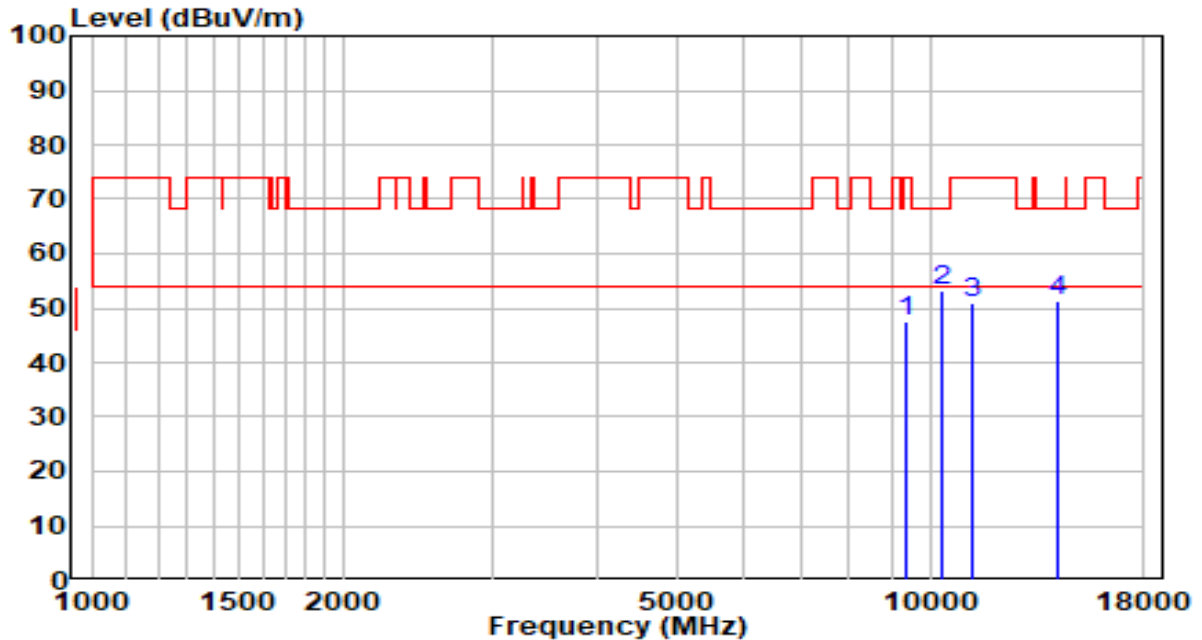

No	Frequency (MHz)	Reading (dB $\mu$ V)	C.F (dB/m)	Measurement (dB $\mu$ V/m)	Margin (dB)	Limit (dB $\mu$ V/m)	Remark (QP/PK/AV)
1	9355.500	32.22	15.48	47.69	-26.31	74.00	Peak
2	* 10316.000	35.41	17.83	53.24	-14.96	68.20	Peak
3	11217.000	31.42	19.61	51.03	-22.97	74.00	Peak
4	14166.500	29.05	22.43	51.48	-16.72	68.20	Peak

Note:

1. " \*", means this data is the worst emission level.
2. C.F (Correction Factor) = Antenna Factor (dB/m)+ Cable Loss (dB)– Preamplifier(dB).
3. Measurement(dB $\mu$ V/m) = Reading(dB $\mu$ V) + C.F (Correction Factor).

EUT	HAN Access Point	Date of Test	2021-11-13
Factor	BBHA 9120D (1GHz~18GHz)	Temp. / Humidity	23°C/53%
Polarity	Vertical	Site / Test Engineer	AC1 / Tim
Test Mode	Transmit at 5210MHz by 802.11ac-VHT80	Test Voltage	AC 120V/60Hz

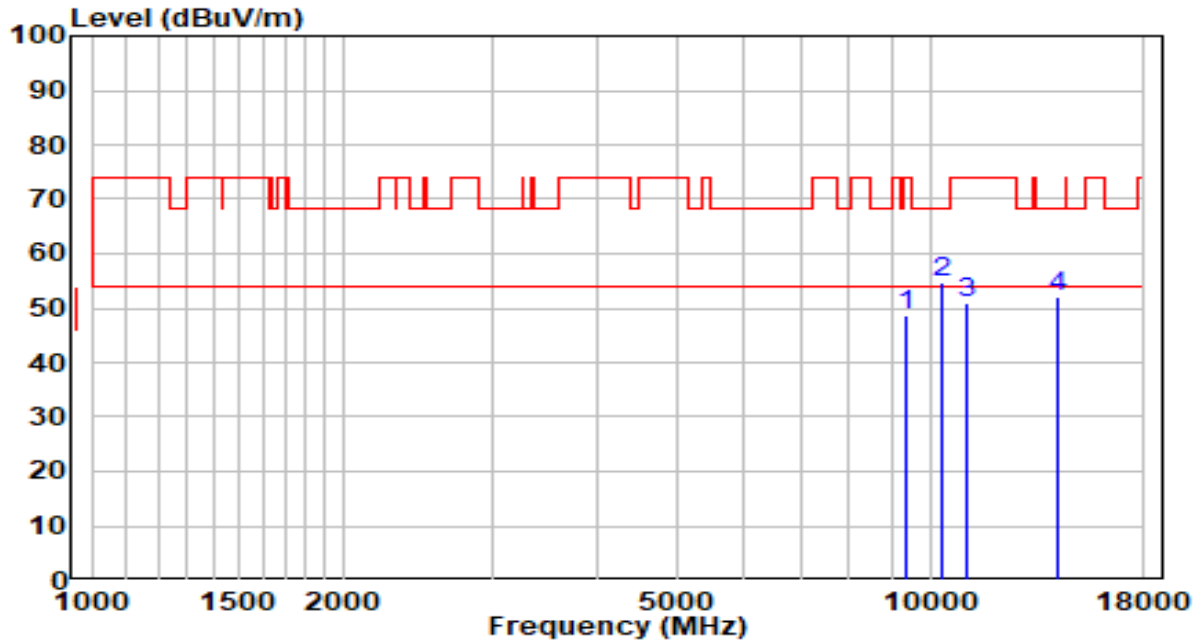

No	Frequency (MHz)	Reading (dB $\mu$ V)	C.F (dB/m)	Measurement (dB $\mu$ V/m)	Margin (dB)	Limit (dB $\mu$ V/m)	Remark (QP/PK/AV)
1	9381.000	33.27	15.52	48.79	-25.21	74.00	Peak
2	* 10316.000	37.06	17.83	54.89	-13.31	68.20	Peak
3	11055.500	31.64	19.37	51.00	-23.00	74.00	Peak
4	14226.000	29.58	22.44	52.02	-16.18	68.20	Peak

Note:

1. " \*", means this data is the worst emission level.
2. C.F (Correction Factor) = Antenna Factor (dB/m)+ Cable Loss (dB)– Preamplifier(dB).
3. Measurement(dB $\mu$ V/m) = Reading(dB $\mu$ V) + C.F (Correction Factor).

EUT	HAN Access Point	Date of Test	2021-11-13
Factor	BBHA 9120D (1GHz~18GHz)	Temp. / Humidity	23°C/53%
Polarity	Horizontal	Site / Test Engineer	AC1 / Tim
Test Mode	Transmit at 5775MHz by 802.11ac-VHT80	Test Voltage	AC 120V/60Hz

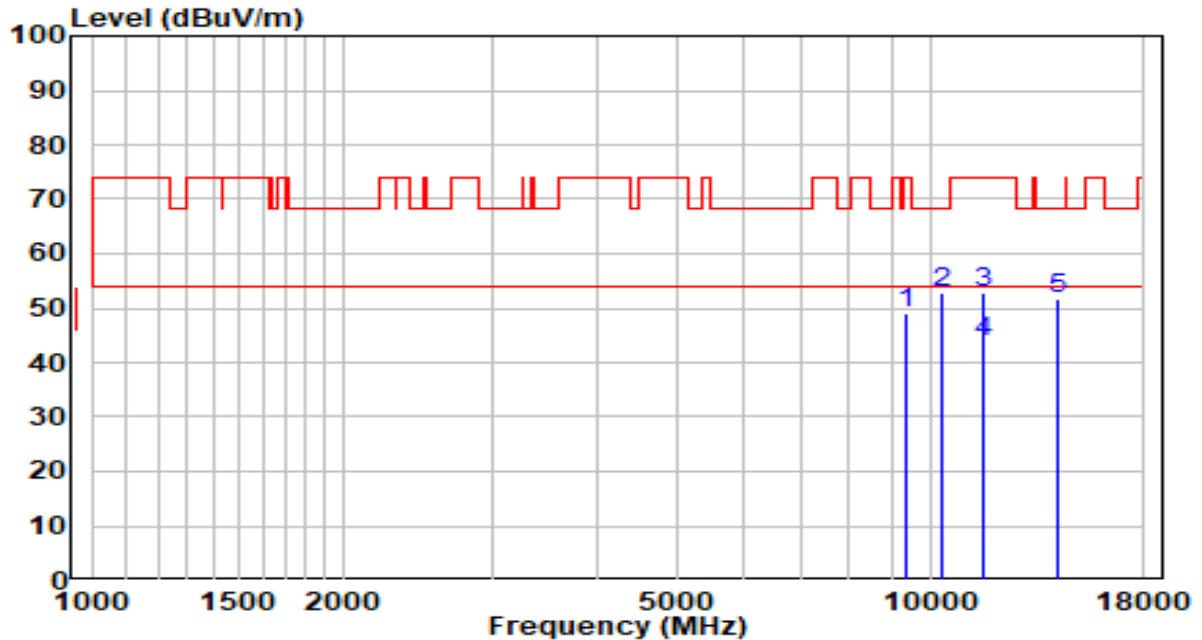

No	Frequency (MHz)	Reading (dB $\mu$ V)	C.F (dB/m)	Measurement (dB $\mu$ V/m)	Margin (dB)	Limit (dB $\mu$ V/m)	Remark (QP/PK/AV)
1	9355.500	33.50	15.48	48.98	-25.02	74.00	Peak
2	10316.000	34.94	17.83	52.77	-15.43	68.20	Peak
3	11540.000	32.80	19.96	52.76	-21.24	74.00	Peak
4	* 11540.000	23.63	19.96	43.59	-10.41	54.00	Average
5	14149.500	29.26	22.43	51.69	-16.51	68.20	Peak

Note:

1. " \*", means this data is the worst emission level.
2. C.F (Correction Factor) = Antenna Factor (dB/m)+ Cable Loss (dB)– Preamplifier(dB).
3. Measurement(dB $\mu$ V/m) = Reading(dB $\mu$ V) + C.F (Correction Factor).

EUT	HAN Access Point	Date of Test	2021-11-13
Factor	BBHA 9120D (1GHz~18GHz)	Temp. / Humidity	23°C/53%
Polarity	Vertical	Site / Test Engineer	AC1 / Tim
Test Mode	Transmit at 5775MHz by 802.11ac-VHT80	Test Voltage	AC 120V/60Hz

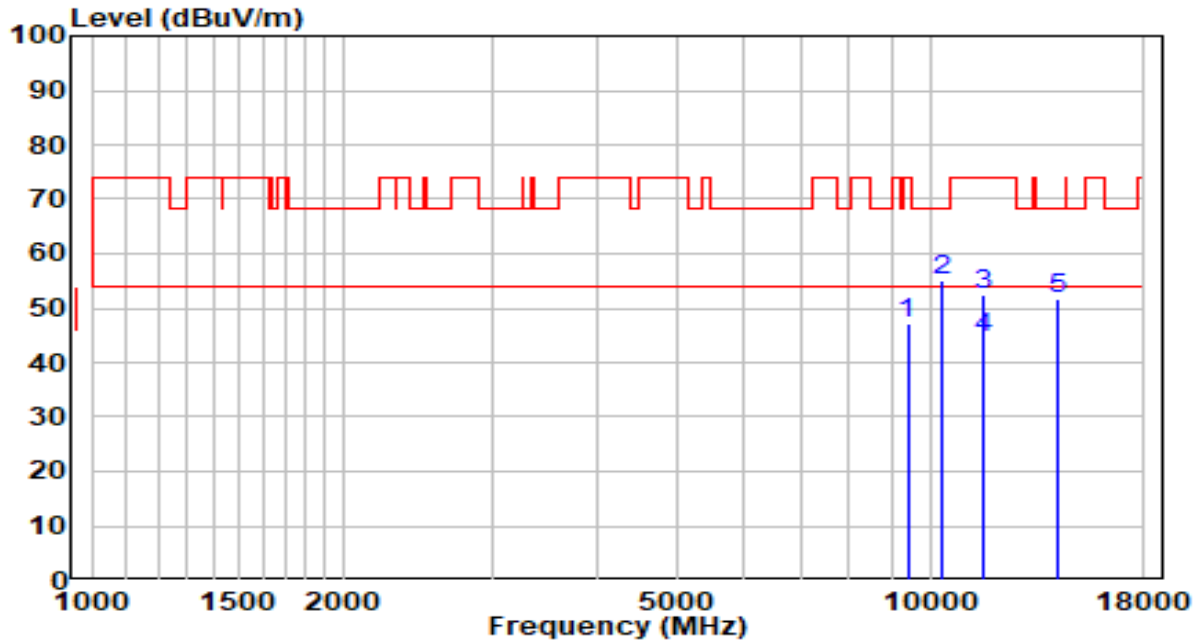

No	Frequency (MHz)	Reading (dB $\mu$ V)	C.F (dB/m)	Measurement (dB $\mu$ V/m)	Margin (dB)	Limit (dB $\mu$ V/m)	Remark (QP/PK/AV)
1	9398.000	31.65	15.55	47.20	-26.80	74.00	Peak
2	10316.000	37.13	17.83	54.96	-13.24	68.20	Peak
3	11548.500	32.47	19.94	52.41	-21.59	74.00	Peak
4	* 11548.500	24.77	19.94	44.71	-9.29	54.00	Average
5	14200.500	29.27	22.43	51.70	-16.50	68.20	Peak

Note:

1. " \*", means this data is the worst emission level.
2. C.F (Correction Factor) = Antenna Factor (dB/m)+ Cable Loss (dB)– Preamplifier(dB).
3. Measurement(dB $\mu$ V/m) = Reading(dB $\mu$ V) + C.F (Correction Factor).



**The Co-located Test Result:**

EUT	HAN Access Point	Date of Test	2021-11-14
Factor	BBHA 9120D (1GHz~18GHz)	Temp. / Humidity	23°C/54%
Polarity	Horizontal	Site / Test Engineer	AC1 / Tim
Test Mode	Transmit by 2.4GHz+5GHz	Test Voltage	AC 120V/60Hz

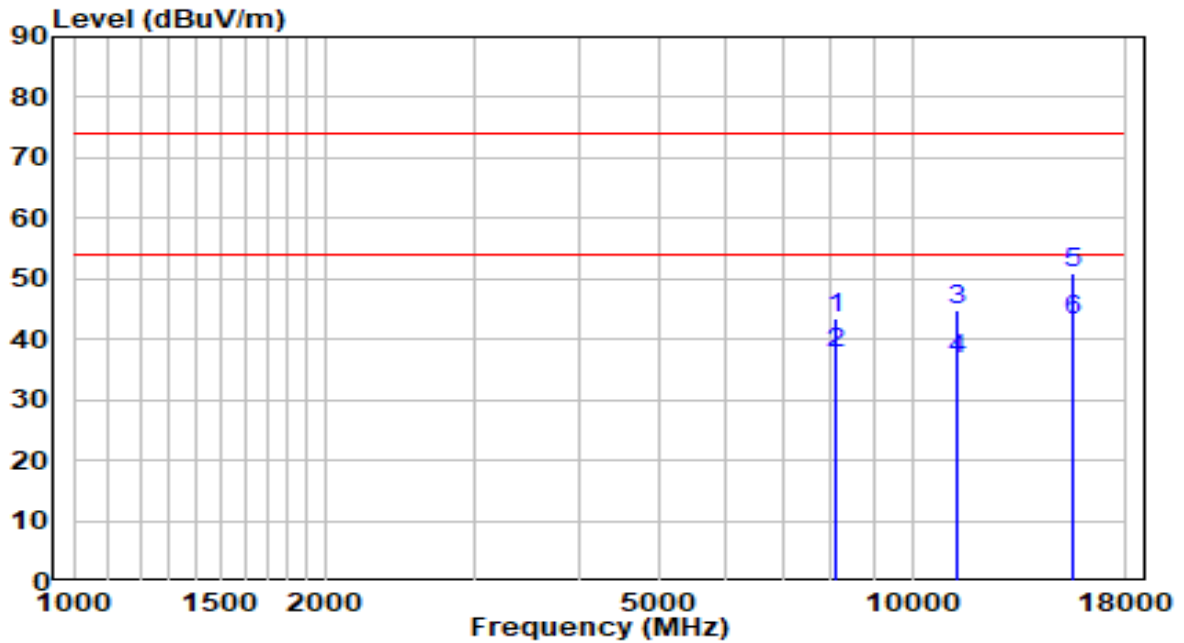

No	Frequency (MHz)	Reading (dBμV)	C.F (dB/m)	Measurement (dBμV/m)	Margin (dB)	Limit (dBμV/m)	Remark (QP/PK/AV)
1	8131.500	30.03	13.49	43.52	-30.48	74.00	Peak
2	8131.500	24.07	13.49	37.56	-16.44	54.00	Average
3	11327.500	25.10	19.78	44.88	-29.12	74.00	Peak
4	11327.500	16.80	19.78	36.58	-17.42	54.00	Average
5	15535.000	29.77	21.26	51.03	-22.97	74.00	Peak
6	* 15535.000	21.98	21.26	43.24	-10.76	54.00	Average

**Note:**

1. " \*", means this data is the worst emission level.
2. C.F (Correction Factor) = Antenna Factor (dB/m)+ Cable Loss (dB)– Preamplifier(dB).
3. Measurement(dBμV/m) = Reading(dBμV) + C.F (Correction Factor).
4. Test configuration: 802.11b 2412MHz + 802.11a 5180MHz

EUT	HAN Access Point	Date of Test	2021-11-14
Factor	BBHA 9120D (1GHz~18GHz)	Temp. / Humidity	23°C/54%
Polarity	Vertical	Site / Test Engineer	AC1 / Tim
Test Mode	Transmit by 2.4GHz+5GHz	Test Voltage	AC 120V/60Hz

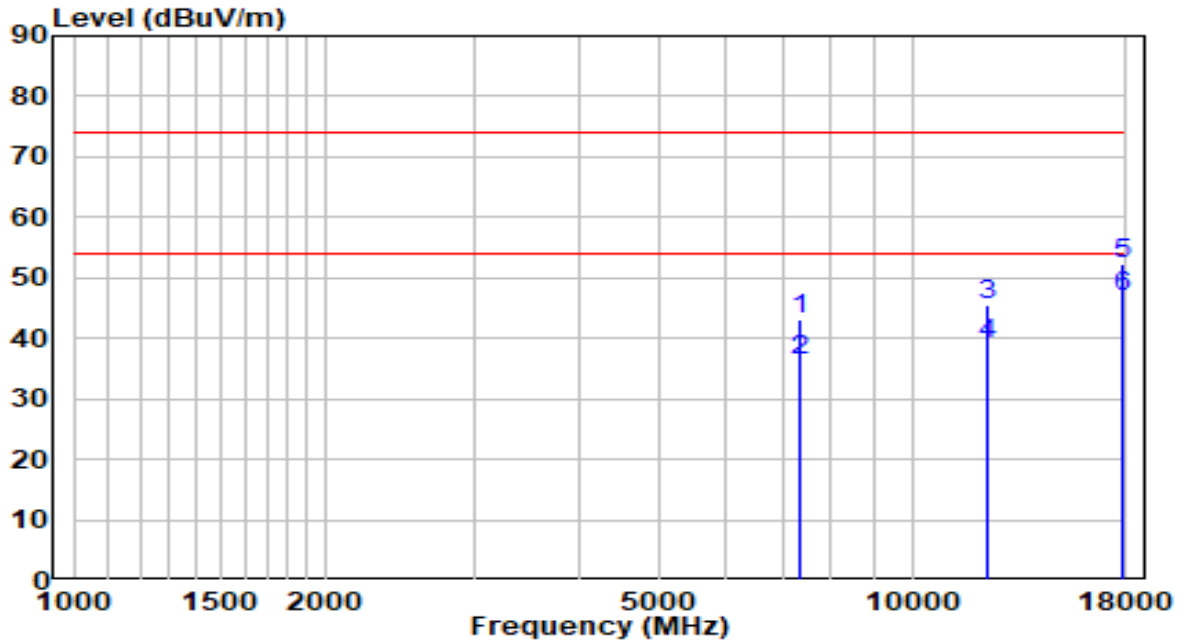

No	Frequency (MHz)	Reading (dB $\mu$ V)	C.F (dB/m)	Measurement (dB $\mu$ V/m)	Margin (dB)	Limit (dB $\mu$ V/m)	Remark (QP/PK/AV)
1	7324.000	30.74	12.24	42.97	-31.03	74.00	Peak
2	7324.000	24.10	12.24	36.34	-17.66	54.00	Average
3	12313.500	26.82	18.60	45.41	-28.59	74.00	Peak
4	12313.500	20.46	18.60	39.06	-14.94	54.00	Average
5	17770.500	21.87	30.40	52.27	-21.73	74.00	Peak
6	* 17770.500	16.58	30.40	46.98	-7.02	54.00	Average

Note:

- "\*" , means this data is the worst emission level.
- C.F (Correction Factor) = Antenna Factor (dB/m)+ Cable Loss (dB)– Preamplifier(dB).
- Measurement(dB $\mu$ V/m) = Reading(dB $\mu$ V) + C.F (Correction Factor).
- Test configuration: 802.11b 2412MHz + 802.11a 5180MHz

**The Result of Radiated Emission below 1GHz:**

EUT	HAN Access Point	Date of Test	2021-11-13
Factor	VULB 9162	Temp. / Humidity	21°C /47%
Polarity	Horizontal	Site / Test Engineer	AC1 / Tim
Test Mode	Transmit by 802.11a at channel 5745MHz	Test Voltage	AC 120V/60Hz

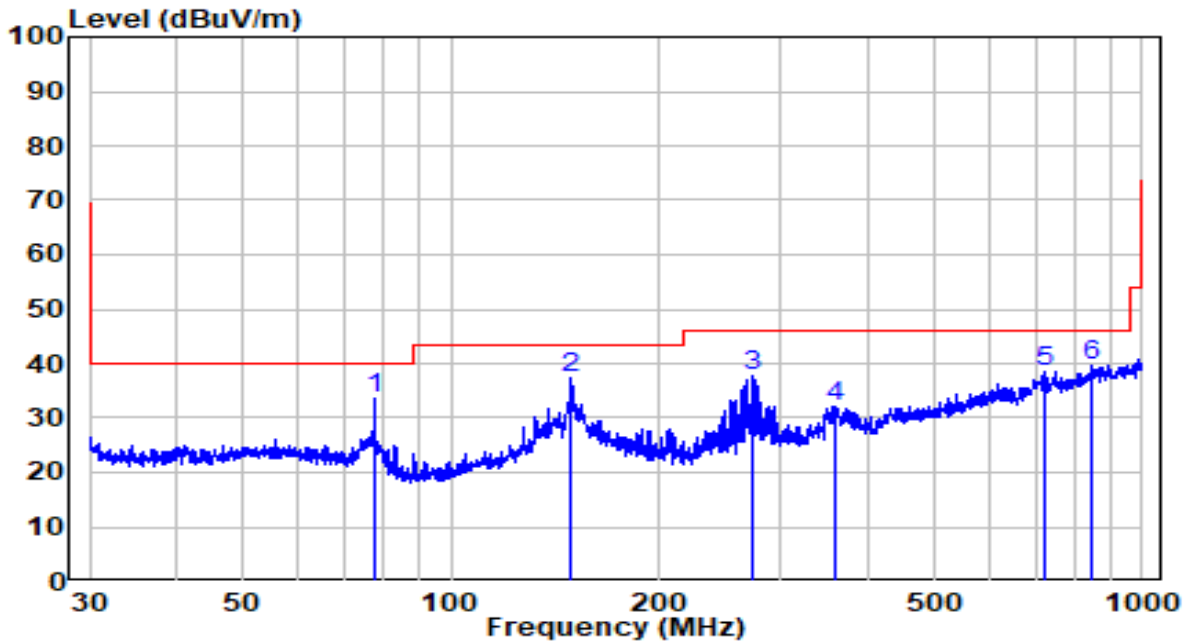

No	Frequency (MHz)	Reading (dBμV)	C.F (dB/m)	Measurement (dBμV/m)	Margin (dB)	Limit (dBμV/m)	Remark (QP/PK/AV)
1	77.321	18.54	15.05	33.59	-6.41	40.00	Peak
2	* 149.224	21.55	15.98	37.53	-5.97	43.50	Peak
3	272.278	16.99	20.78	37.77	-8.23	46.00	Peak
4	359.816	8.85	23.39	32.24	-13.76	46.00	Peak
5	725.532	8.62	29.72	38.34	-7.66	46.00	Peak
6	845.088	8.17	31.39	39.56	-6.44	46.00	Peak

Note:

- "\*" , means this data is the worst emission level.
- C.F (Correction Factor) = Antenna Factor (dB/m)+ Cable Loss (dB).
- Measurement(dBμV/m) = Reading(dBμV) + C.F (Correction Factor).
- The amplitude of Radiated emissions (the test frequency range: 9kHz ~ 30MHz, 18GHz ~ 40GHz), is that proximity to ambient noise, which also are attenuated more than 20 dB below the permissible value. Therefore, the data is not presented in the report.

EUT	HAN Access Point	Date of Test	2021-11-13
Factor	VULB 9162	Temp. / Humidity	21°C /47%
Polarity	Vertical	Site / Test Engineer	AC1 / Tim
Test Mode	Transmit by 802.11a at channel 5745MHz	Test Voltage	AC 120V/60Hz

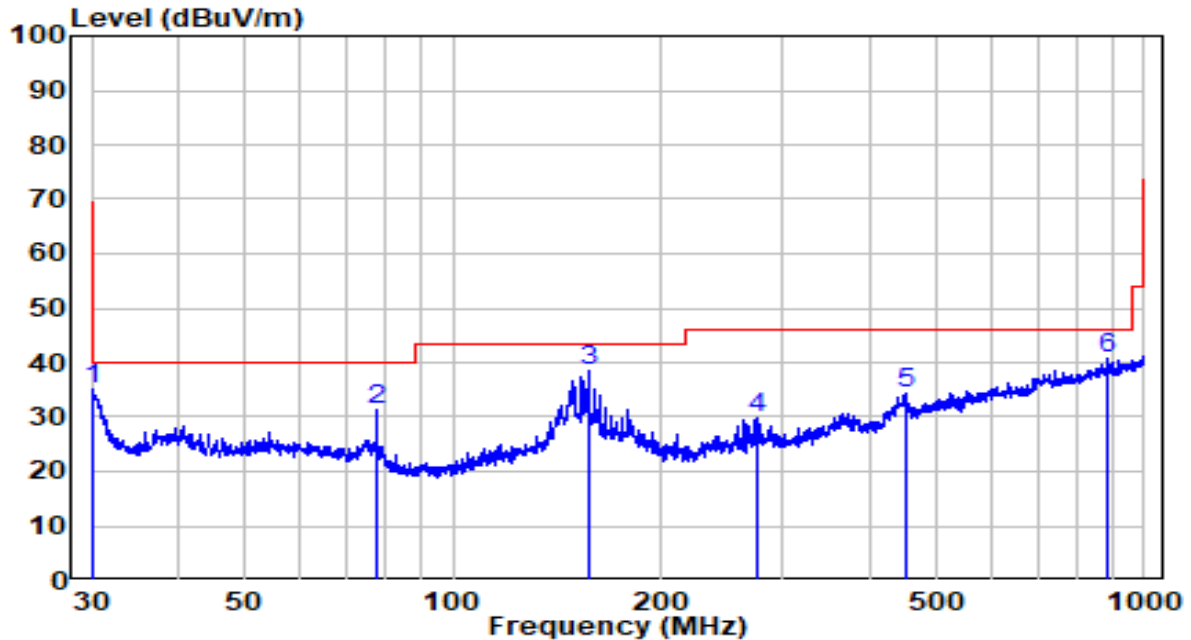

No	Frequency (MHz)	Reading (dB $\mu$ V)	C.F (dB/m)	Measurement (dB $\mu$ V/m)	Margin (dB)	Limit (dB $\mu$ V/m)	Remark (QP/PK/AV)
1	30.000	16.56	18.40	34.96	-5.04	40.00	Peak
2	77.457	16.25	15.02	31.27	-8.73	40.00	Peak
3	* 156.732	22.26	16.21	38.47	-5.03	43.50	Peak
4	275.157	8.86	20.88	29.74	-16.26	46.00	Peak
5	451.135	9.56	24.92	34.48	-11.52	46.00	Peak
6	886.055	9.15	31.69	40.84	-5.16	46.00	Peak

Note:

1. " \*", means this data is the worst emission level.
2. C.F (Correction Factor) = Antenna Factor (dB/m)+ Cable Loss (dB).
3. Measurement(dB $\mu$ V/m) = Reading(dB $\mu$ V) + C.F (Correction Factor).
4. The amplitude of Radiated emissions (the test frequency range: 9kHz ~ 30MHz, 18GHz ~ 40GHz), is that proximity to ambient noise, which also are attenuated more than 20 dB below the permissible value. Therefore, the data is not presented in the report.

## 7.7. Radiated Restricted Band Edge Measurement

### 7.7.1. Test Limit

#### **For 15.205 requirement:**

Radiated emissions which fall in the restricted bands, as defined in Section 15.205(a) of FCC part 15, must also comply with the radiated emission limits specified in Section 15.209(a).

Frequency (MHz)	Frequency (MHz)	Frequency (MHz)	Frequency (GHz)
0.090 - 0.110	16.42-16.423	399.9 - 410	4.5-5.15
<sup>1</sup> 0.495 - 0.505	16.69475-16.69525	608 - 614	5.35-5.46
2.1735-2.1905	16.80425-16.80475	960 - 1240	7.25-7.75
4.125-4.128	25.5 -25.67	1300 - 1427	8.025 - 8.5
4.17725-4.17775	37.5-38.25	1435-1626.5	9.0-9.2
4.20725-4.20775	73-74.6	1645.5-1646.5	9.3-9.5
6.215-6.218	74.8-75.2	1660 - 1710	10.6-12.7
6.26775-6.26825	108-121.94	1718.8-1722.2	13.25-13.4
6.31175-6.31225	123 - 138	2200 - 2300	14.47-14.5
8.291-8.294	149.9-150.05	2310 - 2390	15.35-16.2
8.362-8.366	156.52475-156.525	2483.5 - 2500	17.7-21.4
8.37625-8.38675	156.7-156.9	2690 - 2900	22.01-23.12
8.41425-8.41475	162.0125-167.17	3260 - 3267	23.6-24.0
12.29-12.293	167.72-173.2	3332 - 3339	31.2-31.8
12.51975-12.52025	240 - 285	3345.8 - 3358	36.43-36.5
12.57675-12.57725	322-335.4	3600 - 4400	( <sup>2</sup> )
13.36-13.41	--	--	--

#### **For 15.407(b) requirement:**

For transmitters operating in the 5.15-5.25 GHz band: All emissions outside of the 5.15-5.35 GHz band shall not exceed an e.i.r.p. of -27 dBm/MHz.

For transmitters operating in the 5.25-5.35 GHz band: All emissions outside of the 5.15-5.35 GHz band shall not exceed an e.i.r.p. of -27 dBm/MHz.

For transmitters operating in the 5.47-5.725 GHz band: All emissions outside of the 5.47-5.725 GHz band shall not exceed an e.i.r.p. of -27 dBm/MHz.

For transmitters operating in the 5.725-5.85 GHz band: All emissions shall be limited to a level of -27 dBm/MHz at 75 MHz or more above or below the band edge increasing linearly to 10 dBm/MHz at 25 MHz above or below the band edge, and from 25 MHz above or below the band edge increasing linearly to a level of 15.6 dBm/MHz at 5 MHz above or below the band edge, and from 5 MHz above or below the band edge increasing linearly to a level of 27 dBm/MHz at the band edge.

Refer to KDB 789033 D02v02r01 G)2)c), as specified in § 15.407(b), emissions above 1000 MHz.

- 1) Sections 15.407(b)(1-3) specifies the unwanted emissions limit for the U-NII-1 and U-NII-2 bands. As specified, emissions above 1000 MHz that are outside of the restricted bands are subject to a peak emission limit of -27 dBm/MHz.
- 2) Section 15.407(b)(4) specifies the unwanted emissions limit for the U-NII-3 band. A band emissions mask is specified in Section 15.407(b)(4)(i). The emission limits are based on the use of a peak detector.

All out of band emissions appearing in a restricted band as specified in Section 15.205 of the Title 47CFR must not exceed the limits shown in Table per Section 15.209.

FCC Part 15 Subpart C Paragraph 15.209		
Frequency [MHz]	Field Strength [ $\mu$ V/m]	Measured Distance [Meters]
0.009 - 0.490	2400/F (kHz)	300
0.490 - 1.705	24000/F (kHz)	30
1.705 - 30	30	30
30 - 88	100	3
88 - 216	150	3
216 - 960	200	3
Above 960	500	3

**7.7.2.Test Procedure Used**

KDB 789033 D02v02r01 – Section G

### **7.7.3.Test Setting**

#### **Peak Measurements above 1GHz**

1. Analyzer center frequency was set to the frequency of the radiated spurious emission of interest
2. RBW = 1MHz
3. VBW = 3MHz
4. Detector = peak
5. Sweep time = auto couple
6. Trace mode = max hold
7. Trace was allowed to stabilize

#### **Average Measurements above 1GHz (Method VB)**

1. Analyzer center frequency was set to the frequency of the radiated spurious emission of interest
2. RBW = 1MHz
3. VBW If the EUT is configured to transmit with duty cycle  $\geq 98\%$ , set  $VBW \leq RBW/100$  (i.e., 10 kHz) but not less than 10 Hz. If the EUT duty cycle is  $< 98\%$ , set  $VBW \geq 1/T$ .
4. Detector = Peak
5. Sweep time = auto
6. Allow max hold to run for at least 50 traces if the transmitted signal is continuous or has at least 98% duty cycle. For lower duty cycles, increase the minimum number of traces by a factor of  $1/x$ , where  $x$  is the duty cycle.

### 7.7.4. Test Setup

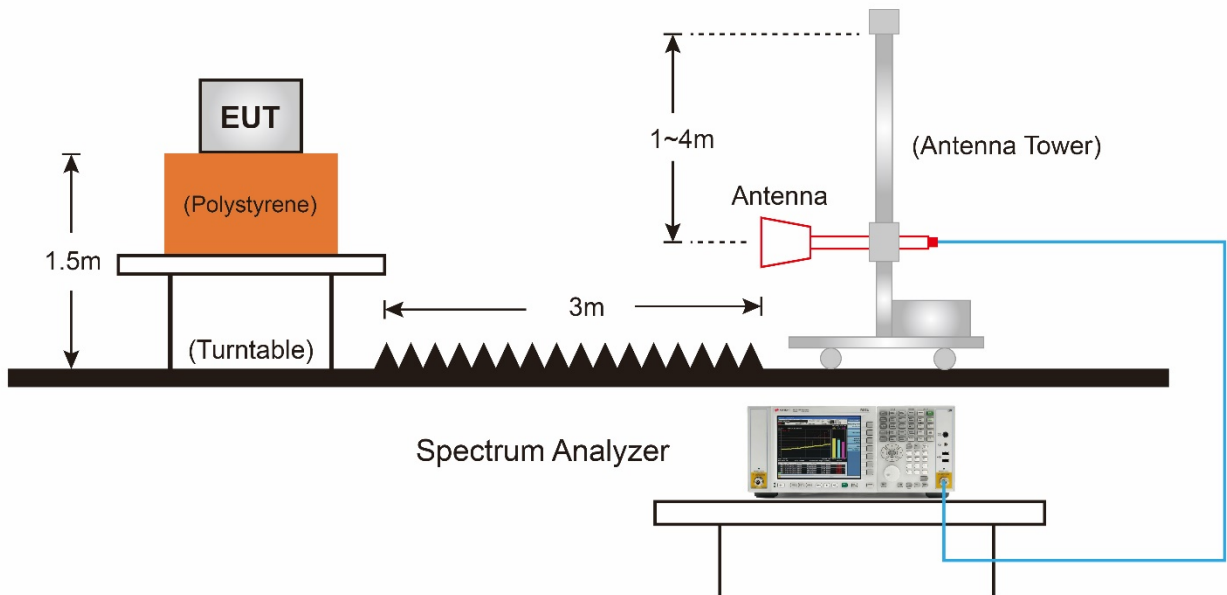



### 7.7.5.Test Result

#### CDD Mode:

EUT	HAN Access Point	Date of Test	2021-10-07
Factor	DRH18-E	Temp. / Humidity	23°C /49%
Polarity	Horizontal	Site / Test Engineer	AC2 / Jay
Test Mode	802.11a_TX_Band1_CH 36	Test Voltage	AC 120V/60Hz

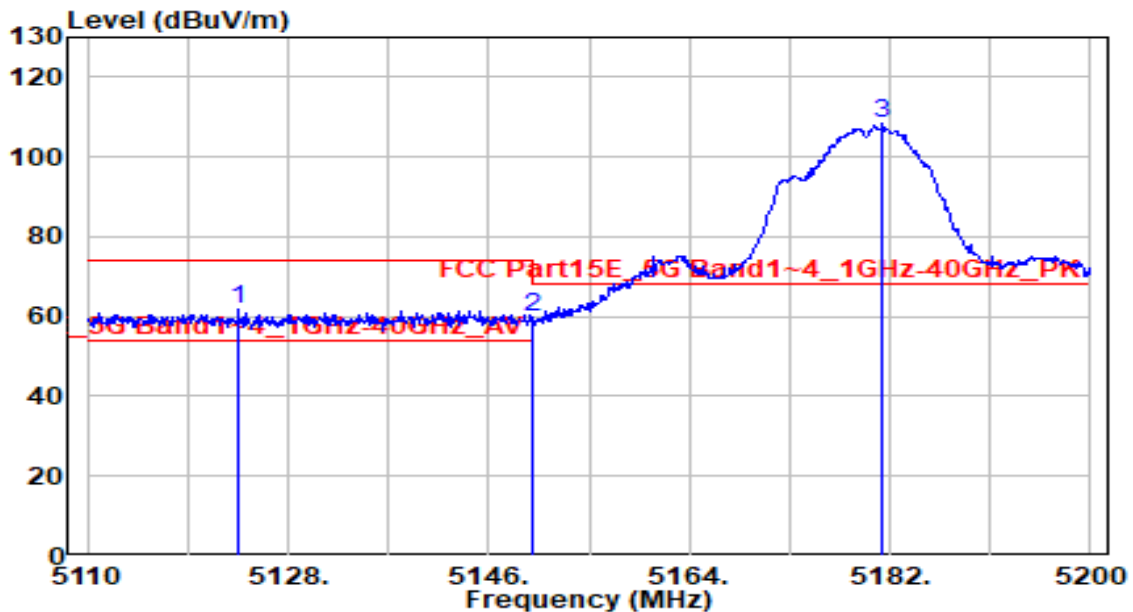

No	Frequency (MHz)	Reading (dB $\mu$ V)	C.F (dB/m)	Measurement (dB $\mu$ V/m)	Margin (dB)	Limit (dB $\mu$ V/m)	Height (cm)	Angle (deg)	Remark (QP/PK/AV)
1	* 5123.500	61.92	-0.31	61.60	-12.40	74.00	150	80	Peak
2	5150.000	60.08	-0.32	59.76	-14.24	74.00	150	80	Peak
3	5181.370	108.63	-0.32	108.31	N/A	N/A	150	80	Peak

#### Note:

1. " \*", means this data is the worst emission level.
2. C.F (Correction Factor) = Antenna Factor (dB/m)+ Cable Loss (dB) – Preamplifier(dB) + 20dB Attenuation.
3. Measurement (dB $\mu$ V/m) = Reading(dB $\mu$ V) + C.F (Correction Factor).
4. The emission levels of other frequencies are very lower than the limit and not show in test report.

EUT	HAN Access Point	Date of Test	2021-10-07
Factor	DRH18-E	Temp. / Humidity	23°C /49%
Polarity	Horizontal	Site / Test Engineer	AC2 / Jay
Test Mode	802.11a_TX_Band1_CH 36	Test Voltage	AC 120V/60Hz

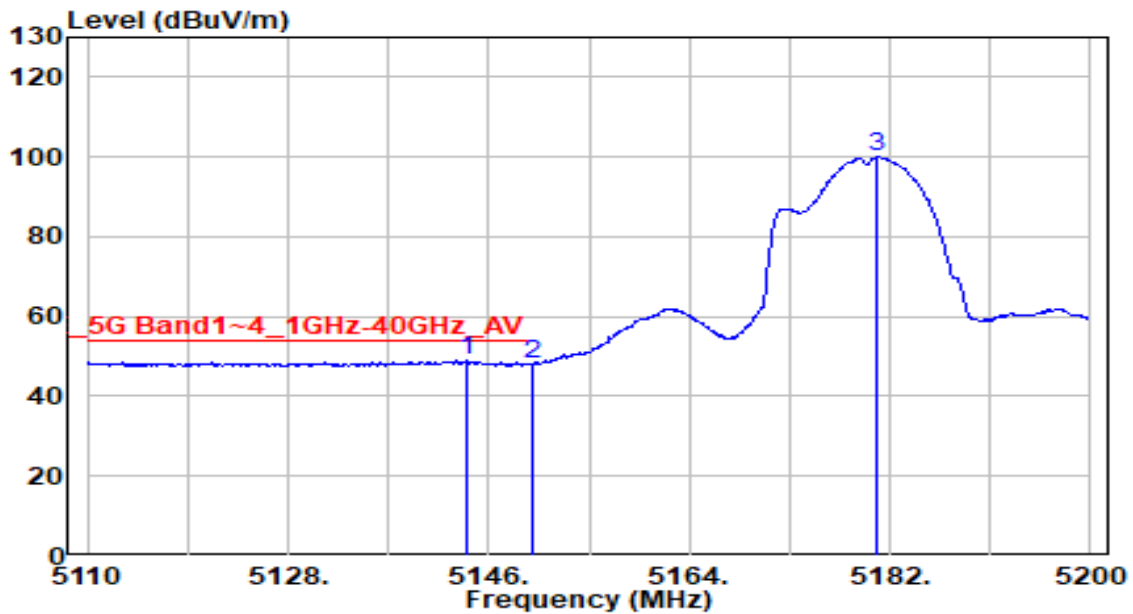

No	Frequency (MHz)	Reading (dB $\mu$ V)	C.F (dB/m)	Measurement (dB $\mu$ V/m)	Margin (dB)	Limit (dB $\mu$ V/m)	Height (cm)	Angle (deg)	Remark (QP/PK/AV)
1	* 5144.110	49.28	-0.32	48.96	-5.04	54.00	150	80	Average
2	5150.000	48.48	-0.32	48.16	-5.84	54.00	150	80	Average
3	5180.830	100.22	-0.32	99.89	N/A	N/A	150	80	Average

Note:

- "\*" means this data is the worst emission level.
- C.F (Correction Factor) = Antenna Factor (dB/m)+ Cable Loss (dB) – Preamplifier(dB) + 20dB Attenuation.
- Measurement (dB $\mu$ V/m) = Reading(dB $\mu$ V) + C.F (Correction Factor).
- The emission levels of other frequencies are very lower than the limit and not show in test report.

EUT	HAN Access Point	Date of Test	2021-10-07
Factor	DRH18-E	Temp. / Humidity	23°C /49%
Polarity	Vertical	Site / Test Engineer	AC2 / Jay
Test Mode	802.11a_TX_Band1_CH 36	Test Voltage	AC 120V/60Hz

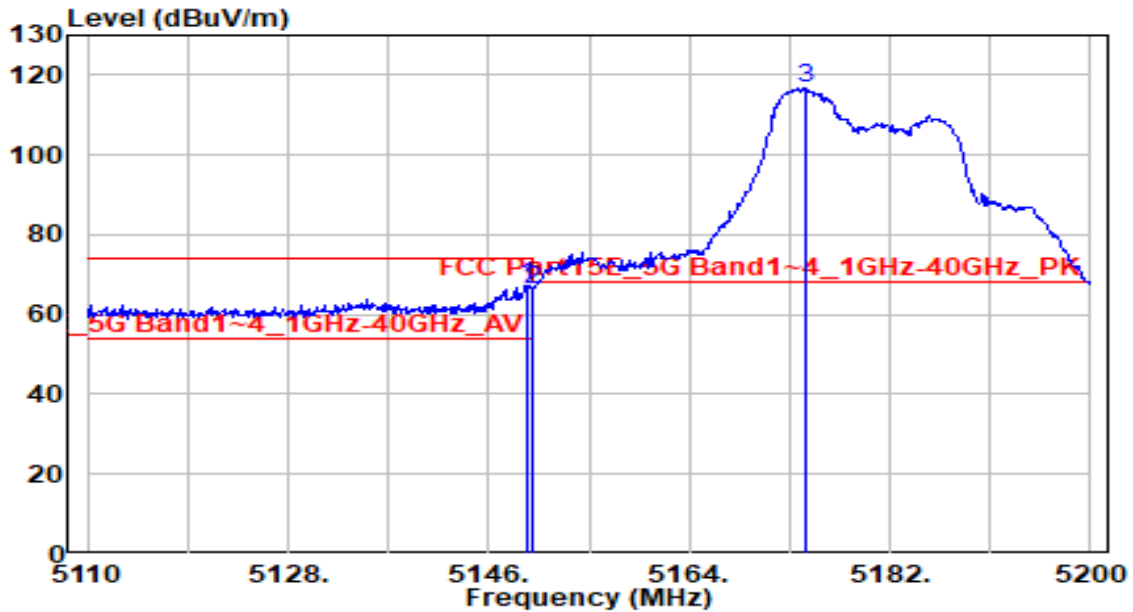

No	Frequency (MHz)	Reading (dB $\mu$ V)	C.F (dB/m)	Measurement (dB $\mu$ V/m)	Margin (dB)	Limit (dB $\mu$ V/m)	Height (cm)	Angle (deg)	Remark (QP/PK/AV)
1	* 5149.510	67.66	-0.32	67.34	-6.66	74.00	270	170	Peak
2	5150.000	66.74	-0.32	66.42	-7.58	74.00	270	170	Peak
3	5174.440	117.25	-0.32	116.93	N/A	N/A	270	170	Peak

Note:

- "\*" means this data is the worst emission level.
- C.F (Correction Factor) = Antenna Factor (dB/m)+ Cable Loss (dB) – Preamplifier(dB) + 20dB Attenuation.
- Measurement (dB $\mu$ V/m) = Reading(dB $\mu$ V) + C.F (Correction Factor).
- The emission levels of other frequencies are very lower than the limit and not show in test report.

EUT	HAN Access Point	Date of Test	2021-10-07
Factor	DRH18-E	Temp. / Humidity	23°C /49%
Polarity	Vertical	Site / Test Engineer	AC2 / Jay
Test Mode	802.11a_TX_Band1_CH 36	Test Voltage	AC 120V/60Hz

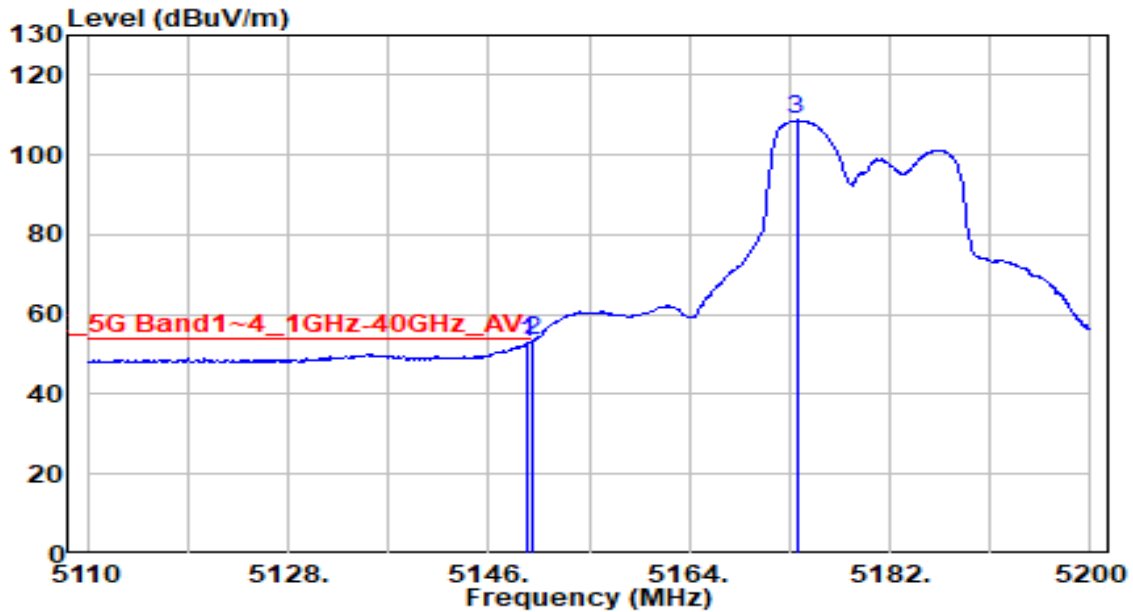

No	Frequency (MHz)	Reading (dBμV)	C.F (dB/m)	Measurement (dBμV/m)	Margin (dB)	Limit (dBμV/m)	Height (cm)	Angle (deg)	Remark (QP/PK/AV)
1	5149.510	53.08	-0.32	52.76	-1.24	54.00	270	170	Average
2	* 5150.000	53.75	-0.32	53.43	-0.57	54.00	270	170	Average
3	5173.630	109.02	-0.32	108.70	N/A	N/A	270	170	Average

Note:

- "\*" means this data is the worst emission level.
- C.F (Correction Factor) = Antenna Factor (dB/m)+ Cable Loss (dB) – Preamplifier(dB) + 20dB Attenuation.
- Measurement (dBμV/m) = Reading(dBμV) + C.F (Correction Factor).
- The emission levels of other frequencies are very lower than the limit and not show in test report.

EUT	HAN Access Point	Date of Test	2021-10-07
Factor	DRH18-E	Temp. / Humidity	23°C /49%
Polarity	Horizontal	Site / Test Engineer	AC2 / Jay
Test Mode	802.11a_TX_Band2_CH 64	Test Voltage	AC 120V/60Hz

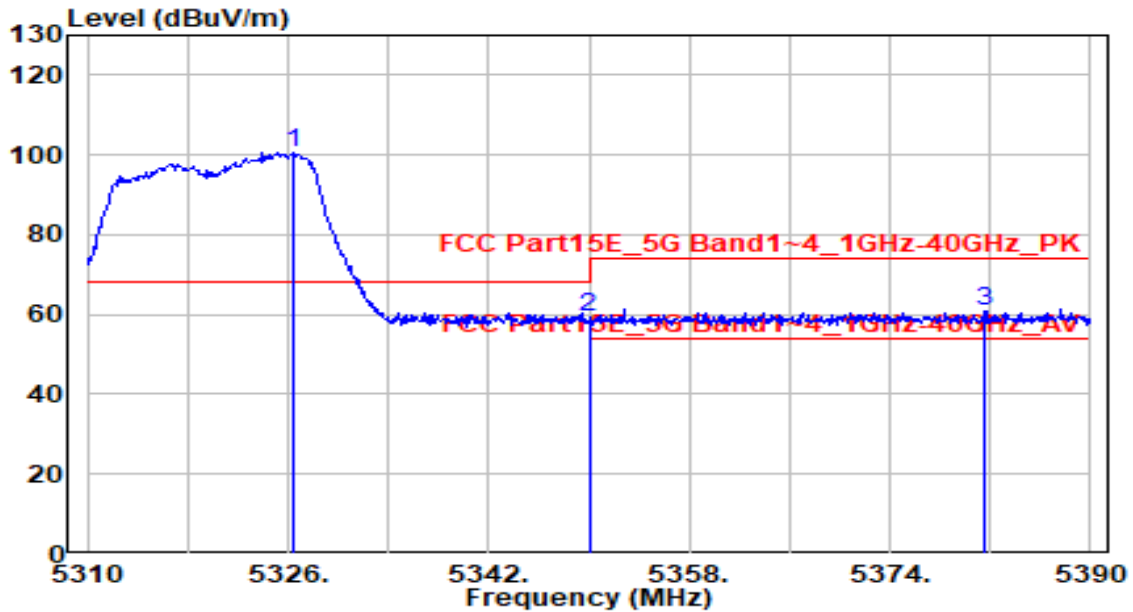

No	Frequency (MHz)	Reading (dB $\mu$ V)	C.F (dB/m)	Measurement (dB $\mu$ V/m)	Margin (dB)	Limit (dB $\mu$ V/m)	Height (cm)	Angle (deg)	Remark (QP/PK/AV)
1	5326.480	101.01	-0.33	100.68	N/A	N/A	215	80	Peak
2	* 5350.000	59.84	-0.33	59.51	-8.69	68.20	215	80	Peak
3	5381.520	61.09	-0.32	60.77	-13.23	74.00	215	80	Peak

Note:

- "\*" means this data is the worst emission level.
- C.F (Correction Factor) = Antenna Factor (dB/m)+ Cable Loss (dB) – Preamplifier(dB) + 20dB Attenuation.
- Measurement (dB $\mu$ V/m) = Reading(dB $\mu$ V) + C.F (Correction Factor).
- The emission levels of other frequencies are very lower than the limit and not show in test report.

EUT	HAN Access Point	Date of Test	2021-10-07
Factor	DRH18-E	Temp. / Humidity	23°C /49%
Polarity	Horizontal	Site / Test Engineer	AC2 / Jay
Test Mode	802.11a_TX_Band2_CH 64	Test Voltage	AC 120V/60Hz

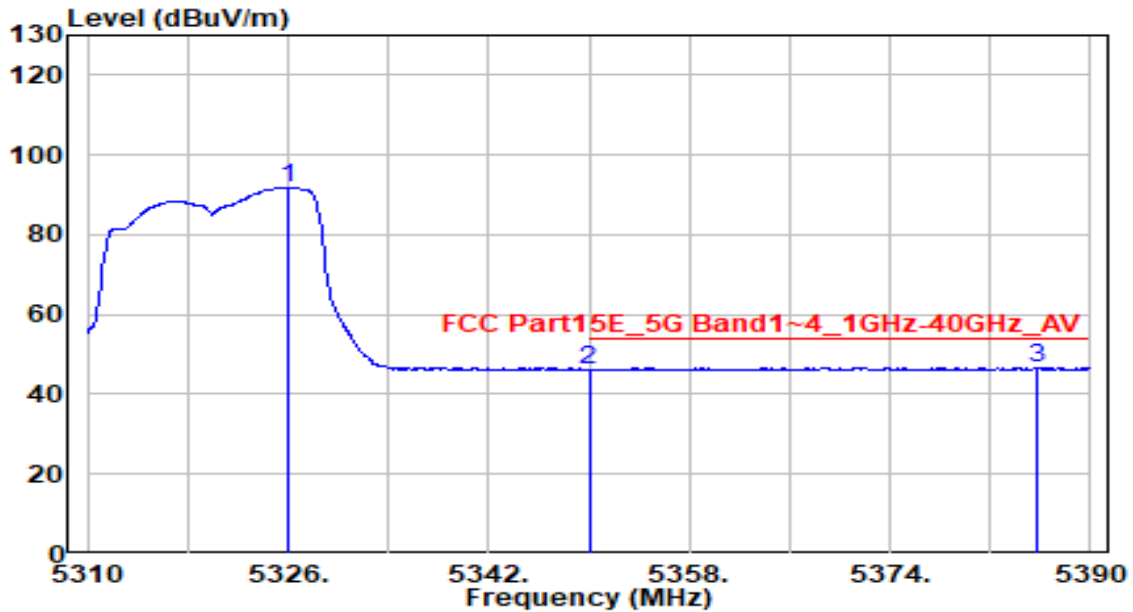

No	Frequency (MHz)	Reading (dBμV)	C.F (dB/m)	Measurement (dBμV/m)	Margin (dB)	Limit (dBμV/m)	Height (cm)	Angle (deg)	Remark (QP/PK/AV)
1	5326.000	92.23	-0.33	91.90	N/A	N/A	215	80	Average
2	5350.000	46.40	-0.33	46.07	-7.93	54.00	215	80	Average
3	* 5385.760	46.93	-0.32	46.60	-7.40	54.00	215	80	Average

Note:

- "\*", means this data is the worst emission level.
- C.F (Correction Factor) = Antenna Factor (dB/m)+ Cable Loss (dB) – Preamplifier(dB) + 20dB Attenuation.
- Measurement (dBμV/m) = Reading(dBμV) + C.F (Correction Factor).
- The emission levels of other frequencies are very lower than the limit and not show in test report.

EUT	HAN Access Point	Date of Test	2021-10-07
Factor	DRH18-E	Temp. / Humidity	23°C /49%
Polarity	Vertical	Site / Test Engineer	AC2 / Jay
Test Mode	802.11a_TX_Band2_CH 64	Test Voltage	AC 120V/60Hz

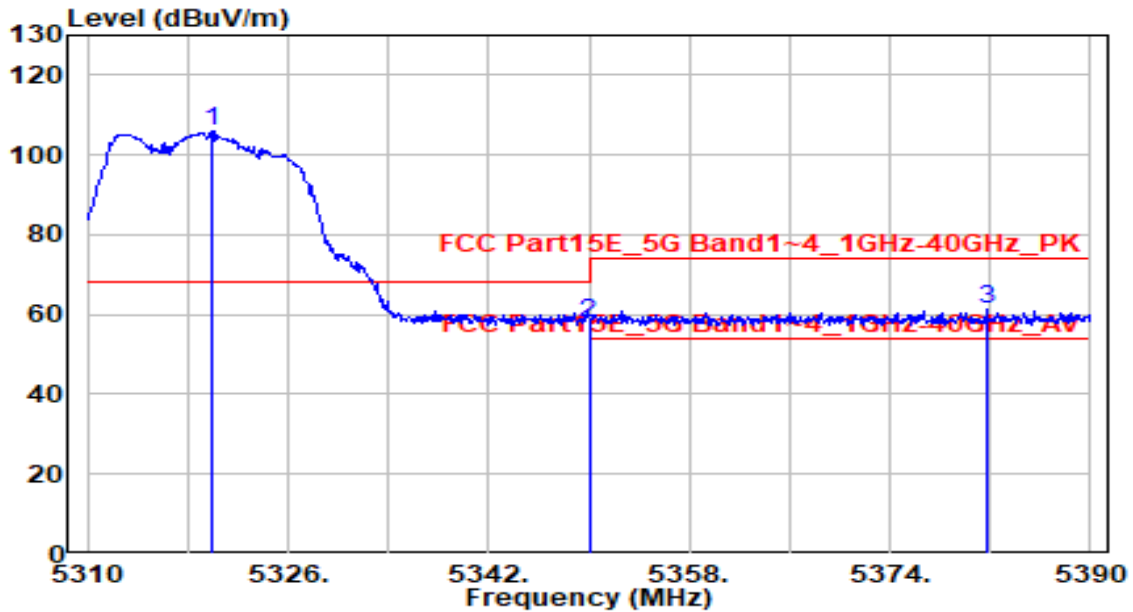

No	Frequency (MHz)	Reading (dBμV)	C.F (dB/m)	Measurement (dBμV/m)	Margin (dB)	Limit (dBμV/m)	Height (cm)	Angle (deg)	Remark (QP/PK/AV)
1	5320.000	106.23	-0.33	105.91	N/A	N/A	230	200	Peak
2	* 5350.000	58.46	-0.33	58.13	-10.07	68.20	230	200	Peak
3	5381.680	61.58	-0.32	61.25	-12.75	74.00	230	200	Peak

Note:

- "\*" means this data is the worst emission level.
- C.F (Correction Factor) = Antenna Factor (dB/m)+ Cable Loss (dB) – Preamplifier(dB) + 20dB Attenuation.
- Measurement (dBμV/m) = Reading(dBμV) + C.F (Correction Factor).
- The emission levels of other frequencies are very lower than the limit and not show in test report.

EUT	HAN Access Point	Date of Test	2021-10-07
Factor	DRH18-E	Temp. / Humidity	23°C /49%
Polarity	Vertical	Site / Test Engineer	AC2 / Jay
Test Mode	802.11a_TX_Band2_CH 64	Test Voltage	AC 120V/60Hz

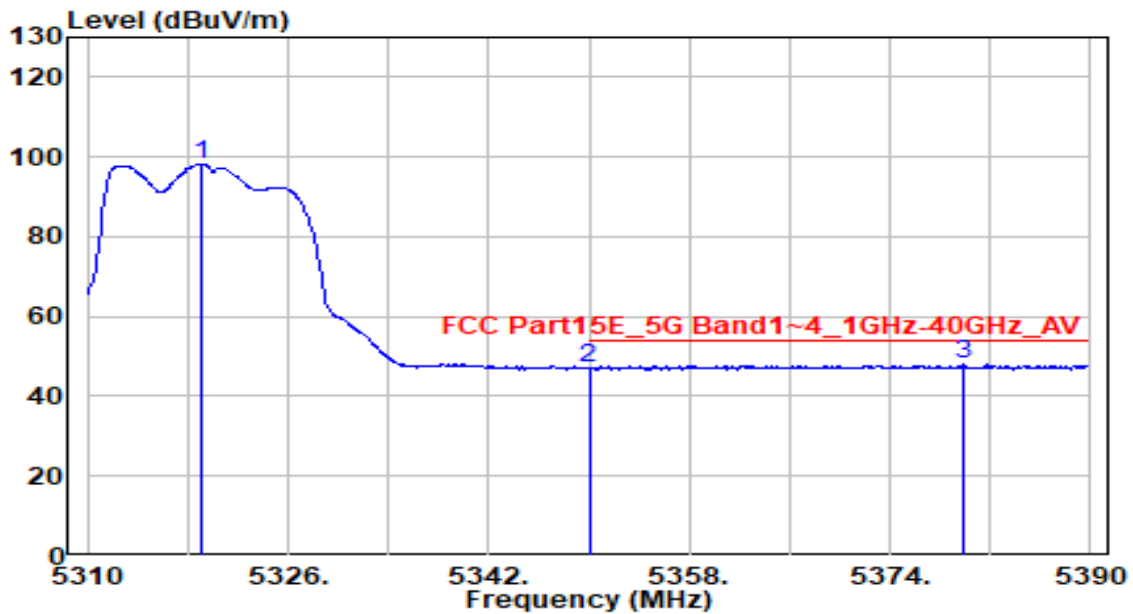

No	Frequency (MHz)	Reading (dBμV)	C.F (dB/m)	Measurement (dBμV/m)	Margin (dB)	Limit (dBμV/m)	Height (cm)	Angle (deg)	Remark (QP/PK/AV)
1	5319.120	98.59	-0.33	98.26	N/A	N/A	230	200	Average
2	5350.000	47.66	-0.33	47.34	-6.66	54.00	230	200	Average
3	* 5379.840	48.33	-0.32	48.01	-5.99	54.00	230	200	Average

Note:

- "\*", means this data is the worst emission level.
- C.F (Correction Factor) = Antenna Factor (dB/m)+ Cable Loss (dB) – Preamplifier(dB) + 20dB Attenuation.
- Measurement (dBμV/m) = Reading(dBμV) + C.F (Correction Factor).
- The emission levels of other frequencies are very lower than the limit and not show in test report.



EUT	HAN Access Point	Date of Test	2021-10-07
Factor	DRH18-E	Temp. / Humidity	23°C /49%
Polarity	Horizontal	Site / Test Engineer	AC2 / Jay
Test Mode	802.11a_TX_Band3_CH 100	Test Voltage	AC 120V/60Hz

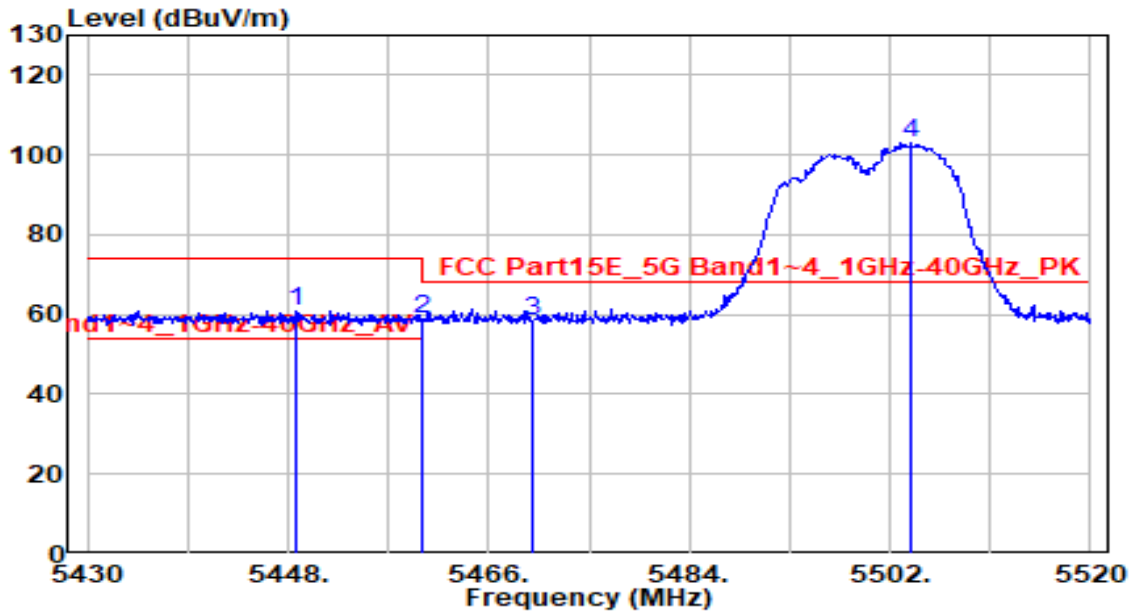

No	Frequency (MHz)	Reading (dBμV)	C.F (dB/m)	Measurement (dBμV/m)	Margin (dB)	Limit (dBμV/m)	Height (cm)	Angle (deg)	Remark (QP/PK/AV)
1	5448.630	60.90	-0.15	60.75	-13.25	74.00	220	140	Peak
2	* 5460.000	58.78	-0.11	58.67	-9.53	68.20	220	140	Peak
3	5470.000	58.67	-0.07	58.60	-9.60	68.20	220	140	Peak
4	5503.980	102.86	0.05	102.91	N/A	N/A	220	140	Peak

Note:

- "\*" means this data is the worst emission level.
- C.F (Correction Factor) = Antenna Factor (dB/m)+ Cable Loss (dB) – Preamplifier(dB) + 20dB Attenuation.
- Measurement (dBμV/m) = Reading(dBμV) + C.F (Correction Factor).
- The emission levels of other frequencies are very lower than the limit and not show in test report.

EUT	HAN Access Point	Date of Test	2021-10-07
Factor	DRH18-E	Temp. / Humidity	23°C /49%
Polarity	Horizontal	Site / Test Engineer	AC2 / Jay
Test Mode	802.11a_TX_Band3_CH 100	Test Voltage	AC 120V/60Hz

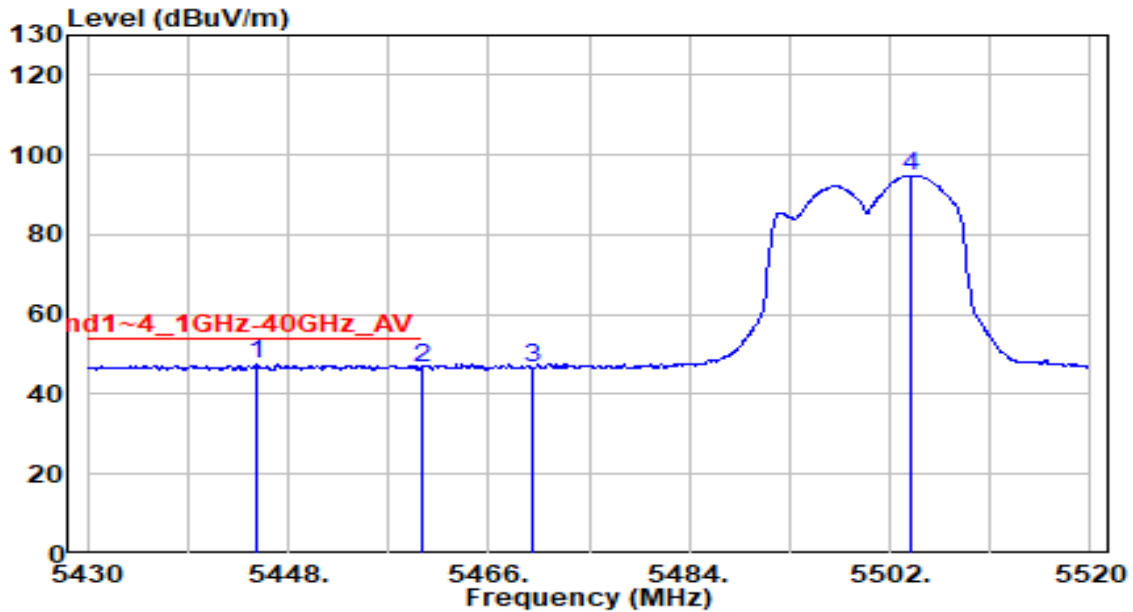

No	Frequency (MHz)	Reading (dB $\mu$ V)	C.F (dB/m)	Measurement (dB $\mu$ V/m)	Margin (dB)	Limit (dB $\mu$ V/m)	Height (cm)	Angle (deg)	Remark (QP/PK/AV)
1	* 5445.120	47.56	-0.16	47.40	-6.60	54.00	220	140	Average
2	5460.000	46.65	-0.11	46.54	-7.46	54.00	220	140	Average
3	5470.000	46.46	-0.07	46.39	-453.61	500.00	220	140	Average
4	5503.980	94.77	0.05	94.82	N/A	N/A	220	140	Average

Note:

1. "\*" means this data is the worst emission level.
2. C.F (Correction Factor) = Antenna Factor (dB/m)+ Cable Loss (dB) – Preamplifier(dB) + 20dB Attenuation.
3. Measurement (dB $\mu$ V/m) = Reading(dB $\mu$ V) + C.F (Correction Factor).
4. The emission levels of other frequencies are very lower than the limit and not show in test report.

EUT	HAN Access Point	Date of Test	2021-10-07
Factor	DRH18-E	Temp. / Humidity	23°C /49%
Polarity	Vertical	Site / Test Engineer	AC2 / Jay
Test Mode	802.11a_TX_Band3_CH 100	Test Voltage	AC 120V/60Hz

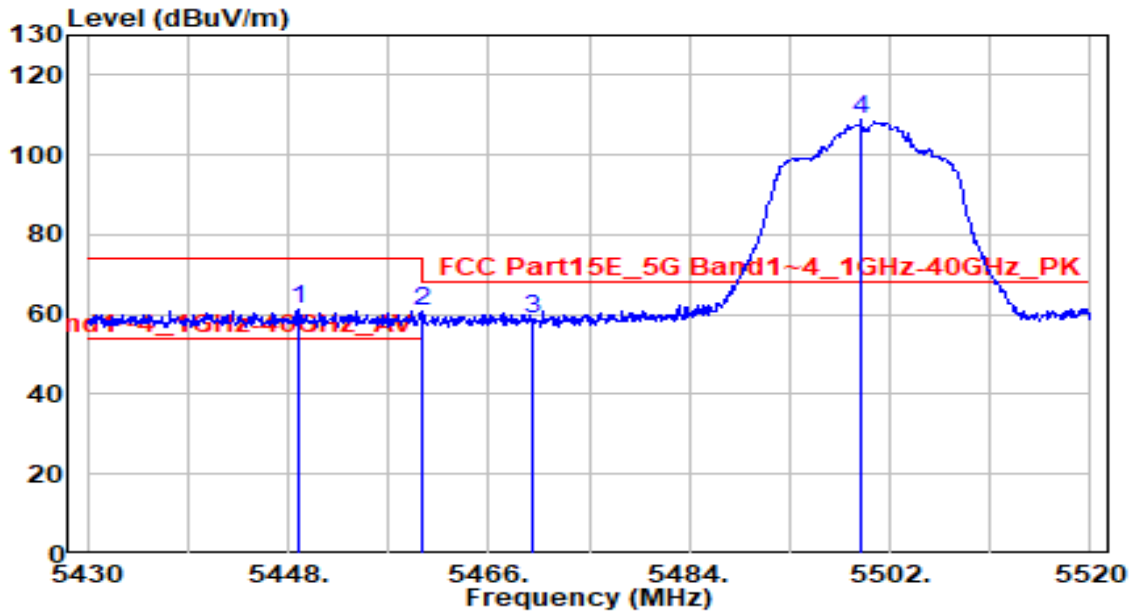

No	Frequency (MHz)	Reading (dB $\mu$ V)	C.F (dB/m)	Measurement (dB $\mu$ V/m)	Margin (dB)	Limit (dB $\mu$ V/m)	Height (cm)	Angle (deg)	Remark (QP/PK/AV)
1	5448.900	61.31	-0.15	61.17	-12.83	74.00	230	170	Peak
2	5460.000	60.87	-0.11	60.77	-7.43	68.20	230	170	Peak
3	* 5470.000	58.81	-0.07	58.73	-9.47	68.20	230	170	Peak
4	5499.390	108.67	0.03	108.70	N/A	N/A	230	170	Peak

Note:

1. " \*", means this data is the worst emission level.
2. C.F (Correction Factor) = Antenna Factor (dB/m)+ Cable Loss (dB) – Preamplifier(dB) + 20dB Attenuation.
3. Measurement (dB $\mu$ V/m) = Reading(dB $\mu$ V) + C.F (Correction Factor).
4. The emission levels of other frequencies are very lower than the limit and not show in test report.

EUT	HAN Access Point	Date of Test	2021-10-07
Factor	DRH18-E	Temp. / Humidity	23°C /49%
Polarity	Vertical	Site / Test Engineer	AC2 / Jay
Test Mode	802.11a_TX_Band3_CH 100	Test Voltage	AC 120V/60Hz

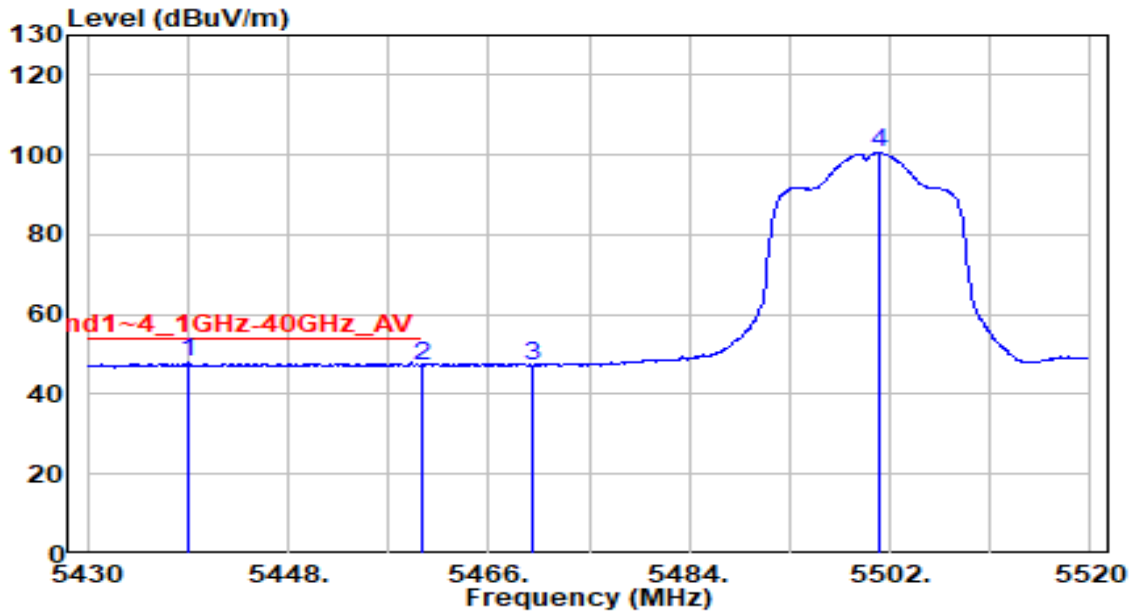

No	Frequency (MHz)	Reading (dBμV)	C.F (dB/m)	Measurement (dBμV/m)	Margin (dB)	Limit (dBμV/m)	Height (cm)	Angle (deg)	Remark (QP/PK/AV)
1	* 5439.000	48.02	-0.18	47.84	-6.16	54.00	230	170	Average
2	5460.000	47.44	-0.11	47.33	-6.67	54.00	230	170	Average
3	5470.000	47.41	-0.07	47.34	N/A	N/A	230	170	Average
4	5501.010	100.62	0.04	100.66	N/A	N/A	230	170	Average

Note:

1. " \*", means this data is the worst emission level.
2. C.F (Correction Factor) = Antenna Factor (dB/m)+ Cable Loss (dB) – Preamplifier(dB) + 20dB Attenuation.
3. Measurement (dBμV/m) = Reading(dBμV) + C.F (Correction Factor).
4. The emission levels of other frequencies are very lower than the limit and not show in test report.

EUT	HAN Access Point	Date of Test	2021-10-07
Factor	DRH18-E	Temp. / Humidity	23°C /49%
Polarity	Horizontal	Site / Test Engineer	AC2 / Jay
Test Mode	802.11a_TX_Band3_CH 140	Test Voltage	AC 120V/60Hz

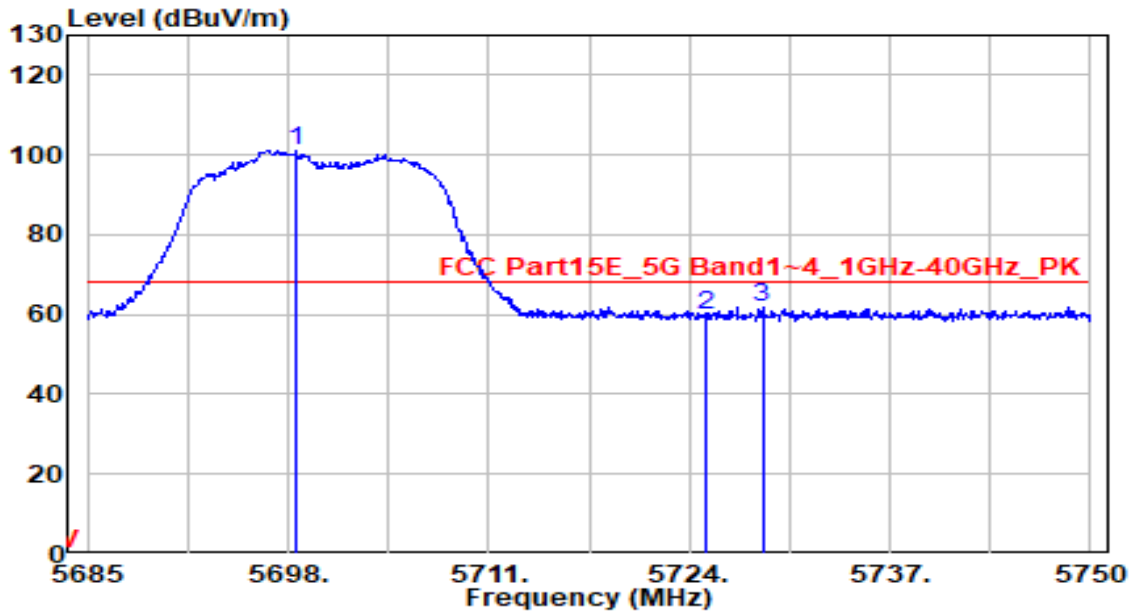

No	Frequency (MHz)	Reading (dB $\mu$ V)	C.F (dB/m)	Measurement (dB $\mu$ V/m)	Margin (dB)	Limit (dB $\mu$ V/m)	Height (cm)	Angle (deg)	Remark (QP/PK/AV)
1	5698.585	100.39	0.80	101.20	N/A	N/A	230	130	Peak
2	5725.000	58.93	0.91	59.84	-8.36	68.20	230	130	Peak
3	* 5728.745	61.01	0.93	61.94	-6.26	68.20	230	130	Peak

Note:

- "\*", means this data is the worst emission level.
- C.F (Correction Factor) = Antenna Factor (dB/m)+ Cable Loss (dB) – Preamplifier(dB) + 20dB Attenuation.
- Measurement (dB $\mu$ V/m) = Reading(dB $\mu$ V) + C.F (Correction Factor).
- The emission levels of other frequencies are very lower than the limit and not show in test report.

EUT	HAN Access Point	Date of Test	2021-10-07
Factor	DRH18-E	Temp. / Humidity	23°C /49%
Polarity	Vertical	Site / Test Engineer	AC2 / Jay
Test Mode	802.11a_TX_Band3_CH 140	Test Voltage	AC 120V/60Hz

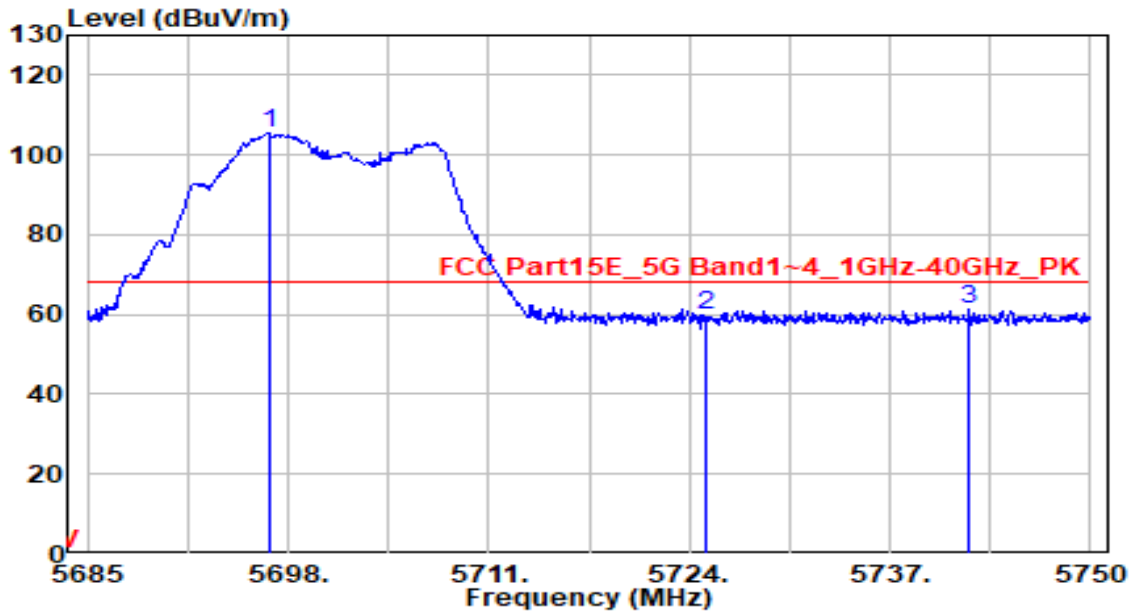

No	Frequency (MHz)	Reading (dB $\mu$ V)	C.F (dB/m)	Measurement (dB $\mu$ V/m)	Margin (dB)	Limit (dB $\mu$ V/m)	Height (cm)	Angle (deg)	Remark (QP/PK/AV)
1	5696.765	104.58	0.80	105.38	N/A	N/A	230	50	Peak
2	5725.000	58.97	0.91	59.89	-8.31	68.20	230	50	Peak
3	* 5742.135	60.41	0.98	61.40	-6.80	68.20	230	50	Peak

Note:

- "\*", means this data is the worst emission level.
- C.F (Correction Factor) = Antenna Factor (dB/m)+ Cable Loss (dB) – Preamplifier(dB) + 20dB Attenuation.
- Measurement (dB $\mu$ V/m) = Reading(dB $\mu$ V) + C.F (Correction Factor).
- The emission levels of other frequencies are very lower than the limit and not show in test report.

EUT	HAN Access Point	Date of Test	2021-10-07
Factor	DRH18-E	Temp. / Humidity	23°C /49%
Polarity	Horizontal	Site / Test Engineer	AC2 / Jay
Test Mode	802.11a_TX_Band4_CH 149	Test Voltage	AC 120V/60Hz

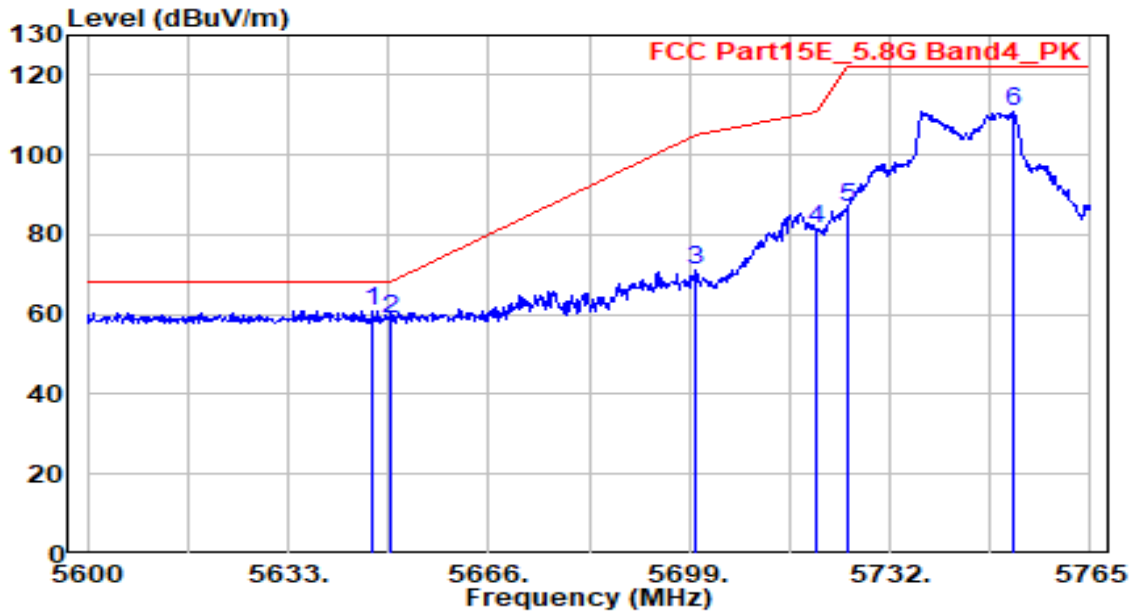

No	Frequency (MHz)	Reading (dB $\mu$ V)	C.F (dB/m)	Measurement (dB $\mu$ V/m)	Margin (dB)	Limit (dB $\mu$ V/m)	Height (cm)	Angle (deg)	Remark (QP/PK/AV)
1	* 5646.860	60.45	0.59	61.05	-7.15	68.20	220	165	Peak
2	5650.000	58.26	0.60	58.87	-9.33	68.20	220	165	Peak
3	5700.000	70.41	0.81	71.22	-33.98	105.20	220	165	Peak
4	5720.000	80.67	0.89	81.56	-29.24	110.80	220	165	Peak
5	5725.000	85.79	0.91	86.70	-35.50	122.20	220	165	Peak
6	5752.295	109.75	1.03	110.78	N/A	N/A	220	165	Peak

Note:

1. " \*", means this data is the worst emission level.
2. C.F (Correction Factor) = Antenna Factor (dB/m)+ Cable Loss (dB) – Preamplifier(dB) + 20dB Attenuation.
3. Measurement (dB $\mu$ V/m) = Reading(dB $\mu$ V) + C.F (Correction Factor).
4. The emission levels of other frequencies are very lower than the limit and not show in test report.

EUT	HAN Access Point	Date of Test	2021-10-07
Factor	DRH18-E	Temp. / Humidity	23°C /49%
Polarity	Vertical	Site / Test Engineer	AC2 / Jay
Test Mode	802.11a_TX_Band4_CH 149	Test Voltage	AC 120V/60Hz

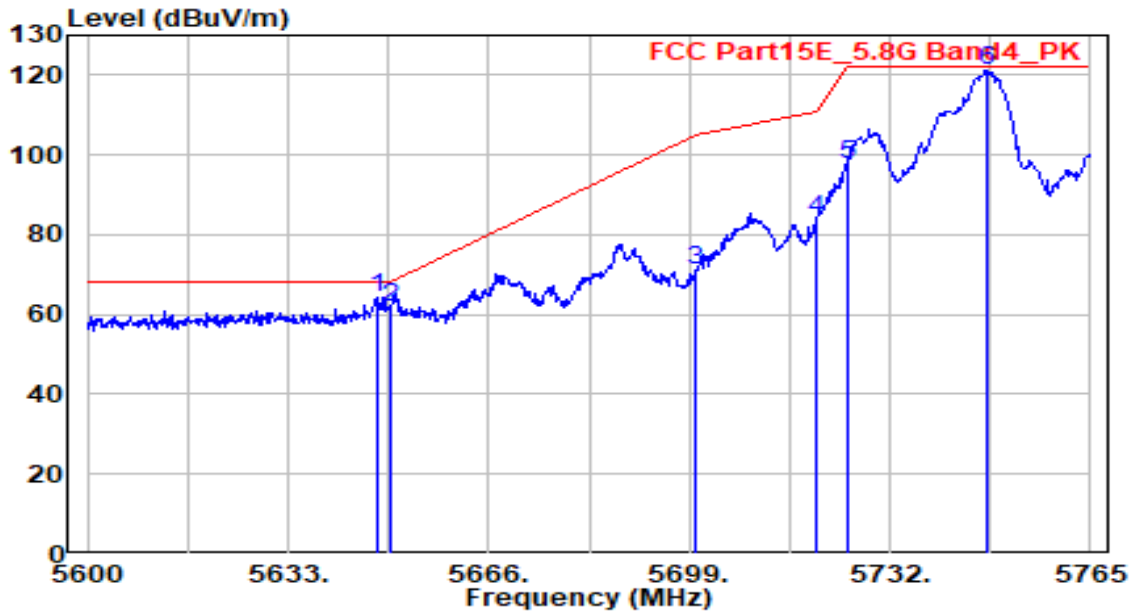

No	Frequency (MHz)	Reading (dBμV)	C.F (dB/m)	Measurement (dBμV/m)	Margin (dB)	Limit (dBμV/m)	Height (cm)	Angle (deg)	Remark (QP/PK/AV)
1	* 5647.520	63.68	0.59	64.27	-3.93	68.20	230	110	Peak
2	5649.995	61.09	0.60	61.70	-6.50	68.20	230	110	Peak
3	5700.000	70.50	0.81	71.31	-33.89	105.20	230	110	Peak
4	5720.000	82.82	0.89	83.71	-27.09	110.80	230	110	Peak
5	5725.000	96.91	0.91	97.82	-24.38	122.20	230	110	Peak
6	5748.170	120.31	1.01	121.32	N/A	N/A	230	110	Peak

Note:

1. " \*", means this data is the worst emission level.
2. C.F (Correction Factor) = Antenna Factor (dB/m)+ Cable Loss (dB) – Preamplifier(dB) + 20dB Attenuation.
3. Measurement (dBμV/m) = Reading(dBμV) + C.F (Correction Factor).
4. The emission levels of other frequencies are very lower than the limit and not show in test report.



EUT	HAN Access Point	Date of Test	2021-10-07
Factor	DRH18-E	Temp. / Humidity	23°C /49%
Polarity	Horizontal	Site / Test Engineer	AC2 / Jay
Test Mode	802.11a_TX_Band4_CH 165	Test Voltage	AC 120V/60Hz

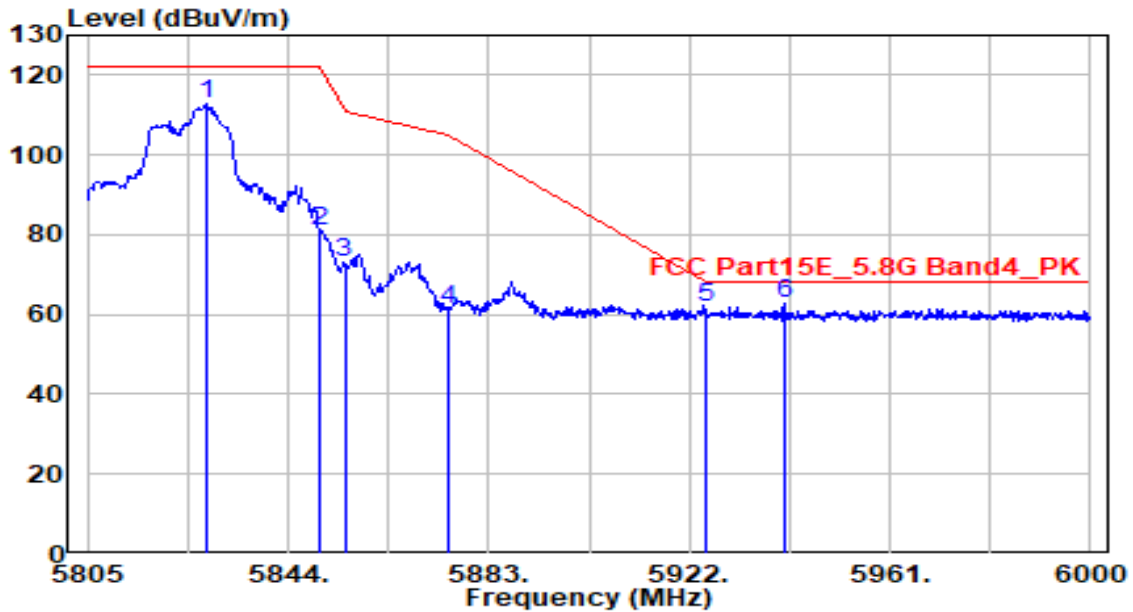

No	Frequency (MHz)	Reading (dBμV)	C.F (dB/m)	Measurement (dBμV/m)	Margin (dB)	Limit (dBμV/m)	Height (cm)	Angle (deg)	Remark (QP/PK/AV)
1	5828.205	111.48	1.25	112.73	N/A	N/A	220	125	Peak
2	5850.000	79.91	1.28	81.18	-41.02	122.20	220	125	Peak
3	5855.000	71.66	1.28	72.94	-37.86	110.80	220	125	Peak
4	5875.000	60.01	1.30	61.31	-43.89	105.20	220	125	Peak
5	5925.000	60.29	1.35	61.64	-6.56	68.20	220	125	Peak
6	* 5940.330	61.51	1.37	62.88	-5.32	68.20	220	125	Peak

Note:

1. " \*", means this data is the worst emission level.
2. C.F (Correction Factor) = Antenna Factor (dB/m)+ Cable Loss (dB) – Preamplifier(dB) + 20dB Attenuation.
3. Measurement (dBμV/m) = Reading(dBμV) + C.F (Correction Factor).
4. The emission levels of other frequencies are very lower than the limit and not show in test report.

EUT	HAN Access Point	Date of Test	2021-10-07
Factor	DRH18-E	Temp. / Humidity	23°C /49%
Polarity	Vertical	Site / Test Engineer	AC2 / Jay
Test Mode	802.11a_TX_Band4_CH 165	Test Voltage	AC 120V/60Hz

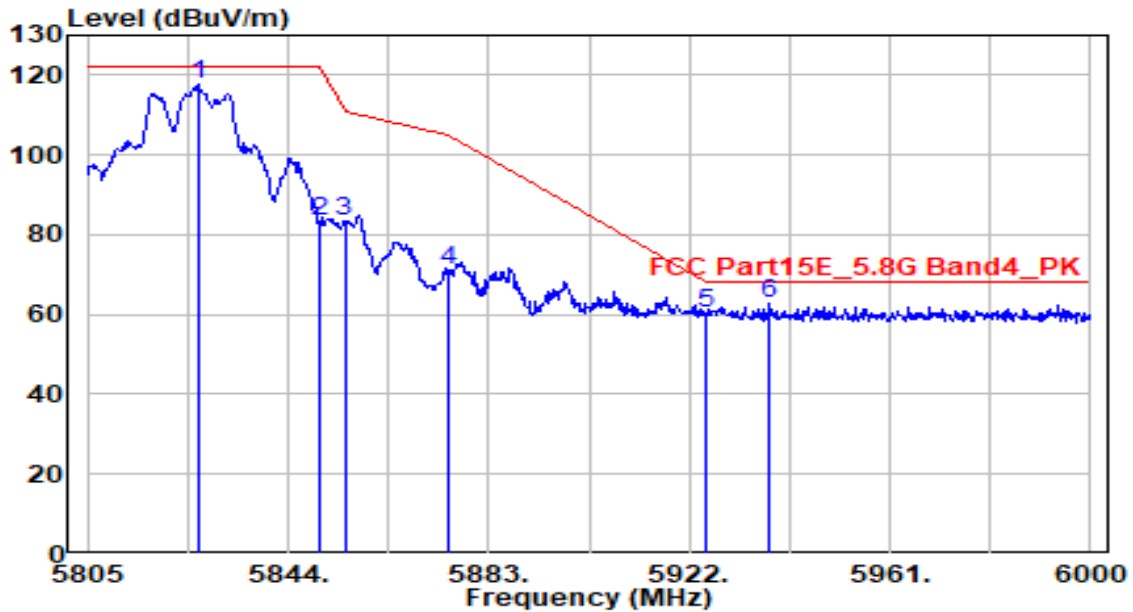

No	Frequency (MHz)	Reading (dB $\mu$ V)	C.F (dB/m)	Measurement (dB $\mu$ V/m)	Margin (dB)	Limit (dB $\mu$ V/m)	Height (cm)	Angle (deg)	Remark (QP/PK/AV)
1	5826.450	116.47	1.25	117.72	N/A	N/A	230	100	Peak
2	5850.045	81.99	1.28	83.26	-38.83	122.10	230	100	Peak
3	5855.000	82.06	1.28	83.34	-27.46	110.80	230	100	Peak
4	5875.000	69.79	1.30	71.09	-34.11	105.20	230	100	Peak
5	5925.000	59.06	1.35	60.41	-7.79	68.20	230	100	Peak
6	* 5937.600	61.50	1.37	62.86	-5.34	68.20	230	100	Peak

Note:

1. " \*", means this data is the worst emission level.
2. C.F (Correction Factor) = Antenna Factor (dB/m)+ Cable Loss (dB) – Preamplifier(dB) + 20dB Attenuation.
3. Measurement (dB $\mu$ V/m) = Reading(dB $\mu$ V) + C.F (Correction Factor).
4. The emission levels of other frequencies are very lower than the limit and not show in test report.

EUT	HAN Access Point	Date of Test	2021-10-07
Factor	DRH18-E	Temp. / Humidity	23°C /49%
Polarity	Horizontal	Site / Test Engineer	AC2 / Jay
Test Mode	802.11ac20_TX_Band1_CH 36	Test Voltage	AC 120V/60Hz

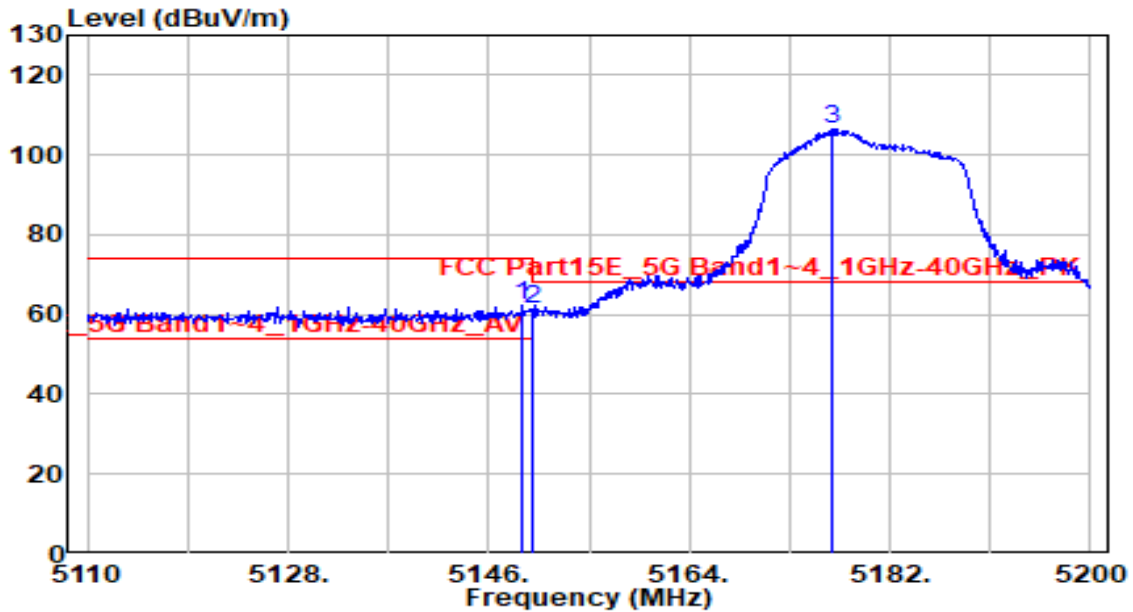

No	Frequency (MHz)	Reading (dBμV)	C.F (dB/m)	Measurement (dBμV/m)	Margin (dB)	Limit (dBμV/m)	Height (cm)	Angle (deg)	Remark (QP/PK/AV)
1	* 5148.970	62.40	-0.32	62.09	-11.91	74.00	150	80	Peak
2	5150.000	61.67	-0.32	61.35	-12.65	74.00	150	80	Peak
3	5176.780	106.86	-0.32	106.54	N/A	N/A	150	80	Peak

Note:

- "\*" means this data is the worst emission level.
- C.F (Correction Factor) = Antenna Factor (dB/m)+ Cable Loss (dB) – Preamplifier(dB) + 20dB Attenuation.
- Measurement (dBμV/m) = Reading(dBμV) + C.F (Correction Factor).
- The emission levels of other frequencies are very lower than the limit and not show in test report.

EUT	HAN Access Point	Date of Test	2021-10-07
Factor	DRH18-E	Temp. / Humidity	23°C /49%
Polarity	Horizontal	Site / Test Engineer	AC2 / Jay
Test Mode	802.11ac20_TX_Band1_CH 36	Test Voltage	AC 120V/60Hz

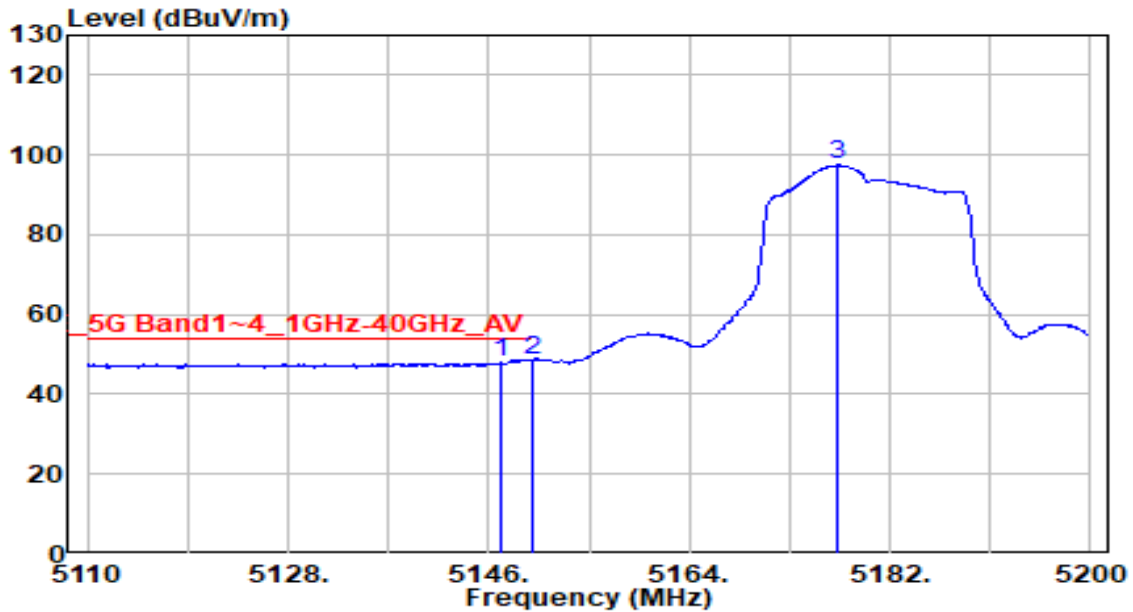

No	Frequency (MHz)	Reading (dB $\mu$ V)	C.F (dB/m)	Measurement (dB $\mu$ V/m)	Margin (dB)	Limit (dB $\mu$ V/m)	Height (cm)	Angle (deg)	Remark (QP/PK/AV)
1	5147.170	48.16	-0.32	47.84	-6.16	54.00	150	80	Average
2	* 5150.000	48.87	-0.32	48.55	-5.45	54.00	150	80	Average
3	5177.320	97.77	-0.32	97.45	N/A	N/A	150	80	Average

Note:

- "\*" means this data is the worst emission level.
- C.F (Correction Factor) = Antenna Factor (dB/m)+ Cable Loss (dB) – Preamplifier(dB) + 20dB Attenuation.
- Measurement (dB $\mu$ V/m) = Reading(dB $\mu$ V) + C.F (Correction Factor).
- The emission levels of other frequencies are very lower than the limit and not show in test report.

EUT	HAN Access Point	Date of Test	2021-10-07
Factor	DRH18-E	Temp. / Humidity	23°C /49%
Polarity	Vertical	Site / Test Engineer	AC2 / Jay
Test Mode	802.11ac20_TX_Band1_CH 36	Test Voltage	AC 120V/60Hz

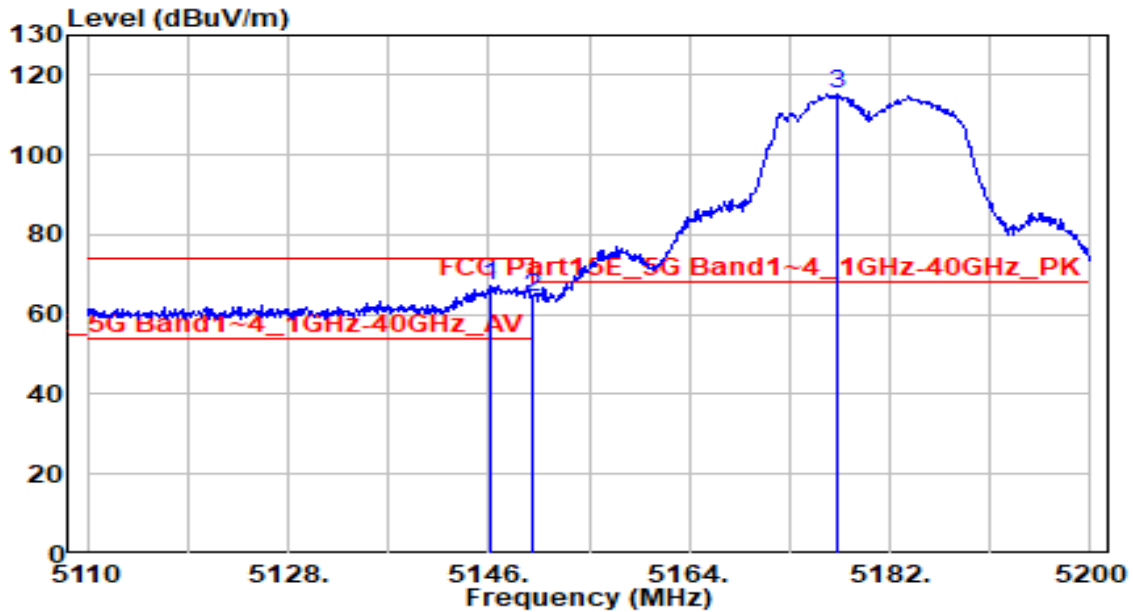

No	Frequency (MHz)	Reading (dBμV)	C.F (dB/m)	Measurement (dBμV/m)	Margin (dB)	Limit (dBμV/m)	Height (cm)	Angle (deg)	Remark (QP/PK/AV)
1	* 5146.270	67.63	-0.32	67.31	-6.69	74.00	270	170	Peak
2	5150.000	64.80	-0.32	64.48	-9.52	74.00	270	170	Peak
3	5177.320	115.83	-0.32	115.50	N/A	N/A	270	170	Peak

Note:

1. " \*", means this data is the worst emission level.
2. C.F (Correction Factor) = Antenna Factor (dB/m)+ Cable Loss (dB) – Preamplifier(dB) + 20dB Attenuation.
3. Measurement (dBμV/m) = Reading(dBμV) + C.F (Correction Factor).
4. The emission levels of other frequencies are very lower than the limit and not show in test report.

EUT	HAN Access Point	Date of Test	2021-10-07
Factor	DRH18-E	Temp. / Humidity	23°C /49%
Polarity	Vertical	Site / Test Engineer	AC2 / Jay
Test Mode	802.11ac20_TX_Band1_CH 36	Test Voltage	AC 120V/60Hz

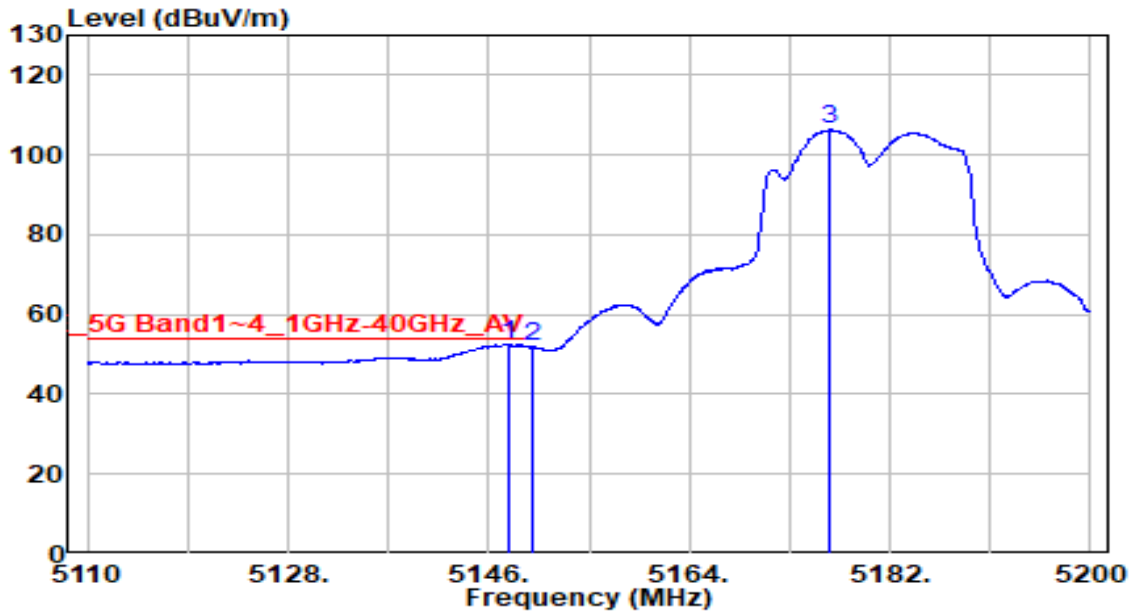

No	Frequency (MHz)	Reading (dB $\mu$ V)	C.F (dB/m)	Measurement (dB $\mu$ V/m)	Margin (dB)	Limit (dB $\mu$ V/m)	Height (cm)	Angle (deg)	Remark (QP/PK/AV)
1	*	52.95	-0.32	52.63	-1.37	54.00	270	170	Average
2		52.25	-0.32	51.93	-2.07	54.00	270	170	Average
3		106.60	-0.32	106.28	N/A	N/A	270	170	Average

Note:

- "\*" means this data is the worst emission level.
- C.F (Correction Factor) = Antenna Factor (dB/m)+ Cable Loss (dB) – Preamplifier(dB) + 20dB Attenuation.
- Measurement (dB $\mu$ V/m) = Reading(dB $\mu$ V) + C.F (Correction Factor).
- The emission levels of other frequencies are very lower than the limit and not show in test report.

EUT	HAN Access Point	Date of Test	2021-10-07
Factor	DRH18-E	Temp. / Humidity	23°C /49%
Polarity	Horizontal	Site / Test Engineer	AC2 / Jay
Test Mode	802.11ac_TX_Band2_CH 64	Test Voltage	AC 120V/60Hz

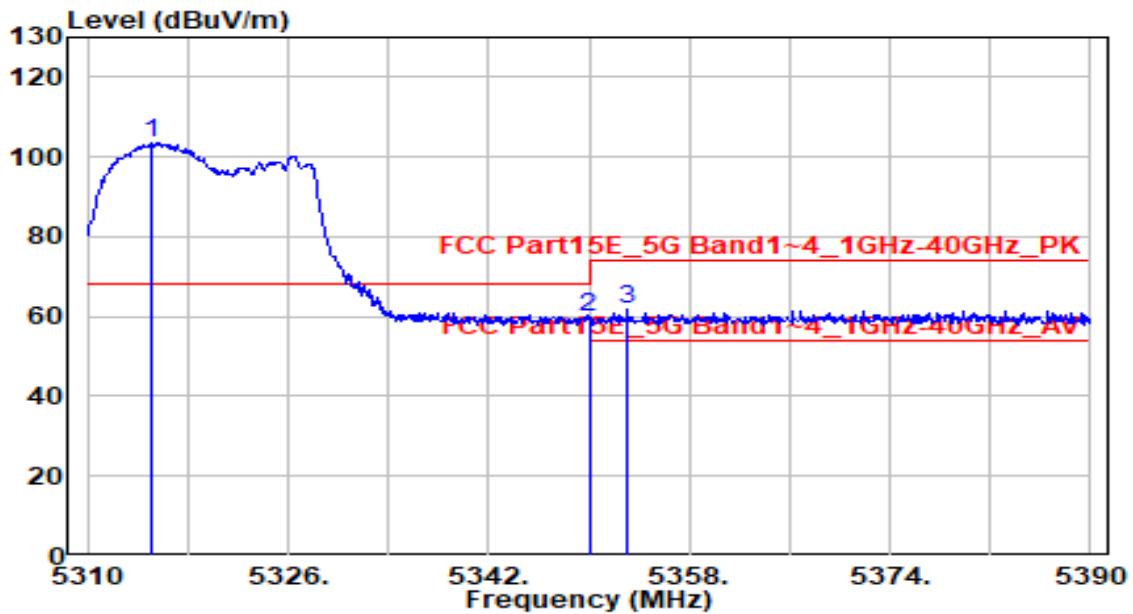

No	Frequency (MHz)	Reading (dB $\mu$ V)	C.F (dB/m)	Measurement (dB $\mu$ V/m)	Margin (dB)	Limit (dB $\mu$ V/m)	Height (cm)	Angle (deg)	Remark (QP/PK/AV)
1	5315.040	103.94	-0.33	103.61	N/A	N/A	215	80	Peak
2	* 5350.000	60.14	-0.33	59.81	-8.39	68.20	215	80	Peak
3	5353.120	62.13	-0.33	61.80	-12.20	74.00	215	80	Peak

Note:

- "\*" means this data is the worst emission level.
- C.F (Correction Factor) = Antenna Factor (dB/m)+ Cable Loss (dB) – Preamplifier(dB) + 20dB Attenuation.
- Measurement (dB $\mu$ V/m) = Reading(dB $\mu$ V) + C.F (Correction Factor).
- The emission levels of other frequencies are very lower than the limit and not show in test report.

EUT	HAN Access Point	Date of Test	2021-10-07
Factor	DRH18-E	Temp. / Humidity	23°C /49%
Polarity	Horizontal	Site / Test Engineer	AC2 / Jay
Test Mode	802.11ac_TX_Band2_CH 64	Test Voltage	AC 120V/60Hz

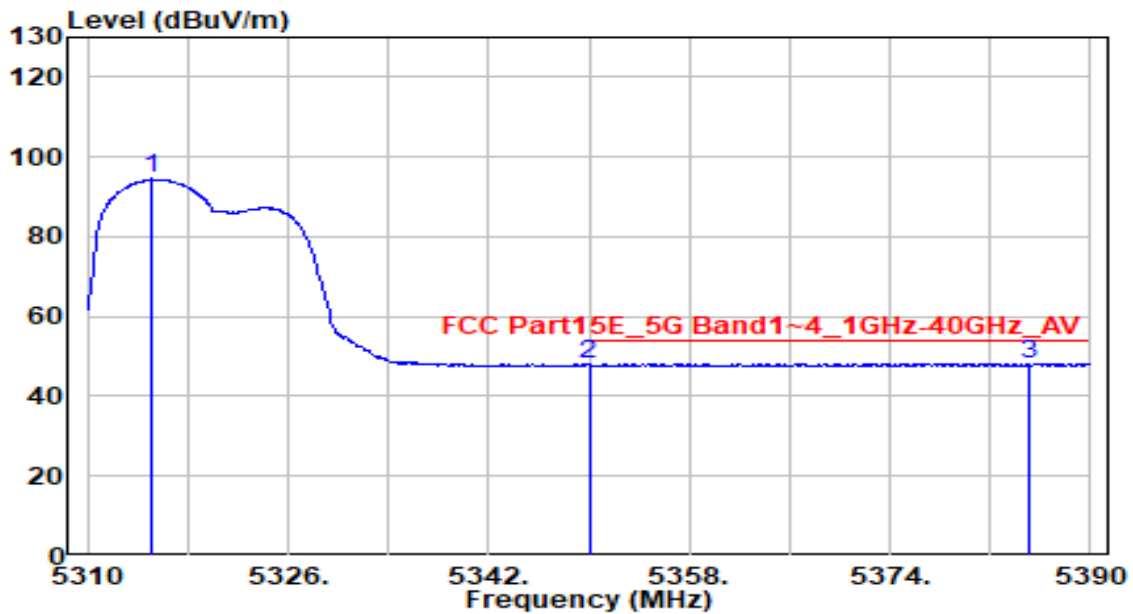

No	Frequency (MHz)	Reading (dBμV)	C.F (dB/m)	Measurement (dBμV/m)	Margin (dB)	Limit (dBμV/m)	Height (cm)	Angle (deg)	Remark (QP/PK/AV)
1	5315.200	94.77	-0.33	94.44	N/A	N/A	215	80	Average
2	5350.000	48.16	-0.33	47.83	-6.17	54.00	215	80	Average
3	* 5385.040	48.56	-0.32	48.24	-5.76	54.00	215	80	Average

Note:

- "\*" means this data is the worst emission level.
- C.F (Correction Factor) = Antenna Factor (dB/m)+ Cable Loss (dB) – Preamplifier(dB) + 20dB Attenuation.
- Measurement (dBμV/m) = Reading(dBμV) + C.F (Correction Factor).
- The emission levels of other frequencies are very lower than the limit and not show in test report.



EUT	HAN Access Point	Date of Test	2021-10-07
Factor	DRH18-E	Temp. / Humidity	23°C /49%
Polarity	Vertical	Site / Test Engineer	AC2 / Jay
Test Mode	802.11ac_TX_Band2_CH 64	Test Voltage	AC 120V/60Hz

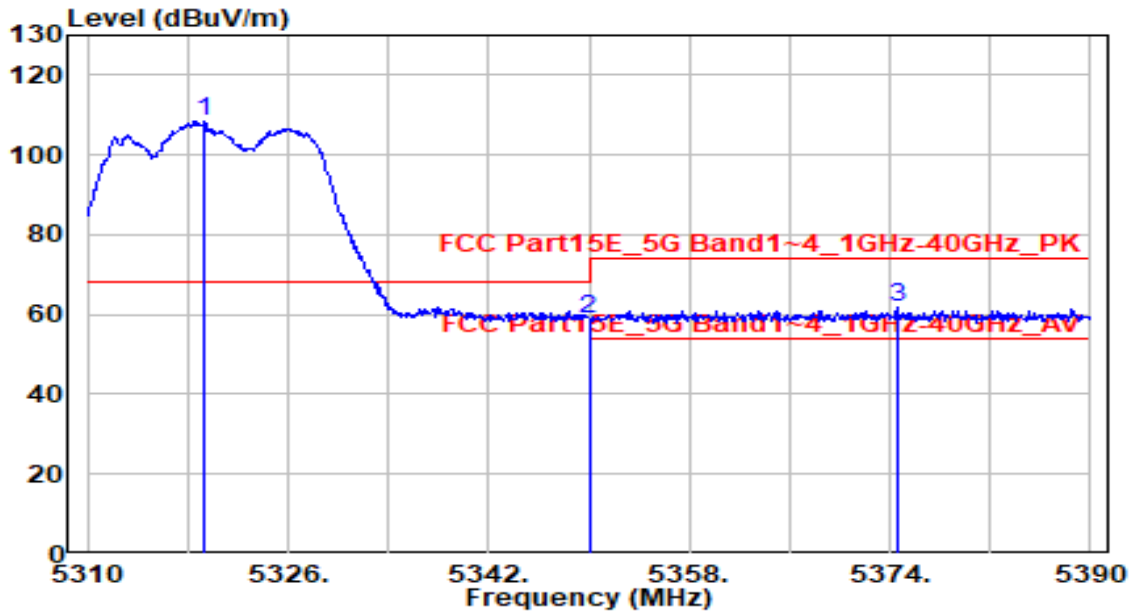

No	Frequency (MHz)	Reading (dB $\mu$ V)	C.F (dB/m)	Measurement (dB $\mu$ V/m)	Margin (dB)	Limit (dB $\mu$ V/m)	Height (cm)	Angle (deg)	Remark (QP/PK/AV)
1	5319.280	108.96	-0.33	108.63	N/A	N/A	230	200	Peak
2	* 5350.000	59.40	-0.33	59.07	-9.13	68.20	230	200	Peak
3	5374.560	62.01	-0.32	61.69	-12.31	74.00	230	200	Peak

Note:

- "\*" means this data is the worst emission level.
- C.F (Correction Factor) = Antenna Factor (dB/m)+ Cable Loss (dB) – Preamplifier(dB) + 20dB Attenuation.
- Measurement (dB $\mu$ V/m) = Reading(dB $\mu$ V) + C.F (Correction Factor).
- The emission levels of other frequencies are very lower than the limit and not show in test report.

EUT	HAN Access Point	Date of Test	2021-10-07
Factor	DRH18-E	Temp. / Humidity	23°C /49%
Polarity	Vertical	Site / Test Engineer	AC2 / Jay
Test Mode	802.11ac_TX_Band2_CH 64	Test Voltage	AC 120V/60Hz

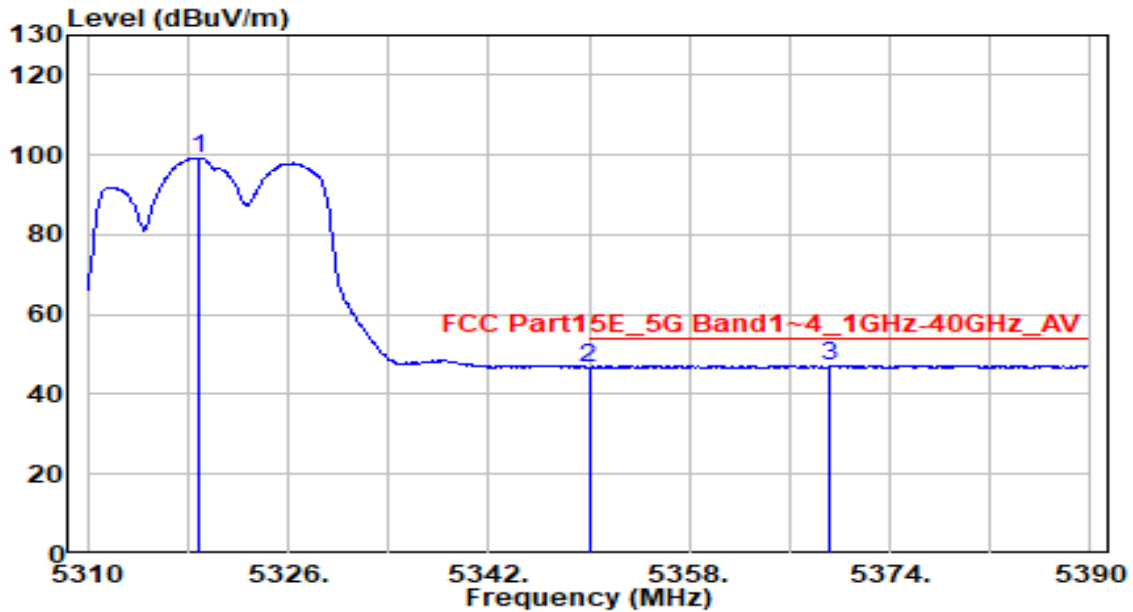

No	Frequency (MHz)	Reading (dB $\mu$ V)	C.F (dB/m)	Measurement (dB $\mu$ V/m)	Margin (dB)	Limit (dB $\mu$ V/m)	Height (cm)	Angle (deg)	Remark (QP/PK/AV)
1	5318.880	99.61	-0.33	99.28	N/A	N/A	230	200	Average
2	5350.000	47.17	-0.33	46.84	-7.16	54.00	230	200	Average
3	* 5369.280	47.65	-0.32	47.33	-6.67	54.00	230	200	Average

Note:

- "\*" means this data is the worst emission level.
- C.F (Correction Factor) = Antenna Factor (dB/m)+ Cable Loss (dB) – Preamplifier(dB) + 20dB Attenuation.
- Measurement (dB $\mu$ V/m) = Reading(dB $\mu$ V) + C.F (Correction Factor).
- The emission levels of other frequencies are very lower than the limit and not show in test report.

EUT	HAN Access Point	Date of Test	2021-10-07
Factor	DRH18-E	Temp. / Humidity	23°C /49%
Polarity	Horizontal	Site / Test Engineer	AC2 / Jay
Test Mode	802.11ac20_TX_Band3_CH 100	Test Voltage	AC 120V/60Hz

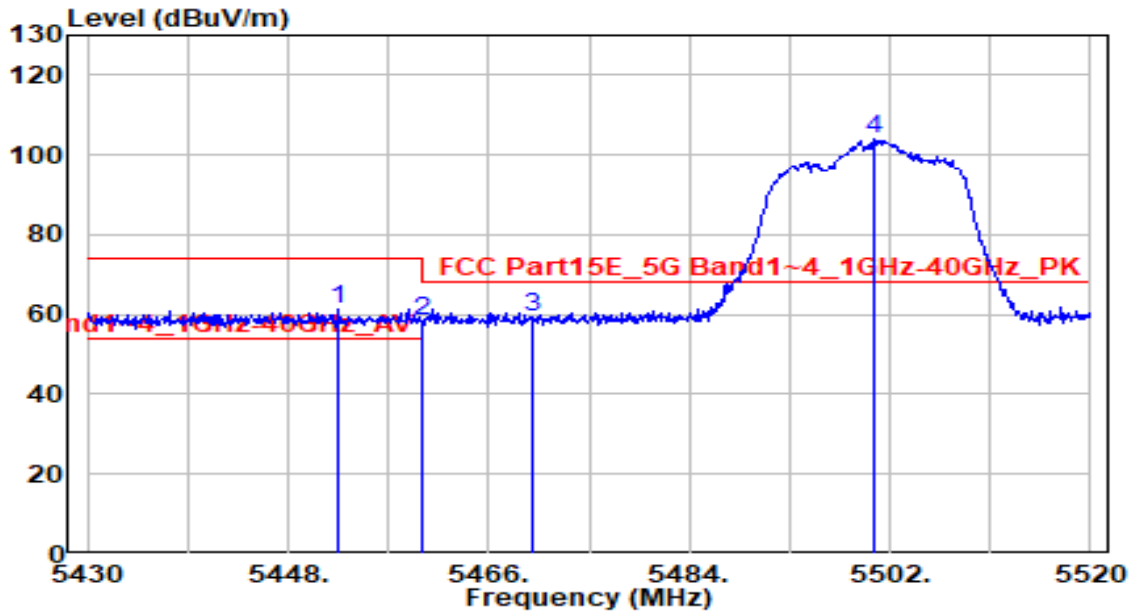

No	Frequency (MHz)	Reading (dB $\mu$ V)	C.F (dB/m)	Measurement (dB $\mu$ V/m)	Margin (dB)	Limit (dB $\mu$ V/m)	Height (cm)	Angle (deg)	Remark (QP/PK/AV)
1	5452.590	61.67	-0.13	61.54	-12.46	74.00	220	140	Peak
2	5460.000	58.46	-0.11	58.35	-9.85	68.20	220	140	Peak
3	* 5470.000	59.33	-0.07	59.26	-8.94	68.20	220	140	Peak
4	5500.650	103.81	0.04	103.85	N/A	N/A	220	140	Peak

Note:

1. " \*", means this data is the worst emission level.
2. C.F (Correction Factor) = Antenna Factor (dB/m)+ Cable Loss (dB) – Preamplifier(dB) + 20dB Attenuation.
3. Measurement (dB $\mu$ V/m) = Reading(dB $\mu$ V) + C.F (Correction Factor).
4. The emission levels of other frequencies are very lower than the limit and not show in test report.

EUT	HAN Access Point	Date of Test	2021-10-07
Factor	DRH18-E	Temp. / Humidity	23°C /49%
Polarity	Horizontal	Site / Test Engineer	AC2 / Jay
Test Mode	802.11ac20_TX_Band3_CH 100	Test Voltage	AC 120V/60Hz

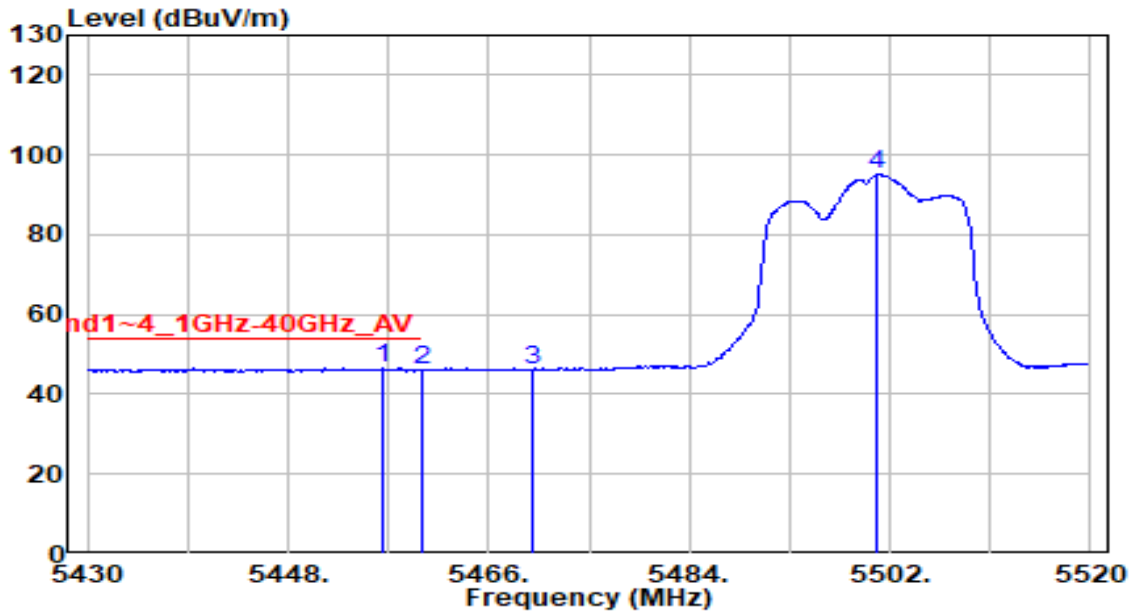

No	Frequency (MHz)	Reading (dB $\mu$ V)	C.F (dB/m)	Measurement (dB $\mu$ V/m)	Margin (dB)	Limit (dB $\mu$ V/m)	Height (cm)	Angle (deg)	Remark (QP/PK/AV)
1	* 5456.460	46.55	-0.12	46.43	-7.57	54.00	220	140	Average
2	5460.000	46.27	-0.11	46.16	-7.84	54.00	220	140	Average
3	5470.000	46.27	-0.07	46.20	N/A	N/A	220	140	Average
4	5500.920	94.99	0.04	95.03	N/A	N/A	220	140	Average

Note:

1. "\*" , means this data is the worst emission level.
2. C.F (Correction Factor) = Antenna Factor (dB/m)+ Cable Loss (dB) – Preamplifier(dB) + 20dB Attenuation.
3. Measurement (dB $\mu$ V/m) = Reading(dB $\mu$ V) + C.F (Correction Factor).
4. The emission levels of other frequencies are very lower than the limit and not show in test report.

EUT	HAN Access Point	Date of Test	2021-10-07
Factor	DRH18-E	Temp. / Humidity	23°C /49%
Polarity	Vertical	Site / Test Engineer	AC2 / Jay
Test Mode	802.11ac20_TX_Band3_CH 100	Test Voltage	AC 120V/60Hz

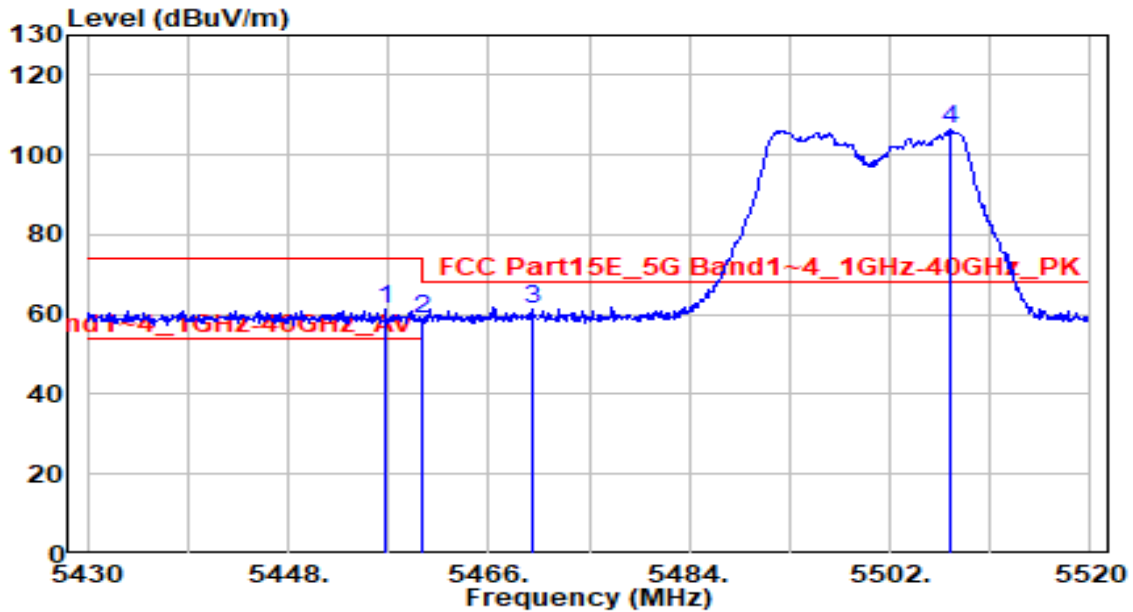

No	Frequency (MHz)	Reading (dB $\mu$ V)	C.F (dB/m)	Measurement (dB $\mu$ V/m)	Margin (dB)	Limit (dB $\mu$ V/m)	Height (cm)	Angle (deg)	Remark (QP/PK/AV)
1	5456.730	61.44	-0.12	61.32	-12.68	74.00	230	170	Peak
2	5460.000	59.03	-0.11	58.93	-9.27	68.20	230	170	Peak
3	* 5470.000	61.52	-0.07	61.44	-6.76	68.20	230	170	Peak
4	5507.490	106.41	0.06	106.48	N/A	N/A	230	170	Peak

Note:

1. " \*", means this data is the worst emission level.
2. C.F (Correction Factor) = Antenna Factor (dB/m)+ Cable Loss (dB) – Preamplifier(dB) + 20dB Attenuation.
3. Measurement (dB $\mu$ V/m) = Reading(dB $\mu$ V) + C.F (Correction Factor).
4. The emission levels of other frequencies are very lower than the limit and not show in test report.

EUT	HAN Access Point	Date of Test	2021-10-07
Factor	DRH18-E	Temp. / Humidity	23°C /49%
Polarity	Vertical	Site / Test Engineer	AC2 / Jay
Test Mode	802.11ac20_TX_Band3_CH 100	Test Voltage	AC 120V/60Hz

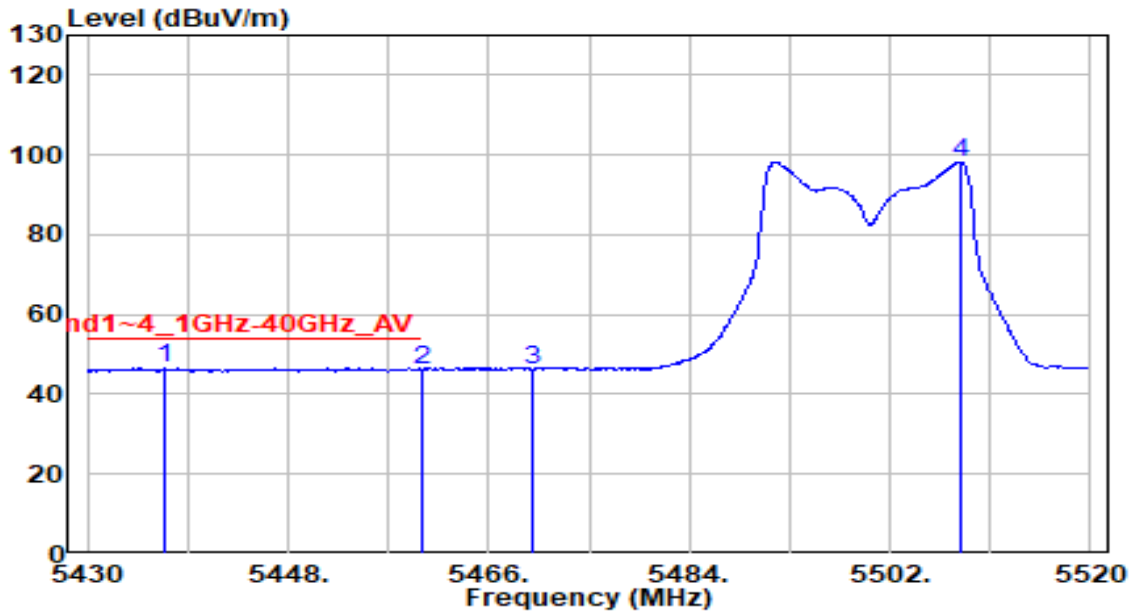

No	Frequency (MHz)	Reading (dBμV)	C.F (dB/m)	Measurement (dBμV/m)	Margin (dB)	Limit (dBμV/m)	Height (cm)	Angle (deg)	Remark (QP/PK/AV)
1	* 5436.930	46.68	-0.19	46.49	-7.51	54.00	230	170	Average
2	5460.000	46.32	-0.11	46.21	-7.79	54.00	230	170	Average
3	5470.000	46.35	-0.07	46.28	N/A	N/A	230	170	Average
4	5508.300	98.09	0.07	98.15	N/A	N/A	230	170	Average

Note:

- "\*" means this data is the worst emission level.
- C.F (Correction Factor) = Antenna Factor (dB/m)+ Cable Loss (dB) – Preamplifier(dB) + 20dB Attenuation.
- Measurement (dBμV/m) = Reading(dBμV) + C.F (Correction Factor).
- The emission levels of other frequencies are very lower than the limit and not show in test report.

EUT	HAN Access Point	Date of Test	2021-10-07
Factor	DRH18-E	Temp. / Humidity	23°C /49%
Polarity	Horizontal	Site / Test Engineer	AC2 / Jay
Test Mode	802.11ac20_TX_Band3_CH 140	Test Voltage	AC 120V/60Hz

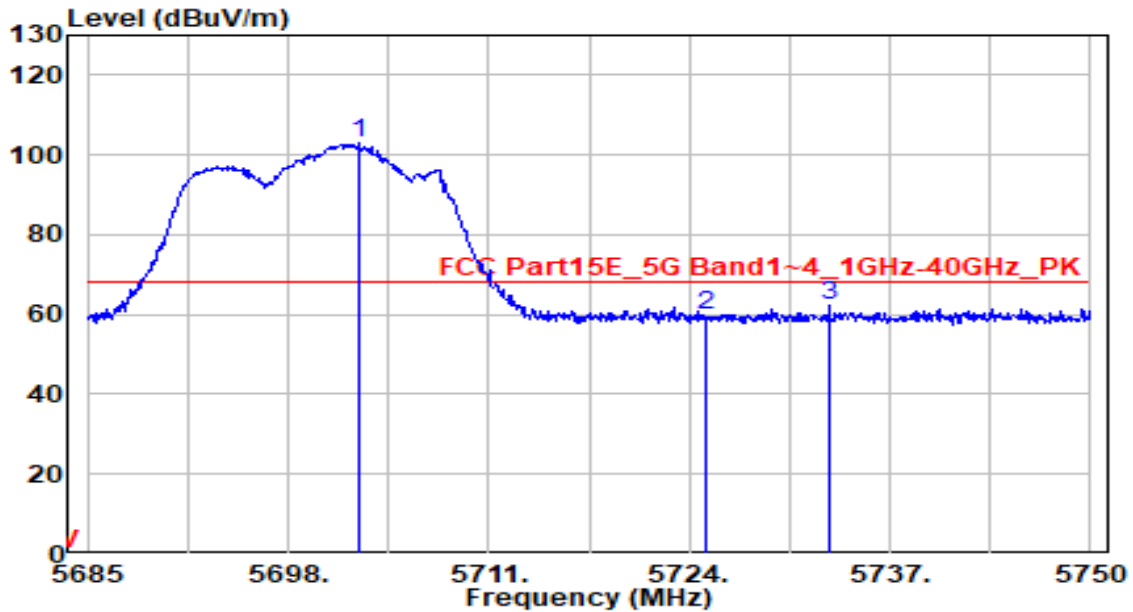

No	Frequency (MHz)	Reading (dB $\mu$ V)	C.F (dB/m)	Measurement (dB $\mu$ V/m)	Margin (dB)	Limit (dB $\mu$ V/m)	Height (cm)	Angle (deg)	Remark (QP/PK/AV)
1	5702.615	102.00	0.82	102.82	N/A	N/A	230	130	Peak
2	5725.000	59.11	0.91	60.02	-8.18	68.20	230	130	Peak
3	* 5733.100	61.19	0.95	62.14	-6.06	68.20	230	130	Peak

Note:

- "\*", means this data is the worst emission level.
- C.F (Correction Factor) = Antenna Factor (dB/m)+ Cable Loss (dB) – Preamplifier(dB) + 20dB Attenuation.
- Measurement (dB $\mu$ V/m) = Reading(dB $\mu$ V) + C.F (Correction Factor).
- The emission levels of other frequencies are very lower than the limit and not show in test report.

EUT	HAN Access Point	Date of Test	2021-10-07
Factor	DRH18-E	Temp. / Humidity	23°C /49%
Polarity	Vertical	Site / Test Engineer	AC2 / Jay
Test Mode	802.11ac20_TX_Band3_CH 140	Test Voltage	AC 120V/60Hz

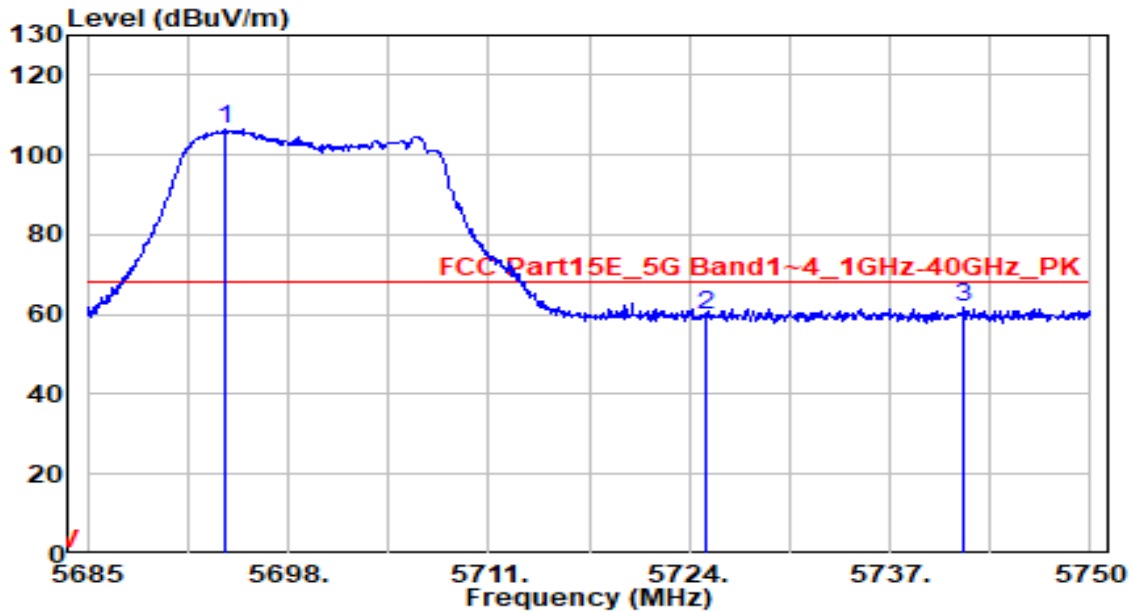

No	Frequency (MHz)	Reading (dBµV)	C.F (dB/m)	Measurement (dBµV/m)	Margin (dB)	Limit (dBµV/m)	Height (cm)	Angle (deg)	Remark (QP/PK/AV)
1	5693.840	105.66	0.79	106.45	N/A	N/A	230	50	Peak
2	5725.000	59.03	0.91	59.94	-8.26	68.20	230	50	Peak
3	* 5741.745	60.72	0.98	61.70	-6.50	68.20	230	50	Peak

Note:

- "\*", means this data is the worst emission level.
- C.F (Correction Factor) = Antenna Factor (dB/m)+ Cable Loss (dB) – Preamplifier(dB) + 20dB Attenuation.
- Measurement (dBµV/m) = Reading(dBµV) + C.F (Correction Factor).
- The emission levels of other frequencies are very lower than the limit and not show in test report.



EUT	HAN Access Point	Date of Test	2021-10-07
Factor	DRH18-E	Temp. / Humidity	23°C /49%
Polarity	Horizontal	Site / Test Engineer	AC2 / Jay
Test Mode	802.11ac20_TX_Band4_CH 149	Test Voltage	AC 120V/60Hz

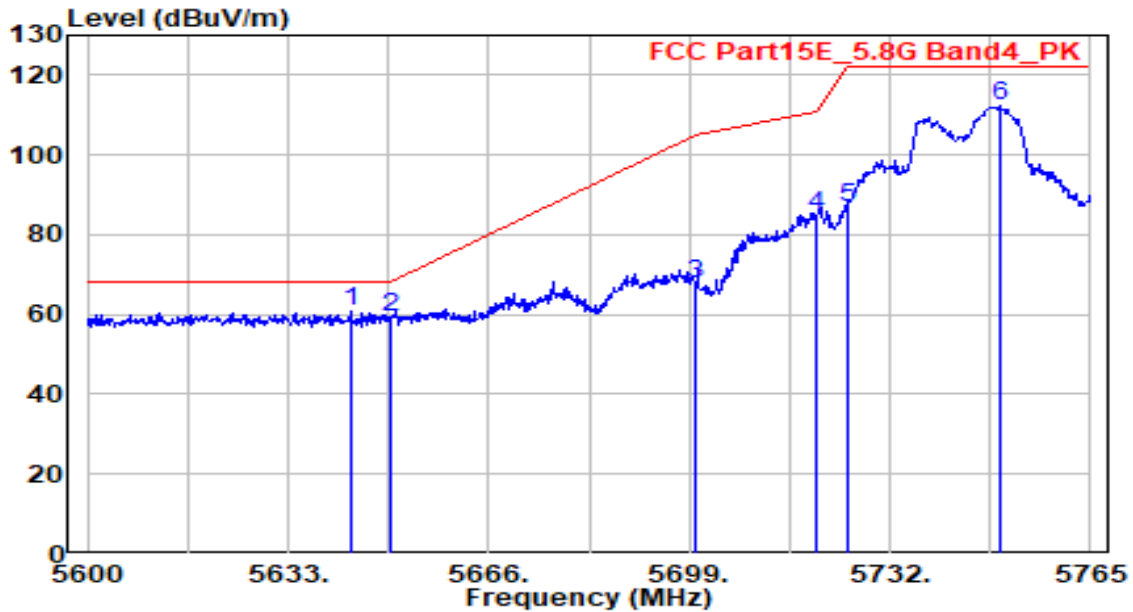

No	Frequency (MHz)	Reading (dBμV)	C.F (dB/m)	Measurement (dBμV/m)	Margin (dB)	Limit (dBμV/m)	Height (cm)	Angle (deg)	Remark (QP/PK/AV)
1	* 5643.230	60.15	0.58	60.73	-7.47	68.20	220	165	Peak
2	5650.000	58.82	0.60	59.43	-8.77	68.20	220	165	Peak
3	5700.000	66.95	0.81	67.76	-37.44	105.20	220	165	Peak
4	5720.000	83.94	0.89	84.83	-25.97	110.80	220	165	Peak
5	5725.000	85.75	0.91	86.66	-35.54	122.20	220	165	Peak
6	5750.150	111.17	1.02	112.19	N/A	N/A	220	165	Peak

Note:

1. " \*", means this data is the worst emission level.
2. C.F (Correction Factor) = Antenna Factor (dB/m)+ Cable Loss (dB) – Preamplifier(dB) + 20dB Attenuation.
3. Measurement (dBμV/m) = Reading(dBμV) + C.F (Correction Factor).
4. The emission levels of other frequencies are very lower than the limit and not show in test report.

EUT	HAN Access Point	Date of Test	2021-10-07
Factor	DRH18-E	Temp. / Humidity	23°C /49%
Polarity	Vertical	Site / Test Engineer	AC2 / Jay
Test Mode	802.11ac20_TX_Band4_CH 149	Test Voltage	AC 120V/60Hz

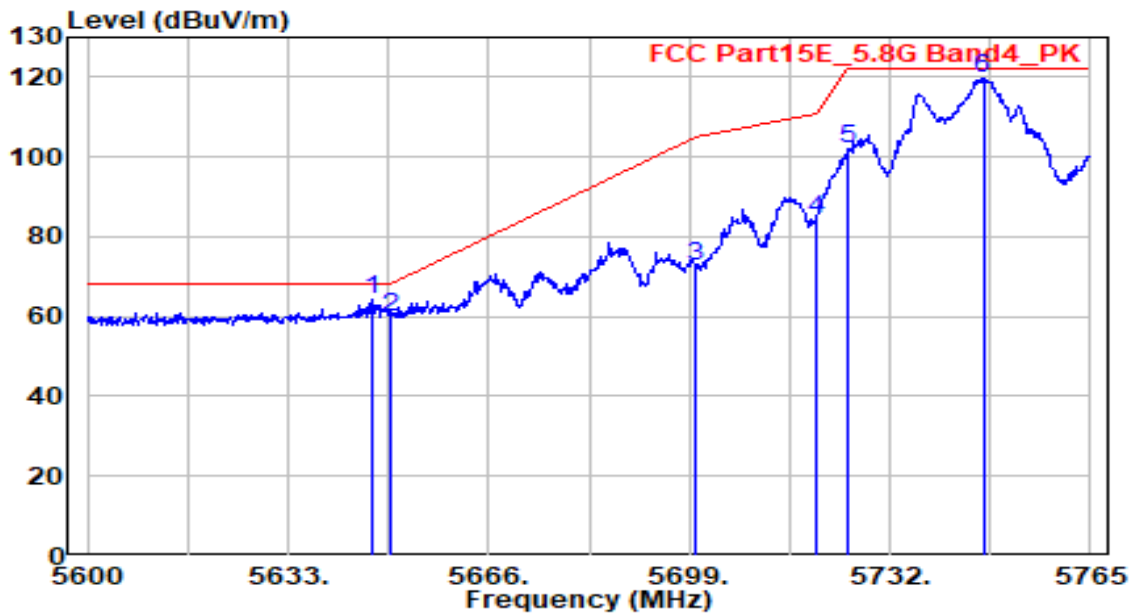

No	Frequency (MHz)	Reading (dB $\mu$ V)	C.F (dB/m)	Measurement (dB $\mu$ V/m)	Margin (dB)	Limit (dB $\mu$ V/m)	Height (cm)	Angle (deg)	Remark (QP/PK/AV)
1	* 5646.860	63.70	0.59	64.29	-3.91	68.20	230	110	Peak
2	5650.000	59.18	0.60	59.79	-8.41	68.20	230	110	Peak
3	5700.000	71.55	0.81	72.36	-32.84	105.20	230	110	Peak
4	5720.000	83.48	0.89	84.37	-26.43	110.80	230	110	Peak
5	5725.000	100.93	0.91	101.84	-20.36	122.20	230	110	Peak
6	5747.345	118.77	1.01	119.77	N/A	N/A	230	110	Peak

Note:

1. " \*", means this data is the worst emission level.
2. C.F (Correction Factor) = Antenna Factor (dB/m)+ Cable Loss (dB) – Preamplifier(dB) + 20dB Attenuation.
3. Measurement (dB $\mu$ V/m) = Reading(dB $\mu$ V) + C.F (Correction Factor).
4. The emission levels of other frequencies are very lower than the limit and not show in test report.

EUT	HAN Access Point	Date of Test	2021-10-07
Factor	DRH18-E	Temp. / Humidity	23°C /49%
Polarity	Horizontal	Site / Test Engineer	AC2 / Jay
Test Mode	802.11ac20_TX_Band4_CH 165	Test Voltage	AC 120V/60Hz

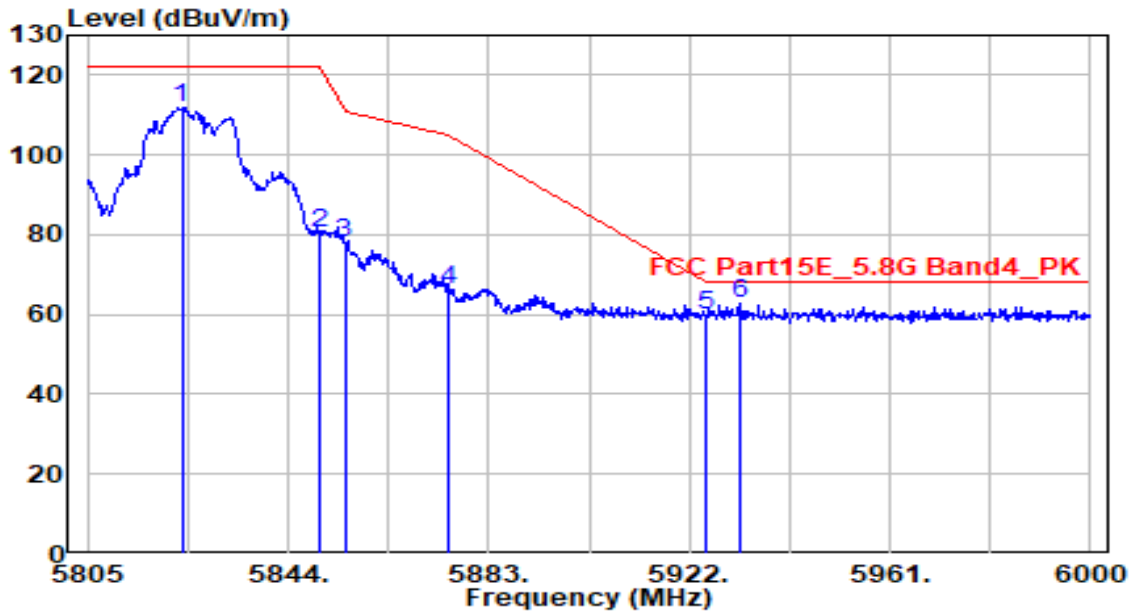

No	Frequency (MHz)	Reading (dB $\mu$ V)	C.F (dB/m)	Measurement (dB $\mu$ V/m)	Margin (dB)	Limit (dB $\mu$ V/m)	Height (cm)	Angle (deg)	Remark (QP/PK/AV)
1	5823.330	110.81	1.25	112.06	N/A	N/A	220	125	Peak
2	5850.000	79.27	1.28	80.54	-41.66	122.20	220	125	Peak
3	5855.000	76.57	1.28	77.85	-32.95	110.80	220	125	Peak
4	5875.000	64.71	1.30	66.01	-39.19	105.20	220	125	Peak
5	5925.000	58.72	1.35	60.07	-8.13	68.20	220	125	Peak
6	* 5931.945	61.50	1.36	62.86	-5.34	68.20	200	125	Peak

Note:

1. " \*", means this data is the worst emission level.
2. C.F (Correction Factor) = Antenna Factor (dB/m)+ Cable Loss (dB) – Preamplifier(dB) + 20dB Attenuation.
3. Measurement (dB $\mu$ V/m) = Reading(dB $\mu$ V) + C.F (Correction Factor).
4. The emission levels of other frequencies are very lower than the limit and not show in test report.

EUT	HAN Access Point	Date of Test	2021-10-07
Factor	DRH18-E	Temp. / Humidity	23°C /49%
Polarity	Vertical	Site / Test Engineer	AC2 / Jay
Test Mode	802.11ac20_TX_Band4_CH 165	Test Voltage	AC 120V/60Hz

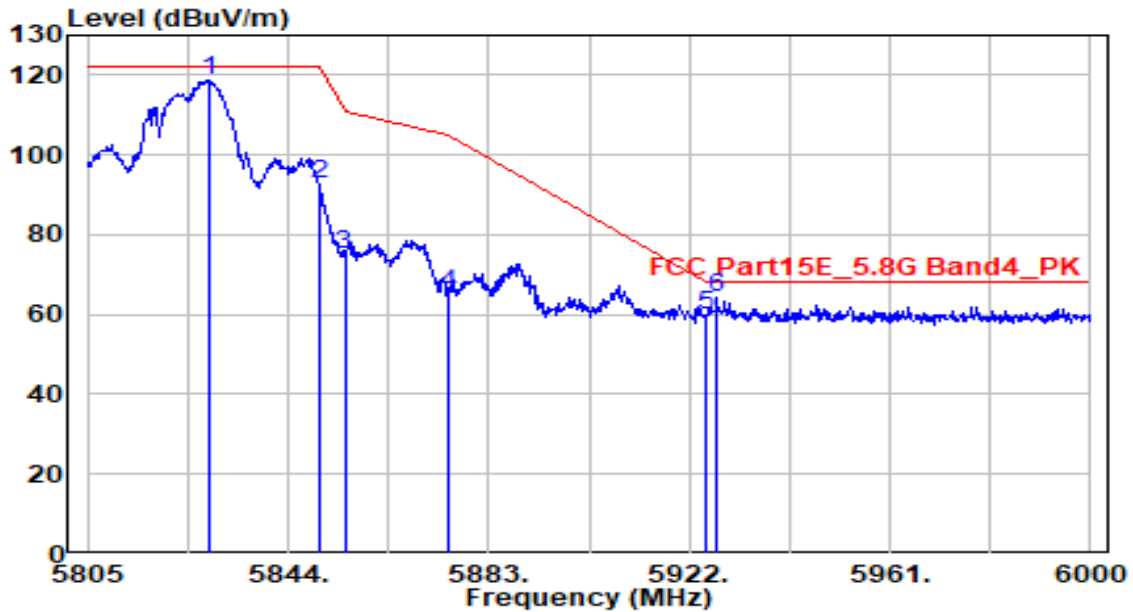

No	Frequency (MHz)	Reading (dBμV)	C.F (dB/m)	Measurement (dBμV/m)	Margin (dB)	Limit (dBμV/m)	Height (cm)	Angle (deg)	Remark (QP/PK/AV)
1	5828.790	117.57	1.25	118.82	N/A	N/A	230	100	Peak
2	5850.000	91.58	1.28	92.86	-29.34	122.20	230	100	Peak
3	5855.000	73.64	1.28	74.92	-35.88	110.80	230	100	Peak
4	5875.000	63.85	1.30	65.15	-40.05	105.20	230	100	Peak
5	5925.000	58.30	1.35	59.65	-8.55	68.20	230	100	Peak
6	* 5927.265	63.04	1.36	64.40	-3.80	68.20	230	100	Peak

Note:

1. " \*", means this data is the worst emission level.
2. C.F (Correction Factor) = Antenna Factor (dB/m)+ Cable Loss (dB) – Preamplifier(dB) + 20dB Attenuation.
3. Measurement (dBμV/m) = Reading(dBμV) + C.F (Correction Factor).
4. The emission levels of other frequencies are very lower than the limit and not show in test report.

EUT	HAN Access Point	Date of Test	2021-10-07
Factor	DRH18-E	Temp. / Humidity	23°C /49%
Polarity	Horizontal	Site / Test Engineer	AC2 / Jay
Test Mode	802.11ac40_TX_Band1_CH 38	Test Voltage	AC 120V/60Hz

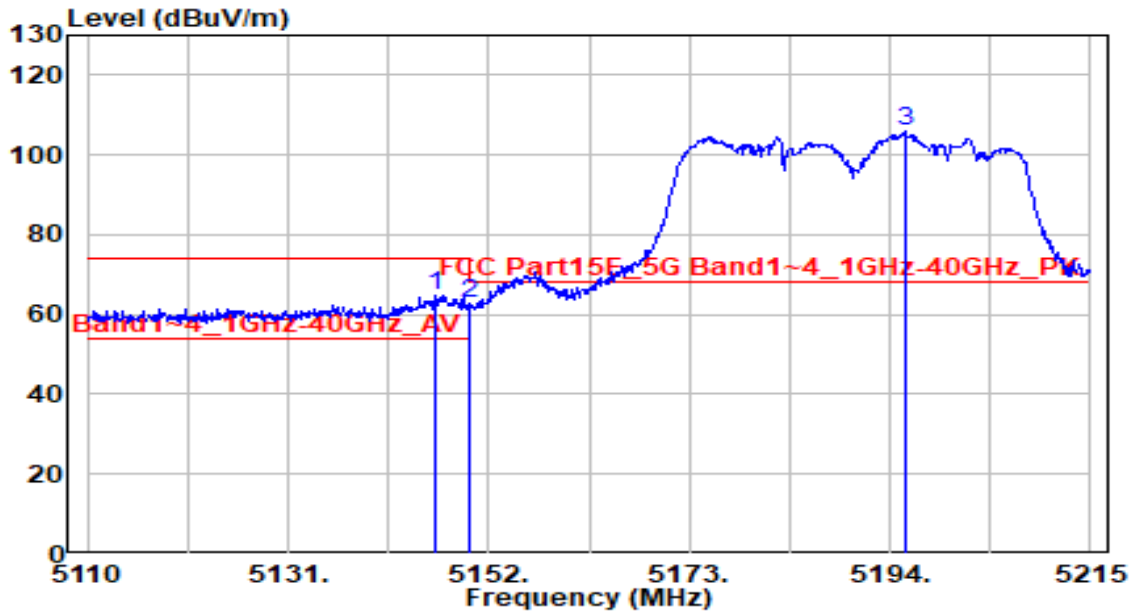

No	Frequency (MHz)	Reading (dB $\mu$ V)	C.F (dB/m)	Measurement (dB $\mu$ V/m)	Margin (dB)	Limit (dB $\mu$ V/m)	Height (cm)	Angle (deg)	Remark (QP/PK/AV)
1	* 5146.435	65.15	-0.32	64.84	-9.16	74.00	220	40	Peak
2	5150.000	62.97	-0.32	62.65	-11.35	74.00	220	40	Peak
3	5195.575	106.11	-0.32	105.79	N/A	N/A	220	40	Peak

Note:

- "\*" means this data is the worst emission level.
- C.F (Correction Factor) = Antenna Factor (dB/m)+ Cable Loss (dB) – Preamplifier(dB) + 20dB Attenuation.
- Measurement (dB $\mu$ V/m) = Reading(dB $\mu$ V) + C.F (Correction Factor).
- The emission levels of other frequencies are very lower than the limit and not show in test report.

EUT	HAN Access Point	Date of Test	2021-10-07
Factor	DRH18-E	Temp. / Humidity	23°C /49%
Polarity	Horizontal	Site / Test Engineer	AC2 / Jay
Test Mode	802.11ac40_TX_Band1_CH 38	Test Voltage	AC 120V/60Hz

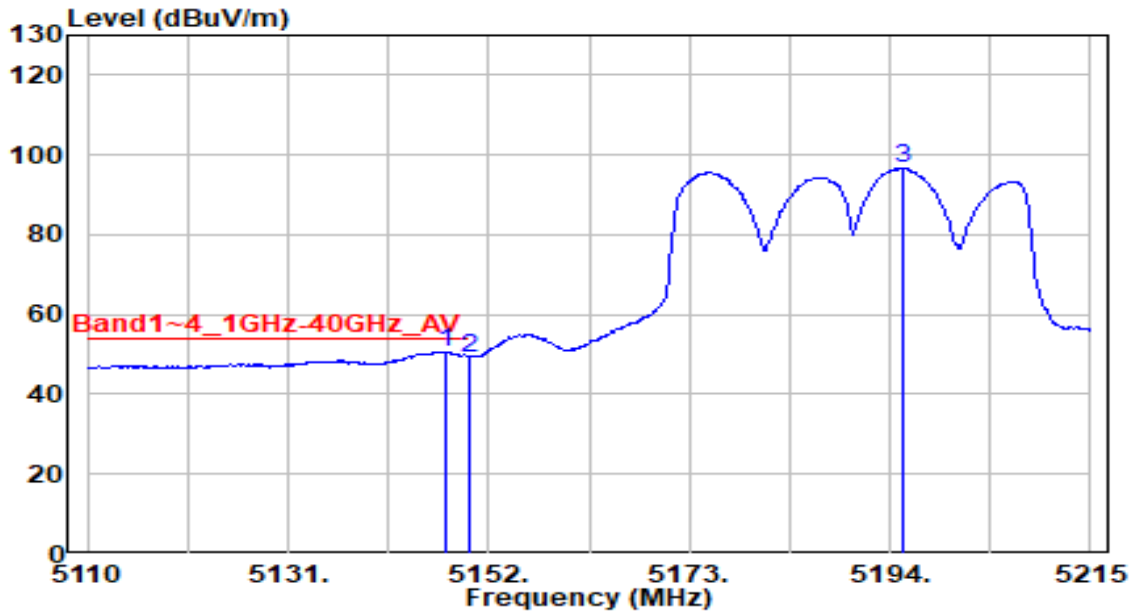

No	Frequency (MHz)	Reading (dB $\mu$ V)	C.F (dB/m)	Measurement (dB $\mu$ V/m)	Margin (dB)	Limit (dB $\mu$ V/m)	Height (cm)	Angle (deg)	Remark (QP/PK/AV)
1	*	51.04	-0.32	50.72	-3.28	54.00	220	40	Average
2		49.34	-0.32	49.02	-4.98	54.00	220	40	Average
3		96.98	-0.32	96.66	N/A	N/A	220	40	Average

Note:

- "\*" means this data is the worst emission level.
- C.F (Correction Factor) = Antenna Factor (dB/m)+ Cable Loss (dB) – Preamplifier(dB) + 20dB Attenuation.
- Measurement (dB $\mu$ V/m) = Reading(dB $\mu$ V) + C.F (Correction Factor).
- The emission levels of other frequencies are very lower than the limit and not show in test report.

EUT	HAN Access Point	Date of Test	2021-10-07
Factor	DRH18-E	Temp. / Humidity	23°C /49%
Polarity	Vertical	Site / Test Engineer	AC2 / Jay
Test Mode	802.11ac40_TX_Band1_CH 38	Test Voltage	AC 120V/60Hz

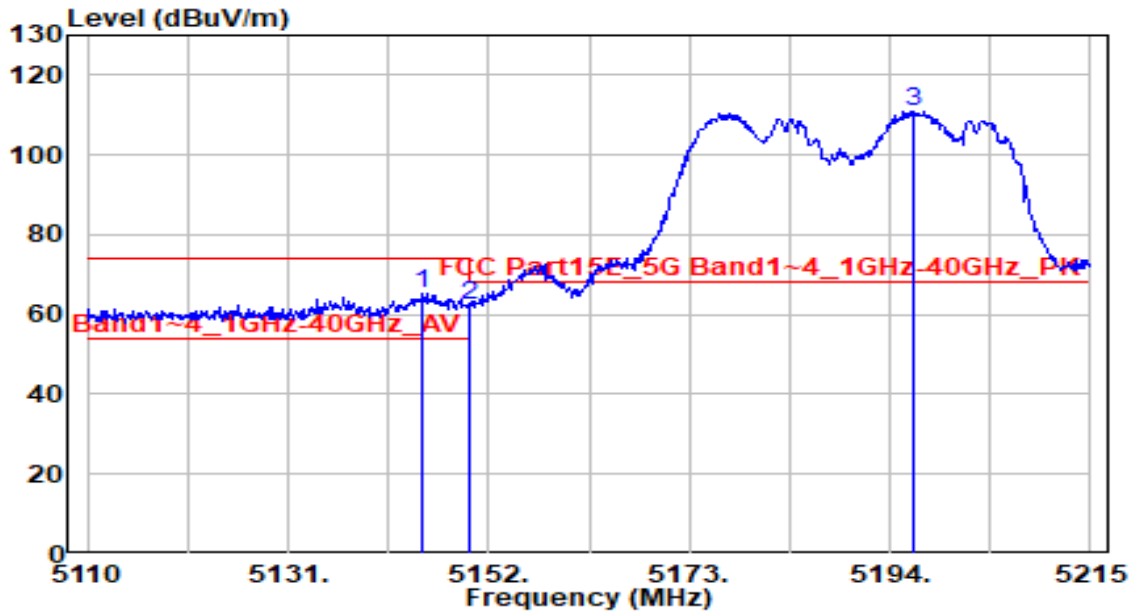

No	Frequency (MHz)	Reading (dBμV)	C.F (dB/m)	Measurement (dBμV/m)	Margin (dB)	Limit (dBμV/m)	Height (cm)	Angle (deg)	Remark (QP/PK/AV)
1	* 5145.070	65.56	-0.32	65.24	-8.76	74.00	255	320	Peak
2	5150.000	62.51	-0.32	62.19	-11.81	74.00	255	320	Peak
3	5196.415	111.24	-0.32	110.92	N/A	N/A	255	320	Peak

Note:

- "\*" means this data is the worst emission level.
- C.F (Correction Factor) = Antenna Factor (dB/m)+ Cable Loss (dB) – Preamplifier(dB) + 20dB Attenuation.
- Measurement (dBμV/m) = Reading(dBμV) + C.F (Correction Factor).
- The emission levels of other frequencies are very lower than the limit and not show in test report.

EUT	HAN Access Point	Date of Test	2021-10-07
Factor	DRH18-E	Temp. / Humidity	23°C /49%
Polarity	Vertical	Site / Test Engineer	AC2 / Jay
Test Mode	802.11ac40_TX_Band1_CH 38	Test Voltage	AC 120V/60Hz

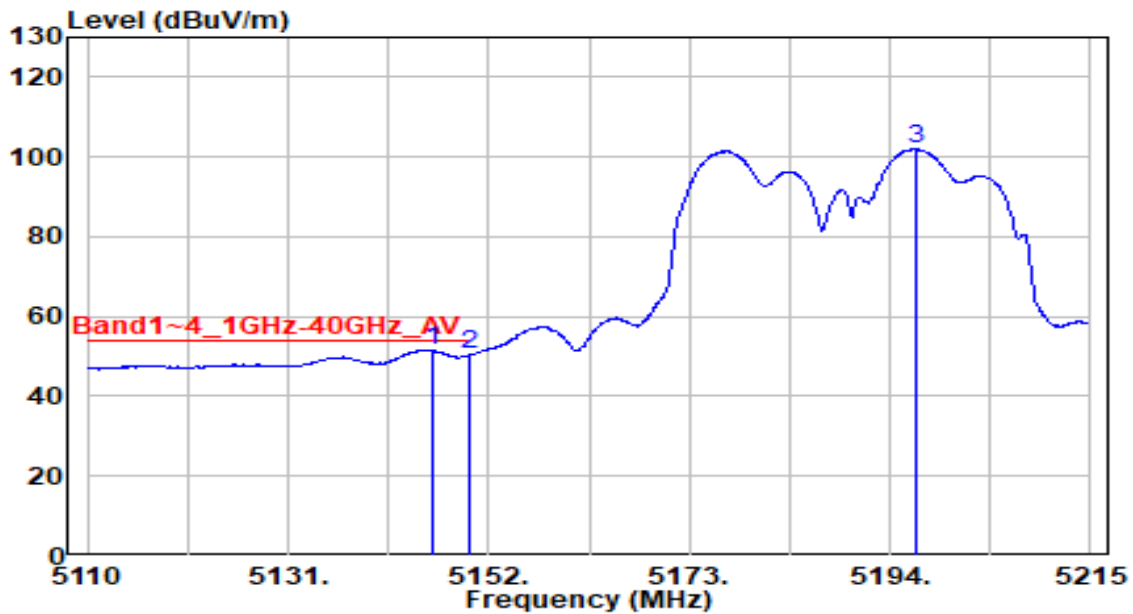

No	Frequency (MHz)	Reading (dBμV)	C.F (dB/m)	Measurement (dBμV/m)	Margin (dB)	Limit (dBμV/m)	Height (cm)	Angle (deg)	Remark (QP/PK/AV)
1	* 5146.120	51.97	-0.32	51.65	-2.35	54.00	255	320	Average
2	5150.000	50.67	-0.32	50.35	-3.65	54.00	255	320	Average
3	5196.730	102.26	-0.32	101.94	N/A	N/A	255	320	Average

Note:

- "\*" means this data is the worst emission level.
- C.F (Correction Factor) = Antenna Factor (dB/m)+ Cable Loss (dB) – Preamplifier(dB) + 20dB Attenuation.
- Measurement (dBμV/m) = Reading(dBμV) + C.F (Correction Factor).
- The emission levels of other frequencies are very lower than the limit and not show in test report.



EUT	HAN Access Point	Date of Test	2021-10-07
Factor	DRH18-E	Temp. / Humidity	23°C /49%
Polarity	Horizontal	Site / Test Engineer	AC2 / Jay
Test Mode	802.11ac40_TX_Band2_CH 62	Test Voltage	AC 120V/60Hz

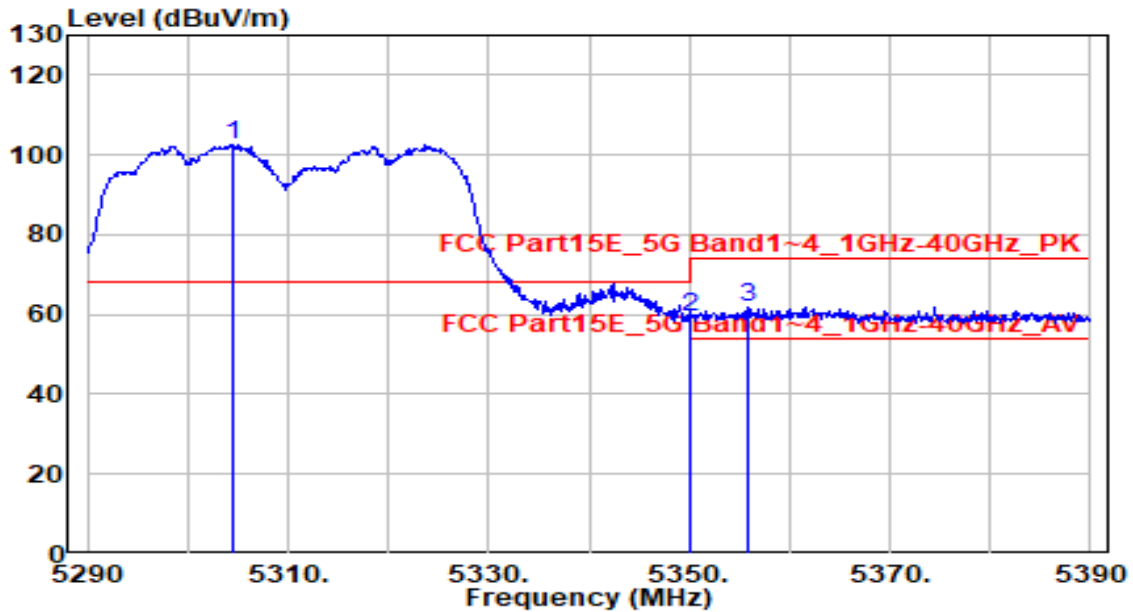

No	Frequency (MHz)	Reading (dBμV)	C.F (dB/m)	Measurement (dBμV/m)	Margin (dB)	Limit (dBμV/m)	Height (cm)	Angle (deg)	Remark (QP/PK/AV)
1	5304.400	103.04	-0.33	102.71	N/A	N/A	220	65	Peak
2	* 5350.000	59.85	-0.33	59.52	-8.68	68.20	220	65	Peak
3	5355.800	62.15	-0.33	61.83	-12.17	74.00	220	65	Peak

Note:

- "\*" means this data is the worst emission level.
- C.F (Correction Factor) = Antenna Factor (dB/m)+ Cable Loss (dB) – Preamplifier(dB) + 20dB Attenuation.
- Measurement (dBμV/m) = Reading(dBμV) + C.F (Correction Factor).
- The emission levels of other frequencies are very lower than the limit and not show in test report.

EUT	HAN Access Point	Date of Test	2021-10-07
Factor	DRH18-E	Temp. / Humidity	23°C /49%
Polarity	Horizontal	Site / Test Engineer	AC2 / Jay
Test Mode	802.11ac40_TX_Band2_CH 62	Test Voltage	AC 120V/60Hz

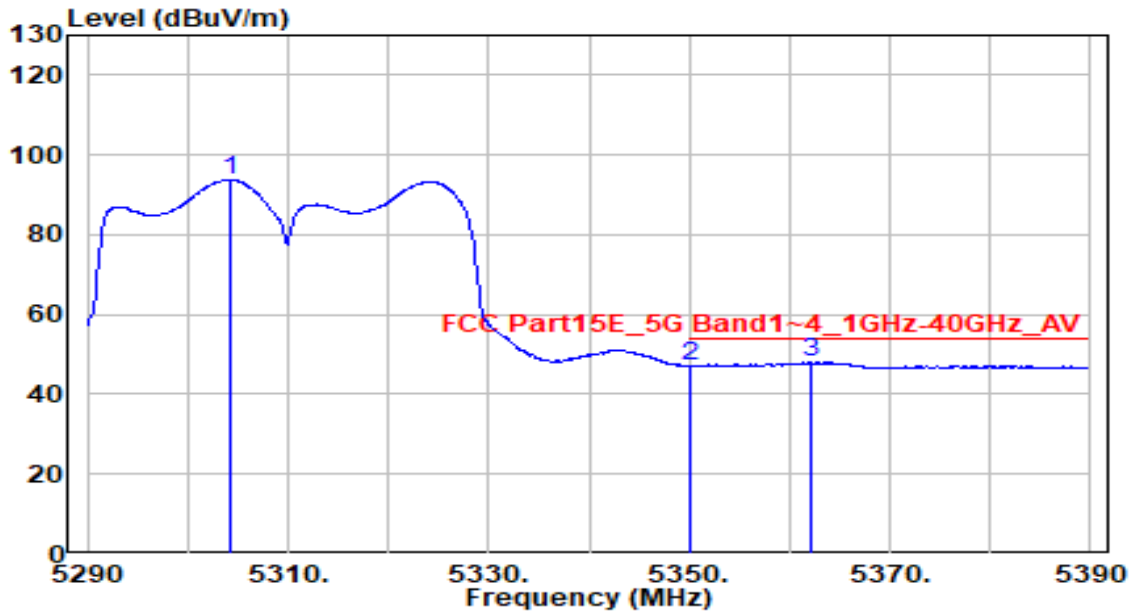

No	Frequency (MHz)	Reading (dB $\mu$ V)	C.F (dB/m)	Measurement (dB $\mu$ V/m)	Margin (dB)	Limit (dB $\mu$ V/m)	Height (cm)	Angle (deg)	Remark (QP/PK/AV)
1	5304.200	94.11	-0.33	93.78	N/A	N/A	220	65	Average
2	* 5350.000	47.42	-0.33	47.09	-6.91	54.00	220	65	Average
3	5362.100	48.34	-0.33	48.02	-5.98	54.00	220	65	Average

Note:

- "\*" means this data is the worst emission level.
- C.F (Correction Factor) = Antenna Factor (dB/m)+ Cable Loss (dB) – Preamplifier(dB) + 20dB Attenuation.
- Measurement (dB $\mu$ V/m) = Reading(dB $\mu$ V) + C.F (Correction Factor).
- The emission levels of other frequencies are very lower than the limit and not show in test report.

EUT	HAN Access Point	Date of Test	2021-10-07
Factor	DRH18-E	Temp. / Humidity	23°C /49%
Polarity	Vertical	Site / Test Engineer	AC2 / Jay
Test Mode	802.11ac40_TX_Band2_CH 62	Test Voltage	AC 120V/60Hz

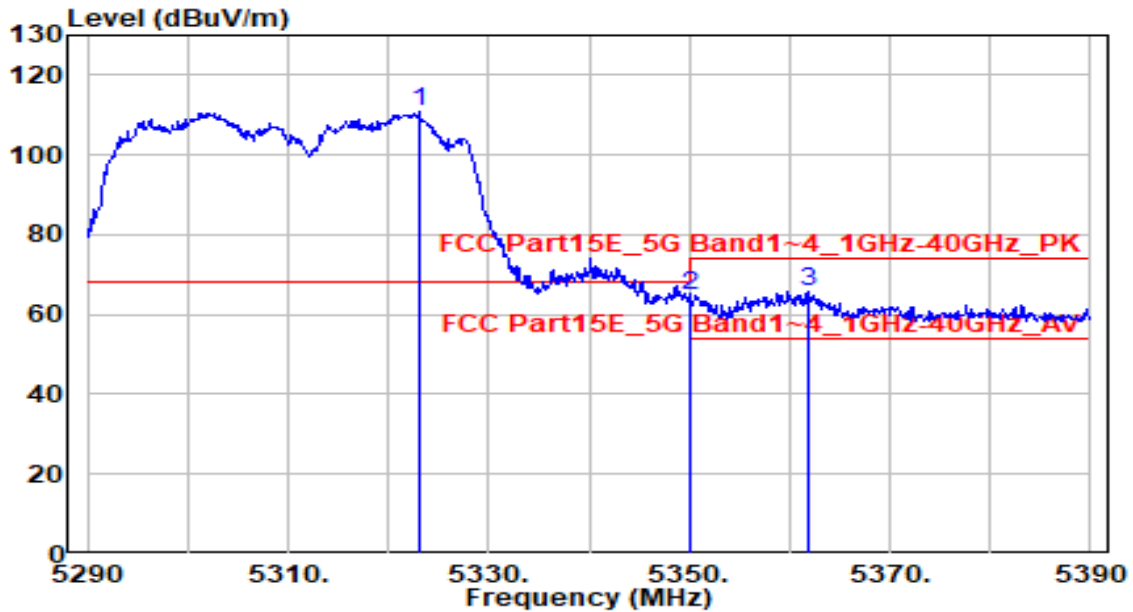

No	Frequency (MHz)	Reading (dB $\mu$ V)	C.F (dB/m)	Measurement (dB $\mu$ V/m)	Margin (dB)	Limit (dB $\mu$ V/m)	Height (cm)	Angle (deg)	Remark (QP/PK/AV)
1	5323.000	111.36	-0.33	111.03	N/A	N/A	240	195	Peak
2	* 5350.000	65.10	-0.33	64.77	-3.43	68.20	240	195	Peak
3	5361.900	66.12	-0.33	65.80	-8.20	74.00	240	195	Peak

Note:

- "\*" means this data is the worst emission level.
- C.F (Correction Factor) = Antenna Factor (dB/m)+ Cable Loss (dB) – Preamplifier(dB) + 20dB Attenuation.
- Measurement (dB $\mu$ V/m) = Reading(dB $\mu$ V) + C.F (Correction Factor).
- The emission levels of other frequencies are very lower than the limit and not show in test report.

EUT	HAN Access Point	Date of Test	2021-10-07
Factor	DRH18-E	Temp. / Humidity	23°C /49%
Polarity	Vertical	Site / Test Engineer	AC2 / Jay
Test Mode	802.11ac40_TX_Band2_CH 62	Test Voltage	AC 120V/60Hz

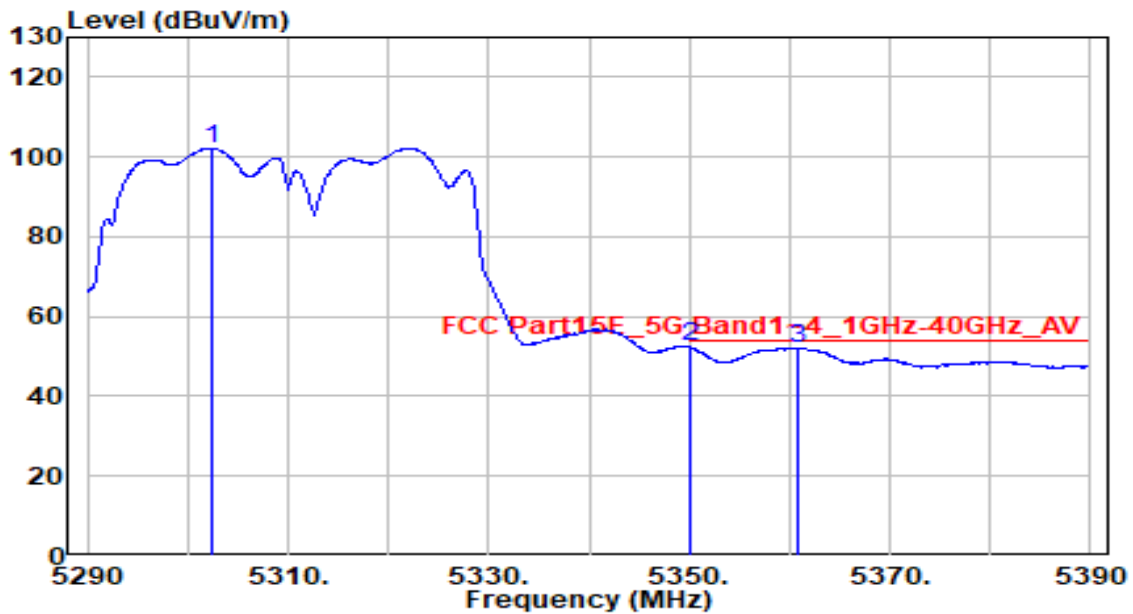

No	Frequency (MHz)	Reading (dBμV)	C.F (dB/m)	Measurement (dBμV/m)	Margin (dB)	Limit (dBμV/m)	Height (cm)	Angle (deg)	Remark (QP/PK/AV)
1	5302.300	102.53	-0.33	102.20	N/A	N/A	240	195	Average
2	* 5350.000	52.72	-0.33	52.40	-1.60	54.00	240	195	Average
3	5360.800	52.44	-0.33	52.12	-1.88	54.00	240	195	Average

Note:

- "\*" means this data is the worst emission level.
- C.F (Correction Factor) = Antenna Factor (dB/m)+ Cable Loss (dB) – Preamplifier(dB) + 20dB Attenuation.
- Measurement (dBμV/m) = Reading(dBμV) + C.F (Correction Factor).
- The emission levels of other frequencies are very lower than the limit and not show in test report.

EUT	HAN Access Point	Date of Test	2021-10-07
Factor	DRH18-E	Temp. / Humidity	23°C /49%
Polarity	Horizontal	Site / Test Engineer	AC2 / Jay
Test Mode	802.11ac40_TX_Band3_CH 102	Test Voltage	AC 120V/60Hz

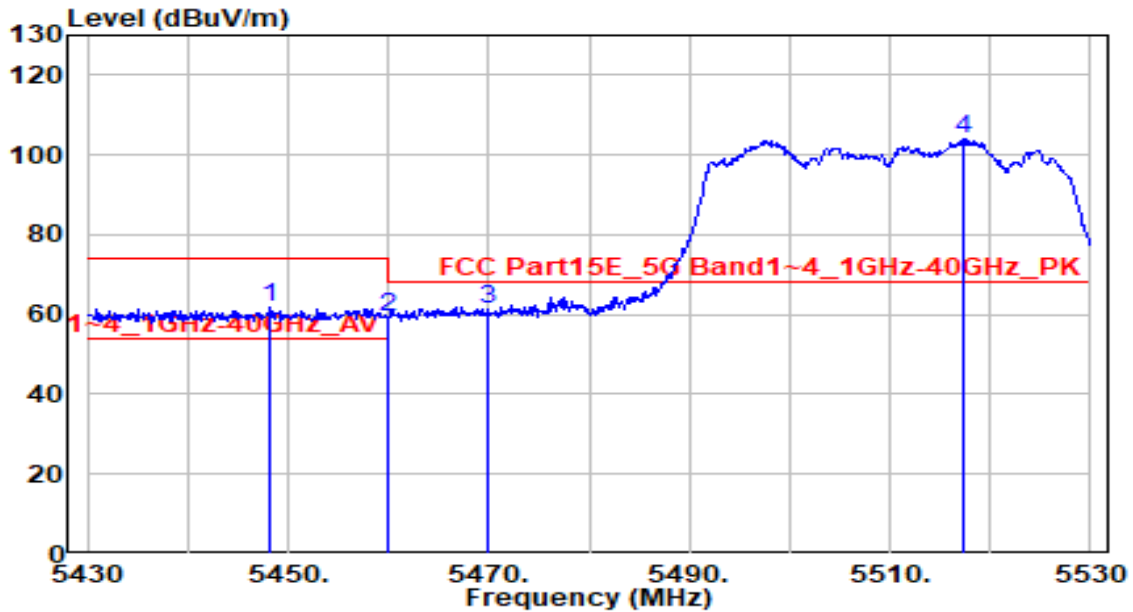

No	Frequency (MHz)	Reading (dB $\mu$ V)	C.F (dB/m)	Measurement (dB $\mu$ V/m)	Margin (dB)	Limit (dB $\mu$ V/m)	Height (cm)	Angle (deg)	Remark (QP/PK/AV)
1	5448.200	62.14	-0.15	61.99	-12.01	74.00	230	160	Peak
2	5460.000	59.33	-0.11	59.22	-8.98	68.20	230	160	Peak
3	* 5470.000	61.64	-0.07	61.56	-6.64	68.20	230	160	Peak
4	5517.400	103.86	0.10	103.96	N/A	N/A	230	160	Peak

Note:

1. " \*", means this data is the worst emission level.
2. C.F (Correction Factor) = Antenna Factor (dB/m)+ Cable Loss (dB) – Preamplifier(dB) + 20dB Attenuation.
3. Measurement (dB $\mu$ V/m) = Reading(dB $\mu$ V) + C.F (Correction Factor).
4. The emission levels of other frequencies are very lower than the limit and not show in test report.

EUT	HAN Access Point	Date of Test	2021-10-07
Factor	DRH18-E	Temp. / Humidity	23°C /49%
Polarity	Horizontal	Site / Test Engineer	AC2 / Jay
Test Mode	802.11ac40_TX_Band3_CH 102	Test Voltage	AC 120V/60Hz

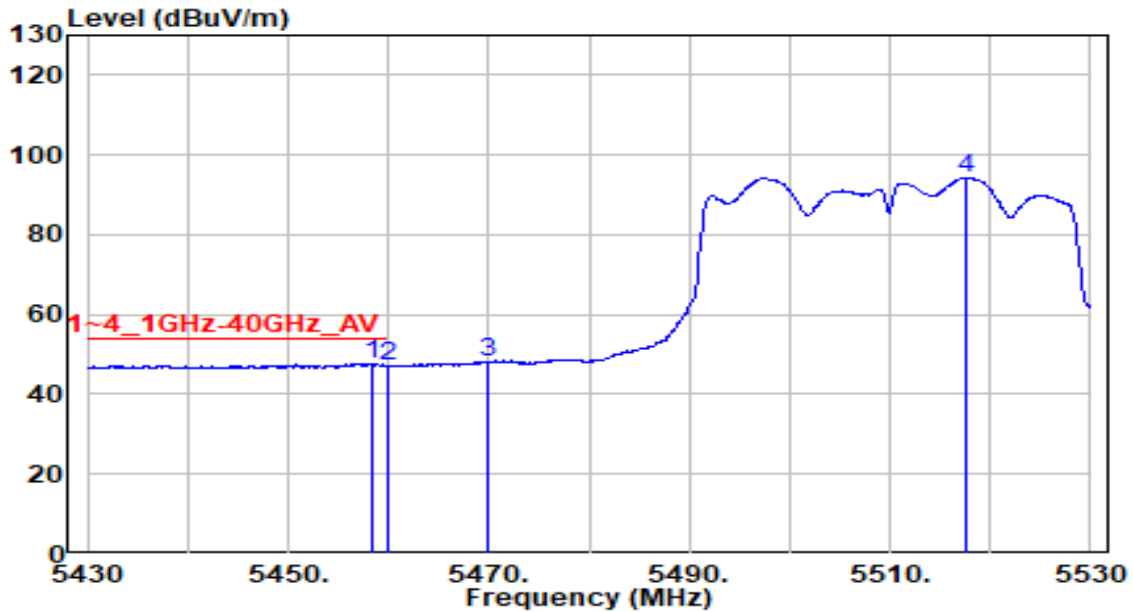

No	Frequency (MHz)	Reading (dB $\mu$ V)	C.F (dB/m)	Measurement (dB $\mu$ V/m)	Margin (dB)	Limit (dB $\mu$ V/m)	Height (cm)	Angle (deg)	Remark (QP/PK/AV)
1	* 5458.500	47.56	-0.11	47.45	-6.55	54.00	230	160	Average
2	5460.000	47.30	-0.11	47.19	-6.81	54.00	230	160	Average
3	5470.000	48.13	-0.07	48.06	N/A	N/A	230	160	Average
4	5517.500	94.33	0.10	94.43	N/A	N/A	230	160	Average

Note:

1. " \*", means this data is the worst emission level.
2. C.F (Correction Factor) = Antenna Factor (dB/m)+ Cable Loss (dB) – Preamplifier(dB) + 20dB Attenuation.
3. Measurement (dB $\mu$ V/m) = Reading(dB $\mu$ V) + C.F (Correction Factor).
4. The emission levels of other frequencies are very lower than the limit and not show in test report.

EUT	HAN Access Point	Date of Test	2021-10-07
Factor	DRH18-E	Temp. / Humidity	23°C /49%
Polarity	Vertical	Site / Test Engineer	AC2 / Jay
Test Mode	802.11ac40_TX_Band3_CH 102	Test Voltage	AC 120V/60Hz

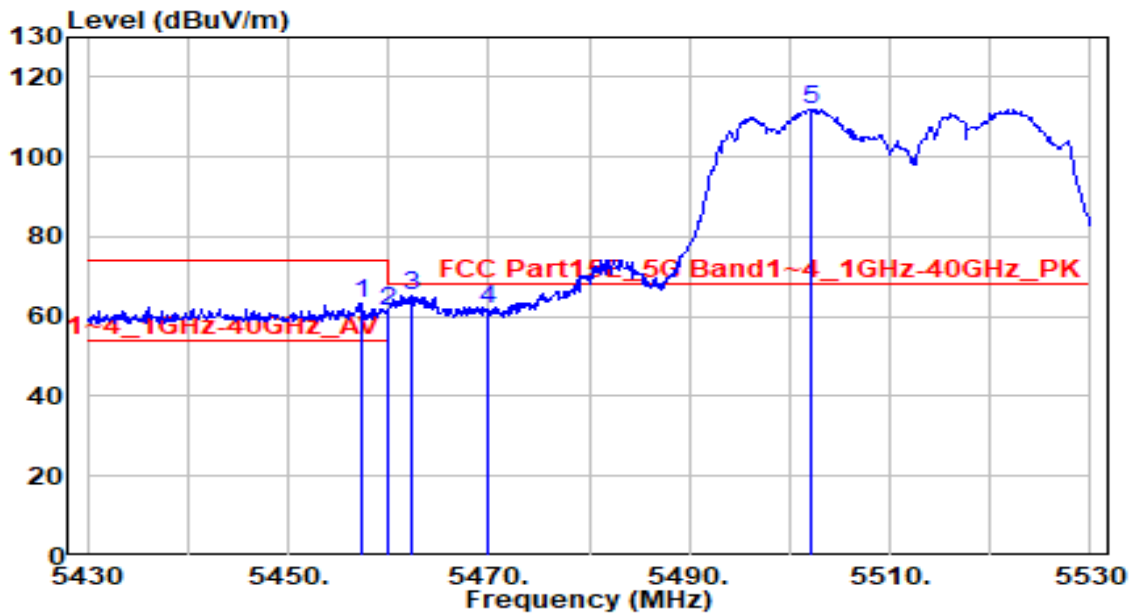

No	Frequency (MHz)	Reading (dBμV)	C.F (dB/m)	Measurement (dBμV/m)	Margin (dB)	Limit (dBμV/m)	Height (cm)	Angle (deg)	Remark (QP/PK/AV)
1	5457.400	63.53	-0.12	63.41	-10.59	74.00	260	190	Peak
2	5460.000	61.51	-0.11	61.40	-6.80	68.20	260	190	Peak
3	* 5462.400	65.16	-0.10	65.06	-3.14	68.20	260	190	Peak
4	5470.000	61.70	-0.07	61.63	-6.57	68.20	260	190	Peak
5	5502.100	111.98	0.04	112.03	N/A	N/A	260	190	Peak

Note:

1. " \*", means this data is the worst emission level.
2. C.F (Correction Factor) = Antenna Factor (dB/m)+ Cable Loss (dB) – Preamplifier(dB) + 20dB Attenuation.
3. Measurement (dBμV/m) = Reading(dBμV) + C.F (Correction Factor).
4. The emission levels of other frequencies are very lower than the limit and not show in test report.

EUT	HAN Access Point	Date of Test	2021-10-07
Factor	DRH18-E	Temp. / Humidity	23°C /49%
Polarity	Vertical	Site / Test Engineer	AC2 / Jay
Test Mode	802.11ac40_TX_Band3_CH 102	Test Voltage	AC 120V/60Hz

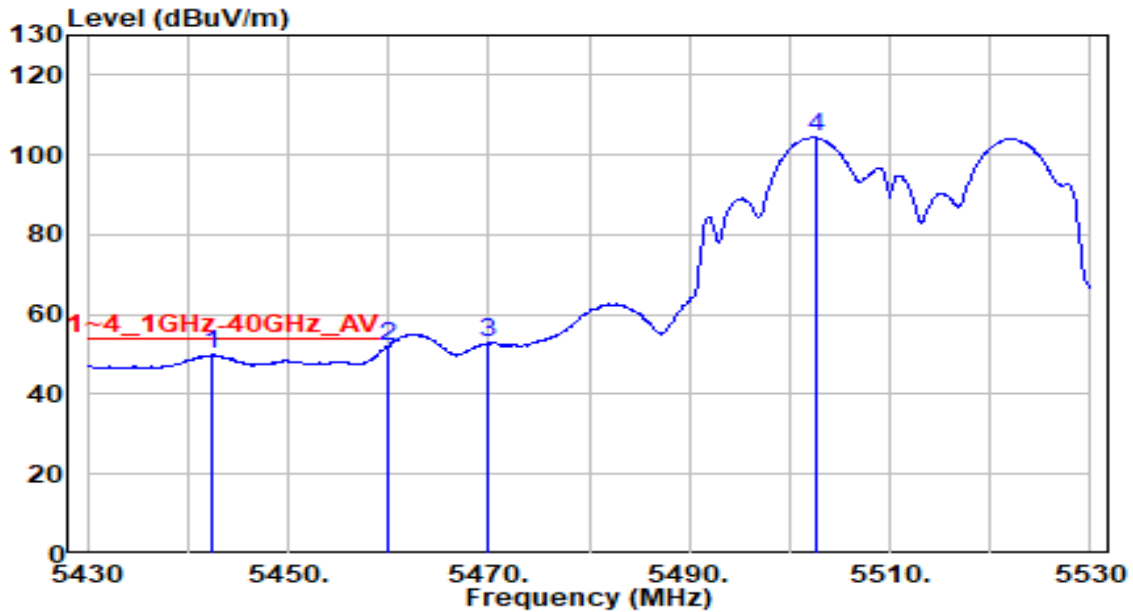

No	Frequency (MHz)	Reading (dB $\mu$ V)	C.F (dB/m)	Measurement (dB $\mu$ V/m)	Margin (dB)	Limit (dB $\mu$ V/m)	Height (cm)	Angle (deg)	Remark (QP/PK/AV)
1	5442.500	50.24	-0.17	50.07	-3.93	54.00	260	190	Average
2	* 5460.000	52.22	-0.11	52.12	-1.88	54.00	260	190	Average
3	5470.000	53.09	-0.07	53.02	N/A	N/A	260	190	Average
4	5502.600	104.32	0.05	104.37	N/A	N/A	260	190	Average

Note:

1. " \*", means this data is the worst emission level.
2. C.F (Correction Factor) = Antenna Factor (dB/m)+ Cable Loss (dB) – Preamplifier(dB) + 20dB Attenuation.
3. Measurement (dB $\mu$ V/m) = Reading(dB $\mu$ V) + C.F (Correction Factor).
4. The emission levels of other frequencies are very lower than the limit and not show in test report.



EUT	HAN Access Point	Date of Test	2021-10-07
Factor	DRH18-E	Temp. / Humidity	23°C /49%
Polarity	Horizontal	Site / Test Engineer	AC2 / Jay
Test Mode	802.11ac40_TX_Band3_CH 134	Test Voltage	AC 120V/60Hz

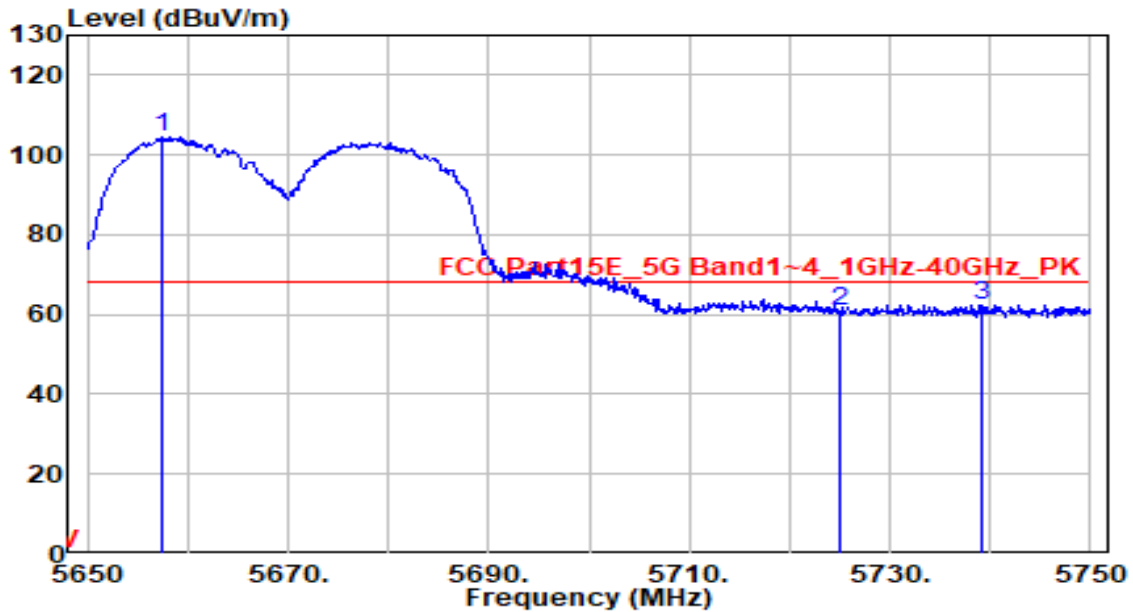

No	Frequency (MHz)	Reading (dB $\mu$ V)	C.F (dB/m)	Measurement (dB $\mu$ V/m)	Margin (dB)	Limit (dB $\mu$ V/m)	Height (cm)	Angle (deg)	Remark (QP/PK/AV)
1	5657.400	103.97	0.64	104.61	N/A	N/A	180	70	Peak
2	5725.000	60.09	0.91	61.00	-7.20	68.20	180	70	Peak
3	* 5739.100	61.53	0.97	62.50	-5.70	68.20	180	70	Peak

Note:

- "\*", means this data is the worst emission level.
- C.F (Correction Factor) = Antenna Factor (dB/m)+ Cable Loss (dB) – Preamplifier(dB) + 20dB Attenuation.
- Measurement (dB $\mu$ V/m) = Reading(dB $\mu$ V) + C.F (Correction Factor).
- The emission levels of other frequencies are very lower than the limit and not show in test report.

EUT	HAN Access Point	Date of Test	2021-10-07
Factor	DRH18-E	Temp. / Humidity	23°C /49%
Polarity	Vertical	Site / Test Engineer	AC2 / Jay
Test Mode	802.11ac40_TX_Band3_CH 134	Test Voltage	AC 120V/60Hz

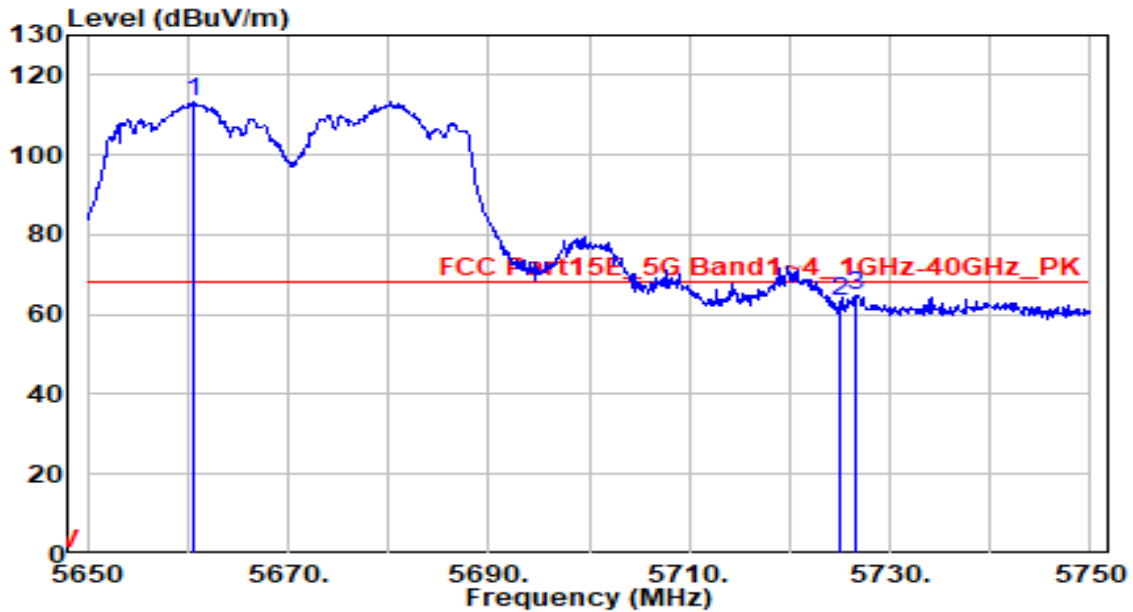

No	Frequency (MHz)	Reading (dBμV)	C.F (dB/m)	Measurement (dBμV/m)	Margin (dB)	Limit (dBμV/m)	Height (cm)	Angle (deg)	Remark (QP/PK/AV)
1	5660.600	112.75	0.65	113.40	N/A	N/A	255	95	Peak
2	5725.000	62.20	0.91	63.11	-5.09	68.20	255	95	Peak
3	* 5726.700	63.66	0.92	64.58	-3.62	68.20	255	95	Peak

Note:

- "\*", means this data is the worst emission level.
- C.F (Correction Factor) = Antenna Factor (dB/m)+ Cable Loss (dB) – Preamplifier(dB) + 20dB Attenuation.
- Measurement (dBμV/m) = Reading(dBμV) + C.F (Correction Factor).
- The emission levels of other frequencies are very lower than the limit and not show in test report.

EUT	HAN Access Point	Date of Test	2021-10-07
Factor	DRH18-E	Temp. / Humidity	23°C /49%
Polarity	Horizontal	Site / Test Engineer	AC2 / Jay
Test Mode	802.11ac40_TX_Band4_CH 151	Test Voltage	AC 120V/60Hz

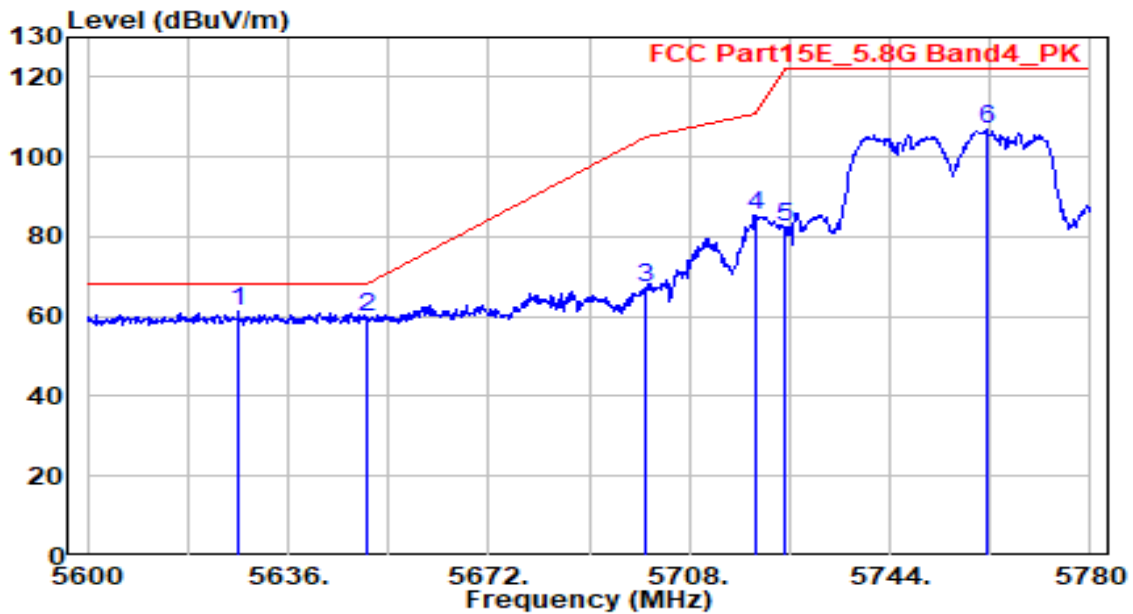

No	Frequency (MHz)	Reading (dB $\mu$ V)	C.F (dB/m)	Measurement (dB $\mu$ V/m)	Margin (dB)	Limit (dB $\mu$ V/m)	Height (cm)	Angle (deg)	Remark (QP/PK/AV)
1	* 5627.000	60.92	0.51	61.43	-6.77	68.20	220	155	Peak
2	5650.000	59.06	0.60	59.67	-8.53	68.20	220	155	Peak
3	5700.000	66.51	0.81	67.32	-37.88	105.20	220	155	Peak
4	5720.000	84.47	0.89	85.37	-25.43	110.80	220	155	Peak
5	5725.000	81.30	0.91	82.22	-39.98	122.20	220	155	Peak
6	5761.460	105.68	1.06	106.75	N/A	N/A	220	155	Peak

Note:

1. " \*", means this data is the worst emission level.
2. C.F (Correction Factor) = Antenna Factor (dB/m)+ Cable Loss (dB) – Preamplifier(dB) + 20dB Attenuation.
3. Measurement (dB $\mu$ V/m) = Reading(dB $\mu$ V) + C.F (Correction Factor).
4. The emission levels of other frequencies are very lower than the limit and not show in test report.

EUT	HAN Access Point	Date of Test	2021-10-07
Factor	DRH18-E	Temp. / Humidity	23°C /49%
Polarity	Vertical	Site / Test Engineer	AC2 / Jay
Test Mode	802.11ac40_TX_Band4_CH 151	Test Voltage	AC 120V/60Hz

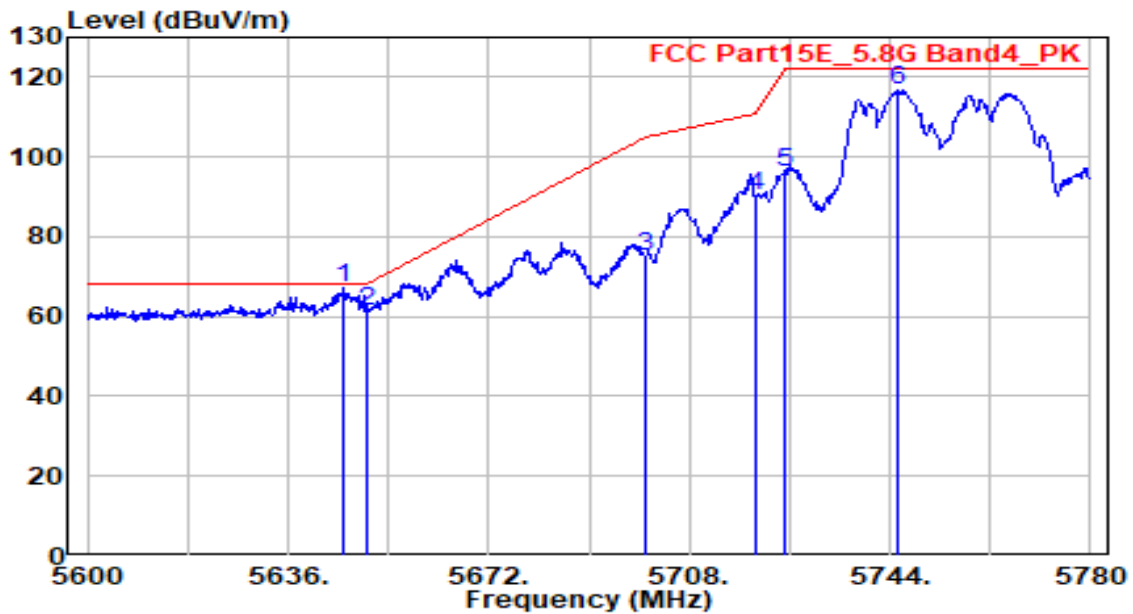

No	Frequency (MHz)	Reading (dBμV)	C.F (dB/m)	Measurement (dBμV/m)	Margin (dB)	Limit (dBμV/m)	Height (cm)	Angle (deg)	Remark (QP/PK/AV)
1	* 5646.080	66.62	0.59	67.21	-0.99	68.20	245	105	Peak
2	5650.000	60.85	0.60	61.46	-6.74	68.20	245	105	Peak
3	5700.000	74.46	0.81	75.27	-29.93	105.20	245	105	Peak
4	5720.000	89.53	0.89	90.42	-20.38	110.80	245	105	Peak
5	5725.000	95.07	0.91	95.98	-26.22	122.20	245	105	Peak
6	5745.260	115.58	1.00	116.58	N/A	N/A	245	105	Peak

Note:

1. " \*", means this data is the worst emission level.
2. C.F (Correction Factor) = Antenna Factor (dB/m)+ Cable Loss (dB) – Preamplifier(dB) + 20dB Attenuation.
3. Measurement (dBμV/m) = Reading(dBμV) + C.F (Correction Factor).
4. The emission levels of other frequencies are very lower than the limit and not show in test report.

EUT	HAN Access Point	Date of Test	2021-10-07
Factor	DRH18-E	Temp. / Humidity	23°C /49%
Polarity	Horizontal	Site / Test Engineer	AC2 / Jay
Test Mode	802.11ac40_TX_Band4_CH 159	Test Voltage	AC 120V/60Hz

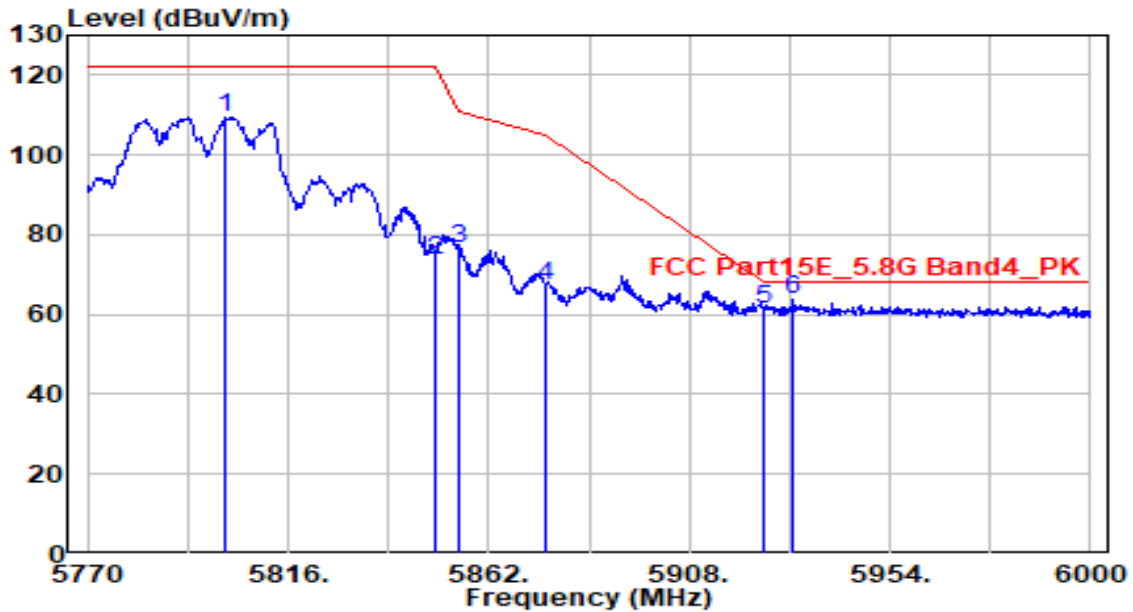

No	Frequency (MHz)	Reading (dBµV)	C.F (dB/m)	Measurement (dBµV/m)	Margin (dB)	Limit (dBµV/m)	Height (cm)	Angle (deg)	Remark (QP/PK/AV)
1	5801.280	108.19	1.22	109.42	N/A	N/A	245	35	Peak
2	5850.000	72.42	1.28	73.70	-48.50	122.20	245	35	Peak
3	5855.000	75.34	1.28	76.62	-34.18	110.80	245	35	Peak
4	5875.000	66.07	1.30	67.38	-37.82	105.20	245	35	Peak
5	5925.000	59.95	1.35	61.30	-6.90	68.20	245	35	Peak
6	* 5931.920	62.32	1.36	63.68	-4.52	68.20	245	35	Peak

Note:

1. " \*", means this data is the worst emission level.
2. C.F (Correction Factor) = Antenna Factor (dB/m)+ Cable Loss (dB) – Preamplifier(dB) + 20dB Attenuation.
3. Measurement (dBµV/m) = Reading(dBµV) + C.F (Correction Factor).
4. The emission levels of other frequencies are very lower than the limit and not show in test report.

EUT	HAN Access Point	Date of Test	2021-10-07
Factor	DRH18-E	Temp. / Humidity	23°C /49%
Polarity	Vertical	Site / Test Engineer	AC2 / Jay
Test Mode	802.11ac40_TX_Band4_CH 159	Test Voltage	AC 120V/60Hz

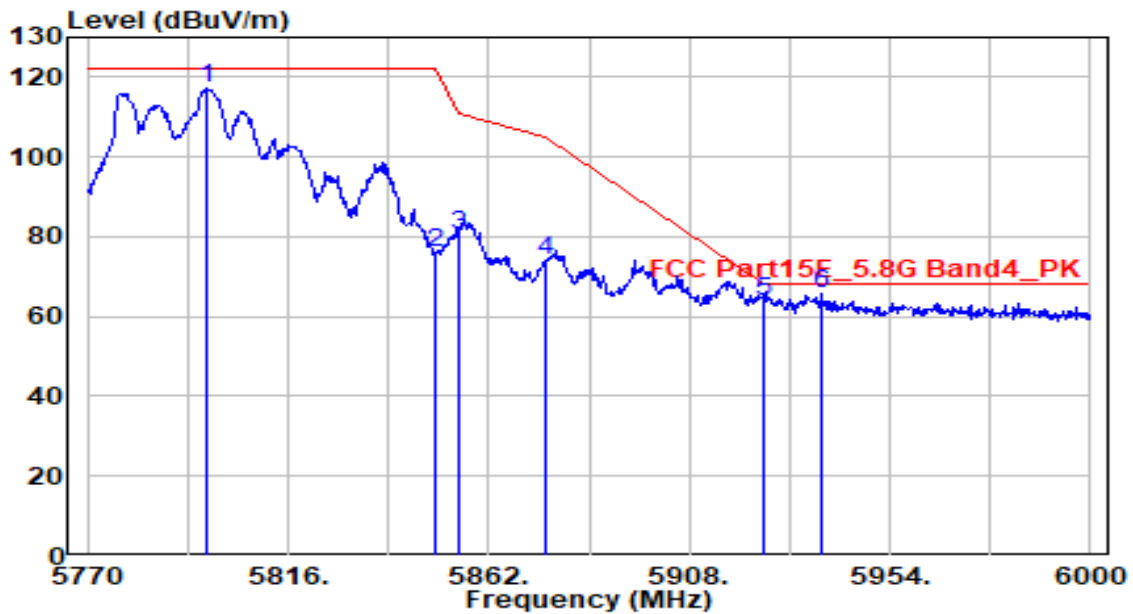

No	Frequency (MHz)	Reading (dB $\mu$ V)	C.F (dB/m)	Measurement (dB $\mu$ V/m)	Margin (dB)	Limit (dB $\mu$ V/m)	Height (cm)	Angle (deg)	Remark (QP/PK/AV)
1	5797.370	115.85	1.21	117.06	N/A	N/A	250	110	Peak
2	5850.000	74.64	1.28	75.92	-46.28	122.20	250	110	Peak
3	5855.000	79.40	1.28	80.68	-30.12	110.80	250	110	Peak
4	5875.000	72.54	1.30	73.84	-31.36	105.20	250	110	Peak
5	5925.000	62.57	1.35	63.92	-4.28	68.20	250	110	Peak
6	* 5938.130	64.60	1.37	65.97	-2.23	68.20	250	110	Peak

Note:

1. " \*", means this data is the worst emission level.
2. C.F (Correction Factor) = Antenna Factor (dB/m)+ Cable Loss (dB) – Preamplifier(dB) + 20dB Attenuation.
3. Measurement (dB $\mu$ V/m) = Reading(dB $\mu$ V) + C.F (Correction Factor).
4. The emission levels of other frequencies are very lower than the limit and not show in test report.

EUT	HAN Access Point	Date of Test	2021-10-07
Factor	DRH18-E	Temp. / Humidity	23°C /49%
Polarity	Horizontal	Site / Test Engineer	AC2 / Jay
Test Mode	802.11ac80_TX_Band1_CH 42	Test Voltage	AC 120V/60Hz

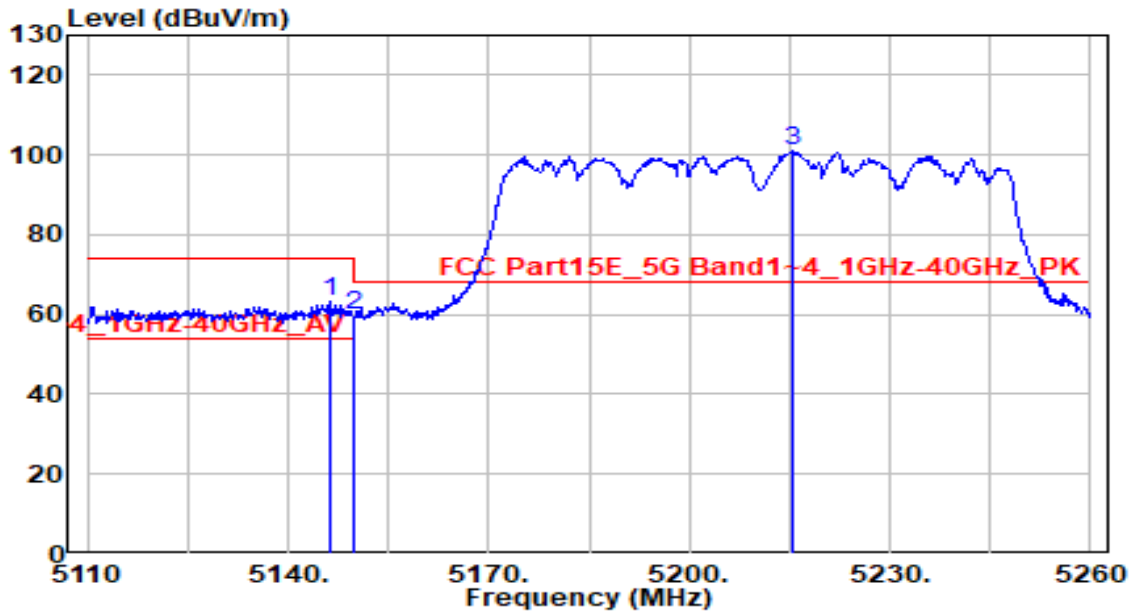

No	Frequency (MHz)	Reading (dB $\mu$ V)	C.F (dB/m)	Measurement (dB $\mu$ V/m)	Margin (dB)	Limit (dB $\mu$ V/m)	Height (cm)	Angle (deg)	Remark (QP/PK/AV)
1	* 5146.150	63.40	-0.32	63.08	-10.92	74.00	260	40	Peak
2	5150.000	60.35	-0.32	60.03	-13.97	74.00	260	40	Peak
3	5215.600	101.54	-0.32	101.22	N/A	N/A	260	40	Peak

Note:

- "\*" means this data is the worst emission level.
- C.F (Correction Factor) = Antenna Factor (dB/m)+ Cable Loss (dB) – Preamplifier(dB) + 20dB Attenuation.
- Measurement (dB $\mu$ V/m) = Reading(dB $\mu$ V) + C.F (Correction Factor).
- The emission levels of other frequencies are very lower than the limit and not show in test report.

EUT	HAN Access Point	Date of Test	2021-10-07
Factor	DRH18-E	Temp. / Humidity	23°C /49%
Polarity	Horizontal	Site / Test Engineer	AC2 / Jay
Test Mode	802.11ac80_TX_Band1_CH 42	Test Voltage	AC 120V/60Hz

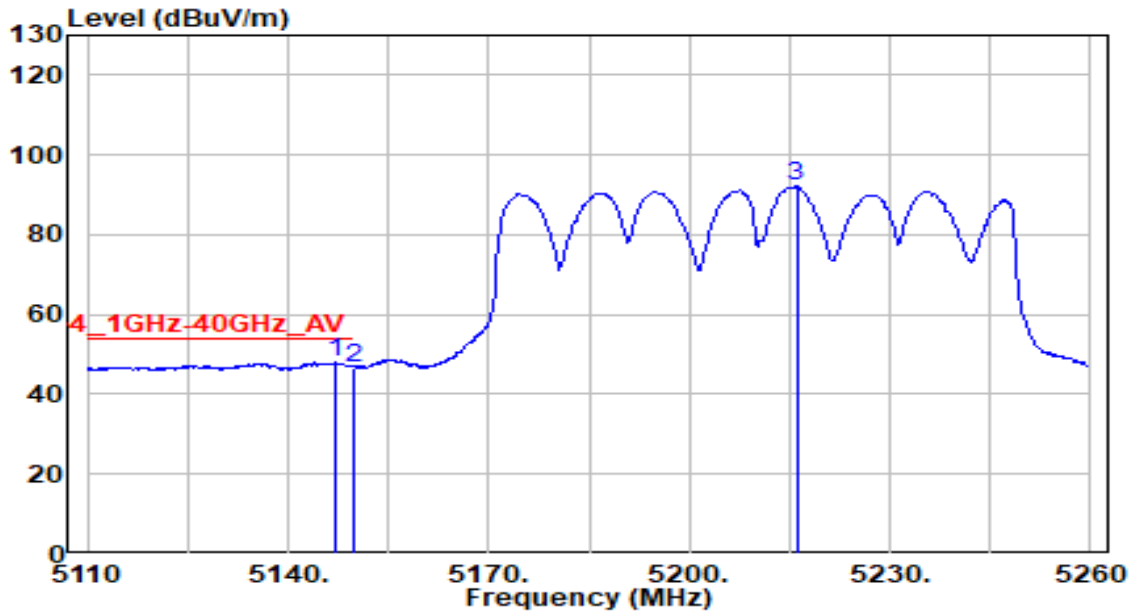

No	Frequency (MHz)	Reading (dB $\mu$ V)	C.F (dB/m)	Measurement (dB $\mu$ V/m)	Margin (dB)	Limit (dB $\mu$ V/m)	Height (cm)	Angle (deg)	Remark (QP/PK/AV)
1	* 5147.050	48.22	-0.32	47.91	-6.09	54.00	260	40	Average
2	5150.000	47.16	-0.32	46.85	-7.15	54.00	260	40	Average
3	5216.050	92.33	-0.32	92.00	N/A	N/A	260	40	Average

Note:

- "\*", means this data is the worst emission level.
- C.F (Correction Factor) = Antenna Factor (dB/m)+ Cable Loss (dB) – Preamplifier(dB) + 20dB Attenuation.
- Measurement (dB $\mu$ V/m) = Reading(dB $\mu$ V) + C.F (Correction Factor).
- The emission levels of other frequencies are very lower than the limit and not show in test report.



EUT	HAN Access Point	Date of Test	2021-10-07
Factor	DRH18-E	Temp. / Humidity	23°C /49%
Polarity	Horizontal	Site / Test Engineer	AC2 / Jay
Test Mode	802.11ac80_TX_Band1_CH 42	Test Voltage	AC 120V/60Hz

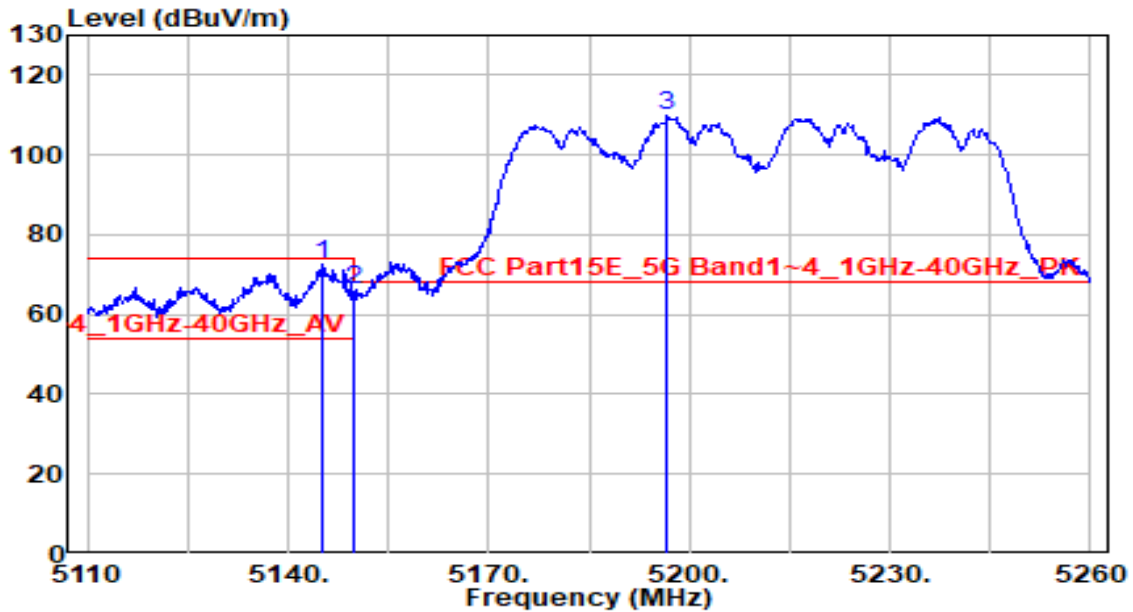

No	Frequency (MHz)	Reading (dB $\mu$ V)	C.F (dB/m)	Measurement (dB $\mu$ V/m)	Margin (dB)	Limit (dB $\mu$ V/m)	Height (cm)	Angle (deg)	Remark (QP/PK/AV)
1	* 5145.250	72.88	-0.32	72.56	-1.44	74.00	255	170	Peak
2	5150.000	66.33	-0.32	66.01	-7.99	74.00	255	170	Peak
3	5196.700	110.11	-0.32	109.79	N/A	N/A	255	170	Peak

Note:

- "\*" means this data is the worst emission level.
- C.F (Correction Factor) = Antenna Factor (dB/m)+ Cable Loss (dB) – Preamplifier(dB) + 20dB Attenuation.
- Measurement (dB $\mu$ V/m) = Reading(dB $\mu$ V) + C.F (Correction Factor).
- The emission levels of other frequencies are very lower than the limit and not show in test report.

EUT	HAN Access Point	Date of Test	2021-10-07
Factor	DRH18-E	Temp. / Humidity	23°C /49%
Polarity	Vertical	Site / Test Engineer	AC2 / Jay
Test Mode	802.11ac80_TX_Band1_CH 42	Test Voltage	AC 120V/60Hz

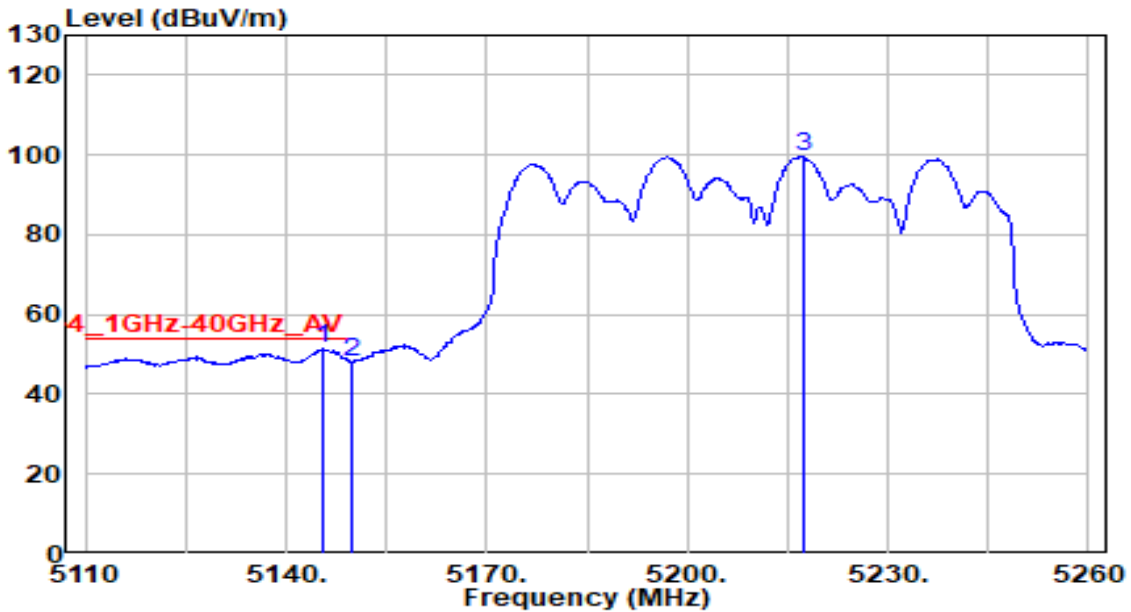

No	Frequency (MHz)	Reading (dBμV)	C.F (dB/m)	Measurement (dBμV/m)	Margin (dB)	Limit (dBμV/m)	Height (cm)	Angle (deg)	Remark (QP/PK/AV)
1	*	51.60	-0.32	51.29	-2.71	54.00	255	170	Average
2		48.38	-0.32	48.06	-5.94	54.00	255	170	Average
3		99.78	-0.32	99.45	N/A	N/A	255	170	Average

Note:

1. " \*", means this data is the worst emission level.
2. C.F (Correction Factor) = Antenna Factor (dB/m)+ Cable Loss (dB) – Preamplifier(dB) + 20dB Attenuation.
3. Measurement (dBμV/m) = Reading(dBμV) + C.F (Correction Factor).
4. The emission levels of other frequencies are very lower than the limit and not show in test report.

EUT	HAN Access Point	Date of Test	2021-10-07
Factor	DRH18-E	Temp. / Humidity	23°C /49%
Polarity	Horizontal	Site / Test Engineer	AC2 / Jay
Test Mode	802.11ac80_TX_Band2_CH 58	Test Voltage	AC 120V/60Hz

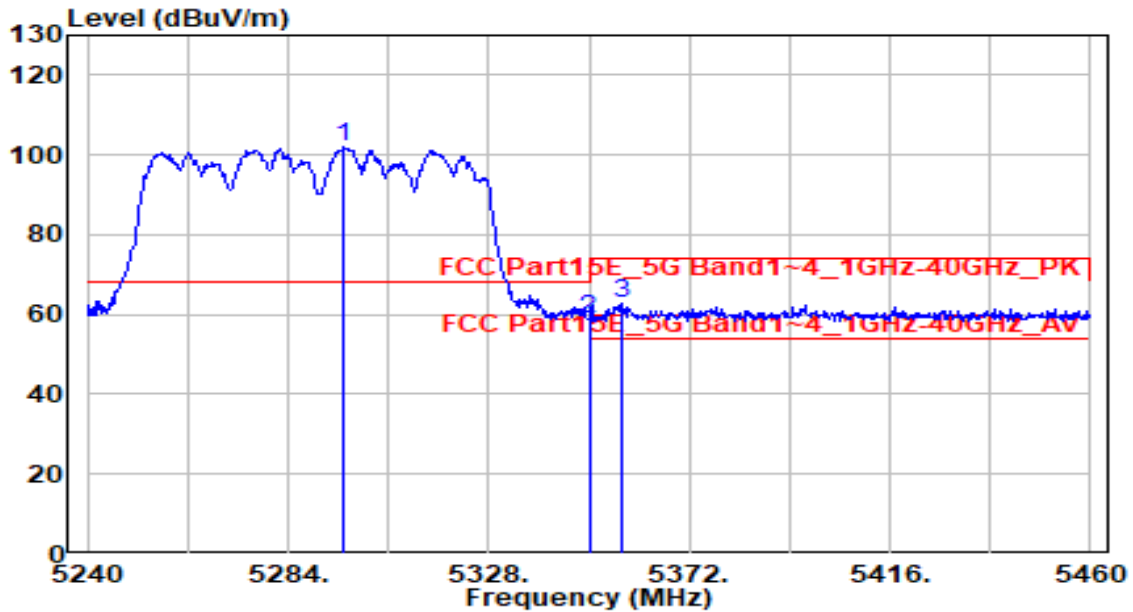

No	Frequency (MHz)	Reading (dBμV)	C.F (dB/m)	Measurement (dBμV/m)	Margin (dB)	Limit (dBμV/m)	Height (cm)	Angle (deg)	Remark (QP/PK/AV)
1	5296.320	102.41	-0.33	102.08	N/A	N/A	220	40	Peak
2	5350.000	59.40	-0.33	59.07	-9.13	68.20	220	40	Peak
3	5357.480	63.14	-0.33	62.81	-11.19	74.00	220	40	Peak

Note:

- "\*\*", means this data is the worst emission level.
- C.F (Correction Factor) = Antenna Factor (dB/m)+ Cable Loss (dB) – Preamplifier(dB) + 20dB Attenuation.
- Measurement (dBμV/m) = Reading(dBμV) + C.F (Correction Factor).
- The emission levels of other frequencies are very lower than the limit and not show in test report.

EUT	HAN Access Point	Date of Test	2021-10-07
Factor	DRH18-E	Temp. / Humidity	23°C /49%
Polarity	Horizontal	Site / Test Engineer	AC2 / Jay
Test Mode	802.11ac80_TX_Band2_CH 58	Test Voltage	AC 120V/60Hz

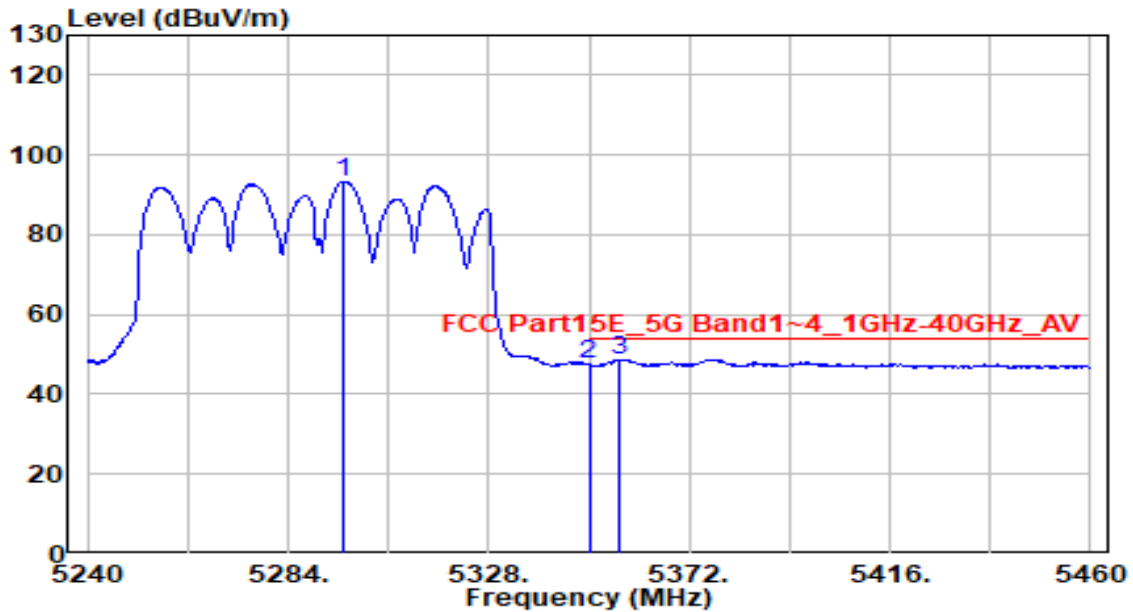

No	Frequency (MHz)	Reading (dBμV)	C.F (dB/m)	Measurement (dBμV/m)	Margin (dB)	Limit (dBμV/m)	Height (cm)	Angle (deg)	Remark (QP/PK/AV)
1	5296.320	93.64	-0.33	93.32	N/A	N/A	220	40	Average
2	5350.000	47.73	-0.33	47.40	-6.60	54.00	220	40	Average
3	5356.600	49.02	-0.33	48.69	-5.31	54.00	220	40	Average

Note:

- "\*\*", means this data is the worst emission level.
- C.F (Correction Factor) = Antenna Factor (dB/m)+ Cable Loss (dB) – Preamplifier(dB) + 20dB Attenuation.
- Measurement (dBμV/m) = Reading(dBμV) + C.F (Correction Factor).
- The emission levels of other frequencies are very lower than the limit and not show in test report.

EUT	HAN Access Point	Date of Test	2021-10-07
Factor	DRH18-E	Temp. / Humidity	23°C /49%
Polarity	Vertical	Site / Test Engineer	AC2 / Jay
Test Mode	802.11ac80_TX_Band2_CH 58	Test Voltage	AC 120V/60Hz

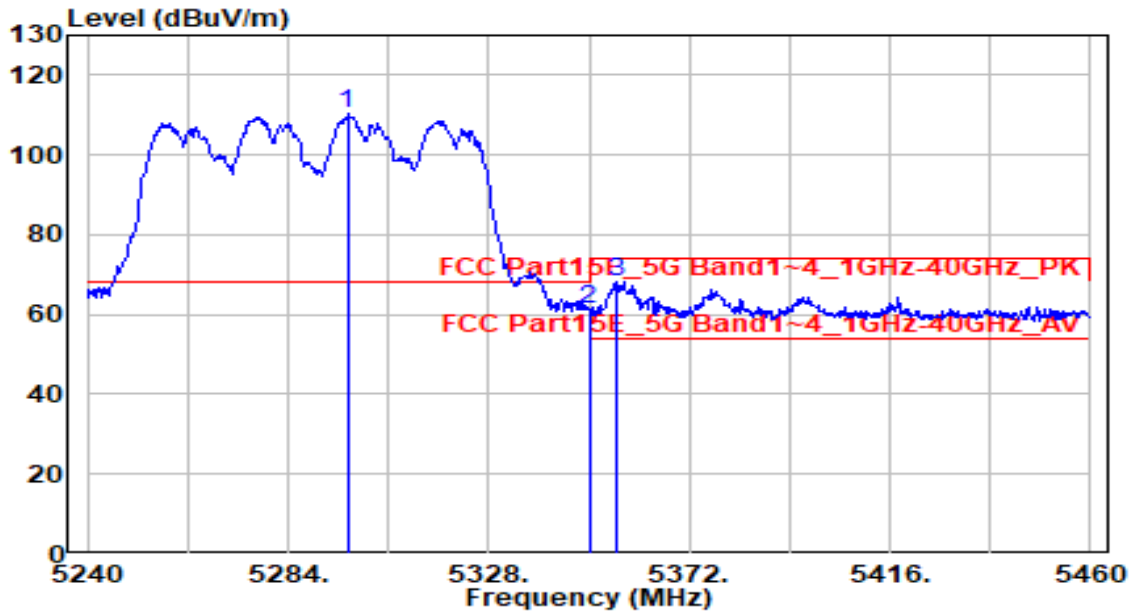

No	Frequency (MHz)	Reading (dBμV)	C.F (dB/m)	Measurement (dBμV/m)	Margin (dB)	Limit (dBμV/m)	Height (cm)	Angle (deg)	Remark (QP/PK/AV)
1	* 5296.980	110.47	-0.33	110.14	N/A	N/A	255	170	Peak
2	5350.000	61.57	-0.33	61.25	-6.95	68.20	255	170	Peak
3	5355.940	68.73	-0.33	68.40	-5.60	74.00	255	170	Peak

Note:

- "\*" means this data is the worst emission level.
- C.F (Correction Factor) = Antenna Factor (dB/m)+ Cable Loss (dB) – Preamplifier(dB) + 20dB Attenuation.
- Measurement (dBμV/m) = Reading(dBμV) + C.F (Correction Factor).
- The emission levels of other frequencies are very lower than the limit and not show in test report.

EUT	HAN Access Point	Date of Test	2021-10-07
Factor	DRH18-E	Temp. / Humidity	23°C /49%
Polarity	Vertical	Site / Test Engineer	AC2 / Jay
Test Mode	802.11ac80_TX_Band2_CH 58	Test Voltage	AC 120V/60Hz

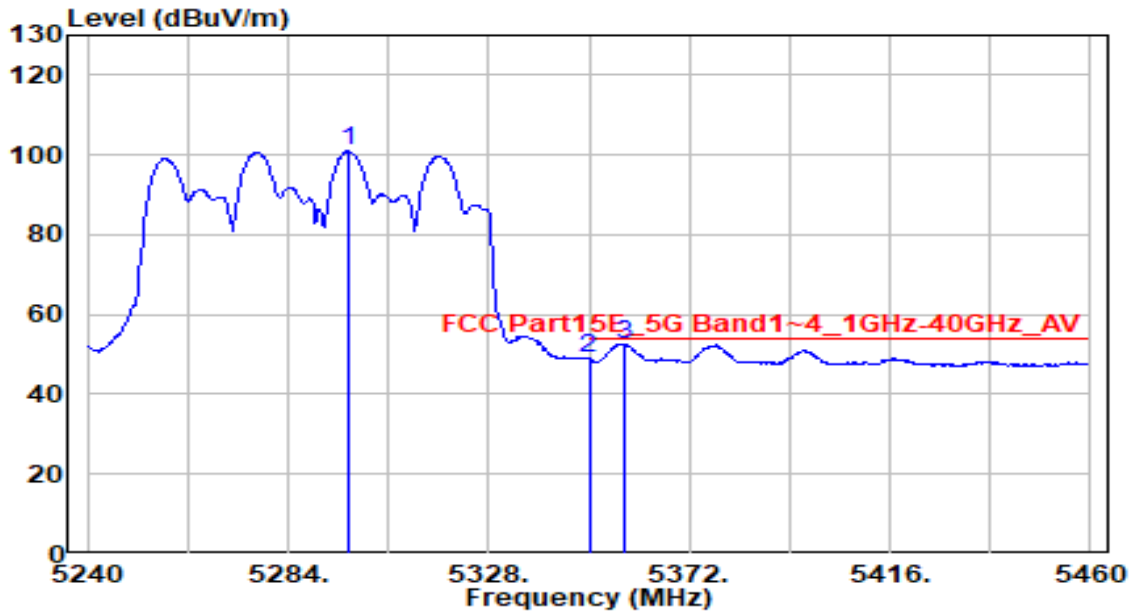

No	Frequency (MHz)	Reading (dB $\mu$ V)	C.F (dB/m)	Measurement (dB $\mu$ V/m)	Margin (dB)	Limit (dB $\mu$ V/m)	Height (cm)	Angle (deg)	Remark (QP/PK/AV)
1	5297.200	101.22	-0.33	100.90	N/A	N/A	255	170	Average
2	5350.000	49.17	-0.33	48.84	-5.16	54.00	255	170	Average
3	* 5357.700	53.00	-0.33	52.67	-1.33	54.00	255	170	Average

Note:

- "\*" means this data is the worst emission level.
- C.F (Correction Factor) = Antenna Factor (dB/m)+ Cable Loss (dB) – Preamplifier(dB) + 20dB Attenuation.
- Measurement (dB $\mu$ V/m) = Reading(dB $\mu$ V) + C.F (Correction Factor).
- The emission levels of other frequencies are very lower than the limit and not show in test report.

EUT	HAN Access Point	Date of Test	2021-10-07
Factor	DRH18-E	Temp. / Humidity	23°C /49%
Polarity	Horizontal	Site / Test Engineer	AC2 / Jay
Test Mode	802.11ac80_TX_Band3_CH 106	Test Voltage	AC 120V/60Hz

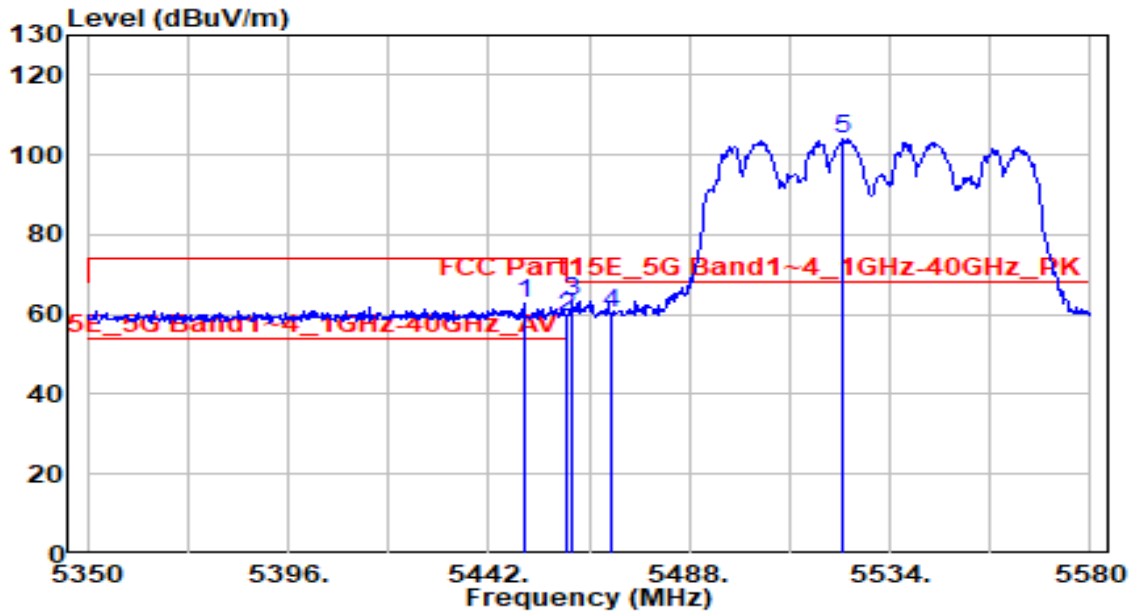

No	Frequency (MHz)	Reading (dBµV)	C.F (dB/m)	Measurement (dBµV/m)	Margin (dB)	Limit (dBµV/m)	Height (cm)	Angle (deg)	Remark (QP/PK/AV)
1	5450.050	62.90	-0.14	62.76	-11.24	74.00	255	140	Peak
2	5460.000	59.63	-0.11	59.52	-8.68	68.20	255	140	Peak
3	* 5461.320	63.55	-0.10	63.45	-4.75	68.20	255	140	Peak
4	5470.000	60.30	-0.07	60.23	-7.97	68.20	255	140	Peak
5	5523.420	103.68	0.12	103.81	N/A	N/A	255	140	Peak

Note:

1. " \*", means this data is the worst emission level.
2. C.F (Correction Factor) = Antenna Factor (dB/m)+ Cable Loss (dB) – Preamplifier(dB) + 20dB Attenuation.
3. Measurement (dBµV/m) = Reading(dBµV) + C.F (Correction Factor).
4. The emission levels of other frequencies are very lower than the limit and not show in test report.

EUT	HAN Access Point	Date of Test	2021-10-07
Factor	DRH18-E	Temp. / Humidity	23°C /49%
Polarity	Horizontal	Site / Test Engineer	AC2 / Jay
Test Mode	802.11ac80_TX_Band3_CH 106	Test Voltage	AC 120V/60Hz

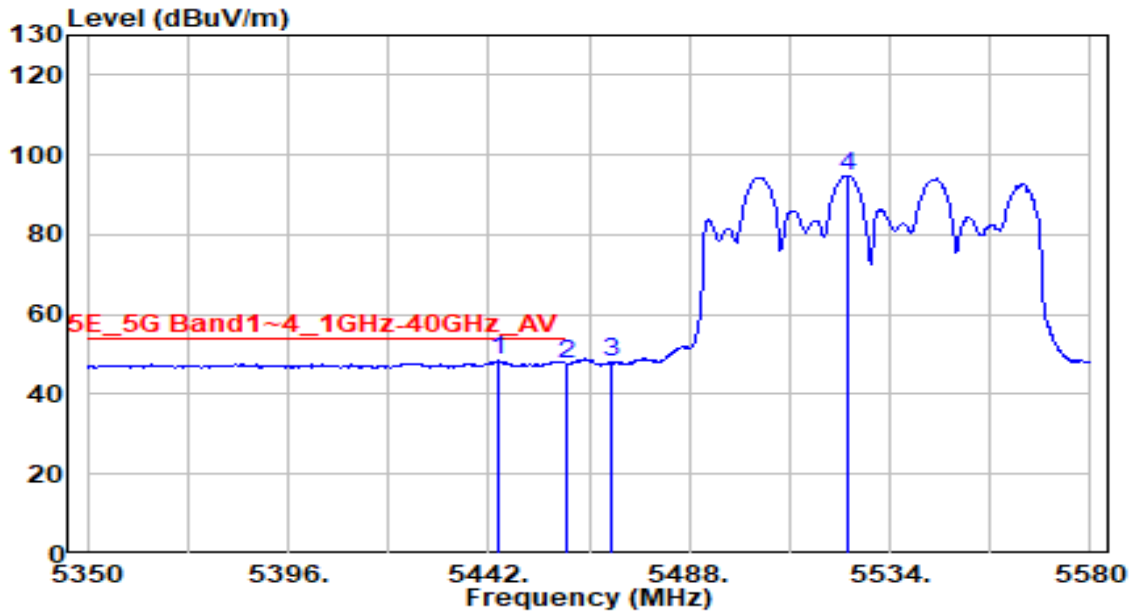

No	Frequency (MHz)	Reading (dBμV)	C.F (dB/m)	Measurement (dBμV/m)	Margin (dB)	Limit (dBμV/m)	Height (cm)	Angle (deg)	Remark (QP/PK/AV)
1	* 5444.070	48.53	-0.16	48.37	-5.63	54.00	255	140	Average
2	5460.000	47.90	-0.11	47.79	-6.21	54.00	255	140	Average
3	5470.000	48.04	-0.07	47.96	N/A	N/A	255	140	Average
4	5524.110	94.80	0.12	94.92	N/A	N/A	255	140	Average

Note:

1. " \*", means this data is the worst emission level.
2. C.F (Correction Factor) = Antenna Factor (dB/m)+ Cable Loss (dB) – Preamplifier(dB) + 20dB Attenuation.
3. Measurement (dBμV/m) = Reading(dBμV) + C.F (Correction Factor).
4. The emission levels of other frequencies are very lower than the limit and not show in test report.



EUT	HAN Access Point	Date of Test	2021-10-07
Factor	DRH18-E	Temp. / Humidity	23°C /49%
Polarity	Vertical	Site / Test Engineer	AC2 / Jay
Test Mode	802.11ac80_TX_Band3_CH 106	Test Voltage	AC 120V/60Hz

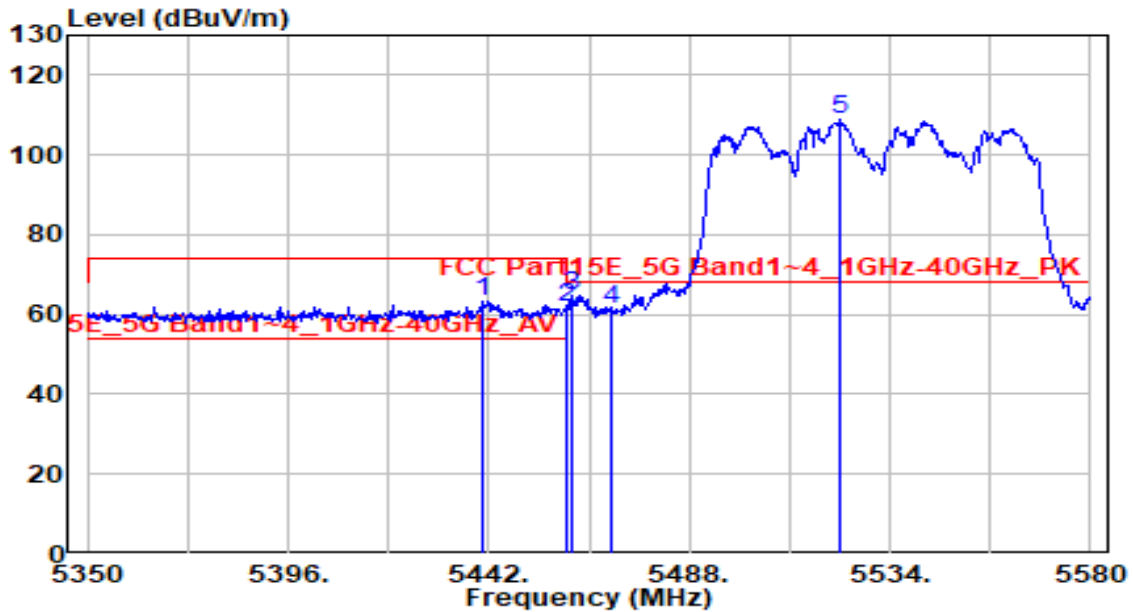

No	Frequency (MHz)	Reading (dB $\mu$ V)	C.F (dB/m)	Measurement (dB $\mu$ V/m)	Margin (dB)	Limit (dB $\mu$ V/m)	Height (cm)	Angle (deg)	Remark (QP/PK/AV)
1	5440.620	63.61	-0.18	63.43	-10.57	74.00	260	190	Peak
2	5460.000	61.99	-0.11	61.88	-6.32	68.20	260	190	Peak
3	* 5461.320	64.98	-0.10	64.88	-3.32	68.20	260	190	Peak
4	5470.000	61.20	-0.07	61.13	-7.07	68.20	260	190	Peak
5	5522.500	108.74	0.12	108.86	N/A	N/A	260	190	Peak

Note:

1. " \*", means this data is the worst emission level.
2. C.F (Correction Factor) = Antenna Factor (dB/m)+ Cable Loss (dB) – Preamplifier(dB) + 20dB Attenuation.
3. Measurement (dB $\mu$ V/m) = Reading(dB $\mu$ V) + C.F (Correction Factor).
4. The emission levels of other frequencies are very lower than the limit and not show in test report.

EUT	HAN Access Point	Date of Test	2021-10-07
Factor	DRH18-E	Temp. / Humidity	23°C /49%
Polarity	Vertical	Site / Test Engineer	AC2 / Jay
Test Mode	802.11ac80_TX_Band3_CH 106	Test Voltage	AC 120V/60Hz

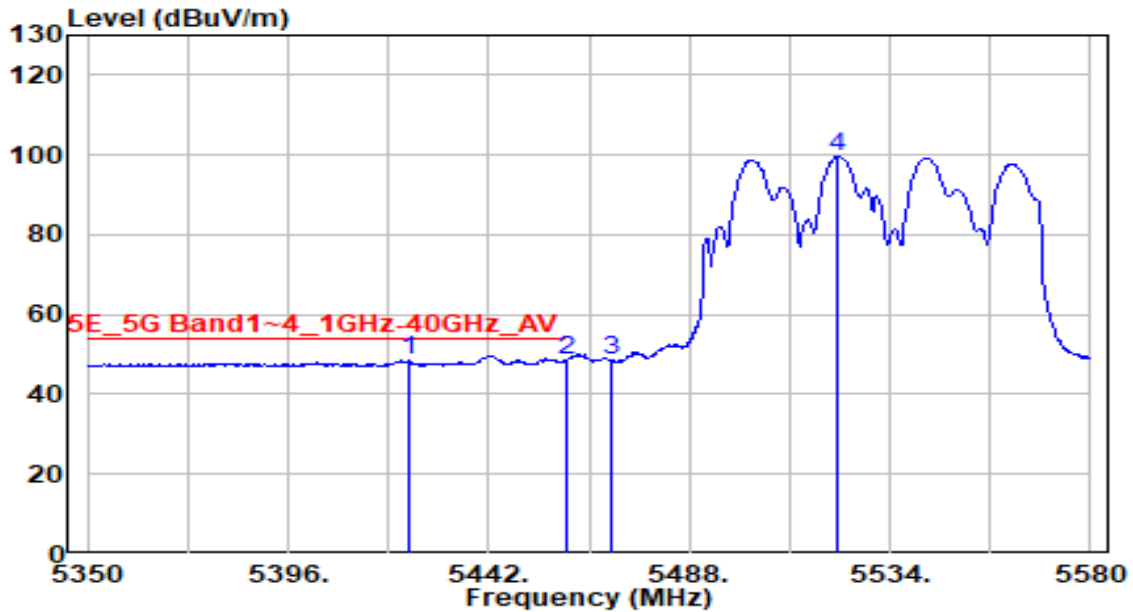

No	Frequency (MHz)	Reading (dBμV)	C.F (dB/m)	Measurement (dBμV/m)	Margin (dB)	Limit (dBμV/m)	Height (cm)	Angle (deg)	Remark (QP/PK/AV)
1	5423.830	48.69	-0.24	48.46	-5.54	54.00	260	190	Average
2	* 5460.000	48.91	-0.11	48.80	-5.20	54.00	260	190	Average
3	5470.000	48.68	-0.07	48.60	N/A	N/A	260	190	Average
4	5522.040	99.52	0.12	99.64	N/A	N/A	260	190	Average

Note:

1. " \*", means this data is the worst emission level.
2. C.F (Correction Factor) = Antenna Factor (dB/m)+ Cable Loss (dB) – Preamplifier(dB) + 20dB Attenuation.
3. Measurement (dBμV/m) = Reading(dBμV) + C.F (Correction Factor).
4. The emission levels of other frequencies are very lower than the limit and not show in test report.

EUT	HAN Access Point	Date of Test	2021-10-07
Factor	DRH18-E	Temp. / Humidity	23°C /49%
Polarity	Horizontal	Site / Test Engineer	AC2 / Jay
Test Mode	802.11ac80_TX_Band4_CH 155	Test Voltage	AC 120V/60Hz

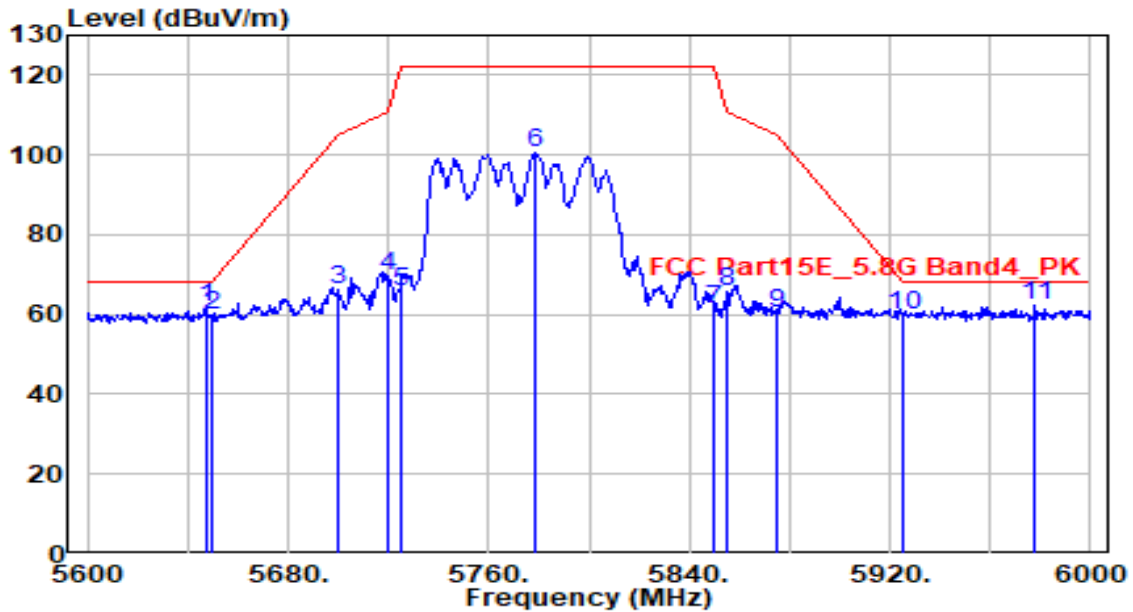

No	Frequency (MHz)	Reading (dBµV)	C.F (dB/m)	Measurement (dBµV/m)	Margin (dB)	Limit (dBµV/m)	Height (cm)	Angle (deg)	Remark (QP/PK/AV)
1	5647.200	61.42	0.59	62.01	-6.19	68.20	200	135	Peak
2	5650.000	59.01	0.60	59.62	-8.58	68.20	200	135	Peak
3	5700.000	65.29	0.81	66.10	-39.10	105.20	200	135	Peak
4	5720.000	68.68	0.89	69.58	-41.22	110.80	200	135	Peak
5	5725.000	64.63	0.91	65.54	-56.66	122.20	200	135	Peak
6	5778.400	99.25	1.13	100.38	N/A	N/A	200	135	Peak
7	5850.000	60.24	1.28	61.51	-60.69	122.20	200	135	Peak
8	5855.000	64.60	1.28	65.88	-44.92	110.80	200	135	Peak
9	5875.000	58.89	1.30	60.19	-45.01	105.20	200	135	Peak
10	5925.000	58.67	1.35	60.03	-8.17	68.20	200	135	Peak
11	* 5978.000	60.81	1.41	62.22	-5.98	68.20	200	135	Peak

Note:

1. " \*", means this data is the worst emission level.
2. C.F (Correction Factor) = Antenna Factor (dB/m)+ Cable Loss (dB) – Preamplifier(dB) + 20dB Attenuation.
3. Measurement (dBµV/m) = Reading(dBµV) + C.F (Correction Factor).

4. The emission levels of other frequencies are very lower than the limit and not show in test report.

EUT	HAN Access Point	Date of Test	2021-10-07
Factor	DRH18-E	Temp. / Humidity	23°C /49%
Polarity	Vertical	Site / Test Engineer	AC2 / Jay
Test Mode	802.11ac80_TX_Band4_CH 155	Test Voltage	AC 120V/60Hz

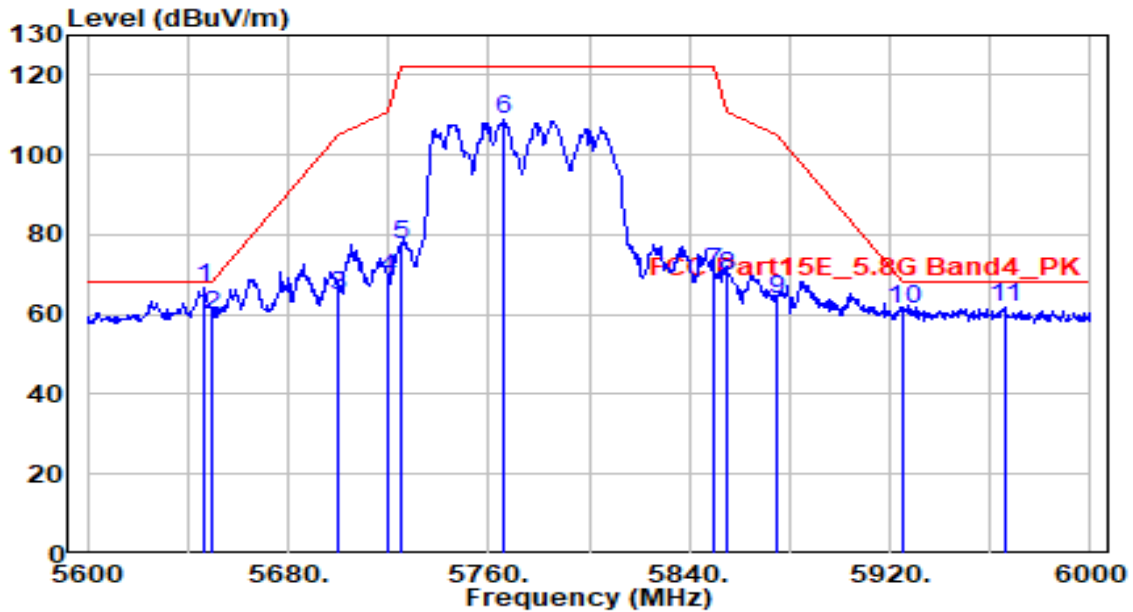

No	Frequency (MHz)	Reading (dBμV)	C.F (dB/m)	Measurement (dBμV/m)	Margin (dB)	Limit (dBμV/m)	Height (cm)	Angle (deg)	Remark (QP/PK/AV)
1	* 5646.400	66.32	0.59	66.91	-1.29	68.20	205	105	Peak
2	5650.000	59.26	0.60	59.86	-8.34	68.20	205	105	Peak
3	5700.000	63.97	0.81	64.79	-40.41	105.20	205	105	Peak
4	5720.000	68.22	0.89	69.11	-41.69	110.80	205	105	Peak
5	5725.000	76.35	0.91	77.27	-44.93	122.20	205	105	Peak
6	5766.000	107.91	1.08	108.99	N/A	N/A	205	105	Peak
7	5850.000	69.38	1.28	70.66	-51.54	122.20	205	105	Peak
8	5855.000	68.59	1.28	69.87	-40.93	110.80	205	105	Peak
9	5875.000	62.30	1.30	63.60	-41.60	105.20	205	105	Peak
10	5925.000	60.09	1.35	61.44	-6.76	68.20	205	105	Peak
11	5965.600	60.29	1.39	61.69	-6.51	68.20	205	105	Peak

Note:

1. " \*", means this data is the worst emission level.
2. C.F (Correction Factor) = Antenna Factor (dB/m)+ Cable Loss (dB) – Preamplifier(dB) + 20dB Attenuation.
3. Measurement (dBμV/m) = Reading(dBμV) + C.F (Correction Factor).

4. The emission levels of other frequencies are very lower than the limit and not show in test report.

EUT	HAN Access Point	Date of Test	2021-10-07
Factor	DRH18-E	Temp. / Humidity	23°C /49%
Polarity	Horizontal	Site / Test Engineer	AC2 / Jay
Test Mode	802.11ac80+80_TX_Band1,2_CH 50	Test Voltage	AC 120V/60Hz

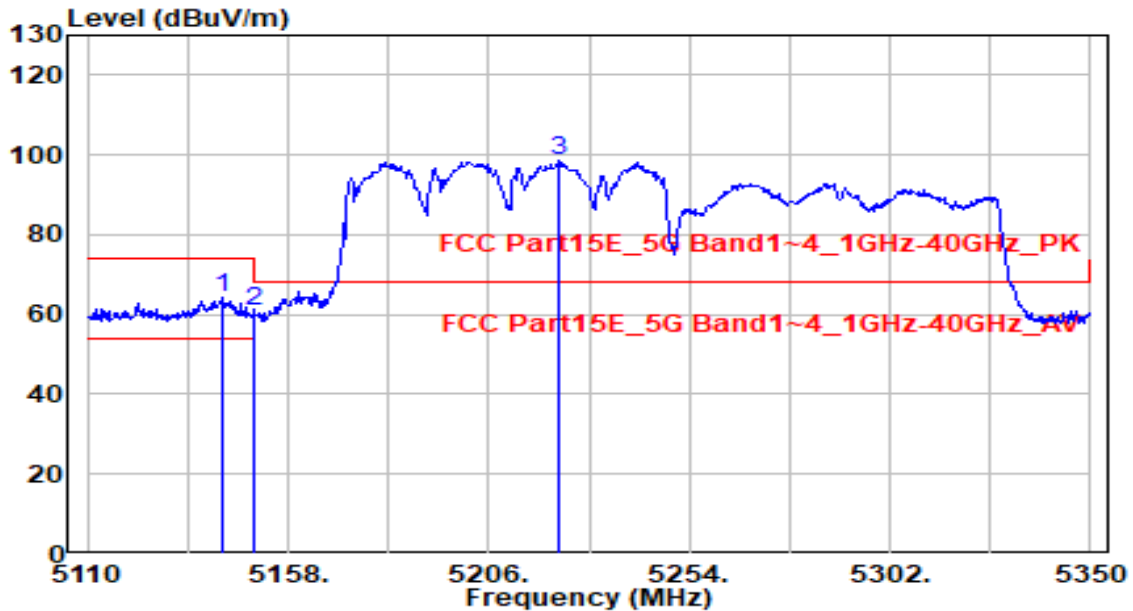

No	Frequency (MHz)	Reading (dBμV)	C.F (dB/m)	Measurement (dBμV/m)	Margin (dB)	Limit (dBμV/m)	Height (cm)	Angle (deg)	Remark (QP/PK/AV)	
1	*	5142.400	64.42	-0.32	64.10	-9.90	74.00	150	40	Peak
2		5150.000	60.91	-0.32	60.59	-13.41	74.00	150	40	Peak
3		5223.040	98.79	-0.32	98.46	N/A	N/A	150	40	Peak

Note:

1. "\*" means this data is the worst emission level.
2. C.F (Correction Factor) = Antenna Factor (dB/m)+ Cable Loss (dB) – Preamplifier(dB) + 20dB Attenuation.
3. Measurement (dBμV/m) = Reading(dBμV) + C.F (Correction Factor).
4. The emission levels of other frequencies are very lower than the limit and not show in test report.

EUT	HAN Access Point	Date of Test	2021-10-07
Factor	DRH18-E	Temp. / Humidity	23°C /49%
Polarity	Horizontal	Site / Test Engineer	AC2 / Jay
Test Mode	802.11ac80+80_TX_Band1,2_CH 50	Test Voltage	AC 120V/60Hz

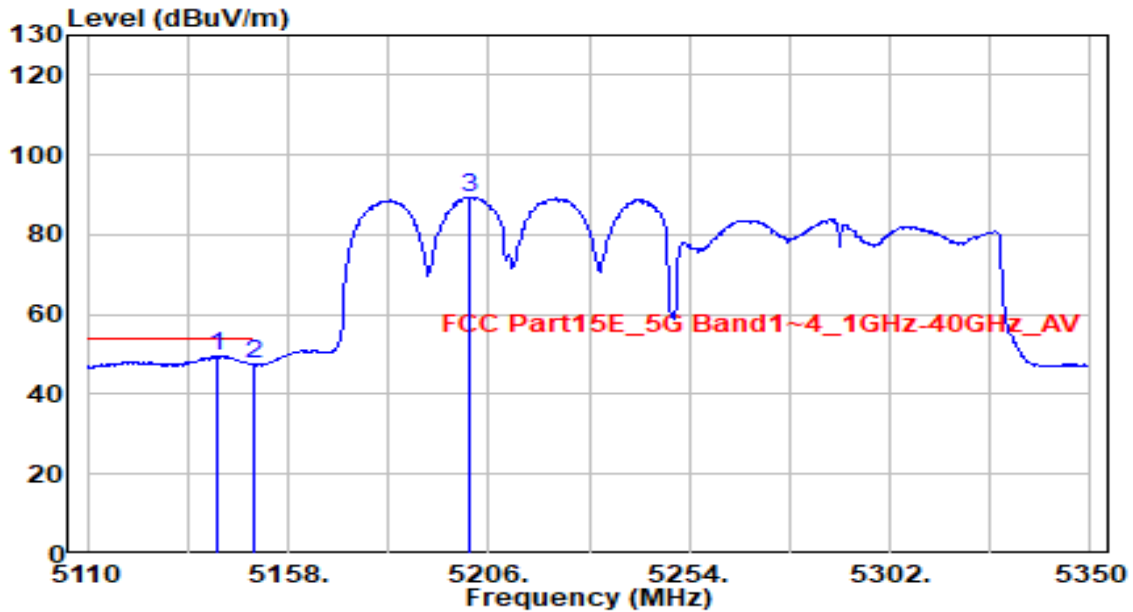

No	Frequency (MHz)	Reading (dBμV)	C.F (dB/m)	Measurement (dBμV/m)	Margin (dB)	Limit (dBμV/m)	Height (cm)	Angle (deg)	Remark (QP/PK/AV)
1	* 5140.960	50.08	-0.32	49.76	-4.24	54.00	150	40	Average
2	5150.000	47.72	-0.32	47.40	-6.60	54.00	150	40	Average
3	5201.680	89.77	-0.32	89.45	N/A	N/A	150	40	Average

Note:

- "\*" means this data is the worst emission level.
- C.F (Correction Factor) = Antenna Factor (dB/m)+ Cable Loss (dB) – Preamplifier(dB) + 20dB Attenuation.
- Measurement (dBμV/m) = Reading(dBμV) + C.F (Correction Factor).
- The emission levels of other frequencies are very lower than the limit and not show in test report.

EUT	HAN Access Point	Date of Test	2021-10-07
Factor	DRH18-E	Temp. / Humidity	23°C /49%
Polarity	Vertical	Site / Test Engineer	AC2 / Jay
Test Mode	802.11ac80+80_TX_Band1,2_CH 50	Test Voltage	AC 120V/60Hz

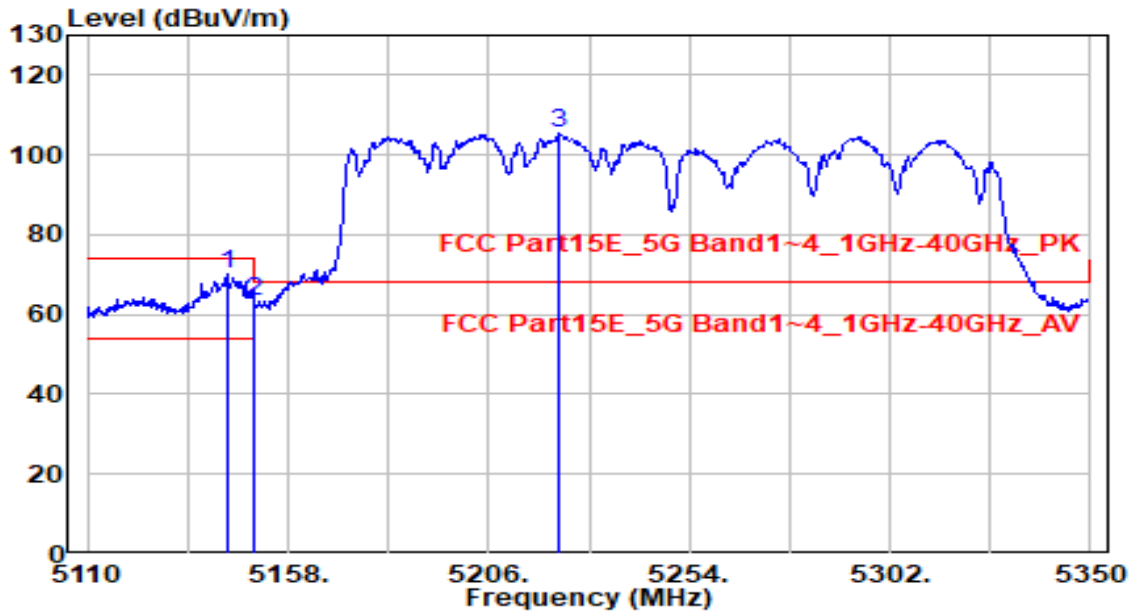

No	Frequency (MHz)	Reading (dB $\mu$ V)	C.F (dB/m)	Measurement (dB $\mu$ V/m)	Margin (dB)	Limit (dB $\mu$ V/m)	Height (cm)	Angle (deg)	Remark (QP/PK/AV)
1	* 5143.360	70.23	-0.32	69.91	-4.09	74.00	200	170	Peak
2	5150.000	63.49	-0.32	63.17	-10.83	74.00	200	170	Peak
3	5223.040	105.58	-0.32	105.25	N/A	N/A	200	170	Peak

Note:

- "\*" means this data is the worst emission level.
- C.F (Correction Factor) = Antenna Factor (dB/m)+ Cable Loss (dB) – Preamplifier(dB) + 20dB Attenuation.
- Measurement (dB $\mu$ V/m) = Reading(dB $\mu$ V) + C.F (Correction Factor).
- The emission levels of other frequencies are very lower than the limit and not show in test report.



EUT	HAN Access Point	Date of Test	2021-10-07
Factor	DRH18-E	Temp. / Humidity	23°C /49%
Polarity	Vertical	Site / Test Engineer	AC2 / Jay
Test Mode	802.11ac80+80_TX_Band1,2_CH 50	Test Voltage	AC 120V/60Hz

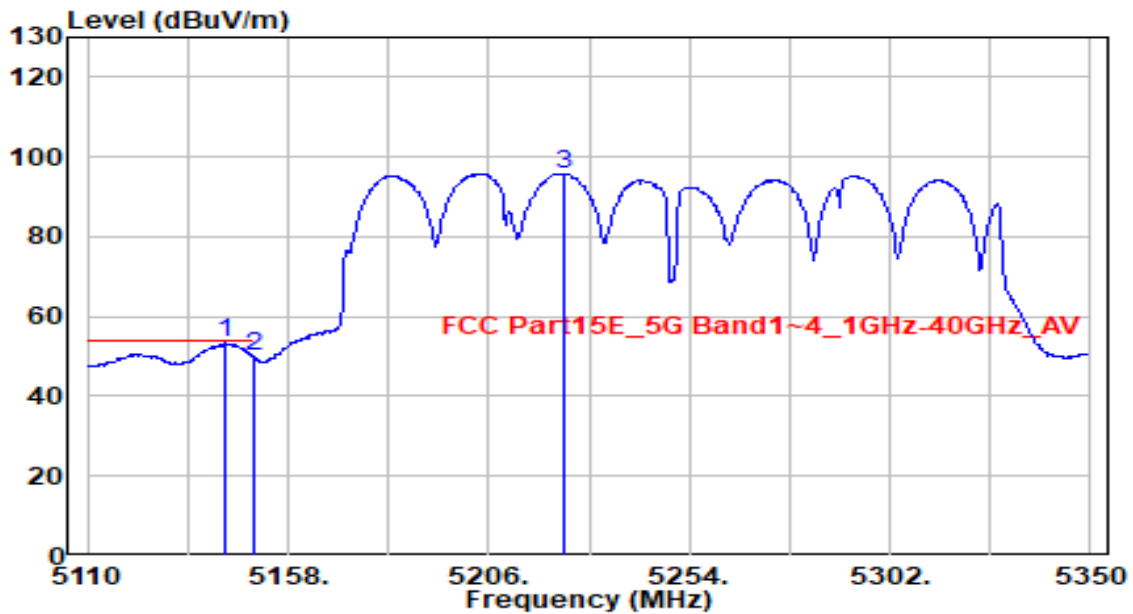

No	Frequency (MHz)	Reading (dB $\mu$ V)	C.F (dB/m)	Measurement (dB $\mu$ V/m)	Margin (dB)	Limit (dB $\mu$ V/m)	Height (cm)	Angle (deg)	Remark (QP/PK/AV)
1	*	53.57	-0.32	53.25	-0.75	54.00	200	170	Average
2		50.15	-0.32	49.83	-4.17	54.00	200	170	Average
3		96.12	-0.32	95.79	N/A	N/A	200	170	Average

Note:

1. " \*", means this data is the worst emission level.
2. C.F (Correction Factor) = Antenna Factor (dB/m)+ Cable Loss (dB) – Preamplifier(dB) + 20dB Attenuation.
3. Measurement (dB $\mu$ V/m) = Reading(dB $\mu$ V) + C.F (Correction Factor).
4. The emission levels of other frequencies are very lower than the limit and not show in test report.

EUT	HAN Access Point	Date of Test	2021-10-07
Factor	DRH18-E	Temp. / Humidity	23°C /49%
Polarity	Horizontal	Site / Test Engineer	AC2 / Jay
Test Mode	802.11ac80+80_TX_Band1,2_CH 50	Test Voltage	AC 120V/60Hz

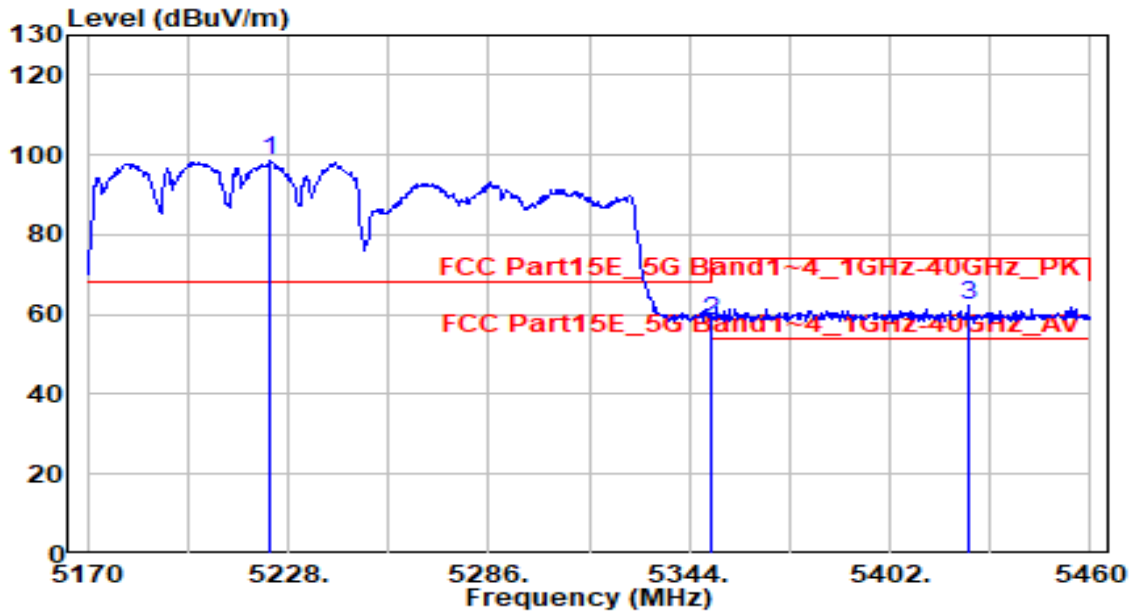

No	Frequency (MHz)	Reading (dB $\mu$ V)	C.F (dB/m)	Measurement (dB $\mu$ V/m)	Margin (dB)	Limit (dB $\mu$ V/m)	Height (cm)	Angle (deg)	Remark (QP/PK/AV)
1	5223.070	98.89	-0.32	98.56	N/A	N/A	150	40	Peak
2	* 5350.000	58.47	-0.33	58.14	-10.06	68.20	150	40	Peak
3	5424.620	62.31	-0.23	62.08	-11.92	74.00	150	40	Peak

Note:

- "\*" means this data is the worst emission level.
- C.F (Correction Factor) = Antenna Factor (dB/m)+ Cable Loss (dB) – Preamplifier(dB) + 20dB Attenuation.
- Measurement (dB $\mu$ V/m) = Reading(dB $\mu$ V) + C.F (Correction Factor).
- The emission levels of other frequencies are very lower than the limit and not show in test report.

EUT	HAN Access Point	Date of Test	2021-10-07
Factor	DRH18-E	Temp. / Humidity	23°C /49%
Polarity	Horizontal	Site / Test Engineer	AC2 / Jay
Test Mode	802.11ac80+80_TX_Band1,2_CH 50	Test Voltage	AC 120V/60Hz

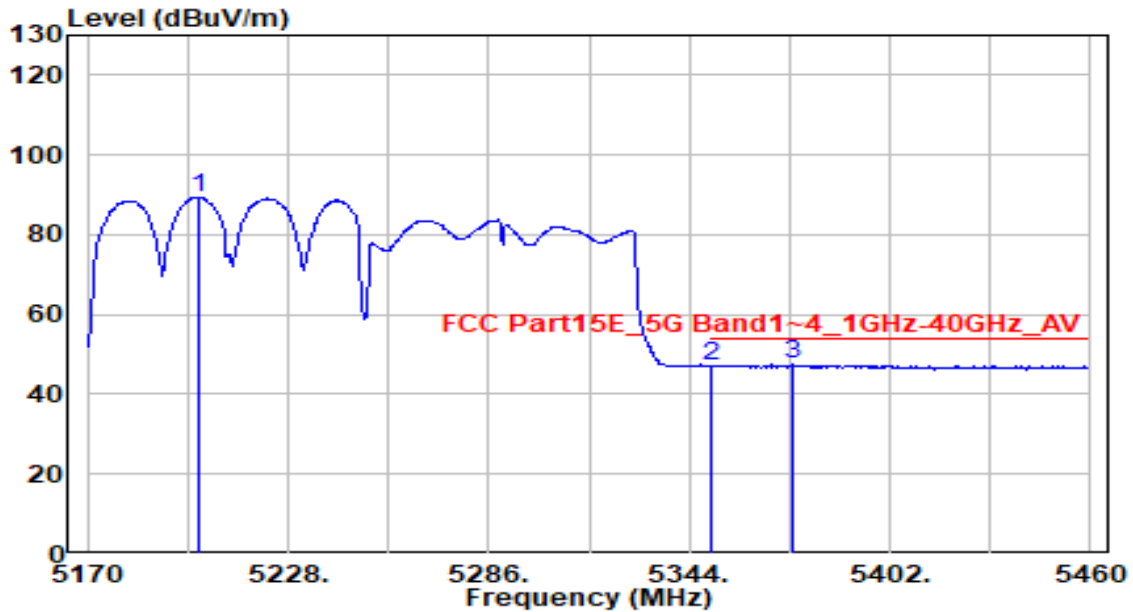

No	Frequency (MHz)	Reading (dBμV)	C.F (dB/m)	Measurement (dBμV/m)	Margin (dB)	Limit (dBμV/m)	Height (cm)	Angle (deg)	Remark (QP/PK/AV)
1	5202.480	89.66	-0.32	89.34	N/A	N/A	150	40	Average
2	5350.000	47.24	-0.33	46.91	-7.09	54.00	150	40	Average
3	* 5374.160	47.75	-0.32	47.43	-6.57	54.00	150	40	Average

Note:

- "\*" means this data is the worst emission level.
- C.F (Correction Factor) = Antenna Factor (dB/m)+ Cable Loss (dB) – Preamplifier(dB) + 20dB Attenuation.
- Measurement (dBμV/m) = Reading(dBμV) + C.F (Correction Factor).
- The emission levels of other frequencies are very lower than the limit and not show in test report.

EUT	HAN Access Point	Date of Test	2021-10-07
Factor	DRH18-E	Temp. / Humidity	23°C /49%
Polarity	Vertical	Site / Test Engineer	AC2 / Jay
Test Mode	802.11ac80+80_TX_Band1,2_CH 50	Test Voltage	AC 120V/60Hz

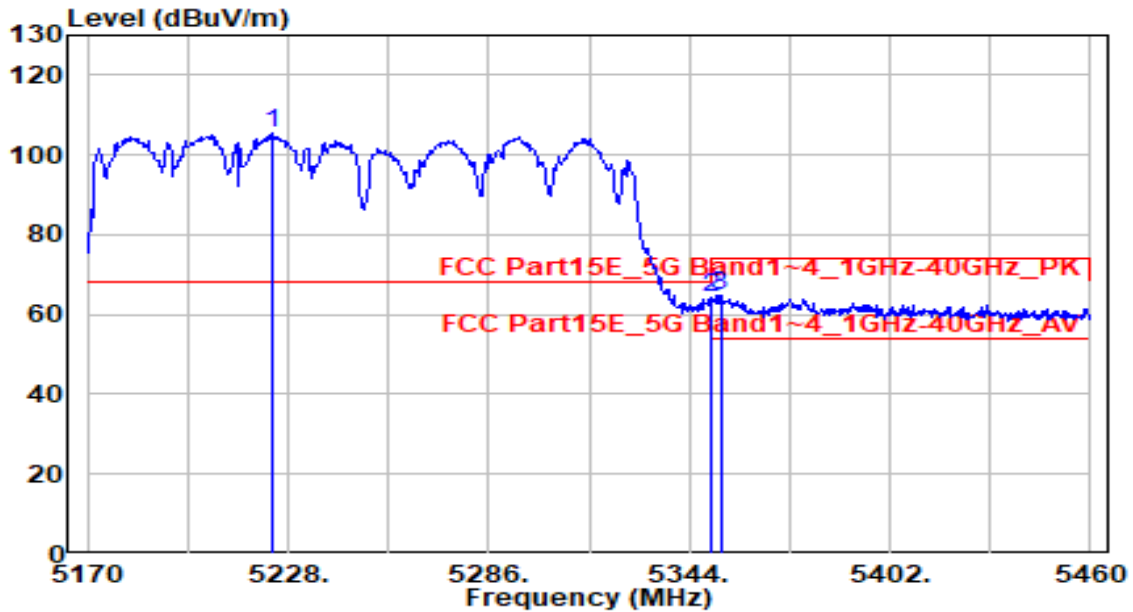

No	Frequency (MHz)	Reading (dBμV)	C.F (dB/m)	Measurement (dBμV/m)	Margin (dB)	Limit (dBμV/m)	Height (cm)	Angle (deg)	Remark (QP/PK/AV)
1	5223.360	105.85	-0.32	105.53	N/A	N/A	200	170	Peak
2	* 5350.000	64.67	-0.33	64.34	-3.86	68.20	200	170	Peak
3	5352.990	65.17	-0.33	64.85	-9.15	74.00	200	170	Peak

Note:

- "\*" means this data is the worst emission level.
- C.F (Correction Factor) = Antenna Factor (dB/m)+ Cable Loss (dB) – Preamplifier(dB) + 20dB Attenuation.
- Measurement (dBμV/m) = Reading(dBμV) + C.F (Correction Factor).
- The emission levels of other frequencies are very lower than the limit and not show in test report.

EUT	HAN Access Point	Date of Test	2021-10-07
Factor	DRH18-E	Temp. / Humidity	23°C /49%
Polarity	Vertical	Site / Test Engineer	AC2 / Jay
Test Mode	802.11ac80+80_TX_Band1,2_CH 50	Test Voltage	AC 120V/60Hz

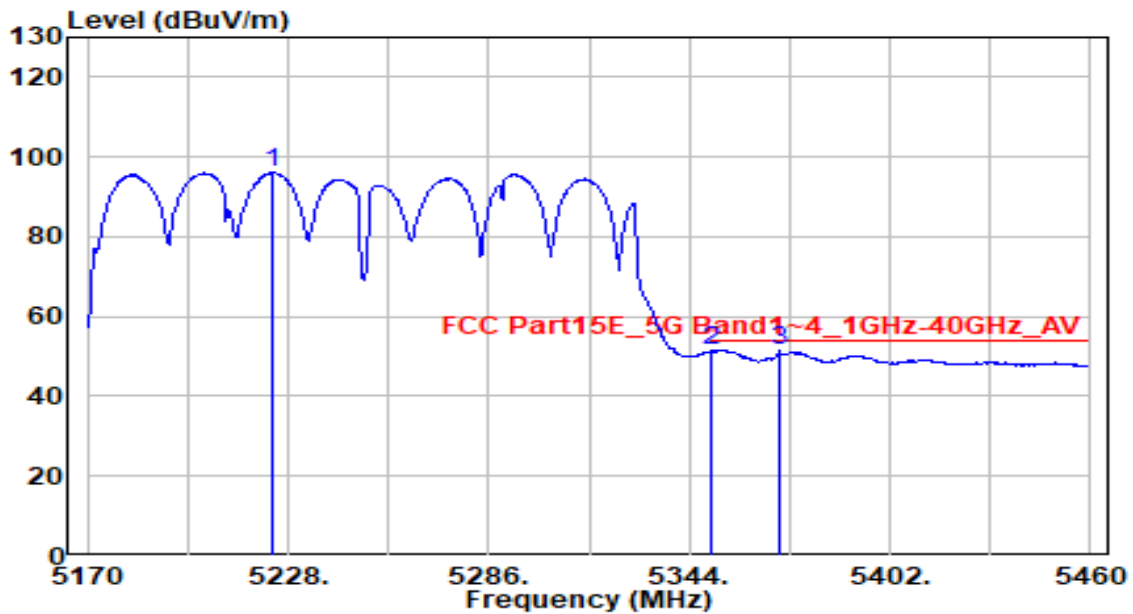

No	Frequency (MHz)	Reading (dB $\mu$ V)	C.F (dB/m)	Measurement (dB $\mu$ V/m)	Margin (dB)	Limit (dB $\mu$ V/m)	Height (cm)	Angle (deg)	Remark (QP/PK/AV)
1	5223.360	96.35	-0.32	96.03	N/A	N/A	200	170	Average
2	5350.000	51.63	-0.33	51.30	-2.70	54.00	200	170	Average
3	* 5370.100	51.82	-0.32	51.49	-2.51	54.00	200	170	Average

Note:

- "\*" means this data is the worst emission level.
- C.F (Correction Factor) = Antenna Factor (dB/m)+ Cable Loss (dB) – Preamplifier(dB) + 20dB Attenuation.
- Measurement (dB $\mu$ V/m) = Reading(dB $\mu$ V) + C.F (Correction Factor).
- The emission levels of other frequencies are very lower than the limit and not show in test report.

EUT	HAN Access Point	Date of Test	2021-10-07
Factor	DRH18-E	Temp. / Humidity	23°C /49%
Polarity	Horizontal	Site / Test Engineer	AC2 / Jay
Test Mode	802.11ac80+80_TX_Band3_CH 114	Test Voltage	AC 120V/60Hz

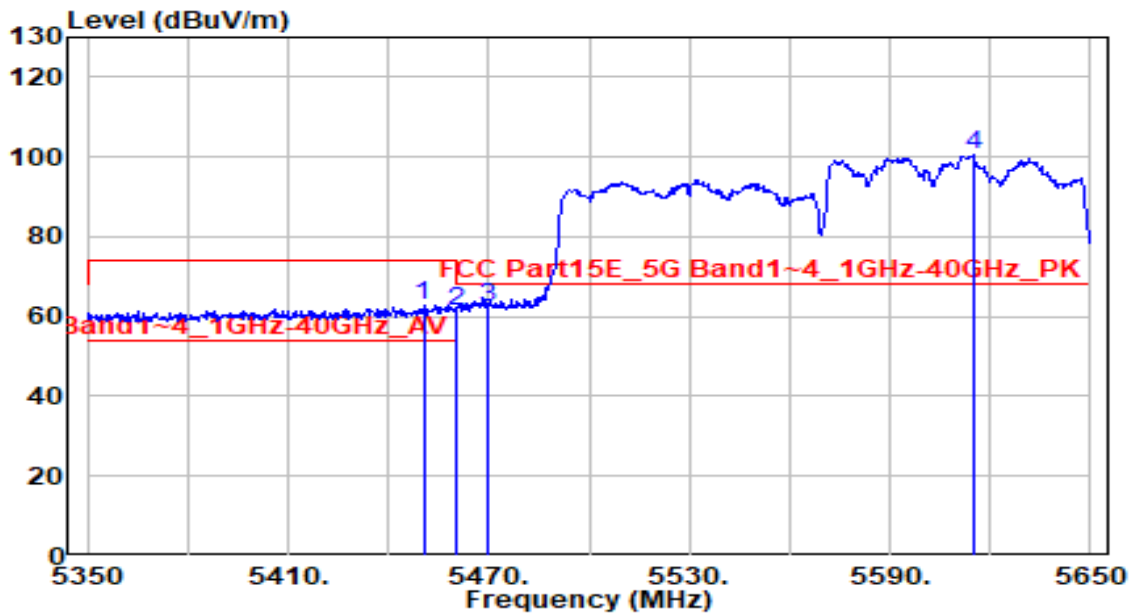

No	Frequency (MHz)	Reading (dB $\mu$ V)	C.F (dB/m)	Measurement (dB $\mu$ V/m)	Margin (dB)	Limit (dB $\mu$ V/m)	Height (cm)	Angle (deg)	Remark (QP/PK/AV)
1	5450.500	63.08	-0.14	62.94	-11.06	74.00	175	75	Peak
2	5460.000	61.45	-0.11	61.34	-6.86	68.20	175	75	Peak
3	* 5470.000	62.45	-0.07	62.38	-5.82	68.20	175	75	Peak
4	5614.900	100.17	0.46	100.63	N/A	N/A	175	75	Peak

Note:

1. " \*", means this data is the worst emission level.
2. C.F (Correction Factor) = Antenna Factor (dB/m)+ Cable Loss (dB) – Preamplifier(dB) + 20dB Attenuation.
3. Measurement (dB $\mu$ V/m) = Reading(dB $\mu$ V) + C.F (Correction Factor).
4. The emission levels of other frequencies are very lower than the limit and not show in test report.

EUT	HAN Access Point	Date of Test	2021-10-07
Factor	DRH18-E	Temp. / Humidity	23°C /49%
Polarity	Horizontal	Site / Test Engineer	AC2 / Jay
Test Mode	802.11ac80+80_TX_Band3_CH 114	Test Voltage	AC 120V/60Hz

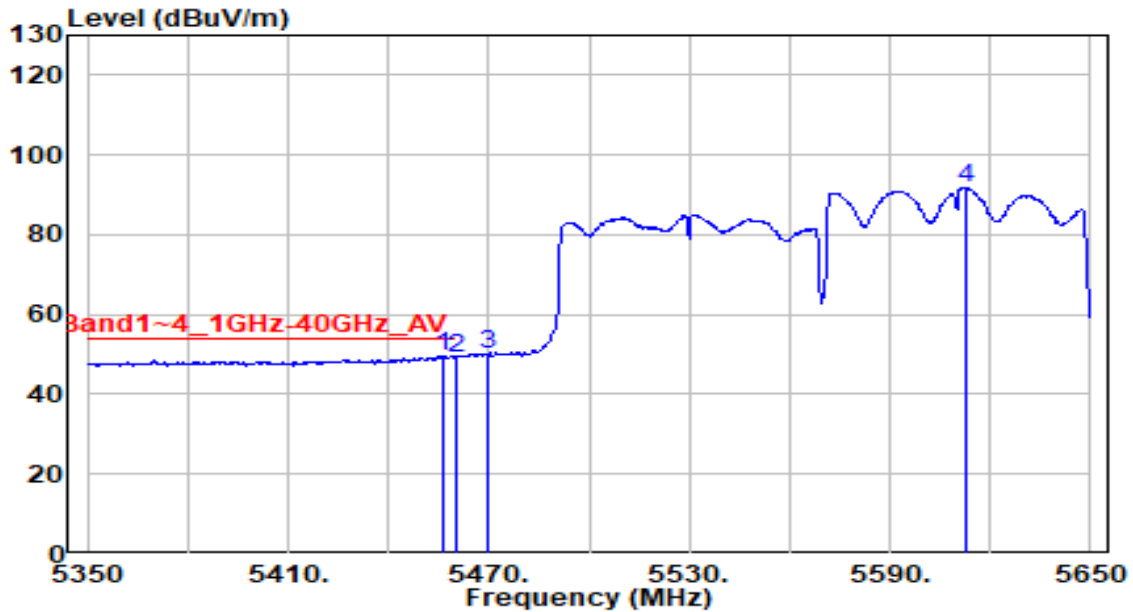

No	Frequency (MHz)	Reading (dBμV)	C.F (dB/m)	Measurement (dBμV/m)	Margin (dB)	Limit (dBμV/m)	Height (cm)	Angle (deg)	Remark (QP/PK/AV)
1	* 5456.200	49.64	-0.12	49.52	-4.48	54.00	175	75	Average
2	5460.000	49.30	-0.11	49.19	-4.81	54.00	175	75	Average
3	5470.000	50.22	-0.07	50.15	N/A	N/A	175	75	Average
4	5612.800	91.43	0.45	91.88	N/A	N/A	175	75	Average

Note:

1. "\*" , means this data is the worst emission level.
2. C.F (Correction Factor) = Antenna Factor (dB/m)+ Cable Loss (dB) – Preamplifier(dB) + 20dB Attenuation.
3. Measurement (dBμV/m) = Reading(dBμV) + C.F (Correction Factor).
4. The emission levels of other frequencies are very lower than the limit and not show in test report.

EUT	HAN Access Point	Date of Test	2021-10-07
Factor	DRH18-E	Temp. / Humidity	23°C /49%
Polarity	Vertical	Site / Test Engineer	AC2 / Jay
Test Mode	802.11ac80+80_TX_Band3_CH 114	Test Voltage	AC 120V/60Hz

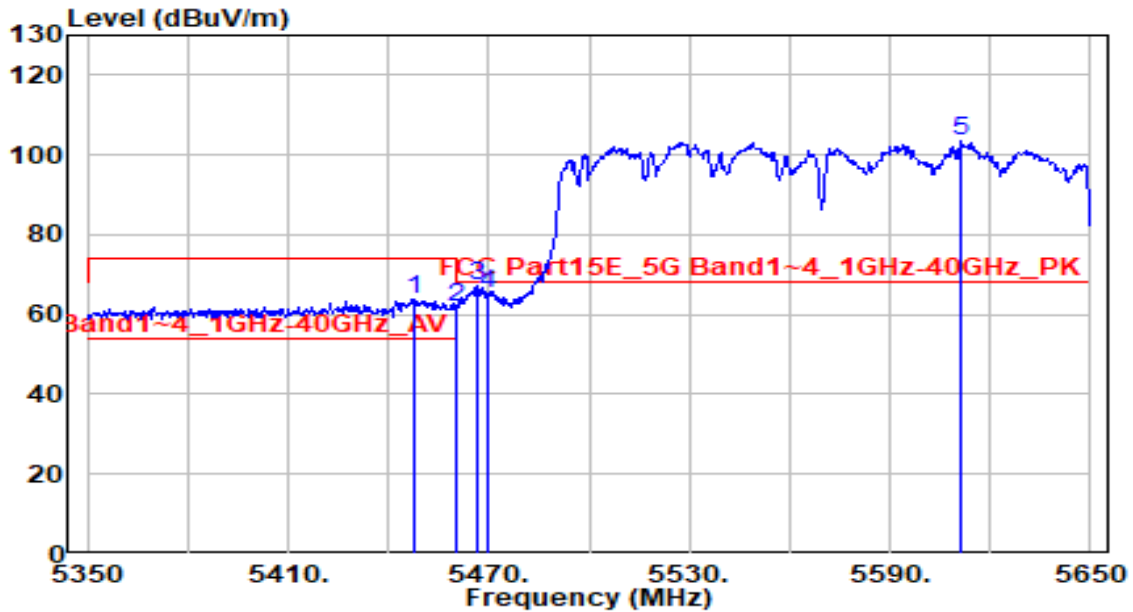

No	Frequency (MHz)	Reading (dB $\mu$ V)	C.F (dB/m)	Measurement (dB $\mu$ V/m)	Margin (dB)	Limit (dB $\mu$ V/m)	Height (cm)	Angle (deg)	Remark (QP/PK/AV)
1	5447.500	64.15	-0.15	64.00	-10.00	74.00	150	95	Peak
2	5460.000	61.89	-0.11	61.78	-6.42	68.20	150	95	Peak
3	* 5466.700	67.14	-0.08	67.06	-1.14	68.20	150	95	Peak
4	5470.000	65.26	-0.07	65.19	-3.01	68.20	150	95	Peak
5	5611.300	103.08	0.44	103.53	N/A	N/A	150	95	Peak

Note:

1. " \*", means this data is the worst emission level.
2. C.F (Correction Factor) = Antenna Factor (dB/m)+ Cable Loss (dB) – Preamplifier(dB) + 20dB Attenuation.
3. Measurement (dB $\mu$ V/m) = Reading(dB $\mu$ V) + C.F (Correction Factor).
4. The emission levels of other frequencies are very lower than the limit and not show in test report.



EUT	HAN Access Point	Date of Test	2021-10-07
Factor	DRH18-E	Temp. / Humidity	23°C /49%
Polarity	Vertical	Site / Test Engineer	AC2 / Jay
Test Mode	802.11ac80+80_TX_Band3_CH 114	Test Voltage	AC 120V/60Hz

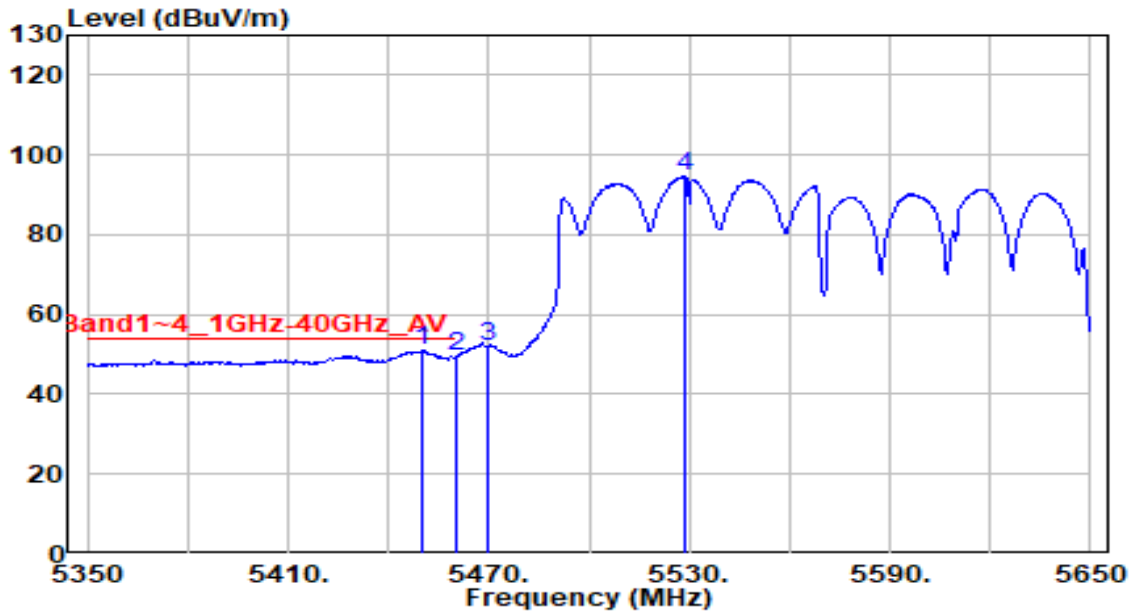

No	Frequency (MHz)	Reading (dBμV)	C.F (dB/m)	Measurement (dBμV/m)	Margin (dB)	Limit (dBμV/m)	Height (cm)	Angle (deg)	Remark (QP/PK/AV)
1	* 5449.900	51.02	-0.14	50.88	-3.12	54.00	150	95	Average
2	5460.000	49.67	-0.11	49.56	-4.44	54.00	150	95	Average
3	5470.000	52.14	-0.07	52.07	N/A	N/A	150	95	Average
4	5528.500	94.50	0.14	94.64	N/A	N/A	150	95	Average

Note:

1. " \*", means this data is the worst emission level.
2. C.F (Correction Factor) = Antenna Factor (dB/m)+ Cable Loss (dB) – Preamplifier(dB) + 20dB Attenuation.
3. Measurement (dBμV/m) = Reading(dBμV) + C.F (Correction Factor).
4. The emission levels of other frequencies are very lower than the limit and not show in test report.

EUT	HAN Access Point	Date of Test	2021-10-07
Factor	DRH18-E	Temp. / Humidity	23°C /49%
Polarity	Horizontal	Site / Test Engineer	AC2 / Jay
Test Mode	802.11ax20_TX_Band1_CH 36	Test Voltage	AC 120V/60Hz

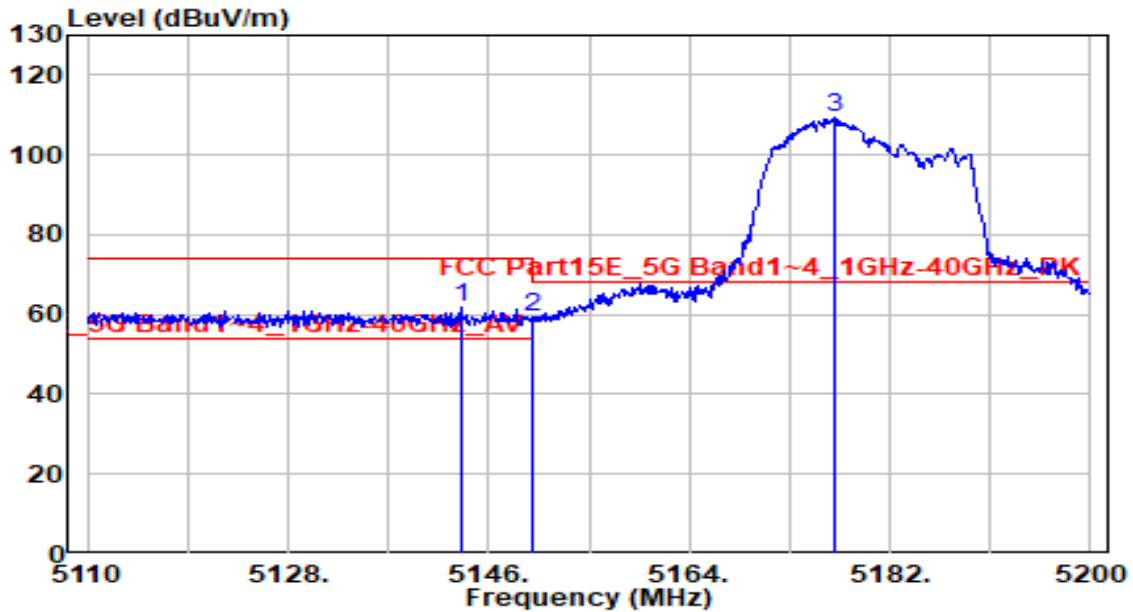

No	Frequency (MHz)	Reading (dB $\mu$ V)	C.F (dB/m)	Measurement (dB $\mu$ V/m)	Margin (dB)	Limit (dB $\mu$ V/m)	Height (cm)	Angle (deg)	Remark (QP/PK/AV)
1	* 5143.570	62.08	-0.32	61.76	-12.24	74.00	150	80	Peak
2	5150.000	59.54	-0.32	59.22	-14.78	74.00	150	80	Peak
3	5177.140	109.66	-0.32	109.34	N/A	N/A	150	80	Peak

Note:

- "\*", means this data is the worst emission level.
- C.F (Correction Factor) = Antenna Factor (dB/m)+ Cable Loss (dB) – Preamplifier(dB) + 20dB Attenuation.
- Measurement (dB $\mu$ V/m) = Reading(dB $\mu$ V) + C.F (Correction Factor).
- The emission levels of other frequencies are very lower than the limit and not show in test report.

EUT	HAN Access Point	Date of Test	2021-10-07
Factor	DRH18-E	Temp. / Humidity	23°C /49%
Polarity	Horizontal	Site / Test Engineer	AC2 / Jay
Test Mode	802.11ax20_TX_Band1_CH 36	Test Voltage	AC 120V/60Hz

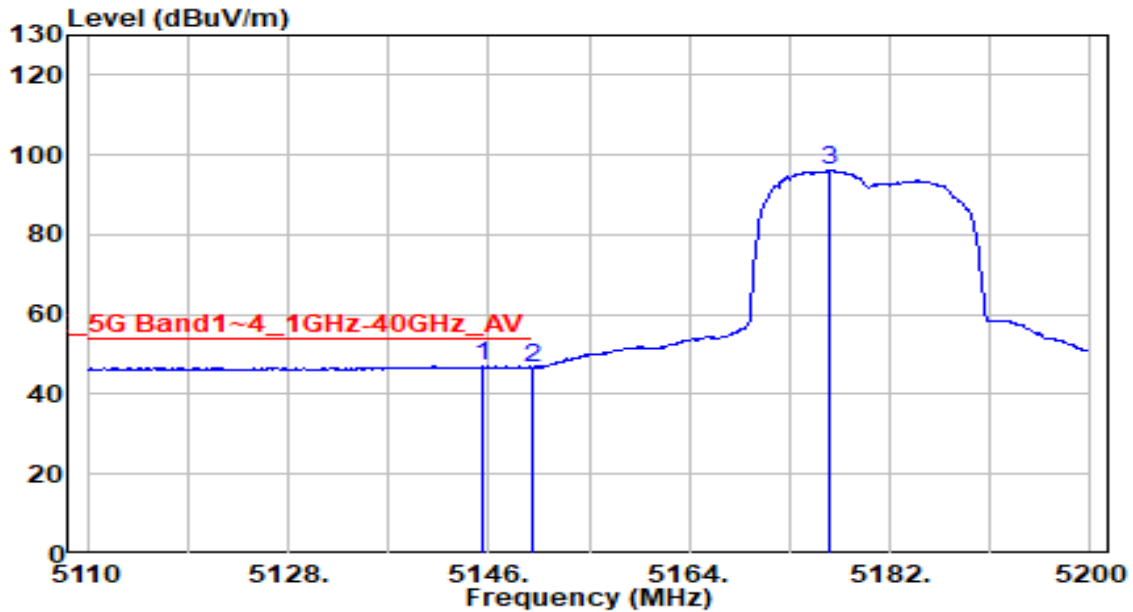

No	Frequency (MHz)	Reading (dB $\mu$ V)	C.F (dB/m)	Measurement (dB $\mu$ V/m)	Margin (dB)	Limit (dB $\mu$ V/m)	Height (cm)	Angle (deg)	Remark (QP/PK/AV)
1	* 5145.370	47.38	-0.32	47.06	-6.94	54.00	150	80	Average
2	5150.000	47.13	-0.32	46.81	-7.19	54.00	150	80	Average
3	5176.510	96.29	-0.32	95.97	N/A	N/A	150	80	Average

Note:

- "\*" means this data is the worst emission level.
- C.F (Correction Factor) = Antenna Factor (dB/m)+ Cable Loss (dB) – Preamplifier(dB) + 20dB Attenuation.
- Measurement (dB $\mu$ V/m) = Reading(dB $\mu$ V) + C.F (Correction Factor).
- The emission levels of other frequencies are very lower than the limit and not show in test report.

EUT	HAN Access Point	Date of Test	2021-10-07
Factor	DRH18-E	Temp. / Humidity	23°C /49%
Polarity	Vertical	Site / Test Engineer	AC2 / Jay
Test Mode	802.11ax20_TX_Band1_CH 36	Test Voltage	AC 120V/60Hz

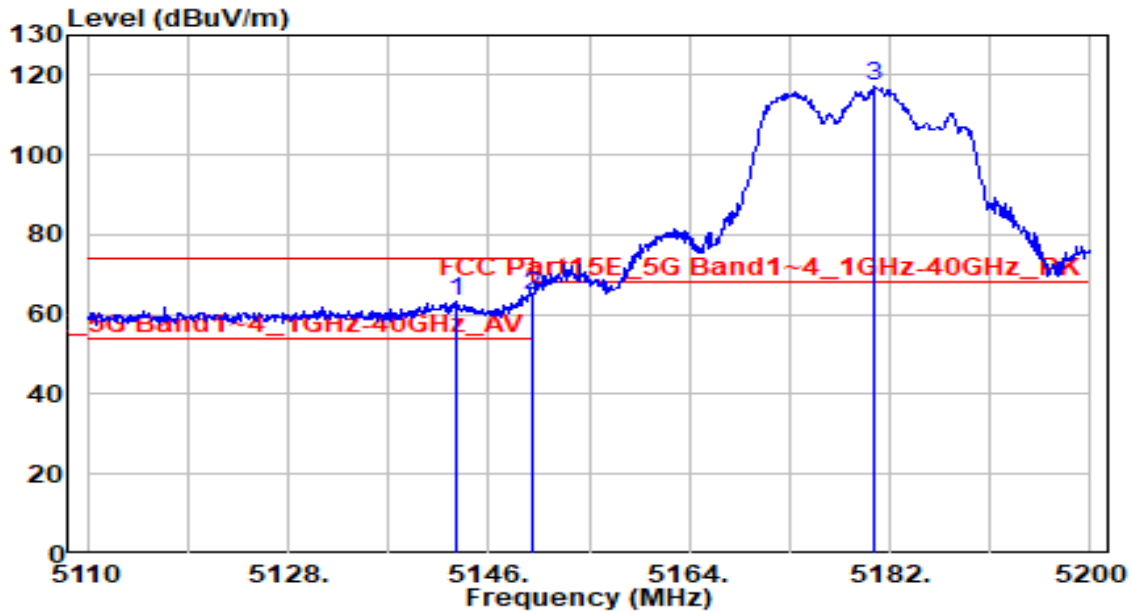

No	Frequency (MHz)	Reading (dB $\mu$ V)	C.F (dB/m)	Measurement (dB $\mu$ V/m)	Margin (dB)	Limit (dB $\mu$ V/m)	Height (cm)	Angle (deg)	Remark (QP/PK/AV)
1	5143.210	63.73	-0.32	63.41	-10.59	74.00	230	170	Peak
2	* 5150.000	65.17	-0.32	64.85	-9.15	74.00	230	170	Peak
3	5180.650	117.35	-0.32	117.03	N/A	N/A	230	170	Peak

Note:

- "\*" means this data is the worst emission level.
- C.F (Correction Factor) = Antenna Factor (dB/m)+ Cable Loss (dB) – Preamplifier(dB) + 20dB Attenuation.
- Measurement (dB $\mu$ V/m) = Reading(dB $\mu$ V) + C.F (Correction Factor).
- The emission levels of other frequencies are very lower than the limit and not show in test report.

EUT	HAN Access Point	Date of Test	2021-10-07
Factor	DRH18-E	Temp. / Humidity	23°C /49%
Polarity	Vertical	Site / Test Engineer	AC2 / Jay
Test Mode	802.11ax20_TX_Band1_CH 36	Test Voltage	AC 120V/60Hz

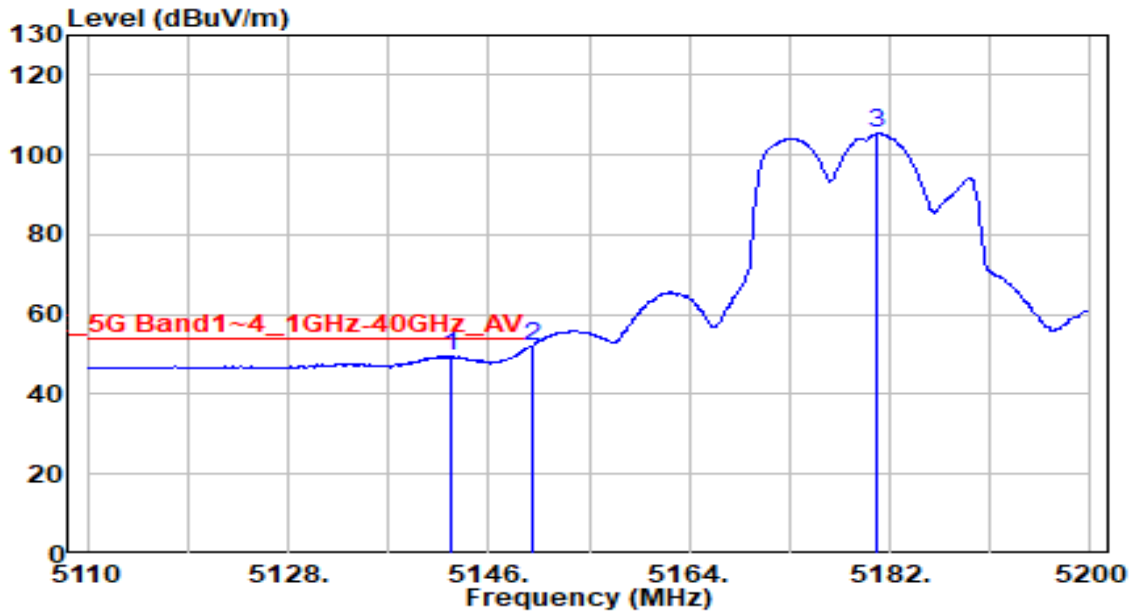

No	Frequency (MHz)	Reading (dB $\mu$ V)	C.F (dB/m)	Measurement (dB $\mu$ V/m)	Margin (dB)	Limit (dB $\mu$ V/m)	Height (cm)	Angle (deg)	Remark (QP/PK/AV)
1	5142.580	49.82	-0.32	49.50	-4.50	54.00	230	170	Average
2	* 5150.000	52.52	-0.32	52.20	-1.80	54.00	230	170	Average
3	5180.920	105.68	-0.32	105.36	N/A	N/A	230	170	Average

Note:

- "\*" means this data is the worst emission level.
- C.F (Correction Factor) = Antenna Factor (dB/m)+ Cable Loss (dB) – Preamplifier(dB) + 20dB Attenuation.
- Measurement (dB $\mu$ V/m) = Reading(dB $\mu$ V) + C.F (Correction Factor).
- The emission levels of other frequencies are very lower than the limit and not show in test report.

EUT	HAN Access Point	Date of Test	2021-10-07
Factor	DRH18-E	Temp. / Humidity	23°C /49%
Polarity	Horizontal	Site / Test Engineer	AC2 / Jay
Test Mode	802.11ax20_TX_Band2_CH 64	Test Voltage	AC 120V/60Hz

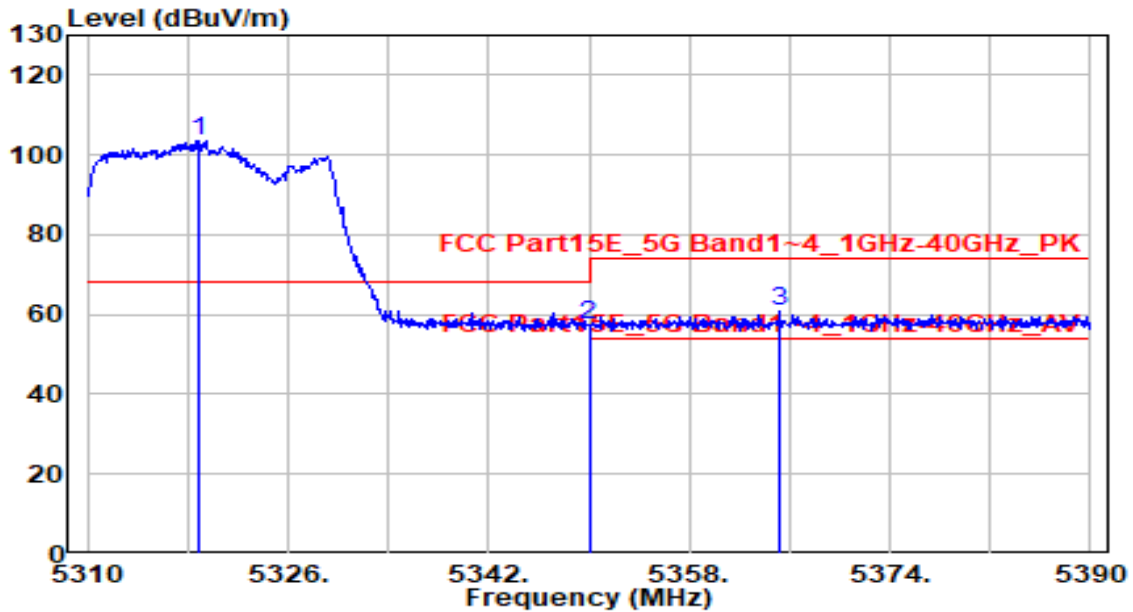

No	Frequency (MHz)	Reading (dB $\mu$ V)	C.F (dB/m)	Measurement (dB $\mu$ V/m)	Margin (dB)	Limit (dB $\mu$ V/m)	Height (cm)	Angle (deg)	Remark (QP/PK/AV)
1	5318.800	103.82	-0.33	103.49	N/A	N/A	215	80	Peak
2	* 5350.000	57.72	-0.33	57.40	-10.80	68.20	215	80	Peak
3	5365.200	61.32	-0.32	60.99	-13.01	74.00	215	80	Peak

Note:

- "\*" means this data is the worst emission level.
- C.F (Correction Factor) = Antenna Factor (dB/m)+ Cable Loss (dB) – Preamplifier(dB) + 20dB Attenuation.
- Measurement (dB $\mu$ V/m) = Reading(dB $\mu$ V) + C.F (Correction Factor).
- The emission levels of other frequencies are very lower than the limit and not show in test report.

EUT	HAN Access Point	Date of Test	2021-10-07
Factor	DRH18-E	Temp. / Humidity	23°C /49%
Polarity	Horizontal	Site / Test Engineer	AC2 / Jay
Test Mode	802.11ax20_TX_Band2_CH 64	Test Voltage	AC 120V/60Hz

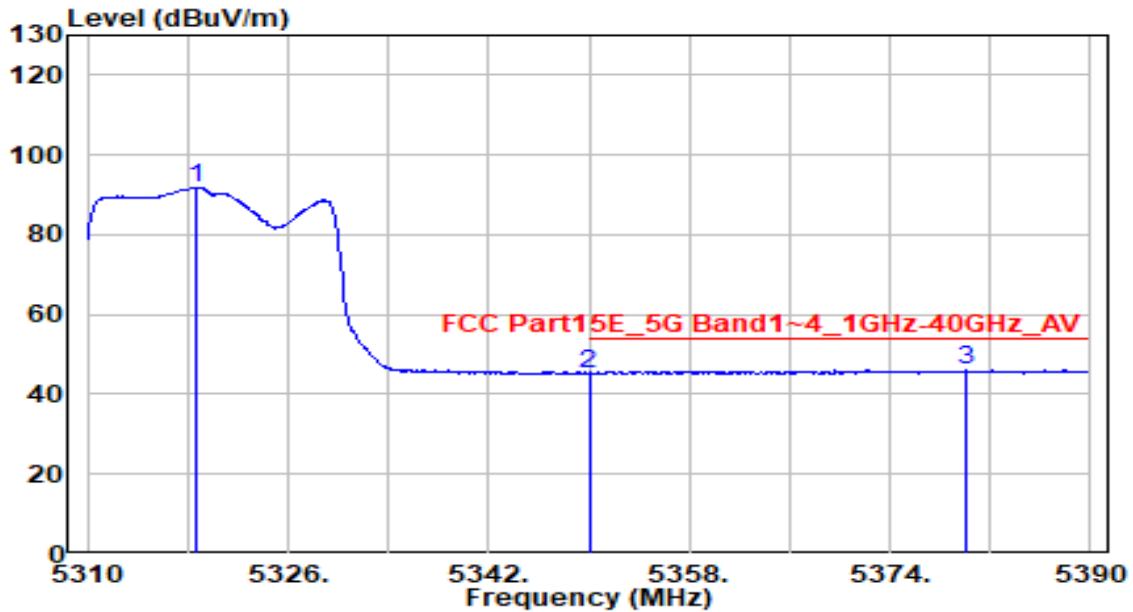

No	Frequency (MHz)	Reading (dBμV)	C.F (dB/m)	Measurement (dBμV/m)	Margin (dB)	Limit (dBμV/m)	Height (cm)	Angle (deg)	Remark (QP/PK/AV)
1	5318.640	91.99	-0.33	91.66	N/A	N/A	215	80	Average
2	5350.000	45.55	-0.33	45.22	-8.78	54.00	215	80	Average
3	* 5380.000	46.31	-0.32	45.99	-8.01	54.00	215	80	Average

Note:

- "\*" means this data is the worst emission level.
- C.F (Correction Factor) = Antenna Factor (dB/m)+ Cable Loss (dB) – Preamplifier(dB) + 20dB Attenuation.
- Measurement (dBμV/m) = Reading(dBμV) + C.F (Correction Factor).
- The emission levels of other frequencies are very lower than the limit and not show in test report.

EUT	HAN Access Point	Date of Test	2021-10-07
Factor	DRH18-E	Temp. / Humidity	23°C /49%
Polarity	Vertical	Site / Test Engineer	AC2 / Jay
Test Mode	802.11ax20_TX_Band2_CH 64	Test Voltage	AC 120V/60Hz

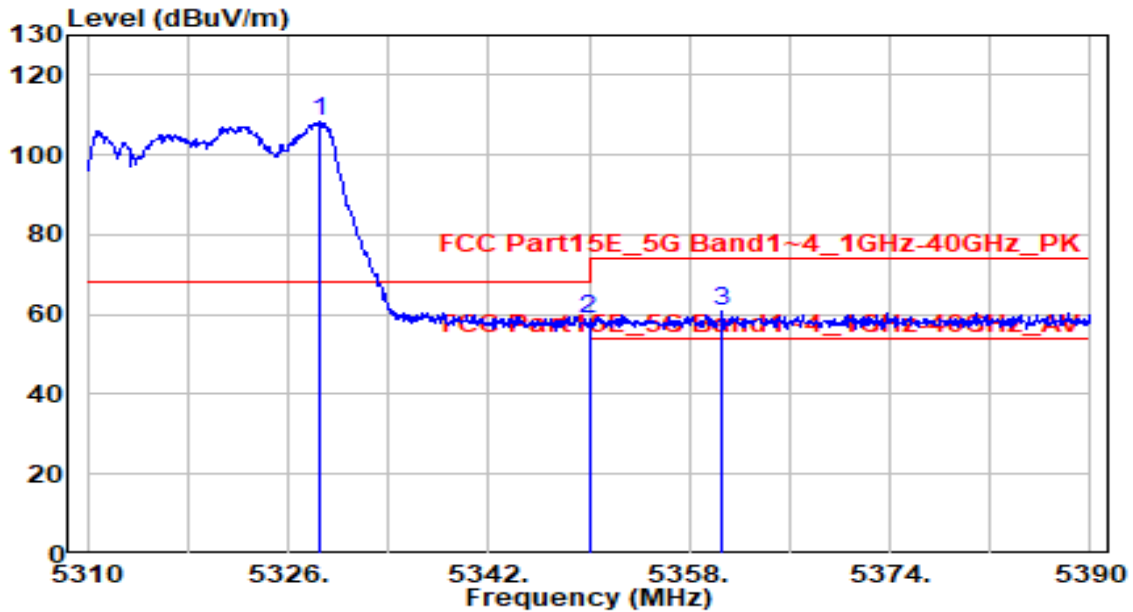

No	Frequency (MHz)	Reading (dB $\mu$ V)	C.F (dB/m)	Measurement (dB $\mu$ V/m)	Margin (dB)	Limit (dB $\mu$ V/m)	Height (cm)	Angle (deg)	Remark (QP/PK/AV)
1	5328.560	108.63	-0.33	108.31	N/A	N/A	230	200	Peak
2	* 5350.000	59.11	-0.33	58.78	-9.42	68.20	230	200	Peak
3	5360.640	61.00	-0.33	60.68	-13.32	74.00	230	200	Peak

Note:

- "\*" means this data is the worst emission level.
- C.F (Correction Factor) = Antenna Factor (dB/m)+ Cable Loss (dB) – Preamplifier(dB) + 20dB Attenuation.
- Measurement (dB $\mu$ V/m) = Reading(dB $\mu$ V) + C.F (Correction Factor).
- The emission levels of other frequencies are very lower than the limit and not show in test report.



EUT	HAN Access Point	Date of Test	2021-10-07
Factor	DRH18-E	Temp. / Humidity	23°C /49%
Polarity	Vertical	Site / Test Engineer	AC2 / Jay
Test Mode	802.11ax20_TX_Band2_CH 64	Test Voltage	AC 120V/60Hz

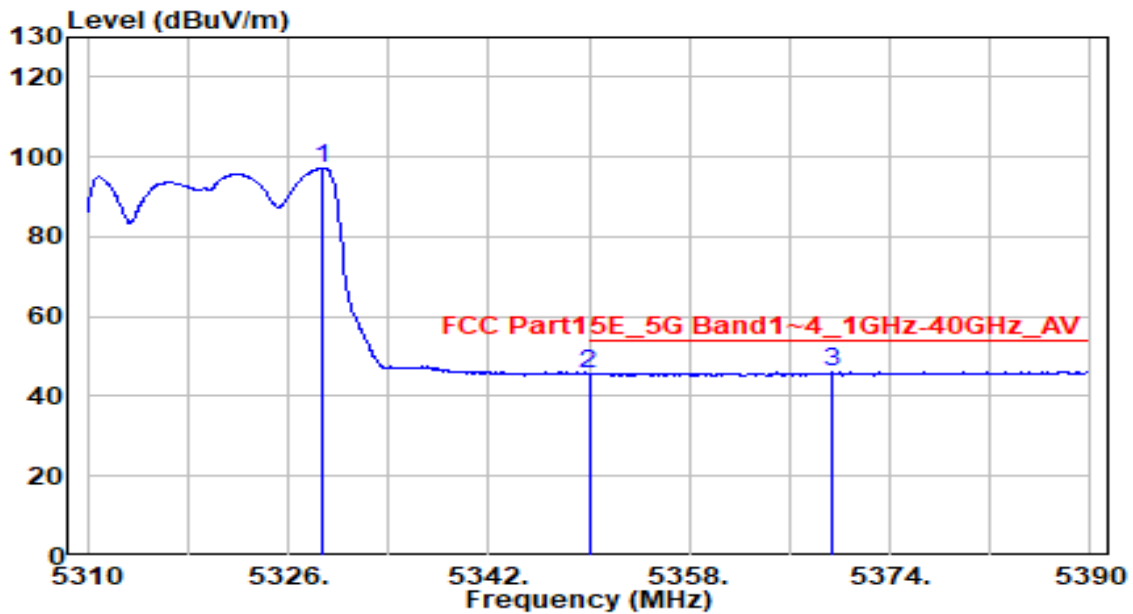

No	Frequency (MHz)	Reading (dBμV)	C.F (dB/m)	Measurement (dBμV/m)	Margin (dB)	Limit (dBμV/m)	Height (cm)	Angle (deg)	Remark (QP/PK/AV)
1	5328.640	97.65	-0.33	97.33	N/A	N/A	230	200	Average
2	5350.000	45.92	-0.33	45.59	-8.41	54.00	230	200	Average
3	* 5369.360	46.24	-0.32	45.91	-8.09	54.00	230	200	Average

Note:

- "\*" means this data is the worst emission level.
- C.F (Correction Factor) = Antenna Factor (dB/m)+ Cable Loss (dB) – Preamplifier(dB) + 20dB Attenuation.
- Measurement (dBμV/m) = Reading(dBμV) + C.F (Correction Factor).
- The emission levels of other frequencies are very lower than the limit and not show in test report.

EUT	HAN Access Point	Date of Test	2021-10-07
Factor	DRH18-E	Temp. / Humidity	23°C /49%
Polarity	Horizontal	Site / Test Engineer	AC2 / Jay
Test Mode	802.11ax20_TX_Band3_CH 100	Test Voltage	AC 120V/60Hz

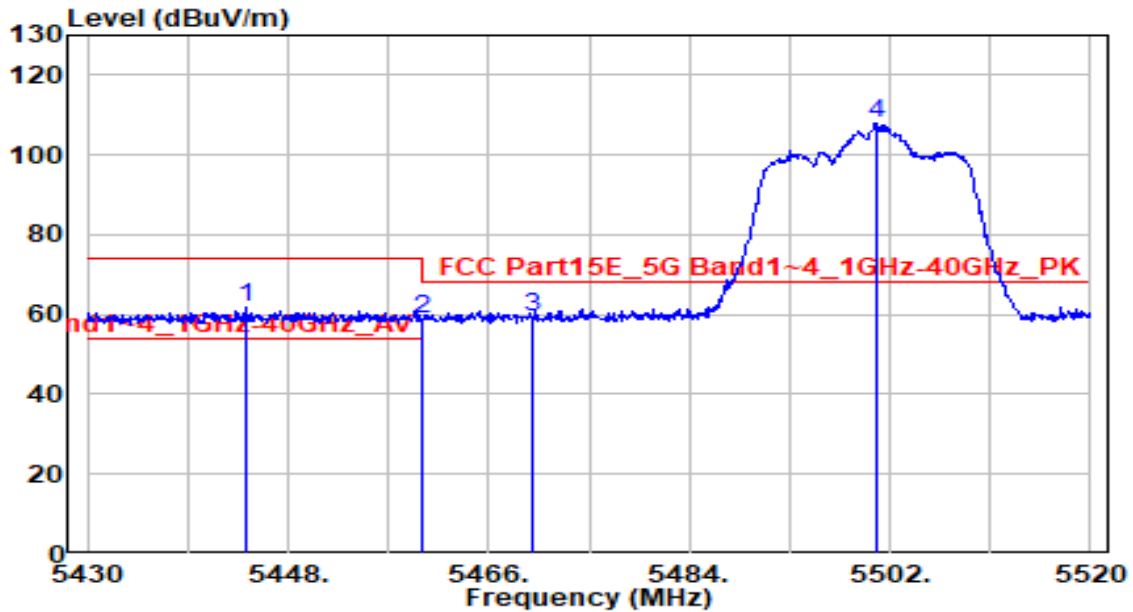

No	Frequency (MHz)	Reading (dB $\mu$ V)	C.F (dB/m)	Measurement (dB $\mu$ V/m)	Margin (dB)	Limit (dB $\mu$ V/m)	Height (cm)	Angle (deg)	Remark (QP/PK/AV)
1	5444.130	62.17	-0.16	62.01	-11.99	74.00	220	140	Peak
2	5460.000	59.03	-0.11	58.92	-9.28	68.20	220	140	Peak
3	* 5470.000	59.36	-0.07	59.29	-8.91	68.20	220	140	Peak
4	5500.740	107.86	0.04	107.90	N/A	N/A	220	140	Peak

Note:

1. "\*" , means this data is the worst emission level.
2. C.F (Correction Factor) = Antenna Factor (dB/m)+ Cable Loss (dB) – Preamplifier(dB) + 20dB Attenuation.
3. Measurement (dB $\mu$ V/m) = Reading(dB $\mu$ V) + C.F (Correction Factor).
4. The emission levels of other frequencies are very lower than the limit and not show in test report.

EUT	HAN Access Point	Date of Test	2021-10-07
Factor	DRH18-E	Temp. / Humidity	23°C /49%
Polarity	Horizontal	Site / Test Engineer	AC2 / Jay
Test Mode	802.11ax20_TX_Band3_CH 100	Test Voltage	AC 120V/60Hz

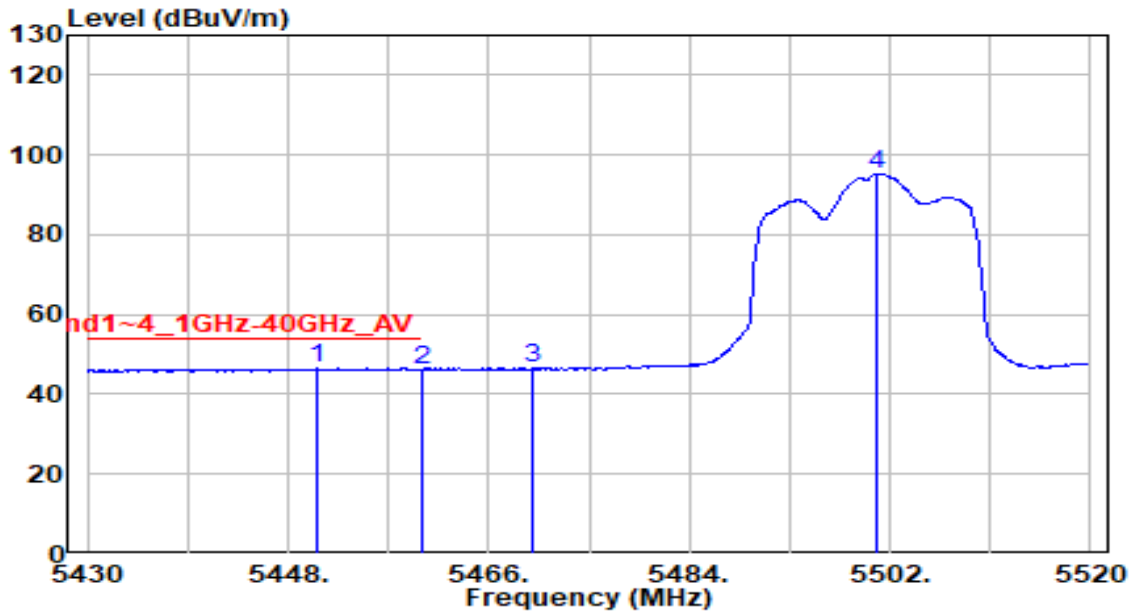

No	Frequency (MHz)	Reading (dBμV)	C.F (dB/m)	Measurement (dBμV/m)	Margin (dB)	Limit (dBμV/m)	Height (cm)	Angle (deg)	Remark (QP/PK/AV)
1	* 5450.520	46.60	-0.14	46.46	-7.54	54.00	220	140	Average
2	5460.000	46.29	-0.11	46.18	-7.82	54.00	220	140	Average
3	5470.000	46.46	-0.07	46.39	N/A	N/A	220	140	Average
4	5500.920	95.36	0.04	95.40	N/A	N/A	220	140	Average

Note:

1. "\*" , means this data is the worst emission level.
2. C.F (Correction Factor) = Antenna Factor (dB/m)+ Cable Loss (dB) – Preamplifier(dB) + 20dB Attenuation.
3. Measurement (dBμV/m) = Reading(dBμV) + C.F (Correction Factor).
4. The emission levels of other frequencies are very lower than the limit and not show in test report.

EUT	HAN Access Point	Date of Test	2021-10-07
Factor	DRH18-E	Temp. / Humidity	23°C /49%
Polarity	Vertical	Site / Test Engineer	AC2 / Jay
Test Mode	802.11ax20_TX_Band3_CH 100	Test Voltage	AC 120V/60Hz

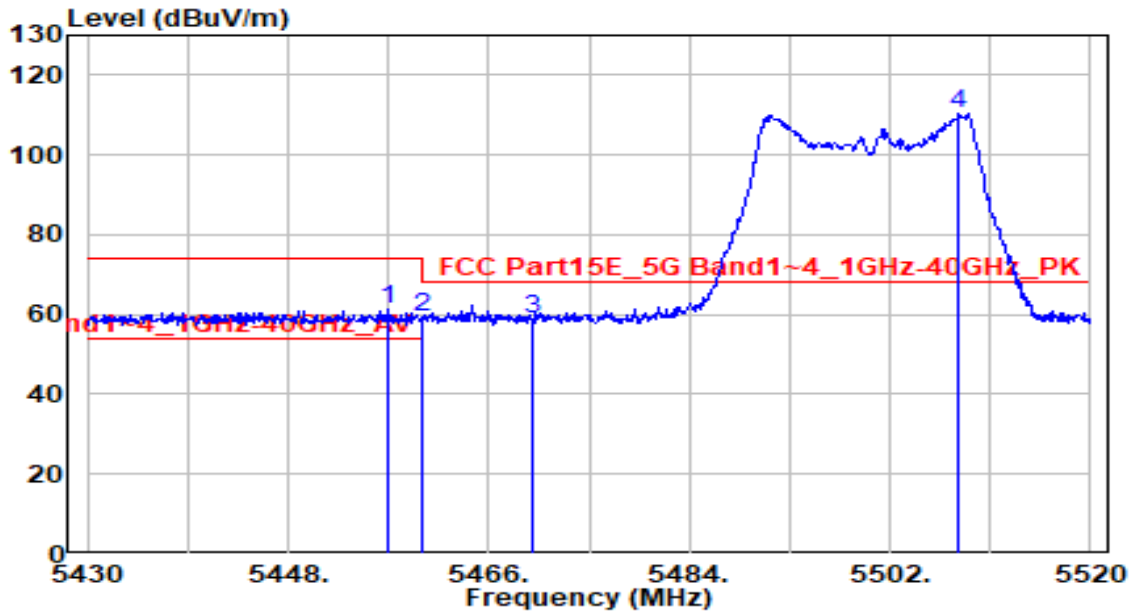

No	Frequency (MHz)	Reading (dB $\mu$ V)	C.F (dB/m)	Measurement (dB $\mu$ V/m)	Margin (dB)	Limit (dB $\mu$ V/m)	Height (cm)	Angle (deg)	Remark (QP/PK/AV)
1	5457.000	61.50	-0.12	61.38	-12.62	74.00	230	170	Peak
2	* 5460.000	59.32	-0.11	59.21	-8.99	68.20	230	170	Peak
3	5470.000	58.75	-0.07	58.68	-9.52	68.20	230	170	Peak
4	5508.120	110.44	0.07	110.51	N/A	N/A	230	170	Peak

Note:

1. " \*", means this data is the worst emission level.
2. C.F (Correction Factor) = Antenna Factor (dB/m)+ Cable Loss (dB) – Preamplifier(dB) + 20dB Attenuation.
3. Measurement (dB $\mu$ V/m) = Reading(dB $\mu$ V) + C.F (Correction Factor).
4. The emission levels of other frequencies are very lower than the limit and not show in test report.

EUT	HAN Access Point	Date of Test	2021-10-07
Factor	DRH18-E	Temp. / Humidity	23°C /49%
Polarity	Vertical	Site / Test Engineer	AC2 / Jay
Test Mode	802.11ax20_TX_Band3_CH 100	Test Voltage	AC 120V/60Hz

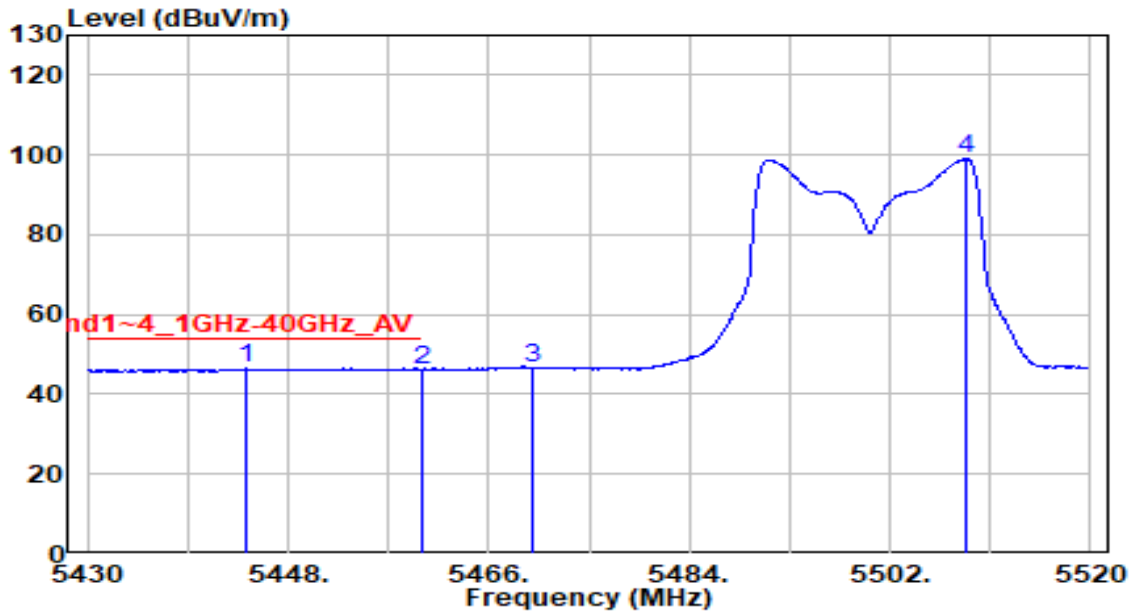

No	Frequency (MHz)	Reading (dB $\mu$ V)	C.F (dB/m)	Measurement (dB $\mu$ V/m)	Margin (dB)	Limit (dB $\mu$ V/m)	Height (cm)	Angle (deg)	Remark (QP/PK/AV)
1	* 5444.310	46.69	-0.16	46.53	-7.47	54.00	230	170	Average
2	5460.000	46.14	-0.11	46.03	-7.97	54.00	230	170	Average
3	5470.000	46.56	-0.07	46.49	N/A	N/A	230	170	Average
4	5508.750	98.87	0.07	98.94	N/A	N/A	230	170	Average

Note:

- "\*" means this data is the worst emission level.
- C.F (Correction Factor) = Antenna Factor (dB/m)+ Cable Loss (dB) – Preamplifier(dB) + 20dB Attenuation.
- Measurement (dB $\mu$ V/m) = Reading(dB $\mu$ V) + C.F (Correction Factor).
- The emission levels of other frequencies are very lower than the limit and not show in test report.

EUT	HAN Access Point	Date of Test	2021-10-07
Factor	DRH18-E	Temp. / Humidity	23°C /49%
Polarity	Horizontal	Site / Test Engineer	AC2 / Jay
Test Mode	802.11ax20_TX_Band3_CH 140	Test Voltage	AC 120V/60Hz

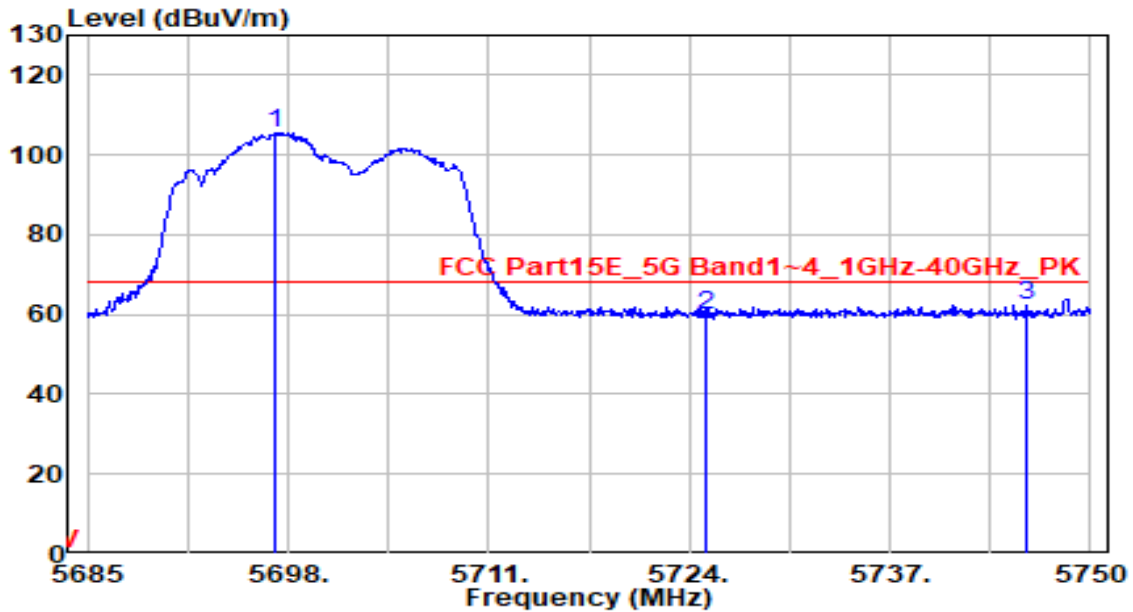

No	Frequency (MHz)	Reading (dB $\mu$ V)	C.F (dB/m)	Measurement (dB $\mu$ V/m)	Margin (dB)	Limit (dB $\mu$ V/m)	Height (cm)	Angle (deg)	Remark (QP/PK/AV)
1	5697.220	104.83	0.80	105.63	N/A	N/A	230	130	Peak
2	5725.000	58.80	0.91	59.72	-8.48	68.20	230	130	Peak
3	* 5745.775	61.11	1.00	62.11	-6.09	68.20	230	130	Peak

Note:

- "\*", means this data is the worst emission level.
- C.F (Correction Factor) = Antenna Factor (dB/m)+ Cable Loss (dB) – Preamplifier(dB) + 20dB Attenuation.
- Measurement (dB $\mu$ V/m) = Reading(dB $\mu$ V) + C.F (Correction Factor).
- The emission levels of other frequencies are very lower than the limit and not show in test report.

EUT	HAN Access Point	Date of Test	2021-10-07
Factor	DRH18-E	Temp. / Humidity	23°C /49%
Polarity	Vertical	Site / Test Engineer	AC2 / Jay
Test Mode	802.11ax20_TX_Band3_CH 140	Test Voltage	AC 120V/60Hz

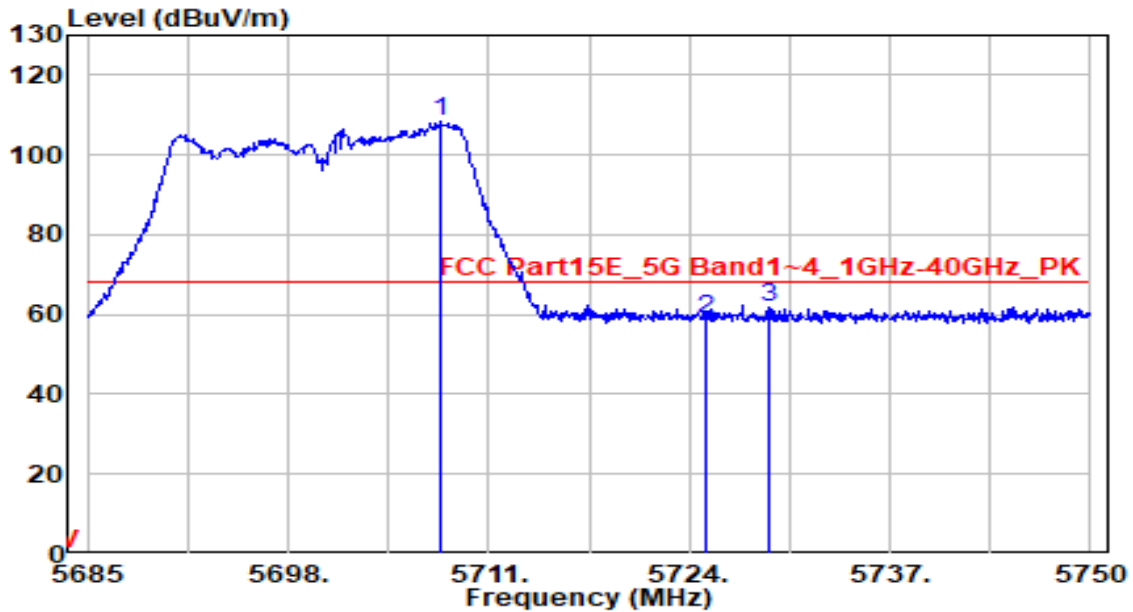

No	Frequency (MHz)	Reading (dB $\mu$ V)	C.F (dB/m)	Measurement (dB $\mu$ V/m)	Margin (dB)	Limit (dB $\mu$ V/m)	Height (cm)	Angle (deg)	Remark (QP/PK/AV)
1	5707.880	107.38	0.84	108.23	N/A	N/A	230	50	Peak
2	5725.000	58.12	0.91	59.03	-9.17	68.20	230	50	Peak
3	* 5729.135	60.78	0.93	61.71	-6.49	68.20	230	50	Peak

Note:

- "\*", means this data is the worst emission level.
- C.F (Correction Factor) = Antenna Factor (dB/m)+ Cable Loss (dB) – Preamplifier(dB) + 20dB Attenuation.
- Measurement (dB $\mu$ V/m) = Reading(dB $\mu$ V) + C.F (Correction Factor).
- The emission levels of other frequencies are very lower than the limit and not show in test report.

EUT	HAN Access Point	Date of Test	2021-10-07
Factor	DRH18-E	Temp. / Humidity	23°C /49%
Polarity	Horizontal	Site / Test Engineer	AC2 / Jay
Test Mode	802.11ax20_TX_Band4_CH 149	Test Voltage	AC 120V/60Hz

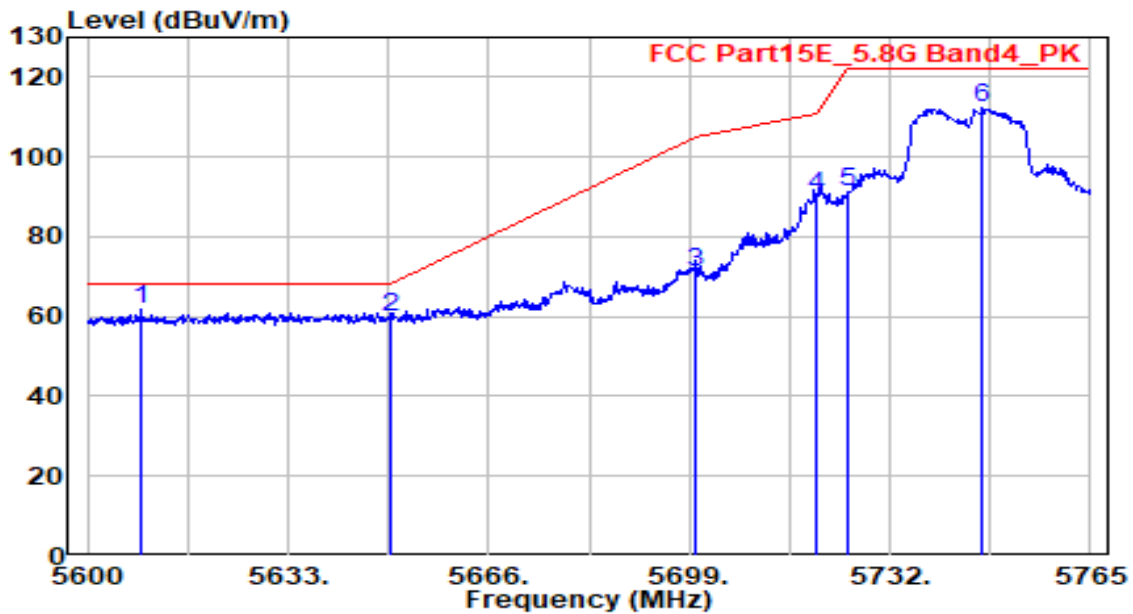

No	Frequency (MHz)	Reading (dBμV)	C.F (dB/m)	Measurement (dBμV/m)	Margin (dB)	Limit (dBμV/m)	Height (cm)	Angle (deg)	Remark (QP/PK/AV)
1	* 5608.910	61.49	0.43	61.93	-6.27	68.20	220	165	Peak
2	5650.000	59.29	0.60	59.89	-8.31	68.20	220	165	Peak
3	5700.000	70.53	0.81	71.34	-33.86	105.20	220	165	Peak
4	5720.000	89.28	0.89	90.18	-20.62	110.80	220	165	Peak
5	5725.000	90.53	0.91	91.44	-30.76	122.20	220	165	Peak
6	5747.180	111.21	1.00	112.21	N/A	N/A	220	165	Peak

Note:

1. " \*", means this data is the worst emission level.
2. C.F (Correction Factor) = Antenna Factor (dB/m)+ Cable Loss (dB) – Preamplifier(dB) + 20dB Attenuation.
3. Measurement (dBμV/m) = Reading(dBμV) + C.F (Correction Factor).
4. The emission levels of other frequencies are very lower than the limit and not show in test report.



EUT	HAN Access Point	Date of Test	2021-10-07
Factor	DRH18-E	Temp. / Humidity	23°C /49%
Polarity	Vertical	Site / Test Engineer	AC2 / Jay
Test Mode	802.11ax20_TX_Band4_CH 149	Test Voltage	AC 120V/60Hz

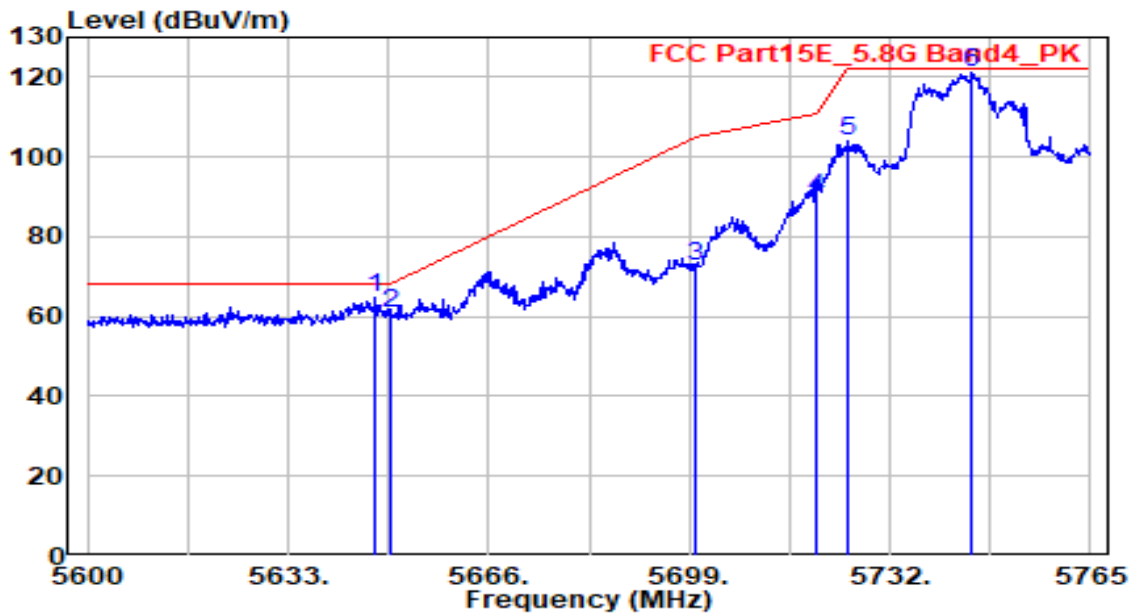

No	Frequency (MHz)	Reading (dBμV)	C.F (dB/m)	Measurement (dBμV/m)	Margin (dB)	Limit (dBμV/m)	Height (cm)	Angle (deg)	Remark (QP/PK/AV)
1	* 5647.355	64.19	0.59	64.78	-3.42	68.20	230	110	Peak
2	5649.995	60.09	0.60	60.69	-7.51	68.20	230	110	Peak
3	5700.000	71.84	0.81	72.65	-32.55	105.20	230	110	Peak
4	5720.000	89.11	0.89	90.00	-20.80	110.80	230	110	Peak
5	5725.000	103.09	0.91	104.00	-18.20	122.20	230	100	Peak
6	5745.530	120.08	1.00	121.07	N/A	N/A	230	110	Peak

Note:

1. " \*", means this data is the worst emission level.
2. C.F (Correction Factor) = Antenna Factor (dB/m)+ Cable Loss (dB) – Preamplifier(dB) + 20dB Attenuation.
3. Measurement (dBμV/m) = Reading(dBμV) + C.F (Correction Factor).
4. The emission levels of other frequencies are very lower than the limit and not show in test report.

EUT	HAN Access Point	Date of Test	2021-10-07
Factor	DRH18-E	Temp. / Humidity	23°C /49%
Polarity	Horizontal	Site / Test Engineer	AC2 / Jay
Test Mode	802.11ax20_TX_Band4_CH 165	Test Voltage	AC 120V/60Hz

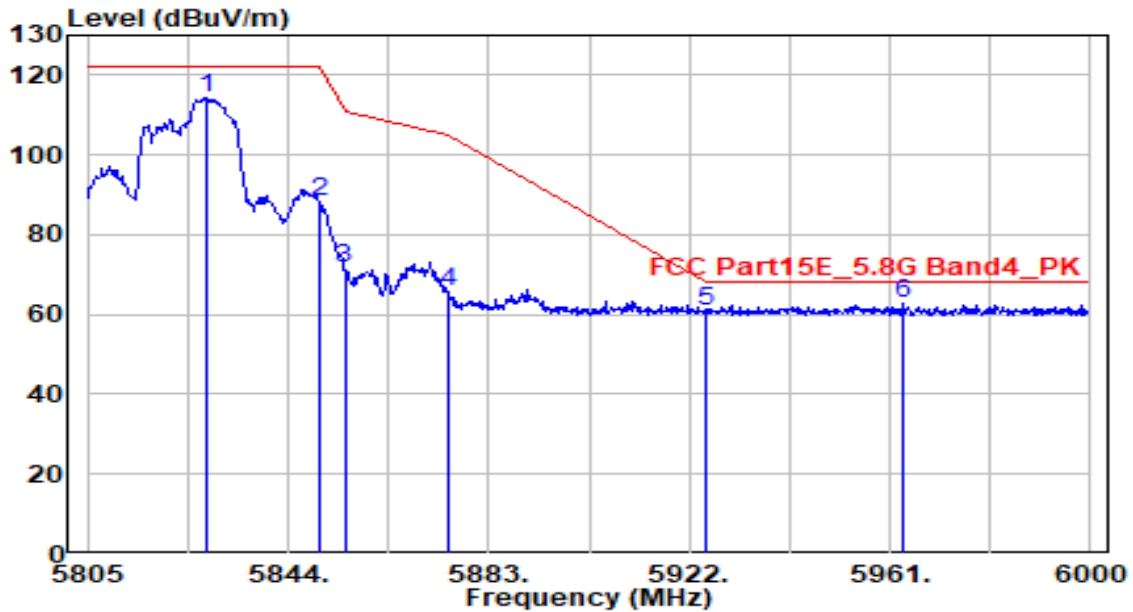

No	Frequency (MHz)	Reading (dB $\mu$ V)	C.F (dB/m)	Measurement (dB $\mu$ V/m)	Margin (dB)	Limit (dB $\mu$ V/m)	Height (cm)	Angle (deg)	Remark (QP/PK/AV)
1	5828.400	113.17	1.25	114.42	N/A	N/A	220	125	Peak
2	5850.000	86.99	1.28	88.27	-33.93	122.20	220	125	Peak
3	5855.000	70.23	1.28	71.51	-39.29	110.80	220	125	Peak
4	5875.000	64.36	1.30	65.66	-39.54	105.20	220	125	Peak
5	5925.000	59.49	1.35	60.84	-7.36	68.20	220	125	Peak
6	* 5963.340	61.18	1.39	62.57	-5.63	68.20	220	125	Peak

Note:

1. " \*", means this data is the worst emission level.
2. C.F (Correction Factor) = Antenna Factor (dB/m)+ Cable Loss (dB) – Preamplifier(dB) + 20dB Attenuation.
3. Measurement (dB $\mu$ V/m) = Reading(dB $\mu$ V) + C.F (Correction Factor).
4. The emission levels of other frequencies are very lower than the limit and not show in test report.

EUT	HAN Access Point	Date of Test	2021-10-07
Factor	DRH18-E	Temp. / Humidity	23°C /49%
Polarity	Vertical	Site / Test Engineer	AC2 / Jay
Test Mode	802.11ax20_TX_Band4_CH 165	Test Voltage	AC 120V/60Hz

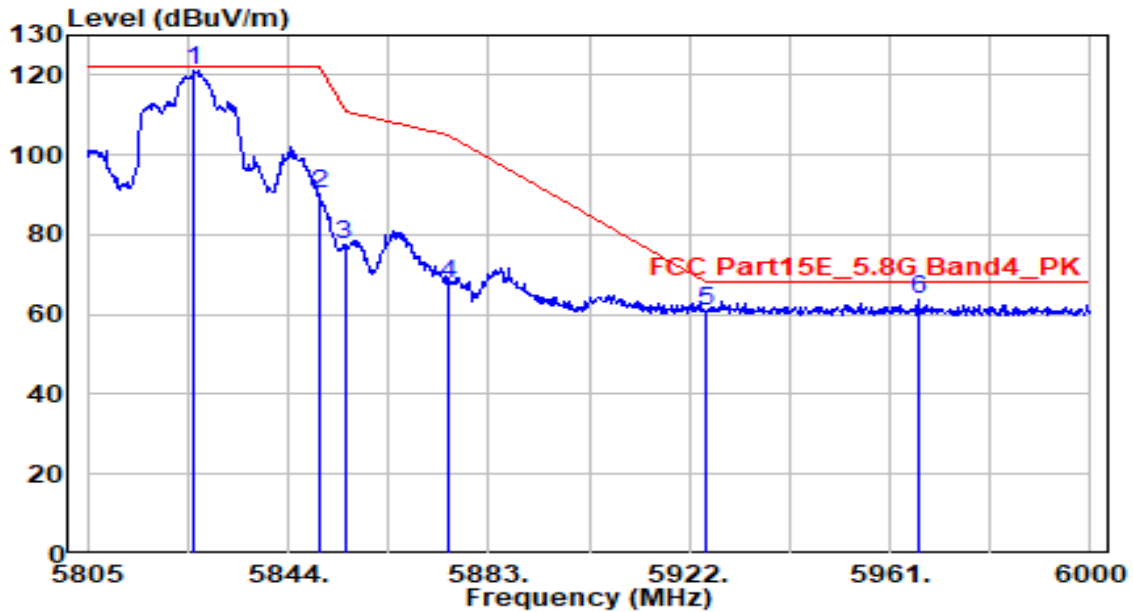

No	Frequency (MHz)	Reading (dBμV)	C.F (dB/m)	Measurement (dBμV/m)	Margin (dB)	Limit (dBμV/m)	Height (cm)	Angle (deg)	Remark (QP/PK/AV)
1	5825.670	119.92	1.25	121.16	N/A	N/A	230	100	Peak
2	5850.045	89.12	1.28	90.39	-31.70	122.10	230	100	Peak
3	5855.000	76.14	1.28	77.42	-33.38	110.80	230	100	Peak
4	5875.000	66.27	1.30	67.57	-37.63	105.20	230	100	Peak
5	5925.000	59.27	1.35	60.62	-7.58	68.20	230	100	Peak
6	* 5966.460	62.14	1.40	63.53	-4.67	68.20	230	100	Peak

Note:

1. " \*", means this data is the worst emission level.
2. C.F (Correction Factor) = Antenna Factor (dB/m)+ Cable Loss (dB) – Preamplifier(dB) + 20dB Attenuation.
3. Measurement (dBμV/m) = Reading(dBμV) + C.F (Correction Factor).
4. The emission levels of other frequencies are very lower than the limit and not show in test report.

EUT	HAN Access Point	Date of Test	2021-10-07
Factor	DRH18-E	Temp. / Humidity	23°C /49%
Polarity	Horizontal	Site / Test Engineer	AC2 / Jay
Test Mode	802.11ax40_TX_Band1_CH 38	Test Voltage	AC 120V/60Hz

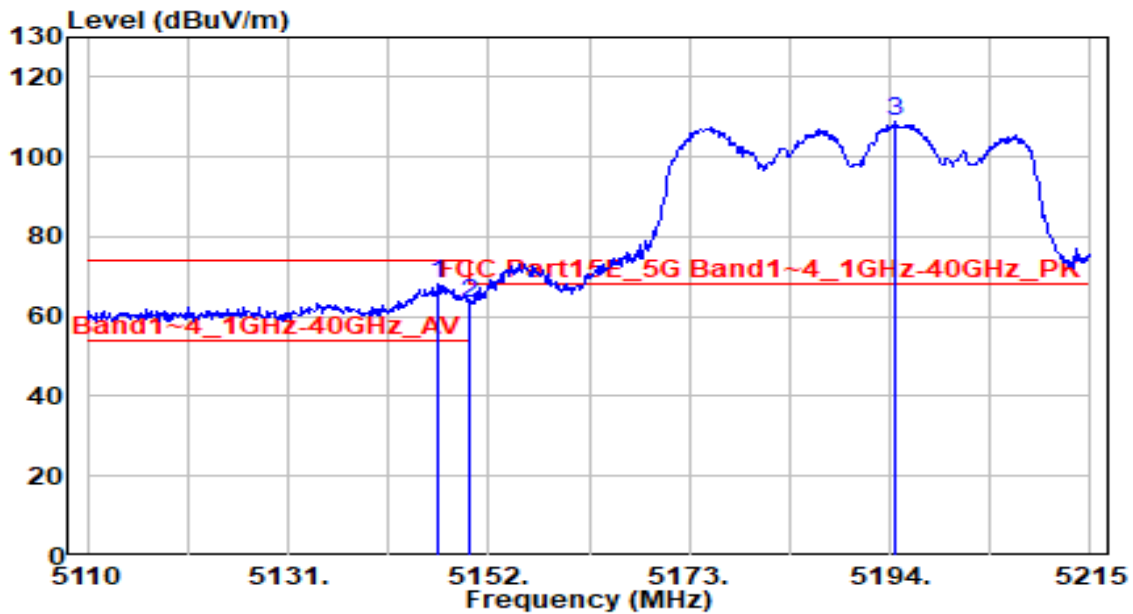

No	Frequency (MHz)	Reading (dB $\mu$ V)	C.F (dB/m)	Measurement (dB $\mu$ V/m)	Margin (dB)	Limit (dB $\mu$ V/m)	Height (cm)	Angle (deg)	Remark (QP/PK/AV)
1	* 5146.750	68.26	-0.32	67.95	-6.05	74.00	220	40	Peak
2	5150.000	63.80	-0.32	63.48	-10.52	74.00	220	40	Peak
3	5194.630	109.02	-0.32	108.70	N/A	N/A	220	40	Peak

Note:

- "\*" means this data is the worst emission level.
- C.F (Correction Factor) = Antenna Factor (dB/m)+ Cable Loss (dB) – Preamplifier(dB) + 20dB Attenuation.
- Measurement (dB $\mu$ V/m) = Reading(dB $\mu$ V) + C.F (Correction Factor).
- The emission levels of other frequencies are very lower than the limit and not show in test report.

EUT	HAN Access Point	Date of Test	2021-10-07
Factor	DRH18-E	Temp. / Humidity	23°C /49%
Polarity	Horizontal	Site / Test Engineer	AC2 / Jay
Test Mode	802.11ax40_TX_Band1_CH 38	Test Voltage	AC 120V/60Hz

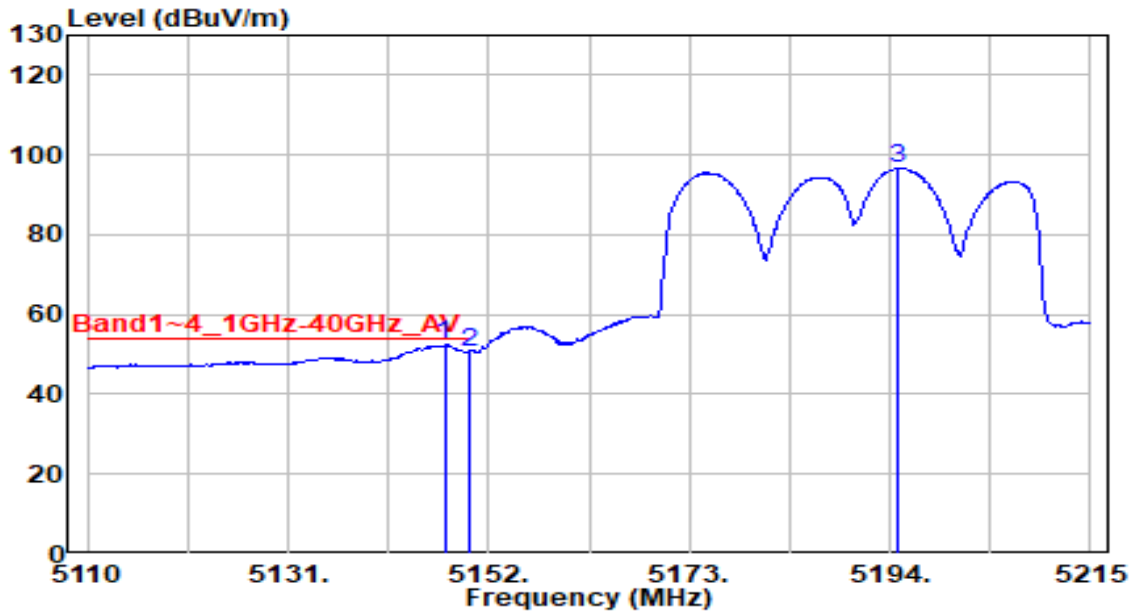

No	Frequency (MHz)	Reading (dB $\mu$ V)	C.F (dB/m)	Measurement (dB $\mu$ V/m)	Margin (dB)	Limit (dB $\mu$ V/m)	Height (cm)	Angle (deg)	Remark (QP/PK/AV)
1	* 5147.380	52.69	-0.32	52.37	-1.63	54.00	220	40	Average
2	5150.000	50.97	-0.32	50.65	-3.35	54.00	220	40	Average
3	5194.945	97.01	-0.32	96.68	N/A	N/A	220	40	Average

Note:

- "\*" means this data is the worst emission level.
- C.F (Correction Factor) = Antenna Factor (dB/m)+ Cable Loss (dB) – Preamplifier(dB) + 20dB Attenuation.
- Measurement (dB $\mu$ V/m) = Reading(dB $\mu$ V) + C.F (Correction Factor).
- The emission levels of other frequencies are very lower than the limit and not show in test report.

EUT	HAN Access Point	Date of Test	2021-10-07
Factor	DRH18-E	Temp. / Humidity	23°C /49%
Polarity	Vertical	Site / Test Engineer	AC2 / Jay
Test Mode	802.11ax40_TX_Band1_CH 38	Test Voltage	AC 120V/60Hz

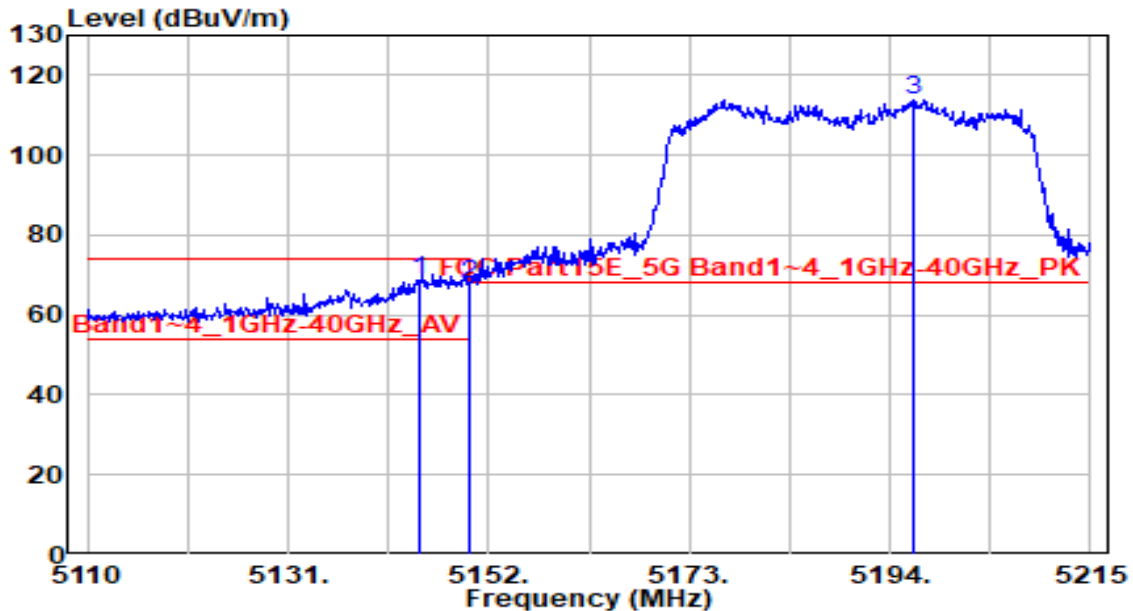

No	Frequency (MHz)	Reading (dB $\mu$ V)	C.F (dB/m)	Measurement (dB $\mu$ V/m)	Margin (dB)	Limit (dB $\mu$ V/m)	Height (cm)	Angle (deg)	Remark (QP/PK/AV)
1	* 5144.860	69.20	-0.32	68.88	-5.12	74.00	255	320	Peak
2	5150.000	68.16	-0.32	67.84	-6.16	74.00	255	320	Peak
3	5196.520	114.27	-0.32	113.95	N/A	N/A	255	320	Peak

Note:

1. " \*", means this data is the worst emission level.
2. C.F (Correction Factor) = Antenna Factor (dB/m)+ Cable Loss (dB) – Preamplifier(dB) + 20dB Attenuation.
3. Measurement (dB $\mu$ V/m) = Reading(dB $\mu$ V) + C.F (Correction Factor).
4. The emission levels of other frequencies are very lower than the limit and not show in test report.

EUT	HAN Access Point	Date of Test	2021-10-07
Factor	DRH18-E	Temp. / Humidity	23°C /49%
Polarity	Vertical	Site / Test Engineer	AC2 / Jay
Test Mode	802.11ax40_TX_Band1_CH 38	Test Voltage	AC 120V/60Hz

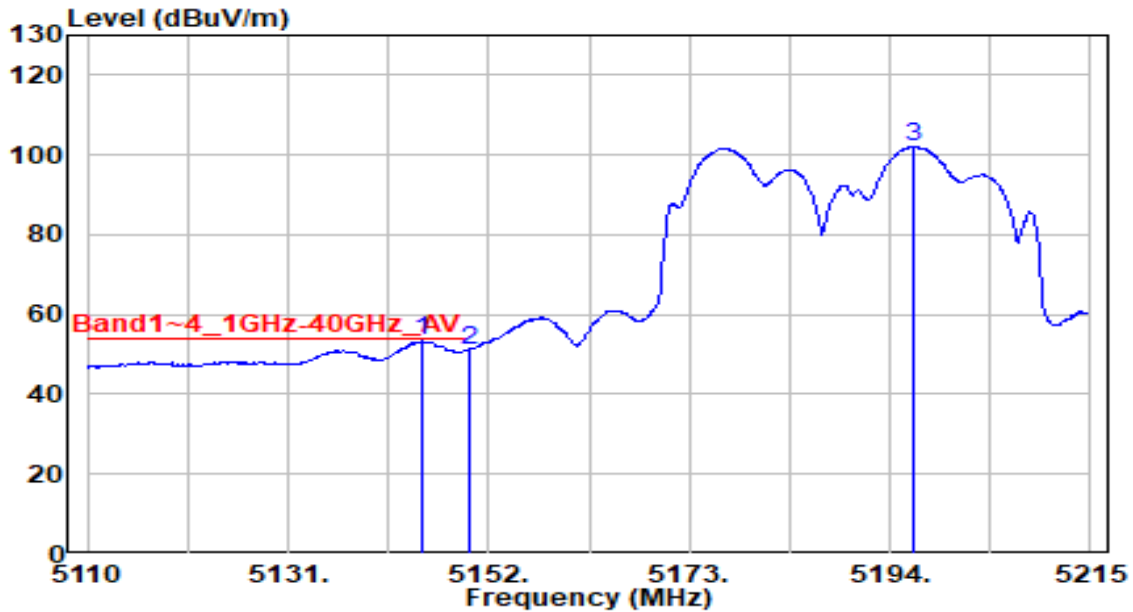

No	Frequency (MHz)	Reading (dBμV)	C.F (dB/m)	Measurement (dBμV/m)	Margin (dB)	Limit (dBμV/m)	Height (cm)	Angle (deg)	Remark (QP/PK/AV)
1	* 5144.965	53.55	-0.32	53.23	-0.77	54.00	255	320	Average
2	5150.000	51.44	-0.32	51.12	-2.88	54.00	255	320	Average
3	5196.520	102.43	-0.32	102.10	N/A	N/A	255	320	Average

Note:

- "\*" means this data is the worst emission level.
- C.F (Correction Factor) = Antenna Factor (dB/m)+ Cable Loss (dB) – Preamplifier(dB) + 20dB Attenuation.
- Measurement (dBμV/m) = Reading(dBμV) + C.F (Correction Factor).
- The emission levels of other frequencies are very lower than the limit and not show in test report.

EUT	HAN Access Point	Date of Test	2021-10-07
Factor	DRH18-E	Temp. / Humidity	23°C /49%
Polarity	Horizontal	Site / Test Engineer	AC2 / Jay
Test Mode	802.11ax40_TX_Band2_CH 62	Test Voltage	AC 120V/60Hz

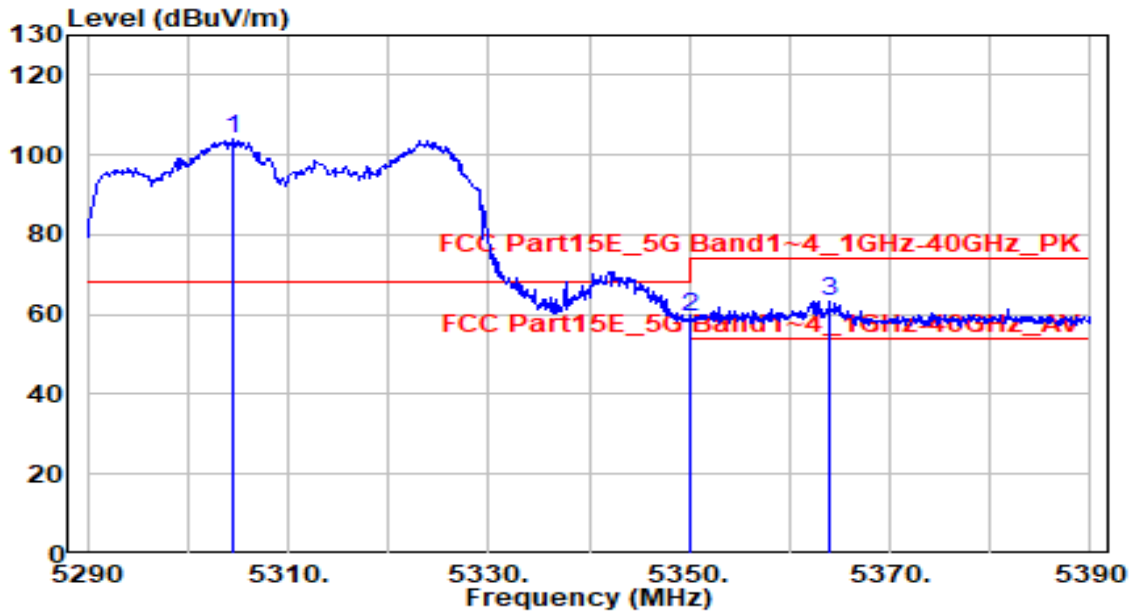

No	Frequency (MHz)	Reading (dBμV)	C.F (dB/m)	Measurement (dBμV/m)	Margin (dB)	Limit (dBμV/m)	Height (cm)	Angle (deg)	Remark (QP/PK/AV)
1	5304.400	104.20	-0.33	103.87	N/A	N/A	220	65	Peak
2	* 5350.000	59.83	-0.33	59.50	-8.70	68.20	220	65	Peak
3	5364.000	63.82	-0.32	63.50	-10.50	74.00	220	65	Peak

Note:

- "\*" means this data is the worst emission level.
- C.F (Correction Factor) = Antenna Factor (dB/m)+ Cable Loss (dB) – Preamplifier(dB) + 20dB Attenuation.
- Measurement (dBμV/m) = Reading(dBμV) + C.F (Correction Factor).
- The emission levels of other frequencies are very lower than the limit and not show in test report.



EUT	HAN Access Point	Date of Test	2021-10-07
Factor	DRH18-E	Temp. / Humidity	23°C /49%
Polarity	Horizontal	Site / Test Engineer	AC2 / Jay
Test Mode	802.11ax40_TX_Band2_CH 62	Test Voltage	AC 120V/60Hz

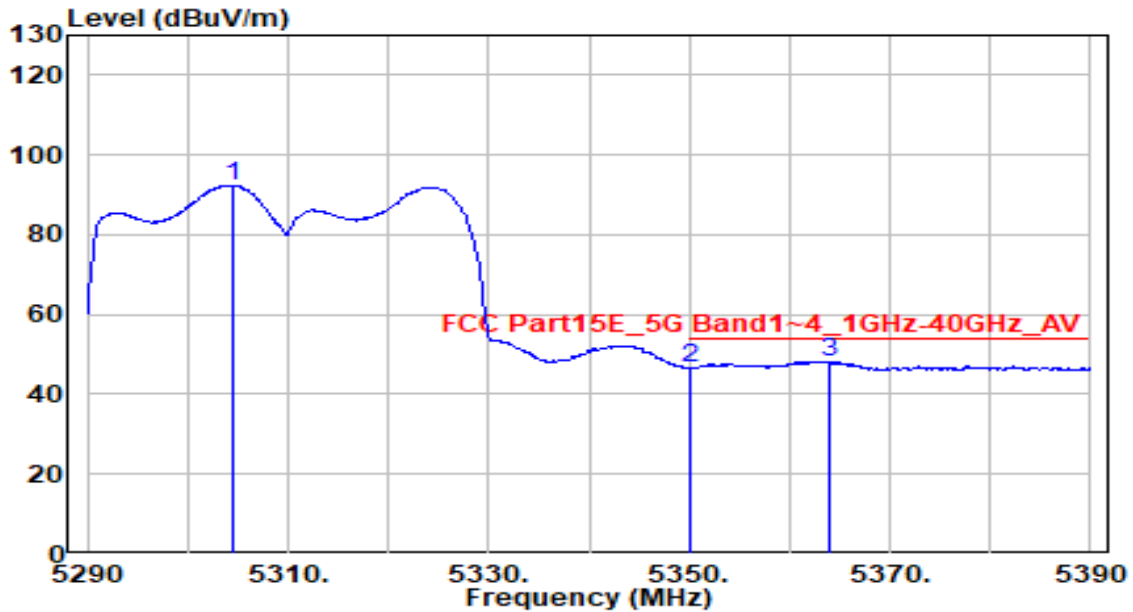

No	Frequency (MHz)	Reading (dB $\mu$ V)	C.F (dB/m)	Measurement (dB $\mu$ V/m)	Margin (dB)	Limit (dB $\mu$ V/m)	Height (cm)	Angle (deg)	Remark (QP/PK/AV)
1	5304.400	92.71	-0.33	92.38	N/A	N/A	220	65	Average
2	5350.000	46.99	-0.33	46.67	-7.33	54.00	220	65	Average
3	* 5364.000	48.51	-0.32	48.18	-5.82	54.00	220	65	Average

Note:

- "\*" means this data is the worst emission level.
- C.F (Correction Factor) = Antenna Factor (dB/m)+ Cable Loss (dB) – Preamplifier(dB) + 20dB Attenuation.
- Measurement (dB $\mu$ V/m) = Reading(dB $\mu$ V) + C.F (Correction Factor).
- The emission levels of other frequencies are very lower than the limit and not show in test report.

EUT	HAN Access Point	Date of Test	2021-10-07
Factor	DRH18-E	Temp. / Humidity	23°C /49%
Polarity	Vertical	Site / Test Engineer	AC2 / Jay
Test Mode	802.11ax40_TX_Band2_CH 62	Test Voltage	AC 120V/60Hz

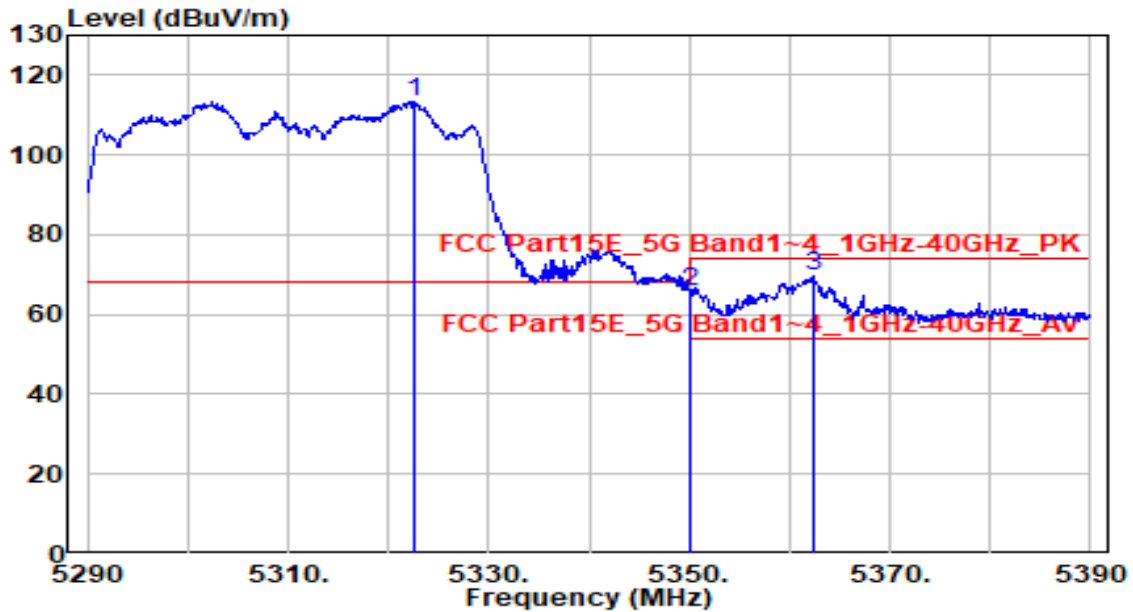

No	Frequency (MHz)	Reading (dB $\mu$ V)	C.F (dB/m)	Measurement (dB $\mu$ V/m)	Margin (dB)	Limit (dB $\mu$ V/m)	Height (cm)	Angle (deg)	Remark (QP/PK/AV)
1	5322.700	113.74	-0.33	113.41	N/A	N/A	240	195	Peak
2	* 5350.000	66.20	-0.33	65.88	-2.32	68.20	240	195	Peak
3	5362.300	69.76	-0.33	69.44	-4.56	74.00	240	195	Peak

Note:

- "\*" means this data is the worst emission level.
- C.F (Correction Factor) = Antenna Factor (dB/m)+ Cable Loss (dB) – Preamplifier(dB) + 20dB Attenuation.
- Measurement (dB $\mu$ V/m) = Reading(dB $\mu$ V) + C.F (Correction Factor).
- The emission levels of other frequencies are very lower than the limit and not show in test report.

EUT	HAN Access Point	Date of Test	2021-10-07
Factor	DRH18-E	Temp. / Humidity	23°C /49%
Polarity	Vertical	Site / Test Engineer	AC2 / Jay
Test Mode	802.11ax40_TX_Band2_CH 62	Test Voltage	AC 120V/60Hz

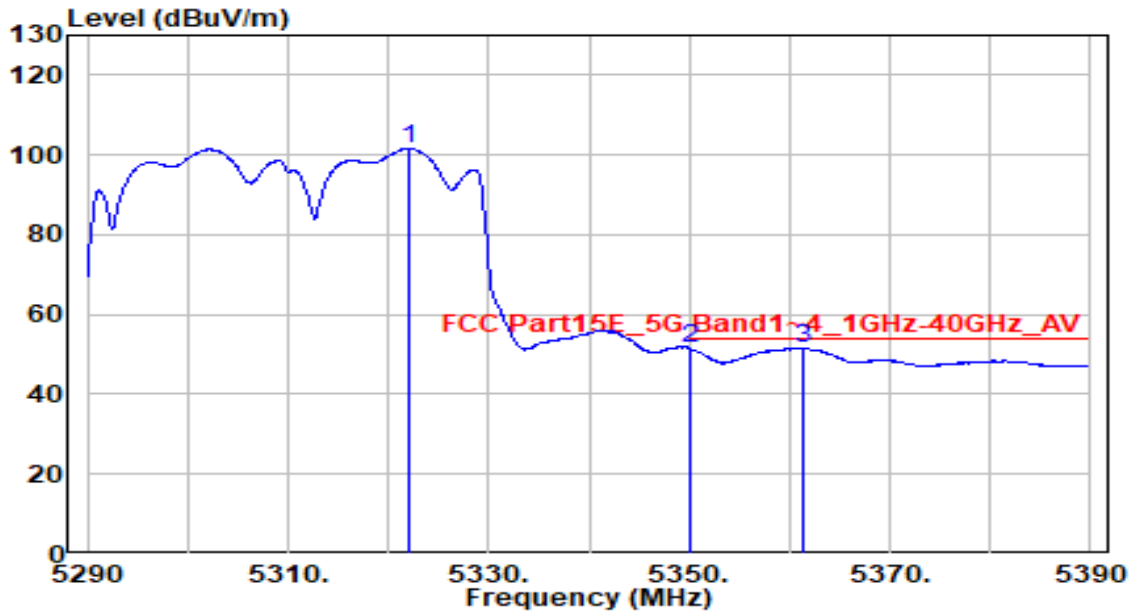

No	Frequency (MHz)	Reading (dB $\mu$ V)	C.F (dB/m)	Measurement (dB $\mu$ V/m)	Margin (dB)	Limit (dB $\mu$ V/m)	Height (cm)	Angle (deg)	Remark (QP/PK/AV)
1	5322.000	101.91	-0.33	101.58	N/A	N/A	240	195	Average
2	5350.000	51.82	-0.33	51.49	-2.51	54.00	240	195	Average
3	* 5361.400	51.88	-0.33	51.55	-2.45	54.00	240	195	Average

Note:

- "\*" means this data is the worst emission level.
- C.F (Correction Factor) = Antenna Factor (dB/m)+ Cable Loss (dB) – Preamplifier(dB) + 20dB Attenuation.
- Measurement (dB $\mu$ V/m) = Reading(dB $\mu$ V) + C.F (Correction Factor).
- The emission levels of other frequencies are very lower than the limit and not show in test report.

EUT	HAN Access Point	Date of Test	2021-10-07
Factor	DRH18-E	Temp. / Humidity	23°C /49%
Polarity	Horizontal	Site / Test Engineer	AC2 / Jay
Test Mode	802.11ax40_TX_Band3_CH 102	Test Voltage	AC 120V/60Hz

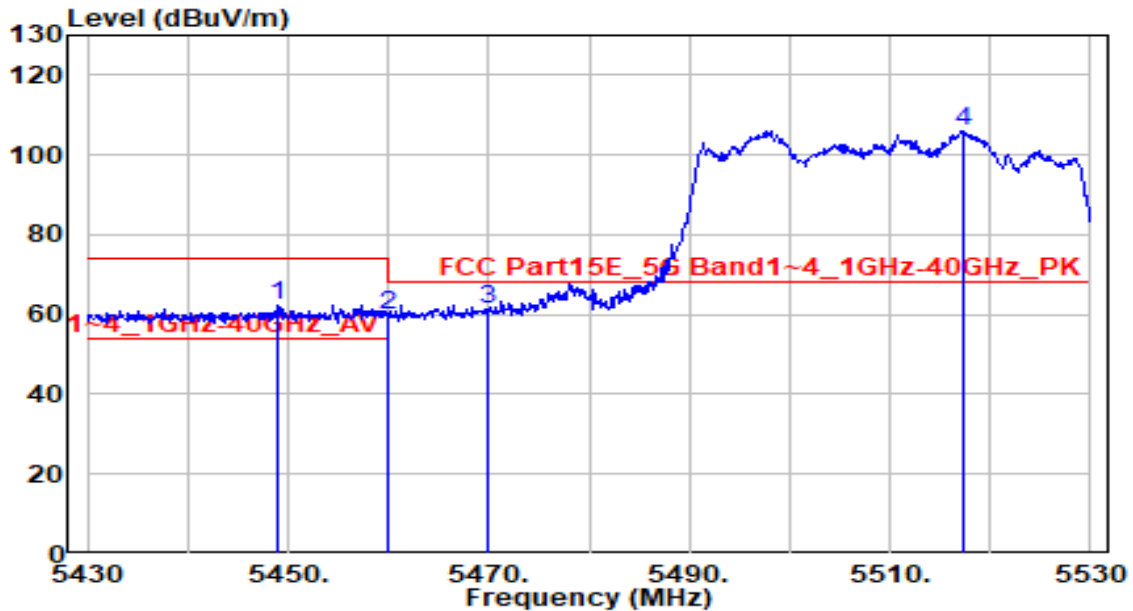

No	Frequency (MHz)	Reading (dBμV)	C.F (dB/m)	Measurement (dBμV/m)	Margin (dB)	Limit (dBμV/m)	Height (cm)	Angle (deg)	Remark (QP/PK/AV)
1	5449.000	62.52	-0.15	62.37	-11.63	74.00	230	160	Peak
2	5460.000	59.86	-0.11	59.75	-8.45	68.20	230	160	Peak
3	* 5470.000	61.25	-0.07	61.18	-7.02	68.20	230	160	Peak
4	5517.400	106.08	0.10	106.18	N/A	N/A	230	160	Peak

Note:

1. " \*", means this data is the worst emission level.
2. C.F (Correction Factor) = Antenna Factor (dB/m)+ Cable Loss (dB) – Preamplifier(dB) + 20dB Attenuation.
3. Measurement (dBμV/m) = Reading(dBμV) + C.F (Correction Factor).
4. The emission levels of other frequencies are very lower than the limit and not show in test report.

EUT	HAN Access Point	Date of Test	2021-10-07
Factor	DRH18-E	Temp. / Humidity	23°C /49%
Polarity	Horizontal	Site / Test Engineer	AC2 / Jay
Test Mode	802.11ax40_TX_Band3_CH 102	Test Voltage	AC 120V/60Hz

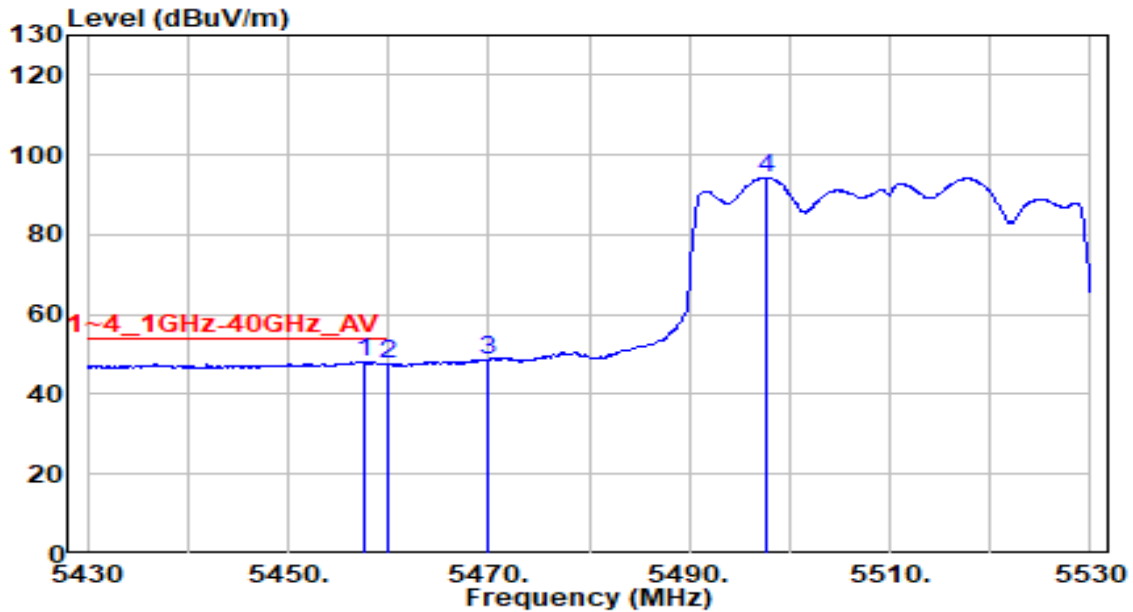

No	Frequency (MHz)	Reading (dB $\mu$ V)	C.F (dB/m)	Measurement (dB $\mu$ V/m)	Margin (dB)	Limit (dB $\mu$ V/m)	Height (cm)	Angle (deg)	Remark (QP/PK/AV)
1	* 5457.600	48.24	-0.12	48.12	-5.88	54.00	230	160	Average
2	5460.000	47.50	-0.11	47.39	-6.61	54.00	230	160	Average
3	5470.000	48.66	-0.07	48.58	N/A	N/A	230	160	Average
4	5497.600	94.23	0.03	94.26	N/A	N/A	230	160	Average

Note:

1. " \*", means this data is the worst emission level.
2. C.F (Correction Factor) = Antenna Factor (dB/m)+ Cable Loss (dB) – Preamplifier(dB) + 20dB Attenuation.
3. Measurement (dB $\mu$ V/m) = Reading(dB $\mu$ V) + C.F (Correction Factor).
4. The emission levels of other frequencies are very lower than the limit and not show in test report.

EUT	HAN Access Point	Date of Test	2021-10-07
Factor	DRH18-E	Temp. / Humidity	23°C /49%
Polarity	Vertical	Site / Test Engineer	AC2 / Jay
Test Mode	802.11ax40_TX_Band3_CH 102	Test Voltage	AC 120V/60Hz

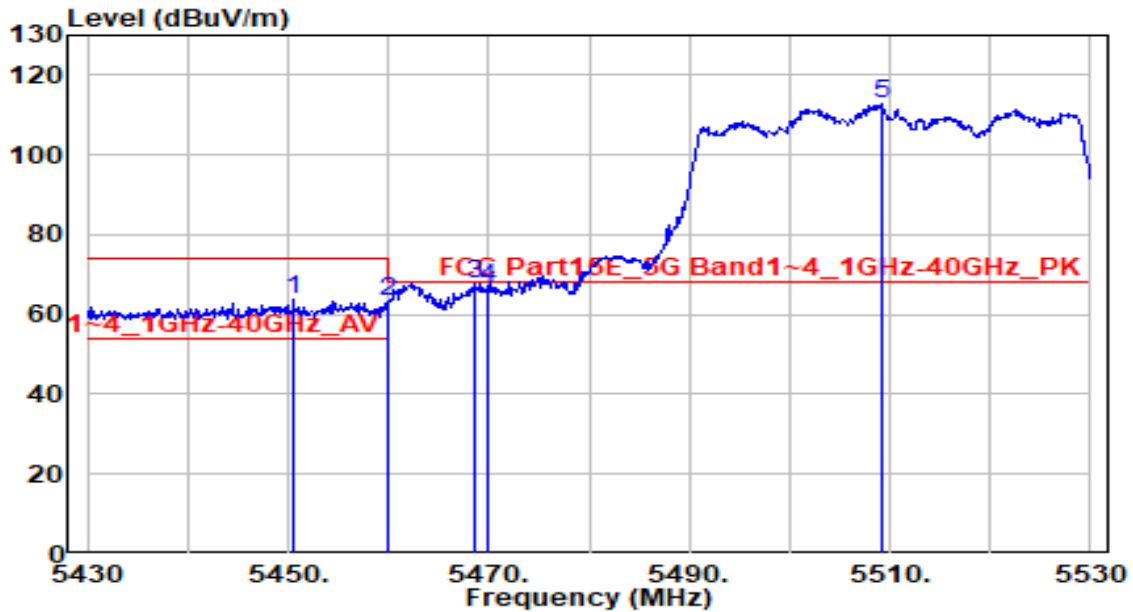

No	Frequency (MHz)	Reading (dBμV)	C.F (dB/m)	Measurement (dBμV/m)	Margin (dB)	Limit (dBμV/m)	Height (cm)	Angle (deg)	Remark (QP/PK/AV)
1	5450.500	63.81	-0.14	63.67	-10.33	74.00	260	190	Peak
2	5460.000	63.25	-0.11	63.14	-5.06	68.20	260	190	Peak
3	* 5468.500	67.71	-0.08	67.63	-0.57	68.20	260	190	Peak
4	5470.000	66.69	-0.07	66.62	-1.58	68.20	260	190	Peak
5	5509.200	112.84	0.07	112.91	N/A	N/A	260	190	Peak

Note:

1. " \*", means this data is the worst emission level.
2. C.F (Correction Factor) = Antenna Factor (dB/m)+ Cable Loss (dB) – Preamplifier(dB) + 20dB Attenuation.
3. Measurement (dBμV/m) = Reading(dBμV) + C.F (Correction Factor).
4. The emission levels of other frequencies are very lower than the limit and not show in test report.

EUT	HAN Access Point	Date of Test	2021-10-07
Factor	DRH18-E	Temp. / Humidity	23°C /49%
Polarity	Vertical	Site / Test Engineer	AC2 / Jay
Test Mode	802.11ax40_TX_Band3_CH 102	Test Voltage	AC 120V/60Hz

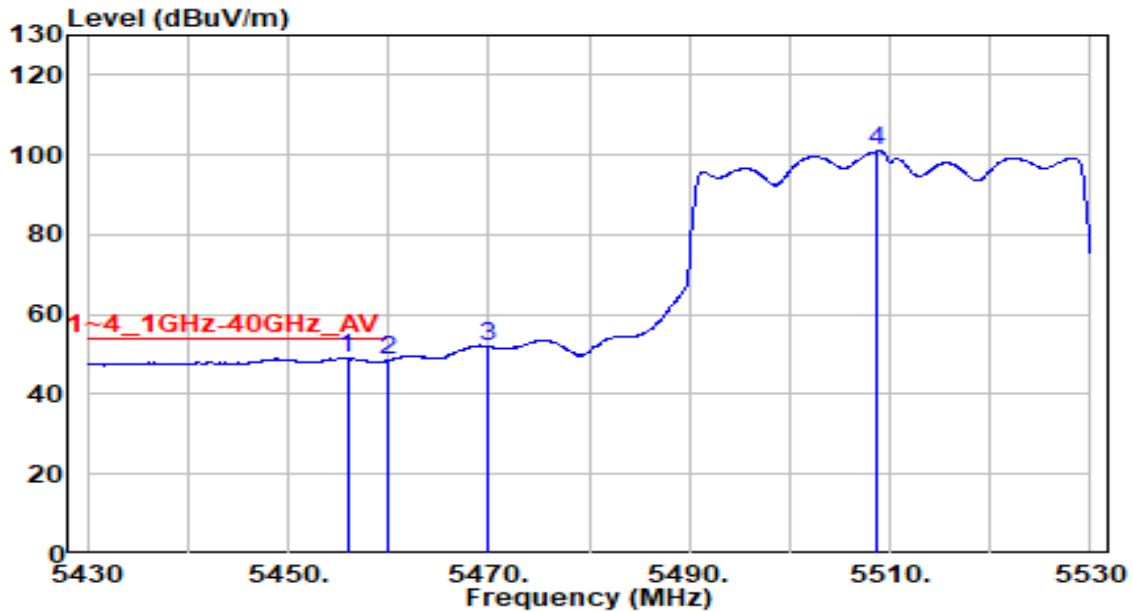

No	Frequency (MHz)	Reading (dBμV)	C.F (dB/m)	Measurement (dBμV/m)	Margin (dB)	Limit (dBμV/m)	Height (cm)	Angle (deg)	Remark (QP/PK/AV)
1	* 5455.900	49.19	-0.12	49.07	-4.93	54.00	260	190	Average
2	5460.000	48.61	-0.11	48.51	-5.49	54.00	260	190	Average
3	5470.000	52.06	-0.07	51.99	N/A	N/A	260	190	Average
4	5508.700	100.87	0.07	100.93	N/A	N/A	260	190	Average

Note:

1. " \*", means this data is the worst emission level.
2. C.F (Correction Factor) = Antenna Factor (dB/m)+ Cable Loss (dB) – Preamplifier(dB) + 20dB Attenuation.
3. Measurement (dBμV/m) = Reading(dBμV) + C.F (Correction Factor).
4. The emission levels of other frequencies are very lower than the limit and not show in test report.

EUT	HAN Access Point	Date of Test	2021-10-07
Factor	DRH18-E	Temp. / Humidity	23°C /49%
Polarity	Horizontal	Site / Test Engineer	AC2 / Jay
Test Mode	802.11ax40_TX_Band3_CH 134	Test Voltage	AC 120V/60Hz

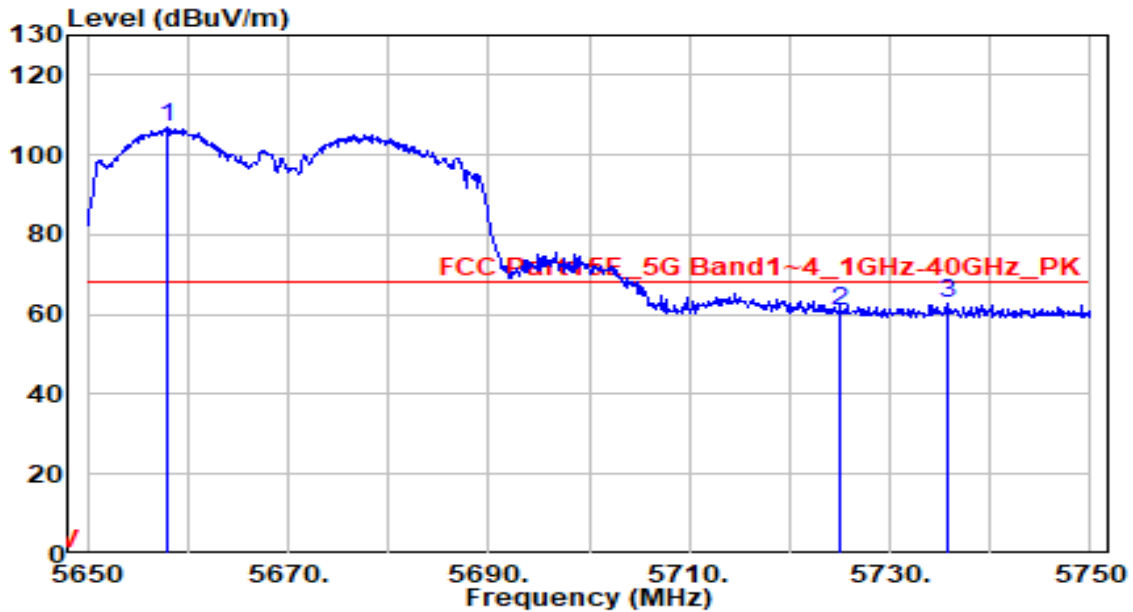

No	Frequency (MHz)	Reading (dB $\mu$ V)	C.F (dB/m)	Measurement (dB $\mu$ V/m)	Margin (dB)	Limit (dB $\mu$ V/m)	Height (cm)	Angle (deg)	Remark (QP/PK/AV)
1	5658.000	106.23	0.64	106.86	N/A	N/A	180	70	Peak
2	5725.000	59.99	0.91	60.90	-7.30	68.20	180	70	Peak
3	* 5735.700	61.75	0.96	62.71	-5.49	68.20	180	70	Peak

Note:

- "\*", means this data is the worst emission level.
- C.F (Correction Factor) = Antenna Factor (dB/m)+ Cable Loss (dB) – Preamplifier(dB) + 20dB Attenuation.
- Measurement (dB $\mu$ V/m) = Reading(dB $\mu$ V) + C.F (Correction Factor).
- The emission levels of other frequencies are very lower than the limit and not show in test report.



EUT	HAN Access Point	Date of Test	2021-10-07
Factor	DRH18-E	Temp. / Humidity	23°C /49%
Polarity	Vertical	Site / Test Engineer	AC2 / Jay
Test Mode	802.11ax40_TX_Band3_CH 134	Test Voltage	AC 120V/60Hz

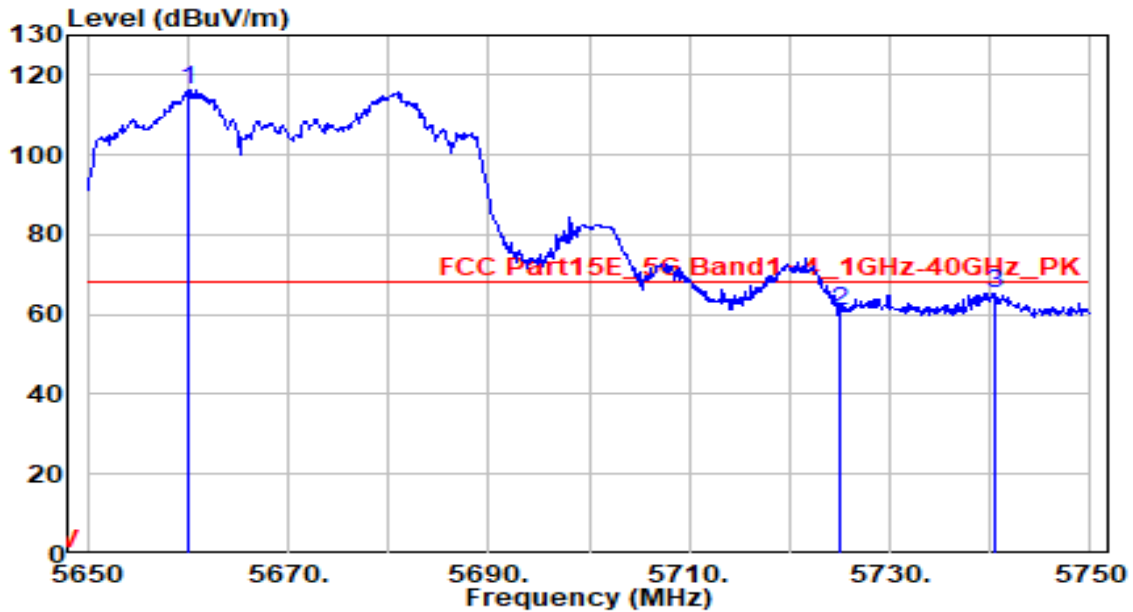

No	Frequency (MHz)	Reading (dBUV)	C.F (dB/m)	Measurement (dBUV/m)	Margin (dB)	Limit (dBUV/m)	Height (cm)	Angle (deg)	Remark (QP/PK/AV)
1	5660.000	115.52	0.65	116.17	N/A	N/A	255	95	Peak
2	5725.000	60.09	0.91	61.00	-7.20	68.20	255	95	Peak
3	* 5740.600	64.40	0.98	65.38	-2.82	68.20	255	95	Peak

Note:

- "\*", means this data is the worst emission level.
- C.F (Correction Factor) = Antenna Factor (dB/m)+ Cable Loss (dB) – Preamplifier(dB) + 20dB Attenuation.
- Measurement (dBUV/m) = Reading(dBUV) + C.F (Correction Factor).
- The emission levels of other frequencies are very lower than the limit and not show in test report.

EUT	HAN Access Point	Date of Test	2021-10-07
Factor	DRH18-E	Temp. / Humidity	23°C /49%
Polarity	Horizontal	Site / Test Engineer	AC2 / Jay
Test Mode	802.11ax40_TX_Band4_CH 151	Test Voltage	AC 120V/60Hz

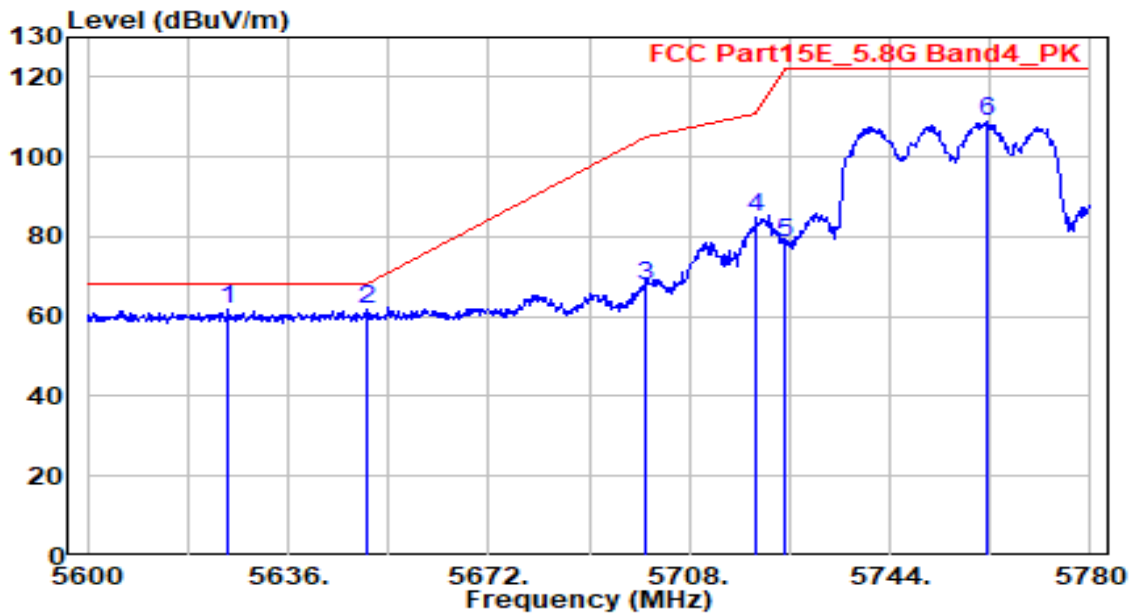

No	Frequency (MHz)	Reading (dBμV)	C.F (dB/m)	Measurement (dBμV/m)	Margin (dB)	Limit (dBμV/m)	Height (cm)	Angle (deg)	Remark (QP/PK/AV)
1	5625.380	61.15	0.50	61.65	-6.55	68.20	220	155	Peak
2	* 5650.000	61.06	0.60	61.67	-6.53	68.20	220	155	Peak
3	5700.000	66.89	0.81	67.70	-37.50	105.20	220	155	Peak
4	5720.000	83.92	0.89	84.82	-25.98	110.80	220	155	Peak
5	5725.000	77.44	0.91	78.36	-43.84	122.20	220	155	Peak
6	5761.640	107.63	1.06	108.70	N/A	N/A	220	155	Peak

Note:

1. " \*", means this data is the worst emission level.
2. C.F (Correction Factor) = Antenna Factor (dB/m)+ Cable Loss (dB) – Preamplifier(dB) + 20dB Attenuation.
3. Measurement (dBμV/m) = Reading(dBμV) + C.F (Correction Factor).
4. The emission levels of other frequencies are very lower than the limit and not show in test report.

EUT	HAN Access Point	Date of Test	2021-10-07
Factor	DRH18-E	Temp. / Humidity	23°C /49%
Polarity	Vertical	Site / Test Engineer	AC2 / Jay
Test Mode	802.11ax40_TX_Band4_CH 151	Test Voltage	AC 120V/60Hz

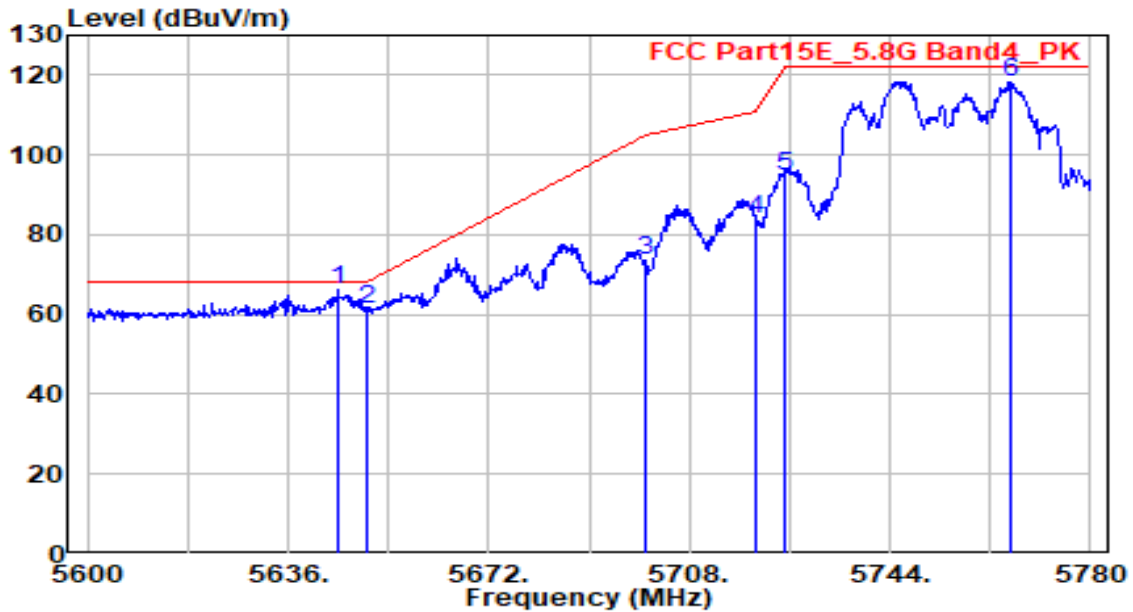

No	Frequency (MHz)	Reading (dB $\mu$ V)	C.F (dB/m)	Measurement (dB $\mu$ V/m)	Margin (dB)	Limit (dB $\mu$ V/m)	Height (cm)	Angle (deg)	Remark (QP/PK/AV)
1	* 5645.000	65.60	0.58	66.18	-2.02	68.20	245	105	Peak
2	5650.000	60.70	0.60	61.31	-6.89	68.20	245	105	Peak
3	5700.000	72.78	0.81	73.59	-31.61	105.20	245	105	Peak
4	5720.060	83.06	0.89	83.95	-26.98	110.94	245	105	Peak
5	5725.000	93.69	0.91	94.60	-27.60	122.20	245	105	Peak
6	5765.780	117.26	1.08	118.34	N/A	N/A	245	105	Peak

Note:

1. " \*", means this data is the worst emission level.
2. C.F (Correction Factor) = Antenna Factor (dB/m)+ Cable Loss (dB) – Preamplifier(dB) + 20dB Attenuation.
3. Measurement (dB $\mu$ V/m) = Reading(dB $\mu$ V) + C.F (Correction Factor).
4. The emission levels of other frequencies are very lower than the limit and not show in test report.

EUT	HAN Access Point	Date of Test	2021-10-07
Factor	DRH18-E	Temp. / Humidity	23°C /49%
Polarity	Horizontal	Site / Test Engineer	AC2 / Jay
Test Mode	802.11ax40_TX_Band4_CH 159	Test Voltage	AC 120V/60Hz

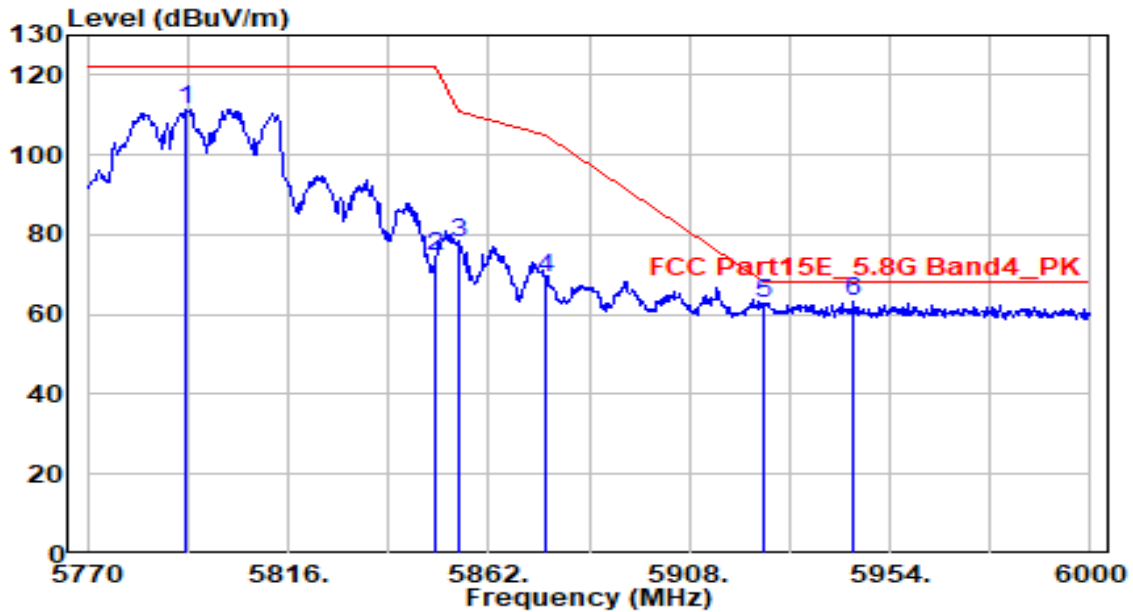

No	Frequency (MHz)	Reading (dBμV)	C.F (dB/m)	Measurement (dBμV/m)	Margin (dB)	Limit (dBμV/m)	Height (cm)	Angle (deg)	Remark (QP/PK/AV)
1	5792.540	110.28	1.19	111.47	N/A	N/A	245	35	Peak
2	5850.000	73.16	1.28	74.44	-47.76	122.20	245	35	Peak
3	5855.000	76.50	1.28	77.78	-33.02	110.80	245	35	Peak
4	5875.000	68.06	1.30	69.37	-35.83	105.20	245	35	Peak
5	5925.000	61.22	1.35	62.57	-5.63	68.20	245	35	Peak
6	* 5945.720	61.92	1.37	63.30	-4.90	68.20	245	35	Peak

Note:

1. " \*", means this data is the worst emission level.
2. C.F (Correction Factor) = Antenna Factor (dB/m)+ Cable Loss (dB) – Preamplifier(dB) + 20dB Attenuation.
3. Measurement (dBμV/m) = Reading(dBμV) + C.F (Correction Factor).
4. The emission levels of other frequencies are very lower than the limit and not show in test report.

EUT	HAN Access Point	Date of Test	2021-10-07
Factor	DRH18-E	Temp. / Humidity	23°C /49%
Polarity	Vertical	Site / Test Engineer	AC2 / Jay
Test Mode	802.11ax40_TX_Band4_CH 159	Test Voltage	AC 120V/60Hz

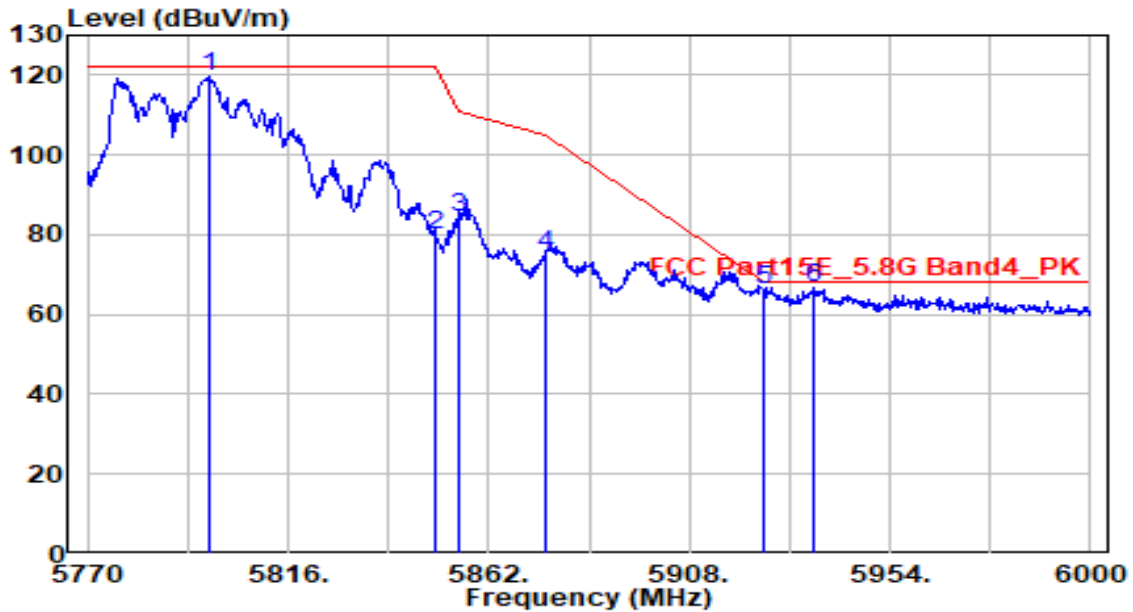

No	Frequency (MHz)	Reading (dBμV)	C.F (dB/m)	Measurement (dBμV/m)	Margin (dB)	Limit (dBμV/m)	Height (cm)	Angle (deg)	Remark (QP/PK/AV)
1	5797.830	118.29	1.21	119.50	N/A	N/A	250	110	Peak
2	5850.000	78.72	1.28	80.00	-42.20	122.20	250	100	Peak
3	5855.000	83.09	1.28	84.37	-26.43	110.80	250	110	Peak
4	5875.000	73.99	1.30	75.29	-29.91	105.20	250	110	Peak
5	5925.000	65.00	1.35	66.35	-1.85	68.20	250	110	Peak
6	* 5936.290	65.59	1.37	66.95	-1.25	68.20	250	110	Peak

Note:

1. " \*", means this data is the worst emission level.
2. C.F (Correction Factor) = Antenna Factor (dB/m)+ Cable Loss (dB) – Preamplifier(dB) + 20dB Attenuation.
3. Measurement (dBμV/m) = Reading(dBμV) + C.F (Correction Factor).
4. The emission levels of other frequencies are very lower than the limit and not show in test report.

EUT	HAN Access Point	Date of Test	2021-10-07
Factor	DRH18-E	Temp. / Humidity	23°C /49%
Polarity	Horizontal	Site / Test Engineer	AC2 / Jay
Test Mode	802.11ax80_TX_Band1_CH 42	Test Voltage	AC 120V/60Hz

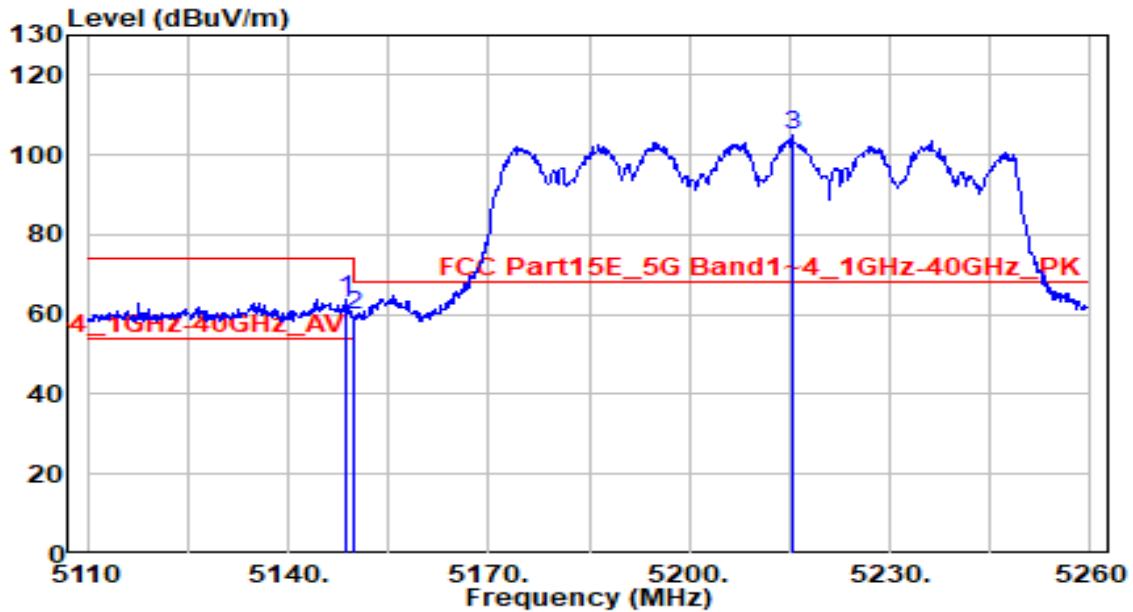

No	Frequency (MHz)	Reading (dB $\mu$ V)	C.F (dB/m)	Measurement (dB $\mu$ V/m)	Margin (dB)	Limit (dB $\mu$ V/m)	Height (cm)	Angle (deg)	Remark (QP/PK/AV)
1	* 5148.550	63.99	-0.32	63.67	-10.33	74.00	260	40	Peak
2	5150.000	60.04	-0.32	59.72	-14.28	74.00	260	40	Peak
3	5215.450	105.53	-0.32	105.21	N/A	N/A	260	40	Peak

Note:

1. " \*", means this data is the worst emission level.
2. C.F (Correction Factor) = Antenna Factor (dB/m)+ Cable Loss (dB) – Preamplifier(dB) + 20dB Attenuation.
3. Measurement (dB $\mu$ V/m) = Reading(dB $\mu$ V) + C.F (Correction Factor).
4. The emission levels of other frequencies are very lower than the limit and not show in test report.

EUT	HAN Access Point	Date of Test	2021-10-07
Factor	DRH18-E	Temp. / Humidity	23°C /49%
Polarity	Horizontal	Site / Test Engineer	AC2 / Jay
Test Mode	802.11ax80_TX_Band1_CH 42	Test Voltage	AC 120V/60Hz

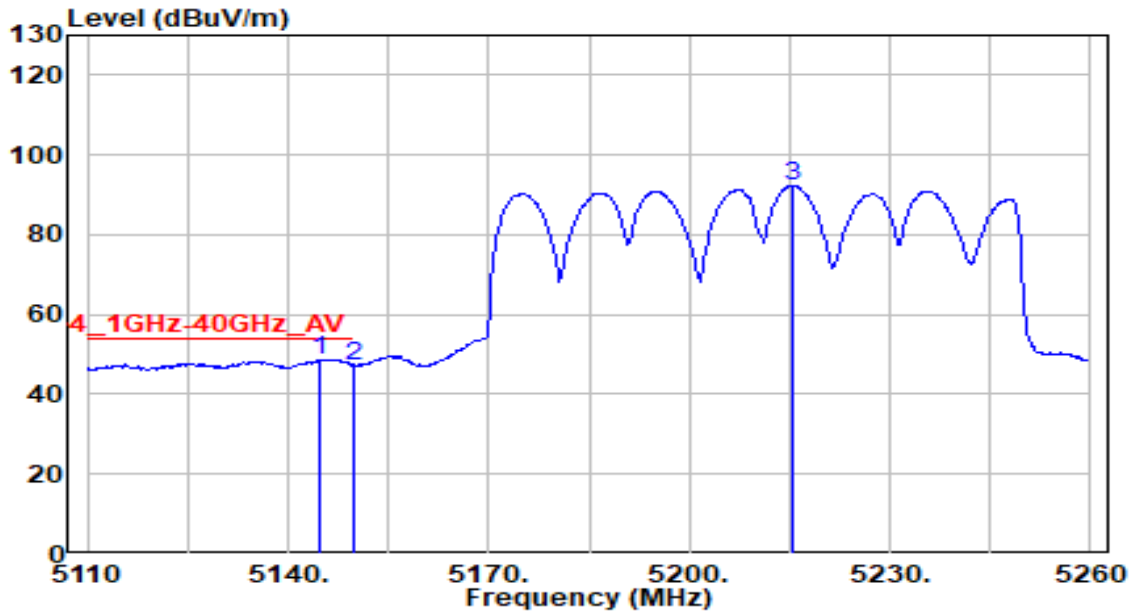

No	Frequency (MHz)	Reading (dB $\mu$ V)	C.F (dB/m)	Measurement (dB $\mu$ V/m)	Margin (dB)	Limit (dB $\mu$ V/m)	Height (cm)	Angle (deg)	Remark (QP/PK/AV)	
1	*	5144.650	49.10	-0.32	48.78	-5.22	54.00	260	40	Average
2		5150.000	47.56	-0.32	47.25	-6.75	54.00	260	40	Average
3		5215.600	92.50	-0.32	92.18	N/A	N/A	260	40	Average

Note:

1. " \*", means this data is the worst emission level.
2. C.F (Correction Factor) = Antenna Factor (dB/m)+ Cable Loss (dB) – Preamplifier(dB) + 20dB Attenuation.
3. Measurement (dB $\mu$ V/m) = Reading(dB $\mu$ V) + C.F (Correction Factor).
4. The emission levels of other frequencies are very lower than the limit and not show in test report.

EUT	HAN Access Point	Date of Test	2021-10-07
Factor	DRH18-E	Temp. / Humidity	23°C /49%
Polarity	Vertical	Site / Test Engineer	AC2 / Jay
Test Mode	802.11ax80_TX_Band1_CH 42	Test Voltage	AC 120V/60Hz

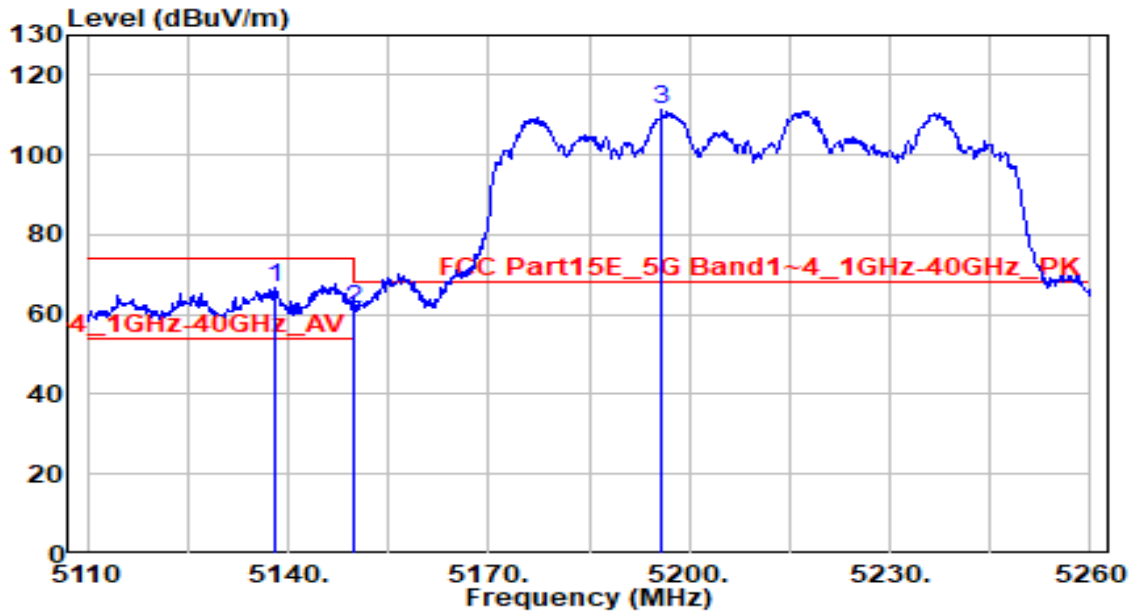

No	Frequency (MHz)	Reading (dBμV)	C.F (dB/m)	Measurement (dBμV/m)	Margin (dB)	Limit (dBμV/m)	Height (cm)	Angle (deg)	Remark (QP/PK/AV)
1	* 5138.200	67.19	-0.32	66.87	-7.13	74.00	255	170	Peak
2	5150.000	61.77	-0.32	61.45	-12.55	74.00	255	170	Peak
3	5195.950	111.45	-0.32	111.13	N/A	N/A	255	170	Peak

Note:

- "\*" means this data is the worst emission level.
- C.F (Correction Factor) = Antenna Factor (dB/m)+ Cable Loss (dB) – Preamplifier(dB) + 20dB Attenuation.
- Measurement (dBμV/m) = Reading(dBμV) + C.F (Correction Factor).
- The emission levels of other frequencies are very lower than the limit and not show in test report.



EUT	HAN Access Point	Date of Test	2021-10-07
Factor	DRH18-E	Temp. / Humidity	23°C /49%
Polarity	Vertical	Site / Test Engineer	AC2 / Jay
Test Mode	802.11ax80_TX_Band1_CH 42	Test Voltage	AC 120V/60Hz

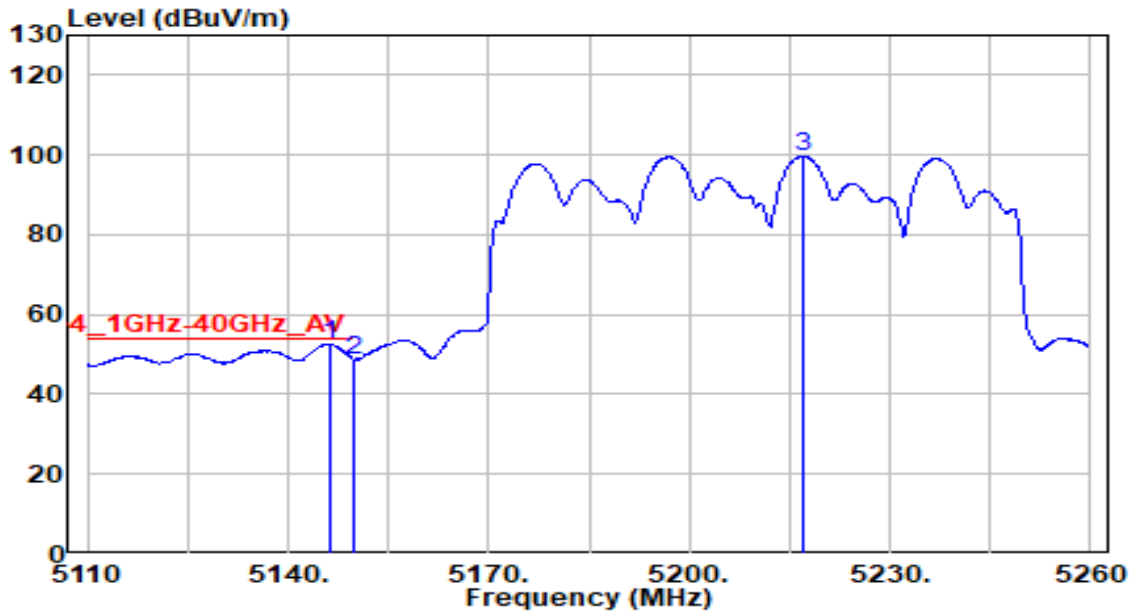

No	Frequency (MHz)	Reading (dB $\mu$ V)	C.F (dB/m)	Measurement (dB $\mu$ V/m)	Margin (dB)	Limit (dB $\mu$ V/m)	Height (cm)	Angle (deg)	Remark (QP/PK/AV)
1	*	52.89	-0.32	52.57	-1.43	54.00	255	170	Average
2		49.09	-0.32	48.77	-5.23	54.00	255	170	Average
3		99.92	-0.32	99.59	N/A	N/A	255	170	Average

Note:

- "\*", means this data is the worst emission level.
- C.F (Correction Factor) = Antenna Factor (dB/m)+ Cable Loss (dB) – Preamplifier(dB) + 20dB Attenuation.
- Measurement (dB $\mu$ V/m) = Reading(dB $\mu$ V) + C.F (Correction Factor).
- The emission levels of other frequencies are very lower than the limit and not show in test report.

EUT	HAN Access Point	Date of Test	2021-10-07
Factor	DRH18-E	Temp. / Humidity	23°C /49%
Polarity	Horizontal	Site / Test Engineer	AC2 / Jay
Test Mode	802.11ax80_TX_Band2_CH 58	Test Voltage	AC 120V/60Hz

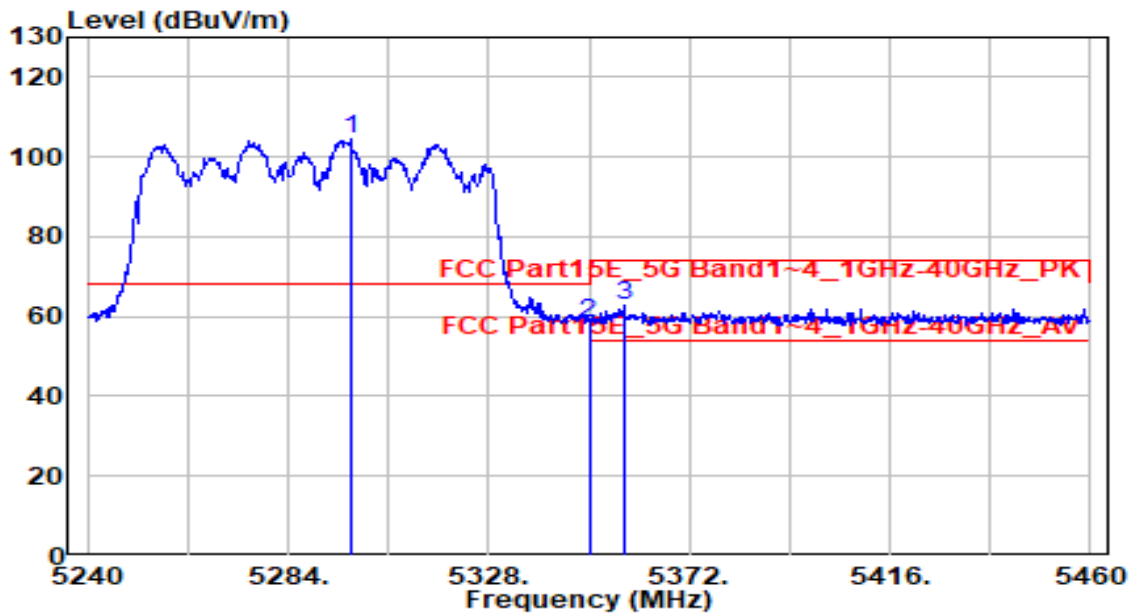

No	Frequency (MHz)	Reading (dBμV)	C.F (dB/m)	Measurement (dBμV/m)	Margin (dB)	Limit (dBμV/m)	Height (cm)	Angle (deg)	Remark (QP/PK/AV)	
1	*	5297.640	104.70	-0.33	104.38	N/A	N/A	220	40	Peak
2		5350.000	58.63	-0.33	58.30	-9.90	68.20	220	40	Peak
3		5357.700	63.01	-0.33	62.68	-11.32	74.00	220	40	Peak

Note:

- "\*" means this data is the worst emission level.
- C.F (Correction Factor) = Antenna Factor (dB/m)+ Cable Loss (dB) – Preamplifier(dB) + 20dB Attenuation.
- Measurement (dBμV/m) = Reading(dBμV) + C.F (Correction Factor).
- The emission levels of other frequencies are very lower than the limit and not show in test report.

EUT	HAN Access Point	Date of Test	2021-10-07
Factor	DRH18-E	Temp. / Humidity	23°C /49%
Polarity	Horizontal	Site / Test Engineer	AC2 / Jay
Test Mode	802.11ax80_TX_Band2_CH 58	Test Voltage	AC 120V/60Hz

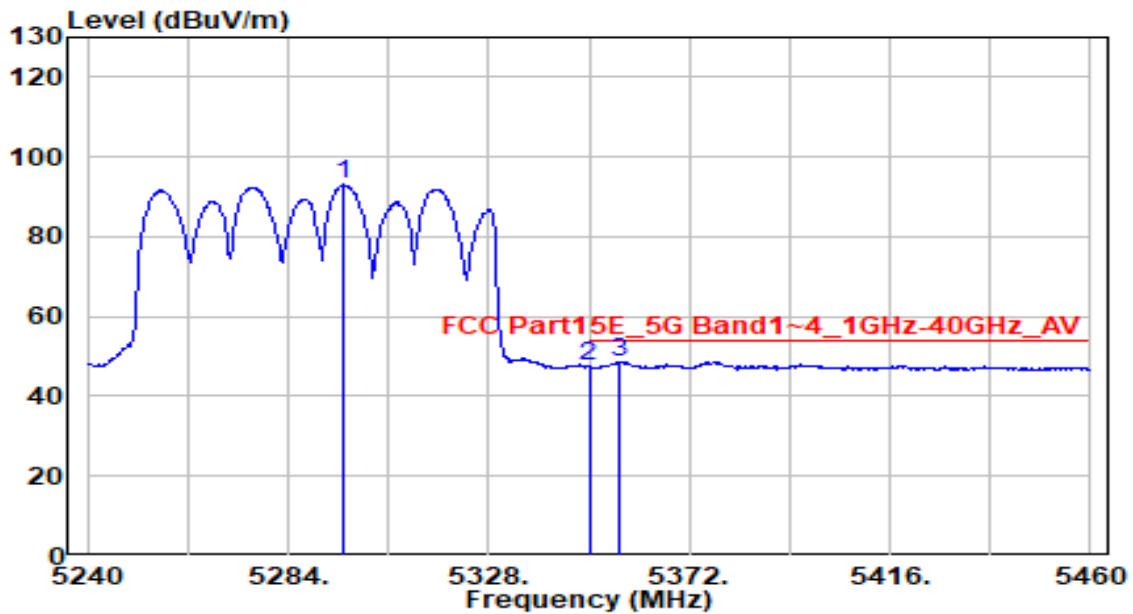

No	Frequency (MHz)	Reading (dB $\mu$ V)	C.F (dB/m)	Measurement (dB $\mu$ V/m)	Margin (dB)	Limit (dB $\mu$ V/m)	Height (cm)	Angle (deg)	Remark (QP/PK/AV)
1	5295.880	93.37	-0.33	93.04	N/A	N/A	220	40	Average
2	5350.000	47.87	-0.33	47.55	-6.45	54.00	220	40	Average
3	* 5356.820	49.02	-0.33	48.69	-5.31	54.00	220	40	Average

Note:

- "\*" means this data is the worst emission level.
- C.F (Correction Factor) = Antenna Factor (dB/m)+ Cable Loss (dB) – Preamplifier(dB) + 20dB Attenuation.
- Measurement (dB $\mu$ V/m) = Reading(dB $\mu$ V) + C.F (Correction Factor).
- The emission levels of other frequencies are very lower than the limit and not show in test report.

EUT	HAN Access Point	Date of Test	2021-10-07
Factor	DRH18-E	Temp. / Humidity	23°C /49%
Polarity	Vertical	Site / Test Engineer	AC2 / Jay
Test Mode	802.11ax80_TX_Band2_CH 58	Test Voltage	AC 120V/60Hz

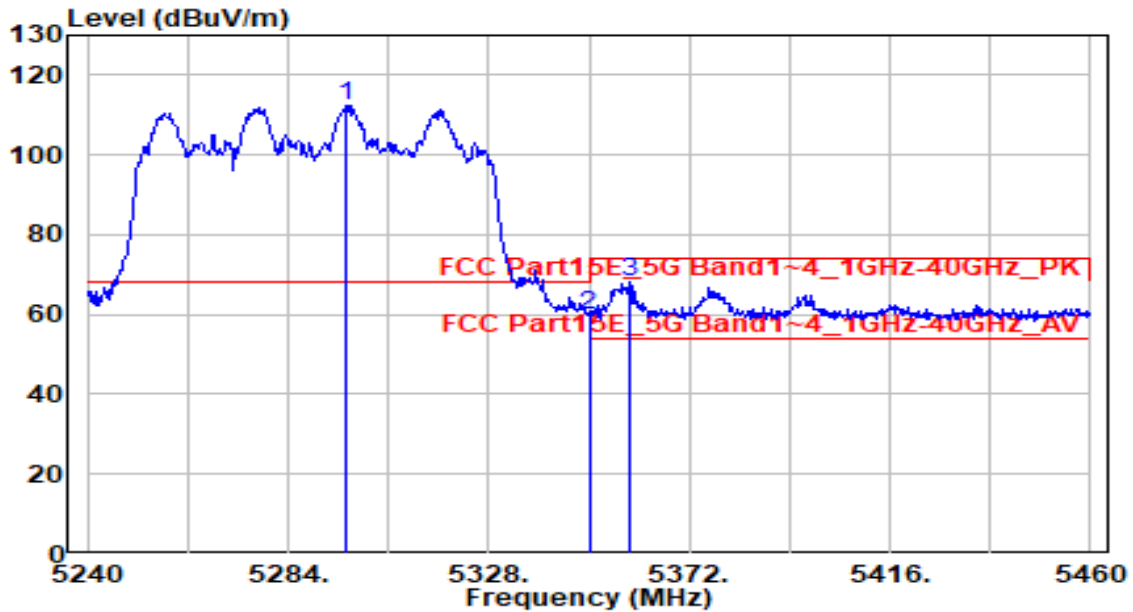

No	Frequency (MHz)	Reading (dBμV)	C.F (dB/m)	Measurement (dBμV/m)	Margin (dB)	Limit (dBμV/m)	Height (cm)	Angle (deg)	Remark (QP/PK/AV)
1	* 5296.760	112.71	-0.33	112.39	N/A	N/A	255	170	Peak
2	5350.000	60.20	-0.33	59.88	-8.32	68.20	255	170	Peak
3	5359.020	68.50	-0.33	68.17	-5.83	74.00	255	170	Peak

Note:

- "\*" means this data is the worst emission level.
- C.F (Correction Factor) = Antenna Factor (dB/m)+ Cable Loss (dB) – Preamplifier(dB) + 20dB Attenuation.
- Measurement (dBμV/m) = Reading(dBμV) + C.F (Correction Factor).
- The emission levels of other frequencies are very lower than the limit and not show in test report.

EUT	HAN Access Point	Date of Test	2021-10-07
Factor	DRH18-E	Temp. / Humidity	23°C /49%
Polarity	Vertical	Site / Test Engineer	AC2 / Jay
Test Mode	802.11ax80_TX_Band2_CH 58	Test Voltage	AC 120V/60Hz

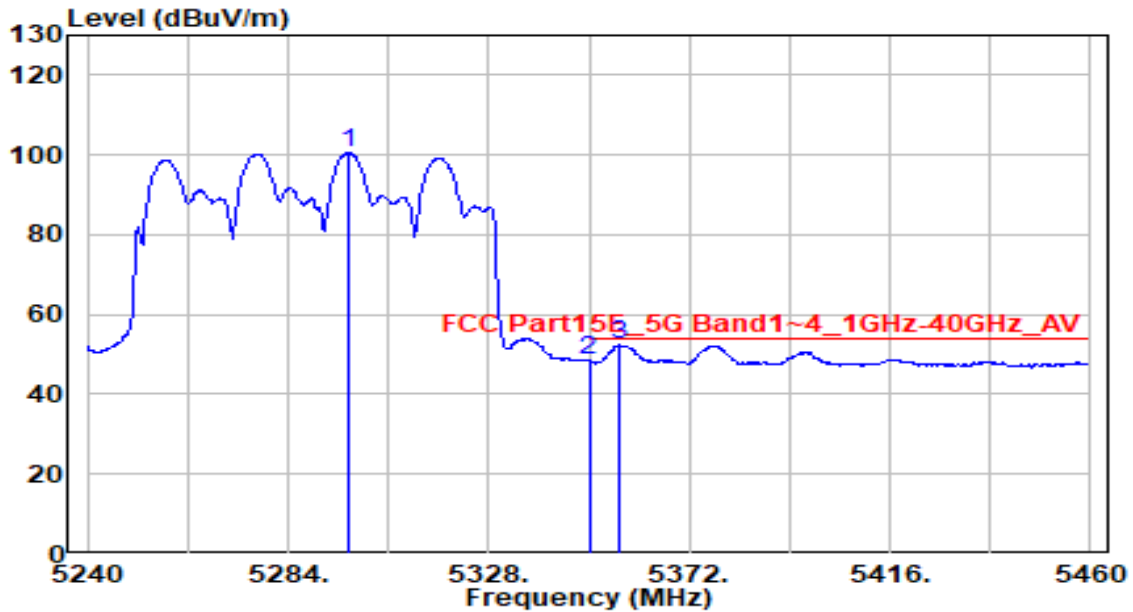

No	Frequency (MHz)	Reading (dB $\mu$ V)	C.F (dB/m)	Measurement (dB $\mu$ V/m)	Margin (dB)	Limit (dB $\mu$ V/m)	Height (cm)	Angle (deg)	Remark (QP/PK/AV)
1	5297.420	100.82	-0.33	100.49	N/A	N/A	255	170	Average
2	5350.000	48.83	-0.33	48.50	-5.50	54.00	255	170	Average
3	* 5356.600	52.63	-0.33	52.31	-1.69	54.00	255	170	Average

Note:

- "\*" means this data is the worst emission level.
- C.F (Correction Factor) = Antenna Factor (dB/m)+ Cable Loss (dB) – Preamplifier(dB) + 20dB Attenuation.
- Measurement (dB $\mu$ V/m) = Reading(dB $\mu$ V) + C.F (Correction Factor).
- The emission levels of other frequencies are very lower than the limit and not show in test report.

EUT	HAN Access Point	Date of Test	2021-10-07
Factor	DRH18-E	Temp. / Humidity	23°C /49%
Polarity	Horizontal	Site / Test Engineer	AC2 / Jay
Test Mode	802.11ax80_TX_Band3_CH 106	Test Voltage	AC 120V/60Hz

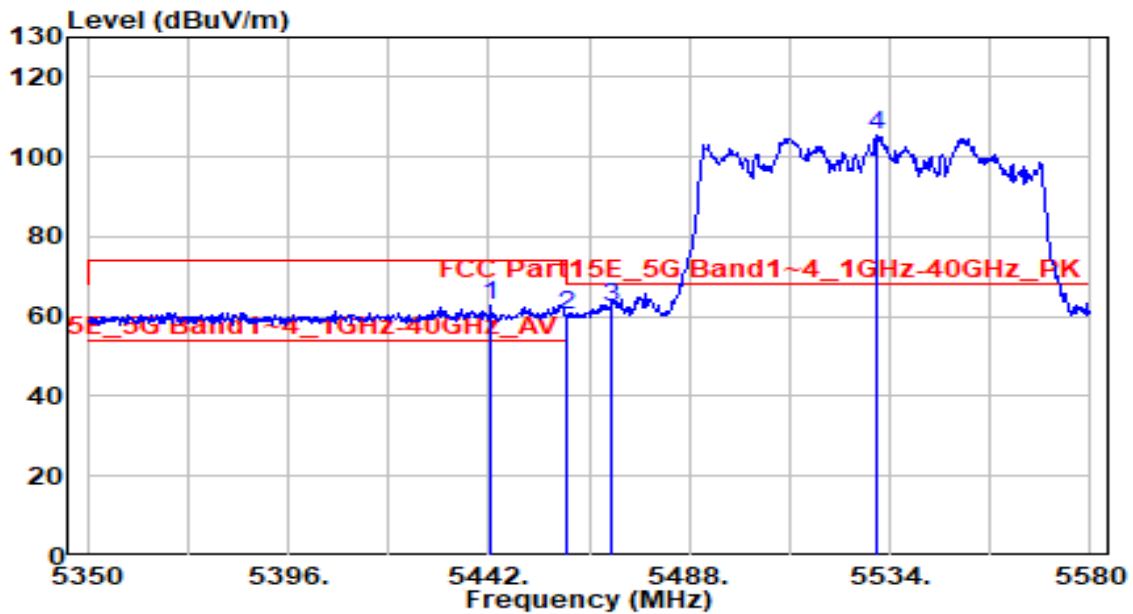

No	Frequency (MHz)	Reading (dB $\mu$ V)	C.F (dB/m)	Measurement (dB $\mu$ V/m)	Margin (dB)	Limit (dB $\mu$ V/m)	Height (cm)	Angle (deg)	Remark (QP/PK/AV)
1	5442.460	63.10	-0.17	62.93	-11.07	74.00	255	140	Peak
2	5460.000	60.56	-0.11	60.45	-7.75	68.20	255	140	Peak
3	* 5470.000	62.55	-0.07	62.47	-5.73	68.20	255	140	Peak
4	5531.010	105.08	0.15	105.23	N/A	N/A	255	140	Peak

Note:

- "\*" , means this data is the worst emission level.
- C.F (Correction Factor) = Antenna Factor (dB/m)+ Cable Loss (dB) – Preamplifier(dB) + 20dB Attenuation.
- Measurement (dB $\mu$ V/m) = Reading(dB $\mu$ V) + C.F (Correction Factor).
- The emission levels of other frequencies are very lower than the limit and not show in test report.

EUT	HAN Access Point	Date of Test	2021-10-07
Factor	DRH18-E	Temp. / Humidity	23°C /49%
Polarity	Horizontal	Site / Test Engineer	AC2 / Jay
Test Mode	802.11ax80_TX_Band3_CH 106	Test Voltage	AC 120V/60Hz

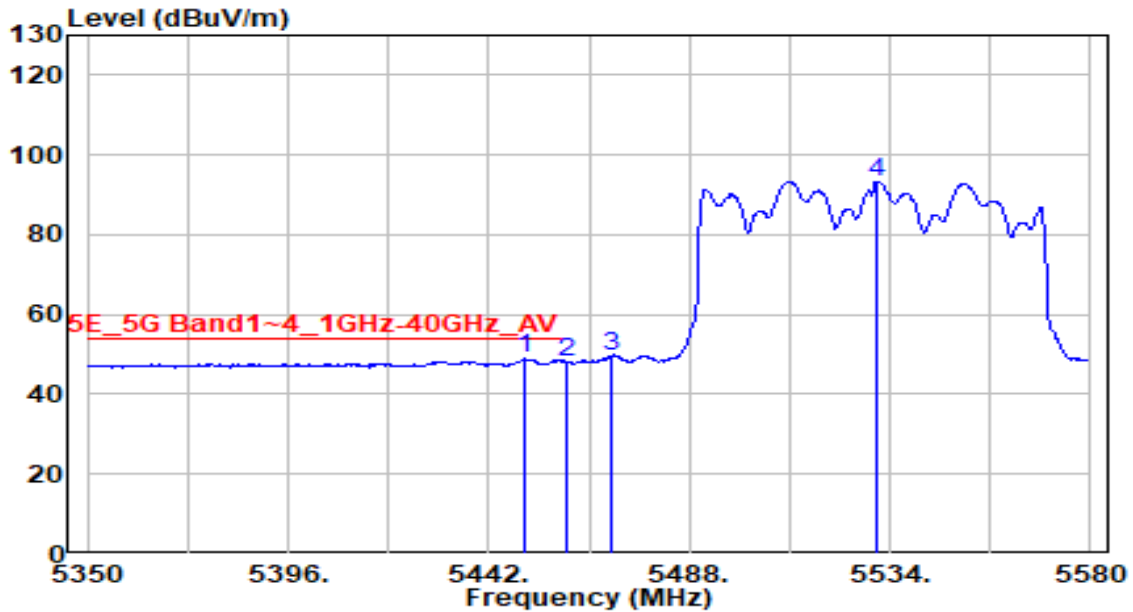

No	Frequency (MHz)	Reading (dB $\mu$ V)	C.F (dB/m)	Measurement (dB $\mu$ V/m)	Margin (dB)	Limit (dB $\mu$ V/m)	Height (cm)	Angle (deg)	Remark (QP/PK/AV)
1	* 5450.510	48.96	-0.14	48.82	-5.18	54.00	255	140	Average
2	5460.000	48.07	-0.11	47.96	-6.04	54.00	255	140	Average
3	5470.000	49.41	-0.07	49.34	N/A	N/A	255	140	Average
4	5531.240	93.24	0.15	93.39	N/A	N/A	255	140	Average

Note:

1. " \*", means this data is the worst emission level.
2. C.F (Correction Factor) = Antenna Factor (dB/m)+ Cable Loss (dB) – Preamplifier(dB) + 20dB Attenuation.
3. Measurement (dB $\mu$ V/m) = Reading(dB $\mu$ V) + C.F (Correction Factor).
4. The emission levels of other frequencies are very lower than the limit and not show in test report.

EUT	HAN Access Point	Date of Test	2021-10-07
Factor	DRH18-E	Temp. / Humidity	23°C /49%
Polarity	Vertical	Site / Test Engineer	AC2 / Jay
Test Mode	802.11ax80_TX_Band3_CH 106	Test Voltage	AC 120V/60Hz

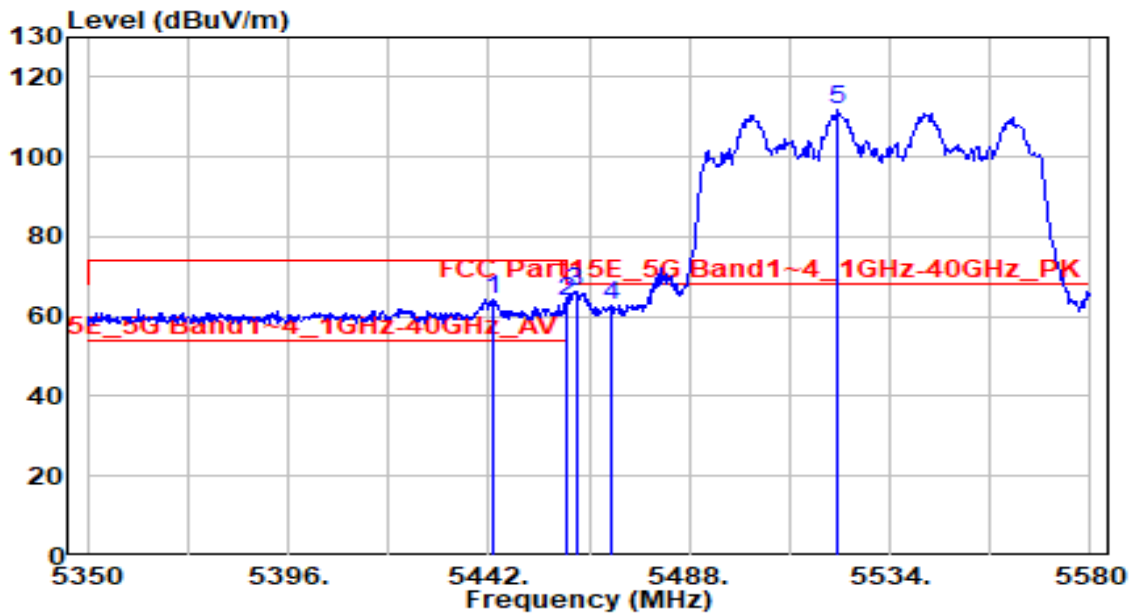

No	Frequency (MHz)	Reading (dB $\mu$ V)	C.F (dB/m)	Measurement (dB $\mu$ V/m)	Margin (dB)	Limit (dB $\mu$ V/m)	Height (cm)	Angle (deg)	Remark (QP/PK/AV)
1	5442.920	64.58	-0.17	64.42	-9.58	74.00	260	190	Peak
2	5460.000	63.75	-0.11	63.64	-4.56	68.20	260	190	Peak
3	* 5462.010	66.52	-0.10	66.42	-1.78	68.20	260	190	Peak
4	5470.000	62.76	-0.07	62.69	-5.51	68.20	260	190	Peak
5	5522.040	111.55	0.12	111.67	N/A	N/A	260	190	Peak

Note:

1. " \*", means this data is the worst emission level.
2. C.F (Correction Factor) = Antenna Factor (dB/m)+ Cable Loss (dB) – Preamplifier(dB) + 20dB Attenuation.
3. Measurement (dB $\mu$ V/m) = Reading(dB $\mu$ V) + C.F (Correction Factor).
4. The emission levels of other frequencies are very lower than the limit and not show in test report.



EUT	HAN Access Point	Date of Test	2021-10-07
Factor	DRH18-E	Temp. / Humidity	23°C /49%
Polarity	Vertical	Site / Test Engineer	AC2 / Jay
Test Mode	802.11ax80_TX_Band3_CH 106	Test Voltage	AC 120V/60Hz

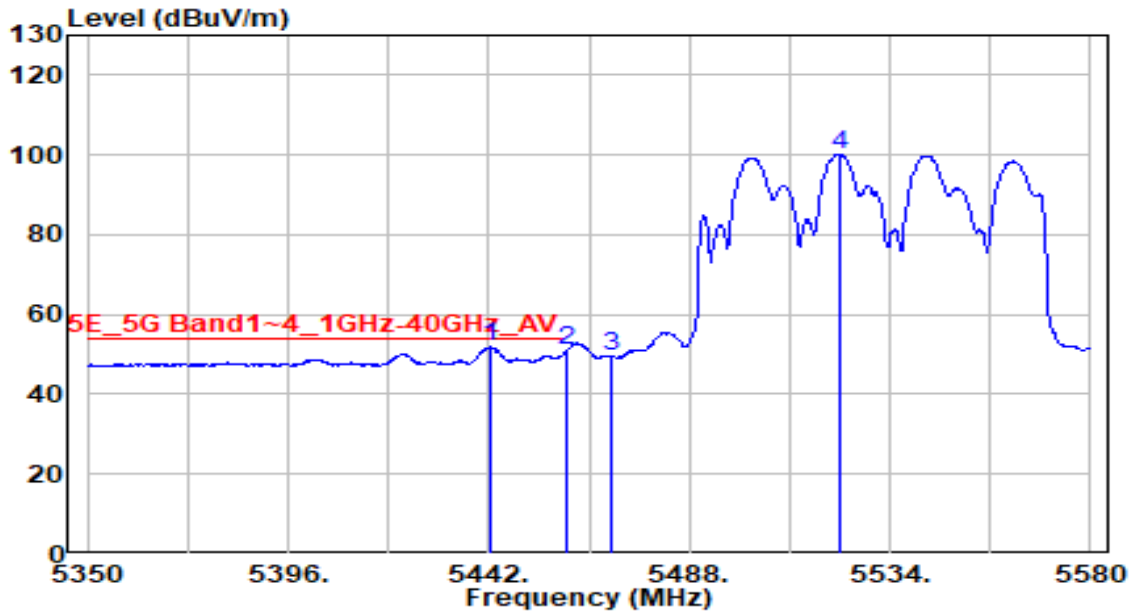

No	Frequency (MHz)	Reading (dBµV)	C.F (dB/m)	Measurement (dBµV/m)	Margin (dB)	Limit (dBµV/m)	Height (cm)	Angle (deg)	Remark (QP/PK/AV)
1	* 5442.690	51.93	-0.17	51.76	-2.24	54.00	260	190	Average
2	5460.000	51.12	-0.11	51.01	-2.99	54.00	260	190	Average
3	5470.000	49.86	-0.07	49.79	N/A	N/A	260	190	Average
4	5522.500	100.04	0.12	100.16	N/A	N/A	260	190	Average

Note:

1. " \*", means this data is the worst emission level.
2. C.F (Correction Factor) = Antenna Factor (dB/m)+ Cable Loss (dB) – Preamplifier(dB) + 20dB Attenuation.
3. Measurement (dBµV/m) = Reading(dBµV) + C.F (Correction Factor).
4. The emission levels of other frequencies are very lower than the limit and not show in test report.

EUT	HAN Access Point	Date of Test	2021-10-07
Factor	DRH18-E	Temp. / Humidity	23°C /49%
Polarity	Horizontal	Site / Test Engineer	AC2 / Jay
Test Mode	802.11ax80_TX_Band4_CH 155	Test Voltage	AC 120V/60Hz

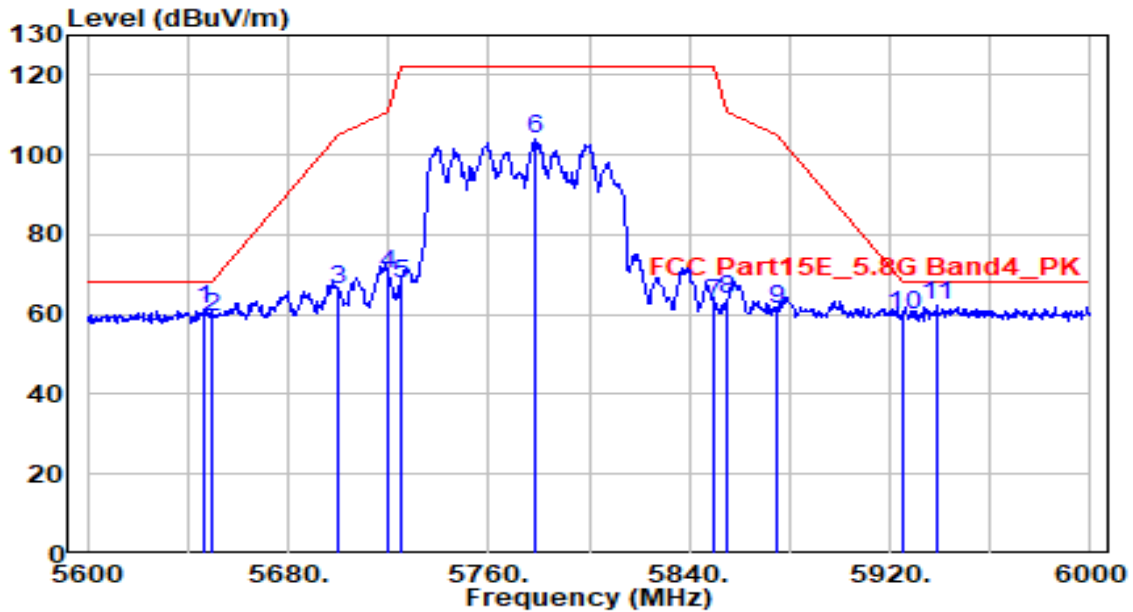

No	Frequency (MHz)	Reading (dBμV)	C.F (dB/m)	Measurement (dBUV/m)	Margin (dB)	Limit (dBUV/m)	Height (cm)	Angle (deg)	Remark (QP/PK/AV)
1	5646.400	60.57	0.59	61.16	-7.04	68.20	200	135	Peak
2	5650.000	58.68	0.60	59.28	-8.92	68.20	200	135	Peak
3	5700.000	65.31	0.81	66.12	-39.08	105.20	200	135	Peak
4	5720.000	69.24	0.89	70.13	-40.67	110.80	200	135	Peak
5	5725.000	67.01	0.91	67.92	-54.28	122.20	200	135	Peak
6	5778.400	103.03	1.13	104.17	N/A	N/A	200	135	Peak
7	5850.000	61.75	1.28	63.03	-59.17	122.20	200	135	Peak
8	5855.000	62.35	1.28	63.63	-47.17	110.80	200	135	Peak
9	5875.000	59.90	1.30	61.20	-44.00	105.20	200	135	Peak
10	5925.000	58.44	1.35	59.79	-8.41	68.20	200	135	Peak
11	* 5938.400	60.72	1.37	62.08	-6.12	68.20	200	135	Peak

Note:

1. " \*", means this data is the worst emission level.
2. C.F (Correction Factor) = Antenna Factor (dB/m)+ Cable Loss (dB) – Preamplifier(dB) + 20dB Attenuation.
3. Measurement (dBUV/m) = Reading(dBμV) + C.F (Correction Factor).

4. The emission levels of other frequencies are very lower than the limit and not show in test report.

EUT	HAN Access Point	Date of Test	2021-10-07
Factor	DRH18-E	Temp. / Humidity	23°C /49%
Polarity	Vertical	Site / Test Engineer	AC2 / Jay
Test Mode	802.11ax80_TX_Band4_CH 155	Test Voltage	AC 120V/60Hz

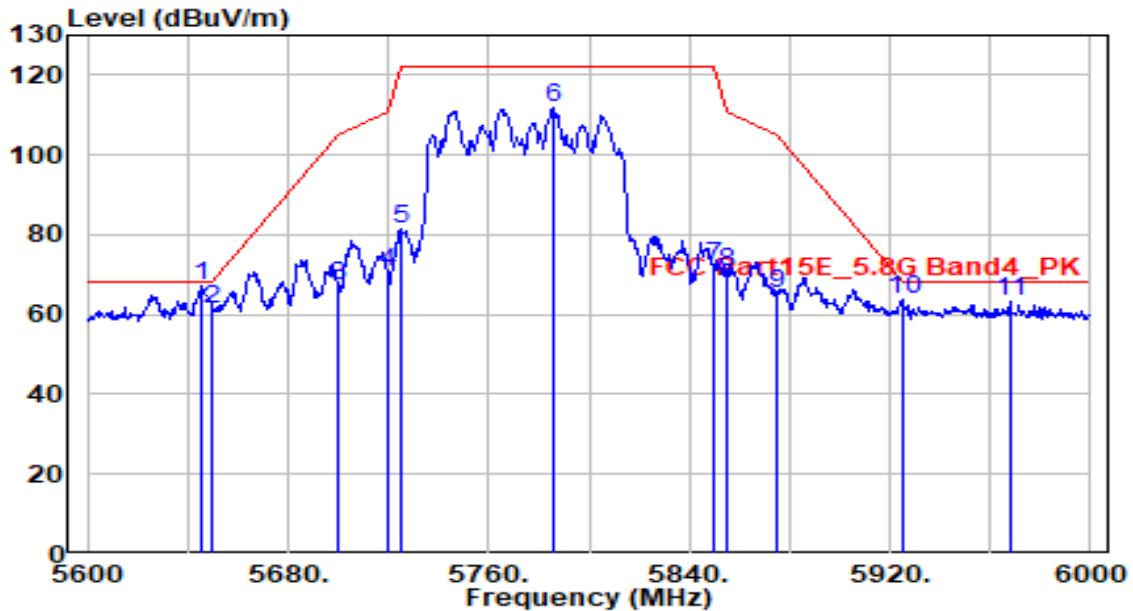

No	Frequency (MHz)	Reading (dBμV)	C.F (dB/m)	Measurement (dBμV/m)	Margin (dB)	Limit (dBμV/m)	Height (cm)	Angle (deg)	Remark (QP/PK/AV)
1	* 5645.600	66.59	0.59	67.18	-1.02	68.20	205	105	Peak
2	5650.000	60.52	0.60	61.12	-7.08	68.20	205	105	Peak
3	5700.000	66.50	0.81	67.31	-37.89	105.20	205	105	Peak
4	5720.000	69.51	0.89	70.41	-40.39	110.80	205	105	Peak
5	5725.000	80.46	0.91	81.38	-40.82	122.20	205	105	Peak
6	5785.600	110.65	1.16	111.81	N/A	N/A	205	105	Peak
7	5850.000	71.01	1.28	72.28	-49.92	122.20	205	105	Peak
8	5855.000	69.50	1.28	70.78	-40.02	110.80	205	105	Peak
9	5875.000	63.80	1.30	65.11	-40.09	105.20	205	105	Peak
10	5925.000	62.41	1.35	63.76	-4.44	68.20	205	105	Peak
11	5968.000	61.67	1.40	63.07	-5.13	68.20	205	105	Peak

Note:

1. " \*", means this data is the worst emission level.

2. C.F (Correction Factor) = Antenna Factor (dB/m)+ Cable Loss (dB) – Preamplifier(dB) + 20dB Attenuation.

3. Measurement (dBμV/m) = Reading(dBμV) + C.F (Correction Factor).

4. The emission levels of other frequencies are very lower than the limit and not show in test report.

EUT	HAN Access Point	Date of Test	2021-10-07
Factor	DRH18-E	Temp. / Humidity	23°C /49%
Polarity	Horizontal	Site / Test Engineer	AC2 / Jay
Test Mode	802.11ax80+80_TX_Band1,2_CH 50	Test Voltage	AC 120V/60Hz

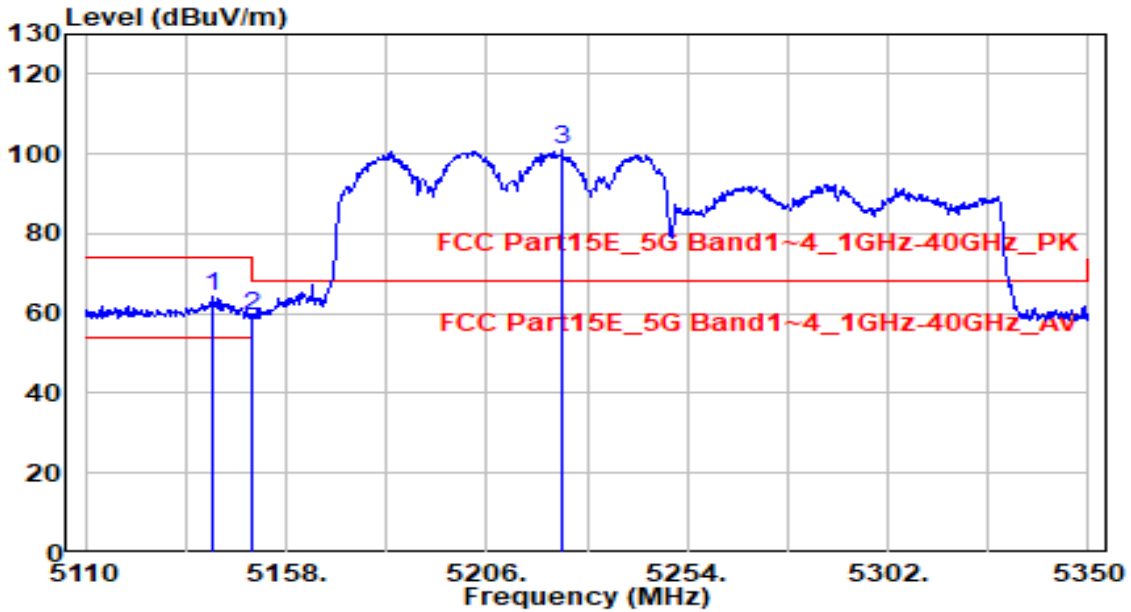

No	Frequency (MHz)	Reading (dBμV)	C.F (dB/m)	Measurement (dBμV/m)	Margin (dB)	Limit (dBμV/m)	Height (cm)	Angle (deg)	Remark (QP/PK/AV)
1	* 5140.720	64.60	-0.32	64.28	-9.72	74.00	150	40	Peak
2	5150.000	59.47	-0.32	59.15	-14.85	74.00	150	40	Peak
3	5224.000	101.22	-0.32	100.89	N/A	N/A	150	40	Peak

Note:

1. " \*", means this data is the worst emission level.

2. C.F (Correction Factor) = Antenna Factor (dB/m)+ Cable Loss (dB) – Preamplifier(dB) + 20dB Attenuation.

3. Measurement (dBμV/m) = Reading(dBμV) + C.F (Correction Factor).

4. The emission levels of other frequencies are very lower than the limit and not show in test report.

EUT	HAN Access Point	Date of Test	2021-10-07
Factor	DRH18-E	Temp. / Humidity	23°C /49%
Polarity	Horizontal	Site / Test Engineer	AC2 / Jay
Test Mode	802.11ax80+80_TX_Band1,2_CH 50	Test Voltage	AC 120V/60Hz

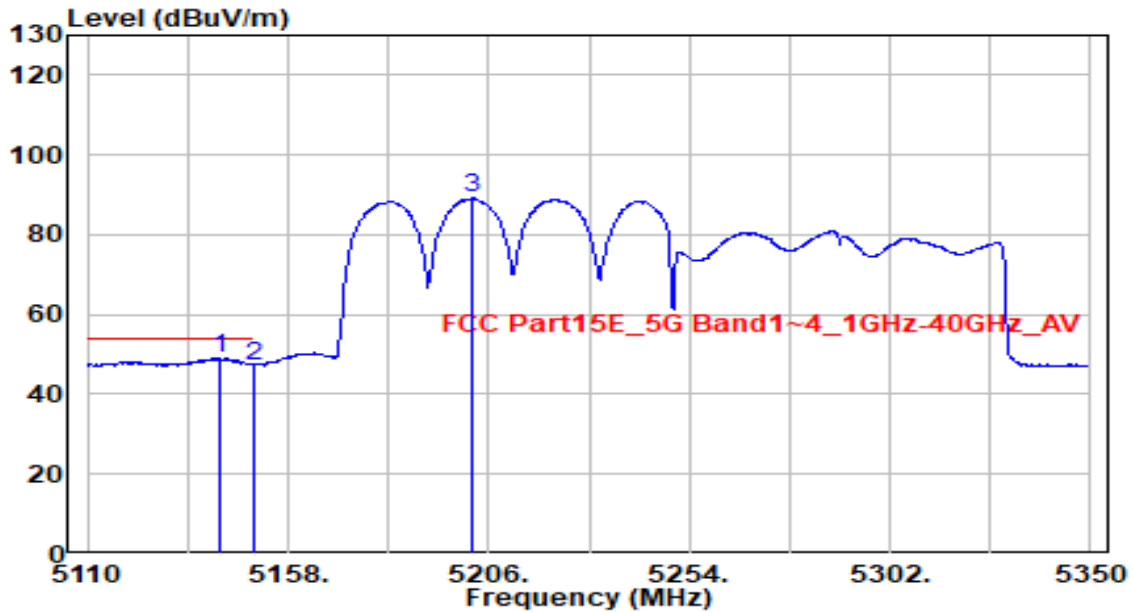

No	Frequency (MHz)	Reading (dB $\mu$ V)	C.F (dB/m)	Measurement (dB $\mu$ V/m)	Margin (dB)	Limit (dB $\mu$ V/m)	Height (cm)	Angle (deg)	Remark (QP/PK/AV)	
1	*	5141.440	49.42	-0.32	49.11	-4.89	54.00	150	40	Average
2		5150.000	47.61	-0.32	47.29	-6.71	54.00	150	40	Average
3		5202.160	89.47	-0.32	89.15	N/A	N/A	150	40	Average

Note:

- "\*" means this data is the worst emission level.
- C.F (Correction Factor) = Antenna Factor (dB/m)+ Cable Loss (dB) – Preamplifier(dB) + 20dB Attenuation.
- Measurement (dB $\mu$ V/m) = Reading(dB $\mu$ V) + C.F (Correction Factor).
- The emission levels of other frequencies are very lower than the limit and not show in test report.

EUT	HAN Access Point	Date of Test	2021-10-07
Factor	DRH18-E	Temp. / Humidity	23°C /49%
Polarity	Vertical	Site / Test Engineer	AC2 / Jay
Test Mode	802.11ax80+80_TX_Band1,2_CH 50	Test Voltage	AC 120V/60Hz

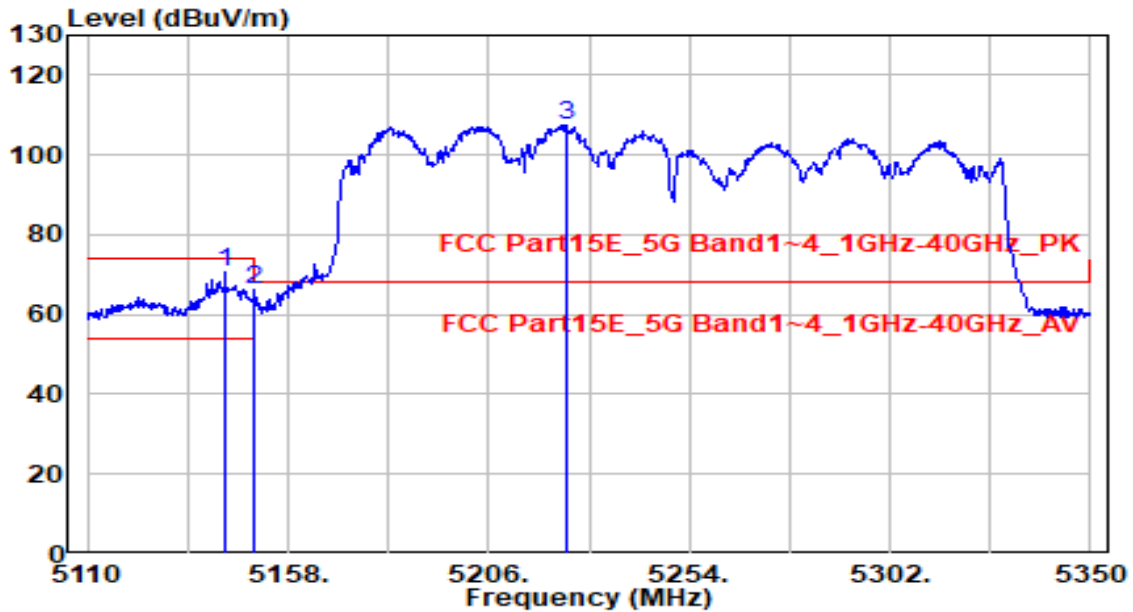

No	Frequency (MHz)	Reading (dB $\mu$ V)	C.F (dB/m)	Measurement (dB $\mu$ V/m)	Margin (dB)	Limit (dB $\mu$ V/m)	Height (cm)	Angle (deg)	Remark (QP/PK/AV)
1	5142.880	70.98	-0.32	70.67	-3.33	74.00	200	170	Peak
2	5150.000	66.47	-0.32	66.15	-7.85	74.00	200	170	Peak
3	* 5224.960	107.99	-0.32	107.66	N/A	N/A	200	170	Peak

Note:

- "\*" means this data is the worst emission level.
- C.F (Correction Factor) = Antenna Factor (dB/m)+ Cable Loss (dB) – Preamplifier(dB) + 20dB Attenuation.
- Measurement (dB $\mu$ V/m) = Reading(dB $\mu$ V) + C.F (Correction Factor).
- The emission levels of other frequencies are very lower than the limit and not show in test report.

EUT	HAN Access Point	Date of Test	2021-10-07
Factor	DRH18-E	Temp. / Humidity	23°C /49%
Polarity	Vertical	Site / Test Engineer	AC2 / Jay
Test Mode	802.11ax80+80_TX_Band1,2_CH 50	Test Voltage	AC 120V/60Hz

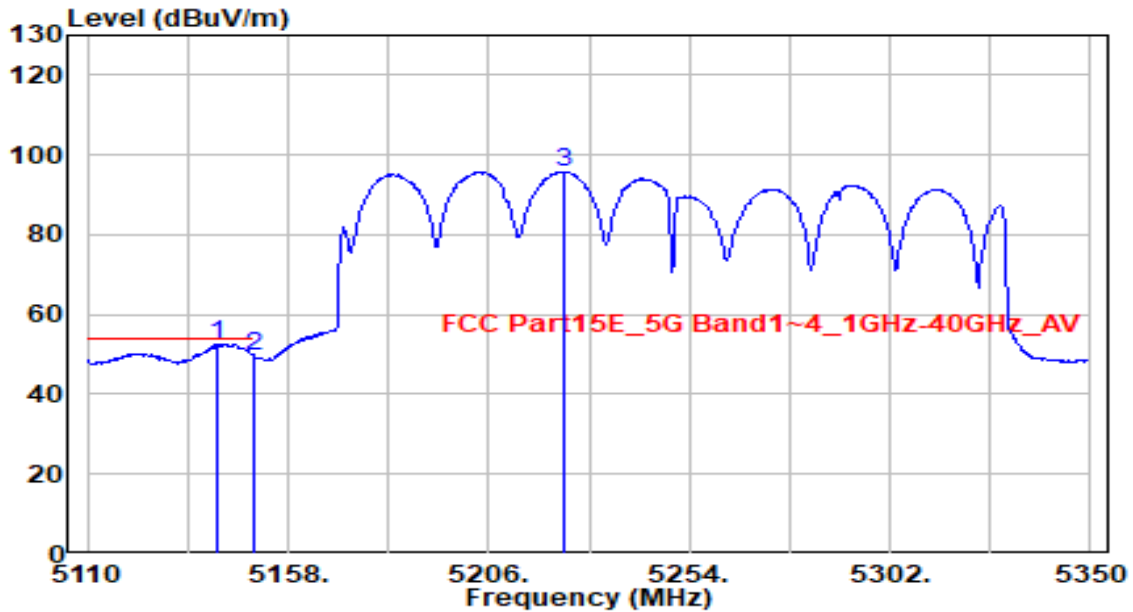

No	Frequency (MHz)	Reading (dB $\mu$ V)	C.F (dB/m)	Measurement (dB $\mu$ V/m)	Margin (dB)	Limit (dB $\mu$ V/m)	Height (cm)	Angle (deg)	Remark (QP/PK/AV)
1	*	52.87	-0.32	52.55	-1.45	54.00	200	170	Average
2		50.05	-0.32	49.74	-4.26	54.00	200	170	Average
3		96.21	-0.32	95.89	N/A	N/A	200	170	Average

Note:

- "\*", means this data is the worst emission level.
- C.F (Correction Factor) = Antenna Factor (dB/m)+ Cable Loss (dB) – Preamplifier(dB) + 20dB Attenuation.
- Measurement (dB $\mu$ V/m) = Reading(dB $\mu$ V) + C.F (Correction Factor).
- The emission levels of other frequencies are very lower than the limit and not show in test report.

EUT	HAN Access Point	Date of Test	2021-10-07
Factor	DRH18-E	Temp. / Humidity	23°C /49%
Polarity	Horizontal	Site / Test Engineer	AC2 / Jay
Test Mode	802.11ax80+80_TX_Band1,2_CH 50	Test Voltage	AC 120V/60Hz

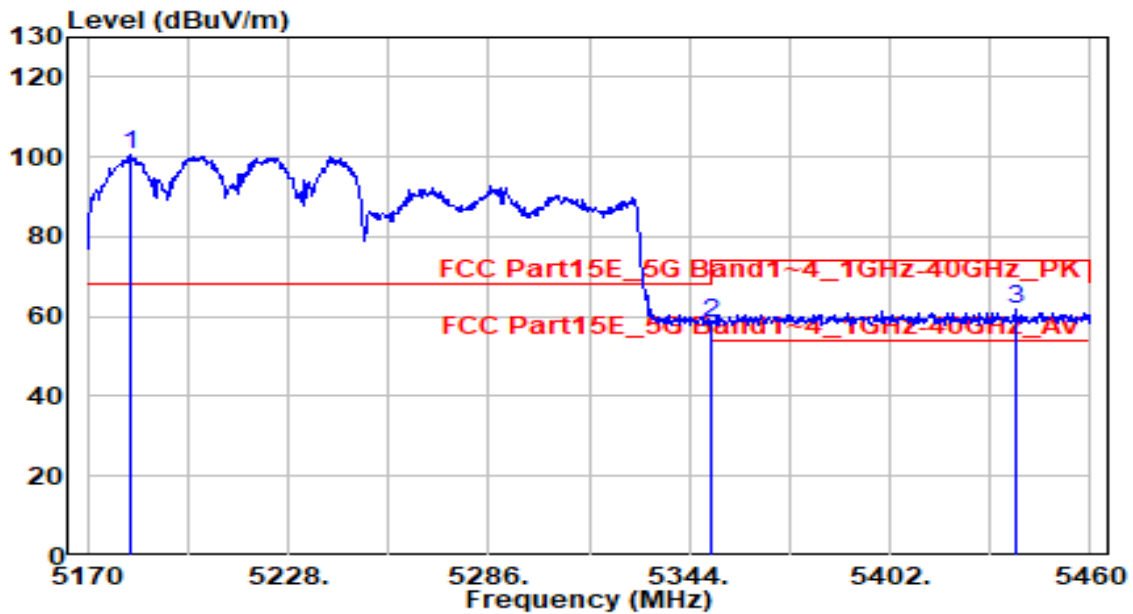

No	Frequency (MHz)	Reading (dB $\mu$ V)	C.F (dB/m)	Measurement (dB $\mu$ V/m)	Margin (dB)	Limit (dB $\mu$ V/m)	Height (cm)	Angle (deg)	Remark (QP/PK/AV)
1	* 5182.470	100.72	-0.32	100.40	N/A	N/A	150	40	Peak
2	5350.000	58.81	-0.33	58.49	-9.71	68.20	150	40	Peak
3	5438.250	61.91	-0.19	61.73	-12.27	74.00	150	40	Peak

Note:

- "\*" means this data is the worst emission level.
- C.F (Correction Factor) = Antenna Factor (dB/m)+ Cable Loss (dB) – Preamplifier(dB) + 20dB Attenuation.
- Measurement (dB $\mu$ V/m) = Reading(dB $\mu$ V) + C.F (Correction Factor).
- The emission levels of other frequencies are very lower than the limit and not show in test report.



EUT	HAN Access Point	Date of Test	2021-10-07
Factor	DRH18-E	Temp. / Humidity	23°C /49%
Polarity	Horizontal	Site / Test Engineer	AC2 / Jay
Test Mode	802.11ax80+80_TX_Band1,2_CH 50	Test Voltage	AC 120V/60Hz

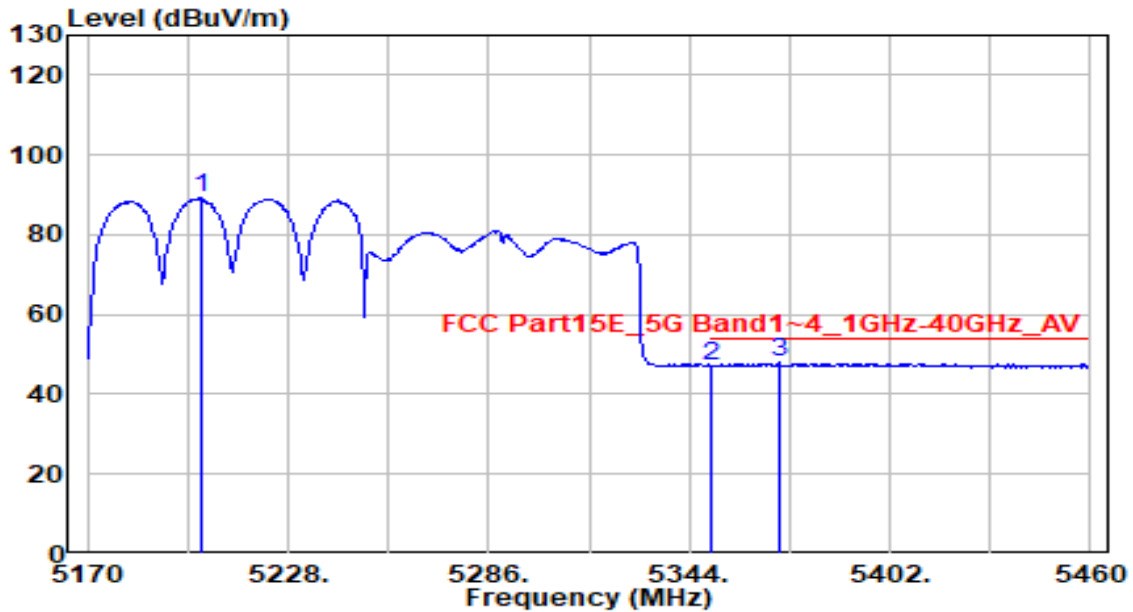

No	Frequency (MHz)	Reading (dB $\mu$ V)	C.F (dB/m)	Measurement (dB $\mu$ V/m)	Margin (dB)	Limit (dB $\mu$ V/m)	Height (cm)	Angle (deg)	Remark (QP/PK/AV)
1	5202.770	89.41	-0.32	89.08	N/A	N/A	150	40	Average
2	5350.000	47.51	-0.33	47.19	-6.81	54.00	150	40	Average
3	* 5369.810	48.29	-0.32	47.96	-6.04	54.00	150	40	Average

Note:

- "\*" means this data is the worst emission level.
- C.F (Correction Factor) = Antenna Factor (dB/m)+ Cable Loss (dB) – Preamplifier(dB) + 20dB Attenuation.
- Measurement (dB $\mu$ V/m) = Reading(dB $\mu$ V) + C.F (Correction Factor).
- The emission levels of other frequencies are very lower than the limit and not show in test report.

EUT	HAN Access Point	Date of Test	2021-10-07
Factor	DRH18-E	Temp. / Humidity	23°C /49%
Polarity	Vertical	Site / Test Engineer	AC2 / Jay
Test Mode	802.11ax80+80_TX_Band1,2_CH 50	Test Voltage	AC 120V/60Hz

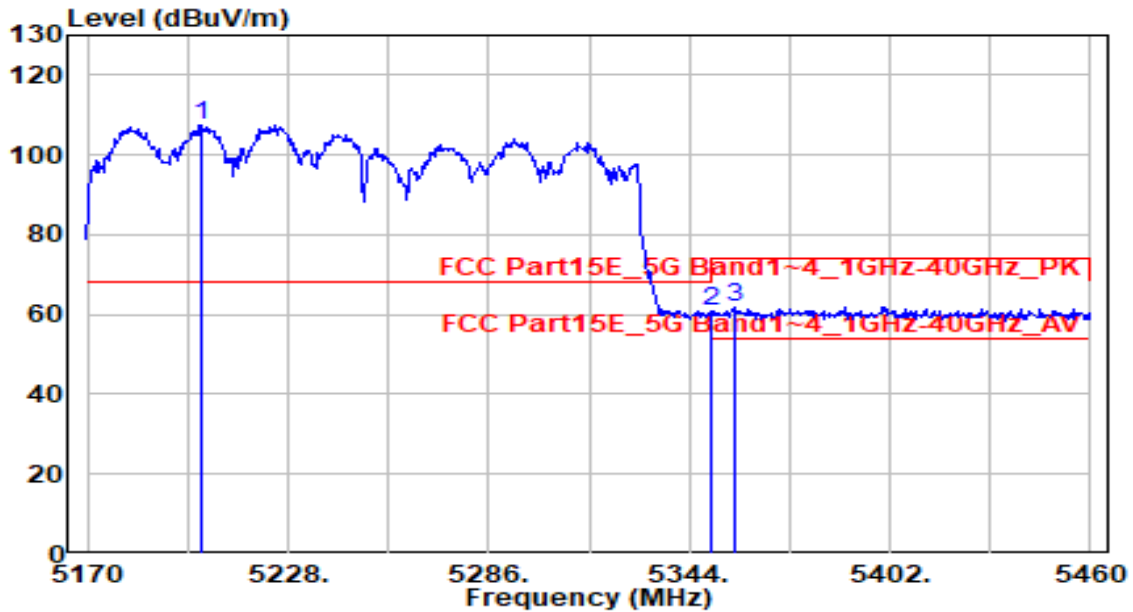

No	Frequency (MHz)	Reading (dBμV)	C.F (dB/m)	Measurement (dBμV/m)	Margin (dB)	Limit (dBμV/m)	Height (cm)	Angle (deg)	Remark (QP/PK/AV)
1	* 5203.100	107.96	-0.32	107.64	N/A	N/A	200	170	Peak
2	5350.000	61.01	-0.33	60.68	-7.52	68.20	200	170	Peak
3	5357.100	62.21	-0.33	61.88	-12.12	74.00	200	170	Peak

Note:

- "\*" means this data is the worst emission level.
- C.F (Correction Factor) = Antenna Factor (dB/m)+ Cable Loss (dB) – Preamplifier(dB) + 20dB Attenuation.
- Measurement (dBμV/m) = Reading(dBμV) + C.F (Correction Factor).
- The emission levels of other frequencies are very lower than the limit and not show in test report.

EUT	HAN Access Point	Date of Test	2021-10-07
Factor	DRH18-E	Temp. / Humidity	23°C /49%
Polarity	Vertical	Site / Test Engineer	AC2 / Jay
Test Mode	802.11ax80+80_TX_Band1,2_CH 50	Test Voltage	AC 120V/60Hz

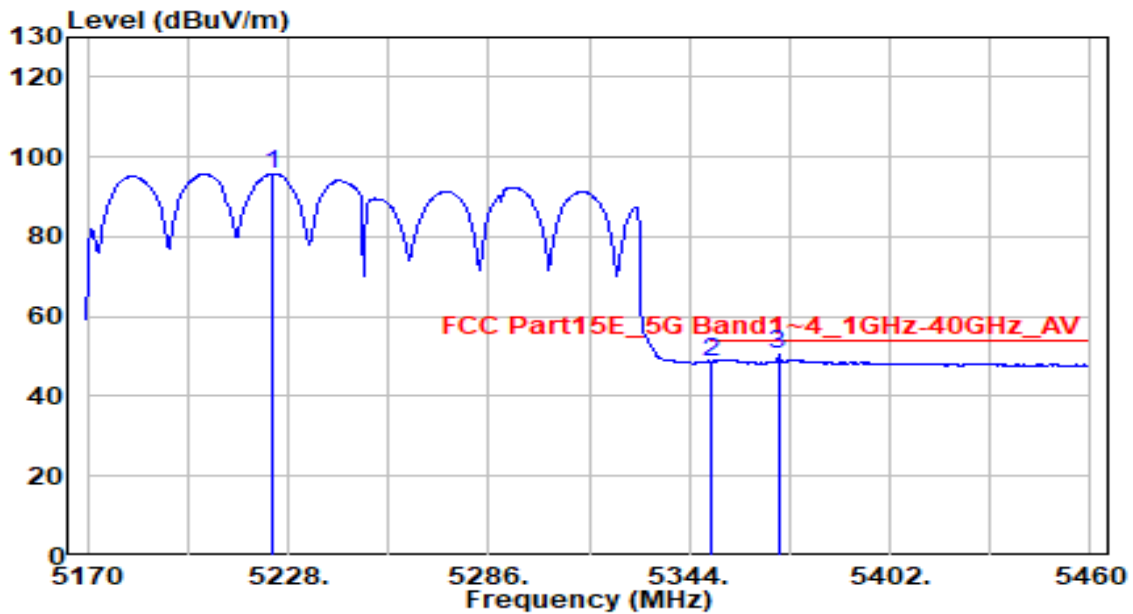

No	Frequency (MHz)	Reading (dBμV)	C.F (dB/m)	Measurement (dBμV/m)	Margin (dB)	Limit (dBμV/m)	Height (cm)	Angle (deg)	Remark (QP/PK/AV)
1	5223.750	96.22	-0.32	95.89	N/A	N/A	200	170	Average
2	5350.000	49.07	-0.33	48.75	-5.25	54.00	200	170	Average
3	* 5369.700	50.65	-0.32	50.33	-3.67	54.00	200	170	Average

Note:

- "\*" means this data is the worst emission level.
- C.F (Correction Factor) = Antenna Factor (dB/m)+ Cable Loss (dB) – Preamplifier(dB) + 20dB Attenuation.
- Measurement (dBμV/m) = Reading(dBμV) + C.F (Correction Factor).
- The emission levels of other frequencies are very lower than the limit and not show in test report.

EUT	HAN Access Point	Date of Test	2021-10-07
Factor	DRH18-E	Temp. / Humidity	23°C /49%
Polarity	Horizontal	Site / Test Engineer	AC2 / Jay
Test Mode	802.11ax80+80_TX_Band3_CH 114	Test Voltage	AC 120V/60Hz

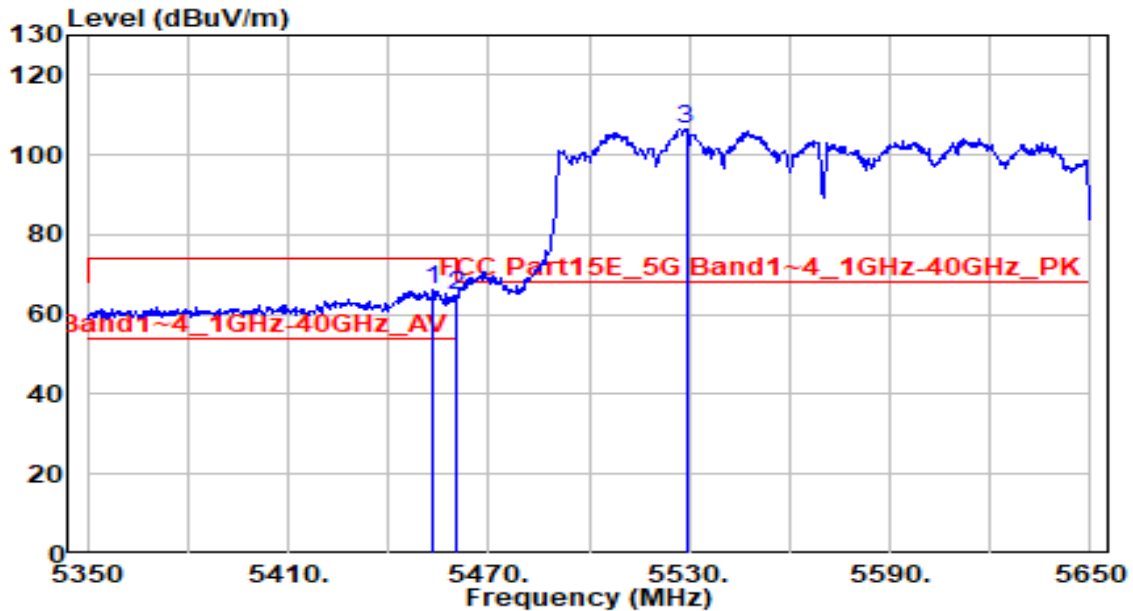

No	Frequency (MHz)	Reading (dBμV)	C.F (dB/m)	Measurement (dBμV/m)	Margin (dB)	Limit (dBμV/m)	Height (cm)	Angle (deg)	Remark (QP/PK/AV)
1	5453.200	66.38	-0.13	66.25	-7.75	74.00	170	75	Peak
2	* 5460.000	64.64	-0.11	64.53	-3.67	68.20	170	75	Peak
3	5529.100	106.53	0.14	106.67	N/A	N/A	175	75	Peak

Note:

1. " \*" , means this data is the worst emission level.
2. C.F (Correction Factor) = Antenna Factor (dB/m)+ Cable Loss (dB) – Preamplifier(dB) + 20dB Attenuation.
3. Measurement (dBμV/m) = Reading(dBμV) + C.F (Correction Factor).
4. The emission levels of other frequencies are very lower than the limit and not show in test report.

EUT	HAN Access Point	Date of Test	2021-10-07
Factor	DRH18-E	Temp. / Humidity	23°C /49%
Polarity	Horizontal	Site / Test Engineer	AC2 / Jay
Test Mode	802.11ax80+80_TX_Band3_CH 114	Test Voltage	AC 120V/60Hz

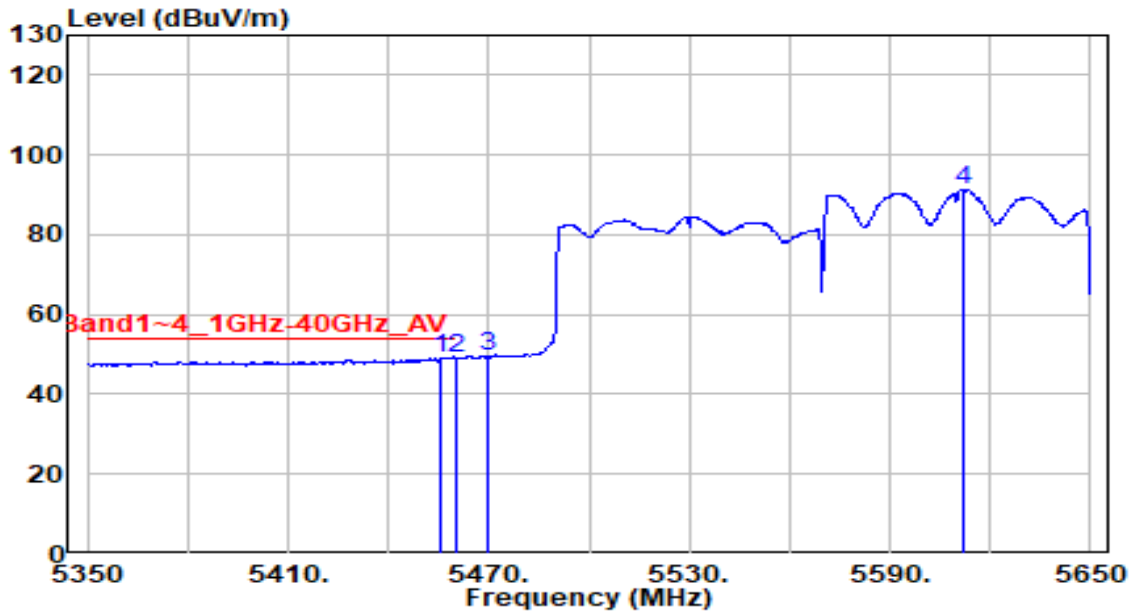

No	Frequency (MHz)	Reading (dBμV)	C.F (dB/m)	Measurement (dBμV/m)	Margin (dB)	Limit (dBμV/m)	Height (cm)	Angle (deg)	Remark (QP/PK/AV)
1	5455.300	49.10	-0.12	48.98	-5.02	54.00	175	75	Average
2	* 5460.000	49.25	-0.11	49.14	-4.86	54.00	175	75	Average
3	5470.000	49.58	-0.07	49.50	N/A	N/A	175	75	Average
4	5612.200	90.88	0.45	91.33	N/A	N/A	175	75	Average

Note:

1. " \*", means this data is the worst emission level.
2. C.F (Correction Factor) = Antenna Factor (dB/m)+ Cable Loss (dB) – Preamplifier(dB) + 20dB Attenuation.
3. Measurement (dBμV/m) = Reading(dBμV) + C.F (Correction Factor).
4. The emission levels of other frequencies are very lower than the limit and not show in test report.

EUT	HAN Access Point	Date of Test	2021-10-07
Factor	DRH18-E	Temp. / Humidity	23°C /49%
Polarity	Vertical	Site / Test Engineer	AC2 / Jay
Test Mode	802.11ax80+80_TX_Band3_CH 114	Test Voltage	AC 120V/60Hz

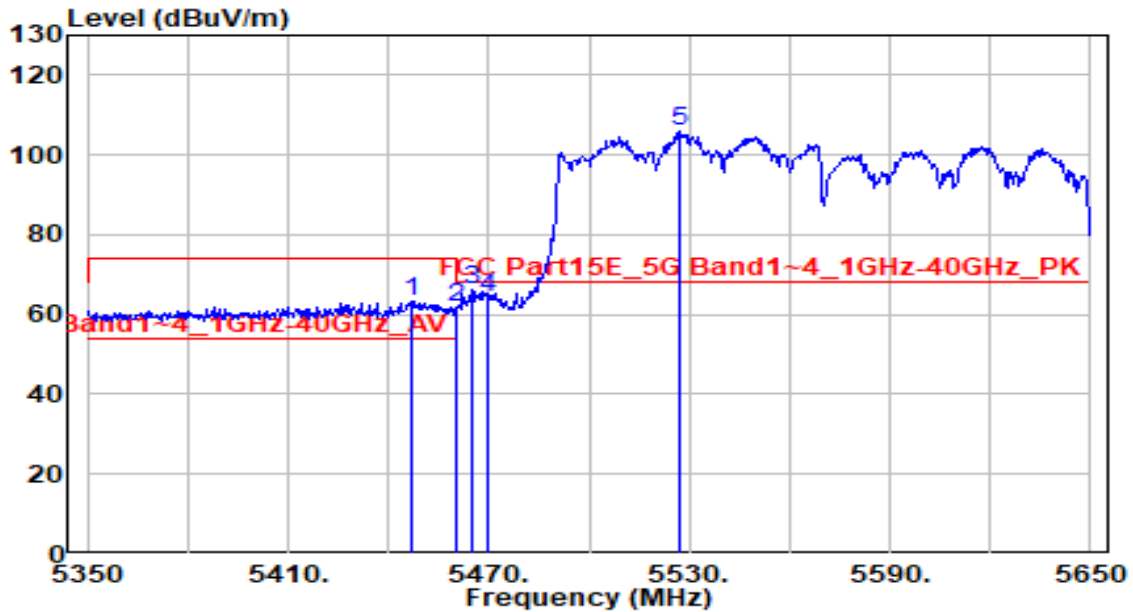

No	Frequency (MHz)	Reading (dBμV)	C.F (dB/m)	Measurement (dBμV/m)	Margin (dB)	Limit (dBμV/m)	Height (cm)	Angle (deg)	Remark (QP/PK/AV)
1	5446.900	63.24	-0.15	63.09	-10.91	74.00	150	95	Peak
2	5460.000	61.74	-0.11	61.63	-6.57	68.20	150	95	Peak
3	* 5464.900	66.09	-0.09	66.00	-2.20	68.20	150	95	Peak
4	5470.000	64.20	-0.07	64.13	-4.07	68.20	150	95	Peak
5	5527.000	105.90	0.13	106.03	N/A	N/A	150	95	Peak

Note:

1. " \*", means this data is the worst emission level.
2. C.F (Correction Factor) = Antenna Factor (dB/m)+ Cable Loss (dB) – Preamplifier(dB) + 20dB Attenuation.
3. Measurement (dBμV/m) = Reading(dBμV) + C.F (Correction Factor).
4. The emission levels of other frequencies are very lower than the limit and not show in test report.

EUT	HAN Access Point	Date of Test	2021-10-07
Factor	DRH18-E	Temp. / Humidity	23°C /49%
Polarity	Vertical	Site / Test Engineer	AC2 / Jay
Test Mode	802.11ax80+80_TX_Band3_CH 114	Test Voltage	AC 120V/60Hz

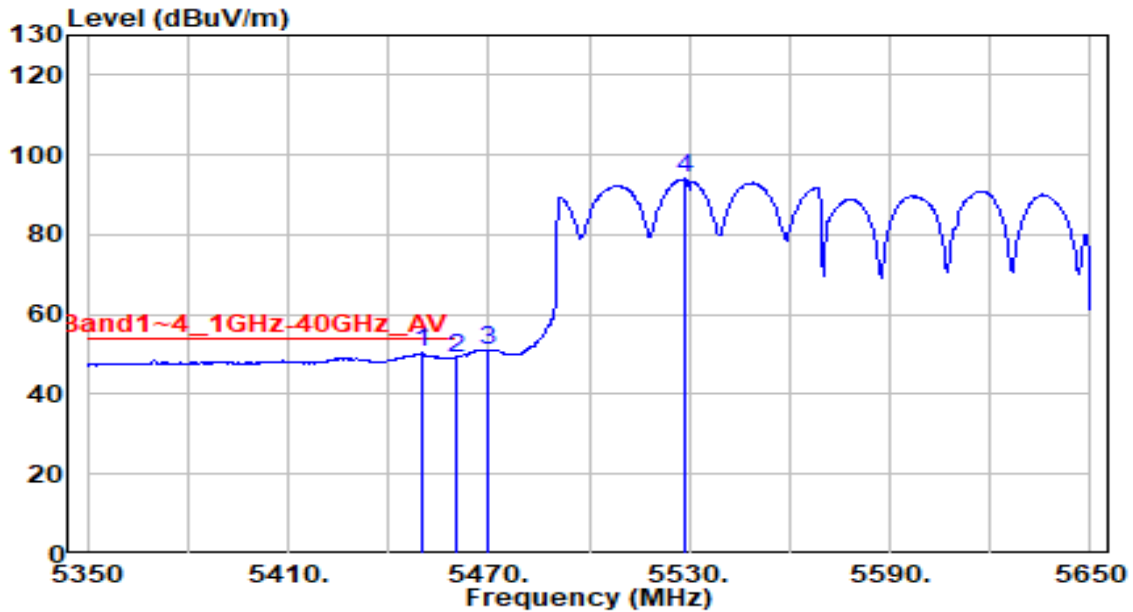

No	Frequency (MHz)	Reading (dB $\mu$ V)	C.F (dB/m)	Measurement (dB $\mu$ V/m)	Margin (dB)	Limit (dB $\mu$ V/m)	Height (cm)	Angle (deg)	Remark (QP/PK/AV)
1	* 5449.900	50.44	-0.14	50.29	-3.71	54.00	150	95	Average
2	5460.000	49.24	-0.11	49.13	-4.87	54.00	150	95	Average
3	5470.000	51.23	-0.07	51.16	N/A	N/A	150	95	Average
4	5528.800	93.81	0.14	93.95	N/A	N/A	150	95	Average

Note:

1. " \*", means this data is the worst emission level.
2. C.F (Correction Factor) = Antenna Factor (dB/m)+ Cable Loss (dB) – Preamplifier(dB) + 20dB Attenuation.
3. Measurement (dB $\mu$ V/m) = Reading(dB $\mu$ V) + C.F (Correction Factor).
4. The emission levels of other frequencies are very lower than the limit and not show in test report.

**Scan Mode:**

EUT	HAN Access Point	Date of Test	2021-10-07
Factor	DRH18-E	Temp. / Humidity	23°C /49%
Polarity	Horizontal	Site / Test Engineer	AC2 / Jay
Test Mode	802.11a_TX_Band1_CH 36	Test Voltage	AC 120V/60Hz

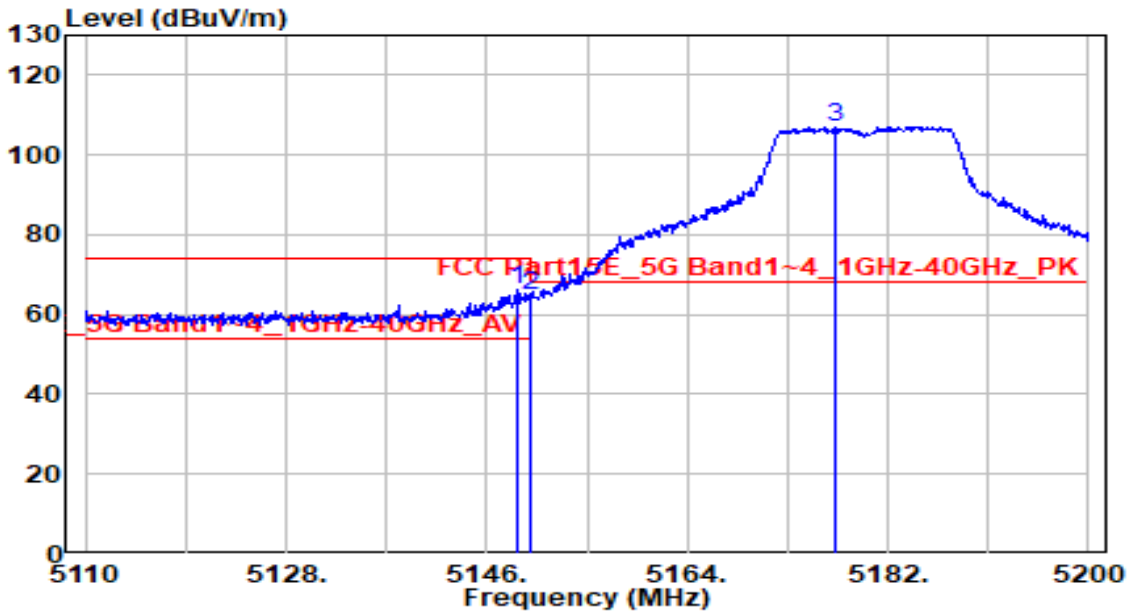

No	Frequency (MHz)	Reading (dBμV)	C.F (dB/m)	Measurement (dBμV/m)	Margin (dB)	Limit (dBμV/m)	Height (cm)	Angle (deg)	Remark (QP/PK/AV)	
1	*	5148.700	66.69	-0.32	66.38	-7.62	74.00	160	190	Peak
2		5150.000	65.13	-0.32	64.81	-9.19	74.00	160	190	Peak
3		5177.320	107.44	-0.32	107.12	N/A	N/A	160	190	Peak

**Note:**

1. " \*", means this data is the worst emission level.
2. C.F (Correction Factor) = Antenna Factor (dB/m)+ Cable Loss (dB) – Preamplifier(dB) + 20dB Attenuation.
3. Measurement (dBμV/m) = Reading(dBμV) + C.F (Correction Factor).
4. The emission levels of other frequencies are very lower than the limit and not show in test report.



EUT	HAN Access Point	Date of Test	2021-10-07
Factor	DRH18-E	Temp. / Humidity	23°C /49%
Polarity	Horizontal	Site / Test Engineer	AC2 / Jay
Test Mode	802.11a_TX_Band1_CH 36	Test Voltage	AC 120V/60Hz

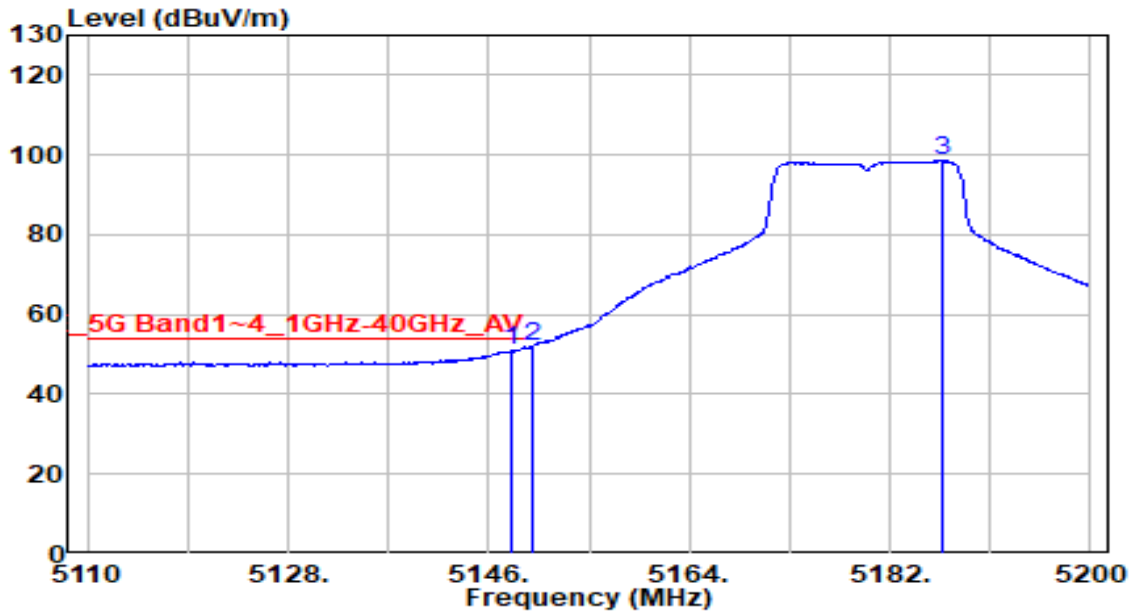

No	Frequency (MHz)	Reading (dB $\mu$ V)	C.F (dB/m)	Measurement (dB $\mu$ V/m)	Margin (dB)	Limit (dB $\mu$ V/m)	Height (cm)	Angle (deg)	Remark (QP/PK/AV)
1	5147.980	51.24	-0.32	50.92	-3.08	54.00	160	190	Average
2	* 5150.000	52.46	-0.32	52.14	-1.86	54.00	160	190	Average
3	5186.770	98.86	-0.32	98.54	N/A	N/A	160	190	Average

Note:

- "\*", means this data is the worst emission level.
- C.F (Correction Factor) = Antenna Factor (dB/m)+ Cable Loss (dB) – Preamplifier(dB) + 20dB Attenuation.
- Measurement (dB $\mu$ V/m) = Reading(dB $\mu$ V) + C.F (Correction Factor).
- The emission levels of other frequencies are very lower than the limit and not show in test report.

EUT	HAN Access Point	Date of Test	2021-10-07
Factor	DRH18-E	Temp. / Humidity	23°C /49%
Polarity	Vertical	Site / Test Engineer	AC2 / Jay
Test Mode	802.11a_TX_Band1_CH 36	Test Voltage	AC 120V/60Hz

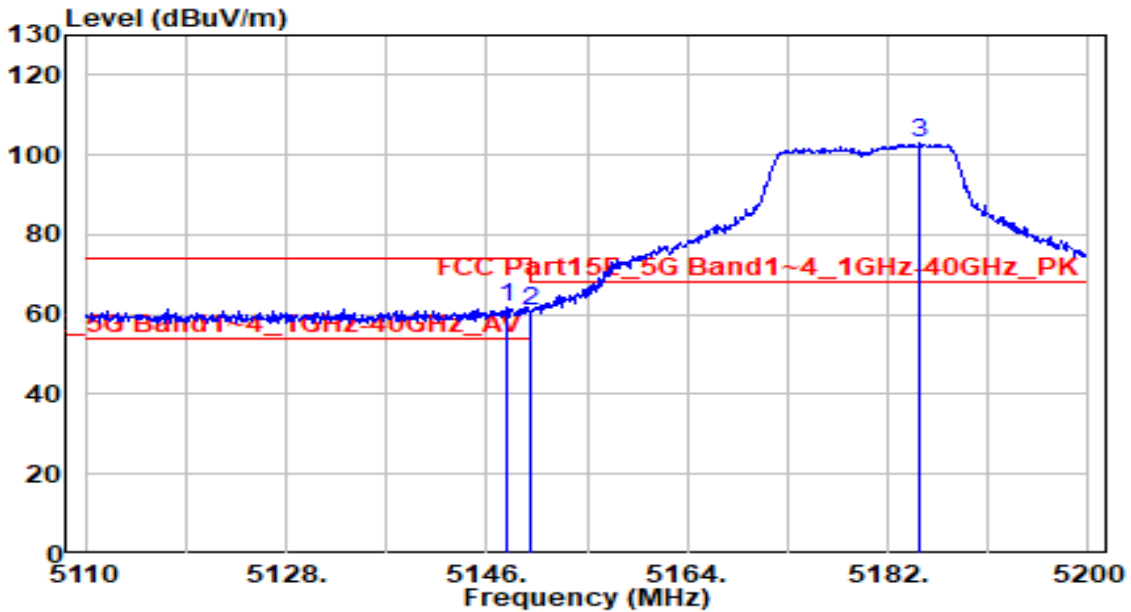

No	Frequency (MHz)	Reading (dBμV)	C.F (dB/m)	Measurement (dBμV/m)	Margin (dB)	Limit (dBμV/m)	Height (cm)	Angle (deg)	Remark (QP/PK/AV)
1	* 5147.710	61.97	-0.32	61.65	-12.35	74.00	150	205	Peak
2	5149.960	61.26	-0.32	60.94	-13.06	74.00	150	205	Peak
3	5184.880	103.21	-0.32	102.88	N/A	N/A	150	205	Peak

Note:

1. " \*", means this data is the worst emission level.
2. C.F (Correction Factor) = Antenna Factor (dB/m)+ Cable Loss (dB) – Preamplifier(dB) + 20dB Attenuation.
3. Measurement (dBμV/m) = Reading(dBμV) + C.F (Correction Factor).
4. The emission levels of other frequencies are very lower than the limit and not show in test report.

EUT	HAN Access Point	Date of Test	2021-10-07
Factor	DRH18-E	Temp. / Humidity	23°C /49%
Polarity	Vertical	Site / Test Engineer	AC2 / Jay
Test Mode	802.11a_TX_Band1_CH 36	Test Voltage	AC 120V/60Hz

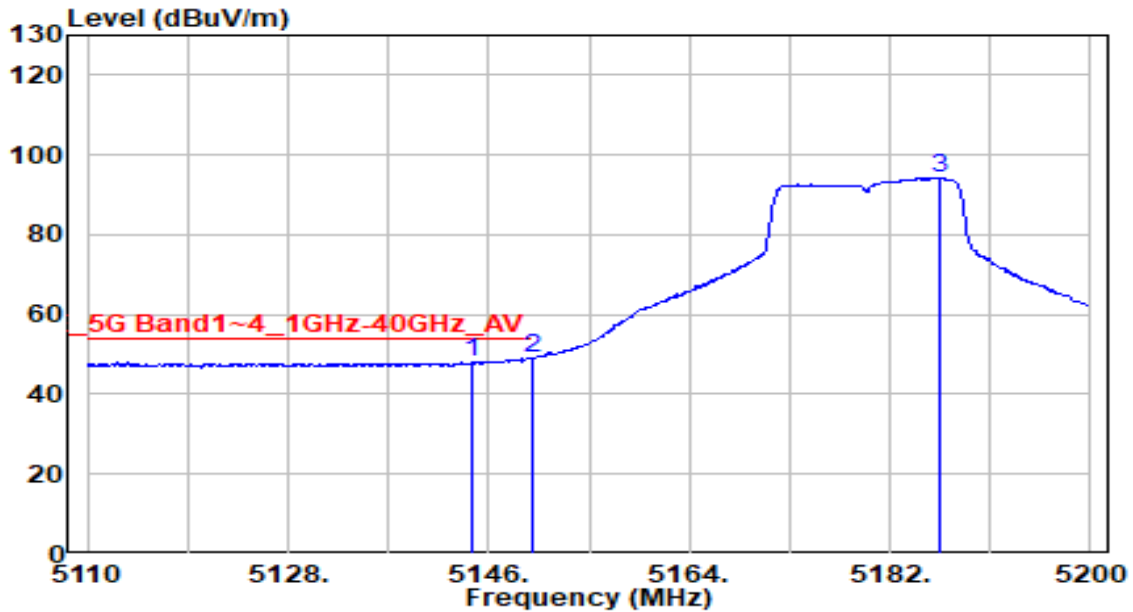

No	Frequency (MHz)	Reading (dBμV)	C.F (dB/m)	Measurement (dBμV/m)	Margin (dB)	Limit (dBμV/m)	Height (cm)	Angle (deg)	Remark (QP/PK/AV)
1	5144.470	48.45	-0.32	48.13	-5.87	54.00	150	205	Average
2	* 5150.000	49.46	-0.32	49.14	-4.86	54.00	150	205	Average
3	5186.410	94.48	-0.32	94.16	N/A	N/A	150	205	Average

Note:

1. " \*", means this data is the worst emission level.
2. C.F (Correction Factor) = Antenna Factor (dB/m)+ Cable Loss (dB) – Preamplifier(dB) + 20dB Attenuation.
3. Measurement (dBμV/m) = Reading(dBμV) + C.F (Correction Factor).
4. The emission levels of other frequencies are very lower than the limit and not show in test report.

EUT	HAN Access Point	Date of Test	2021-10-07
Factor	DRH18-E	Temp. / Humidity	23°C /49%
Polarity	Horizontal	Site / Test Engineer	AC2 / Jay
Test Mode	802.11a_TX_Band4_CH 149	Test Voltage	AC 120V/60Hz

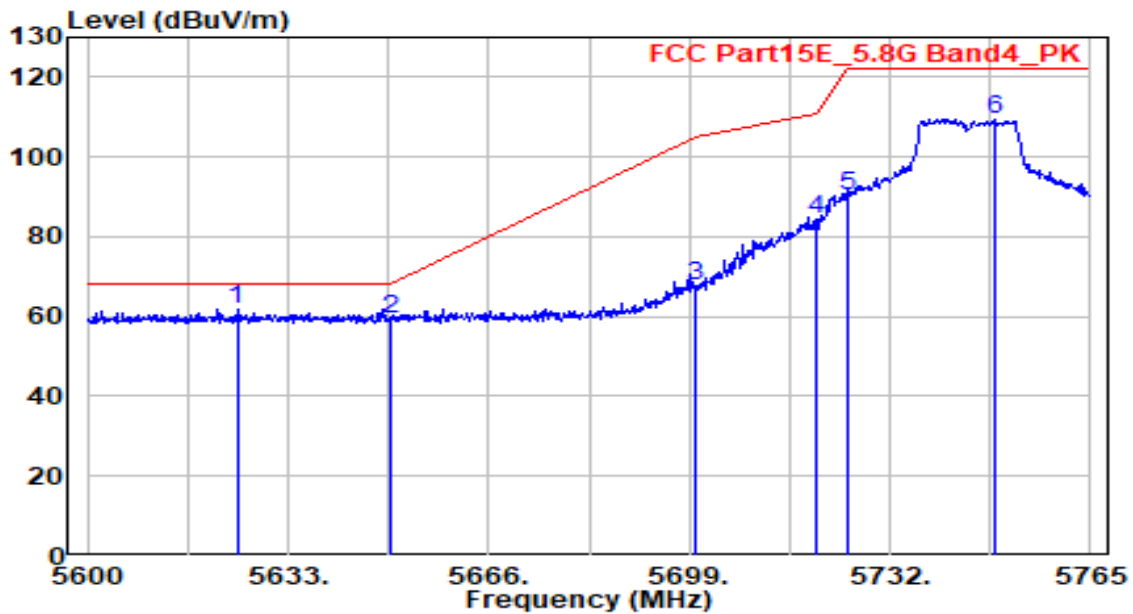

No	Frequency (MHz)	Reading (dBμV)	C.F (dB/m)	Measurement (dBμV/m)	Margin (dB)	Limit (dBμV/m)	Height (cm)	Angle (deg)	Remark (QP/PK/AV)
1	* 5624.585	61.20	0.50	61.70	-6.50	68.20	150	115	Peak
2	5650.000	58.57	0.60	59.17	-9.03	68.20	150	115	Peak
3	5700.000	67.09	0.81	67.90	-37.30	105.20	150	115	Peak
4	5720.000	83.25	0.89	84.14	-26.66	110.80	150	115	Peak
5	5725.000	89.20	0.91	90.12	-32.08	122.20	150	115	Peak
6	5749.490	108.35	1.01	109.37	N/A	N/A	150	115	Peak

Note:

1. " \*", means this data is the worst emission level.
2. C.F (Correction Factor) = Antenna Factor (dB/m)+ Cable Loss (dB) – Preamplifier(dB).
3. Measurement (dBμV/m) = Reading(dBμV) + C.F (Correction Factor).
4. The emission levels of other frequencies are very lower than the limit and not show in test report.

EUT	HAN Access Point	Date of Test	2021-10-07
Factor	DRH18-E	Temp. / Humidity	23°C /49%
Polarity	Vertical	Site / Test Engineer	AC2 / Jay
Test Mode	802.11a_TX_Band4_CH 149	Test Voltage	AC 120V/60Hz

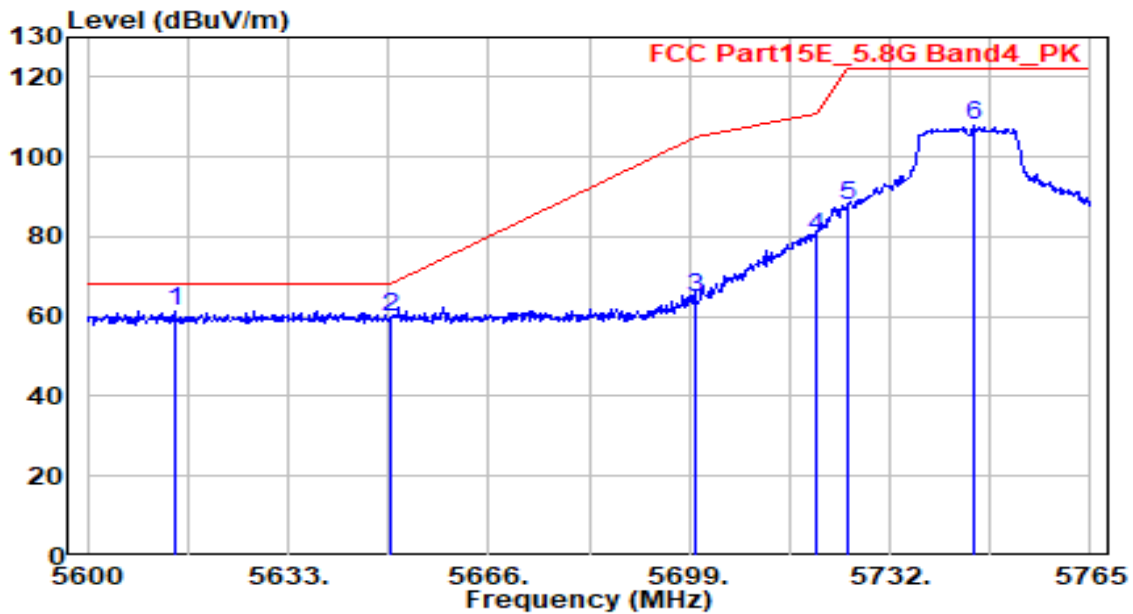

No	Frequency (MHz)	Reading (dBμV)	C.F (dB/m)	Measurement (dBμV/m)	Margin (dB)	Limit (dBμV/m)	Height (cm)	Angle (deg)	Remark (QP/PK/AV)
1	* 5614.355	61.01	0.46	61.47	-6.73	68.20	260	190	Peak
2	5650.000	59.34	0.60	59.94	-8.26	68.20	260	190	Peak
3	5700.000	64.11	0.81	64.92	-40.28	105.20	260	190	Peak
4	5720.000	78.99	0.89	79.88	-30.92	110.80	260	190	Peak
5	5725.000	87.12	0.91	88.04	-34.16	122.20	260	190	Peak
6	5745.695	106.71	1.00	107.71	N/A	N/A	260	190	Peak

Note:

1. " \*", means this data is the worst emission level.
2. C.F (Correction Factor) = Antenna Factor (dB/m)+ Cable Loss (dB) – Preamplifier(dB).
3. Measurement (dBμV/m) = Reading(dBμV) + C.F (Correction Factor).
4. The emission levels of other frequencies are very lower than the limit and not show in test report.

EUT	HAN Access Point	Date of Test	2021-10-07
Factor	DRH18-E	Temp. / Humidity	23°C /49%
Polarity	Horizontal	Site / Test Engineer	AC2 / Jay
Test Mode	802.11a_TX_Band4_CH 165	Test Voltage	AC 120V/60Hz

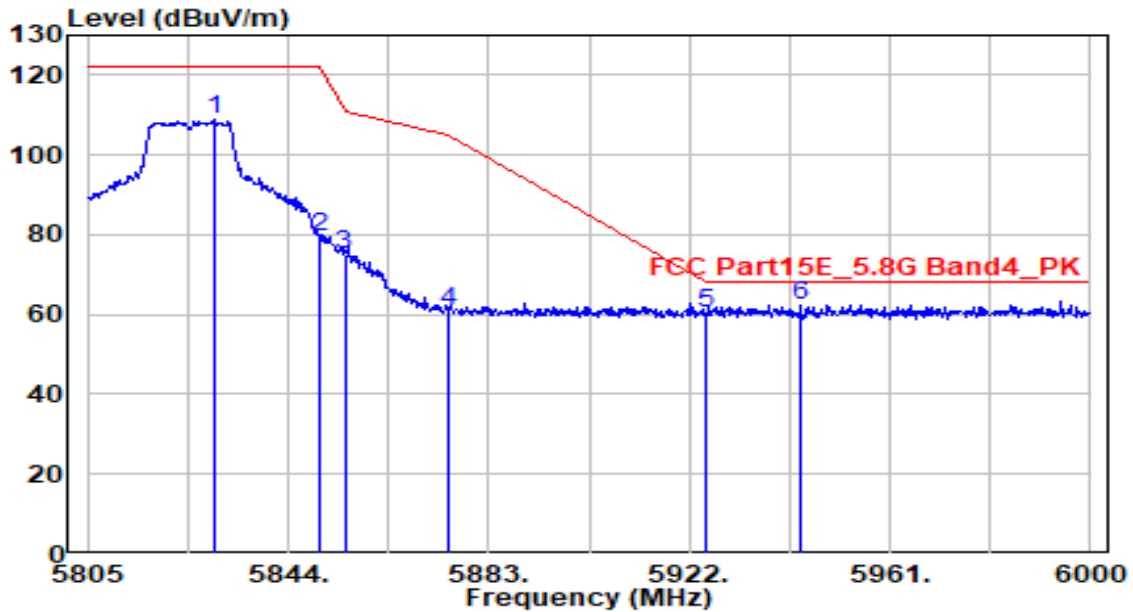

No	Frequency (MHz)	Reading (dB $\mu$ V)	C.F (dB/m)	Measurement (dB $\mu$ V/m)	Margin (dB)	Limit (dB $\mu$ V/m)	Height (cm)	Angle (deg)	Remark (QP/PK/AV)
1	5829.765	107.42	1.25	108.67	N/A	N/A	150	120	Peak
2	5850.000	78.05	1.28	79.33	-42.87	122.20	150	120	Peak
3	5855.000	73.91	1.28	75.19	-35.61	110.80	150	120	Peak
4	5875.000	59.71	1.30	61.01	-44.19	105.20	150	120	Peak
5	5925.000	58.98	1.35	60.33	-7.87	68.20	150	120	Peak
6	* 5943.645	61.09	1.37	62.46	-5.74	68.20	150	120	Peak

Note:

1. " \*", means this data is the worst emission level.
2. C.F (Correction Factor) = Antenna Factor (dB/m)+ Cable Loss (dB) – Preamplifier(dB).
3. Measurement (dB $\mu$ V/m) = Reading(dB $\mu$ V) + C.F (Correction Factor).
4. The emission levels of other frequencies are very lower than the limit and not show in test report.

EUT	HAN Access Point	Date of Test	2021-10-07
Factor	DRH18-E	Temp. / Humidity	23°C /49%
Polarity	Vertical	Site / Test Engineer	AC2 / Jay
Test Mode	802.11a_TX_Band4_CH 165	Test Voltage	AC 120V/60Hz

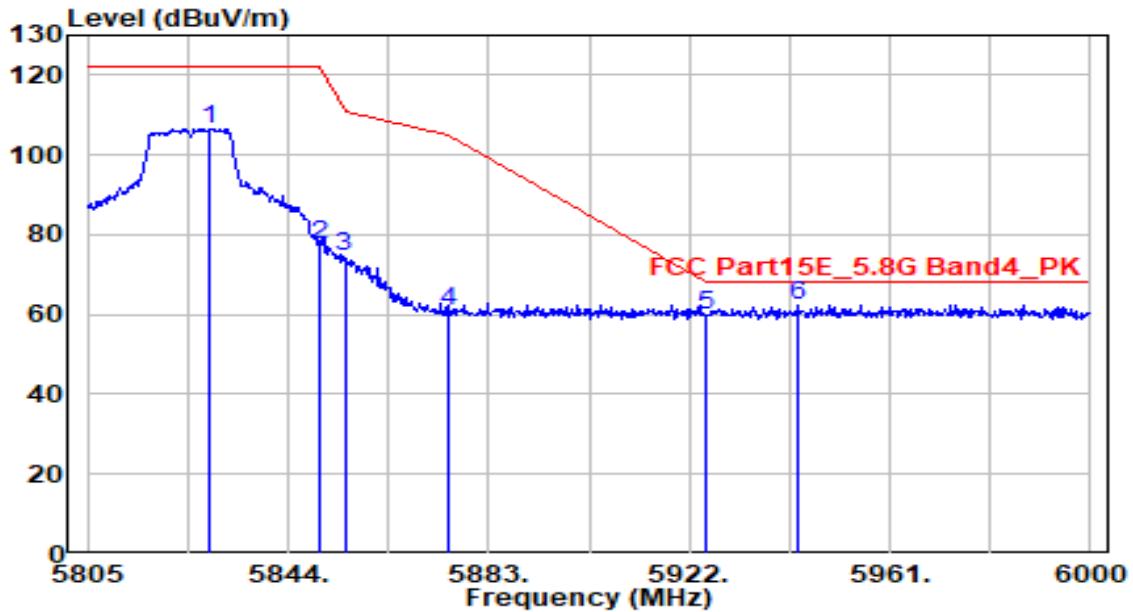

No	Frequency (MHz)	Reading (dB $\mu$ V)	C.F (dB/m)	Measurement (dB $\mu$ V/m)	Margin (dB)	Limit (dB $\mu$ V/m)	Height (cm)	Angle (deg)	Remark (QP/PK/AV)
1	5828.790	105.42	1.25	106.67	N/A	N/A	250	185	Peak
2	5850.000	76.22	1.28	77.50	-44.70	122.20	250	185	Peak
3	5855.000	73.22	1.28	74.50	-36.30	110.80	250	185	Peak
4	5875.000	59.48	1.30	60.78	-44.42	105.20	250	185	Peak
5	5925.000	58.32	1.35	59.68	-8.52	68.20	250	185	Peak
6	* 5943.255	61.10	1.37	62.48	-5.72	68.20	250	185	Peak

Note:

1. " \*", means this data is the worst emission level.
2. C.F (Correction Factor) = Antenna Factor (dB/m)+ Cable Loss (dB) – Preamplifier(dB).
3. Measurement (dB $\mu$ V/m) = Reading(dB $\mu$ V) + C.F (Correction Factor).
4. The emission levels of other frequencies are very lower than the limit and not show in test report.

EUT	HAN Access Point	Date of Test	2021-10-07
Factor	DRH18-E	Temp. / Humidity	23°C /49%
Polarity	Horizontal	Site / Test Engineer	AC2 / Jay
Test Mode	802.11ac20_TX_Band1_CH 36	Test Voltage	AC 120V/60Hz

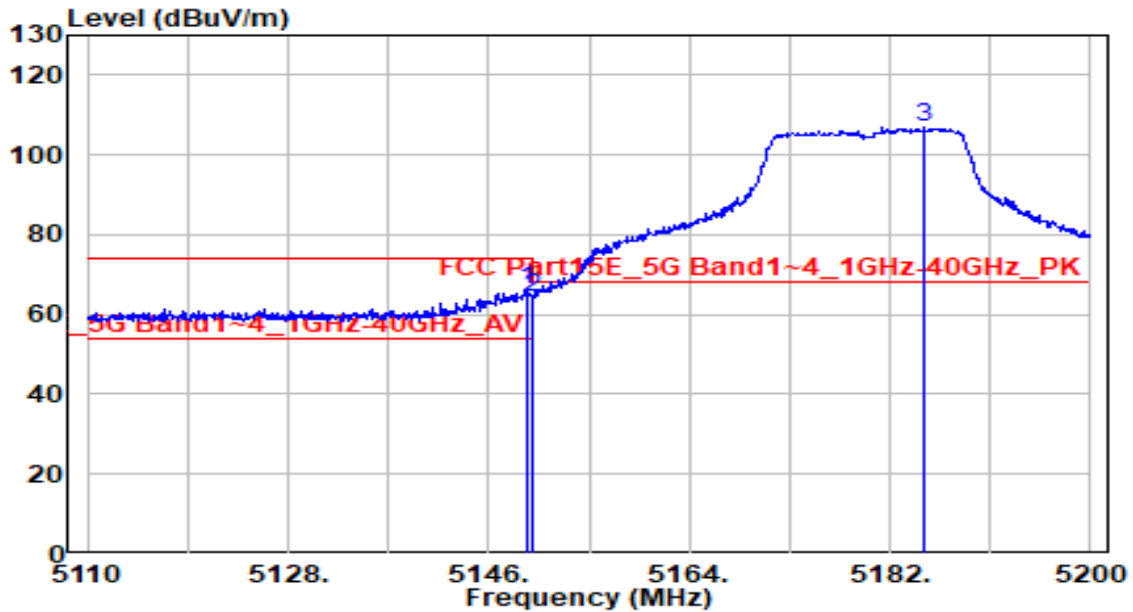

No	Frequency (MHz)	Reading (dBμV)	C.F (dB/m)	Measurement (dBμV/m)	Margin (dB)	Limit (dBμV/m)	Height (cm)	Angle (deg)	Remark (QP/PK/AV)
1	* 5149.420	66.47	-0.32	66.15	-7.85	74.00	160	190	Peak
2	5150.000	64.82	-0.32	64.50	-9.50	74.00	160	190	Peak
3	5185.060	107.08	-0.32	106.75	N/A	N/A	160	190	Peak

Note:

1. " \*", means this data is the worst emission level.
2. C.F (Correction Factor) = Antenna Factor (dB/m)+ Cable Loss (dB) – Preamplifier(dB) + 20dB Attenuation.
3. Measurement (dBμV/m) = Reading(dBμV) + C.F (Correction Factor).
4. The emission levels of other frequencies are very lower than the limit and not show in test report.



EUT	HAN Access Point	Date of Test	2021-10-07
Factor	DRH18-E	Temp. / Humidity	23°C /49%
Polarity	Horizontal	Site / Test Engineer	AC2 / Jay
Test Mode	802.11ac20_TX_Band1_CH 36	Test Voltage	AC 120V/60Hz

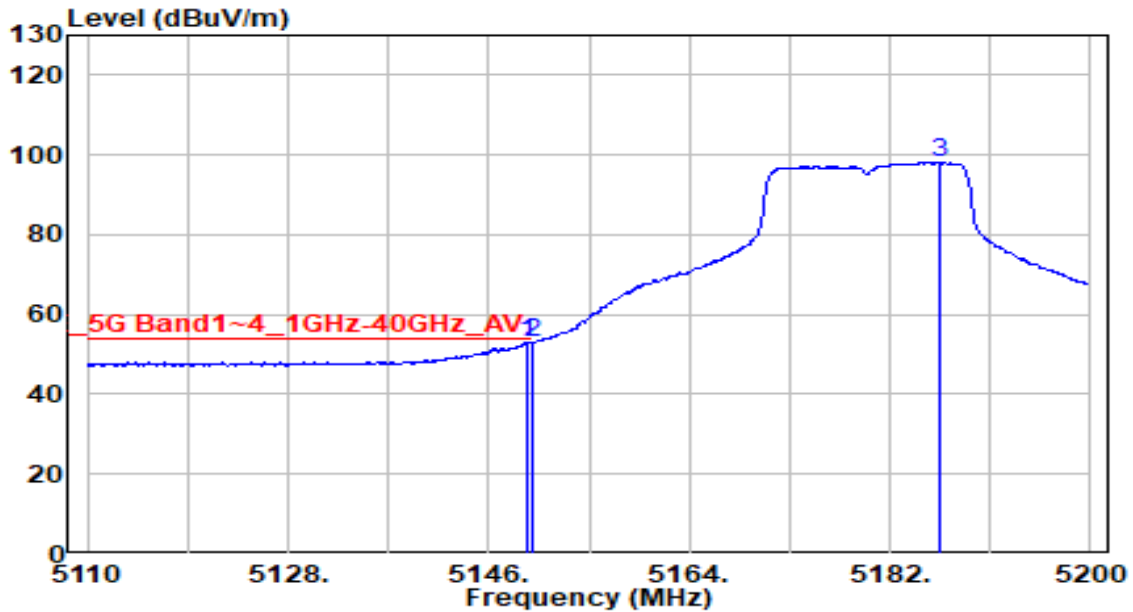

No	Frequency (MHz)	Reading (dB $\mu$ V)	C.F (dB/m)	Measurement (dB $\mu$ V/m)	Margin (dB)	Limit (dB $\mu$ V/m)	Height (cm)	Angle (deg)	Remark (QP/PK/AV)
1	* 5149.510	53.41	-0.32	53.09	-0.91	54.00	160	190	Average
2	5150.000	53.22	-0.32	52.90	-1.10	54.00	160	190	Average
3	5186.500	98.41	-0.32	98.09	N/A	N/A	160	190	Average

Note:

1. " \*", means this data is the worst emission level.
2. C.F (Correction Factor) = Antenna Factor (dB/m)+ Cable Loss (dB) – Preamplifier(dB) + 20dB Attenuation.
3. Measurement (dB $\mu$ V/m) = Reading(dB $\mu$ V) + C.F (Correction Factor).
4. The emission levels of other frequencies are very lower than the limit and not show in test report.

EUT	HAN Access Point	Date of Test	2021-10-07
Factor	DRH18-E	Temp. / Humidity	23°C /49%
Polarity	Vertical	Site / Test Engineer	AC2 / Jay
Test Mode	802.11ac20_TX_Band1_CH 36	Test Voltage	AC 120V/60Hz

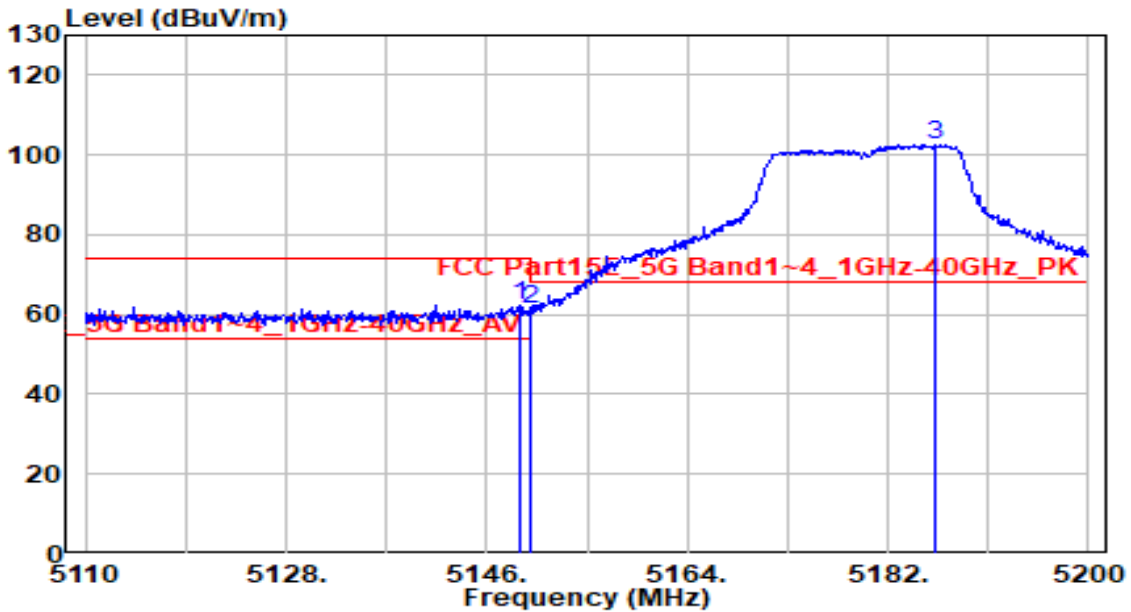

No	Frequency (MHz)	Reading (dBμV)	C.F (dB/m)	Measurement (dBμV/m)	Margin (dB)	Limit (dBμV/m)	Height (cm)	Angle (deg)	Remark (QP/PK/AV)
1	* 5149.060	62.62	-0.32	62.30	-11.70	74.00	150	205	Peak
2	5150.000	61.41	-0.32	61.10	-12.90	74.00	150	205	Peak
3	5186.140	103.01	-0.32	102.68	N/A	N/A	150	205	Peak

Note:

1. " \*", means this data is the worst emission level.
2. C.F (Correction Factor) = Antenna Factor (dB/m)+ Cable Loss (dB) – Preamplifier(dB) + 20dB Attenuation.
3. Measurement (dBμV/m) = Reading(dBμV) + C.F (Correction Factor).
4. The emission levels of other frequencies are very lower than the limit and not show in test report.

EUT	HAN Access Point	Date of Test	2021-10-07
Factor	DRH18-E	Temp. / Humidity	23°C /49%
Polarity	Vertical	Site / Test Engineer	AC2 / Jay
Test Mode	802.11ac20_TX_Band1_CH 36	Test Voltage	AC 120V/60Hz

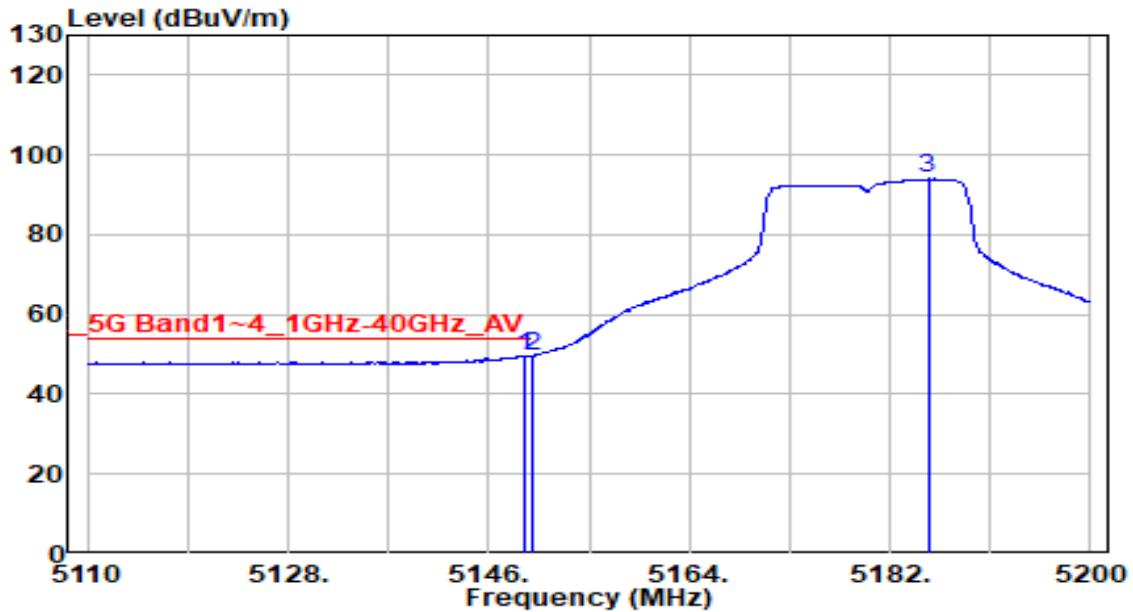

No	Frequency (MHz)	Reading (dB $\mu$ V)	C.F (dB/m)	Measurement (dB $\mu$ V/m)	Margin (dB)	Limit (dB $\mu$ V/m)	Height (cm)	Angle (deg)	Remark (QP/PK/AV)
1	5149.150	49.79	-0.32	49.47	-4.53	54.00	150	205	Average
2	* 5150.000	49.96	-0.32	49.64	-4.36	54.00	150	205	Average
3	5185.420	94.30	-0.32	93.97	N/A	N/A	150	205	Average

Note:

- "\*", means this data is the worst emission level.
- C.F (Correction Factor) = Antenna Factor (dB/m)+ Cable Loss (dB) – Preamplifier(dB) + 20dB Attenuation.
- Measurement (dB $\mu$ V/m) = Reading(dB $\mu$ V) + C.F (Correction Factor).
- The emission levels of other frequencies are very lower than the limit and not show in test report.

EUT	HAN Access Point	Date of Test	2021-10-07
Factor	DRH18-E	Temp. / Humidity	23°C /49%
Polarity	Horizontal	Site / Test Engineer	AC2 / Jay
Test Mode	802.11ac20_TX_Band4_CH 149	Test Voltage	AC 120V/60Hz

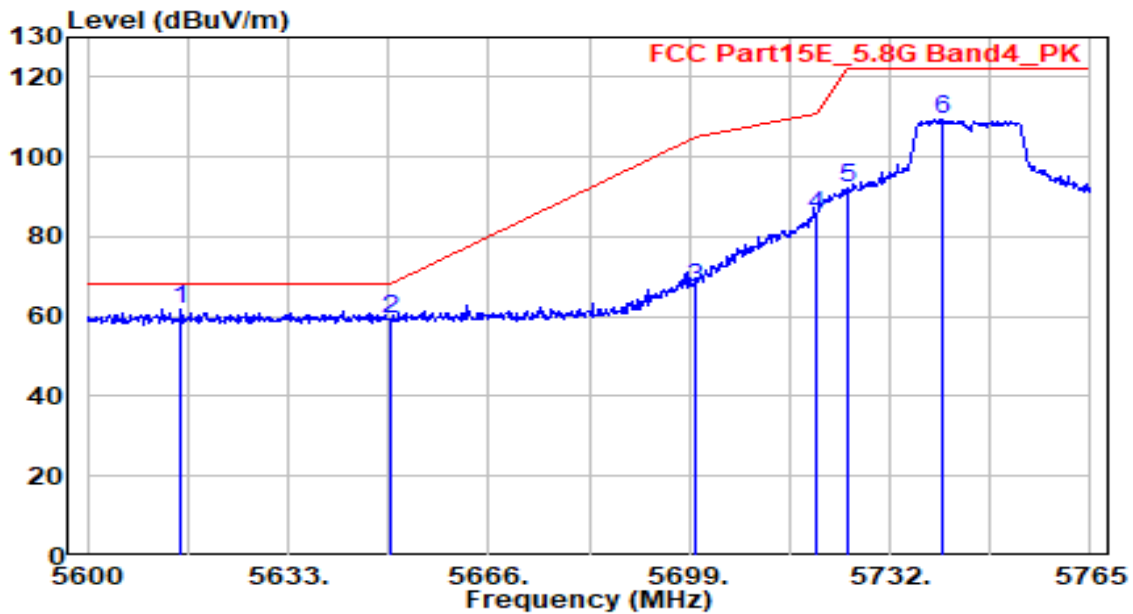

No	Frequency (MHz)	Reading (dB $\mu$ V)	C.F (dB/m)	Measurement (dB $\mu$ V/m)	Margin (dB)	Limit (dB $\mu$ V/m)	Height (cm)	Angle (deg)	Remark (QP/PK/AV)
1	* 5615.345	61.40	0.46	61.86	-6.34	68.20	150	115	Peak
2	5650.000	58.86	0.60	59.46	-8.74	68.20	150	115	Peak
3	5700.000	66.60	0.81	67.42	-37.78	105.20	150	115	Peak
4	5720.000	84.23	0.89	85.12	-25.68	110.80	150	115	Peak
5	5725.000	91.39	0.91	92.30	-29.90	122.20	150	115	Peak
6	5740.580	108.40	0.98	109.38	N/A	N/A	150	115	Peak

Note:

1. " \*", means this data is the worst emission level.
2. C.F (Correction Factor) = Antenna Factor (dB/m)+ Cable Loss (dB) – Preamplifier(dB).
3. Measurement (dB $\mu$ V/m) = Reading(dB $\mu$ V) + C.F (Correction Factor).
4. The emission levels of other frequencies are very lower than the limit and not show in test report.

EUT	HAN Access Point	Date of Test	2021-10-07
Factor	DRH18-E	Temp. / Humidity	23°C /49%
Polarity	Vertical	Site / Test Engineer	AC2 / Jay
Test Mode	802.11ac20_TX_Band4_CH 149	Test Voltage	AC 120V/60Hz

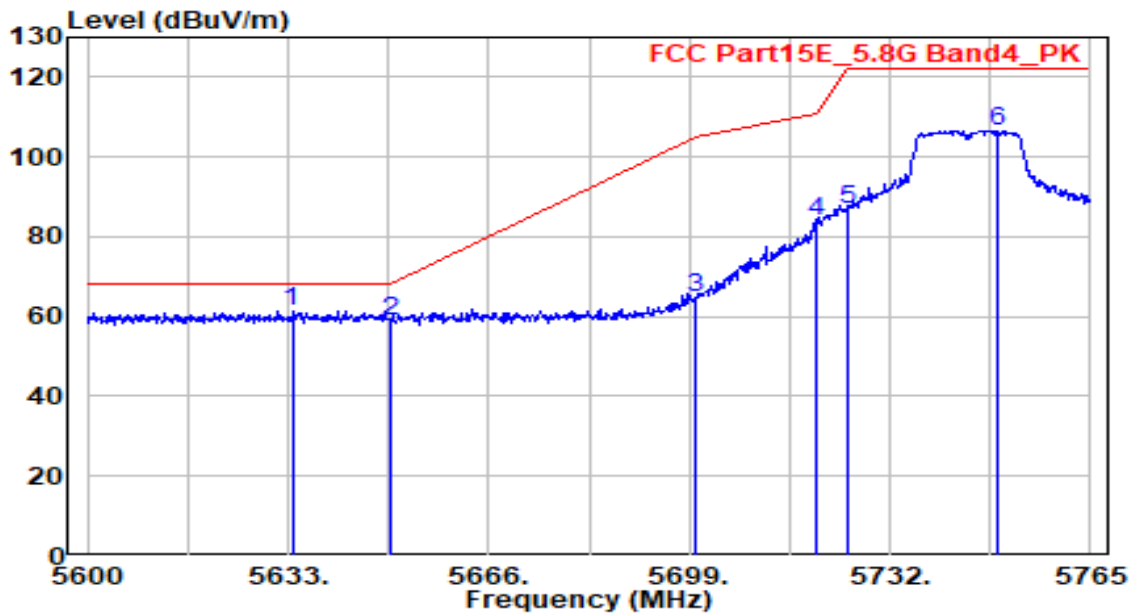

No	Frequency (MHz)	Reading (dBμV)	C.F (dB/m)	Measurement (dBμV/m)	Margin (dB)	Limit (dBμV/m)	Height (cm)	Angle (deg)	Remark (QP/PK/AV)
1	* 5633.660	60.73	0.54	61.27	-6.93	68.20	260	190	Peak
2	5650.000	58.39	0.60	59.00	-9.20	68.20	260	190	Peak
3	5700.000	63.99	0.81	64.80	-40.40	105.20	260	190	Peak
4	5720.000	82.81	0.89	83.70	-27.10	110.80	260	190	Peak
5	5725.000	85.73	0.91	86.65	-35.55	122.20	260	190	Peak
6	5749.655	105.65	1.01	106.66	N/A	N/A	260	190	Peak

Note:

1. " \*", means this data is the worst emission level.
2. C.F (Correction Factor) = Antenna Factor (dB/m)+ Cable Loss (dB) – Preamplifier(dB).
3. Measurement (dBμV/m) = Reading(dBμV) + C.F (Correction Factor).
4. The emission levels of other frequencies are very lower than the limit and not show in test report.

EUT	HAN Access Point	Date of Test	2021-10-07
Factor	DRH18-E	Temp. / Humidity	23°C /49%
Polarity	Horizontal	Site / Test Engineer	AC2 / Jay
Test Mode	802.11ac20_TX_Band4_CH 165	Test Voltage	AC 120V/60Hz

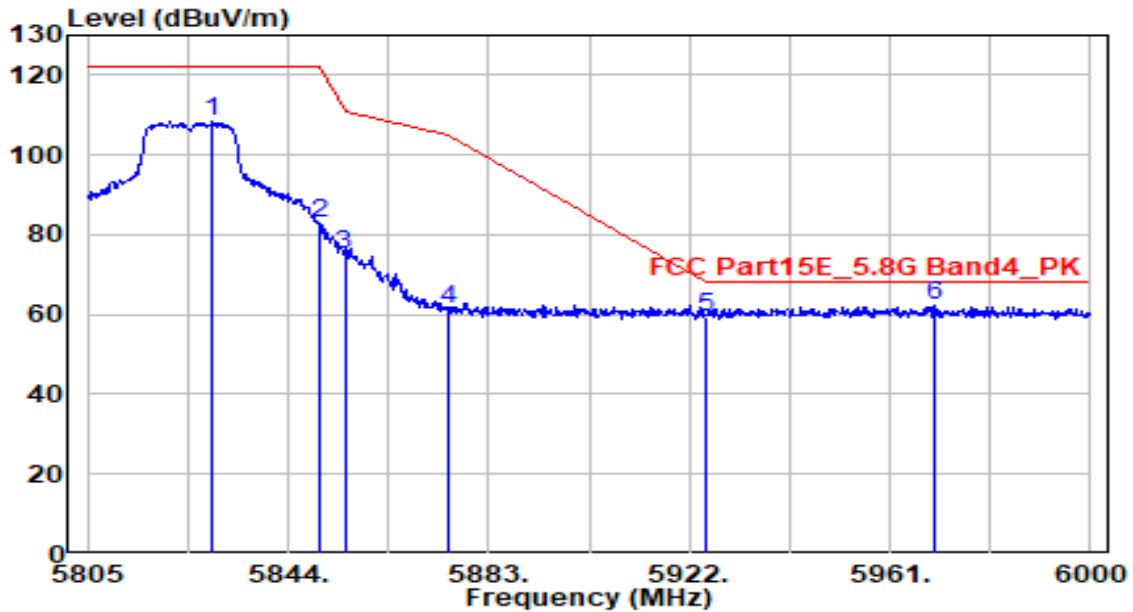

No	Frequency (MHz)	Reading (dBµV)	C.F (dB/m)	Measurement (dBµV/m)	Margin (dB)	Limit (dBµV/m)	Height (cm)	Angle (deg)	Remark (QP/PK/AV)
1	5829.375	107.03	1.25	108.28	N/A	N/A	150	120	Peak
2	5850.000	81.75	1.28	83.03	-39.17	122.20	150	120	Peak
3	5855.000	73.74	1.28	75.02	-35.78	110.80	150	120	Peak
4	5875.000	59.82	1.30	61.12	-44.08	105.20	150	120	Peak
5	5925.000	58.25	1.35	59.60	-8.60	68.20	150	120	Peak
6	* 5969.775	61.02	1.40	62.42	-5.78	68.20	150	120	Peak

Note:

1. " \*", means this data is the worst emission level.
2. C.F (Correction Factor) = Antenna Factor (dB/m)+ Cable Loss (dB) – Preamplifier(dB).
3. Measurement (dBµV/m) = Reading(dBµV) + C.F (Correction Factor).
4. The emission levels of other frequencies are very lower than the limit and not show in test report.

EUT	HAN Access Point	Date of Test	2021-10-07
Factor	DRH18-E	Temp. / Humidity	23°C /49%
Polarity	Vertical	Site / Test Engineer	AC2 / Jay
Test Mode	802.11ac20_TX_Band4_CH 165	Test Voltage	AC 120V/60Hz

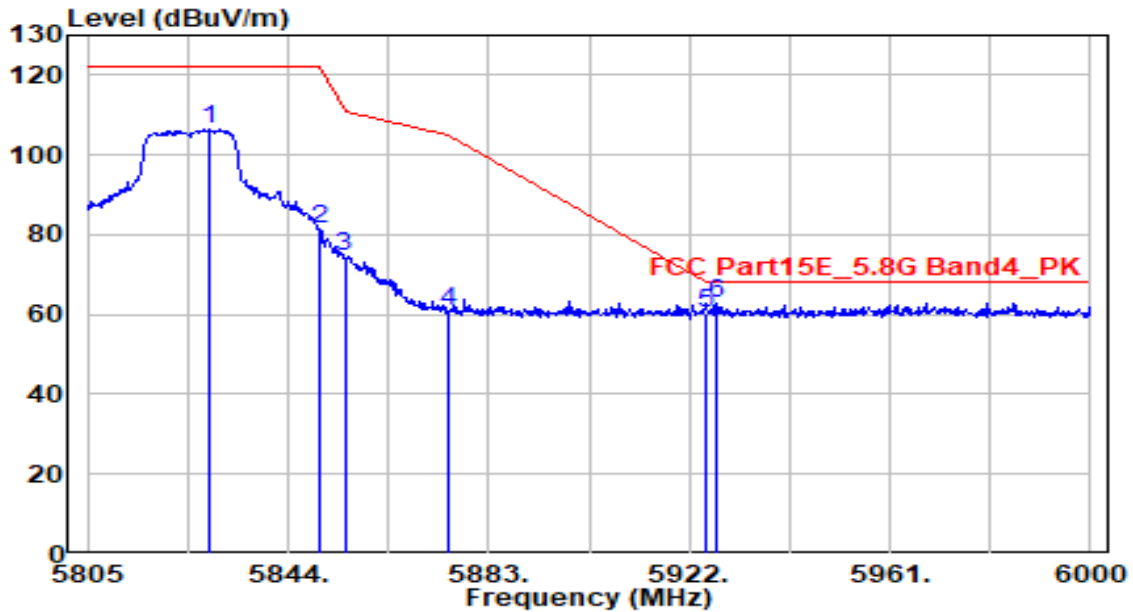

No	Frequency (MHz)	Reading (dB $\mu$ V)	C.F (dB/m)	Measurement (dB $\mu$ V/m)	Margin (dB)	Limit (dB $\mu$ V/m)	Height (cm)	Angle (deg)	Remark (QP/PK/AV)
1	5828.790	105.35	1.25	106.60	N/A	N/A	250	185	Peak
2	5850.000	80.35	1.28	81.62	-40.58	122.20	250	185	Peak
3	5855.000	73.32	1.28	74.60	-36.20	110.80	250	185	Peak
4	5875.000	59.67	1.30	60.97	-44.23	105.20	250	185	Peak
5	5925.000	59.03	1.35	60.39	-7.81	68.20	250	185	Peak
6	* 5927.460	61.40	1.36	62.76	-5.44	68.20	250	185	Peak

Note:

1. " \*", means this data is the worst emission level.
2. C.F (Correction Factor) = Antenna Factor (dB/m)+ Cable Loss (dB) – Preamplifier(dB).
3. Measurement (dB $\mu$ V/m) = Reading(dB $\mu$ V) + C.F (Correction Factor).
4. The emission levels of other frequencies are very lower than the limit and not show in test report.

EUT	HAN Access Point	Date of Test	2021-10-07
Factor	DRH18-E	Temp. / Humidity	23°C /49%
Polarity	Horizontal	Site / Test Engineer	AC2 / Jay
Test Mode	802.11ac40_TX_Band1_CH 38	Test Voltage	AC 120V/60Hz

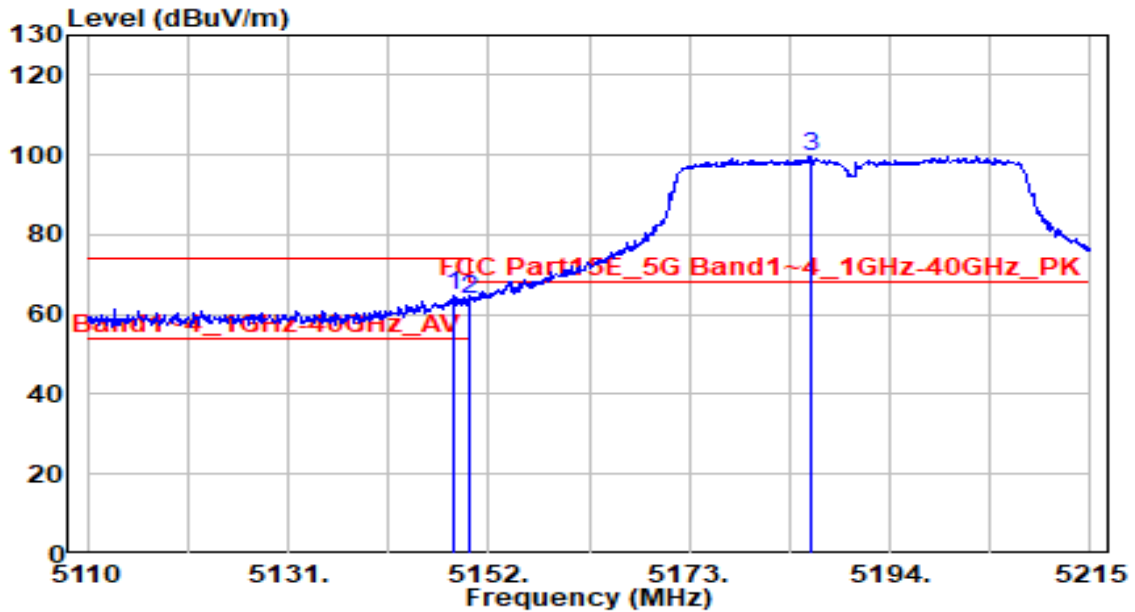

No	Frequency (MHz)	Reading (dB $\mu$ V)	C.F (dB/m)	Measurement (dB $\mu$ V/m)	Margin (dB)	Limit (dB $\mu$ V/m)	Height (cm)	Angle (deg)	Remark (QP/PK/AV)
1	* 5148.430	64.86	-0.32	64.54	-9.46	74.00	150	190	Peak
2	5150.000	63.94	-0.32	63.62	-10.38	74.00	150	190	Peak
3	5185.705	100.07	-0.32	99.75	N/A	N/A	150	190	Peak

Note:

1. " \*", means this data is the worst emission level.
2. C.F (Correction Factor) = Antenna Factor (dB/m)+ Cable Loss (dB) – Preamplifier(dB) + 20dB Attenuation.
3. Measurement (dB $\mu$ V/m) = Reading(dB $\mu$ V) + C.F (Correction Factor).
4. The emission levels of other frequencies are very lower than the limit and not show in test report.



EUT	HAN Access Point	Date of Test	2021-10-07
Factor	DRH18-E	Temp. / Humidity	23°C /49%
Polarity	Horizontal	Site / Test Engineer	AC2 / Jay
Test Mode	802.11ac40_TX_Band1_CH 38	Test Voltage	AC 120V/60Hz

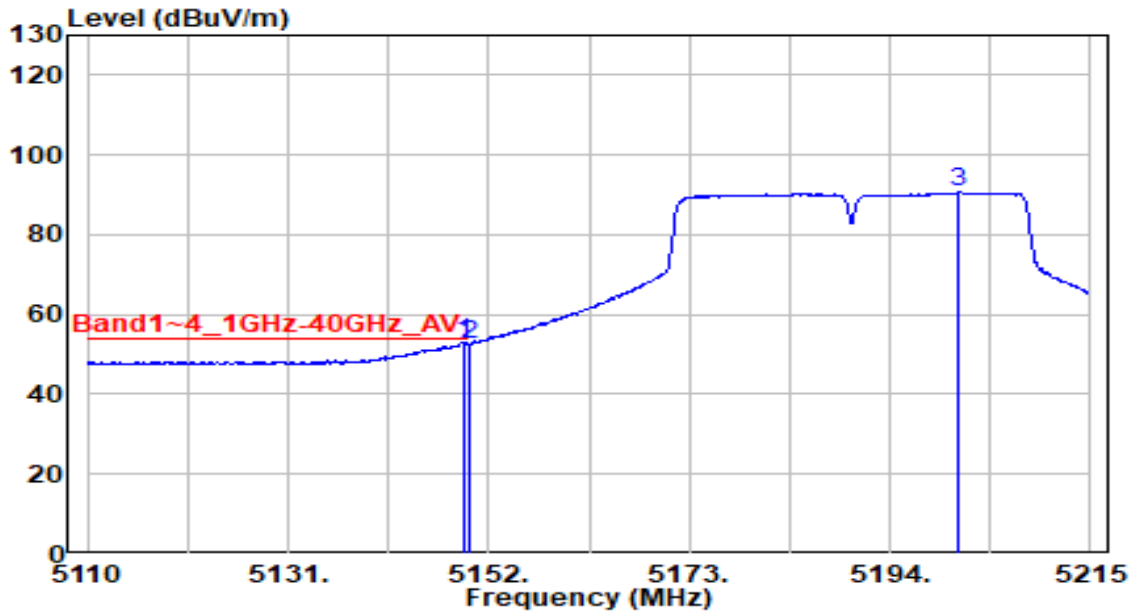

No	Frequency (MHz)	Reading (dBμV)	C.F (dB/m)	Measurement (dBμV/m)	Margin (dB)	Limit (dBμV/m)	Height (cm)	Angle (deg)	Remark (QP/PK/AV)
1	* 5149.375	53.33	-0.32	53.01	-0.99	54.00	150	190	Average
2	5150.000	52.84	-0.32	52.52	-1.48	54.00	150	190	Average
3	5201.245	90.90	-0.32	90.58	N/A	N/A	150	190	Average

Note:

1. " \*", means this data is the worst emission level.
2. C.F (Correction Factor) = Antenna Factor (dB/m)+ Cable Loss (dB) – Preamplifier(dB) + 20dB Attenuation.
3. Measurement (dBμV/m) = Reading(dBμV) + C.F (Correction Factor).
4. The emission levels of other frequencies are very lower than the limit and not show in test report.

EUT	HAN Access Point	Date of Test	2021-10-07
Factor	DRH18-E	Temp. / Humidity	23°C /49%
Polarity	Vertical	Site / Test Engineer	AC2 / Jay
Test Mode	802.11ac40_TX_Band1_CH 38	Test Voltage	AC 120V/60Hz

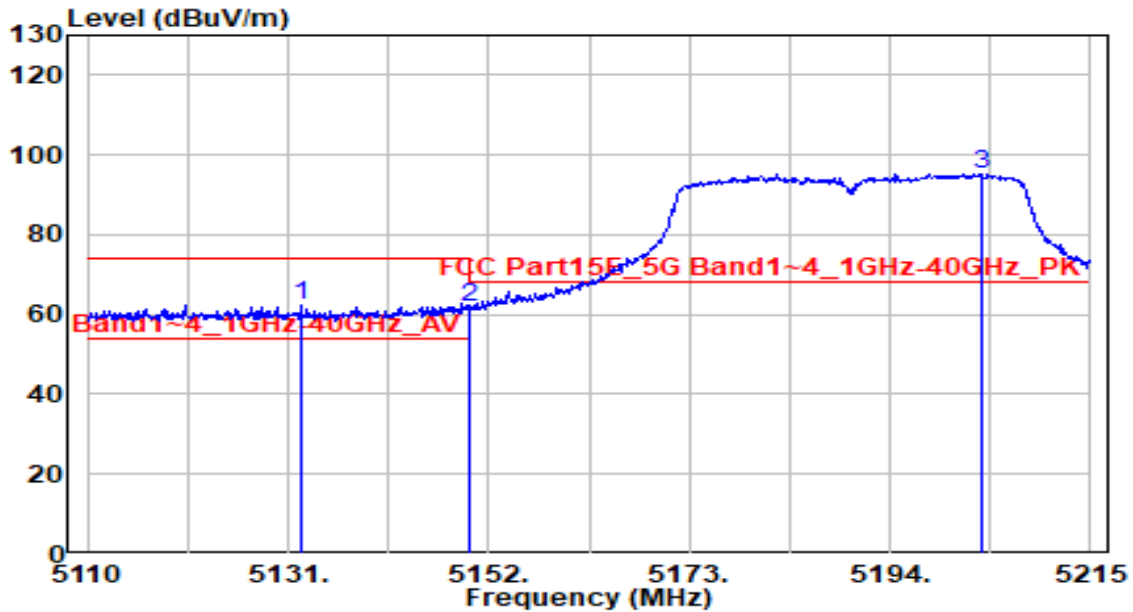

No	Frequency (MHz)	Reading (dBμV)	C.F (dB/m)	Measurement (dBμV/m)	Margin (dB)	Limit (dBμV/m)	Height (cm)	Angle (deg)	Remark (QP/PK/AV)
1	* 5132.260	62.69	-0.32	62.37	-11.63	74.00	255	210	Peak
2	5150.000	62.09	-0.32	61.77	-12.23	74.00	255	210	Peak
3	5203.660	95.65	-0.32	95.32	N/A	N/A	255	210	Peak

Note:

1. " \*", means this data is the worst emission level.
2. C.F (Correction Factor) = Antenna Factor (dB/m)+ Cable Loss (dB) – Preamplifier(dB) + 20dB Attenuation.
3. Measurement (dBμV/m) = Reading(dBμV) + C.F (Correction Factor).
4. The emission levels of other frequencies are very lower than the limit and not show in test report.

EUT	HAN Access Point	Date of Test	2021-10-07
Factor	DRH18-E	Temp. / Humidity	23°C /49%
Polarity	Vertical	Site / Test Engineer	AC2 / Jay
Test Mode	802.11ac40_TX_Band1_CH 38	Test Voltage	AC 120V/60Hz

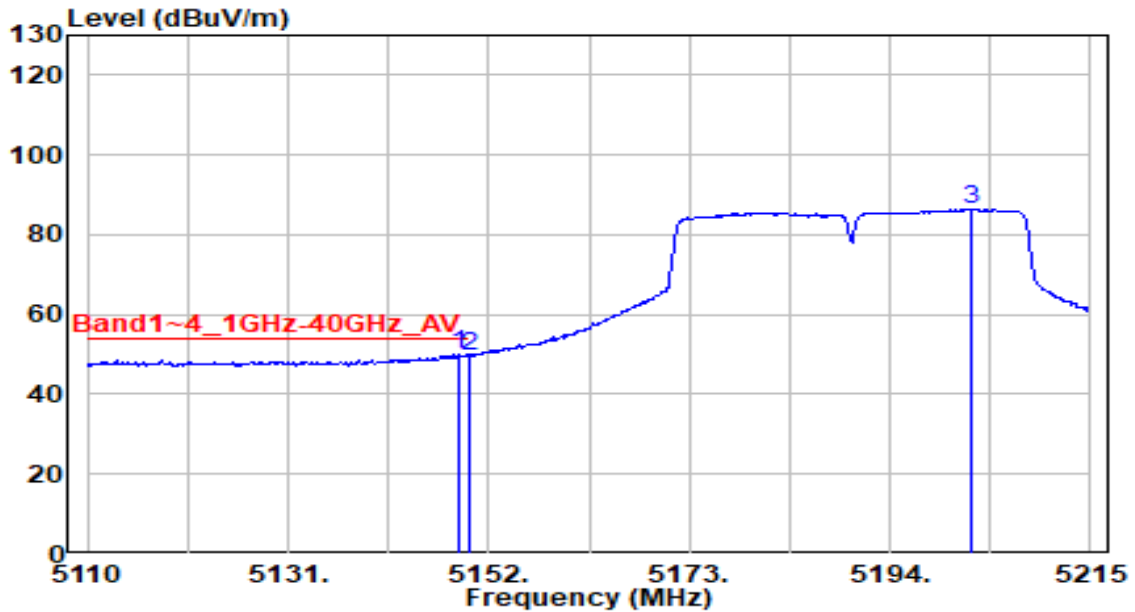

No	Frequency (MHz)	Reading (dB $\mu$ V)	C.F (dB/m)	Measurement (dB $\mu$ V/m)	Margin (dB)	Limit (dB $\mu$ V/m)	Height (cm)	Angle (deg)	Remark (QP/PK/AV)	
1	*	5148.955	50.30	-0.32	49.98	-4.02	54.00	255	210	Average
2		5150.000	50.06	-0.32	49.74	-4.26	54.00	255	210	Average
3		5202.400	86.74	-0.32	86.42	N/A	N/A	255	210	Average

Note:

1. " \*", means this data is the worst emission level.
2. C.F (Correction Factor) = Antenna Factor (dB/m)+ Cable Loss (dB) – Preamplifier(dB) + 20dB Attenuation.
3. Measurement (dB $\mu$ V/m) = Reading(dB $\mu$ V) + C.F (Correction Factor).
4. The emission levels of other frequencies are very lower than the limit and not show in test report.

EUT	HAN Access Point	Date of Test	2021-10-07
Factor	DRH18-E	Temp. / Humidity	23°C /49%
Polarity	Horizontal	Site / Test Engineer	AC2 / Jay
Test Mode	802.11ac40_TX_Band4_CH 151	Test Voltage	AC 120V/60Hz

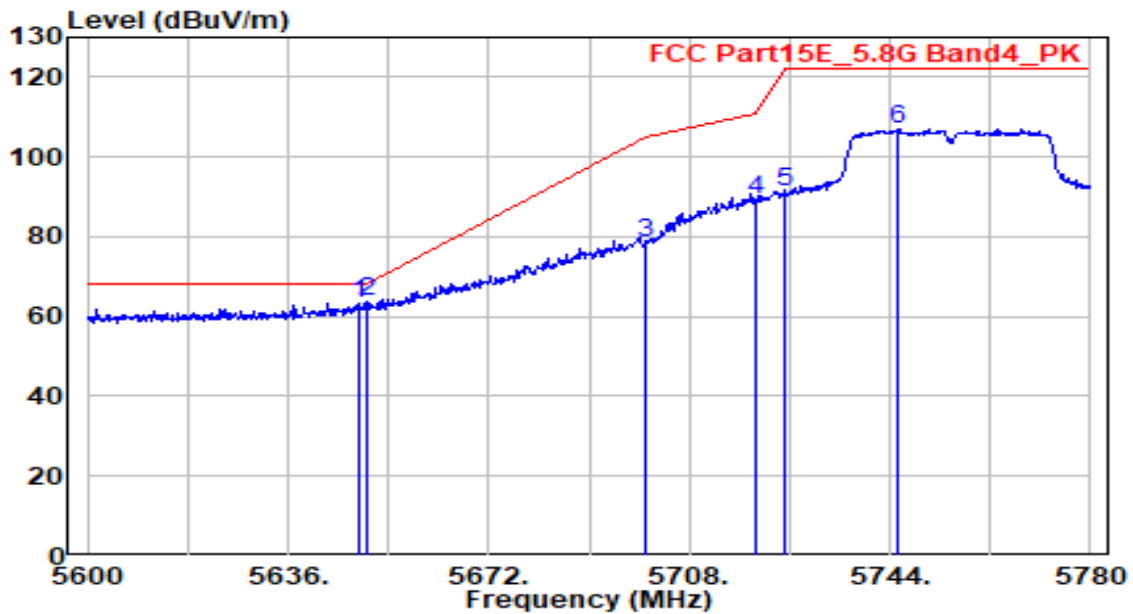

No	Frequency (MHz)	Reading (dB $\mu$ V)	C.F (dB/m)	Measurement (dB $\mu$ V/m)	Margin (dB)	Limit (dB $\mu$ V/m)	Height (cm)	Angle (deg)	Remark (QP/PK/AV)
1	5648.600	62.65	0.60	63.25	-4.95	68.20	150	120	Peak
2	* 5650.000	63.13	0.60	63.73	-4.47	68.20	150	120	Peak
3	5700.000	77.59	0.81	78.40	-26.80	105.20	150	120	Peak
4	5720.000	88.53	0.89	89.42	-21.38	110.80	150	120	Peak
5	5725.000	90.55	0.91	91.46	-30.74	122.20	150	120	Peak
6	5745.440	106.17	1.00	107.17	N/A	N/A	150	120	Peak

Note:

- "\*" means this data is the worst emission level.
- C.F (Correction Factor) = Antenna Factor (dB/m)+ Cable Loss (dB) – Preamplifier(dB) + 20dB Attenuation.
- Measurement (dB $\mu$ V/m) = Reading(dB $\mu$ V) + C.F (Correction Factor).
- The emission levels of other frequencies are very lower than the limit and not show in test report.

EUT	HAN Access Point	Date of Test	2021-10-07
Factor	DRH18-E	Temp. / Humidity	23°C /49%
Polarity	Vertical	Site / Test Engineer	AC2 / Jay
Test Mode	802.11ac40_TX_Band4_CH 151	Test Voltage	AC 120V/60Hz

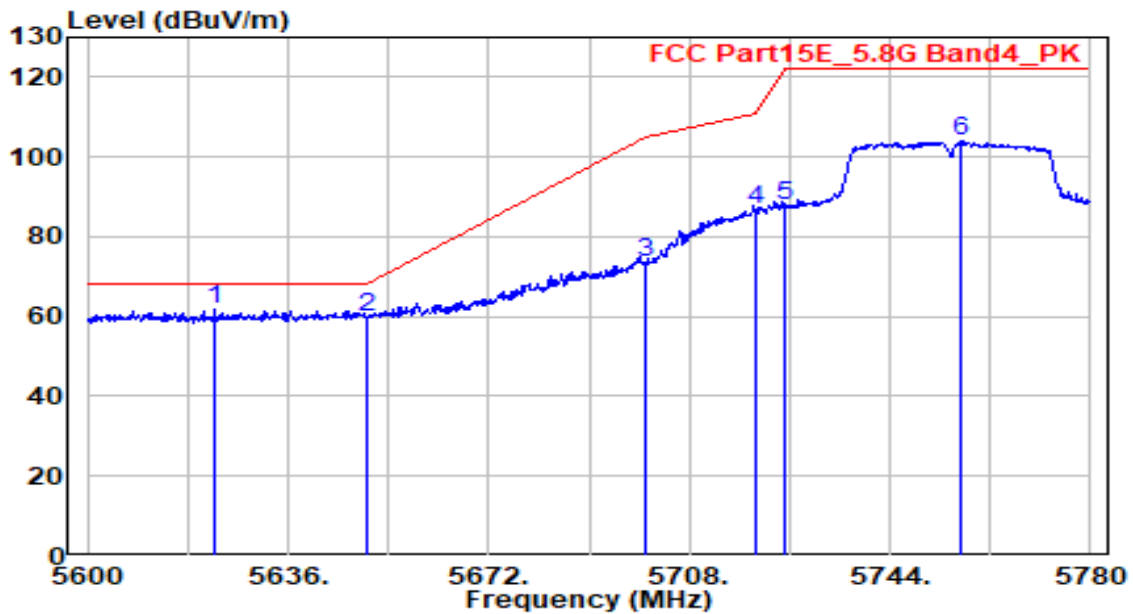

No	Frequency (MHz)	Reading (dB $\mu$ V)	C.F (dB/m)	Measurement (dB $\mu$ V/m)	Margin (dB)	Limit (dB $\mu$ V/m)	Height (cm)	Angle (deg)	Remark (QP/PK/AV)
1	* 5623.040	61.41	0.49	61.91	-6.29	68.20	245	190	Peak
2	5650.000	59.20	0.60	59.81	-8.39	68.20	245	190	Peak
3	5700.000	72.77	0.81	73.58	-31.62	105.20	245	190	Peak
4	5720.000	86.04	0.89	86.94	-23.86	110.80	245	190	Peak
5	5725.000	86.83	0.91	87.74	-34.46	122.20	245	190	Peak
6	5756.780	103.07	1.04	104.12	N/A	N/A	245	190	Peak

Note:

- "\*" means this data is the worst emission level.
- C.F (Correction Factor) = Antenna Factor (dB/m)+ Cable Loss (dB) – Preamplifier(dB) + 20dB Attenuation.
- Measurement (dB $\mu$ V/m) = Reading(dB $\mu$ V) + C.F (Correction Factor).
- The emission levels of other frequencies are very lower than the limit and not show in test report.

EUT	HAN Access Point	Date of Test	2021-10-07
Factor	DRH18-E	Temp. / Humidity	23°C /49%
Polarity	Horizontal	Site / Test Engineer	AC2 / Jay
Test Mode	802.11ac40_TX_Band4_CH 159	Test Voltage	AC 120V/60Hz

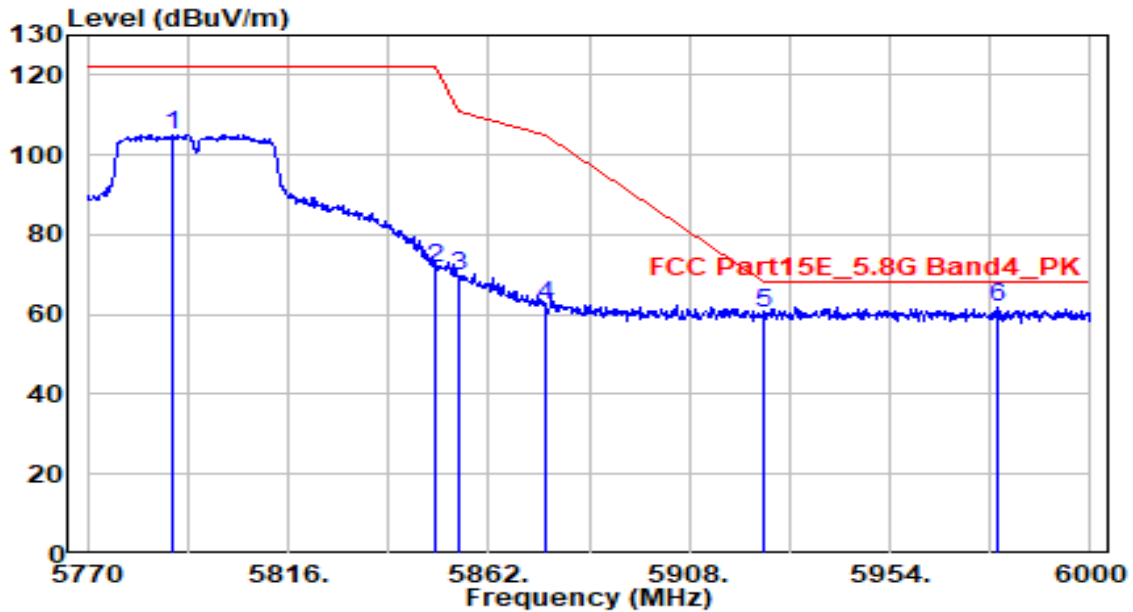

No	Frequency (MHz)	Reading (dBμV)	C.F (dB/m)	Measurement (dBμV/m)	Margin (dB)	Limit (dBμV/m)	Height (cm)	Angle (deg)	Remark (QP/PK/AV)
1	5789.320	104.02	1.18	105.20	N/A	N/A	150	125	Peak
2	5850.000	70.44	1.28	71.71	-50.49	122.20	150	125	Peak
3	5855.000	68.58	1.28	69.86	-40.94	110.80	150	125	Peak
4	5875.000	60.96	1.30	62.26	-42.94	105.20	150	125	Peak
5	5925.000	58.88	1.35	60.23	-7.97	68.20	150	125	Peak
6	* 5978.840	60.46	1.41	61.87	-6.33	68.20	150	125	Peak

Note:

1. " \*", means this data is the worst emission level.
2. C.F (Correction Factor) = Antenna Factor (dB/m)+ Cable Loss (dB) – Preamplifier(dB) + 20dB Attenuation.
3. Measurement (dBμV/m) = Reading(dBμV) + C.F (Correction Factor).
4. The emission levels of other frequencies are very lower than the limit and not show in test report.

EUT	HAN Access Point	Date of Test	2021-10-07
Factor	DRH18-E	Temp. / Humidity	23°C /49%
Polarity	Vertical	Site / Test Engineer	AC2 / Jay
Test Mode	802.11ac40_TX_Band4_CH 159	Test Voltage	AC 120V/60Hz

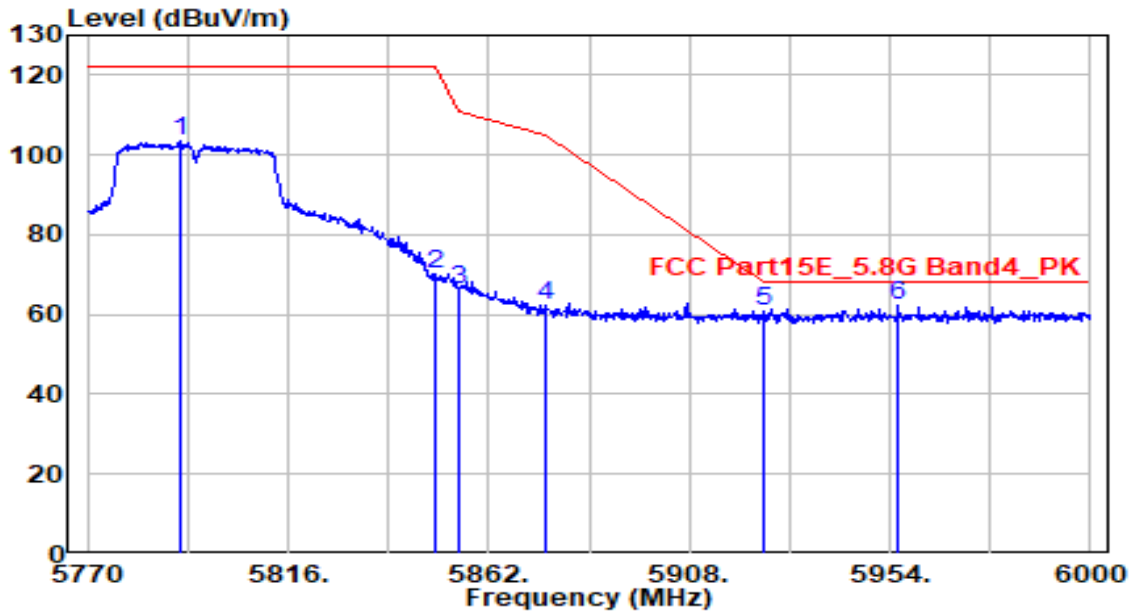

No	Frequency (MHz)	Reading (dB $\mu$ V)	C.F (dB/m)	Measurement (dB $\mu$ V/m)	Margin (dB)	Limit (dB $\mu$ V/m)	Height (cm)	Angle (deg)	Remark (QP/PK/AV)
1	5791.390	102.29	1.19	103.48	N/A	N/A	255	190	Peak
2	5850.000	69.02	1.28	70.30	-51.90	122.20	255	190	Peak
3	5855.000	65.17	1.28	66.45	-44.35	110.80	255	190	Peak
4	5875.000	60.95	1.30	62.25	-42.95	105.20	255	190	Peak
5	5925.000	59.37	1.35	60.73	-7.47	68.20	255	190	Peak
6	* 5956.070	60.90	1.39	62.29	-5.91	68.20	255	190	Peak

Note:

- "\*" means this data is the worst emission level.
- C.F (Correction Factor) = Antenna Factor (dB/m)+ Cable Loss (dB) – Preamplifier(dB) + 20dB Attenuation.
- Measurement (dB $\mu$ V/m) = Reading(dB $\mu$ V) + C.F (Correction Factor).
- The emission levels of other frequencies are very lower than the limit and not show in test report.

EUT	HAN Access Point	Date of Test	2021-10-07
Factor	DRH18-E	Temp. / Humidity	23°C /49%
Polarity	Horizontal	Site / Test Engineer	AC2 / Jay
Test Mode	802.11ac80_TX_Band1_CH 42	Test Voltage	AC 120V/60Hz

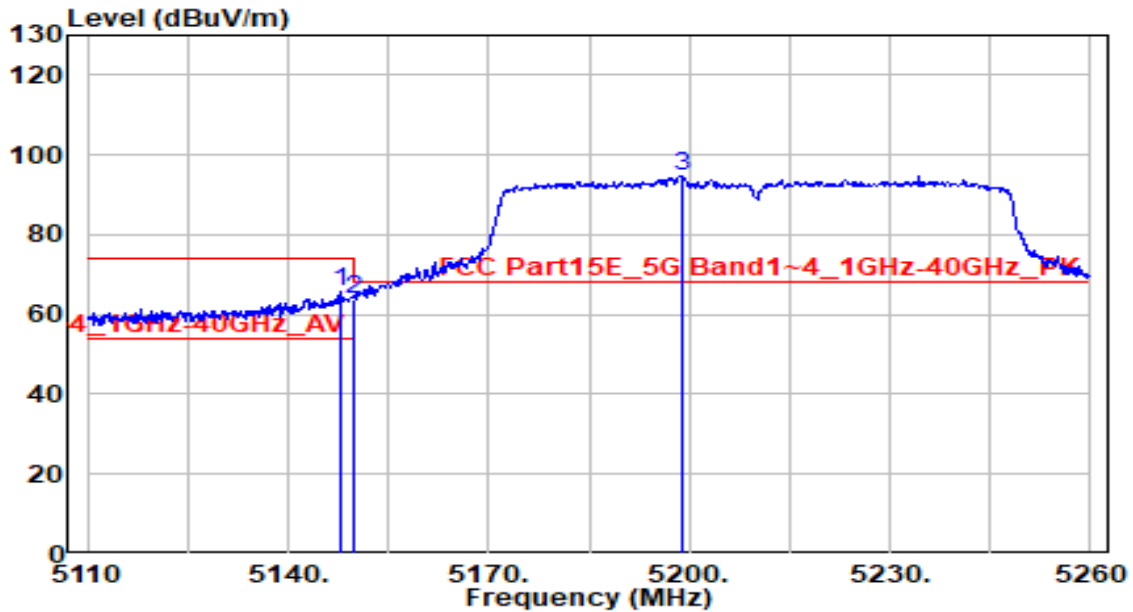

No	Frequency (MHz)	Reading (dB $\mu$ V)	C.F (dB/m)	Measurement (dB $\mu$ V/m)	Margin (dB)	Limit (dB $\mu$ V/m)	Height (cm)	Angle (deg)	Remark (QP/PK/AV)
1	* 5147.950	65.90	-0.32	65.58	-8.42	74.00	170	110	Peak
2	5150.000	64.31	-0.32	63.99	-10.01	74.00	170	110	Peak
3	5198.800	95.21	-0.32	94.89	N/A	N/A	170	110	Peak

Note:

1. " \*", means this data is the worst emission level.
2. C.F (Correction Factor) = Antenna Factor (dB/m)+ Cable Loss (dB) – Preamplifier(dB) + 20dB Attenuation.
3. Measurement (dB $\mu$ V/m) = Reading(dB $\mu$ V) + C.F (Correction Factor).
4. The emission levels of other frequencies are very lower than the limit and not show in test report.



EUT	HAN Access Point	Date of Test	2021-10-07
Factor	DRH18-E	Temp. / Humidity	23°C /49%
Polarity	Horizontal	Site / Test Engineer	AC2 / Jay
Test Mode	802.11ac80_TX_Band1_CH 42	Test Voltage	AC 120V/60Hz

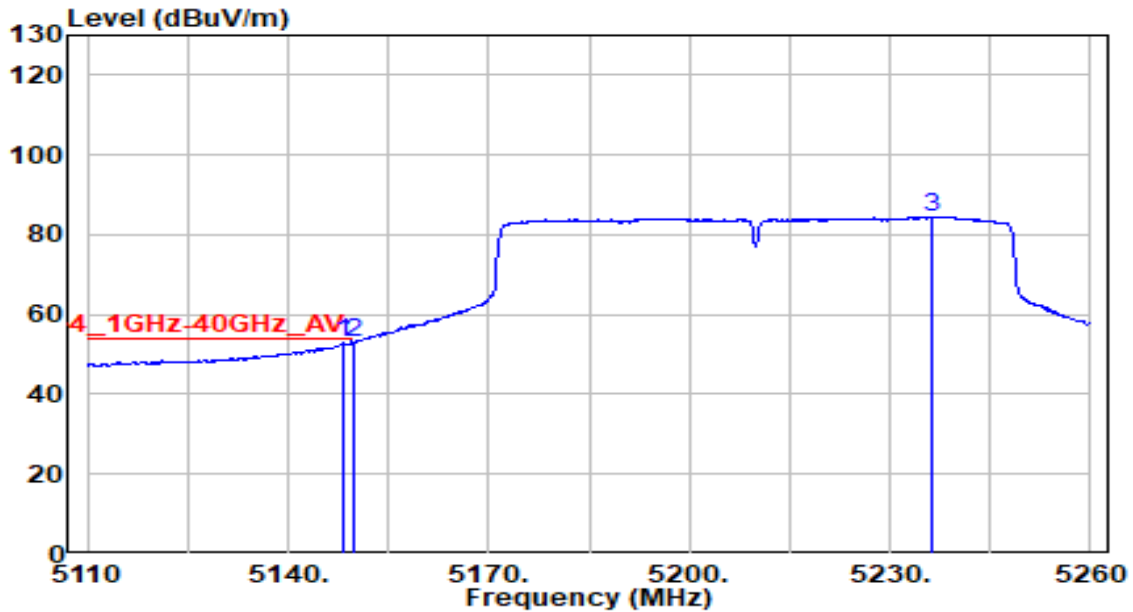

No	Frequency (MHz)	Reading (dB $\mu$ V)	C.F (dB/m)	Measurement (dB $\mu$ V/m)	Margin (dB)	Limit (dB $\mu$ V/m)	Height (cm)	Angle (deg)	Remark (QP/PK/AV)
1	5148.400	53.10	-0.32	52.78	-1.22	54.00	170	110	Average
2	* 5150.000	53.44	-0.32	53.12	-0.88	54.00	170	110	Average
3	5236.450	84.85	-0.33	84.53	N/A	N/A	170	110	Average

Note:

1. " \*", means this data is the worst emission level.
2. C.F (Correction Factor) = Antenna Factor (dB/m)+ Cable Loss (dB) – Preamplifier(dB) + 20dB Attenuation.
3. Measurement (dB $\mu$ V/m) = Reading(dB $\mu$ V) + C.F (Correction Factor).
4. The emission levels of other frequencies are very lower than the limit and not show in test report.

EUT	HAN Access Point	Date of Test	2021-10-07
Factor	DRH18-E	Temp. / Humidity	23°C /49%
Polarity	Vertical	Site / Test Engineer	AC2 / Jay
Test Mode	802.11ac80_TX_Band1_CH 42	Test Voltage	AC 120V/60Hz

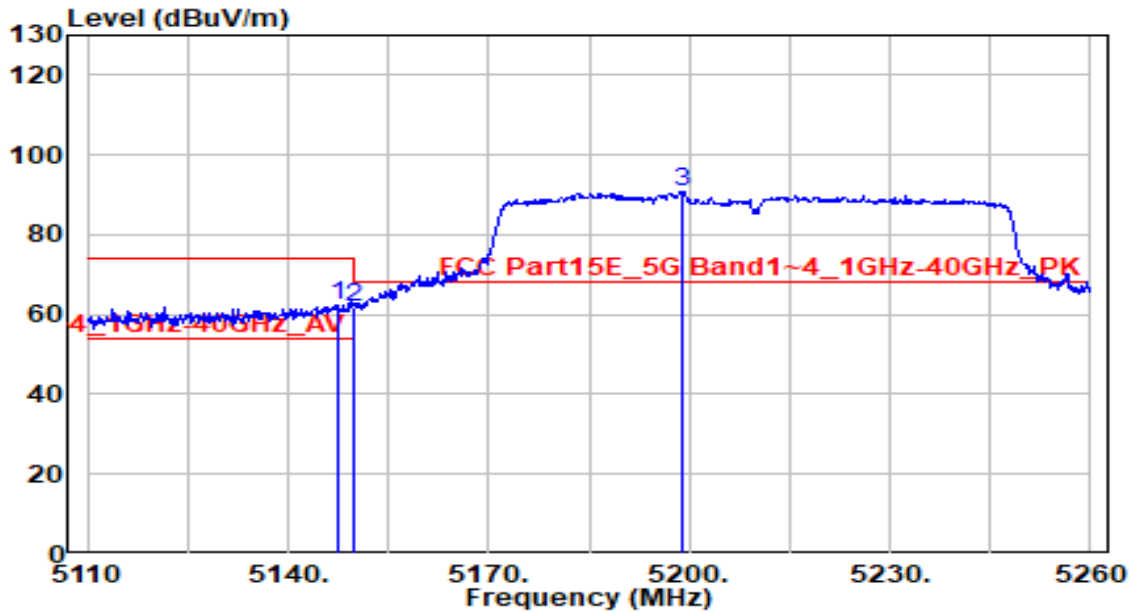

No	Frequency (MHz)	Reading (dB $\mu$ V)	C.F (dB/m)	Measurement (dB $\mu$ V/m)	Margin (dB)	Limit (dB $\mu$ V/m)	Height (cm)	Angle (deg)	Remark (QP/PK/AV)
1	* 5147.650	62.86	-0.32	62.54	-11.46	74.00	150	210	Peak
2	5150.000	62.15	-0.32	61.84	-12.16	74.00	150	210	Peak
3	5198.800	91.31	-0.32	90.98	N/A	N/A	150	210	Peak

Note:

1. " \*", means this data is the worst emission level.
2. C.F (Correction Factor) = Antenna Factor (dB/m)+ Cable Loss (dB) – Preamplifier(dB) + 20dB Attenuation.
3. Measurement (dB $\mu$ V/m) = Reading(dB $\mu$ V) + C.F (Correction Factor).
4. The emission levels of other frequencies are very lower than the limit and not show in test report.

EUT	HAN Access Point	Date of Test	2021-10-07
Factor	DRH18-E	Temp. / Humidity	23°C /49%
Polarity	Vertical	Site / Test Engineer	AC2 / Jay
Test Mode	802.11ac80_TX_Band1_CH 42	Test Voltage	AC 120V/60Hz

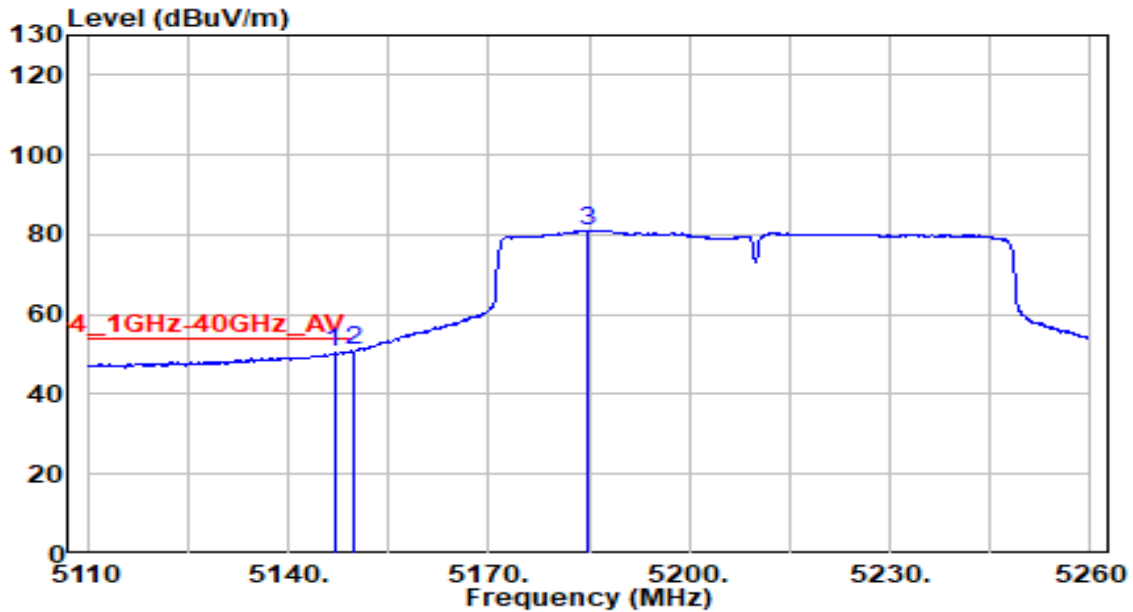

No	Frequency (MHz)	Reading (dBμV)	C.F (dB/m)	Measurement (dBμV/m)	Margin (dB)	Limit (dBμV/m)	Height (cm)	Angle (deg)	Remark (QP/PK/AV)
1	5146.900	50.68	-0.32	50.36	-3.64	54.00	150	210	Average
2	* 5150.000	51.10	-0.32	50.78	-3.22	54.00	150	210	Average
3	5184.850	81.45	-0.32	81.12	N/A	N/A	150	210	Average

Note:

1. " \*", means this data is the worst emission level.
2. C.F (Correction Factor) = Antenna Factor (dB/m)+ Cable Loss (dB) – Preamplifier(dB) + 20dB Attenuation.
3. Measurement (dBμV/m) = Reading(dBμV) + C.F (Correction Factor).
4. The emission levels of other frequencies are very lower than the limit and not show in test report.

EUT	HAN Access Point	Date of Test	2021-10-07
Factor	DRH18-E	Temp. / Humidity	23°C /49%
Polarity	Horizontal	Site / Test Engineer	AC2 / Jay
Test Mode	802.11ac80_TX_Band4_CH 155	Test Voltage	AC 120V/60Hz

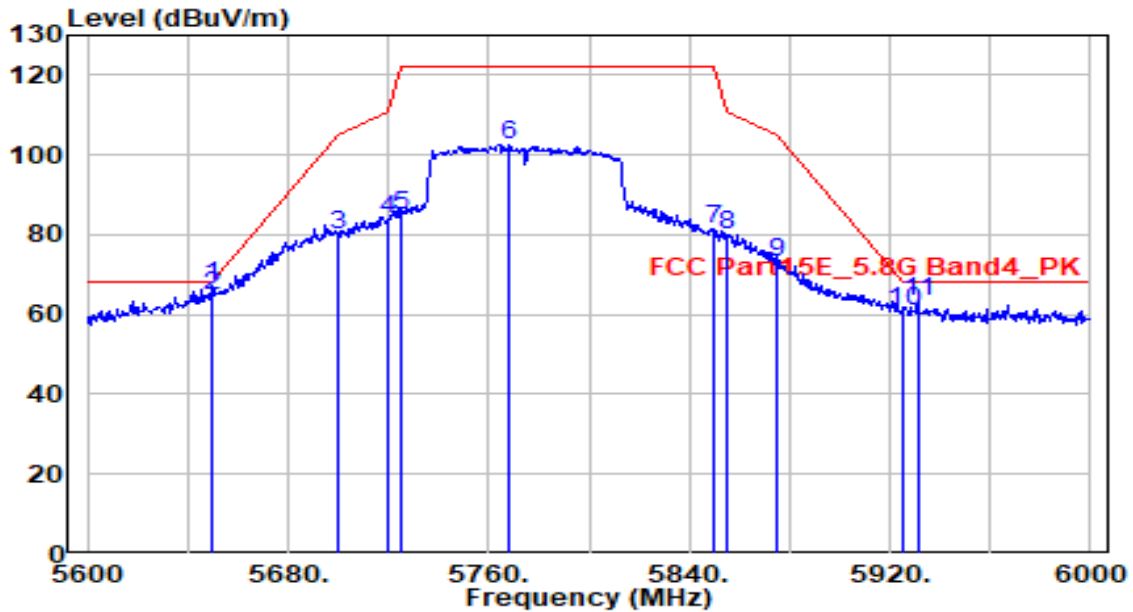

No	Frequency (MHz)	Reading (dBμV)	C.F (dB/m)	Measurement (dBμV/m)	Margin (dB)	Limit (dBμV/m)	Height (cm)	Angle (deg)	Remark (QP/PK/AV)
1	* 5649.200	66.56	0.60	67.16	-1.04	68.20	150	120	Peak
2	5650.000	64.32	0.60	64.93	-3.27	68.20	150	120	Peak
3	5700.000	78.96	0.81	79.77	-25.43	105.20	150	120	Peak
4	5720.000	82.86	0.89	83.76	-27.04	110.80	150	120	Peak
5	5725.000	83.77	0.91	84.68	-37.52	122.20	150	120	Peak
6	5768.400	101.58	1.09	102.67	N/A	N/A	150	120	Peak
7	5850.000	80.30	1.28	81.58	-40.62	122.20	150	120	Peak
8	5855.000	78.68	1.28	79.96	-30.84	110.80	150	120	Peak
9	5875.000	71.71	1.30	73.01	-32.19	105.20	150	120	Peak
10	5925.000	59.39	1.35	60.75	-7.45	68.20	150	120	Peak
11	5931.200	62.13	1.36	63.49	-4.71	68.20	150	120	Peak

Note:

1. " \*", means this data is the worst emission level.
2. C.F (Correction Factor) = Antenna Factor (dB/m)+ Cable Loss (dB) – Preamplifier(dB) + 20dB Attenuation.
3. Measurement (dBμV/m) = Reading(dBμV) + C.F (Correction Factor).
4. The emission levels of other frequencies are very lower than the limit and not show in test report.

EUT	HAN Access Point	Date of Test	2021-10-07
Factor	DRH18-E	Temp. / Humidity	23°C /49%
Polarity	Vertical	Site / Test Engineer	AC2 / Jay
Test Mode	802.11ac80_TX_Band4_CH 155	Test Voltage	AC 120V/60Hz

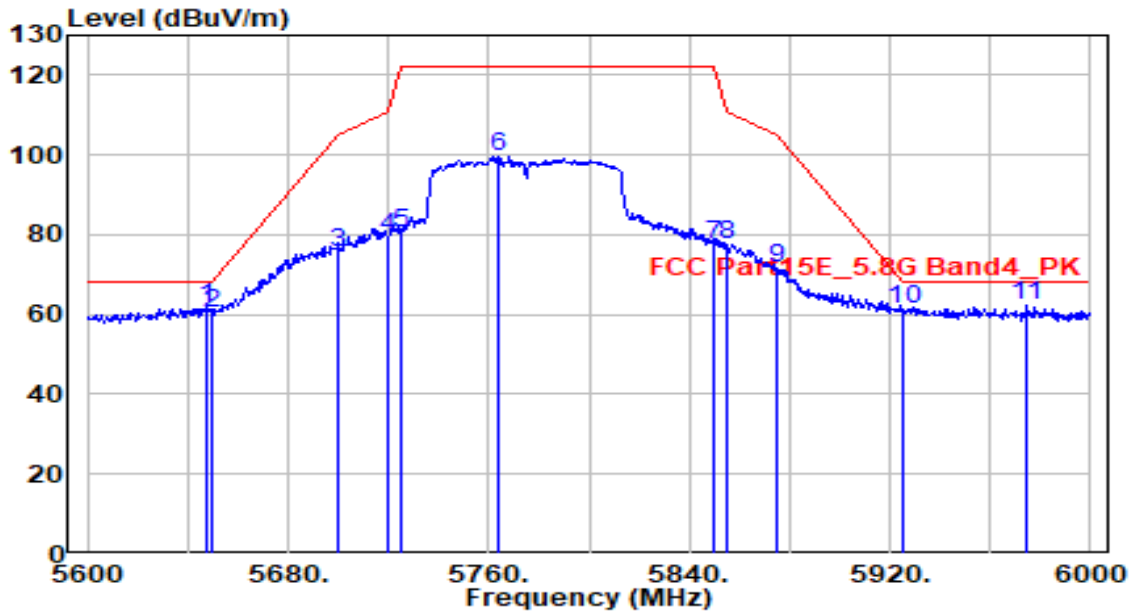

No	Frequency (MHz)	Reading (dBUV)	C.F (dB/m)	Measurement (dBUV/m)	Margin (dB)	Limit (dBUV/m)	Height (cm)	Angle (deg)	Remark (QP/PK/AV)
1	5648.000	61.13	0.60	61.73	-6.47	68.20	250	190	Peak
2	5650.000	59.73	0.60	60.33	-7.87	68.20	250	190	Peak
3	5700.000	74.91	0.81	75.72	-29.48	105.20	250	190	Peak
4	5720.000	78.80	0.89	79.69	-31.11	110.80	250	190	Peak
5	5725.000	79.47	0.91	80.38	-41.82	122.20	250	190	Peak
6	5763.600	98.61	1.07	99.68	N/A	N/A	250	190	Peak
7	5850.000	76.26	1.28	77.53	-44.67	122.20	250	190	Peak
8	5855.000	76.35	1.28	77.63	-33.17	110.80	250	190	Peak
9	5875.000	70.25	1.30	71.55	-33.65	105.20	250	190	Peak
10	5925.000	59.77	1.35	61.12	-7.08	68.20	250	190	Peak
11	* 5974.400	61.05	1.40	62.45	-5.75	68.20	250	190	Peak

Note:

1. " \*", means this data is the worst emission level.
2. C.F (Correction Factor) = Antenna Factor (dB/m)+ Cable Loss (dB) – Preamplifier(dB) + 20dB Attenuation.
3. Measurement (dBUV/m) = Reading(dBUV) + C.F (Correction Factor).
4. The emission levels of other frequencies are very lower than the limit and not show in test report.

## 7.8. AC Conducted Emissions Measurement

### 7.8.1. Test Limit

FCC Part 15.207 Limits		
Frequency (MHz)	QP (dB $\mu$ V)	AV (dB $\mu$ V)
0.15 - 0.50	66 - 56	56 - 46
0.50 - 5.0	56	46
5.0 - 30	60	50

Note 1: The lower limit shall apply at the transition frequencies.

Note 2: The limit decreases linearly with the logarithm of the frequency in the range 0.15MHz to 0.5MHz.

### 7.8.2. Test Setup

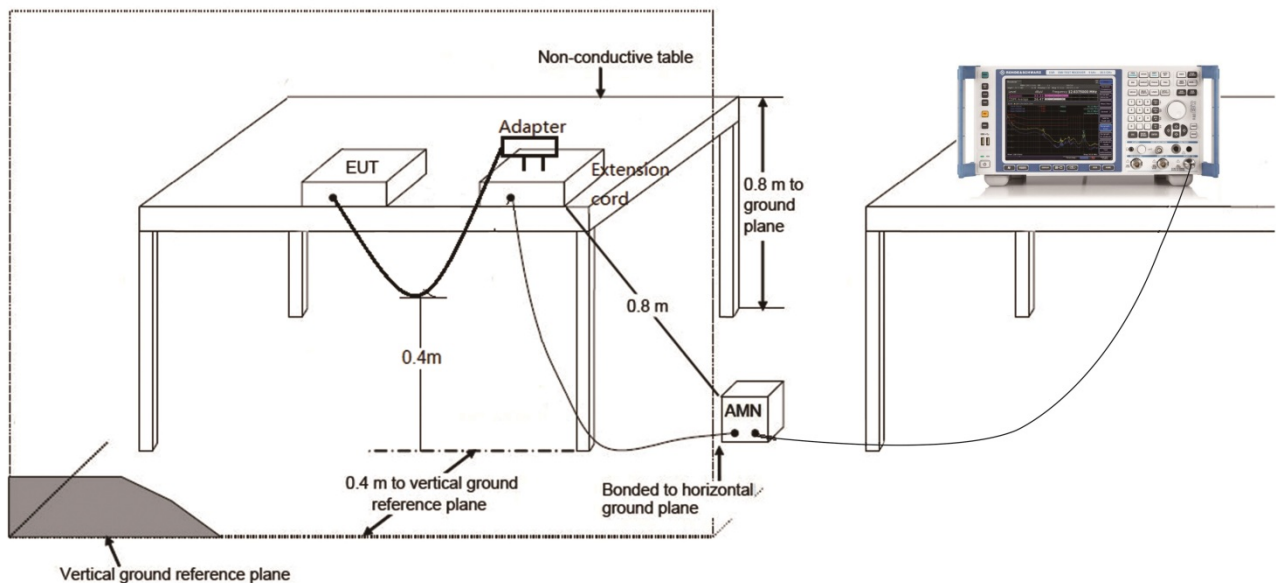

**7.8.3. Test Result**

EUT	HAN Access Point	Date of Test	2021-11-05
Factor	CE_ENV216-N (Filter ON)	Temp. / Humidity	25.3°C / 57.6%
Polarity	Neutral	Site / Test Engineer	SR2 / Eric Lin
Test Mode	Transmit by 802.11a at channel 5745MHz	Test Voltage	AC 120V/60Hz

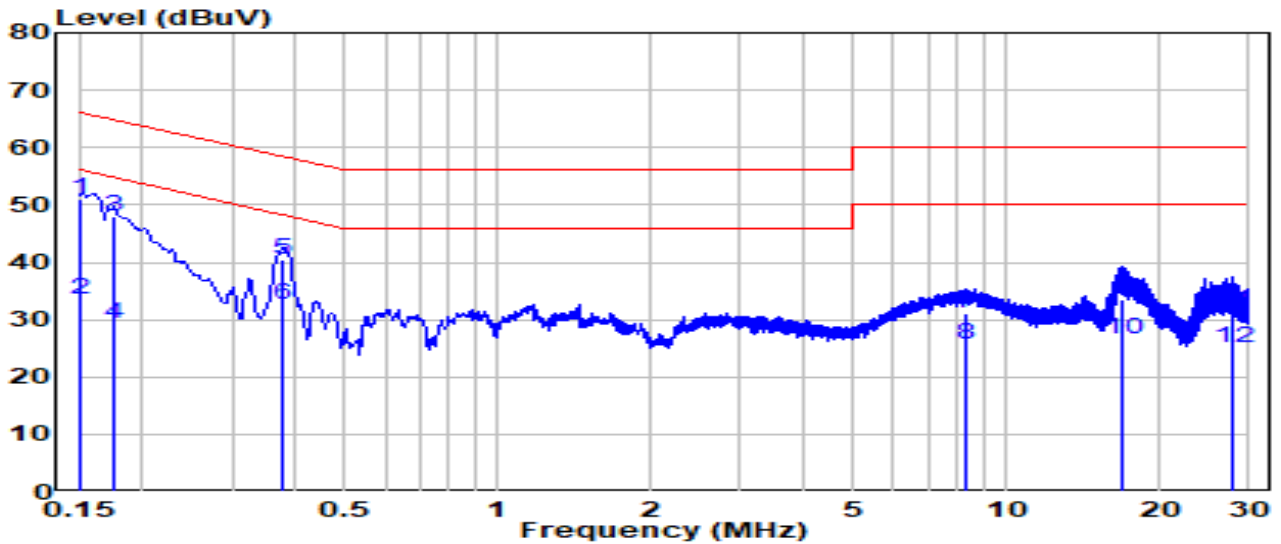

No	Frequency (MHz)	Reading (dBμV)	C.F (dB)	Measurement (dBμV)	Margin (dB)	Limit (dBμV)	Remark (QP/PK/AV)
1	*	41.29	9.62	50.91	-15.08	65.99	QP
2		23.89	9.62	33.51	-22.48	55.99	Average
3		38.29	9.62	47.91	-16.82	64.73	QP
4		19.59	9.62	29.21	-25.52	54.73	Average
5		30.77	9.64	40.41	-17.88	58.29	QP
6		22.97	9.64	32.61	-15.68	48.29	Average
7		21.31	9.87	31.18	-28.82	60.00	QP
8		15.71	9.87	25.58	-24.42	50.00	Average
9		23.39	10.04	33.43	-26.58	60.00	QP
10		16.49	10.04	26.53	-23.48	50.00	Average
11		21.20	10.20	31.39	-28.61	60.00	QP
12		14.90	10.20	25.09	-24.91	50.00	Average

Note:

1. " \*", means this data is the worst emission level.
2. C.F (Correction Factor) = LISN Factor (dB)+ Cable Loss (dB).
3. Measurement(dBμV) = Reading(dBμV) + C.F (Correction Factor).

EUT	HAN Access Point	Date of Test	2021-11-05
Factor	CE_ENV216-L1 (Filter ON)	Temp. / Humidity	25.3°C / 57.6%
Polarity	Line	Site / Test Engineer	SR2 / Eric Lin
Test Mode	Transmit by 802.11a at channel 5745MHz	Test Voltage	AC 120V/60Hz

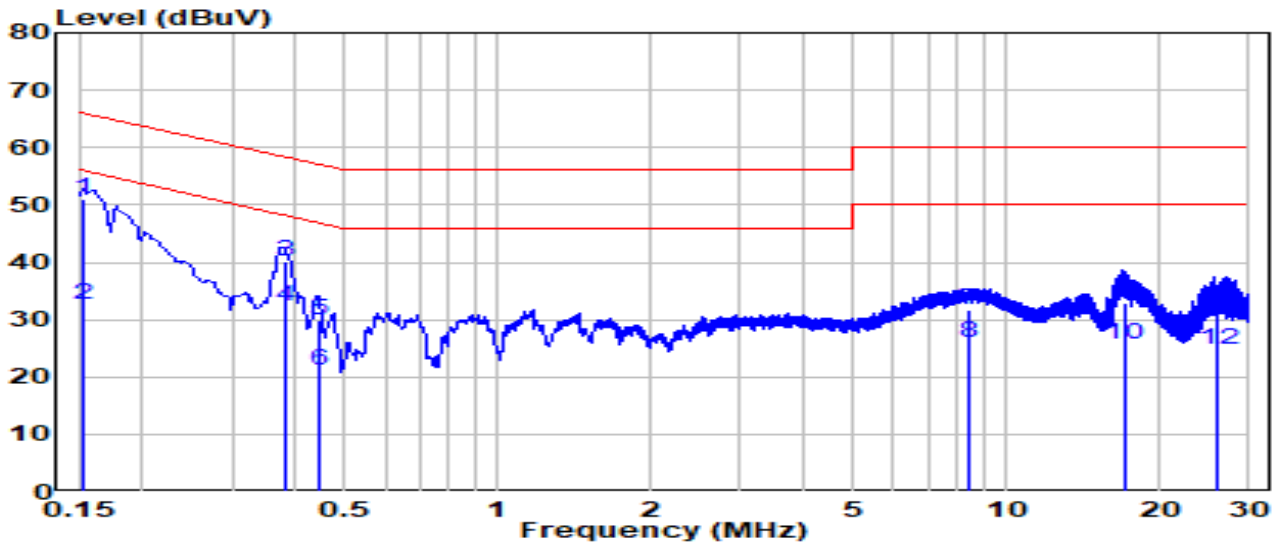

No	Frequency (MHz)	Reading (dBμV)	C.F (dB)	Measurement (dBμV)	Margin (dB)	Limit (dBμV)	Remark (QP/PK/AV)
1	* 0.152	41.41	9.61	51.02	-14.86	65.88	QP
2	0.152	23.11	9.61	32.72	-23.16	55.88	Average
3	0.380	30.48	9.64	40.12	-18.16	58.28	QP
4	0.380	22.78	9.64	32.42	-15.86	48.28	Average
5	0.445	20.38	9.64	30.02	-26.95	56.97	QP
6	0.445	11.38	9.64	21.02	-25.95	46.97	Average
7	8.490	21.74	9.86	31.60	-28.41	60.00	QP
8	8.490	16.04	9.86	25.90	-24.11	50.00	Average
9	17.025	22.84	9.98	32.82	-27.18	60.00	QP
10	17.025	15.74	9.98	25.72	-24.28	50.00	Average
11	26.155	21.51	10.09	31.60	-28.40	60.00	QP
12	26.155	14.81	10.09	24.90	-25.10	50.00	Average

Note:

1. " \*", means this data is the worst emission level.
2. C.F (Correction Factor) = LISN Factor (dB)+ Cable Loss (dB).
3. Measurement(dBμV) = Reading(dBμV) + C.F (Correction Factor).



## 8. CONCLUSION

The data collected relate only the item(s) tested and show that the device is in compliance with Part 15E of the FCC Rules.

————— The End —————

## **Appendix A - Test Setup Photograph**

Refer to “2108TW0005-Test setup photo” file.

## **Appendix B - EUT Photograph**

Refer to "AP331-EUT Photo" file.