

EUT	HAN Access Point	Date of Test	2021-11-12
Factor	BBHA 9120D (1GHz~18GHz)	Temp. / Humidity	23°C/53%
Polarity	Horizontal	Site / Test Engineer	AC1 / Tim
Test Mode	Transmit at 2462MHz by 802.11g	Test Voltage	AC 120V/60Hz

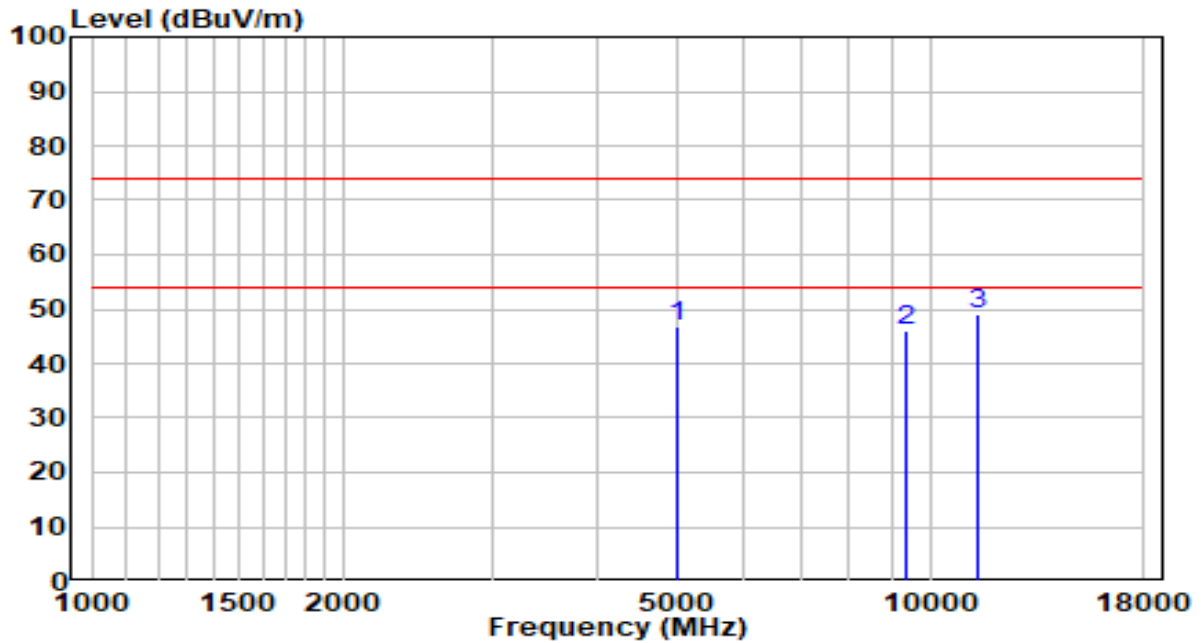

No	Frequency (MHz)	Reading (dB $\mu$ V)	C.F (dB/m)	Measurement (dB $\mu$ V/m)	Margin (dB)	Limit (dB $\mu$ V/m)	Remark (QP/PK/AV)
1	5003.500	42.83	3.96	46.79	-27.21	74.00	Peak
2	9381.000	30.62	15.52	46.14	-27.86	74.00	Peak
3	* 11412.500	29.28	19.92	49.20	-24.80	74.00	Peak

Note:

1. " \*", means this data is the worst emission level.
2. C.F (Correction Factor) = Antenna Factor (dB/m)+ Cable Loss (dB)– Preamplifier(dB).
3. Measurement(dB $\mu$ V/m) = Reading(dB $\mu$ V) + C.F (Correction Factor).

EUT	HAN Access Point	Date of Test	2021-11-12
Factor	BBHA 9120D (1GHz~18GHz)	Temp. / Humidity	23°C/53%
Polarity	Vertical	Site / Test Engineer	AC1 / Tim
Test Mode	Transmit at 2462MHz by 802.11g	Test Voltage	AC 120V/60Hz

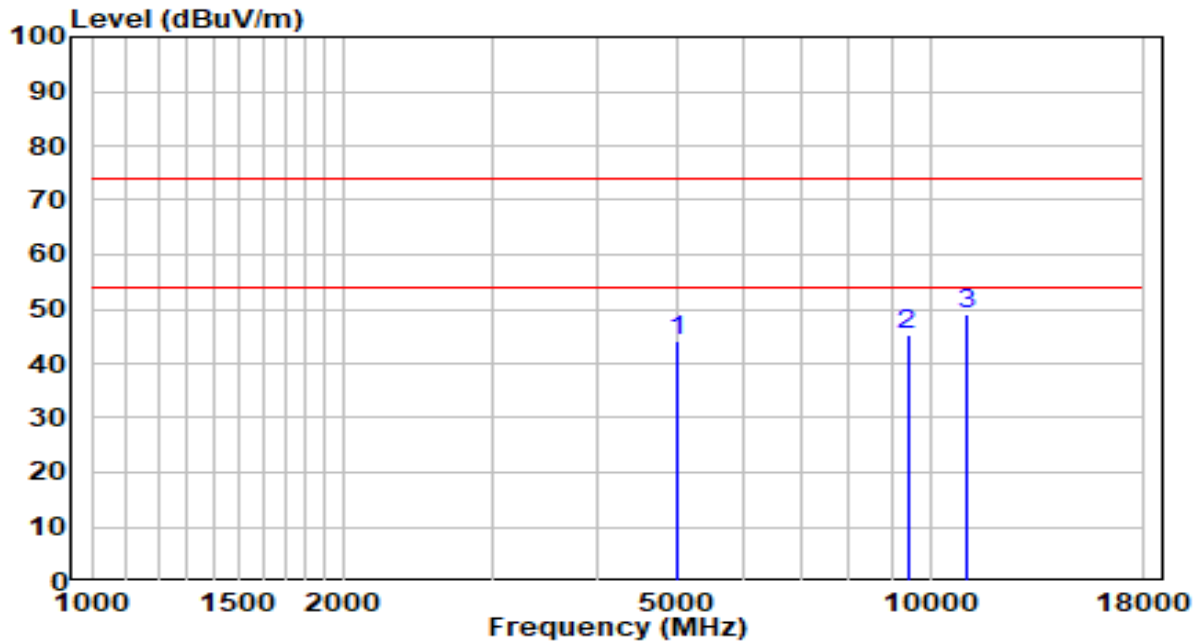

No	Frequency (MHz)	Reading (dB $\mu$ V)	C.F (dB/m)	Measurement (dB $\mu$ V/m)	Margin (dB)	Limit (dB $\mu$ V/m)	Remark (QP/PK/AV)
1	5003.500	40.03	3.96	43.99	-30.01	74.00	Peak
2	9398.000	29.92	15.55	45.47	-28.53	74.00	Peak
3	* 11030.000	29.86	19.33	49.19	-24.81	74.00	Peak

Note:

1. " \*", means this data is the worst emission level.
2. C.F (Correction Factor) = Antenna Factor (dB/m)+ Cable Loss (dB)– Preamplifier(dB).
3. Measurement(dB $\mu$ V/m) = Reading(dB $\mu$ V) + C.F (Correction Factor).

EUT	HAN Access Point	Date of Test	2021-11-12
Factor	BBHA 9120D (1GHz~18GHz)	Temp. / Humidity	23°C/53%
Polarity	Horizontal	Site / Test Engineer	AC1 / Tim
Test Mode	Transmit at 2412MHz by 802.11n-HT20	Test Voltage	AC 120V/60Hz

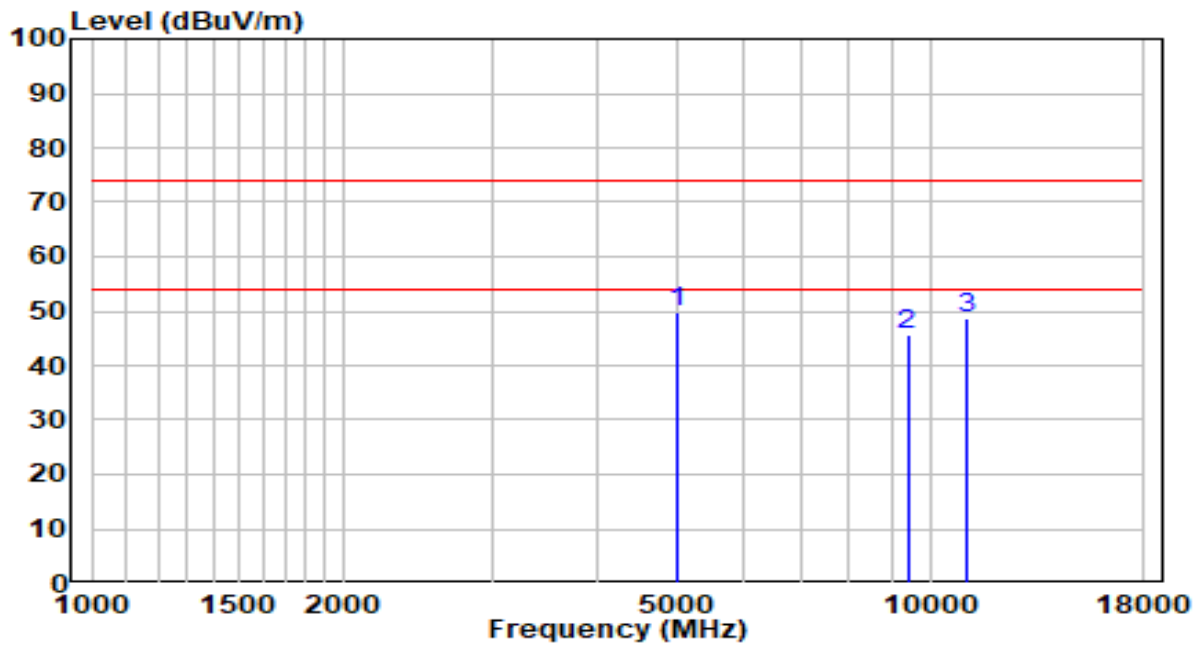

No	Frequency (MHz)	Reading (dB $\mu$ V)	C.F (dB/m)	Measurement (dB $\mu$ V/m)	Margin (dB)	Limit (dB $\mu$ V/m)	Remark (QP/PK/AV)
1	* 5003.500	45.68	3.96	49.64	-24.36	74.00	Peak
2	9398.000	30.15	15.55	45.70	-28.30	74.00	Peak
3	11064.000	29.48	19.38	48.86	-25.14	74.00	Peak

Note:

1. " \*", means this data is the worst emission level.
2. C.F (Correction Factor) = Antenna Factor (dB/m)+ Cable Loss (dB)– Preamplifier(dB).
3. Measurement(dB $\mu$ V/m) = Reading(dB $\mu$ V) + C.F (Correction Factor).

EUT	HAN Access Point	Date of Test	2021-11-12
Factor	BBHA 9120D (1GHz~18GHz)	Temp. / Humidity	23°C/53%
Polarity	Vertical	Site / Test Engineer	AC1 / Tim
Test Mode	Transmit at 2412MHz by 802.11n-HT20	Test Voltage	AC 120V/60Hz

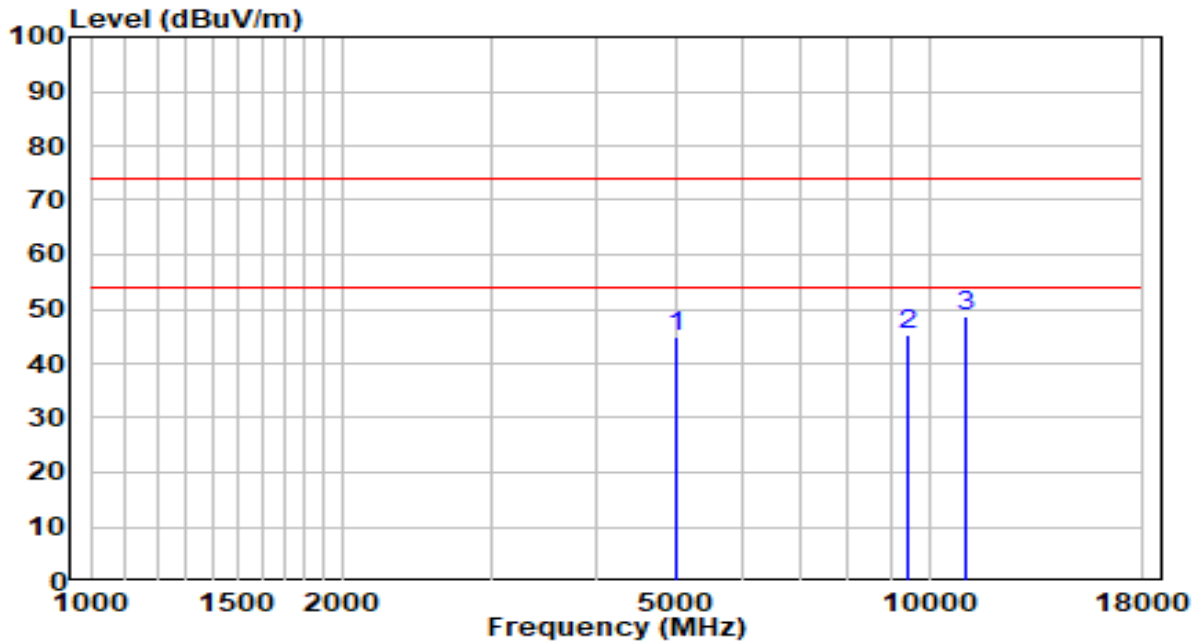

No	Frequency (MHz)	Reading (dB $\mu$ V)	C.F (dB/m)	Measurement (dB $\mu$ V/m)	Margin (dB)	Limit (dB $\mu$ V/m)	Remark (QP/PK/AV)
1	5003.500	41.09	3.96	45.05	-28.95	74.00	Peak
2	9440.500	29.61	15.62	45.23	-28.77	74.00	Peak
3	* 11047.000	29.32	19.35	48.67	-25.33	74.00	Peak

Note:

1. " \*", means this data is the worst emission level.
2. C.F (Correction Factor) = Antenna Factor (dB/m)+ Cable Loss (dB)– Preamplifier(dB).
3. Measurement(dB $\mu$ V/m) = Reading(dB $\mu$ V) + C.F (Correction Factor).

EUT	HAN Access Point	Date of Test	2021-11-12
Factor	BBHA 9120D (1GHz~18GHz)	Temp. / Humidity	23°C/53%
Polarity	Horizontal	Site / Test Engineer	AC1 / Tim
Test Mode	Transmit at 2437MHz by 802.11n-HT20	Test Voltage	AC 120V/60Hz

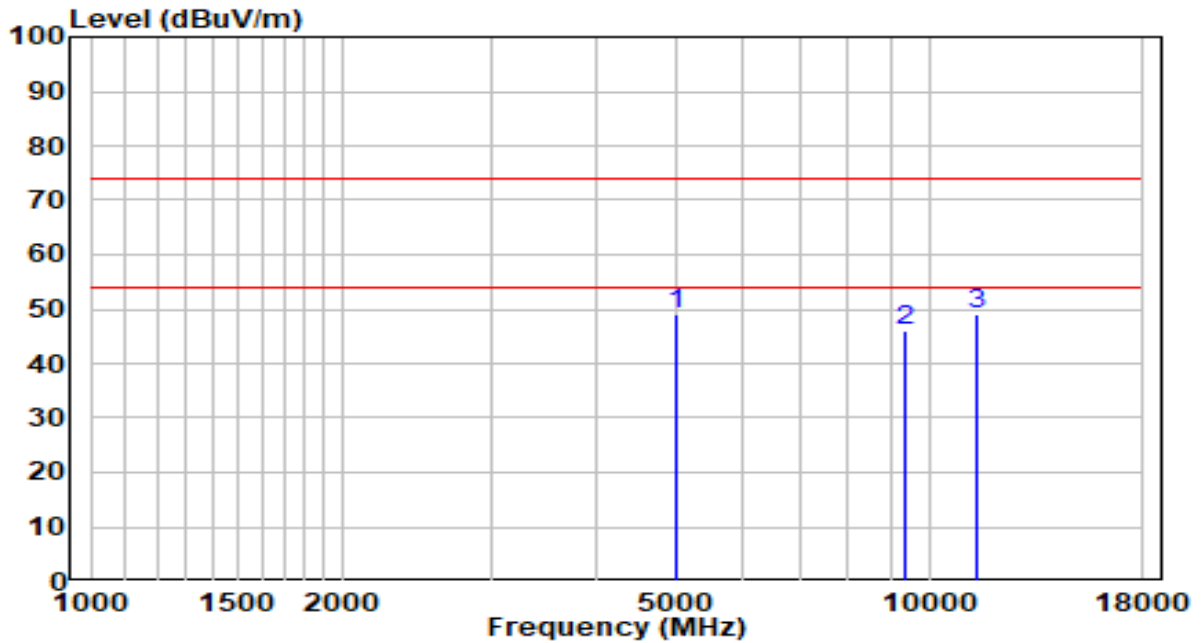

No	Frequency (MHz)	Reading (dB $\mu$ V)	C.F (dB/m)	Measurement (dB $\mu$ V/m)	Margin (dB)	Limit (dB $\mu$ V/m)	Remark (QP/PK/AV)
1	* 5003.500	45.20	3.96	49.16	-24.84	74.00	Peak
2	9355.500	30.40	15.48	45.88	-28.12	74.00	Peak
3	11421.000	29.16	19.93	49.09	-24.91	74.00	Peak

Note:

1. " \*", means this data is the worst emission level.
2. C.F (Correction Factor) = Antenna Factor (dB/m)+ Cable Loss (dB)– Preamplifier(dB).
3. Measurement(dB $\mu$ V/m) = Reading(dB $\mu$ V) + C.F (Correction Factor).

EUT	HAN Access Point	Date of Test	2021-11-12
Factor	BBHA 9120D (1GHz~18GHz)	Temp. / Humidity	23°C/53%
Polarity	Vertical	Site / Test Engineer	AC1 / Tim
Test Mode	Transmit at 2437MHz by 802.11n-HT20	Test Voltage	AC 120V/60Hz

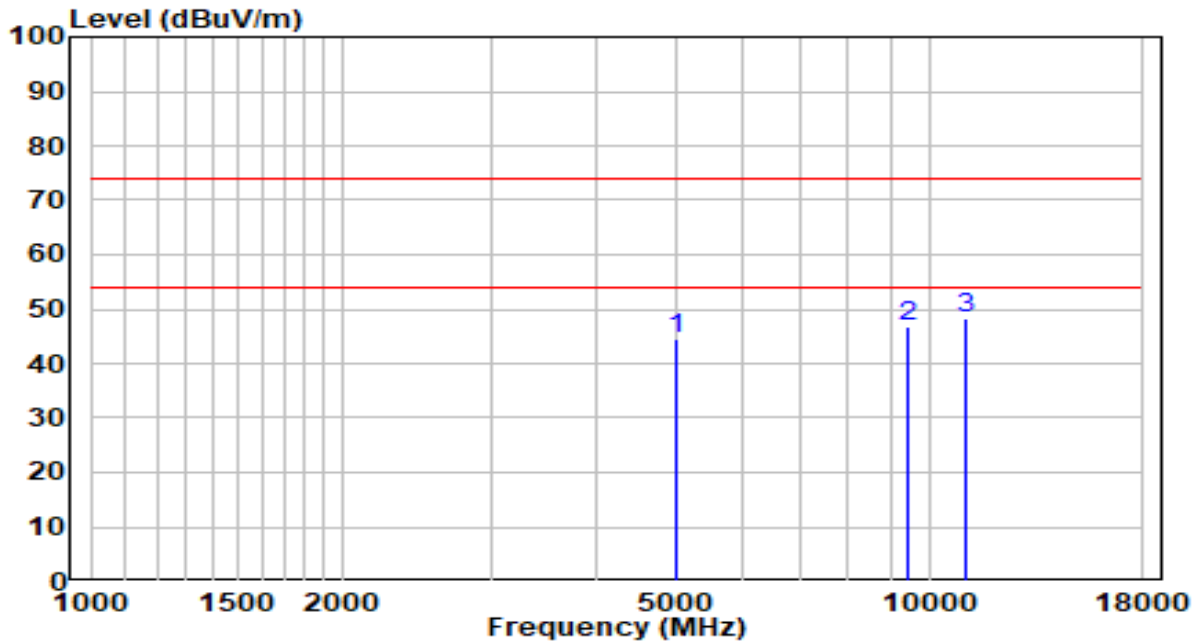

No	Frequency (MHz)	Reading (dB $\mu$ V)	C.F (dB/m)	Measurement (dB $\mu$ V/m)	Margin (dB)	Limit (dB $\mu$ V/m)	Remark (QP/PK/AV)
1	5003.500	40.48	3.96	44.44	-29.56	74.00	Peak
2	9415.000	31.05	15.58	46.63	-27.37	74.00	Peak
3	* 11038.500	28.97	19.34	48.31	-25.69	74.00	Peak

Note:

1. " \*", means this data is the worst emission level.
2. C.F (Correction Factor) = Antenna Factor (dB/m)+ Cable Loss (dB)– Preamplifier(dB).
3. Measurement(dB $\mu$ V/m) = Reading(dB $\mu$ V) + C.F (Correction Factor).

EUT	HAN Access Point	Date of Test	2021-11-12
Factor	BBHA 9120D (1GHz~18GHz)	Temp. / Humidity	23°C/53%
Polarity	Horizontal	Site / Test Engineer	AC1 / Tim
Test Mode	Transmit at 2462MHz by 802.11n-HT20	Test Voltage	AC 120V/60Hz

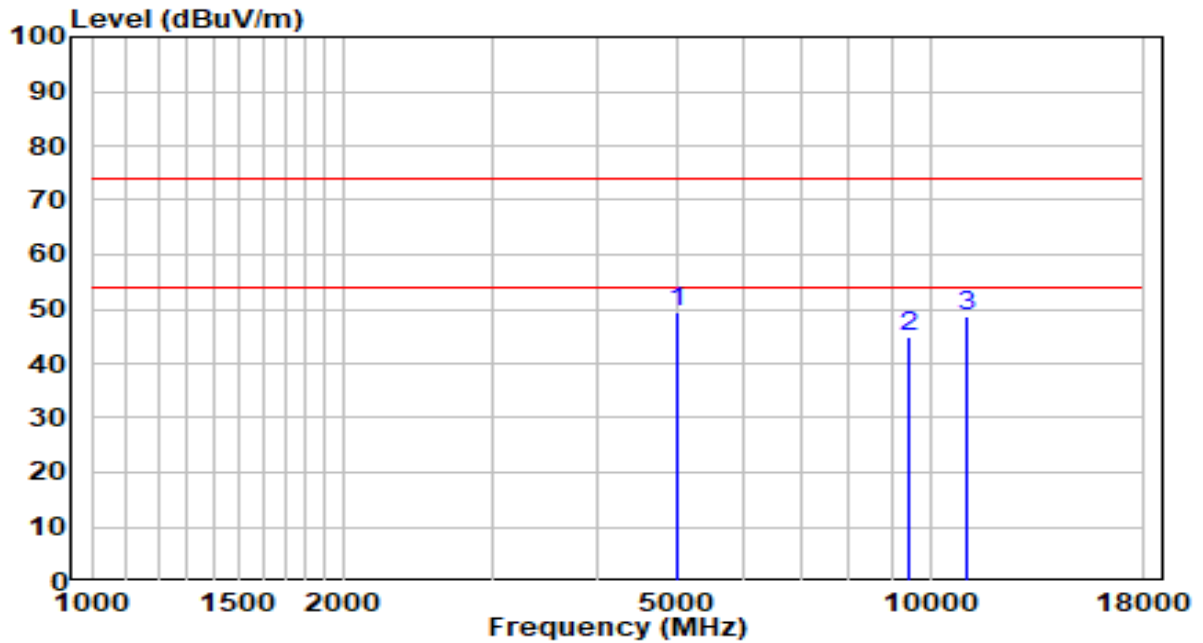

No	Frequency (MHz)	Reading (dB $\mu$ V)	C.F (dB/m)	Measurement (dB $\mu$ V/m)	Margin (dB)	Limit (dB $\mu$ V/m)	Remark (QP/PK/AV)
1	* 5003.500	45.47	3.96	49.43	-24.57	74.00	Peak
2	9415.000	29.29	15.58	44.87	-29.13	74.00	Peak
3	11081.000	29.11	19.40	48.51	-25.49	74.00	Peak

Note:

1. " \*", means this data is the worst emission level.
2. C.F (Correction Factor) = Antenna Factor (dB/m)+ Cable Loss (dB)– Preamplifier(dB).
3. Measurement(dB $\mu$ V/m) = Reading(dB $\mu$ V) + C.F (Correction Factor).

EUT	HAN Access Point	Date of Test	2021-11-12
Factor	BBHA 9120D (1GHz~18GHz)	Temp. / Humidity	23°C/53%
Polarity	Vertical	Site / Test Engineer	AC1 / Tim
Test Mode	Transmit at 2462MHz by 802.11n-HT20	Test Voltage	AC 120V/60Hz

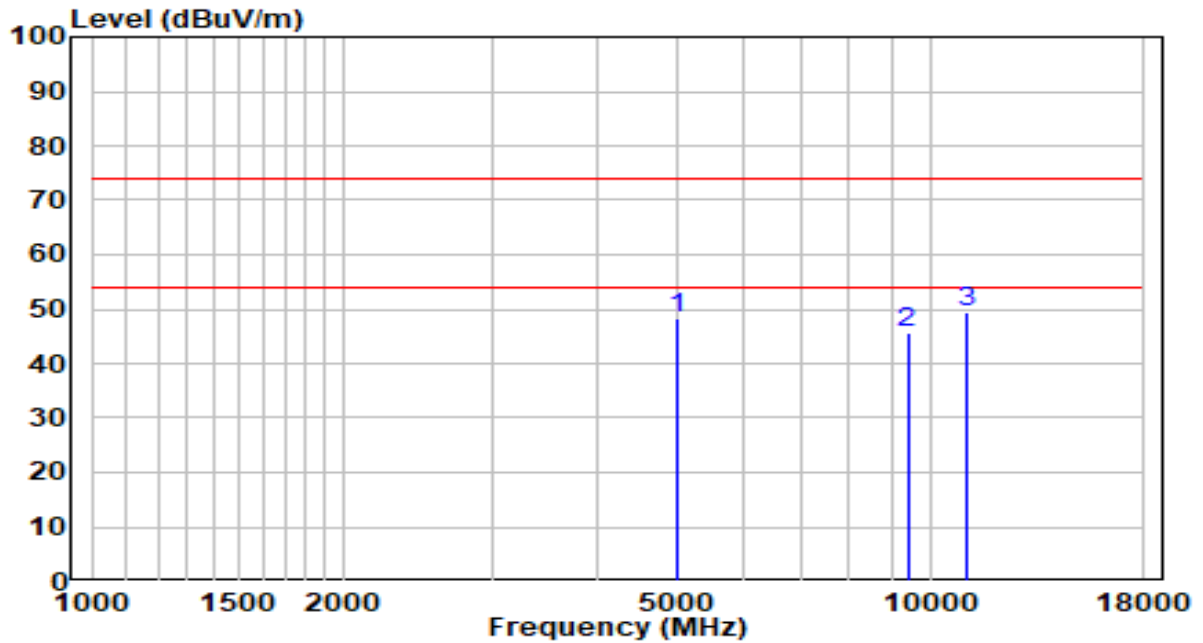

No	Frequency (MHz)	Reading (dB $\mu$ V)	C.F (dB/m)	Measurement (dB $\mu$ V/m)	Margin (dB)	Limit (dB $\mu$ V/m)	Remark (QP/PK/AV)
1	5003.500	44.36	3.96	48.32	-25.68	74.00	Peak
2	9398.000	30.05	15.55	45.60	-28.40	74.00	Peak
3	* 11038.500	30.11	19.34	49.45	-24.55	74.00	Peak

Note:

1. " \*", means this data is the worst emission level.
2. C.F (Correction Factor) = Antenna Factor (dB/m)+ Cable Loss (dB)– Preamplifier(dB).
3. Measurement(dB $\mu$ V/m) = Reading(dB $\mu$ V) + C.F (Correction Factor).



EUT	HAN Access Point	Date of Test	2021-11-12
Factor	BBHA 9120D (1GHz~18GHz)	Temp. / Humidity	23°C/53%
Polarity	Horizontal	Site / Test Engineer	AC1 / Tim
Test Mode	Transmit at 2422MHz by 802.11n-HT40	Test Voltage	AC 120V/60Hz

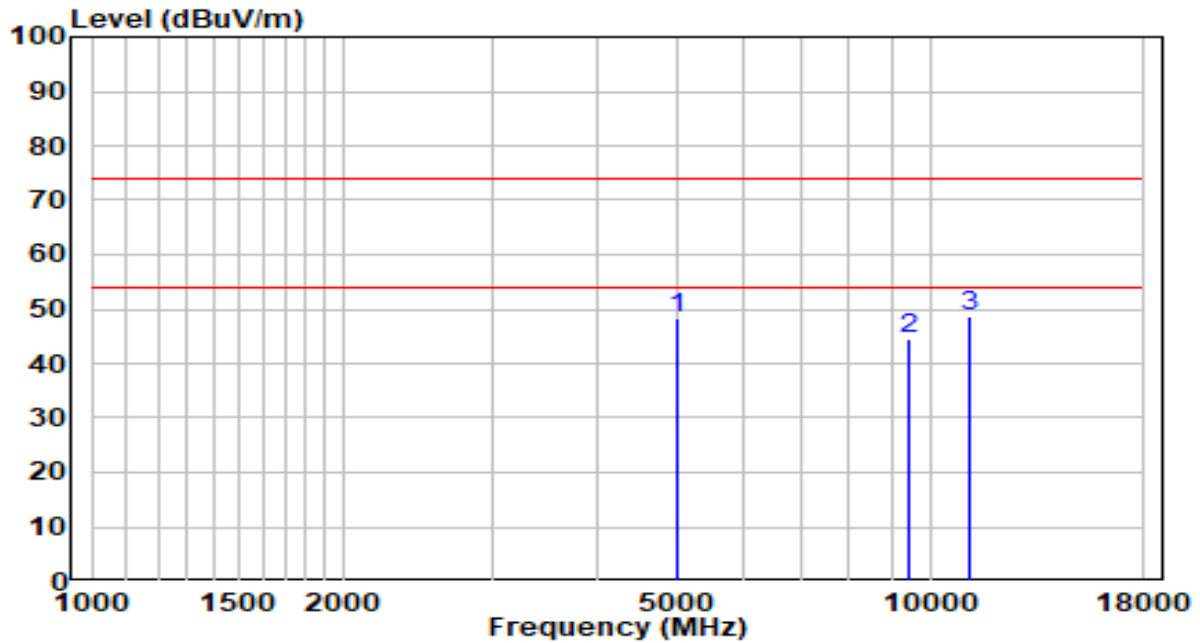

No	Frequency (MHz)	Reading (dB $\mu$ V)	C.F (dB/m)	Measurement (dB $\mu$ V/m)	Margin (dB)	Limit (dB $\mu$ V/m)	Remark (QP/PK/AV)
1	5003.500	44.33	3.96	48.29	-25.71	74.00	Peak
2	9440.500	28.82	15.62	44.44	-29.56	74.00	Peak
3	* 11140.500	29.13	19.50	48.63	-25.37	74.00	Peak

Note:

1. " \*", means this data is the worst emission level.
2. C.F (Correction Factor) = Antenna Factor (dB/m)+ Cable Loss (dB)– Preamplifier(dB).
3. Measurement(dB $\mu$ V/m) = Reading(dB $\mu$ V) + C.F (Correction Factor).

EUT	HAN Access Point	Date of Test	2021-11-12
Factor	BBHA 9120D (1GHz~18GHz)	Temp. / Humidity	23°C/53%
Polarity	Vertical	Site / Test Engineer	AC1 / Tim
Test Mode	Transmit at 2422MHz by 802.11n-HT40	Test Voltage	AC 120V/60Hz

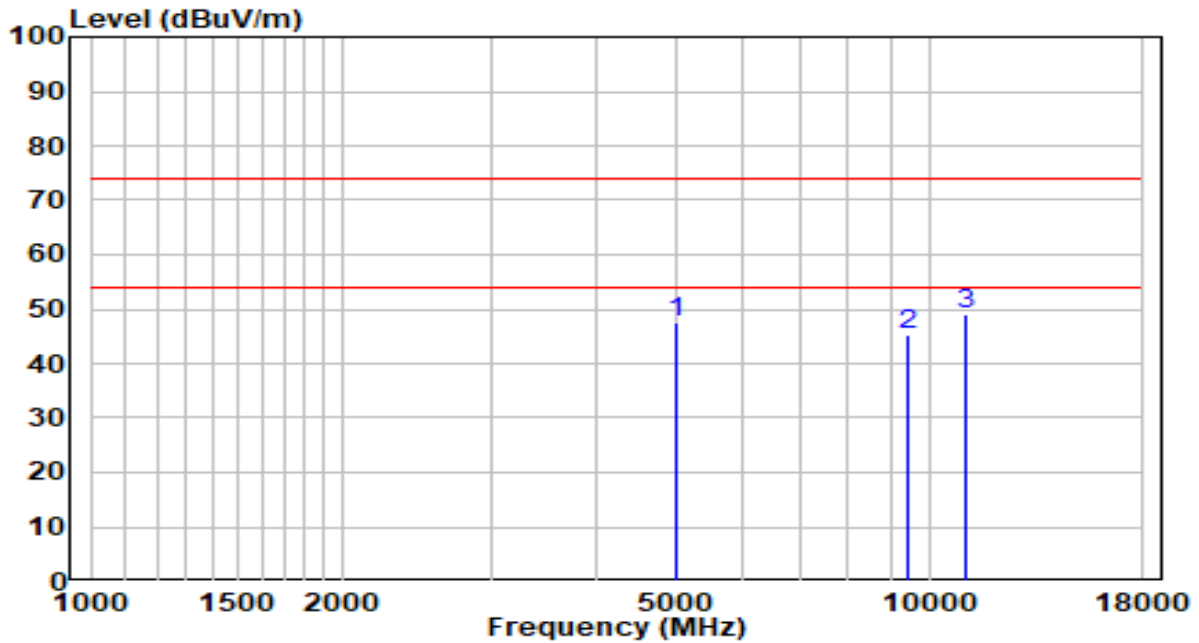

No	Frequency (MHz)	Reading (dB $\mu$ V)	C.F (dB/m)	Measurement (dB $\mu$ V/m)	Margin (dB)	Limit (dB $\mu$ V/m)	Remark (QP/PK/AV)
1	5003.500	43.51	3.96	47.47	-26.53	74.00	Peak
2	9440.500	29.49	15.62	45.11	-28.89	74.00	Peak
3	* 11030.000	29.86	19.33	49.19	-24.81	74.00	Peak

Note:

1. " \*", means this data is the worst emission level.
2. C.F (Correction Factor) = Antenna Factor (dB/m)+ Cable Loss (dB)– Preamplifier(dB).
3. Measurement(dB $\mu$ V/m) = Reading(dB $\mu$ V) + C.F (Correction Factor).

EUT	HAN Access Point	Date of Test	2021-11-12
Factor	BBHA 9120D (1GHz~18GHz)	Temp. / Humidity	23°C/53%
Polarity	Horizontal	Site / Test Engineer	AC1 / Tim
Test Mode	Transmit at 2427MHz by 802.11n-HT40	Test Voltage	AC 120V/60Hz

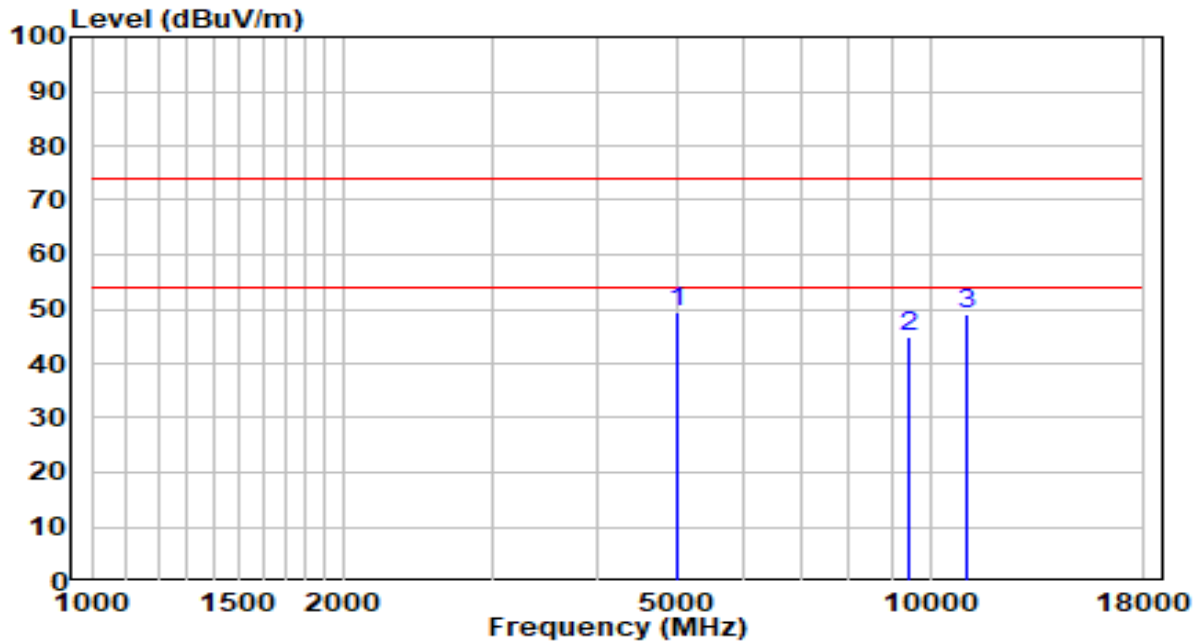

No	Frequency (MHz)	Reading (dB $\mu$ V)	C.F (dB/m)	Measurement (dB $\mu$ V/m)	Margin (dB)	Limit (dB $\mu$ V/m)	Remark (QP/PK/AV)
1	* 5003.500	45.48	3.96	49.44	-24.56	74.00	Peak
2	9440.500	29.29	15.62	44.91	-29.09	74.00	Peak
3	11064.000	29.61	19.38	48.99	-25.01	74.00	Peak

Note:

1. " \*", means this data is the worst emission level.
2. C.F (Correction Factor) = Antenna Factor (dB/m)+ Cable Loss (dB)– Preamplifier(dB).
3. Measurement(dB $\mu$ V/m) = Reading(dB $\mu$ V) + C.F (Correction Factor).

EUT	HAN Access Point	Date of Test	2021-11-12
Factor	BBHA 9120D (1GHz~18GHz)	Temp. / Humidity	23°C/53%
Polarity	Vertical	Site / Test Engineer	AC1 / Tim
Test Mode	Transmit at 2427MHz by 802.11n-HT40	Test Voltage	AC 120V/60Hz

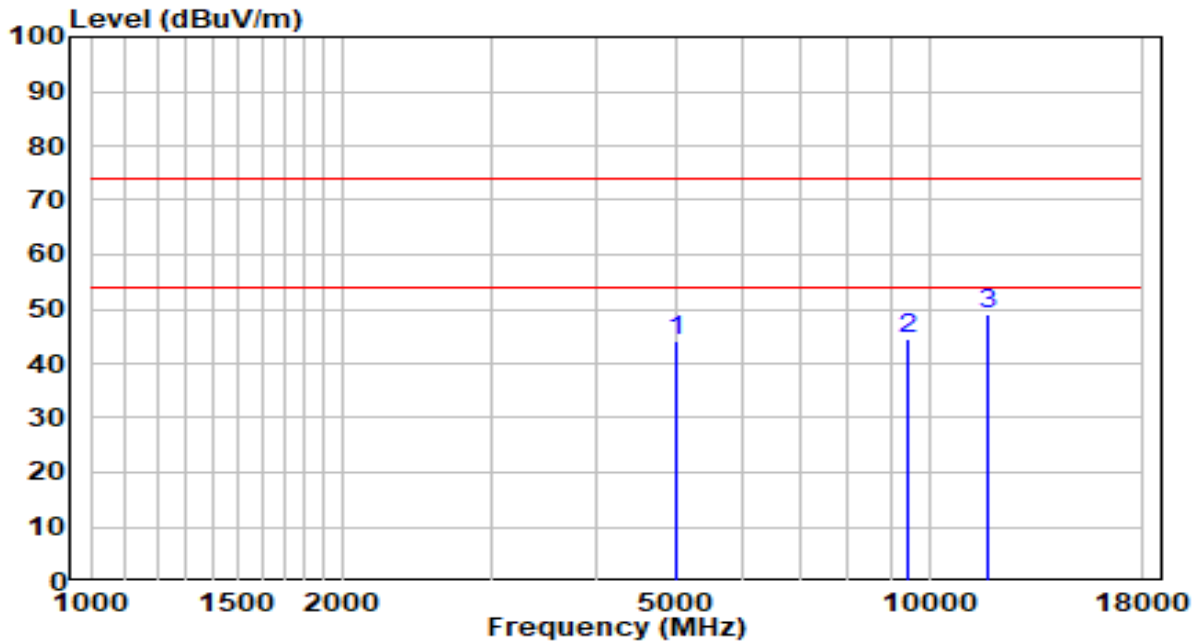

No	Frequency (MHz)	Reading (dB $\mu$ V)	C.F (dB/m)	Measurement (dB $\mu$ V/m)	Margin (dB)	Limit (dB $\mu$ V/m)	Remark (QP/PK/AV)
1	5003.500	40.17	3.96	44.13	-29.87	74.00	Peak
2	9440.500	28.94	15.62	44.56	-29.44	74.00	Peak
3	* 11718.500	29.34	19.56	48.90	-25.10	74.00	Peak

Note:

1. " \*", means this data is the worst emission level.
2. C.F (Correction Factor) = Antenna Factor (dB/m)+ Cable Loss (dB)– Preamplifier(dB).
3. Measurement(dB $\mu$ V/m) = Reading(dB $\mu$ V) + C.F (Correction Factor).

EUT	HAN Access Point	Date of Test	2021-11-12
Factor	BBHA 9120D (1GHz~18GHz)	Temp. / Humidity	23°C/53%
Polarity	Horizontal	Site / Test Engineer	AC1 / Tim
Test Mode	Transmit at 2437MHz by 802.11n-HT40	Test Voltage	AC 120V/60Hz

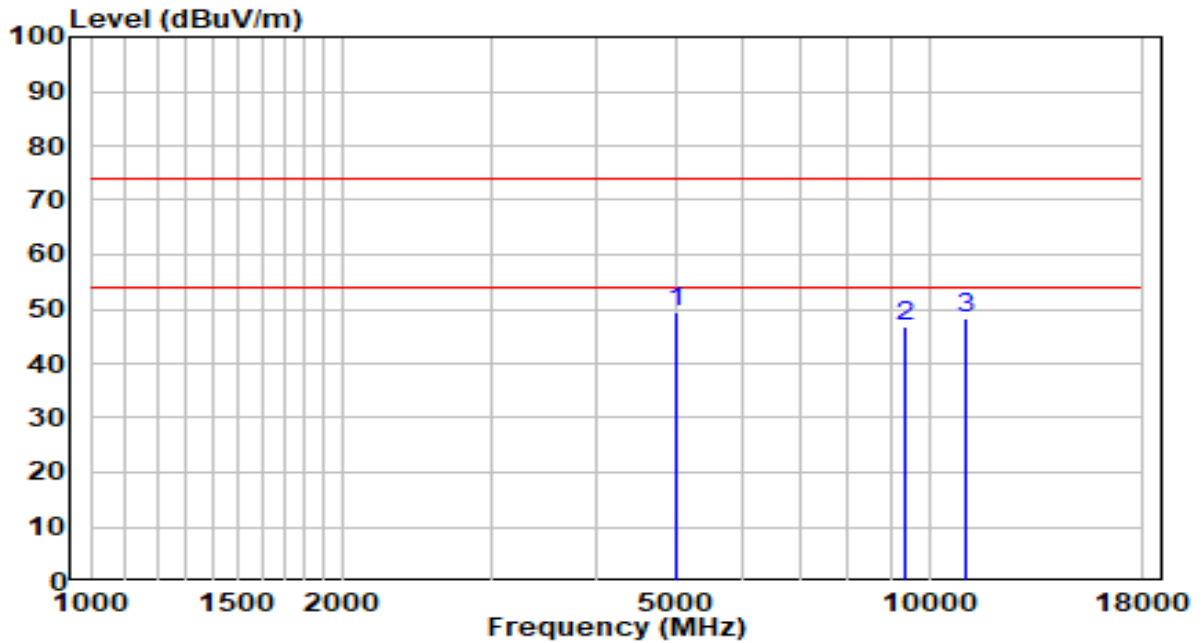

No	Frequency (MHz)	Reading (dB $\mu$ V)	C.F (dB/m)	Measurement (dB $\mu$ V/m)	Margin (dB)	Limit (dB $\mu$ V/m)	Remark (QP/PK/AV)
1	* 5003.500	45.39	3.96	49.35	-24.65	74.00	Peak
2	9381.000	31.09	15.52	46.61	-27.39	74.00	Peak
3	11038.500	29.05	19.34	48.39	-25.61	74.00	Peak

Note:

1. " \*", means this data is the worst emission level.
2. C.F (Correction Factor) = Antenna Factor (dB/m)+ Cable Loss (dB)– Preamplifier(dB).
3. Measurement(dB $\mu$ V/m) = Reading(dB $\mu$ V) + C.F (Correction Factor).

EUT	HAN Access Point	Date of Test	2021-11-12
Factor	BBHA 9120D (1GHz~18GHz)	Temp. / Humidity	23°C/53%
Polarity	Vertical	Site / Test Engineer	AC1 / Tim
Test Mode	Transmit at 2437MHz by 802.11n-HT40	Test Voltage	AC 120V/60Hz

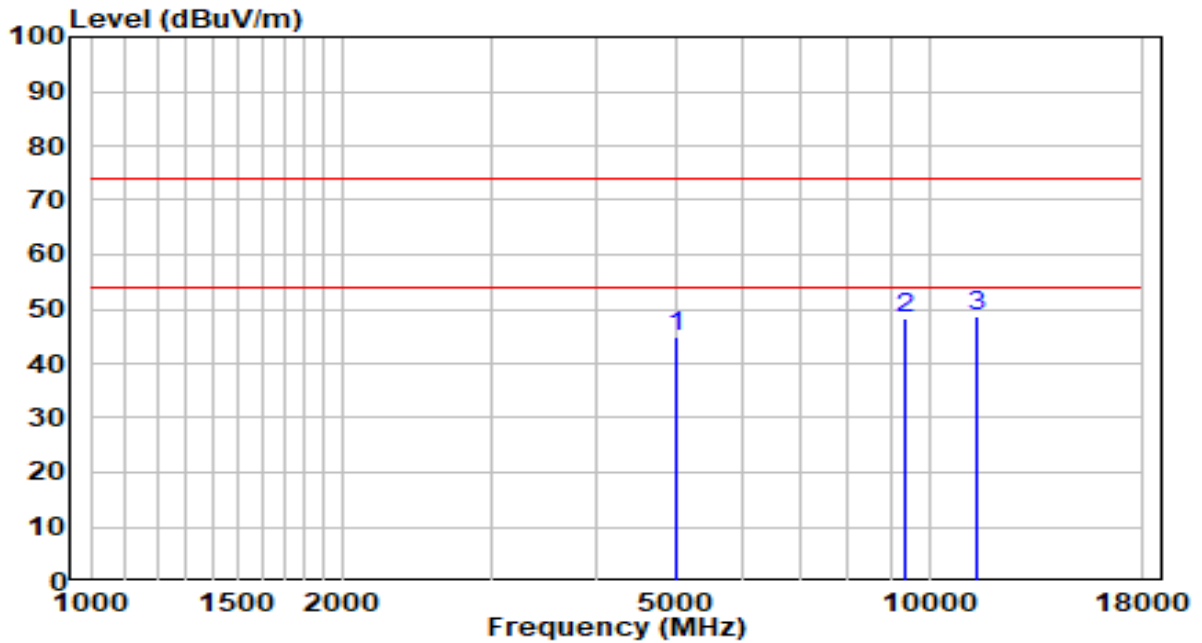

No	Frequency (MHz)	Reading (dB $\mu$ V)	C.F (dB/m)	Measurement (dB $\mu$ V/m)	Margin (dB)	Limit (dB $\mu$ V/m)	Remark (QP/PK/AV)
1	5003.500	40.90	3.96	44.86	-29.14	74.00	Peak
2	9389.500	32.79	15.53	48.32	-25.68	74.00	Peak
3	* 11429.500	28.77	19.94	48.71	-25.29	74.00	Peak

Note:

1. " \*", means this data is the worst emission level.
2. C.F (Correction Factor) = Antenna Factor (dB/m)+ Cable Loss (dB)– Preamplifier(dB).
3. Measurement(dB $\mu$ V/m) = Reading(dB $\mu$ V) + C.F (Correction Factor).

EUT	HAN Access Point	Date of Test	2021-11-12
Factor	BBHA 9120D (1GHz~18GHz)	Temp. / Humidity	23°C/53%
Polarity	Horizontal	Site / Test Engineer	AC1 / Tim
Test Mode	Transmit at 2452MHz by 802.11n-HT40	Test Voltage	AC 120V/60Hz

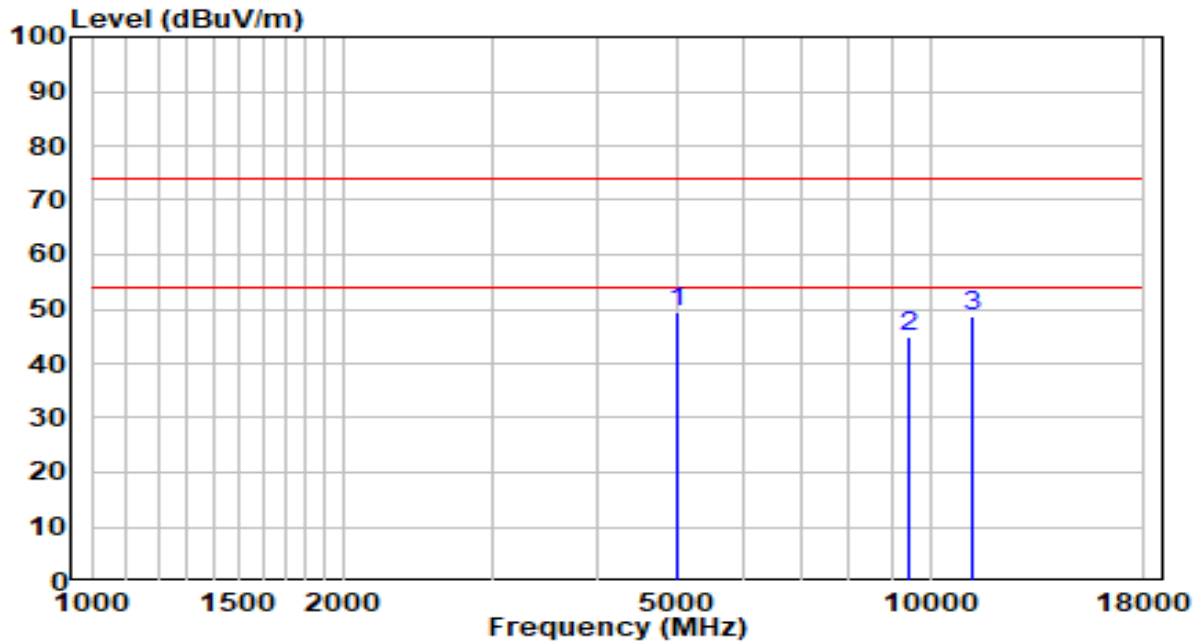

No	Frequency (MHz)	Reading (dB $\mu$ V)	C.F (dB/m)	Measurement (dB $\mu$ V/m)	Margin (dB)	Limit (dB $\mu$ V/m)	Remark (QP/PK/AV)
1	* 5003.500	45.62	3.96	49.58	-24.42	74.00	Peak
2	9440.500	29.21	15.62	44.83	-29.17	74.00	Peak
3	11259.500	29.01	19.68	48.69	-25.31	74.00	Peak

Note:

1. " \*", means this data is the worst emission level.
2. C.F (Correction Factor) = Antenna Factor (dB/m)+ Cable Loss (dB)– Preamplifier(dB).
3. Measurement(dB $\mu$ V/m) = Reading(dB $\mu$ V) + C.F (Correction Factor).

EUT	HAN Access Point	Date of Test	2021-11-12
Factor	BBHA 9120D (1GHz~18GHz)	Temp. / Humidity	23°C/53%
Polarity	Vertical	Site / Test Engineer	AC1 / Tim
Test Mode	Transmit at 2452MHz by 802.11n-HT40	Test Voltage	AC 120V/60Hz

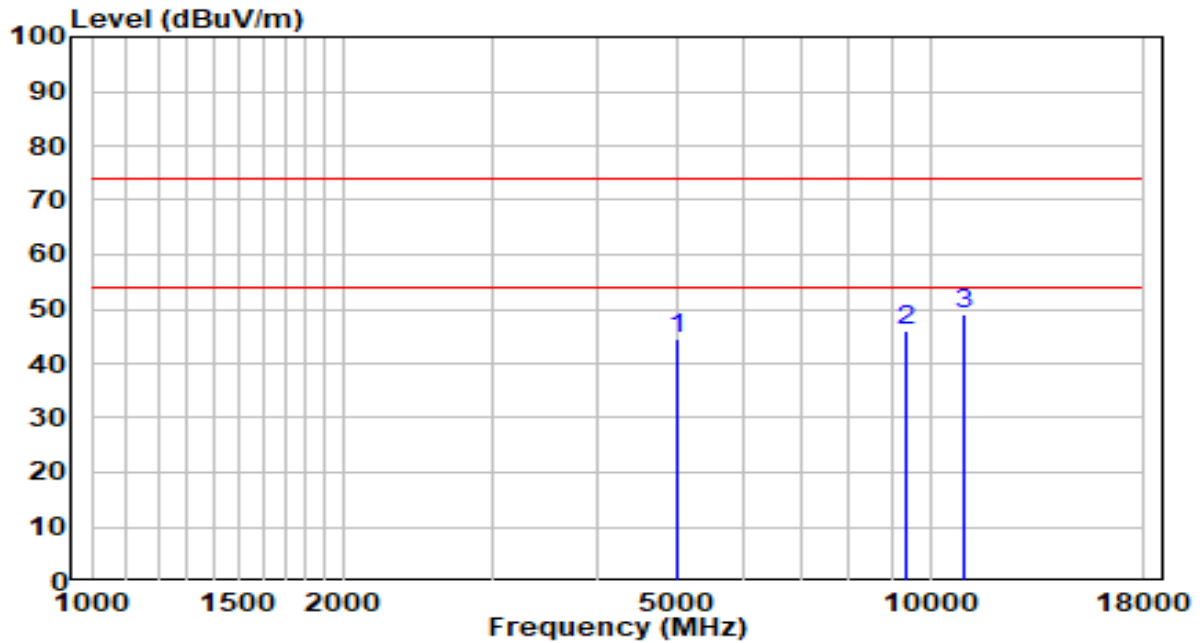

No	Frequency (MHz)	Reading (dB $\mu$ V)	C.F (dB/m)	Measurement (dB $\mu$ V/m)	Margin (dB)	Limit (dB $\mu$ V/m)	Remark (QP/PK/AV)
1	5003.500	40.53	3.96	44.49	-29.51	74.00	Peak
2	9381.000	30.60	15.52	46.12	-27.88	74.00	Peak
3	* 10953.500	29.69	19.21	48.90	-25.10	74.00	Peak

Note:

1. " \*", means this data is the worst emission level.
2. C.F (Correction Factor) = Antenna Factor (dB/m)+ Cable Loss (dB)– Preamplifier(dB).
3. Measurement(dB $\mu$ V/m) = Reading(dB $\mu$ V) + C.F (Correction Factor).



**The Result of Radiated Emission below 1GHz:**

EUT	HAN Access Point	Date of Test	2021-11-13
Factor	VULB 9162	Temp. / Humidity	21°C /47%
Polarity	Horizontal	Site / Test Engineer	AC1 / Tim
Test Mode	Transmit by 802.11b at channel 2437MHz	Test Voltage	AC 120V/60Hz

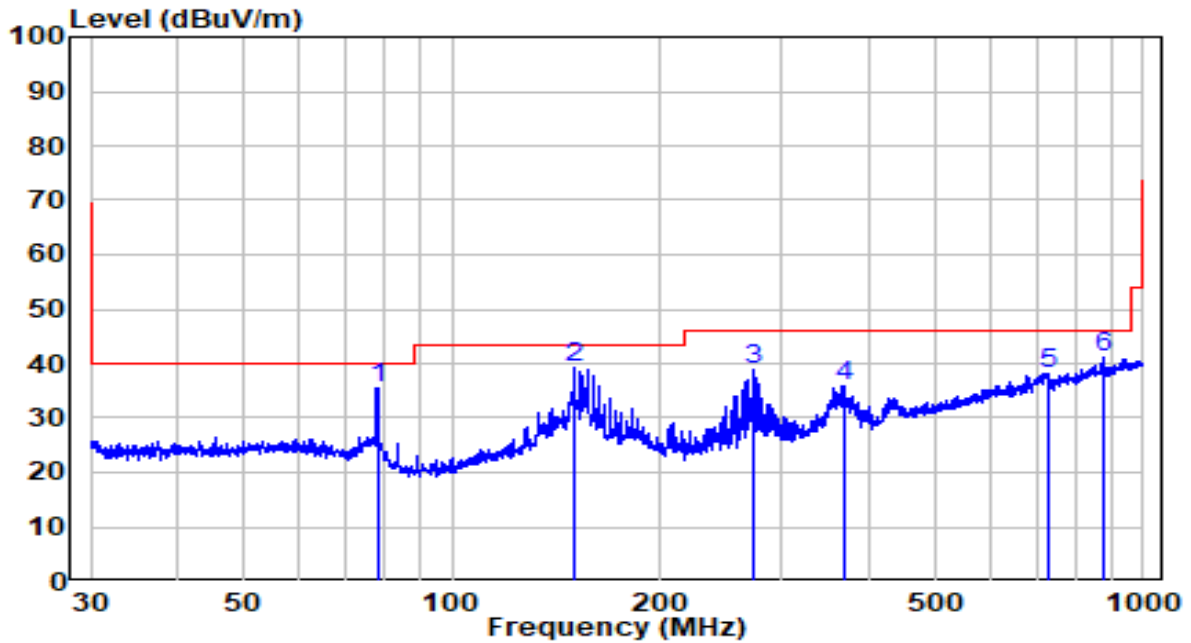

No	Frequency (MHz)	Reading (dBμV)	C.F (dB/m)	Measurement (dBμV/m)	Margin (dB)	Limit (dBμV/m)	Remark (QP/PK/AV)
1	78.002	20.56	14.87	35.44	-4.56	40.00	Peak
2	* 150.274	23.31	15.98	39.30	-4.20	43.50	Peak
3	272.278	17.90	20.78	38.68	-7.32	46.00	Peak
4	368.112	12.47	23.53	36.00	-10.00	46.00	Peak
5	726.805	8.45	29.74	38.20	-7.80	46.00	Peak
6	873.714	9.68	31.62	41.30	-4.70	46.00	Peak

Note:

- "\*", means this data is the worst emission level.
- C.F (Correction Factor) = Antenna Factor (dB/m)+ Cable Loss (dB).
- Measurement(dBμV/m) = Reading(dBμV) + C.F (Correction Factor).
- The amplitude of Radiated emissions (the test frequency range: 9kHz ~ 30MHz, 18GHz ~ 25GHz), is that proximity to ambient noise, which also are attenuated more than 20 dB below the permissible value. Therefore, the data is not presented in the report.

EUT	HAN Access Point	Date of Test	2021-11-13
Factor	VULB 9162	Temp. / Humidity	21°C /47%
Polarity	Vertical	Site / Test Engineer	AC1 / Tim
Test Mode	Transmit by 802.11b at channel 2437MHz	Test Voltage	AC 120V/60Hz

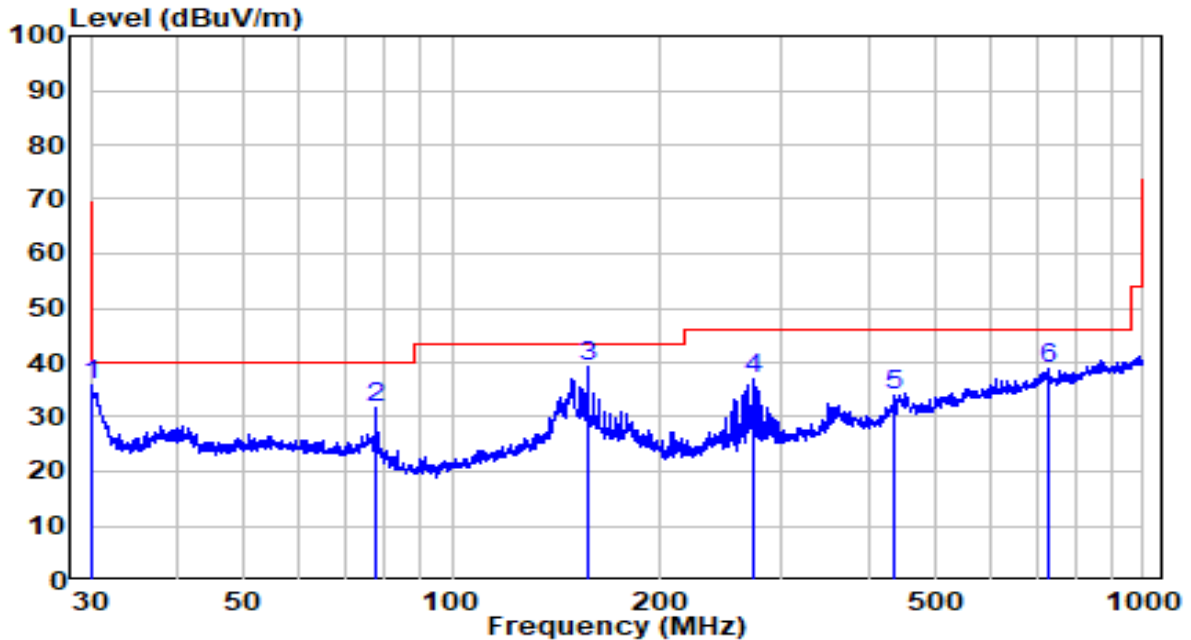

No	Frequency (MHz)	Reading (dB $\mu$ V)	C.F (dB/m)	Measurement (dB $\mu$ V/m)	Margin (dB)	Limit (dB $\mu$ V/m)	Remark (QP/PK/AV)
1	*	17.60	18.40	36.00	-4.00	40.00	Peak
2	77.457	16.85	15.02	31.87	-8.13	40.00	Peak
3	156.732	22.86	16.21	39.07	-4.43	43.50	Peak
4	272.278	16.05	20.78	36.83	-9.17	46.00	Peak
5	437.120	9.38	24.68	34.06	-11.94	46.00	Peak
6	729.358	9.15	29.78	38.93	-7.07	46.00	Peak

Note:

- "\*", means this data is the worst emission level.
- C.F (Correction Factor) = Antenna Factor (dB/m)+ Cable Loss (dB).
- Measurement(dB $\mu$ V/m) = Reading(dB $\mu$ V) + C.F (Correction Factor).
- The amplitude of Radiated emissions (the test frequency range: 9kHz ~ 30MHz, 18GHz ~ 25GHz), is that proximity to ambient noise, which also are attenuated more than 20 dB below the permissible value. Therefore, the data is not presented in the report.

## 7.7. Radiated Restricted Band Edge Measurement

### 7.7.1. Test Limit

#### **For 15.205 requirement:**

Radiated emissions which fall in the restricted bands, as defined in Section 15.205(a) of FCC part 15, must also comply with the radiated emission limits specified in Section 15.209(a).

Frequency (MHz)	Frequency (MHz)	Frequency (MHz)	Frequency (GHz)
0.090 - 0.110	16.42 - 16.423	399.9 - 410	4.5 - 5.15
<sup>1</sup> 0.495 - 0.505	16.69475 - 16.69525	608 - 614	5.35 - 5.46
2.1735 - 2.1905	16.80425 - 16.80475	960 - 1240	7.25 - 7.75
4.125 - 4.128	25.5 - 25.67	1300 - 1427	8.025 - 8.5
4.17725 - 4.17775	37.5 - 38.25	1435 - 1626.5	9.0 - 9.2
4.20725 - 4.20775	73 - 74.6	1645.5 - 1646.5	9.3 - 9.5
6.215 - 6.218	74.8 - 75.2	1660 - 1710	10.6 - 12.7
6.26775 - 6.26825	108 - 121.94	1718.8 - 1722.2	13.25 - 13.4
6.31175 - 6.31225	123 - 138	2200 - 2300	14.47 - 14.5
8.291 - 8.294	149.9 - 150.05	2310 - 2390	15.35 - 16.2
8.362 - 8.366	156.52475 - 156.52525	2483.5 - 2500	17.7 - 21.4
8.37625 - 8.38675	156.7 - 156.9	2690 - 2900	22.01 - 23.12
8.41425 - 8.41475	162.0125 - 167.17	3260 - 3267	23.6 - 24.0
12.29 - 12.293	167.72 - 173.2	3332 - 3339	31.2 - 31.8
12.51975 - 12.52025	240 - 285	3345.8 - 3358	36.43 - 36.5
12.57675 - 12.57725	322 - 335.4	3600 - 4400	( <sup>2</sup> )
13.36 - 13.41	--	--	--

All out of band emissions appearing in a restricted band as specified in Section 15.205 of the Title 47CFR must not exceed the limits shown in Table per Section 15.209.

FCC Part 15 Subpart C Paragraph 15.209 Limits		
Frequency [MHz]	Field Strength [ $\mu\text{V}/\text{m}$ ]	Measured Distance [Meters]
0.009 - 0.490	2400/F (kHz)	300
0.490 - 1.705	24000/F (kHz)	30
1.705 - 30	30	30
30 - 88	100	3
88 - 216	150	3
216 - 960	200	3
Above 960	500	3

### 7.7.2. Test Procedure Used

ANSI C63.10 Section 6.3 (General Requirements)

ANSI C63.10 Section 6.6 (Standard test method above 1GHz)

### 7.7.3. Test Setting

#### Peak Field Strength Measurements

1. Analyzer center frequency was set to the frequency of the radiated spurious emission of interest
2. RBW = 1MHz
3. VBW = 3MHz
4. Detector = peak
5. Sweep time = auto couple
6. Trace mode = max hold
7. Trace was allowed to stabilize

### **Average Measurements above 1GHz (Method VB)**

1. Analyzer center frequency was set to the frequency of the radiated spurious emission of interest
2. RBW = 1MHz
3. VBW; If the EUT is configured to transmit with duty cycle  $\geq 98\%$ , set VBW = 10 Hz.  
If the EUT duty cycle is  $< 98\%$ , set VBW  $\geq 1/T$ . T is the minimum transmission duration.

4. Average Type = Voltage
5. Detector = Peak
6. Sweep time = auto
7. Trace mode = max hold
8. Trace was allowed to stabilize

#### **7.7.4. Test Setup**

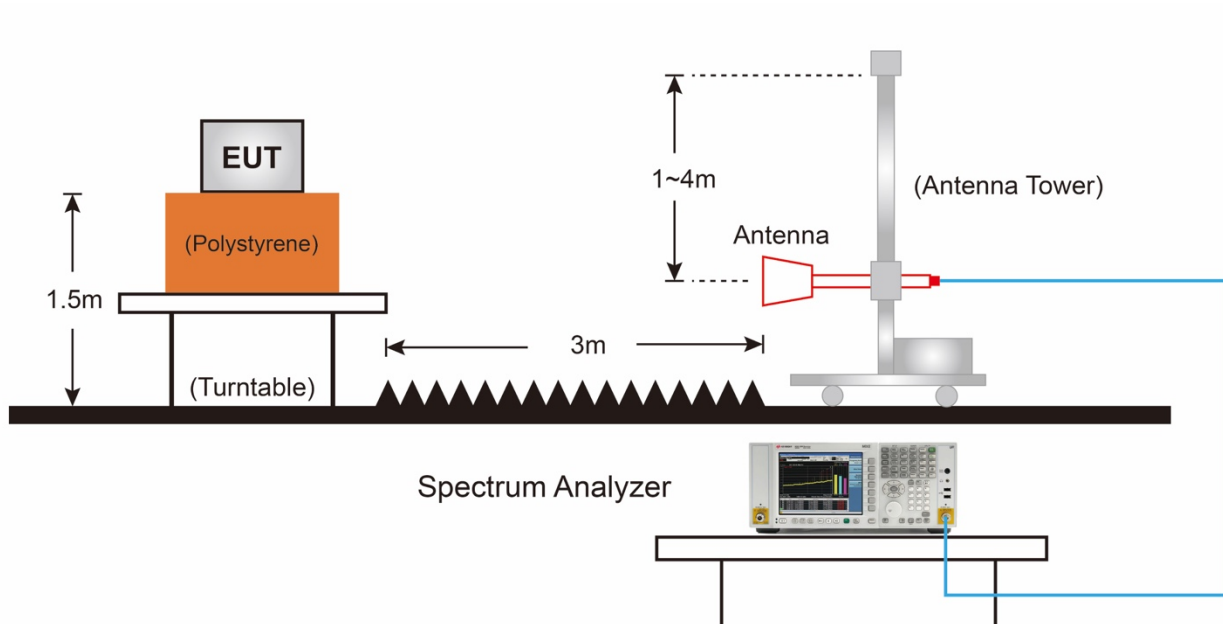

### 7.7.5. Test Result

**CDD Mode:**

EUT	HAN Access Point	Date of Test	2021-09-24
Factor	DRH18-E	Temp. / Humidity	24°C /52%
Polarity	Horizontal	Site / Test Engineer	AC2 / Jay
Test Mode	802.11b_TX_CH 1	Test Voltage	AC 120V/60Hz

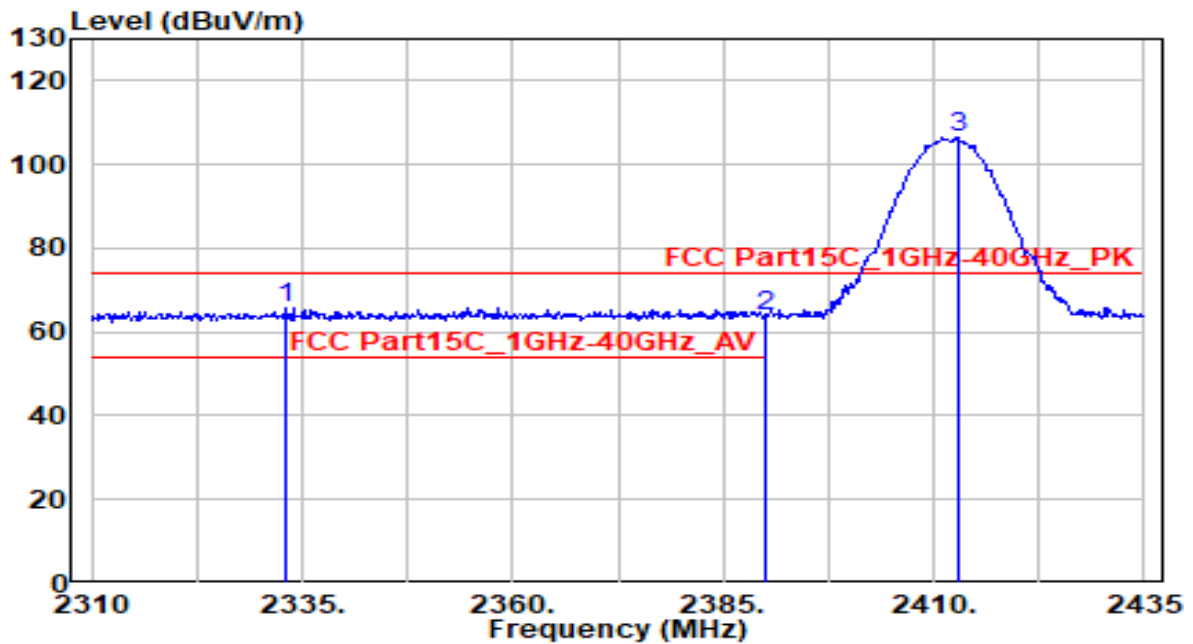

No	Frequency (MHz)	Reading (dBμV)	C.F (dB/m)	Measurement (dBμV/m)	Margin (dB)	Limit (dBμV/m)	Height (cm)	Angle (deg)	Remark (QP/PK/AV)
1	* 2333.125	35.62	30.16	65.78	-8.22	74.00	180	60	Peak
2	2390.000	33.63	30.29	63.91	-10.09	74.00	180	60	Peak
3	2412.875	76.06	30.33	106.39	N/A	N/A	180	60	Peak

**Note:**

1. " \*", means this data is the worst emission level.
2. C.F (Correction Factor) = Antenna Factor (dB/m)+ Cable Loss (dB).
3. Measurement (dBμV/m) = Reading(dBμV) + C.F (Correction Factor).
4. The emission levels of other frequencies are very lower than the limit and not show in test report.

EUT	HAN Access Point	Date of Test	2021-09-24
Factor	DRH18-E	Temp. / Humidity	24°C /52%
Polarity	Horizontal	Site / Test Engineer	AC2 / Jay
Test Mode	802.11b_TX_CH 1	Test Voltage	AC 120V/60Hz

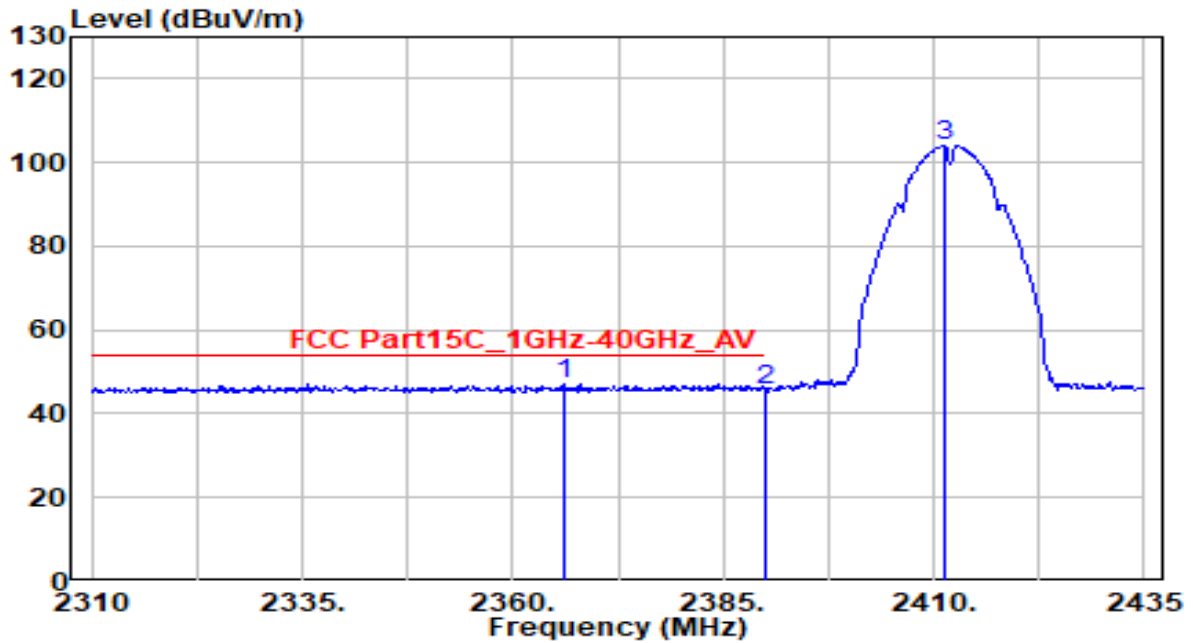

No	Frequency (MHz)	Reading (dBμV)	C.F (dB/m)	Measurement (dBμV/m)	Margin (dB)	Limit (dBμV/m)	Height (cm)	Angle (deg)	Remark (QP/PK/AV)
1	* 2366.250	17.08	30.23	47.31	-6.69	54.00	180	60	Average
2	2390.000	15.50	30.29	45.79	-8.21	54.00	180	60	Average
3	2411.250	73.74	30.33	104.07	N/A	N/A	180	60	Average

Note:

1. " \*", means this data is the worst emission level.
2. C.F (Correction Factor) = Antenna Factor (dB/m)+ Cable Loss (dB).
3. Measurement (dBμV/m) = Reading(dBμV) + C.F (Correction Factor).
4. The emission levels of other frequencies are very lower than the limit and not show in test report.

EUT	HAN Access Point	Date of Test	2021-09-24
Factor	DRH18-E	Temp. / Humidity	24°C /52%
Polarity	Vertical	Site / Test Engineer	AC2 / Jay
Test Mode	802.11b_TX_CH 1	Test Voltage	AC 120V/60Hz

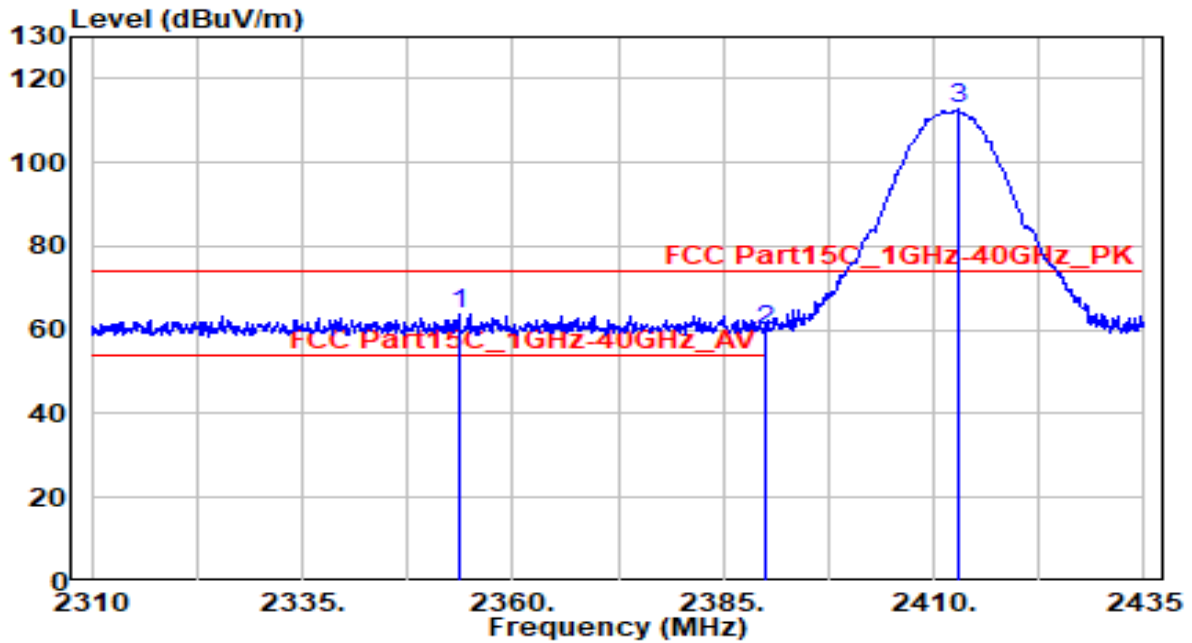

No	Frequency (MHz)	Reading (dBμV)	C.F (dB/m)	Measurement (dBμV/m)	Margin (dB)	Limit (dBμV/m)	Height (cm)	Angle (deg)	Remark (QP/PK/AV)	
1	*	2353.625	33.81	30.20	64.01	-9.99	74.00	150	130	Peak
2		2390.000	29.35	30.29	59.64	-14.36	74.00	150	130	Peak
3		2412.875	82.29	30.33	112.62	N/A	N/A	150	130	Peak

Note:

1. " \*", means this data is the worst emission level.
2. C.F (Correction Factor) = Antenna Factor (dB/m)+ Cable Loss (dB).
3. Measurement (dBμV/m) = Reading(dBμV) + C.F (Correction Factor).
4. The emission levels of other frequencies are very lower than the limit and not show in test report.



EUT	HAN Access Point	Date of Test	2021-09-24
Factor	DRH18-E	Temp. / Humidity	24°C /52%
Polarity	Vertical	Site / Test Engineer	AC2 / Jay
Test Mode	802.11b_TX_CH 1	Test Voltage	AC 120V/60Hz

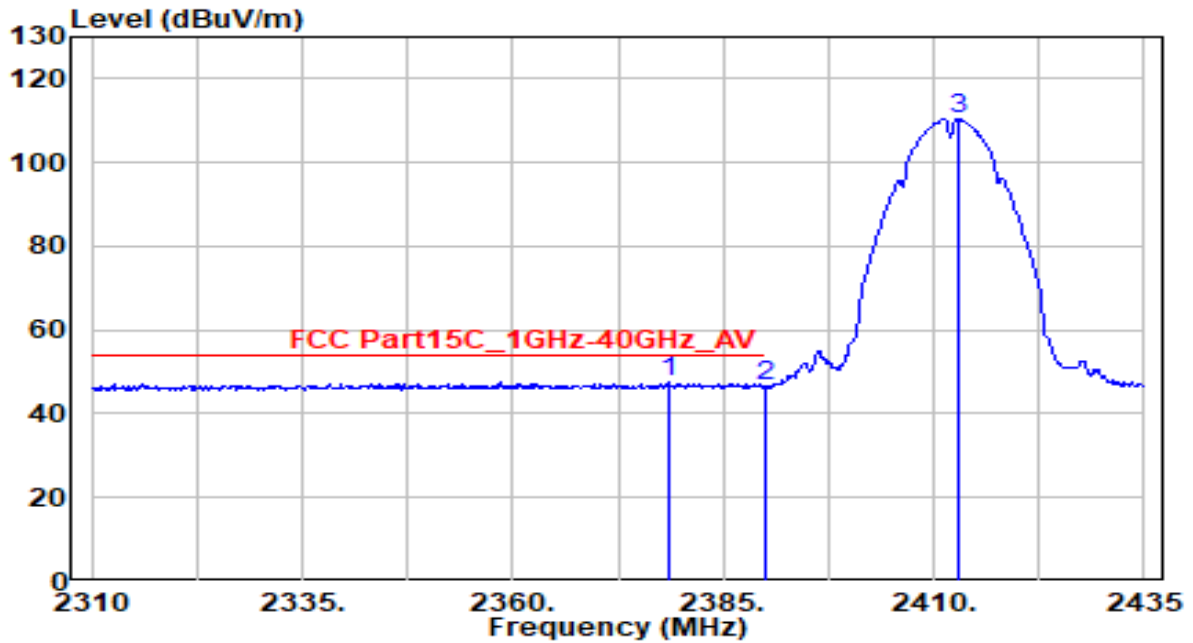

No	Frequency (MHz)	Reading (dB $\mu$ V)	C.F (dB/m)	Measurement (dB $\mu$ V/m)	Margin (dB)	Limit (dB $\mu$ V/m)	Height (cm)	Angle (deg)	Remark (QP/PK/AV)
1	* 2378.500	17.41	30.26	47.67	-6.33	54.00	150	130	Average
2	2390.000	16.14	30.29	46.42	-7.58	54.00	150	130	Average
3	2412.875	80.18	30.33	110.51	N/A	N/A	150	130	Average

Note:

1. " \*", means this data is the worst emission level.
2. C.F (Correction Factor) = Antenna Factor (dB/m)+ Cable Loss (dB).
3. Measurement (dB $\mu$ V/m) = Reading(dB $\mu$ V) + C.F (Correction Factor).
4. The emission levels of other frequencies are very lower than the limit and not show in test report.

EUT	HAN Access Point	Date of Test	2021-09-24
Factor	DRH18-E	Temp. / Humidity	23°C /49%
Polarity	Horizontal	Site / Test Engineer	AC2 / Jay
Test Mode	802.11b_TX_CH 11	Test Voltage	AC 120V/60Hz

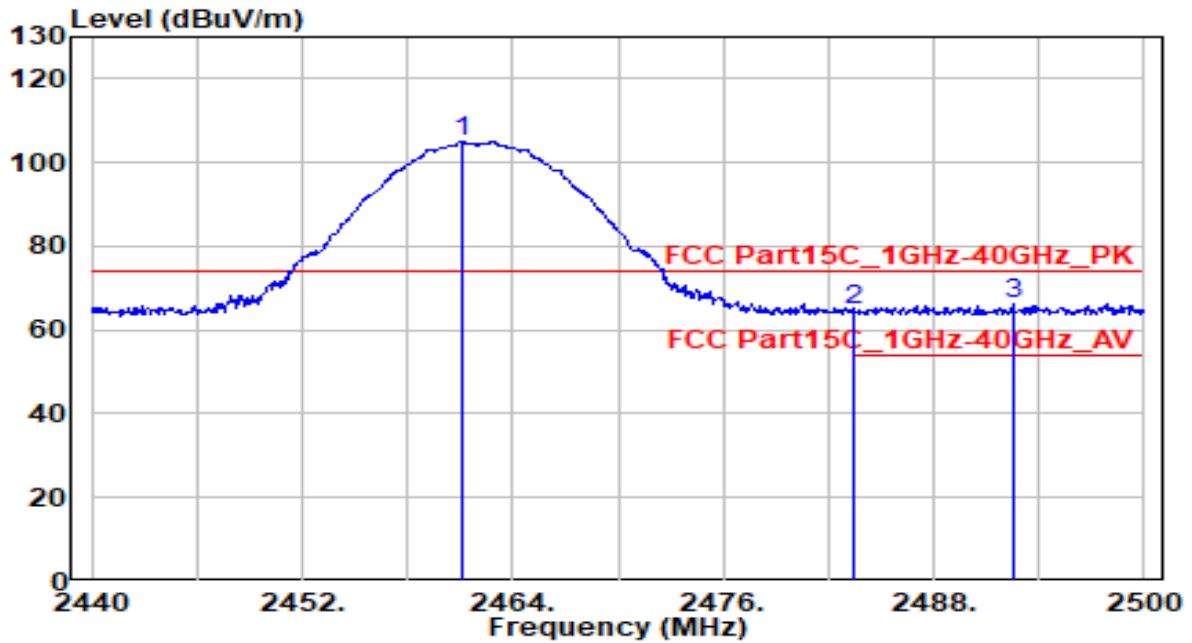

No	Frequency (MHz)	Reading (dBμV)	C.F (dB/m)	Measurement (dBμV/m)	Margin (dB)	Limit (dBμV/m)	Height (cm)	Angle (deg)	Remark (QP/PK/AV)
1	2461.120	74.64	30.42	105.06	N/A	N/A	140	45	Peak
2	2483.500	34.31	30.46	64.77	-9.23	74.00	140	45	Peak
3	* 2492.560	35.81	30.48	66.29	-7.71	74.00	140	45	Peak

Note:

1. " \*", means this data is the worst emission level.
2. C.F (Correction Factor) = Antenna Factor (dB/m)+ Cable Loss (dB).
3. Measurement (dBμV/m) = Reading(dBμV) + C.F (Correction Factor).
4. The emission levels of other frequencies are very lower than the limit and not show in test report.

EUT	HAN Access Point	Date of Test	2021-09-24
Factor	DRH18-E	Temp. / Humidity	23°C /49%
Polarity	Horizontal	Site / Test Engineer	AC2 / Jay
Test Mode	802.11b_TX_CH 11	Test Voltage	AC 120V/60Hz

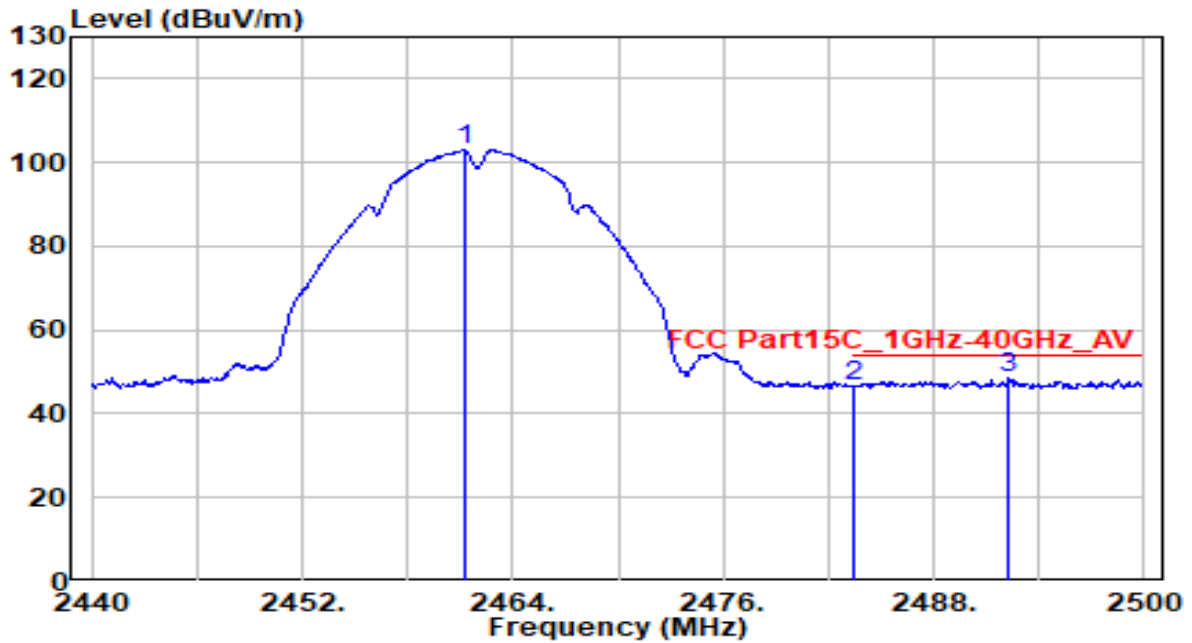

No	Frequency (MHz)	Reading (dBμV)	C.F (dB/m)	Measurement (dBμV/m)	Margin (dB)	Limit (dBμV/m)	Height (cm)	Angle (deg)	Remark (QP/PK/AV)
1	2461.300	72.56	30.42	102.98	N/A	N/A	140	45	Average
2	2483.500	16.04	30.46	46.50	-7.50	54.00	140	45	Average
3	* 2492.260	17.87	30.48	48.35	-5.65	54.00	140	45	Average

Note:

1. " \*", means this data is the worst emission level.
2. C.F (Correction Factor) = Antenna Factor (dB/m)+ Cable Loss (dB).
3. Measurement (dBμV/m) = Reading(dBμV) + C.F (Correction Factor).
4. The emission levels of other frequencies are very lower than the limit and not show in test report.

EUT	HAN Access Point	Date of Test	2021-09-24
Factor	DRH18-E	Temp. / Humidity	23°C /49%
Polarity	Vertical	Site / Test Engineer	AC2 / Jay
Test Mode	802.11b_TX_CH 11	Test Voltage	AC 120V/60Hz

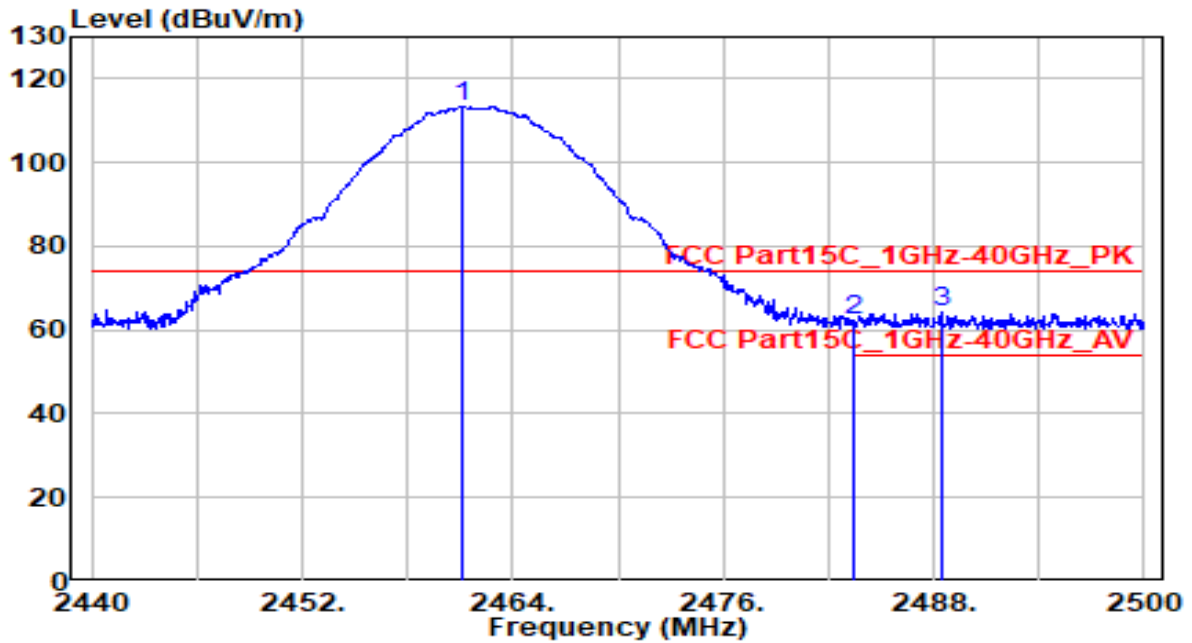

No	Frequency (MHz)	Reading (dB $\mu$ V)	C.F (dB/m)	Measurement (dB $\mu$ V/m)	Margin (dB)	Limit (dB $\mu$ V/m)	Height (cm)	Angle (deg)	Remark (QP/PK/AV)
1	2461.120	83.15	30.42	113.57	N/A	N/A	190	40	Peak
2	2483.500	31.63	30.46	62.09	-11.91	74.00	190	40	Peak
3	* 2488.480	33.56	30.47	64.03	-9.97	74.00	190	40	Peak

Note:

1. " \*", means this data is the worst emission level.
2. C.F (Correction Factor) = Antenna Factor (dB/m)+ Cable Loss (dB).
3. Measurement (dB $\mu$ V/m) = Reading(dB $\mu$ V) + C.F (Correction Factor).
4. The emission levels of other frequencies are very lower than the limit and not show in test report.

EUT	HAN Access Point	Date of Test	2021-09-24
Factor	DRH18-E	Temp. / Humidity	23°C /49%
Polarity	Vertical	Site / Test Engineer	AC2 / Jay
Test Mode	802.11b_TX_CH 11	Test Voltage	AC 120V/60Hz

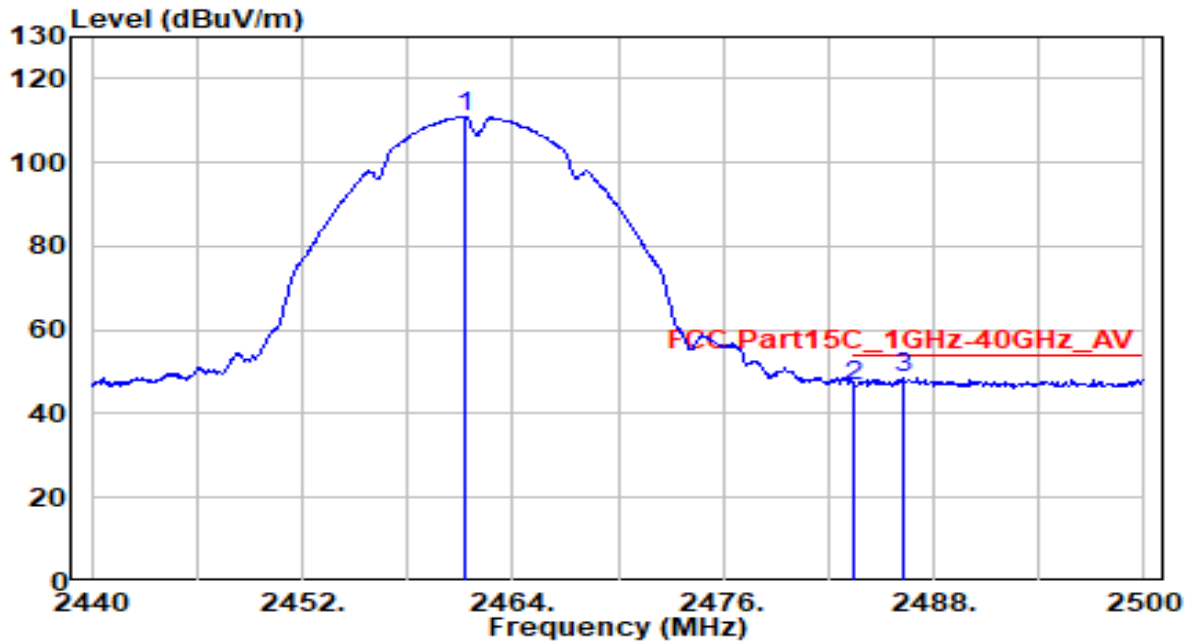

No	Frequency (MHz)	Reading (dBμV)	C.F (dB/m)	Measurement (dBμV/m)	Margin (dB)	Limit (dBμV/m)	Height (cm)	Angle (deg)	Remark (QP/PK/AV)
1	2461.240	80.62	30.42	111.04	N/A	N/A	190	40	Average
2	2483.500	16.32	30.46	46.78	-7.22	54.00	190	40	Average
3	* 2486.260	18.28	30.47	48.74	-5.26	54.00	190	40	Average

Note:

1. " \*", means this data is the worst emission level.
2. C.F (Correction Factor) = Antenna Factor (dB/m)+ Cable Loss (dB).
3. Measurement (dBμV/m) = Reading(dBμV) + C.F (Correction Factor).
4. The emission levels of other frequencies are very lower than the limit and not show in test report.

EUT	HAN Access Point	Date of Test	2021-09-24
Factor	DRH18-E	Temp. / Humidity	24°C /52%
Polarity	Horizontal	Site / Test Engineer	AC2 / Jay
Test Mode	802.11g_TX_CH 1	Test Voltage	AC 120V/60Hz

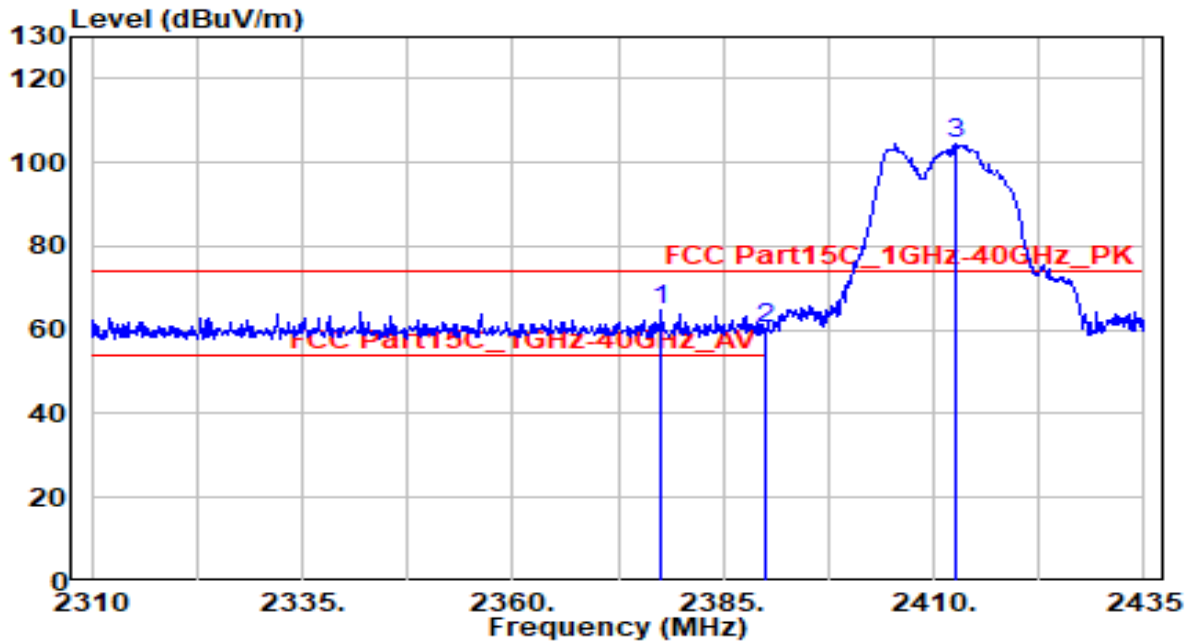

No	Frequency (MHz)	Reading (dBμV)	C.F (dB/m)	Measurement (dBμV/m)	Margin (dB)	Limit (dBμV/m)	Height (cm)	Angle (deg)	Remark (QP/PK/AV)	
1	*	2377.625	34.28	30.26	64.54	-9.46	74.00	180	60	Peak
2		2390.000	29.90	30.29	60.19	-13.81	74.00	180	60	Peak
3		2412.625	74.16	30.33	104.49	N/A	N/A	180	60	Peak

Note:

1. " \*", means this data is the worst emission level.
2. C.F (Correction Factor) = Antenna Factor (dB/m)+ Cable Loss (dB).
3. Measurement (dBμV/m) = Reading(dBμV) + C.F (Correction Factor).
4. The emission levels of other frequencies are very lower than the limit and not show in test report.

EUT	HAN Access Point	Date of Test	2021-09-24
Factor	DRH18-E	Temp. / Humidity	24°C /52%
Polarity	Horizontal	Site / Test Engineer	AC2 / Jay
Test Mode	802.11g_TX_CH 1	Test Voltage	AC 120V/60Hz

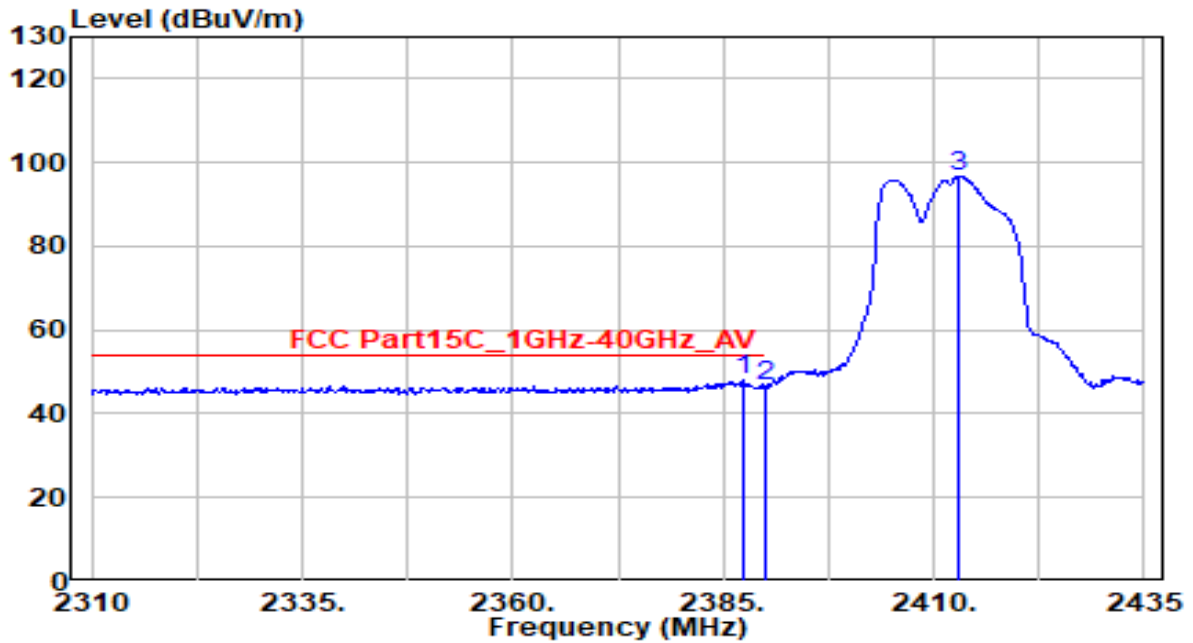

No	Frequency (MHz)	Reading (dBμV)	C.F (dB/m)	Measurement (dBμV/m)	Margin (dB)	Limit (dBμV/m)	Height (cm)	Angle (deg)	Remark (QP/PK/AV)	
1	*	2387.250	17.66	30.28	47.94	-6.06	54.00	180	60	Average
2		2390.000	16.36	30.29	46.65	-7.35	54.00	180	60	Average
3		2413.000	66.38	30.33	96.71	N/A	N/A	180	60	Average

Note:

1. " \*", means this data is the worst emission level.
2. C.F (Correction Factor) = Antenna Factor (dB/m)+ Cable Loss (dB).
3. Measurement (dBμV/m) = Reading(dBμV) + C.F (Correction Factor).
4. The emission levels of other frequencies are very lower than the limit and not show in test report.

EUT	HAN Access Point	Date of Test	2021-09-24
Factor	DRH18-E	Temp. / Humidity	24°C /52%
Polarity	Vertical	Site / Test Engineer	AC2 / Jay
Test Mode	802.11g_TX_CH 1	Test Voltage	AC 120V/60Hz

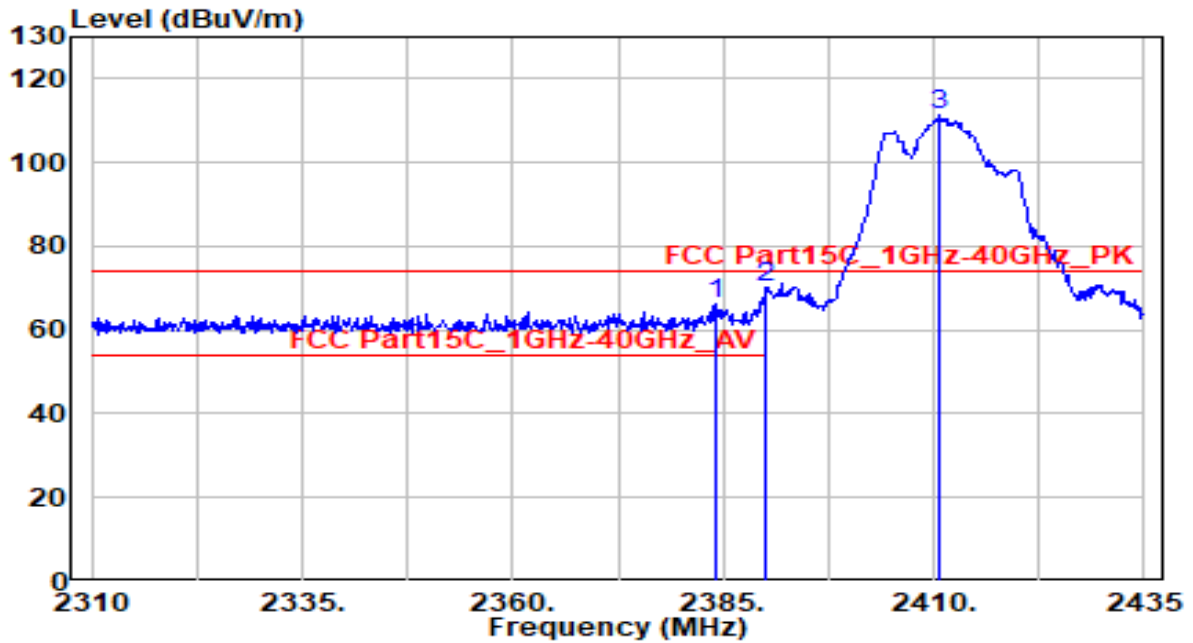

No	Frequency (MHz)	Reading (dBμV)	C.F (dB/m)	Measurement (dBμV/m)	Margin (dB)	Limit (dBμV/m)	Height (cm)	Angle (deg)	Remark (QP/PK/AV)
1	2384.125	35.88	30.27	66.16	-7.84	74.00	150	130	Peak
2	* 2390.000	39.72	30.29	70.01	-3.99	74.00	150	130	Peak
3	2410.750	80.81	30.33	111.14	N/A	N/A	150	130	Peak

Note:

1. " \*", means this data is the worst emission level.
2. C.F (Correction Factor) = Antenna Factor (dB/m)+ Cable Loss (dB).
3. Measurement (dBμV/m) = Reading(dBμV) + C.F (Correction Factor).
4. The emission levels of other frequencies are very lower than the limit and not show in test report.



EUT	HAN Access Point	Date of Test	2021-09-24
Factor	DRH18-E	Temp. / Humidity	24°C /52%
Polarity	Vertical	Site / Test Engineer	AC2 / Jay
Test Mode	802.11g_TX_CH 1	Test Voltage	AC 120V/60Hz

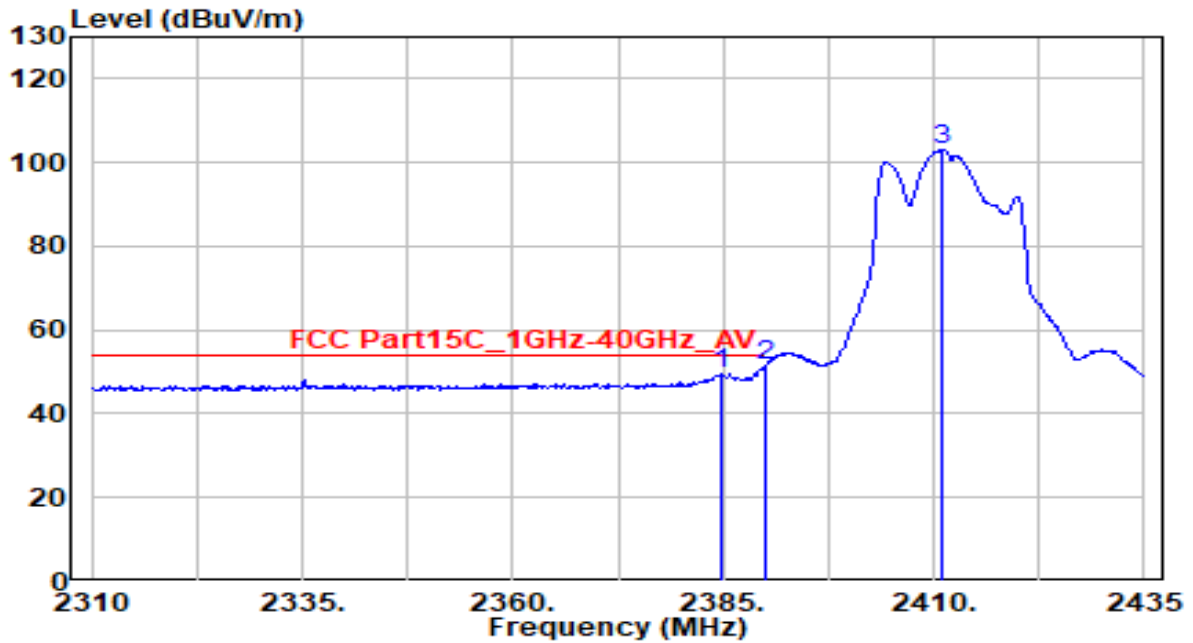

No	Frequency (MHz)	Reading (dB $\mu$ V)	C.F (dB/m)	Measurement (dB $\mu$ V/m)	Margin (dB)	Limit (dB $\mu$ V/m)	Height (cm)	Angle (deg)	Remark (QP/PK/AV)
1	2384.750	19.32	30.27	49.60	-4.40	54.00	150	130	Average
2	* 2390.000	21.20	30.29	51.49	-2.51	54.00	150	130	Average
3	2411.000	72.67	30.33	103.00	N/A	N/A	150	130	Average

Note:

1. " \*", means this data is the worst emission level.
2. C.F (Correction Factor) = Antenna Factor (dB/m)+ Cable Loss (dB).
3. Measurement (dB $\mu$ V/m) = Reading(dB $\mu$ V) + C.F (Correction Factor).
4. The emission levels of other frequencies are very lower than the limit and not show in test report.

EUT	HAN Access Point	Date of Test	2021-09-24
Factor	DRH18-E	Temp. / Humidity	23°C /49%
Polarity	Horizontal	Site / Test Engineer	AC2 / Jay
Test Mode	802.11g_TX_CH 11	Test Voltage	AC 120V/60Hz

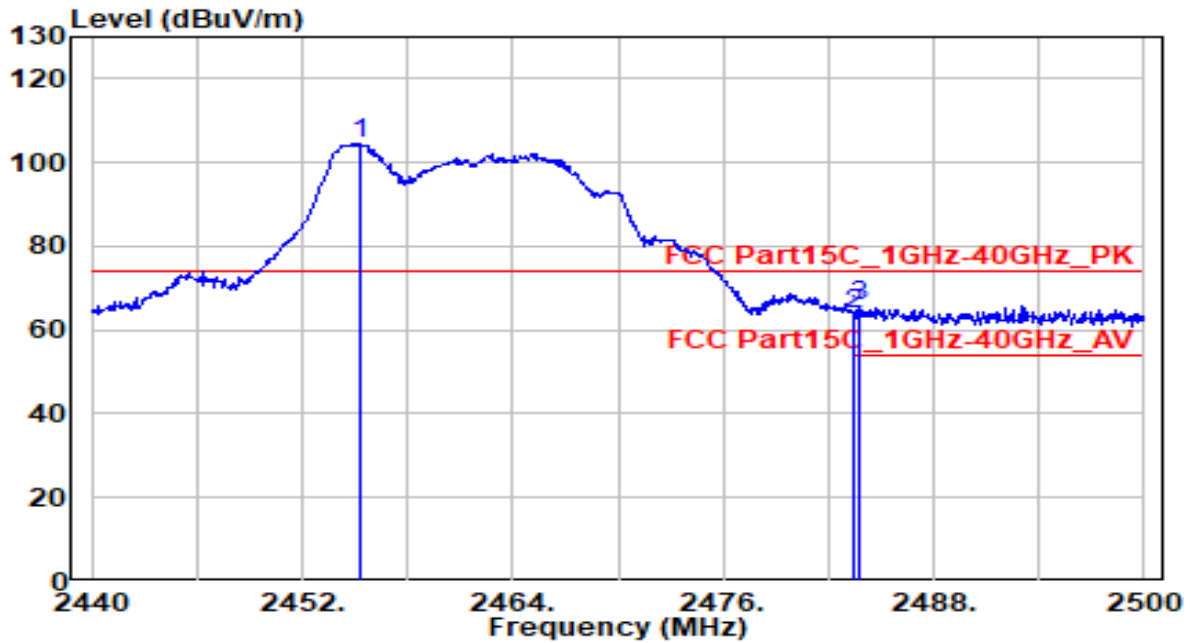

No	Frequency (MHz)	Reading (dB $\mu$ V)	C.F (dB/m)	Measurement (dB $\mu$ V/m)	Margin (dB)	Limit (dB $\mu$ V/m)	Height (cm)	Angle (deg)	Remark (QP/PK/AV)
1	2455.300	73.99	30.41	104.40	N/A	N/A	140	45	Peak
2	2483.500	33.37	30.46	63.83	-10.17	74.00	140	45	Peak
3	* 2483.800	35.18	30.46	65.64	-8.36	74.00	140	45	Peak

Note:

1. " \*", means this data is the worst emission level.
2. C.F (Correction Factor) = Antenna Factor (dB/m)+ Cable Loss (dB).
3. Measurement (dB $\mu$ V/m) = Reading(dB $\mu$ V) + C.F (Correction Factor).
4. The emission levels of other frequencies are very lower than the limit and not show in test report.

EUT	HAN Access Point	Date of Test	2021-09-24
Factor	DRH18-E	Temp. / Humidity	23°C /49%
Polarity	Horizontal	Site / Test Engineer	AC2 / Jay
Test Mode	802.11g_TX_CH 11	Test Voltage	AC 120V/60Hz

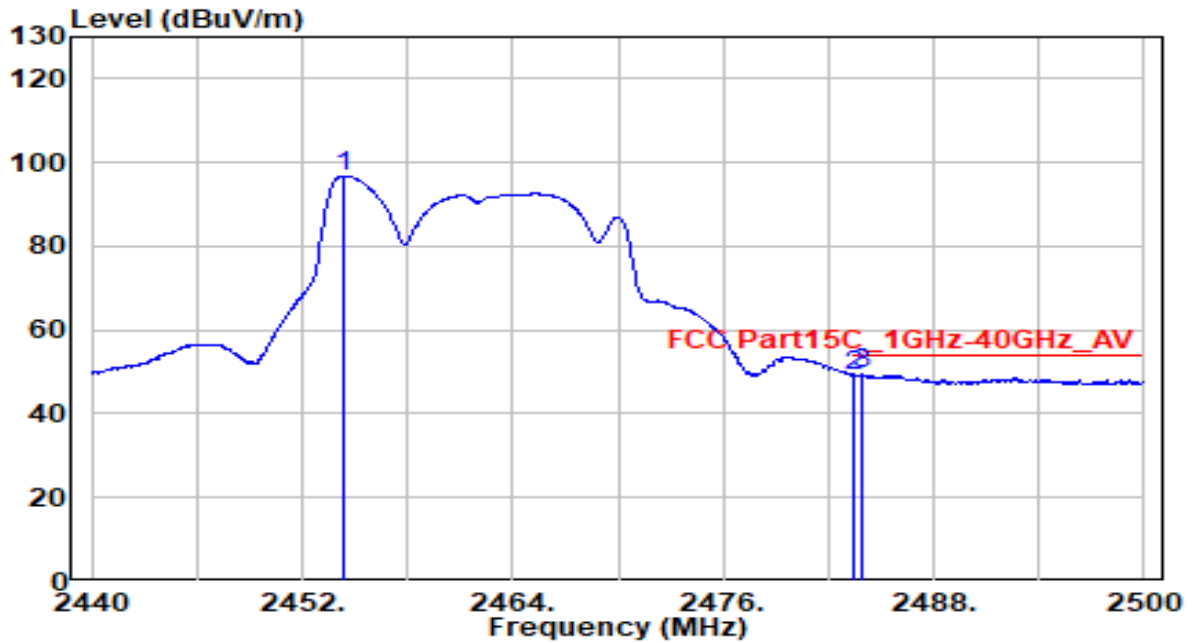

No	Frequency (MHz)	Reading (dBμV)	C.F (dB/m)	Measurement (dBμV/m)	Margin (dB)	Limit (dBμV/m)	Height (cm)	Angle (deg)	Remark (QP/PK/AV)
1	2454.340	66.38	30.41	96.78	N/A	N/A	140	45	Average
2	2483.500	18.69	30.46	49.15	-4.85	54.00	140	45	Average
3	* 2483.920	18.95	30.46	49.41	-4.59	54.00	140	45	Average

Note:

1. " \*", means this data is the worst emission level.
2. C.F (Correction Factor) = Antenna Factor (dB/m)+ Cable Loss (dB).
3. Measurement (dBμV/m) = Reading(dBμV) + C.F (Correction Factor).
4. The emission levels of other frequencies are very lower than the limit and not show in test report.

EUT	HAN Access Point	Date of Test	2021-09-24
Factor	DRH18-E	Temp. / Humidity	23°C /49%
Polarity	Vertical	Site / Test Engineer	AC2 / Jay
Test Mode	802.11g_TX_CH 11	Test Voltage	AC 120V/60Hz

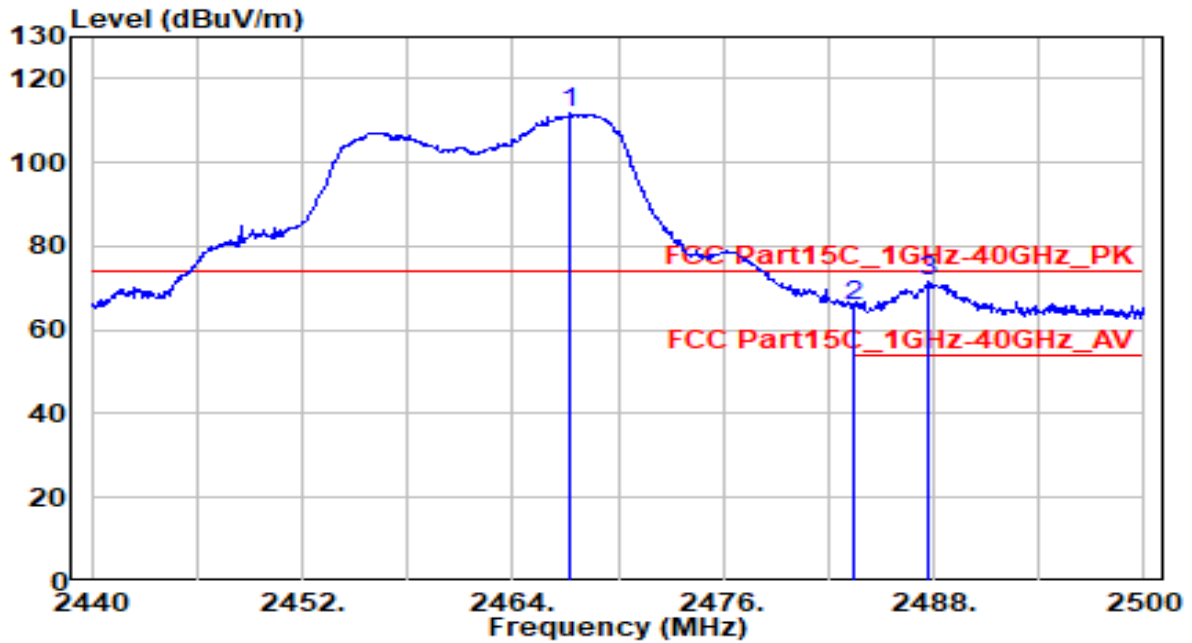

No	Frequency (MHz)	Reading (dBμV)	C.F (dB/m)	Measurement (dBμV/m)	Margin (dB)	Limit (dBμV/m)	Height (cm)	Angle (deg)	Remark (QP/PK/AV)
1	2467.240	81.25	30.43	111.68	N/A	N/A	190	40	Peak
2	2483.500	35.33	30.46	65.79	-8.21	74.00	190	40	Peak
3	* 2487.640	41.08	30.47	71.55	-2.45	74.00	190	40	Peak

Note:

1. " \*", means this data is the worst emission level.
2. C.F (Correction Factor) = Antenna Factor (dB/m)+ Cable Loss (dB).
3. Measurement (dBμV/m) = Reading(dBμV) + C.F (Correction Factor).
4. The emission levels of other frequencies are very lower than the limit and not show in test report.

EUT	HAN Access Point	Date of Test	2021-09-24
Factor	DRH18-E	Temp. / Humidity	23°C /49%
Polarity	Vertical	Site / Test Engineer	AC2 / Jay
Test Mode	802.11g_TX_CH 11	Test Voltage	AC 120V/60Hz

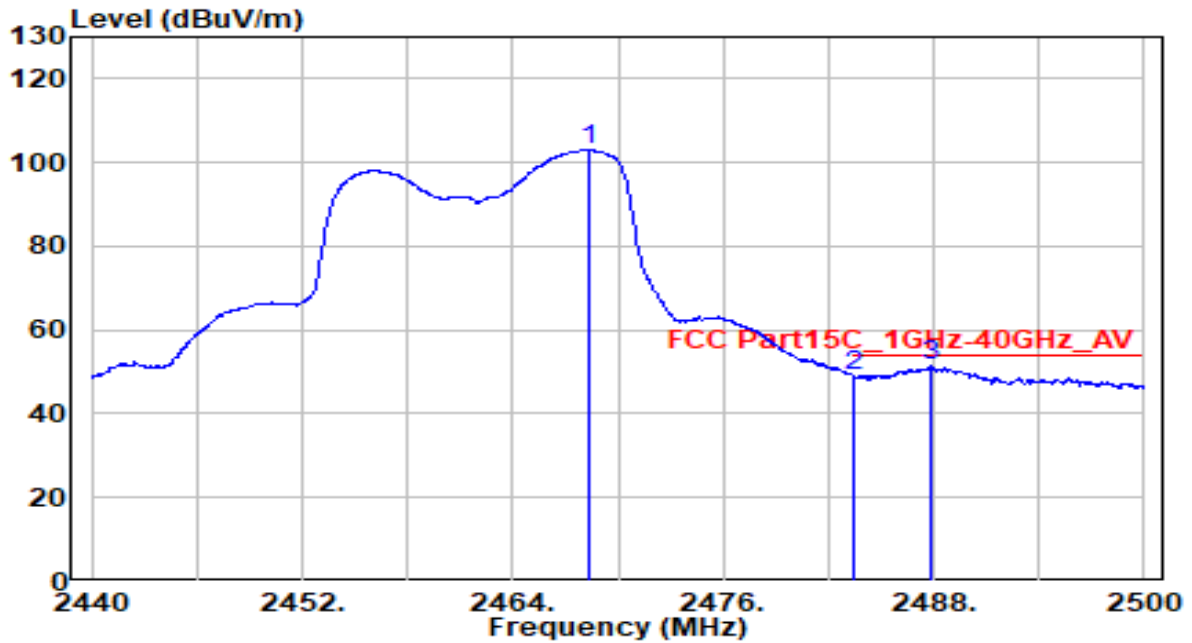

No	Frequency (MHz)	Reading (dBμV)	C.F (dB/m)	Measurement (dBμV/m)	Margin (dB)	Limit (dBμV/m)	Height (cm)	Angle (deg)	Remark (QP/PK/AV)
1	2468.320	72.49	30.43	102.92	N/A	N/A	190	40	Average
2	2483.500	18.42	30.46	48.88	-5.12	54.00	190	40	Average
3	* 2487.820	20.92	30.47	51.39	-2.61	54.00	190	40	Average

Note:

1. " \*", means this data is the worst emission level.
2. C.F (Correction Factor) = Antenna Factor (dB/m)+ Cable Loss (dB).
3. Measurement (dBμV/m) = Reading(dBμV) + C.F (Correction Factor).
4. The emission levels of other frequencies are very lower than the limit and not show in test report.

EUT	HAN Access Point	Date of Test	2021-09-24
Factor	DRH18-E	Temp. / Humidity	24°C /52%
Polarity	Horizontal	Site / Test Engineer	AC2 / Jay
Test Mode	802.11n20_TX_CH 1	Test Voltage	AC 120V/60Hz

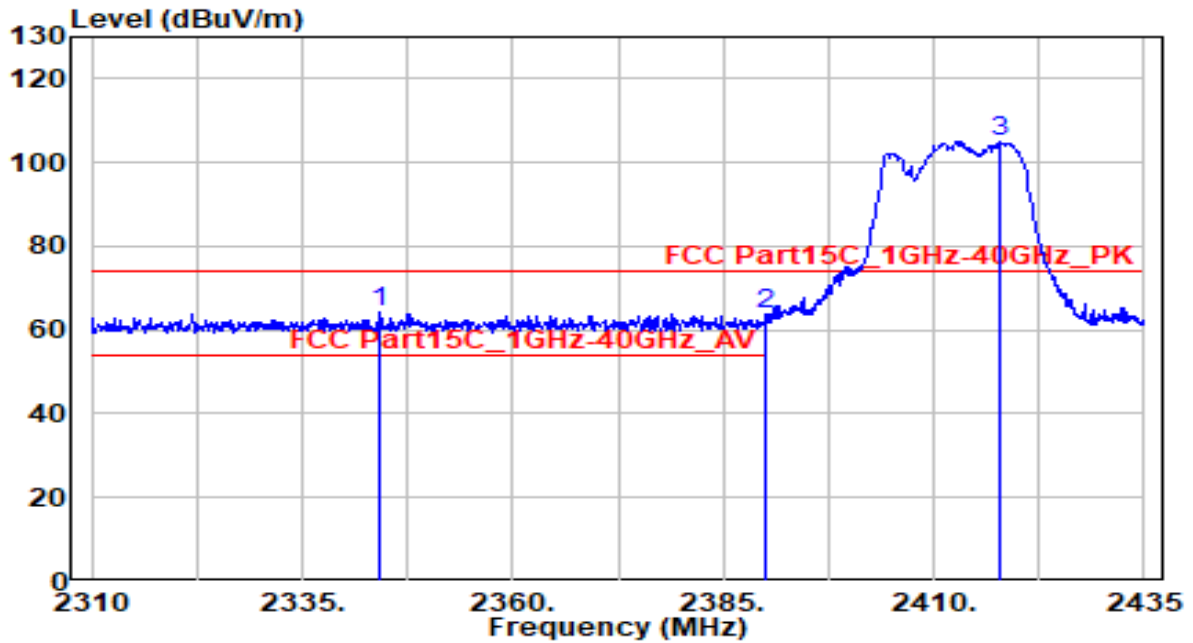

No	Frequency (MHz)	Reading (dB $\mu$ V)	C.F (dB/m)	Measurement (dB $\mu$ V/m)	Margin (dB)	Limit (dB $\mu$ V/m)	Height (cm)	Angle (deg)	Remark (QP/PK/AV)
1	* 2344.125	33.88	30.18	64.06	-9.94	74.00	180	60	Peak
2	2390.000	33.28	30.29	63.57	-10.43	74.00	180	60	Peak
3	2417.875	74.86	30.34	105.20	N/A	N/A	180	60	Peak

Note:

1. " \*", means this data is the worst emission level.
2. C.F (Correction Factor) = Antenna Factor (dB/m)+ Cable Loss (dB).
3. Measurement (dB $\mu$ V/m) = Reading(dB $\mu$ V) + C.F (Correction Factor).
4. The emission levels of other frequencies are very lower than the limit and not show in test report.

EUT	HAN Access Point	Date of Test	2021-09-24
Factor	DRH18-E	Temp. / Humidity	24°C /52%
Polarity	Horizontal	Site / Test Engineer	AC2 / Jay
Test Mode	802.11n20_TX_CH 1	Test Voltage	AC 120V/60Hz

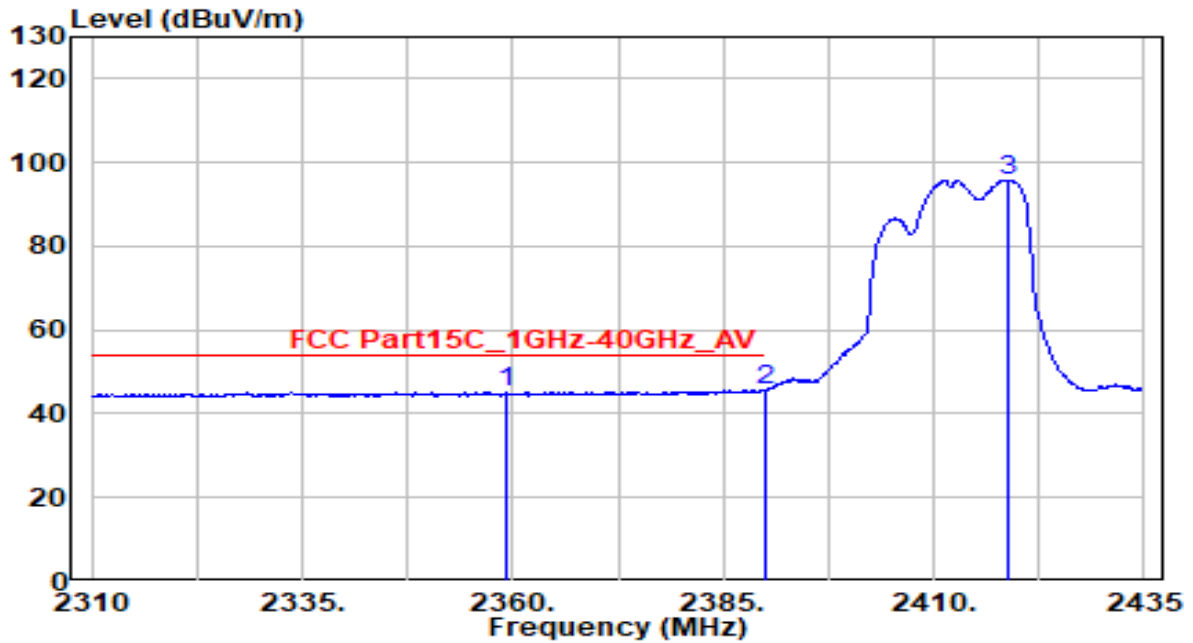

No	Frequency (MHz)	Reading (dB $\mu$ V)	C.F (dB/m)	Measurement (dB $\mu$ V/m)	Margin (dB)	Limit (dB $\mu$ V/m)	Height (cm)	Angle (deg)	Remark (QP/PK/AV)
1	2359.125	14.90	30.22	45.12	-8.88	54.00	180	60	Average
2	* 2390.000	15.30	30.29	45.59	-8.41	54.00	180	60	Average
3	2418.750	65.44	30.34	95.79	N/A	N/A	180	60	Average

Note:

1. " \*", means this data is the worst emission level.
2. C.F (Correction Factor) = Antenna Factor (dB/m)+ Cable Loss (dB).
3. Measurement (dB $\mu$ V/m) = Reading(dB $\mu$ V) + C.F (Correction Factor).
4. The emission levels of other frequencies are very lower than the limit and not show in test report.

EUT	HAN Access Point	Date of Test	2021-09-24
Factor	DRH18-E	Temp. / Humidity	24°C /52%
Polarity	Vertical	Site / Test Engineer	AC2 / Jay
Test Mode	802.11n20_TX_CH 1	Test Voltage	AC 120V/60Hz

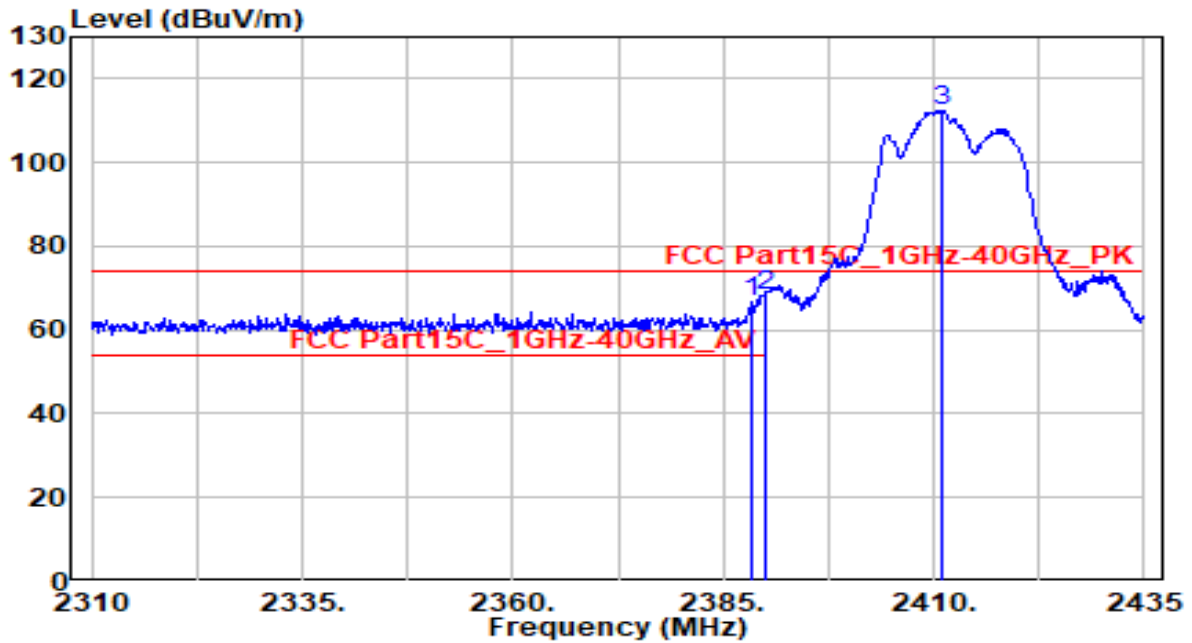

No	Frequency (MHz)	Reading (dBμV)	C.F (dB/m)	Measurement (dBμV/m)	Margin (dB)	Limit (dBμV/m)	Height (cm)	Angle (deg)	Remark (QP/PK/AV)
1	2388.250	36.56	30.28	66.84	-7.16	74.00	150	130	Peak
2	* 2390.000	37.94	30.29	68.22	-5.78	74.00	150	130	Peak
3	2410.875	82.06	30.33	112.38	N/A	N/A	150	130	Peak

Note:

1. " \*", means this data is the worst emission level.
2. C.F (Correction Factor) = Antenna Factor (dB/m)+ Cable Loss (dB).
3. Measurement (dBμV/m) = Reading(dBμV) + C.F (Correction Factor).
4. The emission levels of other frequencies are very lower than the limit and not show in test report.



EUT	HAN Access Point	Date of Test	2021-09-24
Factor	DRH18-E	Temp. / Humidity	24°C /52%
Polarity	Vertical	Site / Test Engineer	AC2 / Jay
Test Mode	802.11n20_TX_CH 1	Test Voltage	AC 120V/60Hz

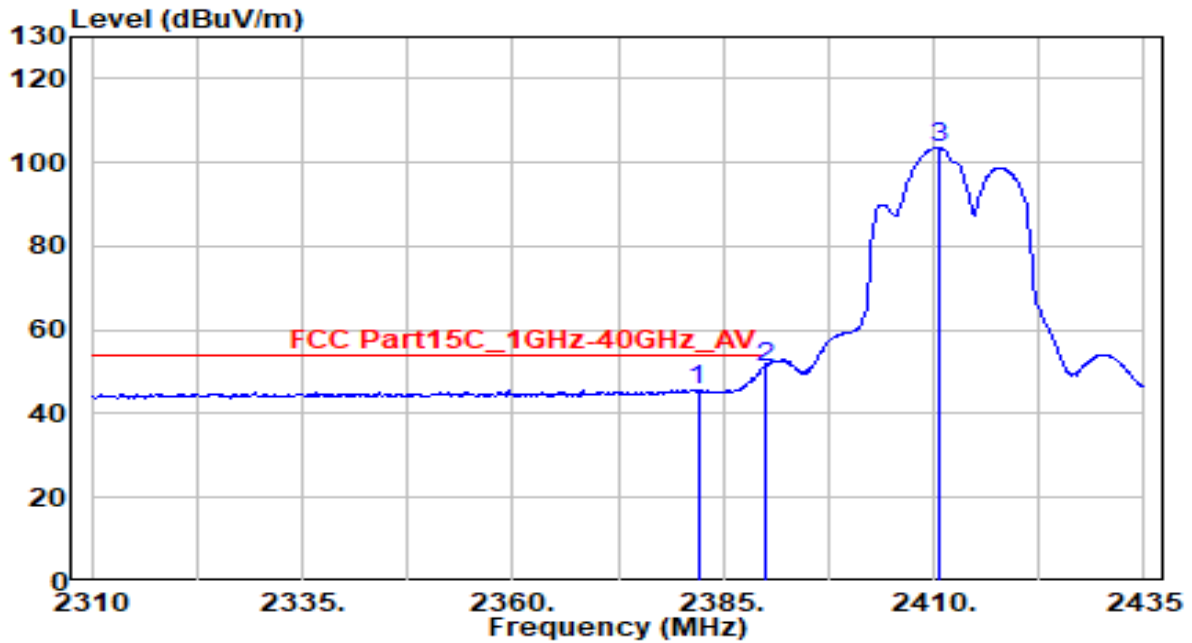

No	Frequency (MHz)	Reading (dB $\mu$ V)	C.F (dB/m)	Measurement (dB $\mu$ V/m)	Margin (dB)	Limit (dB $\mu$ V/m)	Height (cm)	Angle (deg)	Remark (QP/PK/AV)
1	2382.000	15.47	30.27	45.74	-8.26	54.00	150	130	Average
2	* 2390.000	20.87	30.29	51.16	-2.84	54.00	150	130	Average
3	2410.500	73.32	30.33	103.65	N/A	N/A	150	130	Average

Note:

1. " \*", means this data is the worst emission level.
2. C.F (Correction Factor) = Antenna Factor (dB/m)+ Cable Loss (dB).
3. Measurement (dB $\mu$ V/m) = Reading(dB $\mu$ V) + C.F (Correction Factor).
4. The emission levels of other frequencies are very lower than the limit and not show in test report.

EUT	HAN Access Point	Date of Test	2021-09-24
Factor	DRH18-E	Temp. / Humidity	23°C /49%
Polarity	Horizontal	Site / Test Engineer	AC2 / Jay
Test Mode	802.11n20_TX_CH 11	Test Voltage	AC 120V/60Hz

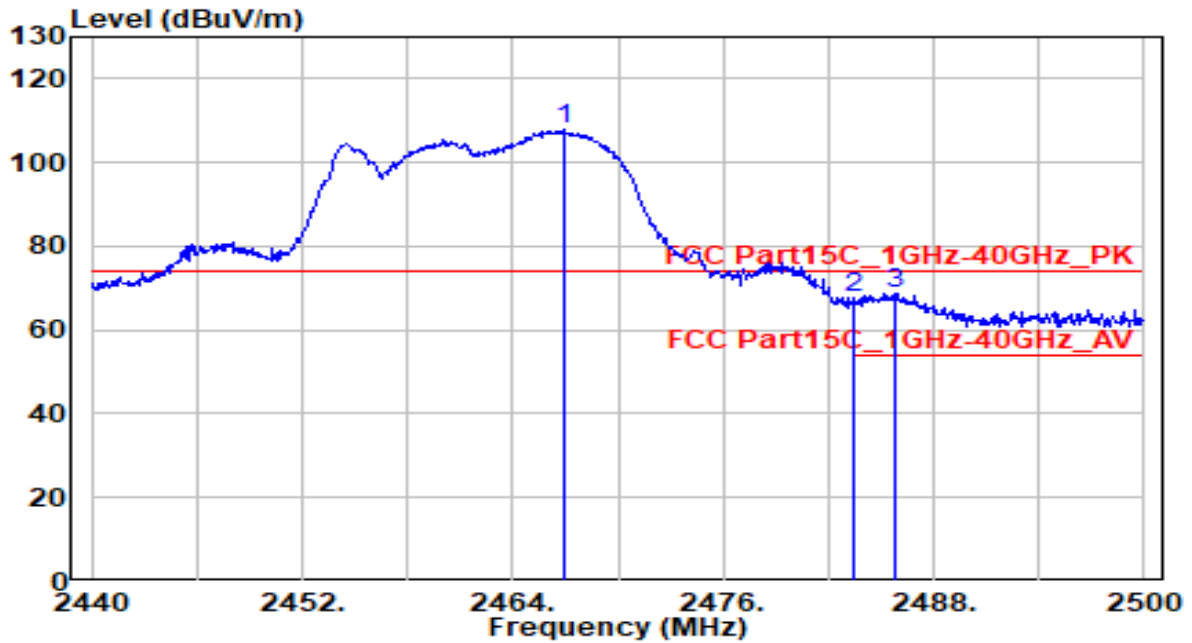

No	Frequency (MHz)	Reading (dB $\mu$ V)	C.F (dB/m)	Measurement (dB $\mu$ V/m)	Margin (dB)	Limit (dB $\mu$ V/m)	Height (cm)	Angle (deg)	Remark (QP/PK/AV)
1	2467.000	77.31	30.43	107.74	N/A	N/A	140	45	Peak
2	2483.500	37.06	30.46	67.52	-6.48	74.00	140	45	Peak
3	* 2485.840	38.13	30.46	68.60	-5.40	74.00	140	45	Peak

Note:

1. " \*", means this data is the worst emission level.
2. C.F (Correction Factor) = Antenna Factor (dB/m)+ Cable Loss (dB).
3. Measurement (dB $\mu$ V/m) = Reading(dB $\mu$ V) + C.F (Correction Factor).
4. The emission levels of other frequencies are very lower than the limit and not show in test report.

EUT	HAN Access Point	Date of Test	2021-09-24
Factor	DRH18-E	Temp. / Humidity	23°C /49%
Polarity	Horizontal	Site / Test Engineer	AC2 / Jay
Test Mode	802.11n20_TX_CH 11	Test Voltage	AC 120V/60Hz

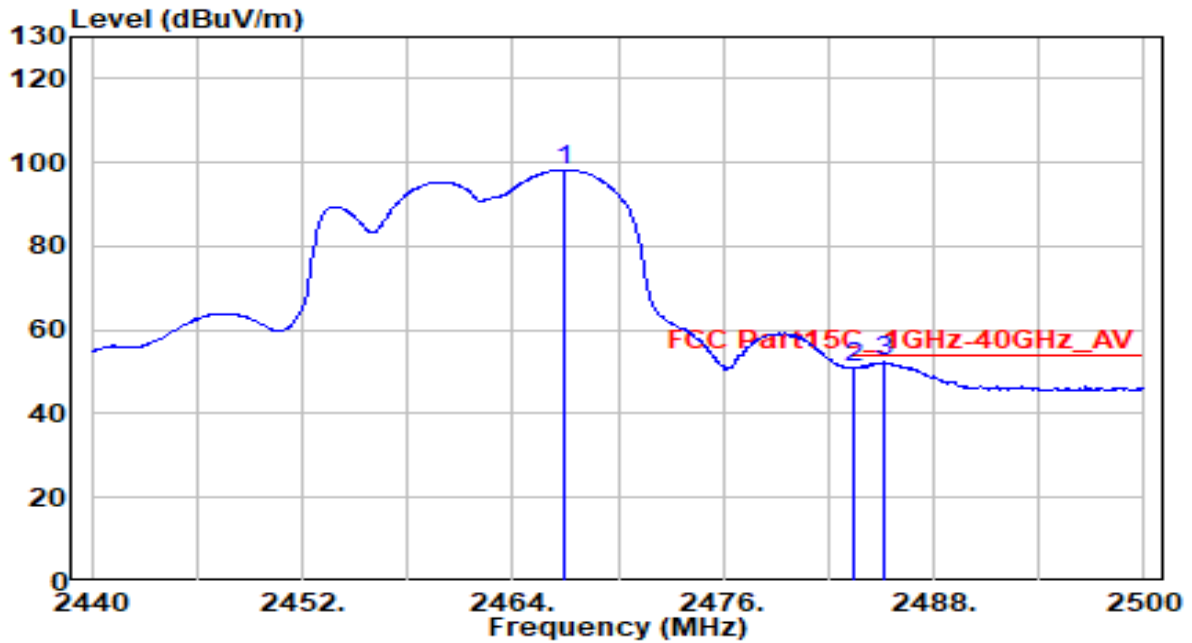

No	Frequency (MHz)	Reading (dBμV)	C.F (dB/m)	Measurement (dBμV/m)	Margin (dB)	Limit (dBμV/m)	Height (cm)	Angle (deg)	Remark (QP/PK/AV)
1	2467.000	67.88	30.43	98.31	N/A	N/A	140	45	Average
2	2483.500	20.38	30.46	50.84	-3.16	54.00	140	45	Average
3	* 2485.180	21.82	30.46	52.28	-1.72	54.00	140	45	Average

Note:

1. " \*", means this data is the worst emission level.
2. C.F (Correction Factor) = Antenna Factor (dB/m)+ Cable Loss (dB).
3. Measurement (dBμV/m) = Reading(dBμV) + C.F (Correction Factor).
4. The emission levels of other frequencies are very lower than the limit and not show in test report.

EUT	HAN Access Point	Date of Test	2021-09-24
Factor	DRH18-E	Temp. / Humidity	23°C /49%
Polarity	Vertical	Site / Test Engineer	AC2 / Jay
Test Mode	802.11n20_TX_CH 11	Test Voltage	AC 120V/60Hz

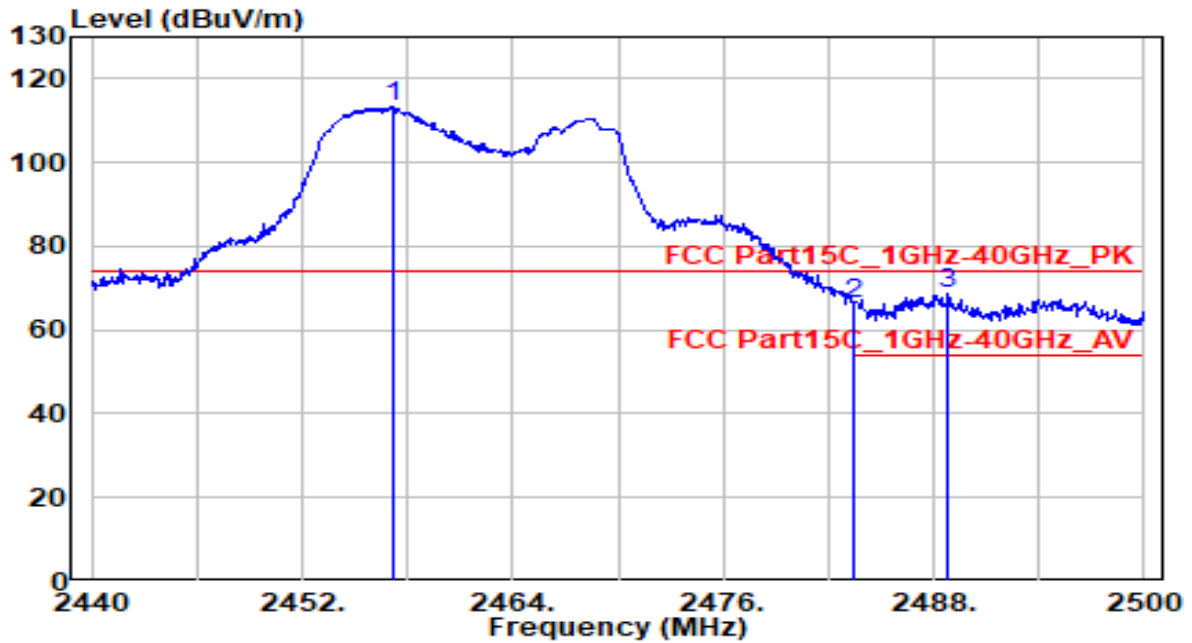

No	Frequency (MHz)	Reading (dB $\mu$ V)	C.F (dB/m)	Measurement (dB $\mu$ V/m)	Margin (dB)	Limit (dB $\mu$ V/m)	Height (cm)	Angle (deg)	Remark (QP/PK/AV)
1	2457.160	82.90	30.41	113.32	N/A	N/A	190	40	Peak
2	2483.500	35.52	30.46	65.98	-8.02	74.00	190	40	Peak
3	* 2488.780	38.18	30.47	68.65	-5.35	74.00	190	40	Peak

Note:

1. " \*", means this data is the worst emission level.
2. C.F (Correction Factor) = Antenna Factor (dB/m)+ Cable Loss (dB).
3. Measurement (dB $\mu$ V/m) = Reading(dB $\mu$ V) + C.F (Correction Factor).
4. The emission levels of other frequencies are very lower than the limit and not show in test report.

EUT	HAN Access Point	Date of Test	2021-09-24
Factor	DRH18-E	Temp. / Humidity	23°C /49%
Polarity	Vertical	Site / Test Engineer	AC2 / Jay
Test Mode	802.11n20_TX_CH 11	Test Voltage	AC 120V/60Hz

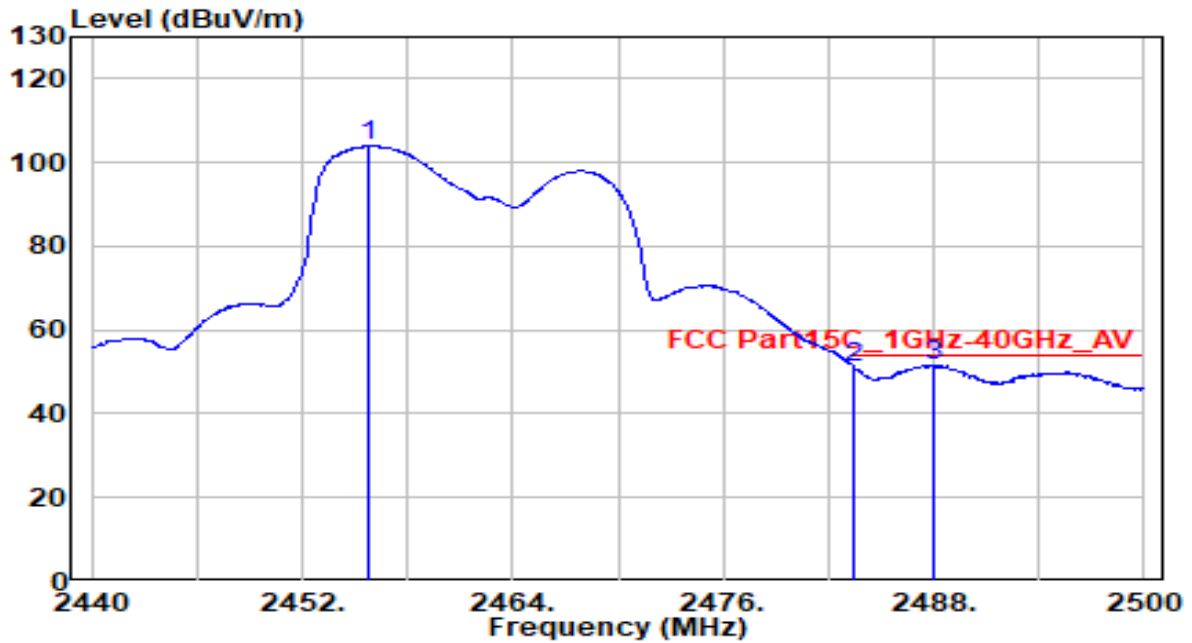

No	Frequency (MHz)	Reading (dBμV)	C.F (dB/m)	Measurement (dBμV/m)	Margin (dB)	Limit (dBμV/m)	Height (cm)	Angle (deg)	Remark (QP/PK/AV)
1	2455.780	73.51	30.41	103.92	N/A	N/A	190	40	Average
2	2483.500	20.51	30.46	50.97	-3.03	54.00	190	40	Average
3	* 2488.060	21.04	30.47	51.51	-2.49	54.00	190	40	Average

Note:

1. " \*", means this data is the worst emission level.
2. C.F (Correction Factor) = Antenna Factor (dB/m)+ Cable Loss (dB).
3. Measurement (dBμV/m) = Reading(dBμV) + C.F (Correction Factor).
4. The emission levels of other frequencies are very lower than the limit and not show in test report.

EUT	HAN Access Point	Date of Test	2021-09-24
Factor	DRH18-E	Temp. / Humidity	23°C /49%
Polarity	Horizontal	Site / Test Engineer	AC2 / Jay
Test Mode	802.11n40_TX_CH 3	Test Voltage	AC 120V/60Hz

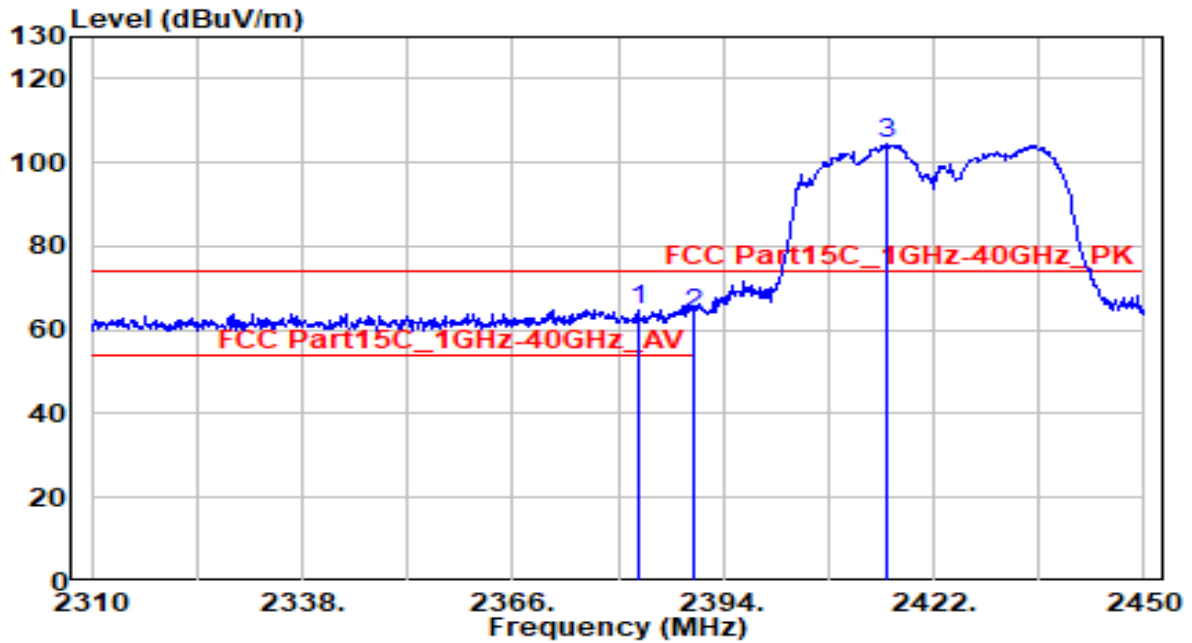

No	Frequency (MHz)	Reading (dBμV)	C.F (dB/m)	Measurement (dBμV/m)	Margin (dB)	Limit (dBμV/m)	Height (cm)	Angle (deg)	Remark (QP/PK/AV)
1	* 2382.660	34.65	30.27	64.92	-9.08	74.00	145	205	Peak
2	2390.000	33.63	30.29	63.91	-10.09	74.00	145	205	Peak
3	2415.700	74.11	30.34	104.45	N/A	N/A	145	205	Peak

Note:

1. " \*", means this data is the worst emission level.
2. C.F (Correction Factor) = Antenna Factor (dB/m)+ Cable Loss (dB).
3. Measurement (dBμV/m) = Reading(dBμV) + C.F (Correction Factor).
4. The emission levels of other frequencies are very lower than the limit and not show in test report.

EUT	HAN Access Point	Date of Test	2021-09-24
Factor	DRH18-E	Temp. / Humidity	23°C /49%
Polarity	Horizontal	Site / Test Engineer	AC2 / Jay
Test Mode	802.11n40_TX_CH 3	Test Voltage	AC 120V/60Hz

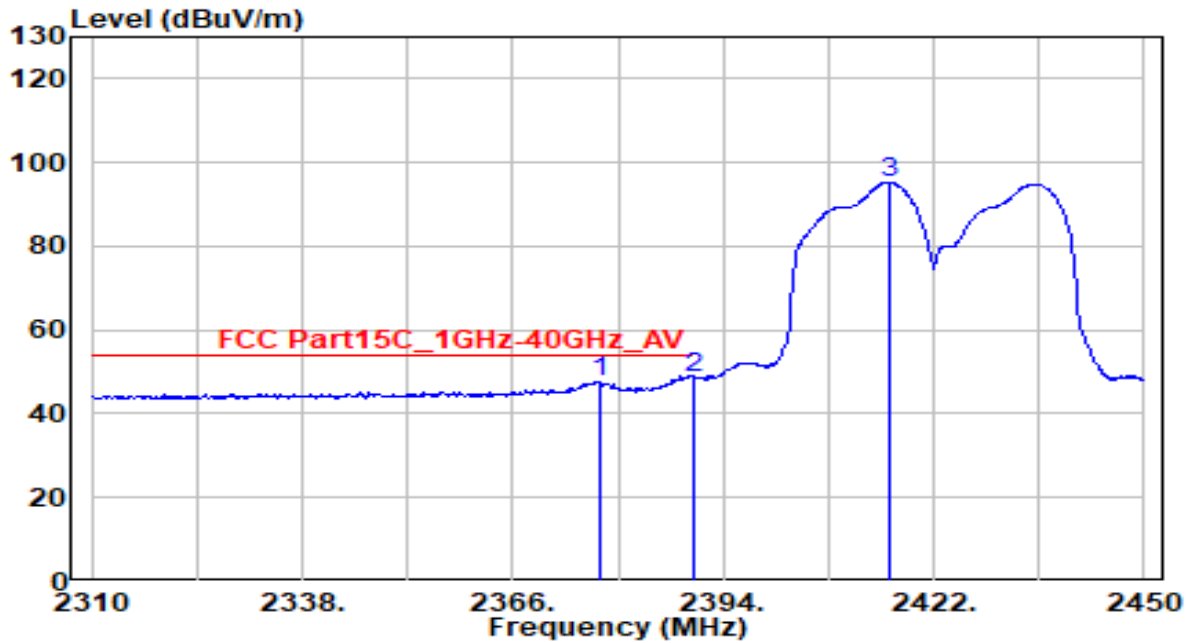

No	Frequency (MHz)	Reading (dB $\mu$ V)	C.F (dB/m)	Measurement (dB $\mu$ V/m)	Margin (dB)	Limit (dB $\mu$ V/m)	Height (cm)	Angle (deg)	Remark (QP/PK/AV)
1	2377.480	17.43	30.26	47.69	-6.31	54.00	145	205	Average
2	* 2390.000	18.29	30.29	48.57	-5.43	54.00	145	205	Average
3	2416.120	64.97	30.34	95.31	N/A	N/A	145	205	Average

Note:

1. " \*", means this data is the worst emission level.
2. C.F (Correction Factor) = Antenna Factor (dB/m)+ Cable Loss (dB).
3. Measurement (dB $\mu$ V/m) = Reading(dB $\mu$ V) + C.F (Correction Factor).
4. The emission levels of other frequencies are very lower than the limit and not show in test report.

EUT	HAN Access Point	Date of Test	2021-09-24
Factor	DRH18-E	Temp. / Humidity	23°C /49%
Polarity	Vertical	Site / Test Engineer	AC2 / Jay
Test Mode	802.11n40_TX_CH 3	Test Voltage	AC 120V/60Hz

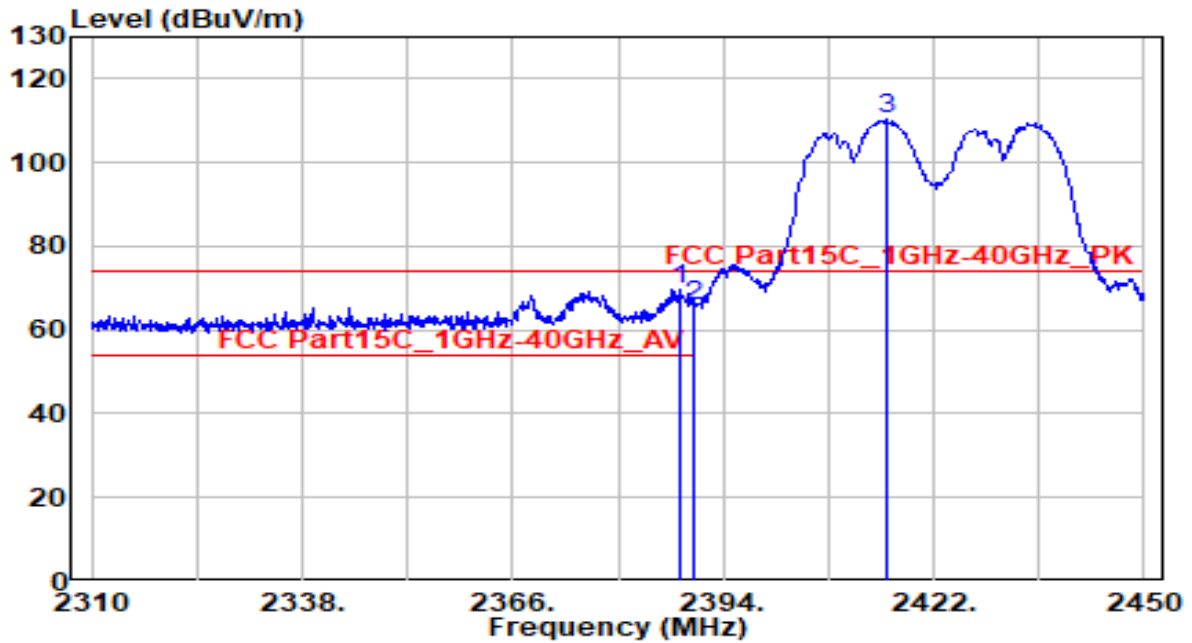

No	Frequency (MHz)	Reading (dBμV)	C.F (dB/m)	Measurement (dBμV/m)	Margin (dB)	Limit (dBμV/m)	Height (cm)	Angle (deg)	Remark (QP/PK/AV)	
1	*	2388.120	39.60	30.28	69.88	-4.12	74.00	150	45	Peak
2		2390.000	35.45	30.29	65.74	-8.26	74.00	150	45	Peak
3		2415.700	79.82	30.34	110.16	N/A	N/A	150	45	Peak

Note:

1. " \*", means this data is the worst emission level.
2. C.F (Correction Factor) = Antenna Factor (dB/m)+ Cable Loss (dB).
3. Measurement (dBμV/m) = Reading(dBμV) + C.F (Correction Factor).
4. The emission levels of other frequencies are very lower than the limit and not show in test report.



EUT	HAN Access Point	Date of Test	2021-09-24
Factor	DRH18-E	Temp. / Humidity	23°C /49%
Polarity	Vertical	Site / Test Engineer	AC2 / Jay
Test Mode	802.11n40_TX_CH 3	Test Voltage	AC 120V/60Hz

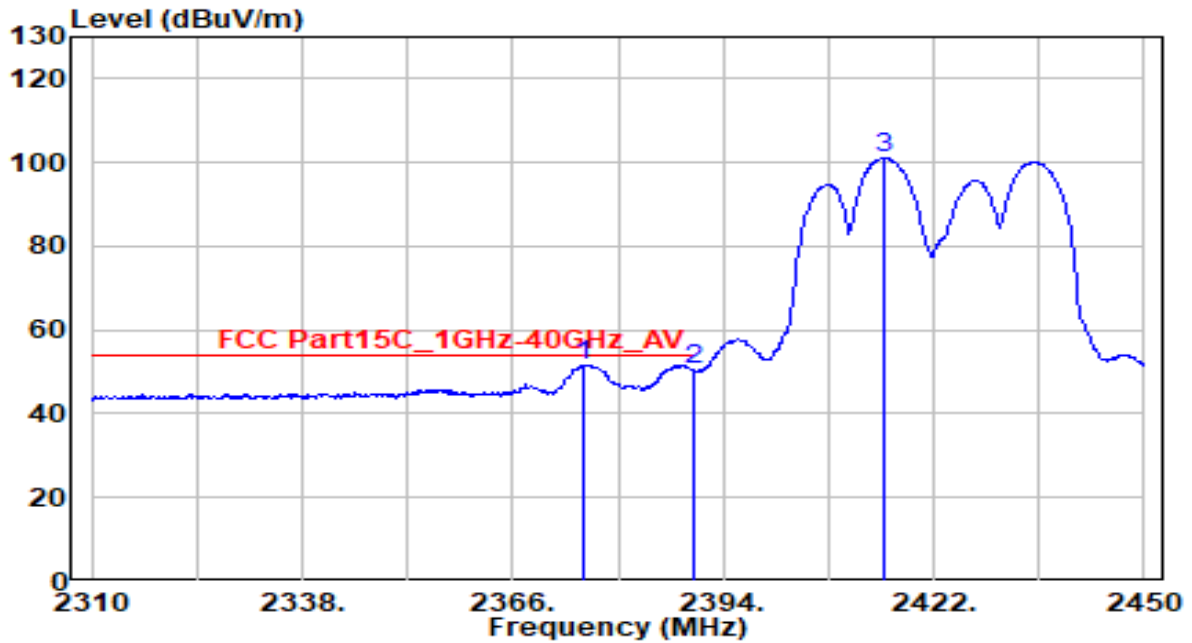

No	Frequency (MHz)	Reading (dBμV)	C.F (dB/m)	Measurement (dBμV/m)	Margin (dB)	Limit (dBμV/m)	Height (cm)	Angle (deg)	Remark (QP/PK/AV)	
1	*	2375.380	21.40	30.25	51.65	-2.35	54.00	150	45	Average
2		2390.000	20.14	30.29	50.42	-3.58	54.00	150	45	Average
3		2415.280	70.77	30.34	101.10	N/A	N/A	150	45	Average

Note:

1. " \*", means this data is the worst emission level.
2. C.F (Correction Factor) = Antenna Factor (dB/m)+ Cable Loss (dB).
3. Measurement (dBμV/m) = Reading(dBμV) + C.F (Correction Factor).
4. The emission levels of other frequencies are very lower than the limit and not show in test report.

EUT	HAN Access Point	Date of Test	2021-09-24
Factor	DRH18-E	Temp. / Humidity	23°C /49%
Polarity	Horizontal	Site / Test Engineer	AC2 / Jay
Test Mode	802.11n40_TX_CH 6	Test Voltage	AC 120V/60Hz

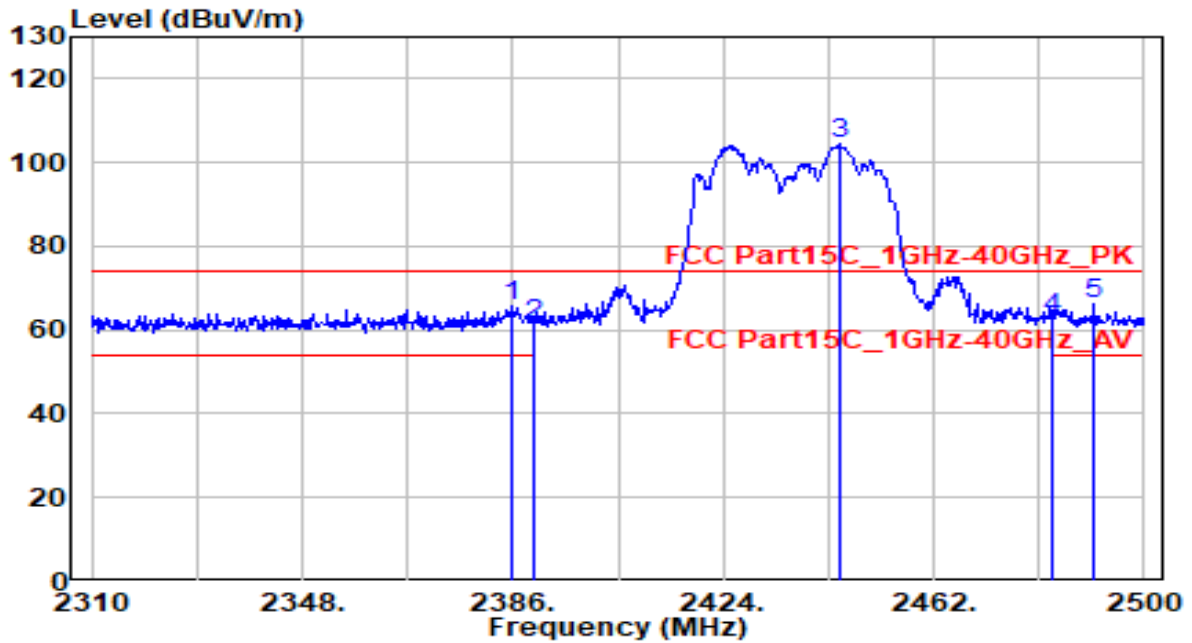

No	Frequency (MHz)	Reading (dBμV)	C.F (dB/m)	Measurement (dBμV/m)	Margin (dB)	Limit (dBμV/m)	Height (cm)	Angle (deg)	Remark (QP/PK/AV)
1	* 2385.810	35.67	30.28	65.95	-8.05	74.00	150	140	Peak
2	2390.000	31.18	30.29	61.47	-12.53	74.00	150	140	Peak
3	2445.090	73.99	30.39	104.38	N/A	N/A	150	140	Peak
4	2483.500	32.57	30.46	63.03	-10.97	74.00	150	140	Peak
5	2491.070	35.78	30.47	66.26	-7.74	74.00	150	140	Peak

Note:

- "\*", means this data is the worst emission level.
- C.F (Correction Factor) = Antenna Factor (dB/m)+ Cable Loss (dB).
- Measurement (dBμV/m) = Reading(dBμV) + C.F (Correction Factor).
- The emission levels of other frequencies are very lower than the limit and not show in test report.

EUT	HAN Access Point	Date of Test	2021-09-24
Factor	DRH18-E	Temp. / Humidity	23°C /49%
Polarity	Horizontal	Site / Test Engineer	AC2 / Jay
Test Mode	802.11n40_TX_CH 6	Test Voltage	AC 120V/60Hz

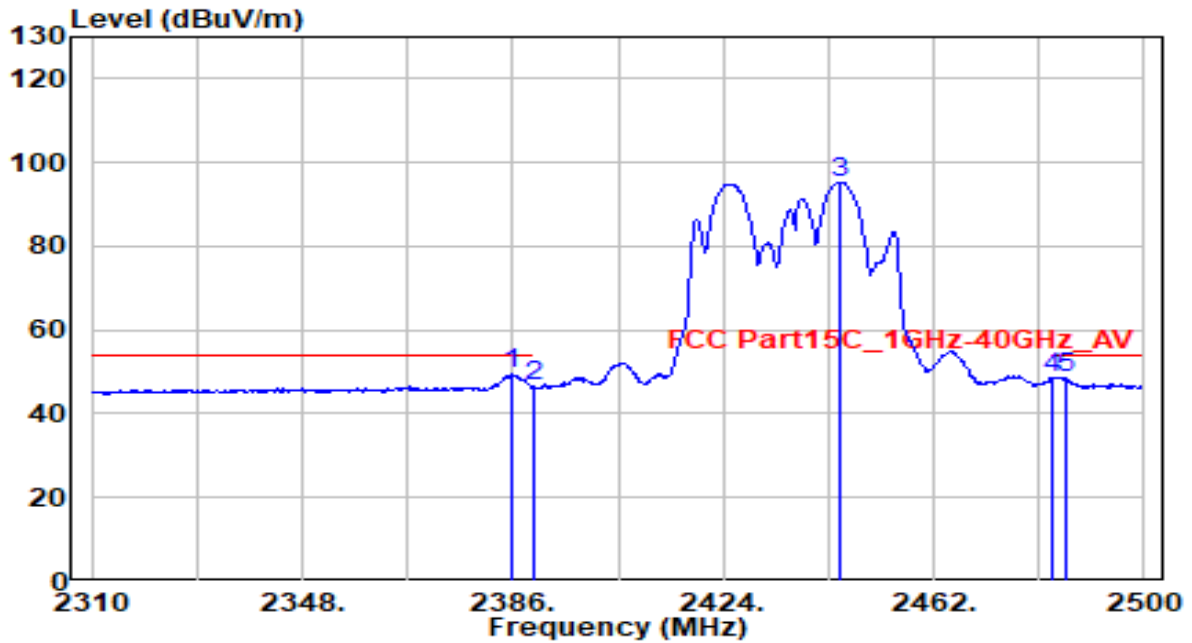

No	Frequency (MHz)	Reading (dBμV)	C.F (dB/m)	Measurement (dBμV/m)	Margin (dB)	Limit (dBμV/m)	Height (cm)	Angle (deg)	Remark (QP/PK/AV)
1	* 2386.000	19.27	30.28	49.55	-4.45	54.00	150	140	Average
2	2390.000	16.48	30.29	46.77	-7.23	54.00	150	140	Average
3	2445.090	65.00	30.39	95.39	N/A	N/A	150	140	Average
4	2483.500	17.95	30.46	48.41	-5.59	54.00	150	140	Average
5	2485.750	18.19	30.46	48.65	-5.35	54.00	150	140	Average

Note:

- " \*", means this data is the worst emission level.
- C.F (Correction Factor) = Antenna Factor (dB/m)+ Cable Loss (dB).
- Measurement (dBμV/m) = Reading(dBμV) + C.F (Correction Factor).
- The emission levels of other frequencies are very lower than the limit and not show in test report.

EUT	HAN Access Point	Date of Test	2021-09-24
Factor	DRH18-E	Temp. / Humidity	23°C /49%
Polarity	Vertical	Site / Test Engineer	AC2 / Jay
Test Mode	802.11n40_TX_CH 6	Test Voltage	AC 120V/60Hz

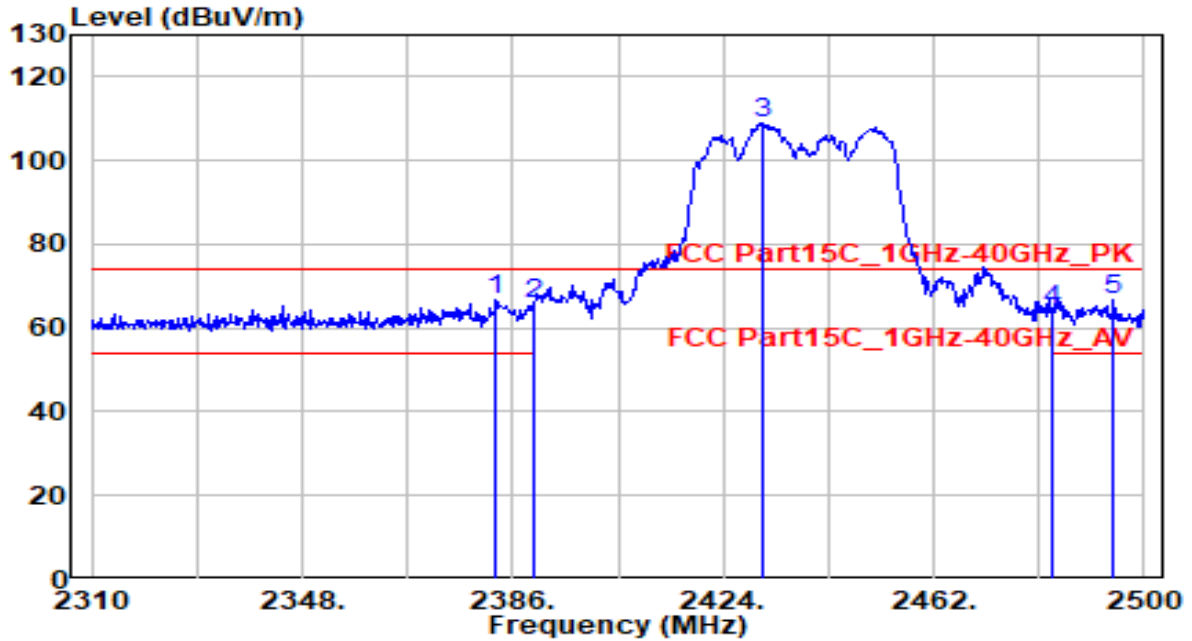

No	Frequency (MHz)	Reading (dBμV)	C.F (dB/m)	Measurement (dBμV/m)	Margin (dB)	Limit (dBμV/m)	Height (cm)	Angle (deg)	Remark (QP/PK/AV)
1	2382.960	36.25	30.27	66.52	-7.48	74.00	150	35	Peak
2	2390.000	35.22	30.29	65.50	-8.50	74.00	150	35	Peak
3	2431.220	78.65	30.37	109.02	N/A	N/A	150	35	Peak
4	2483.500	33.61	30.46	64.07	-9.93	74.00	150	35	Peak
5	* 2494.490	36.36	30.48	66.84	-7.16	74.00	150	35	Peak

Note:

1. " \*", means this data is the worst emission level.
2. C.F (Correction Factor) = Antenna Factor (dB/m)+ Cable Loss (dB).
3. Measurement (dBμV/m) = Reading(dBμV) + C.F (Correction Factor).
4. The emission levels of other frequencies are very lower than the limit and not show in test report.

EUT	HAN Access Point	Date of Test	2021-09-24
Factor	DRH18-E	Temp. / Humidity	23°C /49%
Polarity	Vertical	Site / Test Engineer	AC2 / Jay
Test Mode	802.11n40_TX_CH 6	Test Voltage	AC 120V/60Hz

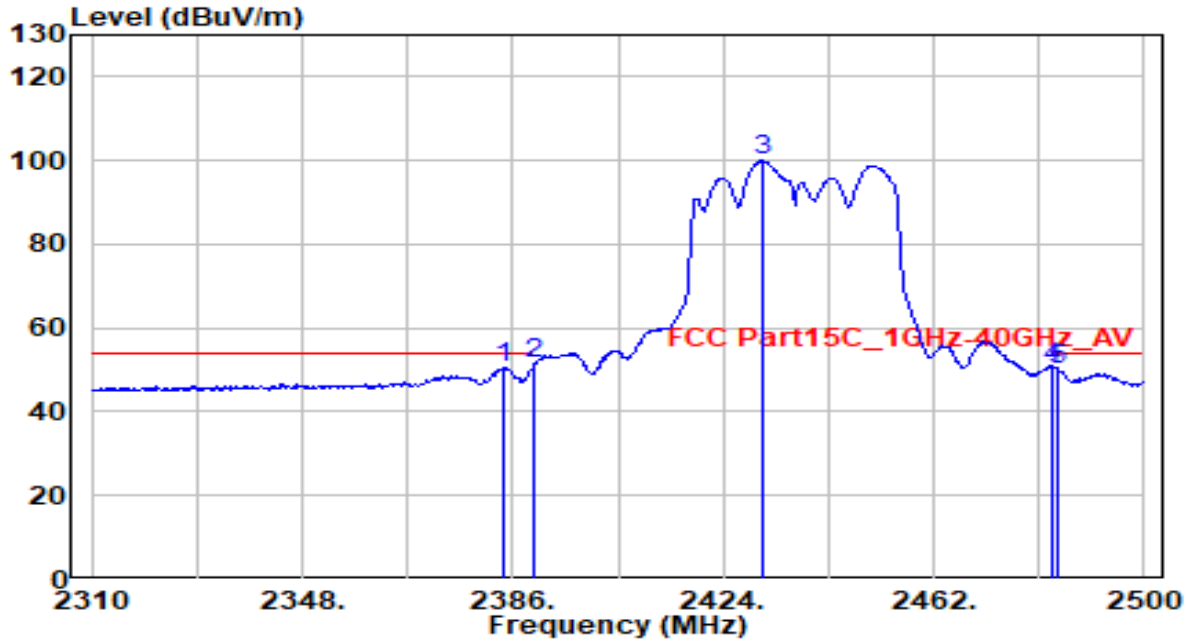

No	Frequency (MHz)	Reading (dBμV)	C.F (dB/m)	Measurement (dBμV/m)	Margin (dB)	Limit (dBμV/m)	Height (cm)	Angle (deg)	Remark (QP/PK/AV)
1	2384.290	20.45	30.27	50.72	-3.28	54.00	150	35	Average
2	* 2390.000	21.02	30.29	51.31	-2.69	54.00	150	35	Average
3	2431.220	69.52	30.37	99.88	N/A	N/A	150	35	Average
4	2483.500	20.25	30.46	50.71	-3.29	54.00	150	35	Average
5	2484.610	19.50	30.46	49.96	-4.04	54.00	150	35	Average

Note:

1. " \*", means this data is the worst emission level.
2. C.F (Correction Factor) = Antenna Factor (dB/m)+ Cable Loss (dB).
3. Measurement (dBμV/m) = Reading(dBμV) + C.F (Correction Factor).
4. The emission levels of other frequencies are very lower than the limit and not show in test report.

EUT	HAN Access Point	Date of Test	2021-09-24
Factor	DRH18-E	Temp. / Humidity	23°C /49%
Polarity	Horizontal	Site / Test Engineer	AC2 / Jay
Test Mode	802.11n40_TX_CH 9	Test Voltage	AC 120V/60Hz

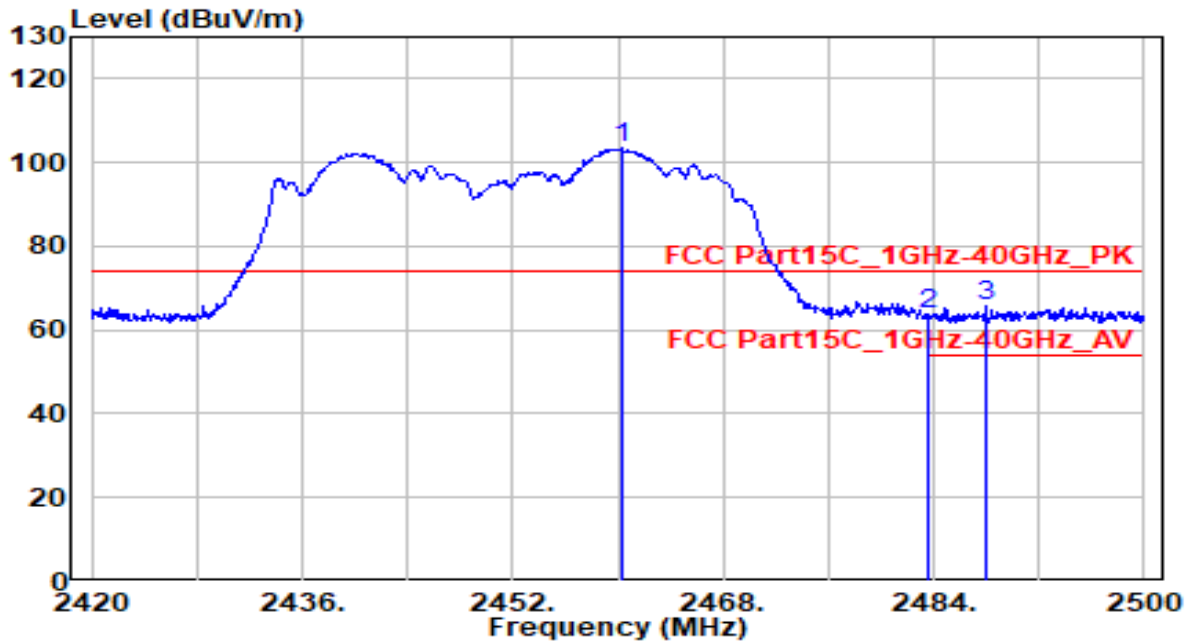

No	Frequency (MHz)	Reading (dB $\mu$ V)	C.F (dB/m)	Measurement (dB $\mu$ V/m)	Margin (dB)	Limit (dB $\mu$ V/m)	Height (cm)	Angle (deg)	Remark (QP/PK/AV)
1	2460.320	72.85	30.42	103.27	N/A	N/A	145	140	Peak
2	2483.500	33.46	30.46	63.92	-10.08	74.00	145	140	Peak
3	* 2487.920	35.07	30.47	65.54	-8.46	74.00	145	140	Peak

Note:

1. " \*", means this data is the worst emission level.
2. C.F (Correction Factor) = Antenna Factor (dB/m)+ Cable Loss (dB).
3. Measurement (dB $\mu$ V/m) = Reading(dB $\mu$ V) + C.F (Correction Factor).
4. The emission levels of other frequencies are very lower than the limit and not show in test report.

EUT	HAN Access Point	Date of Test	2021-09-24
Factor	DRH18-E	Temp. / Humidity	23°C /49%
Polarity	Horizontal	Site / Test Engineer	AC2 / Jay
Test Mode	802.11n40_TX_CH 9	Test Voltage	AC 120V/60Hz

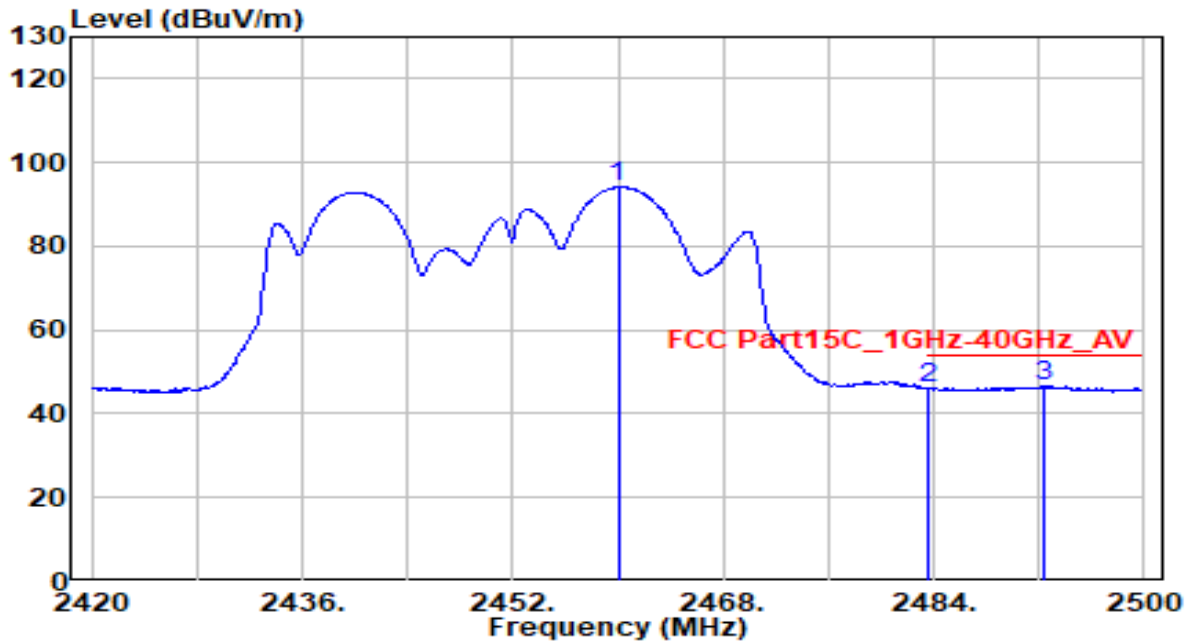

No	Frequency (MHz)	Reading (dBμV)	C.F (dB/m)	Measurement (dBμV/m)	Margin (dB)	Limit (dBμV/m)	Height (cm)	Angle (deg)	Remark (QP/PK/AV)
1	2460.000	63.67	30.42	94.08	N/A	N/A	145	140	Average
2	2483.500	15.80	30.46	46.26	-7.74	54.00	145	140	Average
3	* 2492.480	16.14	30.48	46.61	-7.39	54.00	145	140	Average

Note:

1. " \*", means this data is the worst emission level.
2. C.F (Correction Factor) = Antenna Factor (dB/m)+ Cable Loss (dB).
3. Measurement (dBμV/m) = Reading(dBμV) + C.F (Correction Factor).
4. The emission levels of other frequencies are very lower than the limit and not show in test report.

EUT	HAN Access Point	Date of Test	2021-09-24
Factor	DRH18-E	Temp. / Humidity	23°C /49%
Polarity	Vertical	Site / Test Engineer	AC2 / Jay
Test Mode	802.11n40_TX_CH 9	Test Voltage	AC 120V/60Hz

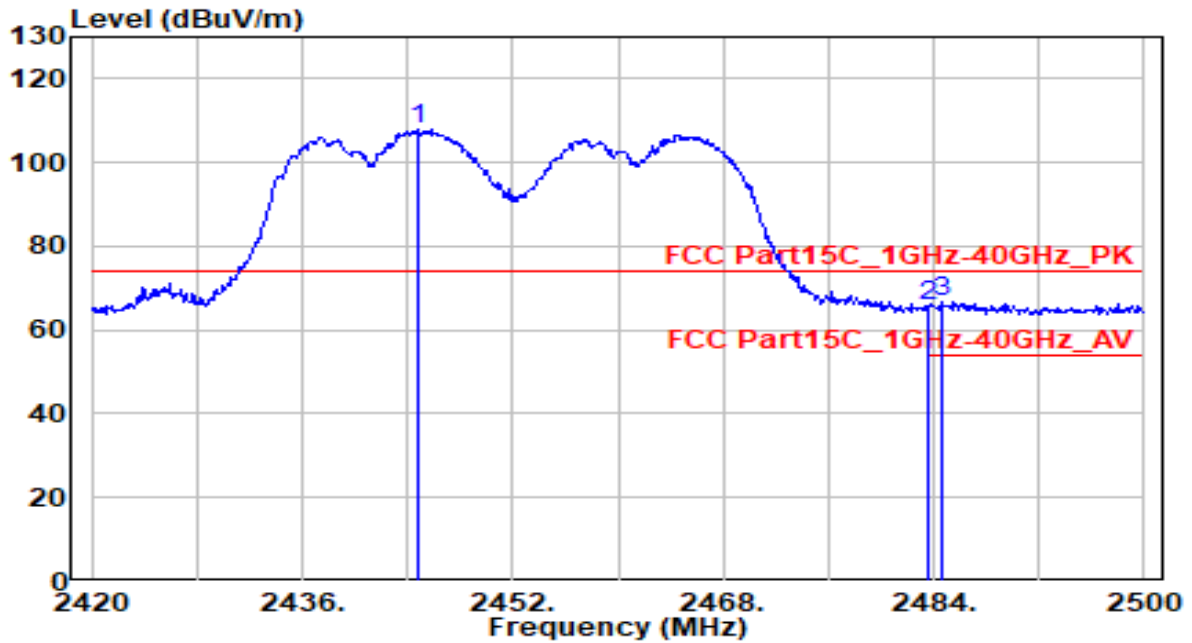

No	Frequency (MHz)	Reading (dB $\mu$ V)	C.F (dB/m)	Measurement (dB $\mu$ V/m)	Margin (dB)	Limit (dB $\mu$ V/m)	Height (cm)	Angle (deg)	Remark (QP/PK/AV)
1	2444.720	77.39	30.39	107.78	N/A	N/A	150	45	Peak
2	2483.500	35.13	30.46	65.59	-8.41	74.00	150	45	Peak
3	* 2484.640	36.38	30.46	66.84	-7.16	74.00	150	45	Peak

Note:

1. " \*", means this data is the worst emission level.
2. C.F (Correction Factor) = Antenna Factor (dB/m)+ Cable Loss (dB).
3. Measurement (dB $\mu$ V/m) = Reading(dB $\mu$ V) + C.F (Correction Factor).
4. The emission levels of other frequencies are very lower than the limit and not show in test report.



EUT	HAN Access Point	Date of Test	2021-09-24
Factor	DRH18-E	Temp. / Humidity	23°C /49%
Polarity	Vertical	Site / Test Engineer	AC2 / Jay
Test Mode	802.11n40_TX_CH 9	Test Voltage	AC 120V/60Hz

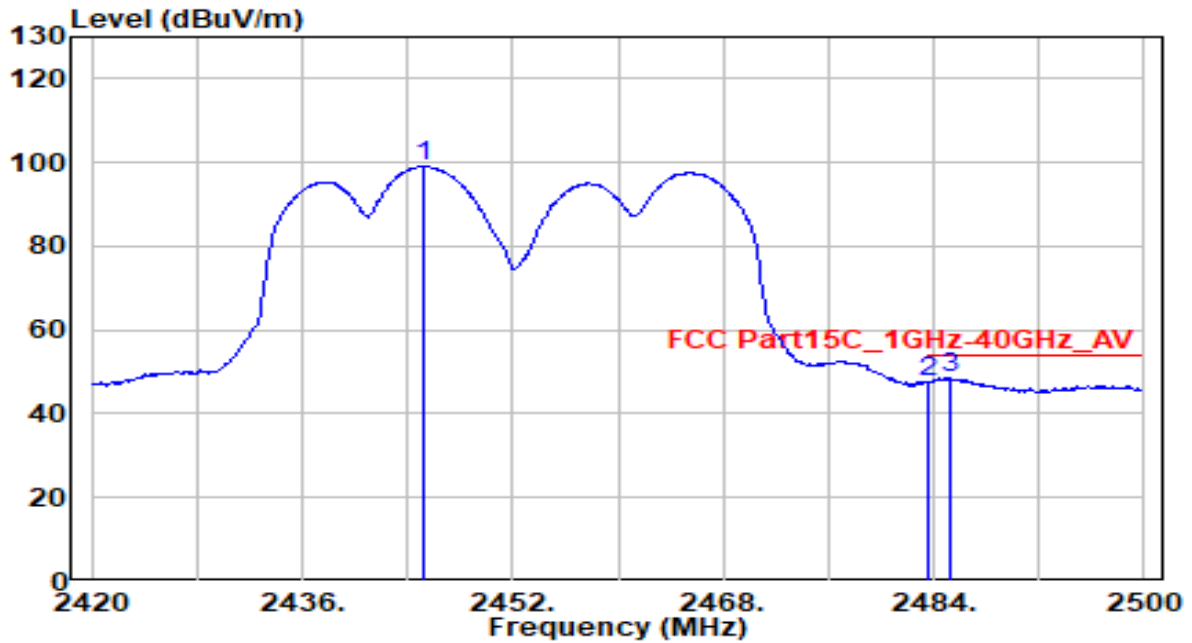

No	Frequency (MHz)	Reading (dB $\mu$ V)	C.F (dB/m)	Measurement (dB $\mu$ V/m)	Margin (dB)	Limit (dB $\mu$ V/m)	Height (cm)	Angle (deg)	Remark (QP/PK/AV)
1	2445.200	68.58	30.39	98.97	N/A	N/A	150	45	Average
2	2483.500	17.33	30.46	47.79	-6.21	54.00	150	45	Average
3	* 2485.280	17.94	30.46	48.41	-5.59	54.00	150	45	Average

Note:

1. " \*", means this data is the worst emission level.
2. C.F (Correction Factor) = Antenna Factor (dB/m)+ Cable Loss (dB).
3. Measurement (dB $\mu$ V/m) = Reading(dB $\mu$ V) + C.F (Correction Factor).
4. The emission levels of other frequencies are very lower than the limit and not show in test report.

EUT	HAN Access Point	Date of Test	2021-09-24
Factor	DRH18-E	Temp. / Humidity	24°C /52%
Polarity	Horizontal	Site / Test Engineer	AC2 / Jay
Test Mode	802.11ax20_TX_CH 1	Test Voltage	AC 120V/60Hz

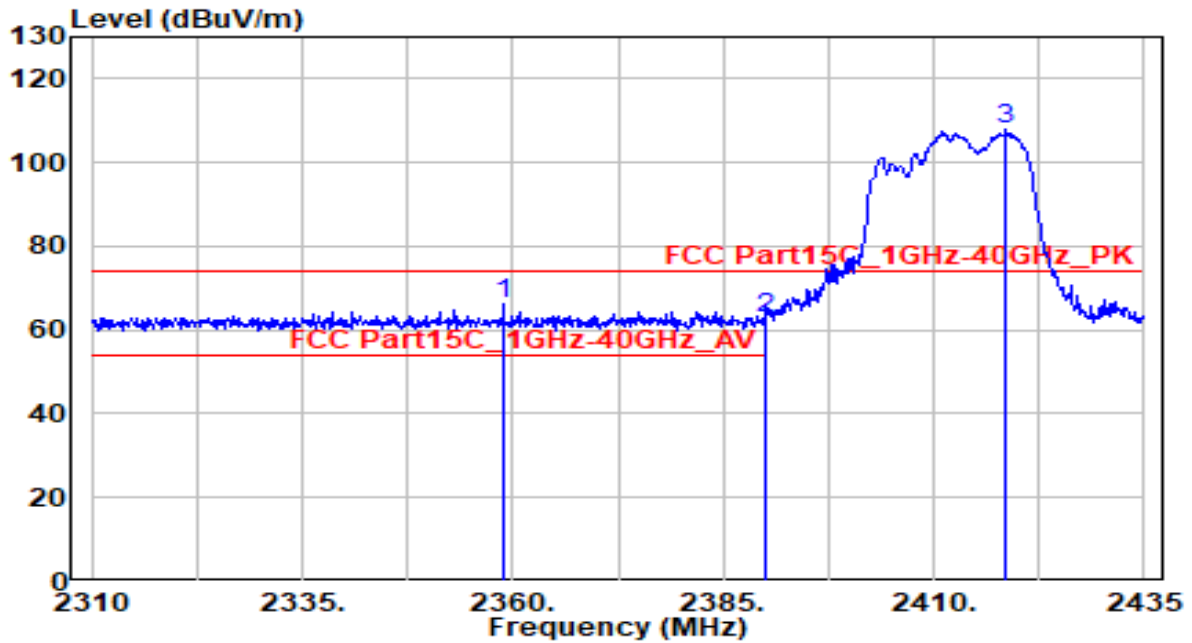

No	Frequency (MHz)	Reading (dB $\mu$ V)	C.F (dB/m)	Measurement (dB $\mu$ V/m)	Margin (dB)	Limit (dB $\mu$ V/m)	Height (cm)	Angle (deg)	Remark (QP/PK/AV)	
1	*	2358.875	35.80	30.22	66.01	-7.99	74.00	180	60	Peak
2		2390.000	32.52	30.29	62.80	-11.20	74.00	180	60	Peak
3		2418.500	77.39	30.34	107.73	N/A	N/A	180	60	Peak

Note:

1. " \*", means this data is the worst emission level.
2. C.F (Correction Factor) = Antenna Factor (dB/m)+ Cable Loss (dB).
3. Measurement (dB $\mu$ V/m) = Reading(dB $\mu$ V) + C.F (Correction Factor).
4. The emission levels of other frequencies are very lower than the limit and not show in test report.

EUT	HAN Access Point	Date of Test	2021-09-24
Factor	DRH18-E	Temp. / Humidity	24°C /52%
Polarity	Horizontal	Site / Test Engineer	AC2 / Jay
Test Mode	802.11ax20_TX_CH 1	Test Voltage	AC 120V/60Hz

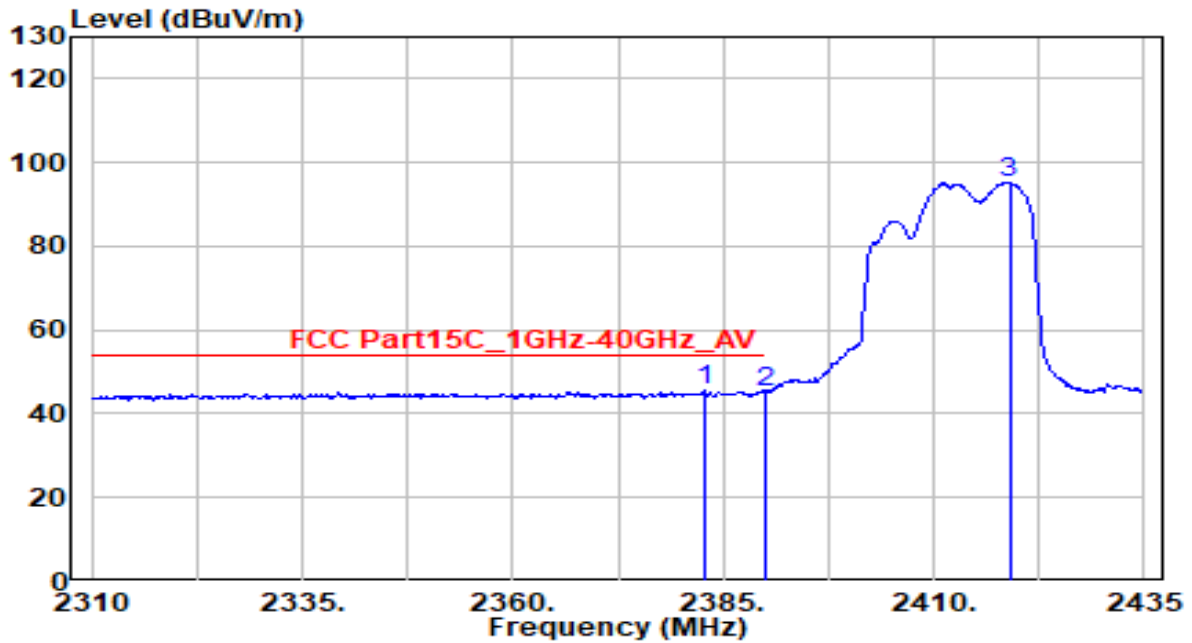

No	Frequency (MHz)	Reading (dBμV)	C.F (dB/m)	Measurement (dBμV/m)	Margin (dB)	Limit (dBμV/m)	Height (cm)	Angle (deg)	Remark (QP/PK/AV)
1	* 2382.750	15.21	30.27	45.48	-8.52	54.00	180	60	Average
2	2390.000	14.87	30.29	45.16	-8.84	54.00	180	60	Average
3	2419.000	64.84	30.34	95.19	N/A	N/A	180	60	Average

Note:

1. " \*", means this data is the worst emission level.
2. C.F (Correction Factor) = Antenna Factor (dB/m)+ Cable Loss (dB).
3. Measurement (dBμV/m) = Reading(dBμV) + C.F (Correction Factor).
4. The emission levels of other frequencies are very lower than the limit and not show in test report.

EUT	HAN Access Point	Date of Test	2021-09-24
Factor	DRH18-E	Temp. / Humidity	24°C /52%
Polarity	Vertical	Site / Test Engineer	AC2 / Jay
Test Mode	802.11ax20_TX_CH 1	Test Voltage	AC 120V/60Hz

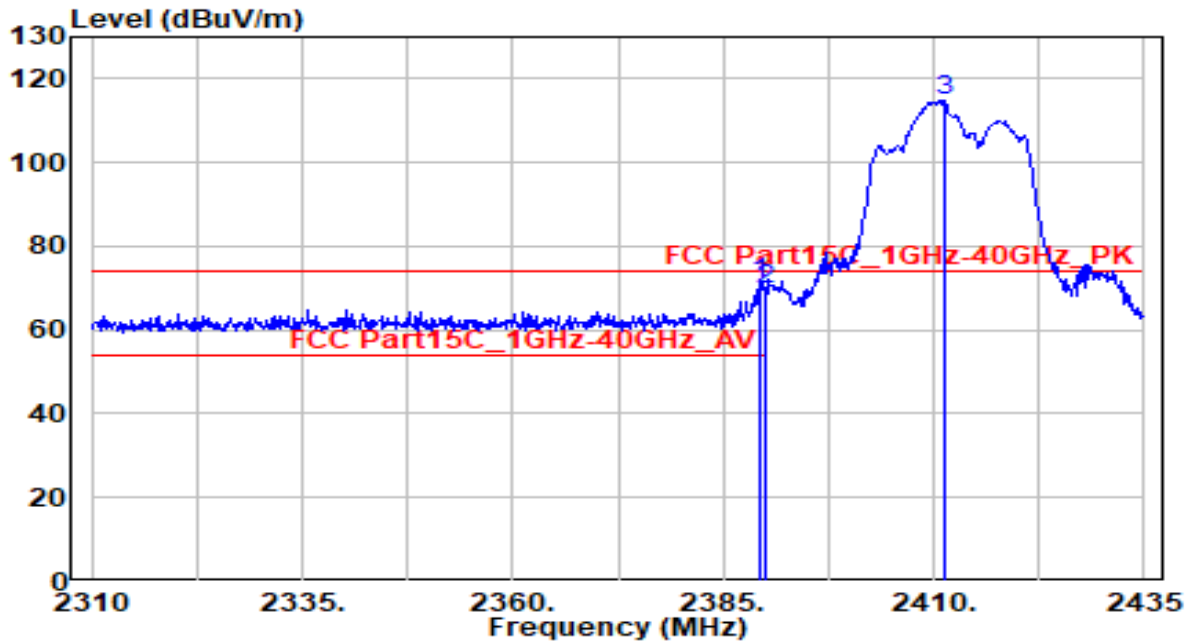

No	Frequency (MHz)	Reading (dBμV)	C.F (dB/m)	Measurement (dBμV/m)	Margin (dB)	Limit (dBμV/m)	Height (cm)	Angle (deg)	Remark (QP/PK/AV)	
1	*	2389.250	40.92	30.29	71.21	-2.79	74.00	150	130	Peak
2		2390.000	39.29	30.29	69.57	-4.43	74.00	150	130	Peak
3		2411.250	84.57	30.33	114.90	N/A	N/A	150	130	Peak

Note:

1. " \*", means this data is the worst emission level.
2. C.F (Correction Factor) = Antenna Factor (dB/m)+ Cable Loss (dB).
3. Measurement (dBμV/m) = Reading(dBμV) + C.F (Correction Factor).
4. The emission levels of other frequencies are very lower than the limit and not show in test report.

EUT	HAN Access Point	Date of Test	2021-09-24
Factor	DRH18-E	Temp. / Humidity	24°C /52%
Polarity	Vertical	Site / Test Engineer	AC2 / Jay
Test Mode	802.11ax20_TX_CH 1	Test Voltage	AC 120V/60Hz

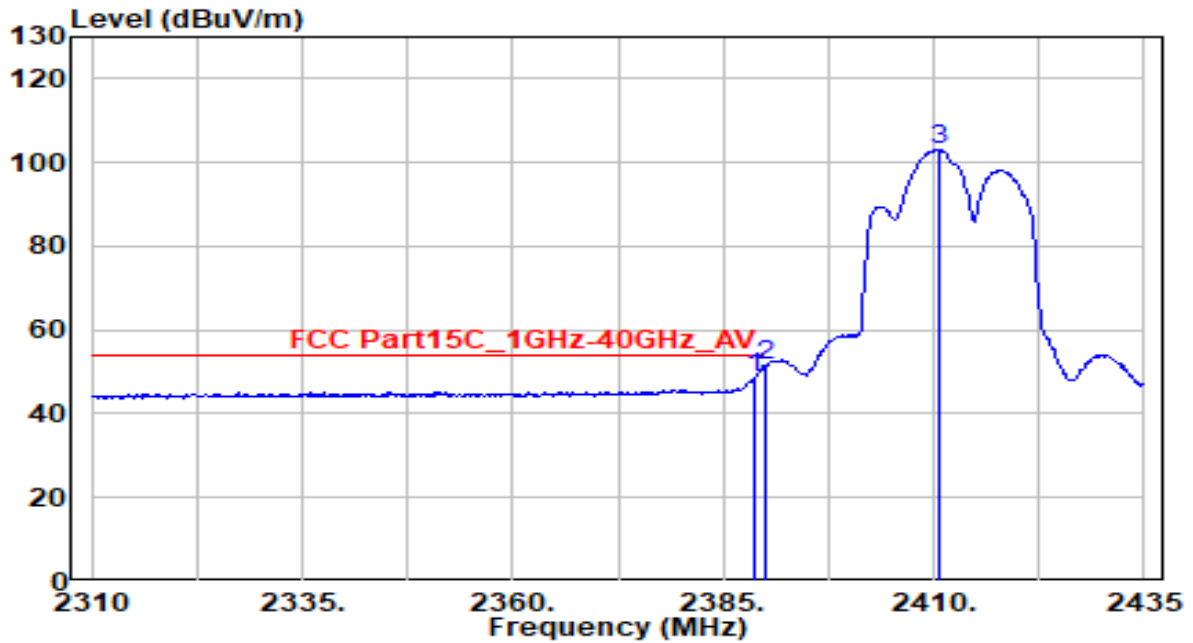

No	Frequency (MHz)	Reading (dBμV)	C.F (dB/m)	Measurement (dBμV/m)	Margin (dB)	Limit (dBμV/m)	Height (cm)	Angle (deg)	Remark (QP/PK/AV)
1	2388.625	18.09	30.28	48.37	-5.63	54.00	150	130	Average
2	* 2390.000	21.18	30.29	51.47	-2.53	54.00	150	130	Average
3	2410.500	72.59	30.33	102.92	N/A	N/A	150	130	Average

Note:

1. " \*", means this data is the worst emission level.
2. C.F (Correction Factor) = Antenna Factor (dB/m)+ Cable Loss (dB).
3. Measurement (dBμV/m) = Reading(dBμV) + C.F (Correction Factor).
4. The emission levels of other frequencies are very lower than the limit and not show in test report.

EUT	HAN Access Point	Date of Test	2021-09-24
Factor	DRH18-E	Temp. / Humidity	23°C /49%
Polarity	Horizontal	Site / Test Engineer	AC2 / Jay
Test Mode	802.11ax20_TX_CH 11	Test Voltage	AC 120V/60Hz

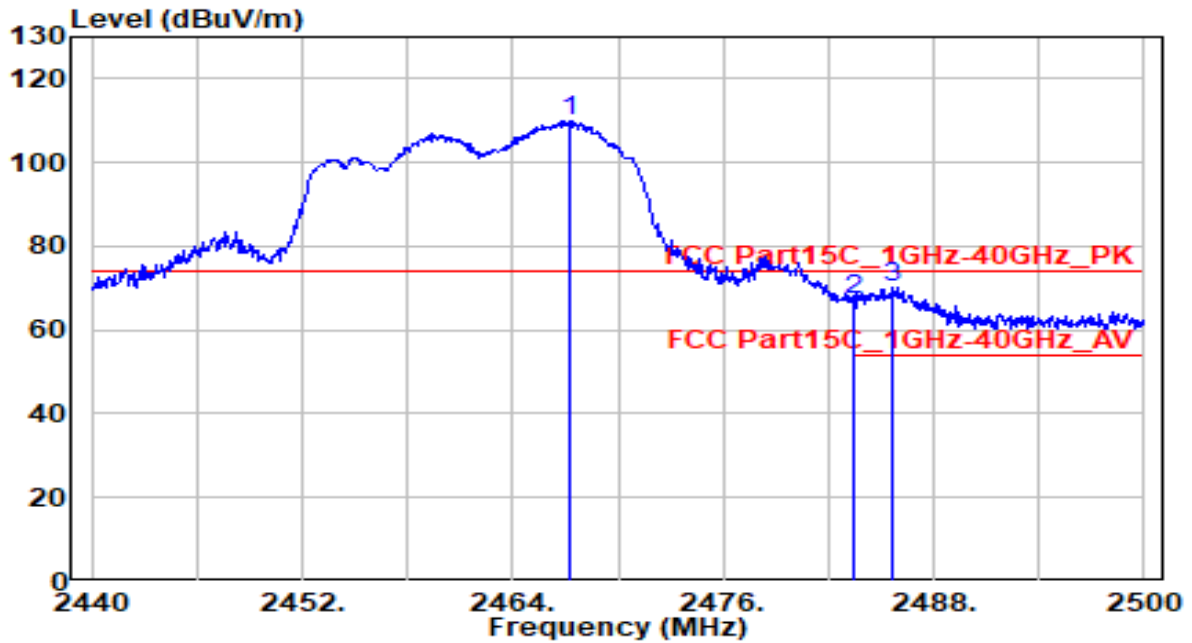

No	Frequency (MHz)	Reading (dBμV)	C.F (dB/m)	Measurement (dBμV/m)	Margin (dB)	Limit (dBμV/m)	Height (cm)	Angle (deg)	Remark (QP/PK/AV)
1	2467.300	79.49	30.43	109.92	N/A	N/A	140	45	Peak
2	2483.500	36.88	30.46	67.34	-6.66	74.00	140	45	Peak
3	* 2485.660	39.78	30.46	70.25	-3.75	74.00	140	45	Peak

Note:

1. " \*", means this data is the worst emission level.
2. C.F (Correction Factor) = Antenna Factor (dB/m)+ Cable Loss (dB).
3. Measurement (dBμV/m) = Reading(dBμV) + C.F (Correction Factor).
4. The emission levels of other frequencies are very lower than the limit and not show in test report.

EUT	HAN Access Point	Date of Test	2021-09-24
Factor	DRH18-E	Temp. / Humidity	23°C /49%
Polarity	Horizontal	Site / Test Engineer	AC2 / Jay
Test Mode	802.11ax20_TX_CH 11	Test Voltage	AC 120V/60Hz

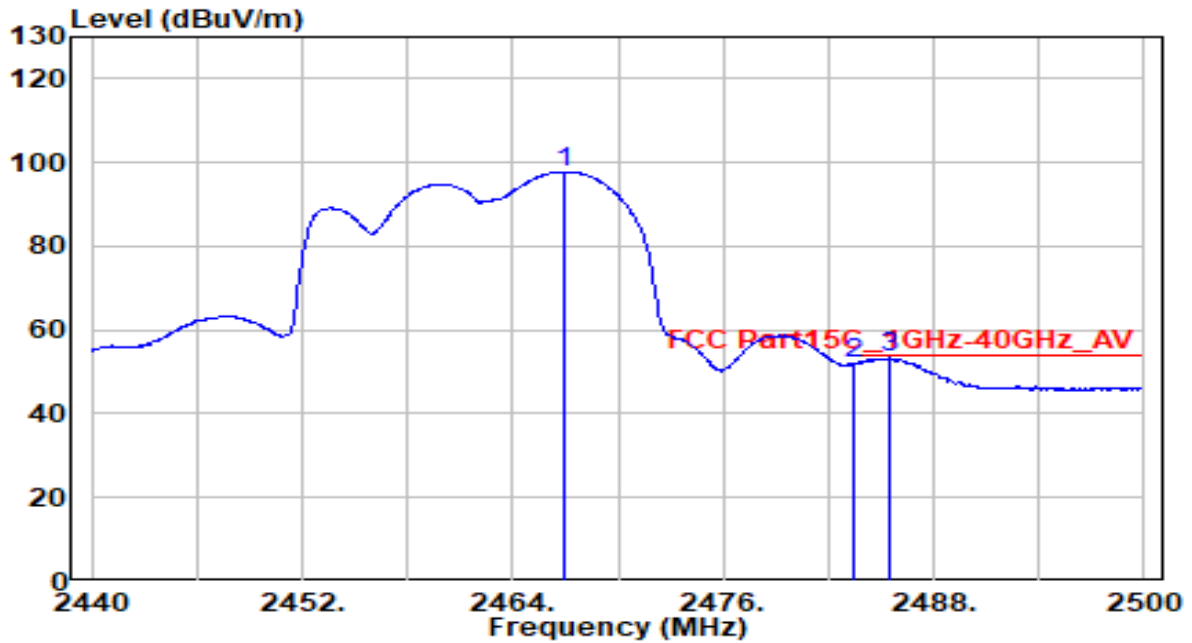

No	Frequency (MHz)	Reading (dBμV)	C.F (dB/m)	Measurement (dBμV/m)	Margin (dB)	Limit (dBμV/m)	Height (cm)	Angle (deg)	Remark (QP/PK/AV)
1	2466.940	67.40	30.43	97.83	N/A	N/A	140	45	Average
2	2483.500	21.49	30.46	51.95	-2.05	54.00	140	45	Average
3	* 2485.540	22.81	30.46	53.28	-0.72	54.00	140	45	Average

Note:

1. " \*", means this data is the worst emission level.
2. C.F (Correction Factor) = Antenna Factor (dB/m)+ Cable Loss (dB).
3. Measurement (dBμV/m) = Reading(dBμV) + C.F (Correction Factor).
4. The emission levels of other frequencies are very lower than the limit and not show in test report.

EUT	HAN Access Point	Date of Test	2021-09-24
Factor	DRH18-E	Temp. / Humidity	23°C /49%
Polarity	Vertical	Site / Test Engineer	AC2 / Jay
Test Mode	802.11ax20_TX_CH 11	Test Voltage	AC 120V/60Hz

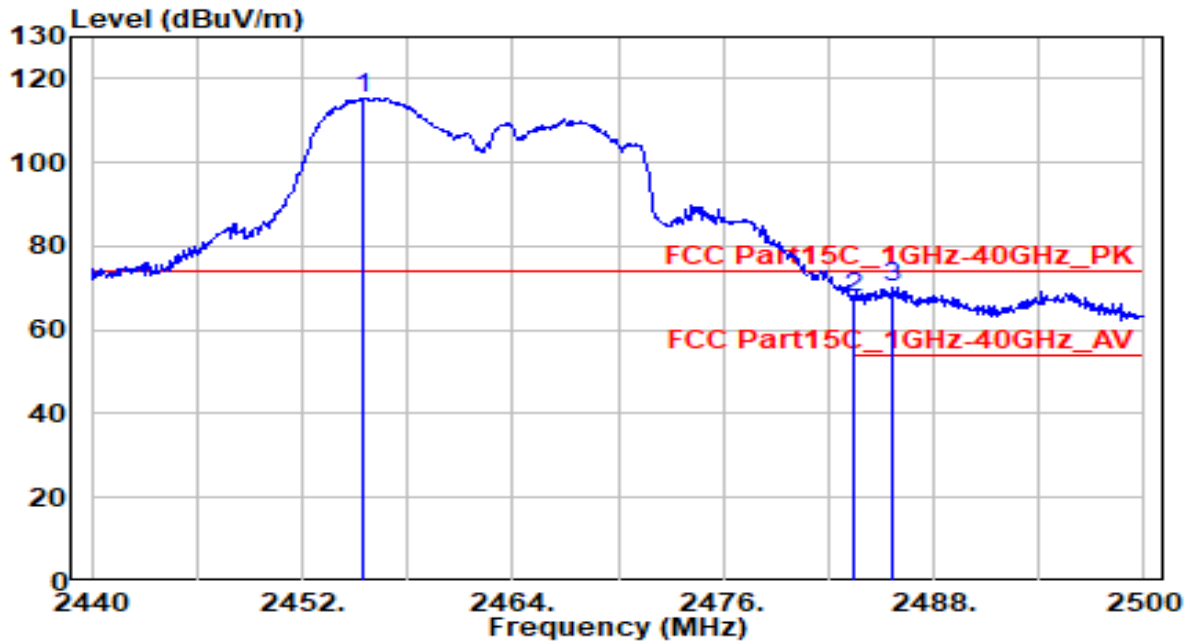

No	Frequency (MHz)	Reading (dB $\mu$ V)	C.F (dB/m)	Measurement (dB $\mu$ V/m)	Margin (dB)	Limit (dB $\mu$ V/m)	Height (cm)	Angle (deg)	Remark (QP/PK/AV)
1	2455.480	85.03	30.41	115.44	N/A	N/A	190	40	Peak
2	2483.500	37.23	30.46	67.69	-6.31	74.00	190	40	Peak
3	* 2485.660	39.78	30.46	70.25	-3.75	74.00	190	40	Peak

Note:

1. " \*", means this data is the worst emission level.
2. C.F (Correction Factor) = Antenna Factor (dB/m)+ Cable Loss (dB).
3. Measurement (dB $\mu$ V/m) = Reading(dB $\mu$ V) + C.F (Correction Factor).
4. The emission levels of other frequencies are very lower than the limit and not show in test report.



EUT	HAN Access Point	Date of Test	2021-09-24
Factor	DRH18-E	Temp. / Humidity	23°C /49%
Polarity	Vertical	Site / Test Engineer	AC2 / Jay
Test Mode	802.11ax20_TX_CH 11	Test Voltage	AC 120V/60Hz

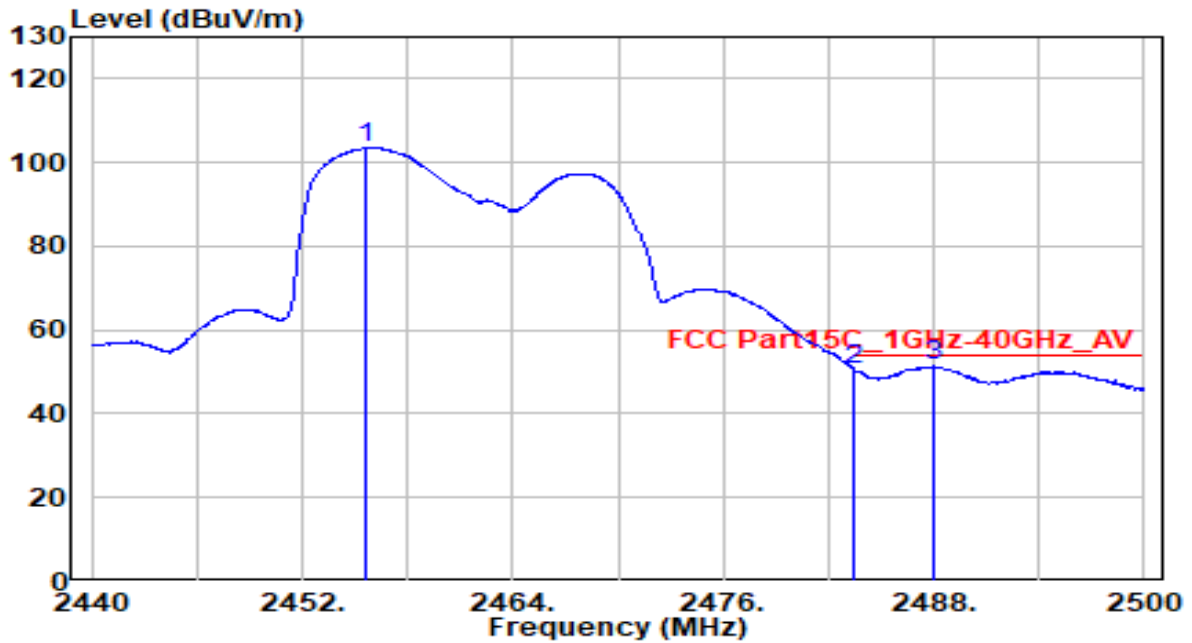

No	Frequency (MHz)	Reading (dBμV)	C.F (dB/m)	Measurement (dBμV/m)	Margin (dB)	Limit (dBμV/m)	Height (cm)	Angle (deg)	Remark (QP/PK/AV)
1	2455.660	73.02	30.41	103.43	N/A	N/A	190	40	Average
2	2483.500	20.05	30.46	50.51	-3.49	54.00	190	40	Average
3	* 2488.060	20.93	30.47	51.39	-2.61	54.00	190	40	Average

Note:

1. " \*", means this data is the worst emission level.
2. C.F (Correction Factor) = Antenna Factor (dB/m)+ Cable Loss (dB).
3. Measurement (dBμV/m) = Reading(dBμV) + C.F (Correction Factor).
4. The emission levels of other frequencies are very lower than the limit and not show in test report.

EUT	HAN Access Point	Date of Test	2021-09-24
Factor	DRH18-E	Temp. / Humidity	23°C /49%
Polarity	Horizontal	Site / Test Engineer	AC2 / Jay
Test Mode	802.11ax40_TX_CH 3	Test Voltage	AC 120V/60Hz

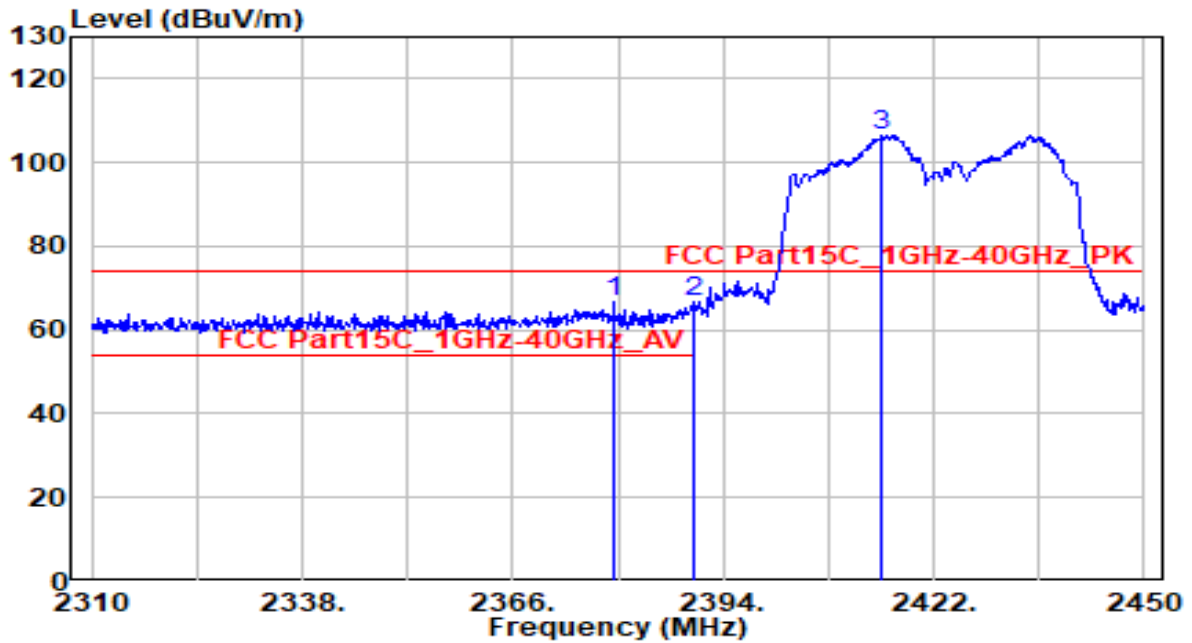

No	Frequency (MHz)	Reading (dB $\mu$ V)	C.F (dB/m)	Measurement (dB $\mu$ V/m)	Margin (dB)	Limit (dB $\mu$ V/m)	Height (cm)	Angle (deg)	Remark (QP/PK/AV)	
1	*	2379.440	36.64	30.26	66.90	-7.10	74.00	145	205	Peak
2		2390.000	36.29	30.29	66.57	-7.43	74.00	145	205	Peak
3		2415.000	76.25	30.34	106.59	N/A	N/A	145	205	Peak

Note:

1. " \*", means this data is the worst emission level.
2. C.F (Correction Factor) = Antenna Factor (dB/m)+ Cable Loss (dB).
3. Measurement (dB $\mu$ V/m) = Reading(dB $\mu$ V) + C.F (Correction Factor).
4. The emission levels of other frequencies are very lower than the limit and not show in test report.

EUT	HAN Access Point	Date of Test	2021-09-24
Factor	DRH18-E	Temp. / Humidity	23°C /49%
Polarity	Horizontal	Site / Test Engineer	AC2 / Jay
Test Mode	802.11ax40_TX_CH 3	Test Voltage	AC 120V/60Hz

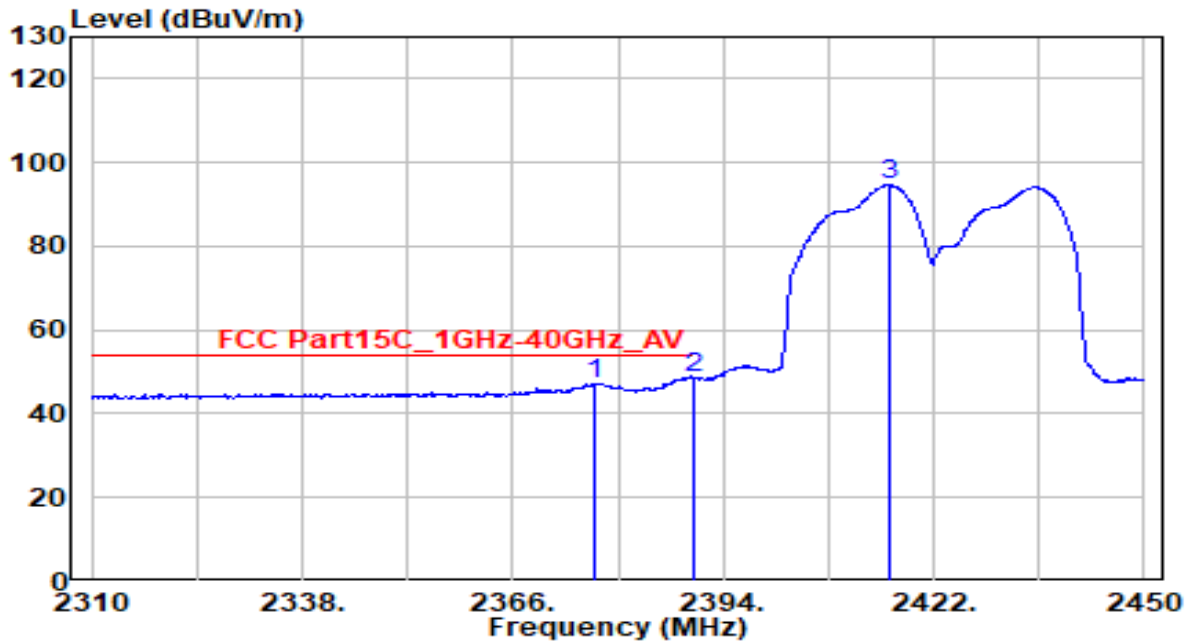

No	Frequency (MHz)	Reading (dB $\mu$ V)	C.F (dB/m)	Measurement (dB $\mu$ V/m)	Margin (dB)	Limit (dB $\mu$ V/m)	Height (cm)	Angle (deg)	Remark (QP/PK/AV)
1	2377.060	17.08	30.26	47.34	-6.66	54.00	145	205	Average
2	* 2390.000	18.27	30.29	48.56	-5.44	54.00	145	205	Average
3	2415.980	64.22	30.34	94.56	N/A	N/A	145	205	Average

Note:

1. " \*", means this data is the worst emission level.
2. C.F (Correction Factor) = Antenna Factor (dB/m)+ Cable Loss (dB).
3. Measurement (dB $\mu$ V/m) = Reading(dB $\mu$ V) + C.F (Correction Factor).
4. The emission levels of other frequencies are very lower than the limit and not show in test report.

EUT	HAN Access Point	Date of Test	2021-09-24
Factor	DRH18-E	Temp. / Humidity	23°C /49%
Polarity	Vertical	Site / Test Engineer	AC2 / Jay
Test Mode	802.11ax40_TX_CH 3	Test Voltage	AC 120V/60Hz

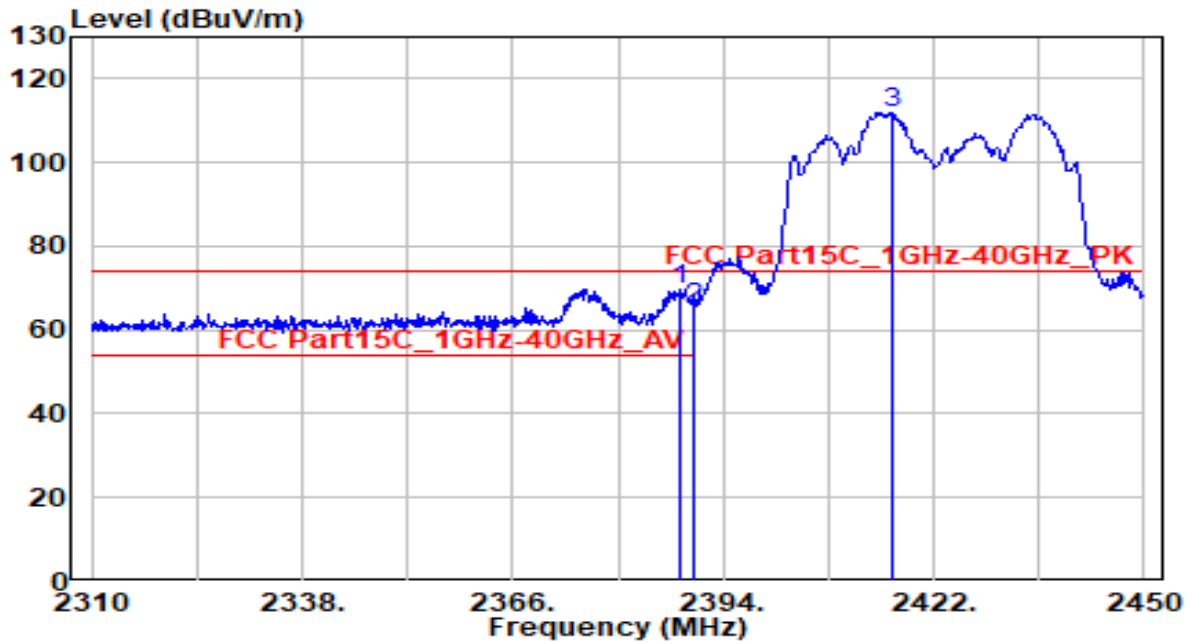

No	Frequency (MHz)	Reading (dBμV)	C.F (dB/m)	Measurement (dBμV/m)	Margin (dB)	Limit (dBμV/m)	Height (cm)	Angle (deg)	Remark (QP/PK/AV)	
1	*	2388.260	39.43	30.28	69.71	-4.29	74.00	150	45	Peak
2		2390.000	35.18	30.29	65.47	-8.53	74.00	150	45	Peak
3		2416.540	81.74	30.34	112.08	N/A	N/A	150	45	Peak

Note:

1. " \*", means this data is the worst emission level.
2. C.F (Correction Factor) = Antenna Factor (dB/m)+ Cable Loss (dB).
3. Measurement (dBμV/m) = Reading(dBμV) + C.F (Correction Factor).
4. The emission levels of other frequencies are very lower than the limit and not show in test report.

EUT	HAN Access Point	Date of Test	2021-09-24
Factor	DRH18-E	Temp. / Humidity	23°C /49%
Polarity	Vertical	Site / Test Engineer	AC2 / Jay
Test Mode	802.11ax40_TX_CH 3	Test Voltage	AC 120V/60Hz

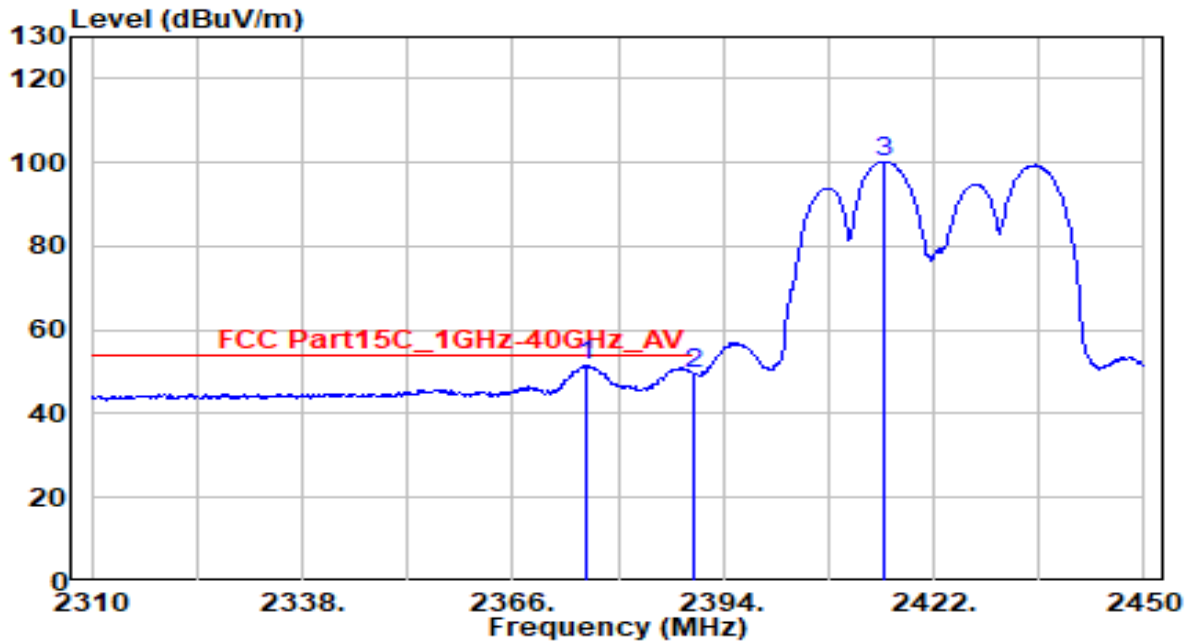

No	Frequency (MHz)	Reading (dB $\mu$ V)	C.F (dB/m)	Measurement (dB $\mu$ V/m)	Margin (dB)	Limit (dB $\mu$ V/m)	Height (cm)	Angle (deg)	Remark (QP/PK/AV)	
1	*	2375.800	21.19	30.25	51.44	-2.56	54.00	150	45	Average
2		2390.000	19.42	30.29	49.71	-4.29	54.00	150	45	Average
3		2415.420	69.93	30.34	100.27	N/A	N/A	150	45	Average

Note:

1. " \*", means this data is the worst emission level.
2. C.F (Correction Factor) = Antenna Factor (dB/m)+ Cable Loss (dB).
3. Measurement (dB $\mu$ V/m) = Reading(dB $\mu$ V) + C.F (Correction Factor).
4. The emission levels of other frequencies are very lower than the limit and not show in test report.

EUT	HAN Access Point	Date of Test	2021-09-24
Factor	DRH18-E	Temp. / Humidity	23°C /49%
Polarity	Horizontal	Site / Test Engineer	AC2 / Jay
Test Mode	802.11ax40_TX_CH 6	Test Voltage	AC 120V/60Hz

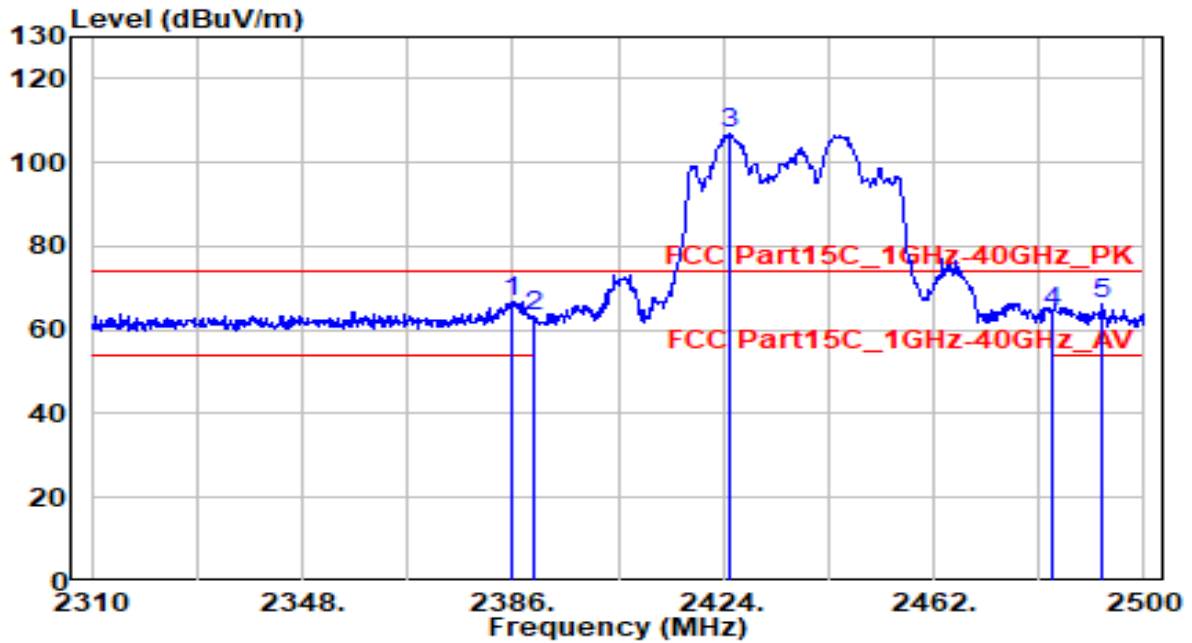

No	Frequency (MHz)	Reading (dBμV)	C.F (dB/m)	Measurement (dBμV/m)	Margin (dB)	Limit (dBμV/m)	Height (cm)	Angle (deg)	Remark (QP/PK/AV)
1	* 2386.000	36.38	30.28	66.66	-7.34	74.00	150	140	Peak
2	2390.000	32.90	30.29	63.18	-10.82	74.00	150	140	Peak
3	2425.140	76.58	30.36	106.94	N/A	N/A	150	140	Peak
4	2483.500	33.91	30.46	64.37	-9.63	74.00	150	140	Peak
5	2492.590	35.53	30.48	66.01	-7.99	74.00	150	140	Peak

Note:

1. " \*", means this data is the worst emission level.
2. C.F (Correction Factor) = Antenna Factor (dB/m)+ Cable Loss (dB).
3. Measurement (dBμV/m) = Reading(dBμV) + C.F (Correction Factor).
4. The emission levels of other frequencies are very lower than the limit and not show in test report.

EUT	HAN Access Point	Date of Test	2021-09-24
Factor	DRH18-E	Temp. / Humidity	23°C /49%
Polarity	Horizontal	Site / Test Engineer	AC2 / Jay
Test Mode	802.11ax40_TX_CH 6	Test Voltage	AC 120V/60Hz

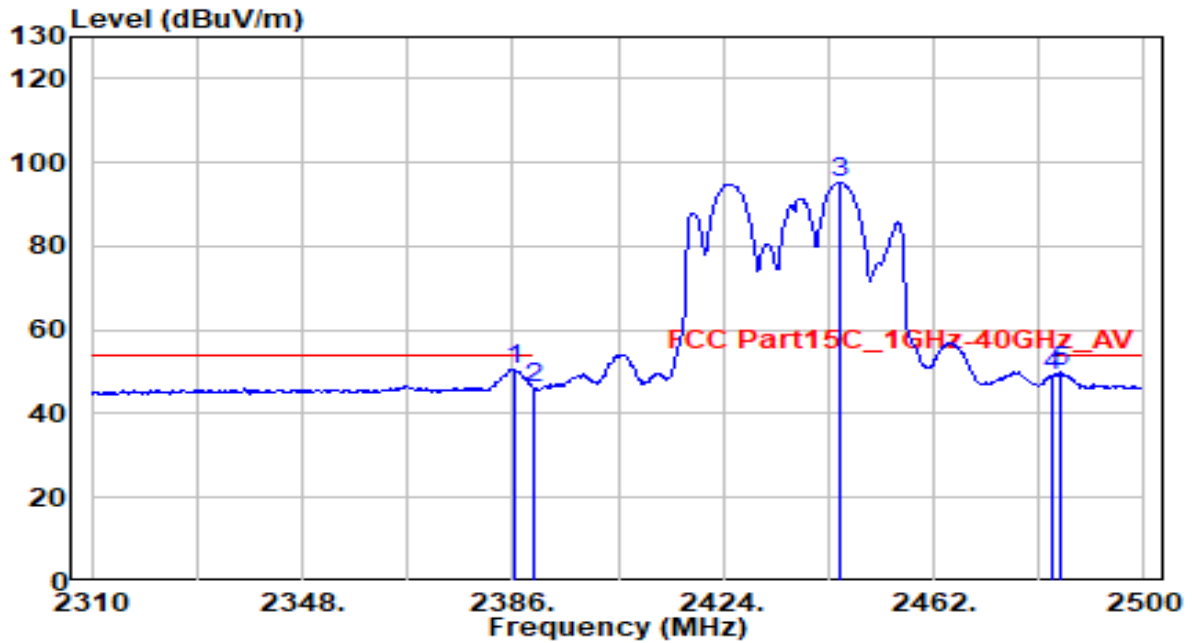

No	Frequency (MHz)	Reading (dBμV)	C.F (dB/m)	Measurement (dBμV/m)	Margin (dB)	Limit (dBμV/m)	Height (cm)	Angle (deg)	Remark (QP/PK/AV)
1	* 2386.190	20.30	30.28	50.57	-3.43	54.00	150	140	Average
2	2390.000	15.74	30.29	46.03	-7.97	54.00	150	140	Average
3	2444.900	64.89	30.39	95.28	N/A	N/A	150	140	Average
4	2483.500	18.71	30.46	49.17	-4.83	54.00	150	140	Average
5	2484.800	19.49	30.46	49.95	-4.05	54.00	150	140	Average

Note:

1. " \*", means this data is the worst emission level.
2. C.F (Correction Factor) = Antenna Factor (dB/m)+ Cable Loss (dB).
3. Measurement (dBμV/m) = Reading(dBμV) + C.F (Correction Factor).
4. The emission levels of other frequencies are very lower than the limit and not show in test report.

EUT	HAN Access Point	Date of Test	2021-09-24
Factor	DRH18-E	Temp. / Humidity	23°C /49%
Polarity	Vertical	Site / Test Engineer	AC2 / Jay
Test Mode	802.11ax40_TX_CH 6	Test Voltage	AC 120V/60Hz

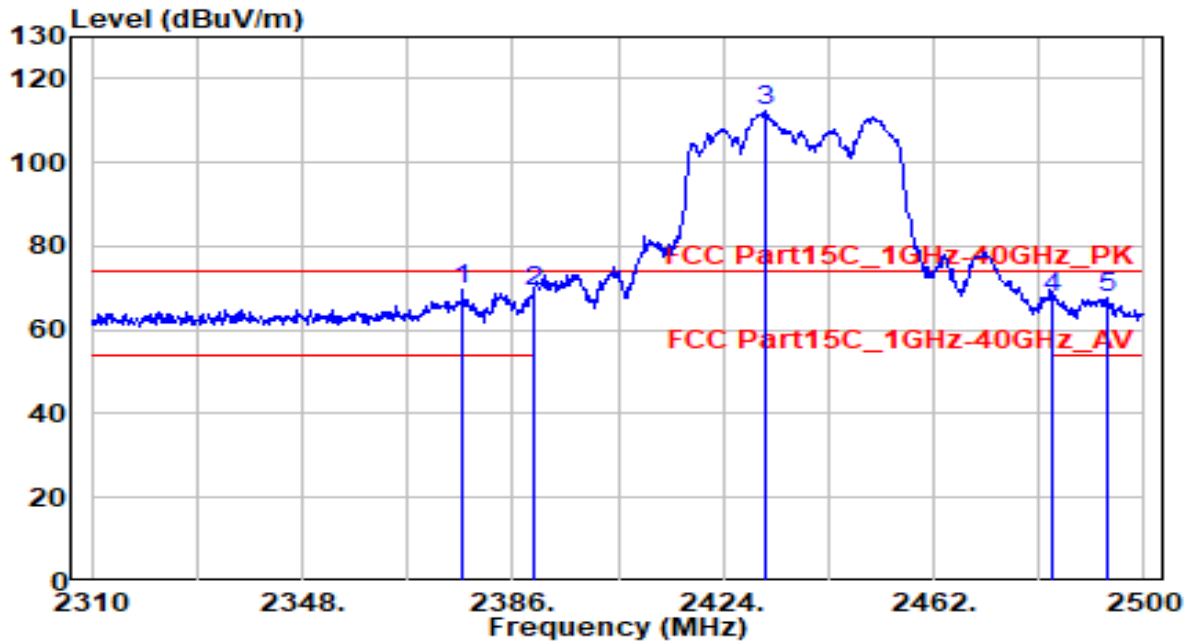

No	Frequency (MHz)	Reading (dBμV)	C.F (dB/m)	Measurement (dBμV/m)	Margin (dB)	Limit (dBμV/m)	Height (cm)	Angle (deg)	Remark (QP/PK/AV)
1	* 2376.880	39.43	30.26	69.68	-4.32	74.00	150	35	Peak
2	2390.000	38.95	30.29	69.24	-4.76	74.00	150	35	Peak
3	2431.410	82.00	30.37	112.37	N/A	N/A	150	35	Peak
4	2483.500	37.27	30.46	67.73	-6.27	74.00	150	35	Peak
5	2493.160	37.26	30.48	67.74	-6.26	74.00	150	35	Peak

Note:

- "\*", means this data is the worst emission level.
- C.F (Correction Factor) = Antenna Factor (dB/m)+ Cable Loss (dB).
- Measurement (dBμV/m) = Reading(dBμV) + C.F (Correction Factor).
- The emission levels of other frequencies are very lower than the limit and not show in test report.



EUT	HAN Access Point	Date of Test	2021-09-24
Factor	DRH18-E	Temp. / Humidity	23°C /49%
Polarity	Vertical	Site / Test Engineer	AC2 / Jay
Test Mode	802.11ax40_TX_CH 6	Test Voltage	AC 120V/60Hz

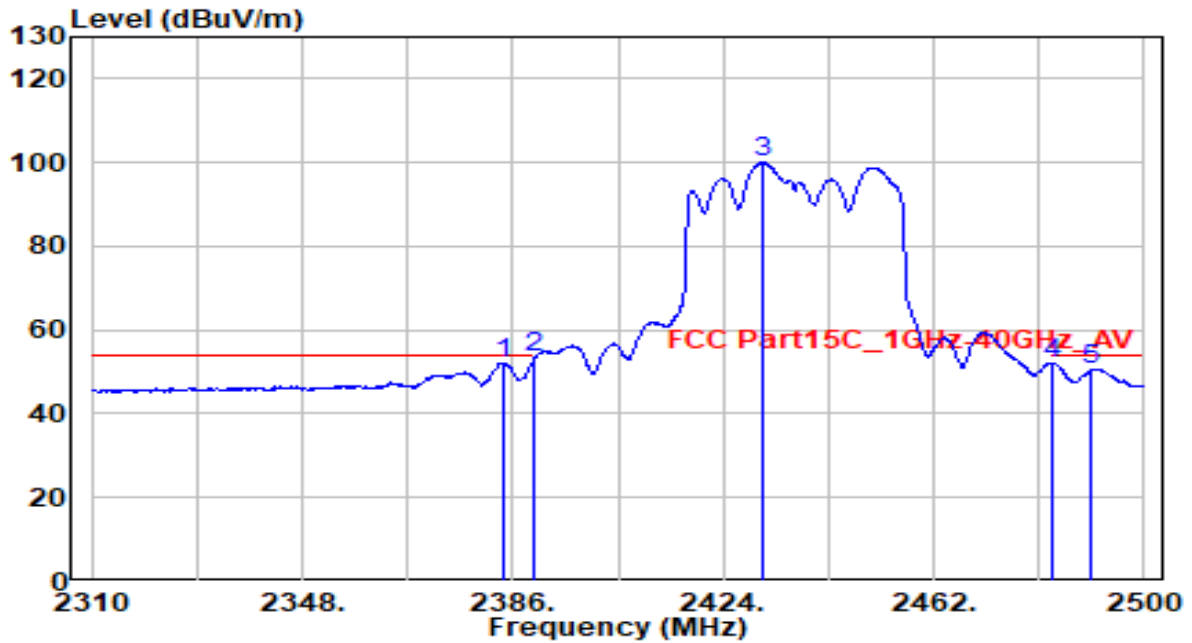

No	Frequency (MHz)	Reading (dBμV)	C.F (dB/m)	Measurement (dBμV/m)	Margin (dB)	Limit (dBμV/m)	Height (cm)	Angle (deg)	Remark (QP/PK/AV)
1	2384.480	21.59	30.27	51.87	-2.13	54.00	150	35	Average
2	* 2390.000	22.95	30.29	53.23	-0.77	54.00	150	35	Average
3	2431.030	69.56	30.37	99.93	N/A	N/A	150	35	Average
4	2483.500	21.51	30.46	51.97	-2.03	54.00	150	35	Average
5	2490.500	20.30	30.47	50.77	-3.23	54.00	150	35	Average

Note:

- "\*", means this data is the worst emission level.
- C.F (Correction Factor) = Antenna Factor (dB/m)+ Cable Loss (dB).
- Measurement (dBμV/m) = Reading(dBμV) + C.F (Correction Factor).
- The emission levels of other frequencies are very lower than the limit and not show in test report.

EUT	HAN Access Point	Date of Test	2021-09-24
Factor	DRH18-E	Temp. / Humidity	23°C /49%
Polarity	Horizontal	Site / Test Engineer	AC2 / Jay
Test Mode	802.11ax40_TX_CH 9	Test Voltage	AC 120V/60Hz

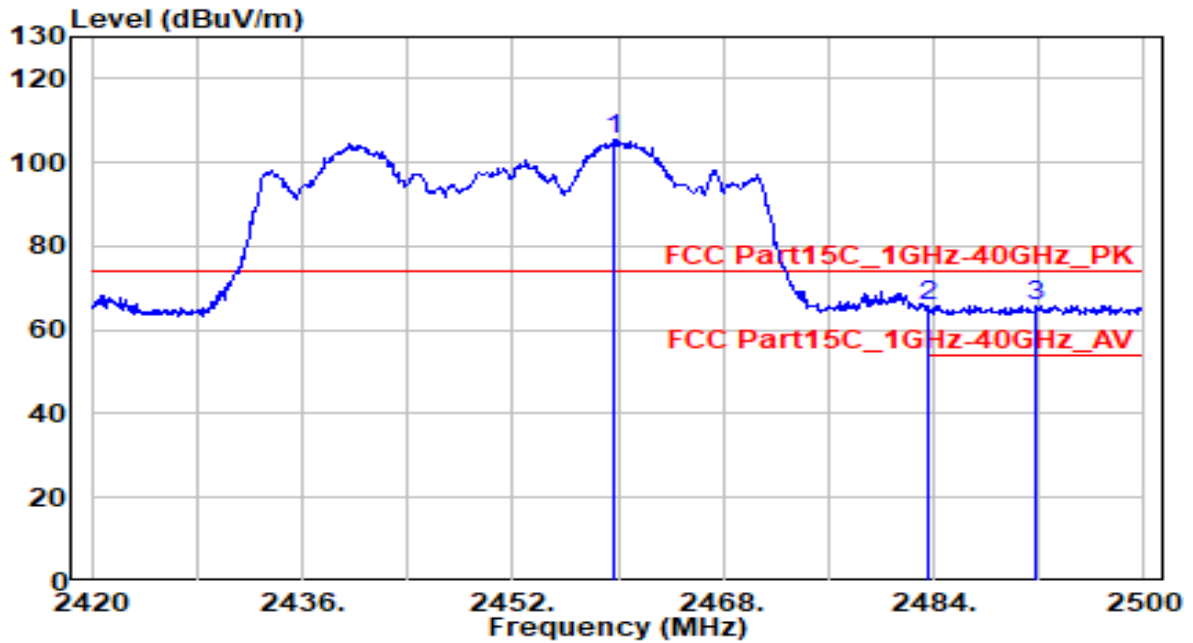

No	Frequency (MHz)	Reading (dBμV)	C.F (dB/m)	Measurement (dBμV/m)	Margin (dB)	Limit (dBμV/m)	Height (cm)	Angle (deg)	Remark (QP/PK/AV)
1	2459.760	75.03	30.42	105.45	N/A	N/A	145	140	Peak
2	2483.500	35.05	30.46	65.51	-8.49	74.00	145	140	Peak
3	* 2491.840	35.48	30.48	65.96	-8.04	74.00	145	140	Peak

Note:

1. " \*", means this data is the worst emission level.
2. C.F (Correction Factor) = Antenna Factor (dB/m)+ Cable Loss (dB).
3. Measurement (dBμV/m) = Reading(dBμV) + C.F (Correction Factor).
4. The emission levels of other frequencies are very lower than the limit and not show in test report.

EUT	HAN Access Point	Date of Test	2021-09-24
Factor	DRH18-E	Temp. / Humidity	23°C /49%
Polarity	Horizontal	Site / Test Engineer	AC2 / Jay
Test Mode	802.11ax40_TX_CH 9	Test Voltage	AC 120V/60Hz

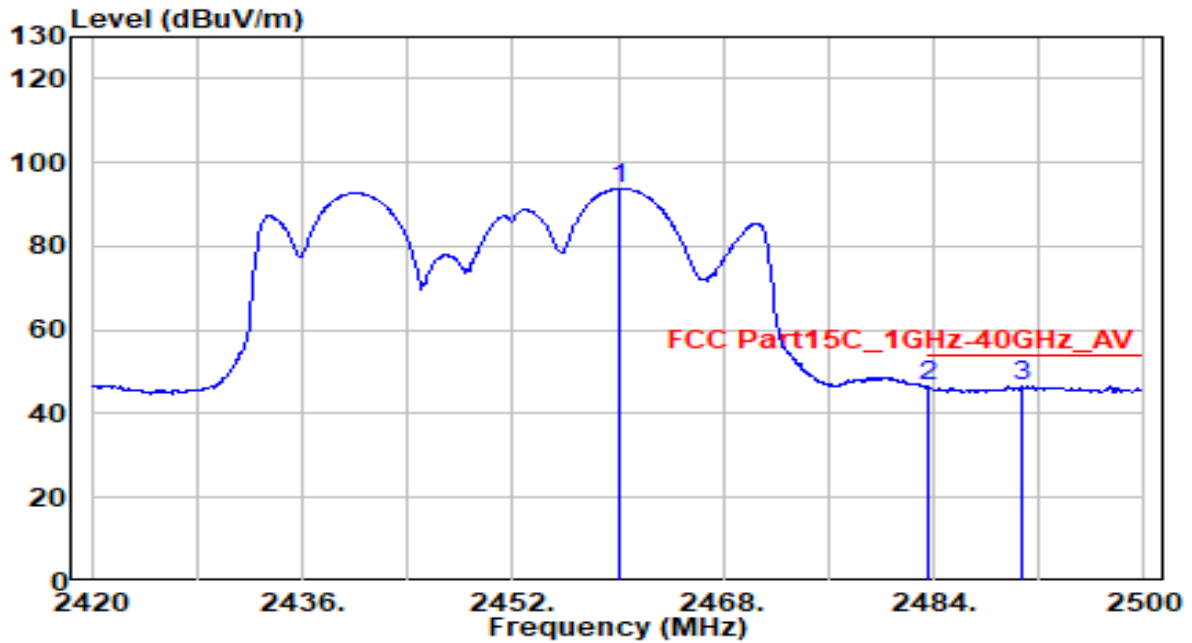

No	Frequency (MHz)	Reading (dBμV)	C.F (dB/m)	Measurement (dBμV/m)	Margin (dB)	Limit (dBμV/m)	Height (cm)	Angle (deg)	Remark (QP/PK/AV)
1	2460.160	63.37	30.42	93.79	N/A	N/A	145	140	Average
2	2483.500	16.02	30.46	46.48	-7.52	54.00	145	140	Average
3	* 2490.720	16.10	30.47	46.57	-7.43	54.00	145	140	Average

Note:

1. " \*", means this data is the worst emission level.
2. C.F (Correction Factor) = Antenna Factor (dB/m)+ Cable Loss (dB).
3. Measurement (dBμV/m) = Reading(dBμV) + C.F (Correction Factor).
4. The emission levels of other frequencies are very lower than the limit and not show in test report.

EUT	HAN Access Point	Date of Test	2021-09-24
Factor	DRH18-E	Temp. / Humidity	23°C /49%
Polarity	Vertical	Site / Test Engineer	AC2 / Jay
Test Mode	802.11ax40_TX_CH 9	Test Voltage	AC 120V/60Hz

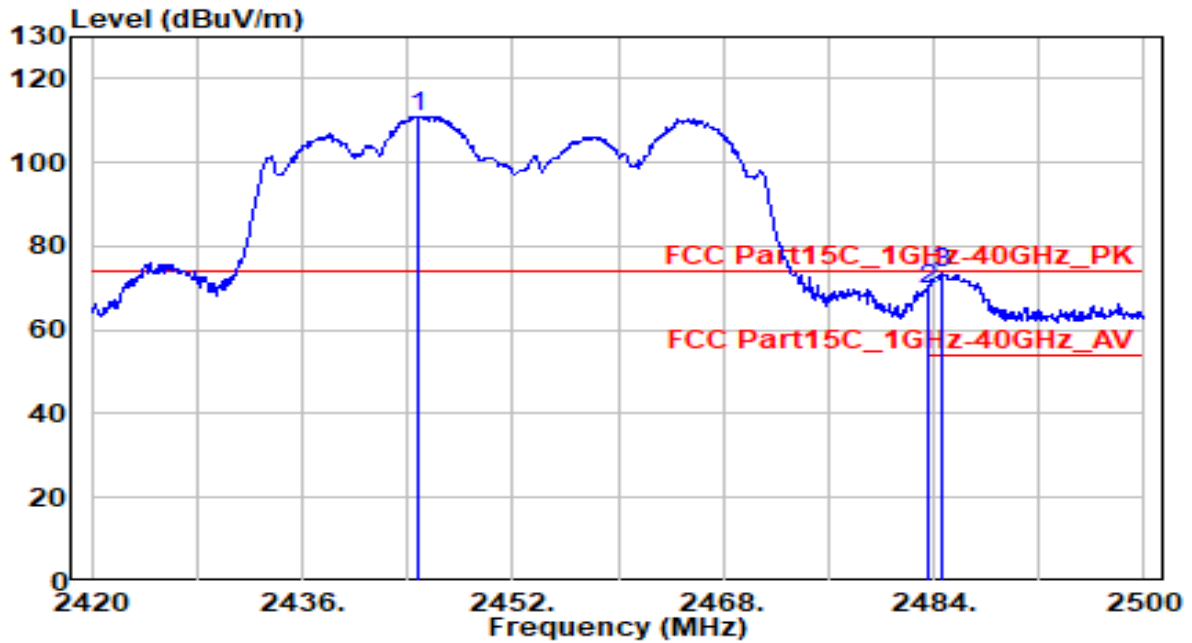

No	Frequency (MHz)	Reading (dB $\mu$ V)	C.F (dB/m)	Measurement (dB $\mu$ V/m)	Margin (dB)	Limit (dB $\mu$ V/m)	Height (cm)	Angle (deg)	Remark (QP/PK/AV)
1	2444.720	80.68	30.39	111.07	N/A	N/A	150	45	Peak
2	2483.500	39.24	30.46	69.70	-4.30	74.00	150	45	Peak
3	* 2484.560	42.92	30.46	73.38	-0.62	74.00	150	45	Peak

Note:

1. " \*", means this data is the worst emission level.
2. C.F (Correction Factor) = Antenna Factor (dB/m)+ Cable Loss (dB).
3. Measurement (dB $\mu$ V/m) = Reading(dB $\mu$ V) + C.F (Correction Factor).
4. The emission levels of other frequencies are very lower than the limit and not show in test report.

EUT	HAN Access Point	Date of Test	2021-09-24
Factor	DRH18-E	Temp. / Humidity	23°C /49%
Polarity	Vertical	Site / Test Engineer	AC2 / Jay
Test Mode	802.11ax40_TX_CH 9	Test Voltage	AC 120V/60Hz

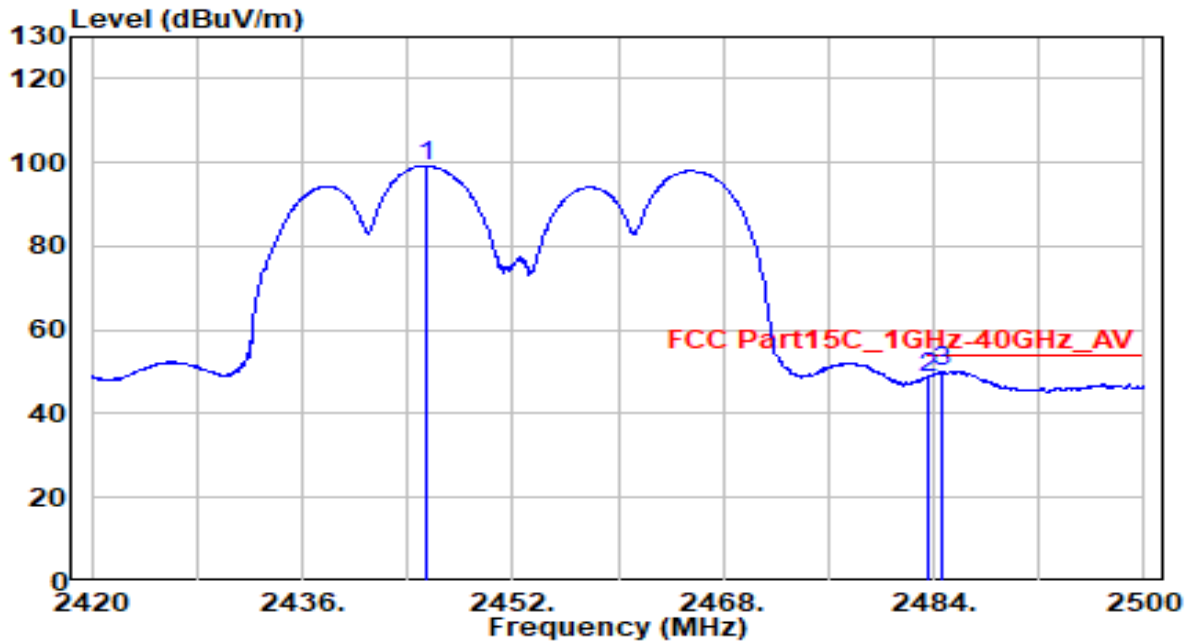

No	Frequency (MHz)	Reading (dBμV)	C.F (dB/m)	Measurement (dBμV/m)	Margin (dB)	Limit (dBμV/m)	Height (cm)	Angle (deg)	Remark (QP/PK/AV)
1	2445.360	68.77	30.39	99.16	N/A	N/A	150	45	Average
2	2483.500	18.00	30.46	48.46	-5.54	54.00	150	45	Average
3	* 2484.640	19.77	30.46	50.24	-3.76	54.00	150	45	Average

Note:

1. " \*", means this data is the worst emission level.
2. C.F (Correction Factor) = Antenna Factor (dB/m)+ Cable Loss (dB).
3. Measurement (dBμV/m) = Reading(dBμV) + C.F (Correction Factor).
4. The emission levels of other frequencies are very lower than the limit and not show in test report.

**Scan Mode:**

EUT	HAN Access Point	Date of Test	2021-10-07
Factor	DRH18-E	Temp. / Humidity	23°C /49%
Polarity	Horizontal	Site / Test Engineer	AC2 / Jay
Test Mode	802.11b_TX_CH 1	Test Voltage	AC 120V/60Hz

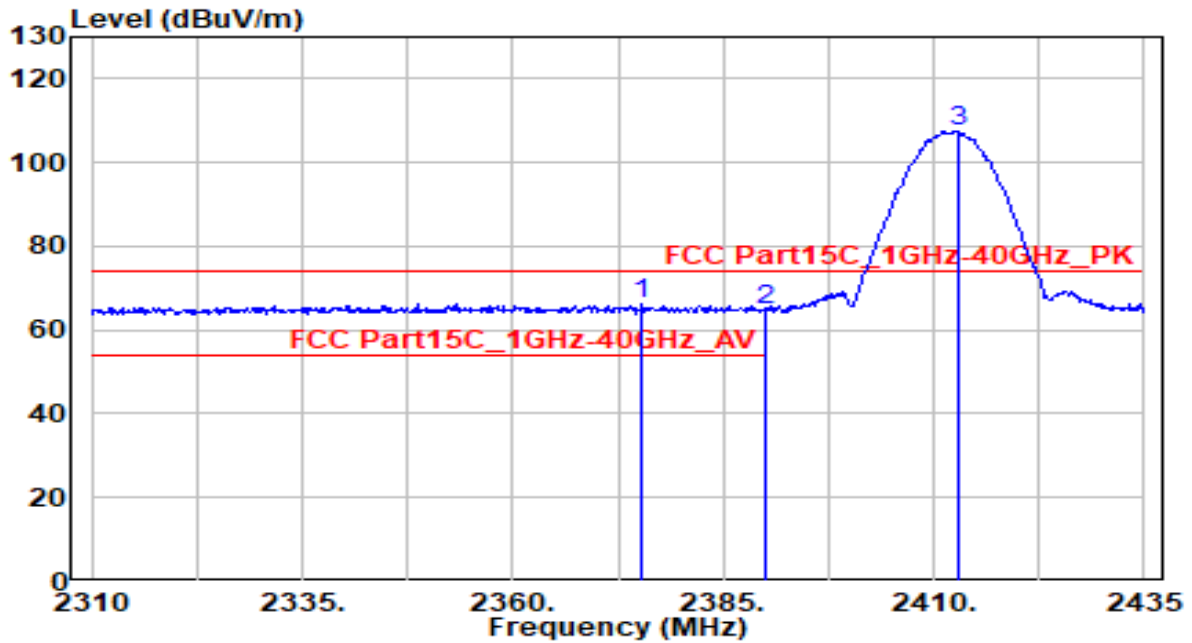

No	Frequency (MHz)	Reading (dBμV)	C.F (dB/m)	Measurement (dBμV/m)	Margin (dB)	Limit (dBμV/m)	Height (cm)	Angle (deg)	Remark (QP/PK/AV)
1	2375.250	35.87	30.25	66.12	-7.88	74.00	155	220	Peak
2	2390.000	34.52	30.29	64.80	-9.20	74.00	155	220	Peak
3	* 2412.875	77.33	30.33	107.67	N/A	N/A	155	220	Peak

**Note:**

1. " \*", means this data is the worst emission level.
2. C.F (Correction Factor) = Antenna Factor (dB/m)+ Cable Loss (dB).
3. Measurement (dBμV/m) = Reading(dBμV) + C.F (Correction Factor).
4. The emission levels of other frequencies are very lower than the limit and not show in test report.

EUT	HAN Access Point	Date of Test	2021-10-07
Factor	DRH18-E	Temp. / Humidity	23°C /49%
Polarity	Horizontal	Site / Test Engineer	AC2 / Jay
Test Mode	802.11b_TX_CH 1	Test Voltage	AC 120V/60Hz

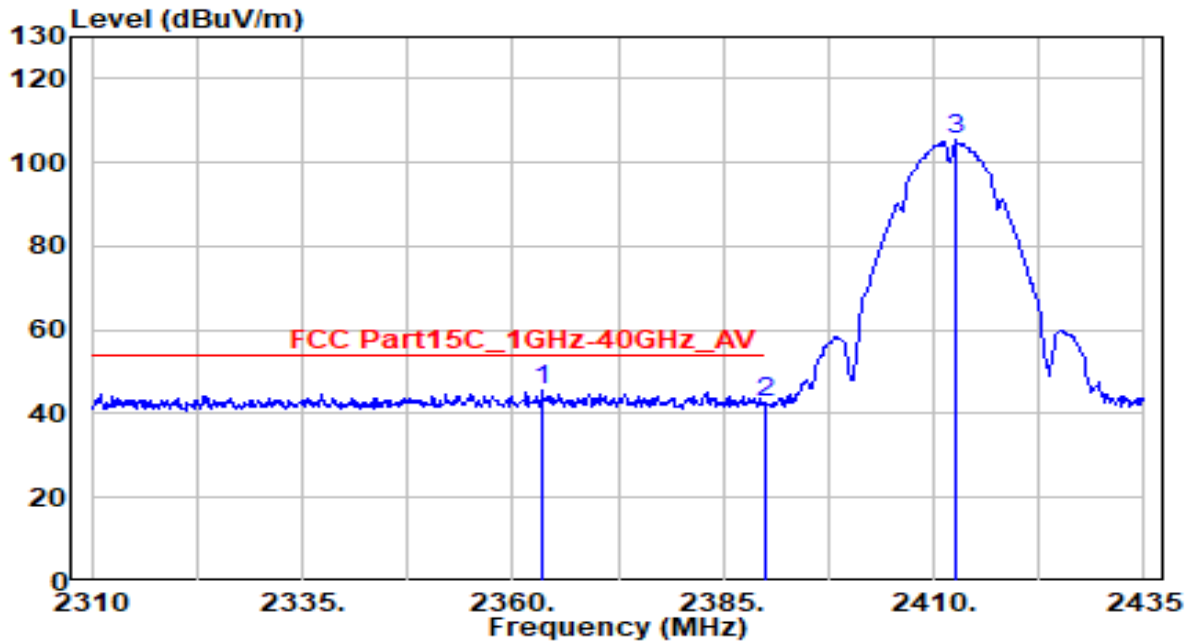

No	Frequency (MHz)	Reading (dBμV)	C.F (dB/m)	Measurement (dBμV/m)	Margin (dB)	Limit (dBμV/m)	Height (cm)	Angle (deg)	Remark (QP/PK/AV)
1	* 2363.500	15.37	30.23	45.60	-8.40	54.00	155	220	Average
2	2390.000	12.16	30.29	42.44	-11.56	54.00	155	220	Average
3	2412.750	74.92	30.33	105.26	N/A	N/A	155	220	Average

Note:

1. " \*", means this data is the worst emission level.
2. C.F (Correction Factor) = Antenna Factor (dB/m)+ Cable Loss (dB).
3. Measurement (dBμV/m) = Reading(dBμV) + C.F (Correction Factor).
4. The emission levels of other frequencies are very lower than the limit and not show in test report.

EUT	HAN Access Point	Date of Test	2021-10-07
Factor	DRH18-E	Temp. / Humidity	23°C /49%
Polarity	Vertical	Site / Test Engineer	AC2 / Jay
Test Mode	802.11b_TX_CH 1	Test Voltage	AC 120V/60Hz

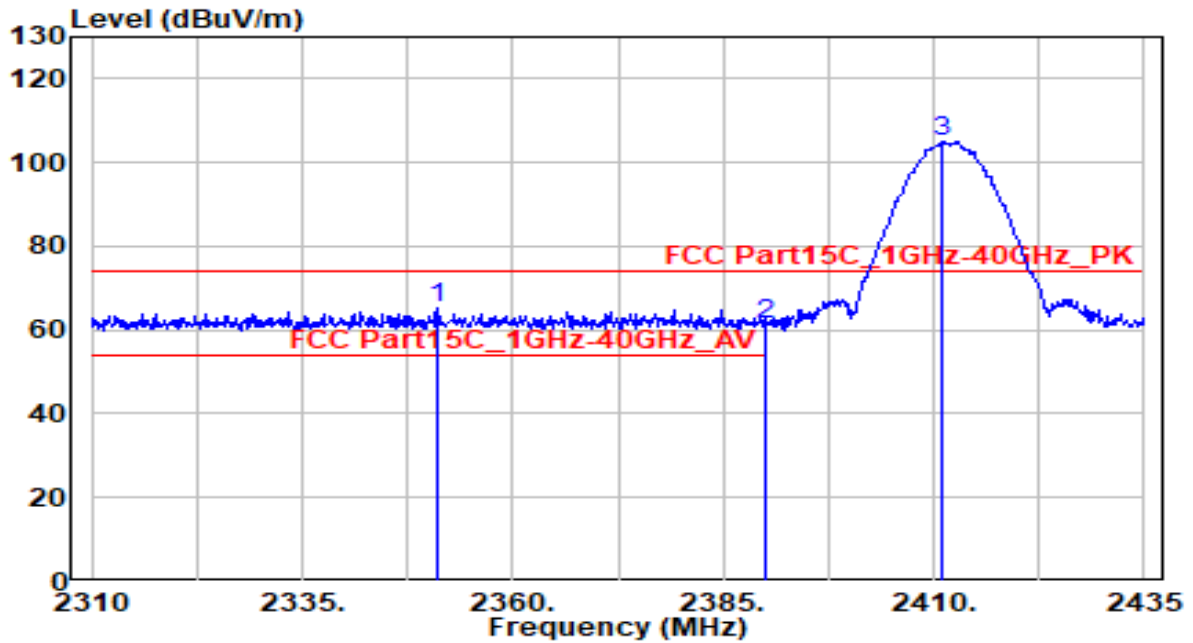

No	Frequency (MHz)	Reading (dB $\mu$ V)	C.F (dB/m)	Measurement (dB $\mu$ V/m)	Margin (dB)	Limit (dB $\mu$ V/m)	Height (cm)	Angle (deg)	Remark (QP/PK/AV)
1	* 2351.125	34.84	30.20	65.03	-8.97	74.00	225	155	Peak
2	2390.000	31.27	30.29	61.56	-12.44	74.00	225	155	Peak
3	2411.125	74.77	30.33	105.10	N/A	N/A	225	155	Peak

Note:

1. " \*", means this data is the worst emission level.
2. C.F (Correction Factor) = Antenna Factor (dB/m)+ Cable Loss (dB).
3. Measurement (dB $\mu$ V/m) = Reading(dB $\mu$ V) + C.F (Correction Factor).
4. The emission levels of other frequencies are very lower than the limit and not show in test report.



EUT	HAN Access Point	Date of Test	2021-10-07
Factor	DRH18-E	Temp. / Humidity	23°C /49%
Polarity	Vertical	Site / Test Engineer	AC2 / Jay
Test Mode	802.11b_TX_CH 1	Test Voltage	AC 120V/60Hz

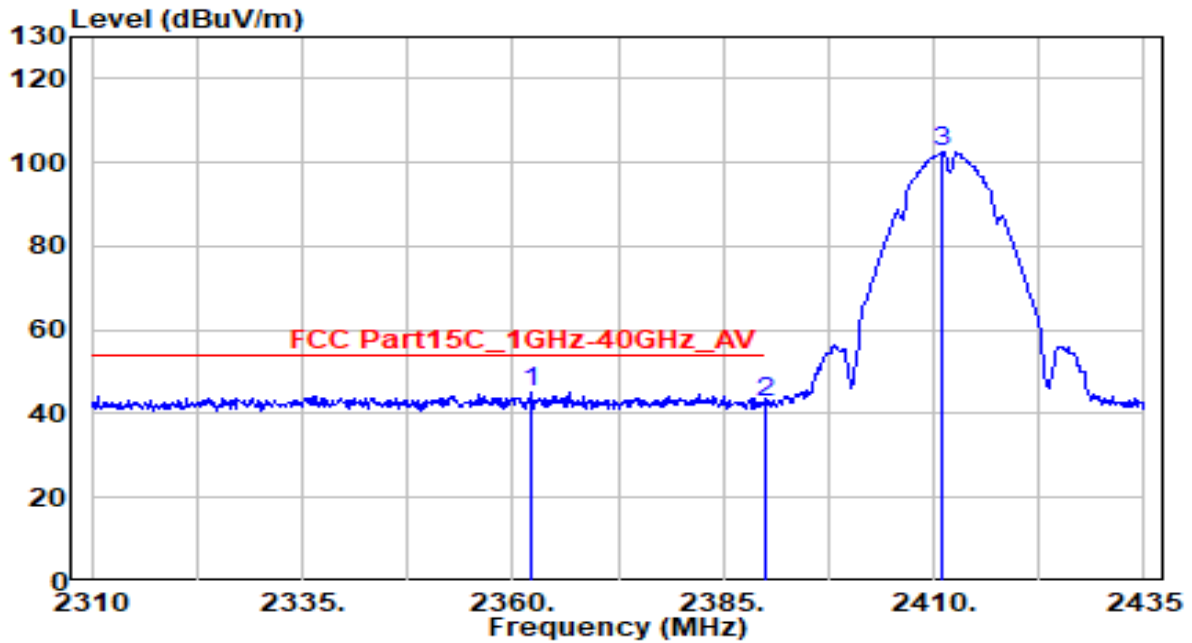

No	Frequency (MHz)	Reading (dBμV)	C.F (dB/m)	Measurement (dBμV/m)	Margin (dB)	Limit (dBμV/m)	Height (cm)	Angle (deg)	Remark (QP/PK/AV)
1	* 2362.125	14.87	30.22	45.09	-8.91	54.00	225	155	Average
2	2390.000	12.55	30.29	42.84	-11.16	54.00	225	155	Average
3	2411.125	72.27	30.33	102.60	N/A	N/A	225	155	Average

Note:

1. " \*", means this data is the worst emission level.
2. C.F (Correction Factor) = Antenna Factor (dB/m)+ Cable Loss (dB).
3. Measurement (dBμV/m) = Reading(dBμV) + C.F (Correction Factor).
4. The emission levels of other frequencies are very lower than the limit and not show in test report.

EUT	HAN Access Point	Date of Test	2021-10-07
Factor	DRH18-E	Temp. / Humidity	23°C /49%
Polarity	Horizontal	Site / Test Engineer	AC2 / Jay
Test Mode	802.11b_TX_CH 11	Test Voltage	AC 120V/60Hz

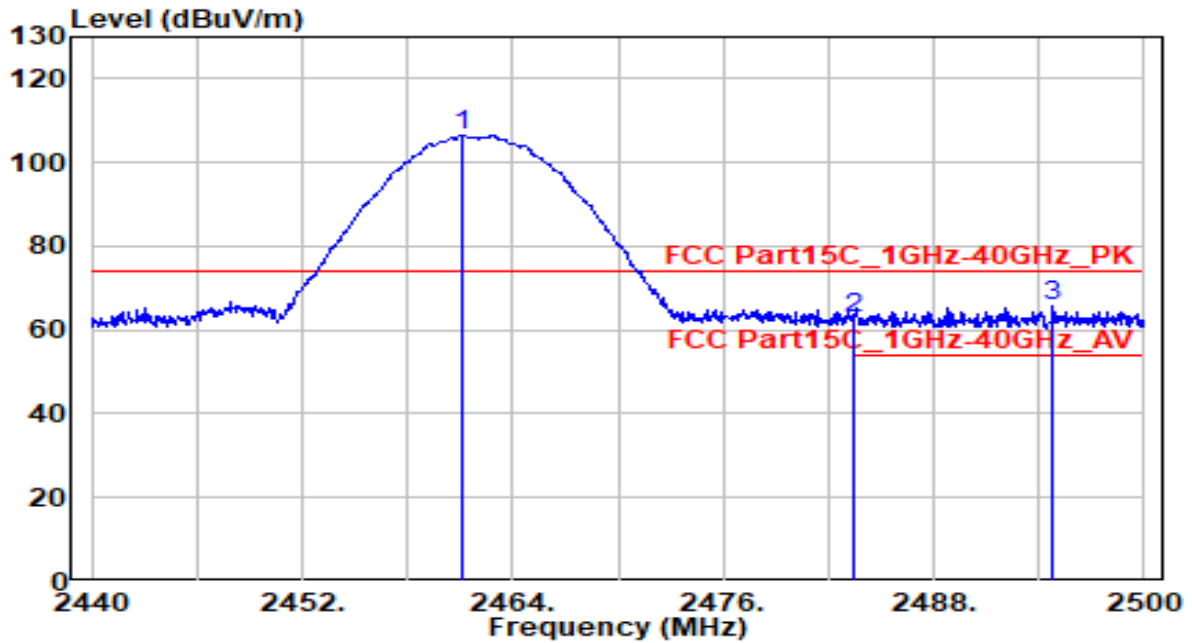

No	Frequency (MHz)	Reading (dBμV)	C.F (dB/m)	Measurement (dBμV/m)	Margin (dB)	Limit (dBμV/m)	Height (cm)	Angle (deg)	Remark (QP/PK/AV)
1	2461.120	76.15	30.42	106.57	N/A	N/A	150	220	Peak
2	2483.500	32.14	30.46	62.60	-11.40	74.00	150	220	Peak
3	* 2494.780	35.26	30.48	65.74	-8.26	74.00	150	220	Peak

Note:

1. " \*", means this data is the worst emission level.
2. C.F (Correction Factor) = Antenna Factor (dB/m)+ Cable Loss (dB).
3. Measurement (dBμV/m) = Reading(dBμV) + C.F (Correction Factor).
4. The emission levels of other frequencies are very lower than the limit and not show in test report.

EUT	HAN Access Point	Date of Test	2021-10-07
Factor	DRH18-E	Temp. / Humidity	23°C /49%
Polarity	Horizontal	Site / Test Engineer	AC2 / Jay
Test Mode	802.11b_TX_CH 11	Test Voltage	AC 120V/60Hz

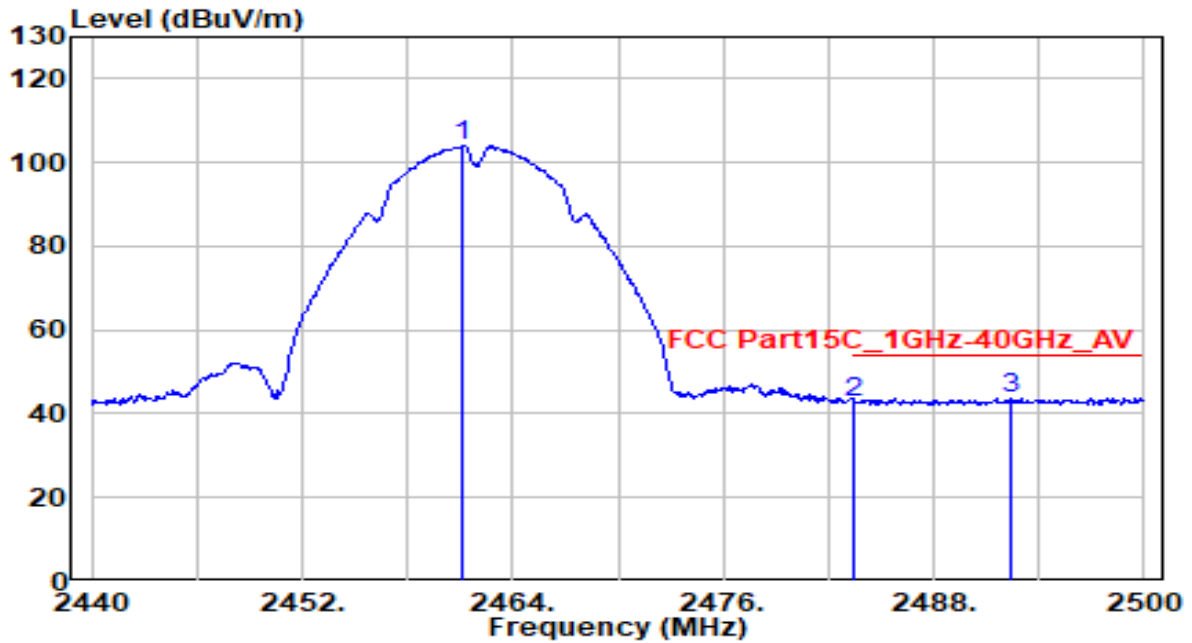

No	Frequency (MHz)	Reading (dBμV)	C.F (dB/m)	Measurement (dBμV/m)	Margin (dB)	Limit (dBμV/m)	Height (cm)	Angle (deg)	Remark (QP/PK/AV)
1	2461.180	73.58	30.42	104.00	N/A	N/A	150	220	Average
2	2483.500	12.15	30.46	42.61	-11.39	54.00	150	220	Average
3	* 2492.380	13.06	30.48	43.54	-10.46	54.00	150	220	Average

Note:

1. " \*", means this data is the worst emission level.
2. C.F (Correction Factor) = Antenna Factor (dB/m)+ Cable Loss (dB).
3. Measurement (dBμV/m) = Reading(dBμV) + C.F (Correction Factor).
4. The emission levels of other frequencies are very lower than the limit and not show in test report.

EUT	HAN Access Point	Date of Test	2021-10-07
Factor	DRH18-E	Temp. / Humidity	23°C /49%
Polarity	Vertical	Site / Test Engineer	AC2 / Jay
Test Mode	802.11b_TX_CH 11	Test Voltage	AC 120V/60Hz

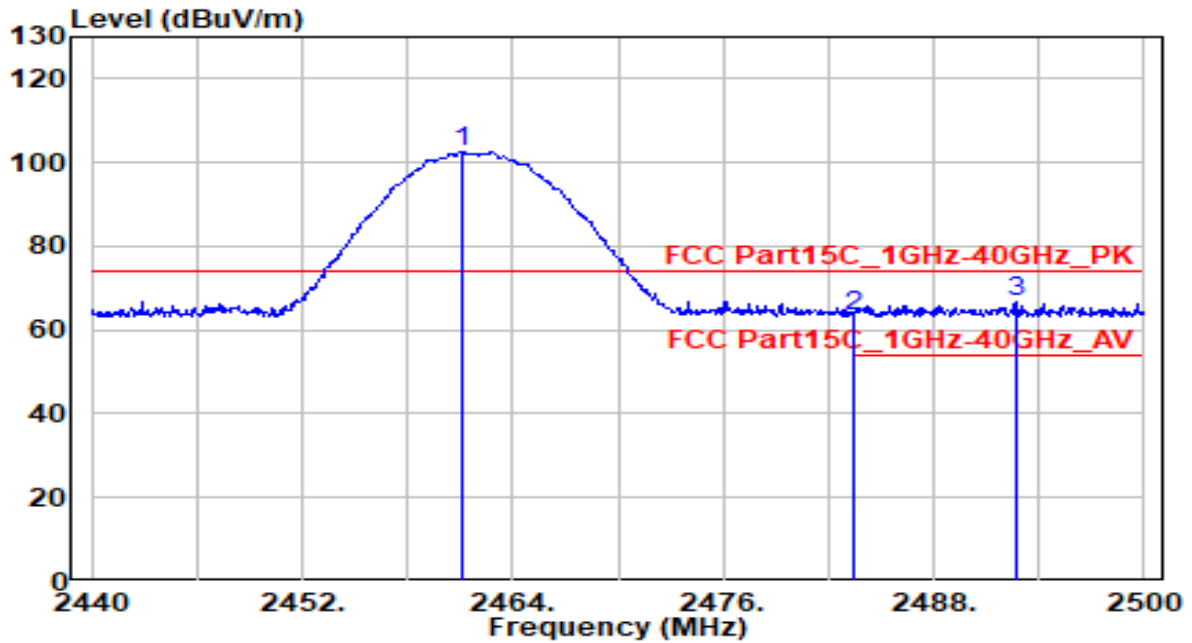

No	Frequency (MHz)	Reading (dBμV)	C.F (dB/m)	Measurement (dBμV/m)	Margin (dB)	Limit (dBμV/m)	Height (cm)	Angle (deg)	Remark (QP/PK/AV)
1	2461.180	72.28	30.42	102.70	N/A	N/A	230	150	Peak
2	2483.500	32.74	30.46	63.20	-10.80	74.00	230	150	Peak
3	* 2492.680	36.42	30.48	66.90	-7.10	74.00	230	150	Peak

Note:

1. " \*", means this data is the worst emission level.
2. C.F (Correction Factor) = Antenna Factor (dB/m)+ Cable Loss (dB).
3. Measurement (dBμV/m) = Reading(dBμV) + C.F (Correction Factor).
4. The emission levels of other frequencies are very lower than the limit and not show in test report.

EUT	HAN Access Point	Date of Test	2021-10-07
Factor	DRH18-E	Temp. / Humidity	23°C /49%
Polarity	Vertical	Site / Test Engineer	AC2 / Jay
Test Mode	802.11b_TX_CH 11	Test Voltage	AC 120V/60Hz

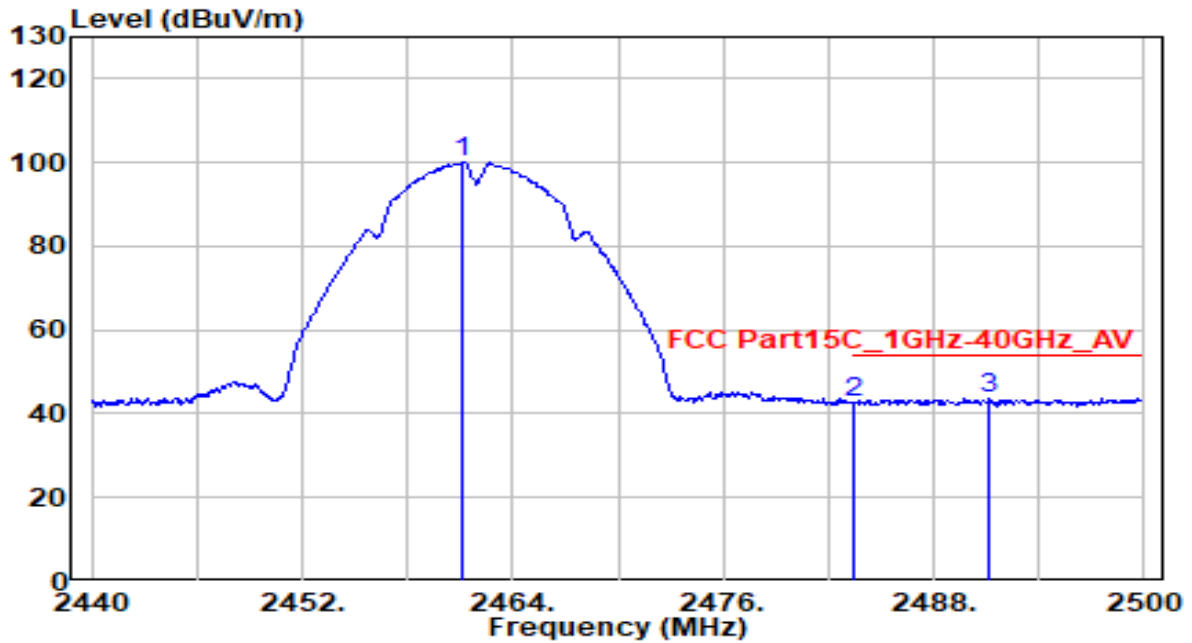

No	Frequency (MHz)	Reading (dBμV)	C.F (dB/m)	Measurement (dBμV/m)	Margin (dB)	Limit (dBμV/m)	Height (cm)	Angle (deg)	Remark (QP/PK/AV)
1	2461.180	69.74	30.42	100.16	N/A	N/A	230	150	Average
2	2483.500	12.35	30.46	42.81	-11.19	54.00	230	150	Average
3	* 2491.180	13.06	30.47	43.53	-10.47	54.00	230	150	Average

Note:

1. " \*", means this data is the worst emission level.
2. C.F (Correction Factor) = Antenna Factor (dB/m)+ Cable Loss (dB).
3. Measurement (dBμV/m) = Reading(dBμV) + C.F (Correction Factor).
4. The emission levels of other frequencies are very lower than the limit and not show in test report.

EUT	HAN Access Point	Date of Test	2021-10-07
Factor	DRH18-E	Temp. / Humidity	23°C /49%
Polarity	Horizontal	Site / Test Engineer	AC2 / Jay
Test Mode	802.11g_TX_CH 1	Test Voltage	AC 120V/60Hz

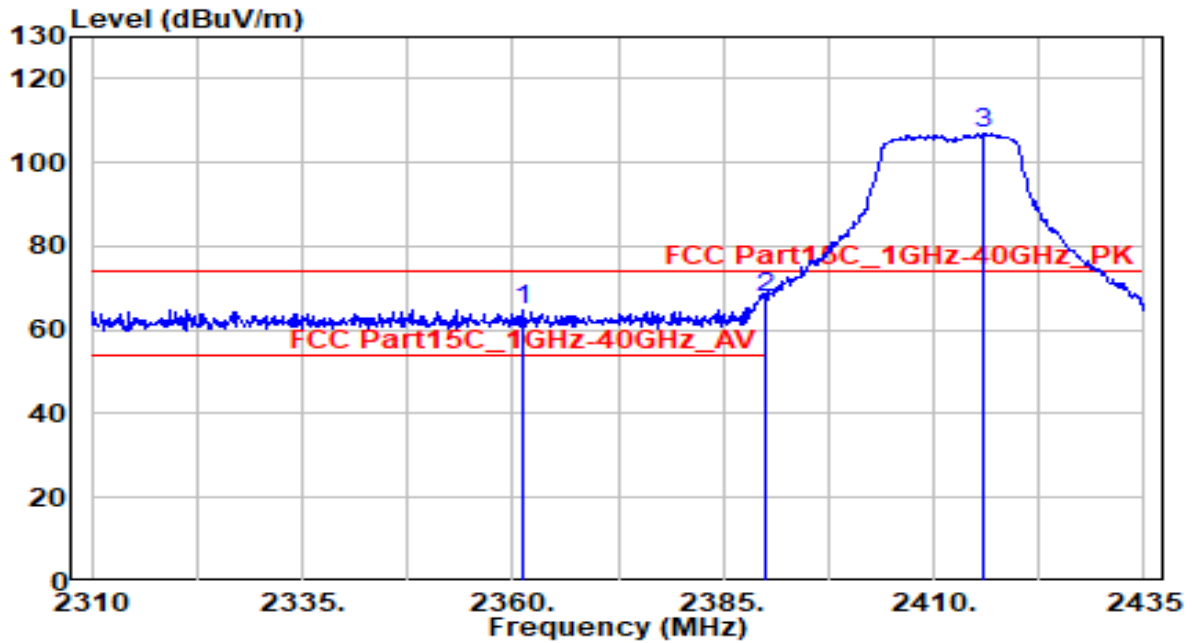

No	Frequency (MHz)	Reading (dB $\mu$ V)	C.F (dB/m)	Measurement (dB $\mu$ V/m)	Margin (dB)	Limit (dB $\mu$ V/m)	Height (cm)	Angle (deg)	Remark (QP/PK/AV)
1	2361.125	34.74	30.22	64.96	-9.04	74.00	155	220	Peak
2	* 2390.000	37.20	30.29	67.49	-6.51	74.00	155	220	Peak
3	2416.000	76.56	30.34	106.90	N/A	N/A	155	220	Peak

Note:

1. " \*", means this data is the worst emission level.
2. C.F (Correction Factor) = Antenna Factor (dB/m)+ Cable Loss (dB).
3. Measurement (dB $\mu$ V/m) = Reading(dB $\mu$ V) + C.F (Correction Factor).
4. The emission levels of other frequencies are very lower than the limit and not show in test report.

EUT	HAN Access Point	Date of Test	2021-10-07
Factor	DRH18-E	Temp. / Humidity	23°C /49%
Polarity	Horizontal	Site / Test Engineer	AC2 / Jay
Test Mode	802.11g_TX_CH 1	Test Voltage	AC 120V/60Hz

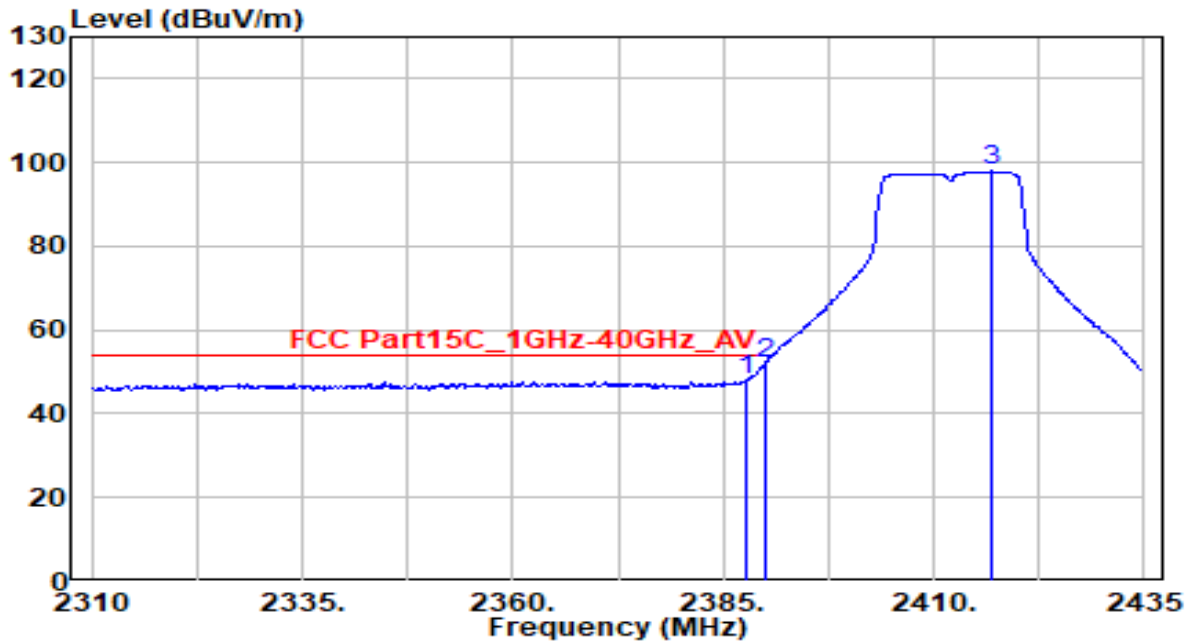

No	Frequency (MHz)	Reading (dBμV)	C.F (dB/m)	Measurement (dBμV/m)	Margin (dB)	Limit (dBμV/m)	Height (cm)	Angle (deg)	Remark (QP/PK/AV)
1	2387.625	17.77	30.28	48.05	-5.95	54.00	155	220	Average
2	* 2390.000	21.72	30.29	52.00	-2.00	54.00	155	220	Average
3	2417.000	67.57	30.34	97.91	N/A	N/A	155	220	Average

Note:

1. " \*", means this data is the worst emission level.
2. C.F (Correction Factor) = Antenna Factor (dB/m)+ Cable Loss (dB).
3. Measurement (dBμV/m) = Reading(dBμV) + C.F (Correction Factor).
4. The emission levels of other frequencies are very lower than the limit and not show in test report.

EUT	HAN Access Point	Date of Test	2021-10-07
Factor	DRH18-E	Temp. / Humidity	23°C /49%
Polarity	Vertical	Site / Test Engineer	AC2 / Jay
Test Mode	802.11g_TX_CH 1	Test Voltage	AC 120V/60Hz

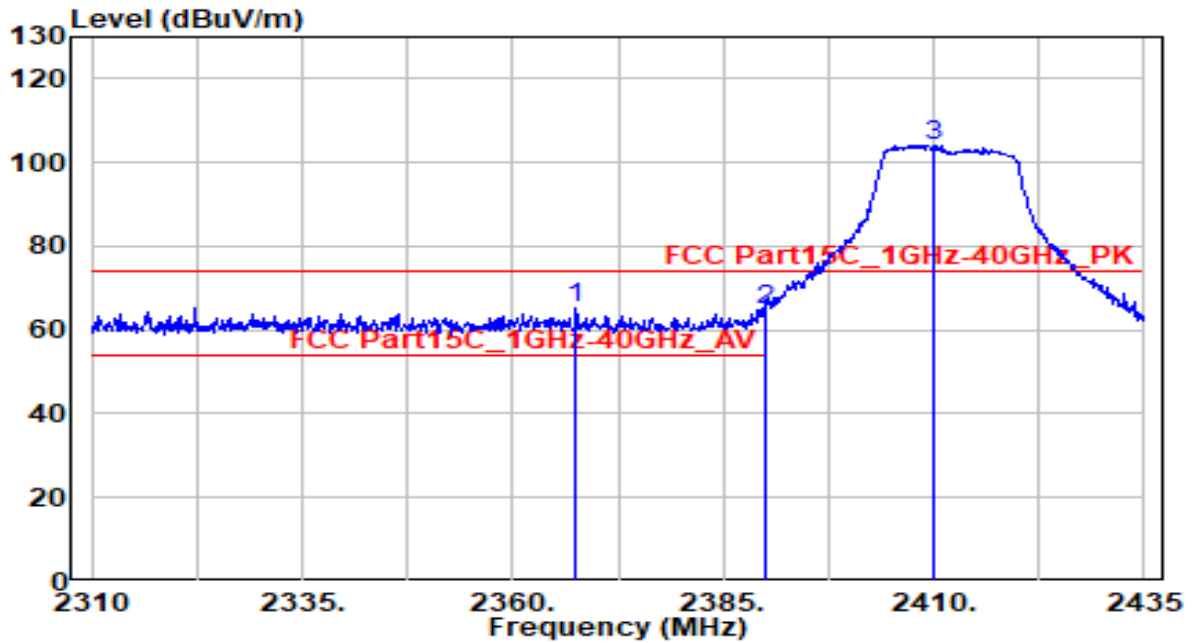

No	Frequency (MHz)	Reading (dB $\mu$ V)	C.F (dB/m)	Measurement (dB $\mu$ V/m)	Margin (dB)	Limit (dB $\mu$ V/m)	Height (cm)	Angle (deg)	Remark (QP/PK/AV)	
1	*	2367.500	35.13	30.24	65.36	-8.64	74.00	225	155	Peak
2		2390.000	34.48	30.29	64.77	-9.23	74.00	225	155	Peak
3		2409.875	73.84	30.33	104.17	N/A	N/A	225	155	Peak

Note:

1. " \*", means this data is the worst emission level.
2. C.F (Correction Factor) = Antenna Factor (dB/m)+ Cable Loss (dB).
3. Measurement (dB $\mu$ V/m) = Reading(dB $\mu$ V) + C.F (Correction Factor).
4. The emission levels of other frequencies are very lower than the limit and not show in test report.



EUT	HAN Access Point	Date of Test	2021-10-07
Factor	DRH18-E	Temp. / Humidity	23°C /49%
Polarity	Vertical	Site / Test Engineer	AC2 / Jay
Test Mode	802.11g_TX_CH 1	Test Voltage	AC 120V/60Hz

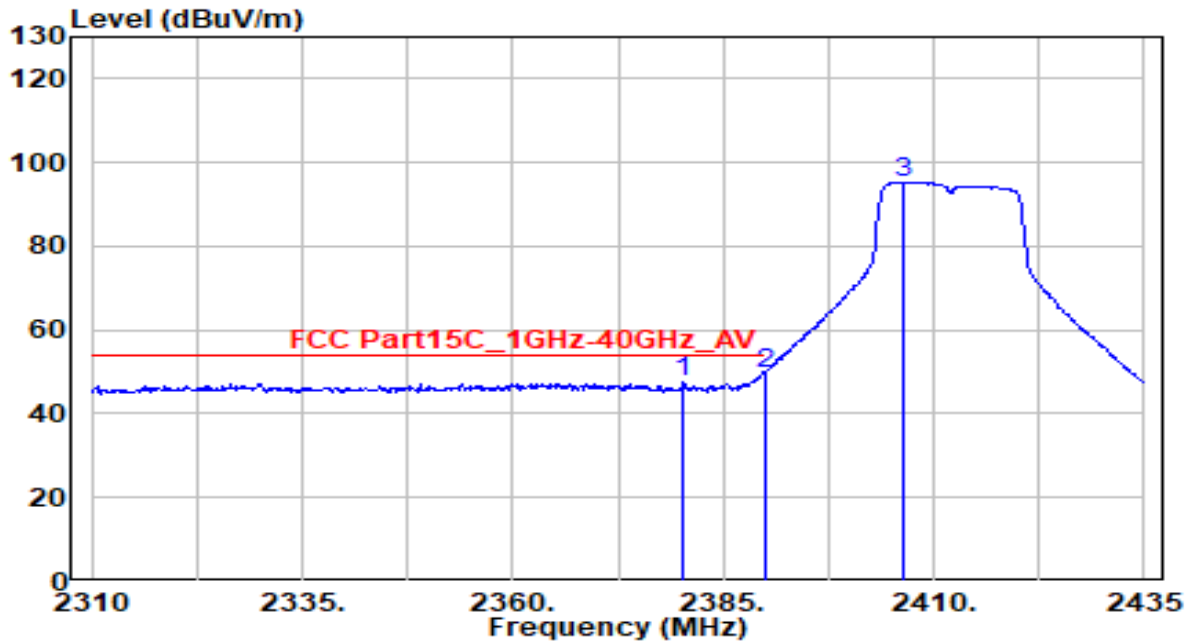

No	Frequency (MHz)	Reading (dBμV)	C.F (dB/m)	Measurement (dBμV/m)	Margin (dB)	Limit (dBμV/m)	Height (cm)	Angle (deg)	Remark (QP/PK/AV)
1	2380.250	17.18	30.26	47.44	-6.56	54.00	225	155	Average
2	* 2390.000	19.28	30.29	49.57	-4.43	54.00	225	155	Average
3	2406.250	65.00	30.32	95.32	N/A	N/A	225	155	Average

Note:

1. " \*", means this data is the worst emission level.
2. C.F (Correction Factor) = Antenna Factor (dB/m)+ Cable Loss (dB).
3. Measurement (dBμV/m) = Reading(dBμV) + C.F (Correction Factor).
4. The emission levels of other frequencies are very lower than the limit and not show in test report.

EUT	HAN Access Point	Date of Test	2021-10-07
Factor	DRH18-E	Temp. / Humidity	23°C /49%
Polarity	Horizontal	Site / Test Engineer	AC2 / Jay
Test Mode	802.11g_TX_CH 2	Test Voltage	AC 120V/60Hz

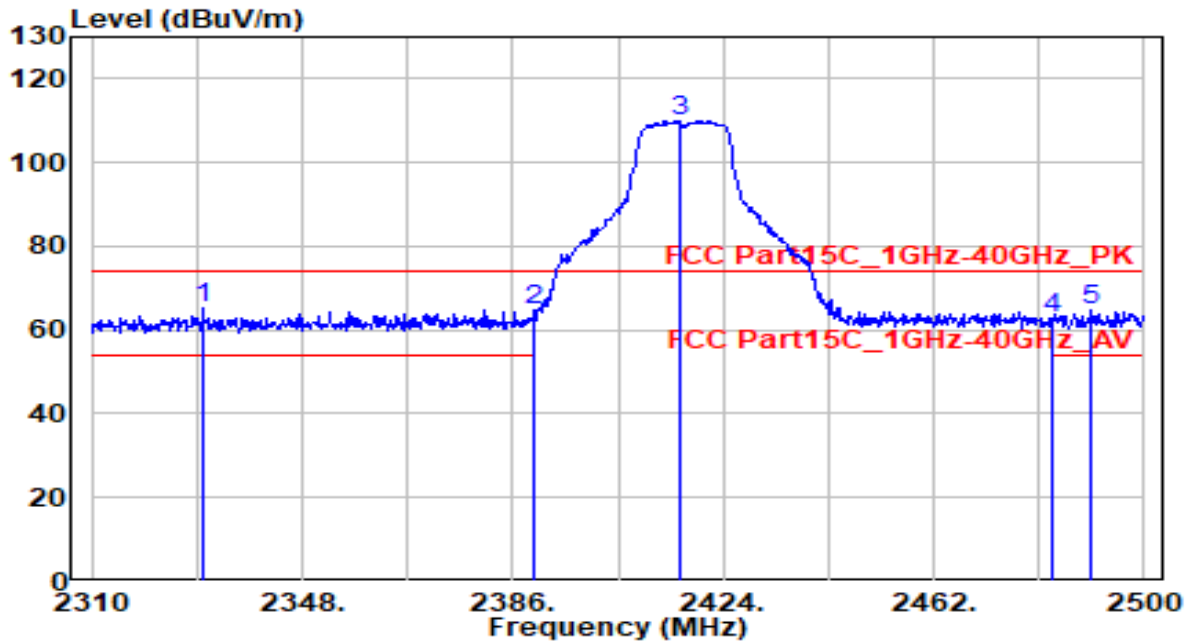

No	Frequency (MHz)	Reading (dBμV)	C.F (dB/m)	Measurement (dBμV/m)	Margin (dB)	Limit (dBμV/m)	Height (cm)	Angle (deg)	Remark (QP/PK/AV)
1	* 2330.140	35.21	30.15	65.36	-8.64	74.00	150	220	Peak
2	2390.000	34.35	30.29	64.64	-9.36	74.00	150	220	Peak
3	2416.210	79.73	30.34	110.07	N/A	N/A	150	220	Peak
4	2483.500	32.50	30.46	62.96	-11.04	74.00	150	220	Peak
5	2490.500	34.05	30.47	64.52	-9.48	74.00	150	220	Peak

Note:

- "\*", means this data is the worst emission level.
- C.F (Correction Factor) = Antenna Factor (dB/m)+ Cable Loss (dB).
- Measurement (dBμV/m) = Reading(dBμV) + C.F (Correction Factor).
- The emission levels of other frequencies are very lower than the limit and not show in test report.

EUT	HAN Access Point	Date of Test	2021-10-07
Factor	DRH18-E	Temp. / Humidity	23°C /49%
Polarity	Horizontal	Site / Test Engineer	AC2 / Jay
Test Mode	802.11g_TX_CH 2	Test Voltage	AC 120V/60Hz

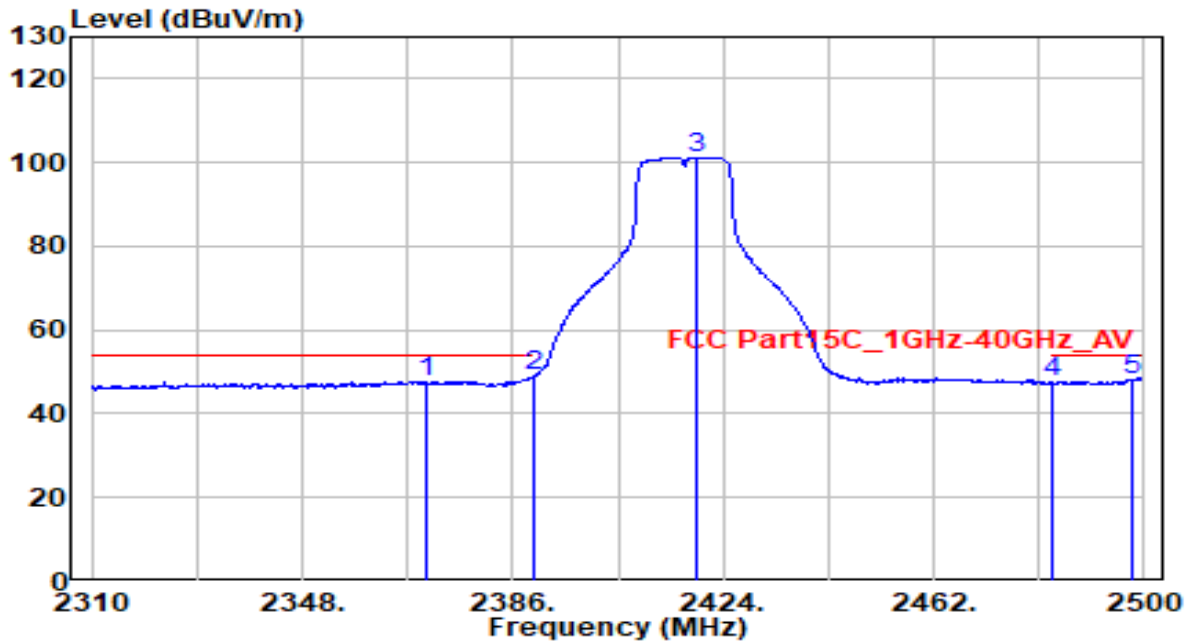

No	Frequency (MHz)	Reading (dBμV)	C.F (dB/m)	Measurement (dBμV/m)	Margin (dB)	Limit (dBμV/m)	Height (cm)	Angle (deg)	Remark (QP/PK/AV)
1	2370.420	17.54	30.24	47.78	-6.22	54.00	150	220	Average
2	* 2390.000	18.65	30.29	48.94	-5.06	54.00	150	220	Average
3	2419.060	70.92	30.34	101.26	N/A	N/A	150	220	Average
4	2483.500	17.16	30.46	47.62	-6.38	54.00	150	220	Average
5	2497.720	17.73	30.49	48.21	-5.79	54.00	150	220	Average

Note:

- "\*", means this data is the worst emission level.
- C.F (Correction Factor) = Antenna Factor (dB/m)+ Cable Loss (dB).
- Measurement (dBμV/m) = Reading(dBμV) + C.F (Correction Factor).
- The emission levels of other frequencies are very lower than the limit and not show in test report.

EUT	HAN Access Point	Date of Test	2021-10-07
Factor	DRH18-E	Temp. / Humidity	23°C /49%
Polarity	Vertical	Site / Test Engineer	AC2 / Jay
Test Mode	802.11g_TX_CH 2	Test Voltage	AC 120V/60Hz

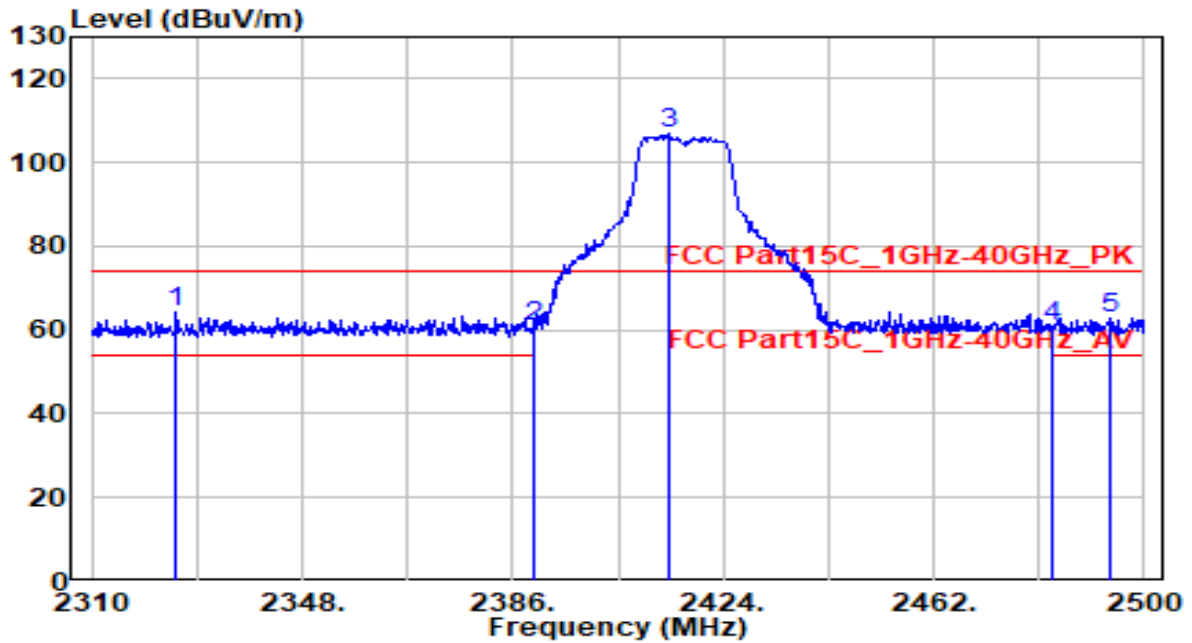

No	Frequency (MHz)	Reading (dBμV)	C.F (dB/m)	Measurement (dBμV/m)	Margin (dB)	Limit (dBμV/m)	Height (cm)	Angle (deg)	Remark (QP/PK/AV)
1	* 2325.200	33.92	30.14	64.06	-9.94	74.00	240	150	Peak
2	2390.000	30.77	30.29	61.06	-12.94	74.00	240	150	Peak
3	2414.310	76.76	30.34	107.09	N/A	N/A	240	150	Peak
4	2483.500	30.38	30.46	60.84	-13.16	74.00	240	150	Peak
5	2493.730	32.53	30.48	63.01	-10.99	74.00	240	150	Peak

Note:

- "\*", means this data is the worst emission level.
- C.F (Correction Factor) = Antenna Factor (dB/m)+ Cable Loss (dB).
- Measurement (dBμV/m) = Reading(dBμV) + C.F (Correction Factor).
- The emission levels of other frequencies are very lower than the limit and not show in test report.

EUT	HAN Access Point	Date of Test	2021-10-07
Factor	DRH18-E	Temp. / Humidity	23°C /49%
Polarity	Vertical	Site / Test Engineer	AC2 / Jay
Test Mode	802.11g_TX_CH 2	Test Voltage	AC 120V/60Hz

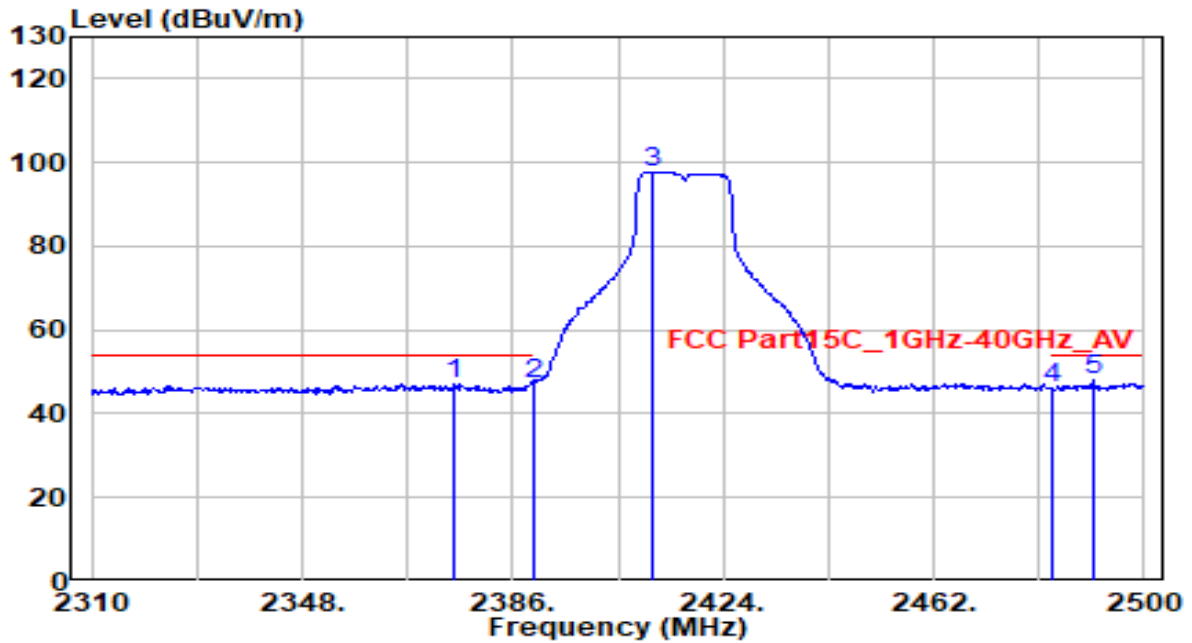

No	Frequency (MHz)	Reading (dBμV)	C.F (dB/m)	Measurement (dBμV/m)	Margin (dB)	Limit (dBμV/m)	Height (cm)	Angle (deg)	Remark (QP/PK/AV)
1	2375.360	16.83	30.25	47.08	-6.92	54.00	240	150	Average
2	2390.000	17.04	30.29	47.33	-6.67	54.00	240	150	Average
3	2411.460	67.41	30.33	97.74	N/A	N/A	240	150	Average
4	2483.500	15.60	30.46	46.06	-7.94	54.00	240	150	Average
5	* 2490.690	17.43	30.47	47.90	-6.10	54.00	240	150	Average

Note:

1. " \*", means this data is the worst emission level.
2. C.F (Correction Factor) = Antenna Factor (dB/m)+ Cable Loss (dB).
3. Measurement (dBμV/m) = Reading(dBμV) + C.F (Correction Factor).
4. The emission levels of other frequencies are very lower than the limit and not show in test report.

EUT	HAN Access Point	Date of Test	2021-10-07
Factor	DRH18-E	Temp. / Humidity	23°C /49%
Polarity	Horizontal	Site / Test Engineer	AC2 / Jay
Test Mode	802.11g_TX_CH 11	Test Voltage	AC 120V/60Hz

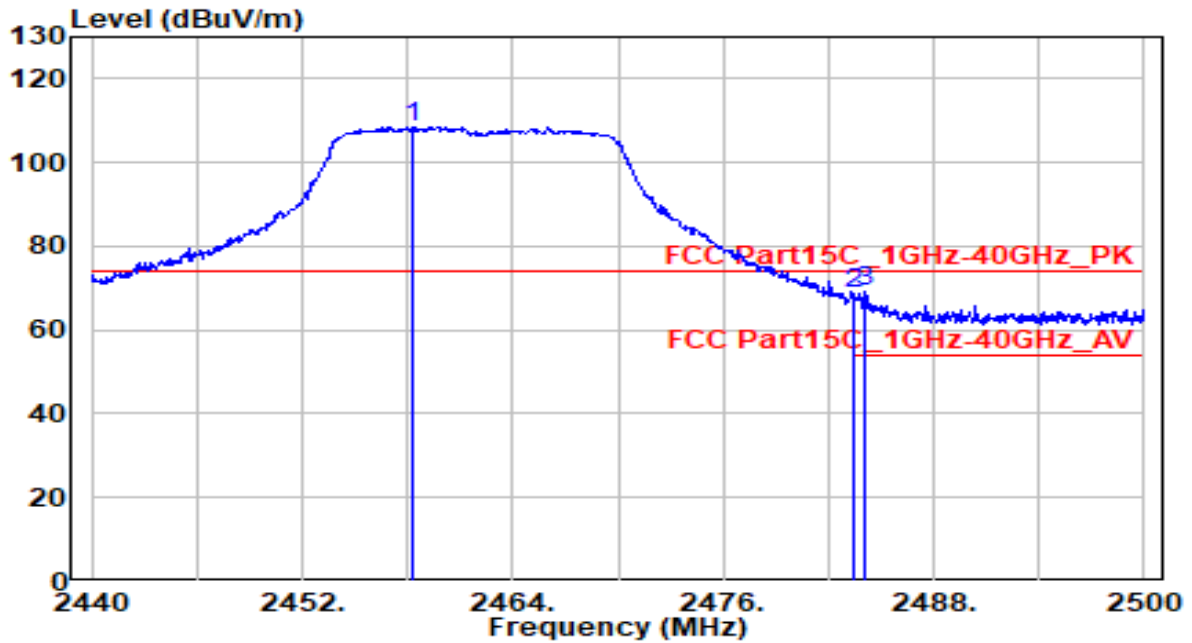

No	Frequency (MHz)	Reading (dBμV)	C.F (dB/m)	Measurement (dBμV/m)	Margin (dB)	Limit (dBμV/m)	Height (cm)	Angle (deg)	Remark (QP/PK/AV)
1	2458.360	78.24	30.42	108.66	N/A	N/A	150	220	Peak
2	2483.500	38.03	30.46	68.49	-5.51	74.00	150	220	Peak
3	* 2484.040	38.72	30.46	69.18	-4.82	74.00	150	220	Peak

Note:

1. " \*", means this data is the worst emission level.
2. C.F (Correction Factor) = Antenna Factor (dB/m)+ Cable Loss (dB).
3. Measurement (dBμV/m) = Reading(dBμV) + C.F (Correction Factor).
4. The emission levels of other frequencies are very lower than the limit and not show in test report.

EUT	HAN Access Point	Date of Test	2021-10-07
Factor	DRH18-E	Temp. / Humidity	23°C /49%
Polarity	Horizontal	Site / Test Engineer	AC2 / Jay
Test Mode	802.11g_TX_CH 11	Test Voltage	AC 120V/60Hz

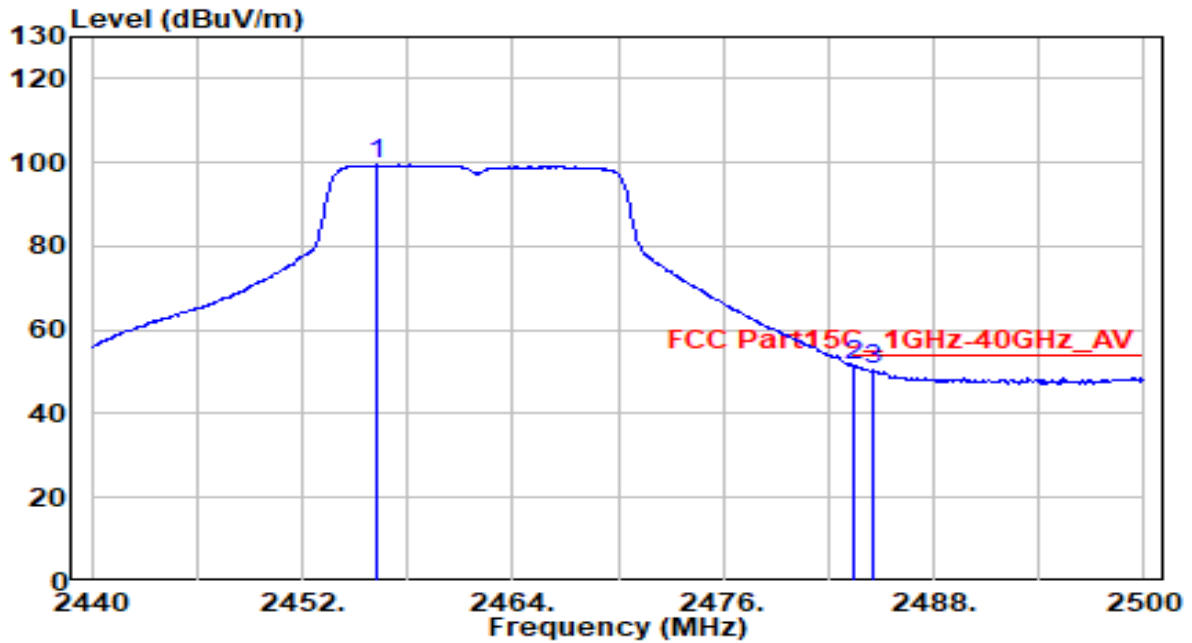

No	Frequency (MHz)	Reading (dB $\mu$ V)	C.F (dB/m)	Measurement (dB $\mu$ V/m)	Margin (dB)	Limit (dB $\mu$ V/m)	Height (cm)	Angle (deg)	Remark (QP/PK/AV)
1	2456.200	68.95	30.41	99.36	N/A	N/A	150	220	Average
2	* 2483.500	21.03	30.46	51.49	-2.51	54.00	150	220	Average
3	2484.520	19.84	30.46	50.31	-3.69	54.00	150	220	Average

Note:

1. " \*", means this data is the worst emission level.
2. C.F (Correction Factor) = Antenna Factor (dB/m)+ Cable Loss (dB).
3. Measurement (dB $\mu$ V/m) = Reading(dB $\mu$ V) + C.F (Correction Factor).
4. The emission levels of other frequencies are very lower than the limit and not show in test report.

EUT	HAN Access Point	Date of Test	2021-10-07
Factor	DRH18-E	Temp. / Humidity	23°C /49%
Polarity	Vertical	Site / Test Engineer	AC2 / Jay
Test Mode	802.11g_TX_CH 11	Test Voltage	AC 120V/60Hz

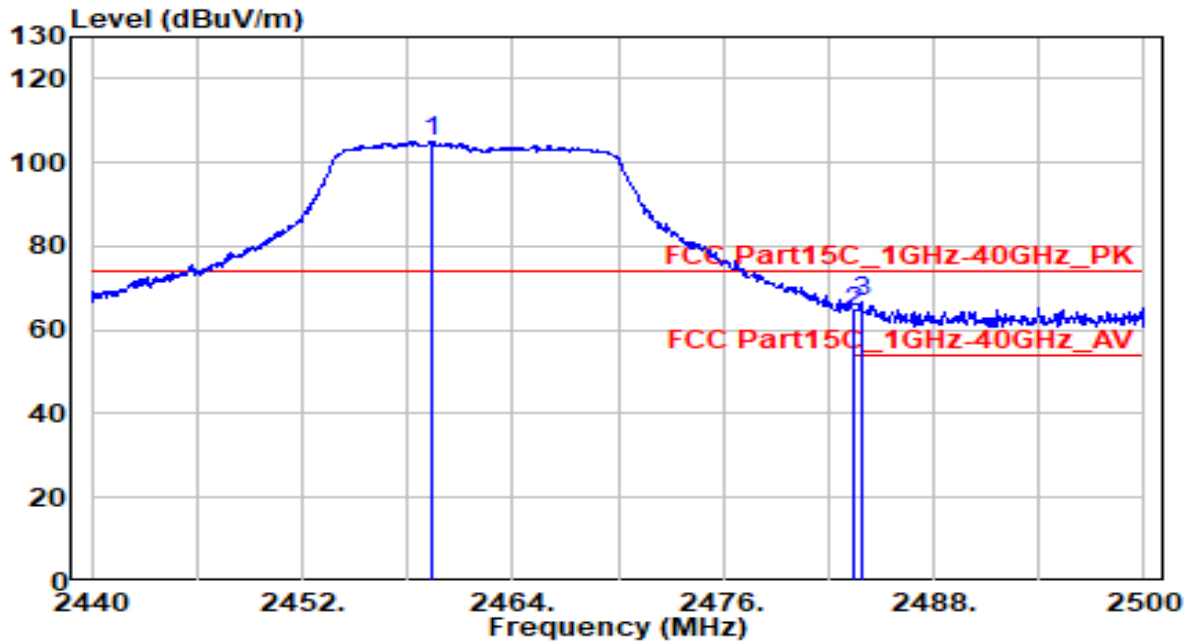

No	Frequency (MHz)	Reading (dBμV)	C.F (dB/m)	Measurement (dBμV/m)	Margin (dB)	Limit (dBμV/m)	Height (cm)	Angle (deg)	Remark (QP/PK/AV)
1	2459.380	74.47	30.42	104.89	N/A	N/A	230	150	Peak
2	2483.500	34.01	30.46	64.47	-9.53	74.00	230	150	Peak
3	* 2483.860	36.02	30.46	66.49	-7.51	74.00	230	150	Peak

Note:

1. " \*", means this data is the worst emission level.
2. C.F (Correction Factor) = Antenna Factor (dB/m)+ Cable Loss (dB).
3. Measurement (dBμV/m) = Reading(dBμV) + C.F (Correction Factor).
4. The emission levels of other frequencies are very lower than the limit and not show in test report.



EUT	HAN Access Point	Date of Test	2021-10-07
Factor	DRH18-E	Temp. / Humidity	23°C /49%
Polarity	Vertical	Site / Test Engineer	AC2 / Jay
Test Mode	802.11g_TX_CH 11	Test Voltage	AC 120V/60Hz

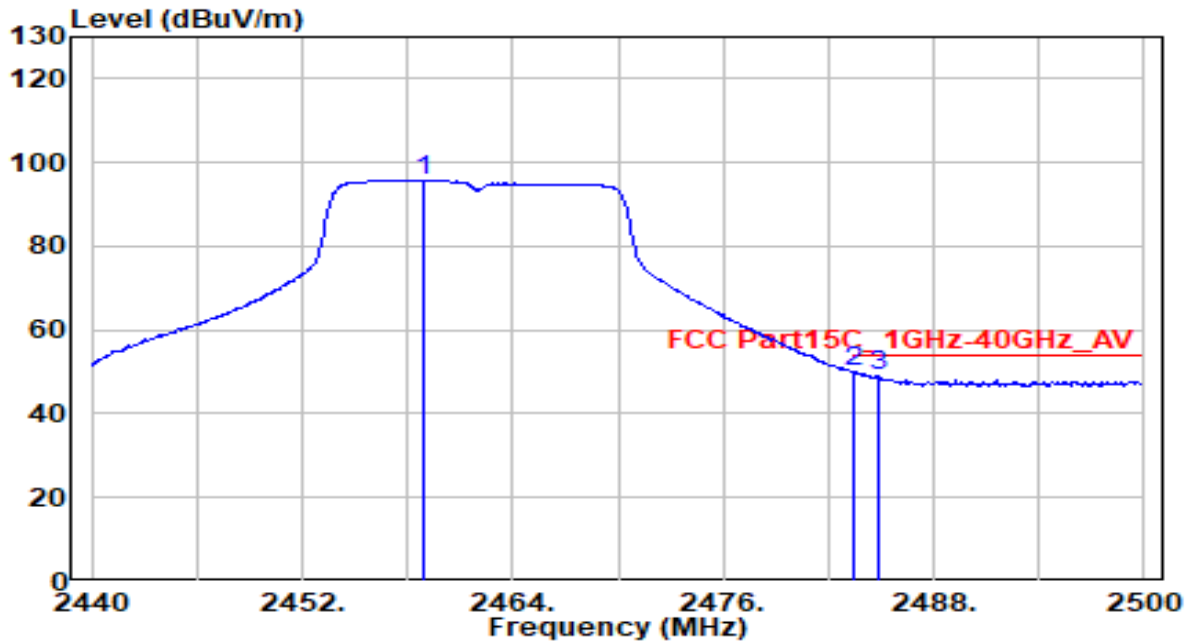

No	Frequency (MHz)	Reading (dBμV)	C.F (dB/m)	Measurement (dBμV/m)	Margin (dB)	Limit (dBμV/m)	Height (cm)	Angle (deg)	Remark (QP/PK/AV)
1	2458.900	65.26	30.42	95.68	N/A	N/A	230	150	Average
2	* 2483.500	19.40	30.46	49.86	-4.14	54.00	230	150	Average
3	2484.820	18.41	30.46	48.88	-5.12	54.00	230	150	Average

Note:

1. " \*", means this data is the worst emission level.
2. C.F (Correction Factor) = Antenna Factor (dB/m)+ Cable Loss (dB).
3. Measurement (dBμV/m) = Reading(dBμV) + C.F (Correction Factor).
4. The emission levels of other frequencies are very lower than the limit and not show in test report.

EUT	HAN Access Point	Date of Test	2021-10-07
Factor	DRH18-E	Temp. / Humidity	23°C /49%
Polarity	Horizontal	Site / Test Engineer	AC2 / Jay
Test Mode	802.11n20_TX_CH 1	Test Voltage	AC 120V/60Hz

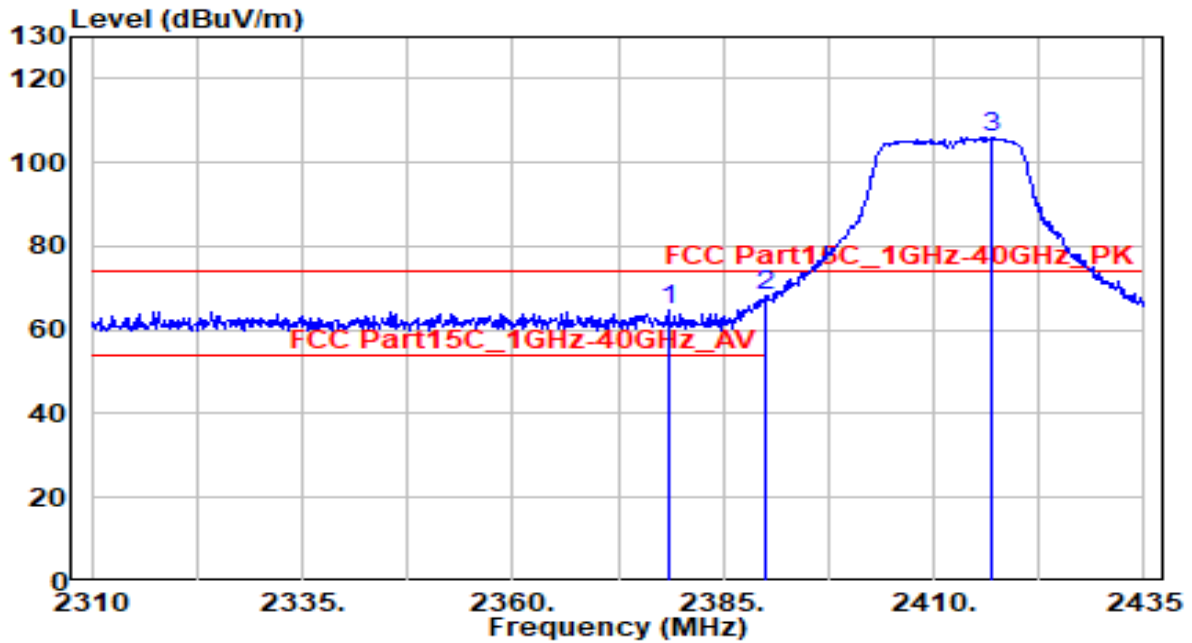

No	Frequency (MHz)	Reading (dB $\mu$ V)	C.F (dB/m)	Measurement (dB $\mu$ V/m)	Margin (dB)	Limit (dB $\mu$ V/m)	Height (cm)	Angle (deg)	Remark (QP/PK/AV)
1	2378.500	34.29	30.26	64.55	-9.45	74.00	155	220	Peak
2	* 2390.000	37.72	30.29	68.01	-5.99	74.00	155	220	Peak
3	2417.000	75.81	30.34	106.15	N/A	N/A	155	220	Peak

Note:

1. " \*", means this data is the worst emission level.
2. C.F (Correction Factor) = Antenna Factor (dB/m)+ Cable Loss (dB).
3. Measurement (dB $\mu$ V/m) = Reading(dB $\mu$ V) + C.F (Correction Factor).
4. The emission levels of other frequencies are very lower than the limit and not show in test report.

EUT	HAN Access Point	Date of Test	2021-10-07
Factor	DRH18-E	Temp. / Humidity	23°C /49%
Polarity	Horizontal	Site / Test Engineer	AC2 / Jay
Test Mode	802.11n20_TX_CH 1	Test Voltage	AC 120V/60Hz

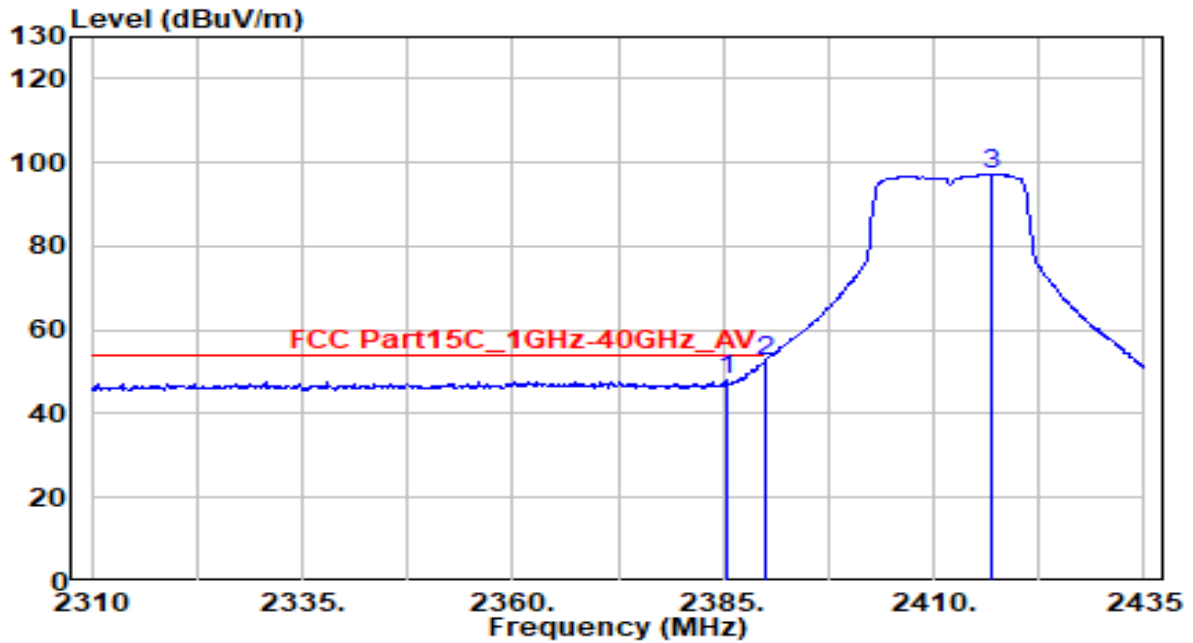

No	Frequency (MHz)	Reading (dBμV)	C.F (dB/m)	Measurement (dBμV/m)	Margin (dB)	Limit (dBμV/m)	Height (cm)	Angle (deg)	Remark (QP/PK/AV)
1	2385.375	17.77	30.28	48.05	-5.95	54.00	155	220	Average
2	* 2390.000	22.28	30.29	52.57	-1.43	54.00	155	220	Average
3	2416.750	66.73	30.34	97.07	N/A	N/A	155	220	Average

Note:

1. " \*", means this data is the worst emission level.
2. C.F (Correction Factor) = Antenna Factor (dB/m)+ Cable Loss (dB).
3. Measurement (dBμV/m) = Reading(dBμV) + C.F (Correction Factor).
4. The emission levels of other frequencies are very lower than the limit and not show in test report.

EUT	HAN Access Point	Date of Test	2021-10-07
Factor	DRH18-E	Temp. / Humidity	23°C /49%
Polarity	Vertical	Site / Test Engineer	AC2 / Jay
Test Mode	802.11n20_TX_CH 1	Test Voltage	AC 120V/60Hz

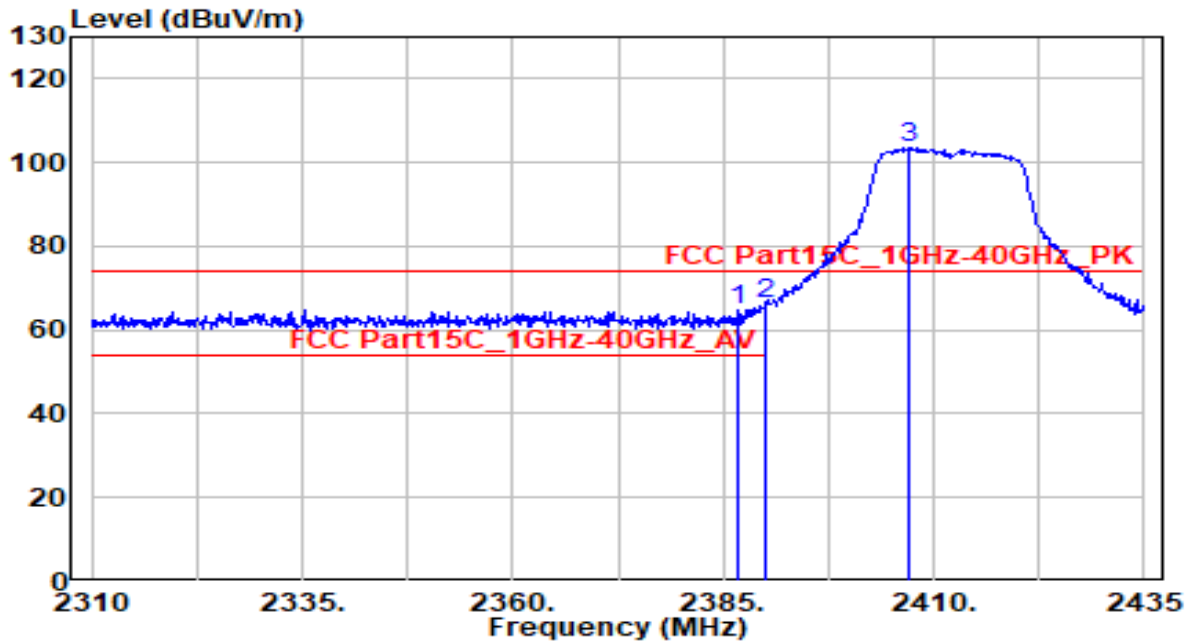

No	Frequency (MHz)	Reading (dBμV)	C.F (dB/m)	Measurement (dBμV/m)	Margin (dB)	Limit (dBμV/m)	Height (cm)	Angle (deg)	Remark (QP/PK/AV)
1	2386.875	34.29	30.28	64.57	-9.43	74.00	225	155	Peak
2	* 2390.000	35.80	30.29	66.09	-7.91	74.00	225	155	Peak
3	2407.125	73.04	30.32	103.36	N/A	N/A	225	155	Peak

Note:

1. " \*", means this data is the worst emission level.
2. C.F (Correction Factor) = Antenna Factor (dB/m)+ Cable Loss (dB).
3. Measurement (dBμV/m) = Reading(dBμV) + C.F (Correction Factor).
4. The emission levels of other frequencies are very lower than the limit and not show in test report.

EUT	HAN Access Point	Date of Test	2021-10-07
Factor	DRH18-E	Temp. / Humidity	23°C /49%
Polarity	Vertical	Site / Test Engineer	AC2 / Jay
Test Mode	802.11n20_TX_CH 1	Test Voltage	AC 120V/60Hz

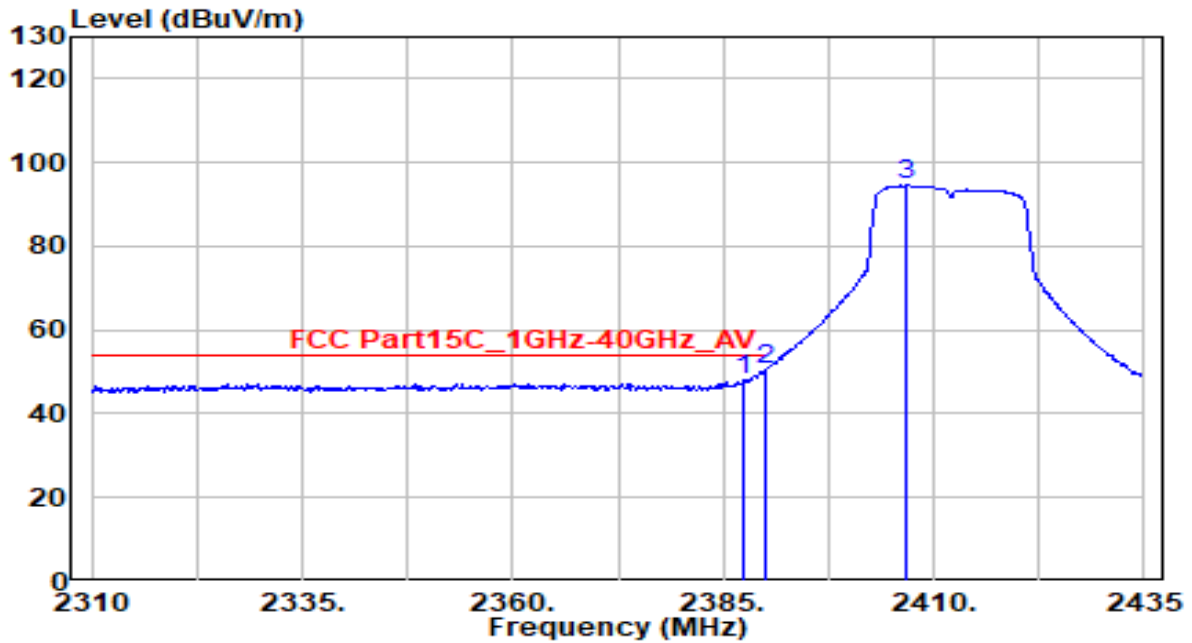

No	Frequency (MHz)	Reading (dBμV)	C.F (dB/m)	Measurement (dBμV/m)	Margin (dB)	Limit (dBμV/m)	Height (cm)	Angle (deg)	Remark (QP/PK/AV)
1	2387.375	17.58	30.28	47.86	-6.14	54.00	225	155	Average
2	* 2390.000	20.05	30.29	50.34	-3.66	54.00	225	155	Average
3	2406.750	64.24	30.32	94.56	N/A	N/A	225	155	Average

Note:

1. " \*", means this data is the worst emission level.
2. C.F (Correction Factor) = Antenna Factor (dB/m)+ Cable Loss (dB).
3. Measurement (dBμV/m) = Reading(dBμV) + C.F (Correction Factor).
4. The emission levels of other frequencies are very lower than the limit and not show in test report.

EUT	HAN Access Point	Date of Test	2021-10-07
Factor	DRH18-E	Temp. / Humidity	23°C /49%
Polarity	Horizontal	Site / Test Engineer	AC2 / Jay
Test Mode	802.11n20_TX_CH 2	Test Voltage	AC 120V/60Hz

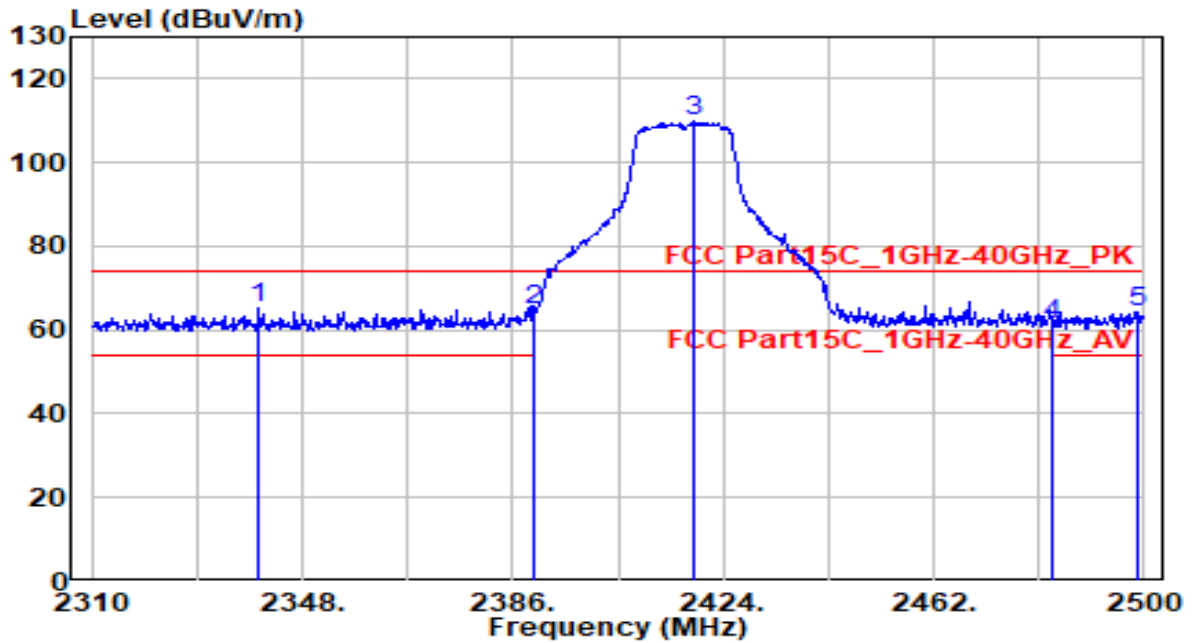

No	Frequency (MHz)	Reading (dBμV)	C.F (dB/m)	Measurement (dBμV/m)	Margin (dB)	Limit (dBμV/m)	Height (cm)	Angle (deg)	Remark (QP/PK/AV)
1	* 2340.210	34.91	30.17	65.08	-8.92	74.00	150	220	Peak
2	2390.000	34.41	30.29	64.69	-9.31	74.00	150	220	Peak
3	2418.870	79.47	30.34	109.81	N/A	N/A	150	220	Peak
4	2483.500	30.77	30.46	61.23	-12.77	74.00	150	220	Peak
5	2498.860	33.89	30.49	64.37	-9.63	74.00	150	220	Peak

Note:

- "\*", means this data is the worst emission level.
- C.F (Correction Factor) = Antenna Factor (dB/m)+ Cable Loss (dB).
- Measurement (dBμV/m) = Reading(dBμV) + C.F (Correction Factor).
- The emission levels of other frequencies are very lower than the limit and not show in test report.

EUT	HAN Access Point	Date of Test	2021-10-07
Factor	DRH18-E	Temp. / Humidity	23°C /49%
Polarity	Horizontal	Site / Test Engineer	AC2 / Jay
Test Mode	802.11n20_TX_CH 2	Test Voltage	AC 120V/60Hz

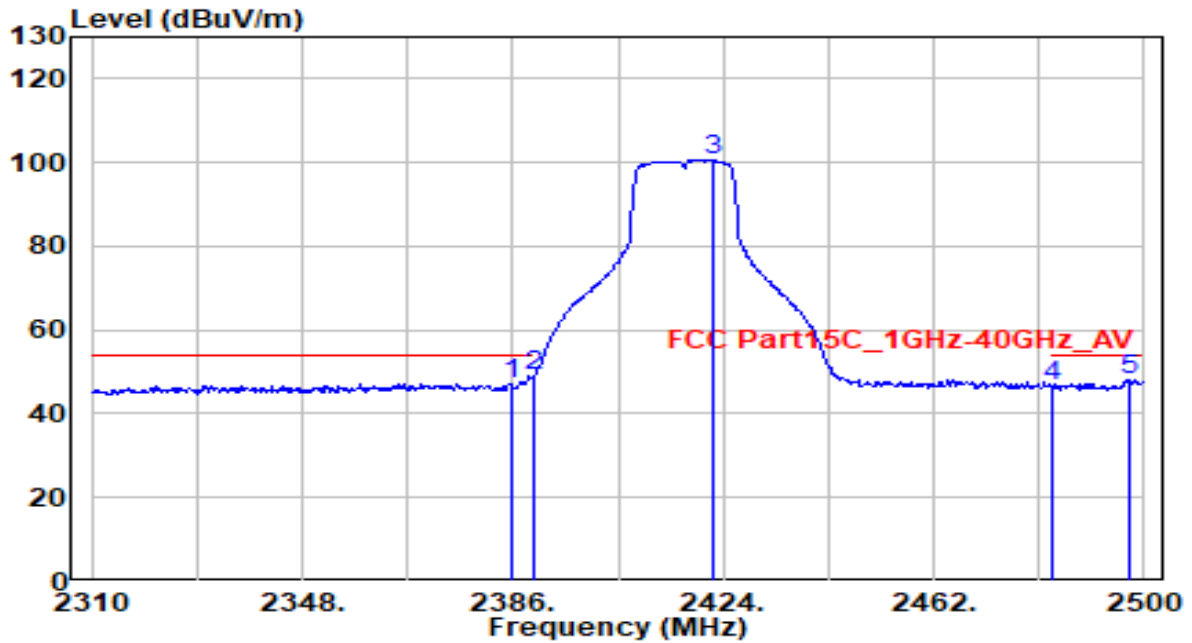

No	Frequency (MHz)	Reading (dB $\mu$ V)	C.F (dB/m)	Measurement (dB $\mu$ V/m)	Margin (dB)	Limit (dB $\mu$ V/m)	Height (cm)	Angle (deg)	Remark (QP/PK/AV)
1	2385.810	16.75	30.28	47.02	-6.98	54.00	150	220	Average
2	* 2390.000	18.72	30.29	49.01	-4.99	54.00	150	220	Average
3	2422.100	70.28	30.35	100.63	N/A	N/A	150	220	Average
4	2483.500	16.32	30.46	46.79	-7.21	54.00	150	220	Average
5	2497.150	17.57	30.48	48.06	-5.94	54.00	150	220	Average

Note:

- " \*", means this data is the worst emission level.
- C.F (Correction Factor) = Antenna Factor (dB/m)+ Cable Loss (dB).
- Measurement (dB $\mu$ V/m) = Reading(dB $\mu$ V) + C.F (Correction Factor).
- The emission levels of other frequencies are very lower than the limit and not show in test report.

EUT	HAN Access Point	Date of Test	2021-10-07
Factor	DRH18-E	Temp. / Humidity	23°C /49%
Polarity	Vertical	Site / Test Engineer	AC2 / Jay
Test Mode	802.11n20_TX_CH 2	Test Voltage	AC 120V/60Hz

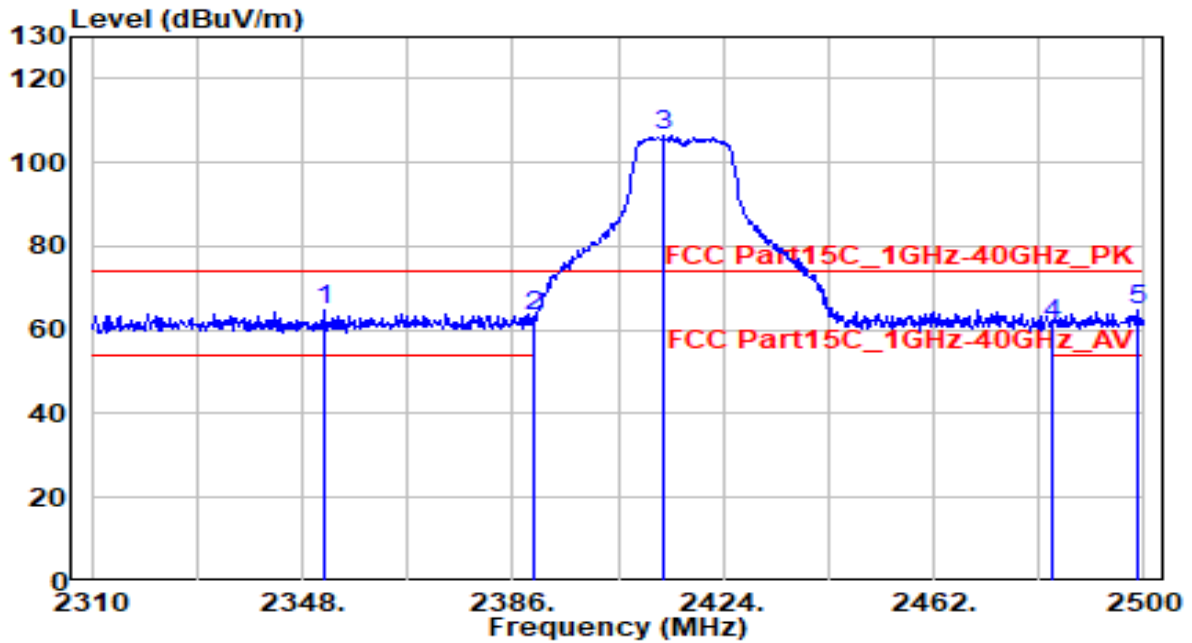

No	Frequency (MHz)	Reading (dBμV)	C.F (dB/m)	Measurement (dBμV/m)	Margin (dB)	Limit (dBμV/m)	Height (cm)	Angle (deg)	Remark (QP/PK/AV)
1	* 2351.800	34.61	30.20	64.81	-9.19	74.00	240	150	Peak
2	2390.000	33.03	30.29	63.32	-10.68	74.00	240	150	Peak
3	2413.170	76.20	30.33	106.54	N/A	N/A	240	150	Peak
4	2483.500	30.62	30.46	61.08	-12.92	74.00	240	150	Peak
5	2499.050	34.28	30.49	64.77	-9.23	74.00	240	150	Peak

Note:

- "\*", means this data is the worst emission level.
- C.F (Correction Factor) = Antenna Factor (dB/m)+ Cable Loss (dB).
- Measurement (dBμV/m) = Reading(dBμV) + C.F (Correction Factor).
- The emission levels of other frequencies are very lower than the limit and not show in test report.



EUT	HAN Access Point	Date of Test	2021-10-07
Factor	DRH18-E	Temp. / Humidity	23°C /49%
Polarity	Vertical	Site / Test Engineer	AC2 / Jay
Test Mode	802.11n20_TX_CH 2	Test Voltage	AC 120V/60Hz

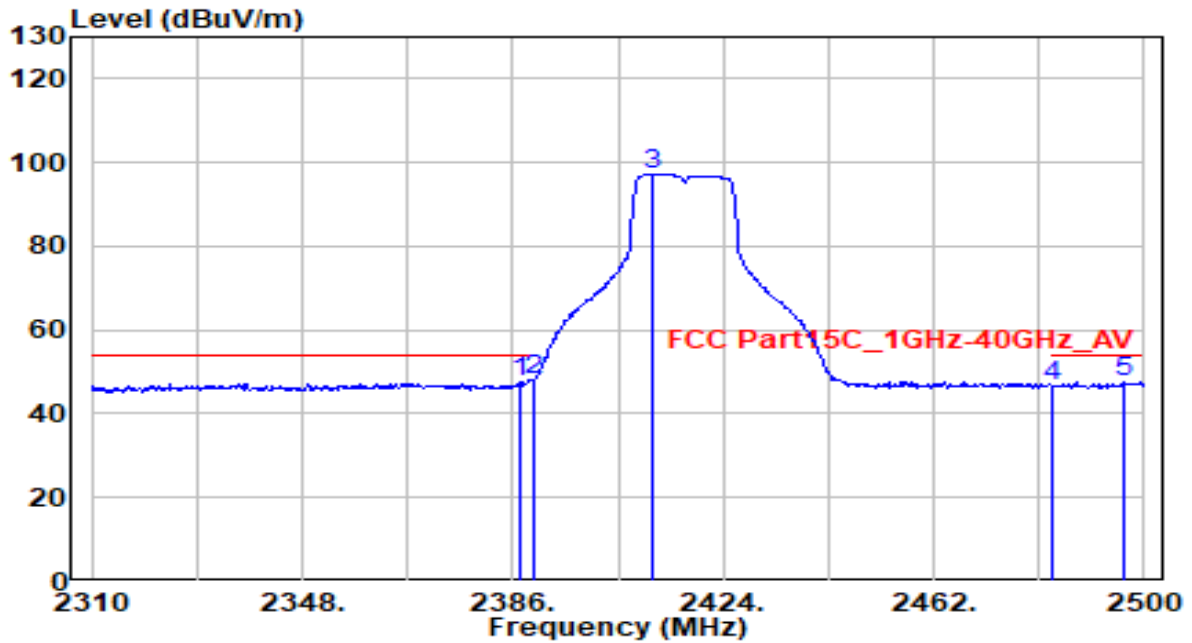

No	Frequency (MHz)	Reading (dBμV)	C.F (dB/m)	Measurement (dBμV/m)	Margin (dB)	Limit (dBμV/m)	Height (cm)	Angle (deg)	Remark (QP/PK/AV)
1	2387.140	17.20	30.28	47.48	-6.52	54.00	240	150	Average
2	* 2390.000	18.01	30.29	48.30	-5.70	54.00	240	150	Average
3	2411.080	66.88	30.33	97.21	N/A	N/A	240	150	Average
4	2483.500	16.21	30.46	46.67	-7.33	54.00	240	150	Average
5	2496.580	17.25	30.48	47.73	-6.27	54.00	240	150	Average

Note:

- "\*", means this data is the worst emission level.
- C.F (Correction Factor) = Antenna Factor (dB/m)+ Cable Loss (dB).
- Measurement (dBμV/m) = Reading(dBμV) + C.F (Correction Factor).
- The emission levels of other frequencies are very lower than the limit and not show in test report.

EUT	HAN Access Point	Date of Test	2021-10-07
Factor	DRH18-E	Temp. / Humidity	23°C /49%
Polarity	Horizontal	Site / Test Engineer	AC2 / Jay
Test Mode	802.11n20_TX_CH 11	Test Voltage	AC 120V/60Hz

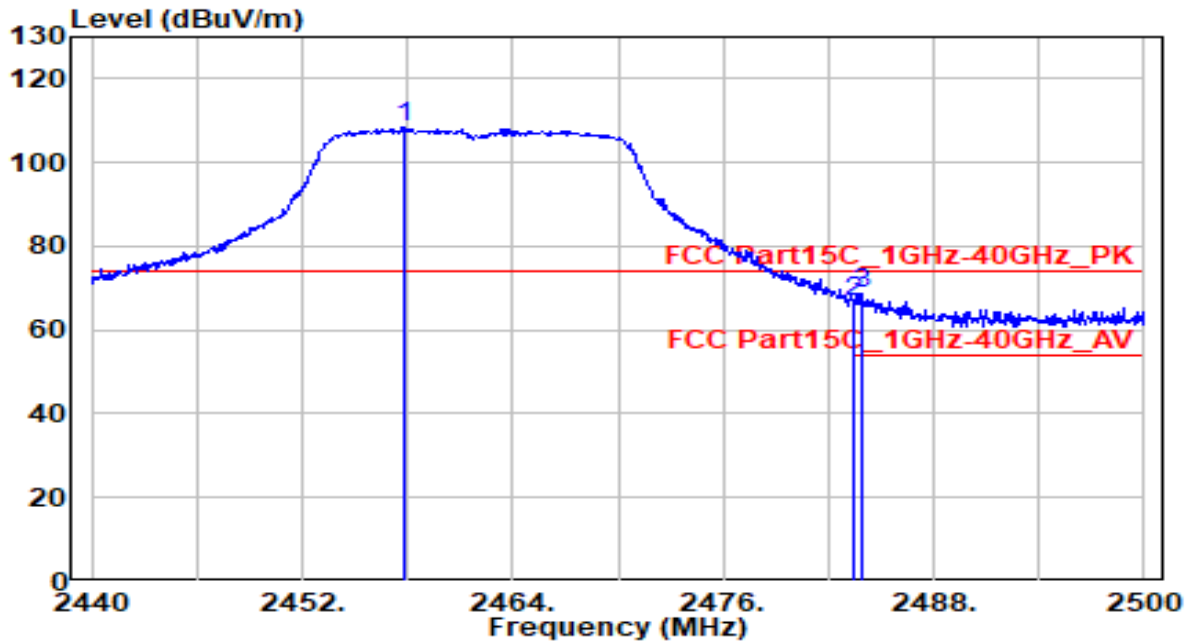

No	Frequency (MHz)	Reading (dBμV)	C.F (dB/m)	Measurement (dBμV/m)	Margin (dB)	Limit (dBμV/m)	Height (cm)	Angle (deg)	Remark (QP/PK/AV)
1	2457.760	78.00	30.41	108.41	N/A	N/A	150	220	Peak
2	2483.500	36.15	30.46	66.61	-7.39	74.00	150	220	Peak
3	* 2483.860	38.34	30.46	68.80	-5.20	74.00	150	220	Peak

Note:

1. " \*", means this data is the worst emission level.
2. C.F (Correction Factor) = Antenna Factor (dB/m)+ Cable Loss (dB).
3. Measurement (dBμV/m) = Reading(dBμV) + C.F (Correction Factor).
4. The emission levels of other frequencies are very lower than the limit and not show in test report.

EUT	HAN Access Point	Date of Test	2021-10-07
Factor	DRH18-E	Temp. / Humidity	23°C /49%
Polarity	Horizontal	Site / Test Engineer	AC2 / Jay
Test Mode	802.11n20_TX_CH 11	Test Voltage	AC 120V/60Hz

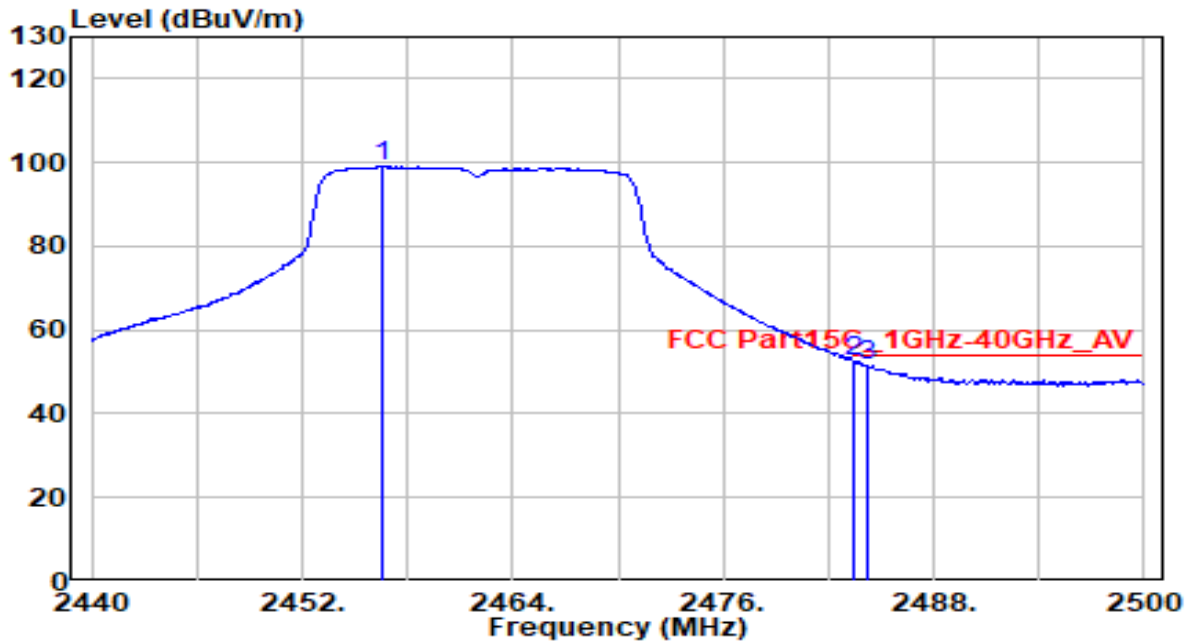

No	Frequency (MHz)	Reading (dB $\mu$ V)	C.F (dB/m)	Measurement (dB $\mu$ V/m)	Margin (dB)	Limit (dB $\mu$ V/m)	Height (cm)	Angle (deg)	Remark (QP/PK/AV)
1	2456.500	68.58	30.41	98.99	N/A	N/A	150	220	Average
2	* 2483.500	22.17	30.46	52.63	-1.37	54.00	150	220	Average
3	2484.160	21.27	30.46	51.74	-2.26	54.00	150	220	Average

Note:

1. " \*", means this data is the worst emission level.
2. C.F (Correction Factor) = Antenna Factor (dB/m)+ Cable Loss (dB).
3. Measurement (dB $\mu$ V/m) = Reading(dB $\mu$ V) + C.F (Correction Factor).
4. The emission levels of other frequencies are very lower than the limit and not show in test report.

EUT	HAN Access Point	Date of Test	2021-10-07
Factor	DRH18-E	Temp. / Humidity	23°C /49%
Polarity	Vertical	Site / Test Engineer	AC2 / Jay
Test Mode	802.11n20_TX_CH 11	Test Voltage	AC 120V/60Hz

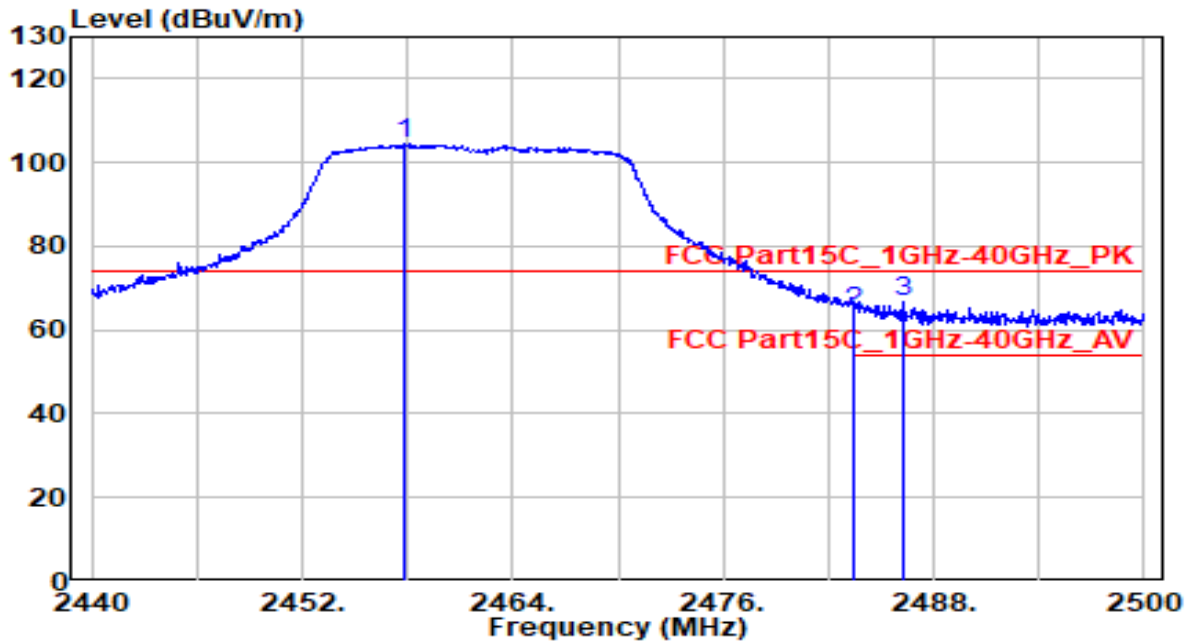

No	Frequency (MHz)	Reading (dBμV)	C.F (dB/m)	Measurement (dBμV/m)	Margin (dB)	Limit (dBμV/m)	Height (cm)	Angle (deg)	Remark (QP/PK/AV)
1	2457.880	73.96	30.41	104.37	N/A	N/A	230	150	Peak
2	2483.500	33.79	30.46	64.25	-9.75	74.00	230	150	Peak
3	* 2486.260	36.15	30.47	66.62	-7.38	74.00	230	150	Peak

Note:

1. " \*", means this data is the worst emission level.
2. C.F (Correction Factor) = Antenna Factor (dB/m)+ Cable Loss (dB).
3. Measurement (dBμV/m) = Reading(dBμV) + C.F (Correction Factor).
4. The emission levels of other frequencies are very lower than the limit and not show in test report.

EUT	HAN Access Point	Date of Test	2021-10-07
Factor	DRH18-E	Temp. / Humidity	23°C /49%
Polarity	Vertical	Site / Test Engineer	AC2 / Jay
Test Mode	802.11n20_TX_CH 11	Test Voltage	AC 120V/60Hz

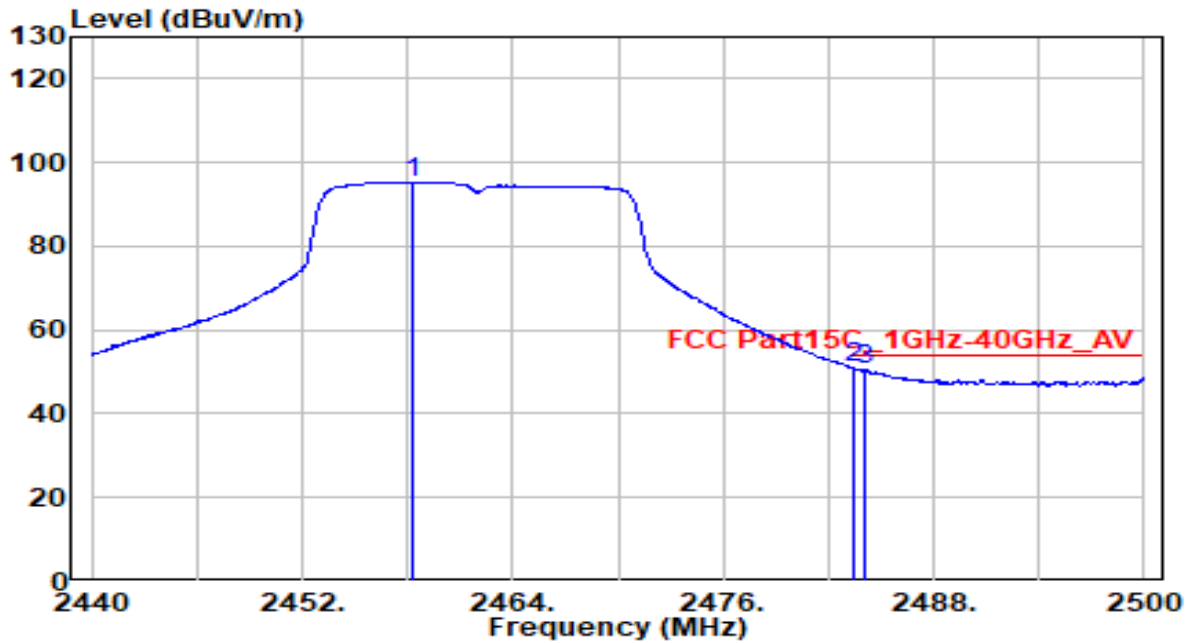

No	Frequency (MHz)	Reading (dBμV)	C.F (dB/m)	Measurement (dBμV/m)	Margin (dB)	Limit (dBμV/m)	Height (cm)	Angle (deg)	Remark (QP/PK/AV)
1	2458.240	64.98	30.41	95.39	N/A	N/A	230	150	Average
2	* 2483.500	20.36	30.46	50.82	-3.18	54.00	230	150	Average
3	2484.040	20.27	30.46	50.73	-3.27	54.00	230	150	Average

Note:

1. " \*", means this data is the worst emission level.
2. C.F (Correction Factor) = Antenna Factor (dB/m)+ Cable Loss (dB).
3. Measurement (dBμV/m) = Reading(dBμV) + C.F (Correction Factor).
4. The emission levels of other frequencies are very lower than the limit and not show in test report.

EUT	HAN Access Point	Date of Test	2021-10-07
Factor	DRH18-E	Temp. / Humidity	23°C /49%
Polarity	Horizontal	Site / Test Engineer	AC2 / Jay
Test Mode	802.11n40_TX_CH 3	Test Voltage	AC 120V/60Hz

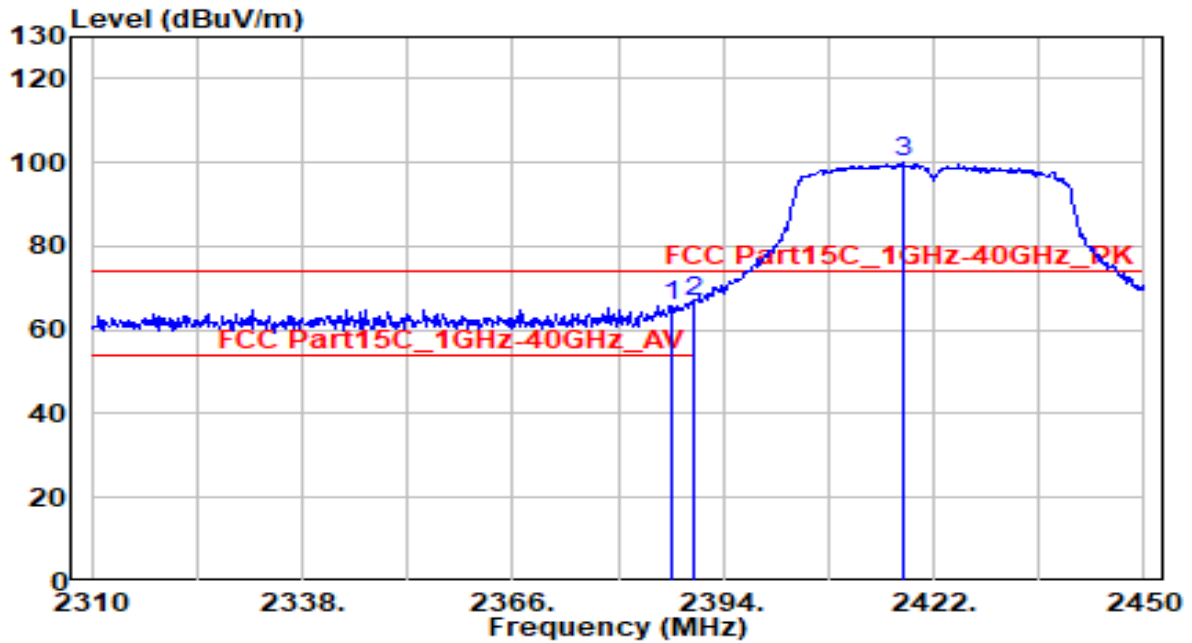

No	Frequency (MHz)	Reading (dB $\mu$ V)	C.F (dB/m)	Measurement (dB $\mu$ V/m)	Margin (dB)	Limit (dB $\mu$ V/m)	Height (cm)	Angle (deg)	Remark (QP/PK/AV)
1	2387.140	35.49	30.28	65.77	-8.23	74.00	150	220	Peak
2	* 2390.000	36.49	30.29	66.78	-7.22	74.00	150	220	Peak
3	2418.080	69.88	30.34	100.23	N/A	N/A	150	220	Peak

Note:

1. " \*", means this data is the worst emission level.
2. C.F (Correction Factor) = Antenna Factor (dB/m)+ Cable Loss (dB).
3. Measurement (dB $\mu$ V/m) = Reading(dB $\mu$ V) + C.F (Correction Factor).
4. The emission levels of other frequencies are very lower than the limit and not show in test report.

EUT	HAN Access Point	Date of Test	2021-10-07
Factor	DRH18-E	Temp. / Humidity	23°C /49%
Polarity	Horizontal	Site / Test Engineer	AC2 / Jay
Test Mode	802.11n40_TX_CH 3	Test Voltage	AC 120V/60Hz

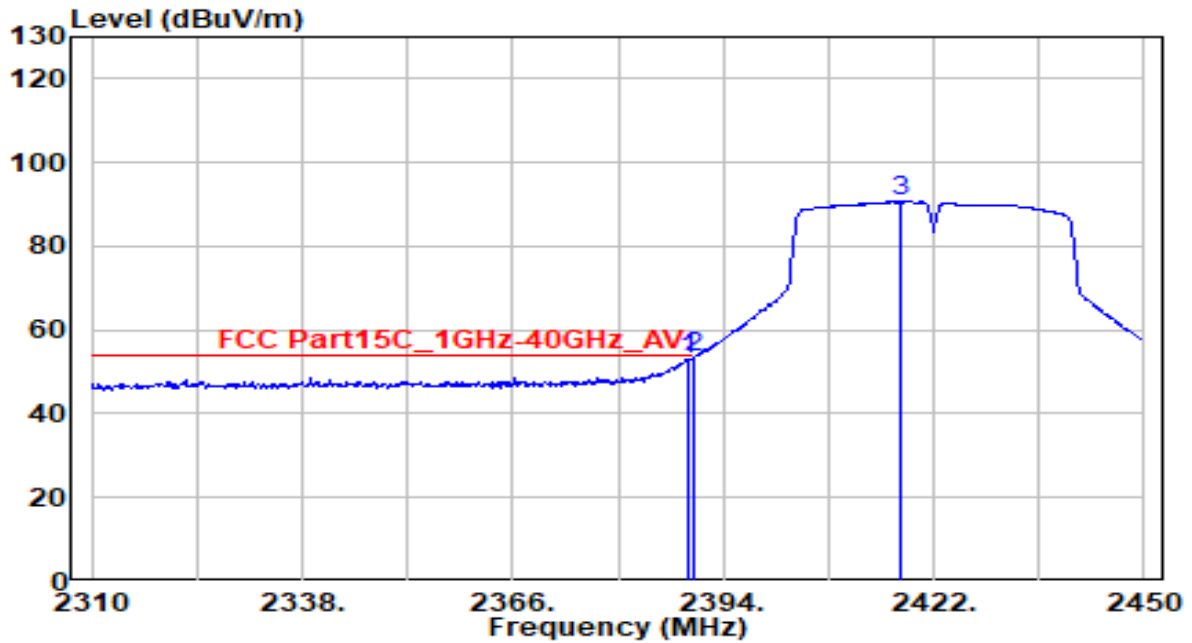

No	Frequency (MHz)	Reading (dBμV)	C.F (dB/m)	Measurement (dBμV/m)	Margin (dB)	Limit (dBμV/m)	Height (cm)	Angle (deg)	Remark (QP/PK/AV)
1	2389.240	22.74	30.29	53.03	-0.97	54.00	150	220	Average
2	* 2390.000	23.21	30.29	53.50	-0.50	54.00	150	220	Average
3	2417.660	60.33	30.34	90.67	N/A	N/A	150	220	Average

Note:

1. " \*", means this data is the worst emission level.
2. C.F (Correction Factor) = Antenna Factor (dB/m)+ Cable Loss (dB).
3. Measurement (dBμV/m) = Reading(dBμV) + C.F (Correction Factor).
4. The emission levels of other frequencies are very lower than the limit and not show in test report.

EUT	HAN Access Point	Date of Test	2021-10-07
Factor	DRH18-E	Temp. / Humidity	23°C /49%
Polarity	Vertical	Site / Test Engineer	AC2 / Jay
Test Mode	802.11n40_TX_CH 3	Test Voltage	AC 120V/60Hz

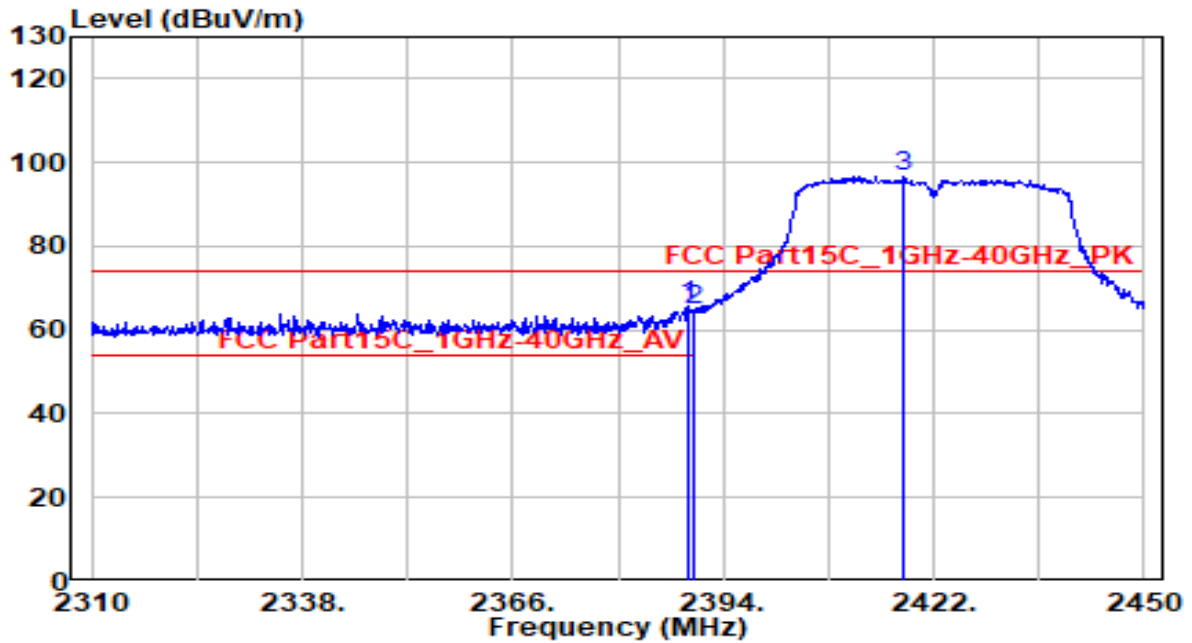

No	Frequency (MHz)	Reading (dBμV)	C.F (dB/m)	Measurement (dBμV/m)	Margin (dB)	Limit (dBμV/m)	Height (cm)	Angle (deg)	Remark (QP/PK/AV)	
1	*	2389.240	35.25	30.29	65.54	-8.46	74.00	245	155	Peak
2		2390.000	34.69	30.29	64.97	-9.03	74.00	245	155	Peak
3		2418.080	66.40	30.34	96.75	N/A	N/A	245	155	Peak

Note:

1. " \*", means this data is the worst emission level.
2. C.F (Correction Factor) = Antenna Factor (dB/m)+ Cable Loss (dB).
3. Measurement (dBμV/m) = Reading(dBμV) + C.F (Correction Factor).
4. The emission levels of other frequencies are very lower than the limit and not show in test report.



EUT	HAN Access Point	Date of Test	2021-10-07
Factor	DRH18-E	Temp. / Humidity	23°C /49%
Polarity	Vertical	Site / Test Engineer	AC2 / Jay
Test Mode	802.11n40_TX_CH 3	Test Voltage	AC 120V/60Hz

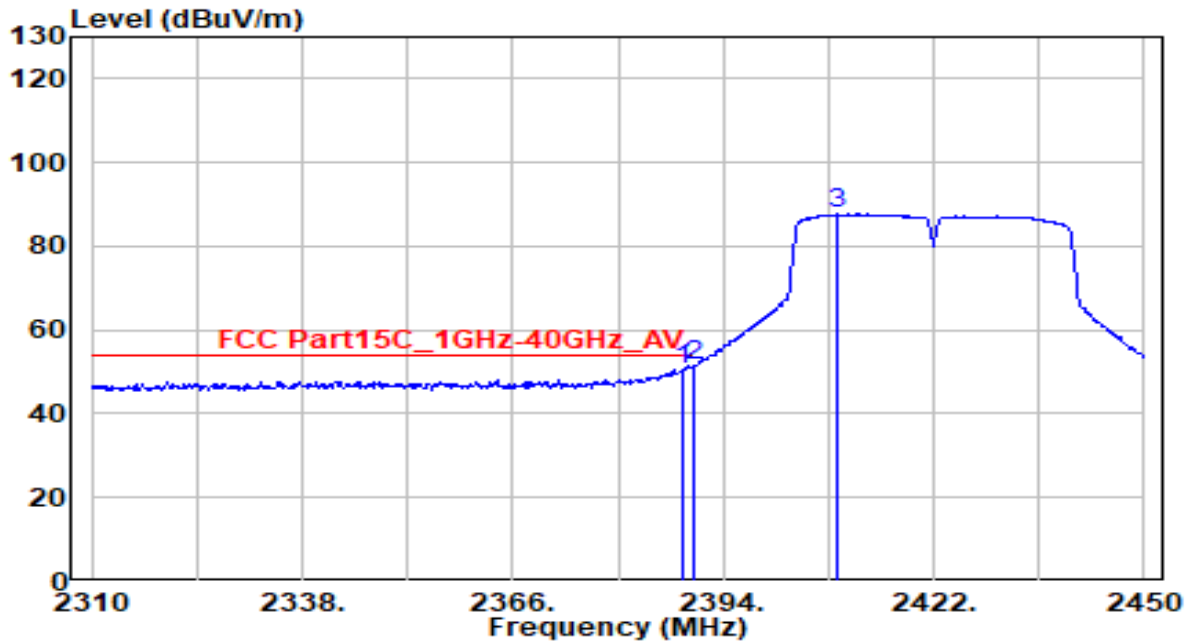

No	Frequency (MHz)	Reading (dBμV)	C.F (dB/m)	Measurement (dBμV/m)	Margin (dB)	Limit (dBμV/m)	Height (cm)	Angle (deg)	Remark (QP/PK/AV)
1	2388.540	20.14	30.28	50.43	-3.57	54.00	245	155	Average
2	* 2390.000	21.24	30.29	51.53	-2.47	54.00	245	155	Average
3	2409.260	57.37	30.33	87.70	N/A	N/A	245	155	Average

Note:

1. " \*", means this data is the worst emission level.
2. C.F (Correction Factor) = Antenna Factor (dB/m)+ Cable Loss (dB).
3. Measurement (dBμV/m) = Reading(dBμV) + C.F (Correction Factor).
4. The emission levels of other frequencies are very lower than the limit and not show in test report.

EUT	HAN Access Point	Date of Test	2021-10-07
Factor	DRH18-E	Temp. / Humidity	23°C /49%
Polarity	Horizontal	Site / Test Engineer	AC2 / Jay
Test Mode	802.11n40_TX_CH 4	Test Voltage	AC 120V/60Hz

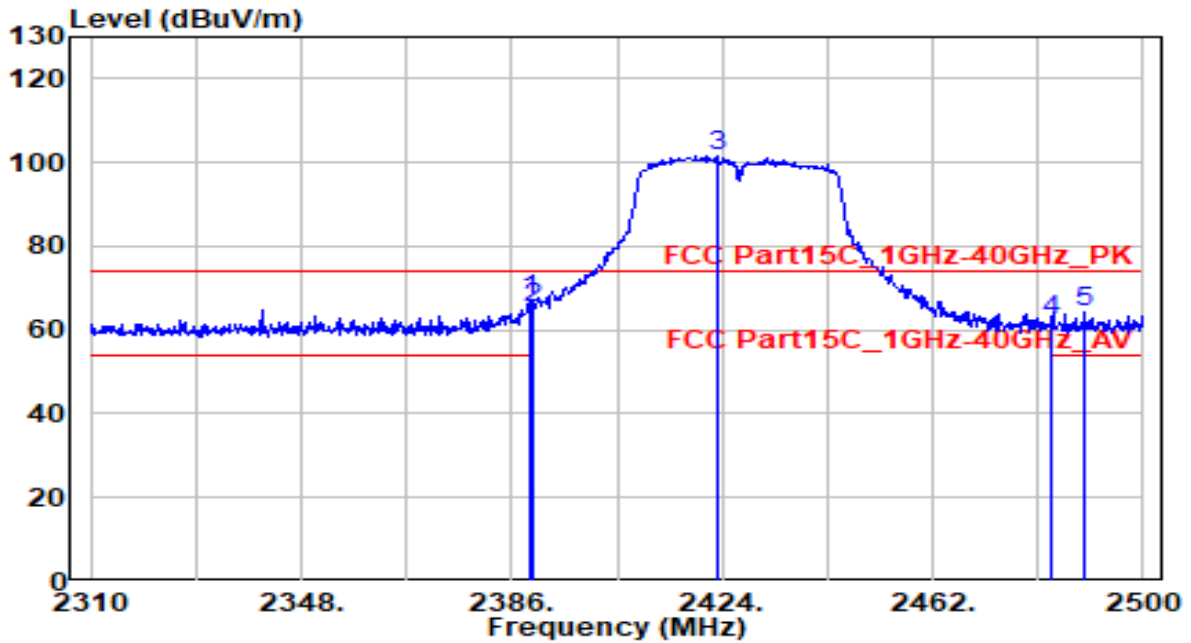

No	Frequency (MHz)	Reading (dB $\mu$ V)	C.F (dB/m)	Measurement (dB $\mu$ V/m)	Margin (dB)	Limit (dB $\mu$ V/m)	Height (cm)	Angle (deg)	Remark (QP/PK/AV)	
1	*	2389.230	37.09	30.29	67.37	-6.63	74.00	150	220	Peak
2		2390.000	34.86	30.29	65.15	-8.85	74.00	150	220	Peak
3		2423.050	71.36	30.35	101.71	N/A	N/A	150	220	Peak
4		2483.500	31.86	30.46	62.32	-11.68	74.00	150	220	Peak
5		2489.550	33.74	30.47	64.21	-9.79	74.00	150	220	Peak

Note:

- "\*", means this data is the worst emission level.
- C.F (Correction Factor) = Antenna Factor (dB/m)+ Cable Loss (dB).
- Measurement (dB $\mu$ V/m) = Reading(dB $\mu$ V) + C.F (Correction Factor).
- The emission levels of other frequencies are very lower than the limit and not show in test report.

EUT	HAN Access Point	Date of Test	2021-10-07
Factor	DRH18-E	Temp. / Humidity	23°C /49%
Polarity	Horizontal	Site / Test Engineer	AC2 / Jay
Test Mode	802.11n40_TX_CH 4	Test Voltage	AC 120V/60Hz

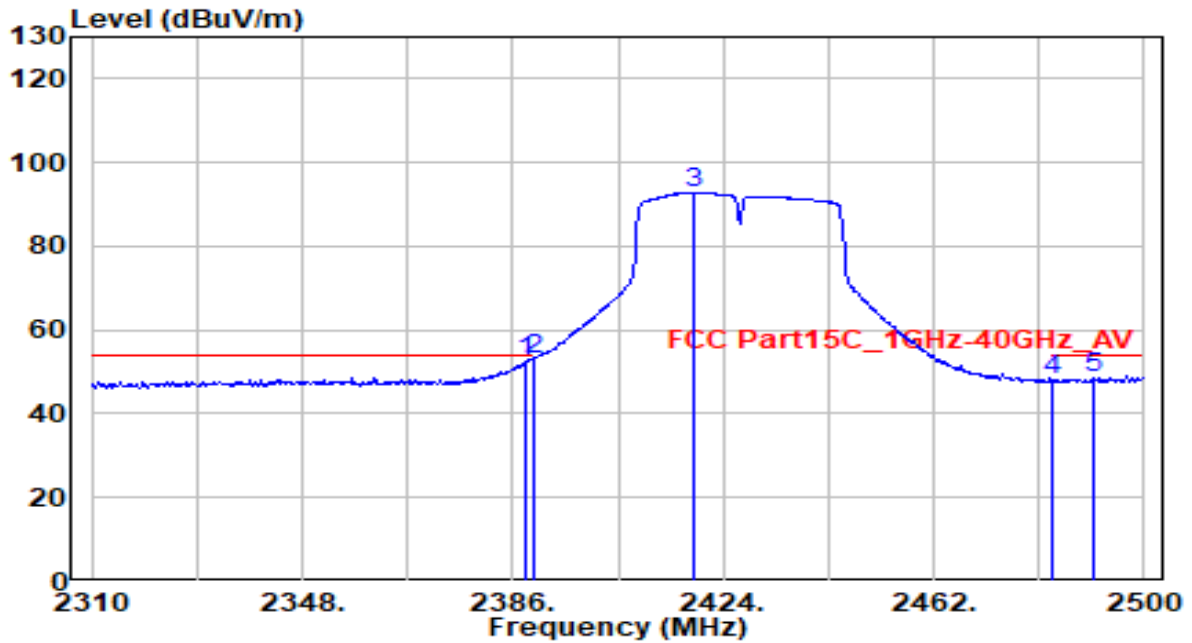

No	Frequency (MHz)	Reading (dBμV)	C.F (dB/m)	Measurement (dBμV/m)	Margin (dB)	Limit (dBμV/m)	Height (cm)	Angle (deg)	Remark (QP/PK/AV)
1	2388.280	22.25	30.28	52.53	-1.47	54.00	150	220	Average
2	* 2390.000	22.83	30.29	53.12	-0.88	54.00	150	220	Average
3	2418.870	62.54	30.34	92.88	N/A	N/A	150	220	Average
4	2483.500	17.60	30.46	48.06	-5.94	54.00	150	220	Average
5	2490.880	18.01	30.47	48.48	-5.52	54.00	150	220	Average

Note:

- "\*", means this data is the worst emission level.
- C.F (Correction Factor) = Antenna Factor (dB/m)+ Cable Loss (dB).
- Measurement (dBμV/m) = Reading(dBμV) + C.F (Correction Factor).
- The emission levels of other frequencies are very lower than the limit and not show in test report.

EUT	HAN Access Point	Date of Test	2021-10-07
Factor	DRH18-E	Temp. / Humidity	23°C /49%
Polarity	Vertical	Site / Test Engineer	AC2 / Jay
Test Mode	802.11n40_TX_CH 4	Test Voltage	AC 120V/60Hz

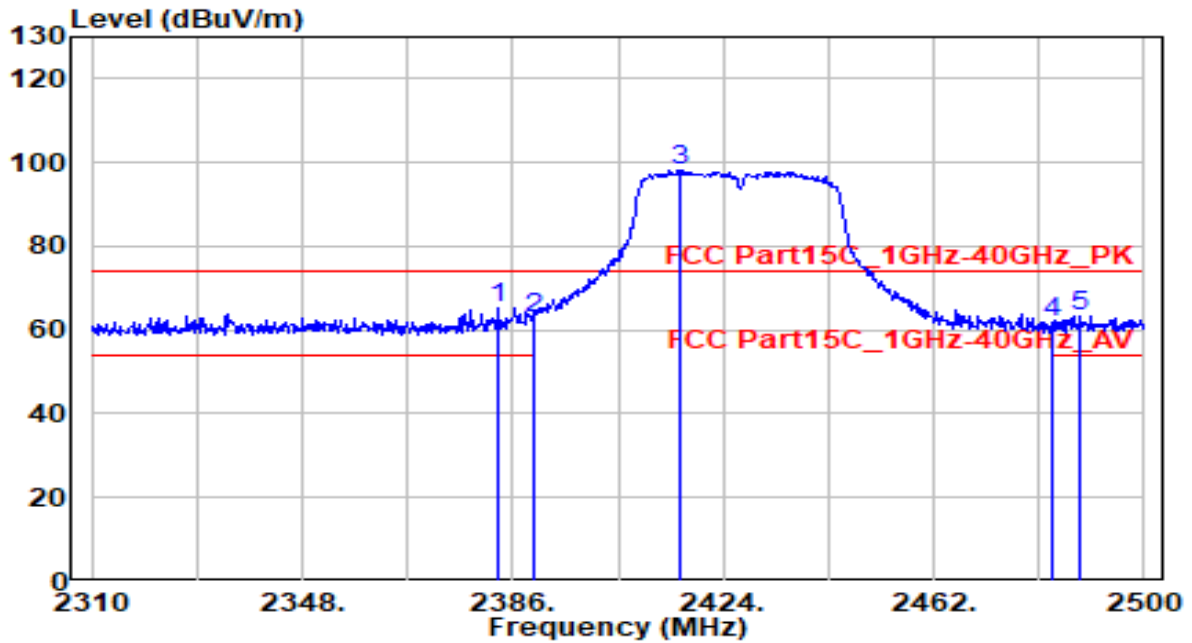

No	Frequency (MHz)	Reading (dBμV)	C.F (dB/m)	Measurement (dBμV/m)	Margin (dB)	Limit (dBμV/m)	Height (cm)	Angle (deg)	Remark (QP/PK/AV)
1	* 2383.530	34.90	30.27	65.17	-8.83	74.00	240	150	Peak
2	2390.000	32.43	30.29	62.72	-11.28	74.00	240	150	Peak
3	2416.400	67.70	30.34	98.04	N/A	N/A	240	150	Peak
4	2483.500	31.29	30.46	61.75	-12.25	74.00	240	150	Peak
5	2488.410	33.05	30.47	63.52	-10.48	74.00	240	150	Peak

Note:

- "\*", means this data is the worst emission level.
- C.F (Correction Factor) = Antenna Factor (dB/m)+ Cable Loss (dB).
- Measurement (dBμV/m) = Reading(dBμV) + C.F (Correction Factor).
- The emission levels of other frequencies are very lower than the limit and not show in test report.

EUT	HAN Access Point	Date of Test	2021-10-07
Factor	DRH18-E	Temp. / Humidity	23°C /49%
Polarity	Vertical	Site / Test Engineer	AC2 / Jay
Test Mode	802.11n40_TX_CH 4	Test Voltage	AC 120V/60Hz

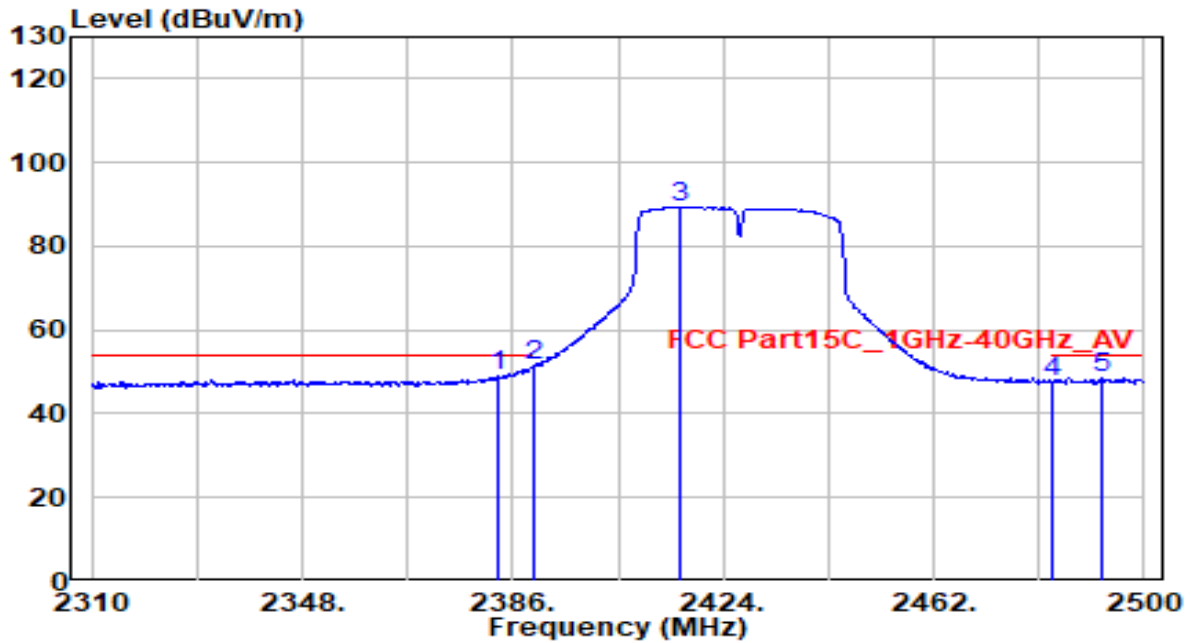

No	Frequency (MHz)	Reading (dBμV)	C.F (dB/m)	Measurement (dBμV/m)	Margin (dB)	Limit (dBμV/m)	Height (cm)	Angle (deg)	Remark (QP/PK/AV)
1	2383.150	18.59	30.27	48.86	-5.14	54.00	240	150	Average
2	* 2390.000	21.24	30.29	51.53	-2.47	54.00	240	150	Average
3	2416.210	58.96	30.34	89.30	N/A	N/A	240	150	Average
4	2483.500	17.26	30.46	47.72	-6.28	54.00	240	150	Average
5	2492.210	18.31	30.48	48.79	-5.21	54.00	240	150	Average

Note:

1. " \*", means this data is the worst emission level.
2. C.F (Correction Factor) = Antenna Factor (dB/m)+ Cable Loss (dB).
3. Measurement (dBμV/m) = Reading(dBμV) + C.F (Correction Factor).
4. The emission levels of other frequencies are very lower than the limit and not show in test report.

EUT	HAN Access Point	Date of Test	2021-10-07
Factor	DRH18-E	Temp. / Humidity	23°C /49%
Polarity	Horizontal	Site / Test Engineer	AC2 / Jay
Test Mode	802.11n40_TX_CH 5	Test Voltage	AC 120V/60Hz

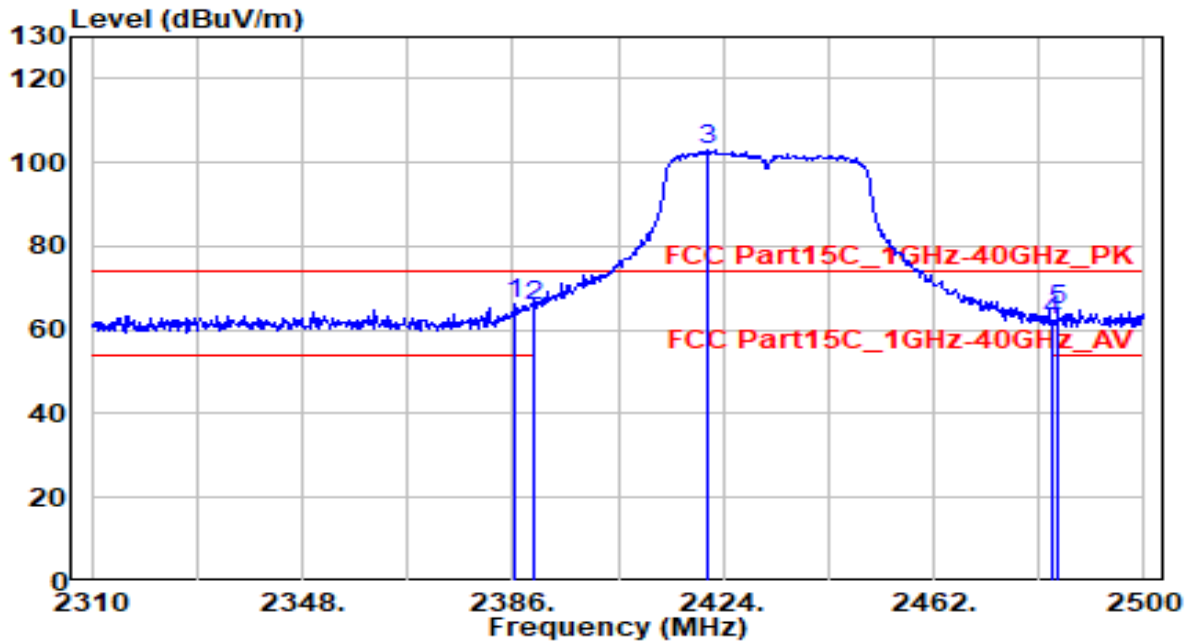

No	Frequency (MHz)	Reading (dBμV)	C.F (dB/m)	Measurement (dBμV/m)	Margin (dB)	Limit (dBμV/m)	Height (cm)	Angle (deg)	Remark (QP/PK/AV)	
1	*	2386.380	35.85	30.28	66.13	-7.87	74.00	150	220	Peak
2		2390.000	35.57	30.29	65.86	-8.14	74.00	150	220	Peak
3		2421.150	72.74	30.35	103.08	N/A	N/A	150	220	Peak
4		2483.500	31.92	30.46	62.38	-11.62	74.00	150	220	Peak
5		2484.420	34.14	30.46	64.60	-9.40	74.00	150	220	Peak

Note:

- "\*", means this data is the worst emission level.
- C.F (Correction Factor) = Antenna Factor (dB/m)+ Cable Loss (dB).
- Measurement (dBμV/m) = Reading(dBμV) + C.F (Correction Factor).
- The emission levels of other frequencies are very lower than the limit and not show in test report.

EUT	HAN Access Point	Date of Test	2021-10-07
Factor	DRH18-E	Temp. / Humidity	23°C /49%
Polarity	Horizontal	Site / Test Engineer	AC2 / Jay
Test Mode	802.11n40_TX_CH 5	Test Voltage	AC 120V/60Hz

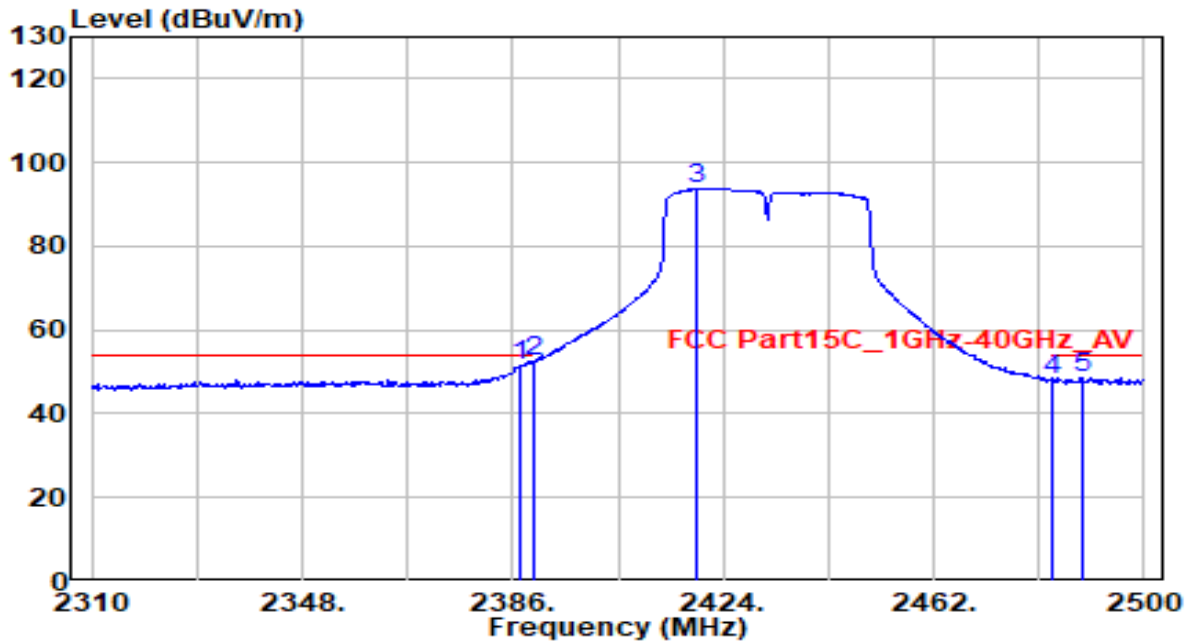

No	Frequency (MHz)	Reading (dBμV)	C.F (dB/m)	Measurement (dBμV/m)	Margin (dB)	Limit (dBμV/m)	Height (cm)	Angle (deg)	Remark (QP/PK/AV)
1	2387.520	21.31	30.28	51.59	-2.41	54.00	150	220	Average
2	* 2390.000	22.22	30.29	52.51	-1.49	54.00	150	220	Average
3	2419.060	63.60	30.34	93.94	N/A	N/A	150	220	Average
4	2483.500	17.56	30.46	48.02	-5.98	54.00	150	220	Average
5	2488.790	18.09	30.47	48.56	-5.44	54.00	150	220	Average

Note:

- "\*", means this data is the worst emission level.
- C.F (Correction Factor) = Antenna Factor (dB/m)+ Cable Loss (dB).
- Measurement (dBμV/m) = Reading(dBμV) + C.F (Correction Factor)
- The emission levels of other frequencies are very lower than the limit and not show in test report.

EUT	HAN Access Point	Date of Test	2021-10-07
Factor	DRH18-E	Temp. / Humidity	23°C /49%
Polarity	Vertical	Site / Test Engineer	AC2 / Jay
Test Mode	802.11n40_TX_CH 5	Test Voltage	AC 120V/60Hz

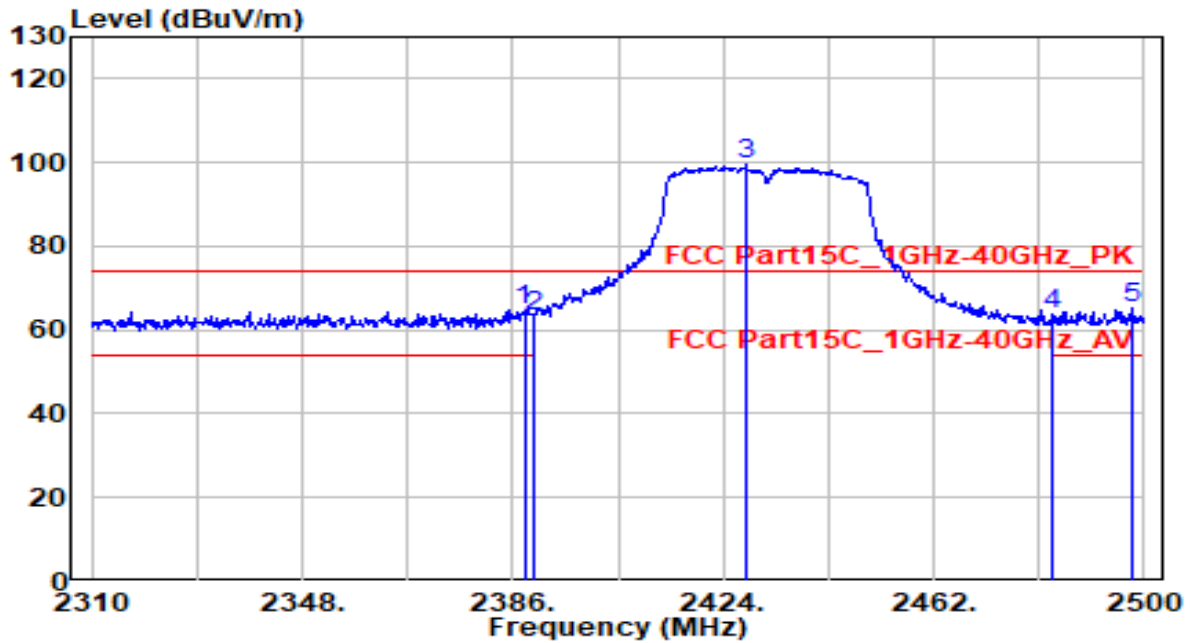

No	Frequency (MHz)	Reading (dB $\mu$ V)	C.F (dB/m)	Measurement (dB $\mu$ V/m)	Margin (dB)	Limit (dB $\mu$ V/m)	Height (cm)	Angle (deg)	Remark (QP/PK/AV)
1	2388.090	34.44	30.28	64.72	-9.28	74.00	240	150	Peak
2	2390.000	33.06	30.29	63.35	-10.65	74.00	240	150	Peak
3	2428.180	69.04	30.36	99.40	N/A	N/A	240	150	Peak
4	2483.500	33.31	30.46	63.77	-10.23	74.00	240	150	Peak
5	* 2497.720	34.57	30.49	65.06	-8.94	74.00	240	150	Peak

Note:

1. " \*", means this data is the worst emission level.
2. C.F (Correction Factor) = Antenna Factor (dB/m)+ Cable Loss (dB).
3. Measurement (dB $\mu$ V/m) = Reading(dB $\mu$ V) + C.F (Correction Factor).
4. The emission levels of other frequencies are very lower than the limit and not show in test report.



EUT	HAN Access Point	Date of Test	2021-10-07
Factor	DRH18-E	Temp. / Humidity	23°C /49%
Polarity	Vertical	Site / Test Engineer	AC2 / Jay
Test Mode	802.11n40_TX_CH 5	Test Voltage	AC 120V/60Hz

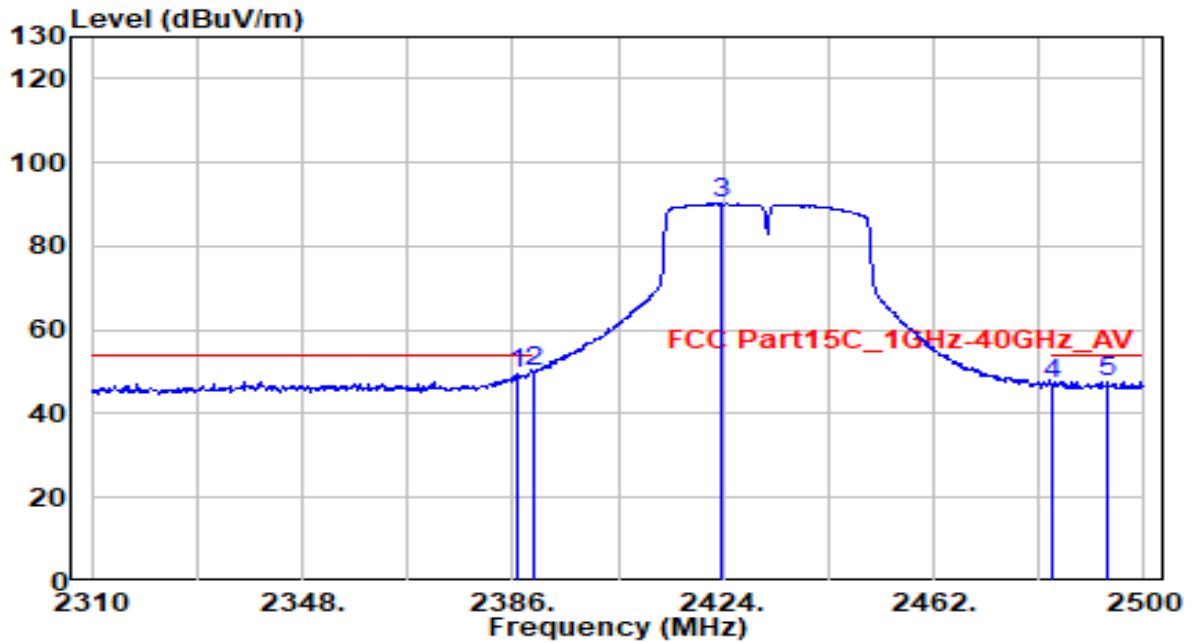

No	Frequency (MHz)	Reading (dBμV)	C.F (dB/m)	Measurement (dBμV/m)	Margin (dB)	Limit (dBμV/m)	Height (cm)	Angle (deg)	Remark (QP/PK/AV)
1	2386.950	19.28	30.28	49.56	-4.44	54.00	240	150	Average
2	* 2390.000	19.73	30.29	50.02	-3.98	54.00	240	150	Average
3	2423.810	59.84	30.35	90.19	N/A	N/A	240	150	Average
4	2483.500	16.76	30.46	47.22	-6.78	54.00	240	150	Average
5	2493.540	17.07	30.48	47.55	-6.45	54.00	240	150	Average

Note:

- "\*", means this data is the worst emission level.
- C.F (Correction Factor) = Antenna Factor (dB/m)+ Cable Loss (dB).
- Measurement (dBμV/m) = Reading(dBμV) + C.F (Correction Factor).
- The emission levels of other frequencies are very lower than the limit and not show in test report.

EUT	HAN Access Point	Date of Test	2021-10-07
Factor	DRH18-E	Temp. / Humidity	23°C /49%
Polarity	Horizontal	Site / Test Engineer	AC2 / Jay
Test Mode	802.11n40_TX_CH 6	Test Voltage	AC 120V/60Hz

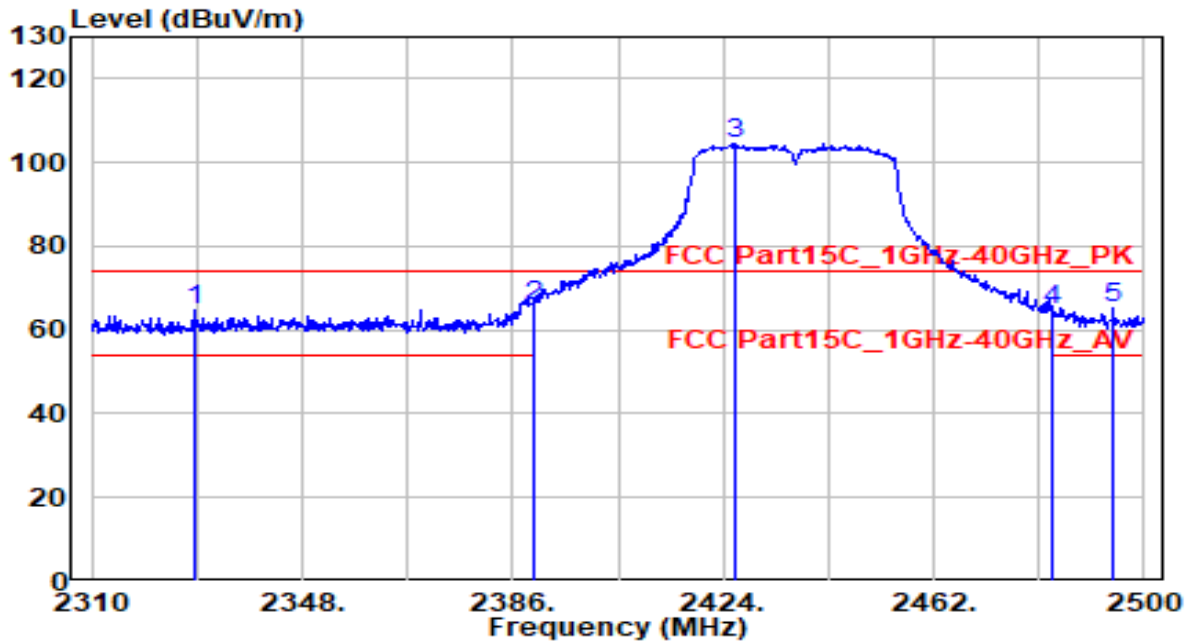

No	Frequency (MHz)	Reading (dBμV)	C.F (dB/m)	Measurement (dBμV/m)	Margin (dB)	Limit (dBμV/m)	Height (cm)	Angle (deg)	Remark (QP/PK/AV)
1	2328.430	34.52	30.15	64.67	-9.33	74.00	150	220	Peak
2	* 2390.000	35.42	30.29	65.71	-8.29	74.00	150	220	Peak
3	2426.280	74.26	30.36	104.61	N/A	N/A	150	220	Peak
4	2483.500	34.53	30.46	64.99	-9.01	74.00	150	220	Peak
5	2494.300	34.77	30.48	65.25	-8.75	74.00	150	220	Peak

Note:

- " \*", means this data is the worst emission level.
- C.F (Correction Factor) = Antenna Factor (dB/m)+ Cable Loss (dB).
- Measurement (dBμV/m) = Reading(dBμV) + C.F (Correction Factor).
- The emission levels of other frequencies are very lower than the limit and not show in test report.

EUT	HAN Access Point	Date of Test	2021-10-07
Factor	DRH18-E	Temp. / Humidity	23°C /49%
Polarity	Horizontal	Site / Test Engineer	AC2 / Jay
Test Mode	802.11n40_TX_CH 6	Test Voltage	AC 120V/60Hz

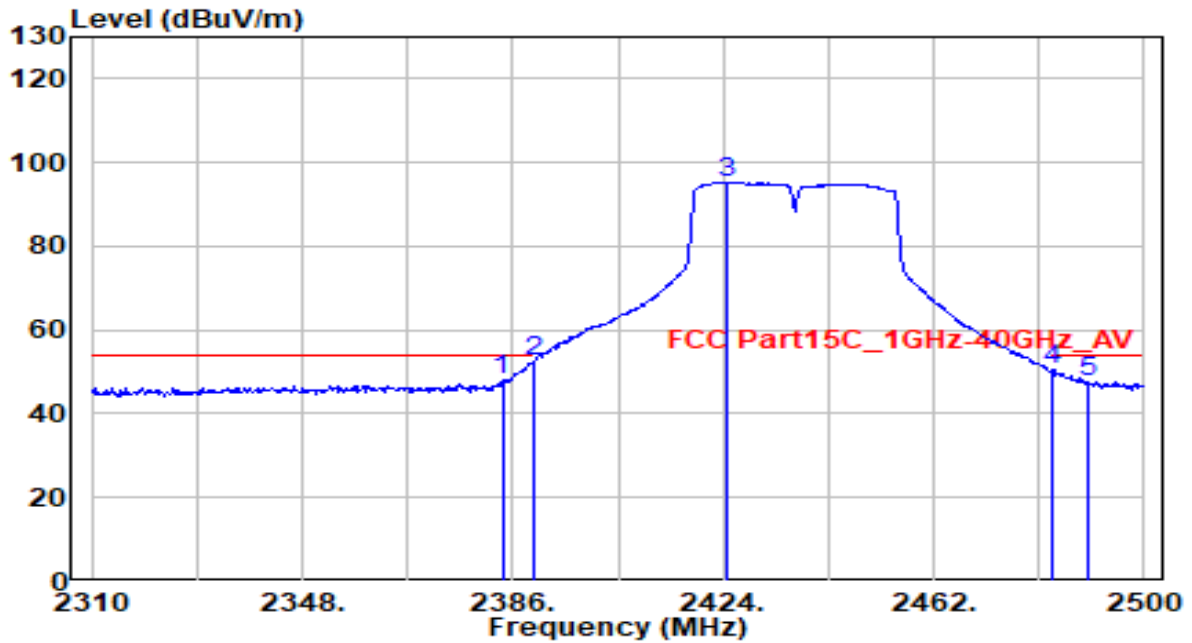

No	Frequency (MHz)	Reading (dB $\mu$ V)	C.F (dB/m)	Measurement (dB $\mu$ V/m)	Margin (dB)	Limit (dB $\mu$ V/m)	Height (cm)	Angle (deg)	Remark (QP/PK/AV)
1	2384.100	17.57	30.27	47.85	-6.15	54.00	150	220	Average
2	* 2390.000	22.25	30.29	52.54	-1.46	54.00	150	220	Average
3	2424.760	64.88	30.35	95.23	N/A	N/A	150	220	Average
4	2483.500	19.97	30.46	50.43	-3.57	54.00	150	220	Average
5	2489.930	17.17	30.47	47.64	-6.36	54.00	150	220	Average

Note:

- "\*", means this data is the worst emission level.
- C.F (Correction Factor) = Antenna Factor (dB/m)+ Cable Loss (dB).
- Measurement (dB $\mu$ V/m) = Reading(dB $\mu$ V) + C.F (Correction Factor).
- The emission levels of other frequencies are very lower than the limit and not show in test report.

EUT	HAN Access Point	Date of Test	2021-10-07
Factor	DRH18-E	Temp. / Humidity	23°C /49%
Polarity	Vertical	Site / Test Engineer	AC2 / Jay
Test Mode	802.11n40_TX_CH 6	Test Voltage	AC 120V/60Hz

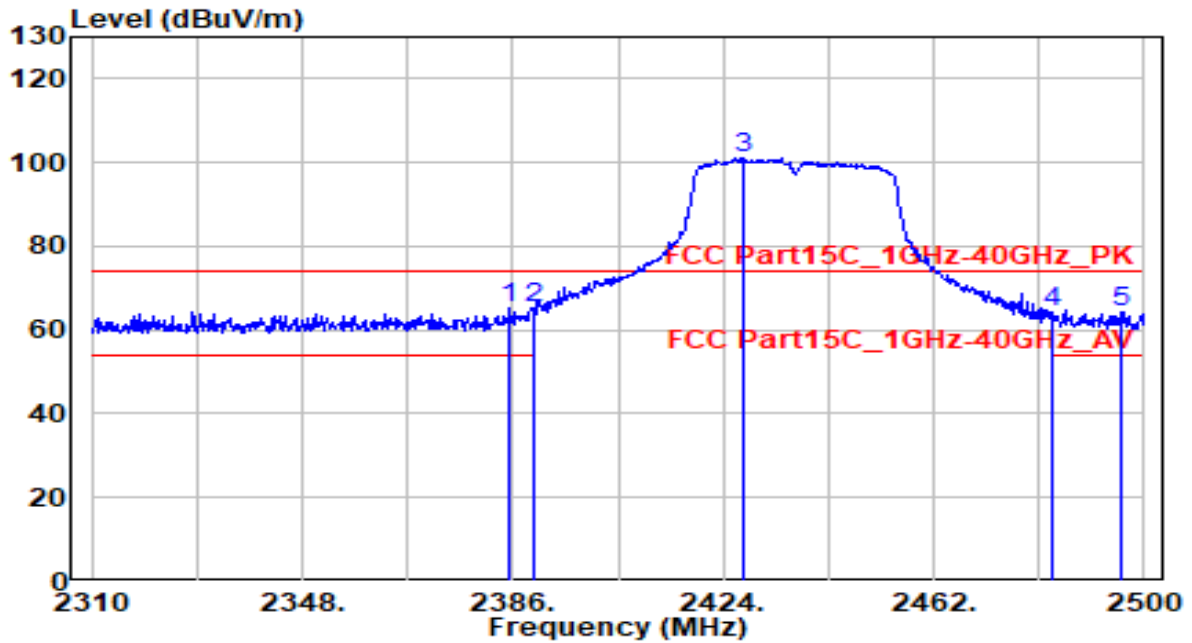

No	Frequency (MHz)	Reading (dBμV)	C.F (dB/m)	Measurement (dBμV/m)	Margin (dB)	Limit (dBμV/m)	Height (cm)	Angle (deg)	Remark (QP/PK/AV)
1	* 2385.430	35.17	30.28	65.45	-8.55	74.00	240	150	Peak
2	2390.000	34.82	30.29	65.11	-8.89	74.00	240	150	Peak
3	2427.610	70.90	30.36	101.26	N/A	N/A	240	150	Peak
4	2483.500	33.75	30.46	64.21	-9.79	74.00	240	150	Peak
5	2496.010	33.82	30.48	64.30	-9.70	74.00	240	150	Peak

Note:

1. " \*", means this data is the worst emission level.
2. C.F (Correction Factor) = Antenna Factor (dB/m)+ Cable Loss (dB).
3. Measurement (dBμV/m) = Reading(dBμV) + C.F (Correction Factor).
4. The emission levels of other frequencies are very lower than the limit and not show in test report.

EUT	HAN Access Point	Date of Test	2021-10-07
Factor	DRH18-E	Temp. / Humidity	23°C /49%
Polarity	Vertical	Site / Test Engineer	AC2 / Jay
Test Mode	802.11n40_TX_CH 6	Test Voltage	AC 120V/60Hz

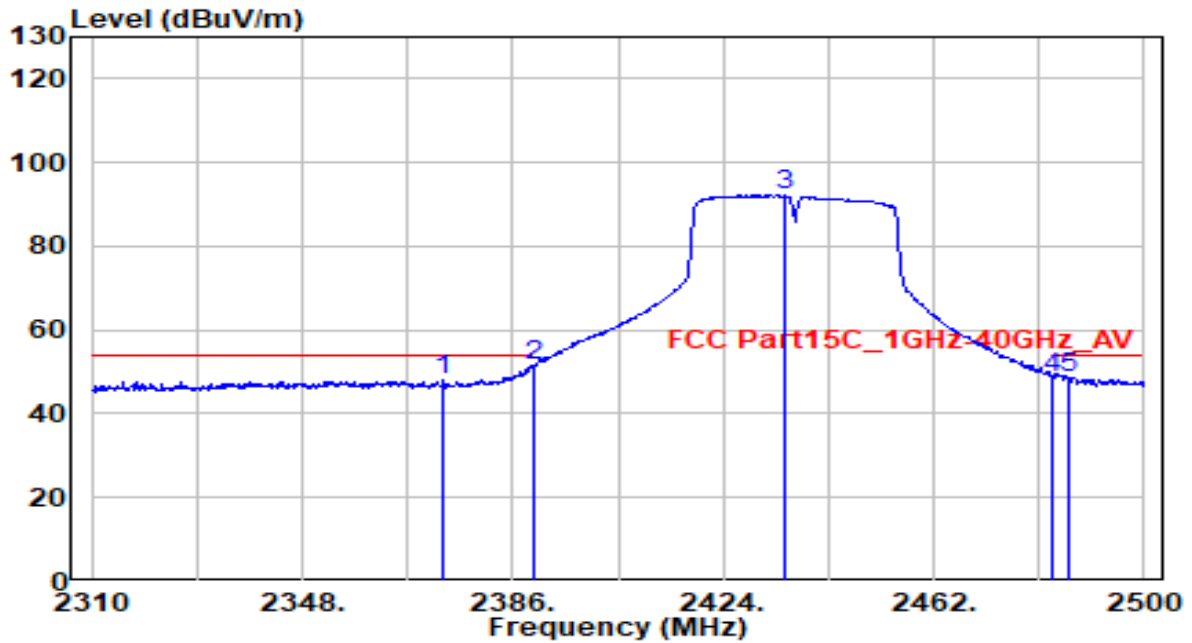

No	Frequency (MHz)	Reading (dBμV)	C.F (dB/m)	Measurement (dBμV/m)	Margin (dB)	Limit (dBμV/m)	Height (cm)	Angle (deg)	Remark (QP/PK/AV)
1	2373.460	17.74	30.25	47.99	-6.01	54.00	240	150	Average
2	* 2390.000	21.38	30.29	51.67	-2.33	54.00	240	150	Average
3	2435.020	61.76	30.37	92.13	N/A	N/A	240	150	Average
4	2483.500	18.28	30.46	48.74	-5.26	54.00	240	150	Average
5	2486.320	18.05	30.47	48.51	-5.49	54.00	240	150	Average

Note:

- " \*", means this data is the worst emission level.
- C.F (Correction Factor) = Antenna Factor (dB/m)+ Cable Loss (dB).
- Measurement (dBμV/m) = Reading(dBμV) + C.F (Correction Factor).
- The emission levels of other frequencies are very lower than the limit and not show in test report.

EUT	HAN Access Point	Date of Test	2021-10-07
Factor	DRH18-E	Temp. / Humidity	23°C /49%
Polarity	Horizontal	Site / Test Engineer	AC2 / Jay
Test Mode	802.11n40_TX_CH 8	Test Voltage	AC 120V/60Hz

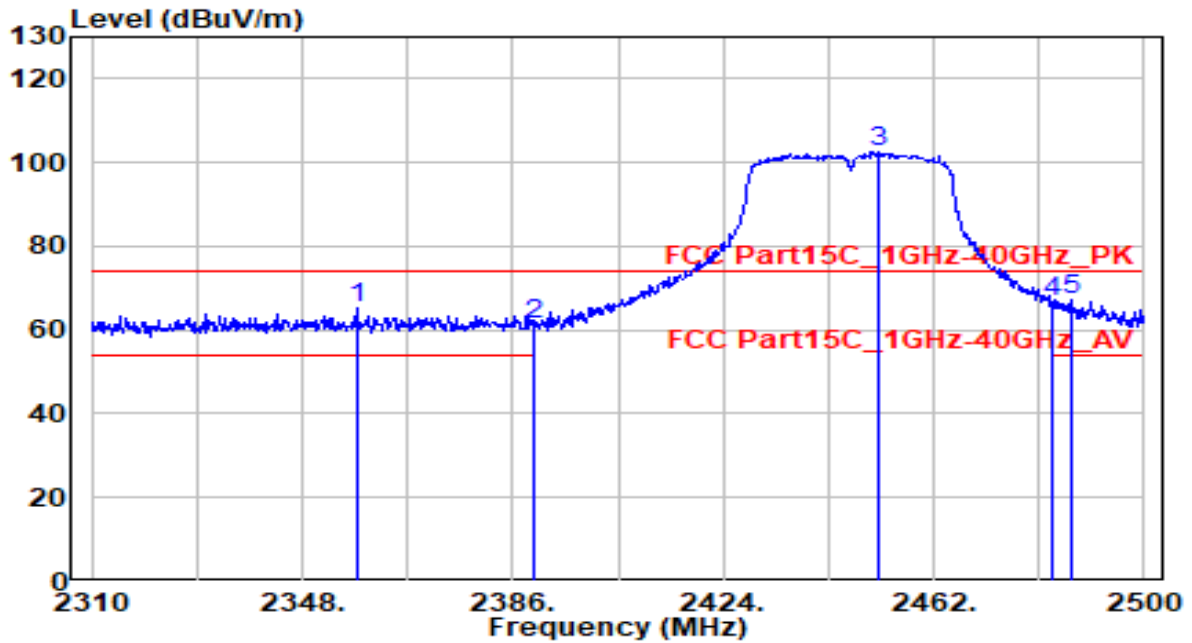

No	Frequency (MHz)	Reading (dBμV)	C.F (dB/m)	Measurement (dBμV/m)	Margin (dB)	Limit (dBμV/m)	Height (cm)	Angle (deg)	Remark (QP/PK/AV)
1	2357.880	34.86	30.21	65.07	-8.93	74.00	150	230	Peak
2	2390.000	31.04	30.29	61.32	-12.68	74.00	150	230	Peak
3	2452.120	72.23	30.40	102.64	N/A	N/A	150	230	Peak
4	2483.500	36.23	30.46	66.69	-7.31	74.00	150	230	Peak
5	* 2486.700	36.92	30.47	67.39	-6.61	74.00	150	230	Peak

Note:

- "\*", means this data is the worst emission level.
- C.F (Correction Factor) = Antenna Factor (dB/m)+ Cable Loss (dB).
- Measurement (dBμV/m) = Reading(dBμV) + C.F (Correction Factor).
- The emission levels of other frequencies are very lower than the limit and not show in test report.

EUT	HAN Access Point	Date of Test	2021-10-07
Factor	DRH18-E	Temp. / Humidity	23°C /49%
Polarity	Horizontal	Site / Test Engineer	AC2 / Jay
Test Mode	802.11n40_TX_CH 8	Test Voltage	AC 120V/60Hz

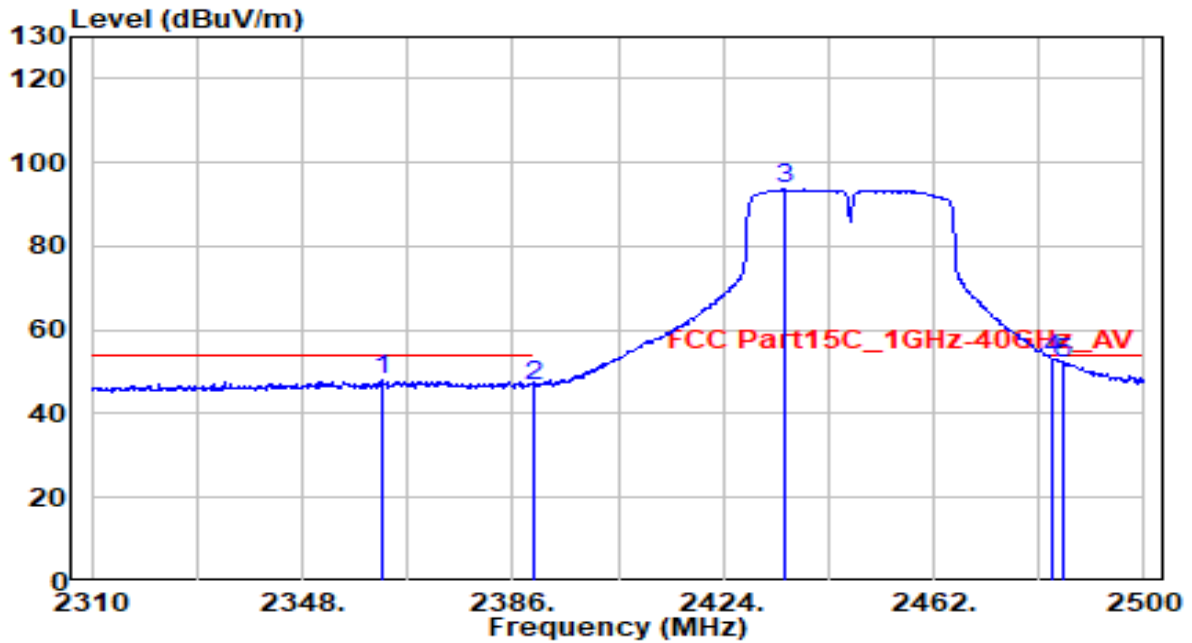

No	Frequency (MHz)	Reading (dBμV)	C.F (dB/m)	Measurement (dBμV/m)	Margin (dB)	Limit (dBμV/m)	Height (cm)	Angle (deg)	Remark (QP/PK/AV)
1	2362.250	17.77	30.22	48.00	-6.00	54.00	150	230	Average
2	2390.000	16.47	30.29	46.75	-7.25	54.00	150	230	Average
3	2435.020	63.24	30.37	93.61	N/A	N/A	150	230	Average
4	* 2483.500	22.76	30.46	53.22	-0.78	54.00	150	230	Average
5	2485.560	21.74	30.46	52.21	-1.79	54.00	150	230	Average

Note:

- " \*", means this data is the worst emission level.
- C.F (Correction Factor) = Antenna Factor (dB/m)+ Cable Loss (dB).
- Measurement (dBμV/m) = Reading(dBμV) + C.F (Correction Factor).
- The emission levels of other frequencies are very lower than the limit and not show in test report.

EUT	HAN Access Point	Date of Test	2021-10-07
Factor	DRH18-E	Temp. / Humidity	23°C /49%
Polarity	Vertical	Site / Test Engineer	AC2 / Jay
Test Mode	802.11n40_TX_CH 8	Test Voltage	AC 120V/60Hz

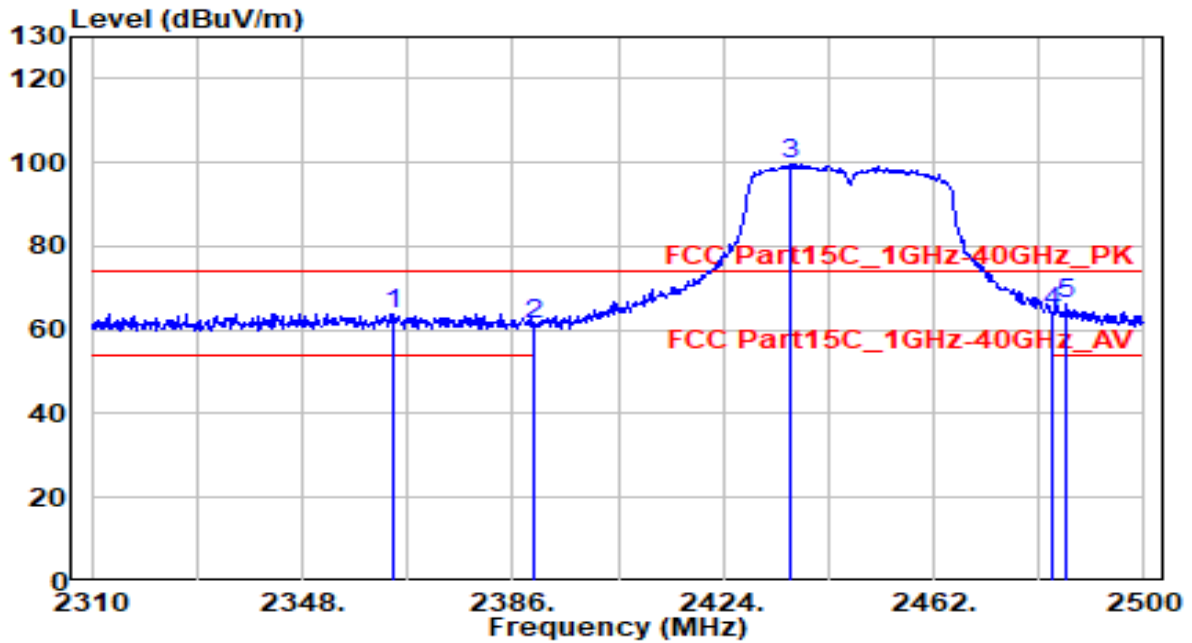

No	Frequency (MHz)	Reading (dB $\mu$ V)	C.F (dB/m)	Measurement (dB $\mu$ V/m)	Margin (dB)	Limit (dB $\mu$ V/m)	Height (cm)	Angle (deg)	Remark (QP/PK/AV)
1	2364.340	33.74	30.23	63.96	-10.04	74.00	235	150	Peak
2	2390.000	30.93	30.29	61.22	-12.78	74.00	235	150	Peak
3	2436.160	69.08	30.38	99.46	N/A	N/A	235	150	Peak
4	2483.500	33.80	30.46	64.26	-9.74	74.00	235	150	Peak
5	* 2486.130	35.70	30.47	66.16	-7.84	74.00	235	150	Peak

Note:

- "\*", means this data is the worst emission level.
- C.F (Correction Factor) = Antenna Factor (dB/m)+ Cable Loss (dB).
- Measurement (dB $\mu$ V/m) = Reading(dB $\mu$ V) + C.F (Correction Factor).
- The emission levels of other frequencies are very lower than the limit and not show in test report.



EUT	HAN Access Point	Date of Test	2021-10-07
Factor	DRH18-E	Temp. / Humidity	23°C /49%
Polarity	Vertical	Site / Test Engineer	AC2 / Jay
Test Mode	802.11n40_TX_CH 8	Test Voltage	AC 120V/60Hz

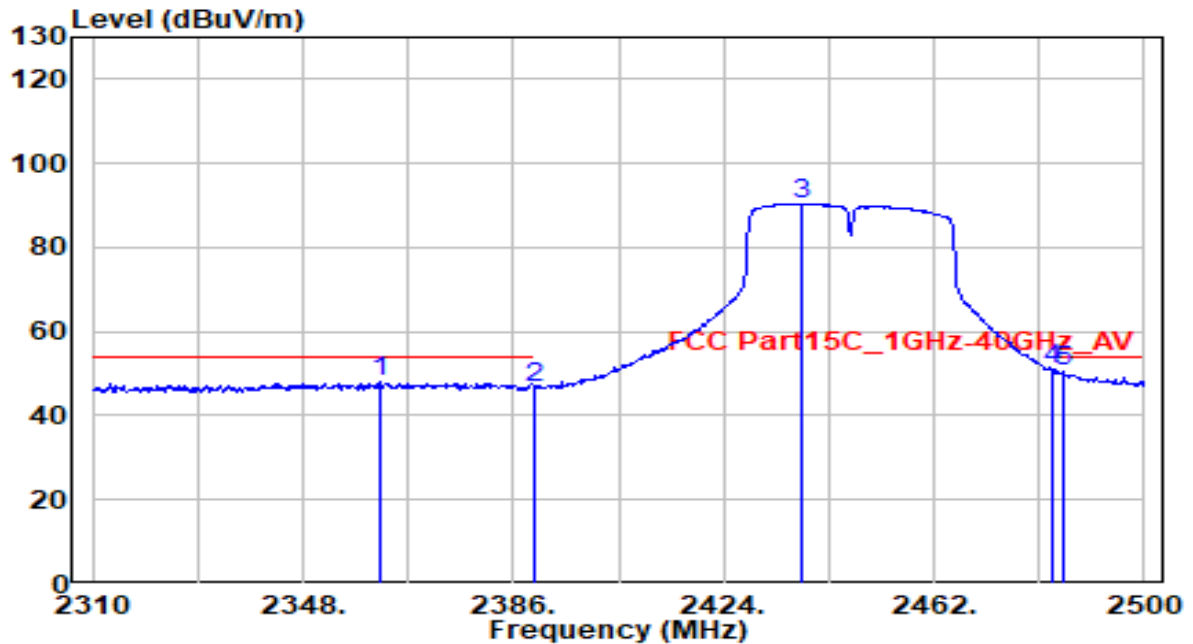

No	Frequency (MHz)	Reading (dBμV)	C.F (dB/m)	Measurement (dBμV/m)	Margin (dB)	Limit (dBμV/m)	Height (cm)	Angle (deg)	Remark (QP/PK/AV)
1	2362.060	17.87	30.22	48.09	-5.91	54.00	235	150	Average
2	2390.000	16.32	30.29	46.60	-7.40	54.00	235	150	Average
3	2438.250	60.12	30.38	90.50	N/A	N/A	235	150	Average
4	* 2483.500	20.44	30.46	50.90	-3.10	54.00	235	150	Average
5	2485.370	19.85	30.46	50.31	-3.69	54.00	235	150	Average

Note:

1. " \*", means this data is the worst emission level.
2. C.F (Correction Factor) = Antenna Factor (dB/m)+ Cable Loss (dB).
3. Measurement (dBμV/m) = Reading(dBμV) + C.F (Correction Factor).
4. The emission levels of other frequencies are very lower than the limit and not show in test report.

EUT	HAN Access Point	Date of Test	2021-10-07
Factor	DRH18-E	Temp. / Humidity	23°C /49%
Polarity	Horizontal	Site / Test Engineer	AC2 / Jay
Test Mode	802.11n40_TX_CH 9	Test Voltage	AC 120V/60Hz

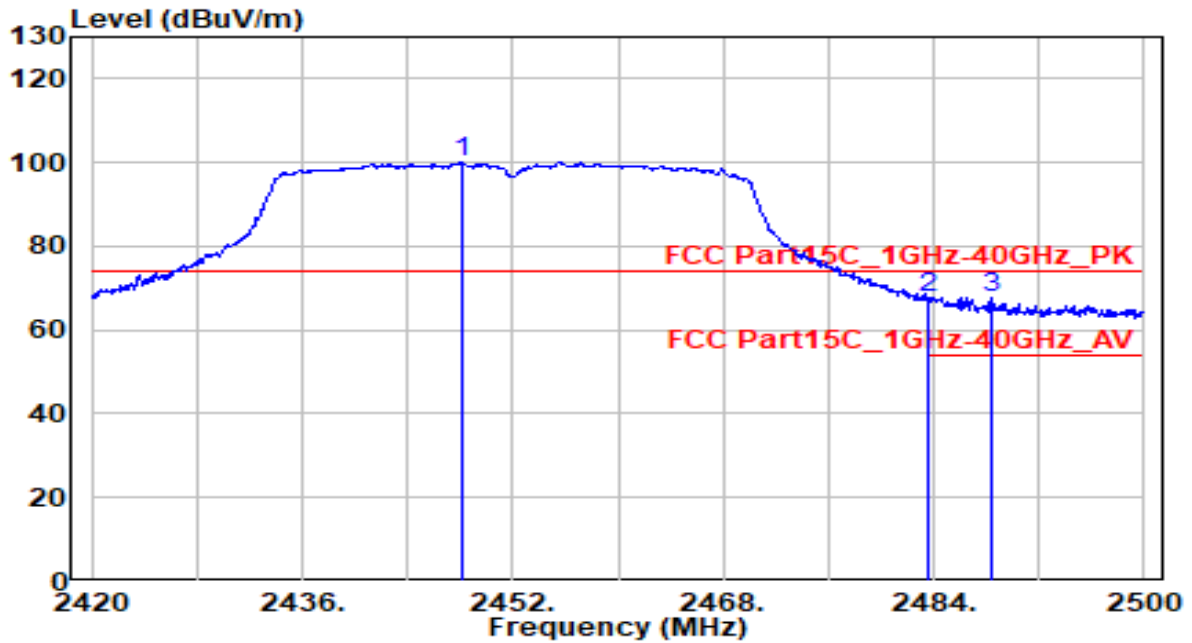

No	Frequency (MHz)	Reading (dB $\mu$ V)	C.F (dB/m)	Measurement (dB $\mu$ V/m)	Margin (dB)	Limit (dB $\mu$ V/m)	Height (cm)	Angle (deg)	Remark (QP/PK/AV)
1	2448.160	69.66	30.40	100.05	N/A	N/A	150	230	Peak
2	* 2483.500	37.41	30.46	67.88	-6.12	74.00	150	230	Peak
3	2488.320	37.33	30.47	67.80	-6.20	74.00	150	230	Peak

Note:

1. " \*", means this data is the worst emission level.
2. C.F (Correction Factor) = Antenna Factor (dB/m)+ Cable Loss (dB).
3. Measurement (dB $\mu$ V/m) = Reading(dB $\mu$ V) + C.F (Correction Factor).
4. The emission levels of other frequencies are very lower than the limit and not show in test report.

EUT	HAN Access Point	Date of Test	2021-10-07
Factor	DRH18-E	Temp. / Humidity	23°C /49%
Polarity	Horizontal	Site / Test Engineer	AC2 / Jay
Test Mode	802.11n40_TX_CH 9	Test Voltage	AC 120V/60Hz

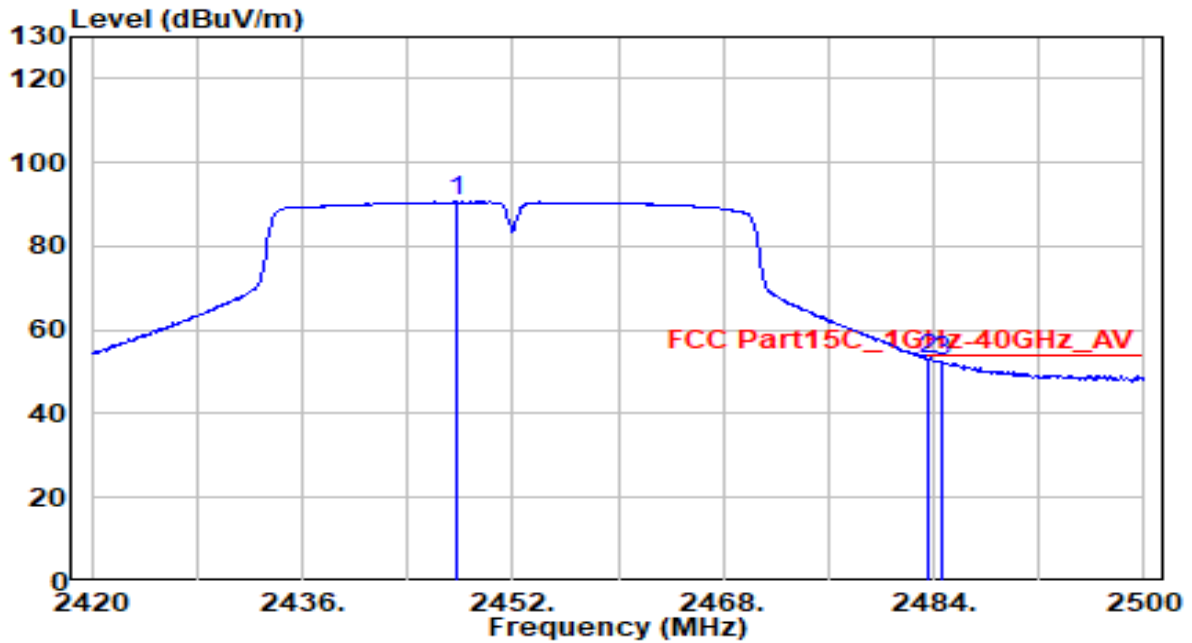

No	Frequency (MHz)	Reading (dB $\mu$ V)	C.F (dB/m)	Measurement (dB $\mu$ V/m)	Margin (dB)	Limit (dB $\mu$ V/m)	Height (cm)	Angle (deg)	Remark (QP/PK/AV)
1	2447.760	60.22	30.40	90.62	N/A	N/A	150	230	Average
2	* 2483.500	22.56	30.46	53.02	-0.98	54.00	150	230	Average
3	2484.640	22.18	30.46	52.64	-1.36	54.00	150	230	Average

Note:

1. " \*", means this data is the worst emission level.
2. C.F (Correction Factor) = Antenna Factor (dB/m)+ Cable Loss (dB).
3. Measurement (dB $\mu$ V/m) = Reading(dB $\mu$ V) + C.F (Correction Factor).
4. The emission levels of other frequencies are very lower than the limit and not show in test report.

EUT	HAN Access Point	Date of Test	2021-10-07
Factor	DRH18-E	Temp. / Humidity	23°C /49%
Polarity	Vertical	Site / Test Engineer	AC2 / Jay
Test Mode	802.11n40_TX_CH 9	Test Voltage	AC 120V/60Hz

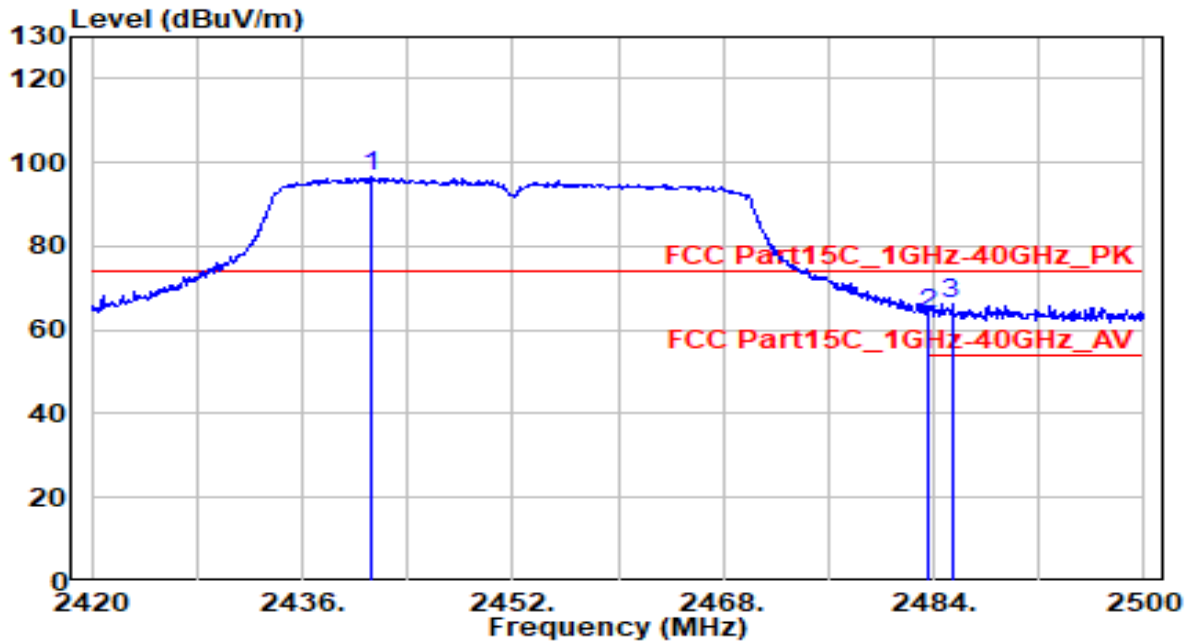

No	Frequency (MHz)	Reading (dBμV)	C.F (dB/m)	Measurement (dBμV/m)	Margin (dB)	Limit (dBμV/m)	Height (cm)	Angle (deg)	Remark (QP/PK/AV)
1	2441.280	66.30	30.38	96.68	N/A	N/A	240	160	Peak
2	2483.500	33.07	30.46	63.53	-10.47	74.00	240	160	Peak
3	* 2485.360	35.70	30.46	66.17	-7.83	74.00	240	160	Peak

Note:

1. " \*", means this data is the worst emission level.
2. C.F (Correction Factor) = Antenna Factor (dB/m)+ Cable Loss (dB).
3. Measurement (dBμV/m) = Reading(dBμV) + C.F (Correction Factor).
4. The emission levels of other frequencies are very lower than the limit and not show in test report.

EUT	HAN Access Point	Date of Test	2021-10-07
Factor	DRH18-E	Temp. / Humidity	23°C /49%
Polarity	Vertical	Site / Test Engineer	AC2 / Jay
Test Mode	802.11n40_TX_CH 9	Test Voltage	AC 120V/60Hz

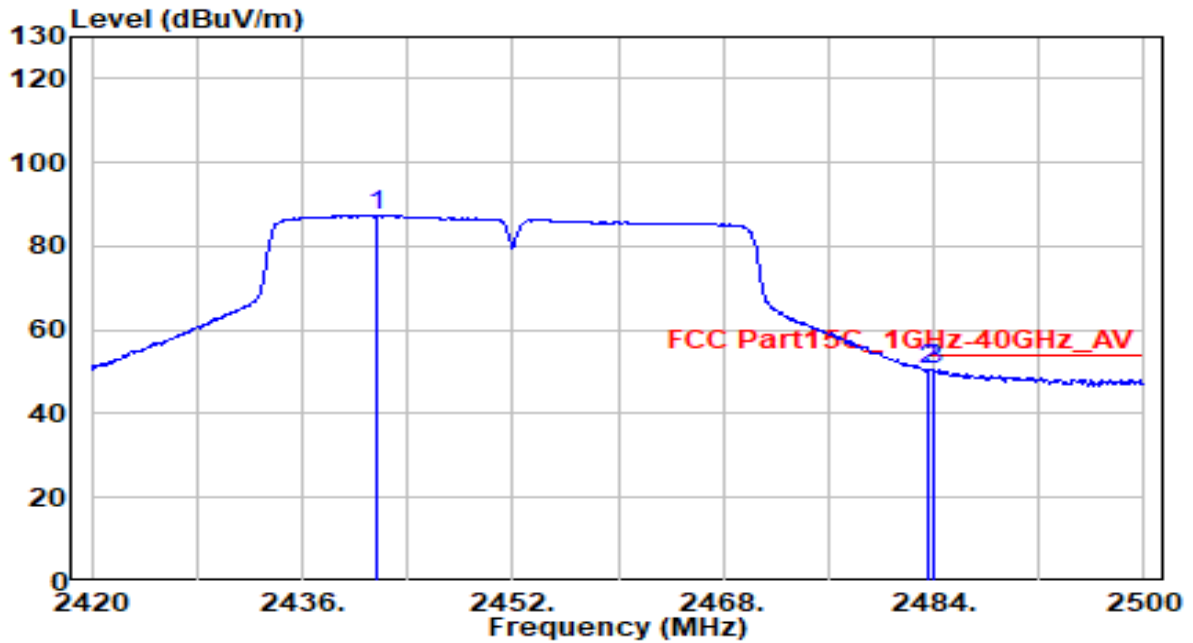

No	Frequency (MHz)	Reading (dBμV)	C.F (dB/m)	Measurement (dBμV/m)	Margin (dB)	Limit (dBμV/m)	Height (cm)	Angle (deg)	Remark (QP/PK/AV)
1	2441.680	56.93	30.39	87.31	N/A	N/A	240	160	Average
2	2483.500	20.09	30.46	50.55	-3.45	54.00	240	160	Average
3	* 2483.920	20.29	30.46	50.75	-3.25	54.00	240	160	Average

Note:

1. " \*", means this data is the worst emission level.
2. C.F (Correction Factor) = Antenna Factor (dB/m)+ Cable Loss (dB).
3. Measurement (dBμV/m) = Reading(dBμV) + C.F (Correction Factor).
4. The emission levels of other frequencies are very lower than the limit and not show in test report.

## 7.8. AC Conducted Emissions Measurement

### 7.8.1. Test Limit

FCC Part 15 Subpart C Paragraph 15.207 Limits		
Frequency (MHz)	QP (dB $\mu$ V)	AV (dB $\mu$ V)
0.15 - 0.50	66 - 56	56 - 46
0.50 - 5.0	56	46
5.0 - 30	60	50

Note 1: The lower limit shall apply at the transition frequencies.

Note 2: The limit decreases linearly with the logarithm of the frequency in the range 0.15MHz to 0.5MHz.

### 7.8.2. Test Setup

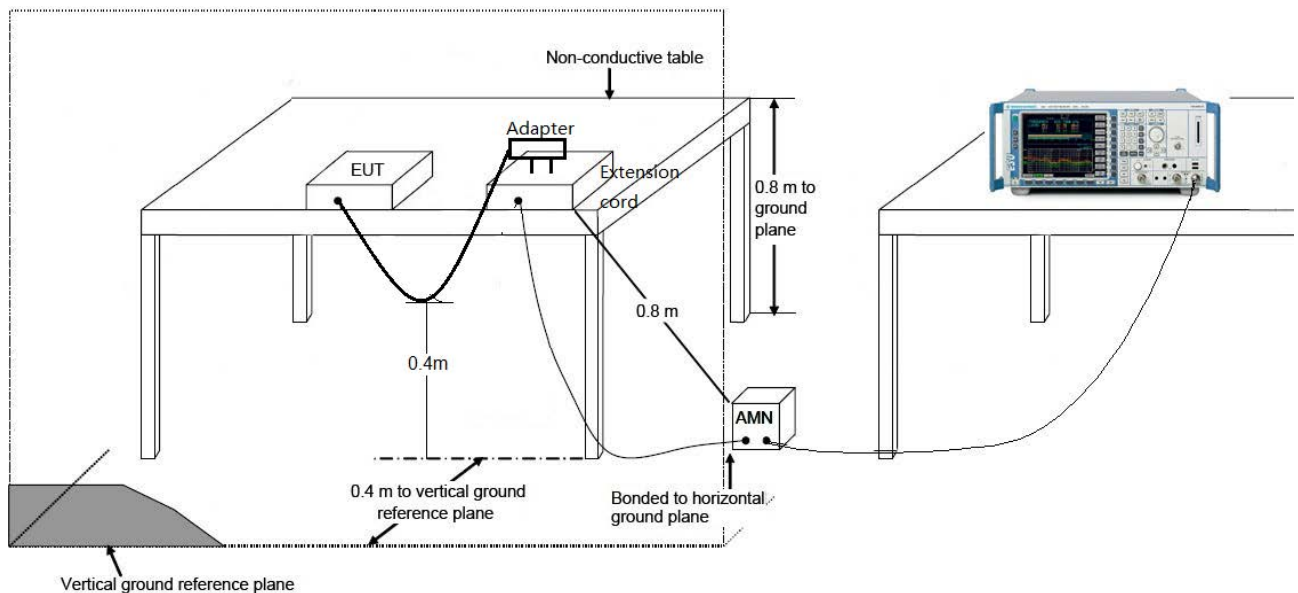

### 7.8.3. Test Result

EUT	HAN Access Point	Date of Test	2021-11-05
Factor	CE_ENV216-L1 (Filter ON)	Temp. / Humidity	25.3°C / 57.6%
Polarity	Line1	Site / Test Engineer	SR2 / Eric Lin
Test Mode	Transmit by 802.11b at channel 2437MHz	Test Voltage	AC 120V/60Hz

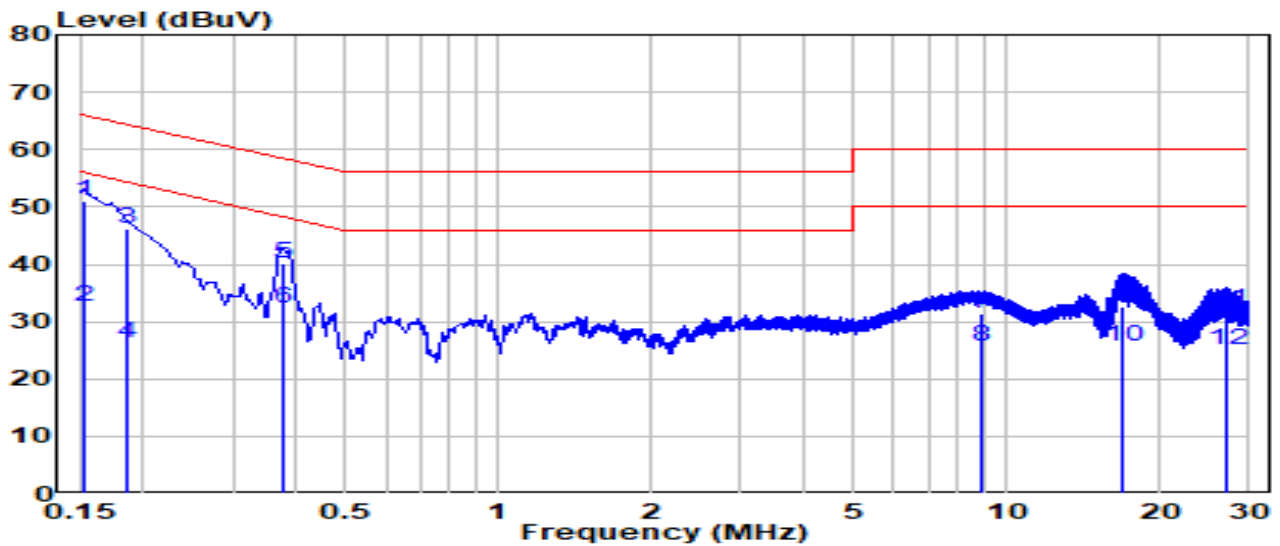

No	Frequency (MHz)	Reading (dBμV)	C.F (dB)	Measurement (dBμV)	Margin (dB)	Limit (dBμV)	Remark (QP/PK/AV)
1	*	41.51	9.61	51.12	-14.76	65.88	QP
2		23.11	9.61	32.72	-23.16	55.88	Average
3		36.50	9.62	46.12	-18.08	64.20	QP
4		16.50	9.62	26.12	-28.08	54.20	Average
5		30.58	9.64	40.22	-18.08	58.30	QP
6		22.78	9.64	32.42	-15.88	48.30	Average
7		21.54	9.87	31.41	-28.59	60.00	QP
8		15.94	9.87	25.81	-24.19	50.00	Average
9		22.76	9.98	32.74	-27.26	60.00	QP
10		15.76	9.98	25.74	-24.26	50.00	Average
11		22.06	10.09	32.14	-27.86	60.00	QP
12		15.06	10.09	25.14	-24.86	50.00	Average

Note:

1. " \*", means this data is the worst emission level.
2. C.F (Correction Factor) = LISN Factor (dB)+ Cable Loss (dB).
3. Measurement(dBμV) = Reading(dBμV) + C.F (Correction Factor).

EUT	HAN Access Point	Date of Test	2021-11-05
Factor	CE_ENV216-N (Filter ON)	Temp. / Humidity	25.3°C / 57.6%
Polarity	Neutral	Site / Test Engineer	SR2 / Eric Lin
Test Mode	Transmit by 802.11b at channel 2437MHz	Test Voltage	AC 120V/60Hz

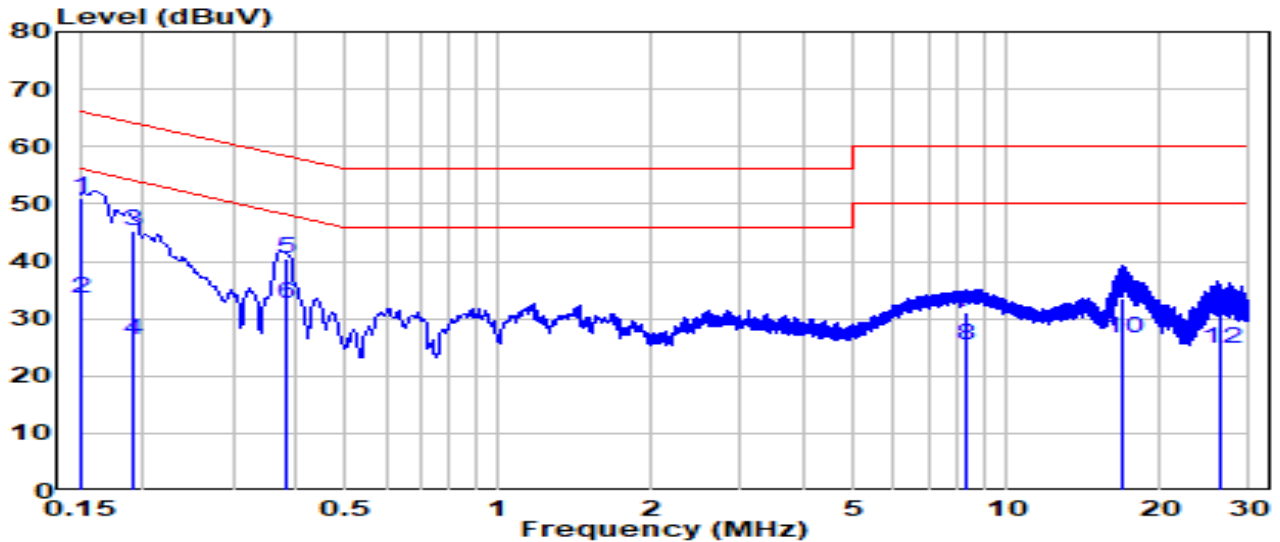

No	Frequency (MHz)	Reading (dB $\mu$ V)	C.F (dB)	Measurement (dB $\mu$ V)	Margin (dB)	Limit (dB $\mu$ V)	Remark (QP/PK/AV)
1	*	41.39	9.62	51.01	-14.93	65.93	QP
2		23.99	9.62	33.61	-22.33	55.93	Average
3		35.79	9.62	45.41	-18.63	64.04	QP
4		16.59	9.62	26.21	-27.83	54.04	Average
5		30.77	9.64	40.41	-17.88	58.29	QP
6		22.97	9.64	32.61	-15.68	48.29	Average
7		21.21	9.87	31.08	-28.92	60.00	QP
8		15.61	9.87	25.48	-24.52	50.00	Average
9		23.39	10.04	33.43	-26.57	60.00	QP
10		16.39	10.04	26.43	-23.57	50.00	Average
11		20.86	10.19	31.05	-28.95	60.00	QP
12		14.56	10.19	24.75	-25.25	50.00	Average

Note:

1. " \*", means this data is the worst emission level.
2. C.F (Correction Factor) = LISN Factor (dB)+ Cable Loss (dB).
3. Measurement(dB $\mu$ V) = Reading(dB $\mu$ V) + C.F (Correction Factor).



## 8. CONCLUSION

The data collected relate only the item(s) tested and show that the device is compliance with Part 15C of the FCC Rules.

————— The End —————

## **Appendix A - Test Setup Photograph**

Refer to "2108TW0005-Test setup photo" file.

## **Appendix B - EUT Photograph**

Refer to "AP331-EUT photo" file.