

EUT	AP311	Date of Test	2020-10-12
Factor	BBHA 9120D (1GHz~18GHz)_2020	Temp. / Humidity	23.7°C/37%
Polarity	Vertical	Site / Test Engineer	AC1 / Kevin Ker
Test Mode	Transmit by 802.11ac-VHT80 at channel 5530MHz	Test Voltage	120V/60Hz

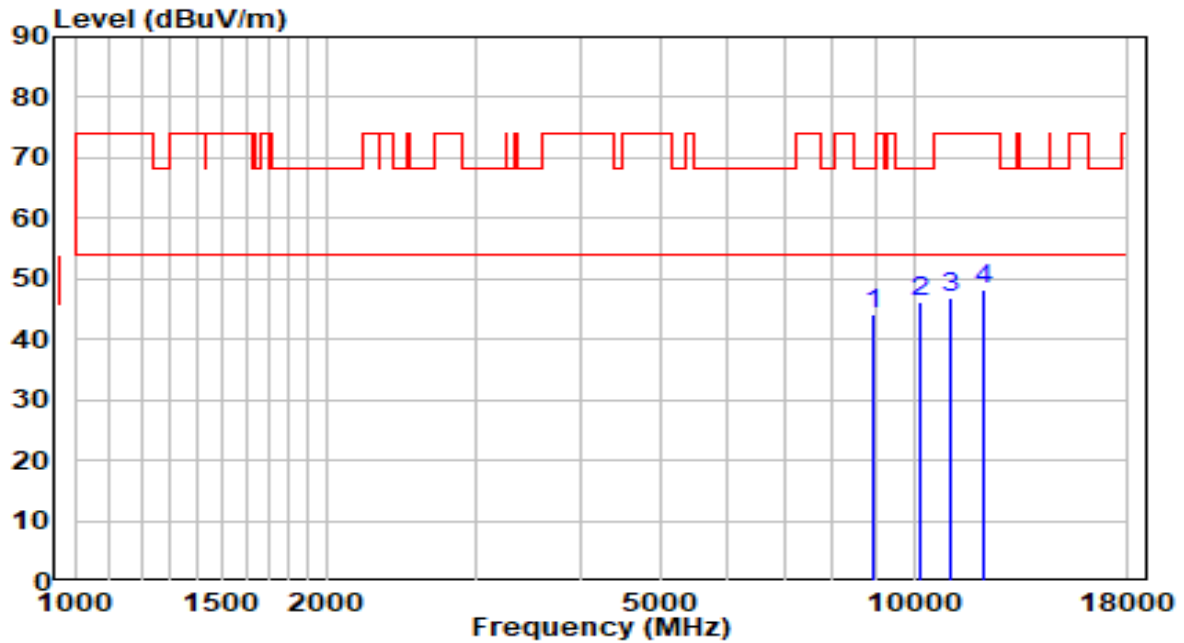

No	Frequency (MHz)	Reading (dBuV)	C.F (dB)	Measurement (dBuV/m)	Margin (dB)	Limit (dBuV/m)	Remark (QP/PK/AV)
1	8947.500	30.48	13.55	44.03	-24.17	68.20	Peak
2	* 10163.000	30.22	15.92	46.14	-22.06	68.20	Peak
3	11089.500	29.08	17.90	46.98	-27.02	74.00	Peak
4	12143.500	30.50	17.84	48.35	-25.65	74.00	Peak

Note:

1. " *", means this data is the worst emission level.
2. C.F (Correction Factor) = Antenna Factor (dB)+ Cable Loss (dB)– Preamplifier(dB).
3. Measurement(dBuV/m) = Reading(dBuV) + C.F (Correction Factor).
- 4.The emission levels of other frequencies are very lower than the limit and not show in test report.

EUT	AP311	Date of Test	2020-10-12
Factor	BBHA 9120D (1GHz~18GHz)_2020	Temp. / Humidity	23.7°C/37%
Polarity	Horizontal	Site / Test Engineer	AC1 / Kevin Ker
Test Mode	Transmit by 802.11ac-VHT80 at channel 5610MHz	Test Voltage	120V/60Hz

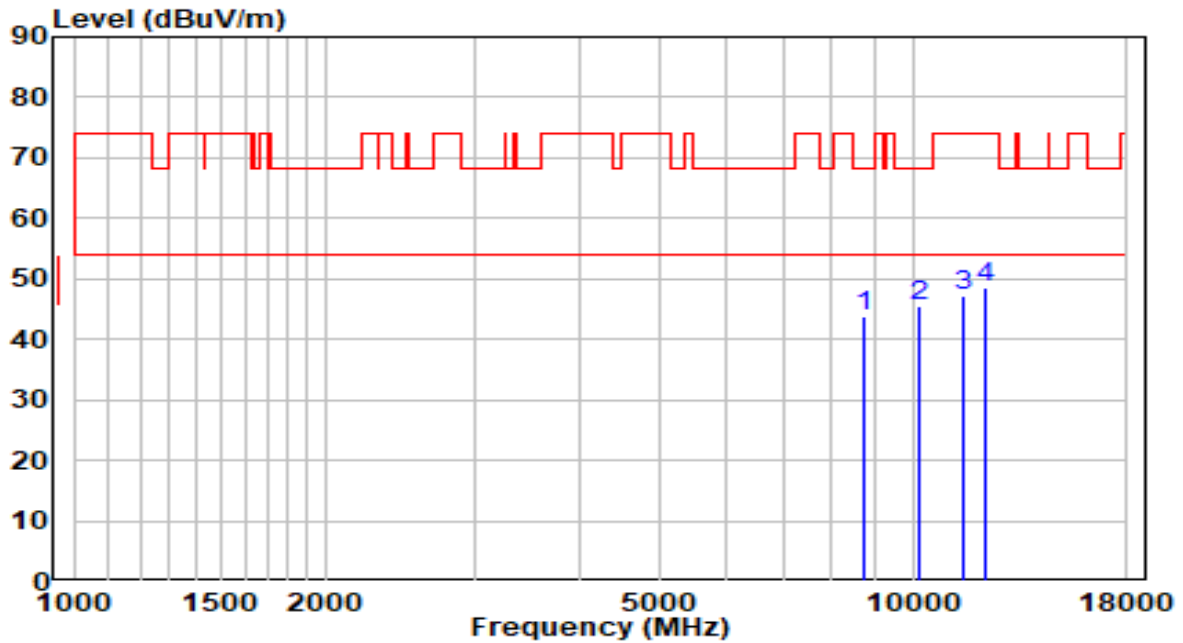

No	Frequency (MHz)	Reading (dBuV)	C.F (dB)	Measurement (dBuV/m)	Margin (dB)	Limit (dBuV/m)	Remark (QP/PK/AV)
1	8743.500	30.77	13.05	43.82	-24.38	68.20	Peak
2	* 10171.500	29.50	15.95	45.45	-22.75	68.20	Peak
3	11523.000	28.76	18.42	47.18	-26.82	74.00	Peak
4	12211.500	30.62	17.86	48.47	-25.53	74.00	Peak

Note:

- "*", means this data is the worst emission level.
- C.F (Correction Factor) = Antenna Factor (dB)+ Cable Loss (dB)– Preamplifier(dB).
- Measurement(dBuV/m) = Reading(dBuV) + C.F (Correction Factor).
- The emission levels of other frequencies are very lower than the limit and not show in test report.

EUT	AP311	Date of Test	2020-10-12
Factor	BBHA 9120D (1GHz~18GHz)_2020	Temp. / Humidity	23.7°C/37%
Polarity	Vertical	Site / Test Engineer	AC1 / Kevin Ker
Test Mode	Transmit by 802.11ac-VHT80 at channel 5610MHz	Test Voltage	120V/60Hz

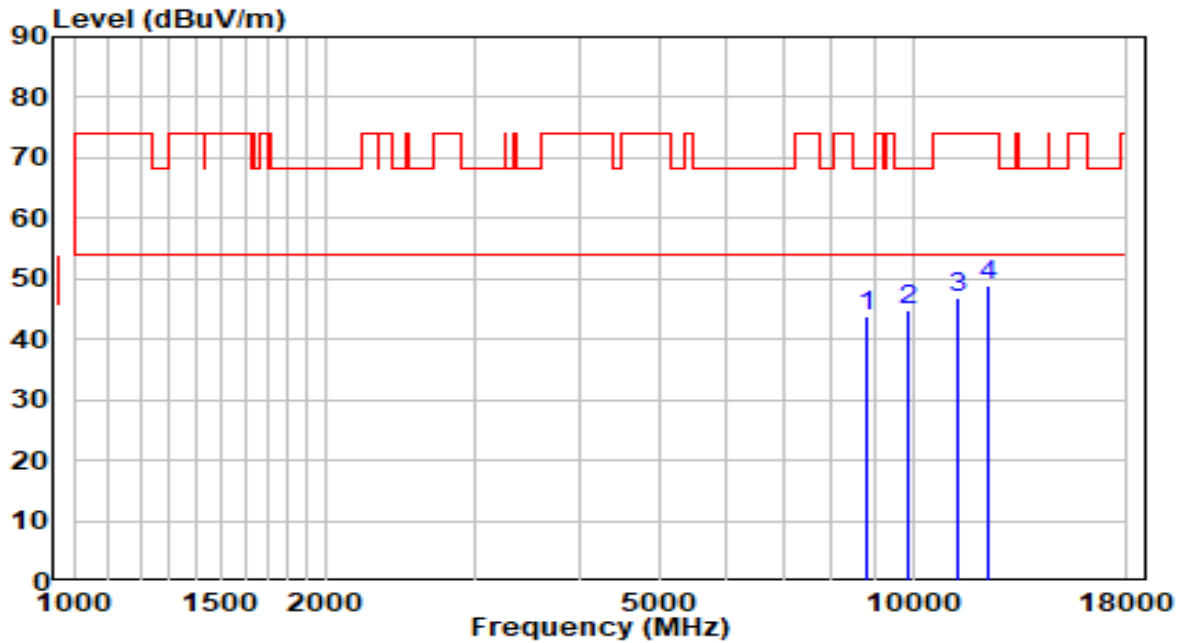

No	Frequency (MHz)	Reading (dBuV)	C.F (dB)	Measurement (dBuV/m)	Margin (dB)	Limit (dBuV/m)	Remark (QP/PK/AV)
1	8794.500	30.66	13.18	43.84	-24.36	68.20	Peak
2	* 9899.500	29.74	15.17	44.91	-23.29	68.20	Peak
3	11353.000	28.59	18.25	46.84	-27.16	74.00	Peak
4	12305.000	31.06	17.87	48.93	-25.07	74.00	Peak

Note:

1. " *", means this data is the worst emission level.
2. C.F (Correction Factor) = Antenna Factor (dB)+ Cable Loss (dB)– Preamplifier(dB).
3. Measurement(dBuV/m) = Reading(dBuV) + C.F (Correction Factor).
- 4.The emission levels of other frequencies are very lower than the limit and not show in test report.

EUT	AP311	Date of Test	2020-10-12
Factor	BBHA 9120D (1GHz~18GHz)_2020	Temp. / Humidity	23.7°C/37%
Polarity	Horizontal	Site / Test Engineer	AC1 / Kevin Ker
Test Mode	Transmit by 802.11ac-VHT80 at channel 5690MHz	Test Voltage	120V/60Hz

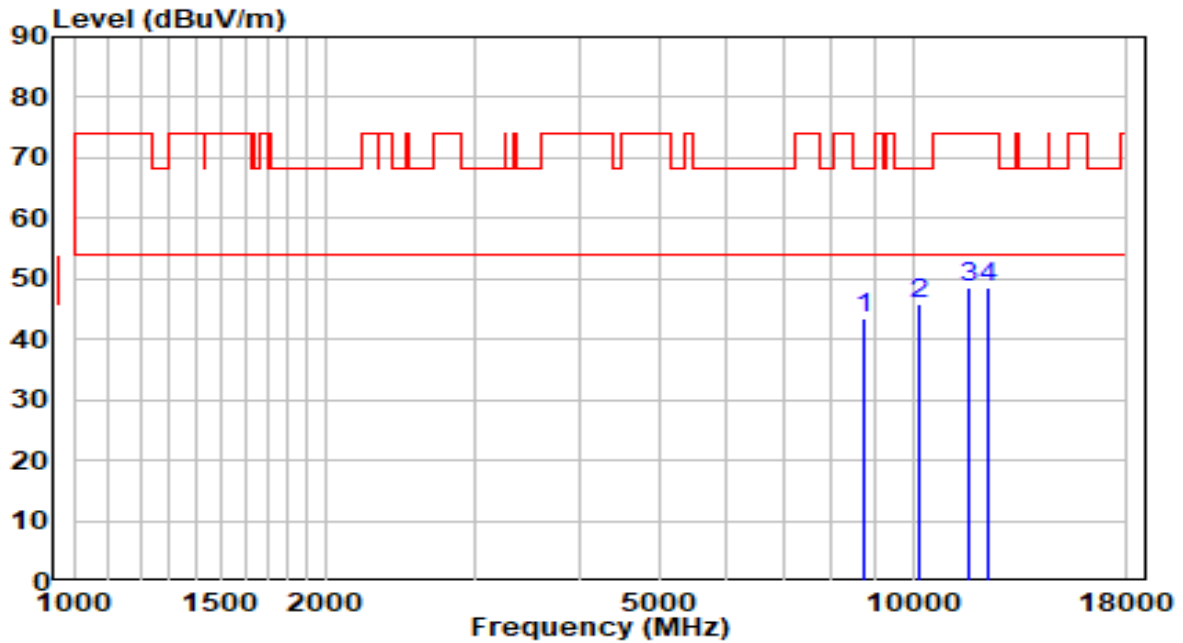

No	Frequency (MHz)	Reading (dBuV)	C.F (dB)	Measurement (dBuV/m)	Margin (dB)	Limit (dBuV/m)	Remark (QP/PK/AV)
1	8743.500	30.28	13.05	43.33	-24.87	68.20	Peak
2	* 10163.000	29.84	15.92	45.76	-22.44	68.20	Peak
3	11676.000	30.29	18.23	48.52	-25.48	74.00	Peak
4	12288.000	30.72	17.87	48.59	-25.41	74.00	Peak

Note:

1. " *", means this data is the worst emission level.
2. C.F (Correction Factor) = Antenna Factor (dB)+ Cable Loss (dB)– Preamplifier(dB).
3. Measurement(dBuV/m) = Reading(dBuV) + C.F (Correction Factor).
- 4.The emission levels of other frequencies are very lower than the limit and not show in test report.

EUT	AP311	Date of Test	2020-10-12
Factor	BBHA 9120D (1GHz~18GHz)_2020	Temp. / Humidity	23.7°C/37%
Polarity	Vertical	Site / Test Engineer	AC1 / Kevin Ker
Test Mode	Transmit by 802.11ac-VHT80 at channel 5690MHz	Test Voltage	120V/60Hz

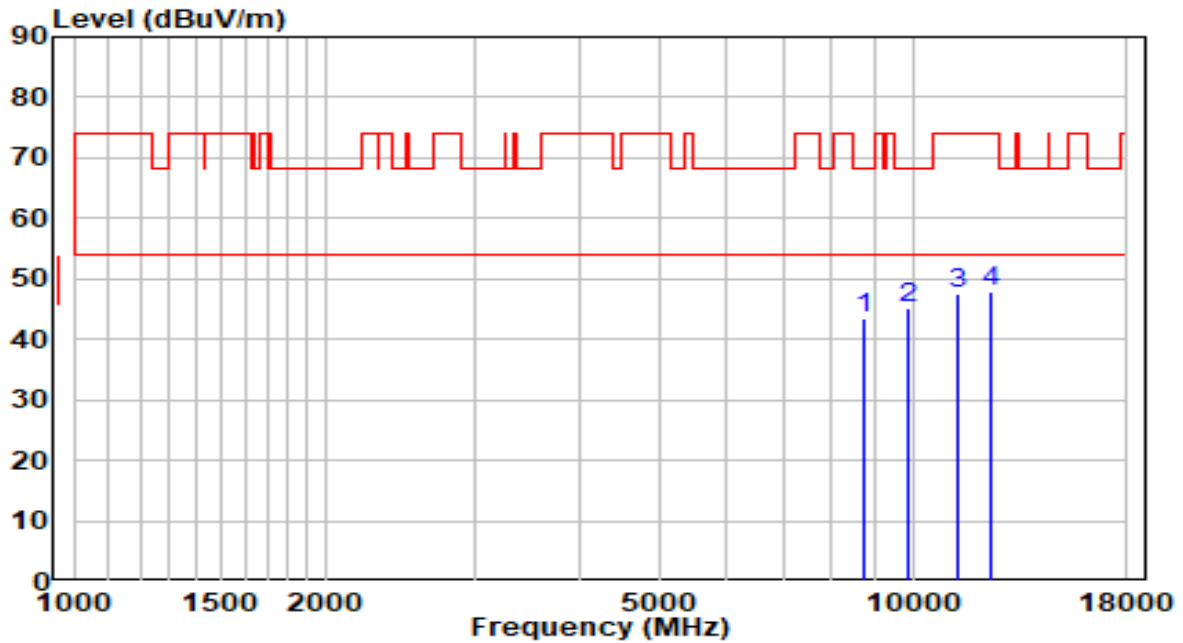

No	Frequency (MHz)	Reading (dBuV)	C.F (dB)	Measurement (dBuV/m)	Margin (dB)	Limit (dBuV/m)	Remark (QP/PK/AV)
1	8752.000	30.35	13.07	43.42	-24.78	68.20	Peak
2	* 9857.000	29.94	15.09	45.03	-23.17	68.20	Peak
3	11310.500	29.24	18.20	47.44	-26.56	74.00	Peak
4	12356.000	30.07	17.88	47.95	-26.05	74.00	Peak

Note:

- "*", means this data is the worst emission level.
- C.F (Correction Factor) = Antenna Factor (dB)+ Cable Loss (dB)– Preamplifier(dB).
- Measurement(dBuV/m) = Reading(dBuV) + C.F (Correction Factor).
- The emission levels of other frequencies are very lower than the limit and not show in test report.

EUT	AP311	Date of Test	2020-10-12
Factor	BBHA 9120D (1GHz~18GHz)_2020	Temp. / Humidity	23.7°C/37%
Polarity	Horizontal	Site / Test Engineer	AC1 / Kevin Ker
Test Mode	Transmit by 802.11ac-VHT80 at channel 5775MHz	Test Voltage	120V/60Hz

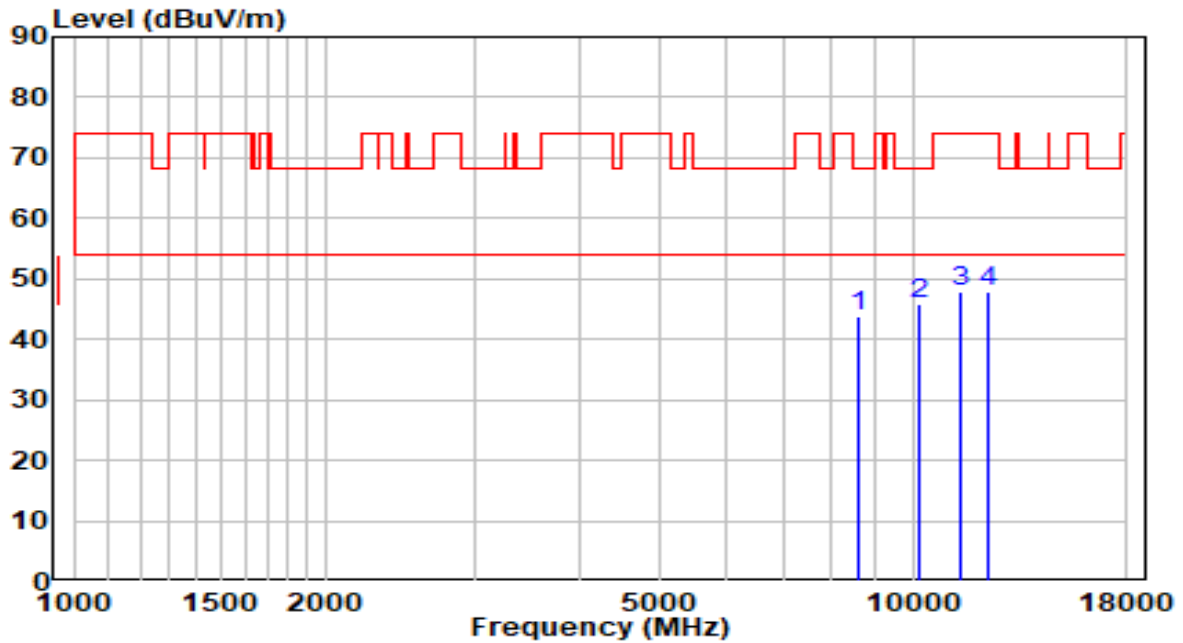

No	Frequency (MHz)	Reading (dBuV)	C.F (dB)	Measurement (dBuV/m)	Margin (dB)	Limit (dBuV/m)	Remark (QP/PK/AV)
1	8641.500	31.10	12.80	43.90	-24.30	68.20	Peak
2	* 10154.500	30.07	15.89	45.96	-22.24	68.20	Peak
3	11361.500	29.47	18.26	47.74	-26.26	74.00	Peak
4	12279.500	30.07	17.87	47.94	-26.06	74.00	Peak

Note:

- "*", means this data is the worst emission level.
- C.F (Correction Factor) = Antenna Factor (dB)+ Cable Loss (dB)– Preamplifier(dB).
- Measurement(dBuV/m) = Reading(dBuV) + C.F (Correction Factor).
- The emission levels of other frequencies are very lower than the limit and not show in test report.

EUT	AP311	Date of Test	2020-10-12
Factor	BBHA 9120D (1GHz~18GHz)_2020	Temp. / Humidity	23.7°C/37%
Polarity	Vertical	Site / Test Engineer	AC1 / Kevin Ker
Test Mode	Transmit by 802.11ac-VHT80 at channel 5775MHz	Test Voltage	120V/60Hz

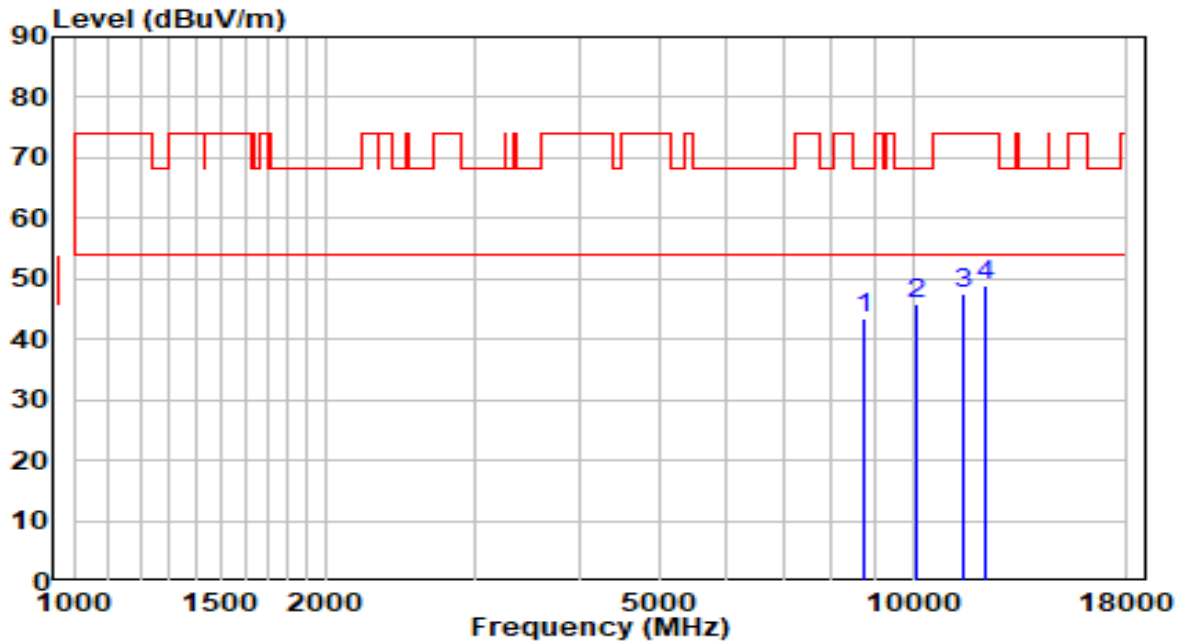

No	Frequency (MHz)	Reading (dBuV)	C.F (dB)	Measurement (dBuV/m)	Margin (dB)	Limit (dBuV/m)	Remark (QP/PK/AV)
1	8752.000	30.54	13.07	43.61	-24.59	68.20	Peak
2	* 10086.500	30.04	15.66	45.69	-22.51	68.20	Peak
3	11480.500	29.05	18.42	47.47	-26.53	74.00	Peak
4	12228.500	30.98	17.86	48.84	-25.16	74.00	Peak

Note:

1. " *", means this data is the worst emission level.
2. C.F (Correction Factor) = Antenna Factor (dB)+ Cable Loss (dB)– Preamplifier(dB).
3. Measurement(dBuV/m) = Reading(dBuV) + C.F (Correction Factor).
- 4.The emission levels of other frequencies are very lower than the limit and not show in test report.

EUT	AP311	Date of Test	2020-10-12
Factor	BBHA 9120D (1GHz~18GHz)_2020	Temp. / Humidity	23.7°C/37%
Polarity	Horizontal	Site / Test Engineer	AC1 / Kevin Ker
Test Mode	Transmit by 802.11ax-HE20 at channel 5180MHz	Test Voltage	120V/60Hz

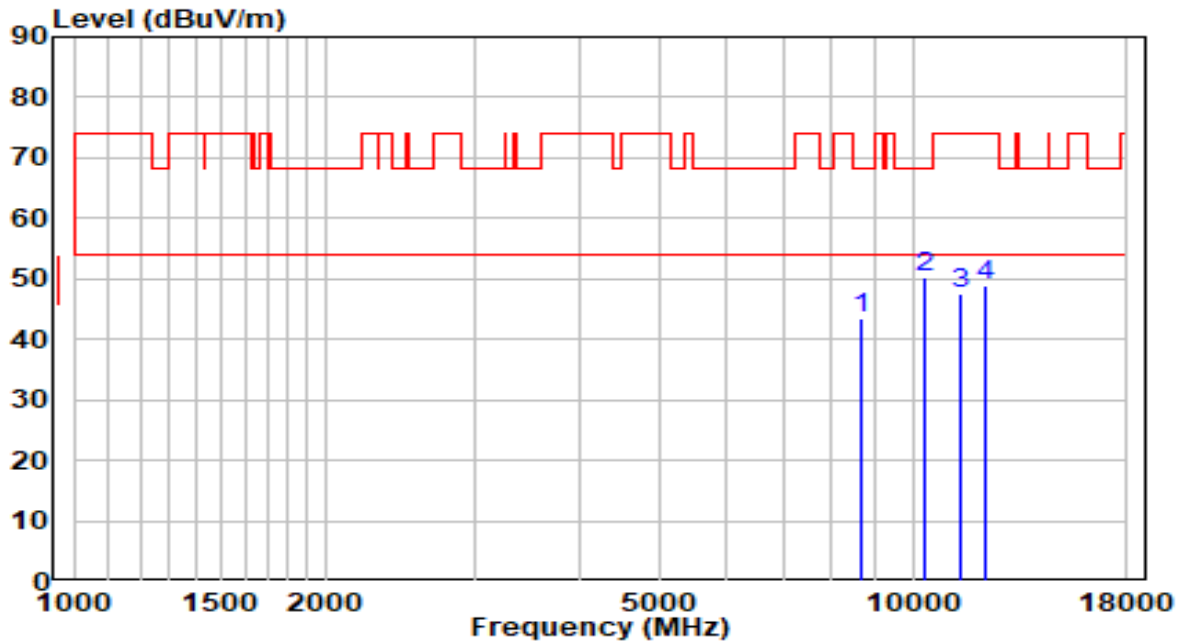

No	Frequency (MHz)	Reading (dBuV)	C.F (dB)	Measurement (dBuV/m)	Margin (dB)	Limit (dBuV/m)	Remark (QP/PK/AV)
1	8658.500	30.52	12.84	43.37	-24.83	68.20	Peak
2	* 10358.500	33.60	16.59	50.19	-18.01	68.20	Peak
3	11361.500	29.12	18.26	47.38	-26.62	74.00	Peak
4	12245.500	30.91	17.86	48.77	-25.23	74.00	Peak

Note:

1. " *", means this data is the worst emission level.
2. C.F (Correction Factor) = Antenna Factor (dB)+ Cable Loss (dB)– Preamplifier(dB).
3. Measurement(dBuV/m) = Reading(dBuV) + C.F (Correction Factor).
- 4.The emission levels of other frequencies are very lower than the limit and not show in test report.

EUT	AP311	Date of Test	2020-10-12
Factor	BBHA 9120D (1GHz~18GHz)_2020	Temp. / Humidity	23.7°C/37%
Polarity	Vertical	Site / Test Engineer	AC1 / Kevin Ker
Test Mode	Transmit by 802.11ax-HE20 at channel 5180MHz	Test Voltage	120V/60Hz

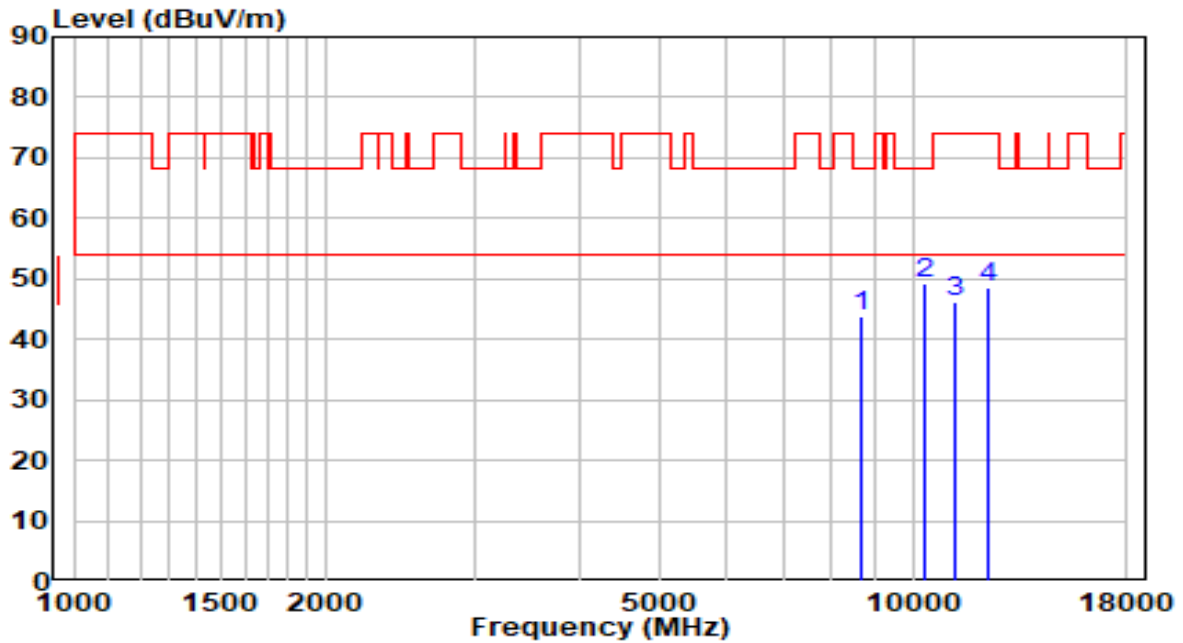

No	Frequency (MHz)	Reading (dBuV)	C.F (dB)	Measurement (dBuV/m)	Margin (dB)	Limit (dBuV/m)	Remark (QP/PK/AV)
1	8709.500	30.77	12.97	43.74	-24.46	68.20	Peak
2	* 10358.500	32.72	16.59	49.30	-18.90	68.20	Peak
3	11191.500	28.26	18.04	46.29	-27.71	74.00	Peak
4	12330.500	30.69	17.88	48.57	-25.43	74.00	Peak

Note:

1. " *", means this data is the worst emission level.
2. C.F (Correction Factor) = Antenna Factor (dB)+ Cable Loss (dB)– Preamplifier(dB).
3. Measurement(dBuV/m) = Reading(dBuV) + C.F (Correction Factor).
- 4.The emission levels of other frequencies are very lower than the limit and not show in test report.

EUT	AP311	Date of Test	2020-10-12
Factor	BBHA 9120D (1GHz~18GHz)_2020	Temp. / Humidity	23.7°C/37%
Polarity	Horizontal	Site / Test Engineer	AC1 / Kevin Ker
Test Mode	Transmit by 802.11ax-HE20 at channel 5220MHz	Test Voltage	120V/60Hz

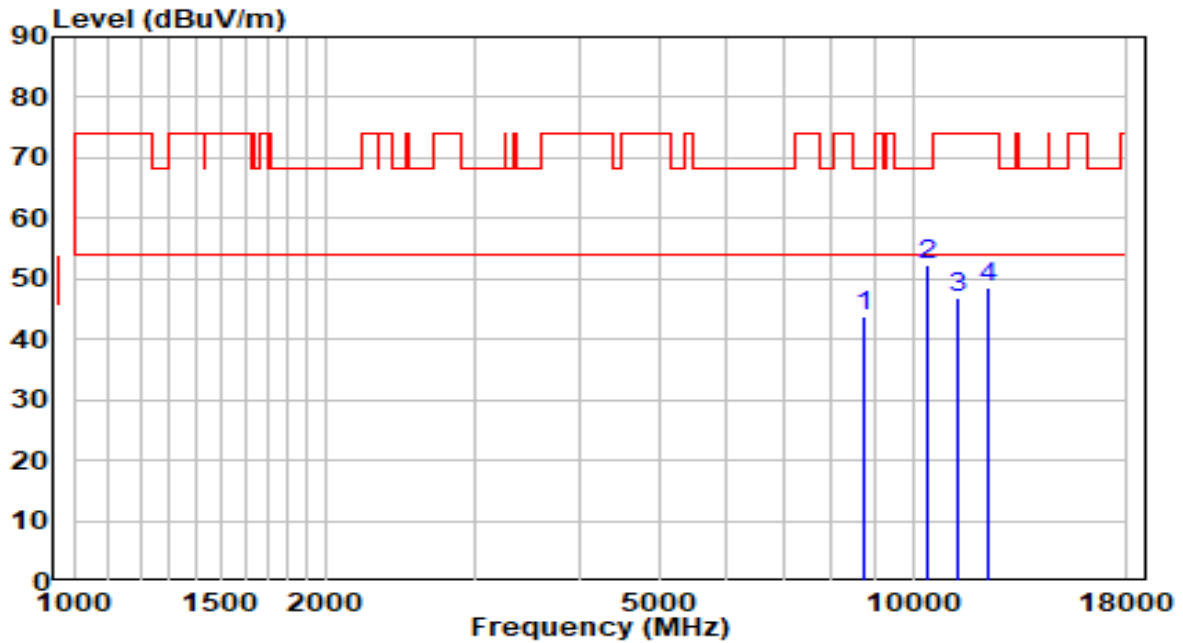

No	Frequency (MHz)	Reading (dBuV)	C.F (dB)	Measurement (dBuV/m)	Margin (dB)	Limit (dBuV/m)	Remark (QP/PK/AV)
1	8726.500	30.76	13.01	43.77	-24.43	68.20	Peak
2	* 10435.000	35.50	16.85	52.35	-15.85	68.20	Peak
3	11336.000	28.75	18.23	46.98	-27.02	74.00	Peak
4	12288.000	30.54	17.87	48.41	-25.59	74.00	Peak

Note:

1. " *", means this data is the worst emission level.
2. C.F (Correction Factor) = Antenna Factor (dB)+ Cable Loss (dB)– Preamplifier(dB).
3. Measurement(dBuV/m) = Reading(dBuV) + C.F (Correction Factor).
- 4.The emission levels of other frequencies are very lower than the limit and not show in test report.

EUT	AP311	Date of Test	2020-10-12
Factor	BBHA 9120D (1GHz~18GHz)_2020	Temp. / Humidity	23.7°C/37%
Polarity	Vertical	Site / Test Engineer	AC1 / Kevin Ker
Test Mode	Transmit by 802.11ax-HE20 at channel 5220MHz	Test Voltage	120V/60Hz

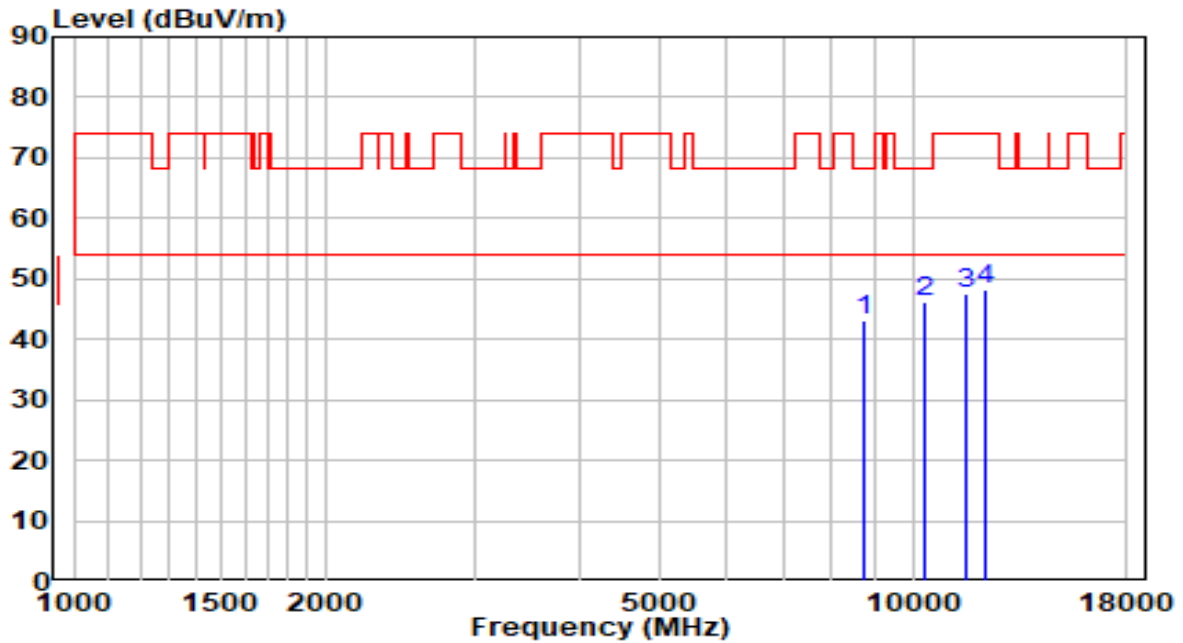

No	Frequency (MHz)	Reading (dBuV)	C.F (dB)	Measurement (dBuV/m)	Margin (dB)	Limit (dBuV/m)	Remark (QP/PK/AV)
1	8726.500	30.23	13.01	43.24	-24.96	68.20	Peak
2	* 10324.500	29.82	16.47	46.29	-21.91	68.20	Peak
3	11582.500	29.14	18.35	47.49	-26.51	74.00	Peak
4	12194.500	30.42	17.85	48.27	-25.73	74.00	Peak

Note:

1. " *", means this data is the worst emission level.
2. C.F (Correction Factor) = Antenna Factor (dB)+ Cable Loss (dB)– Preamplifier(dB).
3. Measurement(dBuV/m) = Reading(dBuV) + C.F (Correction Factor).
- 4.The emission levels of other frequencies are very lower than the limit and not show in test report.

EUT	AP311	Date of Test	2020-10-12
Factor	BBHA 9120D (1GHz~18GHz)_2020	Temp. / Humidity	23.7°C/37%
Polarity	Horizontal	Site / Test Engineer	AC1 / Kevin Ker
Test Mode	Transmit by 802.11ax-HE20 at channel 5240MHz	Test Voltage	120V/60Hz

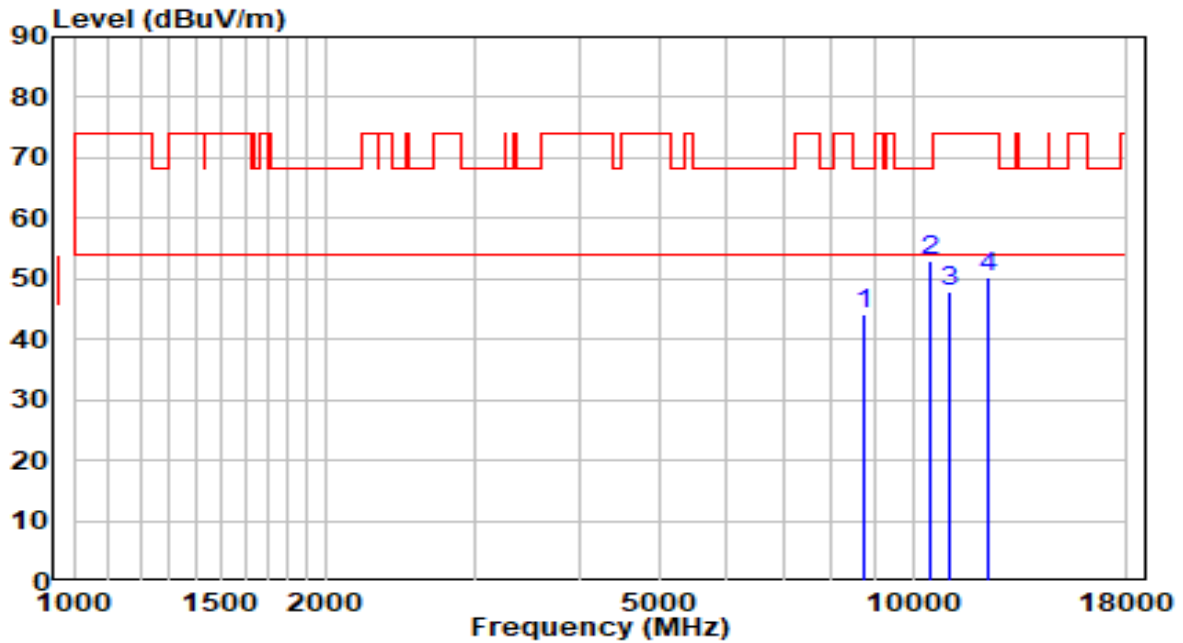

No	Frequency (MHz)	Reading (dBuV)	C.F (dB)	Measurement (dBuV/m)	Margin (dB)	Limit (dBuV/m)	Remark (QP/PK/AV)
1	8735.000	31.19	13.03	44.22	-23.98	68.20	Peak
2	* 10486.000	36.01	17.02	53.03	-15.17	68.20	Peak
3	11021.500	30.03	17.81	47.83	-26.17	74.00	Peak
4	12288.000	32.35	17.87	50.21	-23.79	74.00	Peak

Note:

1. " *", means this data is the worst emission level.
2. C.F (Correction Factor) = Antenna Factor (dB)+ Cable Loss (dB)– Preamplifier(dB).
3. Measurement(dBuV/m) = Reading(dBuV) + C.F (Correction Factor).
- 4.The emission levels of other frequencies are very lower than the limit and not show in test report.

EUT	AP311	Date of Test	2020-10-12
Factor	BBHA 9120D (1GHz~18GHz)_2020	Temp. / Humidity	23.7°C/37%
Polarity	Vertical	Site / Test Engineer	AC1 / Kevin Ker
Test Mode	Transmit by 802.11ax-HE20 at channel 5240MHz	Test Voltage	120V/60Hz

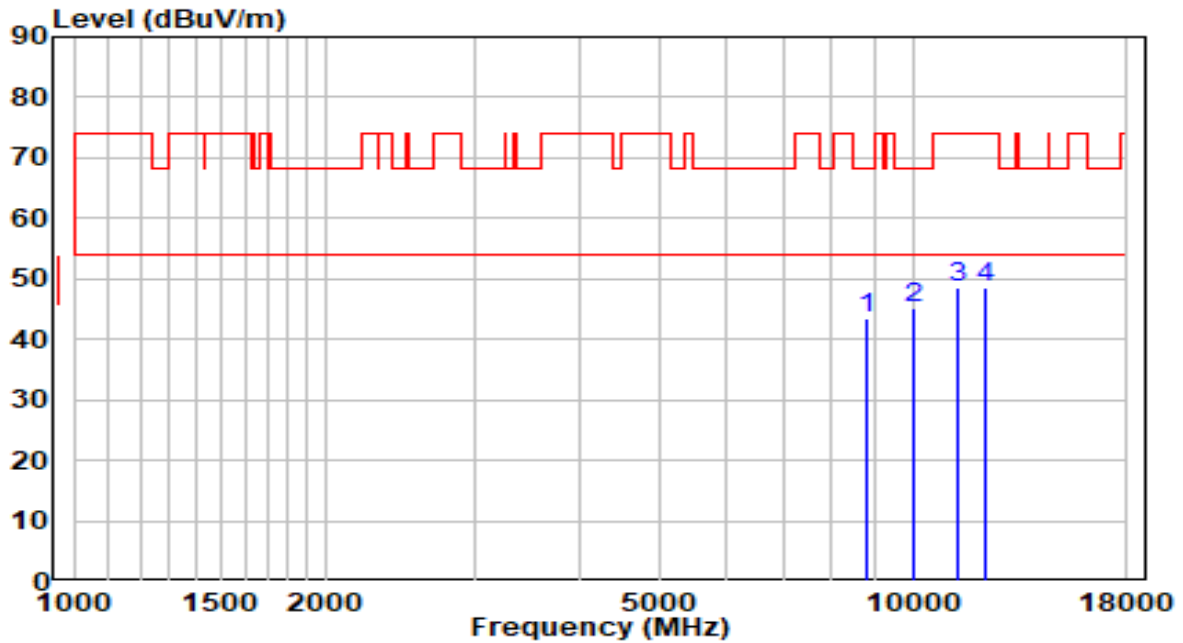

No	Frequency (MHz)	Reading (dBuV)	C.F (dB)	Measurement (dBuV/m)	Margin (dB)	Limit (dBuV/m)	Remark (QP/PK/AV)
1	8837.000	30.16	13.28	43.44	-24.76	68.20	Peak
2	* 10001.500	29.78	15.37	45.14	-23.06	68.20	Peak
3	11285.000	30.43	18.16	48.59	-25.41	74.00	Peak
4	12237.000	30.81	17.86	48.67	-25.33	74.00	Peak

Note:

- "*", means this data is the worst emission level.
- C.F (Correction Factor) = Antenna Factor (dB)+ Cable Loss (dB)– Preamplifier(dB).
- Measurement(dBuV/m) = Reading(dBuV) + C.F (Correction Factor).
- The emission levels of other frequencies are very lower than the limit and not show in test report.

EUT	AP311	Date of Test	2020-10-12
Factor	BBHA 9120D (1GHz~18GHz)_2020	Temp. / Humidity	23.7°C/37%
Polarity	Horizontal	Site / Test Engineer	AC1 / Kevin Ker
Test Mode	Transmit by 802.11ax-HE20 at channel 5260MHz	Test Voltage	120V/60Hz

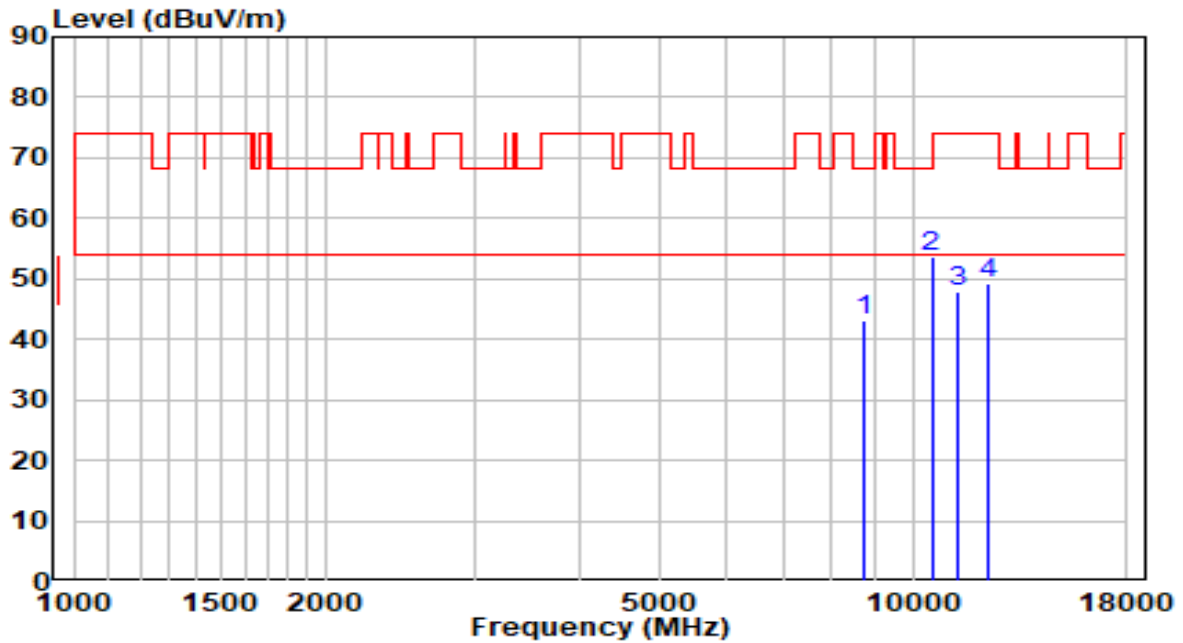

No	Frequency (MHz)	Reading (dBuV)	C.F (dB)	Measurement (dBuV/m)	Margin (dB)	Limit (dBuV/m)	Remark (QP/PK/AV)
1	8752.000	30.06	13.07	43.13	-25.07	68.20	Peak
2	* 10528.500	36.71	17.11	53.82	-14.38	68.20	Peak
3	11319.000	29.62	18.21	47.83	-26.17	74.00	Peak
4	12254.000	31.37	17.86	49.23	-24.77	74.00	Peak

Note:

1. " *", means this data is the worst emission level.
2. C.F (Correction Factor) = Antenna Factor (dB)+ Cable Loss (dB)– Preamplifier(dB).
3. Measurement(dBuV/m) = Reading(dBuV) + C.F (Correction Factor).
- 4.The emission levels of other frequencies are very lower than the limit and not show in test report.

EUT	AP311	Date of Test	2020-10-12
Factor	BBHA 9120D (1GHz~18GHz)_2020	Temp. / Humidity	23.7°C/37%
Polarity	Vertical	Site / Test Engineer	AC1 / Kevin Ker
Test Mode	Transmit by 802.11ax-HE20 at channel 5260MHz	Test Voltage	120V/60Hz

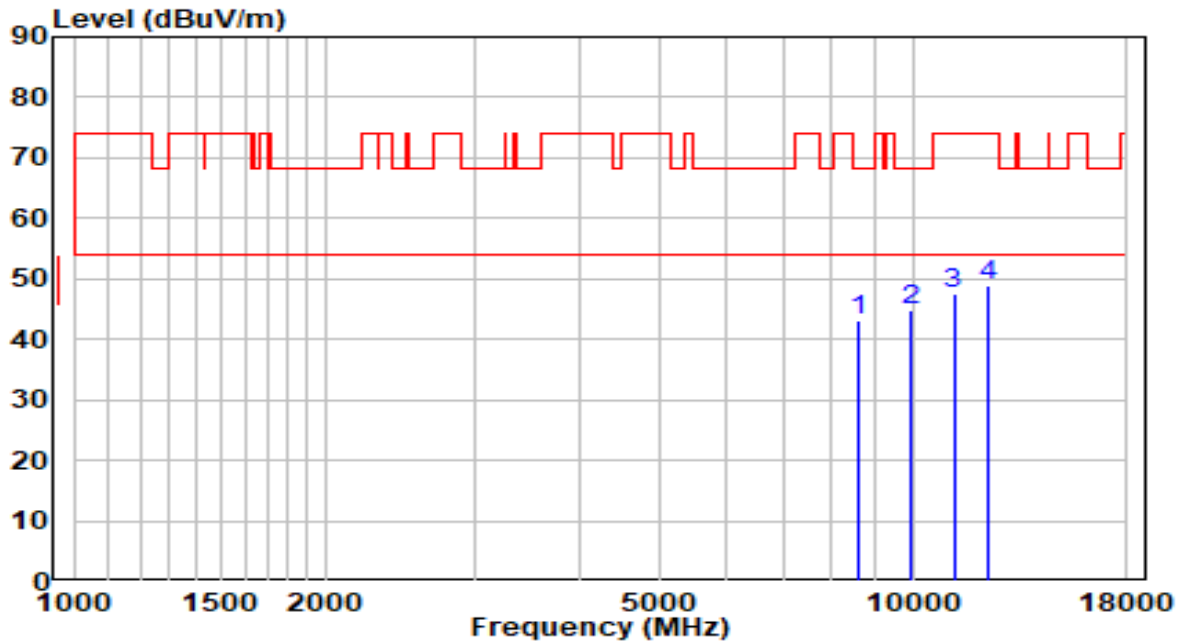

No	Frequency (MHz)	Reading (dBuV)	C.F (dB)	Measurement (dBuV/m)	Margin (dB)	Limit (dBuV/m)	Remark (QP/PK/AV)
1	8599.000	30.57	12.70	43.26	-24.94	68.20	Peak
2	* 9967.500	29.59	15.30	44.89	-23.31	68.20	Peak
3	11183.000	29.59	18.03	47.61	-26.39	74.00	Peak
4	12254.000	31.09	17.86	48.96	-25.04	74.00	Peak

Note:

1. " *", means this data is the worst emission level.
2. C.F (Correction Factor) = Antenna Factor (dB)+ Cable Loss (dB)– Preamplifier(dB).
3. Measurement(dBuV/m) = Reading(dBuV) + C.F (Correction Factor).
- 4.The emission levels of other frequencies are very lower than the limit and not show in test report.

EUT	AP311	Date of Test	2020-10-12
Factor	BBHA 9120D (1GHz~18GHz)_2020	Temp. / Humidity	23.7°C/37%
Polarity	Horizontal	Site / Test Engineer	AC1 / Kevin Ker
Test Mode	Transmit by 802.11ax-HE20 at channel 5300MHz	Test Voltage	120V/60Hz

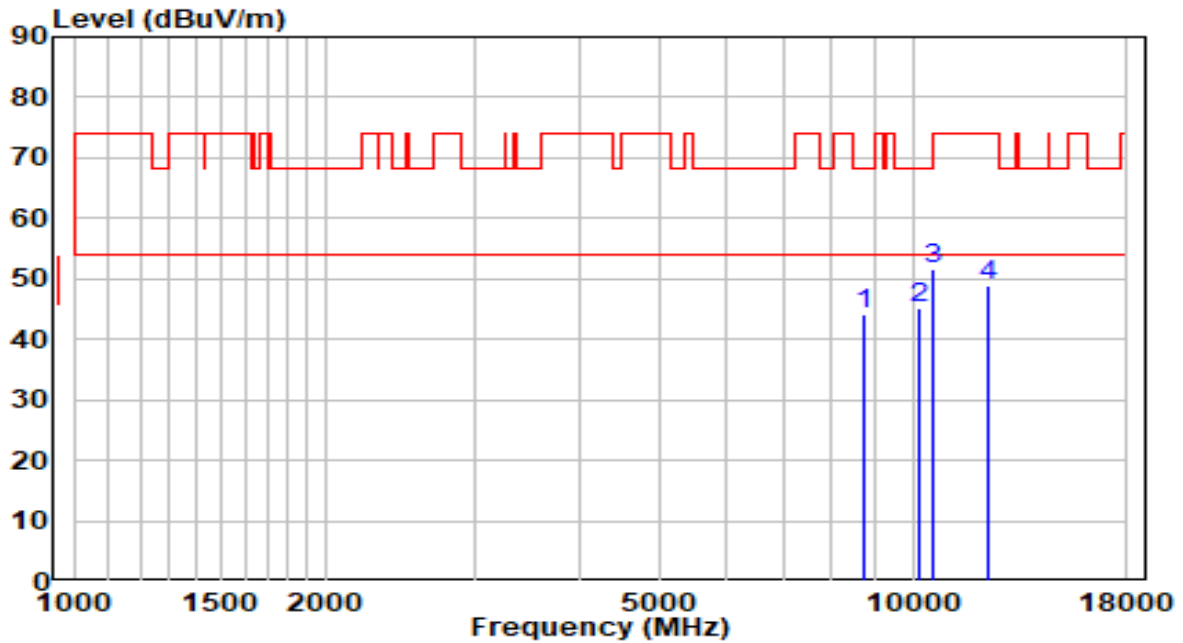

No	Frequency (MHz)	Reading (dBuV)	C.F (dB)	Measurement (dBuV/m)	Margin (dB)	Limit (dBuV/m)	Remark (QP/PK/AV)
1	8735.000	31.20	13.03	44.23	-23.97	68.20	Peak
2	10180.000	29.08	15.98	45.06	-23.14	68.20	Peak
3	* 10605.000	34.53	17.22	51.74	-22.26	74.00	Peak
4	12279.500	31.00	17.87	48.87	-25.13	74.00	Peak

Note:

1. " *", means this data is the worst emission level.
2. C.F (Correction Factor) = Antenna Factor (dB)+ Cable Loss (dB)– Preamplifier(dB).
3. Measurement(dBuV/m) = Reading(dBuV) + C.F (Correction Factor).
- 4.The emission levels of other frequencies are very lower than the limit and not show in test report.

EUT	AP311	Date of Test	2020-10-12
Factor	BBHA 9120D (1GHz~18GHz)_2020	Temp. / Humidity	23.7°C/37%
Polarity	Vertical	Site / Test Engineer	AC1 / Kevin Ker
Test Mode	Transmit by 802.11ax-HE20 at channel 5300MHz	Test Voltage	120V/60Hz

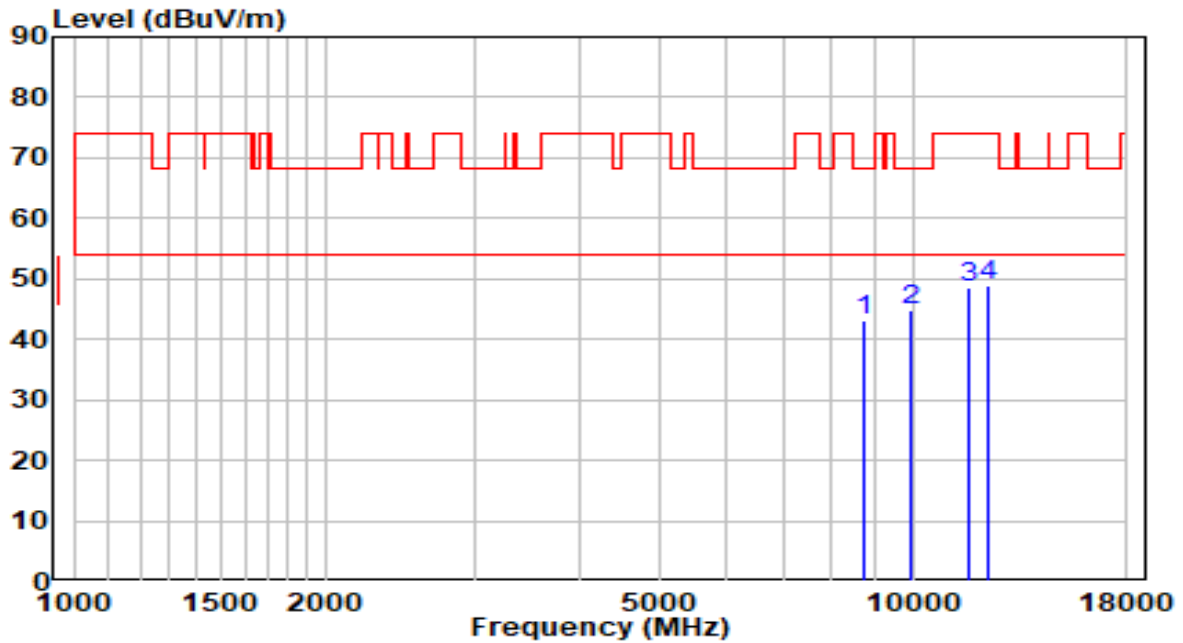

No	Frequency (MHz)	Reading (dBuV)	C.F (dB)	Measurement (dBuV/m)	Margin (dB)	Limit (dBuV/m)	Remark (QP/PK/AV)
1	8743.500	30.01	13.05	43.06	-25.14	68.20	Peak
2	* 9976.000	29.52	15.31	44.84	-23.36	68.20	Peak
3	11642.000	30.40	18.27	48.67	-25.33	74.00	Peak
4	12254.000	30.99	17.86	48.85	-25.15	74.00	Peak

Note:

- "*", means this data is the worst emission level.
- C.F (Correction Factor) = Antenna Factor (dB)+ Cable Loss (dB)– Preamplifier(dB).
- Measurement(dBuV/m) = Reading(dBuV) + C.F (Correction Factor).
- The emission levels of other frequencies are very lower than the limit and not show in test report.

EUT	AP311	Date of Test	2020-10-12
Factor	BBHA 9120D (1GHz~18GHz)_2020	Temp. / Humidity	23.7°C/37%
Polarity	Horizontal	Site / Test Engineer	AC1 / Kevin Ker
Test Mode	Transmit by 802.11ax-HE20 at channel 5320MHz	Test Voltage	120V/60Hz

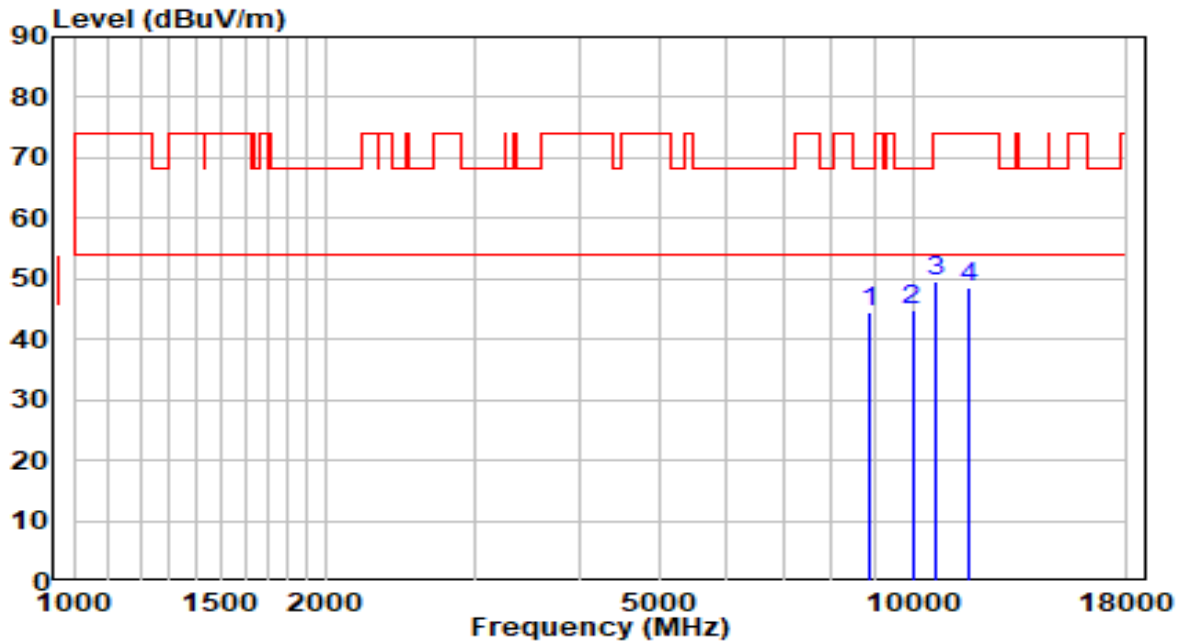

No	Frequency (MHz)	Reading (dBuV)	C.F (dB)	Measurement (dBuV/m)	Margin (dB)	Limit (dBuV/m)	Remark (QP/PK/AV)
1	8905.000	30.95	13.45	44.39	-23.81	68.20	Peak
2	* 9984.500	29.53	15.33	44.87	-23.34	68.20	Peak
3	10630.500	32.43	17.26	49.68	-24.32	74.00	Peak
4	11684.500	30.23	18.22	48.45	-25.55	74.00	Peak

Note:

- "*", means this data is the worst emission level.
- C.F (Correction Factor) = Antenna Factor (dB)+ Cable Loss (dB)– Preamplifier(dB).
- Measurement(dBuV/m) = Reading(dBuV) + C.F (Correction Factor).
- The emission levels of other frequencies are very lower than the limit and not show in test report.

EUT	AP311	Date of Test	2020-10-12
Factor	BBHA 9120D (1GHz~18GHz)_2020	Temp. / Humidity	23.7°C/37%
Polarity	Vertical	Site / Test Engineer	AC1 / Kevin Ker
Test Mode	Transmit by 802.11ax-HE20 at channel 5320MHz	Test Voltage	120V/60Hz

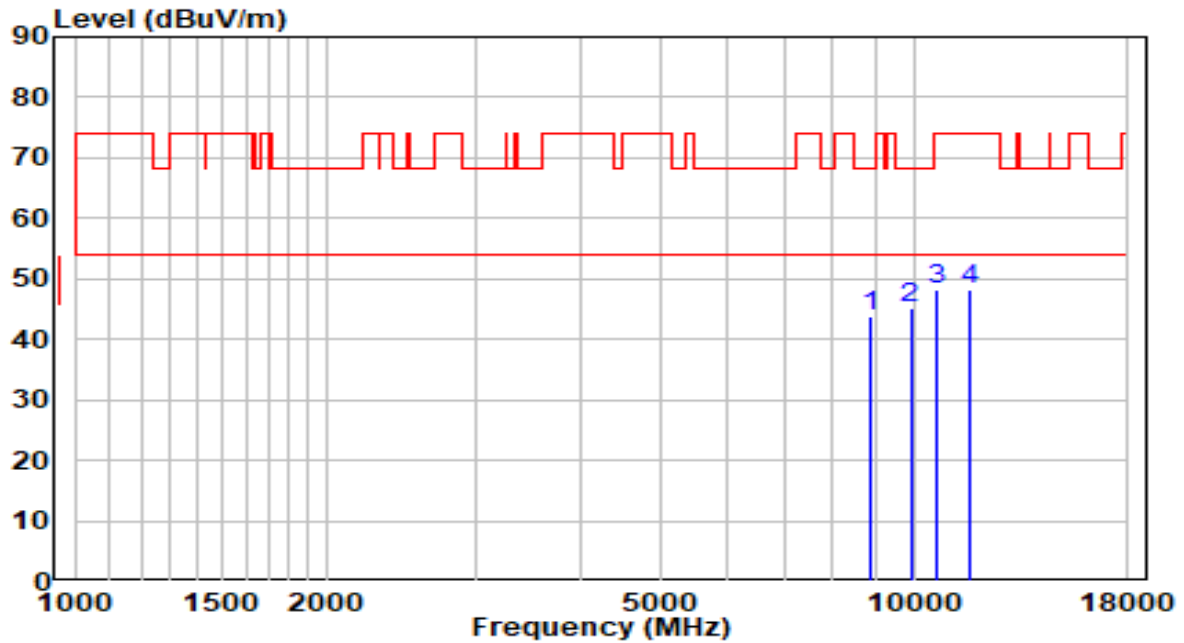

No	Frequency (MHz)	Reading (dBuV)	C.F (dB)	Measurement (dBuV/m)	Margin (dB)	Limit (dBuV/m)	Remark (QP/PK/AV)
1	8871.000	30.51	13.36	43.87	-24.33	68.20	Peak
2	* 9908.000	30.06	15.19	45.25	-22.95	68.20	Peak
3	10639.000	31.09	17.27	48.36	-25.64	74.00	Peak
4	11684.500	29.93	18.22	48.15	-25.85	74.00	Peak

Note:

1. " *", means this data is the worst emission level.
2. C.F (Correction Factor) = Antenna Factor (dB)+ Cable Loss (dB)– Preamplifier(dB).
3. Measurement(dBuV/m) = Reading(dBuV) + C.F (Correction Factor).
- 4.The emission levels of other frequencies are very lower than the limit and not show in test report.

EUT	AP311	Date of Test	2020-10-12
Factor	BBHA 9120D (1GHz~18GHz)_2020	Temp. / Humidity	23.7°C/37%
Polarity	Horizontal	Site / Test Engineer	AC1 / Kevin Ker
Test Mode	Transmit by 802.11ax-HE20 at channel 5500MHz	Test Voltage	120V/60Hz

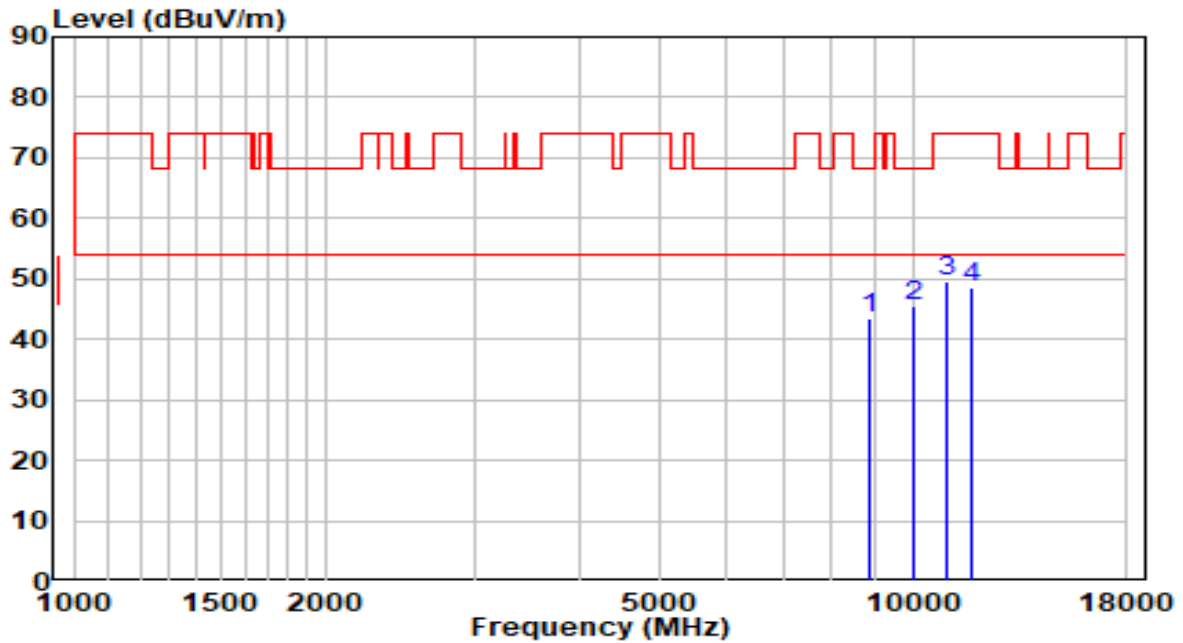

No	Frequency (MHz)	Reading (dBuV)	C.F (dB)	Measurement (dBuV/m)	Margin (dB)	Limit (dBuV/m)	Remark (QP/PK/AV)
1	8871.000	30.11	13.36	43.48	-24.72	68.20	Peak
2	* 9993.000	30.13	15.35	45.48	-22.72	68.20	Peak
3	10996.000	31.88	17.77	49.65	-24.35	74.00	Peak
4	11718.500	30.33	18.17	48.50	-25.50	74.00	Peak

Note:

1. " *", means this data is the worst emission level.
2. C.F (Correction Factor) = Antenna Factor (dB)+ Cable Loss (dB)– Preamplifier(dB).
3. Measurement(dBuV/m) = Reading(dBuV) + C.F (Correction Factor).
- 4.The emission levels of other frequencies are very lower than the limit and not show in test report.

EUT	AP311	Date of Test	2020-10-12
Factor	BBHA 9120D (1GHz~18GHz)_2020	Temp. / Humidity	23.7°C/37%
Polarity	Vertical	Site / Test Engineer	AC1 / Kevin Ker
Test Mode	Transmit by 802.11ax-HE20 at channel 5500MHz	Test Voltage	120V/60Hz

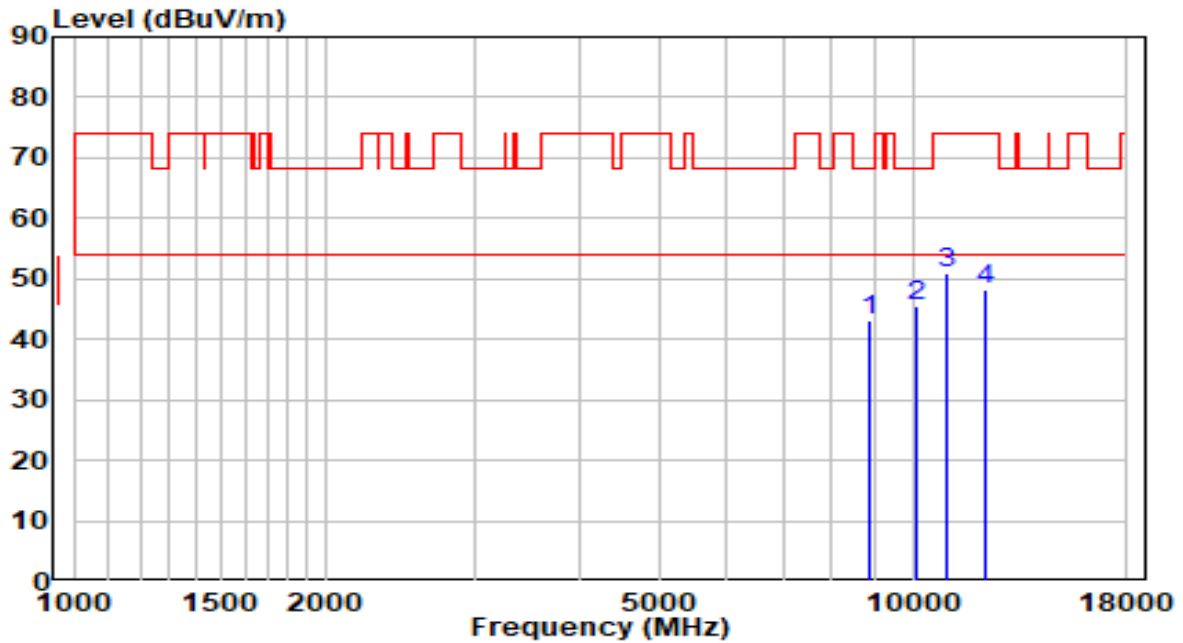

No	Frequency (MHz)	Reading (dBuV)	C.F (dB)	Measurement (dBuV/m)	Margin (dB)	Limit (dBuV/m)	Remark (QP/PK/AV)
1	8905.000	29.71	13.45	43.15	-25.05	68.20	Peak
2	* 10069.500	29.78	15.60	45.38	-22.82	68.20	Peak
3	11004.500	33.06	17.79	50.85	-23.15	74.00	Peak
4	12237.000	30.25	17.86	48.11	-25.89	74.00	Peak

Note:

1. " *", means this data is the worst emission level.
2. C.F (Correction Factor) = Antenna Factor (dB)+ Cable Loss (dB)– Preamplifier(dB).
3. Measurement(dBuV/m) = Reading(dBuV) + C.F (Correction Factor).
- 4.The emission levels of other frequencies are very lower than the limit and not show in test report.

EUT	AP311	Date of Test	2020-10-12
Factor	BBHA 9120D (1GHz~18GHz)_2020	Temp. / Humidity	23.7°C/37%
Polarity	Horizontal	Site / Test Engineer	AC1 / Kevin Ker
Test Mode	Transmit by 802.11ax-HE20 at channel 5580MHz	Test Voltage	120V/60Hz

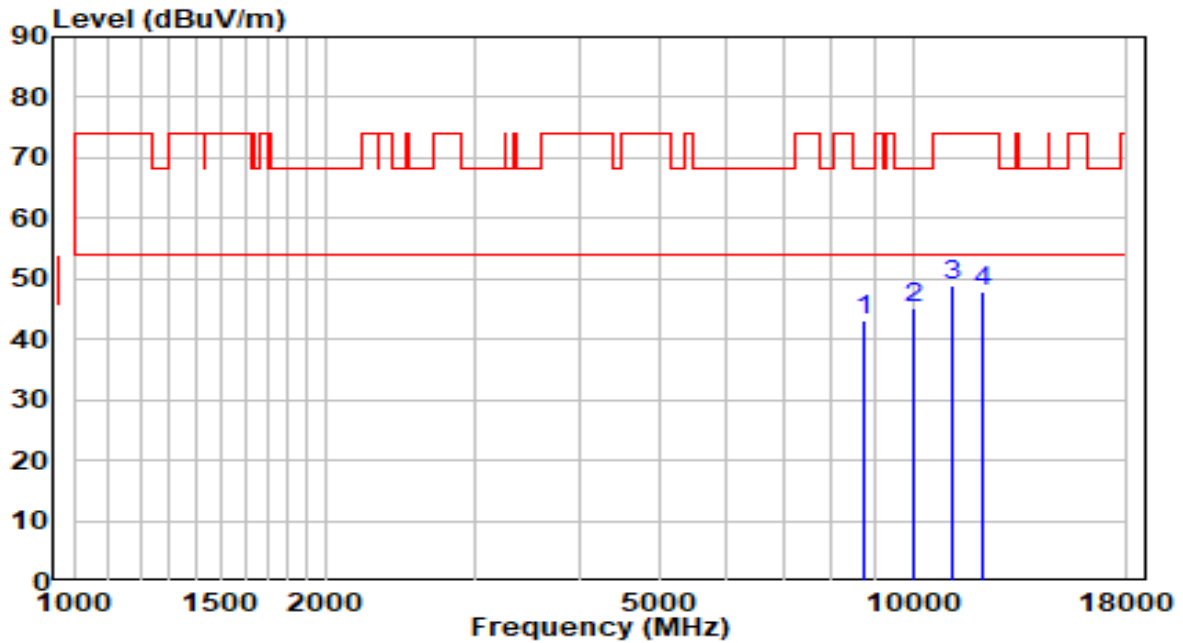

No	Frequency (MHz)	Reading (dBuV)	C.F (dB)	Measurement (dBuV/m)	Margin (dB)	Limit (dBuV/m)	Remark (QP/PK/AV)
1	8752.000	29.95	13.07	43.02	-25.18	68.20	Peak
2	* 9993.000	29.97	15.35	45.31	-22.89	68.20	Peak
3	11166.000	30.83	18.00	48.84	-25.16	74.00	Peak
4	12143.500	30.19	17.84	48.03	-25.97	74.00	Peak

Note:

- "*", means this data is the worst emission level.
- C.F (Correction Factor) = Antenna Factor (dB)+ Cable Loss (dB)– Preamplifier(dB).
- Measurement(dBuV/m) = Reading(dBuV) + C.F (Correction Factor).
- The emission levels of other frequencies are very lower than the limit and not show in test report.

EUT	AP311	Date of Test	2020-10-12
Factor	BBHA 9120D (1GHz~18GHz)_2020	Temp. / Humidity	23.7°C/37%
Polarity	Vertical	Site / Test Engineer	AC1 / Kevin Ker
Test Mode	Transmit by 802.11ax-HE20 at channel 5580MHz	Test Voltage	120V/60Hz

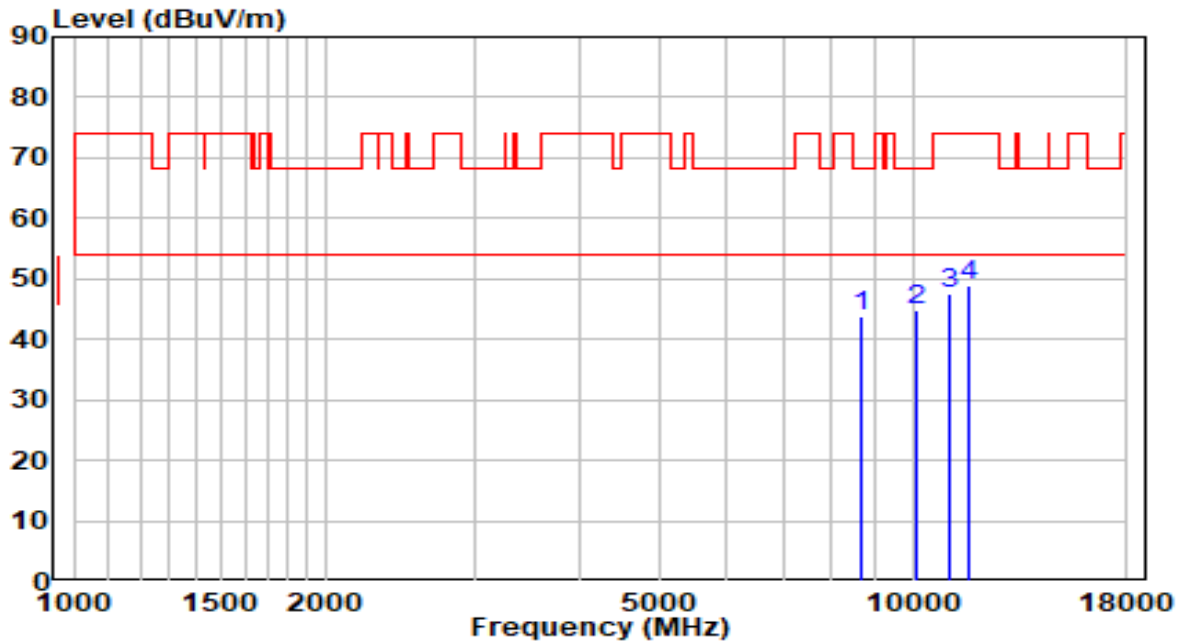

No	Frequency (MHz)	Reading (dBuV)	C.F (dB)	Measurement (dBuV/m)	Margin (dB)	Limit (dBuV/m)	Remark (QP/PK/AV)
1	8650.000	31.00	12.82	43.82	-24.38	68.20	Peak
2	* 10078.000	29.31	15.63	44.93	-23.27	68.20	Peak
3	11030.000	29.80	17.82	47.62	-26.38	74.00	Peak
4	11633.500	30.62	18.28	48.90	-25.10	74.00	Peak

Note:

- "*", means this data is the worst emission level.
- C.F (Correction Factor) = Antenna Factor (dB)+ Cable Loss (dB)– Preamplifier(dB).
- Measurement(dBuV/m) = Reading(dBuV) + C.F (Correction Factor).
- The emission levels of other frequencies are very lower than the limit and not show in test report.

EUT	AP311	Date of Test	2020-10-12
Factor	BBHA 9120D (1GHz~18GHz)_2020	Temp. / Humidity	23.7°C/37%
Polarity	Horizontal	Site / Test Engineer	AC1 / Kevin Ker
Test Mode	Transmit by 802.11ax-HE20 at channel 5700MHz	Test Voltage	120V/60Hz

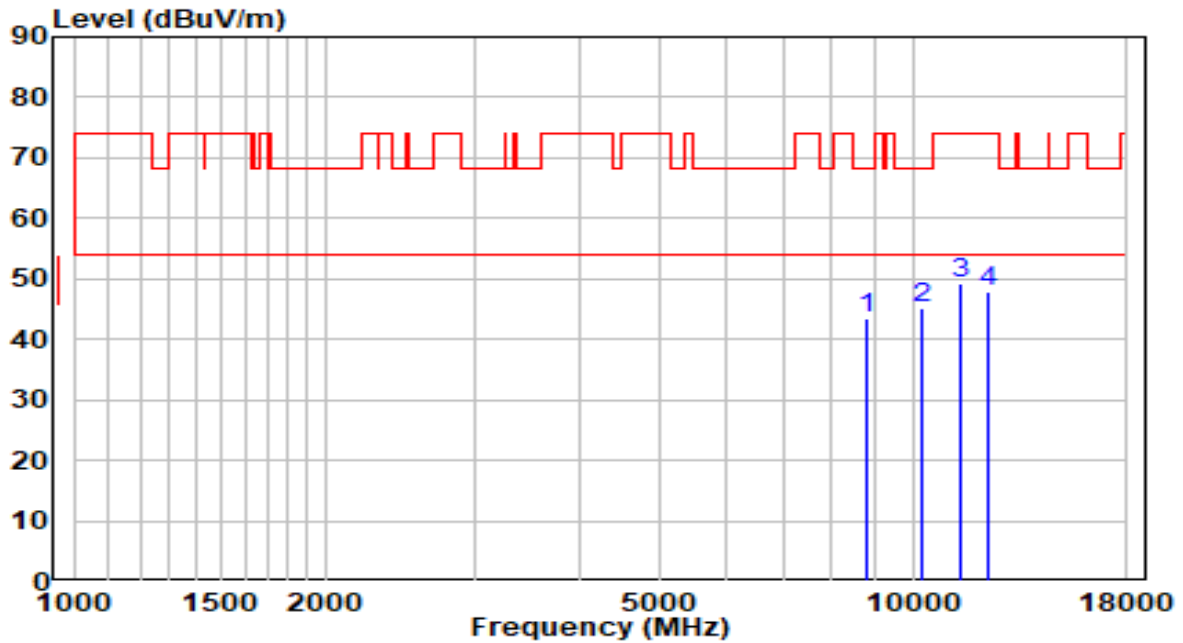

No	Frequency (MHz)	Reading (dBuV)	C.F (dB)	Measurement (dBuV/m)	Margin (dB)	Limit (dBuV/m)	Remark (QP/PK/AV)
1	8820.000	30.33	13.24	43.57	-24.63	68.20	Peak
2	* 10239.500	28.97	16.18	45.15	-23.05	68.20	Peak
3	11404.000	31.07	18.32	49.39	-24.61	74.00	Peak
4	12305.000	29.93	17.87	47.80	-26.20	74.00	Peak

Note:

1. " *", means this data is the worst emission level.
2. C.F (Correction Factor) = Antenna Factor (dB)+ Cable Loss (dB)– Preamplifier(dB).
3. Measurement(dBuV/m) = Reading(dBuV) + C.F (Correction Factor).
- 4.The emission levels of other frequencies are very lower than the limit and not show in test report.

EUT	AP311	Date of Test	2020-10-12
Factor	BBHA 9120D (1GHz~18GHz)_2020	Temp. / Humidity	23.7°C/37%
Polarity	Vertical	Site / Test Engineer	AC1 / Kevin Ker
Test Mode	Transmit by 802.11ax-HE20 at channel 5700MHz	Test Voltage	120V/60Hz

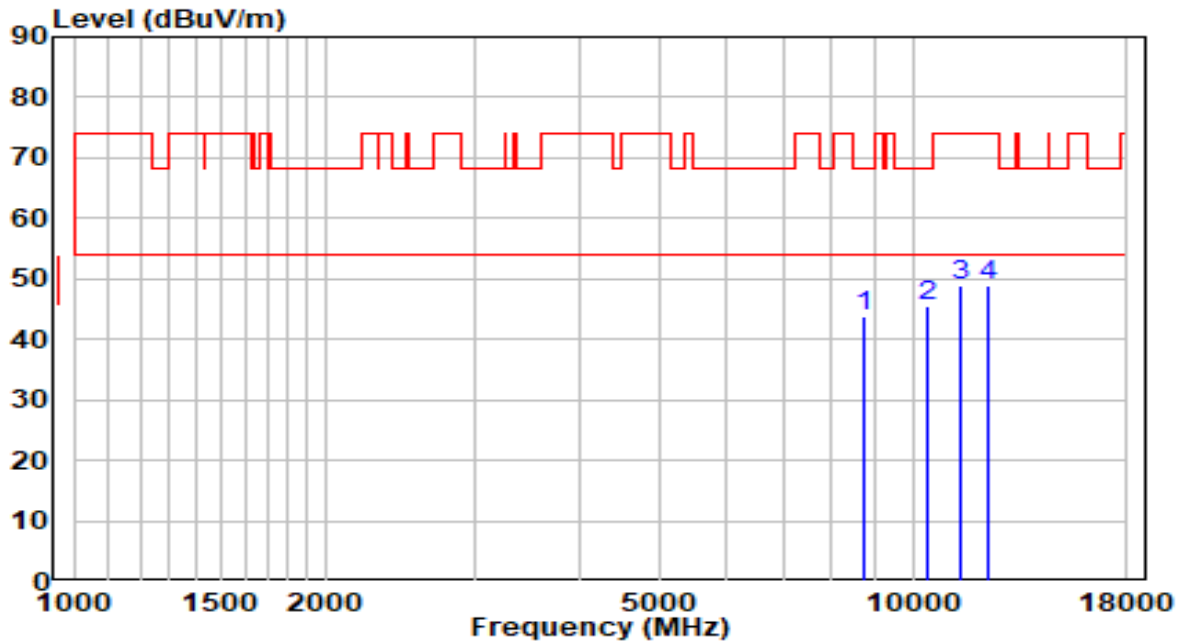

No	Frequency (MHz)	Reading (dBuV)	C.F (dB)	Measurement (dBuV/m)	Margin (dB)	Limit (dBuV/m)	Remark (QP/PK/AV)
1	8735.000	30.61	13.03	43.64	-24.56	68.20	Peak
2	* 10409.500	28.73	16.76	45.49	-22.71	68.20	Peak
3	11395.500	30.44	18.31	48.75	-25.25	74.00	Peak
4	12279.500	30.88	17.87	48.75	-25.25	74.00	Peak

Note:

1. " *", means this data is the worst emission level.
2. C.F (Correction Factor) = Antenna Factor (dB)+ Cable Loss (dB)– Preamplifier(dB).
3. Measurement(dBuV/m) = Reading(dBuV) + C.F (Correction Factor).
- 4.The emission levels of other frequencies are very lower than the limit and not show in test report.

EUT	AP311	Date of Test	2020-10-12
Factor	BBHA 9120D (1GHz~18GHz)_2020	Temp. / Humidity	23.7°C/37%
Polarity	Horizontal	Site / Test Engineer	AC1 / Kevin Ker
Test Mode	Transmit by 802.11ax-HE20 at channel 5720MHz	Test Voltage	120V/60Hz

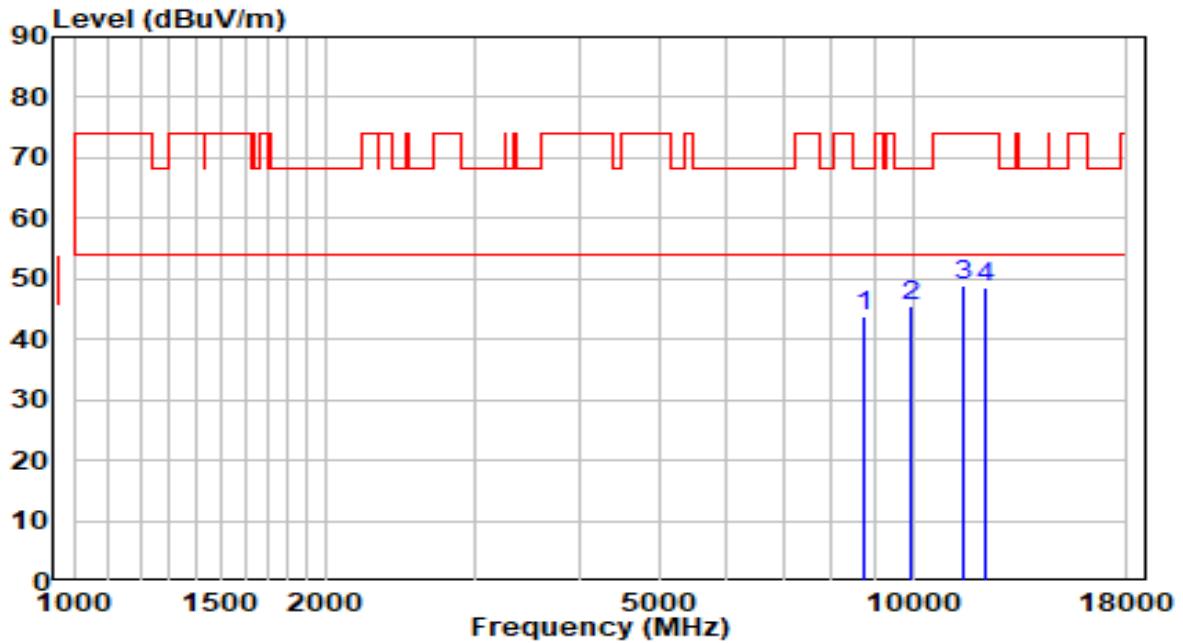

No	Frequency (MHz)	Reading (dBuV)	C.F (dB)	Measurement (dBuV/m)	Margin (dB)	Limit (dBuV/m)	Remark (QP/PK/AV)
1	8726.500	30.71	13.01	43.72	-24.48	68.20	Peak
2	* 9967.500	30.12	15.30	45.42	-22.78	68.20	Peak
3	11446.500	30.57	18.38	48.95	-25.05	74.00	Peak
4	12169.000	30.69	17.85	48.54	-25.46	74.00	Peak

Note:

- "*", means this data is the worst emission level.
- C.F (Correction Factor) = Antenna Factor (dB)+ Cable Loss (dB)– Preamplifier(dB).
- Measurement(dBuV/m) = Reading(dBuV) + C.F (Correction Factor).
- The emission levels of other frequencies are very lower than the limit and not show in test report.

EUT	AP311	Date of Test	2020-10-12
Factor	BBHA 9120D (1GHz~18GHz)_2020	Temp. / Humidity	23.7°C/37%
Polarity	Vertical	Site / Test Engineer	AC1 / Kevin Ker
Test Mode	Transmit by 802.11ax-HE20 at channel 5720MHz	Test Voltage	120V/60Hz

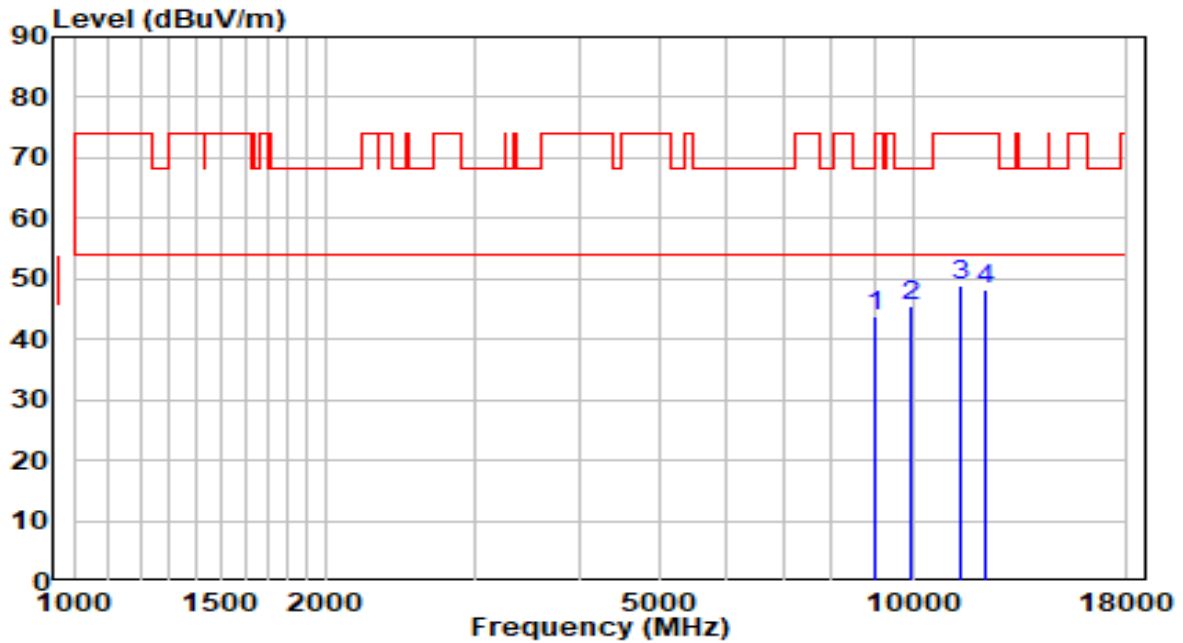

No	Frequency (MHz)	Reading (dBuV)	C.F (dB)	Measurement (dBuV/m)	Margin (dB)	Limit (dBuV/m)	Remark (QP/PK/AV)
1	8990.000	30.16	13.66	43.81	-24.39	68.20	Peak
2	* 9967.500	30.34	15.30	45.64	-22.56	68.20	Peak
3	11438.000	30.71	18.37	49.08	-24.92	74.00	Peak
4	12245.500	30.48	17.86	48.34	-25.66	74.00	Peak

Note:

1. " *", means this data is the worst emission level.
2. C.F (Correction Factor) = Antenna Factor (dB)+ Cable Loss (dB)– Preamplifier(dB).
3. Measurement(dBuV/m) = Reading(dBuV) + C.F (Correction Factor).
- 4.The emission levels of other frequencies are very lower than the limit and not show in test report.

EUT	AP311	Date of Test	2020-10-12
Factor	BBHA 9120D (1GHz~18GHz)_2020	Temp. / Humidity	23.7°C/37%
Polarity	Horizontal	Site / Test Engineer	AC1 / Kevin Ker
Test Mode	Transmit by 802.11ax-HE20 at channel 5745MHz	Test Voltage	120V/60Hz

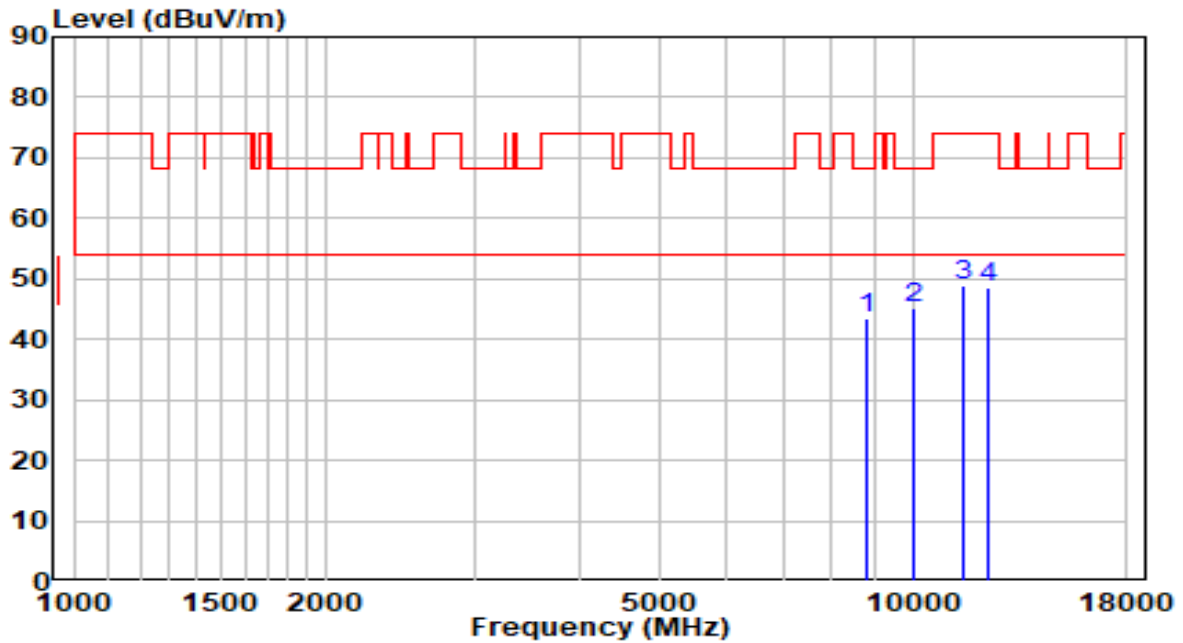

No	Frequency (MHz)	Reading (dBuV)	C.F (dB)	Measurement (dBuV/m)	Margin (dB)	Limit (dBuV/m)	Remark (QP/PK/AV)
1	8794.500	30.37	13.18	43.55	-24.65	68.20	Peak
2	* 9993.000	29.85	15.35	45.19	-23.01	68.20	Peak
3	11497.500	30.53	18.45	48.98	-25.02	74.00	Peak
4	12262.500	30.54	17.86	48.40	-25.60	74.00	Peak

Note:

1. " *", means this data is the worst emission level.
2. C.F (Correction Factor) = Antenna Factor (dB)+ Cable Loss (dB)– Preamplifier(dB).
3. Measurement(dBuV/m) = Reading(dBuV) + C.F (Correction Factor).
- 4.The emission levels of other frequencies are very lower than the limit and not show in test report.

EUT	AP311	Date of Test	2020-10-12
Factor	BBHA 9120D (1GHz~18GHz)_2020	Temp. / Humidity	23.7°C/37%
Polarity	Vertical	Site / Test Engineer	AC1 / Kevin Ker
Test Mode	Transmit by 802.11ax-HE20 at channel 5745MHz	Test Voltage	120V/60Hz

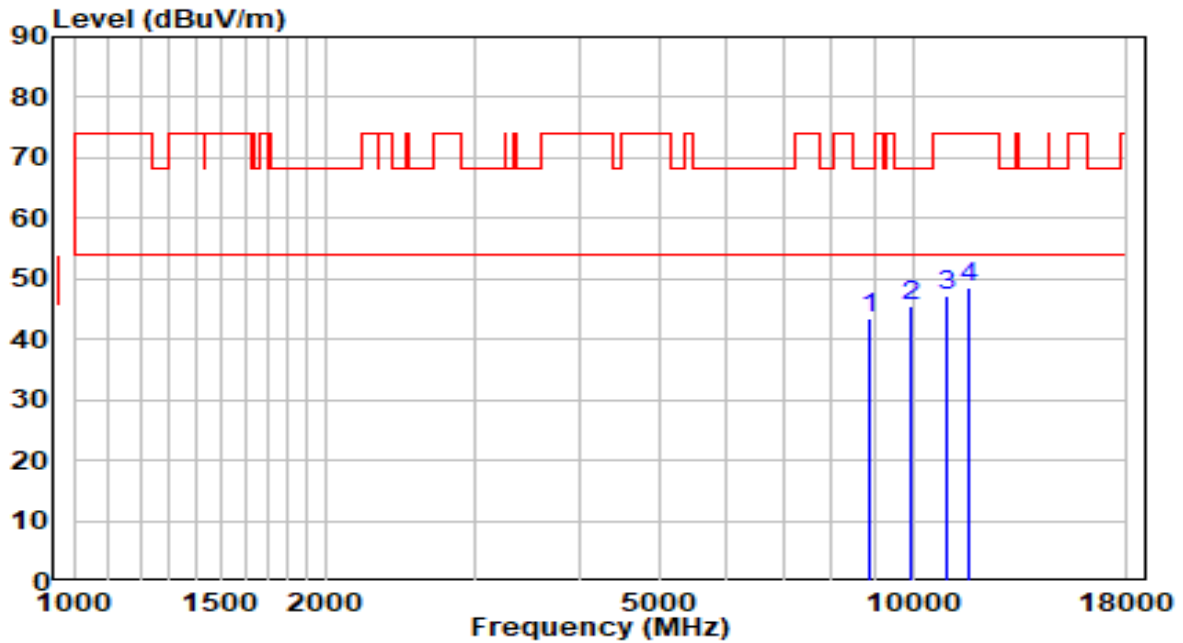

No	Frequency (MHz)	Reading (dBuV)	C.F (dB)	Measurement (dBuV/m)	Margin (dB)	Limit (dBuV/m)	Remark (QP/PK/AV)
1	8871.000	29.97	13.36	43.33	-24.87	68.20	Peak
2	* 9976.000	30.18	15.31	45.50	-22.70	68.20	Peak
3	10979.000	29.57	17.75	47.32	-26.68	74.00	Peak
4	11693.000	30.49	18.21	48.70	-25.30	74.00	Peak

Note:

1. " *", means this data is the worst emission level.
2. C.F (Correction Factor) = Antenna Factor (dB)+ Cable Loss (dB)– Preamplifier(dB).
3. Measurement(dBuV/m) = Reading(dBuV) + C.F (Correction Factor).
- 4.The emission levels of other frequencies are very lower than the limit and not show in test report.

EUT	AP311	Date of Test	2020-10-12
Factor	BBHA 9120D (1GHz~18GHz)_2020	Temp. / Humidity	23.7°C/37%
Polarity	Horizontal	Site / Test Engineer	AC1 / Kevin Ker
Test Mode	Transmit by 802.11ax-HE20 at channel 5785MHz	Test Voltage	120V/60Hz

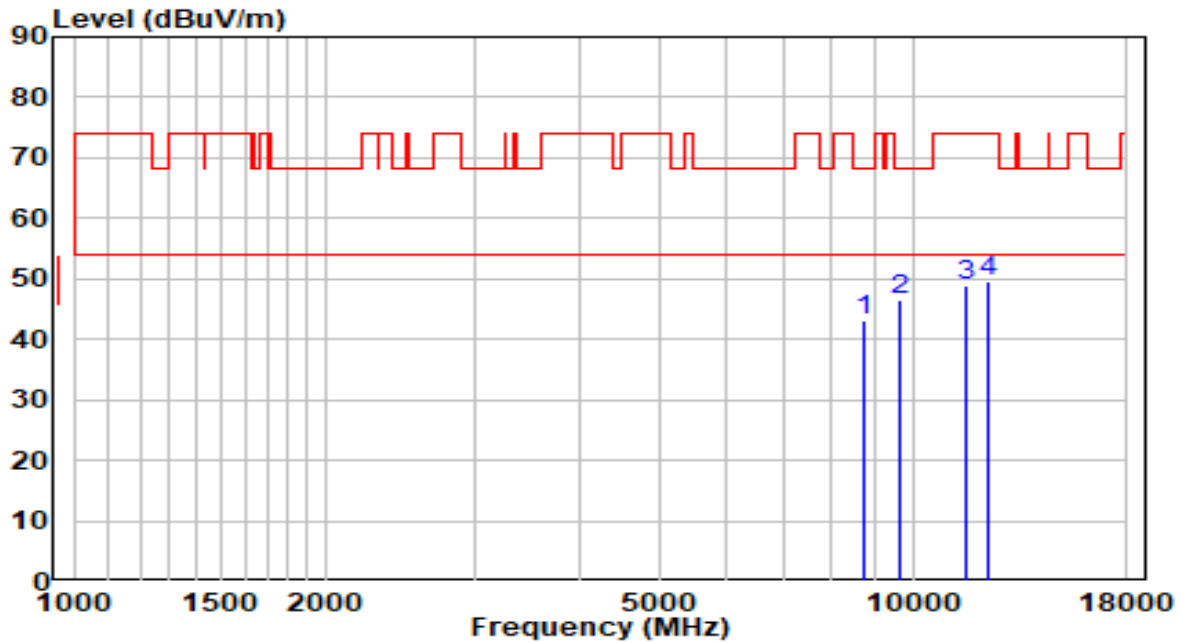

No	Frequency (MHz)	Reading (dBuV)	C.F (dB)	Measurement (dBuV/m)	Margin (dB)	Limit (dBuV/m)	Remark (QP/PK/AV)
1	8752.000	30.11	13.07	43.19	-25.01	68.20	Peak
2	* 9644.500	31.85	14.69	46.54	-21.66	68.20	Peak
3	11565.500	30.45	18.37	48.82	-25.18	74.00	Peak
4	12254.000	31.68	17.86	49.54	-24.46	74.00	Peak

Note:

1. " *", means this data is the worst emission level.
2. C.F (Correction Factor) = Antenna Factor (dB)+ Cable Loss (dB)– Preamplifier(dB).
3. Measurement(dBuV/m) = Reading(dBuV) + C.F (Correction Factor).
- 4.The emission levels of other frequencies are very lower than the limit and not show in test report.

EUT	AP311	Date of Test	2020-10-12
Factor	BBHA 9120D (1GHz~18GHz)_2020	Temp. / Humidity	23.7°C/37%
Polarity	Vertical	Site / Test Engineer	AC1 / Kevin Ker
Test Mode	Transmit by 802.11ax-HE20 at channel 5785MHz	Test Voltage	120V/60Hz

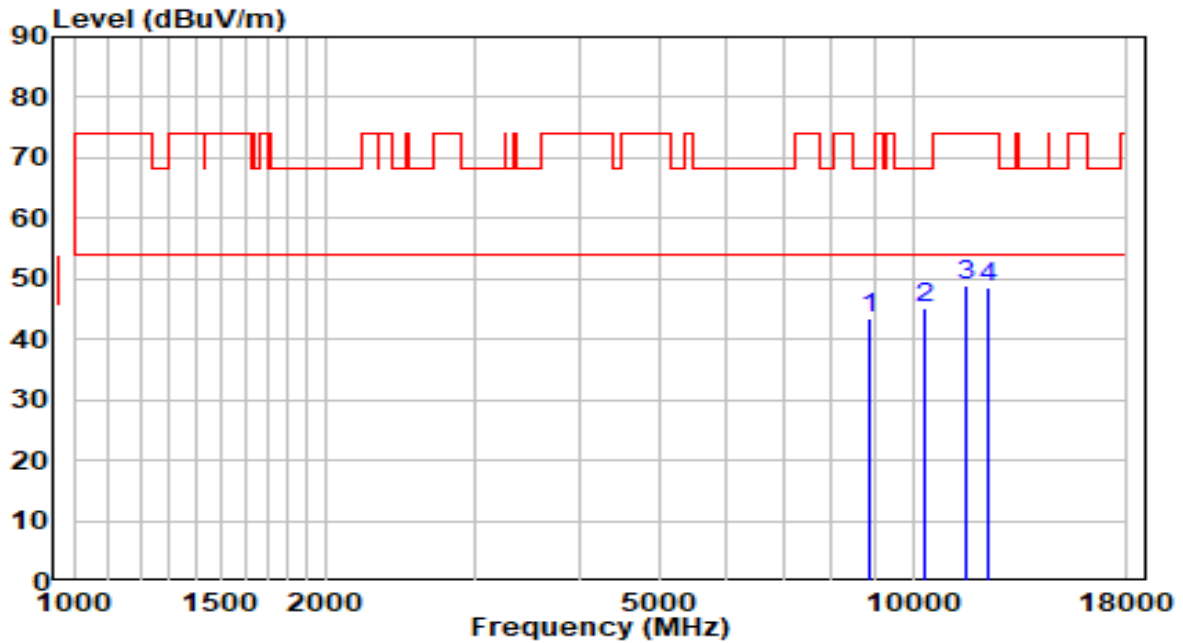

No	Frequency (MHz)	Reading (dBuV)	C.F (dB)	Measurement (dBuV/m)	Margin (dB)	Limit (dBuV/m)	Remark (QP/PK/AV)
1	8879.500	30.05	13.38	43.44	-24.76	68.20	Peak
2	* 10316.000	28.68	16.44	45.12	-23.08	68.20	Peak
3	11565.500	30.37	18.37	48.74	-25.26	74.00	Peak
4	12296.500	30.76	17.87	48.63	-25.37	74.00	Peak

Note:

- "*", means this data is the worst emission level.
- C.F (Correction Factor) = Antenna Factor (dB)+ Cable Loss (dB)– Preamplifier(dB).
- Measurement(dBuV/m) = Reading(dBuV) + C.F (Correction Factor).
- The emission levels of other frequencies are very lower than the limit and not show in test report.

EUT	AP311	Date of Test	2020-10-12
Factor	BBHA 9120D (1GHz~18GHz)_2020	Temp. / Humidity	23.7°C/37%
Polarity	Horizontal	Site / Test Engineer	AC1 / Kevin Ker
Test Mode	Transmit by 802.11ax-HE20 at channel 5825MHz	Test Voltage	120V/60Hz

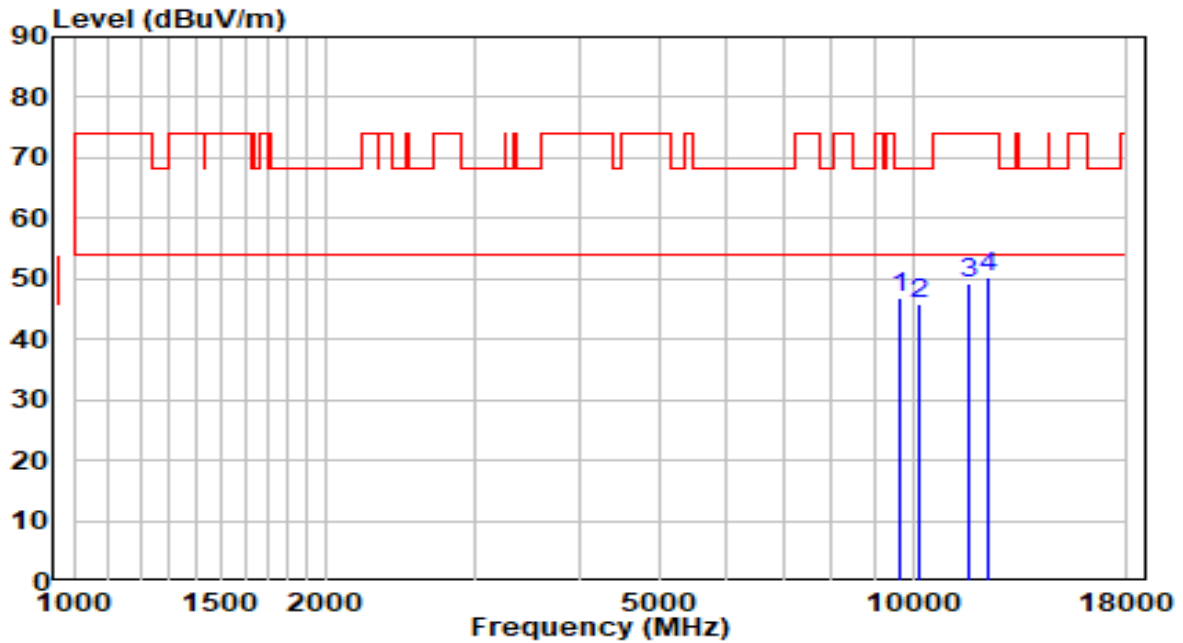

No	Frequency (MHz)	Reading (dBuV)	C.F (dB)	Measurement (dBuV/m)	Margin (dB)	Limit (dBuV/m)	Remark (QP/PK/AV)
1	* 9644.500	32.07	14.69	46.76	-21.44	68.20	Peak
2	10188.500	29.77	16.00	45.77	-22.43	68.20	Peak
3	11642.000	30.86	18.27	49.13	-24.87	74.00	Peak
4	12288.000	32.34	17.87	50.21	-23.79	74.00	Peak

Note:

1. " *", means this data is the worst emission level.
2. C.F (Correction Factor) = Antenna Factor (dB)+ Cable Loss (dB)– Preamplifier(dB).
3. Measurement(dBuV/m) = Reading(dBuV) + C.F (Correction Factor).
- 4.The emission levels of other frequencies are very lower than the limit and not show in test report.

EUT	AP311	Date of Test	2020-10-12
Factor	BBHA 9120D (1GHz~18GHz)_2020	Temp. / Humidity	23.7°C/37%
Polarity	Vertical	Site / Test Engineer	AC1 / Kevin Ker
Test Mode	Transmit by 802.11ax-HE20 at channel 5825MHz	Test Voltage	120V/60Hz

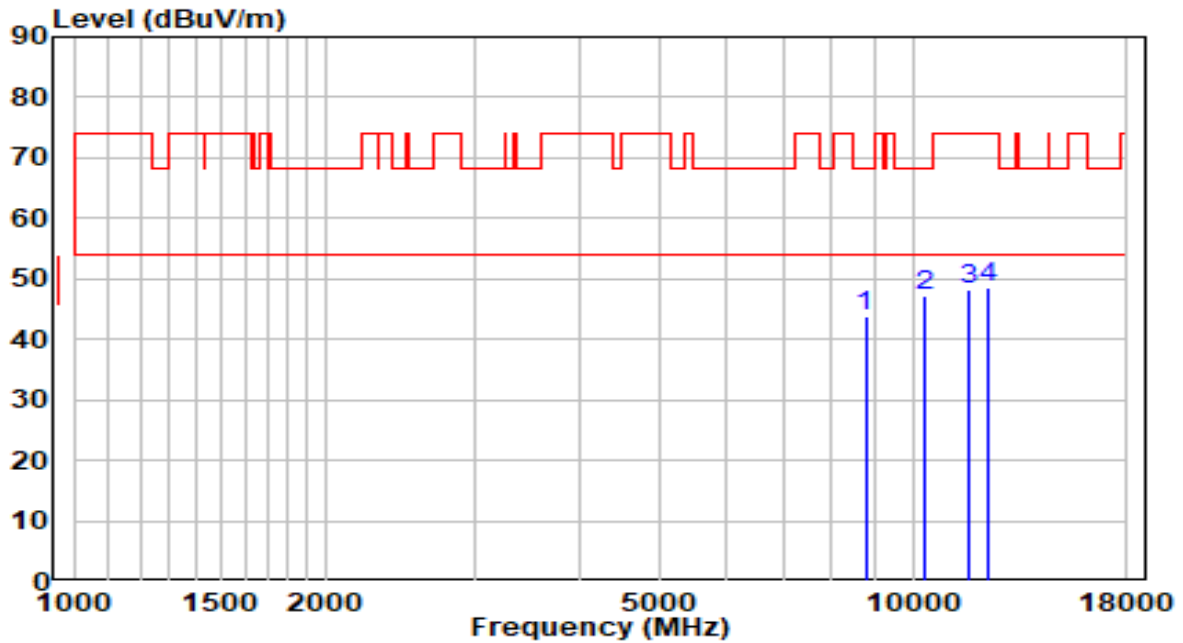

No	Frequency (MHz)	Reading (dBuV)	C.F (dB)	Measurement (dBuV/m)	Margin (dB)	Limit (dBuV/m)	Remark (QP/PK/AV)
1	8777.500	30.55	13.13	43.69	-24.51	68.20	Peak
2	* 10341.500	30.76	16.53	47.29	-20.91	68.20	Peak
3	11642.000	29.85	18.27	48.12	-25.88	74.00	Peak
4	12296.500	30.73	17.87	48.60	-25.40	74.00	Peak

Note:

1. " *", means this data is the worst emission level.
2. C.F (Correction Factor) = Antenna Factor (dB)+ Cable Loss (dB)– Preamplifier(dB).
3. Measurement(dBuV/m) = Reading(dBuV) + C.F (Correction Factor).
- 4.The emission levels of other frequencies are very lower than the limit and not show in test report.

EUT	AP311	Date of Test	2020-10-12
Factor	BBHA 9120D (1GHz~18GHz)_2020	Temp. / Humidity	23.7°C/37%
Polarity	Horizontal	Site / Test Engineer	AC1 / Kevin Ker
Test Mode	Transmit by 802.11ax-HE40 at channel 5190MHz	Test Voltage	120V/60Hz

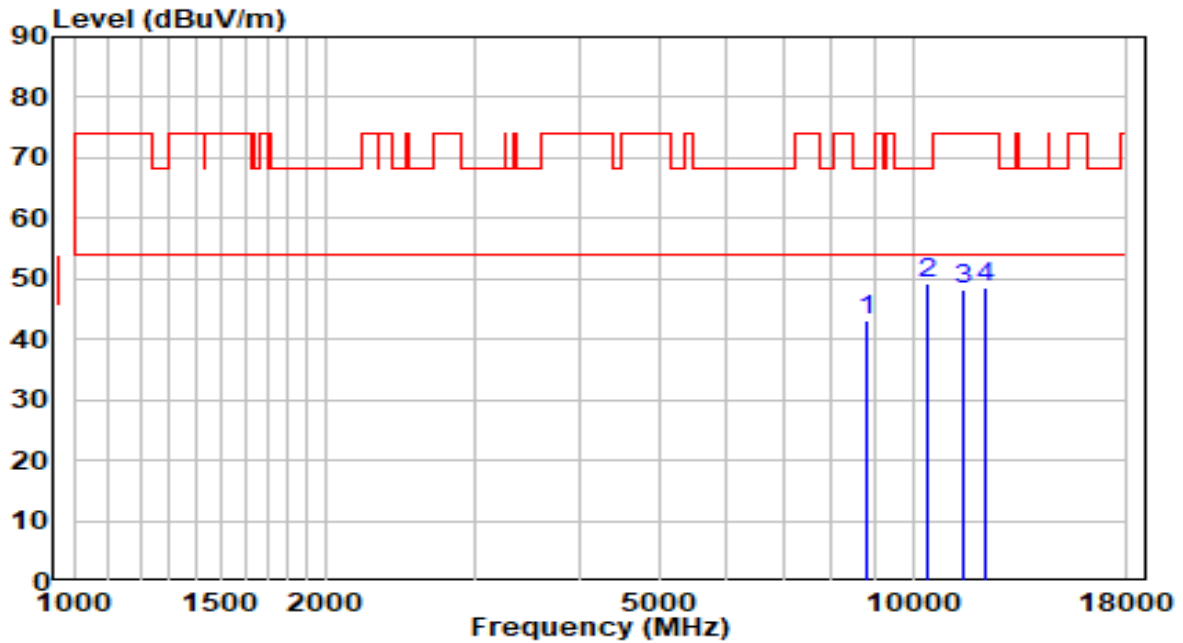

No	Frequency (MHz)	Reading (dBuV)	C.F (dB)	Measurement (dBuV/m)	Margin (dB)	Limit (dBuV/m)	Remark (QP/PK/AV)
1	8811.500	30.02	13.22	43.24	-24.96	68.20	Peak
2	* 10384.000	32.53	16.67	49.20	-19.00	68.20	Peak
3	11446.500	29.95	18.38	48.33	-25.67	74.00	Peak
4	12245.500	30.72	17.86	48.58	-25.42	74.00	Peak

Note:

1. " *", means this data is the worst emission level.
2. C.F (Correction Factor) = Antenna Factor (dB)+ Cable Loss (dB)– Preamplifier(dB).
3. Measurement(dBuV/m) = Reading(dBuV) + C.F (Correction Factor).
- 4.The emission levels of other frequencies are very lower than the limit and not show in test report.

EUT	AP311	Date of Test	2020-10-12
Factor	BBHA 9120D (1GHz~18GHz)_2020	Temp. / Humidity	23.7°C/37%
Polarity	Vertical	Site / Test Engineer	AC1 / Kevin Ker
Test Mode	Transmit by 802.11ax-HE40 at channel 5190MHz	Test Voltage	120V/60Hz

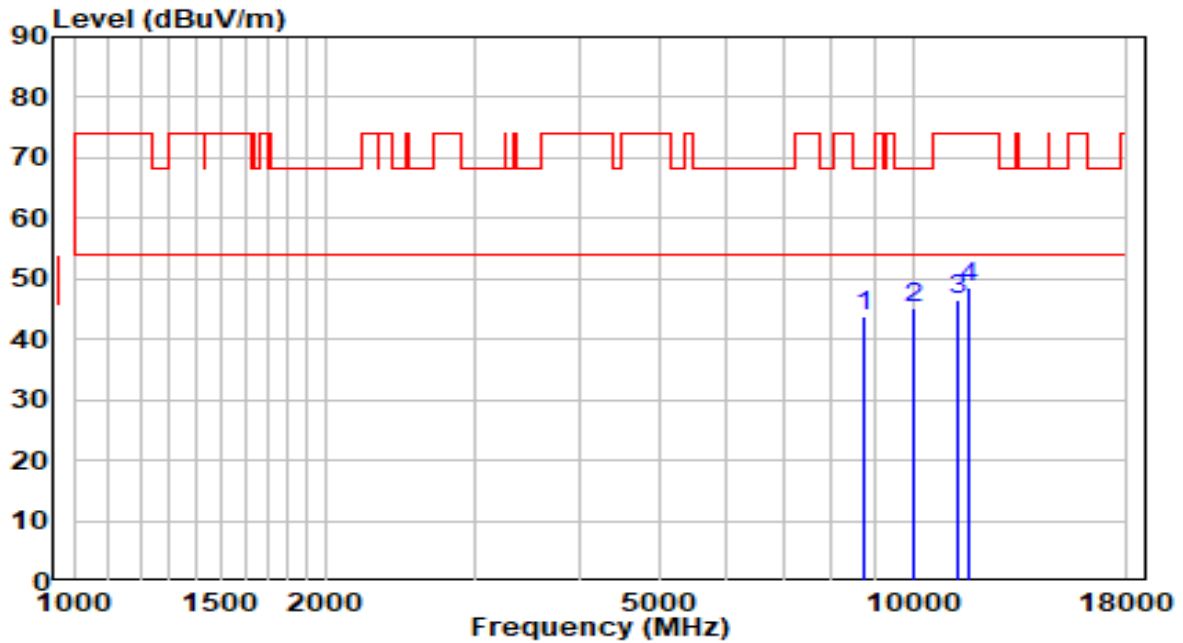

No	Frequency (MHz)	Reading (dBuV)	C.F (dB)	Measurement (dBuV/m)	Margin (dB)	Limit (dBuV/m)	Remark (QP/PK/AV)
1	8743.500	30.62	13.05	43.67	-24.53	68.20	Peak
2	* 10001.500	29.70	15.37	45.06	-23.14	68.20	Peak
3	11276.500	28.52	18.15	46.67	-27.33	74.00	Peak
4	11642.000	30.26	18.27	48.54	-25.46	74.00	Peak

Note:

1. " *", means this data is the worst emission level.
2. C.F (Correction Factor) = Antenna Factor (dB)+ Cable Loss (dB)– Preamplifier(dB).
3. Measurement(dBuV/m) = Reading(dBuV) + C.F (Correction Factor).
- 4.The emission levels of other frequencies are very lower than the limit and not show in test report.

EUT	AP311	Date of Test	2020-10-12
Factor	BBHA 9120D (1GHz~18GHz)_2020	Temp. / Humidity	23.7°C/37%
Polarity	Horizontal	Site / Test Engineer	AC1 / Kevin Ker
Test Mode	Transmit by 802.11ax-HE40 at channel 5230MHz	Test Voltage	120V/60Hz

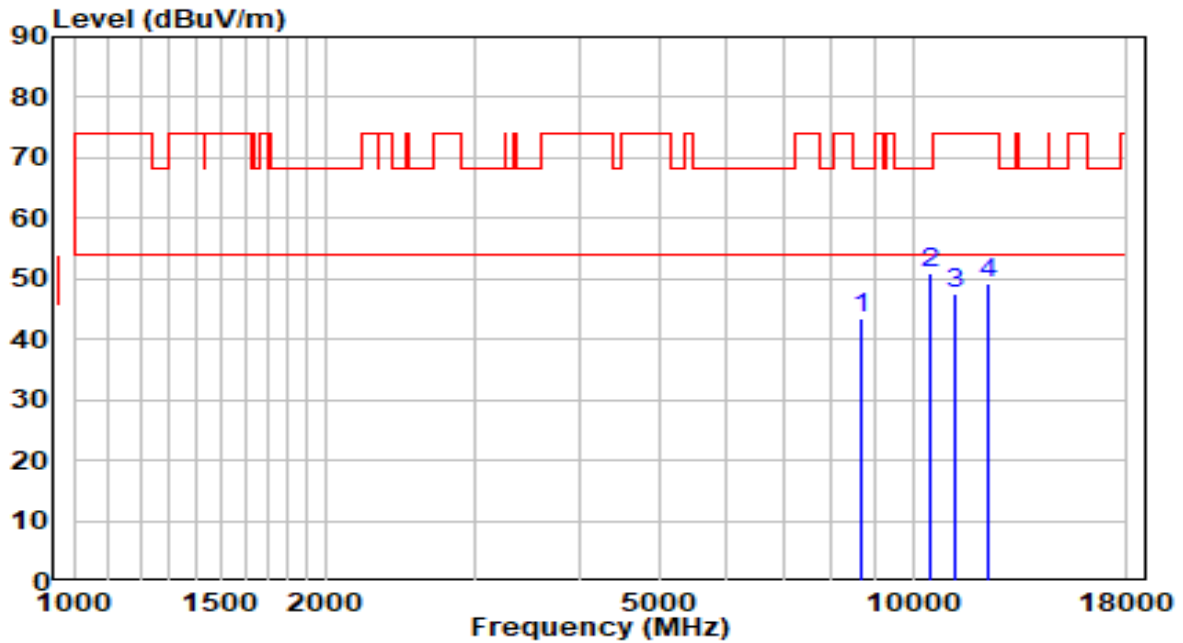

No	Frequency (MHz)	Reading (dBuV)	C.F (dB)	Measurement (dBuV/m)	Margin (dB)	Limit (dBuV/m)	Remark (QP/PK/AV)
1	8667.000	30.74	12.86	43.60	-24.60	68.20	Peak
2	* 10452.000	34.17	16.91	51.08	-17.12	68.20	Peak
3	11208.500	29.35	18.06	47.41	-26.59	74.00	Peak
4	12296.500	31.35	17.87	49.22	-24.78	74.00	Peak

Note:

- "*", means this data is the worst emission level.
- C.F (Correction Factor) = Antenna Factor (dB)+ Cable Loss (dB)– Preamplifier(dB).
- Measurement(dBuV/m) = Reading(dBuV) + C.F (Correction Factor).
- The emission levels of other frequencies are very lower than the limit and not show in test report.

EUT	AP311	Date of Test	2020-10-12
Factor	BBHA 9120D (1GHz~18GHz)_2020	Temp. / Humidity	23.7°C/37%
Polarity	Vertical	Site / Test Engineer	AC1 / Kevin Ker
Test Mode	Transmit by 802.11ax-HE40 at channel 5230MHz	Test Voltage	120V/60Hz

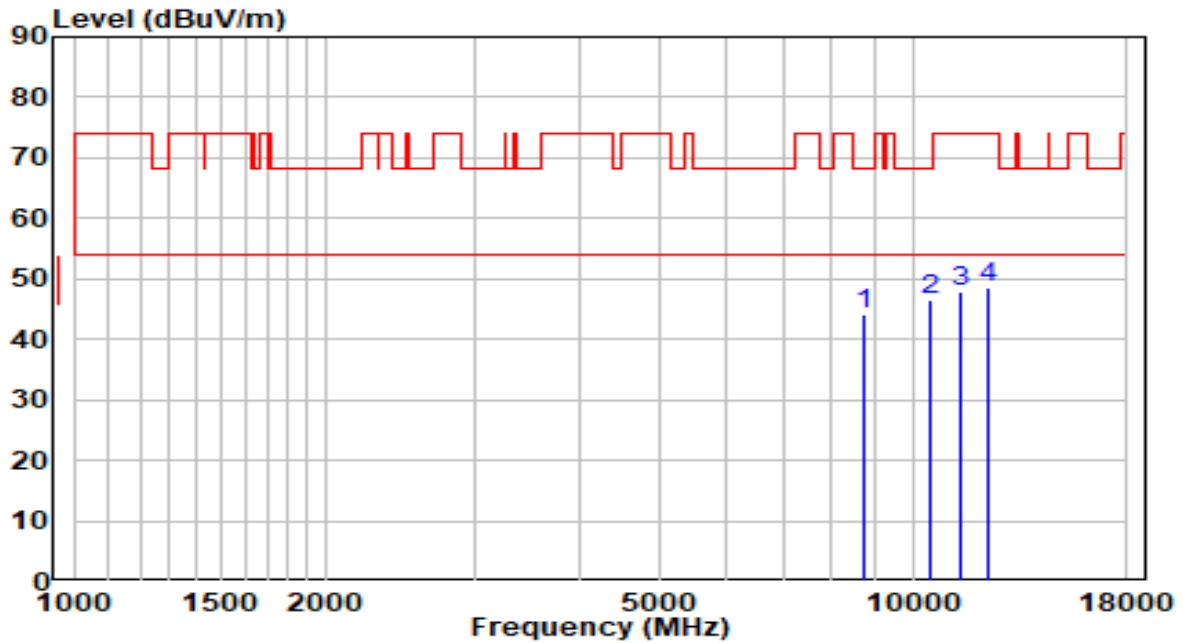

No	Frequency (MHz)	Reading (dBuV)	C.F (dB)	Measurement (dBuV/m)	Margin (dB)	Limit (dBuV/m)	Remark (QP/PK/AV)
1	8735.000	31.25	13.03	44.28	-23.92	68.20	Peak
2	* 10469.000	29.66	16.96	46.63	-21.57	68.20	Peak
3	11370.000	29.49	18.28	47.76	-26.24	74.00	Peak
4	12296.500	30.54	17.87	48.41	-25.59	74.00	Peak

Note:

- "*", means this data is the worst emission level.
- C.F (Correction Factor) = Antenna Factor (dB)+ Cable Loss (dB)– Preamplifier(dB).
- Measurement(dBuV/m) = Reading(dBuV) + C.F (Correction Factor).
- The emission levels of other frequencies are very lower than the limit and not show in test report.

EUT	AP311	Date of Test	2020-10-12
Factor	BBHA 9120D (1GHz~18GHz)_2020	Temp. / Humidity	23.7°C/37%
Polarity	Horizontal	Site / Test Engineer	AC1 / Kevin Ker
Test Mode	Transmit by 802.11ax-HE40 at channel 5270MHz	Test Voltage	120V/60Hz

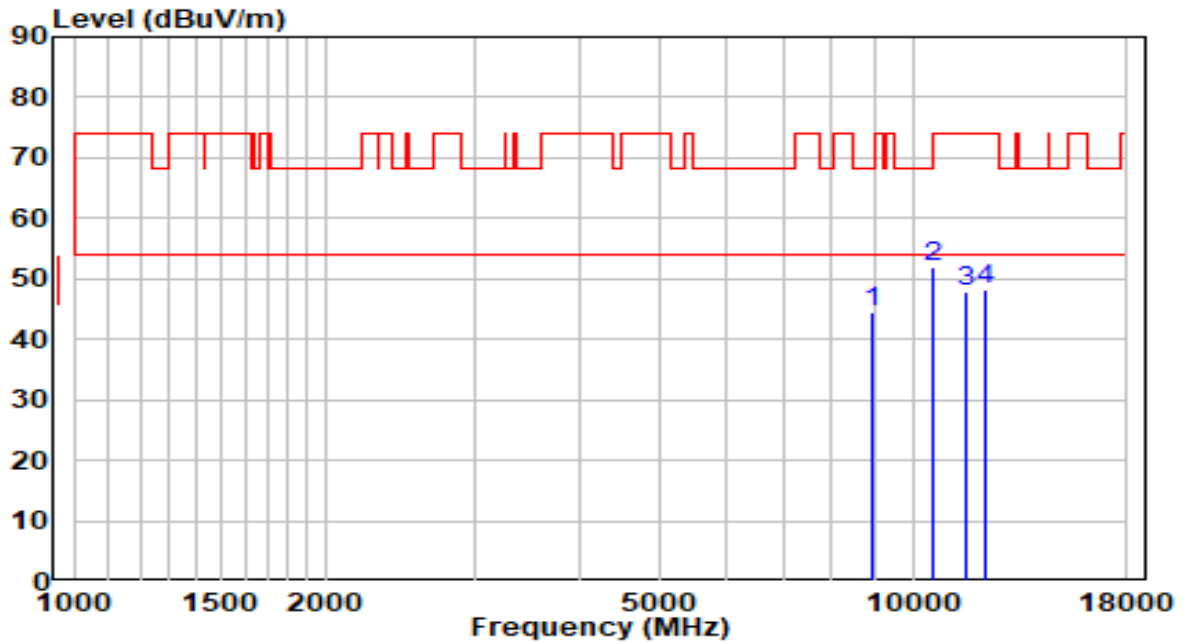

No	Frequency (MHz)	Reading (dBuV)	C.F (dB)	Measurement (dBuV/m)	Margin (dB)	Limit (dBuV/m)	Remark (QP/PK/AV)
1	8964.500	30.87	13.59	44.46	-23.74	68.20	Peak
2	* 10537.000	34.83	17.12	51.95	-16.25	68.20	Peak
3	11591.000	29.61	18.34	47.94	-26.06	74.00	Peak
4	12186.000	30.54	17.85	48.39	-25.61	74.00	Peak

Note:

- "*", means this data is the worst emission level.
- C.F (Correction Factor) = Antenna Factor (dB)+ Cable Loss (dB)– Preamplifier(dB).
- Measurement(dBuV/m) = Reading(dBuV) + C.F (Correction Factor).
- The emission levels of other frequencies are very lower than the limit and not show in test report.

EUT	AP311	Date of Test	2020-10-12
Factor	BBHA 9120D (1GHz~18GHz)_2020	Temp. / Humidity	23.7°C/37%
Polarity	Vertical	Site / Test Engineer	AC1 / Kevin Ker
Test Mode	Transmit by 802.11ax-HE40 at channel 5270MHz	Test Voltage	120V/60Hz

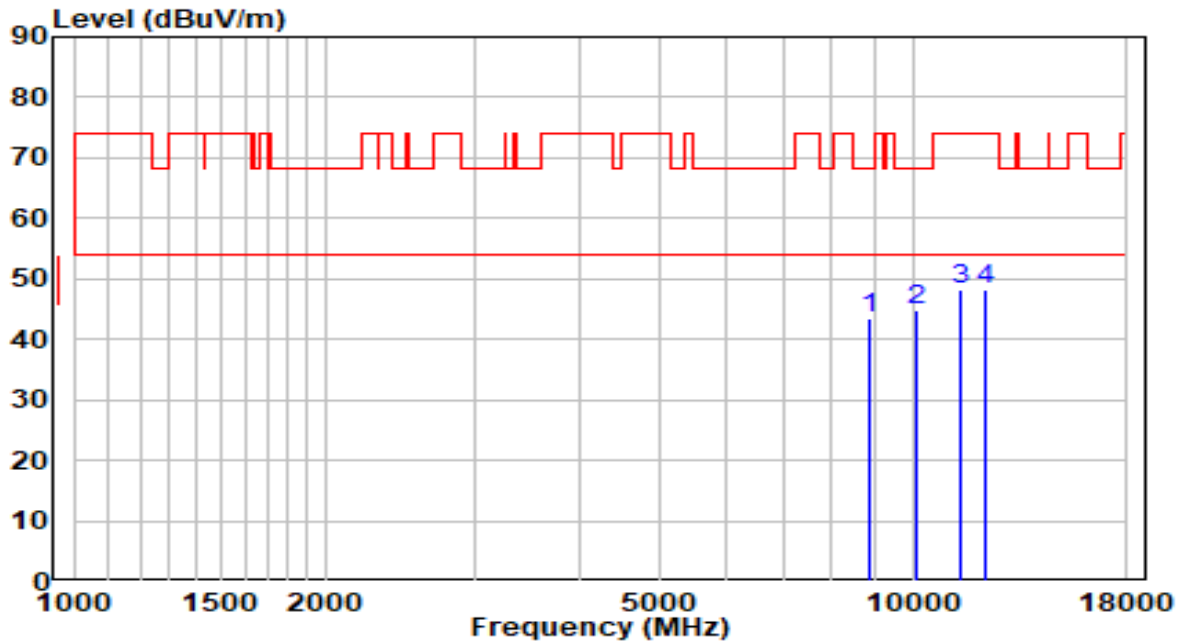

No	Frequency (MHz)	Reading (dBuV)	C.F (dB)	Measurement (dBuV/m)	Margin (dB)	Limit (dBuV/m)	Remark (QP/PK/AV)
1	8905.000	30.18	13.45	43.63	-24.57	68.20	Peak
2	* 10112.000	29.15	15.74	44.90	-23.30	68.20	Peak
3	11421.000	29.97	18.34	48.32	-25.68	74.00	Peak
4	12220.000	30.45	17.86	48.31	-25.69	74.00	Peak

Note:

- "*", means this data is the worst emission level.
- C.F (Correction Factor) = Antenna Factor (dB)+ Cable Loss (dB)– Preamplifier(dB).
- Measurement(dBuV/m) = Reading(dBuV) + C.F (Correction Factor).
- The emission levels of other frequencies are very lower than the limit and not show in test report.

EUT	AP311	Date of Test	2020-10-12
Factor	BBHA 9120D (1GHz~18GHz)_2020	Temp. / Humidity	23.7°C/37%
Polarity	Horizontal	Site / Test Engineer	AC1 / Kevin Ker
Test Mode	Transmit by 802.11ax-HE40 at channel 5310MHz	Test Voltage	120V/60Hz

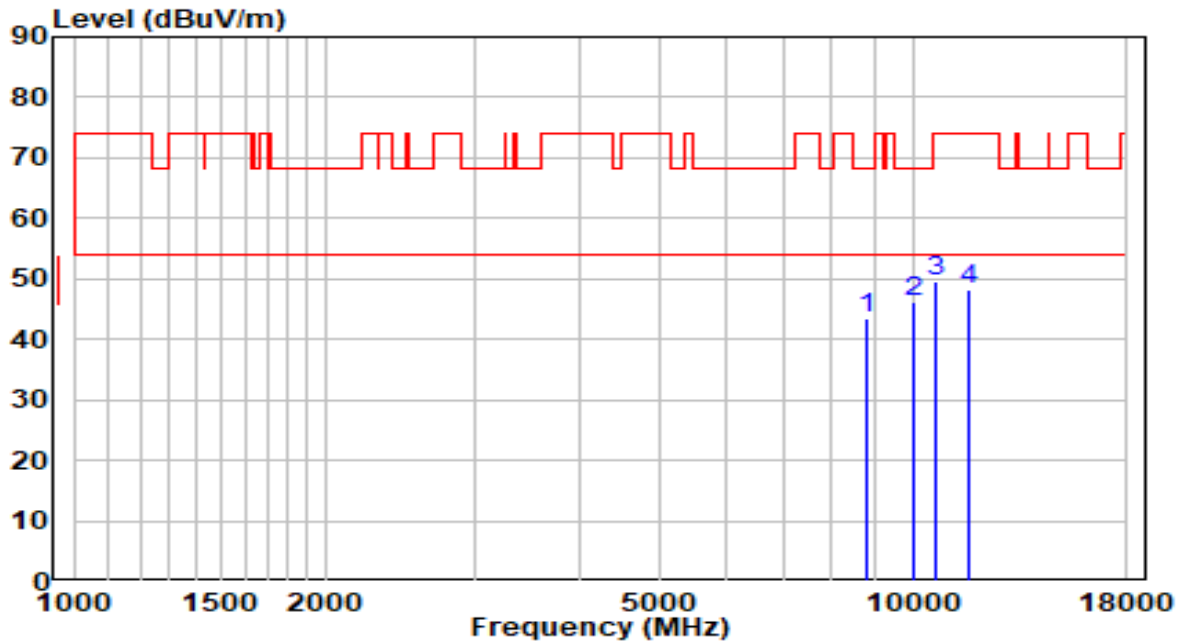

No	Frequency (MHz)	Reading (dBuV)	C.F (dB)	Measurement (dBuV/m)	Margin (dB)	Limit (dBuV/m)	Remark (QP/PK/AV)
1	8828.500	30.27	13.26	43.53	-24.67	68.20	Peak
2	* 9993.000	30.81	15.35	46.16	-22.04	68.20	Peak
3	10613.500	32.27	17.23	49.51	-24.49	74.00	Peak
4	11650.500	30.07	18.26	48.33	-25.67	74.00	Peak

Note:

1. " *", means this data is the worst emission level.
2. C.F (Correction Factor) = Antenna Factor (dB)+ Cable Loss (dB)– Preamplifier(dB).
3. Measurement(dBuV/m) = Reading(dBuV) + C.F (Correction Factor).
- 4.The emission levels of other frequencies are very lower than the limit and not show in test report.

EUT	AP311	Date of Test	2020-10-12
Factor	BBHA 9120D (1GHz~18GHz)_2020	Temp. / Humidity	23.7°C/37%
Polarity	Vertical	Site / Test Engineer	AC1 / Kevin Ker
Test Mode	Transmit by 802.11ax-HE40 at channel 5310MHz	Test Voltage	120V/60Hz

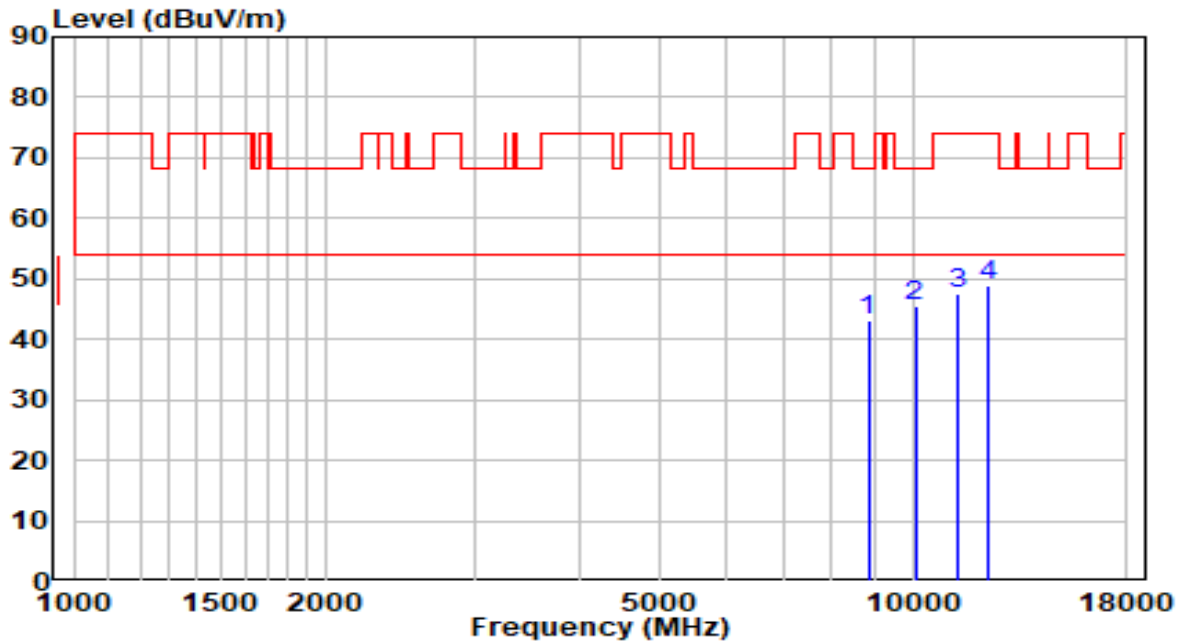

No	Frequency (MHz)	Reading (dBuV)	C.F (dB)	Measurement (dBuV/m)	Margin (dB)	Limit (dBuV/m)	Remark (QP/PK/AV)
1	8845.500	29.67	13.30	42.97	-25.23	68.20	Peak
2	* 10061.000	30.11	15.57	45.68	-22.52	68.20	Peak
3	11276.500	29.36	18.15	47.52	-26.48	74.00	Peak
4	12296.500	30.90	17.87	48.78	-25.22	74.00	Peak

Note:

- "*", means this data is the worst emission level.
- C.F (Correction Factor) = Antenna Factor (dB)+ Cable Loss (dB)– Preamplifier(dB).
- Measurement(dBuV/m) = Reading(dBuV) + C.F (Correction Factor).
- The emission levels of other frequencies are very lower than the limit and not show in test report.

EUT	AP311	Date of Test	2020-10-12
Factor	BBHA 9120D (1GHz~18GHz)_2020	Temp. / Humidity	23.7°C/37%
Polarity	Horizontal	Site / Test Engineer	AC1 / Kevin Ker
Test Mode	Transmit by 802.11ax-HE40 at channel 5510MHz	Test Voltage	120V/60Hz

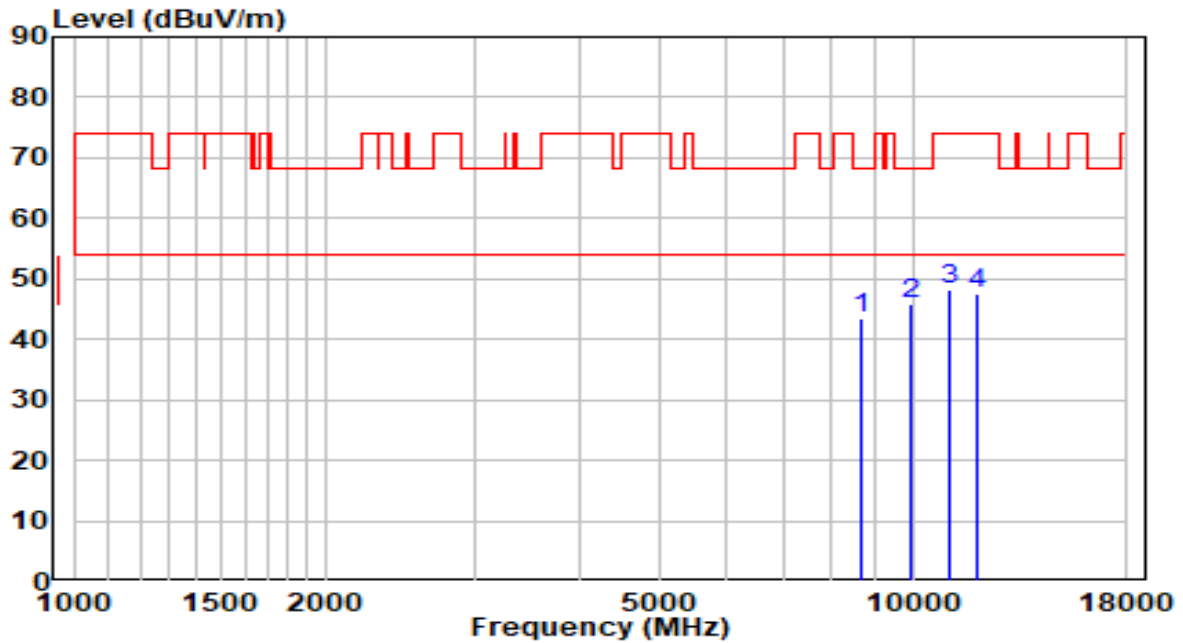

No	Frequency (MHz)	Reading (dBuV)	C.F (dB)	Measurement (dBuV/m)	Margin (dB)	Limit (dBuV/m)	Remark (QP/PK/AV)
1	8692.500	30.71	12.93	43.63	-24.57	68.20	Peak
2	* 9976.000	30.48	15.31	45.79	-22.41	68.20	Peak
3	11021.500	30.58	17.81	48.39	-25.61	74.00	Peak
4	11888.500	29.52	17.96	47.48	-26.52	74.00	Peak

Note:

- "*", means this data is the worst emission level.
- C.F (Correction Factor) = Antenna Factor (dB)+ Cable Loss (dB)– Preamplifier(dB).
- Measurement(dBuV/m) = Reading(dBuV) + C.F (Correction Factor).
- The emission levels of other frequencies are very lower than the limit and not show in test report.

EUT	AP311	Date of Test	2020-10-12
Factor	BBHA 9120D (1GHz~18GHz)_2020	Temp. / Humidity	23.7°C/37%
Polarity	Vertical	Site / Test Engineer	AC1 / Kevin Ker
Test Mode	Transmit by 802.11ax-HE40 at channel 5510MHz	Test Voltage	120V/60Hz

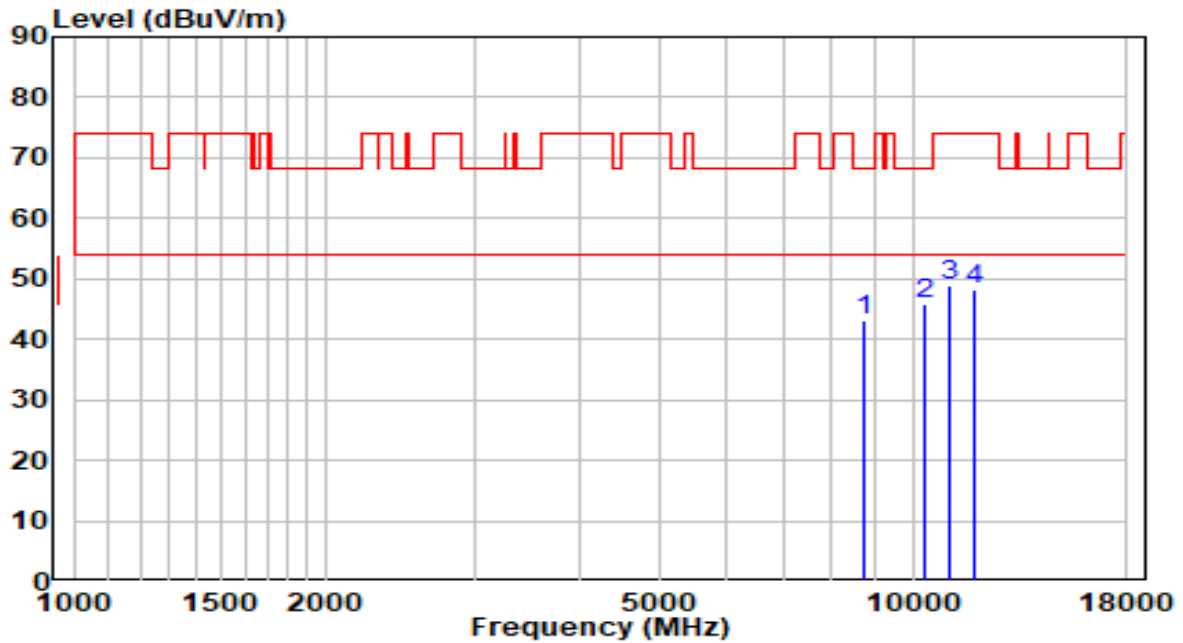

No	Frequency (MHz)	Reading (dBuV)	C.F (dB)	Measurement (dBuV/m)	Margin (dB)	Limit (dBuV/m)	Remark (QP/PK/AV)
1	8752.000	30.13	13.07	43.20	-25.00	68.20	Peak
2	* 10358.500	29.11	16.59	45.69	-22.51	68.20	Peak
3	11030.000	30.93	17.82	48.75	-25.25	74.00	Peak
4	11803.500	30.29	18.07	48.36	-25.64	74.00	Peak

Note:

- "*", means this data is the worst emission level.
- C.F (Correction Factor) = Antenna Factor (dB)+ Cable Loss (dB)– Preamplifier(dB).
- Measurement(dBuV/m) = Reading(dBuV) + C.F (Correction Factor).
- The emission levels of other frequencies are very lower than the limit and not show in test report.

EUT	AP311	Date of Test	2020-10-12
Factor	BBHA 9120D (1GHz~18GHz)_2020	Temp. / Humidity	23.7°C/37%
Polarity	Horizontal	Site / Test Engineer	AC1 / Kevin Ker
Test Mode	Transmit by 802.11ax-HE40 at channel 5550MHz	Test Voltage	120V/60Hz

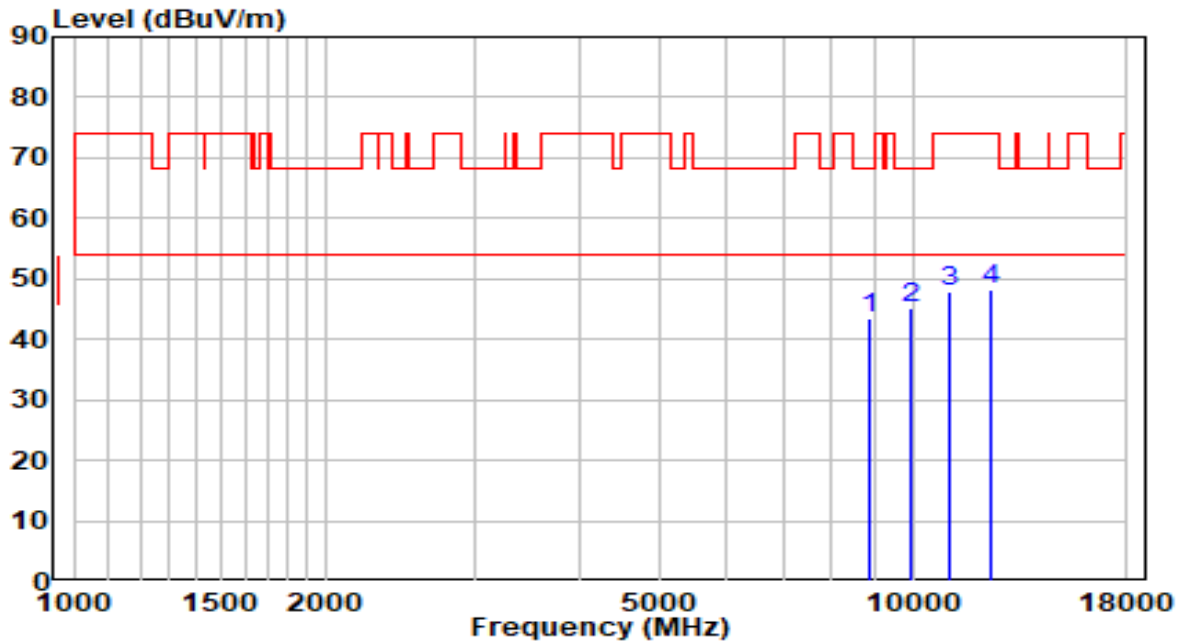

No	Frequency (MHz)	Reading (dBuV)	C.F (dB)	Measurement (dBuV/m)	Margin (dB)	Limit (dBuV/m)	Remark (QP/PK/AV)
1	8879.500	29.95	13.38	43.34	-24.86	68.20	Peak
2	* 9976.000	29.75	15.31	45.06	-23.14	68.20	Peak
3	11089.500	30.06	17.90	47.96	-26.04	74.00	Peak
4	12364.500	30.35	17.88	48.24	-25.76	74.00	Peak

Note:

1. " *", means this data is the worst emission level.
2. C.F (Correction Factor) = Antenna Factor (dB)+ Cable Loss (dB)– Preamplifier(dB).
3. Measurement(dBuV/m) = Reading(dBuV) + C.F (Correction Factor).
- 4.The emission levels of other frequencies are very lower than the limit and not show in test report.

EUT	AP311	Date of Test	2020-10-12
Factor	BBHA 9120D (1GHz~18GHz)_2020	Temp. / Humidity	23.7°C/37%
Polarity	Vertical	Site / Test Engineer	AC1 / Kevin Ker
Test Mode	Transmit by 802.11ax-HE40 at channel 5550MHz	Test Voltage	120V/60Hz

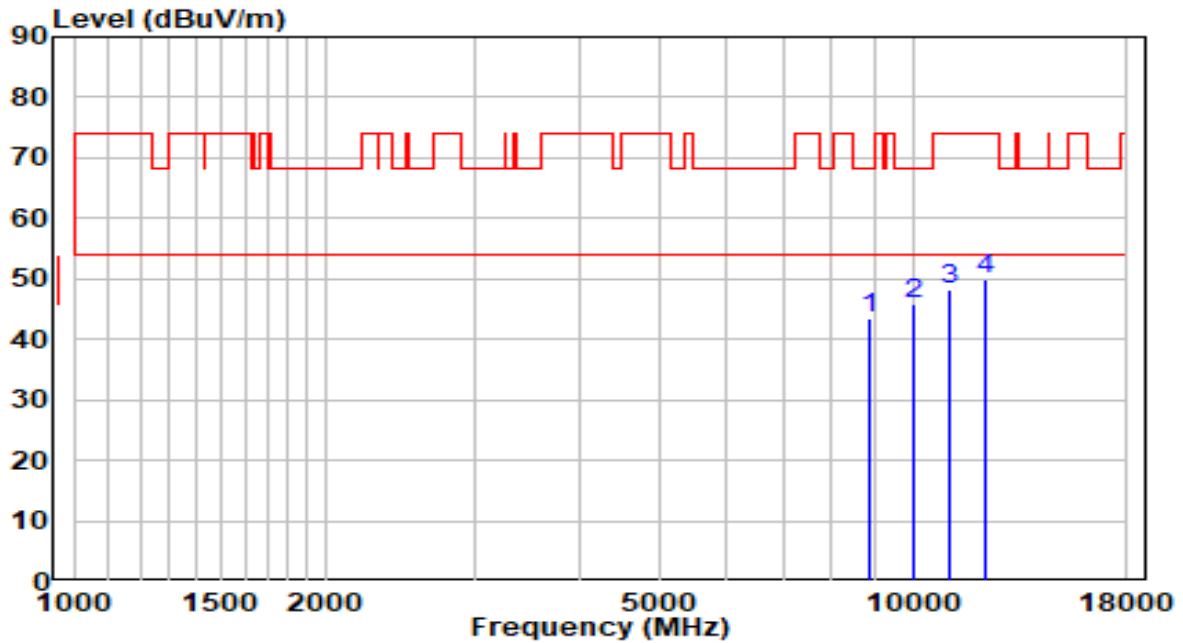

No	Frequency (MHz)	Reading (dBuV)	C.F (dB)	Measurement (dBuV/m)	Margin (dB)	Limit (dBuV/m)	Remark (QP/PK/AV)
1	8871.000	29.96	13.36	43.32	-24.88	68.20	Peak
2	* 10018.500	30.30	15.42	45.73	-22.47	68.20	Peak
3	11089.500	30.39	17.90	48.29	-25.71	74.00	Peak
4	12245.500	32.12	17.86	49.98	-24.02	74.00	Peak

Note:

- "*", means this data is the worst emission level.
- C.F (Correction Factor) = Antenna Factor (dB)+ Cable Loss (dB)– Preamplifier(dB).
- Measurement(dBuV/m) = Reading(dBuV) + C.F (Correction Factor).
- The emission levels of other frequencies are very lower than the limit and not show in test report.

EUT	AP311	Date of Test	2020-10-12
Factor	BBHA 9120D (1GHz~18GHz)_2020	Temp. / Humidity	23.7°C/37%
Polarity	Horizontal	Site / Test Engineer	AC1 / Kevin Ker
Test Mode	Transmit by 802.11ax-HE40 at channel 5670MHz	Test Voltage	120V/60Hz

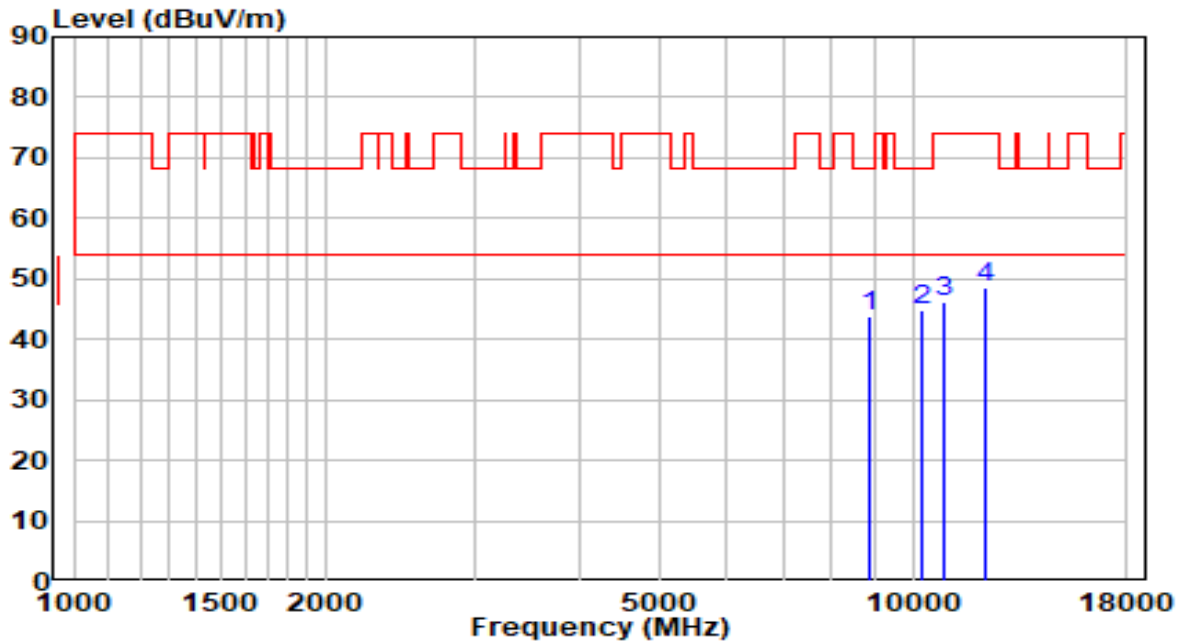

No	Frequency (MHz)	Reading (dBuV)	C.F (dB)	Measurement (dBuV/m)	Margin (dB)	Limit (dBuV/m)	Remark (QP/PK/AV)
1	8888.000	30.31	13.41	43.72	-24.48	68.20	Peak
2	* 10273.500	28.53	16.30	44.82	-23.38	68.20	Peak
3	10868.500	28.69	17.59	46.29	-27.71	74.00	Peak
4	12220.000	30.56	17.86	48.41	-25.59	74.00	Peak

Note:

1. " *", means this data is the worst emission level.
2. C.F (Correction Factor) = Antenna Factor (dB)+ Cable Loss (dB)– Preamplifier(dB).
3. Measurement(dBuV/m) = Reading(dBuV) + C.F (Correction Factor).
- 4.The emission levels of other frequencies are very lower than the limit and not show in test report.

EUT	AP311	Date of Test	2020-10-12
Factor	BBHA 9120D (1GHz~18GHz)_2020	Temp. / Humidity	23.7°C/37%
Polarity	Vertical	Site / Test Engineer	AC1 / Kevin Ker
Test Mode	Transmit by 802.11ax-HE40 at channel 5670MHz	Test Voltage	120V/60Hz

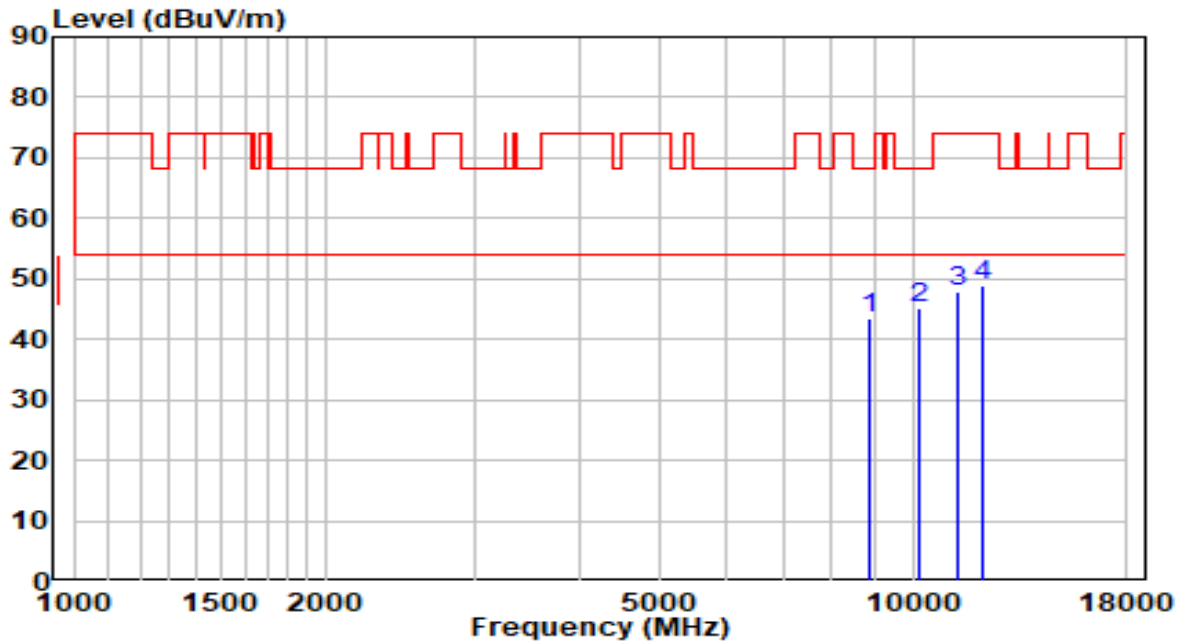

No	Frequency (MHz)	Reading (dBuV)	C.F (dB)	Measurement (dBuV/m)	Margin (dB)	Limit (dBuV/m)	Remark (QP/PK/AV)
1	8854.000	30.27	13.32	43.59	-24.61	68.20	Peak
2	* 10154.500	29.18	15.89	45.07	-23.13	68.20	Peak
3	11336.000	29.78	18.23	48.01	-25.99	74.00	Peak
4	12135.000	30.90	17.84	48.75	-25.25	74.00	Peak

Note:

1. " *", means this data is the worst emission level.
2. C.F (Correction Factor) = Antenna Factor (dB)+ Cable Loss (dB)– Preamplifier(dB).
3. Measurement(dBuV/m) = Reading(dBuV) + C.F (Correction Factor).
- 4.The emission levels of other frequencies are very lower than the limit and not show in test report.

EUT	AP311	Date of Test	2020-10-12
Factor	BBHA 9120D (1GHz~18GHz)_2020	Temp. / Humidity	23.7°C/37%
Polarity	Horizontal	Site / Test Engineer	AC1 / Kevin Ker
Test Mode	Transmit by 802.11ax-HE40 at channel 5710MHz	Test Voltage	120V/60Hz

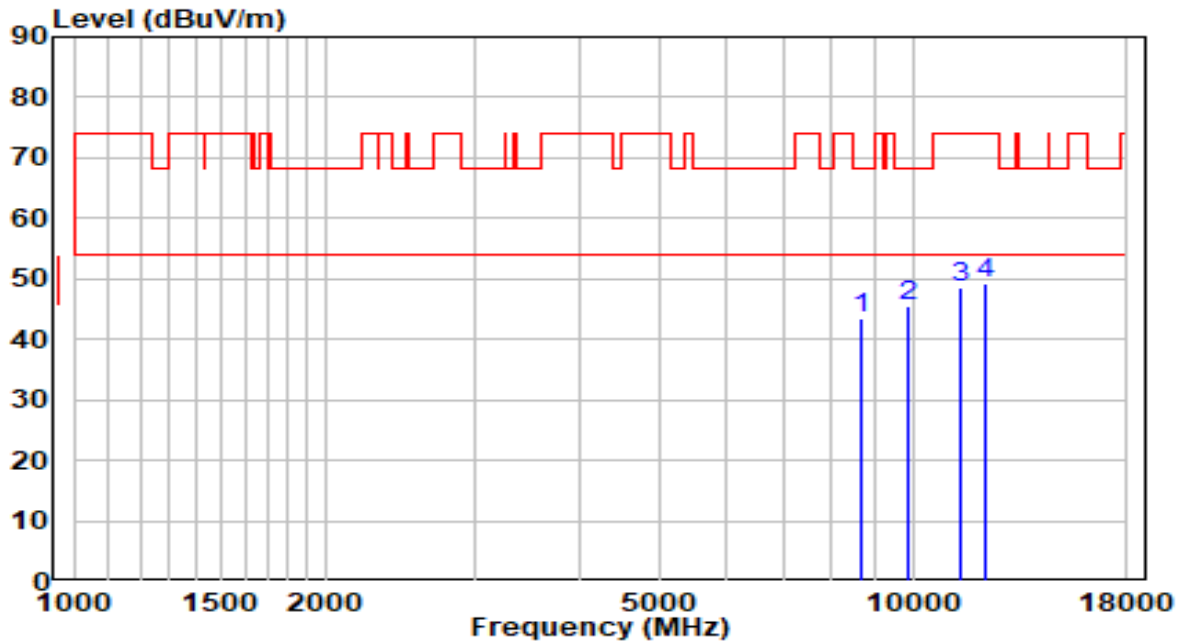

No	Frequency (MHz)	Reading (dBuV)	C.F (dB)	Measurement (dBuV/m)	Margin (dB)	Limit (dBuV/m)	Remark (QP/PK/AV)
1	8692.500	30.51	12.93	43.44	-24.76	68.20	Peak
2	* 9899.500	30.18	15.17	45.35	-22.85	68.20	Peak
3	11421.000	30.32	18.34	48.66	-25.34	74.00	Peak
4	12245.500	31.22	17.86	49.09	-24.91	74.00	Peak

Note:

1. " *", means this data is the worst emission level.
2. C.F (Correction Factor) = Antenna Factor (dB)+ Cable Loss (dB)– Preamplifier(dB).
3. Measurement(dBuV/m) = Reading(dBuV) + C.F (Correction Factor).
- 4.The emission levels of other frequencies are very lower than the limit and not show in test report.

EUT	AP311	Date of Test	2020-10-12
Factor	BBHA 9120D (1GHz~18GHz)_2020	Temp. / Humidity	23.7°C/37%
Polarity	Vertical	Site / Test Engineer	AC1 / Kevin Ker
Test Mode	Transmit by 802.11ax-HE40 at channel 5710MHz	Test Voltage	120V/60Hz

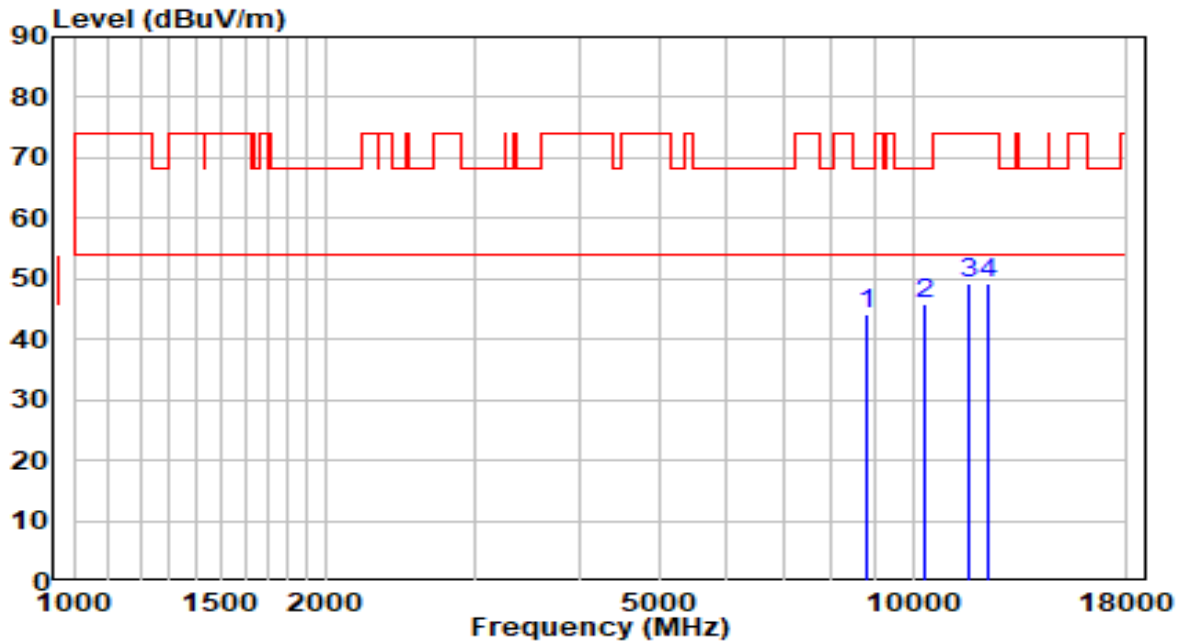

No	Frequency (MHz)	Reading (dBuV)	C.F (dB)	Measurement (dBuV/m)	Margin (dB)	Limit (dBuV/m)	Remark (QP/PK/AV)
1	8803.000	30.88	13.20	44.08	-24.12	68.20	Peak
2	* 10367.000	29.27	16.62	45.89	-22.31	68.20	Peak
3	11693.000	31.20	18.21	49.41	-24.59	74.00	Peak
4	12305.000	31.30	17.87	49.17	-24.83	74.00	Peak

Note:

1. " *", means this data is the worst emission level.
2. C.F (Correction Factor) = Antenna Factor (dB)+ Cable Loss (dB)– Preamplifier(dB).
3. Measurement(dBuV/m) = Reading(dBuV) + C.F (Correction Factor).
- 4.The emission levels of other frequencies are very lower than the limit and not show in test report.

EUT	AP311	Date of Test	2020-10-12
Factor	BBHA 9120D (1GHz~18GHz)_2020	Temp. / Humidity	23.7°C/37%
Polarity	Horizontal	Site / Test Engineer	AC1 / Kevin Ker
Test Mode	Transmit by 802.11ax-HE40 at channel 5755MHz	Test Voltage	120V/60Hz

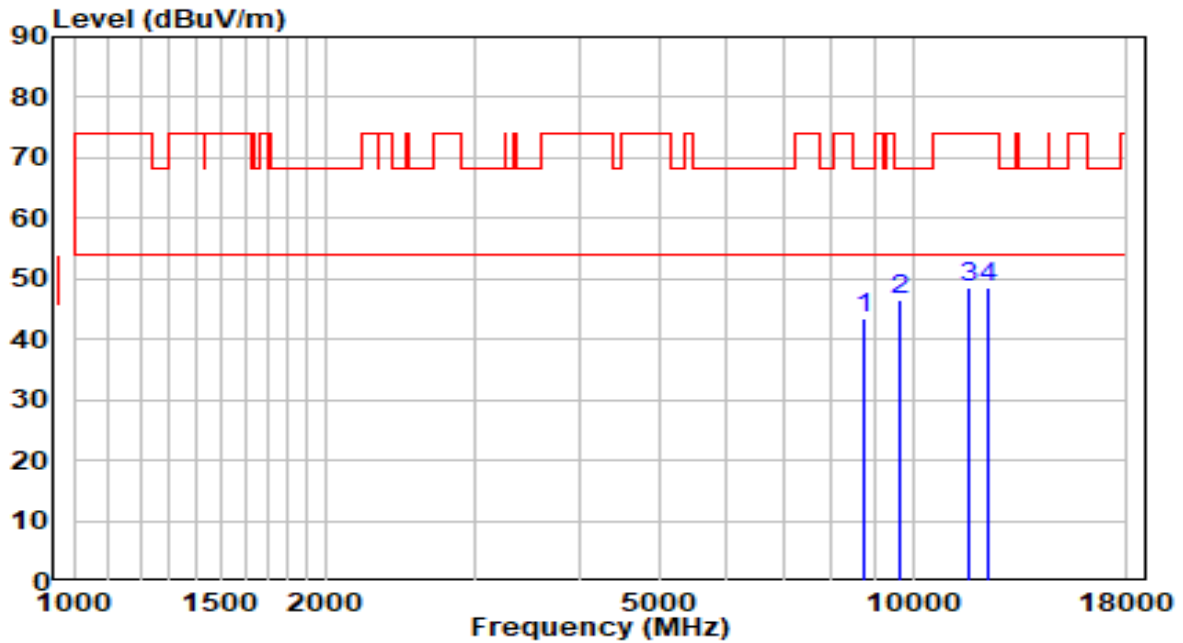

No	Frequency (MHz)	Reading (dBuV)	C.F (dB)	Measurement (dBuV/m)	Margin (dB)	Limit (dBuV/m)	Remark (QP/PK/AV)
1	8752.000	30.53	13.07	43.60	-24.60	68.20	Peak
2	* 9644.500	31.83	14.69	46.52	-21.68	68.20	Peak
3	11650.500	30.35	18.26	48.61	-25.39	74.00	Peak
4	12254.000	30.58	17.86	48.45	-25.55	74.00	Peak

Note:

- "*", means this data is the worst emission level.
- C.F (Correction Factor) = Antenna Factor (dB)+ Cable Loss (dB)– Preamplifier(dB).
- Measurement(dBuV/m) = Reading(dBuV) + C.F (Correction Factor).
- The emission levels of other frequencies are very lower than the limit and not show in test report.

EUT	AP311	Date of Test	2020-10-12
Factor	BBHA 9120D (1GHz~18GHz)_2020	Temp. / Humidity	23.7°C/37%
Polarity	Vertical	Site / Test Engineer	AC1 / Kevin Ker
Test Mode	Transmit by 802.11ax-HE40 at channel 5755MHz	Test Voltage	120V/60Hz

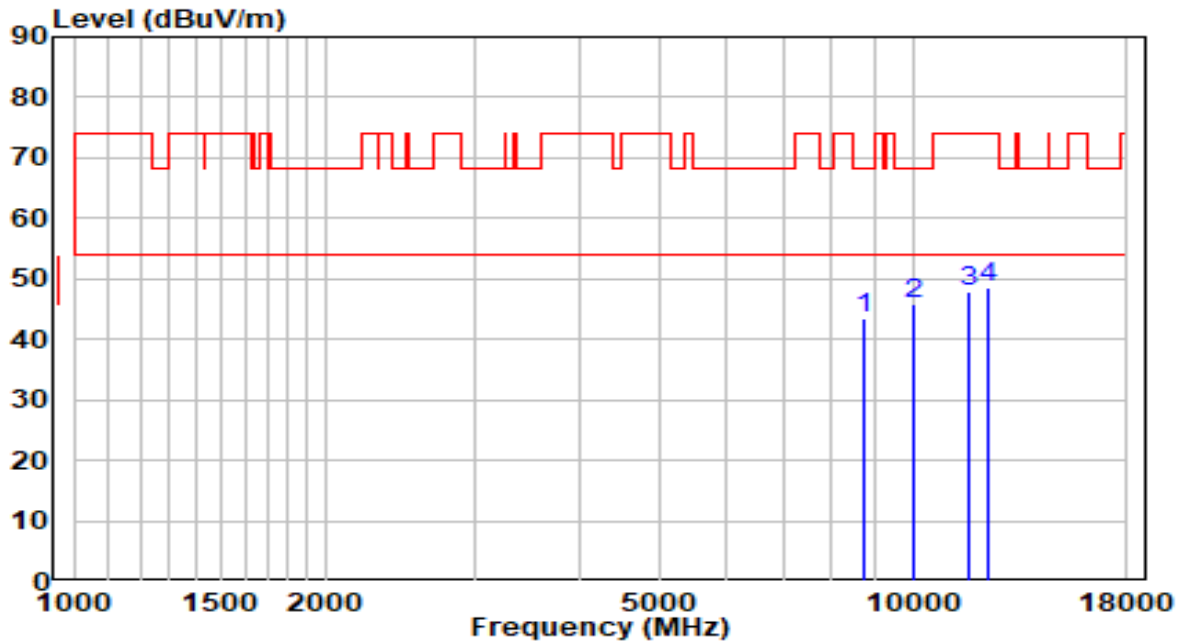

No	Frequency (MHz)	Reading (dBuV)	C.F (dB)	Measurement (dBuV/m)	Margin (dB)	Limit (dBuV/m)	Remark (QP/PK/AV)
1	8735.000	30.49	13.03	43.52	-24.68	68.20	Peak
2	* 10010.000	30.40	15.39	45.80	-22.40	68.20	Peak
3	11701.500	29.84	18.20	48.04	-25.96	74.00	Peak
4	12254.000	30.84	17.86	48.70	-25.30	74.00	Peak

Note:

1. " *", means this data is the worst emission level.
2. C.F (Correction Factor) = Antenna Factor (dB)+ Cable Loss (dB)– Preamplifier(dB).
3. Measurement(dBuV/m) = Reading(dBuV) + C.F (Correction Factor).
- 4.The emission levels of other frequencies are very lower than the limit and not show in test report.

EUT	AP311	Date of Test	2020-10-12
Factor	BBHA 9120D (1GHz~18GHz)_2020	Temp. / Humidity	23.7°C/37%
Polarity	Horizontal	Site / Test Engineer	AC1 / Kevin Ker
Test Mode	Transmit by 802.11ax-HE40 at channel 5795MHz	Test Voltage	120V/60Hz

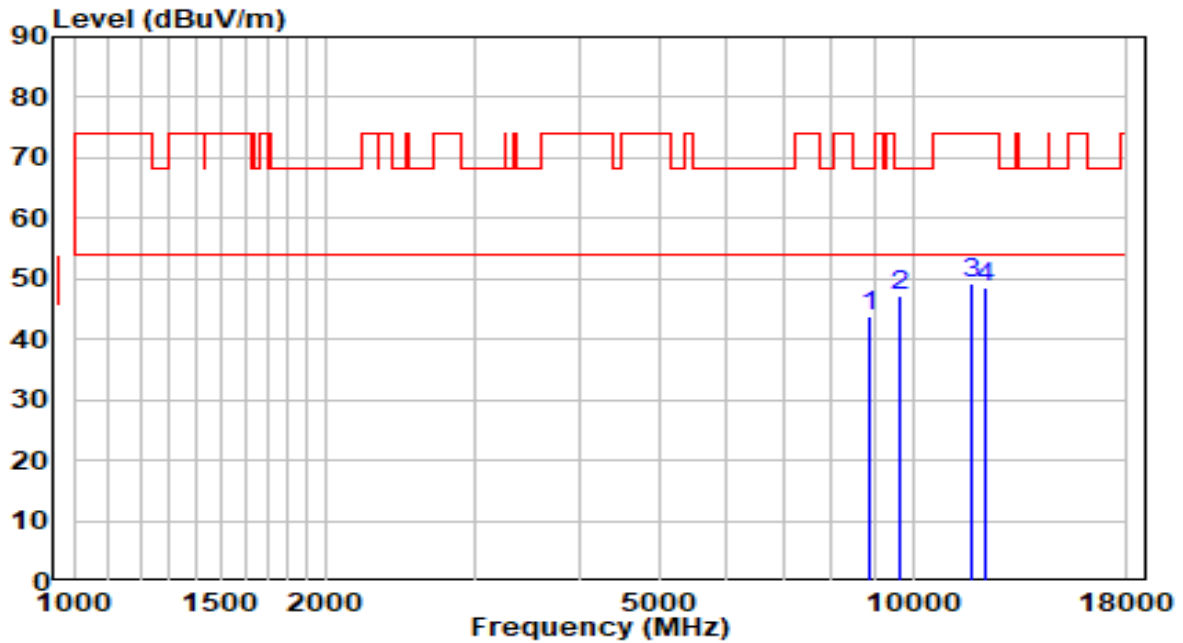

No	Frequency (MHz)	Reading (dBuV)	C.F (dB)	Measurement (dBuV/m)	Margin (dB)	Limit (dBuV/m)	Remark (QP/PK/AV)
1	8905.000	30.40	13.45	43.85	-24.35	68.20	Peak
2	* 9644.500	32.37	14.69	47.06	-21.14	68.20	Peak
3	11718.500	30.92	18.17	49.09	-24.91	74.00	Peak
4	12245.500	30.61	17.86	48.47	-25.53	74.00	Peak

Note:

1. " *", means this data is the worst emission level.
2. C.F (Correction Factor) = Antenna Factor (dB)+ Cable Loss (dB)– Preamplifier(dB).
3. Measurement(dBuV/m) = Reading(dBuV) + C.F (Correction Factor).
- 4.The emission levels of other frequencies are very lower than the limit and not show in test report.

EUT	AP311	Date of Test	2020-10-12
Factor	BBHA 9120D (1GHz~18GHz)_2020	Temp. / Humidity	23.7°C/37%
Polarity	Vertical	Site / Test Engineer	AC1 / Kevin Ker
Test Mode	Transmit by 802.11ax-HE40 at channel 5795MHz	Test Voltage	120V/60Hz

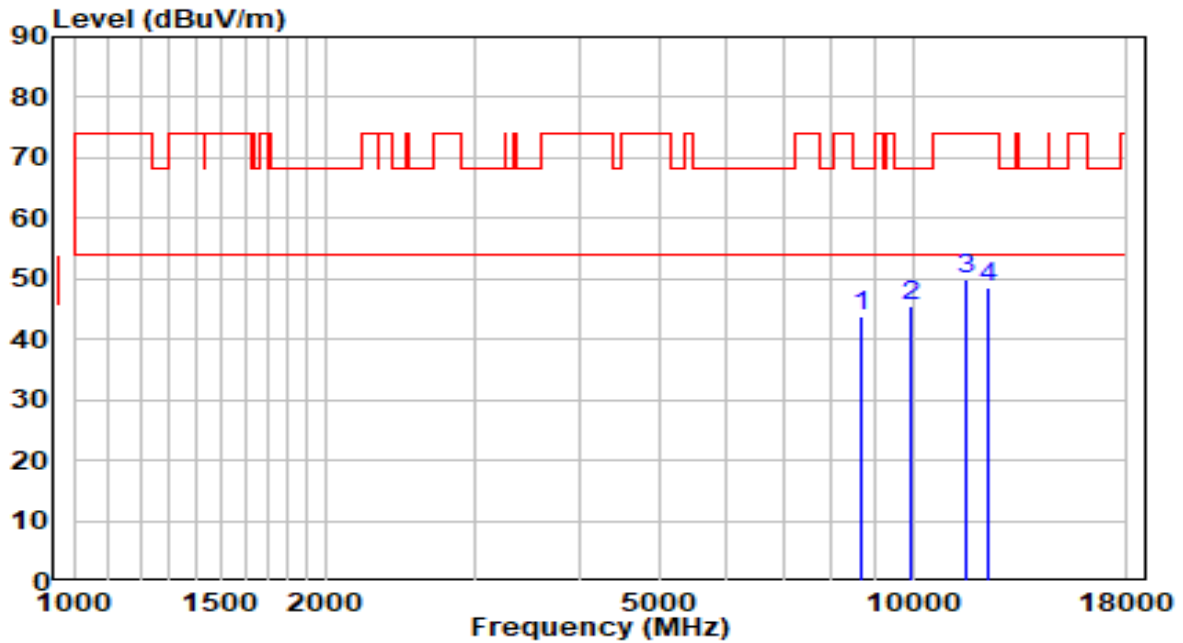

No	Frequency (MHz)	Reading (dBuV)	C.F (dB)	Measurement (dBuV/m)	Margin (dB)	Limit (dBuV/m)	Remark (QP/PK/AV)
1	8667.000	31.07	12.86	43.93	-24.27	68.20	Peak
2	* 9967.500	30.38	15.30	45.68	-22.52	68.20	Peak
3	11599.500	31.68	18.32	50.00	-24.00	74.00	Peak
4	12254.000	30.60	17.86	48.46	-25.54	74.00	Peak

Note:

1. " *", means this data is the worst emission level.
2. C.F (Correction Factor) = Antenna Factor (dB)+ Cable Loss (dB)– Preamplifier(dB).
3. Measurement(dBuV/m) = Reading(dBuV) + C.F (Correction Factor).
- 4.The emission levels of other frequencies are very lower than the limit and not show in test report.

EUT	AP311	Date of Test	2020-10-12
Factor	BBHA 9120D (1GHz~18GHz)_2020	Temp. / Humidity	23.7°C/37%
Polarity	Horizontal	Site / Test Engineer	AC1 / Kevin Ker
Test Mode	Transmit by 802.11ax-HE80 at channel 5210MHz	Test Voltage	120V/60Hz

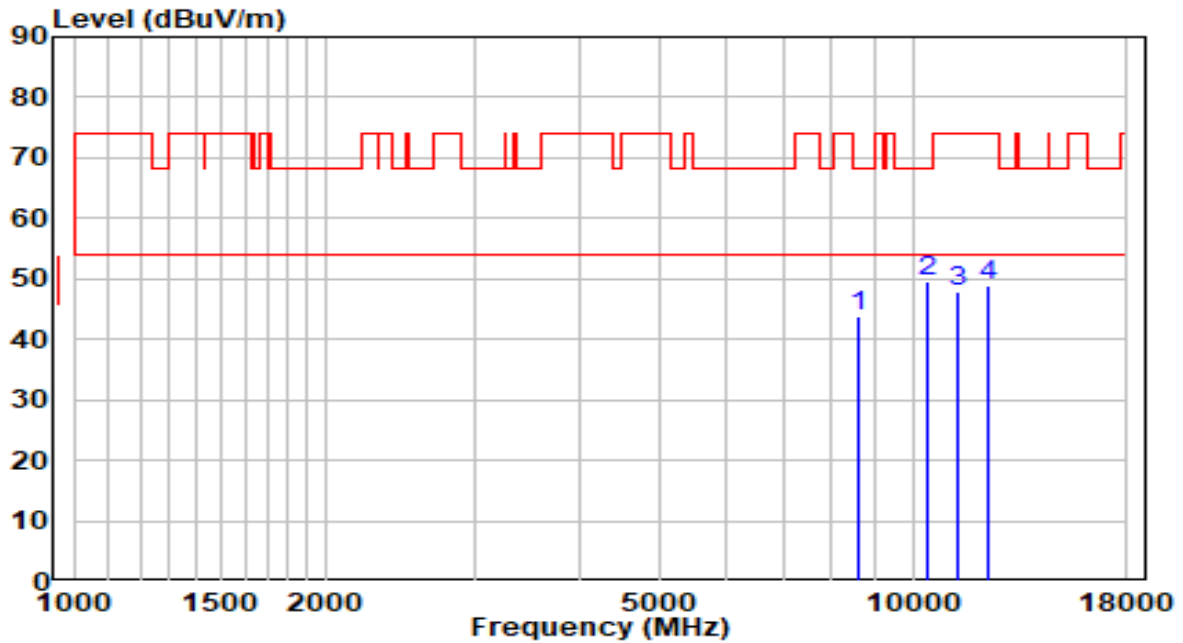

No	Frequency (MHz)	Reading (dBuV)	C.F (dB)	Measurement (dBuV/m)	Margin (dB)	Limit (dBuV/m)	Remark (QP/PK/AV)
1	8607.500	30.99	12.72	43.70	-24.50	68.20	Peak
2	* 10418.000	32.75	16.79	49.54	-18.66	68.20	Peak
3	11276.500	29.68	18.15	47.83	-26.17	74.00	Peak
4	12271.000	31.15	17.87	49.02	-24.98	74.00	Peak

Note:

1. " *", means this data is the worst emission level.
2. C.F (Correction Factor) = Antenna Factor (dB)+ Cable Loss (dB)– Preamplifier(dB).
3. Measurement(dBuV/m) = Reading(dBuV) + C.F (Correction Factor).
- 4.The emission levels of other frequencies are very lower than the limit and not show in test report.

EUT	AP311	Date of Test	2020-10-12
Factor	BBHA 9120D (1GHz~18GHz)_2020	Temp. / Humidity	23.7°C/37%
Polarity	Vertical	Site / Test Engineer	AC1 / Kevin Ker
Test Mode	Transmit by 802.11ax-HE80 at channel 5210MHz	Test Voltage	120V/60Hz

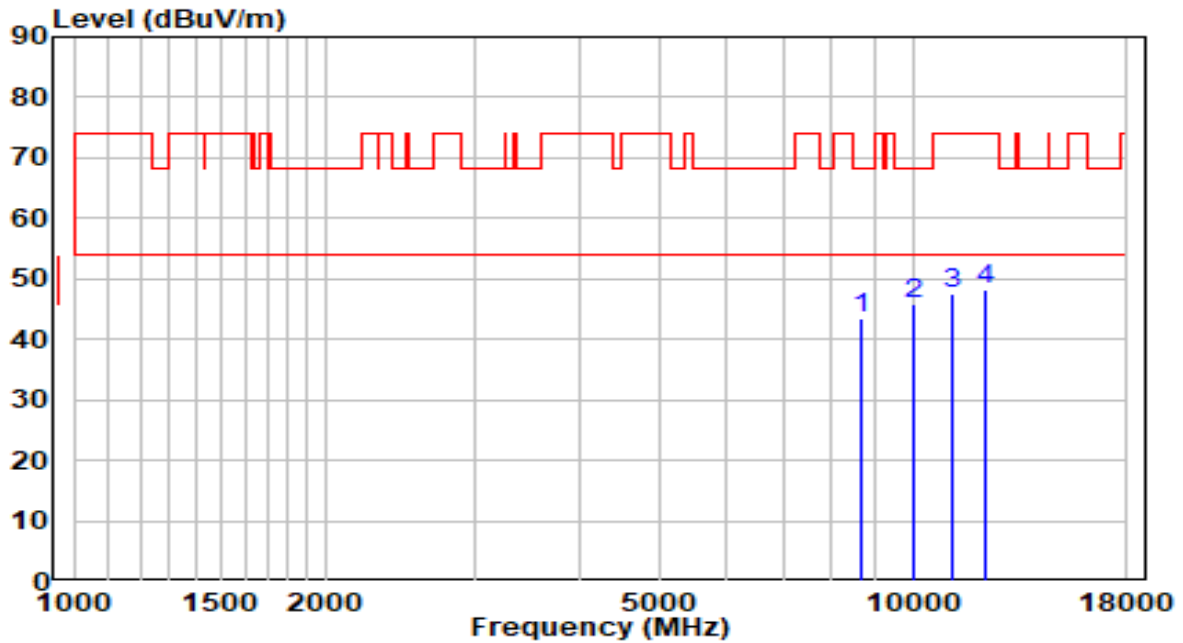

No	Frequency (MHz)	Reading (dBuV)	C.F (dB)	Measurement (dBuV/m)	Margin (dB)	Limit (dBuV/m)	Remark (QP/PK/AV)
1	8692.500	30.69	12.93	43.61	-24.59	68.20	Peak
2	* 10001.500	30.65	15.37	46.01	-22.19	68.20	Peak
3	11174.500	29.37	18.01	47.38	-26.62	74.00	Peak
4	12237.000	30.38	17.86	48.24	-25.76	74.00	Peak

Note:

1. " *", means this data is the worst emission level.
2. C.F (Correction Factor) = Antenna Factor (dB)+ Cable Loss (dB)– Preamplifier(dB).
3. Measurement(dBuV/m) = Reading(dBuV) + C.F (Correction Factor).
4. The emission levels of other frequencies are very lower than the limit and not show in test report.

EUT	AP311	Date of Test	2020-10-12
Factor	BBHA 9120D (1GHz~18GHz)_2020	Temp. / Humidity	23.7°C/37%
Polarity	Horizontal	Site / Test Engineer	AC1 / Kevin Ker
Test Mode	Transmit by 802.11ax-HE80 at channel 5290MHz	Test Voltage	120V/60Hz

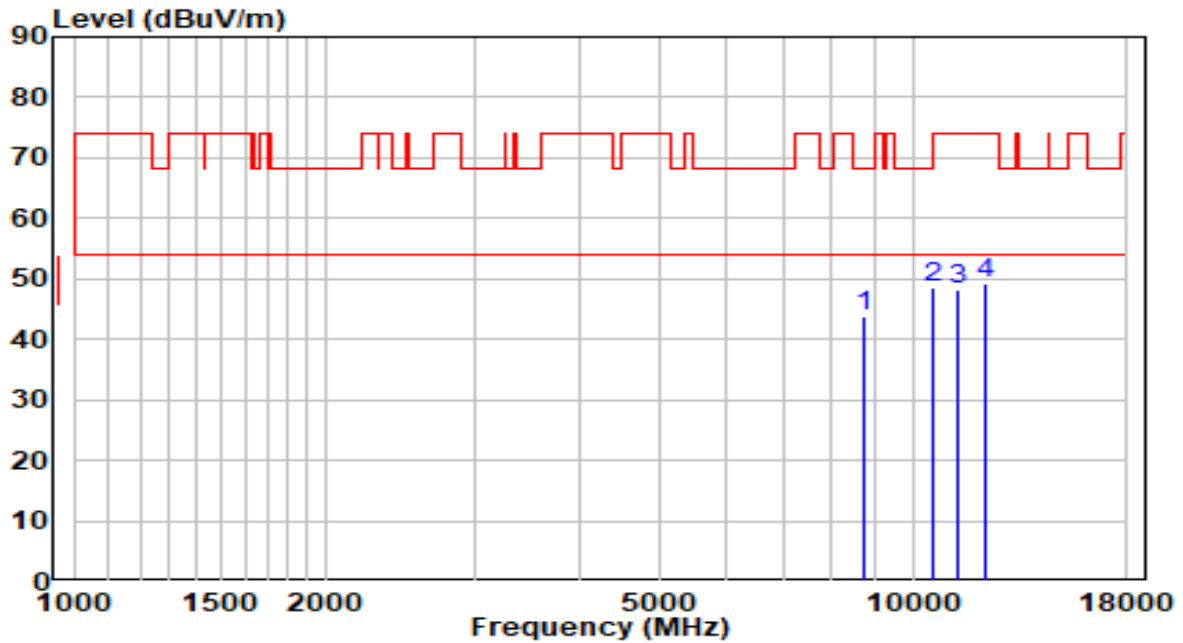

No	Frequency (MHz)	Reading (dBuV)	C.F (dB)	Measurement (dBuV/m)	Margin (dB)	Limit (dBuV/m)	Remark (QP/PK/AV)
1	8743.500	30.67	13.05	43.72	-24.48	68.20	Peak
2	* 10571.000	31.35	17.17	48.52	-19.68	68.20	Peak
3	11336.000	29.98	18.23	48.21	-25.79	74.00	Peak
4	12203.000	31.53	17.85	49.39	-24.61	74.00	Peak

Note:

- "*", means this data is the worst emission level.
- C.F (Correction Factor) = Antenna Factor (dB)+ Cable Loss (dB)– Preamplifier(dB).
- Measurement(dBuV/m) = Reading(dBuV) + C.F (Correction Factor).
- The emission levels of other frequencies are very lower than the limit and not show in test report.

EUT	AP311	Date of Test	2020-10-12
Factor	BBHA 9120D (1GHz~18GHz)_2020	Temp. / Humidity	23.7°C/37%
Polarity	Vertical	Site / Test Engineer	AC1 / Kevin Ker
Test Mode	Transmit by 802.11ax-HE80 at channel 5290MHz	Test Voltage	120V/60Hz

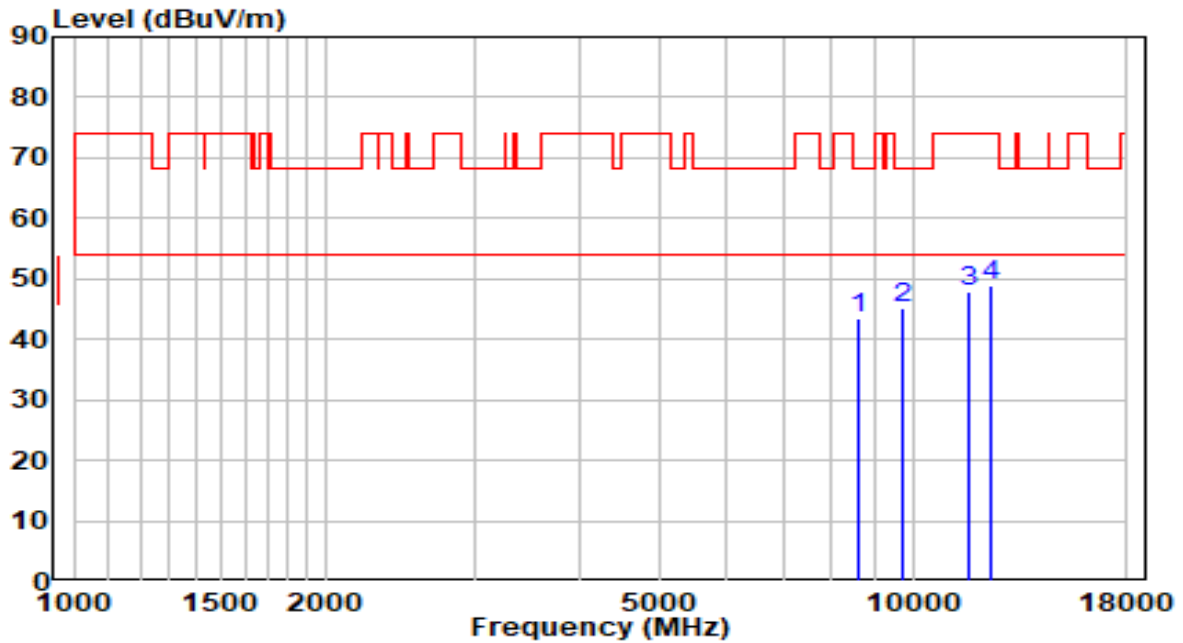

No	Frequency (MHz)	Reading (dBuV)	C.F (dB)	Measurement (dBuV/m)	Margin (dB)	Limit (dBuV/m)	Remark (QP/PK/AV)
1	8607.500	30.72	12.72	43.44	-24.76	68.20	Peak
2	* 9738.000	30.27	14.87	45.14	-23.06	68.20	Peak
3	11684.500	29.83	18.22	48.04	-25.96	74.00	Peak
4	12364.500	31.13	17.88	49.01	-24.99	74.00	Peak

Note:

1. " *", means this data is the worst emission level.
2. C.F (Correction Factor) = Antenna Factor (dB)+ Cable Loss (dB)– Preamplifier(dB).
3. Measurement(dBuV/m) = Reading(dBuV) + C.F (Correction Factor).
- 4.The emission levels of other frequencies are very lower than the limit and not show in test report.

EUT	AP311	Date of Test	2020-10-12
Factor	BBHA 9120D (1GHz~18GHz)_2020	Temp. / Humidity	23.7°C/37%
Polarity	Horizontal	Site / Test Engineer	AC1 / Kevin Ker
Test Mode	Transmit by 802.11ax-HE80 at channel 5530MHz	Test Voltage	120V/60Hz

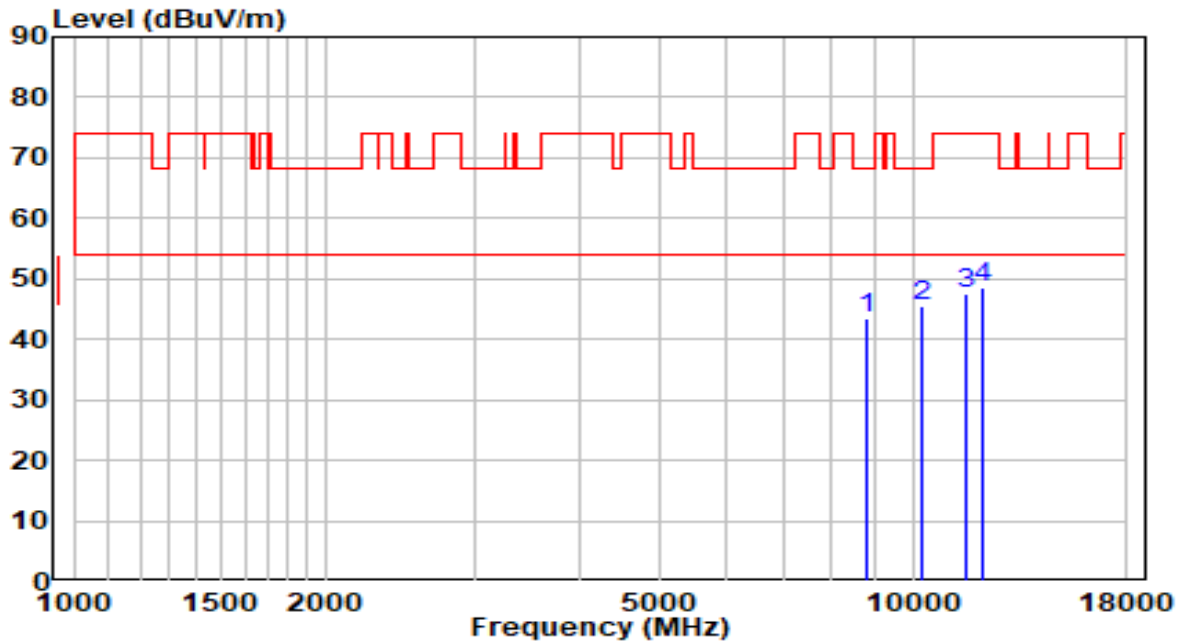

No	Frequency (MHz)	Reading (dBuV)	C.F (dB)	Measurement (dBuV/m)	Margin (dB)	Limit (dBuV/m)	Remark (QP/PK/AV)
1	8803.000	30.32	13.20	43.52	-24.68	68.20	Peak
2	* 10273.500	29.22	16.30	45.52	-22.68	68.20	Peak
3	11540.000	29.10	18.40	47.50	-26.50	74.00	Peak
4	12143.500	30.87	17.84	48.71	-25.29	74.00	Peak

Note:

- "*", means this data is the worst emission level.
- C.F (Correction Factor) = Antenna Factor (dB)+ Cable Loss (dB)– Preamplifier(dB).
- Measurement(dBuV/m) = Reading(dBuV) + C.F (Correction Factor).
- The emission levels of other frequencies are very lower than the limit and not show in test report.

EUT	AP311	Date of Test	2020-10-12
Factor	BBHA 9120D (1GHz~18GHz)_2020	Temp. / Humidity	23.7°C/37%
Polarity	Vertical	Site / Test Engineer	AC1 / Kevin Ker
Test Mode	Transmit by 802.11ax-HE80 at channel 5530MHz	Test Voltage	120V/60Hz

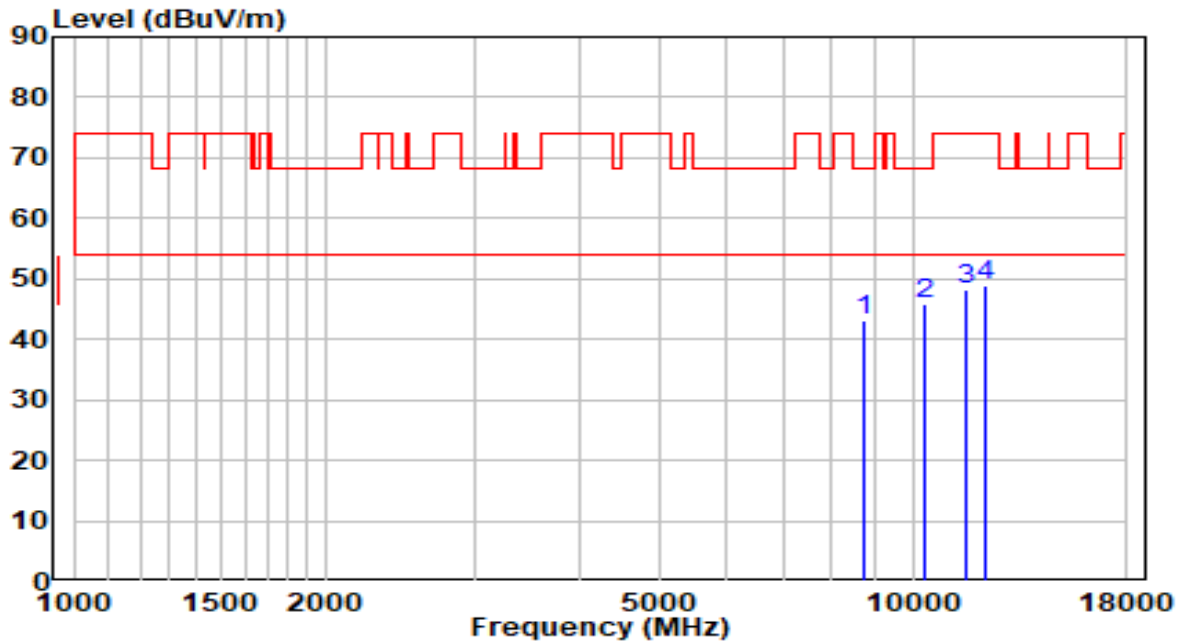

No	Frequency (MHz)	Reading (dBuV)	C.F (dB)	Measurement (dBuV/m)	Margin (dB)	Limit (dBuV/m)	Remark (QP/PK/AV)
1	8752.000	30.15	13.07	43.22	-24.98	68.20	Peak
2	* 10324.500	29.54	16.47	46.01	-22.19	68.20	Peak
3	11548.500	29.76	18.39	48.15	-25.85	74.00	Peak
4	12245.500	31.17	17.86	49.03	-24.97	74.00	Peak

Note:

1. " *", means this data is the worst emission level.
2. C.F (Correction Factor) = Antenna Factor (dB)+ Cable Loss (dB)– Preamplifier(dB).
3. Measurement(dBuV/m) = Reading(dBuV) + C.F (Correction Factor).
- 4.The emission levels of other frequencies are very lower than the limit and not show in test report.

EUT	AP311	Date of Test	2020-10-12
Factor	BBHA 9120D (1GHz~18GHz)_2020	Temp. / Humidity	23.7°C/37%
Polarity	Horizontal	Site / Test Engineer	AC1 / Kevin Ker
Test Mode	Transmit by 802.11ax-HE80 at channel 5610MHz	Test Voltage	120V/60Hz

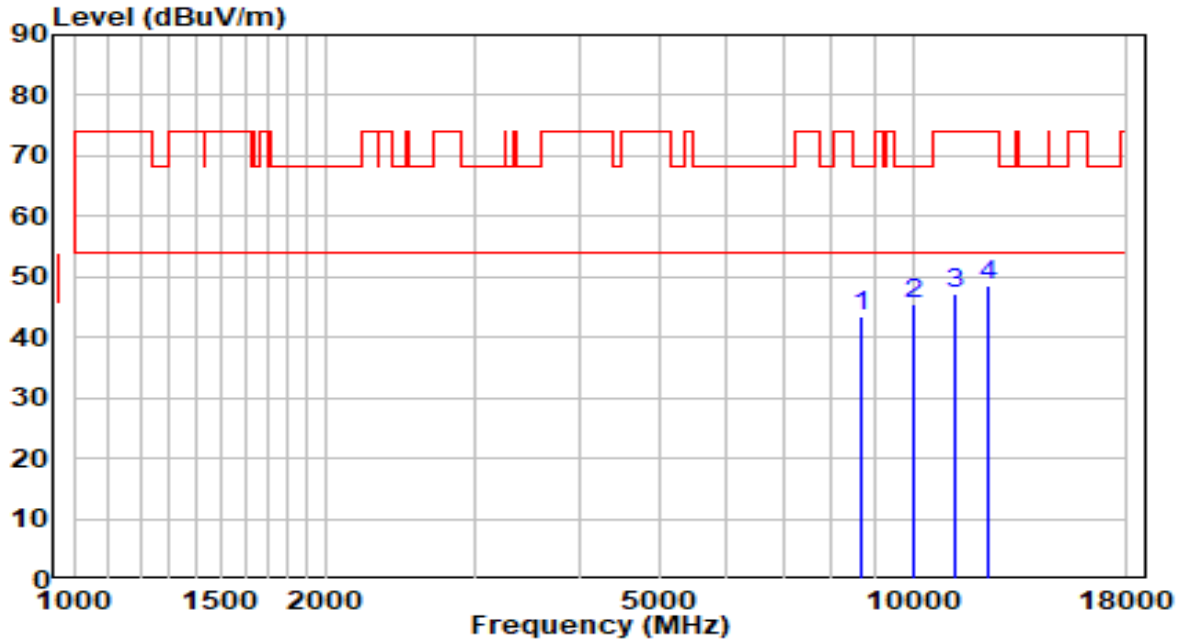

No	Frequency (MHz)	Reading (dBuV)	C.F (dB)	Measurement (dBuV/m)	Margin (dB)	Limit (dBuV/m)	Remark (QP/PK/AV)
1	8675.500	30.66	12.88	43.55	-24.65	68.20	Peak
2	* 10001.500	30.13	15.37	45.49	-22.71	68.20	Peak
3	11217.000	29.28	18.07	47.35	-26.65	74.00	Peak
4	12296.500	30.81	17.87	48.68	-25.32	74.00	Peak

Note:

- "*", means this data is the worst emission level.
- C.F (Correction Factor) = Antenna Factor (dB)+ Cable Loss (dB)– Preamplifier(dB).
- Measurement(dBuV/m) = Reading(dBuV) + C.F (Correction Factor).
- The emission levels of other frequencies are very lower than the limit and not show in test report.

EUT	AP311	Date of Test	2020-10-12
Factor	BBHA 9120D (1GHz~18GHz)_2020	Temp. / Humidity	23.7°C/37%
Polarity	Vertical	Site / Test Engineer	AC1 / Kevin Ker
Test Mode	Transmit by 802.11ax-HE80 at channel 5610MHz	Test Voltage	120V/60Hz

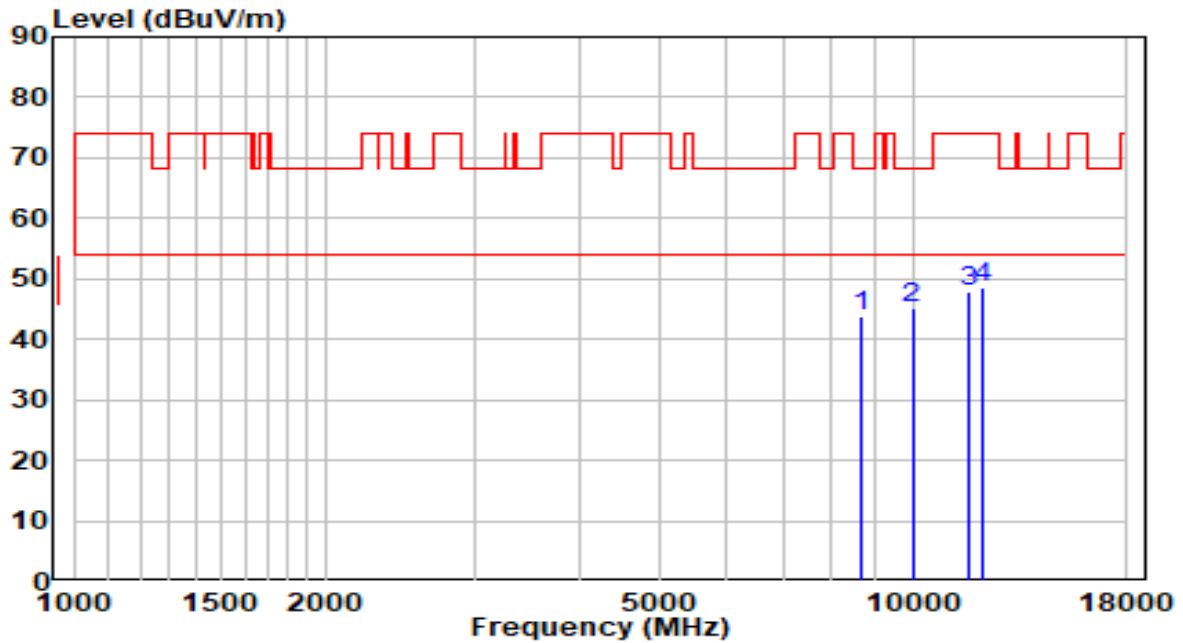

No	Frequency (MHz)	Reading (dBuV)	C.F (dB)	Measurement (dBuV/m)	Margin (dB)	Limit (dBuV/m)	Remark (QP/PK/AV)
1	8675.500	30.92	12.88	43.80	-24.40	68.20	Peak
2	* 9984.500	30.00	15.33	45.34	-22.86	68.20	Peak
3	11684.500	29.82	18.22	48.03	-25.97	74.00	Peak
4	12135.000	30.81	17.84	48.65	-25.35	74.00	Peak

Note:

- "*", means this data is the worst emission level.
- C.F (Correction Factor) = Antenna Factor (dB)+ Cable Loss (dB)– Preamplifier(dB).
- Measurement(dBuV/m) = Reading(dBuV) + C.F (Correction Factor).
- The emission levels of other frequencies are very lower than the limit and not show in test report.

EUT	AP311	Date of Test	2020-10-12
Factor	BBHA 9120D (1GHz~18GHz)_2020	Temp. / Humidity	23.7°C/37%
Polarity	Horizontal	Site / Test Engineer	AC1 / Kevin Ker
Test Mode	Transmit by 802.11ax-HE80 at channel 5690MHz	Test Voltage	120V/60Hz

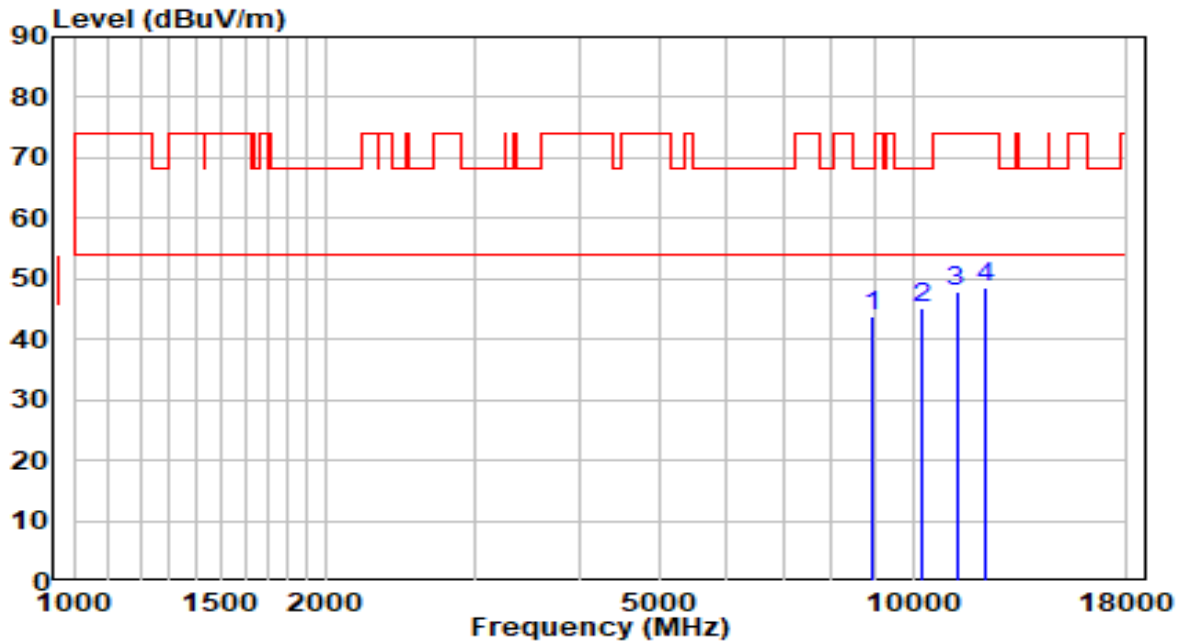

No	Frequency (MHz)	Reading (dBuV)	C.F (dB)	Measurement (dBuV/m)	Margin (dB)	Limit (dBuV/m)	Remark (QP/PK/AV)
1	8922.000	30.27	13.49	43.76	-24.44	68.20	Peak
2	* 10231.000	28.98	16.15	45.13	-23.07	68.20	Peak
3	11268.000	29.84	18.14	47.98	-26.02	74.00	Peak
4	12245.500	30.54	17.86	48.40	-25.60	74.00	Peak

Note:

- "*", means this data is the worst emission level.
- C.F (Correction Factor) = Antenna Factor (dB)+ Cable Loss (dB)– Preamplifier(dB).
- Measurement(dBuV/m) = Reading(dBuV) + C.F (Correction Factor).
- The emission levels of other frequencies are very lower than the limit and not show in test report.

EUT	AP311	Date of Test	2020-10-12
Factor	BBHA 9120D (1GHz~18GHz)_2020	Temp. / Humidity	23.7°C/37%
Polarity	Vertical	Site / Test Engineer	AC1 / Kevin Ker
Test Mode	Transmit by 802.11ax-HE80 at channel 5690MHz	Test Voltage	120V/60Hz

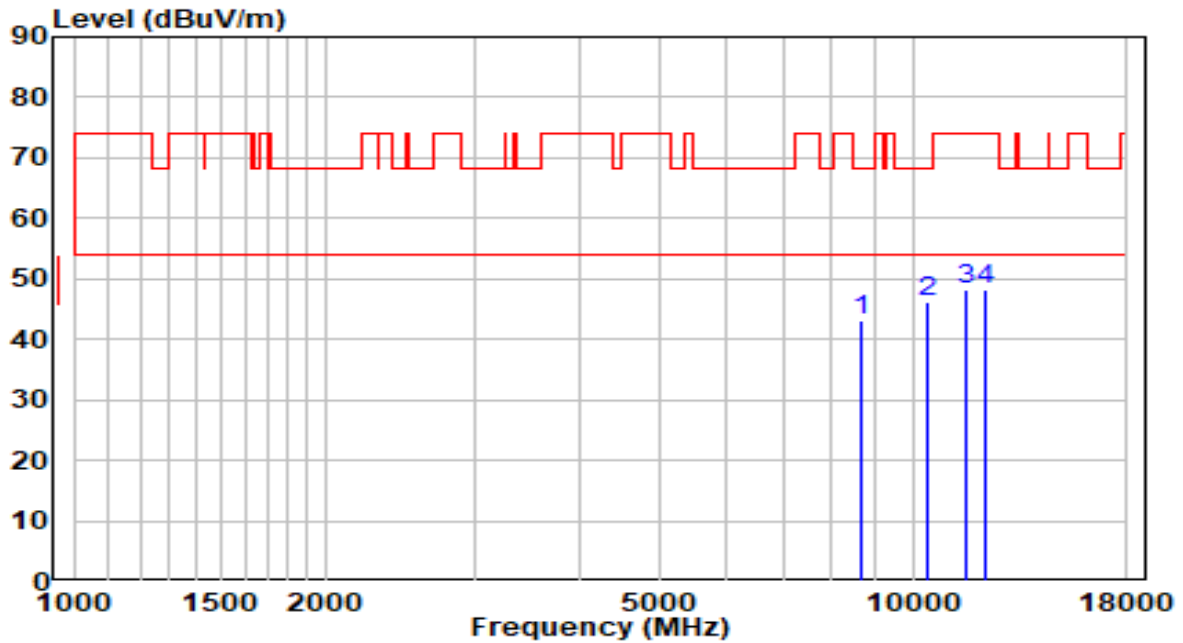

No	Frequency (MHz)	Reading (dBuV)	C.F (dB)	Measurement (dBuV/m)	Margin (dB)	Limit (dBuV/m)	Remark (QP/PK/AV)
1	8667.000	30.44	12.86	43.30	-24.90	68.20	Peak
2	* 10409.500	29.51	16.76	46.27	-21.93	68.20	Peak
3	11591.000	29.78	18.34	48.12	-25.88	74.00	Peak
4	12245.500	30.26	17.86	48.12	-25.88	74.00	Peak

Note:

- "*", means this data is the worst emission level.
- C.F (Correction Factor) = Antenna Factor (dB)+ Cable Loss (dB)– Preamplifier(dB).
- Measurement(dBuV/m) = Reading(dBuV) + C.F (Correction Factor).
- The emission levels of other frequencies are very lower than the limit and not show in test report.

EUT	AP311	Date of Test	2020-10-12
Factor	BBHA 9120D (1GHz~18GHz)_2020	Temp. / Humidity	23.7°C/37%
Polarity	Horizontal	Site / Test Engineer	AC1 / Kevin Ker
Test Mode	Transmit by 802.11ax-HE80 at channel 5775MHz	Test Voltage	120V/60Hz

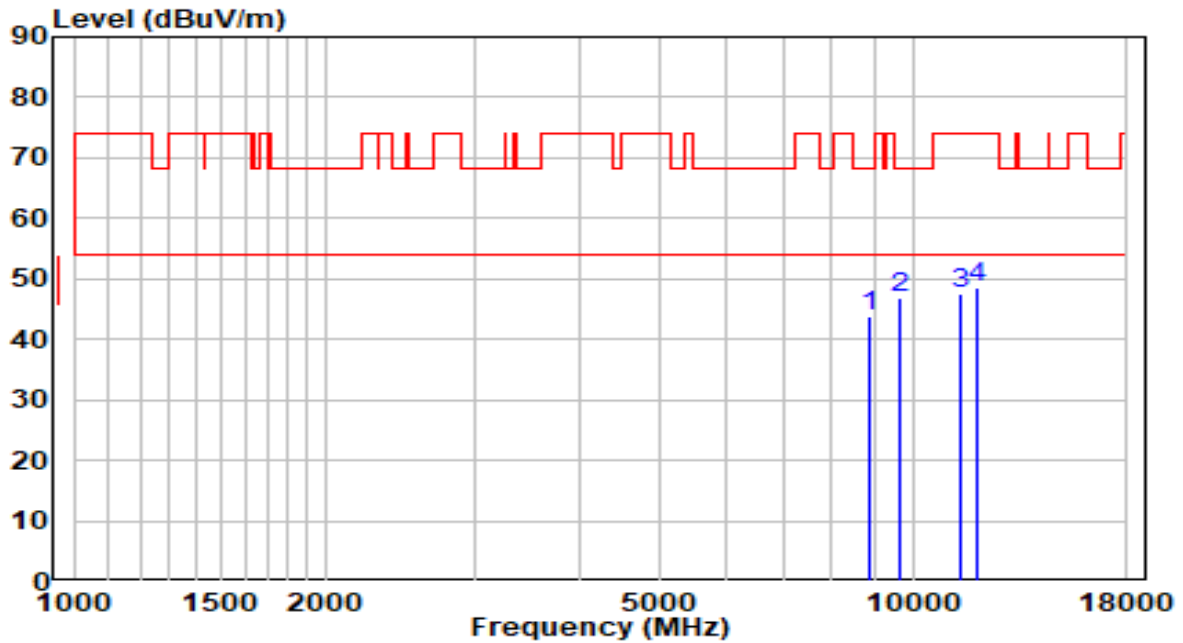

No	Frequency (MHz)	Reading (dBuV)	C.F (dB)	Measurement (dBuV/m)	Margin (dB)	Limit (dBuV/m)	Remark (QP/PK/AV)
1	8854.000	30.40	13.32	43.72	-24.48	68.20	Peak
2	* 9644.500	32.28	14.69	46.97	-21.23	68.20	Peak
3	11361.500	29.36	18.26	47.62	-26.38	74.00	Peak
4	11897.000	30.51	17.95	48.46	-25.54	74.00	Peak

Note:

- "*", means this data is the worst emission level.
- C.F (Correction Factor) = Antenna Factor (dB)+ Cable Loss (dB)– Preamplifier(dB).
- Measurement(dBuV/m) = Reading(dBuV) + C.F (Correction Factor).
- The emission levels of other frequencies are very lower than the limit and not show in test report.

EUT	AP311	Date of Test	2020-10-12
Factor	BBHA 9120D (1GHz~18GHz)_2020	Temp. / Humidity	23.7°C/37%
Polarity	Vertical	Site / Test Engineer	AC1 / Kevin Ker
Test Mode	Transmit by 802.11ax-HE80 at channel 5775MHz	Test Voltage	120V/60Hz

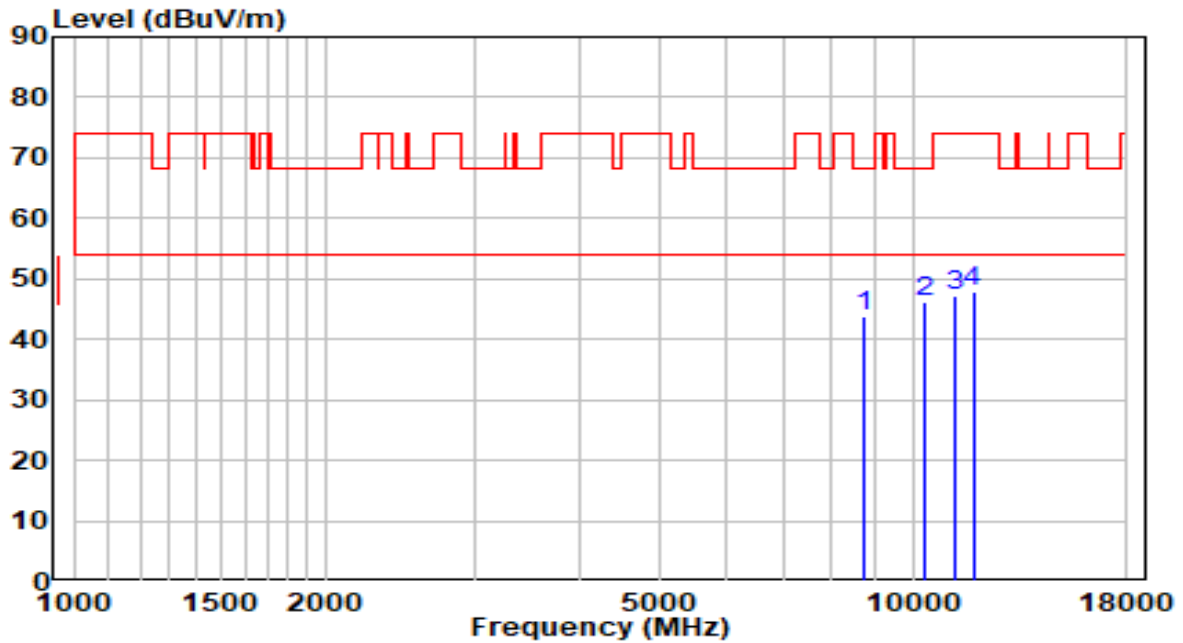

No	Frequency (MHz)	Reading (dBuV)	C.F (dB)	Measurement (dBuV/m)	Margin (dB)	Limit (dBuV/m)	Remark (QP/PK/AV)
1	8735.000	30.64	13.03	43.67	-24.53	68.20	Peak
2	* 10316.000	29.60	16.44	46.04	-22.16	68.20	Peak
3	11200.000	28.99	18.05	47.04	-26.96	74.00	Peak
4	11795.000	29.64	18.08	47.72	-26.28	74.00	Peak

Note:

- "*", means this data is the worst emission level.
- C.F (Correction Factor) = Antenna Factor (dB)+ Cable Loss (dB)– Preamplifier(dB).
- Measurement(dBuV/m) = Reading(dBuV) + C.F (Correction Factor).
- The emission levels of other frequencies are very lower than the limit and not show in test report.

EUT	AP311	Date of Test	2020-09-27
Factor	BBHA 9120D (1GHz~18GHz)_2020	Temp. / Humidity	25.6°C/51.3%
Polarity	Horizontal	Site / Test Engineer	AC1 / Kevin Ker
Test Mode	Transmit by 802.11a at Channel 5180MHz-Scan Antenna	Test Voltage	120V/60Hz

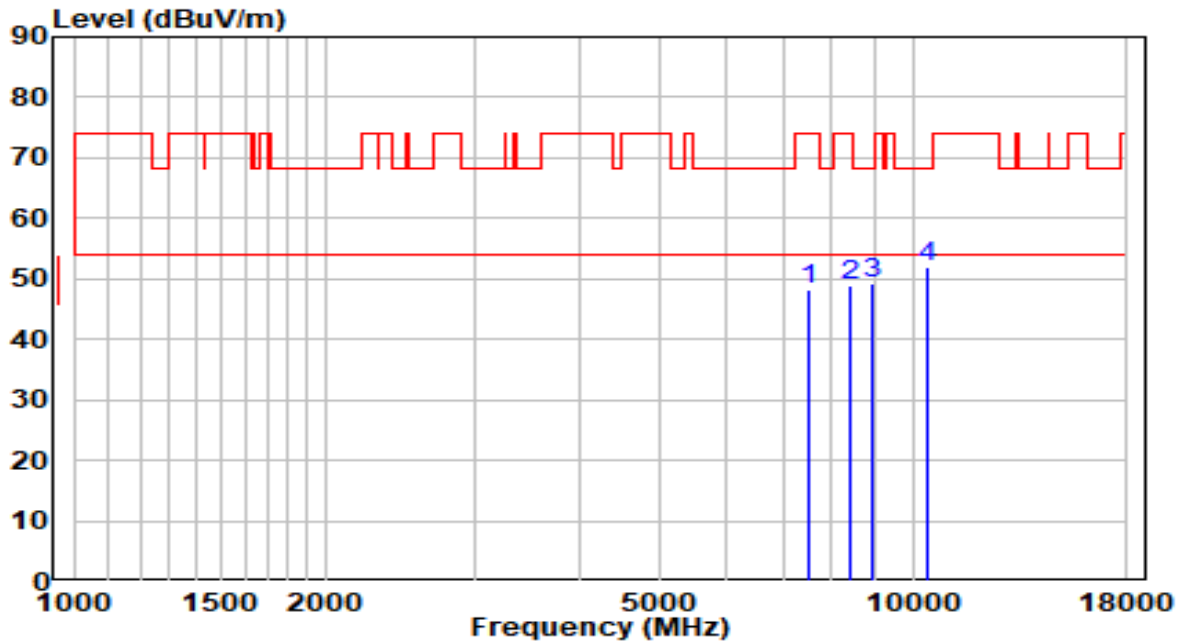

No	Frequency (MHz)	Reading (dBUV)	C.F (dB)	Measurement (dBUV/m)	Margin (dB)	Limit (dBUV/m)	Remark (QP/PK/AV)
1	7519.500	36.53	11.75	48.28	-25.72	74.00	Peak
2	8437.500	36.41	12.46	48.88	-25.12	74.00	Peak
3	8956.000	35.83	13.57	49.41	-18.79	68.20	Peak
4	* 10392.500	35.34	16.70	52.04	-16.16	68.20	Peak

Note:

1. " *", means this data is the worst emission level.
2. C.F (Correction Factor) = Antenna Factor (dB)+ Cable Loss (dB)– Preamplifier(dB).
3. Measurement(dBUV/m) = Reading(dBUV) + C.F (Correction Factor).
- 4.The emission levels of other frequencies are very lower than the limit and not show in test report.

EUT	AP311	Date of Test	2020-09-27
Factor	BBHA 9120D (1GHz~18GHz)_2020	Temp. / Humidity	25.6°C/51.3%
Polarity	Vertical	Site / Test Engineer	AC1 / Kevin Ker
Test Mode	Transmit by 802.11a at Channel 5180MHz-Scan Antenna	Test Voltage	120V/60Hz

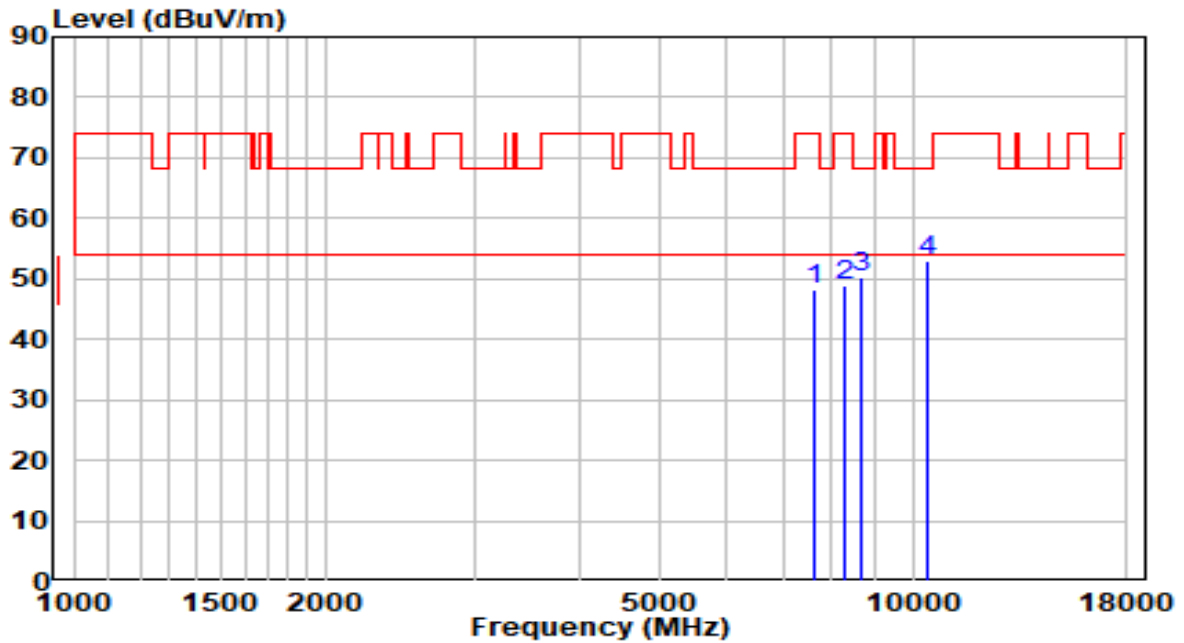

No	Frequency (MHz)	Reading (dBuV)	C.F (dB)	Measurement (dBuV/m)	Margin (dB)	Limit (dBuV/m)	Remark (QP/PK/AV)
1	7655.500	36.18	11.97	48.14	-25.86	74.00	Peak
2	8284.500	36.35	12.49	48.84	-25.16	74.00	Peak
3	8701.000	37.24	12.95	50.19	-18.01	68.20	Peak
4	* 10443.500	36.26	16.88	53.14	-15.06	68.20	Peak

Note:

1. " *", means this data is the worst emission level.
2. C.F (Correction Factor) = Antenna Factor (dB)+ Cable Loss (dB)– Preamplifier(dB).
3. Measurement(dBuV/m) = Reading(dBuV) + C.F (Correction Factor).
- 4.The emission levels of other frequencies are very lower than the limit and not show in test report.

EUT	AP311	Date of Test	2020-09-27
Factor	BBHA 9120D (1GHz~18GHz)_2020	Temp. / Humidity	25.6°C/51.3%
Polarity	Horizontal	Site / Test Engineer	AC1 / Kevin Ker
Test Mode	Transmit by 802.11a at Channel 5220MHz-Scan Antenna	Test Voltage	120V/60Hz

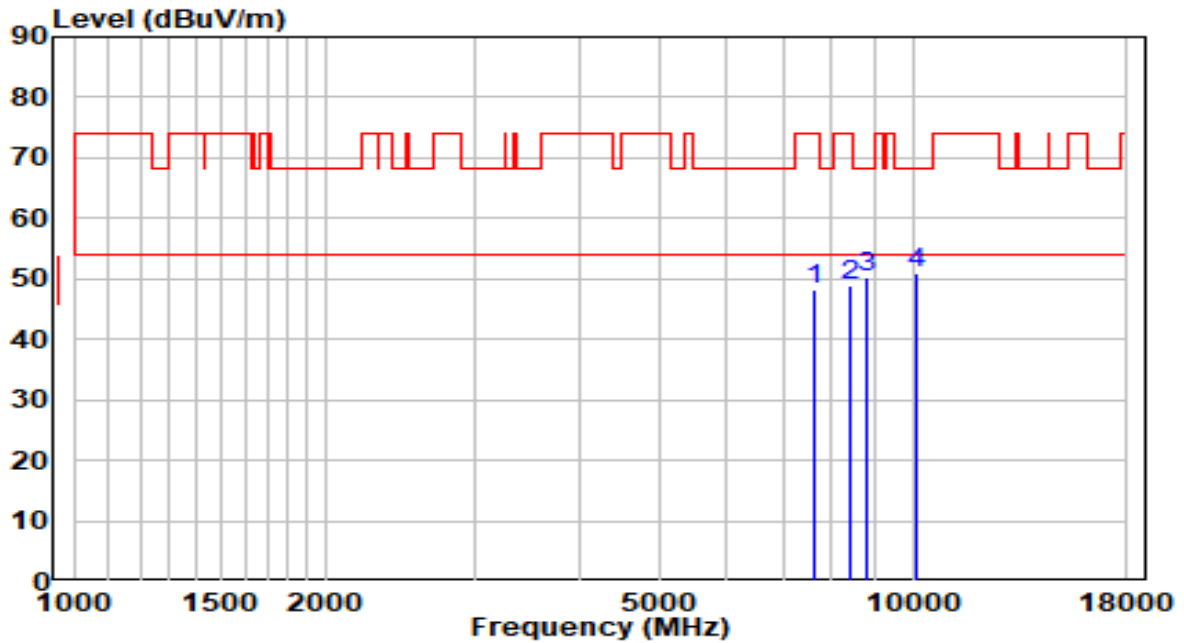

No	Frequency (MHz)	Reading (dBUV)	C.F (dB)	Measurement (dBUV/m)	Margin (dB)	Limit (dBUV/m)	Remark (QP/PK/AV)
1	7647.000	36.36	11.95	48.32	-25.68	74.00	Peak
2	8420.500	36.30	12.47	48.77	-25.23	74.00	Peak
3	8837.000	36.87	13.28	50.15	-18.05	68.20	Peak
4	* 10129.000	35.15	15.80	50.95	-17.25	68.20	Peak

Note:

1. " *", means this data is the worst emission level.
2. C.F (Correction Factor) = Antenna Factor (dB)+ Cable Loss (dB)– Preamplifier(dB).
3. Measurement(dBUV/m) = Reading(dBUV) + C.F (Correction Factor).
- 4.The emission levels of other frequencies are very lower than the limit and not show in test report.

EUT	AP311	Date of Test	2020-09-27
Factor	BBHA 9120D (1GHz~18GHz)_2020	Temp. / Humidity	25.6°C/51.3%
Polarity	Vertical	Site / Test Engineer	AC1 / Kevin Ker
Test Mode	Transmit by 802.11a at Channel 5220MHz-Scan Antenna	Test Voltage	120V/60Hz

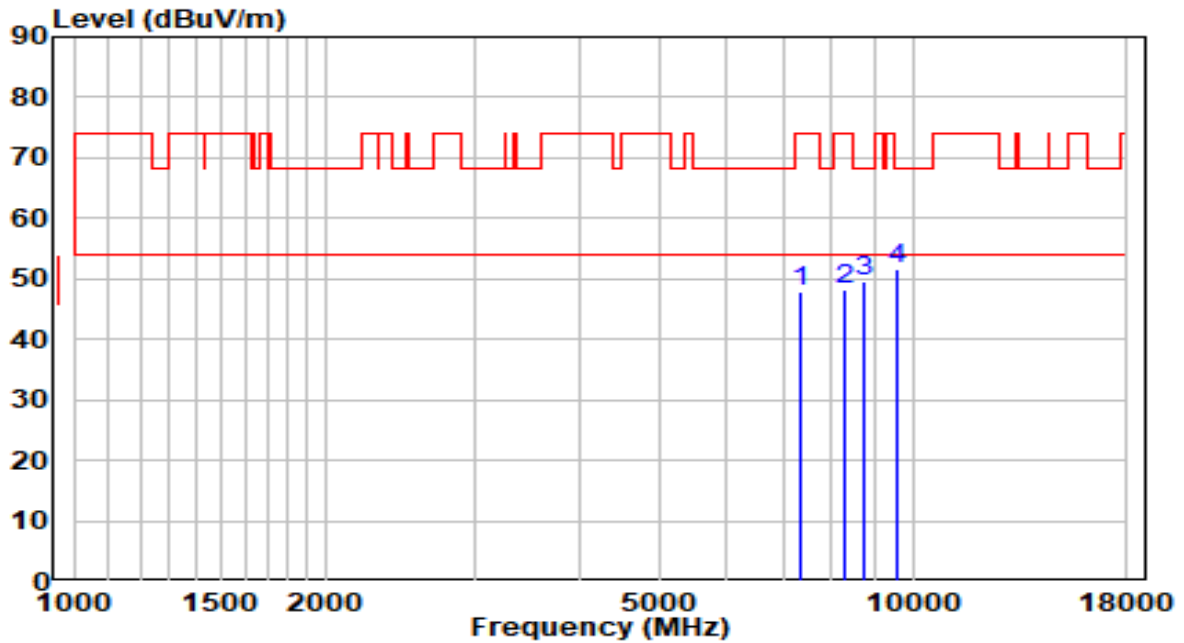

No	Frequency (MHz)	Reading (dBuV)	C.F (dB)	Measurement (dBuV/m)	Margin (dB)	Limit (dBuV/m)	Remark (QP/PK/AV)
1	7341.000	36.79	11.27	48.05	-25.95	74.00	Peak
2	8267.500	35.87	12.49	48.36	-25.64	74.00	Peak
3	8769.000	36.41	13.11	49.53	-18.67	68.20	Peak
4	* 9593.500	37.09	14.60	51.69	-16.51	68.20	Peak

Note:

1. " *", means this data is the worst emission level.
2. C.F (Correction Factor) = Antenna Factor (dB)+ Cable Loss (dB)– Preamplifier(dB).
3. Measurement(dBuV/m) = Reading(dBuV) + C.F (Correction Factor).
- 4.The emission levels of other frequencies are very lower than the limit and not show in test report.

EUT	AP311	Date of Test	2020-09-27
Factor	BBHA 9120D (1GHz~18GHz)_2020	Temp. / Humidity	25.6°C/51.3%
Polarity	Horizontal	Site / Test Engineer	AC1 / Kevin Ker
Test Mode	Transmit by 802.11a at Channel 5240MHz-Scan Antenna	Test Voltage	120V/60Hz

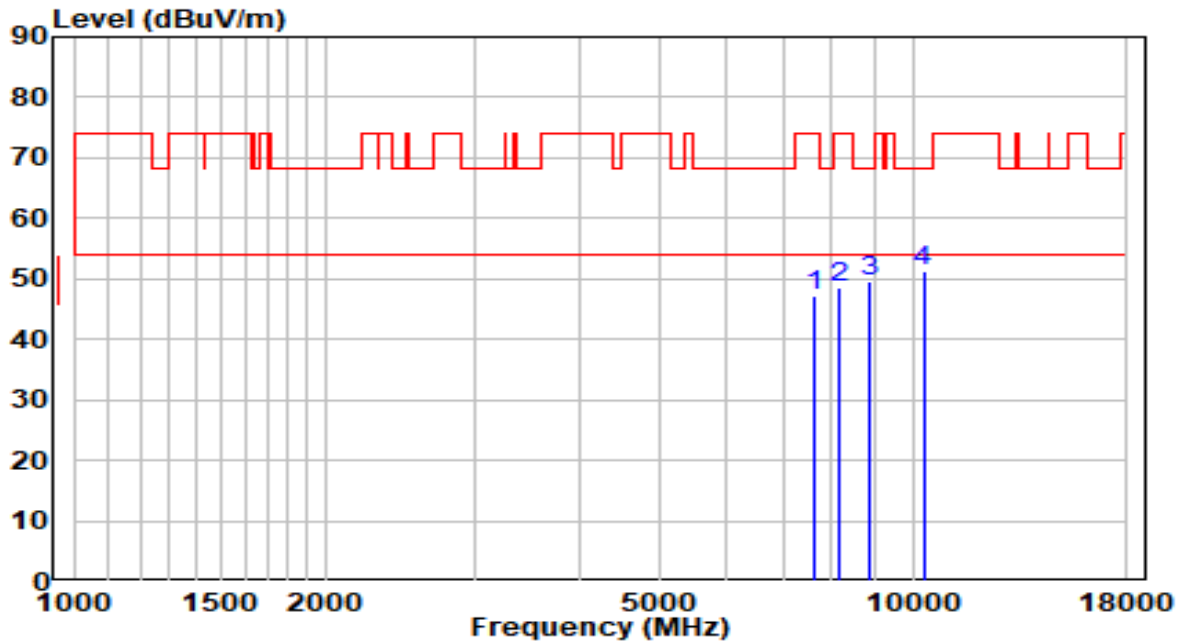

No	Frequency (MHz)	Reading (dBuV)	C.F (dB)	Measurement (dBuV/m)	Margin (dB)	Limit (dBuV/m)	Remark (QP/PK/AV)
1	7655.500	35.33	11.97	47.29	-26.71	74.00	Peak
2	8140.000	36.06	12.51	48.57	-25.43	74.00	Peak
3	8896.500	36.20	13.43	49.62	-18.58	68.20	Peak
4	* 10290.500	35.08	16.35	51.43	-16.77	68.20	Peak

Note:

1. " *", means this data is the worst emission level.
2. C.F (Correction Factor) = Antenna Factor (dB)+ Cable Loss (dB)– Preamplifier(dB).
3. Measurement(dBuV/m) = Reading(dBuV) + C.F (Correction Factor).
- 4.The emission levels of other frequencies are very lower than the limit and not show in test report.

EUT	AP311	Date of Test	2020-09-27
Factor	BBHA 9120D (1GHz~18GHz)_2020	Temp. / Humidity	25.6°C/51.3%
Polarity	Vertical	Site / Test Engineer	AC1 / Kevin Ker
Test Mode	Transmit by 802.11a at Channel 5240MHz-Scan Antenna	Test Voltage	120V/60Hz

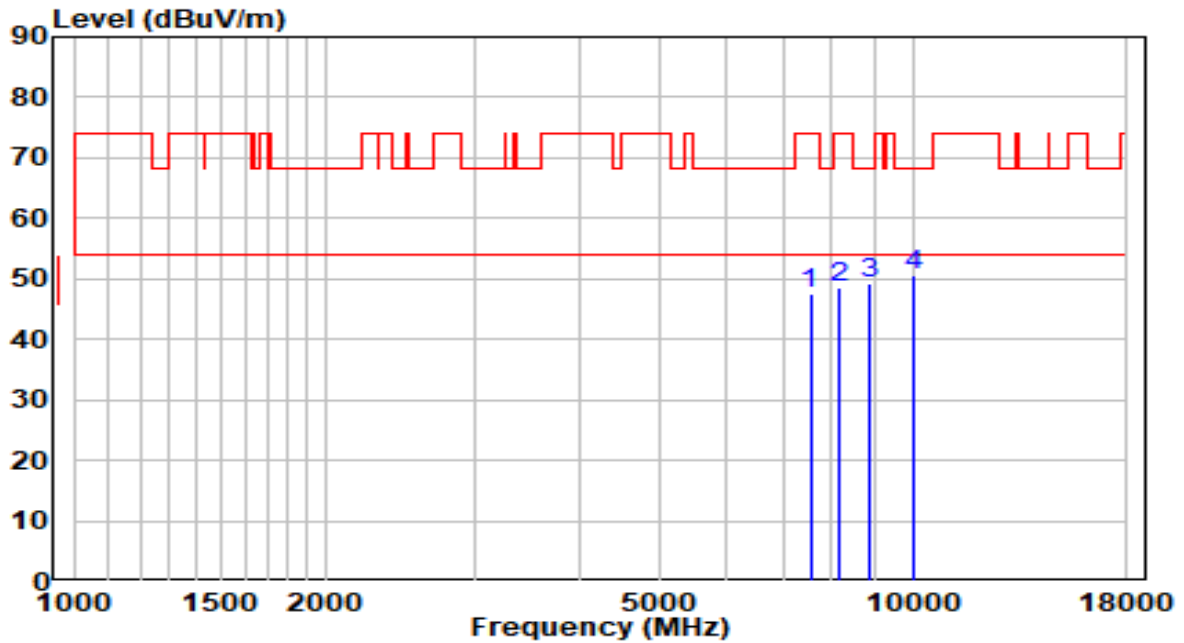

No	Frequency (MHz)	Reading (dBUV)	C.F (dB)	Measurement (dBUV/m)	Margin (dB)	Limit (dBUV/m)	Remark (QP/PK/AV)
1	7545.000	35.65	11.79	47.44	-26.56	74.00	Peak
2	8165.500	36.21	12.51	48.72	-25.28	74.00	Peak
3	8896.500	35.69	13.43	49.12	-19.08	68.20	Peak
4	* 10027.000	35.31	15.45	50.76	-17.44	68.20	Peak

Note:

1. " *", means this data is the worst emission level.
2. C.F (Correction Factor) = Antenna Factor (dB)+ Cable Loss (dB)– Preamplifier(dB).
3. Measurement(dBUV/m) = Reading(dBUV) + C.F (Correction Factor).
- 4.The emission levels of other frequencies are very lower than the limit and not show in test report.

EUT	AP311	Date of Test	2020-09-27
Factor	BBHA 9120D (1GHz~18GHz)_2020	Temp. / Humidity	25.6°C/51.3%
Polarity	Horizontal	Site / Test Engineer	AC1 / Kevin Ker
Test Mode	Transmit by 802.11a at Channel 5745MHz-Scan Antenna	Test Voltage	120V/60Hz

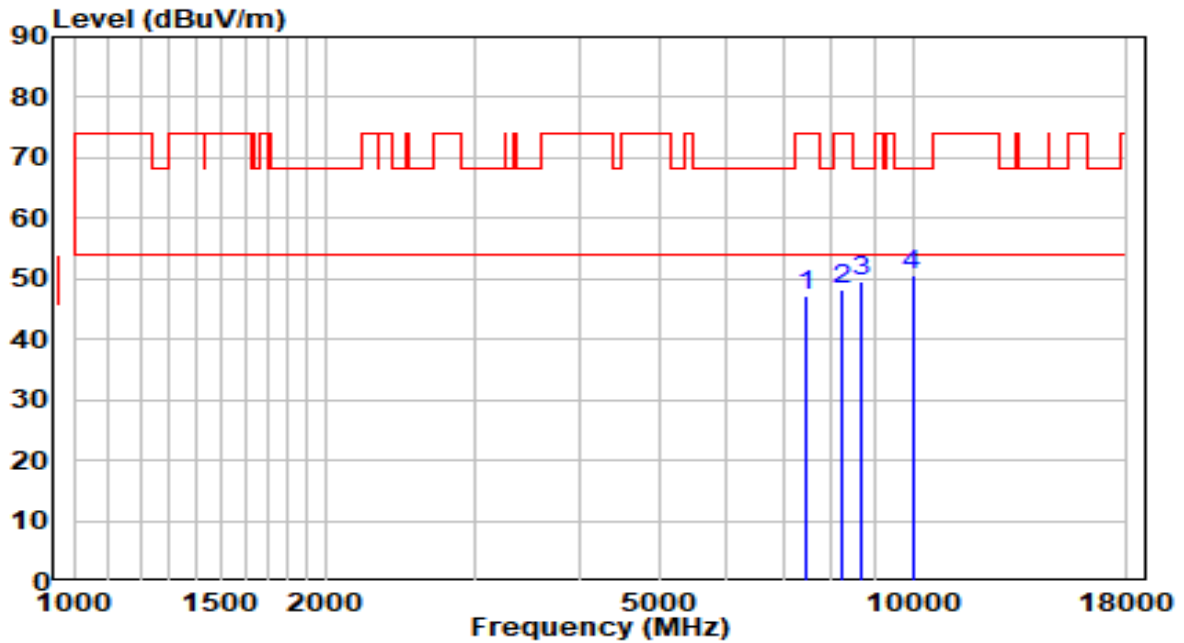

No	Frequency (MHz)	Reading (dBUV)	C.F (dB)	Measurement (dBUV/m)	Margin (dB)	Limit (dBUV/m)	Remark (QP/PK/AV)
1	7460.000	35.66	11.60	47.27	-26.73	74.00	Peak
2	8233.500	35.85	12.49	48.34	-25.66	74.00	Peak
3	8701.000	36.52	12.95	49.47	-18.73	68.20	Peak
4	* 9984.500	35.15	15.33	50.48	-17.72	68.20	Peak

Note:

1. " *", means this data is the worst emission level.
2. C.F (Correction Factor) = Antenna Factor (dB)+ Cable Loss (dB)– Preamplifier(dB).
3. Measurement(dBUV/m) = Reading(dBUV) + C.F (Correction Factor).
- 4.The emission levels of other frequencies are very lower than the limit and not show in test report.

EUT	AP311	Date of Test	2020-09-27
Factor	BBHA 9120D (1GHz~18GHz)_2020	Temp. / Humidity	25.6°C/51.3%
Polarity	Vertical	Site / Test Engineer	AC1 / Kevin Ker
Test Mode	Transmit by 802.11a at Channel 5745MHz-Scan Antenna	Test Voltage	120V/60Hz

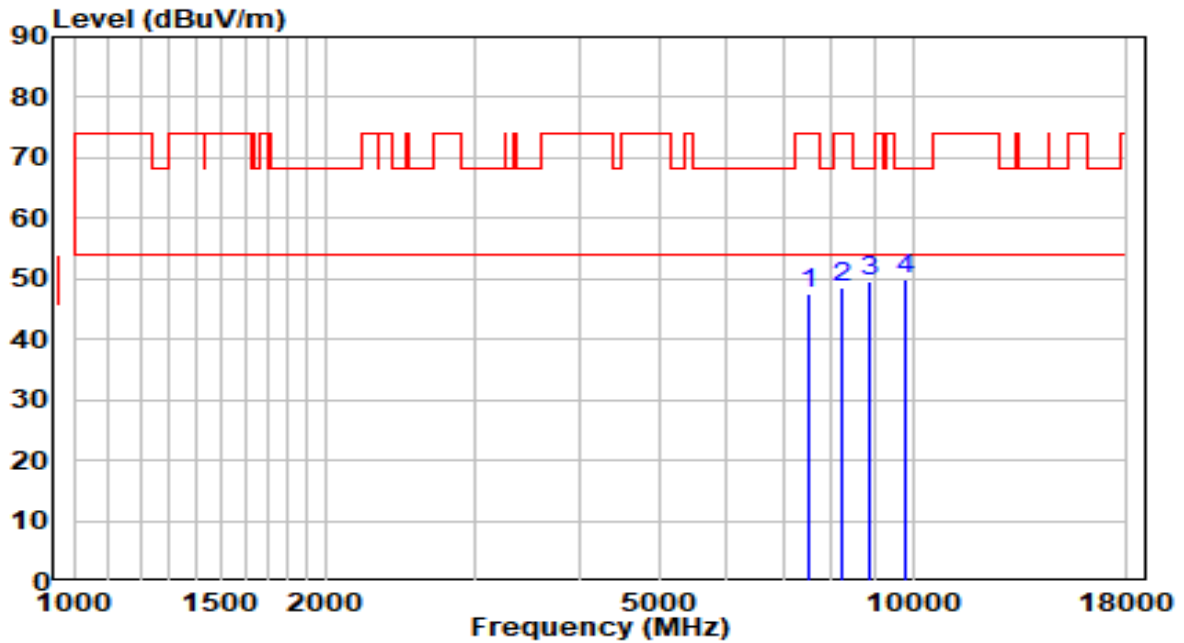

No	Frequency (MHz)	Reading (dBuV)	C.F (dB)	Measurement (dBuV/m)	Margin (dB)	Limit (dBuV/m)	Remark (QP/PK/AV)
1	7502.500	35.69	11.72	47.41	-26.59	74.00	Peak
2	8242.000	35.96	12.49	48.46	-25.54	74.00	Peak
3	8879.500	36.07	13.38	49.46	-18.74	68.20	Peak
4	* 9823.000	34.93	15.03	49.95	-18.25	68.20	Peak

Note:

1. " *", means this data is the worst emission level.
2. C.F (Correction Factor) = Antenna Factor (dB)+ Cable Loss (dB)– Preamplifier(dB).
3. Measurement(dBuV/m) = Reading(dBuV) + C.F (Correction Factor).
- 4.The emission levels of other frequencies are very lower than the limit and not show in test report.

EUT	AP311	Date of Test	2020-09-27
Factor	BBHA 9120D (1GHz~18GHz)_2020	Temp. / Humidity	25.6°C/51.3%
Polarity	Horizontal	Site / Test Engineer	AC1 / Kevin Ker
Test Mode	Transmit by 802.11a at Channel 5785MHz-Scan Antenna	Test Voltage	120V/60Hz

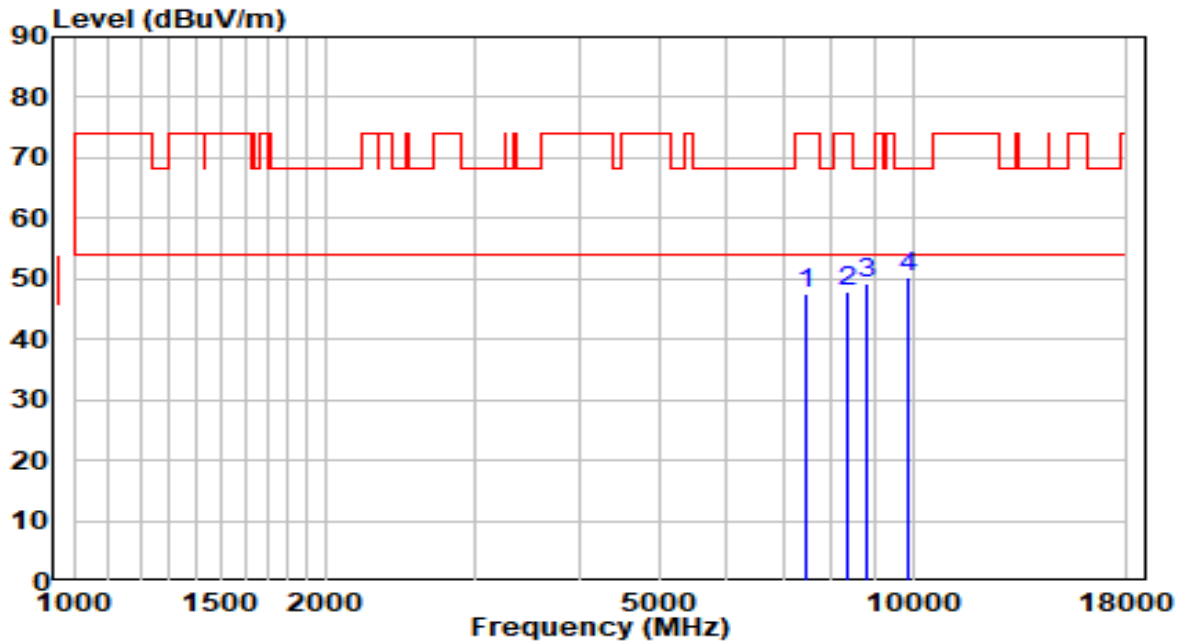

No	Frequency (MHz)	Reading (dBUV)	C.F (dB)	Measurement (dBUV/m)	Margin (dB)	Limit (dBUV/m)	Remark (QP/PK/AV)
1	7485.500	35.71	11.67	47.39	-26.61	74.00	Peak
2	8335.500	35.33	12.48	47.81	-26.19	74.00	Peak
3	8828.500	35.89	13.26	49.15	-19.05	68.20	Peak
4	* 9857.000	35.22	15.09	50.31	-17.89	68.20	Peak

Note:

1. " *", means this data is the worst emission level.
2. C.F (Correction Factor) = Antenna Factor (dB)+ Cable Loss (dB)– Preamplifier(dB).
3. Measurement(dBUV/m) = Reading(dBUV) + C.F (Correction Factor).
- 4.The emission levels of other frequencies are very lower than the limit and not show in test report.

EUT	AP311	Date of Test	2020-09-27
Factor	BBHA 9120D (1GHz~18GHz)_2020	Temp. / Humidity	25.6°C/51.3%
Polarity	Vertical	Site / Test Engineer	AC1 / Kevin Ker
Test Mode	Transmit by 802.11a at Channel 5785MHz-Scan Antenna	Test Voltage	120V/60Hz

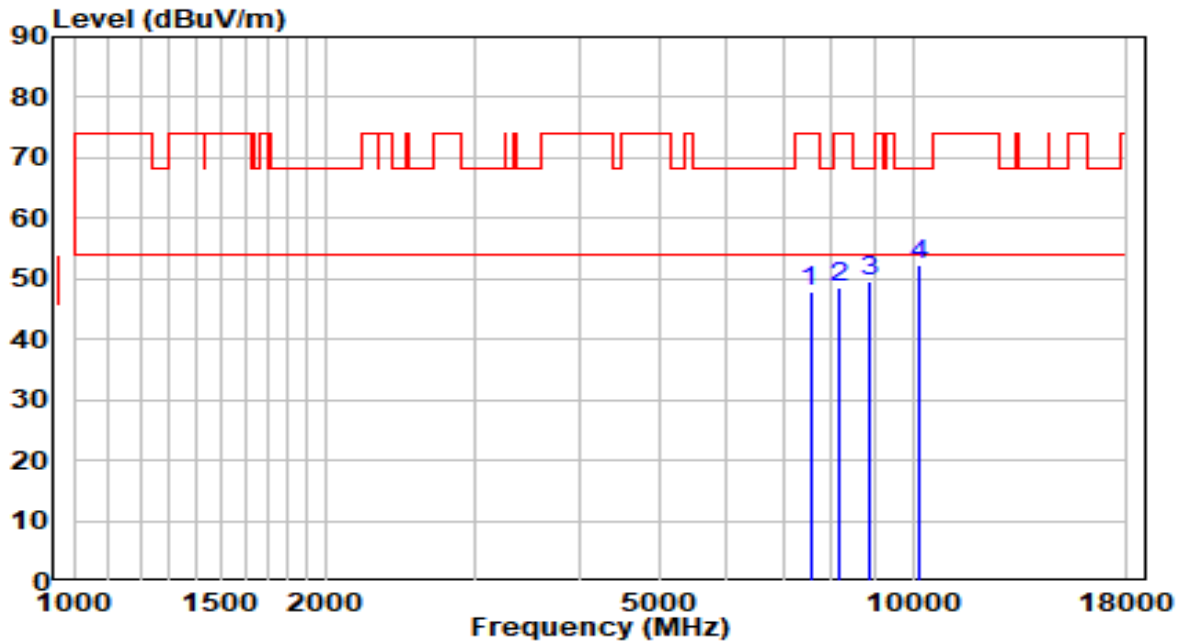

No	Frequency (MHz)	Reading (dBUV)	C.F (dB)	Measurement (dBUV/m)	Margin (dB)	Limit (dBUV/m)	Remark (QP/PK/AV)
1	7545.000	36.03	11.79	47.82	-26.18	74.00	Peak
2	8165.500	36.09	12.51	48.59	-25.41	74.00	Peak
3	8879.500	36.16	13.38	49.55	-18.65	68.20	Peak
4	* 10180.000	36.41	15.98	52.39	-15.81	68.20	Peak

Note:

1. " *", means this data is the worst emission level.
2. C.F (Correction Factor) = Antenna Factor (dB)+ Cable Loss (dB)– Preamplifier(dB).
3. Measurement(dBUV/m) = Reading(dBUV) + C.F (Correction Factor).
- 4.The emission levels of other frequencies are very lower than the limit and not show in test report.

EUT	AP311	Date of Test	2020-09-27
Factor	BBHA 9120D (1GHz~18GHz)_2020	Temp. / Humidity	25.6°C/51.3%
Polarity	Horizontal	Site / Test Engineer	AC1 / Kevin Ker
Test Mode	Transmit by 802.11a at Channel 5825MHz-Scan Antenna	Test Voltage	120V/60Hz

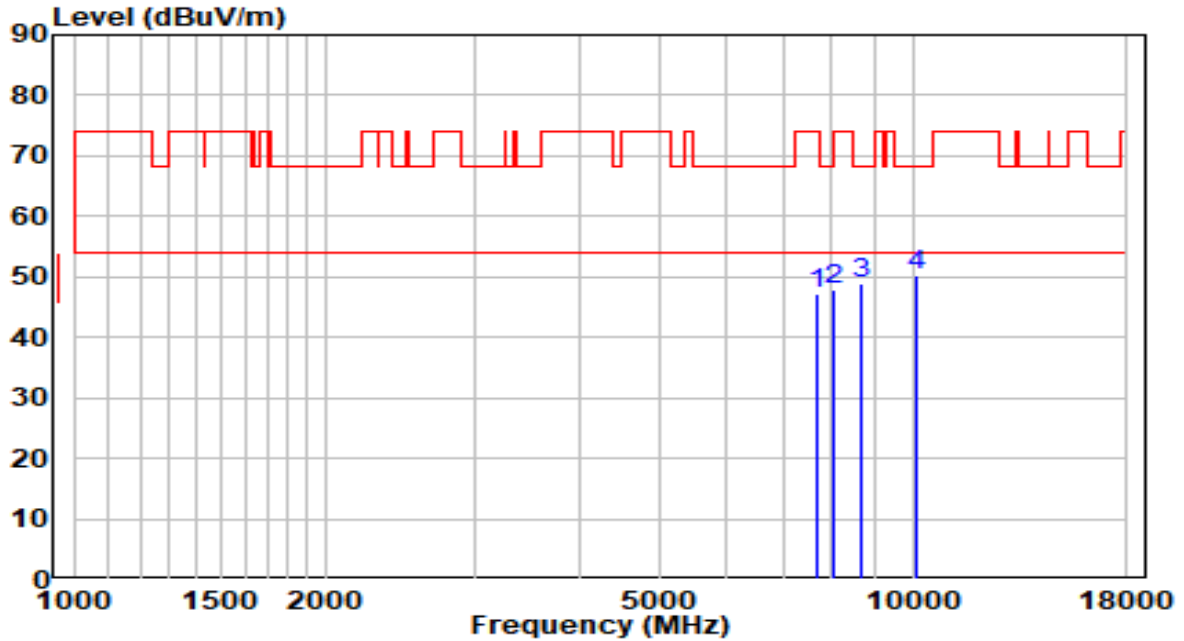

No	Frequency (MHz)	Reading (dBUV)	C.F (dB)	Measurement (dBUV/m)	Margin (dB)	Limit (dBUV/m)	Remark (QP/PK/AV)
1	7681.000	35.07	12.01	47.08	-26.92	74.00	Peak
2	8072.000	35.33	12.52	47.84	-26.16	74.00	Peak
3	8709.500	36.01	12.97	48.98	-19.22	68.20	Peak
4	* 10120.500	34.62	15.77	50.40	-17.80	68.20	Peak

Note:

1. " *", means this data is the worst emission level.
2. C.F (Correction Factor) = Antenna Factor (dB)+ Cable Loss (dB)– Preamplifier(dB).
3. Measurement(dBUV/m) = Reading(dBUV) + C.F (Correction Factor).
- 4.The emission levels of other frequencies are very lower than the limit and not show in test report.

EUT	AP311	Date of Test	2020-09-27
Factor	BBHA 9120D (1GHz~18GHz)_2020	Temp. / Humidity	25.6°C/51.3%
Polarity	Vertical	Site / Test Engineer	AC1 / Kevin Ker
Test Mode	Transmit by 802.11a at Channel 5825MHz-Scan Antenna	Test Voltage	120V/60Hz

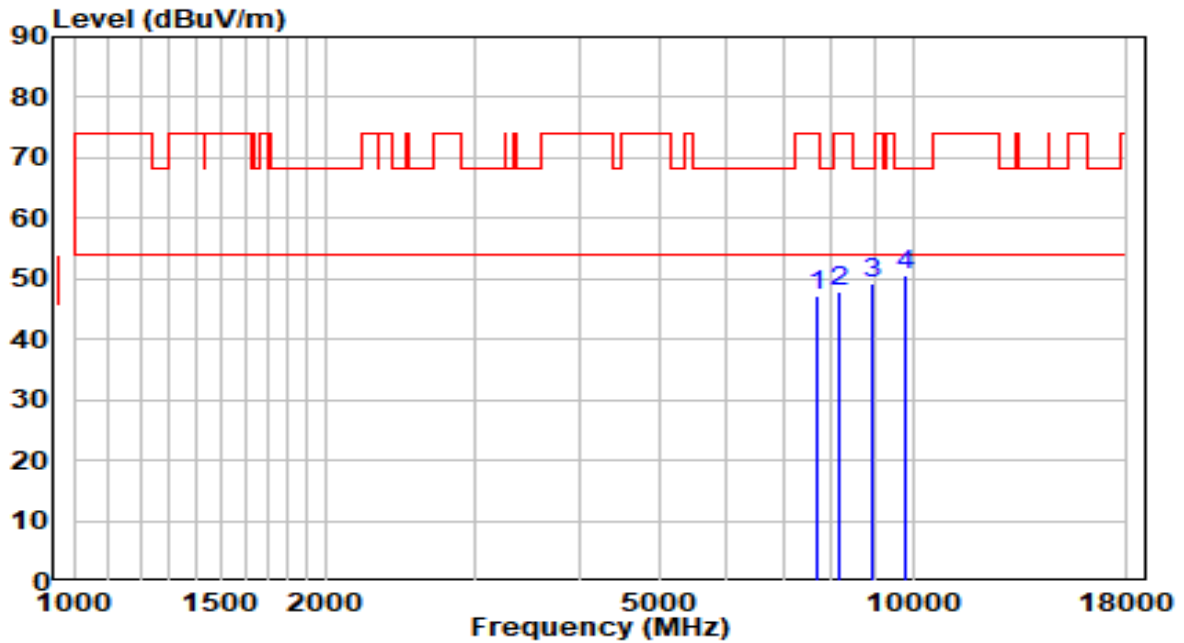

No	Frequency (MHz)	Reading (dBUV)	C.F (dB)	Measurement (dBUV/m)	Margin (dB)	Limit (dBUV/m)	Remark (QP/PK/AV)
1	7672.500	35.05	12.00	47.05	-26.95	74.00	Peak
2	8165.500	35.25	12.51	47.76	-26.24	74.00	Peak
3	8922.000	35.87	13.49	49.36	-18.84	68.20	Peak
4	* 9823.000	35.63	15.03	50.66	-17.54	68.20	Peak

Note:

1. " *", means this data is the worst emission level.
2. C.F (Correction Factor) = Antenna Factor (dB)+ Cable Loss (dB)– Preamplifier(dB).
3. Measurement(dBUV/m) = Reading(dBUV) + C.F (Correction Factor).
- 4.The emission levels of other frequencies are very lower than the limit and not show in test report.

The Worst Case of Radiated Emission below 1GHz:

EUT	AP311	Date of Test	2020-05-14
Factor	AC1_VULB 9162_20-2000MHz	Temp. / Humidity	25°C /54%
Polarity	Horizontal	Site / Test Engineer	AC1 / Kevin Ker
Test Mode	Worse Case	Test Voltage	120V/60Hz

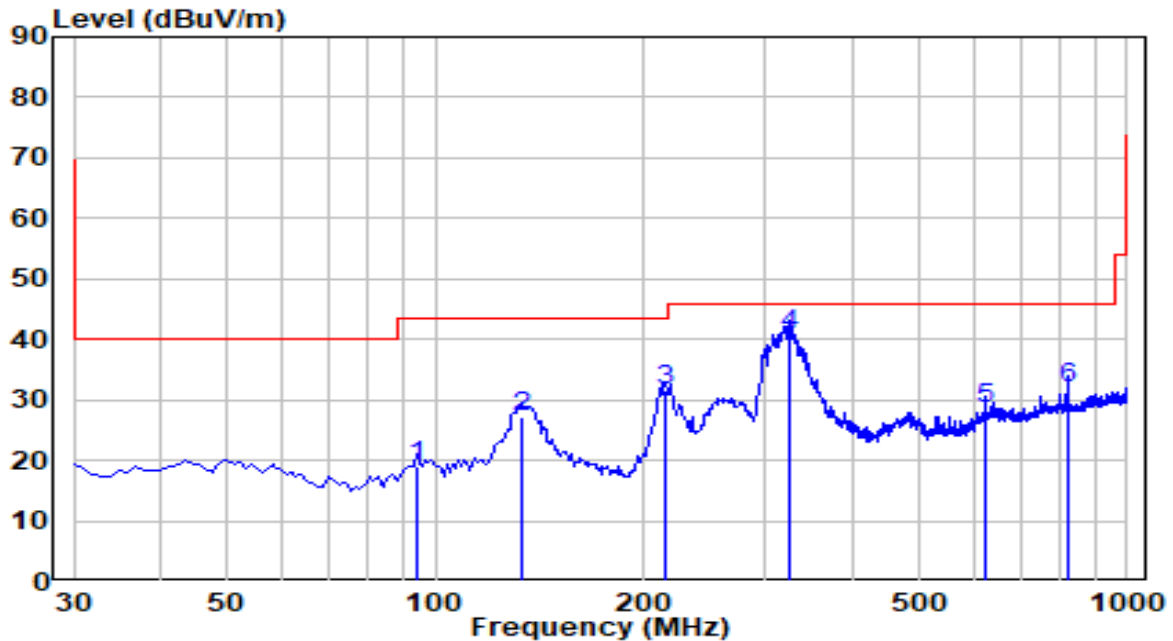

No	Frequency (MHz)	Reading (dBuV)	C.F (dB)	Measurement (dBuV/m)	Margin (dB)	Limit (dBuV/m)	Remark (QP/PK/AV)
1	94.020	8.42	10.57	18.99	-24.51	43.50	QP
2	133.790	13.05	14.08	27.13	-16.37	43.50	QP
3	214.300	19.88	11.61	31.49	-12.01	43.50	QP
4	* 325.850	25.61	15.04	40.65	-5.35	46.00	QP
5	624.610	7.32	21.09	28.41	-17.59	46.00	QP
6	819.580	8.54	23.45	31.99	-14.01	46.00	QP

Note:

- "*" means this data is the worst emission level.
- C.F (Correction Factor) = Antenna Factor (dB)+ Cable Loss (dB).
- Measurement(dBuV/m) = Reading(dBuV) + C.F (Correction Factor).
- The emission levels of other frequencies are very lower than the limit and not show in test report.
- The amplitude of Radiated emissions (the test frequency range: 9kHz ~ 30MHz, 18GHz ~ 40GHz), is that proximity to ambient noise, which also are attenuated more than 20 dB below the permissible value. Therefore, the data is not presented in the report

EUT	AP311	Date of Test	2020-05-14
Factor	AC1_VULB 9168_20-2000MHz	Temp. / Humidity	25°C /54%
Polarity	Vertical	Site / Test Engineer	AC1 / Kevin Ker
Test Mode	Worse Case	Test Voltage	120V/60Hz

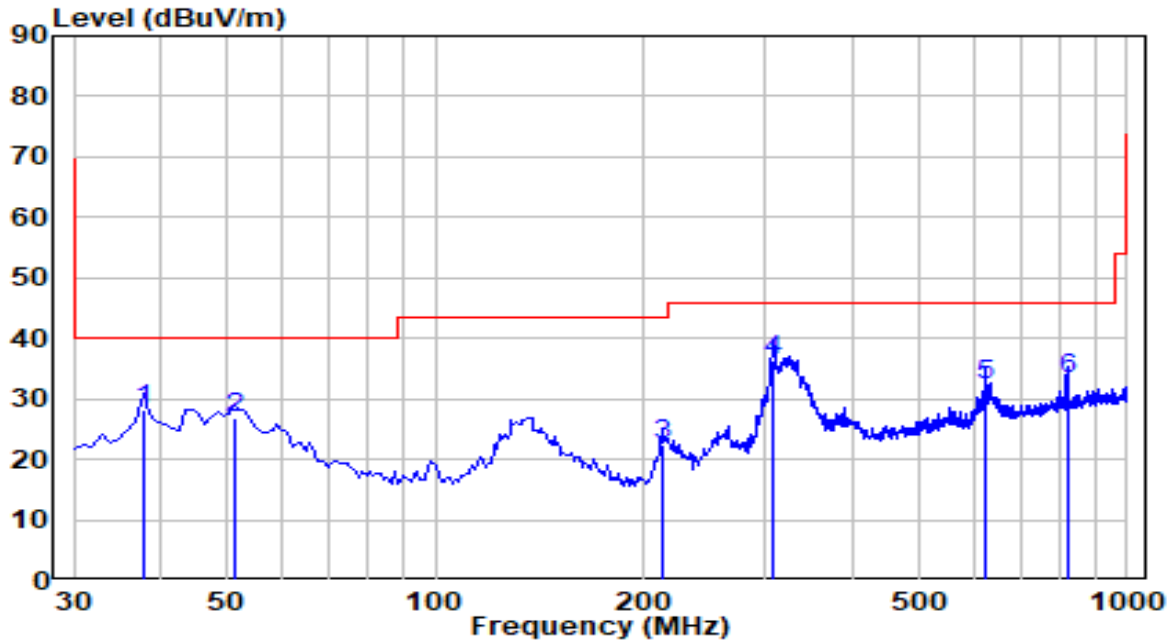

No	Frequency (MHz)	Reading (dBUV)	C.F (dB)	Measurement (dBUV/m)	Margin (dB)	Limit (dBUV/m)	Remark (QP/PK/AV)
1	37.760	14.04	14.29	28.33	-11.67	40.00	QP
2	51.340	12.95	14.04	26.99	-13.01	40.00	QP
3	212.360	11.04	11.50	22.54	-20.96	43.50	QP
4	* 308.390	21.85	14.57	36.42	-9.58	46.00	QP
5	624.610	11.24	21.09	32.33	-13.67	46.00	QP
6	821.520	9.75	23.46	33.21	-12.79	46.00	QP

Note:

1. " *", means this data is the worst emission level.
2. C.F (Correction Factor) = Antenna Factor (dB)+ Cable Loss (dB).
3. Measurement(dBUV/m) = Reading(dBUV) + C.F (Correction Factor).
4. The emission levels of other frequencies are very lower than the limit and not show in test report.
5. The amplitude of Radiated emissions (the test frequency range: 9kHz ~ 30MHz, 18GHz ~ 40GHz), is that proximityto ambient noise, which also are attenuated more than 20 dB below the permissible value. Therefore, the data is not presented in the report.

The worst case of Radiated Emission below 1GHz:

EUT	AP311	Date of Test	2020-10-15
Factor	AC1_VULB 9168_20-2000MHz	Temp. / Humidity	22.8°C /44%
Polarity	Horizontal	Site / Test Engineer	AC1 / Kevin Ker
Test Mode	Transmit by 802.11ax-HE20 at channel 5260MHz	Test Voltage	120V/60Hz

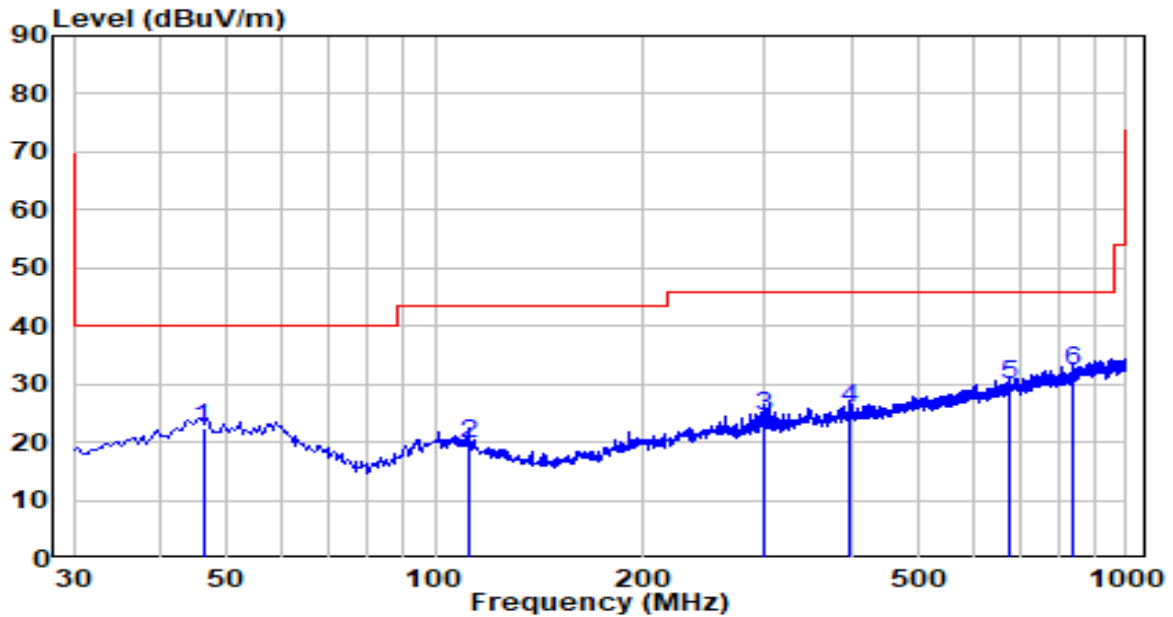

No	Frequency (MHz)	Reading (dBuV)	C.F (dB)	Measurement (dBuV/m)	Margin (dB)	Limit (dBuV/m)	Remark (QP/PK/AV)
1	46.150	0.87	21.46	22.33	-17.67	40.00	QP
2	111.650	1.43	18.42	19.85	-23.65	43.50	QP
3	300.165	2.94	21.41	24.35	-21.65	46.00	QP
4	396.650	1.81	24.11	25.92	-20.08	46.00	QP
5	678.540	0.90	28.83	29.73	-16.27	46.00	QP
6	* 839.950	1.34	31.09	32.43	-13.57	46.00	QP

Note:

1. " *", means this data is the worst emission level.
2. C.F (Correction Factor) = Antenna Factor (dB)+ Cable Loss (dB).
3. Measurement(dBuV/m) = Reading(dBuV) + C.F (Correction Factor).
- 4.The emission levels of other frequencies are very lower than the limit and not show in test report.
- 5.The amplitude of Radiated emissions (the test frequency range: 9kHz ~ 30MHz, 18GHz ~ 25GHz), is that proximity to ambient noise, which also are attenuated more than 20 dB below the permissible value. Therefore, the data is not presented in the report.

EUT	AP311	Date of Test	2020-10-15
Factor	AC1_VULB 9162_20-2000MHz	Temp. / Humidity	22.8°C /44%
Polarity	Vertical	Site / Test Engineer	AC1 / Kevin Ker
Test Mode	Transmit by 802.11ax-HE20 at channel 5260MHz	Test Voltage	120V/60Hz

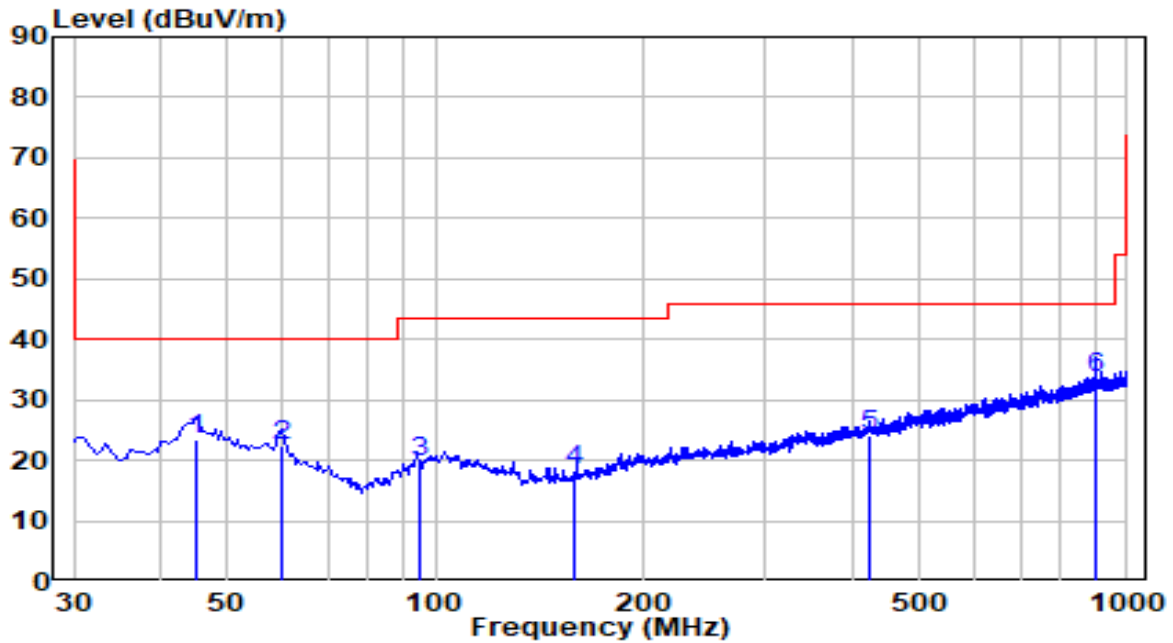

No	Frequency (MHz)	Reading (dBuV)	C.F (dB)	Measurement (dBuV/m)	Margin (dB)	Limit (dBuV/m)	Remark (QP/PK/AV)
1	45.120	1.98	21.41	23.39	-16.61	40.00	QP
2	60.150	2.23	20.06	22.29	-17.71	40.00	QP
3	94.630	1.38	18.24	19.62	-23.88	43.50	QP
4	159.240	2.25	16.09	18.34	-25.16	43.50	QP
5	425.210	-0.51	24.53	24.02	-21.98	46.00	QP
6	* 899.650	2.27	31.47	33.74	-12.26	46.00	QP

Note:

1. " *", means this data is the worst emission level.
2. C.F (Correction Factor) = Antenna Factor (dB)+ Cable Loss (dB).
3. Measurement(dBuV/m) = Reading(dBuV) + C.F (Correction Factor).
- 4.The emission levels of other frequencies are very lower than the limit and not show in test report.
- 5.The amplitude of Radiated emissions (the test frequency range: 9kHz ~ 30MHz, 18GHz ~ 25GHz), is that proximity to ambient noise, which also are attenuated more than 20 dB below the permissible value. Therefore, the data is not presented in the report.

EUT	AP311	Date of Test	2020-10-15
Factor	AC1_VULB 9162_20-2000MHz	Temp. / Humidity	22.8°C /44%
Polarity	Horizontal	Site / Test Engineer	AC1 / Kevin Ker
Test Mode	Transmit by 802.11a at channel 5825MHz -Scan Antenna	Test Voltage	120V/60Hz

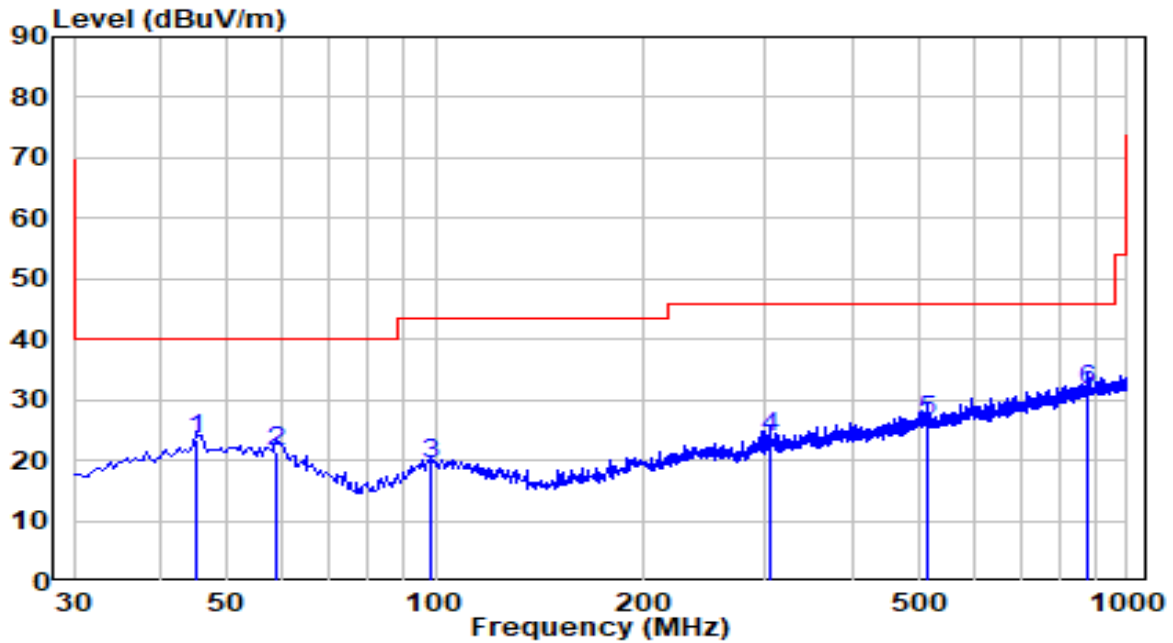

No	Frequency (MHz)	Reading (dBuV)	C.F (dB)	Measurement (dBuV/m)	Margin (dB)	Limit (dBuV/m)	Remark (QP/PK/AV)
1	45.150	2.19	21.41	23.60	-16.40	40.00	QP
2	58.650	1.14	20.32	21.46	-18.54	40.00	QP
3	98.630	0.05	19.31	19.36	-24.14	43.50	QP
4	304.120	2.28	21.57	23.85	-22.15	46.00	QP
5	512.360	0.40	26.02	26.42	-19.58	46.00	QP
6	* 875.320	0.37	31.38	31.75	-14.25	46.00	QP

Note:

1. " *", means this data is the worst emission level.
2. C.F (Correction Factor) = Antenna Factor (dB)+ Cable Loss (dB).
3. Measurement(dBuV/m) = Reading(dBuV) + C.F (Correction Factor).
4. The emission levels of other frequencies are very lower than the limit and not show in test report.
5. The amplitude of Radiated emissions (the test frequency range: 9kHz ~ 30MHz, 18GHz ~ 25GHz), is that proximity to ambient noise, which also are attenuated more than 20 dB below the permissible value. Therefore, the data is not presented in the report.

EUT	AP311	Date of Test	2020-10-15
Factor	AC1_VULB 9162_20-2000MHz	Temp. / Humidity	22.8°C /44%
Polarity	Vertical	Site / Test Engineer	AC1 / Kevin Ker
Test Mode	Transmit by 802.11a at channel 5825MHz -Scan Antenna	Test Voltage	120V/60Hz

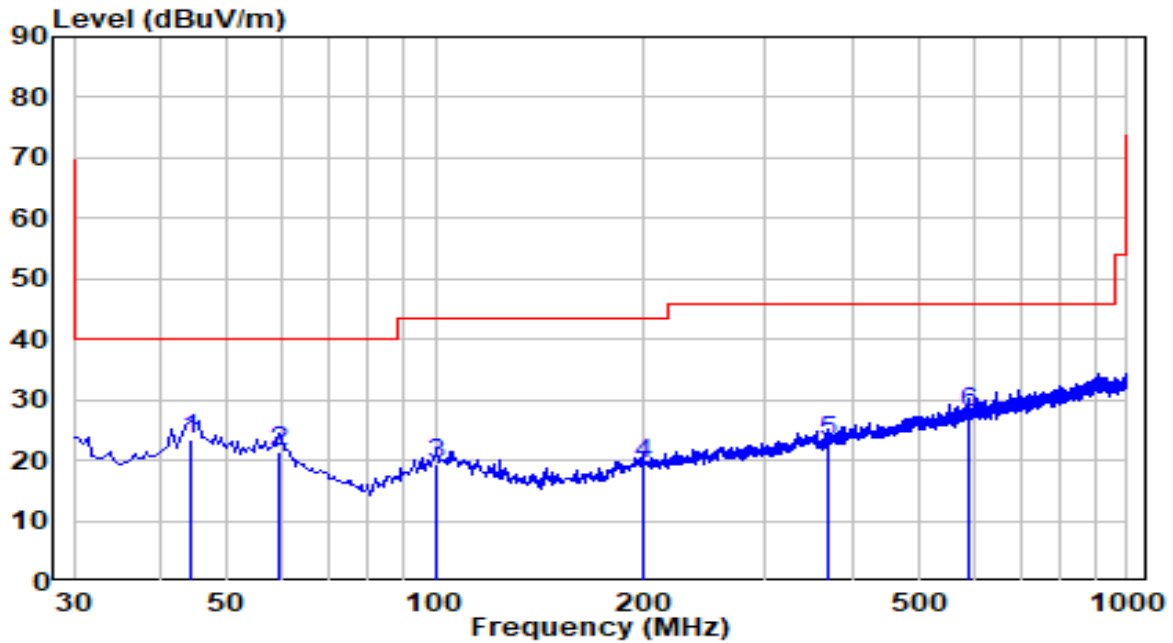

No	Frequency (MHz)	Reading (dBuV)	C.F (dB)	Measurement (dBuV/m)	Margin (dB)	Limit (dBuV/m)	Remark (QP/PK/AV)	
1	*	44.210	2.13	21.29	23.42	-16.58	40.00	QP
2		59.260	1.09	20.22	21.31	-18.69	40.00	QP
3		100.350	-0.13	19.65	19.52	-23.98	43.50	QP
4		199.540	0.43	18.94	19.37	-24.13	43.50	QP
5		370.210	-0.72	23.73	23.01	-22.99	46.00	QP
6		590.630	0.68	27.33	28.01	-17.99	46.00	QP

Note:

1. " *", means this data is the worst emission level.
2. C.F (Correction Factor) = Antenna Factor (dB)+ Cable Loss (dB).
3. Measurement(dBuV/m) = Reading(dBuV) + C.F (Correction Factor).
4. The emission levels of other frequencies are very lower than the limit and not show in test report.
5. The amplitude of Radiated emissions (the test frequency range: 9kHz ~ 30MHz, 18GHz ~ 25GHz), is that proximity to ambient noise, which also are attenuated more than 20 dB below the permissible value. Therefore, the data is not presented in the report

6.9. Radiated Restricted Band Edge Measurement

6.9.1. Test Limit

For 15.205 requirement:

Radiated emissions which fall in the restricted bands, as defined in Section 15.205(a) of FCC part 15, must also comply with the radiated emission limits specified in Section 15.209(a).

Frequency (MHz)	Frequency (MHz)	Frequency (MHz)	Frequency (GHz)
0.090 - 0.110	16.42-16.423	399.9 - 410	4.5-5.15
¹ 0.495 - 0.505	16.69475-16.69525	608 - 614	5.35-5.46
2.1735-2.1905	16.80425-16.80475	960 - 1240	7.25-7.75
4.125-4.128	25.5 -25.67	1300 - 1427	8.025 - 8.5
4.17725-4.17775	37.5-38.25	1435-1626.5	9.0-9.2
4.20725-4.20775	73-74.6	1645.5-1646.5	9.3-9.5
6.215-6.218	74.8-75.2	1660 - 1710	10.6-12.7
6.26775-6.26825	108-121.94	1718.8-1722.2	13.25-13.4
6.31175-6.31225	123 - 138	2200 - 2300	14.47-14.5
8.291-8.294	149.9-150.05	2310 - 2390	15.35-16.2
8.362-8.366	156.52475-156.525	2483.5 - 2500	17.7-21.4
8.37625-8.38675	156.7-156.9	2690 - 2900	22.01-23.12
8.41425-8.41475	162.0125-167.17	3260 - 3267	23.6-24.0
12.29-12.293	167.72-173.2	3332 - 3339	31.2-31.8
12.51975-12.52025	240 - 285	3345.8 - 3358	36.43-36.5
12.57675-12.57725	322-335.4	3600 - 4400	(²)
13.36-13.41	--	--	--

For 15.407(b) requirement:

For transmitters operating in the 5.15-5.25 GHz band: All emissions outside of the 5.15-5.35 GHz band shall not exceed an e.i.r.p. of -27 dBm/MHz.

For transmitters operating in the 5.25-5.35 GHz band: All emissions outside of the 5.15-5.35 GHz band shall not exceed an e.i.r.p. of -27 dBm/MHz.

For transmitters operating in the 5.47-5.725 GHz band: All emissions outside of the 5.47-5.725 GHz band shall not exceed an e.i.r.p. of -27 dBm/MHz.

For transmitters operating in the 5.725-5.85 GHz band: All emissions shall be limited to a level of -27 dBm/MHz at 75 MHz or more above or below the band edge increasing linearly to 10 dBm/MHz at 25 MHz above or below the band edge, and from 25 MHz above or below the band edge

increasing linearly to a level of 15.6 dBm/MHz at 5 MHz above or below the band edge, and from 5 MHz above or below the band edge increasing linearly to a level of 27 dBm/MHz at the band edge.

Refer to KDB 789033 D02v02r01 G)2)c), as specified in § 15.407(b), emissions above 1000 MHz that are outside of the restricted bands are subject to a maximum emission limit of -27 dBm/MHz (or -17 dBm/MHz as specified in § 15.407(b)(4)). However, an out-of-band emission that complies with both the peak and average limits of § 15.209 is not required to satisfy the -27 dBm/MHz or -17 dBm/MHz maximum emission limit.

All out of band emissions appearing in a restricted band as specified in Section 15.205 of the Title 47CFR must not exceed the limits shown in Table per Section 15.209.

FCC Part 15 Subpart C Paragraph 15.209		
Frequency [MHz]	Field Strength [uV/m]	Measured Distance [Meters]
0.009 - 0.490	2400/F (kHz)	300
0.490 - 1.705	24000/F (kHz)	30
1.705 - 30	30	30
30 - 88	100	3
88 - 216	150	3
216 - 960	200	3
Above 960	500	3

6.9.2. Test Procedure Used

ANSI C63.10 Section 6.3 (General Requirements)

ANSI C63.10 Section 6.6 (Standard test method above 1GHz)

6.9.3. Test Setting

Peak Measurements above 1GHz

1. Analyzer center frequency was set to the frequency of the radiated spurious emission of interest
2. RBW = 1MHz
3. VBW = 3MHz
4. Detector = peak
5. Sweep time = auto couple
6. Trace mode = max hold
7. Trace was allowed to stabilize

Average Measurements above 1GHz (Method VB)

1. Analyzer center frequency was set to the frequency of the radiated spurious emission of interest
2. RBW = 1MHz
3. VBW If the EUT is configured to transmit with duty cycle $\geq 98\%$, set $VBW \leq RBW/100$ (i.e., 10 kHz) but not less than 10 Hz. If the EUT duty cycle is $< 98\%$, set $VBW \geq 1/T$.
4. Detector = Peak
5. Sweep time = auto
6. Allow max hold to run for at least 50 traces if the transmitted signal is continuous or has at least 98% duty cycle. For lower duty cycles, increase the minimum number of traces by a factor of $1/x$, where x is the duty cycle.

6.9.4. Test Setup

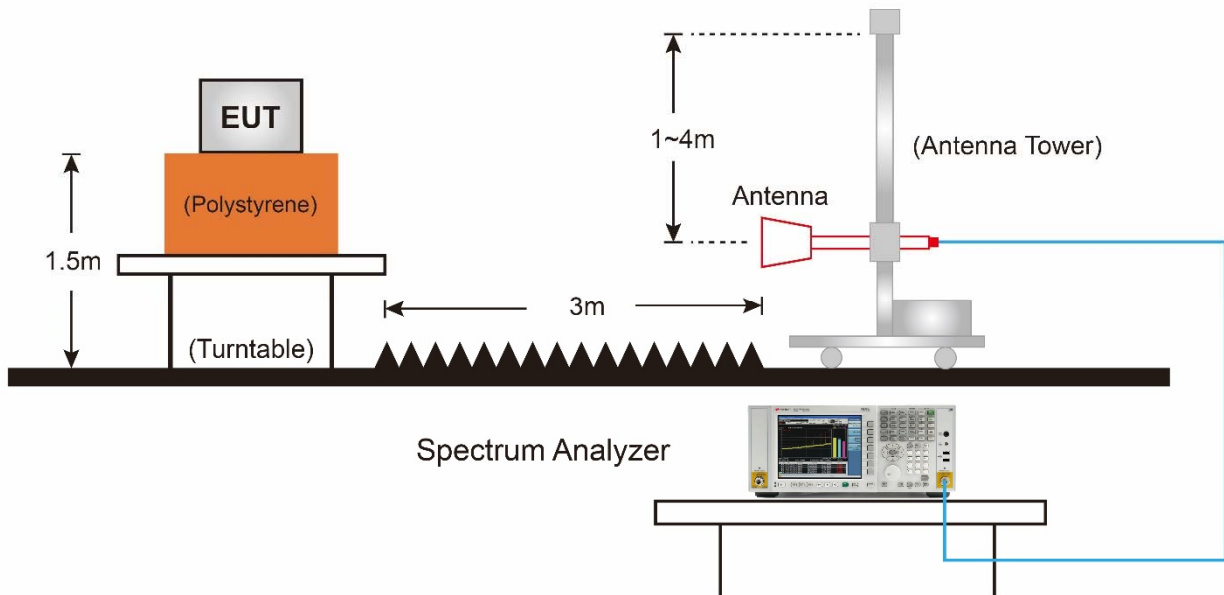

6.9.5. Test Result

EUT	AP311	Date of Test	2020-09-28
Factor	BBHA 9120D (1GHz~18GHz)_2020	Temp. / Humidity	24.9°C/35%
Polarity	Horizontal	Site / Test Engineer	AC1 / Kevin Ker
Test Mode	Transmit by 802.11a at Channel 5180MHz	Test Voltage	120V/60Hz

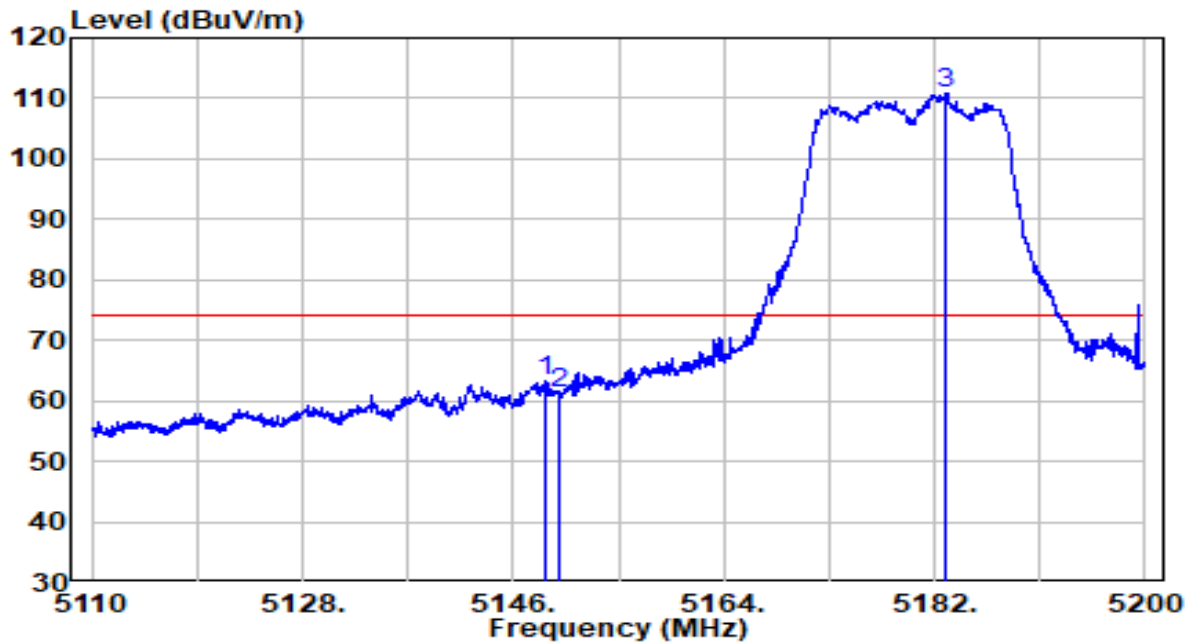

No	Frequency (MHz)	Reading (dBuV)	C.F (dB)	Measurement (dBuV/m)	Margin (dB)	Limit (dBuV/m)	Remark (QP/PK/AV)
1	5148.790	43.24	19.90	63.14	-10.86	74.00	Peak
2	5150.000	41.26	19.91	61.16	-12.84	74.00	Peak
3	* 5182.990	90.78	19.94	110.72	N/A	N/A	Peak

Note:

1. " *", means this data is the worst emission level.
2. C.F (Correction Factor) = Antenna Factor (dB)+ Cable Loss (dB)– Preamplifier(dB)+16db attenuation.
3. Measurement(dBuV/m) = Reading(dBuV) + C.F (Correction Factor).
- 4.The emission levels of other frequencies are very lower than the limit and not show in test report.

EUT	AP311	Date of Test	2020-09-28
Factor	BBHA 9120D (1GHz~18GHz)_2020	Temp. / Humidity	24.9°C/35%
Polarity	Horizontal	Site / Test Engineer	AC1 / Kevin Ker
Test Mode	Transmit by 802.11a at Channel 5180MHz	Test Voltage	120V/60Hz

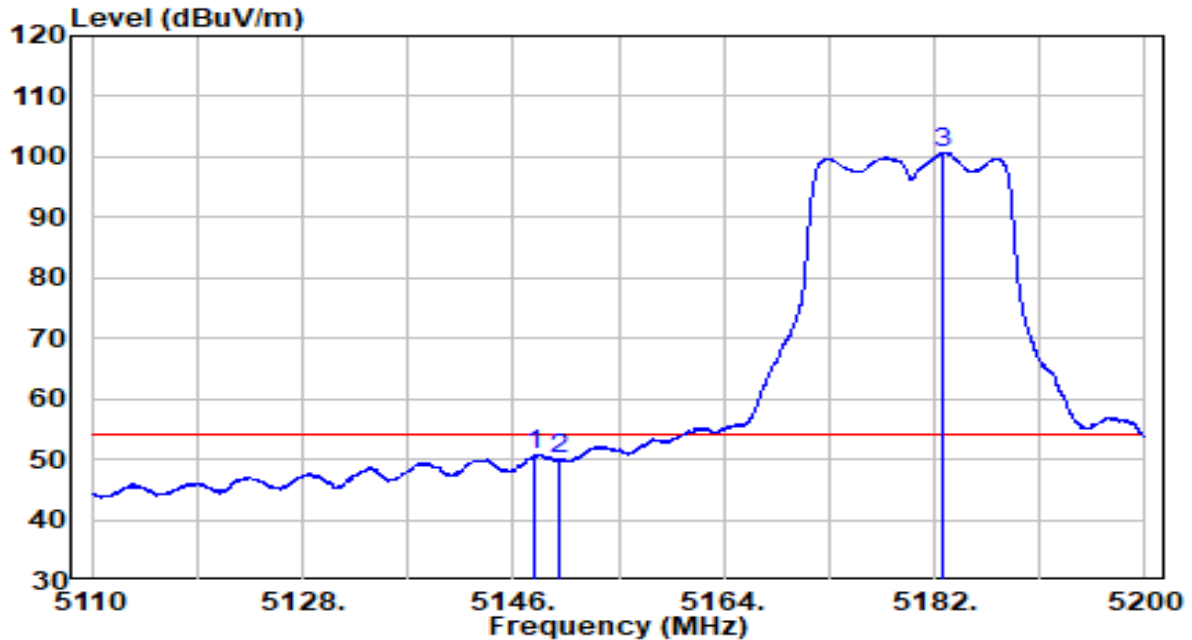

No	Frequency (MHz)	Reading (dBuV)	C.F (dB)	Measurement (dBuV/m)	Margin (dB)	Limit (dBuV/m)	Remark (QP/PK/AV)
1	5147.890	30.89	19.90	50.79	-3.21	54.00	Average
2	5150.000	30.09	19.91	49.99	-4.01	54.00	Average
3	* 5182.720	80.81	19.94	100.75	N/A	N/A	Average

Note:

1. " *", means this data is the worst emission level.
2. C.F (Correction Factor) = Antenna Factor (dB)+ Cable Loss (dB)– Preamplifier(dB)+16db attenuation.
3. Measurement(dBuV/m) = Reading(dBuV) + C.F (Correction Factor).
- 4.The emission levels of other frequencies are very lower than the limit and not show in test report.

EUT	AP311	Date of Test	2020-09-28
Factor	BBHA 9120D (1GHz~18GHz)_2020	Temp. / Humidity	24.9°C/35%
Polarity	Vertical	Site / Test Engineer	AC1 / Kevin Ker
Test Mode	Transmit by 802.11a at Channel 5180MHz	Test Voltage	120V/60Hz

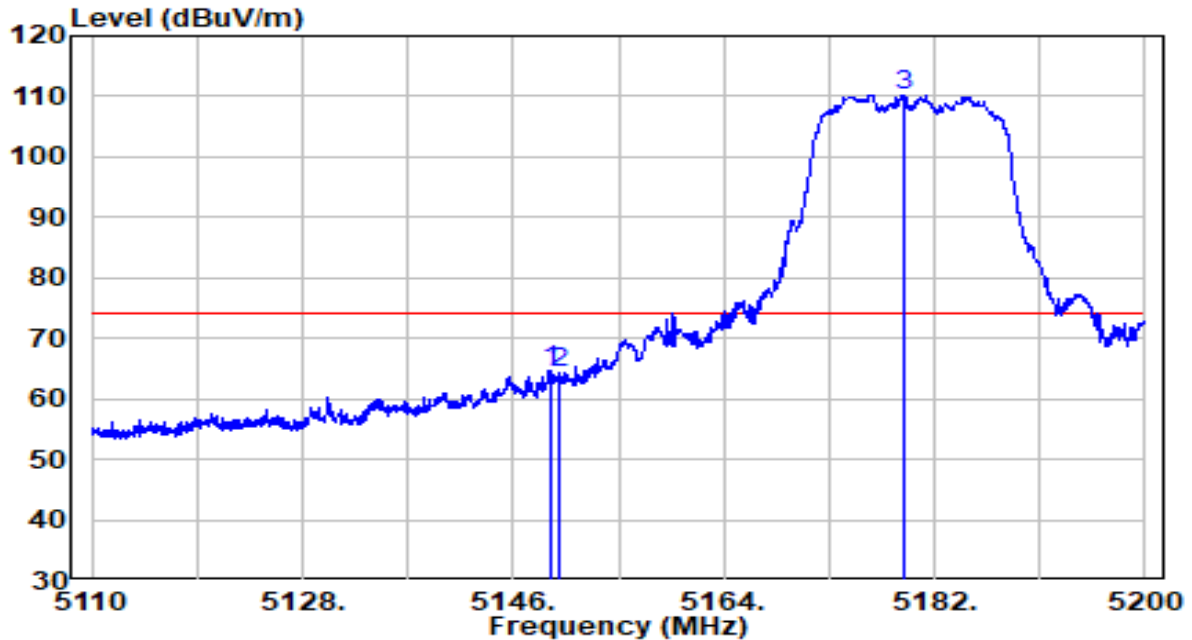

No	Frequency (MHz)	Reading (dBuV)	C.F (dB)	Measurement (dBuV/m)	Margin (dB)	Limit (dBuV/m)	Remark (QP/PK/AV)
1	5149.330	44.80	19.91	64.71	-9.29	74.00	Peak
2	5150.000	44.38	19.91	64.29	-9.71	74.00	Peak
3	* 5179.390	90.36	19.94	110.30	N/A	N/A	Peak

Note:

1. " *", means this data is the worst emission level.
2. C.F (Correction Factor) = Antenna Factor (dB)+ Cable Loss (dB)- Preamplifier(dB)+16db attenuation.
3. Measurement(dBuV/m) = Reading(dBuV) + C.F (Correction Factor).
- 4.The emission levels of other frequencies are very lower than the limit and not show in test report.

EUT	AP311	Date of Test	2020-09-28
Factor	BBHA 9120D (1GHz~18GHz)_2020	Temp. / Humidity	24.9°C/35%
Polarity	Vertical	Site / Test Engineer	AC1 / Kevin Ker
Test Mode	Transmit by 802.11a at Channel 5180MHz	Test Voltage	120V/60Hz

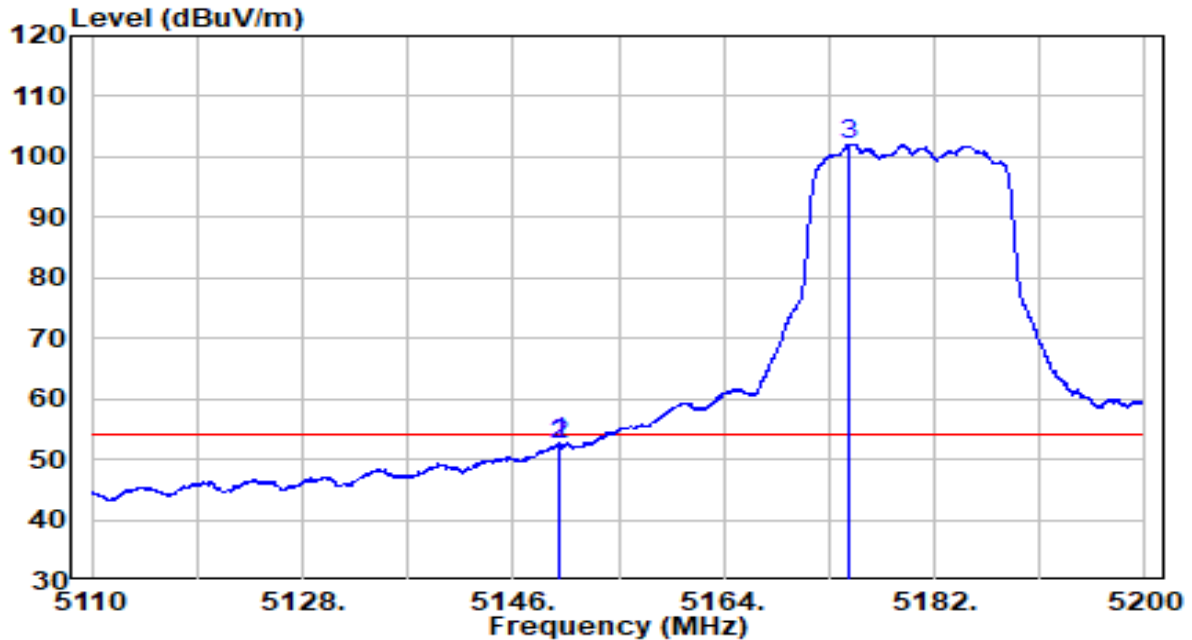

No	Frequency (MHz)	Reading (dBuV)	C.F (dB)	Measurement (dBuV/m)	Margin (dB)	Limit (dBuV/m)	Remark (QP/PK/AV)
1	5149.960	32.74	19.91	52.64	-1.36	54.00	Average
2	5150.000	32.64	19.91	52.55	-1.45	54.00	Average
3	* 5174.800	82.19	19.93	102.12	N/A	N/A	Average

Note:

1. " *", means this data is the worst emission level.
2. C.F (Correction Factor) = Antenna Factor (dB)+ Cable Loss (dB)– Preamplifier(dB)+16db attenuation.
3. Measurement(dBuV/m) = Reading(dBuV) + C.F (Correction Factor).
- 4.The emission levels of other frequencies are very lower than the limit and not show in test report.

EUT	AP311	Date of Test	2020-09-28
Factor	BBHA 9120D (1GHz~18GHz)_2020	Temp. / Humidity	24.9°C/35%
Polarity	Horizontal	Site / Test Engineer	AC1 / Kevin Ker
Test Mode	Transmit by 802.11a at Channel 5240MHz	Test Voltage	120V/60Hz

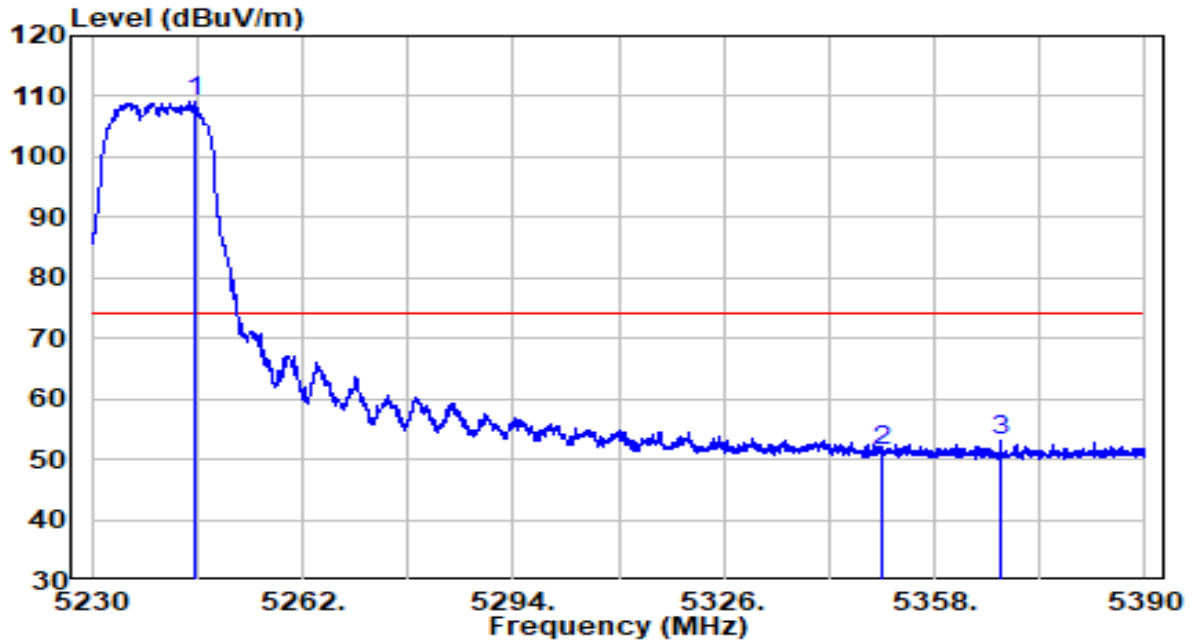

No	Frequency (MHz)	Reading (dBuV)	C.F (dB)	Measurement (dBuV/m)	Margin (dB)	Limit (dBuV/m)	Remark (QP/PK/AV)
1	* 5245.680	89.11	20.01	109.12	N/A	N/A	Peak
2	5350.000	31.19	20.11	51.30	-22.70	74.00	Peak
3	5368.160	32.83	20.13	52.97	-21.03	74.00	Peak

Note:

1. " *", means this data is the worst emission level.
2. C.F (Correction Factor) = Antenna Factor (dB)+ Cable Loss (dB)- Preamplifier(dB)+16db attenuation.
3. Measurement(dBuV/m) = Reading(dBuV) + C.F (Correction Factor).
- 4.The emission levels of other frequencies are very lower than the limit and not show in test report.

EUT	AP311	Date of Test	2020-09-28
Factor	BBHA 9120D (1GHz~18GHz)_2020	Temp. / Humidity	24.9°C/35%
Polarity	Horizontal	Site / Test Engineer	AC1 / Kevin Ker
Test Mode	Transmit by 802.11a at Channel 5240MHz	Test Voltage	120V/60Hz

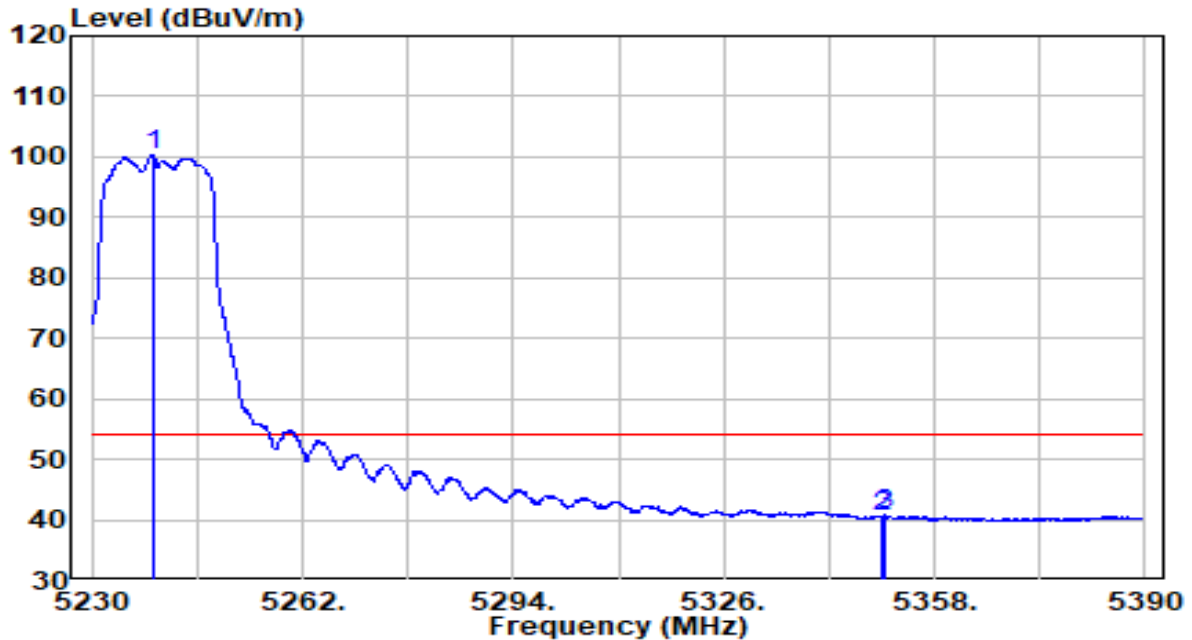

No		Frequency (MHz)	Reading (dBuV)	C.F (dB)	Measurement (dBuV/m)	Margin (dB)	Limit (dBuV/m)	Remark (QP/PK/AV)
1	*	5239.280	80.35	20.00	100.35	N/A	N/A	Average
2		5350.000	20.30	20.11	40.41	-13.59	54.00	Average
3		5350.480	20.60	20.11	40.72	-13.28	54.00	Average

Note:

1. " *", means this data is the worst emission level.
2. C.F (Correction Factor) = Antenna Factor (dB)+ Cable Loss (dB)– Preamplifier(dB)+16db attenuation.
3. Measurement(dBuV/m) = Reading(dBuV) + C.F (Correction Factor).
- 4.The emission levels of other frequencies are very lower than the limit and not show in test report.

EUT	AP311	Date of Test	2020-09-28
Factor	BBHA 9120D (1GHz~18GHz)_2020	Temp. / Humidity	24.9°C/35%
Polarity	Vertical	Site / Test Engineer	AC1 / Kevin Ker
Test Mode	Transmit by 802.11a at Channel 5240MHz	Test Voltage	120V/60Hz

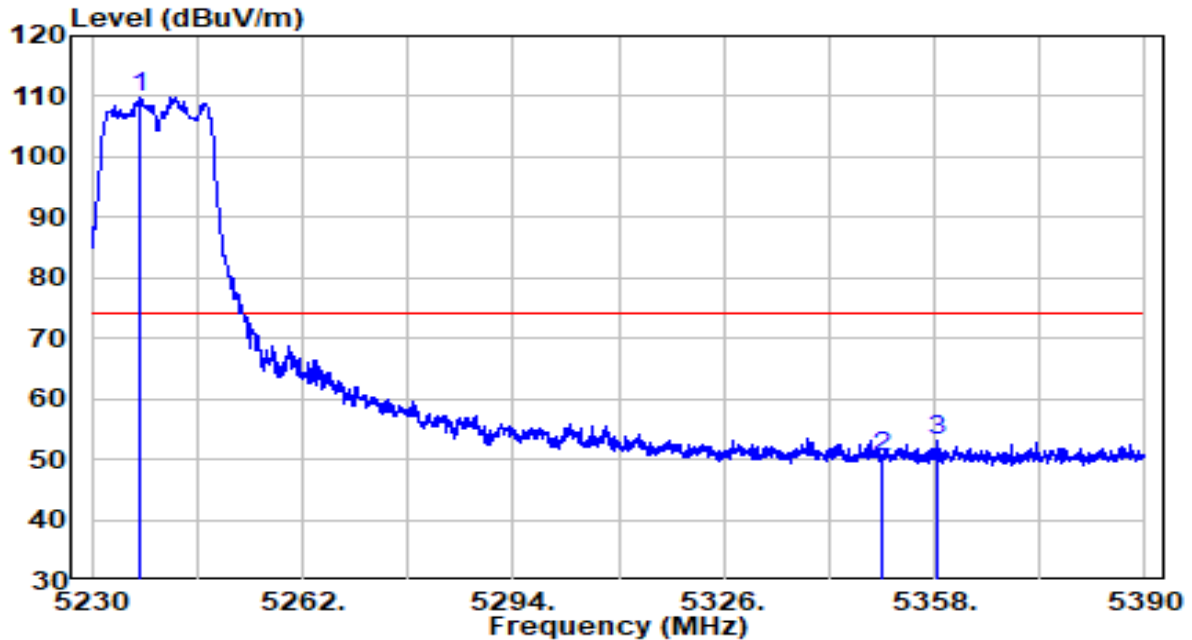

No		Frequency (MHz)	Reading (dBuV)	C.F (dB)	Measurement (dBuV/m)	Margin (dB)	Limit (dBuV/m)	Remark (QP/PK/AV)
1	*	5237.440	89.81	20.00	109.81	N/A	N/A	Peak
2		5350.000	30.29	20.11	50.41	-23.59	74.00	Peak
3		5358.240	32.92	20.12	53.04	-20.96	74.00	Peak

Note:

1. " *", means this data is the worst emission level.
2. C.F (Correction Factor) = Antenna Factor (dB)+ Cable Loss (dB)– Preamplifier(dB)+16db attenuation.
3. Measurement(dBuV/m) = Reading(dBuV) + C.F (Correction Factor).
- 4.The emission levels of other frequencies are very lower than the limit and not show in test report.

EUT	AP311	Date of Test	2020-09-28
Factor	BBHA 9120D (1GHz~18GHz)_2020	Temp. / Humidity	24.9°C/35%
Polarity	Vertical	Site / Test Engineer	AC1 / Kevin Ker
Test Mode	Transmit by 802.11a at Channel 5240MHz	Test Voltage	120V/60Hz

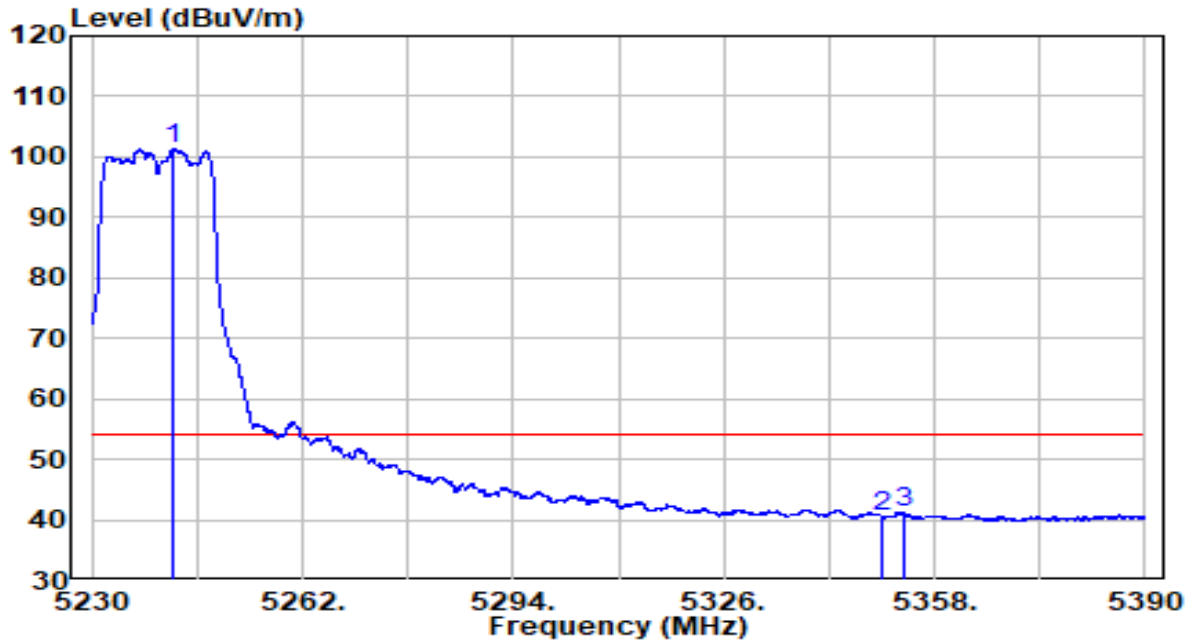

No		Frequency (MHz)	Reading (dBuV)	C.F (dB)	Measurement (dBuV/m)	Margin (dB)	Limit (dBuV/m)	Remark (QP/PK/AV)
1	*	5242.400	81.23	20.00	101.23	N/A	N/A	Average
2		5350.000	20.38	20.11	40.49	-13.51	54.00	Average
3		5353.360	21.04	20.12	41.16	-12.84	54.00	Average

Note:

1. " *", means this data is the worst emission level.
2. C.F (Correction Factor) = Antenna Factor (dB)+ Cable Loss (dB)– Preamplifier(dB)+16db attenuation.
3. Measurement(dBuV/m) = Reading(dBuV) + C.F (Correction Factor).
- 4.The emission levels of other frequencies are very lower than the limit and not show in test report.

EUT	AP311	Date of Test	2020-09-28
Factor	BBHA 9120D (1GHz~18GHz)_2020	Temp. / Humidity	24.9°C/35%
Polarity	Horizontal	Site / Test Engineer	AC1 / Kevin Ker
Test Mode	Transmit by 802.11a at Channel 5320MHz	Test Voltage	120V/60Hz

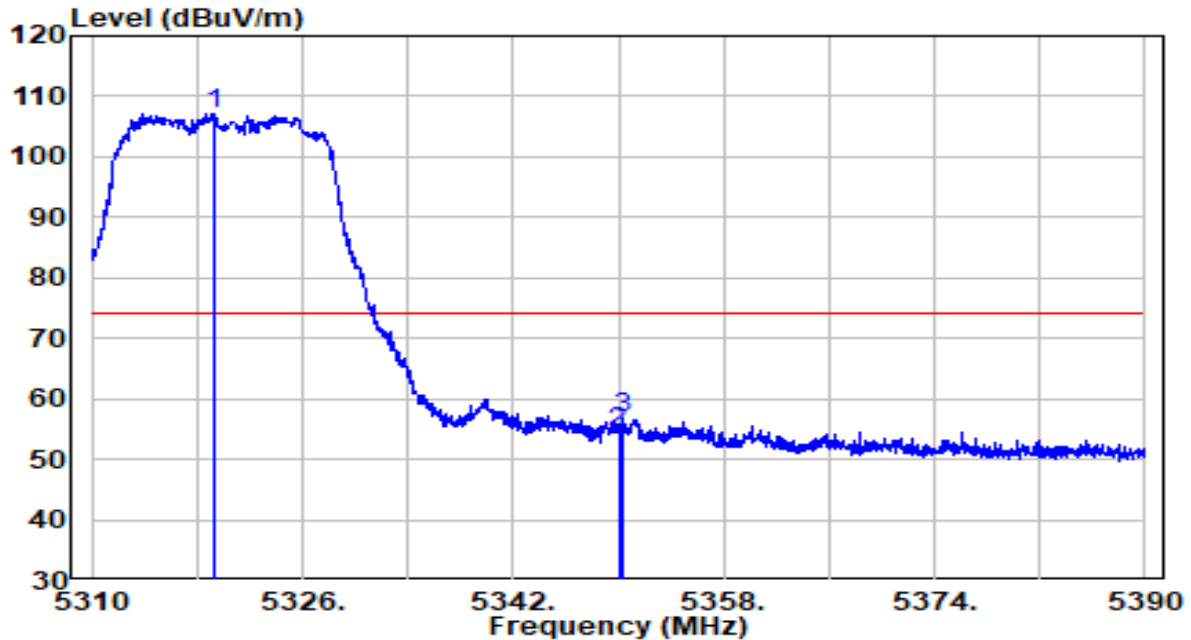

No		Frequency (MHz)	Reading (dBuV)	C.F (dB)	Measurement (dBuV/m)	Margin (dB)	Limit (dBuV/m)	Remark (QP/PK/AV)
1	*	5319.360	87.06	20.08	107.14	N/A	N/A	Peak
2		5350.000	34.45	20.11	54.57	-19.43	74.00	Peak
3		5350.360	36.80	20.11	56.92	-17.08	74.00	Peak

Note:

1. " *", means this data is the worst emission level.
2. C.F (Correction Factor) = Antenna Factor (dB)+ Cable Loss (dB)– Preamplifier(dB)+16db attenuation.
3. Measurement(dBuV/m) = Reading(dBuV) + C.F (Correction Factor).
- 4.The emission levels of other frequencies are very lower than the limit and not show in test report.

EUT	AP311	Date of Test	2020-09-28
Factor	BBHA 9120D (1GHz~18GHz)_2020	Temp. / Humidity	24.9°C/35%
Polarity	Horizontal	Site / Test Engineer	AC1 / Kevin Ker
Test Mode	Transmit by 802.11a at Channel 5320MHz	Test Voltage	120V/60Hz

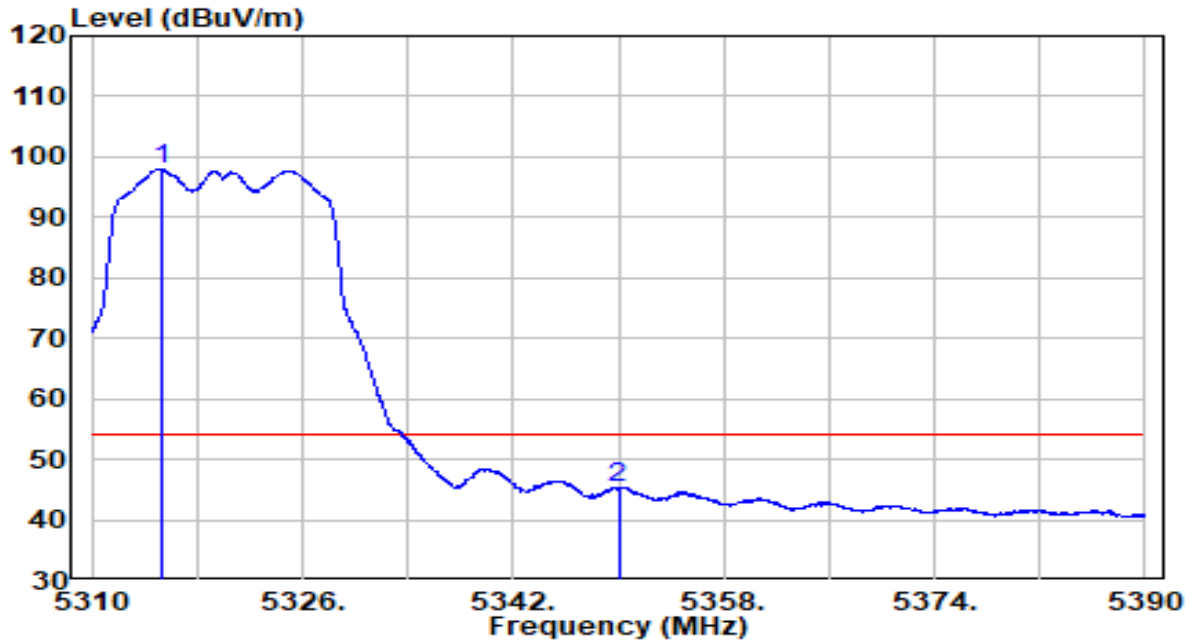

No	Frequency (MHz)	Reading (dBuV)	C.F (dB)	Measurement (dBuV/m)	Margin (dB)	Limit (dBuV/m)	Remark (QP/PK/AV)
1	* 5315.280	77.81	20.08	97.89	N/A	N/A	Average
2	5350.000	25.23	20.11	45.34	-8.66	54.00	Average

Note:

1. " *", means this data is the worst emission level.
2. C.F (Correction Factor) = Antenna Factor (dB)+ Cable Loss (dB)– Preamplifier(dB)+16db attenuation.
3. Measurement(dBuV/m) = Reading(dBuV) + C.F (Correction Factor).
- 4.The emission levels of other frequencies are very lower than the limit and not show in test report.

EUT	AP311	Date of Test	2020-09-28
Factor	BBHA 9120D (1GHz~18GHz)_2020	Temp. / Humidity	24.9°C/35%
Polarity	Vertical	Site / Test Engineer	AC1 / Kevin Ker
Test Mode	Transmit by 802.11a at Channel 5320MHz	Test Voltage	120V/60Hz

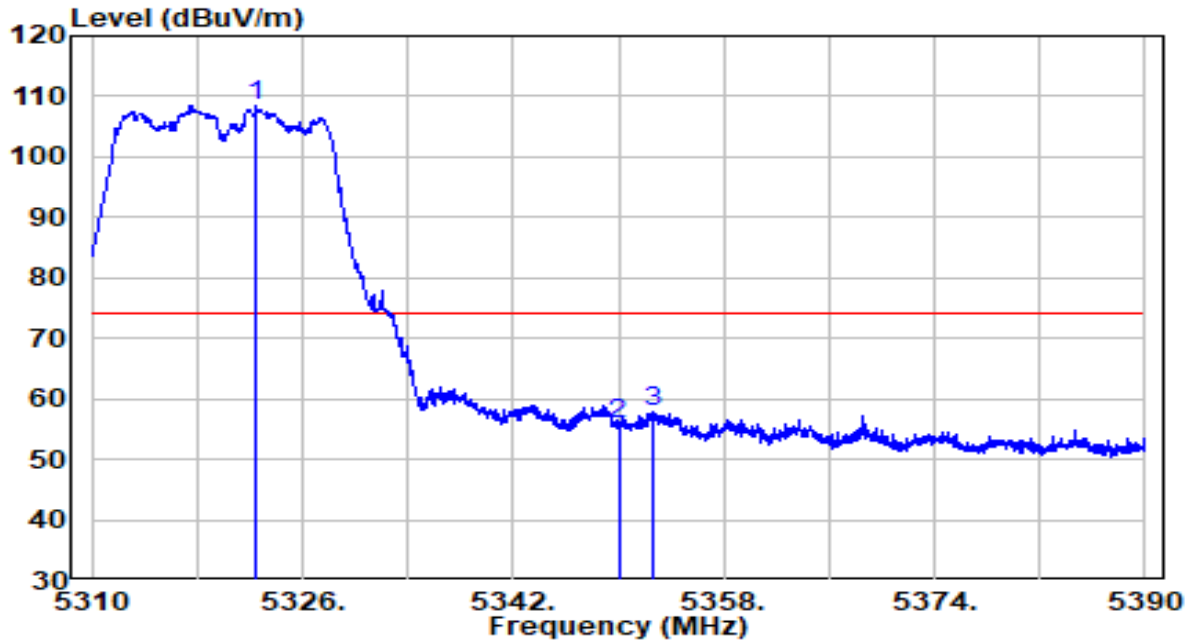

No	Frequency (MHz)	Reading (dBuV)	C.F (dB)	Measurement (dBuV/m)	Margin (dB)	Limit (dBuV/m)	Remark (QP/PK/AV)
1	* 5322.440	88.52	20.09	108.60	N/A	N/A	Peak
2	5350.000	35.66	20.11	55.77	-18.23	74.00	Peak
3	5352.600	37.82	20.12	57.94	-16.06	74.00	Peak

Note:

1. " *", means this data is the worst emission level.
2. C.F (Correction Factor) = Antenna Factor (dB)+ Cable Loss (dB)- Preamplifier(dB)+16db attenuation.
3. Measurement(dBuV/m) = Reading(dBuV) + C.F (Correction Factor).
- 4.The emission levels of other frequencies are very lower than the limit and not show in test report.

EUT	AP311	Date of Test	2020-09-28
Factor	BBHA 9120D (1GHz~18GHz)_2020	Temp. / Humidity	24.9°C/35%
Polarity	Vertical	Site / Test Engineer	AC1 / Kevin Ker
Test Mode	Transmit by 802.11a at Channel 5320MHz	Test Voltage	120V/60Hz

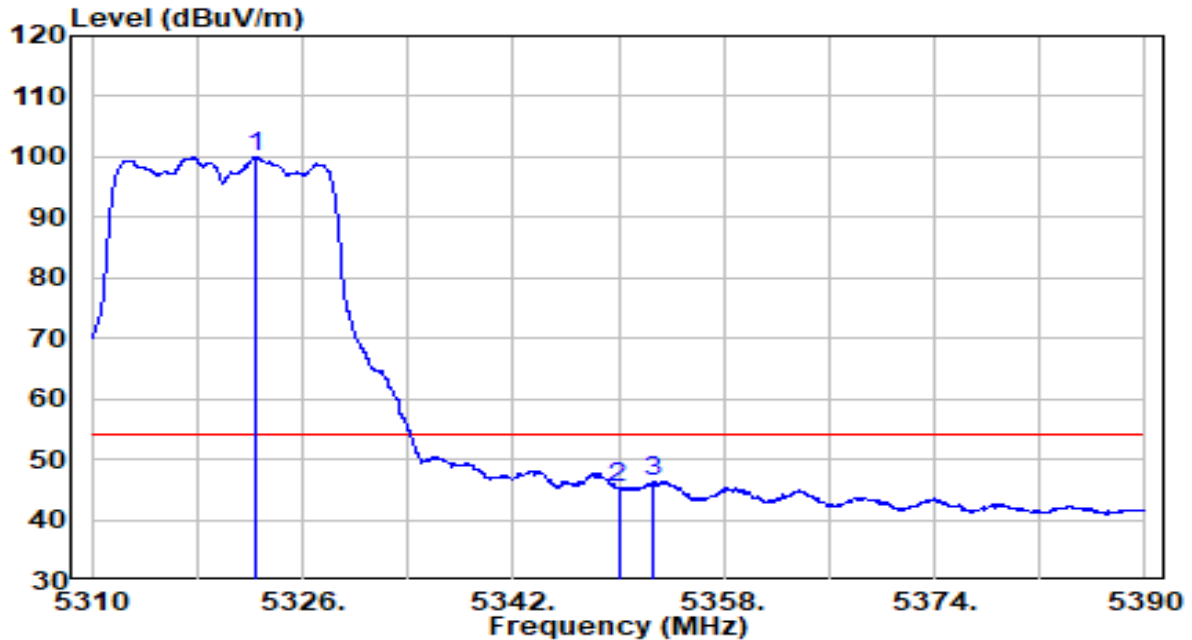

No	Frequency (MHz)	Reading (dBuV)	C.F (dB)	Measurement (dBuV/m)	Margin (dB)	Limit (dBuV/m)	Remark (QP/PK/AV)
1	* 5322.400	79.84	20.09	99.92	N/A	N/A	Average
2	5350.000	25.05	20.11	45.16	-8.84	54.00	Average
3	5352.560	26.13	20.12	46.24	-7.76	54.00	Average

Note:

1. " *", means this data is the worst emission level.
2. C.F (Correction Factor) = Antenna Factor (dB)+ Cable Loss (dB)– Preamplifier(dB)+16db attenuation.
3. Measurement(dBuV/m) = Reading(dBuV) + C.F (Correction Factor).
- 4.The emission levels of other frequencies are very lower than the limit and not show in test report.

EUT	AP311	Date of Test	2020-09-28
Factor	BBHA 9120D (1GHz~18GHz)_2020	Temp. / Humidity	24.9°C/35%
Polarity	Horizontal	Site / Test Engineer	AC1 / Kevin Ker
Test Mode	Transmit by 802.11a at Channel 5500MHz	Test Voltage	120V/60Hz

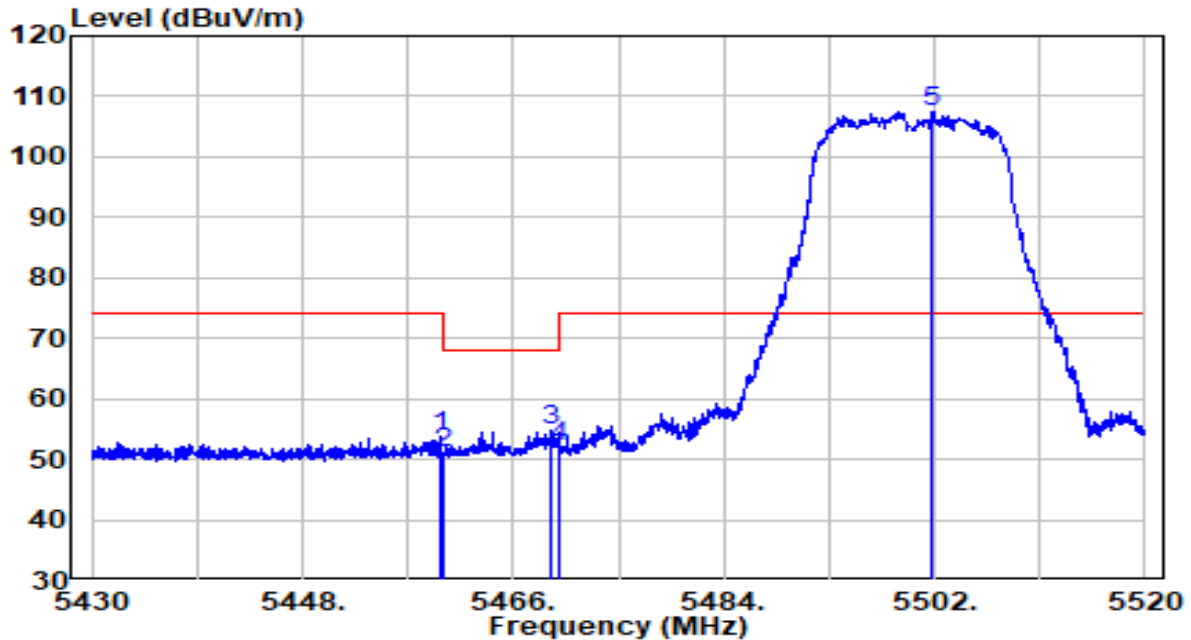

No	Frequency (MHz)	Reading (dBuV)	C.F (dB)	Measurement (dBuV/m)	Margin (dB)	Limit (dBuV/m)	Remark (QP/PK/AV)
1	5459.745	33.44	20.23	53.67	-20.33	74.00	Peak
2	5460.000	30.67	20.23	50.90	-17.30	68.20	Peak
3	5469.240	34.72	20.24	54.96	-13.24	68.20	Peak
4	5470.000	31.72	20.24	51.95	-16.25	68.20	Peak
5	* 5501.820	87.28	20.28	107.55	N/A	N/A	Peak

Note:

1. " *", means this data is the worst emission level.
2. C.F (Correction Factor) = Antenna Factor (dB)+ Cable Loss (dB)– Preamplifier(dB)+16db attenuation.
3. Measurement(dBuV/m) = Reading(dBuV) + C.F (Correction Factor).
- 4.The emission levels of other frequencies are very lower than the limit and not show in test report.

EUT	AP311	Date of Test	2020-09-28
Factor	BBHA 9120D (1GHz~18GHz)_2020	Temp. / Humidity	24.9°C/35%
Polarity	Horizontal	Site / Test Engineer	AC1 / Kevin Ker
Test Mode	Transmit by 802.11a at Channel 5500MHz	Test Voltage	120V/60Hz

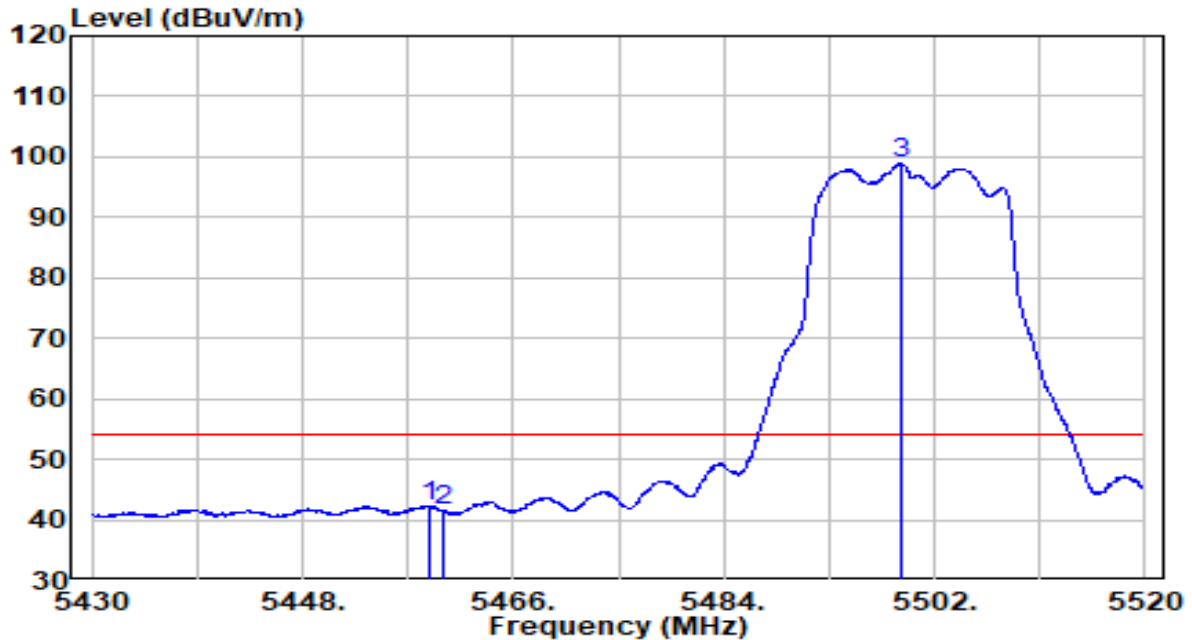

No	Frequency (MHz)	Reading (dBuV)	C.F (dB)	Measurement (dBuV/m)	Margin (dB)	Limit (dBuV/m)	Remark (QP/PK/AV)
1	5458.935	22.08	20.23	42.31	-11.69	54.00	Average
2	5460.000	21.20	20.23	41.42	-12.58	54.00	Average
3	* 5499.075	78.64	20.27	98.91	N/A	N/A	Average

Note:

1. " *", means this data is the worst emission level.
2. C.F (Correction Factor) = Antenna Factor (dB)+ Cable Loss (dB)– Preamplifier(dB)+16db attenuation.
3. Measurement(dBuV/m) = Reading(dBuV) + C.F (Correction Factor).
- 4.The emission levels of other frequencies are very lower than the limit and not show in test report.

EUT	AP311	Date of Test	2020-09-28
Factor	BBHA 9120D (1GHz~18GHz)_2020	Temp. / Humidity	24.9°C/35%
Polarity	Vertical	Site / Test Engineer	AC1 / Kevin Ker
Test Mode	Transmit by 802.11a at Channel 5500MHz	Test Voltage	120V/60Hz

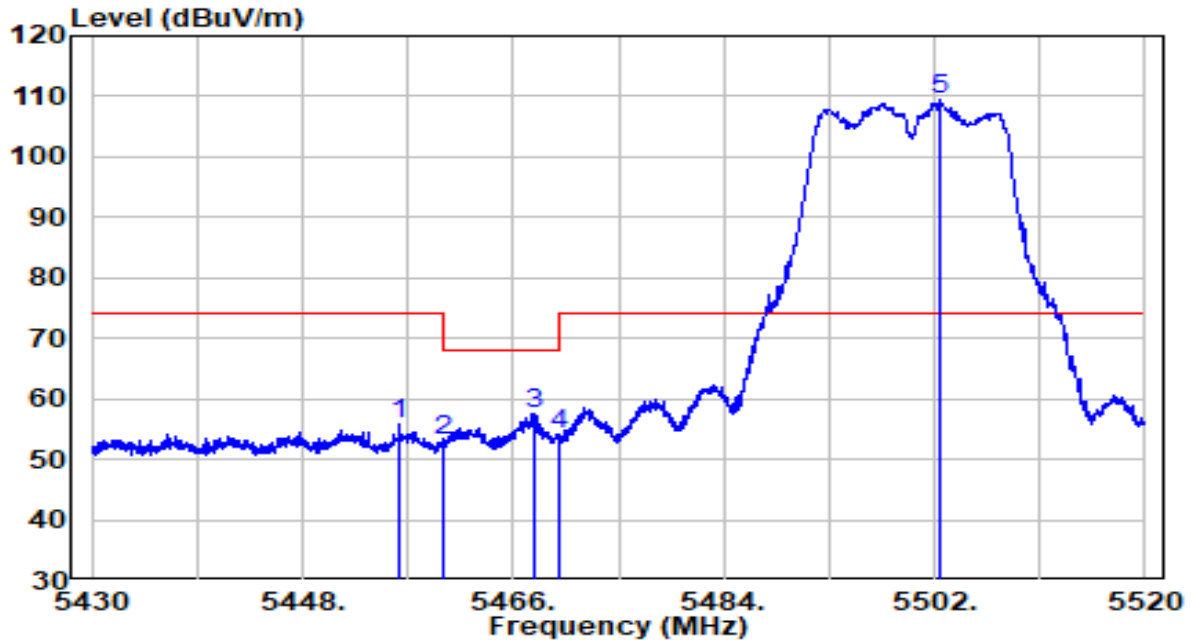

No	Frequency (MHz)	Reading (dBuV)	C.F (dB)	Measurement (dBuV/m)	Margin (dB)	Limit (dBuV/m)	Remark (QP/PK/AV)
1	5456.280	35.53	20.22	55.75	-18.25	74.00	Peak
2	5460.000	32.92	20.23	53.15	-15.05	68.20	Peak
3	5467.755	37.43	20.24	57.67	-10.53	68.20	Peak
4	5470.000	33.72	20.24	53.96	-14.24	68.20	Peak
5	* 5502.540	89.13	20.28	109.41	N/A	N/A	Peak

Note:

1. " *", means this data is the worst emission level.
2. C.F (Correction Factor) = Antenna Factor (dB)+ Cable Loss (dB)– Preamplifier(dB)+16db attenuation.
3. Measurement(dBuV/m) = Reading(dBuV) + C.F (Correction Factor).
- 4.The emission levels of other frequencies are very lower than the limit and not show in test report.

EUT	AP311	Date of Test	2020-09-28
Factor	BBHA 9120D (1GHz~18GHz)_2020	Temp. / Humidity	24.9°C/35%
Polarity	Vertical	Site / Test Engineer	AC1 / Kevin Ker
Test Mode	Transmit by 802.11a at Channel 5500MHz	Test Voltage	120V/60Hz

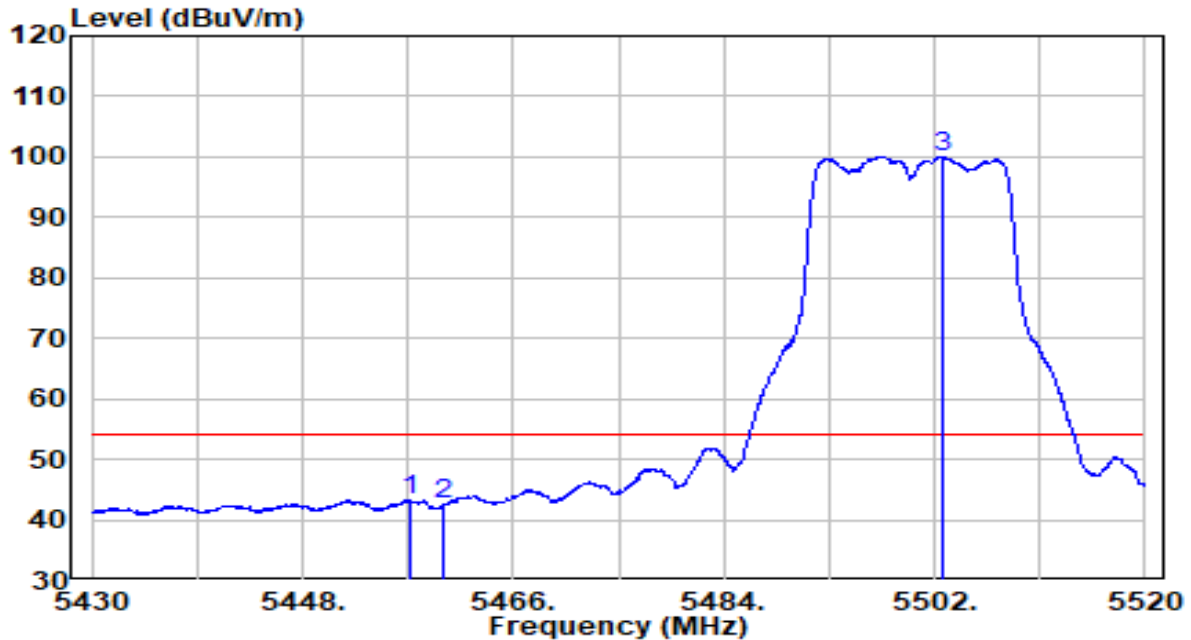

No	Frequency (MHz)	Reading (dBuV)	C.F (dB)	Measurement (dBuV/m)	Margin (dB)	Limit (dBuV/m)	Remark (QP/PK/AV)
1	5457.135	23.07	20.23	43.30	-10.70	54.00	Average
2	5460.000	22.36	20.23	42.59	-11.41	54.00	Average
3	* 5502.630	79.85	20.28	100.13	N/A	N/A	Average

Note:

1. " *", means this data is the worst emission level.
2. C.F (Correction Factor) = Antenna Factor (dB)+ Cable Loss (dB)– Preamplifier(dB)+16db attenuation.
3. Measurement(dBuV/m) = Reading(dBuV) + C.F (Correction Factor).
- 4.The emission levels of other frequencies are very lower than the limit and not show in test report.

EUT	AP311	Date of Test	2020-09-28
Factor	BBHA 9120D (1GHz~18GHz)_2020	Temp. / Humidity	24.9°C/35%
Polarity	Horizontal	Site / Test Engineer	AC1 / Kevin Ker
Test Mode	Transmit by 802.11a at Channel 5700MHz	Test Voltage	120V/60Hz

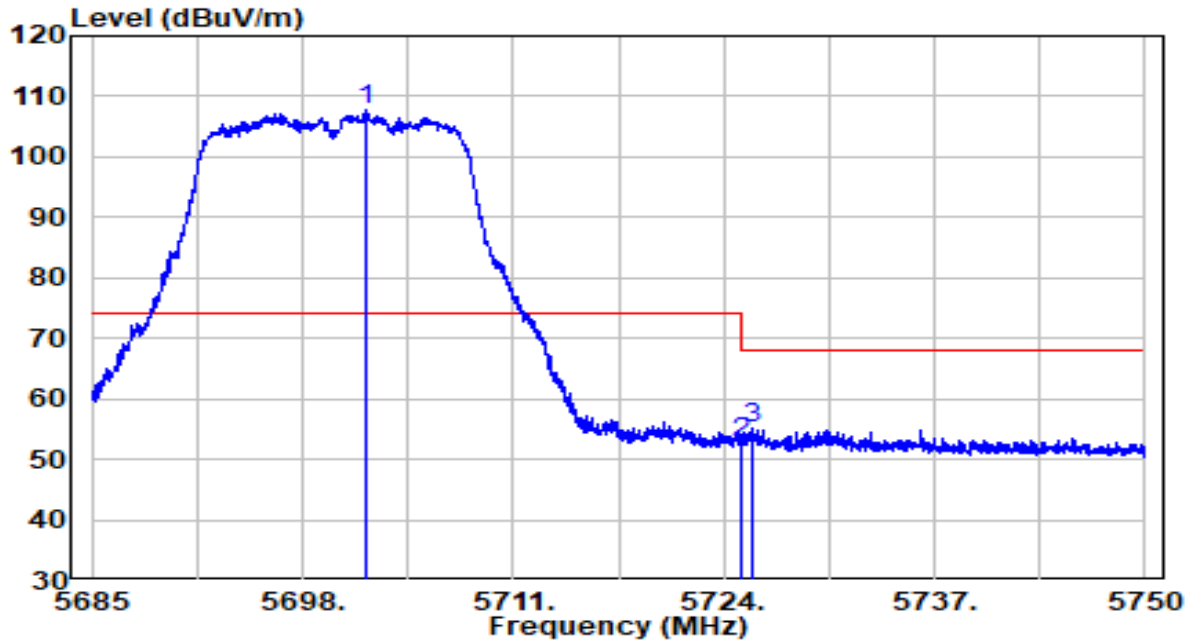

No	Frequency (MHz)	Reading (dBuV)	C.F (dB)	Measurement (dBuV/m)	Margin (dB)	Limit (dBuV/m)	Remark (QP/PK/AV)
1	* 5701.900	86.77	20.92	107.70	N/A	N/A	Peak
2	5725.000	31.90	21.00	52.90	-15.30	68.20	Peak
3	5725.820	34.15	21.00	55.15	-13.05	68.20	Peak

Note:

1. " *", means this data is the worst emission level.
2. C.F (Correction Factor) = Antenna Factor (dB)+ Cable Loss (dB)– Preamplifier(dB)+16db attenuation.
3. Measurement(dBuV/m) = Reading(dBuV) + C.F (Correction Factor).
- 4.The emission levels of other frequencies are very lower than the limit and not show in test report.

EUT	AP311	Date of Test	2020-09-28
Factor	BBHA 9120D (1GHz~18GHz)_2020	Temp. / Humidity	24.9°C/35%
Polarity	Vertical	Site / Test Engineer	AC1 / Kevin Ker
Test Mode	Transmit by 802.11a at Channel 5700MHz	Test Voltage	120V/60Hz

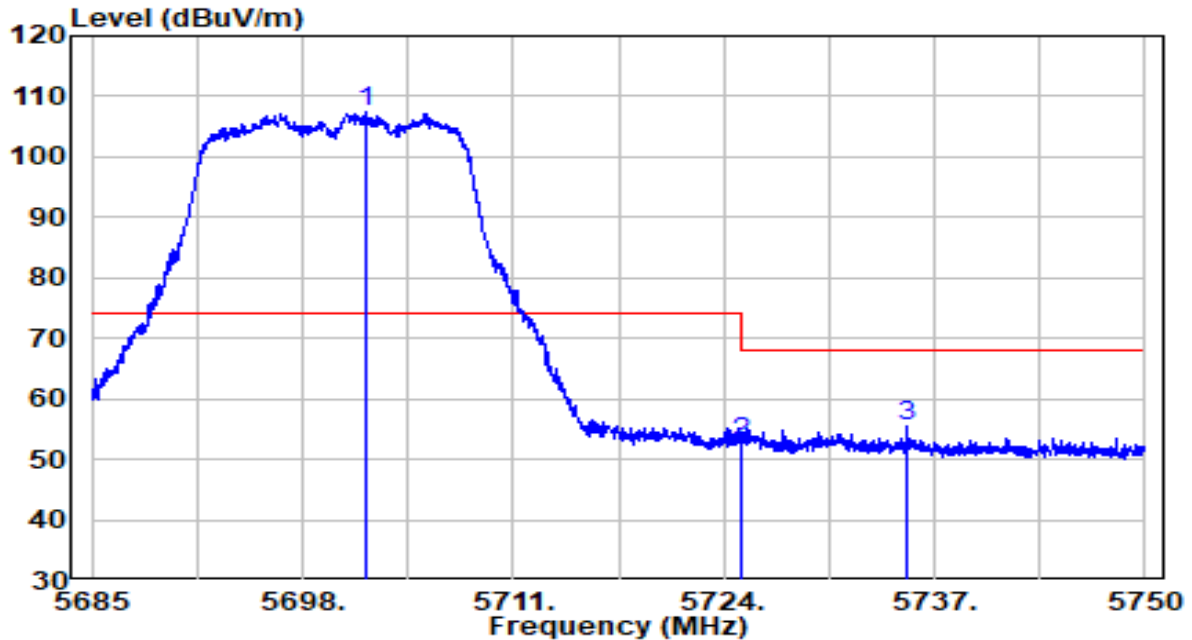

No		Frequency (MHz)	Reading (dBuV)	C.F (dB)	Measurement (dBuV/m)	Margin (dB)	Limit (dBuV/m)	Remark (QP/PK/AV)
1	*	5701.868	86.48	20.92	107.40	N/A	N/A	Peak
2		5725.000	31.90	21.00	52.89	-15.31	68.20	Peak
3		5735.375	34.50	21.03	55.53	-12.67	68.20	Peak

Note:

1. " *", means this data is the worst emission level.
2. C.F (Correction Factor) = Antenna Factor (dB)+ Cable Loss (dB)– Preamplifier(dB)+16db attenuation.
3. Measurement(dBuV/m) = Reading(dBuV) + C.F (Correction Factor).
- 4.The emission levels of other frequencies are very lower than the limit and not show in test report.

EUT	AP311	Date of Test	2020-10-12
Factor	BBHA 9120D (1GHz~18GHz)_2020	Temp. / Humidity	24.9°C/35%
Polarity	Horizontal	Site / Test Engineer	AC1 / Kevin Ker
Test Mode	Transmit by 802.11a at Channel 5745MHz	Test Voltage	120V/60Hz

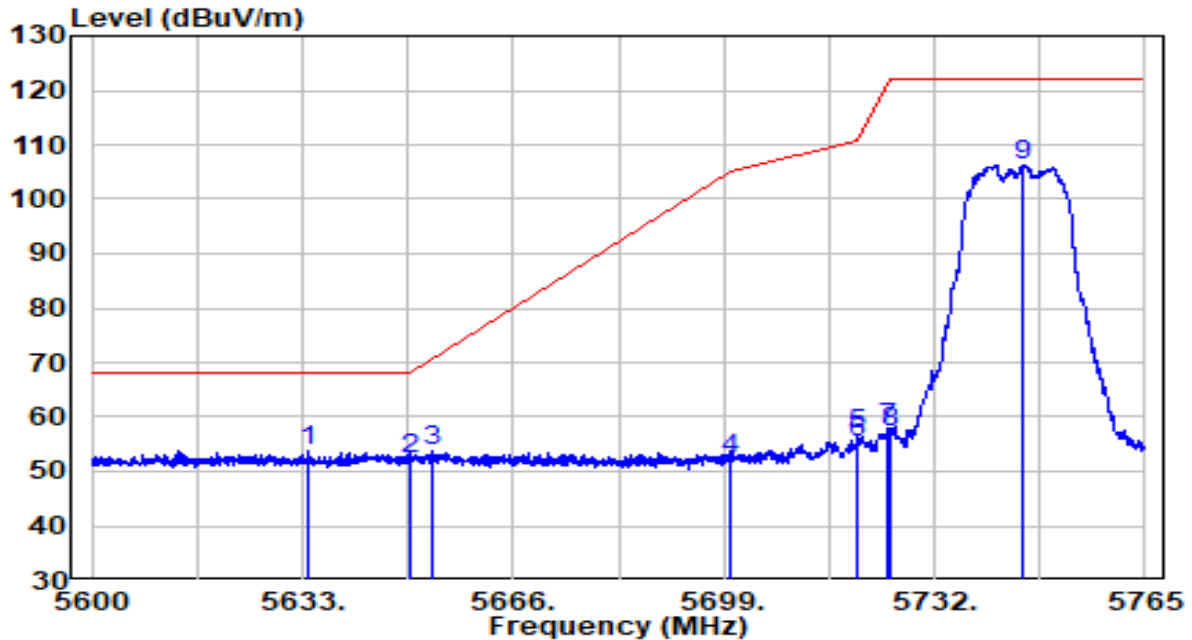

No	Frequency (MHz)	Reading (dBuV)	C.F (dB)	Measurement (dBuV/m)	Margin (dB)	Limit (dBuV/m)	Remark (QP/PK/AV)
1	* 5634.072	8.47	45.24	53.70	-14.50	68.20	Peak
2	5650.000	7.00	45.30	52.30	-15.90	68.20	Peak
3	5653.130	8.32	45.31	53.63	-16.88	70.52	Peak
4	5700.000	6.65	45.50	52.15	-53.05	105.20	Peak
5	5719.955	11.38	45.58	56.96	-53.83	110.79	Peak
6	5720.000	9.72	45.58	55.30	-55.50	110.80	Peak
7	5724.658	12.23	45.60	57.83	-63.59	121.42	Peak
8	5725.000	11.75	45.60	57.35	-64.85	122.20	Peak
9	5745.695	60.71	45.68	106.39	N/A	N/A	Peak

Note:

1. " *", means this data is the worst emission level.
2. C.F (Correction Factor) = Antenna Factor (dB)+ Cable Loss (dB)– Preamplifier(dB)+16db attenuation.
3. Measurement(dBuV/m) = Reading(dBuV) + C.F (Correction Factor).
- 4.The emission levels of other frequencies are very lower than the limit and not show in test report.

EUT	AP311	Date of Test	2020-10-12
Factor	BBHA 9120D (1GHz~18GHz)_2020	Temp. / Humidity	24.9°C/35%
Polarity	Vertical	Site / Test Engineer	AC1 / Kevin Ker
Test Mode	Transmit by 802.11a at Channel 5745MHz	Test Voltage	120V/60Hz

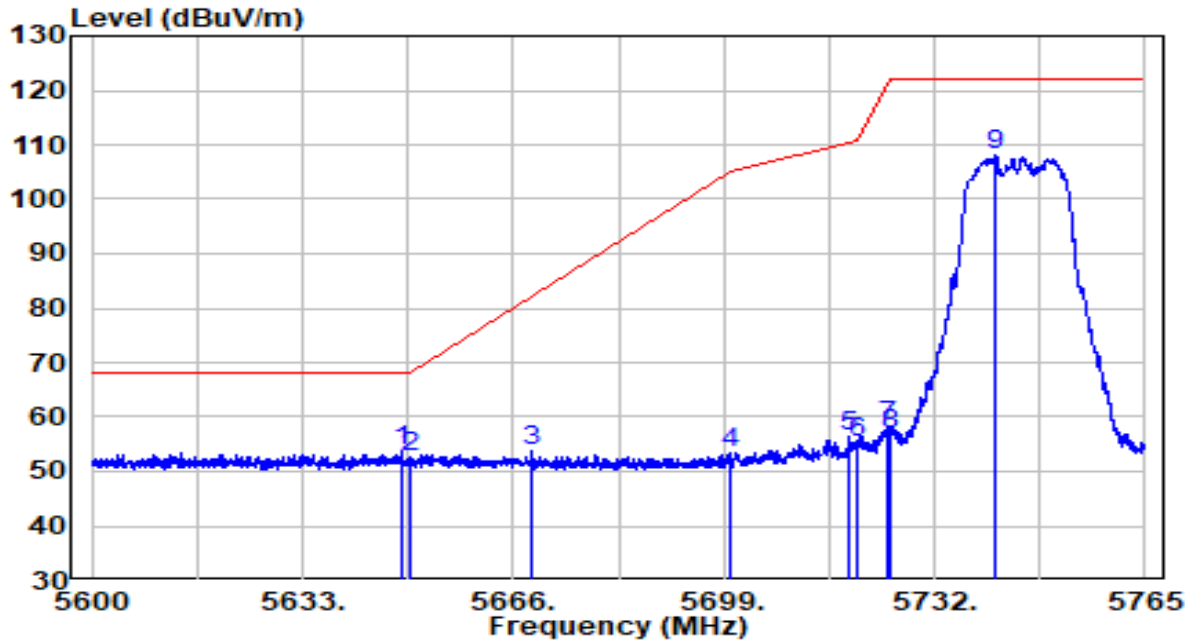

No	Frequency (MHz)	Reading (dBuV)	C.F (dB)	Measurement (dBuV/m)	Margin (dB)	Limit (dBuV/m)	Remark (QP/PK/AV)
1	5648.428	8.49	45.29	53.78	-14.42	68.20	Peak
2	5650.000	7.20	45.30	52.50	-15.70	68.20	Peak
3	5668.805	8.23	45.38	53.60	-28.51	82.12	Peak
4	5700.000	7.77	45.50	53.27	-51.93	105.20	Peak
5	5718.800	10.80	45.58	56.37	-54.09	110.46	Peak
6	5720.000	9.85	45.58	55.43	-55.37	110.80	Peak
7	5724.575	12.85	45.60	58.45	-62.78	121.23	Peak
8	5725.000	11.35	45.60	56.95	-65.25	122.20	Peak
9	* 5741.487	62.29	45.67	107.95	N/A	N/A	Peak

Note:

1. " *", means this data is the worst emission level.
2. C.F (Correction Factor) = Antenna Factor (dB)+ Cable Loss (dB)– Preamplifier(dB)+16db attenuation.
3. Measurement(dBuV/m) = Reading(dBuV) + C.F (Correction Factor).
- 4.The emission levels of other frequencies are very lower than the limit and not show in test report.

EUT	AP311	Date of Test	2020-09-28
Factor	BBHA 9120D (1GHz~18GHz)_2020	Temp. / Humidity	24.9°C/35%
Polarity	Horizontal	Site / Test Engineer	AC1 / Kevin Ker
Test Mode	Transmit by 802.11a at Channel 5825MHz	Test Voltage	120V/60Hz

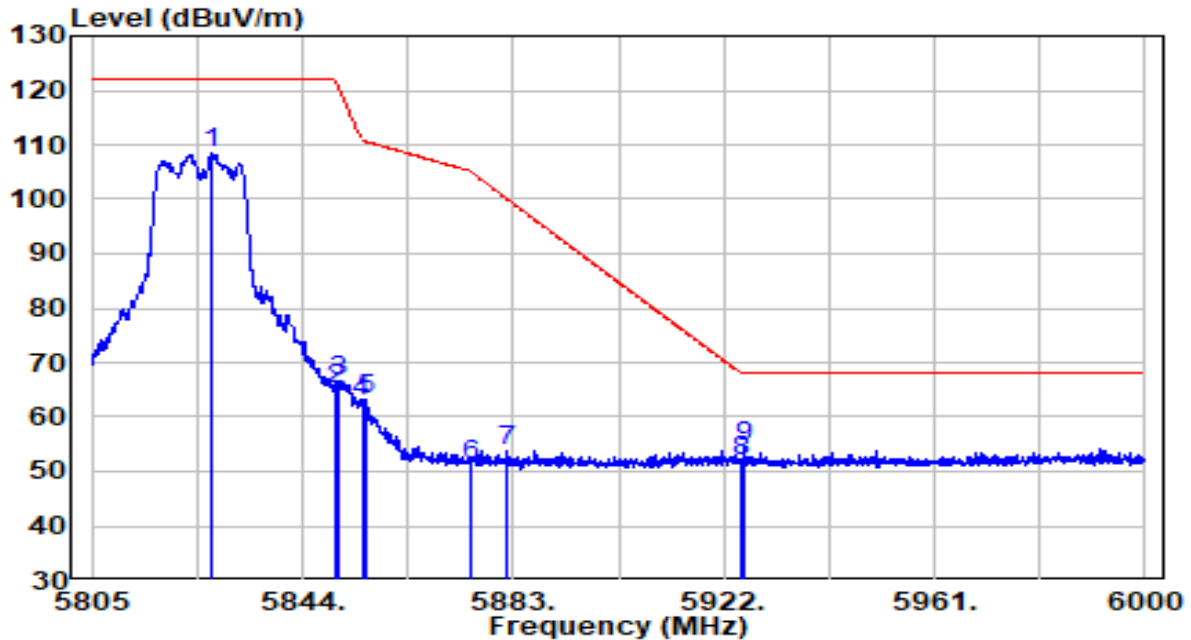

No	Frequency (MHz)	Reading (dBuV)	C.F (dB)	Measurement (dBuV/m)	Margin (dB)	Limit (dBuV/m)	Remark (QP/PK/AV)
1	5826.938	87.00	21.33	108.33	N/A	N/A	Peak
2	5850.000	43.71	21.40	65.11	-57.09	122.20	Peak
3	5850.435	45.08	21.41	66.48	-54.72	121.21	Peak
4	5855.000	41.55	21.42	62.97	-47.83	110.80	Peak
5	5855.700	41.61	21.42	63.03	-47.57	110.60	Peak
6	5875.000	29.61	21.49	51.10	-54.10	105.20	Peak
7	5881.732	32.13	21.51	53.63	-46.57	100.20	Peak
8	5925.000	30.09	21.65	51.74	-16.46	68.20	Peak
9	* 5925.607	32.87	21.65	54.52	-13.68	68.20	Peak

Note:

1. " *", means this data is the worst emission level.
2. C.F (Correction Factor) = Antenna Factor (dB)+ Cable Loss (dB)– Preamplifier(dB)+16db attenuation.
3. Measurement(dBuV/m) = Reading(dBuV) + C.F (Correction Factor).
- 4.The emission levels of other frequencies are very lower than the limit and not show in test report.

EUT	AP311	Date of Test	2020-09-28
Factor	BBHA 9120D (1GHz~18GHz)_2020	Temp. / Humidity	24.9°C/35%
Polarity	Vertical	Site / Test Engineer	AC1 / Kevin Ker
Test Mode	Transmit by 802.11a at Channel 5825MHz	Test Voltage	120V/60Hz

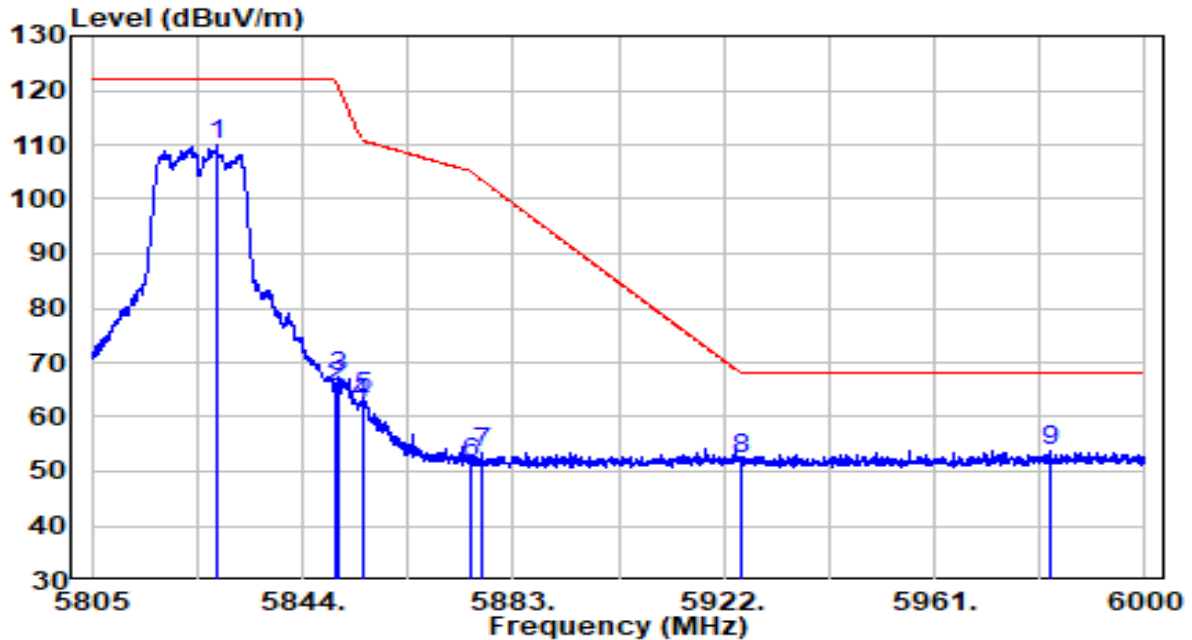

No	Frequency (MHz)	Reading (dBuV)	C.F (dB)	Measurement (dBuV/m)	Margin (dB)	Limit (dBuV/m)	Remark (QP/PK/AV)
1	* 5828.107	88.51	21.33	109.85	N/A	N/A	Peak
2	5850.000	44.23	21.40	65.63	-56.57	122.20	Peak
3	5850.728	45.85	21.41	67.25	-53.29	120.54	Peak
4	5855.000	41.05	21.42	62.47	-48.33	110.80	Peak
5	5855.212	42.26	21.42	63.68	-47.06	110.74	Peak
6	5875.000	30.12	21.49	51.61	-53.59	105.20	Peak
7	5877.150	31.99	21.49	53.48	-50.12	103.60	Peak
8	5925.000	30.44	21.65	52.09	-16.11	68.20	Peak
9	5982.255	32.02	21.83	53.85	-14.35	68.20	Peak

Note:

1. " *", means this data is the worst emission level.
2. C.F (Correction Factor) = Antenna Factor (dB)+ Cable Loss (dB)– Preamplifier(dB)+16db attenuation.
3. Measurement(dBuV/m) = Reading(dBuV) + C.F (Correction Factor).
- 4.The emission levels of other frequencies are very lower than the limit and not show in test report.

EUT	AP311	Date of Test	2020-09-28
Factor	BBHA 9120D (1GHz~18GHz)_2020	Temp. / Humidity	24.9°C/35%
Polarity	Horizontal	Site / Test Engineer	AC1 / Kevin Ker
Test Mode	Transmit by 802.11ac-VHT20 at Channel 5180MHz	Test Voltage	120V/60Hz

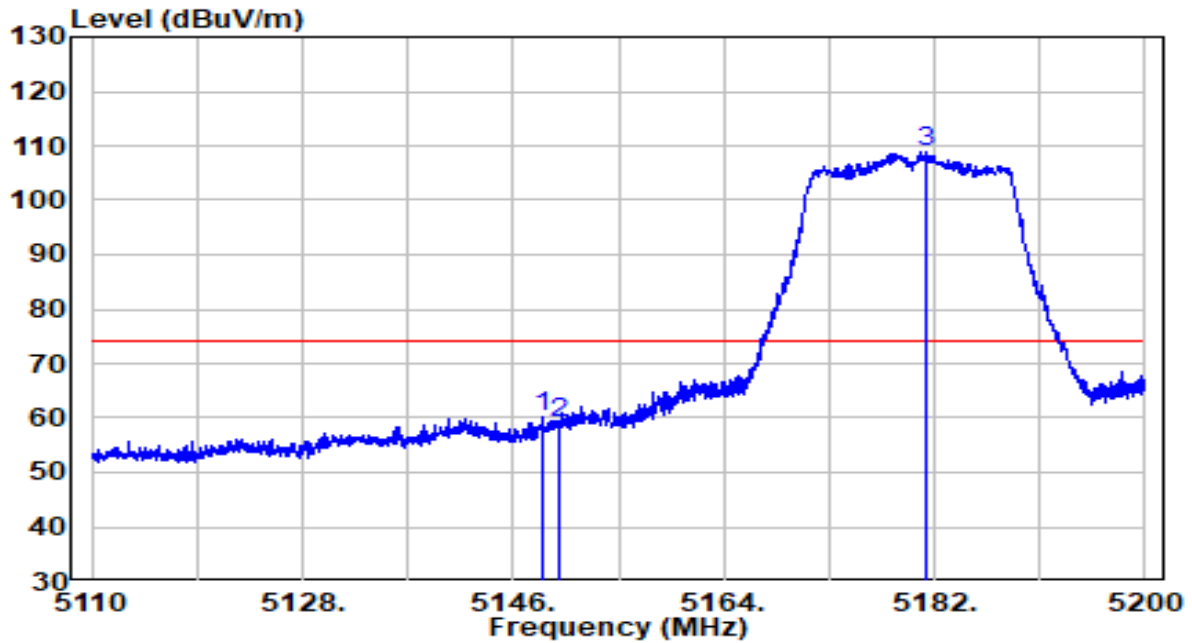

No	Frequency (MHz)	Reading (dBuV)	C.F (dB)	Measurement (dBuV/m)	Margin (dB)	Limit (dBuV/m)	Remark (QP/PK/AV)
1	5148.520	40.33	19.90	60.24	-13.76	74.00	Peak
2	5150.000	39.14	19.91	59.04	-14.96	74.00	Peak
3	* 5181.190	89.07	19.94	109.01	N/A	N/A	Peak

Note:

1. " *", means this data is the worst emission level.
2. C.F (Correction Factor) = Antenna Factor (dB)+ Cable Loss (dB)– Preamplifier(dB)+16db attenuation.
3. Measurement(dBuV/m) = Reading(dBuV) + C.F (Correction Factor).
- 4.The emission levels of other frequencies are very lower than the limit and not show in test report.

EUT	AP311	Date of Test	2020-09-28
Factor	BBHA 9120D (1GHz~18GHz)_2020	Temp. / Humidity	24.9°C/35%
Polarity	Horizontal	Site / Test Engineer	AC1 / Kevin Ker
Test Mode	Transmit by 802.11ac-VHT20 at Channel 5180MHz	Test Voltage	120V/60Hz

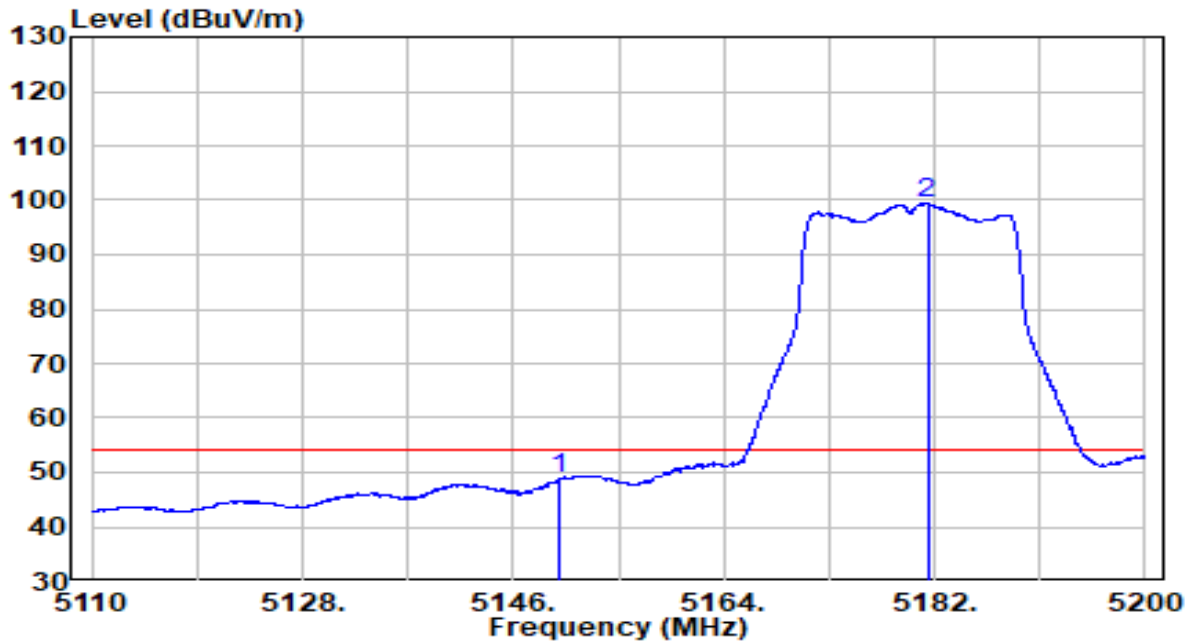

No	Frequency (MHz)	Reading (dBuV)	C.F (dB)	Measurement (dBuV/m)	Margin (dB)	Limit (dBuV/m)	Remark (QP/PK/AV)
1	5150.000	28.92	19.91	48.82	-5.18	54.00	Average
2	* 5181.415	79.44	19.94	99.38	N/A	N/A	Average

Note:

1. " *", means this data is the worst emission level.
2. C.F (Correction Factor) = Antenna Factor (dB)+ Cable Loss (dB)– Preamplifier(dB)+16db attenuation.
3. Measurement(dBuV/m) = Reading(dBuV) + C.F (Correction Factor).
- 4.The emission levels of other frequencies are very lower than the limit and not show in test report.

EUT	AP311	Date of Test	2020-09-28
Factor	BBHA 9120D (1GHz~18GHz)_2020	Temp. / Humidity	24.9°C/35%
Polarity	Vertical	Site / Test Engineer	AC1 / Kevin Ker
Test Mode	Transmit by 802.11ac-VHT20 at Channel 5180MHz	Test Voltage	120V/60Hz

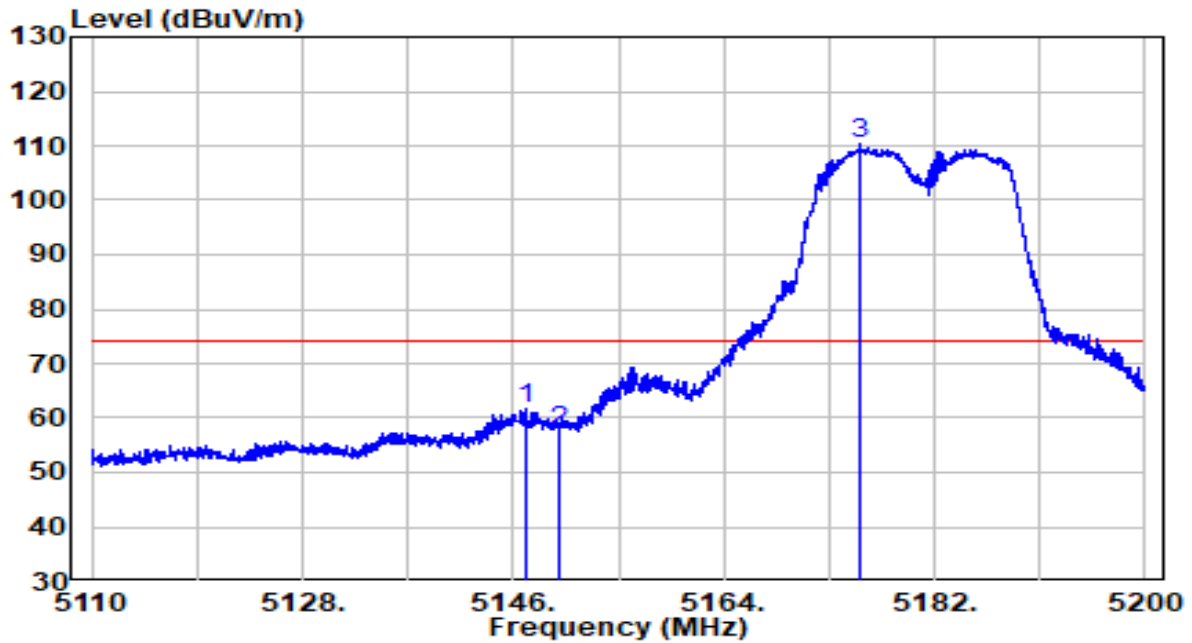

No	Frequency (MHz)	Reading (dBuV)	C.F (dB)	Measurement (dBuV/m)	Margin (dB)	Limit (dBuV/m)	Remark (QP/PK/AV)
1	5147.035	41.97	19.90	61.87	-12.13	74.00	Peak
2	5150.000	37.72	19.91	57.63	-16.37	74.00	Peak
3	* 5175.655	90.47	19.93	110.41	N/A	N/A	Peak

Note:

1. " *", means this data is the worst emission level.
2. C.F (Correction Factor) = Antenna Factor (dB)+ Cable Loss (dB)– Preamplifier(dB)+16db attenuation.
3. Measurement(dBuV/m) = Reading(dBuV) + C.F (Correction Factor).
- 4.The emission levels of other frequencies are very lower than the limit and not show in test report.

EUT	AP311	Date of Test	2020-09-28
Factor	BBHA 9120D (1GHz~18GHz)_2020	Temp. / Humidity	24.9°C/35%
Polarity	Vertical	Site / Test Engineer	AC1 / Kevin Ker
Test Mode	Transmit by 802.11ac-VHT20 at Channel 5180MHz	Test Voltage	120V/60Hz

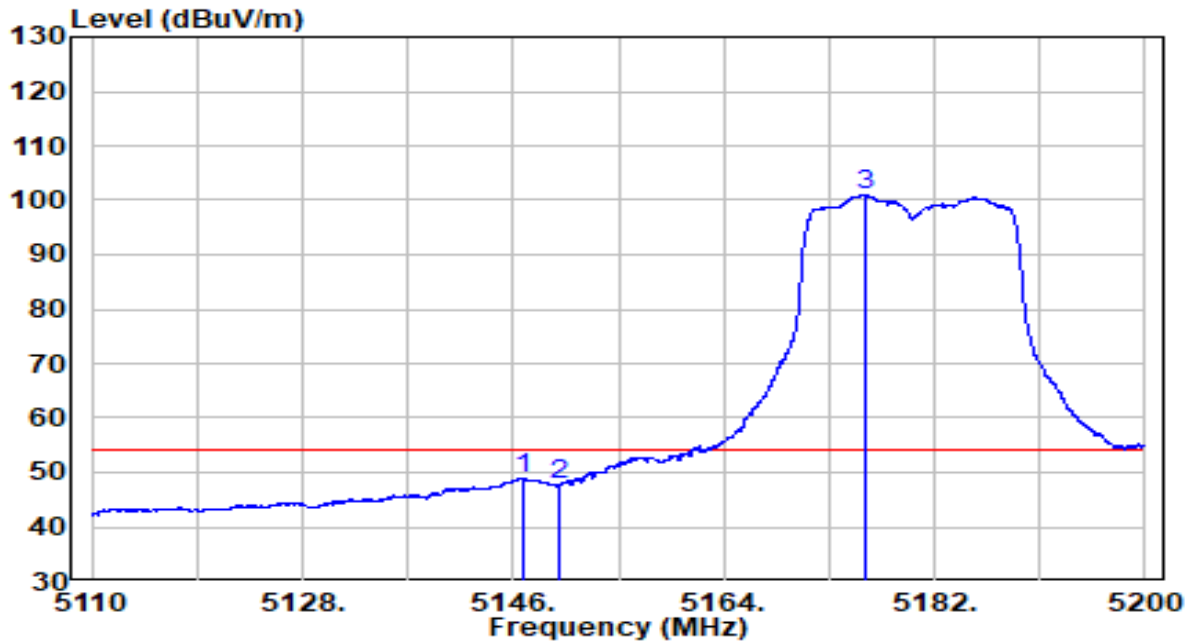

No	Frequency (MHz)	Reading (dBuV)	C.F (dB)	Measurement (dBuV/m)	Margin (dB)	Limit (dBuV/m)	Remark (QP/PK/AV)
1	5146.945	28.93	19.90	48.83	-5.17	54.00	Average
2	5150.000	27.92	19.91	47.82	-6.18	54.00	Average
3	* 5176.105	80.94	19.93	100.87	N/A	N/A	Average

Note:

1. " *", means this data is the worst emission level.
2. C.F (Correction Factor) = Antenna Factor (dB)+ Cable Loss (dB)– Preamplifier(dB)+16db attenuation.
3. Measurement(dBuV/m) = Reading(dBuV) + C.F (Correction Factor).
- 4.The emission levels of other frequencies are very lower than the limit and not show in test report.

EUT	AP311	Date of Test	2020-09-28
Factor	BBHA 9120D (1GHz~18GHz)_2020	Temp. / Humidity	24.9°C/35%
Polarity	Horizontal	Site / Test Engineer	AC1 / Kevin Ker
Test Mode	Transmit by 802.11ac-VHT20 at Channel 5240MHz	Test Voltage	120V/60Hz

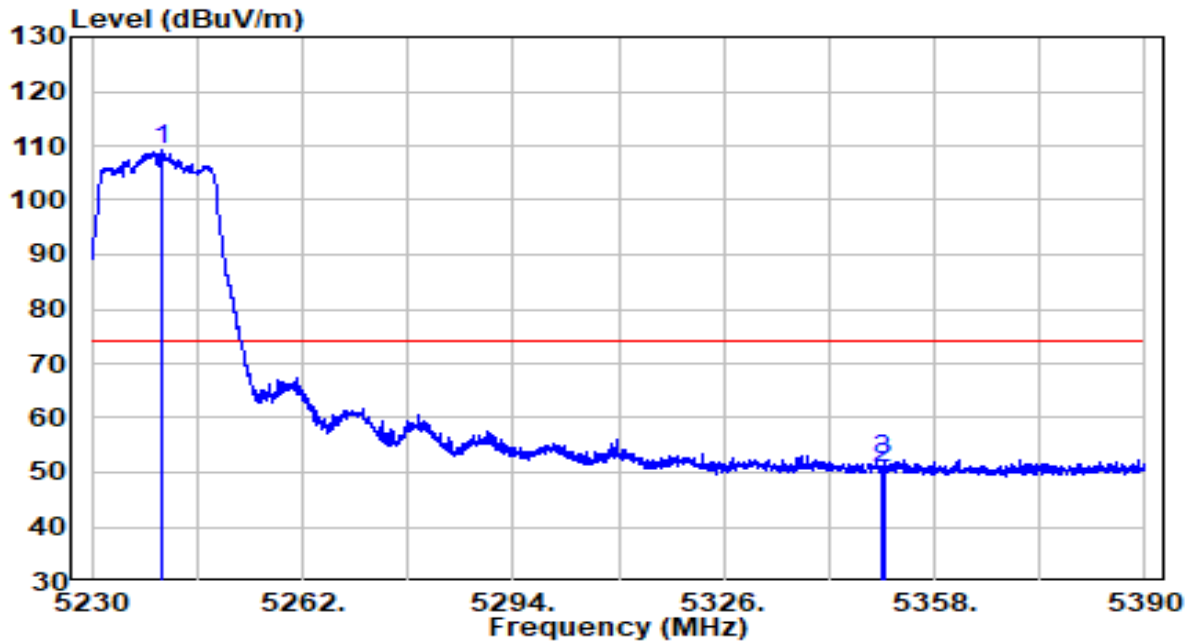

No	Frequency (MHz)	Reading (dBuV)	C.F (dB)	Measurement (dBuV/m)	Margin (dB)	Limit (dBuV/m)	Remark (QP/PK/AV)
1	* 5240.640	89.21	20.00	109.21	N/A	N/A	Peak
2	5350.000	30.61	20.11	50.72	-23.28	74.00	Peak
3	5350.240	32.15	20.11	52.27	-21.73	74.00	Peak

Note:

1. " *", means this data is the worst emission level.
2. C.F (Correction Factor) = Antenna Factor (dB)+ Cable Loss (dB)– Preamplifier(dB)+16db attenuation.
3. Measurement(dBuV/m) = Reading(dBuV) + C.F (Correction Factor).
- 4.The emission levels of other frequencies are very lower than the limit and not show in test report.

EUT	AP311	Date of Test	2020-09-28
Factor	BBHA 9120D (1GHz~18GHz)_2020	Temp. / Humidity	24.9°C/35%
Polarity	Horizontal	Site / Test Engineer	AC1 / Kevin Ker
Test Mode	Transmit by 802.11ac-VHT20 at Channel 5240MHz	Test Voltage	120V/60Hz

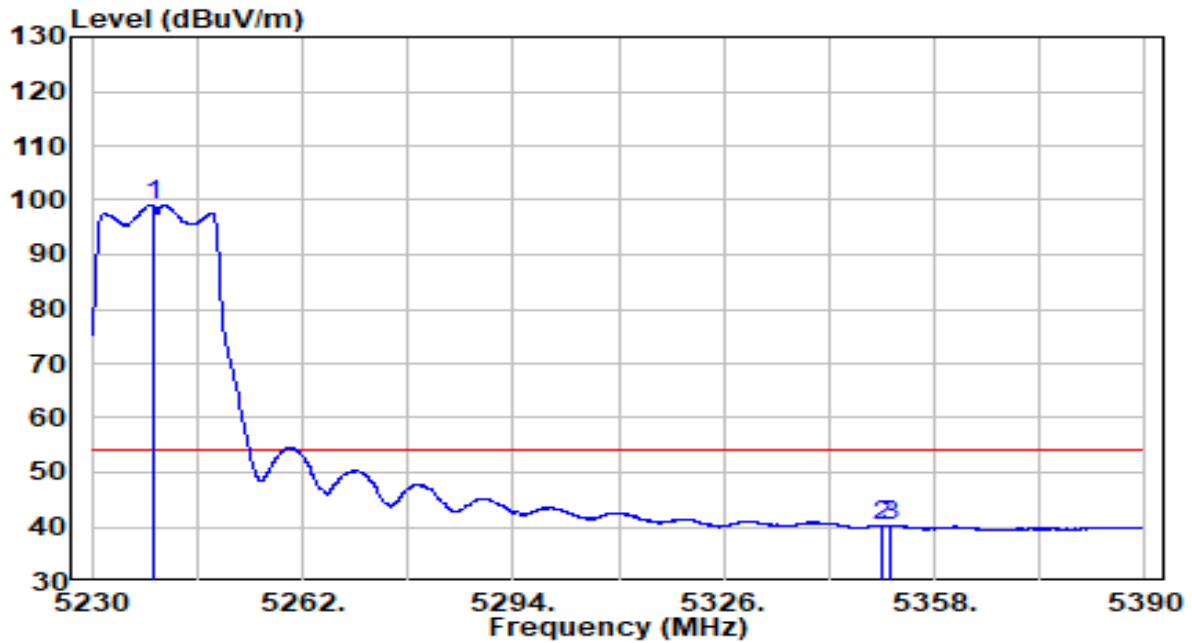

No	Frequency (MHz)	Reading (dBuV)	C.F (dB)	Measurement (dBuV/m)	Margin (dB)	Limit (dBuV/m)	Remark (QP/PK/AV)
1	* 5239.280	79.16	20.00	99.16	N/A	N/A	Average
2	5350.000	20.10	20.11	40.21	-13.79	54.00	Average
3	5351.280	20.22	20.12	40.34	-13.66	54.00	Average

Note:

1. " *", means this data is the worst emission level.
2. C.F (Correction Factor) = Antenna Factor (dB)+ Cable Loss (dB)– Preamplifier(dB)+16db attenuation.
3. Measurement(dBuV/m) = Reading(dBuV) + C.F (Correction Factor).
- 4.The emission levels of other frequencies are very lower than the limit and not show in test report.

EUT	AP311	Date of Test	2020-09-28
Factor	BBHA 9120D (1GHz~18GHz)_2020	Temp. / Humidity	24.9°C/35%
Polarity	Vertical	Site / Test Engineer	AC1 / Kevin Ker
Test Mode	Transmit by 802.11ac-VHT20 at Channel 5240MHz	Test Voltage	120V/60Hz

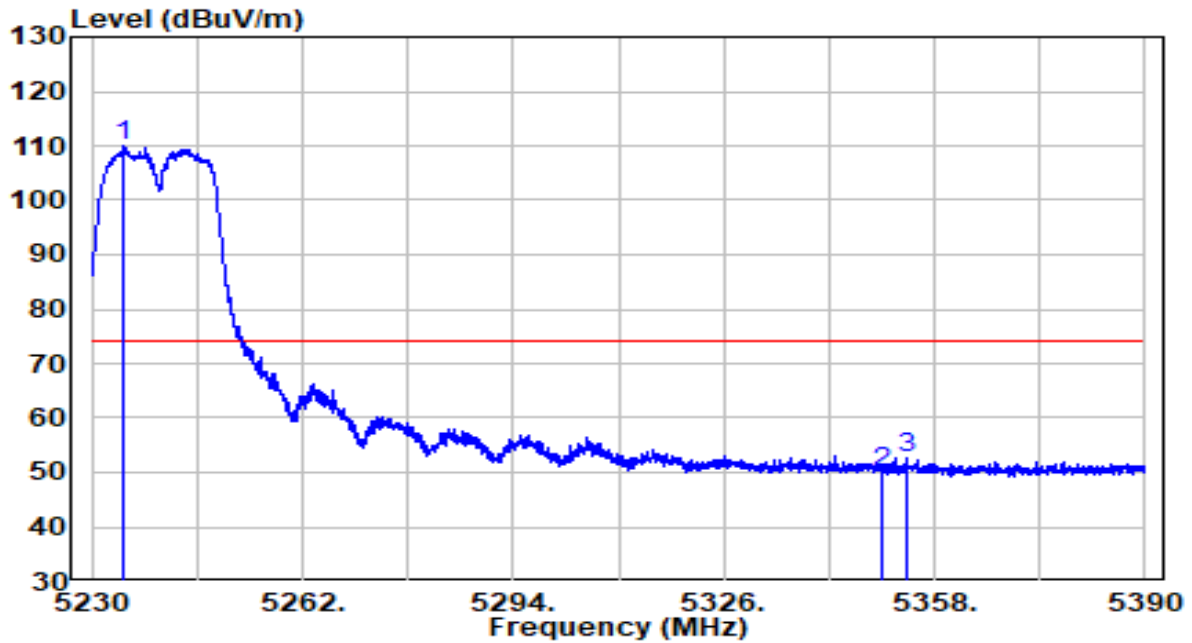

No	Frequency (MHz)	Reading (dBuV)	C.F (dB)	Measurement (dBuV/m)	Margin (dB)	Limit (dBuV/m)	Remark (QP/PK/AV)
1	* 5234.880	90.11	19.99	110.10	N/A	N/A	Peak
2	5350.000	30.00	20.11	50.12	-23.88	74.00	Peak
3	5353.760	32.53	20.12	52.65	-21.35	74.00	Peak

Note:

1. " *", means this data is the worst emission level.
2. C.F (Correction Factor) = Antenna Factor (dB)+ Cable Loss (dB)– Preamplifier(dB)+16db attenuation.
3. Measurement(dBuV/m) = Reading(dBuV) + C.F (Correction Factor).
- 4.The emission levels of other frequencies are very lower than the limit and not show in test report.

EUT	AP311	Date of Test	2020-09-28
Factor	BBHA 9120D (1GHz~18GHz)_2020	Temp. / Humidity	24.9°C/35%
Polarity	Vertical	Site / Test Engineer	AC1 / Kevin Ker
Test Mode	Transmit by 802.11ac-VHT20 at Channel 5240MHz	Test Voltage	120V/60Hz

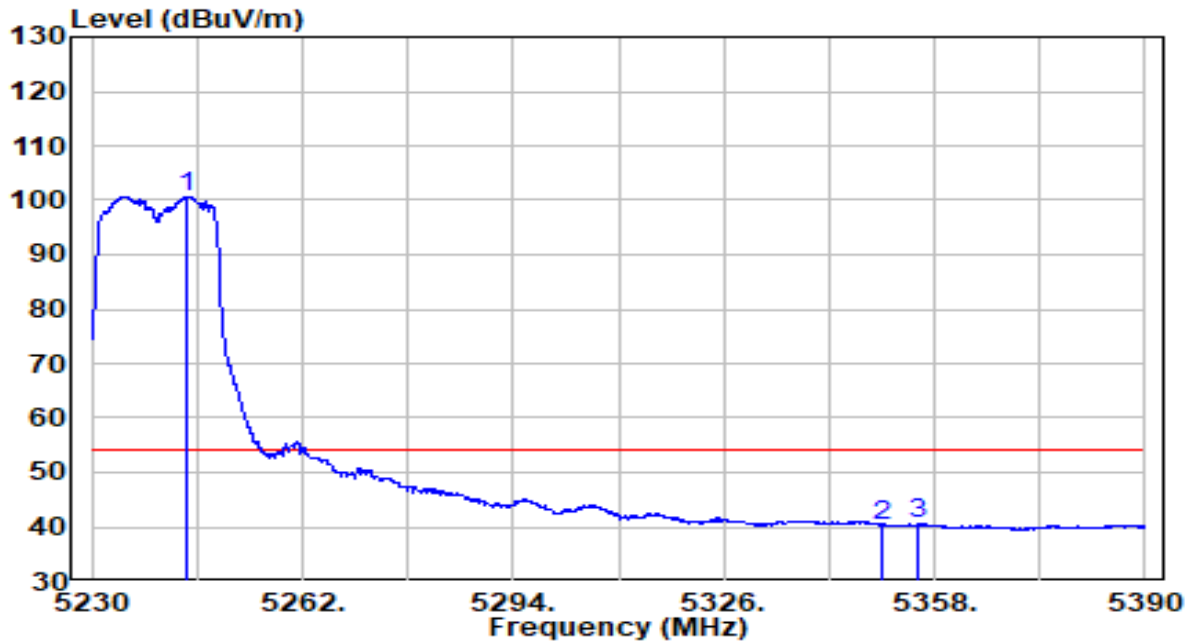

No	Frequency (MHz)	Reading (dBuV)	C.F (dB)	Measurement (dBuV/m)	Margin (dB)	Limit (dBuV/m)	Remark (QP/PK/AV)
1	* 5244.240	80.73	20.00	100.73	N/A	N/A	Average
2	5350.000	20.19	20.11	40.30	-13.70	54.00	Average
3	5355.680	20.41	20.12	40.53	-13.47	54.00	Average

Note:

1. " *", means this data is the worst emission level.
2. C.F (Correction Factor) = Antenna Factor (dB)+ Cable Loss (dB)– Preamplifier(dB)+16db attenuation.
3. Measurement(dBuV/m) = Reading(dBuV) + C.F (Correction Factor).
- 4.The emission levels of other frequencies are very lower than the limit and not show in test report.

EUT	AP311	Date of Test	2020-09-28
Factor	BBHA 9120D (1GHz~18GHz)_2020	Temp. / Humidity	24.9°C/35%
Polarity	Horizontal	Site / Test Engineer	AC1 / Kevin Ker
Test Mode	Transmit by 802.11ac-VHT20 at Channel 5320MHz	Test Voltage	120V/60Hz

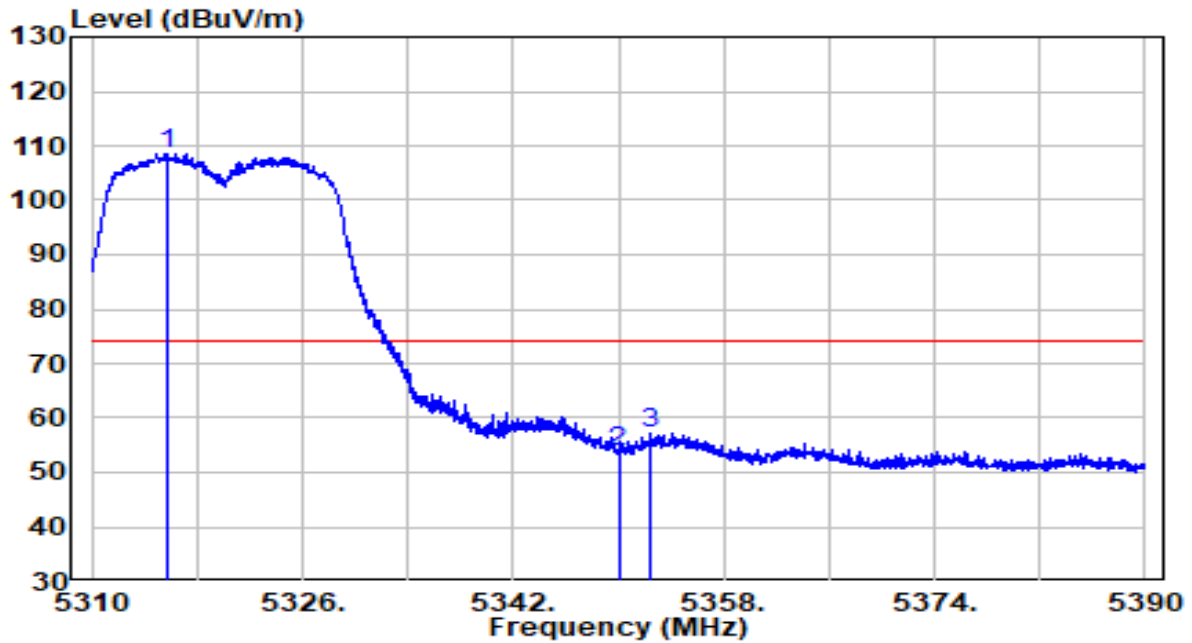

No	Frequency (MHz)	Reading (dBuV)	C.F (dB)	Measurement (dBuV/m)	Margin (dB)	Limit (dBuV/m)	Remark (QP/PK/AV)
1	* 5315.640	88.56	20.08	108.63	N/A	N/A	Peak
2	5350.000	33.69	20.11	53.80	-20.20	74.00	Peak
3	5352.360	37.23	20.12	57.34	-16.66	74.00	Peak

Note:

1. " *", means this data is the worst emission level.
2. C.F (Correction Factor) = Antenna Factor (dB)+ Cable Loss (dB)– Preamplifier(dB)+16db attenuation.
3. Measurement(dBuV/m) = Reading(dBuV) + C.F (Correction Factor).
- 4.The emission levels of other frequencies are very lower than the limit and not show in test report.

EUT	AP311	Date of Test	2020-09-28
Factor	BBHA 9120D (1GHz~18GHz)_2020	Temp. / Humidity	24.9°C/35%
Polarity	Horizontal	Site / Test Engineer	AC1 / Kevin Ker
Test Mode	Transmit by 802.11ac-VHT20 at Channel 5320MHz	Test Voltage	120V/60Hz

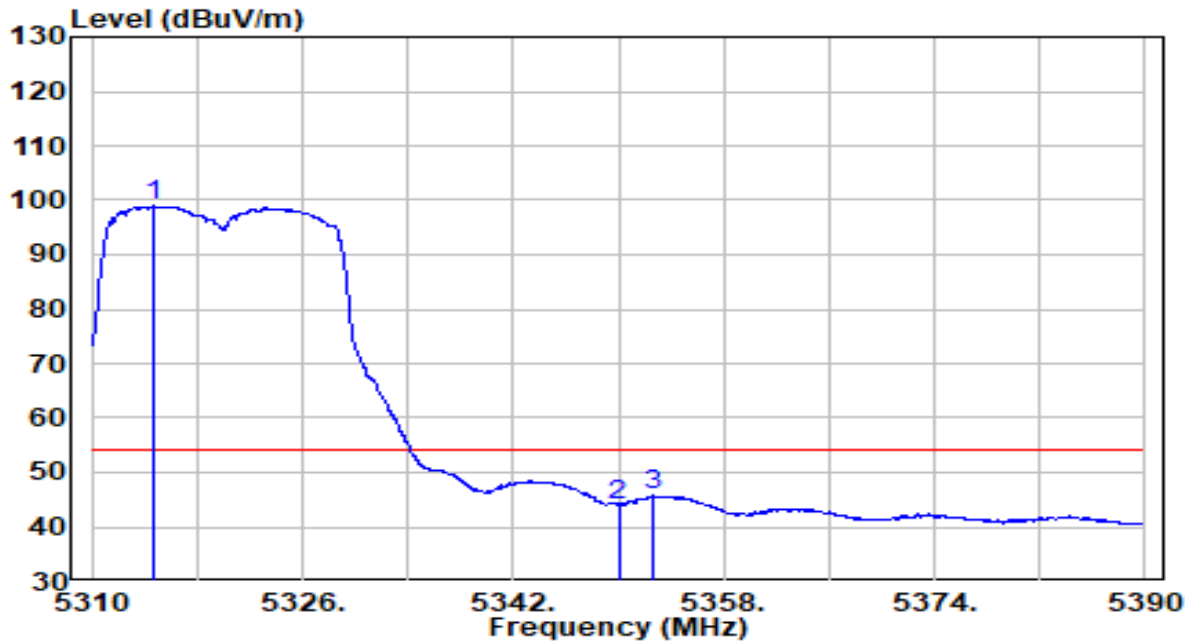

No	Frequency (MHz)	Reading (dBuV)	C.F (dB)	Measurement (dBuV/m)	Margin (dB)	Limit (dBuV/m)	Remark (QP/PK/AV)
1	* 5314.640	78.82	20.08	98.89	N/A	N/A	Average
2	5350.000	23.99	20.11	44.11	-9.89	54.00	Average
3	5352.560	25.60	20.12	45.72	-8.28	54.00	Average

Note:

1. " *", means this data is the worst emission level.
2. C.F (Correction Factor) = Antenna Factor (dB)+ Cable Loss (dB)– Preamplifier(dB)+16db attenuation.
3. Measurement(dBuV/m) = Reading(dBuV) + C.F (Correction Factor).
- 4.The emission levels of other frequencies are very lower than the limit and not show in test report.

EUT	AP311	Date of Test	2020-09-28
Factor	BBHA 9120D (1GHz~18GHz)_2020	Temp. / Humidity	24.9°C/35%
Polarity	Vertical	Site / Test Engineer	AC1 / Kevin Ker
Test Mode	Transmit by 802.11ac-VHT20 at Channel 5320MHz	Test Voltage	120V/60Hz

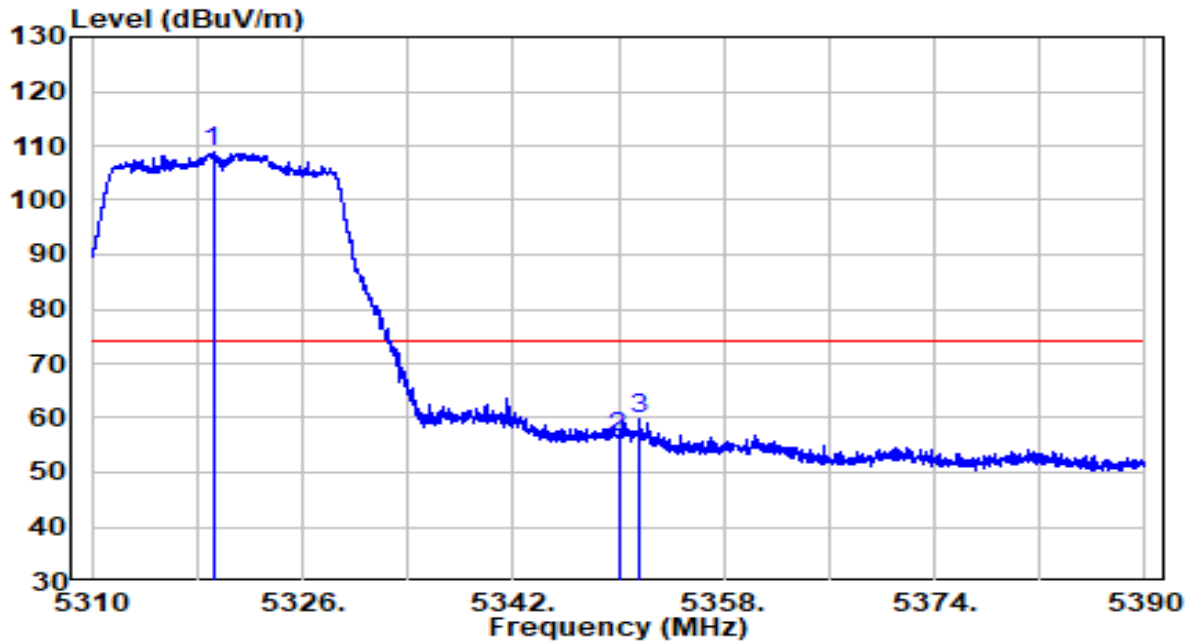

No	Frequency (MHz)	Reading (dBuV)	C.F (dB)	Measurement (dBuV/m)	Margin (dB)	Limit (dBuV/m)	Remark (QP/PK/AV)
1	* 5319.200	88.60	20.08	108.68	N/A	N/A	Peak
2	5350.000	36.25	20.11	56.37	-17.63	74.00	Peak
3	5351.600	39.64	20.12	59.75	-14.25	74.00	Peak

Note:

1. " *", means this data is the worst emission level.
2. C.F (Correction Factor) = Antenna Factor (dB)+ Cable Loss (dB)– Preamplifier(dB)+16db attenuation.
3. Measurement(dBuV/m) = Reading(dBuV) + C.F (Correction Factor).
- 4.The emission levels of other frequencies are very lower than the limit and not show in test report.

EUT	AP311	Date of Test	2020-09-28
Factor	BBHA 9120D (1GHz~18GHz)_2020	Temp. / Humidity	24.9°C/35%
Polarity	Vertical	Site / Test Engineer	AC1 / Kevin Ker
Test Mode	Transmit by 802.11ac-VHT20 at Channel 5320MHz	Test Voltage	120V/60Hz

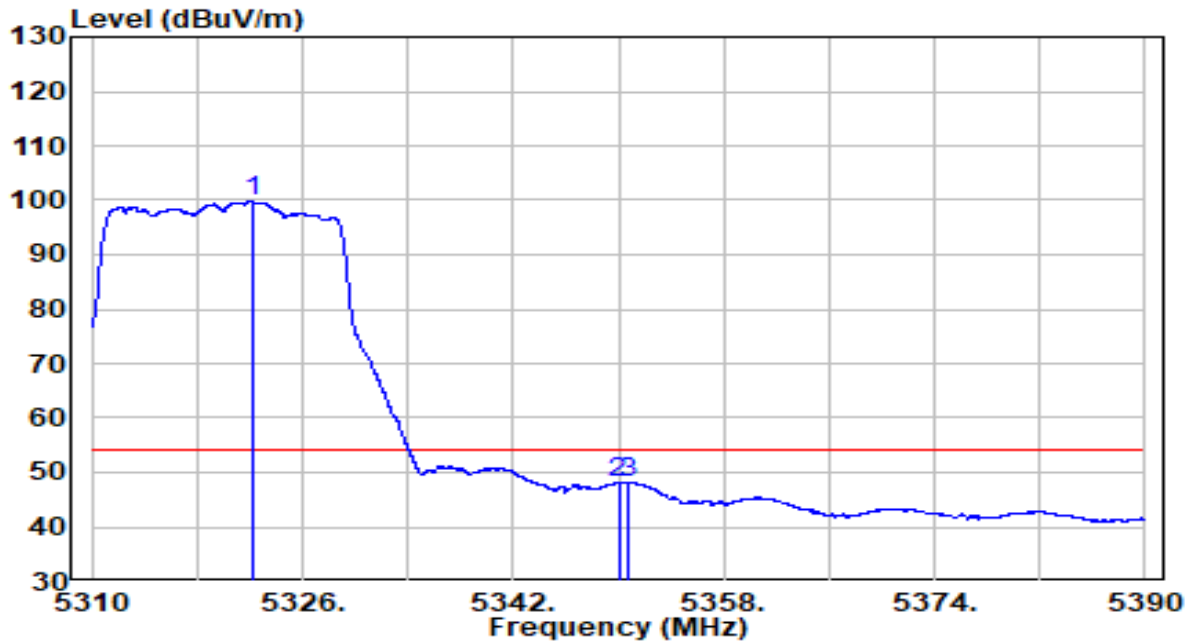

No	Frequency (MHz)	Reading (dBuV)	C.F (dB)	Measurement (dBuV/m)	Margin (dB)	Limit (dBuV/m)	Remark (QP/PK/AV)
1	* 5322.200	79.75	20.09	99.83	N/A	N/A	Average
2	5350.000	27.85	20.11	47.96	-6.04	54.00	Average
3	5350.720	28.10	20.11	48.21	-5.79	54.00	Average

Note:

1. " *", means this data is the worst emission level.
2. C.F (Correction Factor) = Antenna Factor (dB)+ Cable Loss (dB)– Preamplifier(dB)+16db attenuation.
3. Measurement(dBuV/m) = Reading(dBuV) + C.F (Correction Factor).
- 4.The emission levels of other frequencies are very lower than the limit and not show in test report.

EUT	AP311	Date of Test	2020-09-28
Factor	BBHA 9120D (1GHz~18GHz)_2020	Temp. / Humidity	24.9°C/35%
Polarity	Horizontal	Site / Test Engineer	AC1 / Kevin Ker
Test Mode	Transmit by 802.11ac-VHT20 at Channel 5500MHz	Test Voltage	120V/60Hz

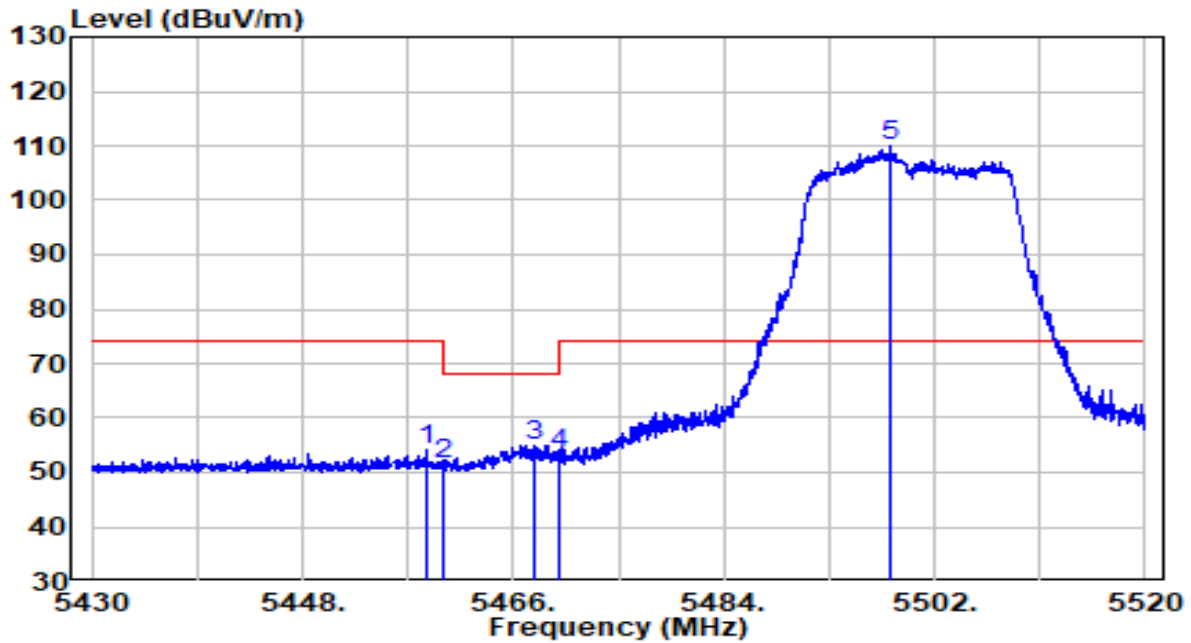

No	Frequency (MHz)	Reading (dBuV)	C.F (dB)	Measurement (dBuV/m)	Margin (dB)	Limit (dBuV/m)	Remark (QP/PK/AV)
1	5458.530	33.94	20.23	54.17	-19.83	74.00	Peak
2	5460.000	31.21	20.23	51.43	-16.77	68.20	Peak
3	5467.845	34.82	20.24	55.05	-13.15	68.20	Peak
4	5470.000	33.00	20.24	53.24	-14.96	68.20	Peak
5	* 5498.220	89.65	20.27	109.92	N/A	N/A	Peak

Note:

1. " *", means this data is the worst emission level.
2. C.F (Correction Factor) = Antenna Factor (dB)+ Cable Loss (dB)– Preamplifier(dB)+16db attenuation.
3. Measurement(dBuV/m) = Reading(dBuV) + C.F (Correction Factor).
- 4.The emission levels of other frequencies are very lower than the limit and not show in test report.

EUT	AP311	Date of Test	2020-09-28
Factor	BBHA 9120D (1GHz~18GHz)_2020	Temp. / Humidity	24.9°C/35%
Polarity	Horizontal	Site / Test Engineer	AC1 / Kevin Ker
Test Mode	Transmit by 802.11ac-VHT20 at Channel 5500MHz	Test Voltage	120V/60Hz

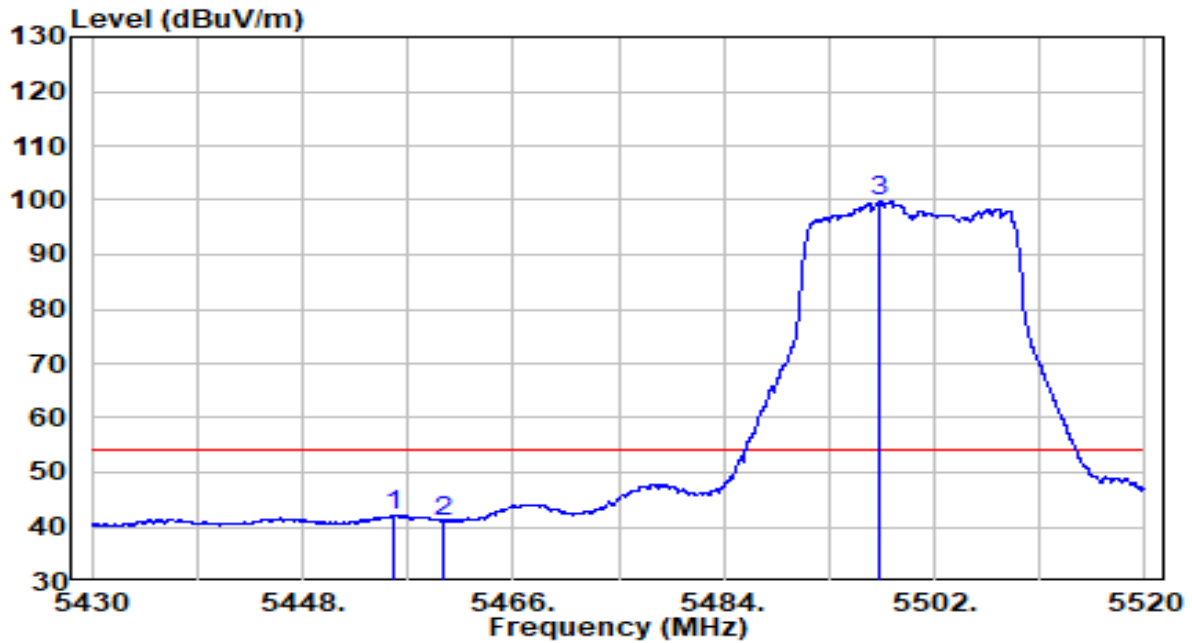

No	Frequency (MHz)	Reading (dBuV)	C.F (dB)	Measurement (dBuV/m)	Margin (dB)	Limit (dBuV/m)	Remark (QP/PK/AV)
1	5455.830	21.85	20.22	42.07	-11.93	54.00	Average
2	5460.000	20.87	20.23	41.10	-12.90	54.00	Average
3	* 5497.230	79.49	20.27	99.76	N/A	N/A	Average

Note:

1. " *", means this data is the worst emission level.
2. C.F (Correction Factor) = Antenna Factor (dB)+ Cable Loss (dB)– Preamplifier(dB)+16db attenuation.
3. Measurement(dBuV/m) = Reading(dBuV) + C.F (Correction Factor).
- 4.The emission levels of other frequencies are very lower than the limit and not show in test report.

EUT	AP311	Date of Test	2020-09-28
Factor	BBHA 9120D (1GHz~18GHz)_2020	Temp. / Humidity	24.9°C/35%
Polarity	Vertical	Site / Test Engineer	AC1 / Kevin Ker
Test Mode	Transmit by 802.11ac-VHT20 at Channel 5500MHz	Test Voltage	120V/60Hz

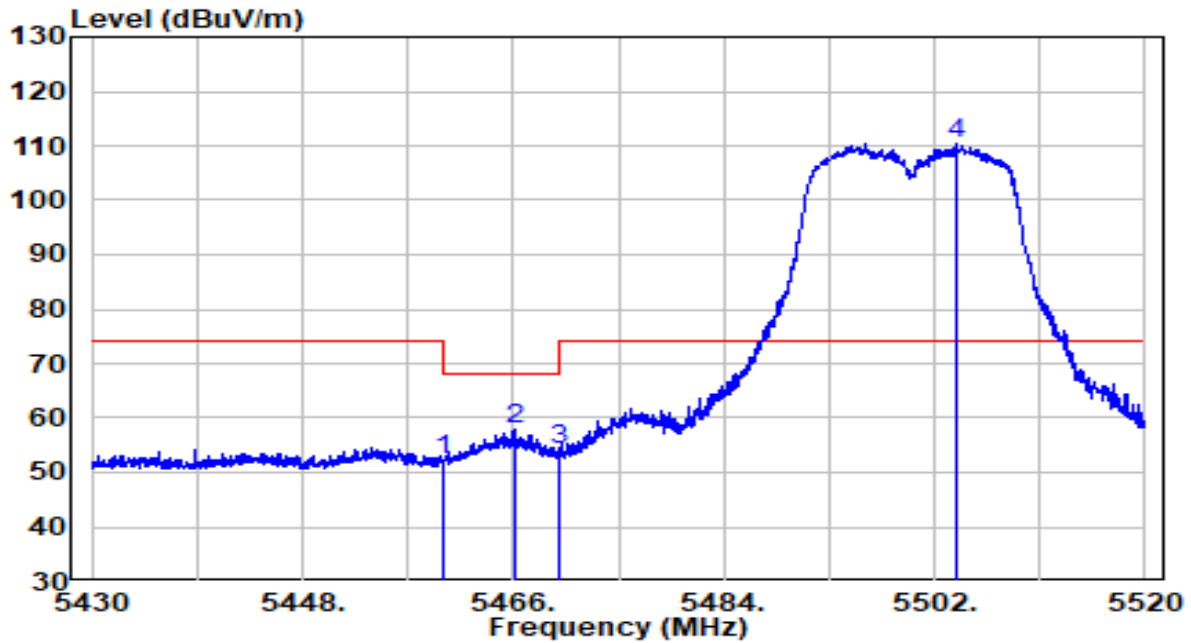

No	Frequency (MHz)	Reading (dBuV)	C.F (dB)	Measurement (dBuV/m)	Margin (dB)	Limit (dBuV/m)	Remark (QP/PK/AV)
1	5460.000	32.07	20.23	52.30	-15.90	68.20	Peak
2	5466.225	37.61	20.23	57.84	-10.36	68.20	Peak
3	5470.000	33.77	20.24	54.01	-14.19	68.20	Peak
4	* 5503.845	89.99	20.28	110.27	N/A	N/A	Peak

Note:

1. " *", means this data is the worst emission level.
2. C.F (Correction Factor) = Antenna Factor (dB)+ Cable Loss (dB)– Preamplifier(dB)+16db attenuation.
3. Measurement(dBuV/m) = Reading(dBuV) + C.F (Correction Factor).
- 4.The emission levels of other frequencies are very lower than the limit and not show in test report.

EUT	AP311	Date of Test	2020-09-28
Factor	BBHA 9120D (1GHz~18GHz)_2020	Temp. / Humidity	24.9°C/35%
Polarity	Vertical	Site / Test Engineer	AC1 / Kevin Ker
Test Mode	Transmit by 802.11ac-VHT20 at Channel 5500MHz	Test Voltage	120V/60Hz

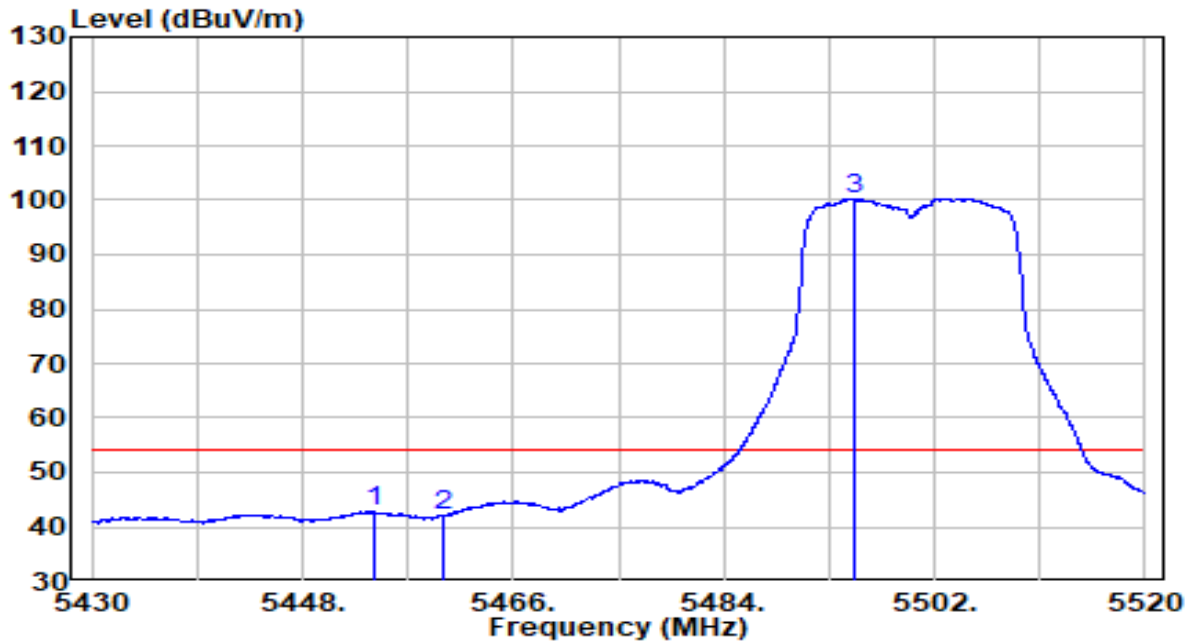

No	Frequency (MHz)	Reading (dBuV)	C.F (dB)	Measurement (dBuV/m)	Margin (dB)	Limit (dBuV/m)	Remark (QP/PK/AV)
1	5454.075	22.53	20.22	42.76	-11.24	54.00	Average
2	5460.000	21.73	20.23	41.96	-12.04	54.00	Average
3	* 5495.205	80.07	20.27	100.34	N/A	N/A	Average

Note:

1. " *", means this data is the worst emission level.
2. C.F (Correction Factor) = Antenna Factor (dB)+ Cable Loss (dB)– Preamplifier(dB)+16db attenuation.
3. Measurement(dBuV/m) = Reading(dBuV) + C.F (Correction Factor).
- 4.The emission levels of other frequencies are very lower than the limit and not show in test report.

EUT	AP311	Date of Test	2020-09-28
Factor	BBHA 9120D (1GHz~18GHz)_2020	Temp. / Humidity	24.9°C/35%
Polarity	Horizontal	Site / Test Engineer	AC1 / Kevin Ker
Test Mode	Transmit by 802.11ac-VHT20 at Channel 5700MHz	Test Voltage	120V/60Hz

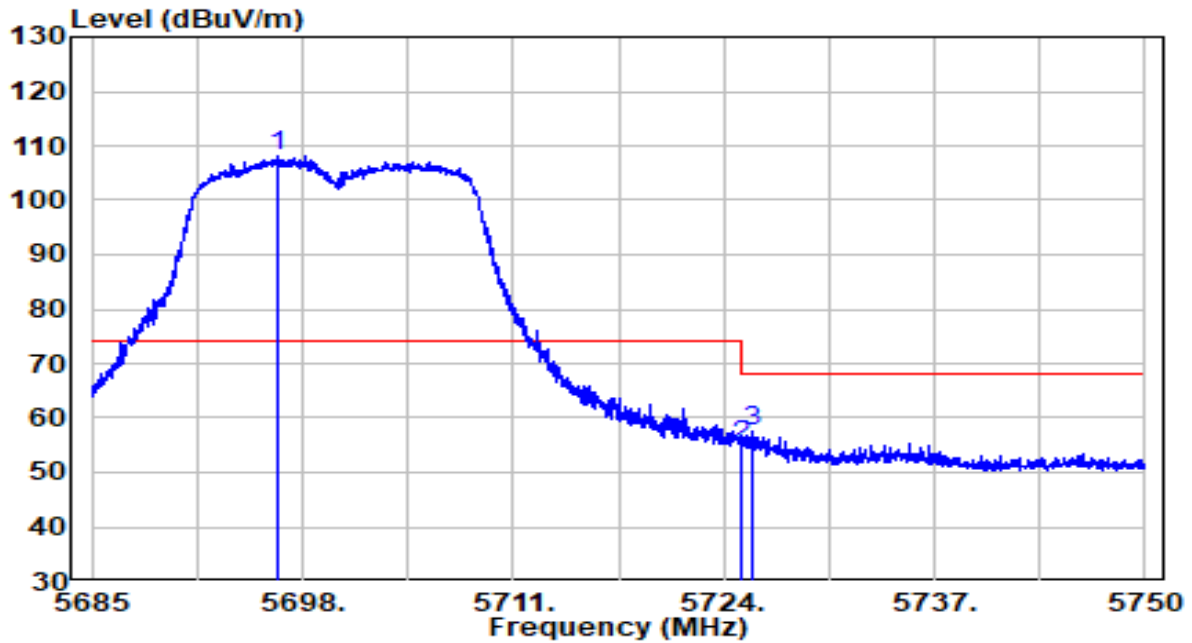

No	Frequency (MHz)	Reading (dBuV)	C.F (dB)	Measurement (dBuV/m)	Margin (dB)	Limit (dBuV/m)	Remark (QP/PK/AV)
1	* 5696.538	87.20	20.91	108.11	N/A	N/A	Peak
2	5725.000	33.85	21.00	54.85	-13.35	68.20	Peak
3	5725.690	36.50	21.00	57.50	-10.70	68.20	Peak

Note:

1. " *", means this data is the worst emission level.
2. C.F (Correction Factor) = Antenna Factor (dB)+ Cable Loss (dB)– Preamplifier(dB)+16db attenuation.
3. Measurement(dBuV/m) = Reading(dBuV) + C.F (Correction Factor).
- 4.The emission levels of other frequencies are very lower than the limit and not show in test report.

EUT	AP311	Date of Test	2020-09-28
Factor	BBHA 9120D (1GHz~18GHz)_2020	Temp. / Humidity	24.9°C/35%
Polarity	Vertical	Site / Test Engineer	AC1 / Kevin Ker
Test Mode	Transmit by 802.11ac-VHT20 at Channel 5700MHz	Test Voltage	120V/60Hz

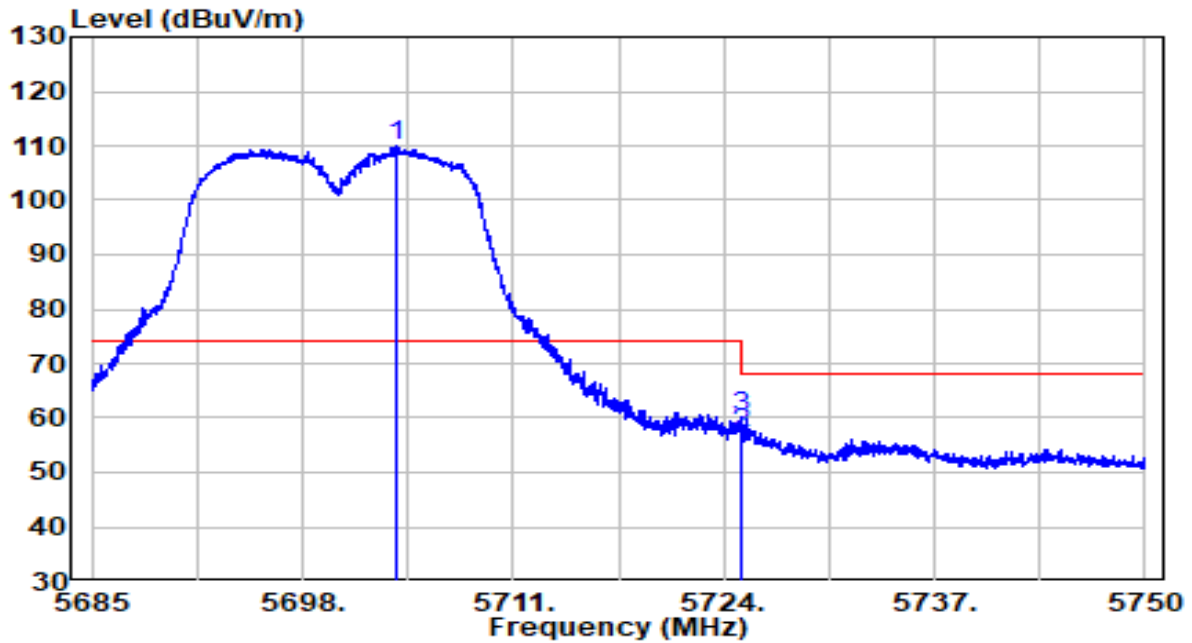

No	Frequency (MHz)	Reading (dBuV)	C.F (dB)	Measurement (dBuV/m)	Margin (dB)	Limit (dBuV/m)	Remark (QP/PK/AV)
1	* 5703.720	88.93	20.93	109.86	N/A	N/A	Peak
2	5725.000	36.21	21.00	57.20	-11.00	68.20	Peak
3	5725.105	39.35	21.00	60.35	-7.85	68.20	Peak

Note:

1. " *", means this data is the worst emission level.
2. C.F (Correction Factor) = Antenna Factor (dB)+ Cable Loss (dB)– Preamplifier(dB)+16db attenuation.
3. Measurement(dBuV/m) = Reading(dBuV) + C.F (Correction Factor).
- 4.The emission levels of other frequencies are very lower than the limit and not show in test report.

EUT	AP311	Date of Test	2020-09-28
Factor	BBHA 9120D (1GHz~18GHz)_2020	Temp. / Humidity	24.9°C/35%
Polarity	Horizontal	Site / Test Engineer	AC1 / Kevin Ker
Test Mode	Transmit by 802.11ac-VHT20 at Channel 5745MHz	Test Voltage	120V/60Hz

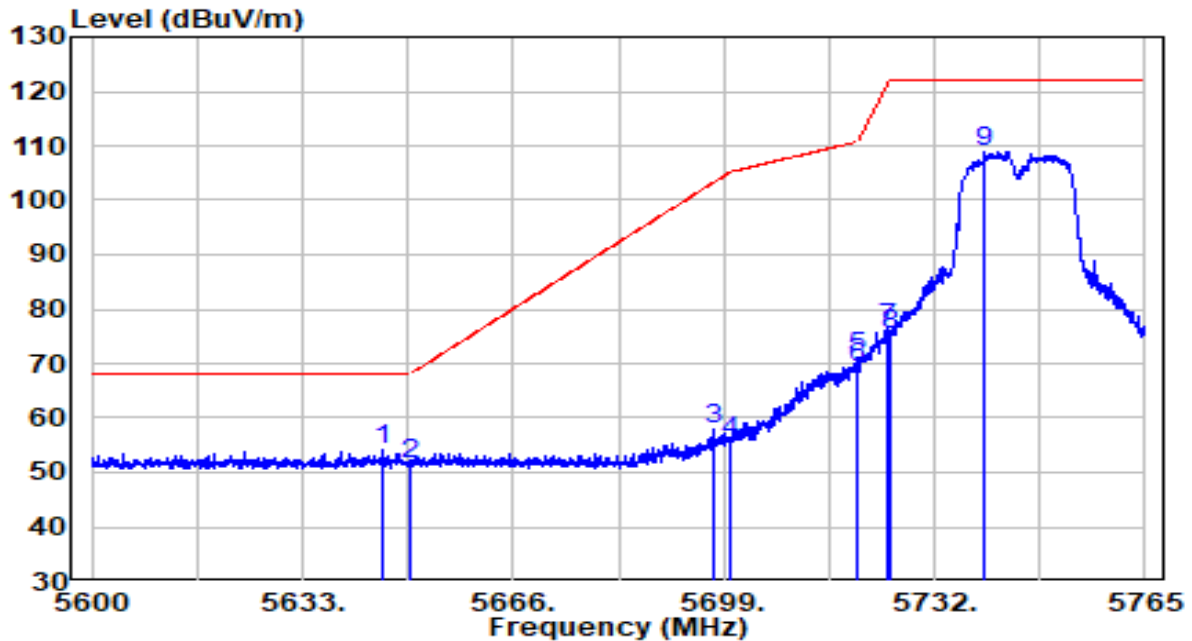

No	Frequency (MHz)	Reading (dBuV)	C.F (dB)	Measurement (dBuV/m)	Margin (dB)	Limit (dBuV/m)	Remark (QP/PK/AV)
1	5645.705	33.27	20.74	54.02	-14.18	68.20	Peak
2	5650.000	30.63	20.76	51.39	-16.81	68.20	Peak
3	5697.515	37.13	20.91	58.04	-45.33	103.37	Peak
4	5700.000	34.70	20.92	55.62	-49.58	105.20	Peak
5	5719.708	49.98	20.98	70.96	-39.76	110.72	Peak
6	5720.000	48.44	20.98	69.43	-41.37	110.80	Peak
7	5724.493	55.37	21.00	76.36	-44.68	121.04	Peak
8	5725.000	54.45	21.00	75.45	-46.75	122.20	Peak
9	* 5739.837	87.90	21.05	108.95	N/A	N/A	Peak

Note:

1. " *", means this data is the worst emission level.
2. C.F (Correction Factor) = Antenna Factor (dB)+ Cable Loss (dB)– Preamplifier(dB)+16db attenuation.
3. Measurement(dBuV/m) = Reading(dBuV) + C.F (Correction Factor).
- 4.The emission levels of other frequencies are very lower than the limit and not show in test report.

EUT	AP311	Date of Test	2020-09-28
Factor	BBHA 9120D (1GHz~18GHz)_2020	Temp. / Humidity	24.9°C/35%
Polarity	Vertical	Site / Test Engineer	AC1 / Kevin Ker
Test Mode	Transmit by 802.11ac-VHT20 at Channel 5745MHz	Test Voltage	120V/60Hz

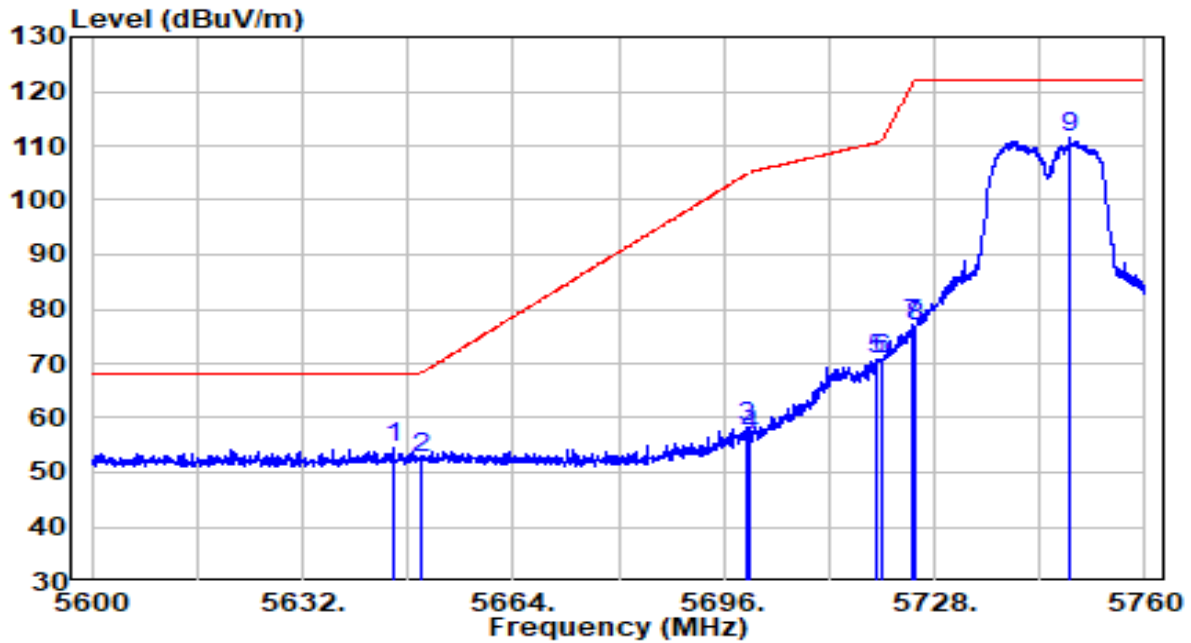

No	Frequency (MHz)	Reading (dBuV)	C.F (dB)	Measurement (dBuV/m)	Margin (dB)	Limit (dBuV/m)	Remark (QP/PK/AV)
1	5645.680	33.60	20.74	54.34	-13.86	68.20	Peak
2	5650.000	31.75	20.76	52.51	-15.69	68.20	Peak
3	5699.680	37.42	20.92	58.34	-46.63	104.96	Peak
4	5700.000	35.85	20.92	56.77	-48.43	105.20	Peak
5	5719.360	49.94	20.98	70.92	-39.70	110.62	Peak
6	5720.000	49.71	20.98	70.69	-40.11	110.80	Peak
7	5724.640	55.99	21.00	76.99	-44.39	121.38	Peak
8	5725.000	55.68	21.00	76.68	-45.52	122.20	Peak
9	* 5748.720	90.48	21.08	111.55	N/A	N/A	Peak

Note:

1. " *", means this data is the worst emission level.
2. C.F (Correction Factor) = Antenna Factor (dB)+ Cable Loss (dB)– Preamplifier(dB)+16db attenuation.
3. Measurement(dBuV/m) = Reading(dBuV) + C.F (Correction Factor).
- 4.The emission levels of other frequencies are very lower than the limit and not show in test report.

EUT	AP311	Date of Test	2020-09-28
Factor	BBHA 9120D (1GHz~18GHz)_2020	Temp. / Humidity	24.9°C/35%
Polarity	Horizontal	Site / Test Engineer	AC1 / Kevin Ker
Test Mode	Transmit by 802.11ac-VHT20 at Channel 5825MHz	Test Voltage	120V/60Hz

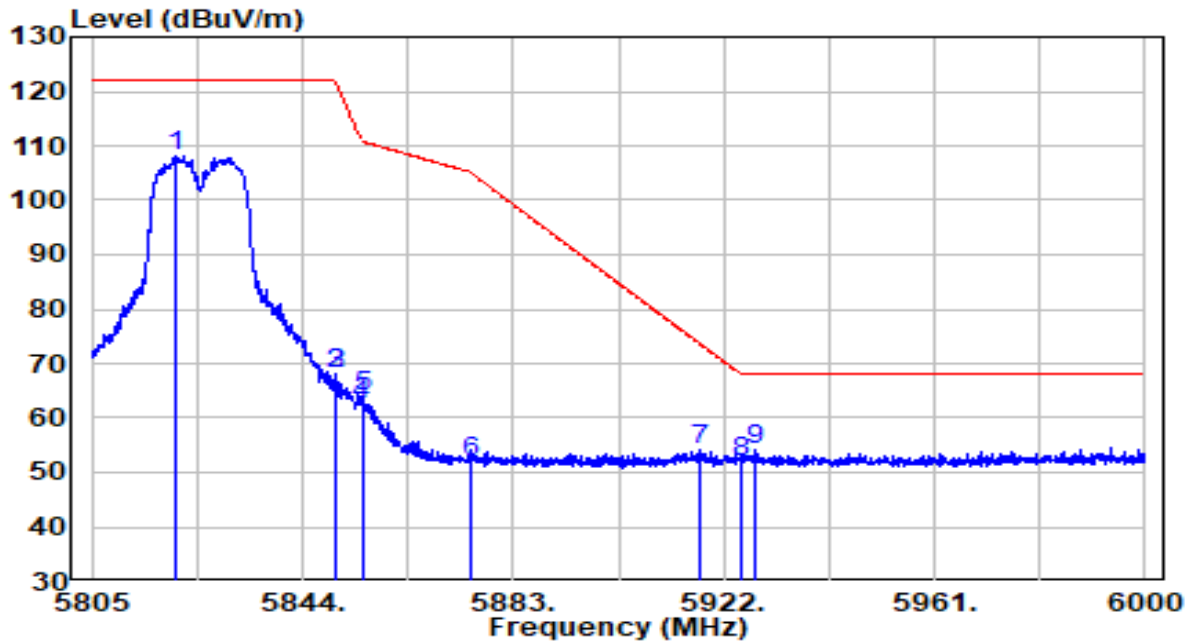

No	Frequency (MHz)	Reading (dBuV)	C.F (dB)	Measurement (dBuV/m)	Margin (dB)	Limit (dBuV/m)	Remark (QP/PK/AV)
1	5820.600	86.72	21.31	108.03	N/A	N/A	Peak
2	5850.000	46.57	21.40	67.98	-54.22	122.20	Peak
3	5850.045	46.57	21.40	67.98	-54.12	122.10	Peak
4	5855.000	40.96	21.42	62.38	-48.42	110.80	Peak
5	5855.115	42.61	21.42	64.03	-46.74	110.77	Peak
6	5875.000	30.45	21.49	51.93	-53.27	105.20	Peak
7	5917.417	32.50	21.62	54.13	-19.67	73.79	Peak
8	5925.000	30.26	21.65	51.91	-16.29	68.20	Peak
9	* 5927.947	32.55	21.66	54.21	-13.99	68.20	Peak

Note:

1. " *", means this data is the worst emission level.
2. C.F (Correction Factor) = Antenna Factor (dB)+ Cable Loss (dB)– Preamplifier(dB)+16db attenuation.
3. Measurement(dBuV/m) = Reading(dBuV) + C.F (Correction Factor).
- 4.The emission levels of other frequencies are very lower than the limit and not show in test report.

EUT	AP311	Date of Test	2020-09-28
Factor	BBHA 9120D (1GHz~18GHz)_2020	Temp. / Humidity	24.9°C/35%
Polarity	Vertical	Site / Test Engineer	AC1 / Kevin Ker
Test Mode	Transmit by 802.11ac-VHT20 at Channel 5825MHz	Test Voltage	120V/60Hz

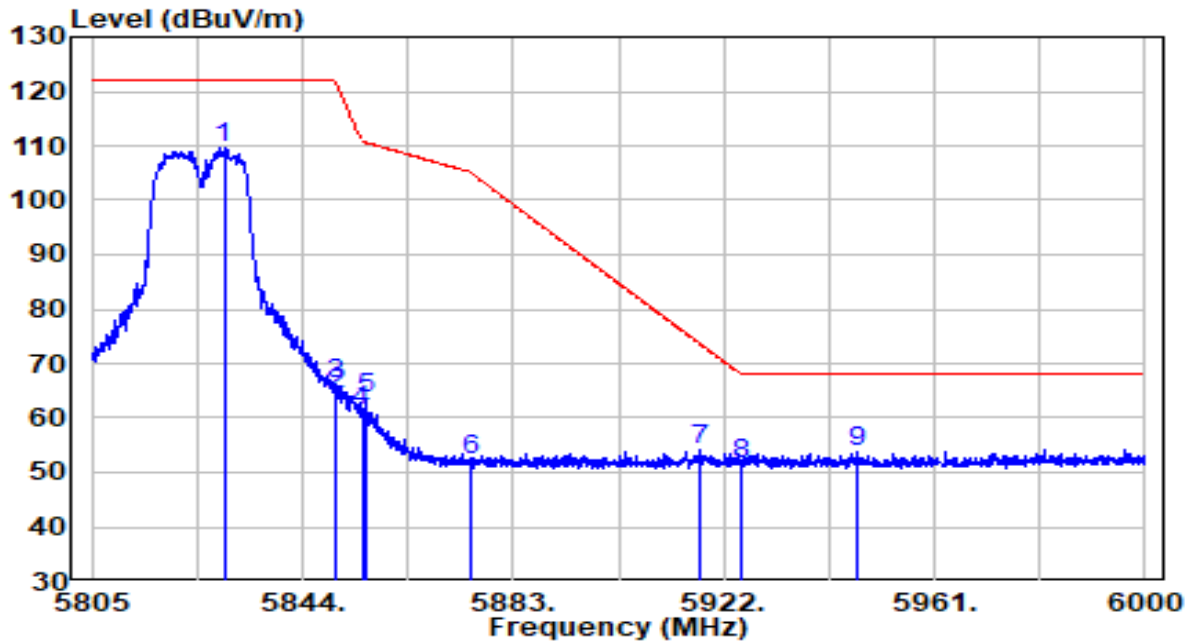

No	Frequency (MHz)	Reading (dBuV)	C.F (dB)	Measurement (dBuV/m)	Margin (dB)	Limit (dBuV/m)	Remark (QP/PK/AV)
1	* 5829.473	88.24	21.34	109.57	N/A	N/A	Peak
2	5850.000	42.88	21.40	64.28	-57.92	122.20	Peak
3	5850.143	44.97	21.40	66.38	-55.50	121.87	Peak
4	5855.000	39.83	21.42	61.25	-49.55	110.80	Peak
5	5855.700	42.33	21.42	63.75	-46.85	110.60	Peak
6	5875.000	30.63	21.49	52.11	-53.09	105.20	Peak
7	5917.808	32.66	21.62	54.28	-19.22	73.50	Peak
8	5925.000	29.98	21.65	51.62	-16.58	68.20	Peak
9	5946.473	31.94	21.72	53.65	-14.55	68.20	Peak

Note:

1. " *", means this data is the worst emission level.
2. C.F (Correction Factor) = Antenna Factor (dB)+ Cable Loss (dB)– Preamplifier(dB)+16db attenuation.
3. Measurement(dBuV/m) = Reading(dBuV) + C.F (Correction Factor).
- 4.The emission levels of other frequencies are very lower than the limit and not show in test report.

EUT	AP311	Date of Test	2020-09-28
Factor	BBHA 9120D (1GHz~18GHz)_2020	Temp. / Humidity	24.9°C/35%
Polarity	Horizontal	Site / Test Engineer	AC1 / Kevin Ker
Test Mode	Transmit by 802.11ac-VHT40 at Channel 5190MHz	Test Voltage	120V/60Hz

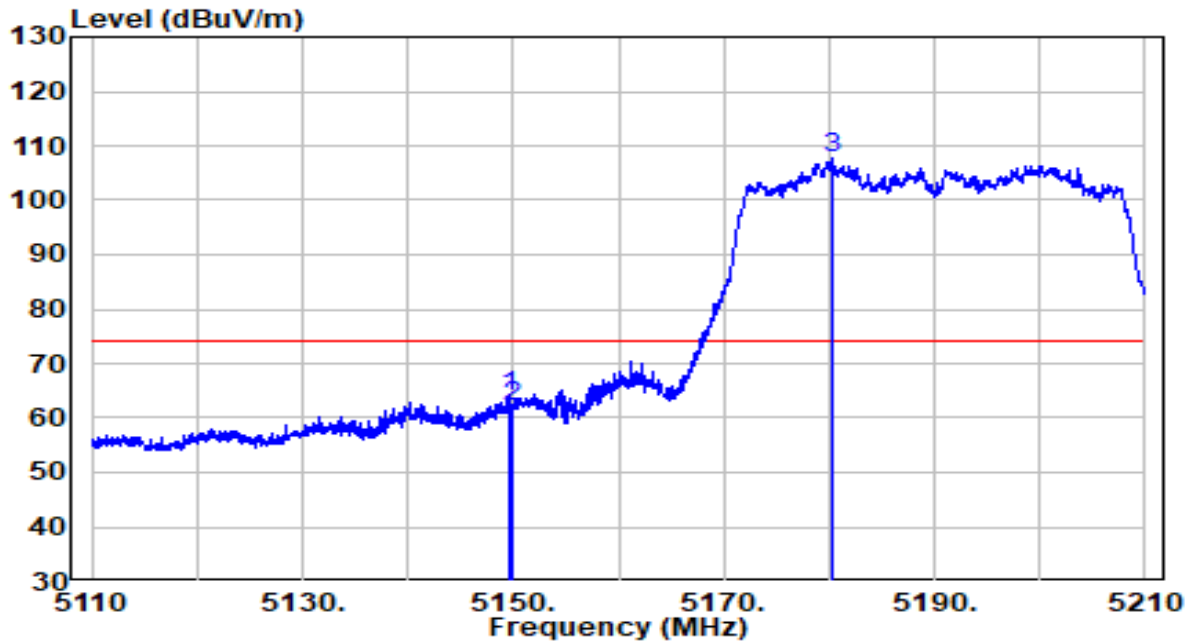

No	Frequency (MHz)	Reading (dBuV)	C.F (dB)	Measurement (dBuV/m)	Margin (dB)	Limit (dBuV/m)	Remark (QP/PK/AV)
1	5149.700	44.08	19.91	63.99	-10.01	74.00	Peak
2	5150.000	42.23	19.91	62.14	-11.86	74.00	Peak
3	* 5180.200	87.74	19.94	107.67	N/A	N/A	Peak

Note:

1. " *", means this data is the worst emission level.
2. C.F (Correction Factor) = Antenna Factor (dB)+ Cable Loss (dB)– Preamplifier(dB)+16db attenuation.
3. Measurement(dBuV/m) = Reading(dBuV) + C.F (Correction Factor).
- 4.The emission levels of other frequencies are very lower than the limit and not show in test report.

EUT	AP311	Date of Test	2020-09-28
Factor	BBHA 9120D (1GHz~18GHz)_2020	Temp. / Humidity	24.9°C/35%
Polarity	Horizontal	Site / Test Engineer	AC1 / Kevin Ker
Test Mode	Transmit by 802.11ac-VHT40 at Channel 5190MHz	Test Voltage	120V/60Hz

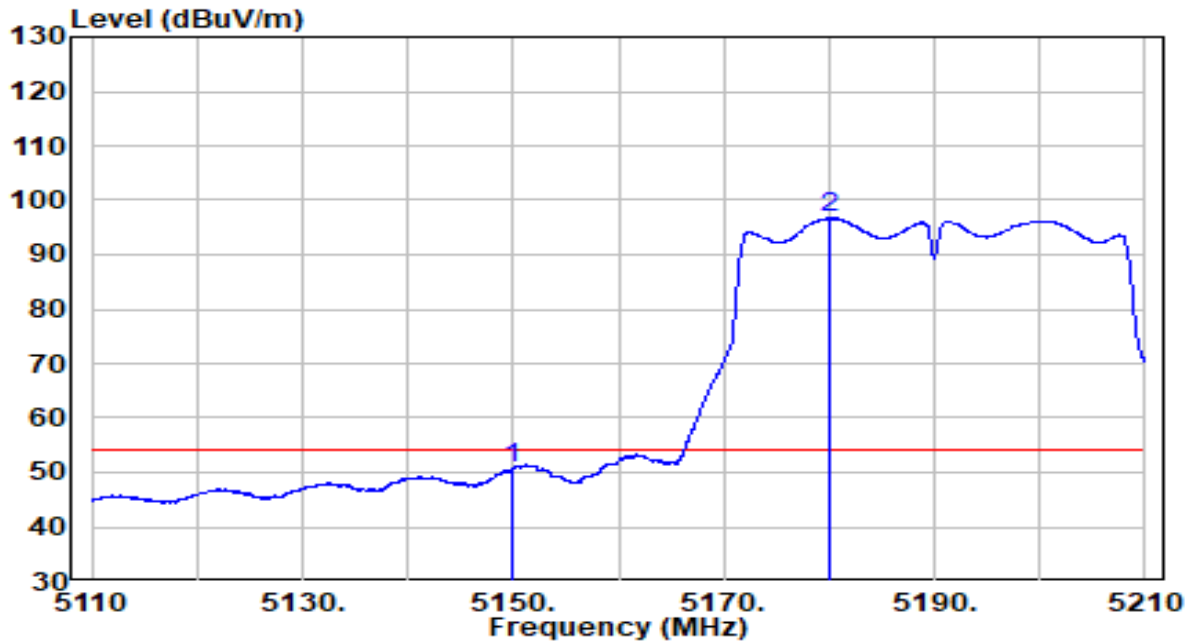

No	Frequency (MHz)	Reading (dBuV)	C.F (dB)	Measurement (dBuV/m)	Margin (dB)	Limit (dBuV/m)	Remark (QP/PK/AV)
1	5150.000	30.97	19.91	50.87	-3.13	54.00	Average
2	* 5180.100	76.74	19.94	96.68	N/A	N/A	Average

Note:

1. " *", means this data is the worst emission level.
2. C.F (Correction Factor) = Antenna Factor (dB)+ Cable Loss (dB)– Preamplifier(dB)+16db attenuation.
3. Measurement(dBuV/m) = Reading(dBuV) + C.F (Correction Factor).
- 4.The emission levels of other frequencies are very lower than the limit and not show in test report.

EUT	AP311	Date of Test	2020-09-28
Factor	BBHA 9120D (1GHz~18GHz)_2020	Temp. / Humidity	24.9°C/35%
Polarity	Vertical	Site / Test Engineer	AC1 / Kevin Ker
Test Mode	Transmit by 802.11ac-VHT40 at Channel 5190MHz	Test Voltage	120V/60Hz

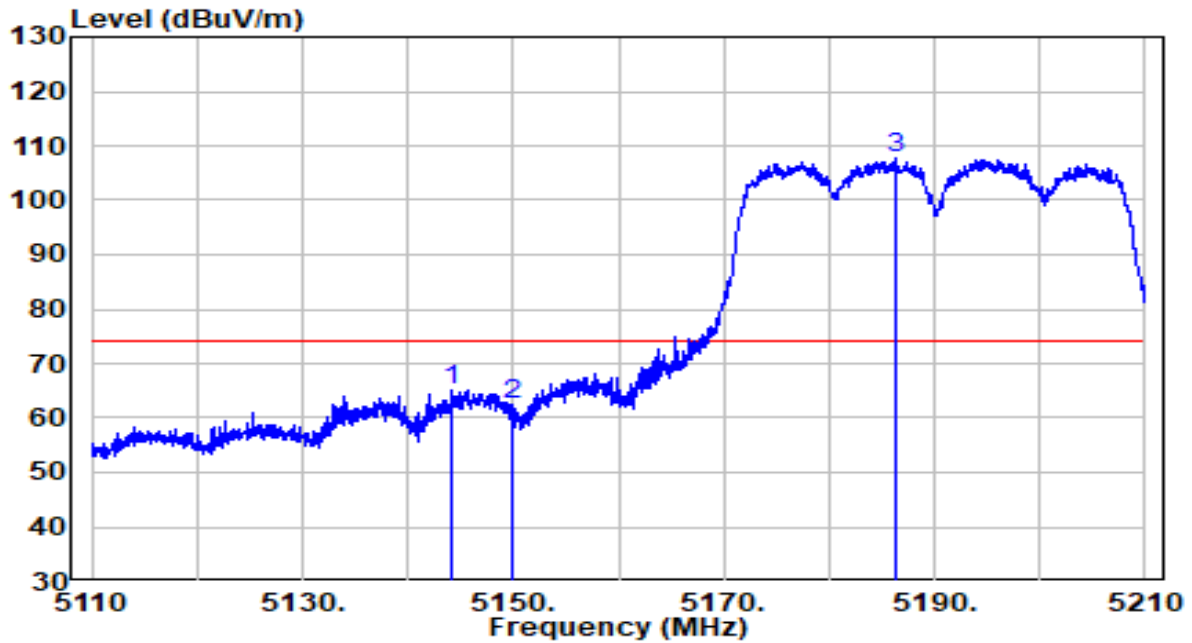

No	Frequency (MHz)	Reading (dBuV)	C.F (dB)	Measurement (dBuV/m)	Margin (dB)	Limit (dBuV/m)	Remark (QP/PK/AV)
1	5144.250	45.10	19.90	65.00	-9.00	74.00	Peak
2	5150.000	42.36	19.91	62.27	-11.73	74.00	Peak
3	* 5186.350	87.97	19.94	107.91	N/A	N/A	Peak

Note:

1. " *", means this data is the worst emission level.
2. C.F (Correction Factor) = Antenna Factor (dB)+ Cable Loss (dB)– Preamplifier(dB)+16db attenuation.
3. Measurement(dBuV/m) = Reading(dBuV) + C.F (Correction Factor).
- 4.The emission levels of other frequencies are very lower than the limit and not show in test report.

EUT	AP311	Date of Test	2020-09-28
Factor	BBHA 9120D (1GHz~18GHz)_2020	Temp. / Humidity	24.9°C/35%
Polarity	Vertical	Site / Test Engineer	AC1 / Kevin Ker
Test Mode	Transmit by 802.11ac-VHT40 at Channel 5190MHz	Test Voltage	120V/60Hz

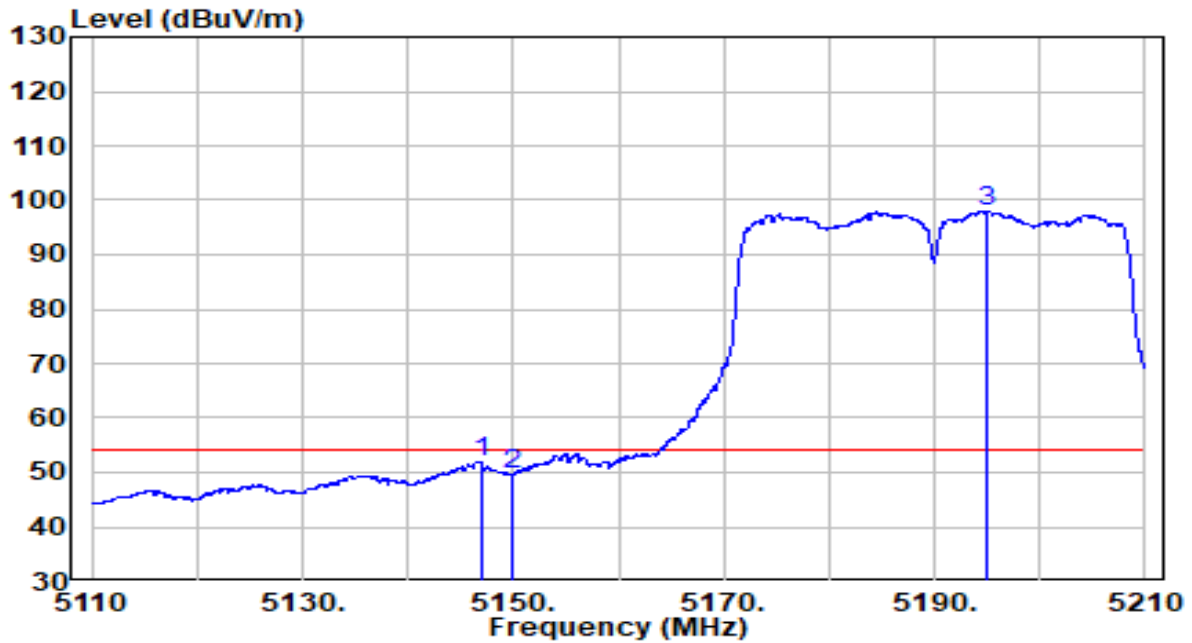

No	Frequency (MHz)	Reading (dBuV)	C.F (dB)	Measurement (dBuV/m)	Margin (dB)	Limit (dBuV/m)	Remark (QP/PK/AV)
1	5146.950	32.15	19.90	52.05	-1.95	54.00	Average
2	5150.000	29.57	19.91	49.48	-4.52	54.00	Average
3	* 5195.100	78.09	19.95	98.04	N/A	N/A	Average

Note:

1. " *", means this data is the worst emission level.
2. C.F (Correction Factor) = Antenna Factor (dB)+ Cable Loss (dB)– Preamplifier(dB)+16db attenuation.
3. Measurement(dBuV/m) = Reading(dBuV) + C.F (Correction Factor).
- 4.The emission levels of other frequencies are very lower than the limit and not show in test report.

EUT	AP311	Date of Test	2020-09-28
Factor	BBHA 9120D (1GHz~18GHz)_2020	Temp. / Humidity	24.9°C/35%
Polarity	Horizontal	Site / Test Engineer	AC1 / Kevin Ker
Test Mode	Transmit by 802.11ac-VHT40 at Channel 5230MHz	Test Voltage	120V/60Hz

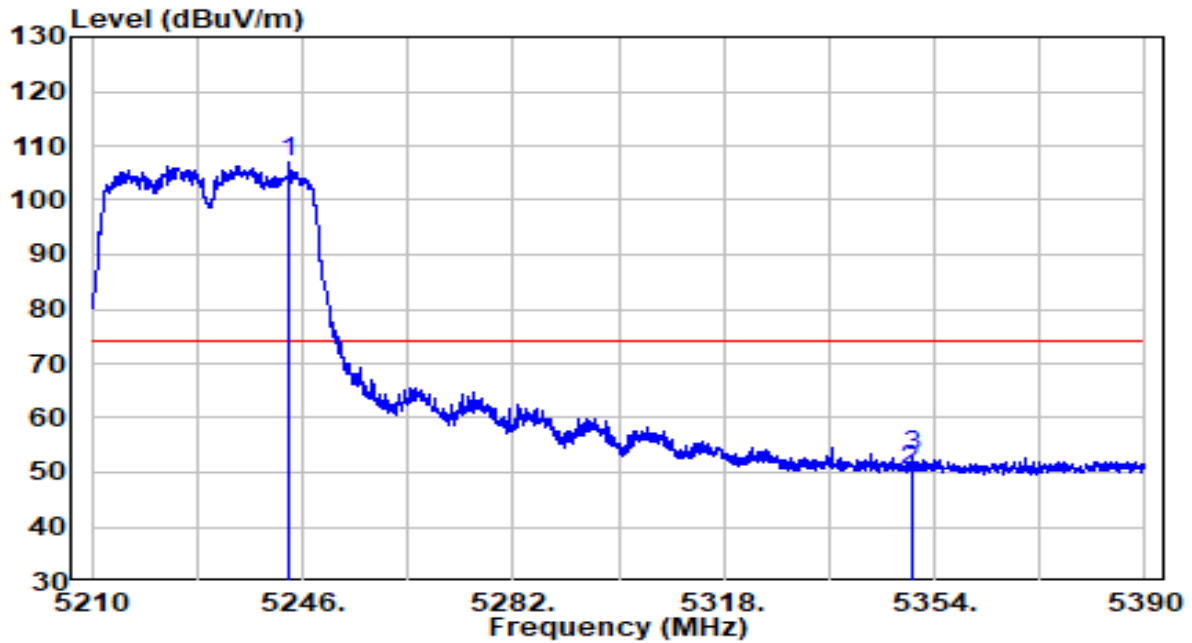

No	Frequency (MHz)	Reading (dBuV)	C.F (dB)	Measurement (dBuV/m)	Margin (dB)	Limit (dBuV/m)	Remark (QP/PK/AV)
1	* 5243.840	86.88	20.00	106.89	N/A	N/A	Peak
2	5350.000	30.26	20.11	50.38	-23.62	74.00	Peak
3	5350.400	32.83	20.11	52.94	-21.06	74.00	Peak

Note:

1. " *", means this data is the worst emission level.
2. C.F (Correction Factor) = Antenna Factor (dB)+ Cable Loss (dB)– Preamplifier(dB)+16db attenuation.
3. Measurement(dBuV/m) = Reading(dBuV) + C.F (Correction Factor).
- 4.The emission levels of other frequencies are very lower than the limit and not show in test report.

EUT	AP311	Date of Test	2020-09-28
Factor	BBHA 9120D (1GHz~18GHz)_2020	Temp. / Humidity	24.9°C/35%
Polarity	Horizontal	Site / Test Engineer	AC1 / Kevin Ker
Test Mode	Transmit by 802.11ac-VHT40 at Channel 5230MHz	Test Voltage	120V/60Hz

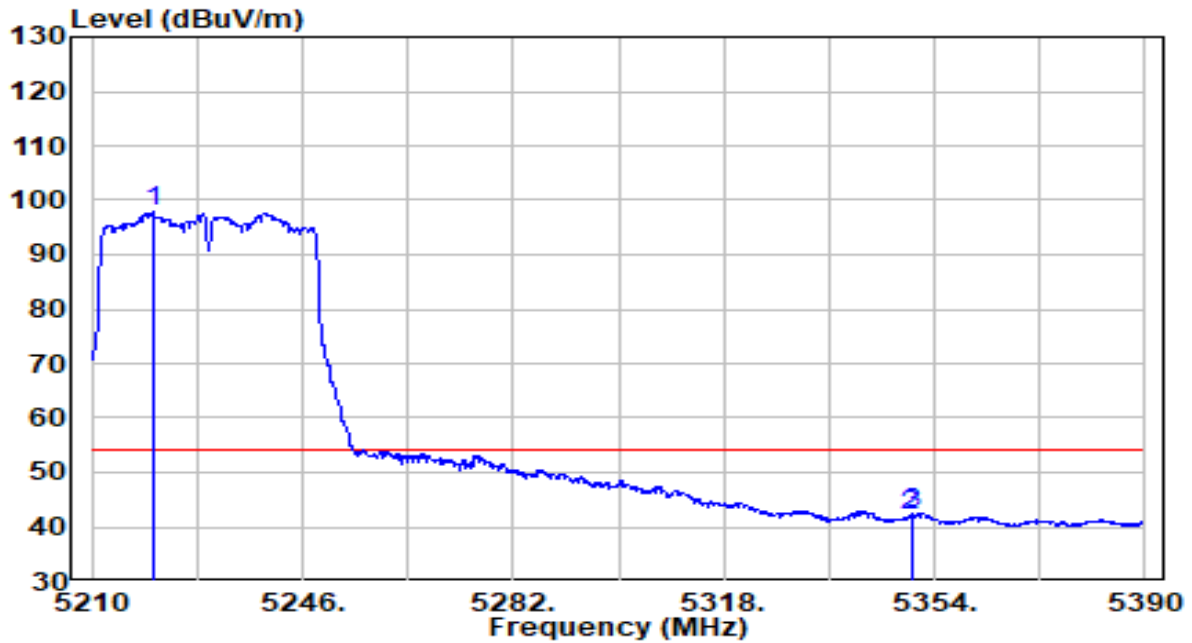

No	Frequency (MHz)	Reading (dBuV)	C.F (dB)	Measurement (dBuV/m)	Margin (dB)	Limit (dBuV/m)	Remark (QP/PK/AV)
1	* 5220.620	77.76	19.98	97.74	N/A	N/A	Average
2	5350.000	22.05	20.11	42.16	-11.84	54.00	Average
3	5350.400	22.29	20.11	42.41	-11.59	54.00	Average

Note:

1. " *", means this data is the worst emission level.
2. C.F (Correction Factor) = Antenna Factor (dB)+ Cable Loss (dB)– Preamplifier(dB)+16db attenuation.
3. Measurement(dBuV/m) = Reading(dBuV) + C.F (Correction Factor).
- 4.The emission levels of other frequencies are very lower than the limit and not show in test report.

EUT	AP311	Date of Test	2020-09-28
Factor	BBHA 9120D (1GHz~18GHz)_2020	Temp. / Humidity	24.9°C/35%
Polarity	Vertical	Site / Test Engineer	AC1 / Kevin Ker
Test Mode	Transmit by 802.11ac-VHT40 at Channel 5230MHz	Test Voltage	120V/60Hz

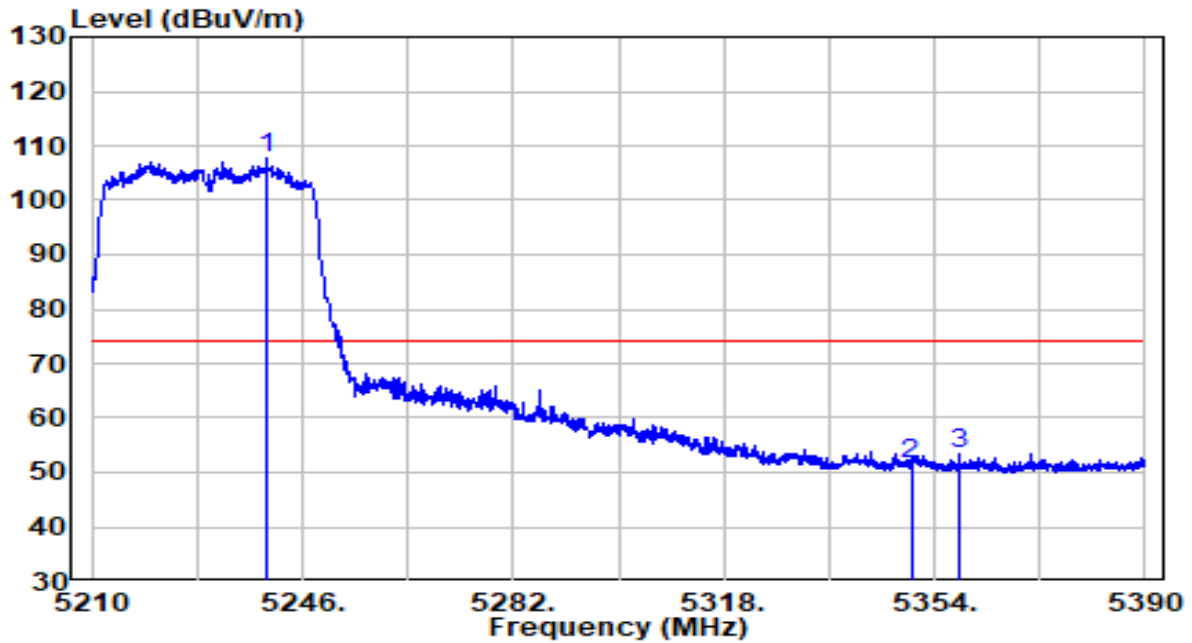

No	Frequency (MHz)	Reading (dBuV)	C.F (dB)	Measurement (dBuV/m)	Margin (dB)	Limit (dBuV/m)	Remark (QP/PK/AV)
1	* 5239.880	87.59	20.00	107.59	N/A	N/A	Peak
2	5350.000	31.23	20.11	51.34	-22.66	74.00	Peak
3	5358.320	33.25	20.12	53.37	-20.63	74.00	Peak

Note:

1. " *", means this data is the worst emission level.
2. C.F (Correction Factor) = Antenna Factor (dB)+ Cable Loss (dB)– Preamplifier(dB)+16db attenuation.
3. Measurement(dBuV/m) = Reading(dBuV) + C.F (Correction Factor).
- 4.The emission levels of other frequencies are very lower than the limit and not show in test report.

EUT	AP311	Date of Test	2020-09-28
Factor	BBHA 9120D (1GHz~18GHz)_2020	Temp. / Humidity	24.9°C/35%
Polarity	Vertical	Site / Test Engineer	AC1 / Kevin Ker
Test Mode	Transmit by 802.11ac-VHT40 at Channel 5230MHz	Test Voltage	120V/60Hz

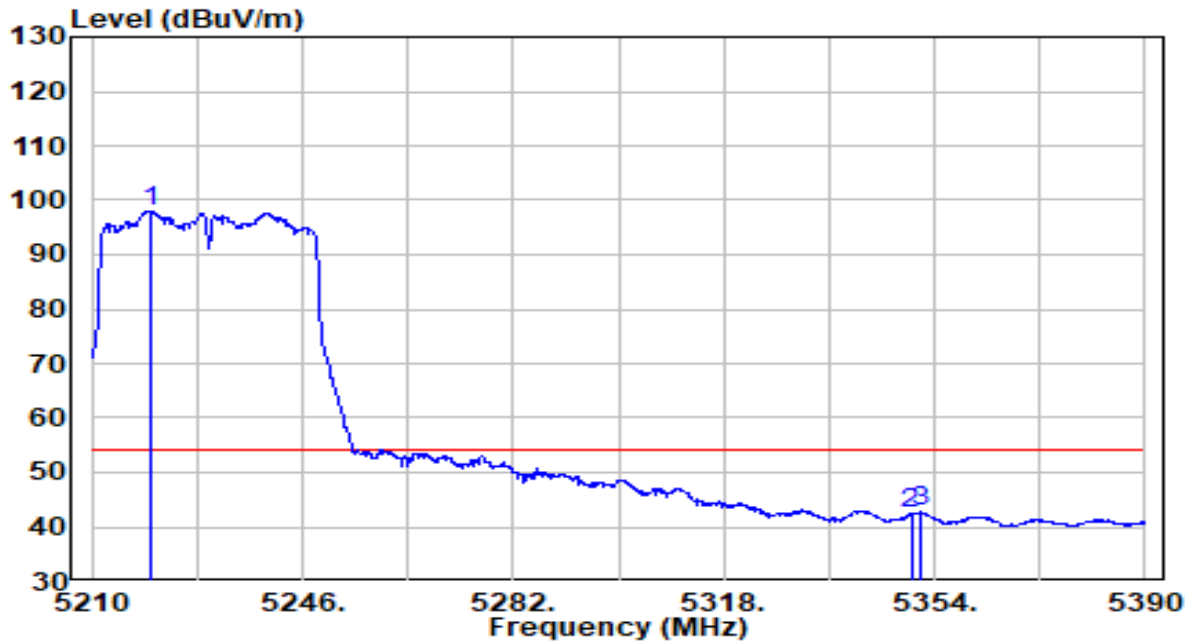

No	Frequency (MHz)	Reading (dBuV)	C.F (dB)	Measurement (dBuV/m)	Margin (dB)	Limit (dBuV/m)	Remark (QP/PK/AV)
1	* 5220.260	77.96	19.98	97.94	N/A	N/A	Average
2	5350.000	22.36	20.11	42.47	-11.53	54.00	Average
3	5351.570	22.60	20.12	42.71	-11.29	54.00	Average

Note:

1. " *", means this data is the worst emission level.
2. C.F (Correction Factor) = Antenna Factor (dB)+ Cable Loss (dB)– Preamplifier(dB)+16db attenuation.
3. Measurement(dBuV/m) = Reading(dBuV) + C.F (Correction Factor).
- 4.The emission levels of other frequencies are very lower than the limit and not show in test report.

EUT	AP311	Date of Test	2020-09-28
Factor	BBHA 9120D (1GHz~18GHz)_2020	Temp. / Humidity	24.9°C/35%
Polarity	Horizontal	Site / Test Engineer	AC1 / Kevin Ker
Test Mode	Transmit by 802.11ac-VHT40 at Channel 5310MHz	Test Voltage	120V/60Hz

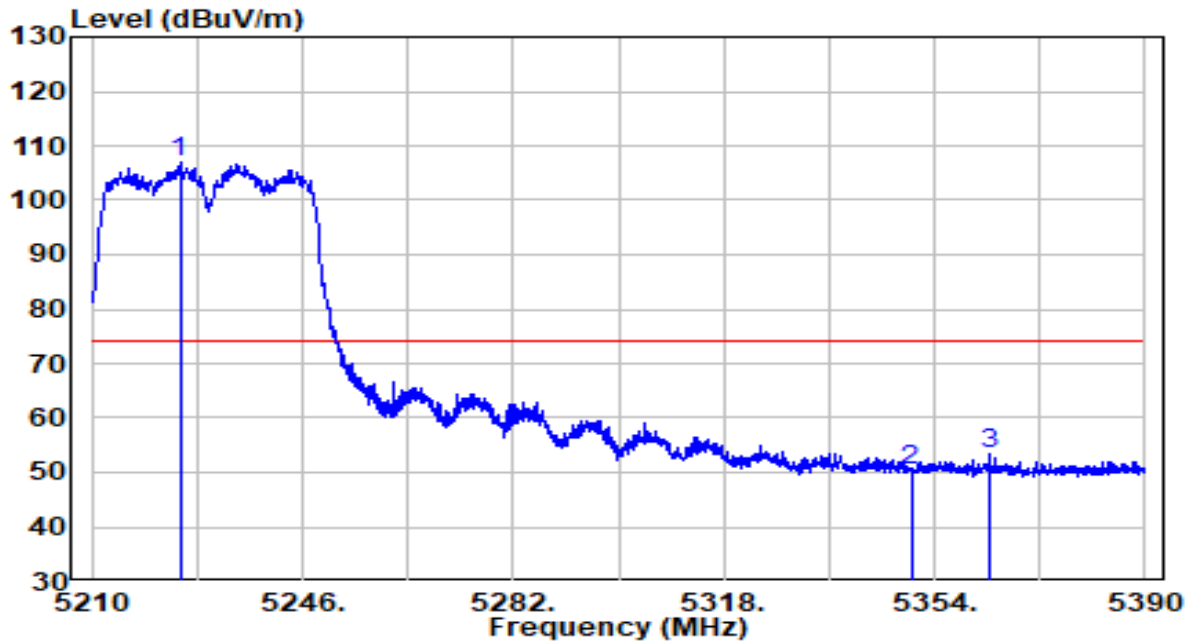

No	Frequency (MHz)	Reading (dBuV)	C.F (dB)	Measurement (dBuV/m)	Margin (dB)	Limit (dBuV/m)	Remark (QP/PK/AV)
1	* 5225.030	87.09	19.98	107.08	N/A	N/A	Peak
2	5350.000	30.13	20.11	50.24	-23.76	74.00	Peak
3	5363.540	33.40	20.13	53.53	-20.47	74.00	Peak

Note:

1. " *", means this data is the worst emission level.
2. C.F (Correction Factor) = Antenna Factor (dB)+ Cable Loss (dB)– Preamplifier(dB)+16db attenuation.
3. Measurement(dBuV/m) = Reading(dBuV) + C.F (Correction Factor).
- 4.The emission levels of other frequencies are very lower than the limit and not show in test report.

EUT	AP311	Date of Test	2020-09-28
Factor	BBHA 9120D (1GHz~18GHz)_2020	Temp. / Humidity	24.9°C/35%
Polarity	Horizontal	Site / Test Engineer	AC1 / Kevin Ker
Test Mode	Transmit by 802.11ac-VHT40 at Channel 5310MHz	Test Voltage	120V/60Hz

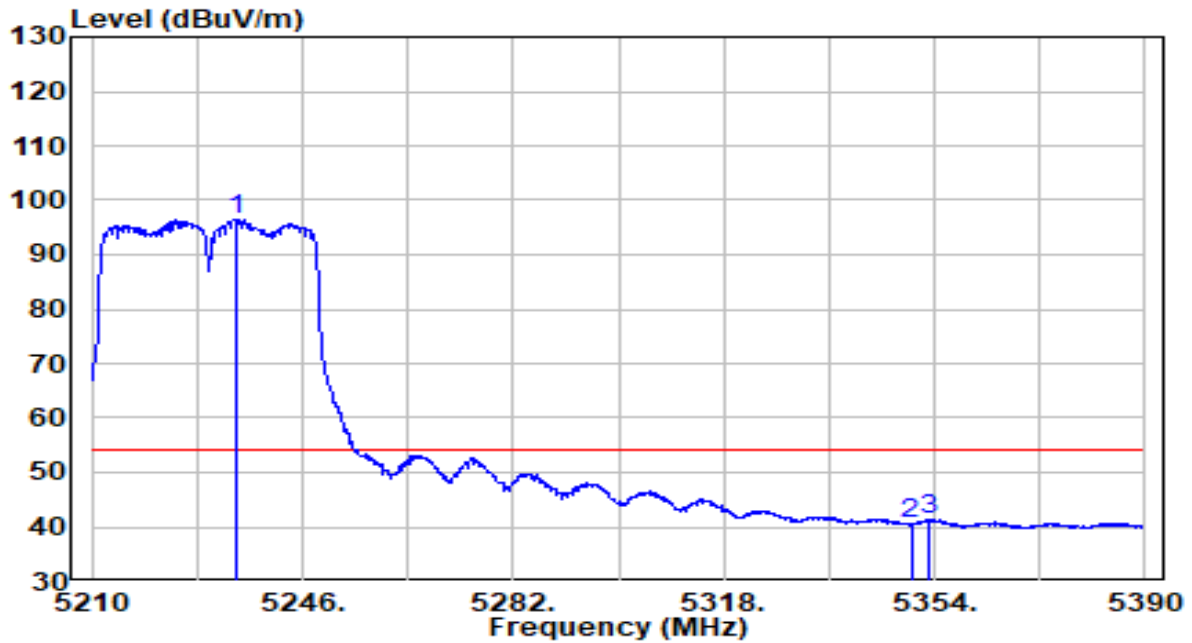

No	Frequency (MHz)	Reading (dBuV)	C.F (dB)	Measurement (dBuV/m)	Margin (dB)	Limit (dBuV/m)	Remark (QP/PK/AV)
1	* 5234.480	76.34	19.99	96.33	N/A	N/A	Average
2	5350.000	20.28	20.11	40.40	-13.60	54.00	Average
3	5353.190	21.15	20.12	41.26	-12.74	54.00	Average

Note:

1. " *", means this data is the worst emission level.
2. C.F (Correction Factor) = Antenna Factor (dB)+ Cable Loss (dB)– Preamplifier(dB)+16db attenuation.
3. Measurement(dBuV/m) = Reading(dBuV) + C.F (Correction Factor).
- 4.The emission levels of other frequencies are very lower than the limit and not show in test report.

EUT	AP311	Date of Test	2020-09-28
Factor	BBHA 9120D (1GHz~18GHz)_2020	Temp. / Humidity	24.9°C/35%
Polarity	Vertical	Site / Test Engineer	AC1 / Kevin Ker
Test Mode	Transmit by 802.11ac-VHT40 at Channel 5310MHz	Test Voltage	120V/60Hz

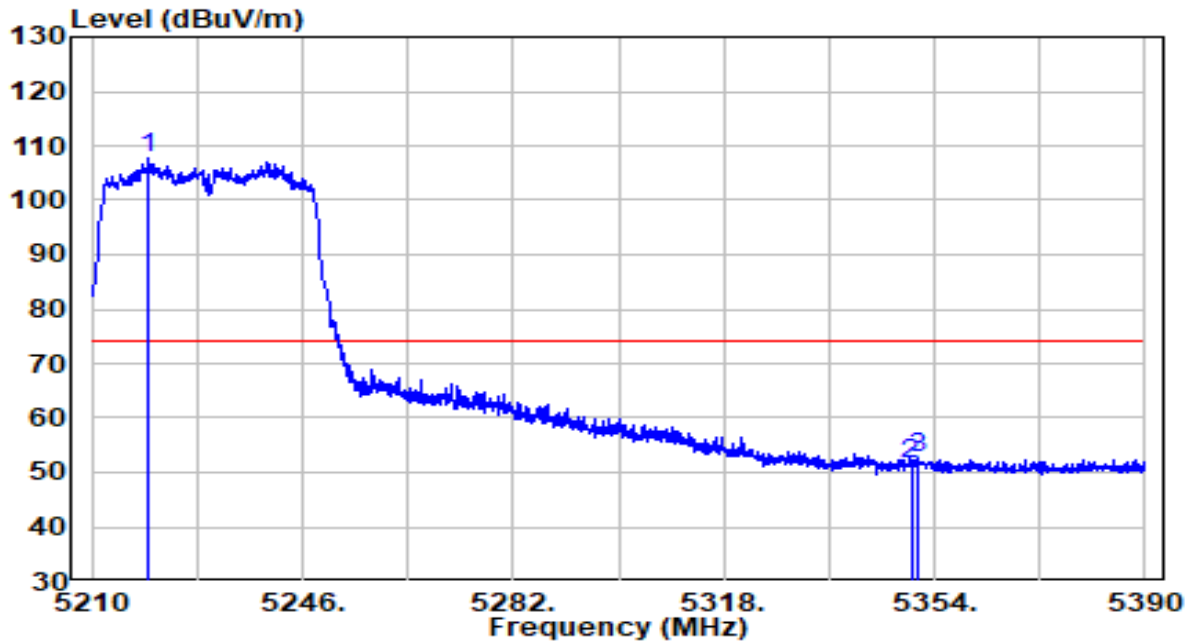

No	Frequency (MHz)	Reading (dBuV)	C.F (dB)	Measurement (dBuV/m)	Margin (dB)	Limit (dBuV/m)	Remark (QP/PK/AV)
1	* 5219.720	87.76	19.98	107.73	N/A	N/A	Peak
2	5350.000	31.42	20.11	51.54	-22.46	74.00	Peak
3	5351.030	32.42	20.12	52.53	-21.47	74.00	Peak

Note:

1. " *", means this data is the worst emission level.
2. C.F (Correction Factor) = Antenna Factor (dB)+ Cable Loss (dB)– Preamplifier(dB)+16db attenuation.
3. Measurement(dBuV/m) = Reading(dBuV) + C.F (Correction Factor).
- 4.The emission levels of other frequencies are very lower than the limit and not show in test report.

EUT	AP311	Date of Test	2020-09-28
Factor	BBHA 9120D (1GHz~18GHz)_2020	Temp. / Humidity	24.9°C/35%
Polarity	Vertical	Site / Test Engineer	AC1 / Kevin Ker
Test Mode	Transmit by 802.11ac-VHT40 at Channel 5310MHz	Test Voltage	120V/60Hz

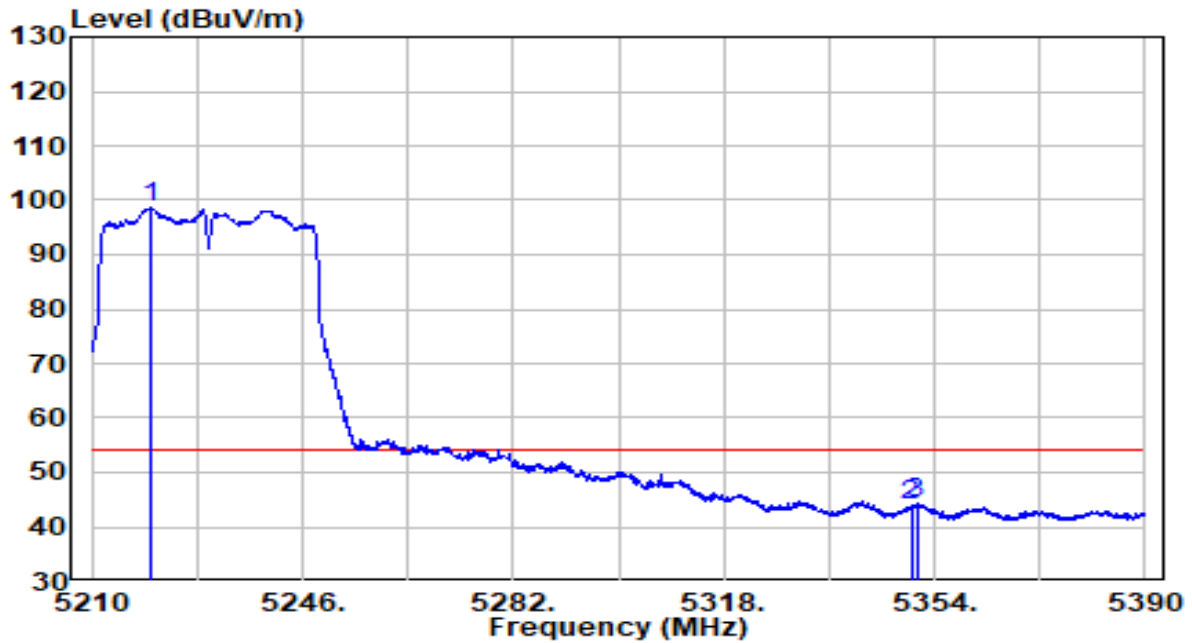

No	Frequency (MHz)	Reading (dBuV)	C.F (dB)	Measurement (dBuV/m)	Margin (dB)	Limit (dBuV/m)	Remark (QP/PK/AV)
1	* 5219.900	78.68	19.98	98.65	N/A	N/A	Average
2	5350.000	23.77	20.11	43.88	-10.12	54.00	Average
3	5350.940	24.07	20.11	44.19	-9.81	54.00	Average

Note:

1. " *", means this data is the worst emission level.
2. C.F (Correction Factor) = Antenna Factor (dB)+ Cable Loss (dB)– Preamplifier(dB)+16db attenuation.
3. Measurement(dBuV/m) = Reading(dBuV) + C.F (Correction Factor).
- 4.The emission levels of other frequencies are very lower than the limit and not show in test report.

EUT	AP311	Date of Test	2020-09-28
Factor	BBHA 9120D (1GHz~18GHz)_2020	Temp. / Humidity	24.9°C/35%
Polarity	Horizontal	Site / Test Engineer	AC1 / Kevin Ker
Test Mode	Transmit by 802.11ac-VHT40 at Channel 5510MHz	Test Voltage	120V/60Hz

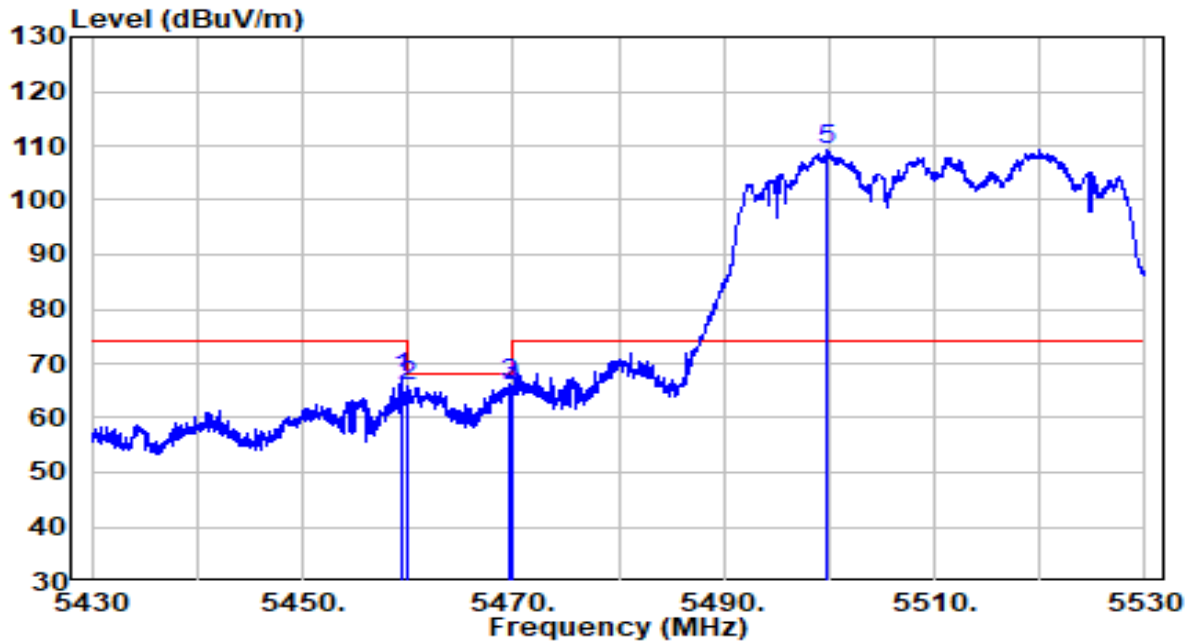

No	Frequency (MHz)	Reading (dBuV)	C.F (dB)	Measurement (dBuV/m)	Margin (dB)	Limit (dBuV/m)	Remark (QP/PK/AV)
1	5459.550	47.10	20.23	67.33	-6.67	74.00	Peak
2	5460.000	45.75	20.23	65.97	-2.23	68.20	Peak
3	5469.550	46.02	20.24	66.26	-1.94	68.20	Peak
4	5470.000	44.91	20.24	65.15	-3.05	68.20	Peak
5	* 5499.900	89.12	20.27	109.39	N/A	N/A	Peak

Note:

1. " *", means this data is the worst emission level.
2. C.F (Correction Factor) = Antenna Factor (dB)+ Cable Loss (dB)– Preamplifier(dB)+16db attenuation.
3. Measurement(dBuV/m) = Reading(dBuV) + C.F (Correction Factor).
- 4.The emission levels of other frequencies are very lower than the limit and not show in test report.

EUT	AP311	Date of Test	2020-09-28
Factor	BBHA 9120D (1GHz~18GHz)_2020	Temp. / Humidity	24.9°C/35%
Polarity	Horizontal	Site / Test Engineer	AC1 / Kevin Ker
Test Mode	Transmit by 802.11ac-VHT40 at Channel 5510MHz	Test Voltage	120V/60Hz

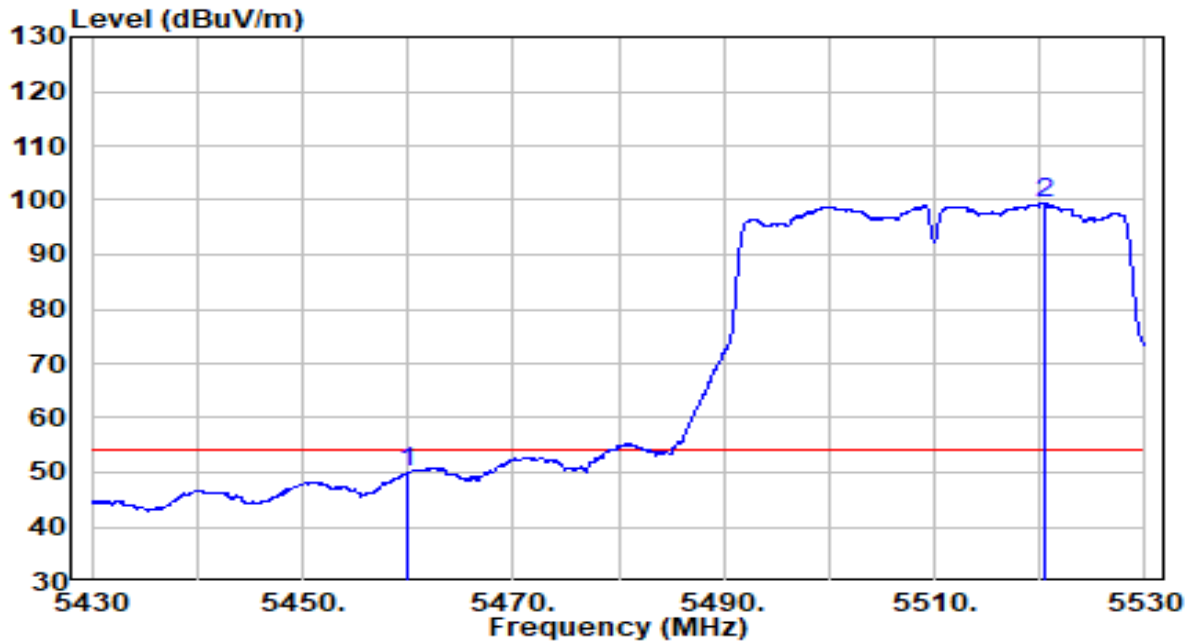

No	Frequency (MHz)	Reading (dBuV)	C.F (dB)	Measurement (dBuV/m)	Margin (dB)	Limit (dBuV/m)	Remark (QP/PK/AV)
1	5460.000	29.75	20.23	49.98	-4.02	54.00	Average
2	* 5520.550	79.12	20.34	99.46	N/A	N/A	Average

Note:

1. " *", means this data is the worst emission level.
2. C.F (Correction Factor) = Antenna Factor (dB)+ Cable Loss (dB)– Preamplifier(dB)+16db attenuation.
3. Measurement(dBuV/m) = Reading(dBuV) + C.F (Correction Factor).
- 4.The emission levels of other frequencies are very lower than the limit and not show in test report.

EUT	AP311	Date of Test	2020-09-28
Factor	BBHA 9120D (1GHz~18GHz)_2020	Temp. / Humidity	24.9°C/35%
Polarity	Vertical	Site / Test Engineer	AC1 / Kevin Ker
Test Mode	Transmit by 802.11ac-VHT40 at Channel 5510MHz	Test Voltage	120V/60Hz

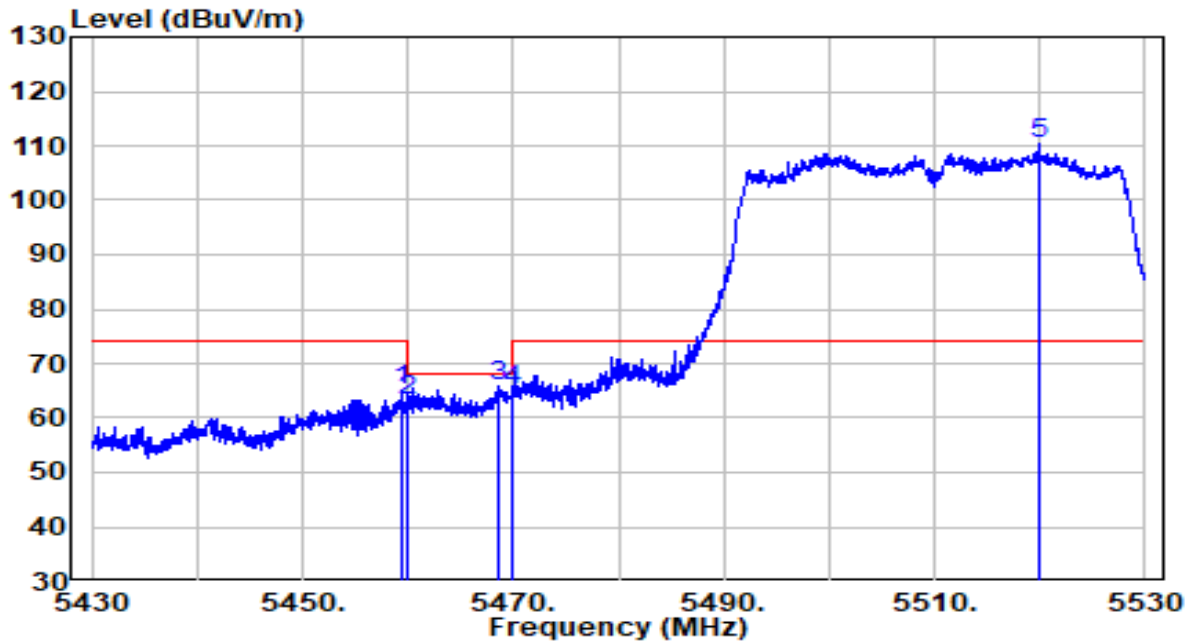

No	Frequency (MHz)	Reading (dBuV)	C.F (dB)	Measurement (dBuV/m)	Margin (dB)	Limit (dBuV/m)	Remark (QP/PK/AV)
1	5459.500	45.00	20.23	65.23	-8.77	74.00	Peak
2	5460.000	42.84	20.23	63.07	-5.13	68.20	Peak
3	5468.550	45.56	20.24	65.80	-2.40	68.20	Peak
4	5470.000	44.84	20.24	65.08	-3.12	68.20	Peak
5	* 5519.850	89.93	20.33	110.27	N/A	N/A	Peak

Note:

1. " *", means this data is the worst emission level.
2. C.F (Correction Factor) = Antenna Factor (dB)+ Cable Loss (dB)– Preamplifier(dB)+16db attenuation.
3. Measurement(dBuV/m) = Reading(dBuV) + C.F (Correction Factor).
- 4.The emission levels of other frequencies are very lower than the limit and not show in test report.

EUT	AP311	Date of Test	2020-09-28
Factor	BBHA 9120D (1GHz~18GHz)_2020	Temp. / Humidity	24.9°C/35%
Polarity	Vertical	Site / Test Engineer	AC1 / Kevin Ker
Test Mode	Transmit by 802.11ac-VHT40 at Channel 5510MHz	Test Voltage	120V/60Hz

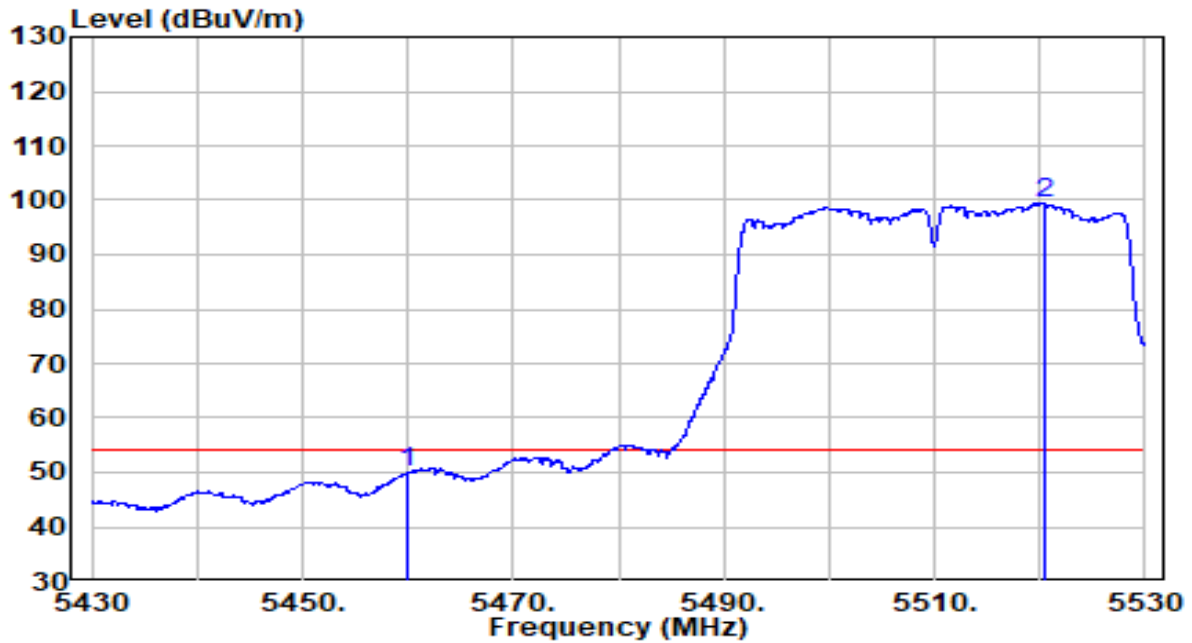

No	Frequency (MHz)	Reading (dBuV)	C.F (dB)	Measurement (dBuV/m)	Margin (dB)	Limit (dBuV/m)	Remark (QP/PK/AV)
1	5460.000	29.62	20.23	49.85	-4.15	54.00	Average
2	* 5520.400	79.11	20.34	99.44	N/A	N/A	Average

Note:

1. " *", means this data is the worst emission level.
2. C.F (Correction Factor) = Antenna Factor (dB)+ Cable Loss (dB)– Preamplifier(dB)+16db attenuation.
3. Measurement(dBuV/m) = Reading(dBuV) + C.F (Correction Factor).
- 4.The emission levels of other frequencies are very lower than the limit and not show in test report.

EUT	AP311	Date of Test	2020-09-28
Factor	BBHA 9120D (1GHz~18GHz)_2020	Temp. / Humidity	24.9°C/35%
Polarity	Horizontal	Site / Test Engineer	AC1 / Kevin Ker
Test Mode	Transmit by 802.11ac-VHT40 at Channel 5670MHz	Test Voltage	120V/60Hz

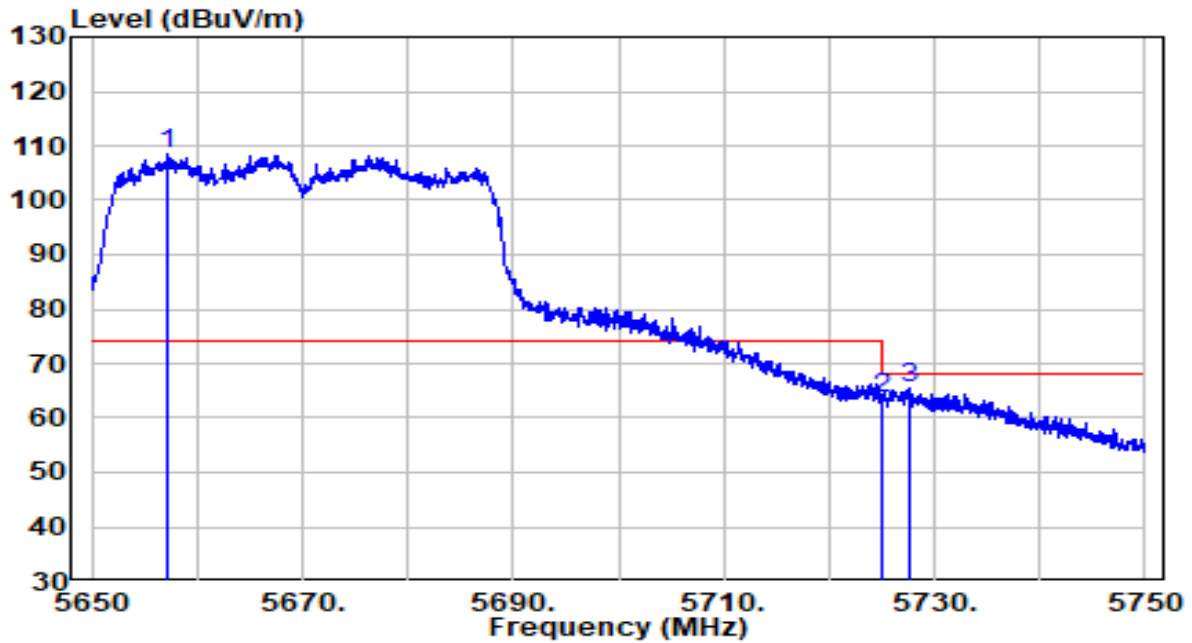

No	Frequency (MHz)	Reading (dBuV)	C.F (dB)	Measurement (dBuV/m)	Margin (dB)	Limit (dBuV/m)	Remark (QP/PK/AV)
1	* 5657.250	87.80	20.78	108.58	N/A	N/A	Peak
2	5725.000	42.58	21.00	63.58	-4.62	68.20	Peak
3	5727.750	44.47	21.01	65.48	-2.72	68.20	Peak

Note:

1. " *", means this data is the worst emission level.
2. C.F (Correction Factor) = Antenna Factor (dB)+ Cable Loss (dB)– Preamplifier(dB)+16db attenuation.
3. Measurement(dBuV/m) = Reading(dBuV) + C.F (Correction Factor).
- 4.The emission levels of other frequencies are very lower than the limit and not show in test report.

EUT	AP311	Date of Test	2020-09-28
Factor	BBHA 9120D (1GHz~18GHz)_2020	Temp. / Humidity	24.9°C/35%
Polarity	Vertical	Site / Test Engineer	AC1 / Kevin Ker
Test Mode	Transmit by 802.11ac-VHT40 at Channel 5670MHz	Test Voltage	120V/60Hz

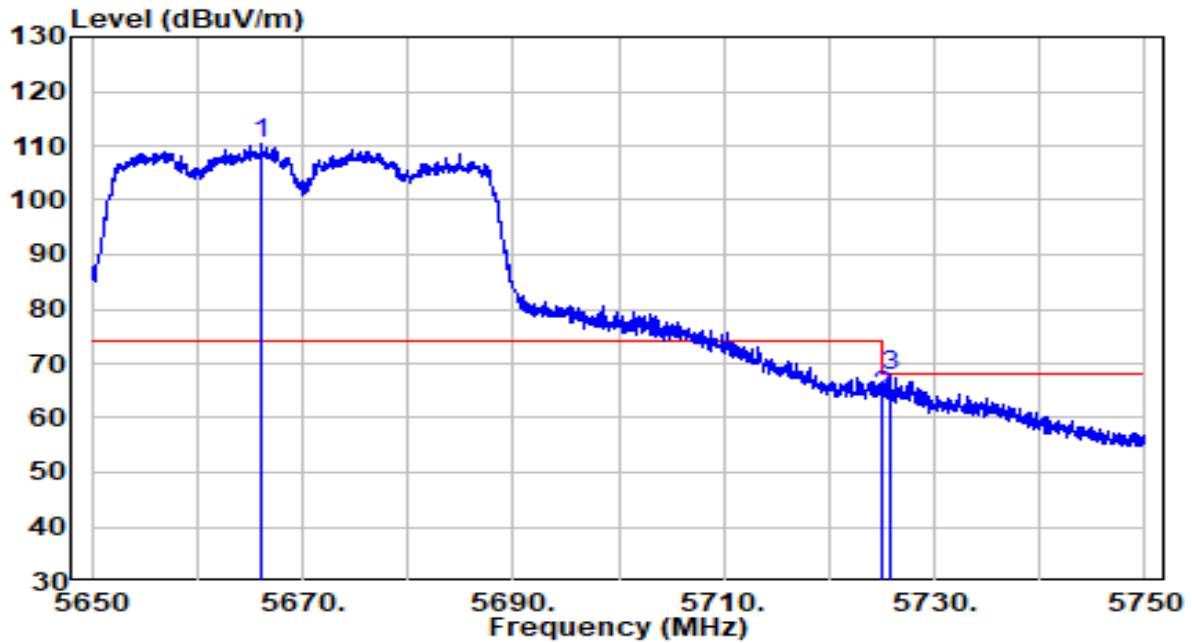

No	Frequency (MHz)	Reading (dBuV)	C.F (dB)	Measurement (dBuV/m)	Margin (dB)	Limit (dBuV/m)	Remark (QP/PK/AV)
1	* 5666.050	89.65	20.81	110.46	N/A	N/A	Peak
2	5725.000	42.93	21.00	63.93	-4.27	68.20	Peak
3	5725.900	46.72	21.00	67.72	-0.48	68.20	Peak

Note:

1. " *", means this data is the worst emission level.
2. C.F (Correction Factor) = Antenna Factor (dB)+ Cable Loss (dB)– Preamplifier(dB)+16db attenuation.
3. Measurement(dBuV/m) = Reading(dBuV) + C.F (Correction Factor).
- 4.The emission levels of other frequencies are very lower than the limit and not show in test report.

EUT	AP311	Date of Test	2020-09-28
Factor	BBHA 9120D (1GHz~18GHz)_2020	Temp. / Humidity	24.9°C/35%
Polarity	Horizontal	Site / Test Engineer	AC1 / Kevin Ker
Test Mode	Transmit by 802.11ac-VHT40 at Channel 5755MHz	Test Voltage	120V/60Hz

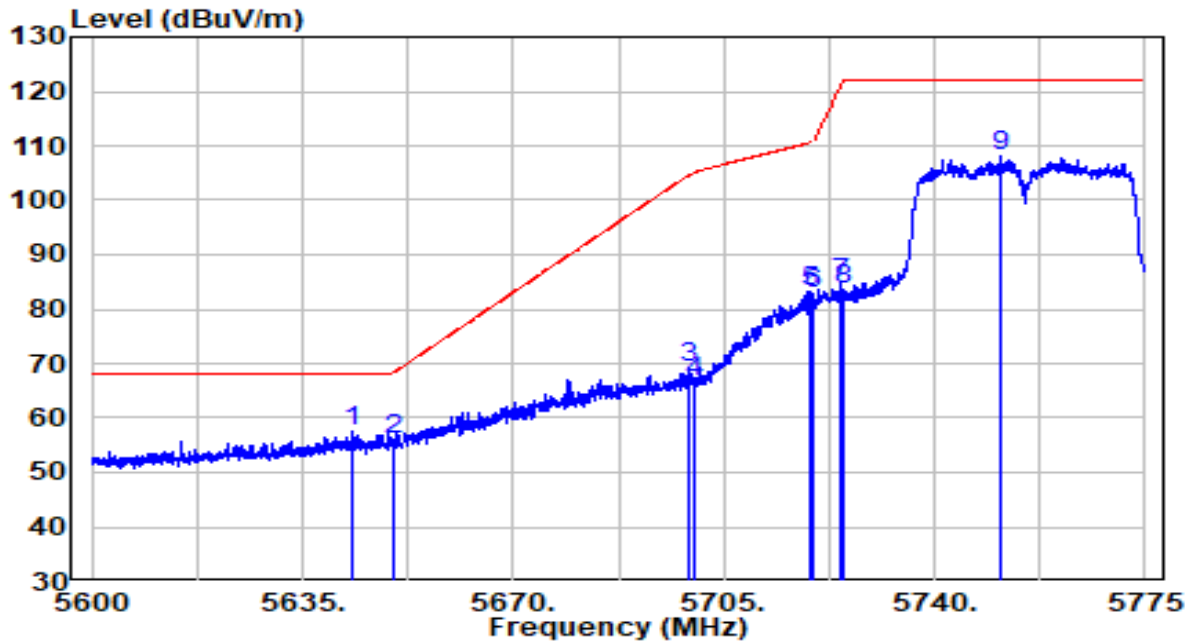

No	Frequency (MHz)	Reading (dBuV)	C.F (dB)	Measurement (dBuV/m)	Margin (dB)	Limit (dBuV/m)	Remark (QP/PK/AV)
1	* 5643.138	36.85	20.73	57.59	-10.61	68.20	Peak
2	5650.000	35.38	20.76	56.14	-12.06	68.20	Peak
3	5699.050	48.21	20.91	69.13	-35.37	104.50	Peak
4	5700.000	45.52	20.92	66.44	-38.76	105.20	Peak
5	5719.175	62.42	20.98	83.40	-27.17	110.57	Peak
6	5720.000	61.91	20.98	82.90	-27.90	110.80	Peak
7	5724.513	63.65	21.00	84.65	-36.44	121.09	Peak
8	5725.000	62.61	21.00	83.61	-38.59	122.20	Peak
9	5751.112	87.00	21.08	108.09	N/A	N/A	Peak

Note:

1. " *", means this data is the worst emission level.
2. C.F (Correction Factor) = Antenna Factor (dB)+ Cable Loss (dB)– Preamplifier(dB)+16db attenuation.
3. Measurement(dBuV/m) = Reading(dBuV) + C.F (Correction Factor).
- 4.The emission levels of other frequencies are very lower than the limit and not show in test report.

EUT	AP311	Date of Test	2020-09-28
Factor	BBHA 9120D (1GHz~18GHz)_2020	Temp. / Humidity	24.9°C/35%
Polarity	Vertical	Site / Test Engineer	AC1 / Kevin Ker
Test Mode	Transmit by 802.11ac-VHT40 at Channel 5755MHz	Test Voltage	120V/60Hz

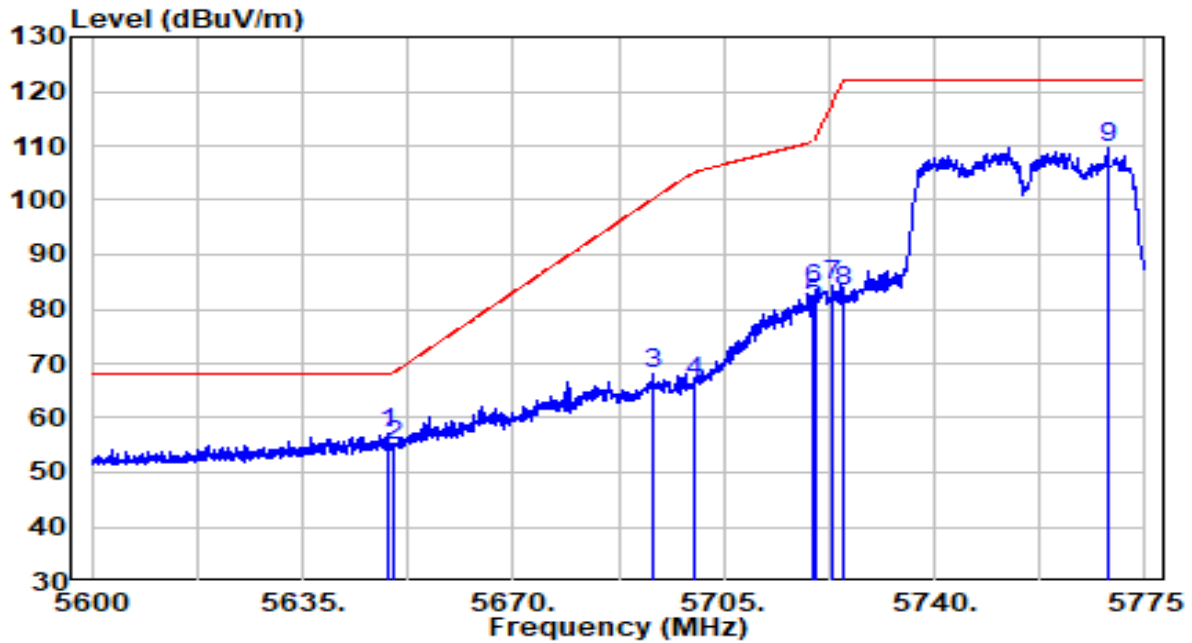

No	Frequency (MHz)	Reading (dBuV)	C.F (dB)	Measurement (dBuV/m)	Margin (dB)	Limit (dBuV/m)	Remark (QP/PK/AV)
1	* 5649.175	36.29	20.75	57.05	-11.15	68.20	Peak
2	5650.000	34.03	20.76	54.79	-13.41	68.20	Peak
3	5693.100	47.09	20.90	67.98	-32.13	100.11	Peak
4	5700.000	45.68	20.92	66.60	-38.60	105.20	Peak
5	5720.000	59.84	20.98	80.83	-29.97	110.80	Peak
6	5720.050	62.67	20.98	83.65	-27.26	110.91	Peak
7	5723.200	63.34	20.99	84.34	-33.76	118.10	Peak
8	5725.000	62.26	21.00	83.26	-38.94	122.20	Peak
9	5768.962	88.43	21.14	109.57	N/A	N/A	Peak

Note:

1. " *", means this data is the worst emission level.
2. C.F (Correction Factor) = Antenna Factor (dB)+ Cable Loss (dB)– Preamplifier(dB)+16db attenuation.
3. Measurement(dBuV/m) = Reading(dBuV) + C.F (Correction Factor).
- 4.The emission levels of other frequencies are very lower than the limit and not show in test report.

EUT	AP311	Date of Test	2020-09-28
Factor	BBHA 9120D (1GHz~18GHz)_2020	Temp. / Humidity	24.9°C/35%
Polarity	Horizontal	Site / Test Engineer	AC1 / Kevin Ker
Test Mode	Transmit by 802.11ac-VHT40 at Channel 5795MHz	Test Voltage	120V/60Hz

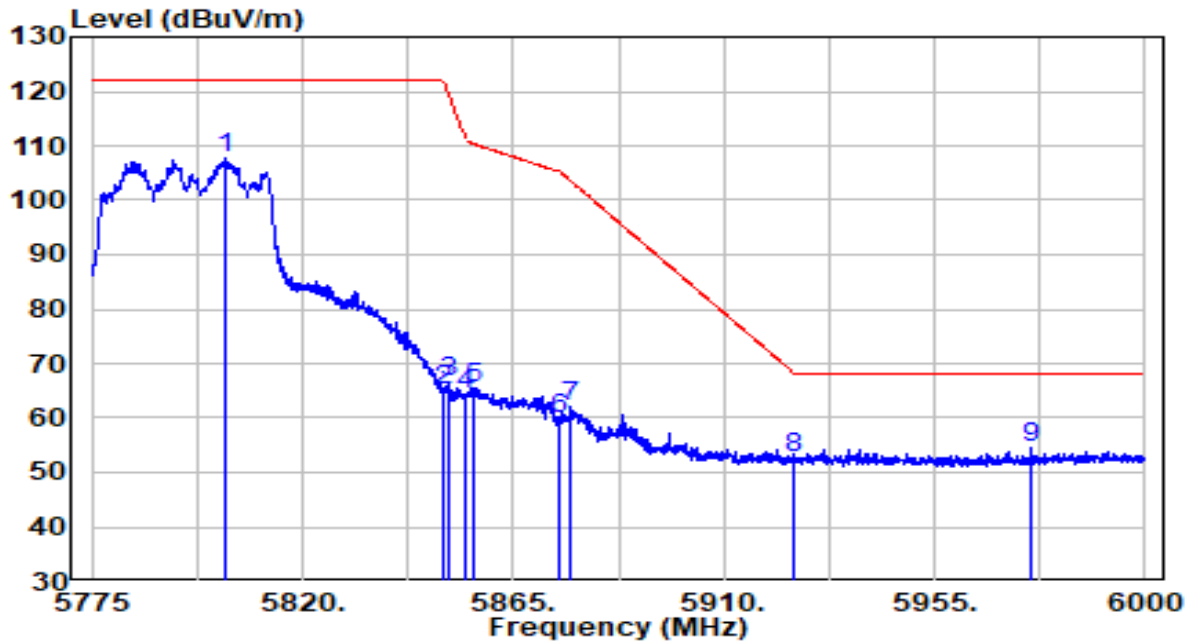

No	Frequency (MHz)	Reading (dBuV)	C.F (dB)	Measurement (dBuV/m)	Margin (dB)	Limit (dBuV/m)	Remark (QP/PK/AV)
1	5803.575	86.46	21.25	107.71	N/A	N/A	Peak
2	5850.000	43.64	21.40	65.04	-57.16	122.20	Peak
3	5851.500	45.16	21.41	66.57	-52.21	118.78	Peak
4	5855.000	42.99	21.42	64.41	-46.39	110.80	Peak
5	5856.337	44.05	21.42	65.47	-44.96	110.42	Peak
6	5875.000	38.26	21.49	59.74	-45.46	105.20	Peak
7	5877.263	40.55	21.49	62.05	-41.47	103.52	Peak
8	5925.000	31.18	21.65	52.82	-15.38	68.20	Peak
9	* 5975.475	32.60	21.81	54.41	-13.79	68.20	Peak

Note:

1. " *", means this data is the worst emission level.
2. C.F (Correction Factor) = Antenna Factor (dB)+ Cable Loss (dB)– Preamplifier(dB)+16db attenuation.
3. Measurement(dBuV/m) = Reading(dBuV) + C.F (Correction Factor).
- 4.The emission levels of other frequencies are very lower than the limit and not show in test report.

EUT	AP311	Date of Test	2020-09-28
Factor	BBHA 9120D (1GHz~18GHz)_2020	Temp. / Humidity	24.9°C/35%
Polarity	Vertical	Site / Test Engineer	AC1 / Kevin Ker
Test Mode	Transmit by 802.11ac-VHT40 at Channel 5795MHz	Test Voltage	120V/60Hz

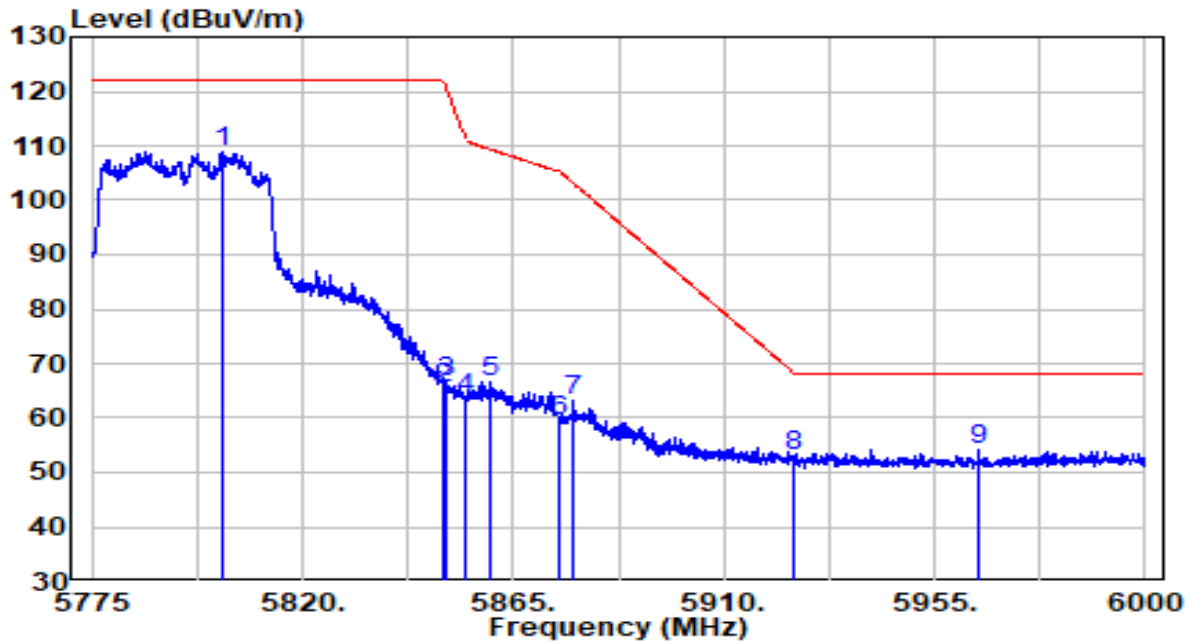

No	Frequency (MHz)	Reading (dBuV)	C.F (dB)	Measurement (dBuV/m)	Margin (dB)	Limit (dBuV/m)	Remark (QP/PK/AV)
1	* 5802.675	87.72	21.25	108.97	N/A	N/A	Peak
2	5850.000	44.24	21.40	65.64	-56.56	122.20	Peak
3	5850.938	45.09	21.41	66.49	-53.57	120.06	Peak
4	5855.000	42.10	21.42	63.52	-47.28	110.80	Peak
5	5860.050	45.11	21.44	66.55	-42.83	109.38	Peak
6	5875.000	37.87	21.49	59.35	-45.85	105.20	Peak
7	5877.938	41.74	21.49	63.23	-39.79	103.02	Peak
8	5925.000	31.42	21.65	53.07	-15.13	68.20	Peak
9	5964.450	32.47	21.77	54.25	-13.95	68.20	Peak

Note:

1. " *", means this data is the worst emission level.
2. C.F (Correction Factor) = Antenna Factor (dB)+ Cable Loss (dB)– Preamplifier(dB)+16db attenuation.
3. Measurement(dBuV/m) = Reading(dBuV) + C.F (Correction Factor).
- 4.The emission levels of other frequencies are very lower than the limit and not show in test report.

EUT	AP311	Date of Test	2020-09-28
Factor	BBHA 9120D (1GHz~18GHz)_2020	Temp. / Humidity	24.9°C/35%
Polarity	Horizontal	Site / Test Engineer	AC1 / Kevin Ker
Test Mode	Transmit by 802.11ac-VHT80 at Channel 5210MHz	Test Voltage	120V/60Hz

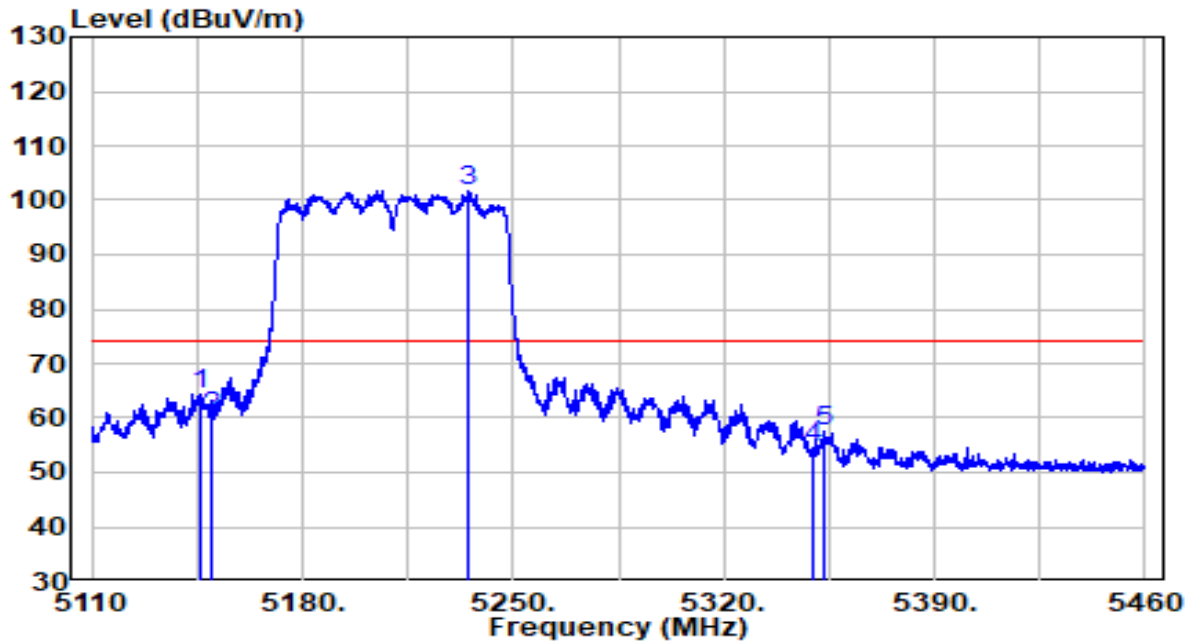

No	Frequency (MHz)	Reading (dBuV)	C.F (dB)	Measurement (dBuV/m)	Margin (dB)	Limit (dBuV/m)	Remark (QP/PK/AV)
1	5145.700	44.48	19.90	64.38	-9.62	74.00	Peak
2	5150.000	40.30	19.91	60.21	-13.79	74.00	Peak
3	* 5235.300	81.81	19.99	101.81	N/A	N/A	Peak
4	5350.000	34.57	20.11	54.68	-19.32	74.00	Peak
5	5353.250	37.26	20.12	57.38	-16.62	74.00	Peak

Note:

1. " *", means this data is the worst emission level.
2. C.F (Correction Factor) = Antenna Factor (dB)+ Cable Loss (dB)– Preamplifier(dB)+16db attenuation.
3. Measurement(dBuV/m) = Reading(dBuV) + C.F (Correction Factor).
- 4.The emission levels of other frequencies are very lower than the limit and not show in test report.

EUT	AP311	Date of Test	2020-09-28
Factor	BBHA 9120D (1GHz~18GHz)_2020	Temp. / Humidity	24.9°C/35%
Polarity	Horizontal	Site / Test Engineer	AC1 / Kevin Ker
Test Mode	Transmit by 802.11ac-VHT80 at Channel 5210MHz	Test Voltage	120V/60Hz

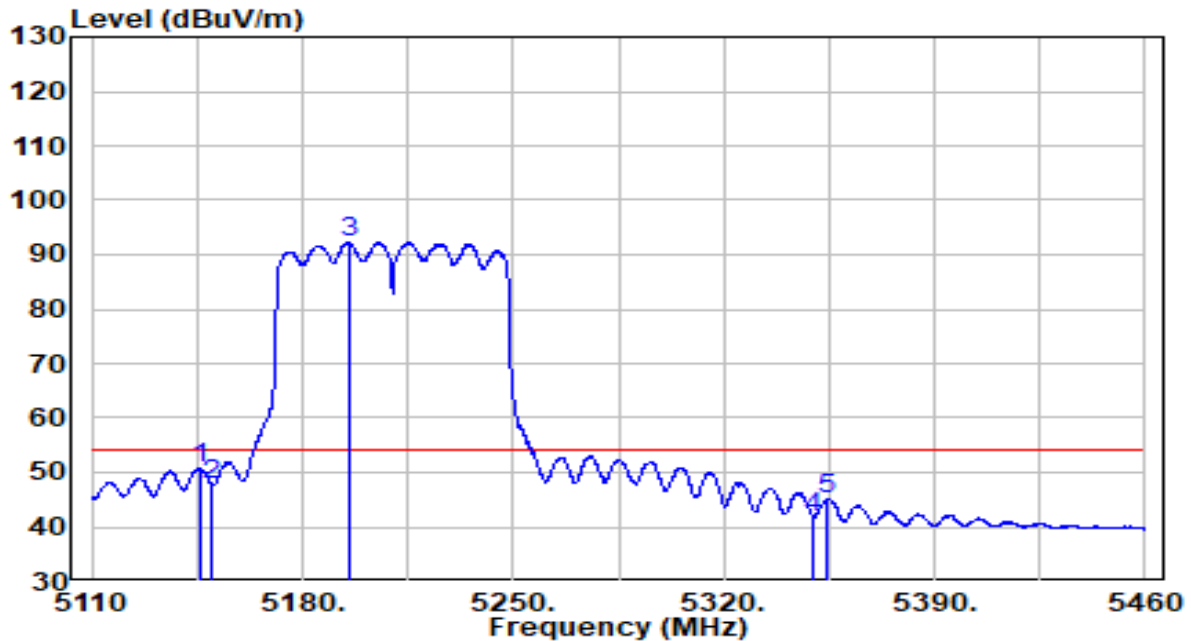

No	Frequency (MHz)	Reading (dBuV)	C.F (dB)	Measurement (dBuV/m)	Margin (dB)	Limit (dBuV/m)	Remark (QP/PK/AV)
1	5145.875	30.76	19.90	50.66	-3.34	54.00	Average
2	5150.000	27.97	19.91	47.88	-6.12	54.00	Average
3	* 5195.225	72.26	19.95	92.21	N/A	N/A	Average
4	5350.000	21.70	20.11	41.82	-12.18	54.00	Average
5	5353.950	25.11	20.12	45.23	-8.77	54.00	Average

Note:

1. " *", means this data is the worst emission level.
2. C.F (Correction Factor) = Antenna Factor (dB)+ Cable Loss (dB)– Preamplifier(dB)+16db attenuation.
3. Measurement(dBuV/m) = Reading(dBuV) + C.F (Correction Factor).
- 4.The emission levels of other frequencies are very lower than the limit and not show in test report.

EUT	AP311	Date of Test	2020-09-28
Factor	BBHA 9120D (1GHz~18GHz)_2020	Temp. / Humidity	24.9°C/35%
Polarity	Vertical	Site / Test Engineer	AC1 / Kevin Ker
Test Mode	Transmit by 802.11ac-VHT80 at Channel 5210MHz	Test Voltage	120V/60Hz

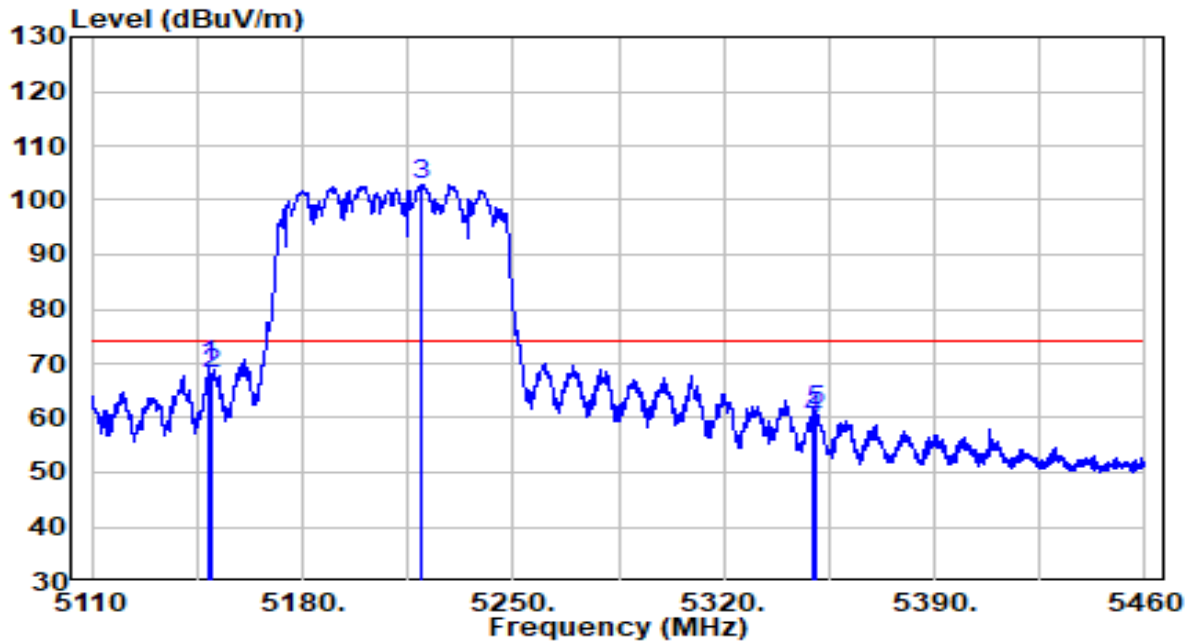

No	Frequency (MHz)	Reading (dBuV)	C.F (dB)	Measurement (dBuV/m)	Margin (dB)	Limit (dBuV/m)	Remark (QP/PK/AV)
1	5148.500	49.71	19.90	69.62	-4.38	74.00	Peak
2	5150.000	48.11	19.91	68.02	-5.98	74.00	Peak
3	* 5219.375	82.82	19.98	102.80	N/A	N/A	Peak
4	5350.000	39.86	20.11	59.97	-14.03	74.00	Peak
5	5350.450	41.28	20.11	61.39	-12.61	74.00	Peak

Note:

- "*" means this data is the worst emission level.
- C.F (Correction Factor) = Antenna Factor (dB)+ Cable Loss (dB)– Preamplifier(dB)+16db attenuation.
- Measurement(dBuV/m) = Reading(dBuV) + C.F (Correction Factor).
- The emission levels of other frequencies are very lower than the limit and not show in test report.

EUT	AP311	Date of Test	2020-09-28
Factor	BBHA 9120D (1GHz~18GHz)_2020	Temp. / Humidity	24.9°C/35%
Polarity	Vertical	Site / Test Engineer	AC1 / Kevin Ker
Test Mode	Transmit by 802.11ac-VHT80 at Channel 5210MHz	Test Voltage	120V/60Hz

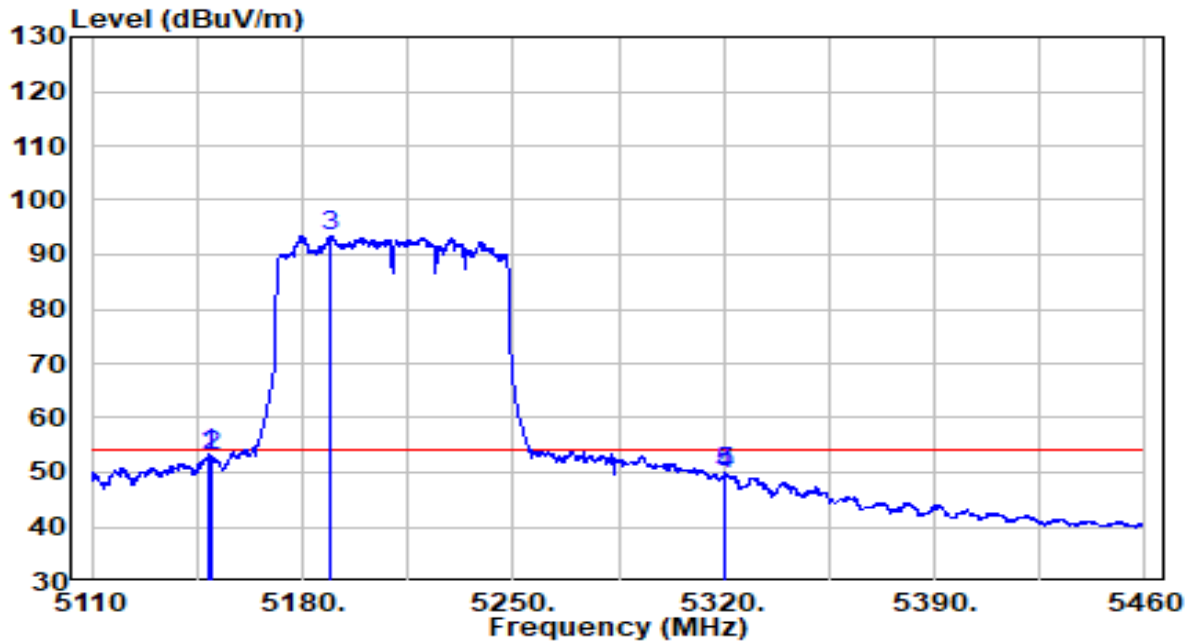

No	Frequency (MHz)	Reading (dBuV)	C.F (dB)	Measurement (dBuV/m)	Margin (dB)	Limit (dBuV/m)	Remark (QP/PK/AV)
1	5149.200	33.47	19.91	53.38	-0.62	54.00	Average
2	5150.000	33.06	19.91	52.97	-1.03	54.00	Average
3	* 5189.450	73.55	19.95	93.50	N/A	N/A	Average
4	5320.000	29.41	20.08	49.49	-4.51	54.00	Average
5	5320.350	29.76	20.08	49.85	-4.15	54.00	Average

Note:

1. " *", means this data is the worst emission level.
2. C.F (Correction Factor) = Antenna Factor (dB)+ Cable Loss (dB)– Preamplifier(dB)+16db attenuation.
3. Measurement(dBuV/m) = Reading(dBuV) + C.F (Correction Factor).
- 4.The emission levels of other frequencies are very lower than the limit and not show in test report.

EUT	AP311	Date of Test	2020-09-28
Factor	BBHA 9120D (1GHz~18GHz)_2020	Temp. / Humidity	24.9°C/35%
Polarity	Horizontal	Site / Test Engineer	AC1 / Kevin Ker
Test Mode	Transmit by 802.11ac-VHT80 at Channel 5290MHz	Test Voltage	120V/60Hz

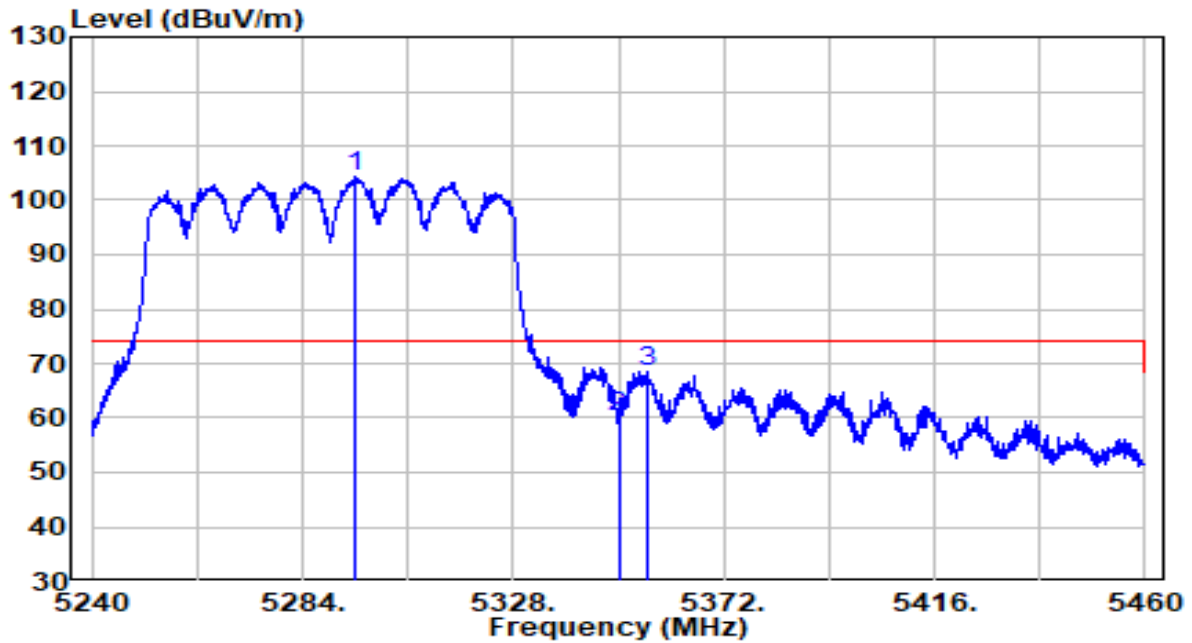

No	Frequency (MHz)	Reading (dBuV)	C.F (dB)	Measurement (dBuV/m)	Margin (dB)	Limit (dBuV/m)	Remark (QP/PK/AV)
1	* 5295.220	84.43	20.06	104.49	N/A	N/A	Peak
2	5350.000	40.23	20.11	60.34	-13.66	74.00	Peak
3	5356.050	48.42	20.12	68.54	-5.46	74.00	Peak

Note:

1. " *", means this data is the worst emission level.
2. C.F (Correction Factor) = Antenna Factor (dB)+ Cable Loss (dB)– Preamplifier(dB)+16db attenuation.
3. Measurement(dBuV/m) = Reading(dBuV) + C.F (Correction Factor).
- 4.The emission levels of other frequencies are very lower than the limit and not show in test report.

EUT	AP311	Date of Test	2020-09-28
Factor	BBHA 9120D (1GHz~18GHz)_2020	Temp. / Humidity	24.9°C/35%
Polarity	Horizontal	Site / Test Engineer	AC1 / Kevin Ker
Test Mode	Transmit by 802.11ac-VHT80 at Channel 5290MHz	Test Voltage	120V/60Hz

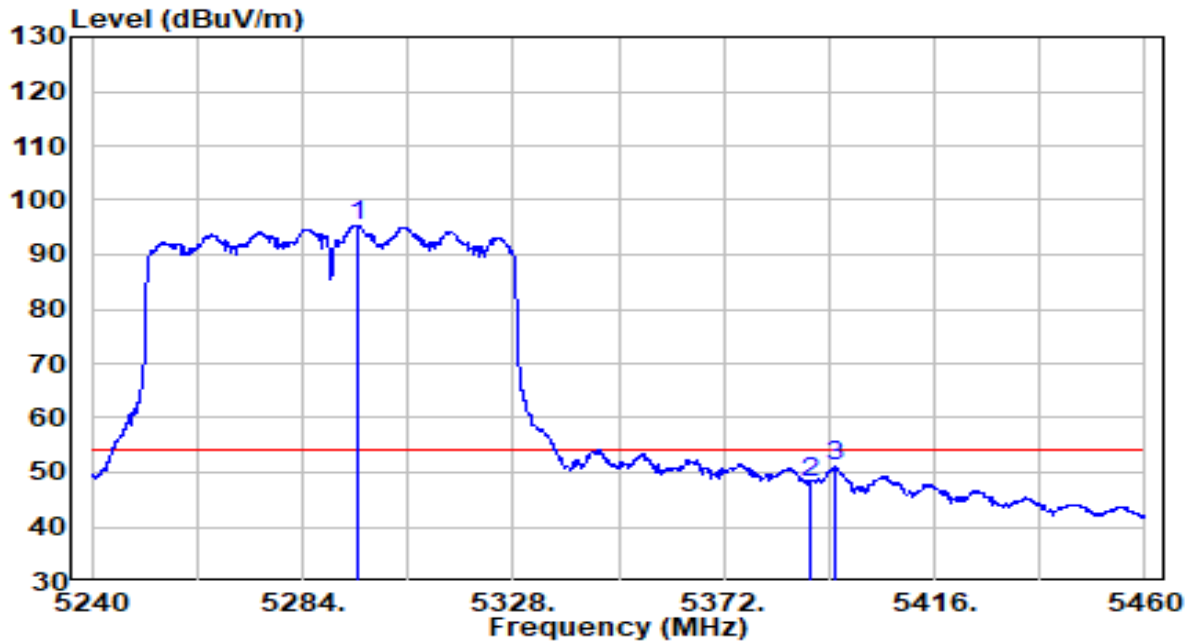

No	Frequency (MHz)	Reading (dBuV)	C.F (dB)	Measurement (dBuV/m)	Margin (dB)	Limit (dBuV/m)	Remark (QP/PK/AV)
1	* 5295.440	75.39	20.06	95.45	N/A	N/A	Average
2	5390.000	28.04	20.16	48.19	-5.81	54.00	Average
3	5394.990	30.79	20.16	50.96	-3.04	54.00	Average

Note:

1. " *", means this data is the worst emission level.
2. C.F (Correction Factor) = Antenna Factor (dB)+ Cable Loss (dB)– Preamplifier(dB)+16db attenuation.
3. Measurement(dBuV/m) = Reading(dBuV) + C.F (Correction Factor).
- 4.The emission levels of other frequencies are very lower than the limit and not show in test report.

EUT	AP311	Date of Test	2020-09-28
Factor	BBHA 9120D (1GHz~18GHz)_2020	Temp. / Humidity	24.9°C/35%
Polarity	Vertical	Site / Test Engineer	AC1 / Kevin Ker
Test Mode	Transmit by 802.11ac-VHT80 at Channel 5290MHz	Test Voltage	120V/60Hz

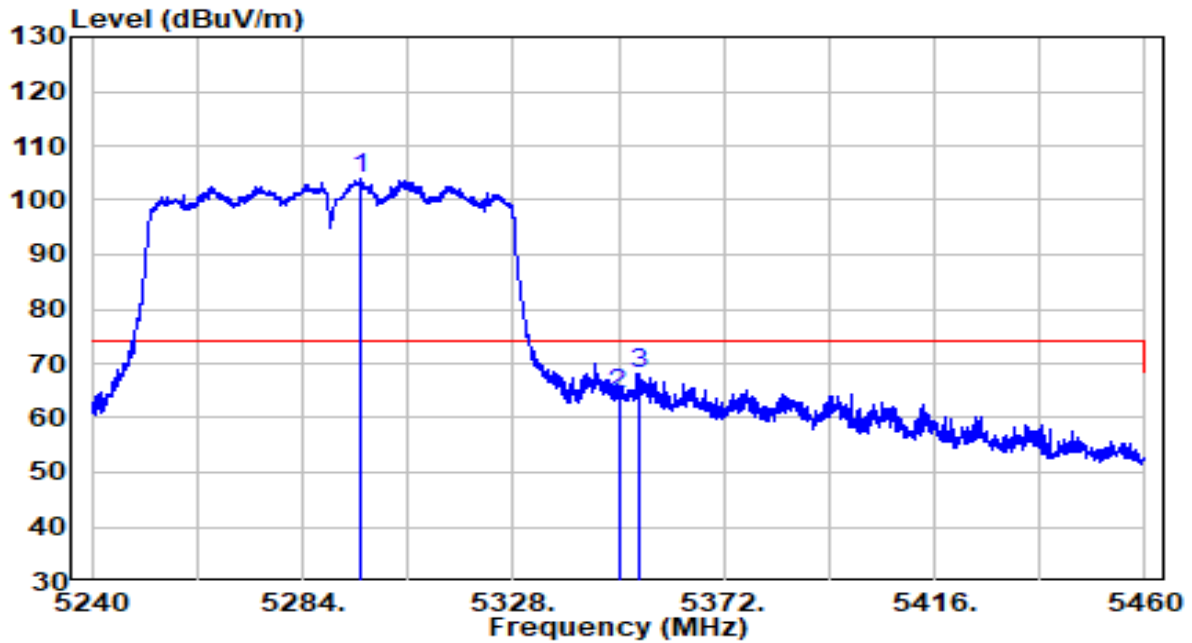

No	Frequency (MHz)	Reading (dBuV)	C.F (dB)	Measurement (dBuV/m)	Margin (dB)	Limit (dBuV/m)	Remark (QP/PK/AV)
1	* 5295.990	83.76	20.06	103.82	N/A	N/A	Peak
2	5350.000	44.34	20.11	64.45	-9.55	74.00	Peak
3	5354.070	48.08	20.12	68.20	-5.80	74.00	Peak

Note:

1. " *", means this data is the worst emission level.
2. C.F (Correction Factor) = Antenna Factor (dB)+ Cable Loss (dB)– Preamplifier(dB)+16db attenuation.
3. Measurement(dBuV/m) = Reading(dBuV) + C.F (Correction Factor).
- 4.The emission levels of other frequencies are very lower than the limit and not show in test report.

EUT	AP311	Date of Test	2020-09-28
Factor	BBHA 9120D (1GHz~18GHz)_2020	Temp. / Humidity	24.9°C/35%
Polarity	Vertical	Site / Test Engineer	AC1 / Kevin Ker
Test Mode	Transmit by 802.11ac-VHT80 at Channel 5290MHz	Test Voltage	120V/60Hz

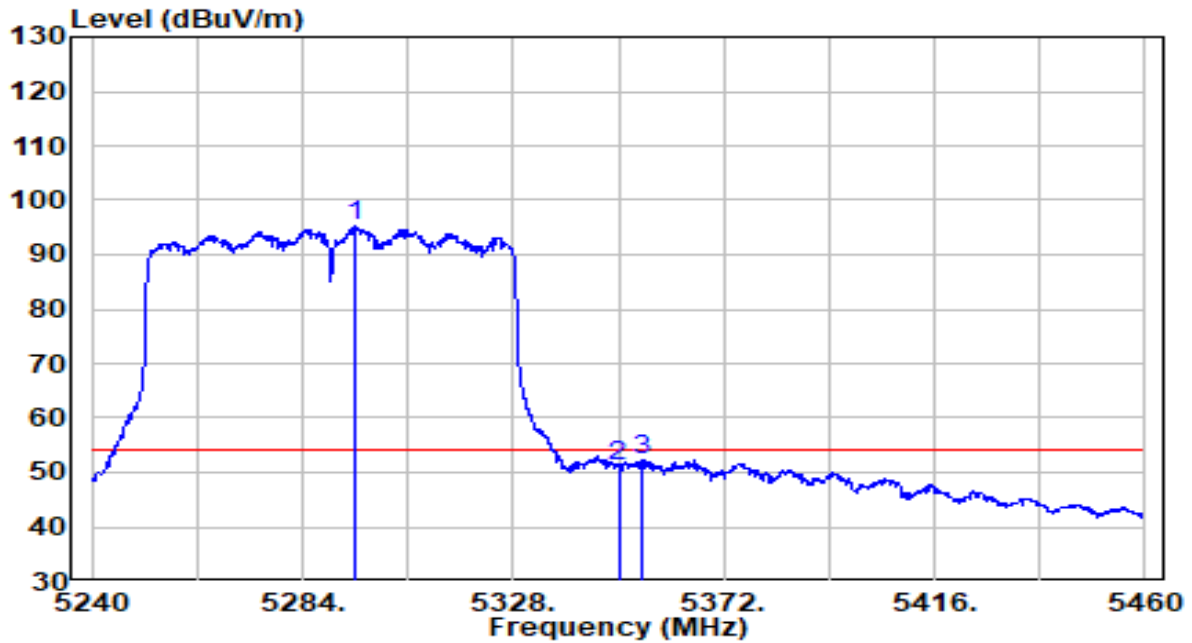

No	Frequency (MHz)	Reading (dBuV)	C.F (dB)	Measurement (dBuV/m)	Margin (dB)	Limit (dBuV/m)	Remark (QP/PK/AV)
1	* 5294.780	75.06	20.06	95.11	N/A	N/A	Average
2	5350.000	31.11	20.11	51.23	-2.77	54.00	Average
3	5354.950	32.17	20.12	52.29	-1.71	54.00	Average

Note:

1. " *", means this data is the worst emission level.
2. C.F (Correction Factor) = Antenna Factor (dB)+ Cable Loss (dB)– Preamplifier(dB)+16db attenuation.
3. Measurement(dBuV/m) = Reading(dBuV) + C.F (Correction Factor).
- 4.The emission levels of other frequencies are very lower than the limit and not show in test report.

EUT	AP311	Date of Test	2020-09-28
Factor	BBHA 9120D (1GHz~18GHz)_2020	Temp. / Humidity	24.9°C/35%
Polarity	Horizontal	Site / Test Engineer	AC1 / Kevin Ker
Test Mode	Transmit by 802.11ac-VHT80 at Channel 5530MHz	Test Voltage	120V/60Hz

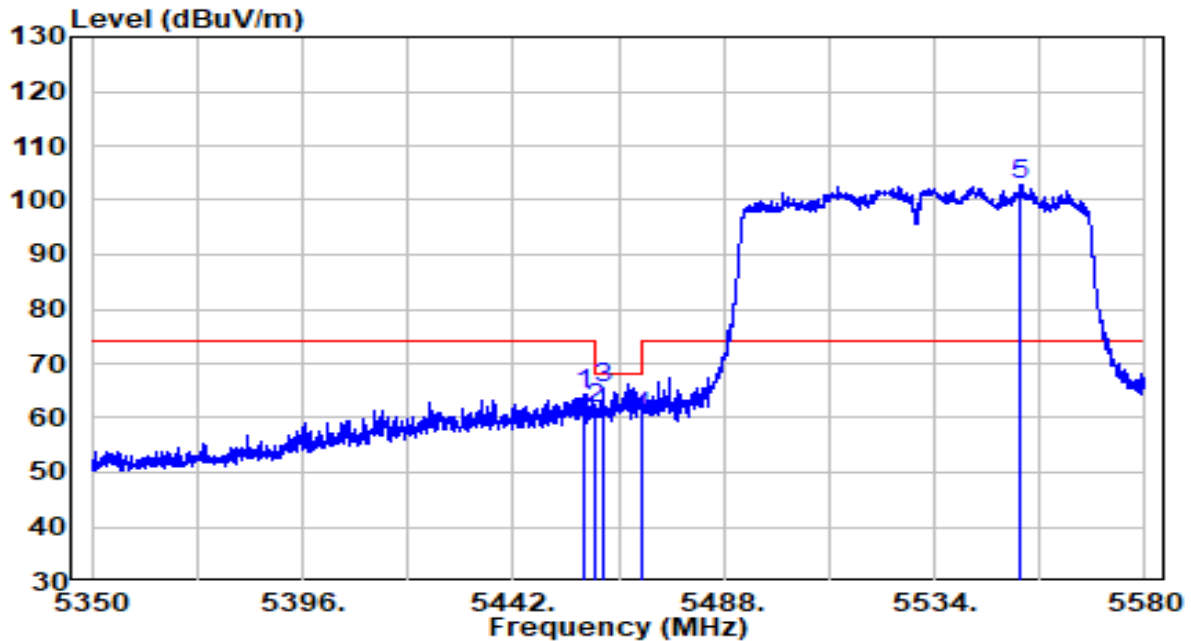

No	Frequency (MHz)	Reading (dBuV)	C.F (dB)	Measurement (dBuV/m)	Margin (dB)	Limit (dBuV/m)	Remark (QP/PK/AV)
1	5457.755	44.15	20.23	64.38	-9.62	74.00	Peak
2	5460.000	41.41	20.23	61.64	-6.56	68.20	Peak
3	5461.665	45.17	20.23	65.40	-2.80	68.20	Peak
4	5470.000	40.05	20.24	60.29	-7.91	68.20	Peak
5	* 5552.515	82.46	20.44	102.90	N/A	N/A	Peak

Note:

1. " *", means this data is the worst emission level.
2. C.F (Correction Factor) = Antenna Factor (dB)+ Cable Loss (dB)– Preamplifier(dB)+16db attenuation.
3. Measurement(dBuV/m) = Reading(dBuV) + C.F (Correction Factor).
- 4.The emission levels of other frequencies are very lower than the limit and not show in test report.

EUT	AP311	Date of Test	2020-09-28
Factor	BBHA 9120D (1GHz~18GHz)_2020	Temp. / Humidity	24.9°C/35%
Polarity	Horizontal	Site / Test Engineer	AC1 / Kevin Ker
Test Mode	Transmit by 802.11ac-VHT80 at Channel 5530MHz	Test Voltage	120V/60Hz

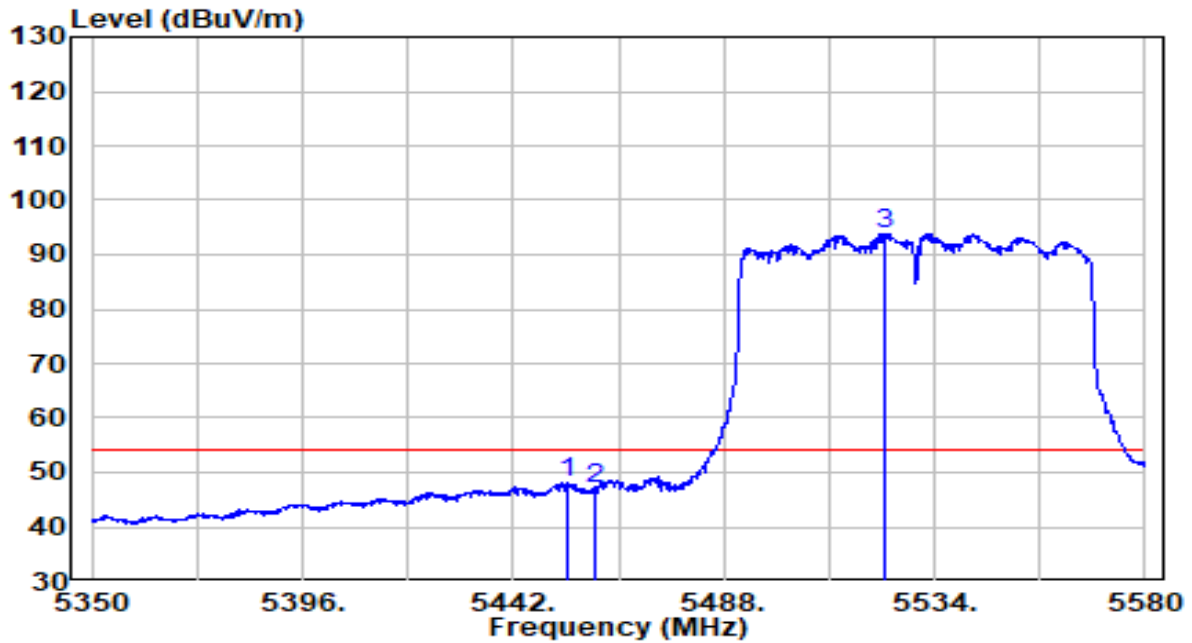

No	Frequency (MHz)	Reading (dBuV)	C.F (dB)	Measurement (dBuV/m)	Margin (dB)	Limit (dBuV/m)	Remark (QP/PK/AV)
1	5453.730	27.78	20.22	48.00	-6.00	54.00	Average
2	5460.000	26.70	20.23	46.93	-7.07	54.00	Average
3	* 5523.190	73.59	20.35	93.94	N/A	N/A	Average

Note:

1. " *", means this data is the worst emission level.
2. C.F (Correction Factor) = Antenna Factor (dB)+ Cable Loss (dB)– Preamplifier(dB)+16db attenuation.
3. Measurement(dBuV/m) = Reading(dBuV) + C.F (Correction Factor).
- 4.The emission levels of other frequencies are very lower than the limit and not show in test report.

EUT	AP311	Date of Test	2020-09-28
Factor	BBHA 9120D (1GHz~18GHz)_2020	Temp. / Humidity	24.9°C/35%
Polarity	Vertical	Site / Test Engineer	AC1 / Kevin Ker
Test Mode	Transmit by 802.11ac-VHT80 at Channel 5530MHz	Test Voltage	120V/60Hz

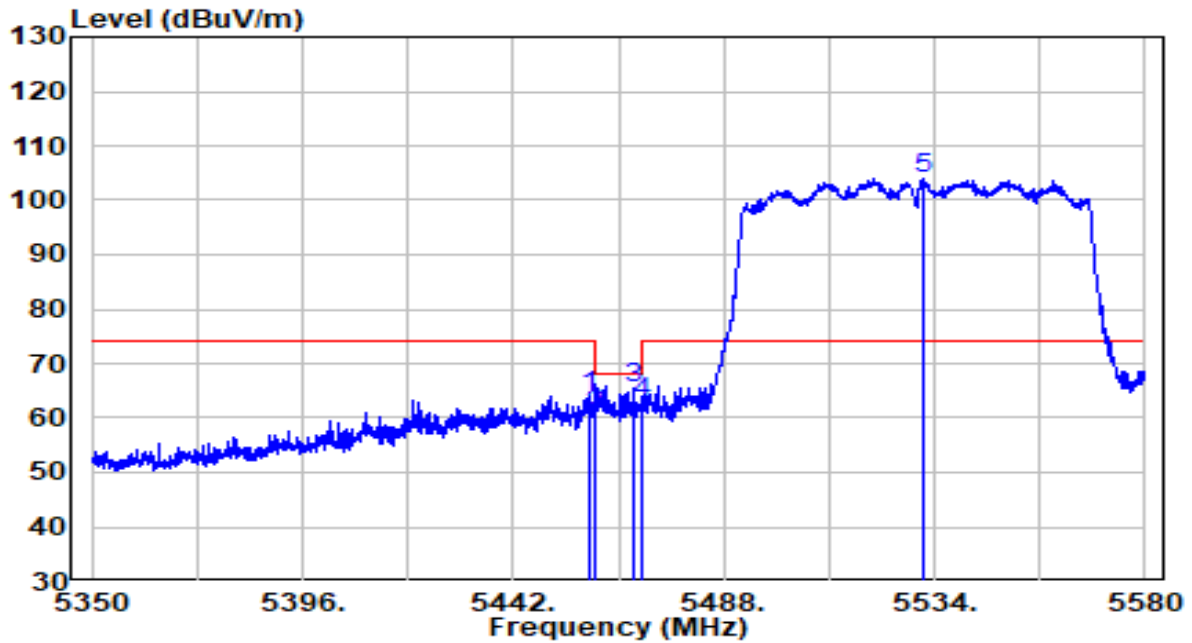

No	Frequency (MHz)	Reading (dBuV)	C.F (dB)	Measurement (dBuV/m)	Margin (dB)	Limit (dBuV/m)	Remark (QP/PK/AV)
1	5458.790	43.58	20.23	63.81	-10.19	74.00	Peak
2	5460.000	40.44	20.23	60.67	-7.53	68.20	Peak
3	5468.565	45.12	20.24	65.35	-2.85	68.20	Peak
4	5470.000	42.51	20.24	62.74	-5.46	68.20	Peak
5	* 5531.355	83.57	20.37	103.94	N/A	N/A	Peak

Note:

1. " *", means this data is the worst emission level.
2. C.F (Correction Factor) = Antenna Factor (dB)+ Cable Loss (dB)– Preamplifier(dB)+16db attenuation.
3. Measurement(dBuV/m) = Reading(dBuV) + C.F (Correction Factor).
- 4.The emission levels of other frequencies are very lower than the limit and not show in test report.

EUT	AP311	Date of Test	2020-09-28
Factor	BBHA 9120D (1GHz~18GHz)_2020	Temp. / Humidity	24.9°C/35%
Polarity	Vertical	Site / Test Engineer	AC1 / Kevin Ker
Test Mode	Transmit by 802.11ac-VHT80 at Channel 5530MHz	Test Voltage	120V/60Hz

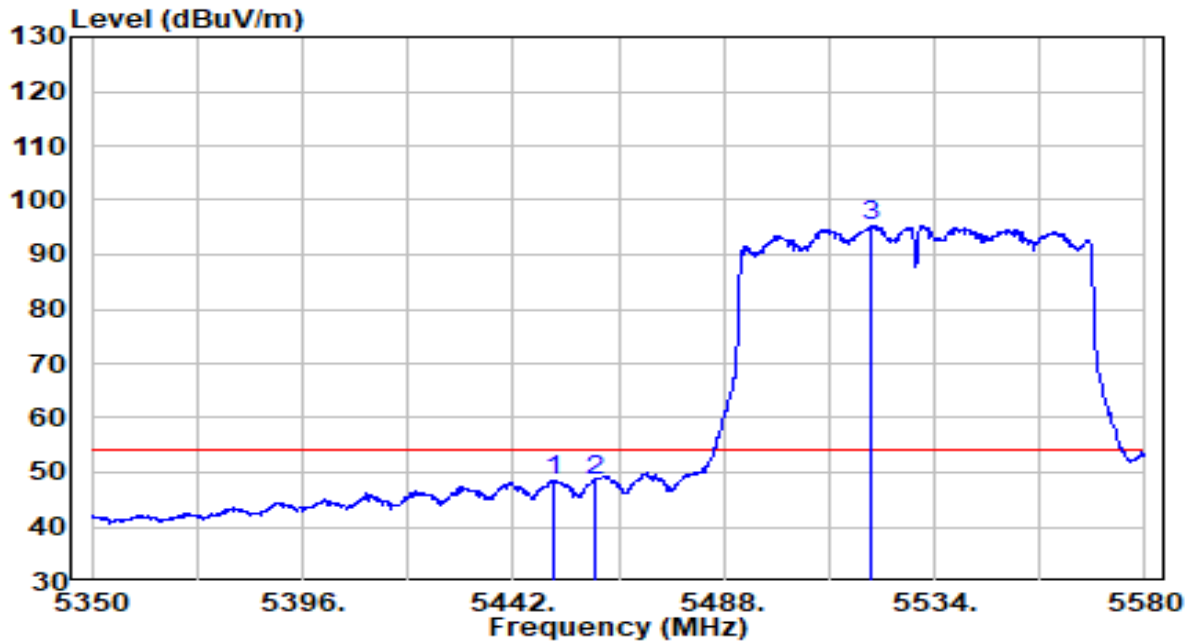

No	Frequency (MHz)	Reading (dBuV)	C.F (dB)	Measurement (dBuV/m)	Margin (dB)	Limit (dBuV/m)	Remark (QP/PK/AV)
1	5451.085	28.45	20.22	48.67	-5.33	54.00	Average
2	5460.000	28.10	20.23	48.33	-5.67	54.00	Average
3	* 5520.200	74.93	20.34	95.26	N/A	N/A	Average

Note:

1. " *", means this data is the worst emission level.
2. C.F (Correction Factor) = Antenna Factor (dB)+ Cable Loss (dB)– Preamplifier(dB)+16db attenuation.
3. Measurement(dBuV/m) = Reading(dBuV) + C.F (Correction Factor).
- 4.The emission levels of other frequencies are very lower than the limit and not show in test report.

EUT	AP311	Date of Test	2020-10-12
Factor	BBHA 9120D (1GHz~18GHz)_2020	Temp. / Humidity	23.2°C/35%
Polarity	Horizontal	Site / Test Engineer	AC1 / Kevin Ker
Test Mode	Transmit by 802.11ac-VHT80 at Channel 5610MHz	Test Voltage	120V/60Hz

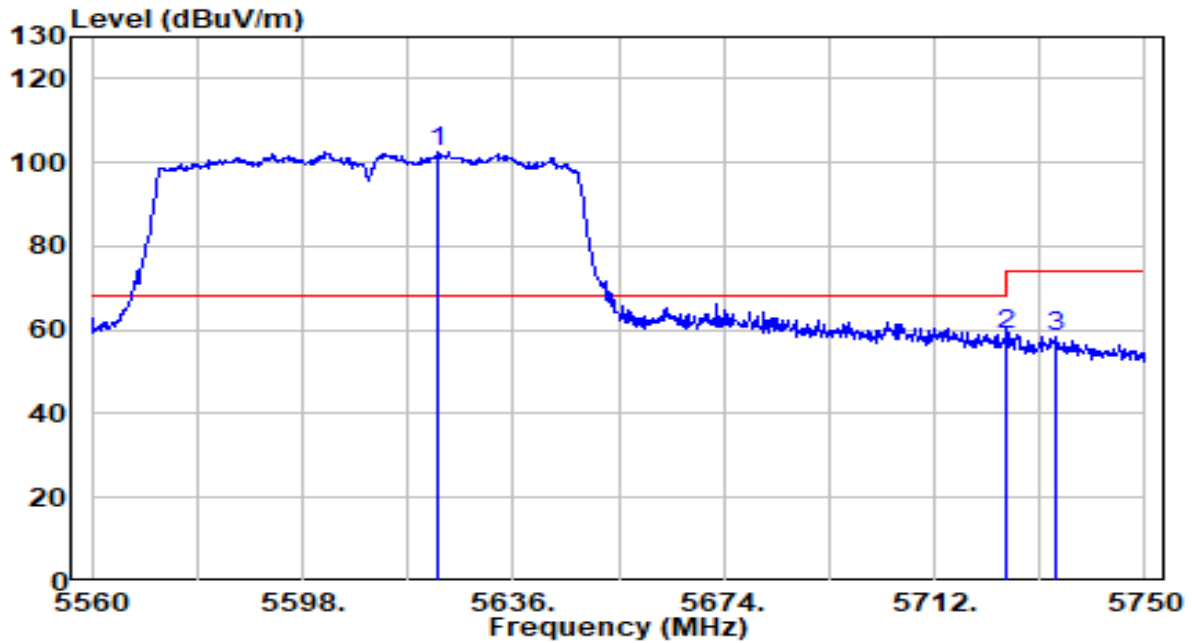

No	Frequency (MHz)	Reading (dBuV)	C.F (dB)	Measurement (dBuV/m)	Margin (dB)	Limit (dBuV/m)	Remark (QP/PK/AV)
1	* 5622.510	81.94	20.67	102.60	N/A	N/A	Peak
2	5725.000	38.04	21.00	59.04	-9.16	68.20	Peak
3	5734.040	37.41	21.03	58.43	-15.57	74.00	Peak

Note:

1. " *", means this data is the worst emission level.
2. C.F (Correction Factor) = Antenna Factor (dB)+ Cable Loss (dB)– Preamplifier(dB)+16db attenuation.
3. Measurement(dBuV/m) = Reading(dBuV) + C.F (Correction Factor).
- 4.The emission levels of other frequencies are very lower than the limit and not show in test report.

EUT	AP311	Date of Test	2020-10-12
Factor	BBHA 9120D (1GHz~18GHz)_2020	Temp. / Humidity	23.2°C/35%
Polarity	Vertical	Site / Test Engineer	AC1 / Kevin Ker
Test Mode	Transmit by 802.11ac-VHT80 at Channel 5610MHz	Test Voltage	120V/60Hz

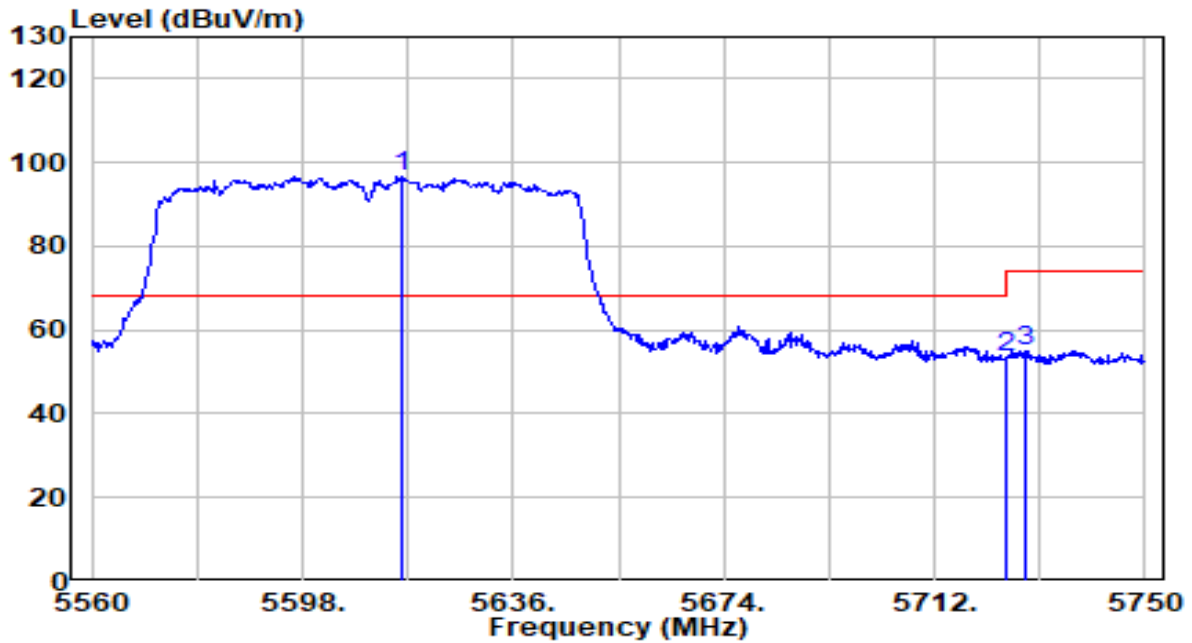

No	Frequency (MHz)	Reading (dBuV)	C.F (dB)	Measurement (dBuV/m)	Margin (dB)	Limit (dBuV/m)	Remark (QP/PK/AV)
1	* 5615.860	75.83	20.65	96.47	N/A	N/A	Peak
2	5725.000	32.27	21.00	53.27	-14.93	68.20	Peak
3	5728.340	33.99	21.01	55.00	-19.00	74.00	Peak

Note:

1. " *", means this data is the worst emission level.
2. C.F (Correction Factor) = Antenna Factor (dB)+ Cable Loss (dB)– Preamplifier(dB)+16db attenuation.
3. Measurement(dBuV/m) = Reading(dBuV) + C.F (Correction Factor).
- 4.The emission levels of other frequencies are very lower than the limit and not show in test report.

EUT	AP311	Date of Test	2020-09-28
Factor	BBHA 9120D (1GHz~18GHz)_2020	Temp. / Humidity	24.9°C/35%
Polarity	Horizontal	Site / Test Engineer	AC1 / Kevin Ker
Test Mode	Transmit by 802.11ac-VHT80 at Channel 5775MHz	Test Voltage	120V/60Hz

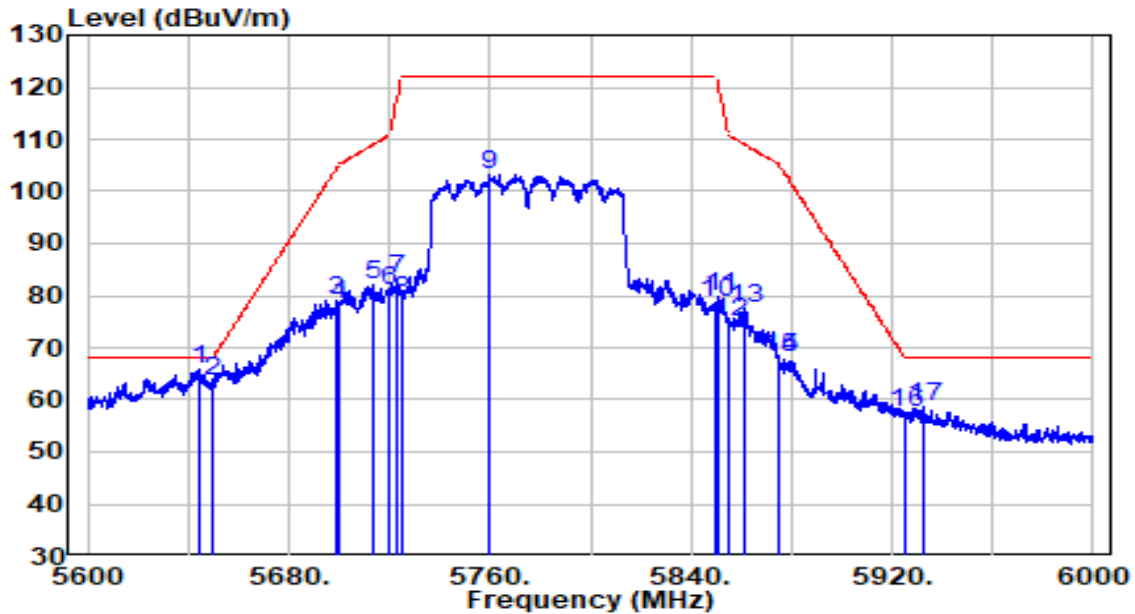

No	Frequency (MHz)	Reading (dBUV)	C.F (dB)	Measurement (dBUV/m)	Margin (dB)	Limit (dBUV/m)	Remark (QP/PK/AV)
1	* 5644.800	45.08	20.74	65.82	-2.38	68.20	Peak
2	5650.000	43.00	20.76	63.76	-4.44	68.20	Peak
3	5698.800	58.14	20.91	79.05	-25.26	104.32	Peak
4	5700.000	57.21	20.92	78.12	-27.08	105.20	Peak
5	5713.400	60.93	20.96	81.90	-27.06	108.95	Peak
6	5720.000	59.87	20.98	80.85	-29.95	110.80	Peak
7	5723.400	62.03	20.99	83.02	-35.53	118.55	Peak
8	5725.000	58.18	21.00	79.18	-43.02	122.20	Peak
9	5760.000	82.01	21.11	103.12	N/A	N/A	Peak
10	5850.000	57.20	21.40	78.60	-43.60	122.20	Peak
11	5851.200	58.38	21.41	79.79	-39.67	119.46	Peak
12	5855.000	53.51	21.42	74.93	-35.87	110.80	Peak
13	5861.200	56.25	21.44	77.69	-31.37	109.06	Peak
14	5875.000	46.72	21.49	68.21	-36.99	105.20	Peak
15	5875.000	46.72	21.49	68.21	-36.99	105.20	Peak
16	5925.000	35.92	21.65	57.57	-10.63	68.20	Peak
17	5932.600	37.07	21.67	58.74	-9.46	68.20	Peak

Note:

1. " *", means this data is the worst emission level.
2. C.F (Correction Factor) = Antenna Factor (dB)+ Cable Loss (dB)– Preamplifier(dB)+16db attenuation.
3. Measurement(dBuV/m) = Reading(dBuV) + C.F (Correction Factor).
- 4.The emission levels of other frequencies are very lower than the limit and not show in test report.

EUT	AP311	Date of Test	2020-09-28
Factor	BBHA 9120D (1GHz~18GHz)_2020	Temp. / Humidity	24.9°C/35%
Polarity	Vertical	Site / Test Engineer	AC1 / Kevin Ker
Test Mode	Transmit by 802.11ac-VHT80 at Channel 5775MHz	Test Voltage	120V/60Hz

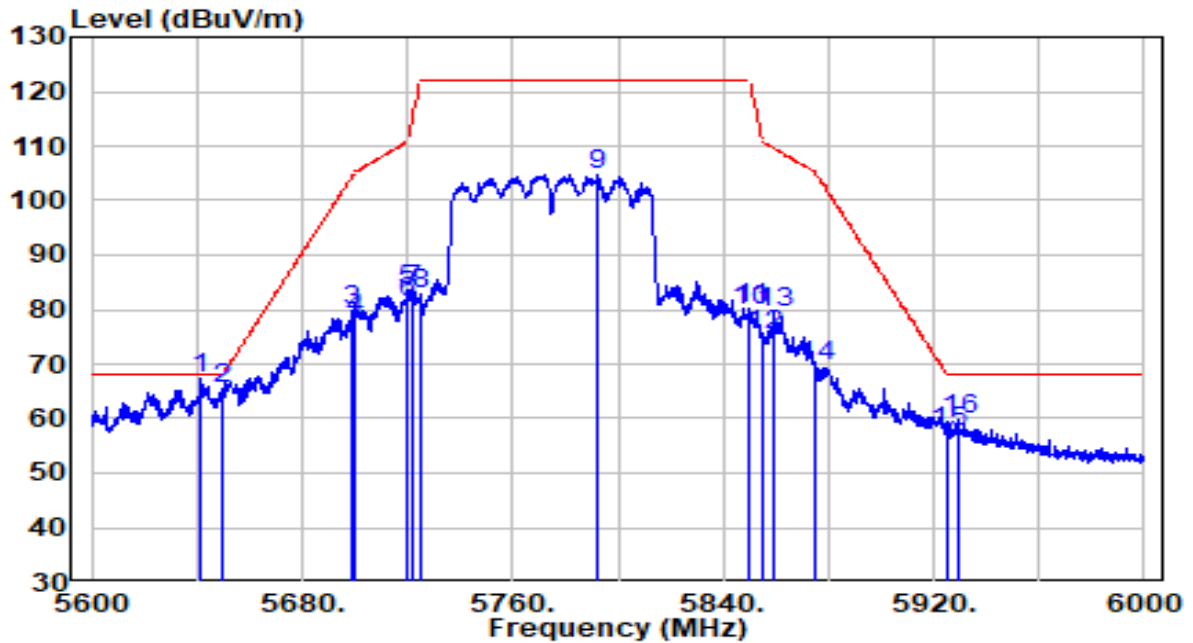

No	Frequency (MHz)	Reading (dBuV)	C.F (dB)	Measurement (dBuV/m)	Margin (dB)	Limit (dBuV/m)	Remark (QP/PK/AV)
1	* 5641.600	46.49	20.73	67.22	-0.98	68.20	Peak
2	5650.000	44.83	20.76	65.59	-2.61	68.20	Peak
3	5699.400	58.88	20.92	79.80	-24.96	104.76	Peak
4	5700.000	57.47	20.92	78.39	-26.81	105.20	Peak
5	5719.600	62.79	20.98	83.77	-26.92	110.69	Peak
6	5720.000	60.24	20.98	81.22	-29.58	110.80	Peak
7	5722.200	62.78	20.99	83.77	-32.05	115.82	Peak
8	5725.000	61.73	21.00	82.73	-39.47	122.20	Peak
9	5792.400	83.54	21.22	104.76	N/A	N/A	Peak
10	5850.000	58.29	21.40	79.69	-42.51	122.20	Peak
11	5850.200	58.68	21.40	80.08	-41.66	121.74	Peak
12	5855.000	53.91	21.42	75.33	-35.47	110.80	Peak
13	5859.000	57.98	21.43	79.41	-30.27	109.68	Peak
14	5875.000	48.06	21.49	69.54	-35.66	105.20	Peak
15	5925.000	36.02	21.65	57.67	-10.53	68.20	Peak
16	5929.400	38.05	21.66	59.71	-8.49	68.20	Peak

Note:

1. " *", means this data is the worst emission level.
2. C.F (Correction Factor) = Antenna Factor (dB)+ Cable Loss (dB)– Preamplifier(dB)+16db attenuation.
3. Measurement(dBuV/m) = Reading(dBuV) + C.F (Correction Factor).
- 4.The emission levels of other frequencies are very lower than the limit and not show in test report.

EUT	AP311	Date of Test	2020-09-28
Factor	BBHA 9120D (1GHz~18GHz)_2020	Temp. / Humidity	23.2°C/35%
Polarity	Horizontal	Site / Test Engineer	AC1 / Hyde Yu
Test Mode	Transmit by 802.11ax-HE20 at Channel 5180MHz	Test Voltage	120V/60Hz

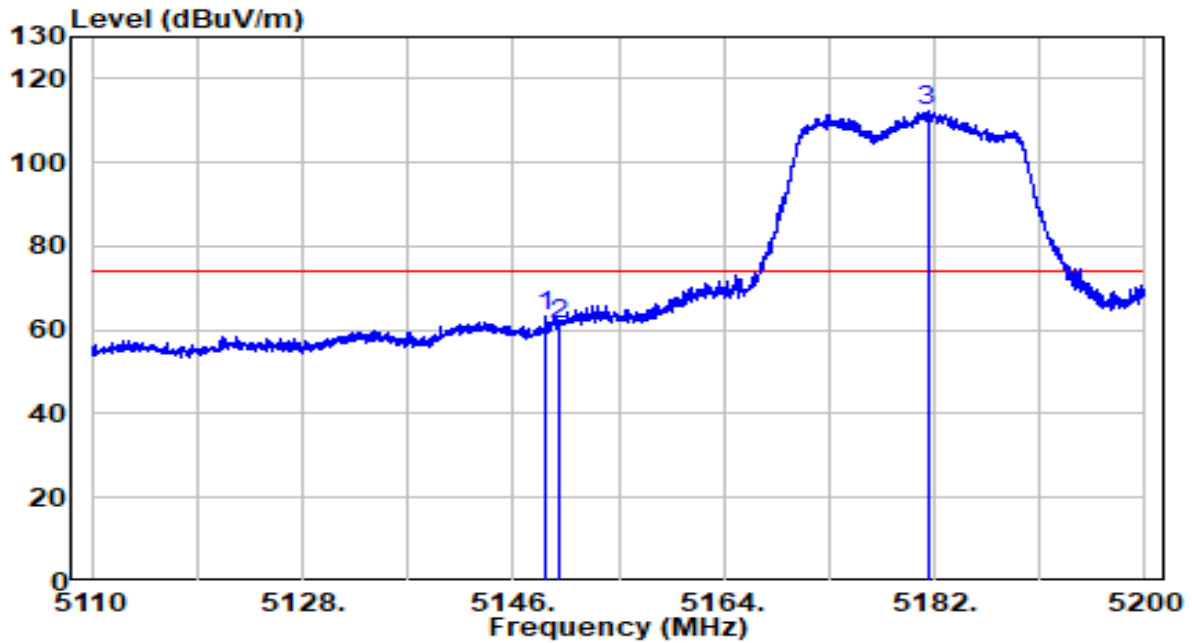

No	Frequency (MHz)	Reading (dBuV)	C.F (dB)	Measurement (dBuV/m)	Margin (dB)	Limit (dBuV/m)	Remark (QP/PK/AV)
1	5148.700	43.60	19.90	63.51	-10.49	74.00	Peak
2	5150.000	41.41	19.91	61.31	-12.69	74.00	Peak
3	* 5181.415	92.63	19.94	112.56	N/A	N/A	Peak

Note:

1. " *", means this data is the worst emission level.
2. C.F (Correction Factor) = Antenna Factor (dB)+ Cable Loss (dB)– Preamplifier(dB)+16db attenuation.
3. Measurement(dBuV/m) = Reading(dBuV) + C.F (Correction Factor).
- 4.The emission levels of other frequencies are very lower than the limit and not show in test report.

EUT	AP311	Date of Test	2020-09-28
Factor	BBHA 9120D (1GHz~18GHz)_2020	Temp. / Humidity	23.2°C/35%
Polarity	Horizontal	Site / Test Engineer	AC1 / Hyde Yu
Test Mode	Transmit by 802.11ax-HE20 at Channel 5180MHz	Test Voltage	120V/60Hz

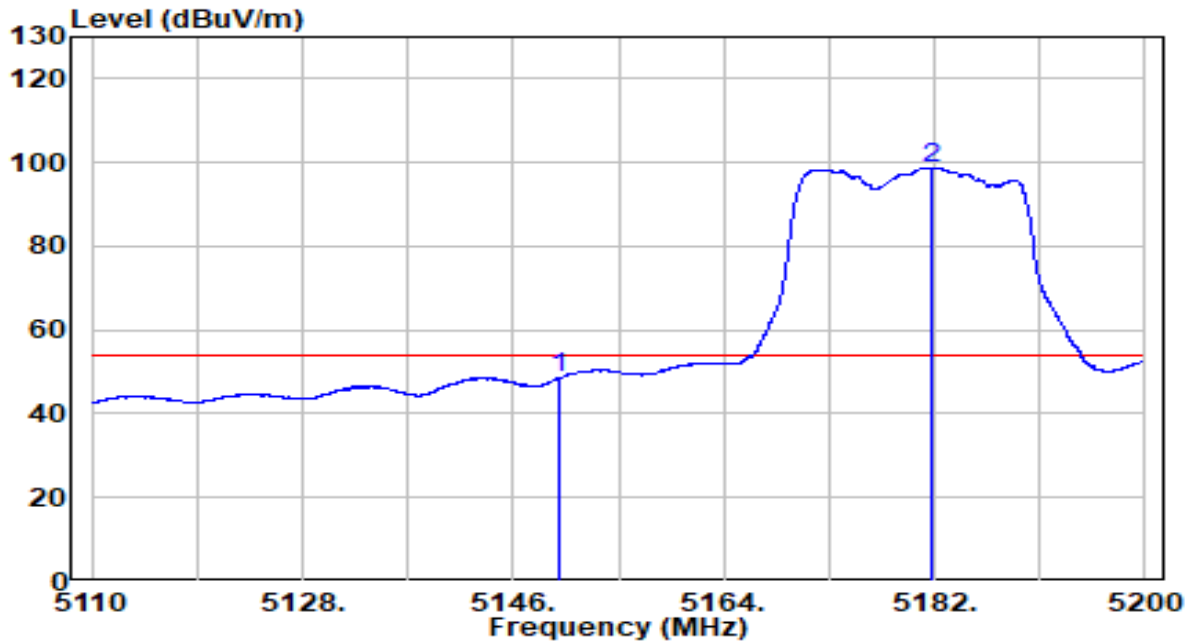

No	Frequency (MHz)	Reading (dBuV)	C.F (dB)	Measurement (dBuV/m)	Margin (dB)	Limit (dBuV/m)	Remark (QP/PK/AV)
1	5150.000	28.59	19.91	48.50	-5.50	54.00	Average
2	* 5181.730	78.89	19.94	98.83	N/A	N/A	Average

Note:

1. " *", means this data is the worst emission level.
2. C.F (Correction Factor) = Antenna Factor (dB)+ Cable Loss (dB)– Preamplifier(dB)+16db attenuation.
3. Measurement(dBuV/m) = Reading(dBuV) + C.F (Correction Factor).
- 4.The emission levels of other frequencies are very lower than the limit and not show in test report.

EUT	AP311	Date of Test	2020-09-28
Factor	BBHA 9120D (1GHz~18GHz)_2020	Temp. / Humidity	23.2°C/35%
Polarity	Vertical	Site / Test Engineer	AC1 / Hyde Yu
Test Mode	Transmit by 802.11ax-HE20 at Channel 5180MHz	Test Voltage	120V/60Hz

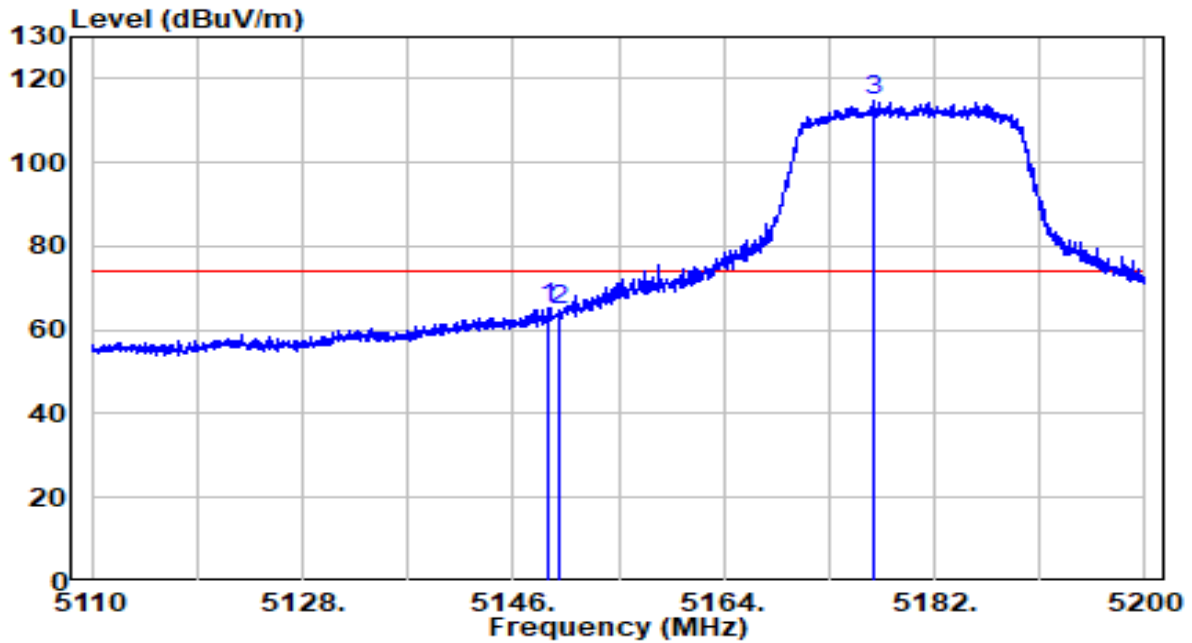

No	Frequency (MHz)	Reading (dBuV)	C.F (dB)	Measurement (dBuV/m)	Margin (dB)	Limit (dBuV/m)	Remark (QP/PK/AV)
1	5148.925	45.14	19.90	65.04	-8.96	74.00	Peak
2	5150.000	44.72	19.91	64.63	-9.37	74.00	Peak
3	* 5176.780	94.64	19.93	114.57	N/A	N/A	Peak

Note:

1. " *", means this data is the worst emission level.
2. C.F (Correction Factor) = Antenna Factor (dB)+ Cable Loss (dB)– Preamplifier(dB)+16db attenuation.
3. Measurement(dBuV/m) = Reading(dBuV) + C.F (Correction Factor).
- 4.The emission levels of other frequencies are very lower than the limit and not show in test report.

EUT	AP311	Date of Test	2020-09-28
Factor	BBHA 9120D (1GHz~18GHz)_2020	Temp. / Humidity	23.2°C/35%
Polarity	Vertical	Site / Test Engineer	AC1 / Hyde Yu
Test Mode	Transmit by 802.11ax-HE20 at Channel 5180MHz	Test Voltage	120V/60Hz

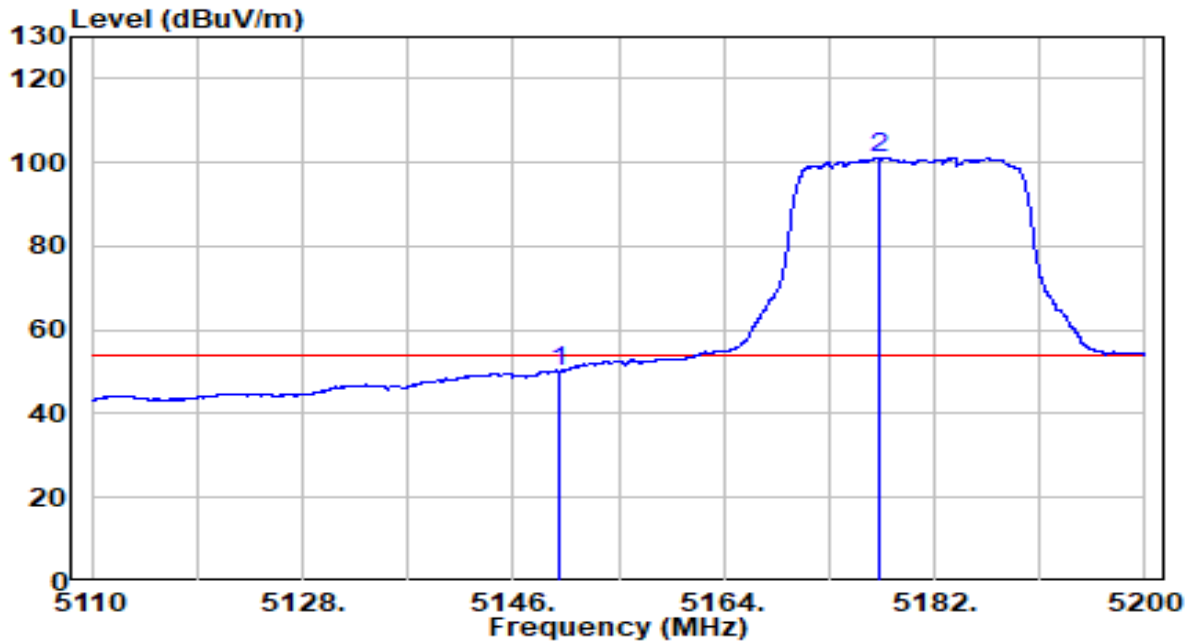

No	Frequency (MHz)	Reading (dBuV)	C.F (dB)	Measurement (dBuV/m)	Margin (dB)	Limit (dBuV/m)	Remark (QP/PK/AV)
1	5150.000	30.12	19.91	50.02	-3.98	54.00	Average
2	* 5177.230	81.20	19.93	101.14	N/A	N/A	Average

Note:

1. " *", means this data is the worst emission level.
2. C.F (Correction Factor) = Antenna Factor (dB)+ Cable Loss (dB)– Preamplifier(dB)+16db attenuation.
3. Measurement(dBuV/m) = Reading(dBuV) + C.F (Correction Factor).
- 4.The emission levels of other frequencies are very lower than the limit and not show in test report.

EUT	AP311	Date of Test	2020-09-28
Factor	BBHA 9120D (1GHz~18GHz)_2020	Temp. / Humidity	23.2°C/35%
Polarity	Horizontal	Site / Test Engineer	AC1 / Hyde Yu
Test Mode	Transmit by 802.11ax-HE20 at Channel 5240MHz	Test Voltage	120V/60Hz

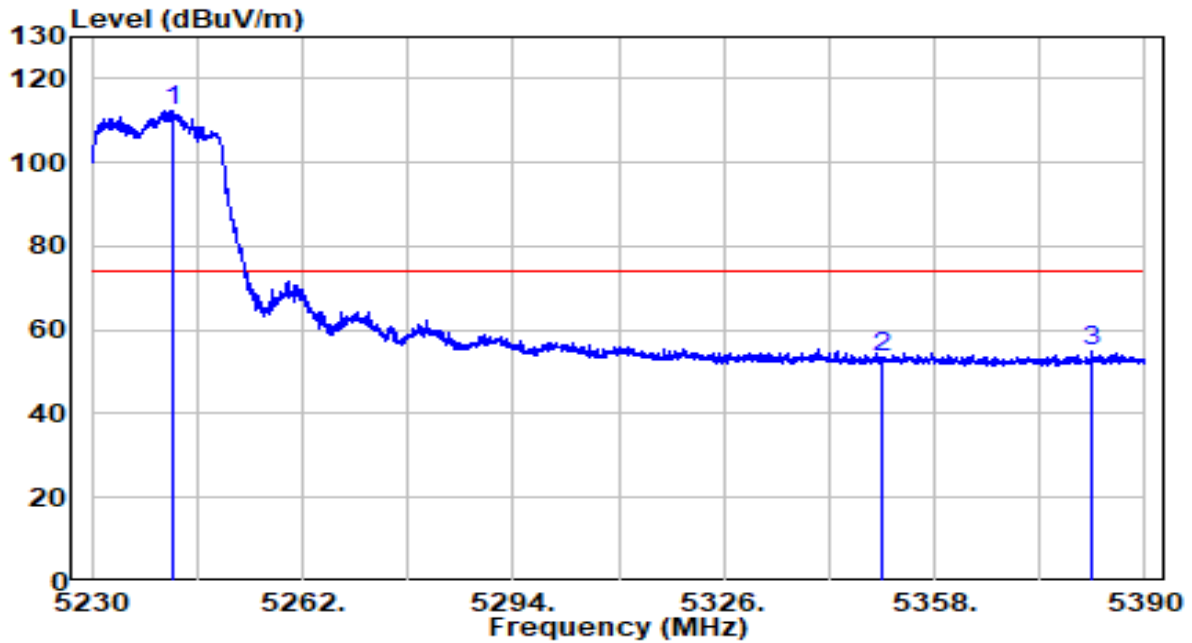

No	Frequency (MHz)	Reading (dBuV)	C.F (dB)	Measurement (dBuV/m)	Margin (dB)	Limit (dBuV/m)	Remark (QP/PK/AV)
1	* 5242.320	92.30	20.00	112.30	N/A	N/A	Peak
2	5350.000	33.38	20.11	53.50	-20.50	74.00	Peak
3	5382.080	34.81	20.15	54.96	-19.04	74.00	Peak

Note:

1. " *", means this data is the worst emission level.
2. C.F (Correction Factor) = Antenna Factor (dB)+ Cable Loss (dB)– Preamplifier(dB)+16db attenuation.
3. Measurement(dBuV/m) = Reading(dBuV) + C.F (Correction Factor).
- 4.The emission levels of other frequencies are very lower than the limit and not show in test report.

EUT	AP311	Date of Test	2020-09-28
Factor	BBHA 9120D (1GHz~18GHz)_2020	Temp. / Humidity	23.2°C/35%
Polarity	Horizontal	Site / Test Engineer	AC1 / Hyde Yu
Test Mode	Transmit by 802.11ax-HE20 at Channel 5240MHz	Test Voltage	120V/60Hz

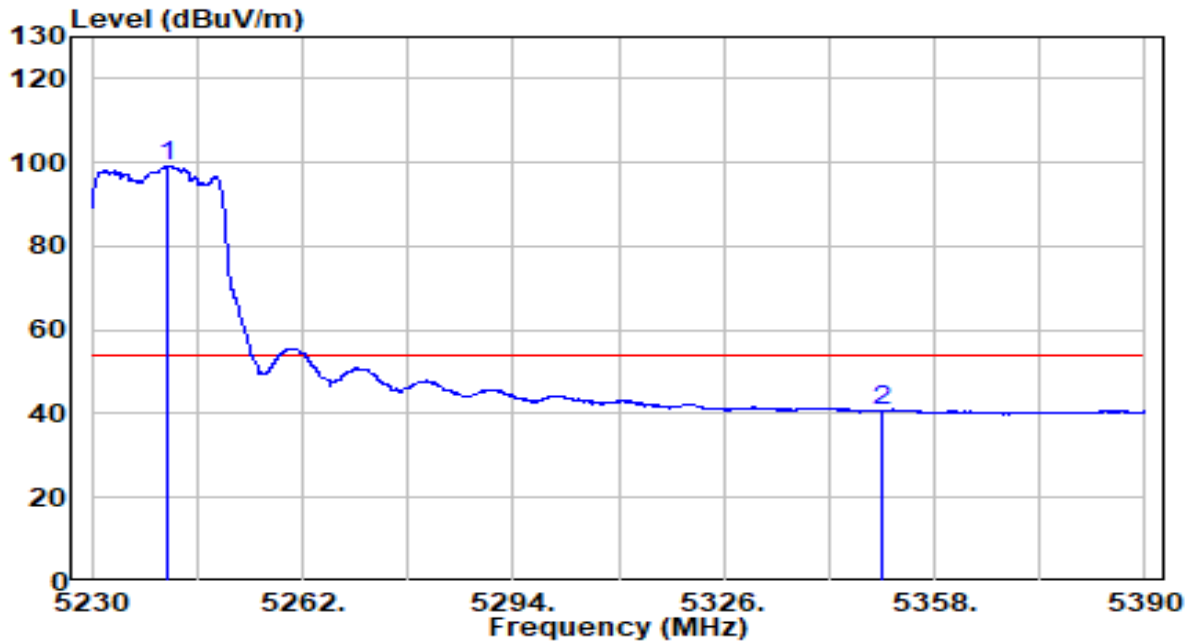

No	Frequency (MHz)	Reading (dBuV)	C.F (dB)	Measurement (dBuV/m)	Margin (dB)	Limit (dBuV/m)	Remark (QP/PK/AV)
1	* 5241.440	79.24	20.00	99.24	N/A	N/A	Average
2	5350.000	20.70	20.11	40.81	-13.19	54.00	Average

Note:

1. " *", means this data is the worst emission level.
2. C.F (Correction Factor) = Antenna Factor (dB)+ Cable Loss (dB)– Preamplifier(dB)+16db attenuation.
3. Measurement(dBuV/m) = Reading(dBuV) + C.F (Correction Factor).
- 4.The emission levels of other frequencies are very lower than the limit and not show in test report.

EUT	AP311	Date of Test	2020-09-28
Factor	BBHA 9120D (1GHz~18GHz)_2020	Temp. / Humidity	23.2°C/35%
Polarity	Vertical	Site / Test Engineer	AC1 / Hyde Yu
Test Mode	Transmit by 802.11ax-HE20 at Channel 5240MHz	Test Voltage	120V/60Hz

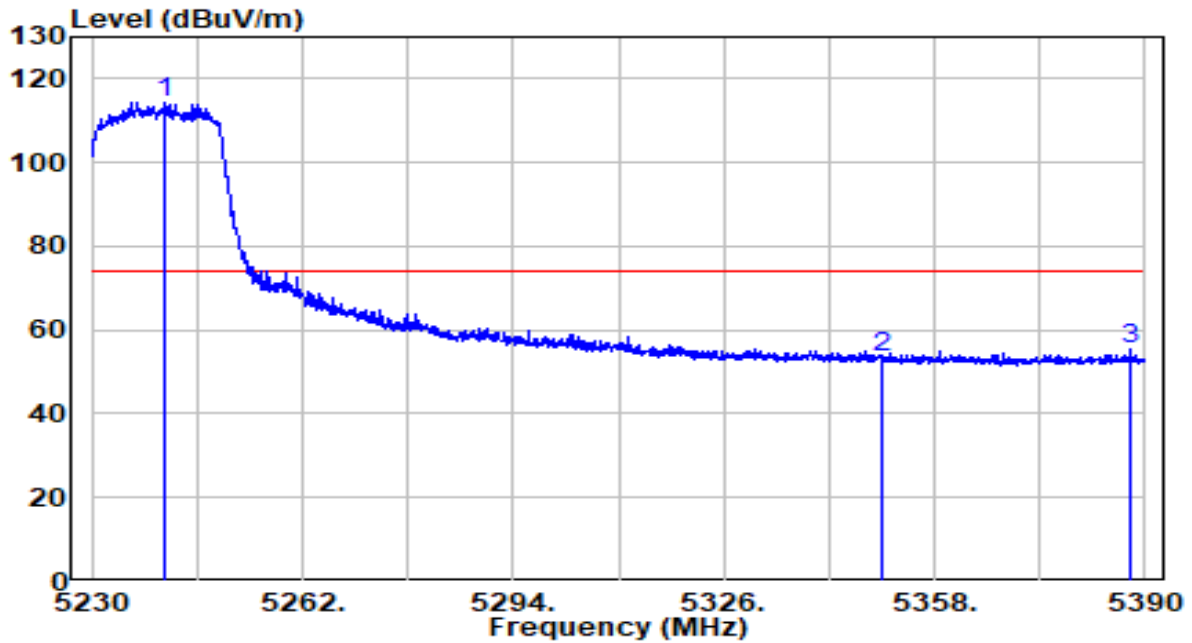

No	Frequency (MHz)	Reading (dBuV)	C.F (dB)	Measurement (dBuV/m)	Margin (dB)	Limit (dBuV/m)	Remark (QP/PK/AV)
1	* 5241.040	94.47	20.00	114.47	N/A	N/A	Peak
2	5350.000	33.31	20.11	53.43	-20.57	74.00	Peak
3	5387.840	35.09	20.15	55.25	-18.75	74.00	Peak

Note:

1. " *", means this data is the worst emission level.
2. C.F (Correction Factor) = Antenna Factor (dB)+ Cable Loss (dB)– Preamplifier(dB)+16db attenuation.
3. Measurement(dBuV/m) = Reading(dBuV) + C.F (Correction Factor).
- 4.The emission levels of other frequencies are very lower than the limit and not show in test report.

EUT	AP311	Date of Test	2020-09-28
Factor	BBHA 9120D (1GHz~18GHz)_2020	Temp. / Humidity	23.2°C/35%
Polarity	Vertical	Site / Test Engineer	AC1 / Hyde Yu
Test Mode	Transmit by 802.11ax-HE20 at Channel 5240MHz	Test Voltage	120V/60Hz

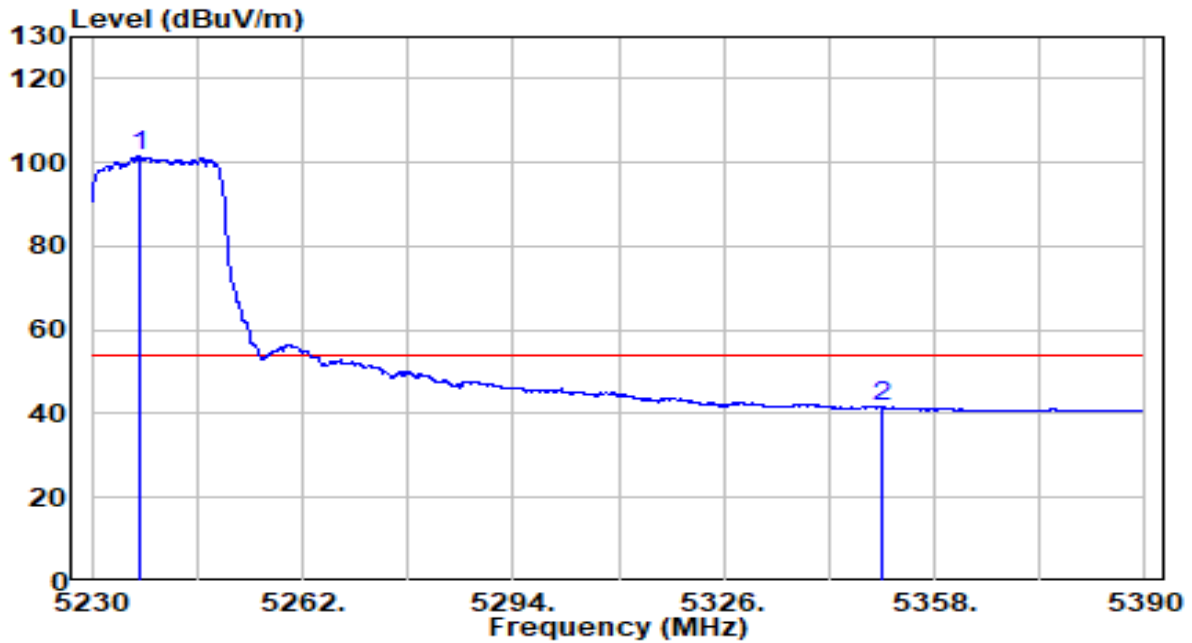

No	Frequency (MHz)	Reading (dBuV)	C.F (dB)	Measurement (dBuV/m)	Margin (dB)	Limit (dBuV/m)	Remark (QP/PK/AV)
1	* 5237.360	81.57	20.00	101.57	N/A	N/A	Average
2	5350.000	21.42	20.11	41.53	-12.47	54.00	Average

Note:

1. " *", means this data is the worst emission level.
2. C.F (Correction Factor) = Antenna Factor (dB)+ Cable Loss (dB)– Preamplifier(dB)+16db attenuation.
3. Measurement(dBuV/m) = Reading(dBuV) + C.F (Correction Factor).
- 4.The emission levels of other frequencies are very lower than the limit and not show in test report.

EUT	AP311	Date of Test	2020-09-28
Factor	BBHA 9120D (1GHz~18GHz)_2020	Temp. / Humidity	23.2°C/35%
Polarity	Horizontal	Site / Test Engineer	AC1 / Hyde Yu
Test Mode	Transmit by 802.11ax-HE20 at Channel 5320MHz	Test Voltage	120V/60Hz

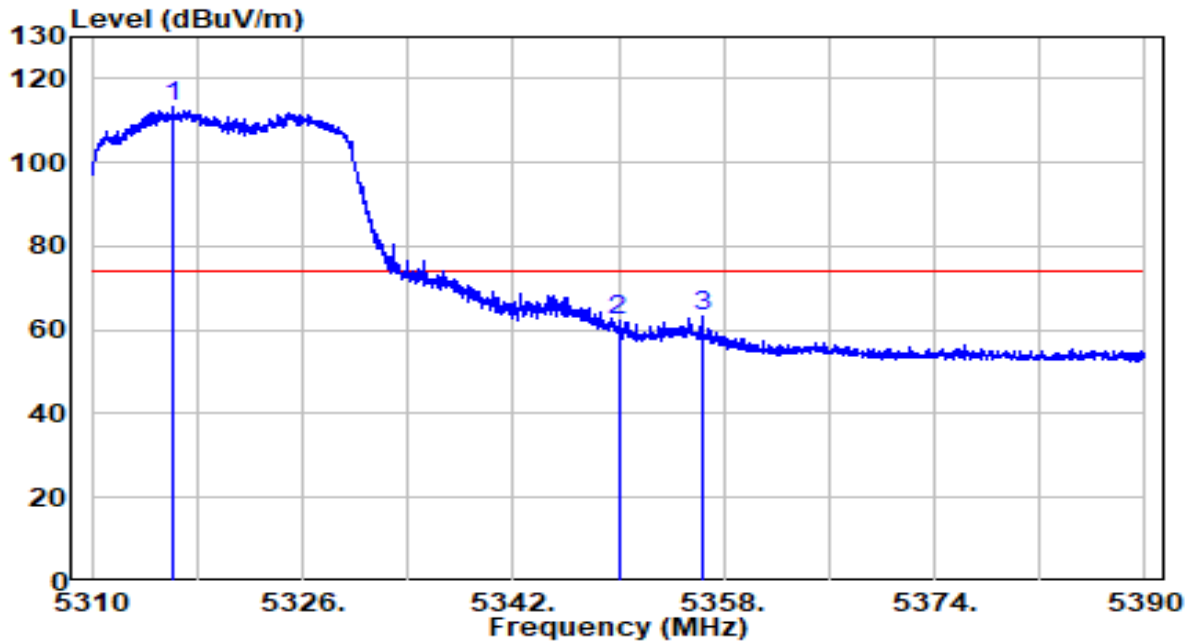

No	Frequency (MHz)	Reading (dBuV)	C.F (dB)	Measurement (dBuV/m)	Margin (dB)	Limit (dBuV/m)	Remark (QP/PK/AV)
1	* 5316.200	93.13	20.08	113.21	N/A	N/A	Peak
2	5350.000	42.00	20.11	62.11	-11.89	74.00	Peak
3	5356.320	43.24	20.12	63.36	-10.64	74.00	Peak

Note:

1. " *", means this data is the worst emission level.
2. C.F (Correction Factor) = Antenna Factor (dB)+ Cable Loss (dB)– Preamplifier(dB)+16db attenuation.
3. Measurement(dBuV/m) = Reading(dBuV) + C.F (Correction Factor).
- 4.The emission levels of other frequencies are very lower than the limit and not show in test report.

EUT	AP311	Date of Test	2020-09-28
Factor	BBHA 9120D (1GHz~18GHz)_2020	Temp. / Humidity	23.2°C/35%
Polarity	Horizontal	Site / Test Engineer	AC1 / Hyde Yu
Test Mode	Transmit by 802.11ax-HE20 at Channel 5320MHz	Test Voltage	120V/60Hz

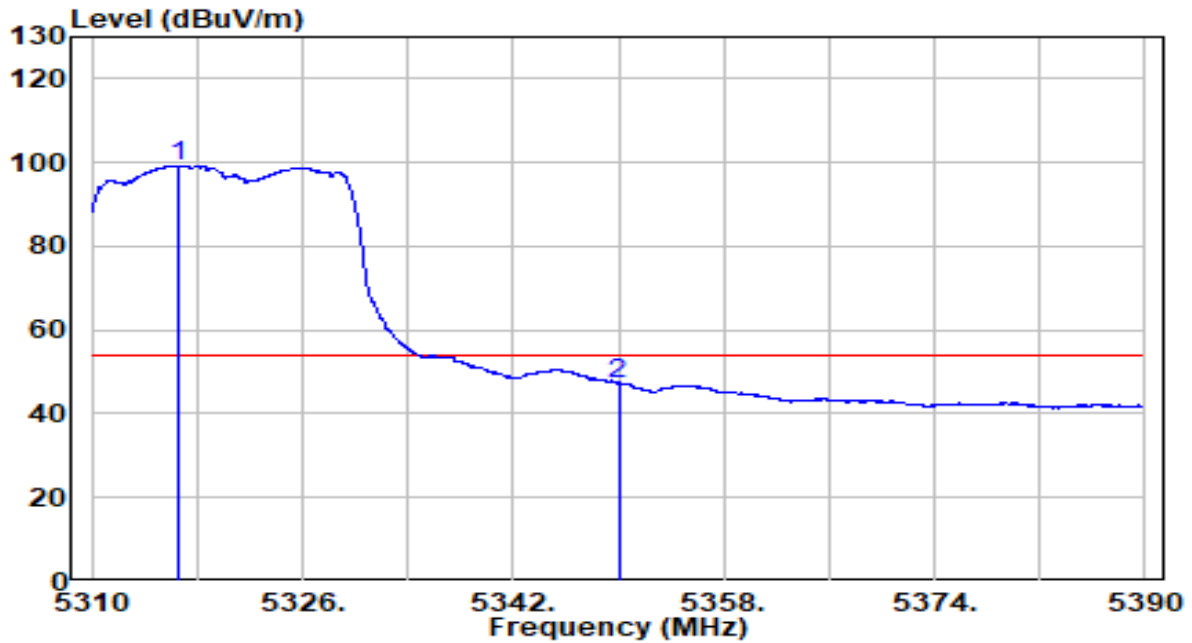

No	Frequency (MHz)	Reading (dBuV)	C.F (dB)	Measurement (dBuV/m)	Margin (dB)	Limit (dBuV/m)	Remark (QP/PK/AV)
1	* 5316.520	79.23	20.08	99.31	N/A	N/A	Average
2	5350.000	27.11	20.11	47.23	-6.77	54.00	Average

Note:

1. " *", means this data is the worst emission level.
2. C.F (Correction Factor) = Antenna Factor (dB)+ Cable Loss (dB)– Preamplifier(dB)+16db attenuation.
3. Measurement(dBuV/m) = Reading(dBuV) + C.F (Correction Factor).
- 4.The emission levels of other frequencies are very lower than the limit and not show in test report.

EUT	AP311	Date of Test	2020-09-28
Factor	BBHA 9120D (1GHz~18GHz)_2020	Temp. / Humidity	23.2°C/35%
Polarity	Vertical	Site / Test Engineer	AC1 / Hyde Yu
Test Mode	Transmit by 802.11ax-HE20 at Channel 5320MHz	Test Voltage	120V/60Hz

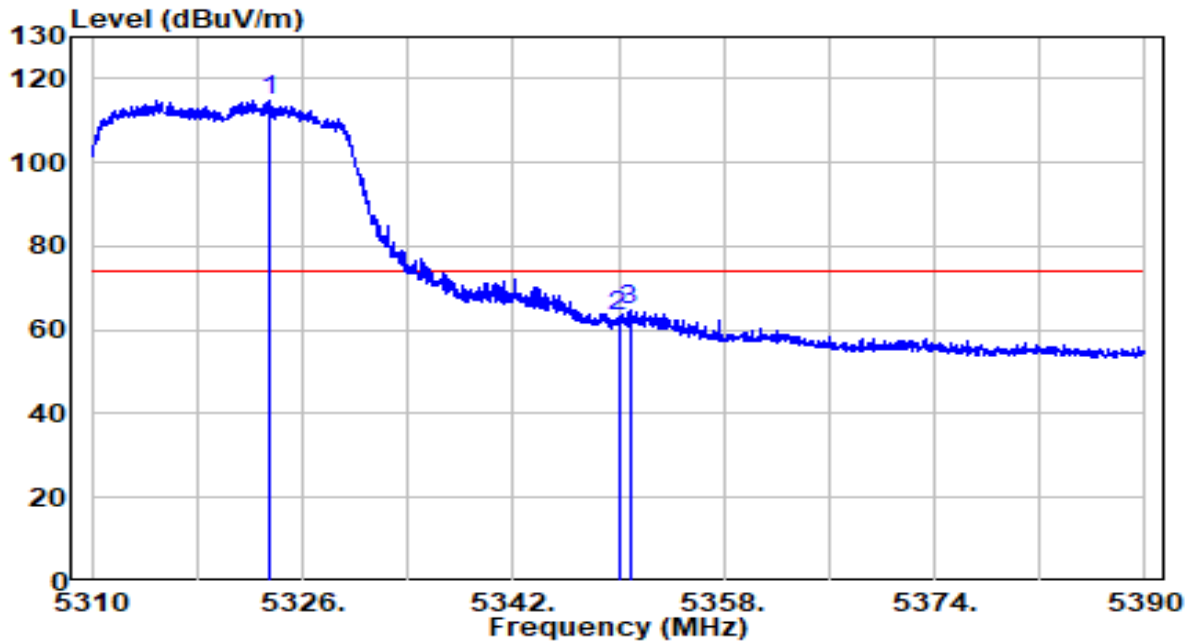

No	Frequency (MHz)	Reading (dBuV)	C.F (dB)	Measurement (dBuV/m)	Margin (dB)	Limit (dBuV/m)	Remark (QP/PK/AV)
1	* 5323.480	94.92	20.09	115.01	N/A	N/A	Peak
2	5350.000	43.10	20.11	63.21	-10.79	74.00	Peak
3	5350.840	44.70	20.11	64.81	-9.19	74.00	Peak

Note:

1. " *", means this data is the worst emission level.
2. C.F (Correction Factor) = Antenna Factor (dB)+ Cable Loss (dB)– Preamplifier(dB)+16db attenuation.
3. Measurement(dBuV/m) = Reading(dBuV) + C.F (Correction Factor).
- 4.The emission levels of other frequencies are very lower than the limit and not show in test report.

EUT	AP311	Date of Test	2020-09-28
Factor	BBHA 9120D (1GHz~18GHz)_2020	Temp. / Humidity	23.2°C/35%
Polarity	Vertical	Site / Test Engineer	AC1 / Hyde Yu
Test Mode	Transmit by 802.11ax-HE20 at Channel 5320MHz	Test Voltage	120V/60Hz

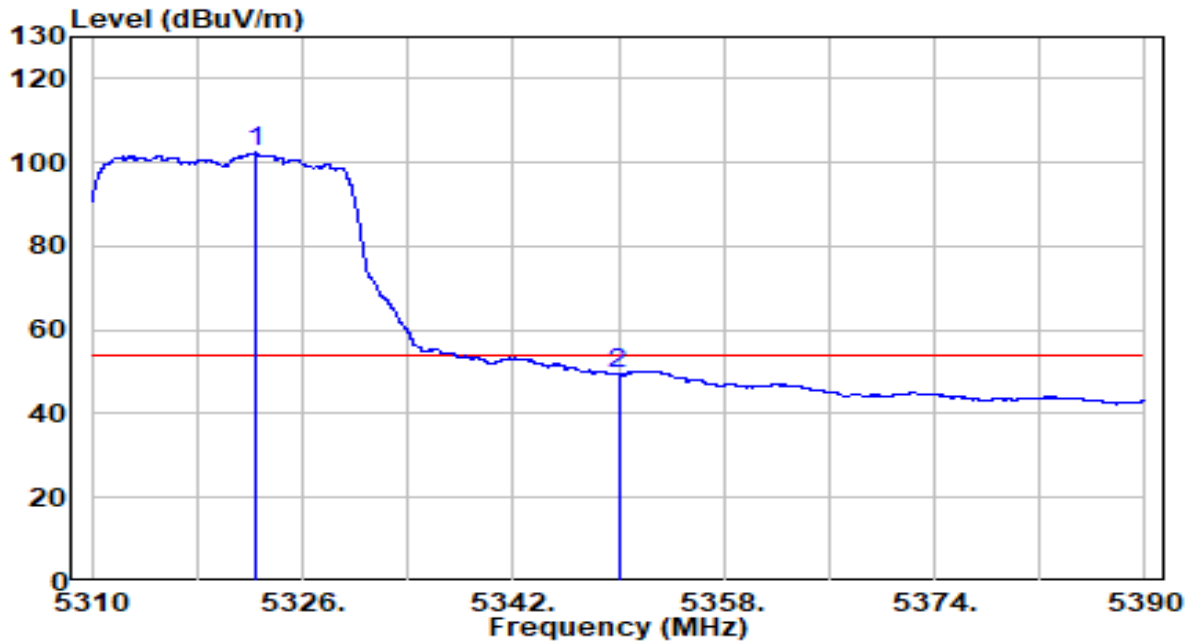

No	Frequency (MHz)	Reading (dBuV)	C.F (dB)	Measurement (dBuV/m)	Margin (dB)	Limit (dBuV/m)	Remark (QP/PK/AV)
1	* 5322.440	82.26	20.09	102.34	N/A	N/A	Average
2	5350.000	29.32	20.11	49.44	-4.56	54.00	Average

Note:

1. " *", means this data is the worst emission level.
2. C.F (Correction Factor) = Antenna Factor (dB)+ Cable Loss (dB)– Preamplifier(dB)+16db attenuation.
3. Measurement(dBuV/m) = Reading(dBuV) + C.F (Correction Factor).
- 4.The emission levels of other frequencies are very lower than the limit and not show in test report.

EUT	AP311	Date of Test	2020-09-28
Factor	BBHA 9120D (1GHz~18GHz)_2020	Temp. / Humidity	23.2°C/35%
Polarity	Horizontal	Site / Test Engineer	AC1 / Hyde Yu
Test Mode	Transmit by 802.11ax-HE20 at Channel 5500MHz	Test Voltage	120V/60Hz

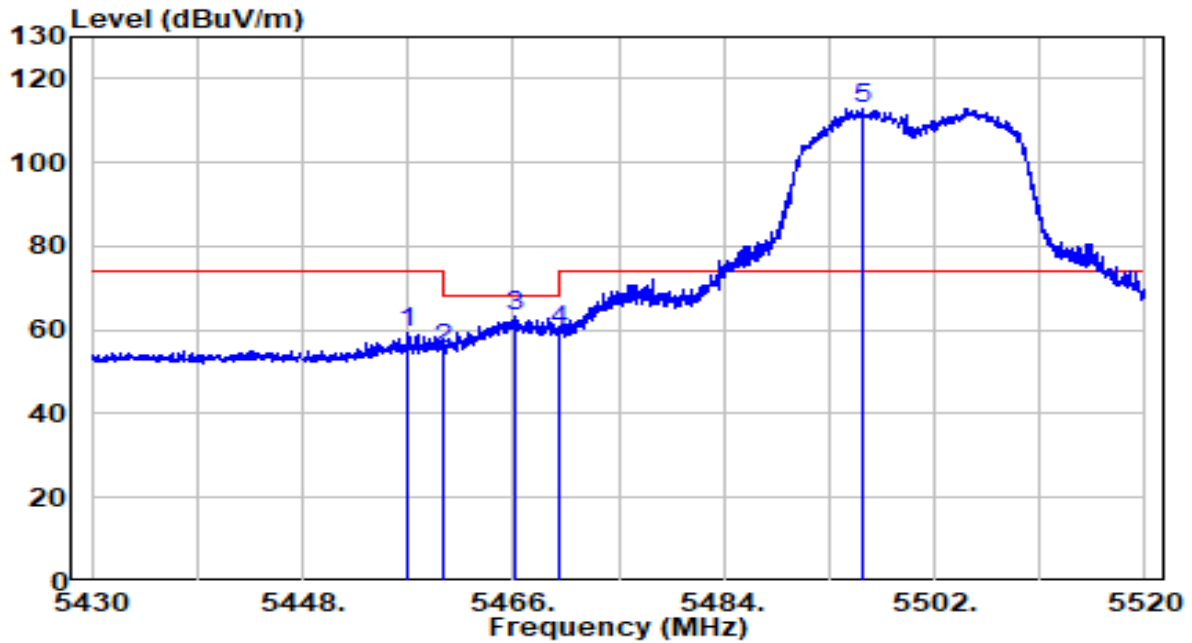

No	Frequency (MHz)	Reading (dBuV)	C.F (dB)	Measurement (dBuV/m)	Margin (dB)	Limit (dBuV/m)	Remark (QP/PK/AV)
1	5457.000	39.10	20.23	59.33	-14.67	74.00	Peak
2	5460.000	35.36	20.23	55.59	-12.61	68.20	Peak
3	5466.225	42.94	20.23	63.18	-5.02	68.20	Peak
4	5470.000	39.78	20.24	60.02	-8.18	68.20	Peak
5	* 5495.880	92.70	20.27	112.96	N/A	N/A	Peak

Note:

1. " *", means this data is the worst emission level.
2. C.F (Correction Factor) = Antenna Factor (dB)+ Cable Loss (dB)– Preamplifier(dB)+16db attenuation.
3. Measurement(dBuV/m) = Reading(dBuV) + C.F (Correction Factor).
- 4.The emission levels of other frequencies are very lower than the limit and not show in test report.

EUT	AP311	Date of Test	2020-09-28
Factor	BBHA 9120D (1GHz~18GHz)_2020	Temp. / Humidity	23.2°C/35%
Polarity	Horizontal	Site / Test Engineer	AC1 / Hyde Yu
Test Mode	Transmit by 802.11ax-HE20 at Channel 5500MHz	Test Voltage	120V/60Hz

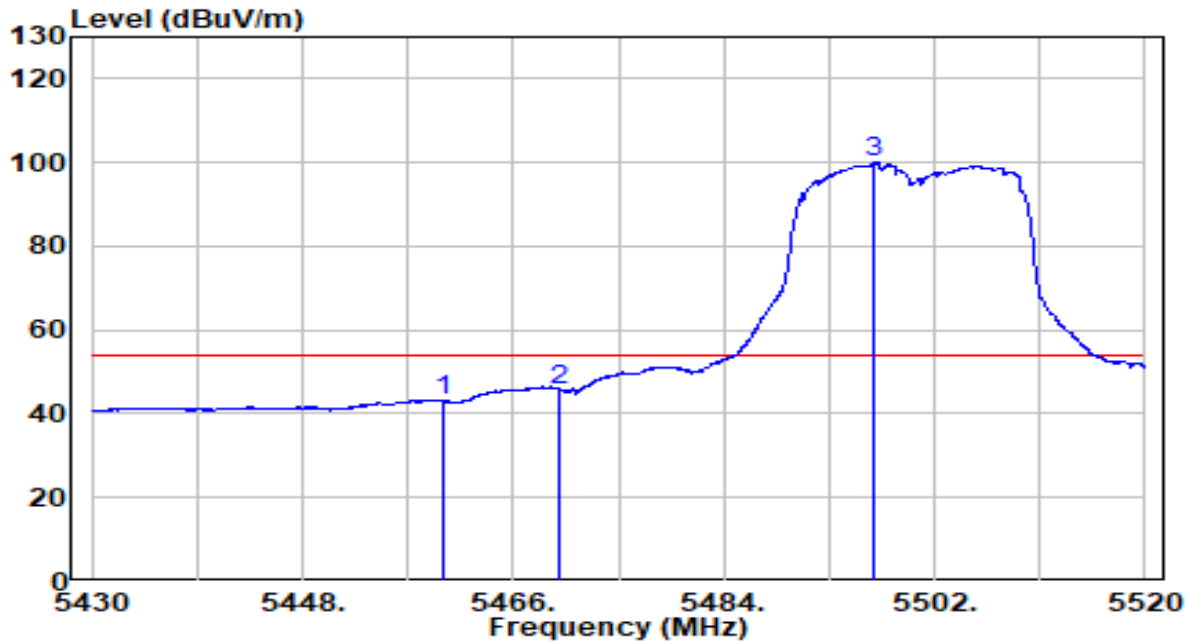

No	Frequency (MHz)	Reading (dBuV)	C.F (dB)	Measurement (dBuV/m)	Margin (dB)	Limit (dBuV/m)	Remark (QP/PK/AV)
1	5460.000	22.81	20.23	43.04	-10.96	54.00	Average
2	5470.000	25.42	20.24	45.66	-8.34	54.00	Average
3	* 5496.870	79.66	20.27	99.92	N/A	N/A	Average

Note:

1. " *", means this data is the worst emission level.
2. C.F (Correction Factor) = Antenna Factor (dB)+ Cable Loss (dB)– Preamplifier(dB)+16db attenuation.
3. Measurement(dBuV/m) = Reading(dBuV) + C.F (Correction Factor).
- 4.The emission levels of other frequencies are very lower than the limit and not show in test report.

EUT	AP311	Date of Test	2020-09-28
Factor	BBHA 9120D (1GHz~18GHz)_2020	Temp. / Humidity	23.2°C/35%
Polarity	Vertical	Site / Test Engineer	AC1 / Hyde Yu
Test Mode	Transmit by 802.11ax-HE20 at Channel 5500MHz	Test Voltage	120V/60Hz

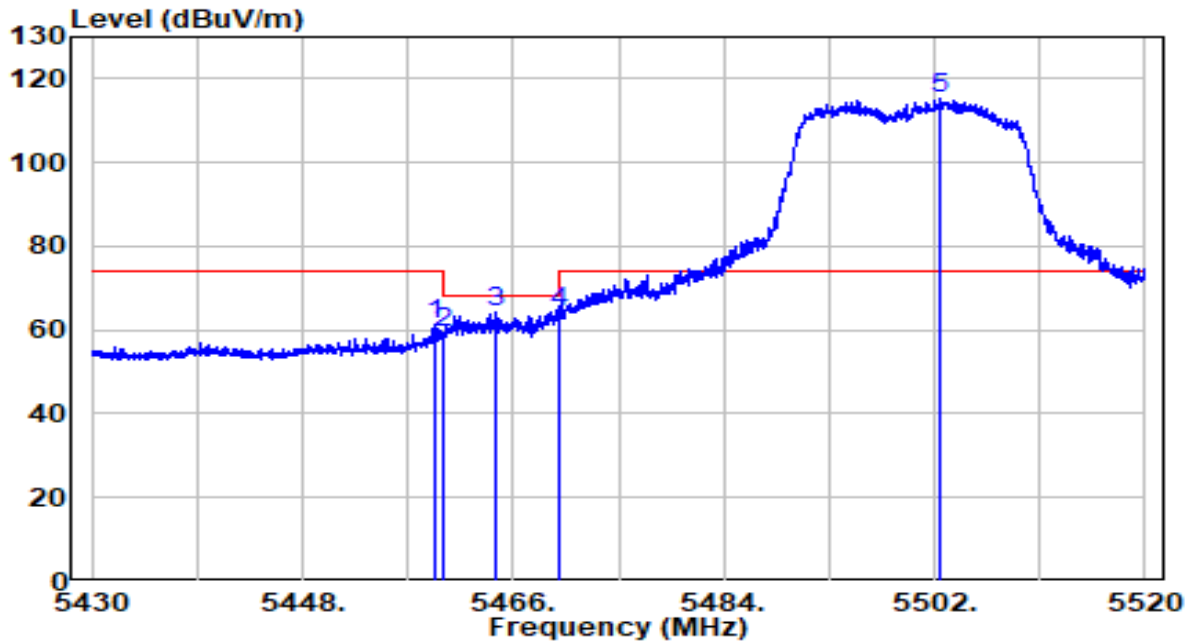

No	Frequency (MHz)	Reading (dBuV)	C.F (dB)	Measurement (dBuV/m)	Margin (dB)	Limit (dBuV/m)	Remark (QP/PK/AV)
1	5459.250	40.98	20.23	61.21	-12.79	74.00	Peak
2	5460.000	39.00	20.23	59.23	-8.97	68.20	Peak
3	5464.560	43.99	20.23	64.22	-3.98	68.20	Peak
4	5470.000	43.95	20.24	64.19	-4.01	68.20	Peak
5	* 5502.360	94.92	20.28	115.20	N/A	N/A	Peak

Note:

1. " *", means this data is the worst emission level.
2. C.F (Correction Factor) = Antenna Factor (dB)+ Cable Loss (dB)– Preamplifier(dB)+16db attenuation.
3. Measurement(dBuV/m) = Reading(dBuV) + C.F (Correction Factor).
- 4.The emission levels of other frequencies are very lower than the limit and not show in test report.

EUT	AP311	Date of Test	2020-09-28
Factor	BBHA 9120D (1GHz~18GHz)_2020	Temp. / Humidity	23.2°C/35%
Polarity	Vertical	Site / Test Engineer	AC1 / Hyde Yu
Test Mode	Transmit by 802.11ax-HE20 at Channel 5500MHz	Test Voltage	120V/60Hz

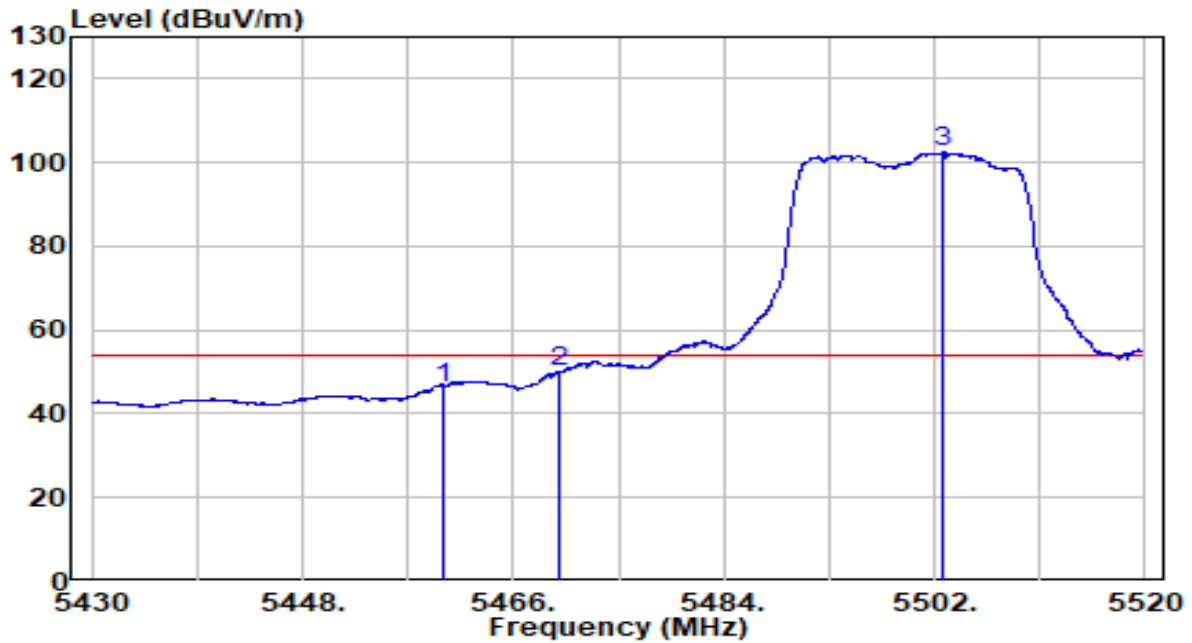

No	Frequency (MHz)	Reading (dBuV)	C.F (dB)	Measurement (dBuV/m)	Margin (dB)	Limit (dBuV/m)	Remark (QP/PK/AV)
1	5460.000	26.01	20.23	46.24	-7.76	54.00	Average
2	5470.000	29.69	20.24	49.93	-4.07	54.00	Average
3	* 5502.765	82.04	20.28	102.32	N/A	N/A	Average

Note:

1. " *", means this data is the worst emission level.
2. C.F (Correction Factor) = Antenna Factor (dB)+ Cable Loss (dB)– Preamplifier(dB)+16db attenuation.
3. Measurement(dBuV/m) = Reading(dBuV) + C.F (Correction Factor).
- 4.The emission levels of other frequencies are very lower than the limit and not show in test report.

EUT	AP311	Date of Test	2020-09-28
Factor	BBHA 9120D (1GHz~18GHz)_2020	Temp. / Humidity	23.2°C/35%
Polarity	Horizontal	Site / Test Engineer	AC1 / Hyde Yu
Test Mode	Transmit by 802.11ax-HE20 at Channel 5700MHz	Test Voltage	120V/60Hz

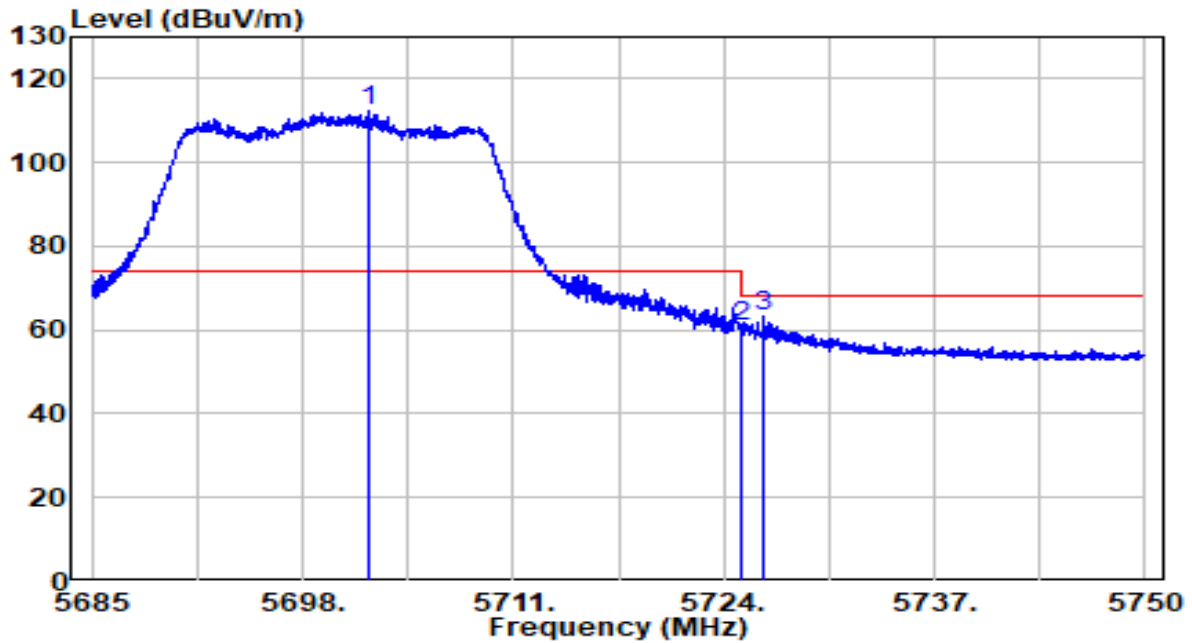

No	Frequency (MHz)	Reading (dBuV)	C.F (dB)	Measurement (dBuV/m)	Margin (dB)	Limit (dBuV/m)	Remark (QP/PK/AV)
1	* 5702.063	91.45	20.92	112.38	N/A	N/A	Peak
2	5725.000	39.92	21.00	60.92	-7.28	68.20	Peak
3	5726.470	42.22	21.00	63.22	-4.98	68.20	Peak

Note:

1. " *", means this data is the worst emission level.
2. C.F (Correction Factor) = Antenna Factor (dB)+ Cable Loss (dB)– Preamplifier(dB)+16db attenuation.
3. Measurement(dBuV/m) = Reading(dBuV) + C.F (Correction Factor).
- 4.The emission levels of other frequencies are very lower than the limit and not show in test report.

EUT	AP311	Date of Test	2020-09-28
Factor	BBHA 9120D (1GHz~18GHz)_2020	Temp. / Humidity	23.2°C/35%
Polarity	Vertical	Site / Test Engineer	AC1 / Hyde Yu
Test Mode	Transmit by 802.11ax-HE20 at Channel 5700MHz	Test Voltage	120V/60Hz

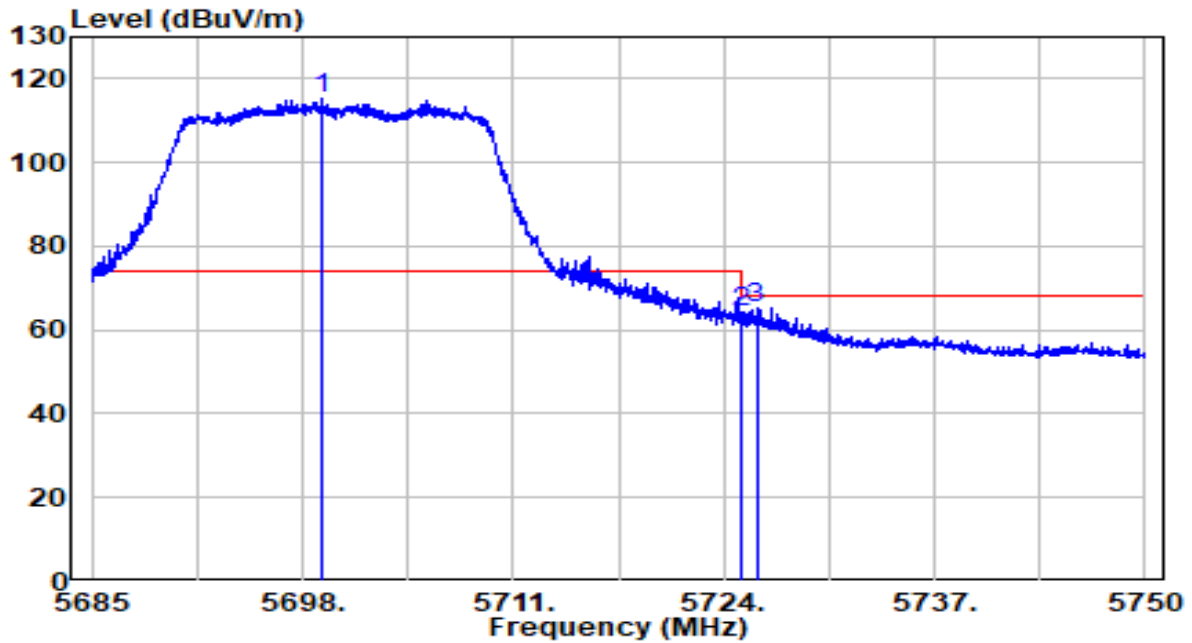

No	Frequency (MHz)	Reading (dBuV)	C.F (dB)	Measurement (dBuV/m)	Margin (dB)	Limit (dBuV/m)	Remark (QP/PK/AV)
1	* 5699.203	94.32	20.92	115.24	N/A	N/A	Peak
2	5725.000	43.08	21.00	64.08	-4.12	68.20	Peak
3	5726.015	44.29	21.00	65.29	-2.91	68.20	Peak

Note:

1. " *", means this data is the worst emission level.
2. C.F (Correction Factor) = Antenna Factor (dB)+ Cable Loss (dB)– Preamplifier(dB)+16db attenuation.
3. Measurement(dBuV/m) = Reading(dBuV) + C.F (Correction Factor).
- 4.The emission levels of other frequencies are very lower than the limit and not show in test report.

EUT	AP311	Date of Test	2020-09-28
Factor	BBHA 9120D (1GHz~18GHz)_2020	Temp. / Humidity	23.2°C/35%
Polarity	Horizontal	Site / Test Engineer	AC1 / Hyde Yu
Test Mode	Transmit by 802.11ax-HE20 at Channel 5745MHz	Test Voltage	120V/60Hz

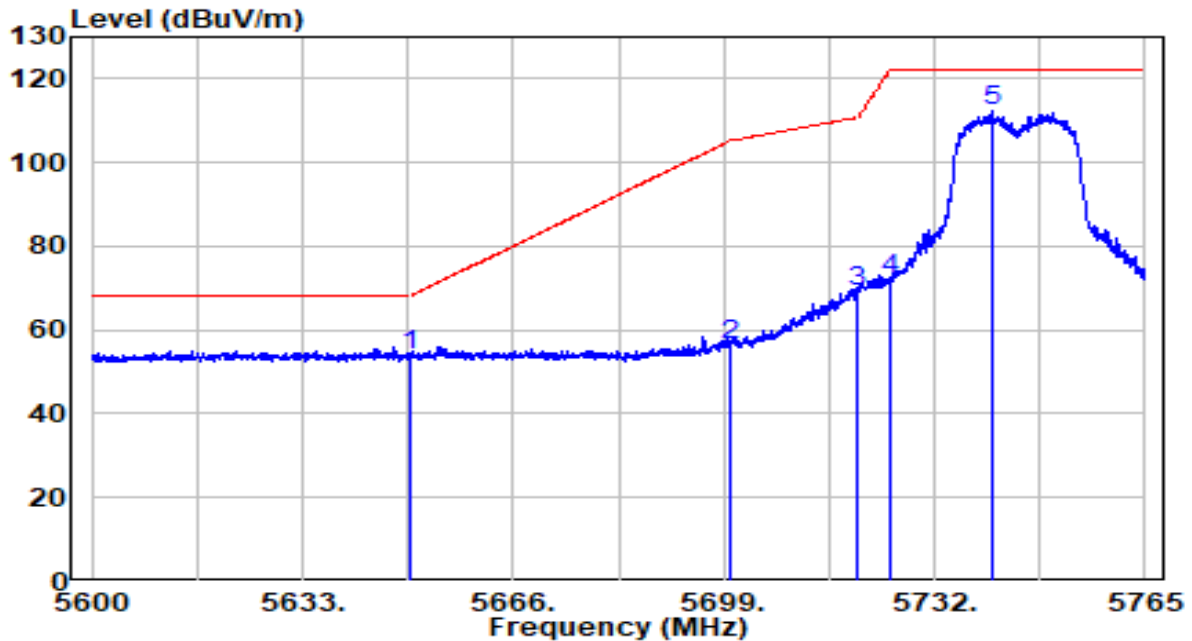

No	Frequency (MHz)	Reading (dBuV)	C.F (dB)	Measurement (dBuV/m)	Margin (dB)	Limit (dBuV/m)	Remark (QP/PK/AV)
1	5650.000	32.97	20.76	53.72	-14.48	68.20	Peak
2	5700.000	35.52	20.92	56.44	-48.76	105.20	Peak
3	5720.000	48.43	20.98	69.41	-41.39	110.80	Peak
4	5725.000	51.29	21.00	72.29	-49.91	122.20	Peak
5	* 5740.910	91.11	21.05	112.16	N/A	N/A	Peak

Note:

1. " *", means this data is the worst emission level.
2. C.F (Correction Factor) = Antenna Factor (dB)+ Cable Loss (dB)– Preamplifier(dB)+16db attenuation.
3. Measurement(dBuV/m) = Reading(dBuV) + C.F (Correction Factor).
- 4.The emission levels of other frequencies are very lower than the limit and not show in test report.

EUT	AP311	Date of Test	2020-09-28
Factor	BBHA 9120D (1GHz~18GHz)_2020	Temp. / Humidity	23.2°C/35%
Polarity	Vertical	Site / Test Engineer	AC1 / Hyde Yu
Test Mode	Transmit by 802.11ax-HE20 at Channel 5745MHz	Test Voltage	120V/60Hz

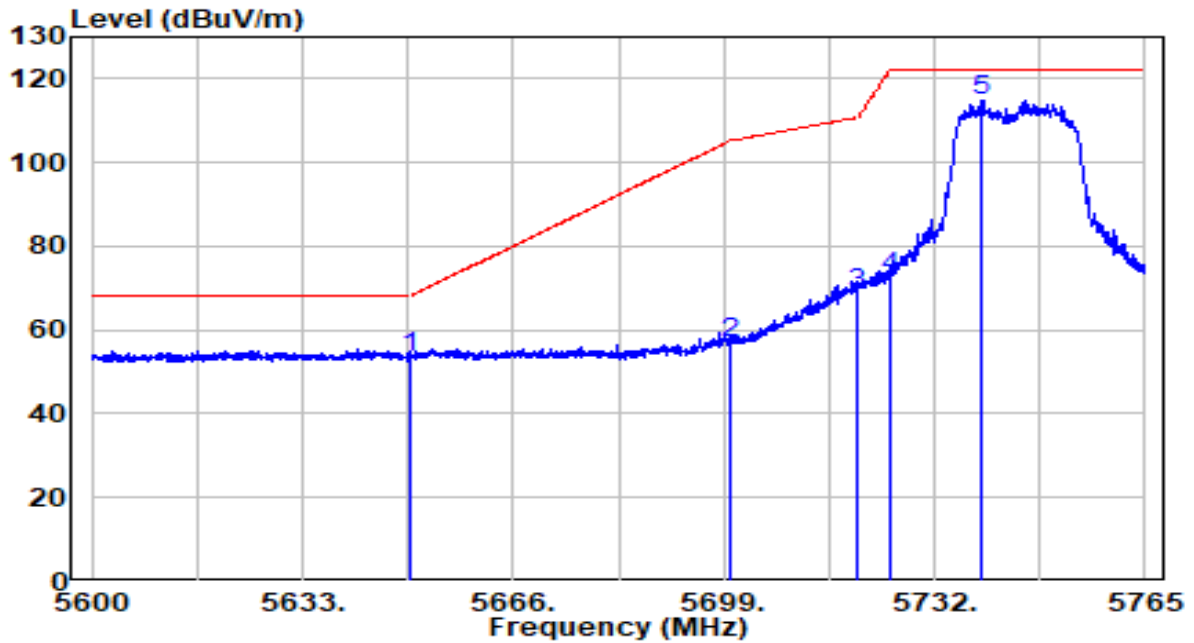

No	Frequency (MHz)	Reading (dBuV)	C.F (dB)	Measurement (dBuV/m)	Margin (dB)	Limit (dBuV/m)	Remark (QP/PK/AV)
1	5650.000	32.81	20.76	53.56	-14.64	68.20	Peak
2	5700.000	35.96	20.92	56.88	-48.32	105.20	Peak
3	5720.000	47.90	20.98	68.89	-41.91	110.80	Peak
4	5725.000	51.36	21.00	72.36	-49.84	122.20	Peak
5	* 5739.425	93.83	21.05	114.88	N/A	N/A	Peak

Note:

1. " *", means this data is the worst emission level.
2. C.F (Correction Factor) = Antenna Factor (dB)+ Cable Loss (dB)– Preamplifier(dB)+16db attenuation.
3. Measurement(dBuV/m) = Reading(dBuV) + C.F (Correction Factor).
- 4.The emission levels of other frequencies are very lower than the limit and not show in test report.

EUT	AP311	Date of Test	2020-09-28
Factor	BBHA 9120D (1GHz~18GHz)_2020	Temp. / Humidity	23.2°C/35%
Polarity	Horizontal	Site / Test Engineer	AC1 / Hyde Yu
Test Mode	Transmit by 802.11ax-HE20 at Channel 5825MHz	Test Voltage	120V/60Hz

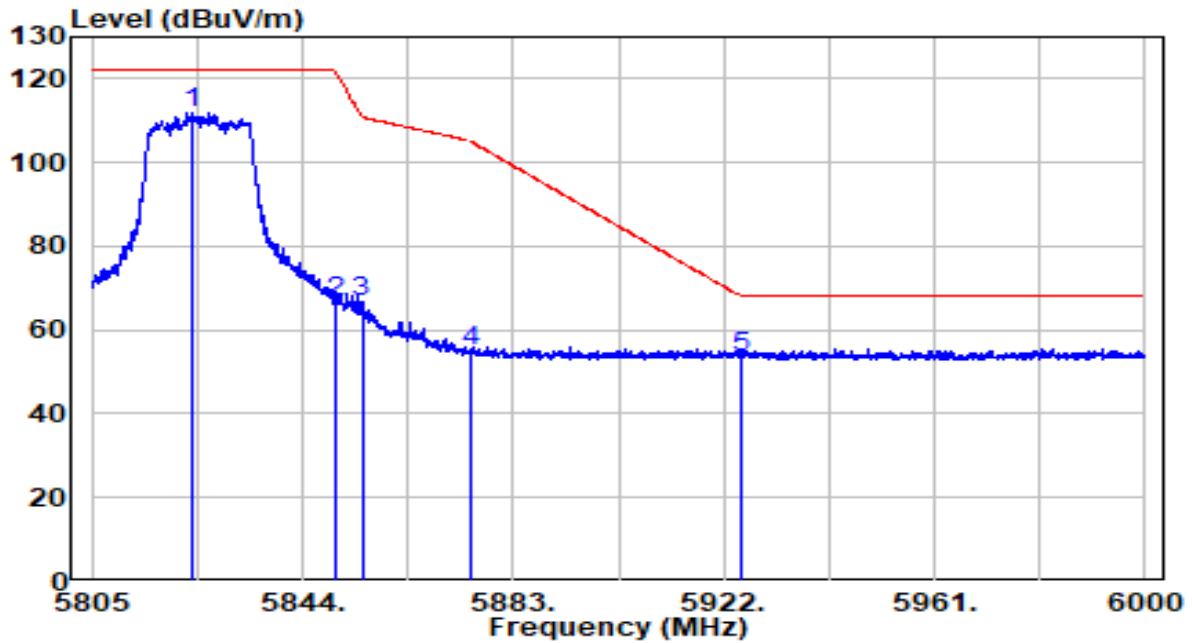

No	Frequency (MHz)	Reading (dBuV)	C.F (dB)	Measurement (dBuV/m)	Margin (dB)	Limit (dBuV/m)	Remark (QP/PK/AV)
1	* 5823.720	90.67	21.32	111.99	N/A	N/A	Peak
2	5850.000	45.24	21.40	66.64	-55.56	122.20	Peak
3	5855.000	45.42	21.42	66.84	-43.96	110.80	Peak
4	5875.000	33.33	21.49	54.81	-50.39	105.20	Peak
5	5925.000	31.68	21.65	53.33	-14.87	68.20	Peak

Note:

1. " *", means this data is the worst emission level.
2. C.F (Correction Factor) = Antenna Factor (dB)+ Cable Loss (dB)– Preamplifier(dB)+16db attenuation.
3. Measurement(dBuV/m) = Reading(dBuV) + C.F (Correction Factor).
- 4.The emission levels of other frequencies are very lower than the limit and not show in test report.

EUT	AP311	Date of Test	2020-09-28
Factor	BBHA 9120D (1GHz~18GHz)_2020	Temp. / Humidity	23.2°C/35%
Polarity	Vertical	Site / Test Engineer	AC1 / Hyde Yu
Test Mode	Transmit by 802.11ax-HE20 at Channel 5825MHz	Test Voltage	120V/60Hz

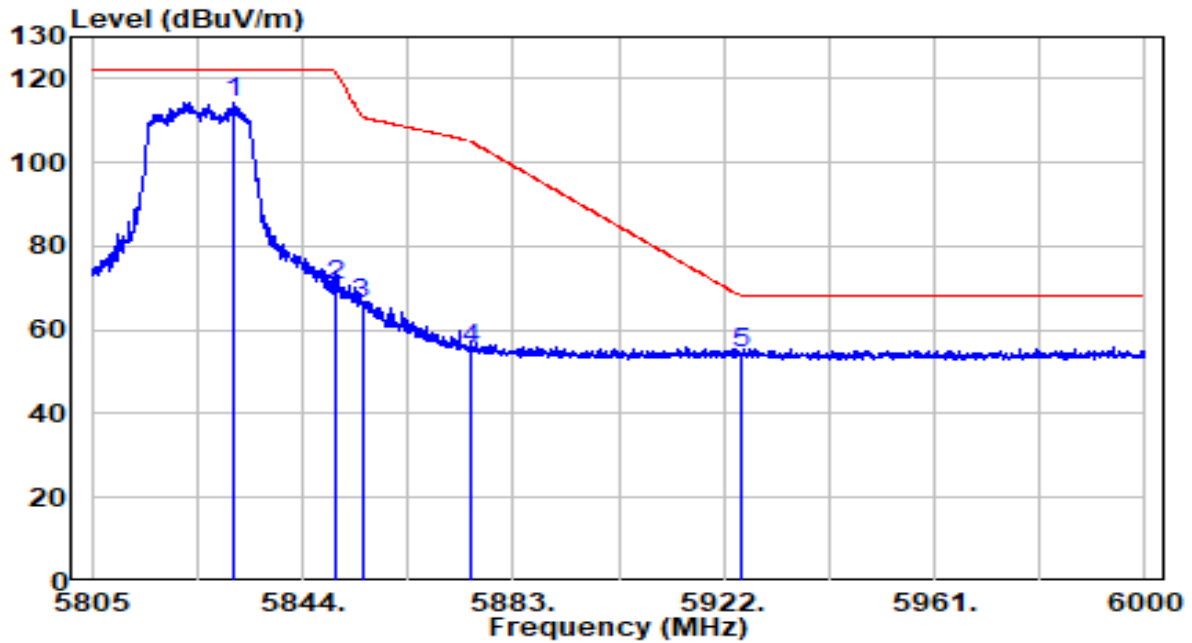

No	Frequency (MHz)	Reading (dBuV)	C.F (dB)	Measurement (dBuV/m)	Margin (dB)	Limit (dBuV/m)	Remark (QP/PK/AV)
1	* 5831.422	93.17	21.34	114.51	N/A	N/A	Peak
2	5850.000	49.04	21.40	70.44	-51.76	122.20	Peak
3	5855.000	44.65	21.42	66.07	-44.73	110.80	Peak
4	5875.000	33.92	21.49	55.40	-49.80	105.20	Peak
5	5925.000	32.67	21.65	54.32	-13.88	68.20	Peak

Note:

1. " *", means this data is the worst emission level.
2. C.F (Correction Factor) = Antenna Factor (dB)+ Cable Loss (dB)– Preamplifier(dB)+16db attenuation.
3. Measurement(dBuV/m) = Reading(dBuV) + C.F (Correction Factor).
- 4.The emission levels of other frequencies are very lower than the limit and not show in test report.

EUT	AP311	Date of Test	2020-09-28
Factor	BBHA 9120D (1GHz~18GHz)_2020	Temp. / Humidity	23.2°C/35%
Polarity	Horizontal	Site / Test Engineer	AC1 / Hyde Yu
Test Mode	Transmit by 802.11ax-HE40 at Channel 5190MHz	Test Voltage	120V/60Hz

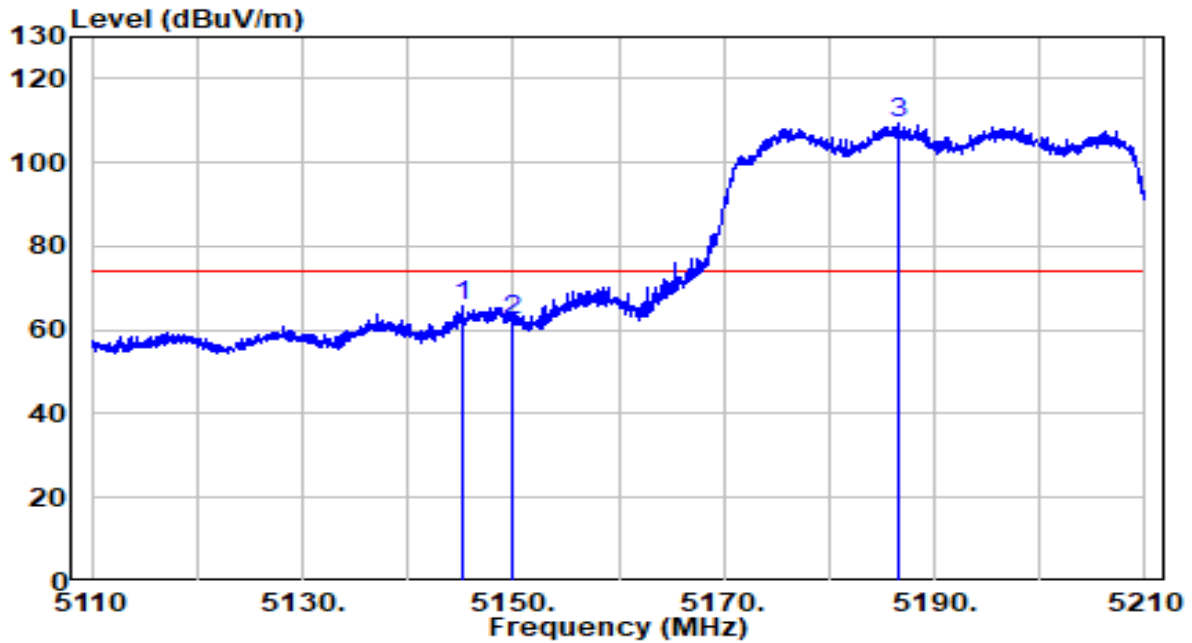

No	Frequency (MHz)	Reading (dBuV)	C.F (dB)	Measurement (dBuV/m)	Margin (dB)	Limit (dBuV/m)	Remark (QP/PK/AV)
1	5145.150	45.94	19.90	65.85	-8.15	74.00	Peak
2	5150.000	42.47	19.91	62.38	-11.62	74.00	Peak
3	* 5186.700	89.22	19.94	109.16	N/A	N/A	Peak

Note:

1. " *", means this data is the worst emission level.
2. C.F (Correction Factor) = Antenna Factor (dB)+ Cable Loss (dB)– Preamplifier(dB)+16db attenuation.
3. Measurement(dBuV/m) = Reading(dBuV) + C.F (Correction Factor).
- 4.The emission levels of other frequencies are very lower than the limit and not show in test report.

EUT	AP311	Date of Test	2020-09-28
Factor	BBHA 9120D (1GHz~18GHz)_2020	Temp. / Humidity	23.2°C/35%
Polarity	Horizontal	Site / Test Engineer	AC1 / Hyde Yu
Test Mode	Transmit by 802.11ax-HE40 at Channel 5190MHz	Test Voltage	120V/60Hz

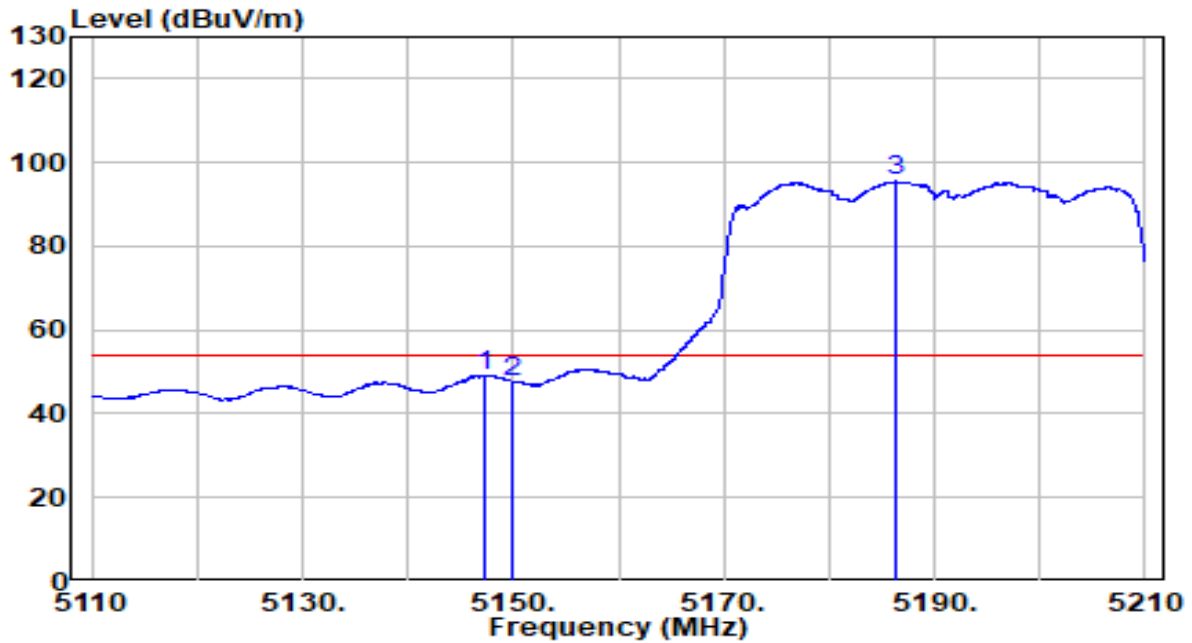

No	Frequency (MHz)	Reading (dBuV)	C.F (dB)	Measurement (dBuV/m)	Margin (dB)	Limit (dBuV/m)	Remark (QP/PK/AV)
1	5147.250	29.29	19.90	49.19	-4.81	54.00	Average
2	5150.000	27.71	19.91	47.62	-6.38	54.00	Average
3	* 5186.300	75.49	19.94	95.43	N/A	N/A	Average

Note:

1. " *", means this data is the worst emission level.
2. C.F (Correction Factor) = Antenna Factor (dB)+ Cable Loss (dB)– Preamplifier(dB)+16db attenuation.
3. Measurement(dBuV/m) = Reading(dBuV) + C.F (Correction Factor).
- 4.The emission levels of other frequencies are very lower than the limit and not show in test report.

EUT	AP311	Date of Test	2020-09-28
Factor	BBHA 9120D (1GHz~18GHz)_2020	Temp. / Humidity	23.2°C/35%
Polarity	Vertical	Site / Test Engineer	AC1 / Hyde Yu
Test Mode	Transmit by 802.11ax-HE40 at Channel 5190MHz	Test Voltage	120V/60Hz

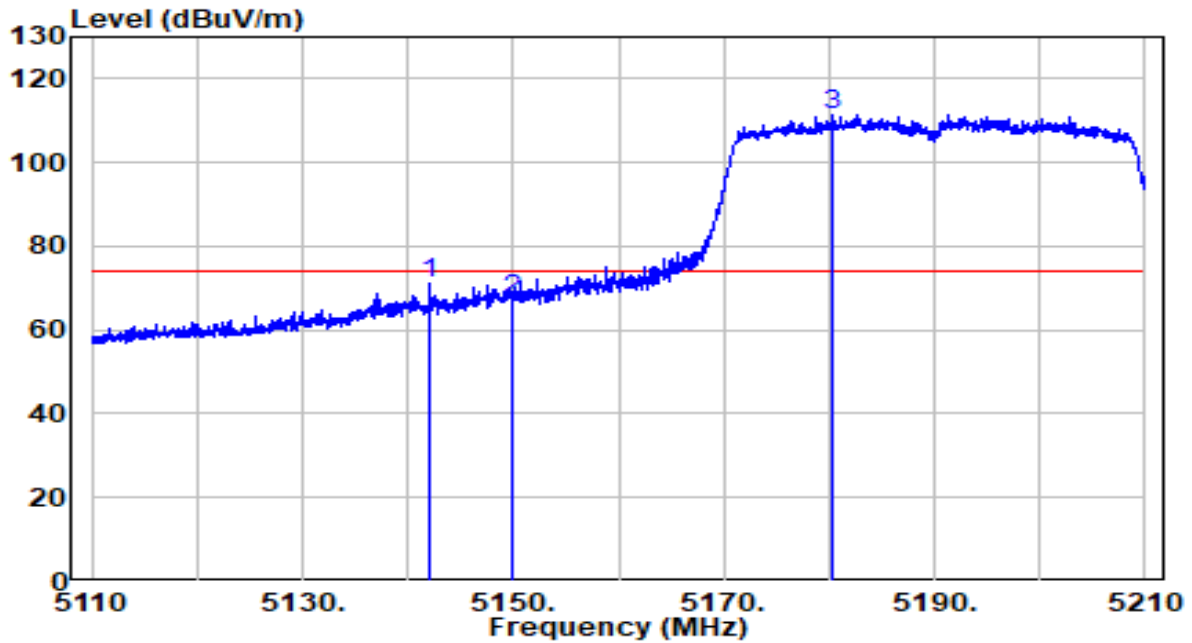

No	Frequency (MHz)	Reading (dBuV)	C.F (dB)	Measurement (dBuV/m)	Margin (dB)	Limit (dBuV/m)	Remark (QP/PK/AV)
1	5142.150	51.15	19.90	71.05	-2.95	74.00	Peak
2	5150.000	47.09	19.91	67.00	-7.00	74.00	Peak
3	* 5180.350	91.41	19.94	111.35	N/A	N/A	Peak

Note:

1. " *", means this data is the worst emission level.
2. C.F (Correction Factor) = Antenna Factor (dB)+ Cable Loss (dB)– Preamplifier(dB)+16db attenuation.
3. Measurement(dBuV/m) = Reading(dBuV) + C.F (Correction Factor).
- 4.The emission levels of other frequencies are very lower than the limit and not show in test report.

EUT	AP311	Date of Test	2020-09-28
Factor	BBHA 9120D (1GHz~18GHz)_2020	Temp. / Humidity	23.2°C/35%
Polarity	Vertical	Site / Test Engineer	AC1 / Hyde Yu
Test Mode	Transmit by 802.11ax-HE40 at Channel 5190MHz	Test Voltage	120V/60Hz

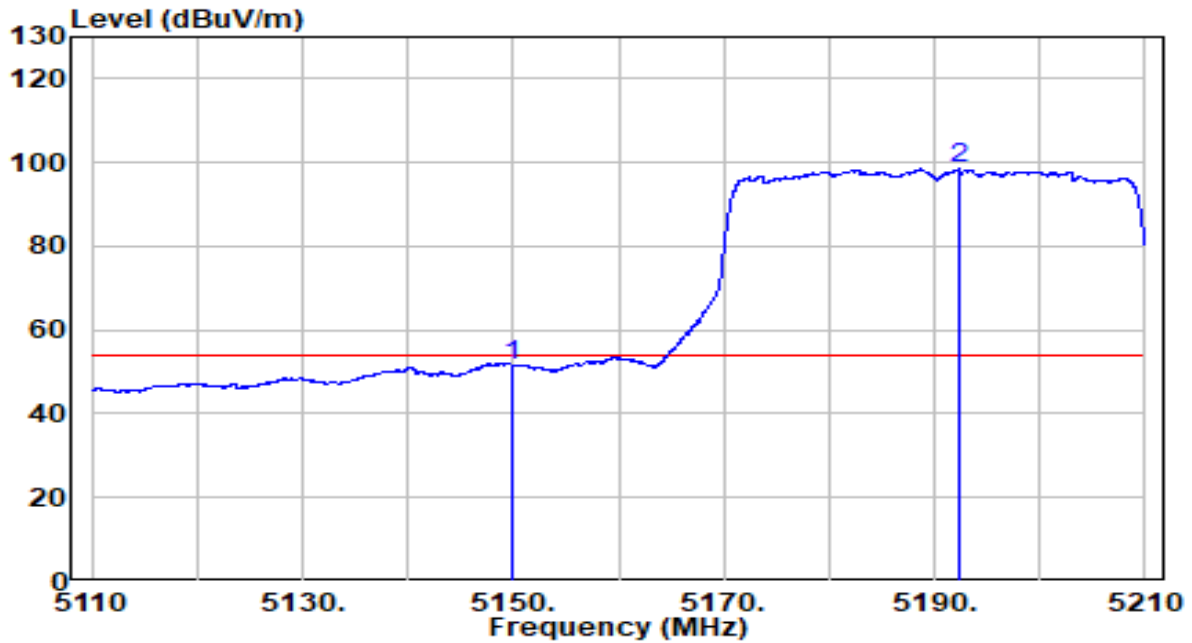

No	Frequency (MHz)	Reading (dBuV)	C.F (dB)	Measurement (dBuV/m)	Margin (dB)	Limit (dBuV/m)	Remark (QP/PK/AV)
1	5150.000	31.66	19.91	51.57	-2.43	54.00	Average
2	* 5192.400	78.59	19.95	98.54	N/A	N/A	Average

Note:

1. " *", means this data is the worst emission level.
2. C.F (Correction Factor) = Antenna Factor (dB)+ Cable Loss (dB)– Preamplifier(dB)+16db attenuation.
3. Measurement(dBuV/m) = Reading(dBuV) + C.F (Correction Factor).
- 4.The emission levels of other frequencies are very lower than the limit and not show in test report.

EUT	AP311	Date of Test	2020-09-28
Factor	BBHA 9120D (1GHz~18GHz)_2020	Temp. / Humidity	23.2°C/35%
Polarity	Horizontal	Site / Test Engineer	AC1 / Hyde Yu
Test Mode	Transmit by 802.11ax-HE40 at Channel 5230MHz	Test Voltage	120V/60Hz

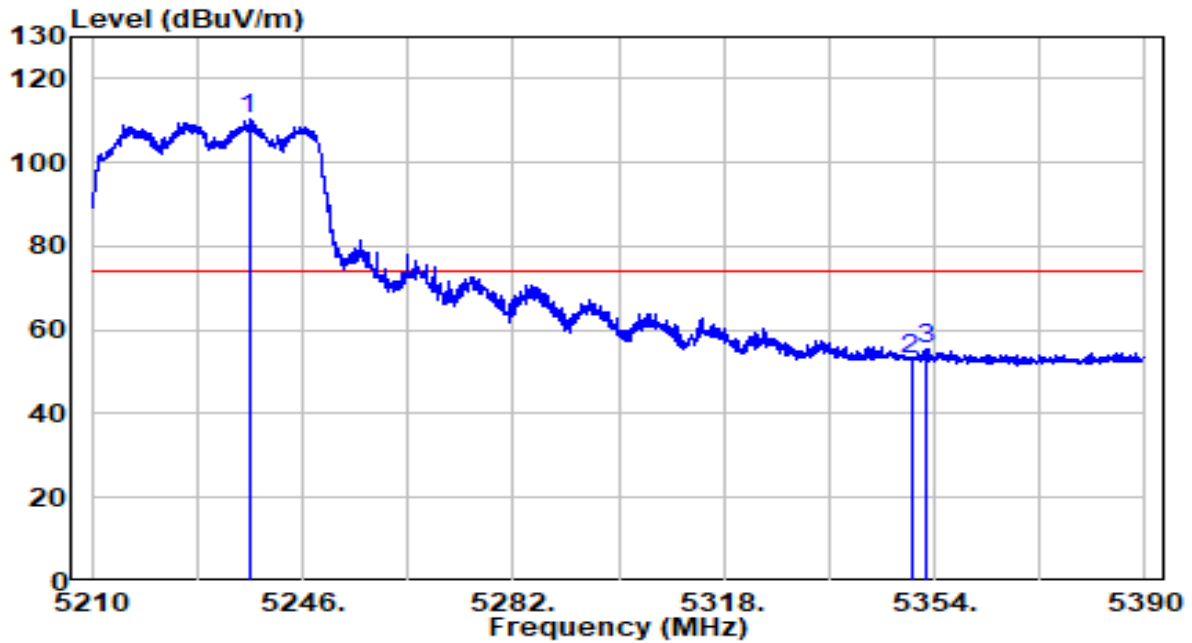

No	Frequency (MHz)	Reading (dBUV)	C.F (dB)	Measurement (dBUV/m)	Margin (dB)	Limit (dBUV/m)	Remark (QP/PK/AV)
1	* 5236.820	90.20	20.00	110.20	N/A	N/A	Peak
2	5350.000	33.00	20.11	53.11	-20.89	74.00	Peak
3	5352.740	35.52	20.12	55.64	-18.36	74.00	Peak

Note:

1. " *", means this data is the worst emission level.
2. C.F (Correction Factor) = Antenna Factor (dB)+ Cable Loss (dB)– Preamplifier(dB)+16db attenuation.
3. Measurement(dBUV/m) = Reading(dBUV) + C.F (Correction Factor).
- 4.The emission levels of other frequencies are very lower than the limit and not show in test report.

EUT	AP311	Date of Test	2020-09-28
Factor	BBHA 9120D (1GHz~18GHz)_2020	Temp. / Humidity	23.2°C/35%
Polarity	Horizontal	Site / Test Engineer	AC1 / Hyde Yu
Test Mode	Transmit by 802.11ax-HE40 at Channel 5230MHz	Test Voltage	120V/60Hz

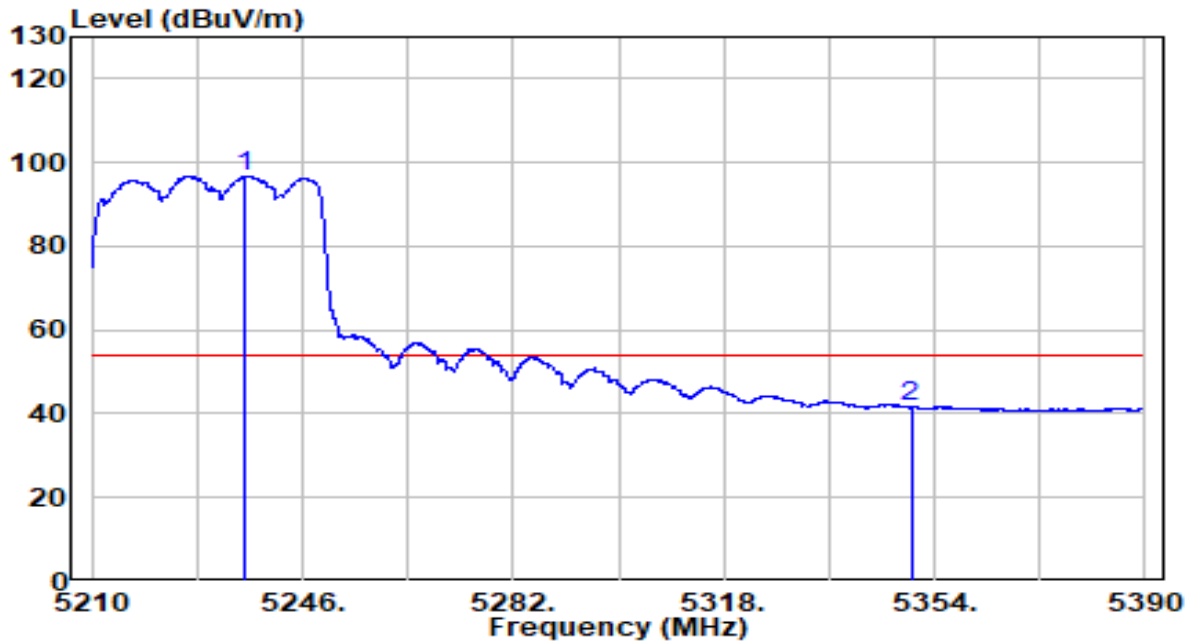

No	Frequency (MHz)	Reading (dBuV)	C.F (dB)	Measurement (dBuV/m)	Margin (dB)	Limit (dBuV/m)	Remark (QP/PK/AV)
1	* 5236.010	76.80	20.00	96.79	N/A	N/A	Average
2	5350.000	21.65	20.11	41.76	-12.24	54.00	Average

Note:

1. " *", means this data is the worst emission level.
2. C.F (Correction Factor) = Antenna Factor (dB)+ Cable Loss (dB)– Preamplifier(dB)+16db attenuation.
3. Measurement(dBuV/m) = Reading(dBuV) + C.F (Correction Factor).
- 4.The emission levels of other frequencies are very lower than the limit and not show in test report.

EUT	AP311	Date of Test	2020-09-28
Factor	BBHA 9120D (1GHz~18GHz)_2020	Temp. / Humidity	23.2°C/35%
Polarity	Vertical	Site / Test Engineer	AC1 / Hyde Yu
Test Mode	Transmit by 802.11ax-HE40 at Channel 5230MHz	Test Voltage	120V/60Hz

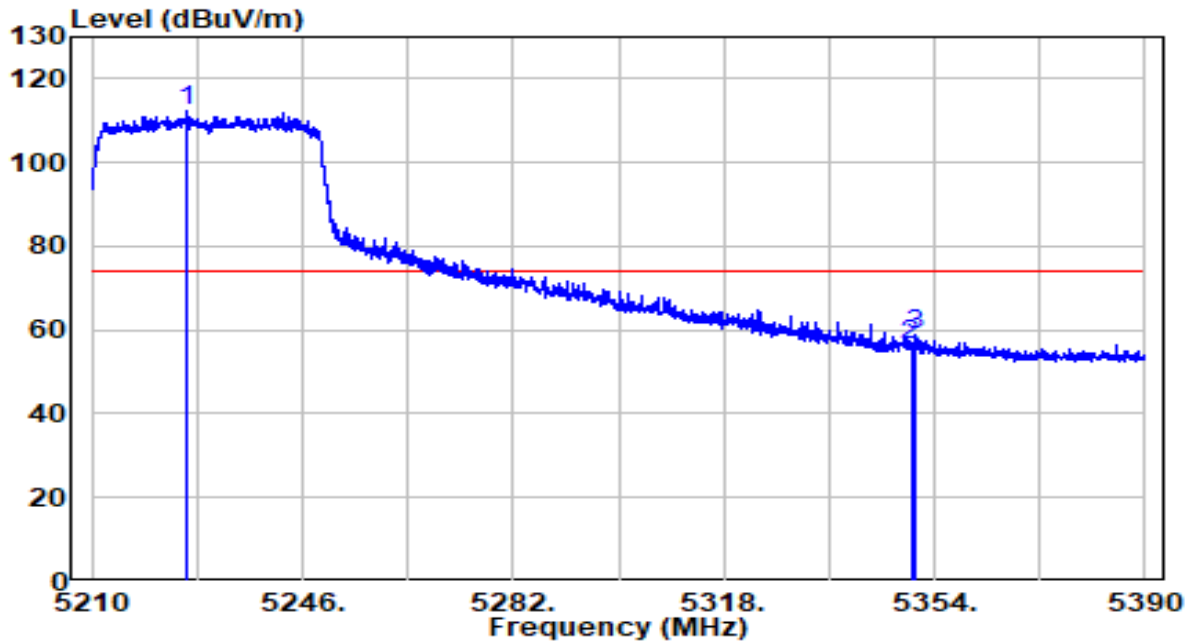

No	Frequency (MHz)	Reading (dBuV)	C.F (dB)	Measurement (dBuV/m)	Margin (dB)	Limit (dBuV/m)	Remark (QP/PK/AV)
1	* 5226.110	92.30	19.99	112.28	N/A	N/A	Peak
2	5350.000	36.38	20.11	56.49	-17.51	74.00	Peak
3	5350.850	38.59	20.11	58.71	-15.29	74.00	Peak

Note:

1. " *", means this data is the worst emission level.
2. C.F (Correction Factor) = Antenna Factor (dB)+ Cable Loss (dB)– Preamplifier(dB)+16db attenuation.
3. Measurement(dBuV/m) = Reading(dBuV) + C.F (Correction Factor).
- 4.The emission levels of other frequencies are very lower than the limit and not show in test report.

EUT	AP311	Date of Test	2020-09-28
Factor	BBHA 9120D (1GHz~18GHz)_2020	Temp. / Humidity	23.2°C/35%
Polarity	Vertical	Site / Test Engineer	AC1 / Hyde Yu
Test Mode	Transmit by 802.11ax-HE40 at Channel 5230MHz	Test Voltage	120V/60Hz

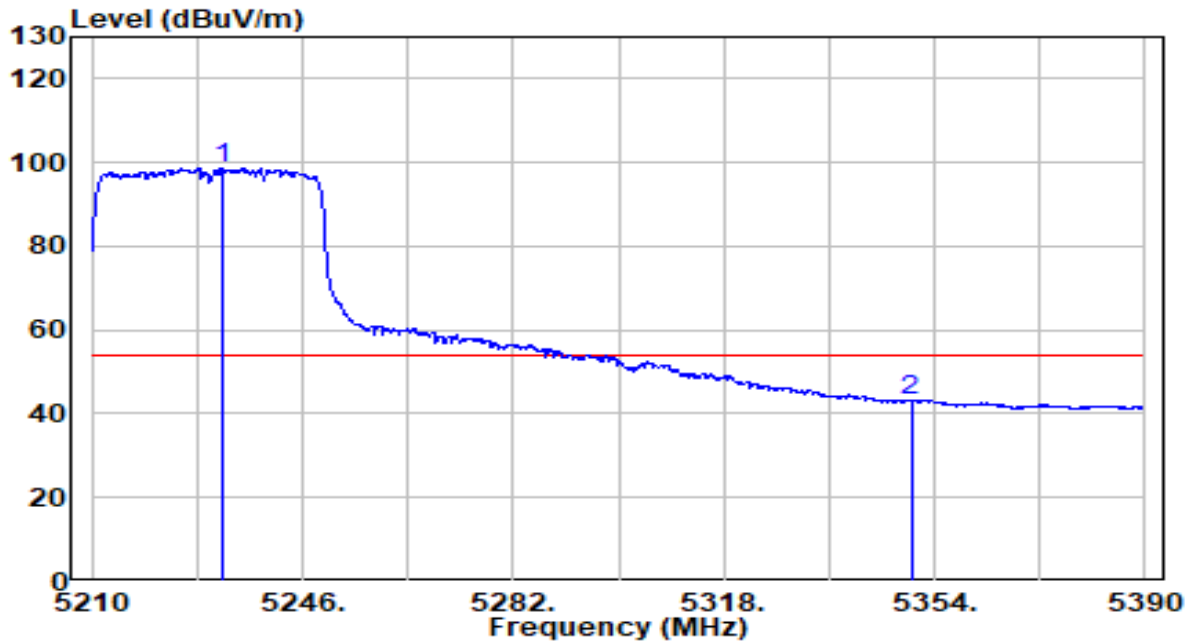

No	Frequency (MHz)	Reading (dBuV)	C.F (dB)	Measurement (dBuV/m)	Margin (dB)	Limit (dBuV/m)	Remark (QP/PK/AV)
1	* 5232.410	78.76	19.99	98.75	N/A	N/A	Average
2	5350.000	22.87	20.11	42.98	-11.02	54.00	Average

Note:

1. " *", means this data is the worst emission level.
2. C.F (Correction Factor) = Antenna Factor (dB)+ Cable Loss (dB)– Preamplifier(dB)+16db attenuation.
3. Measurement(dBuV/m) = Reading(dBuV) + C.F (Correction Factor).
- 4.The emission levels of other frequencies are very lower than the limit and not show in test report.

EUT	AP311	Date of Test	2020-09-28
Factor	BBHA 9120D (1GHz~18GHz)_2020	Temp. / Humidity	23.2°C/35%
Polarity	Horizontal	Site / Test Engineer	AC1 / Hyde Yu
Test Mode	Transmit by 802.11ax-HE40 at Channel 5310MHz	Test Voltage	120V/60Hz

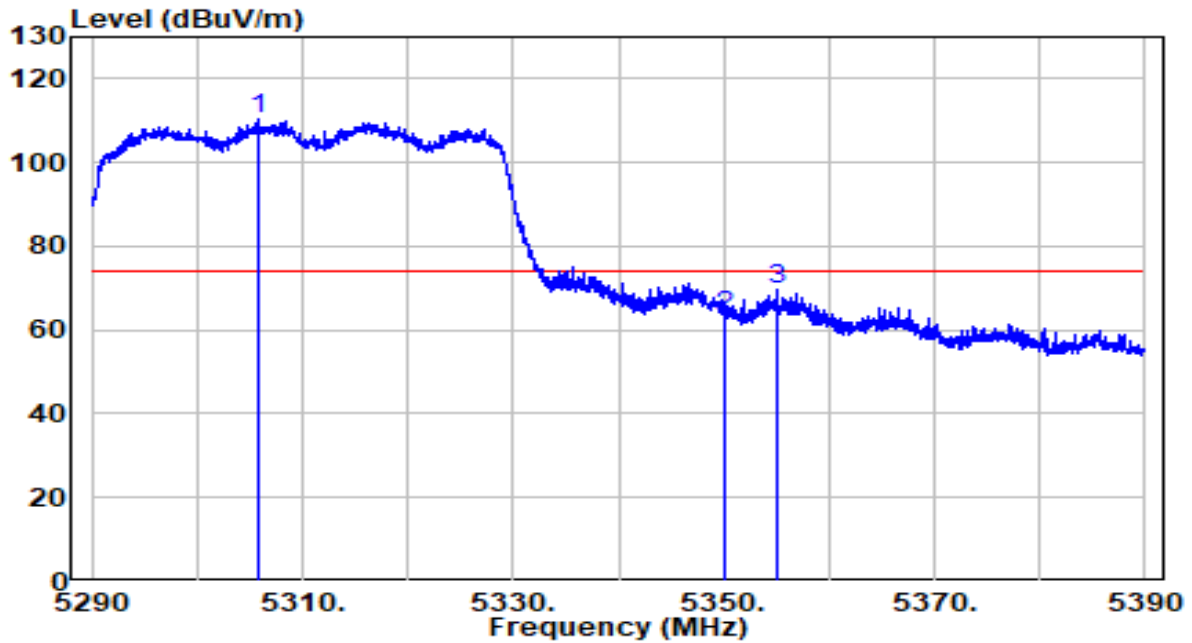

No	Frequency (MHz)	Reading (dBuV)	C.F (dB)	Measurement (dBuV/m)	Margin (dB)	Limit (dBuV/m)	Remark (QP/PK/AV)
1	* 5305.850	90.48	20.07	110.55	N/A	N/A	Peak
2	5350.000	43.02	20.11	63.13	-10.87	74.00	Peak
3	5355.100	49.53	20.12	69.65	-4.35	74.00	Peak

Note:

1. " *", means this data is the worst emission level.
2. C.F (Correction Factor) = Antenna Factor (dB)+ Cable Loss (dB)– Preamplifier(dB)+16db attenuation.
3. Measurement(dBuV/m) = Reading(dBuV) + C.F (Correction Factor).
- 4.The emission levels of other frequencies are very lower than the limit and not show in test report.

EUT	AP311	Date of Test	2020-09-28
Factor	BBHA 9120D (1GHz~18GHz)_2020	Temp. / Humidity	23.2°C/35%
Polarity	Horizontal	Site / Test Engineer	AC1 / Hyde Yu
Test Mode	Transmit by 802.11ax-HE40 at Channel 5310MHz	Test Voltage	120V/60Hz

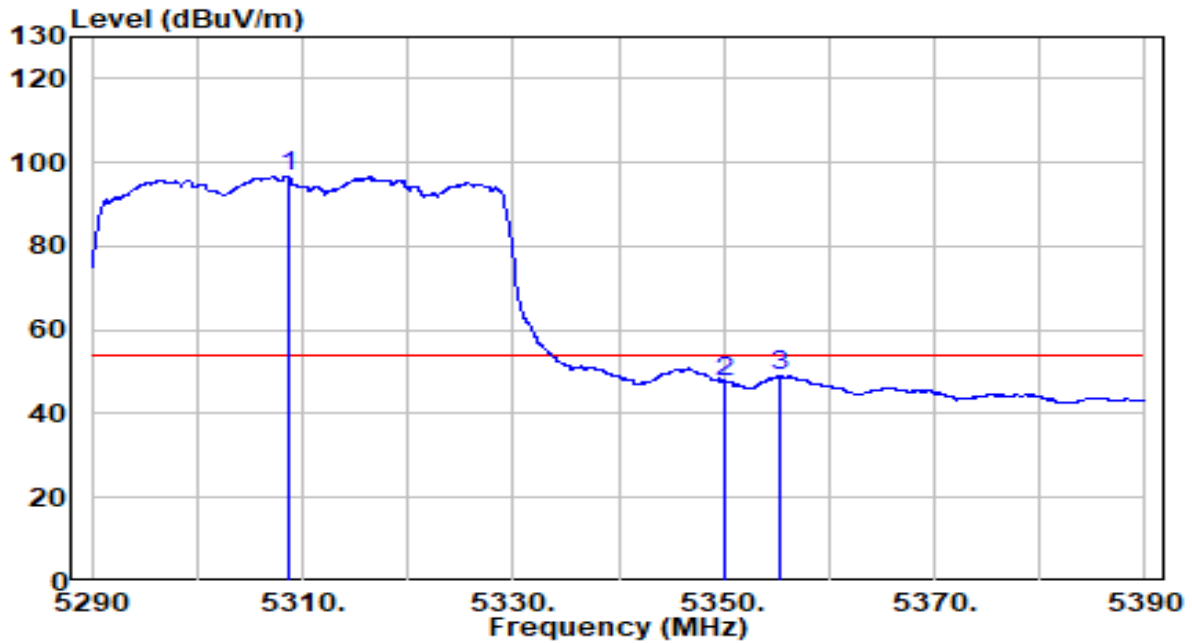

No	Frequency (MHz)	Reading (dBuV)	C.F (dB)	Measurement (dBuV/m)	Margin (dB)	Limit (dBuV/m)	Remark (QP/PK/AV)
1	* 5308.750	76.72	20.07	96.79	N/A	N/A	Average
2	5350.000	27.71	20.11	47.83	-6.17	54.00	Average
3	5355.450	29.02	20.12	49.14	-4.86	54.00	Average

Note:

1. " *", means this data is the worst emission level.
2. C.F (Correction Factor) = Antenna Factor (dB)+ Cable Loss (dB)– Preamplifier(dB)+16db attenuation.
3. Measurement(dBuV/m) = Reading(dBuV) + C.F (Correction Factor).
- 4.The emission levels of other frequencies are very lower than the limit and not show in test report.

EUT	AP311	Date of Test	2020-09-28
Factor	BBHA 9120D (1GHz~18GHz)_2020	Temp. / Humidity	23.2°C/35%
Polarity	Vertical	Site / Test Engineer	AC1 / Hyde Yu
Test Mode	Transmit by 802.11ax-HE40 at Channel 5310MHz	Test Voltage	120V/60Hz

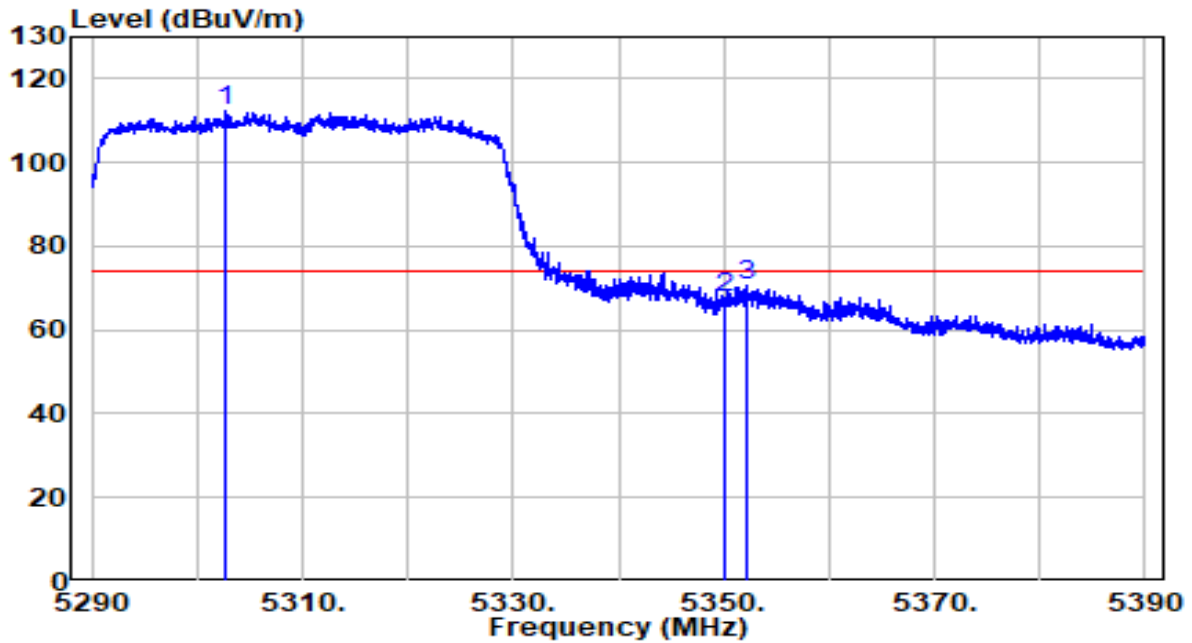

No	Frequency (MHz)	Reading (dBuV)	C.F (dB)	Measurement (dBuV/m)	Margin (dB)	Limit (dBuV/m)	Remark (QP/PK/AV)
1	* 5302.650	92.16	20.06	112.23	N/A	N/A	Peak
2	5350.000	47.40	20.11	67.51	-6.49	74.00	Peak
3	5352.200	50.75	20.12	70.87	-3.13	74.00	Peak

Note:

1. " *", means this data is the worst emission level.
2. C.F (Correction Factor) = Antenna Factor (dB)+ Cable Loss (dB)– Preamplifier(dB)+16db attenuation.
3. Measurement(dBuV/m) = Reading(dBuV) + C.F (Correction Factor).
- 4.The emission levels of other frequencies are very lower than the limit and not show in test report.

EUT	AP311	Date of Test	2020-09-28
Factor	BBHA 9120D (1GHz~18GHz)_2020	Temp. / Humidity	23.2°C/35%
Polarity	Vertical	Site / Test Engineer	AC1 / Hyde Yu
Test Mode	Transmit by 802.11ax-HE40 at Channel 5310MHz	Test Voltage	120V/60Hz

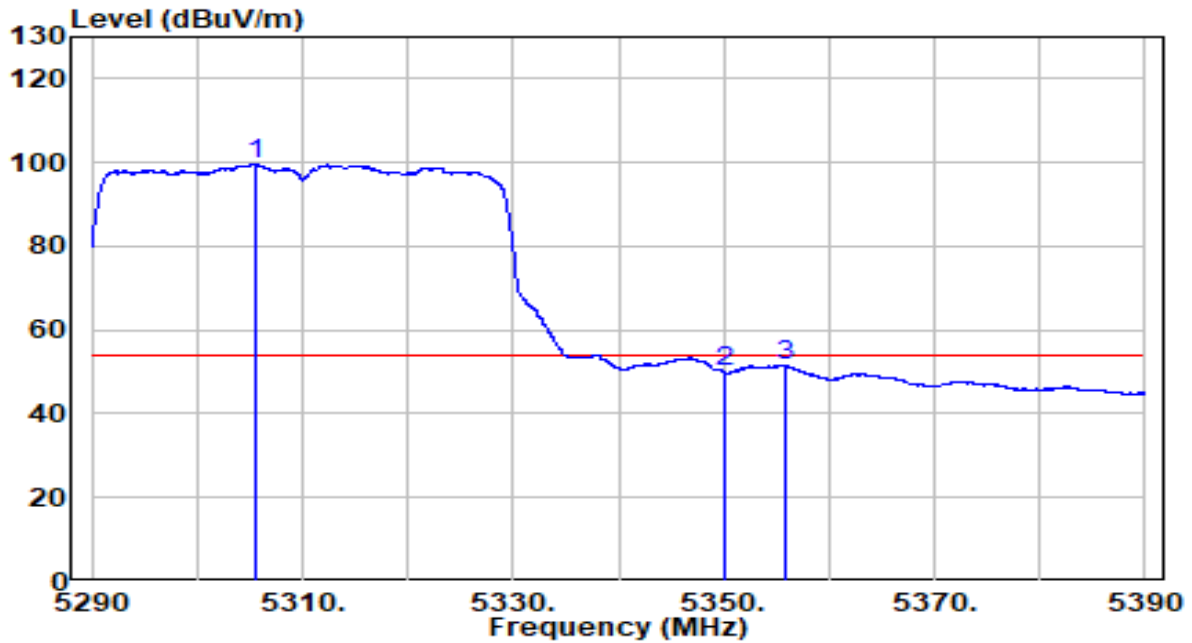

No	Frequency (MHz)	Reading (dBuV)	C.F (dB)	Measurement (dBuV/m)	Margin (dB)	Limit (dBuV/m)	Remark (QP/PK/AV)
1	* 5305.500	79.44	20.07	99.51	N/A	N/A	Average
2	5350.000	29.88	20.11	50.00	-4.00	54.00	Average
3	5355.900	31.43	20.12	51.55	-2.45	54.00	Average

Note:

1. " *", means this data is the worst emission level.
2. C.F (Correction Factor) = Antenna Factor (dB)+ Cable Loss (dB)– Preamplifier(dB)+16db attenuation.
3. Measurement(dBuV/m) = Reading(dBuV) + C.F (Correction Factor).
- 4.The emission levels of other frequencies are very lower than the limit and not show in test report.

EUT	AP311	Date of Test	2020-09-28
Factor	BBHA 9120D (1GHz~18GHz)_2020	Temp. / Humidity	23.2°C/35%
Polarity	Horizontal	Site / Test Engineer	AC1 / Hyde Yu
Test Mode	Transmit by 802.11ax-HE40 at Channel 5510MHz	Test Voltage	120V/60Hz

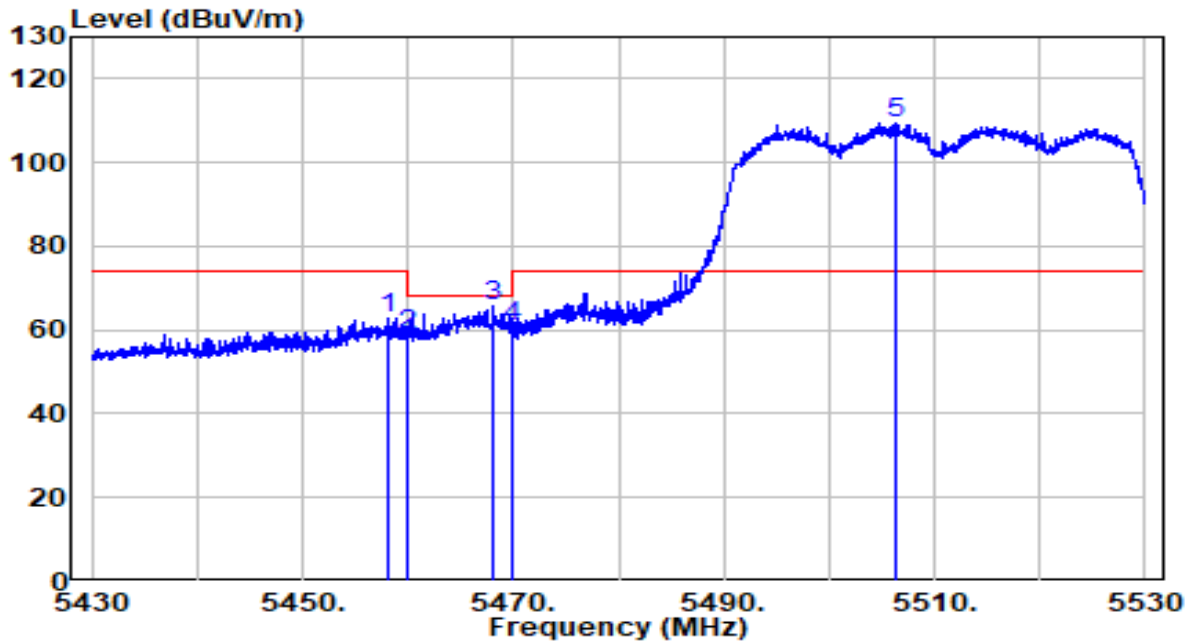

No	Frequency (MHz)	Reading (dBuV)	C.F (dB)	Measurement (dBuV/m)	Margin (dB)	Limit (dBuV/m)	Remark (QP/PK/AV)
1	5458.050	42.59	20.23	62.81	-11.19	74.00	Peak
2	5460.000	38.56	20.23	58.79	-9.41	68.20	Peak
3	5468.200	45.32	20.24	65.56	-2.64	68.20	Peak
4	5470.000	40.43	20.24	60.67	-7.53	68.20	Peak
5	* 5506.300	89.15	20.29	109.44	N/A	N/A	Peak

Note:

1. " *", means this data is the worst emission level.
2. C.F (Correction Factor) = Antenna Factor (dB)+ Cable Loss (dB)– Preamplifier(dB)+16db attenuation.
3. Measurement(dBuV/m) = Reading(dBuV) + C.F (Correction Factor).
- 4.The emission levels of other frequencies are very lower than the limit and not show in test report.

EUT	AP311	Date of Test	2020-09-28
Factor	BBHA 9120D (1GHz~18GHz)_2020	Temp. / Humidity	23.2°C/35%
Polarity	Horizontal	Site / Test Engineer	AC1 / Hyde Yu
Test Mode	Transmit by 802.11ax-HE40 at Channel 5510MHz	Test Voltage	120V/60Hz

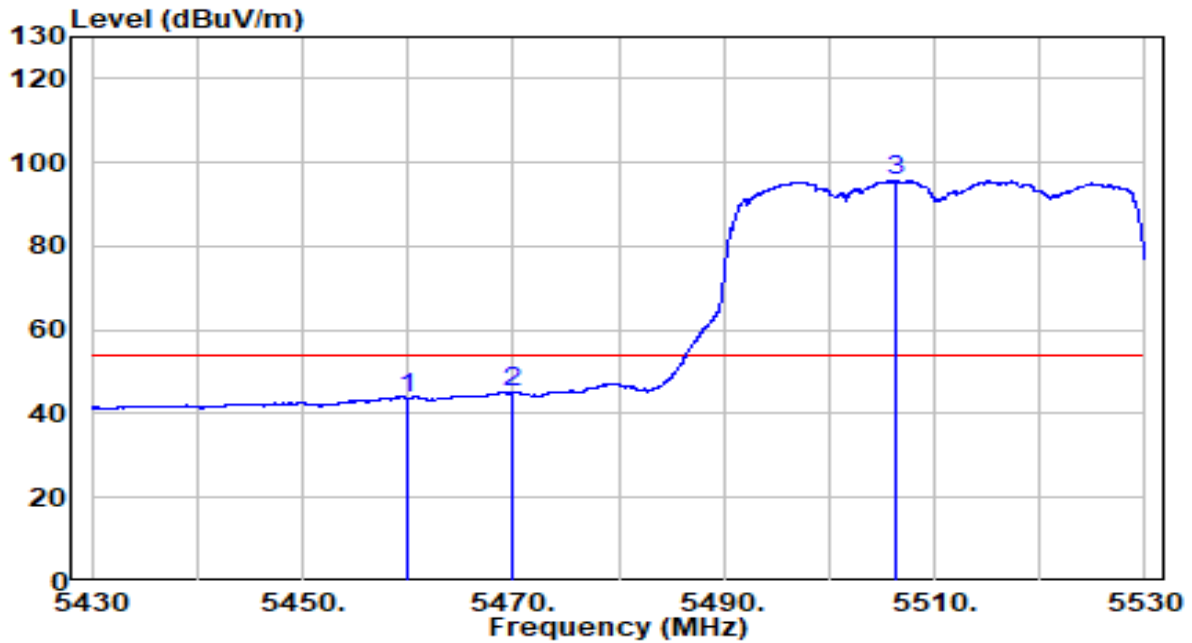

No	Frequency (MHz)	Reading (dBuV)	C.F (dB)	Measurement (dBuV/m)	Margin (dB)	Limit (dBuV/m)	Remark (QP/PK/AV)
1	5460.000	23.41	20.23	43.64	-10.36	54.00	Average
2	5470.000	24.73	20.24	44.97	-9.03	54.00	Average
3	* 5506.400	75.30	20.29	95.59	N/A	N/A	Average

Note:

1. " *", means this data is the worst emission level.
2. C.F (Correction Factor) = Antenna Factor (dB)+ Cable Loss (dB)– Preamplifier(dB)+16db attenuation.
3. Measurement(dBuV/m) = Reading(dBuV) + C.F (Correction Factor).
- 4.The emission levels of other frequencies are very lower than the limit and not show in test report.

EUT	AP311	Date of Test	2020-09-28
Factor	BBHA 9120D (1GHz~18GHz)_2020	Temp. / Humidity	23.2°C/35%
Polarity	Vertical	Site / Test Engineer	AC1 / Hyde Yu
Test Mode	Transmit by 802.11ax-HE40 at Channel 5510MHz	Test Voltage	120V/60Hz

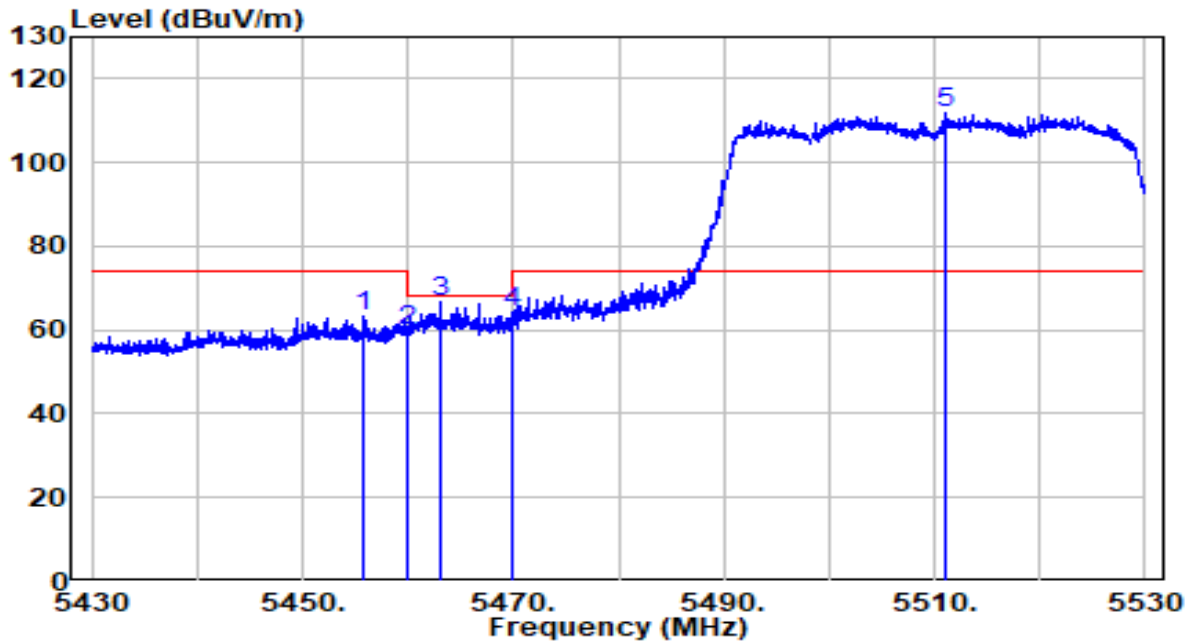

No	Frequency (MHz)	Reading (dBuV)	C.F (dB)	Measurement (dBuV/m)	Margin (dB)	Limit (dBuV/m)	Remark (QP/PK/AV)
1	5455.850	43.20	20.22	63.43	-10.57	74.00	Peak
2	5460.000	39.71	20.23	59.94	-8.26	68.20	Peak
3	5463.050	46.54	20.23	66.77	-1.43	68.20	Peak
4	5470.000	44.20	20.24	64.44	-3.76	68.20	Peak
5	* 5511.150	91.44	20.31	111.74	N/A	N/A	Peak

Note:

1. " *", means this data is the worst emission level.
2. C.F (Correction Factor) = Antenna Factor (dB)+ Cable Loss (dB)– Preamplifier(dB)+16db attenuation.
3. Measurement(dBuV/m) = Reading(dBuV) + C.F (Correction Factor).
- 4.The emission levels of other frequencies are very lower than the limit and not show in test report.

EUT	AP311	Date of Test	2020-09-28
Factor	BBHA 9120D (1GHz~18GHz)_2020	Temp. / Humidity	23.2°C/35%
Polarity	Vertical	Site / Test Engineer	AC1 / Hyde Yu
Test Mode	Transmit by 802.11ax-HE40 at Channel 5510MHz	Test Voltage	120V/60Hz

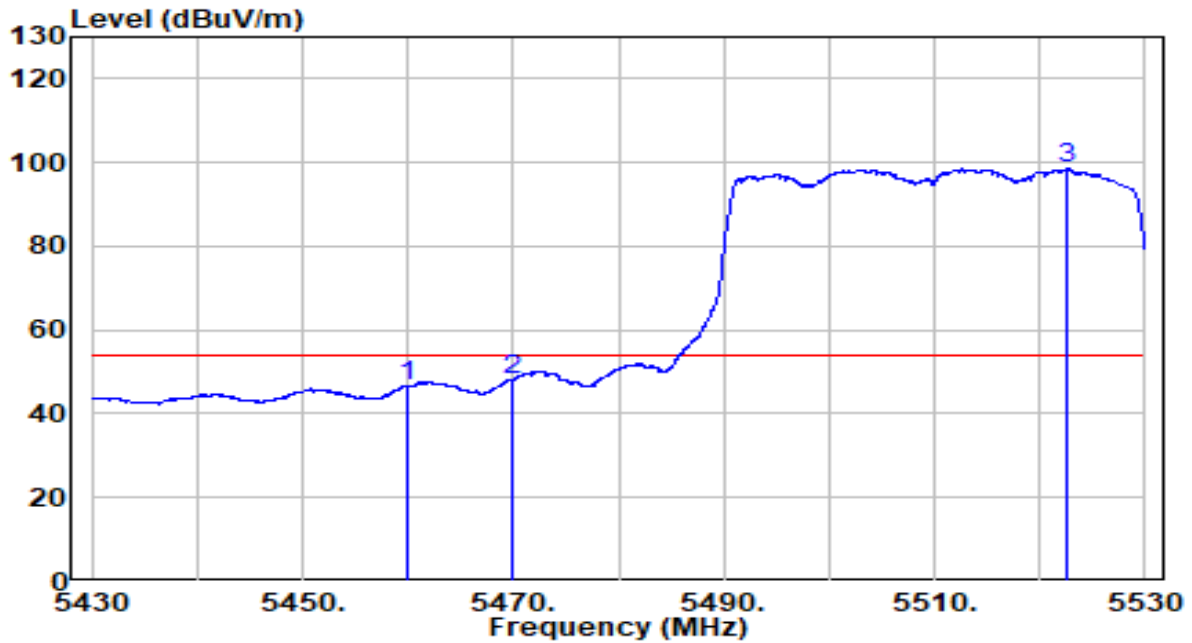

No	Frequency (MHz)	Reading (dBuV)	C.F (dB)	Measurement (dBuV/m)	Margin (dB)	Limit (dBuV/m)	Remark (QP/PK/AV)
1	5460.000	26.48	20.23	46.71	-7.29	54.00	Average
2	5470.000	27.86	20.24	48.10	-5.90	54.00	Average
3	* 5522.600	78.11	20.34	98.45	N/A	N/A	Average

Note:

1. " *", means this data is the worst emission level.
2. C.F (Correction Factor) = Antenna Factor (dB)+ Cable Loss (dB)– Preamplifier(dB)+16db attenuation.
3. Measurement(dBuV/m) = Reading(dBuV) + C.F (Correction Factor).
- 4.The emission levels of other frequencies are very lower than the limit and not show in test report.

EUT	AP311	Date of Test	2020-09-28
Factor	BBHA 9120D (1GHz~18GHz)_2020	Temp. / Humidity	23.2°C/35%
Polarity	Horizontal	Site / Test Engineer	AC1 / Hyde Yu
Test Mode	Transmit by 802.11ax-HE40 at Channel 5670MHz	Test Voltage	120V/60Hz

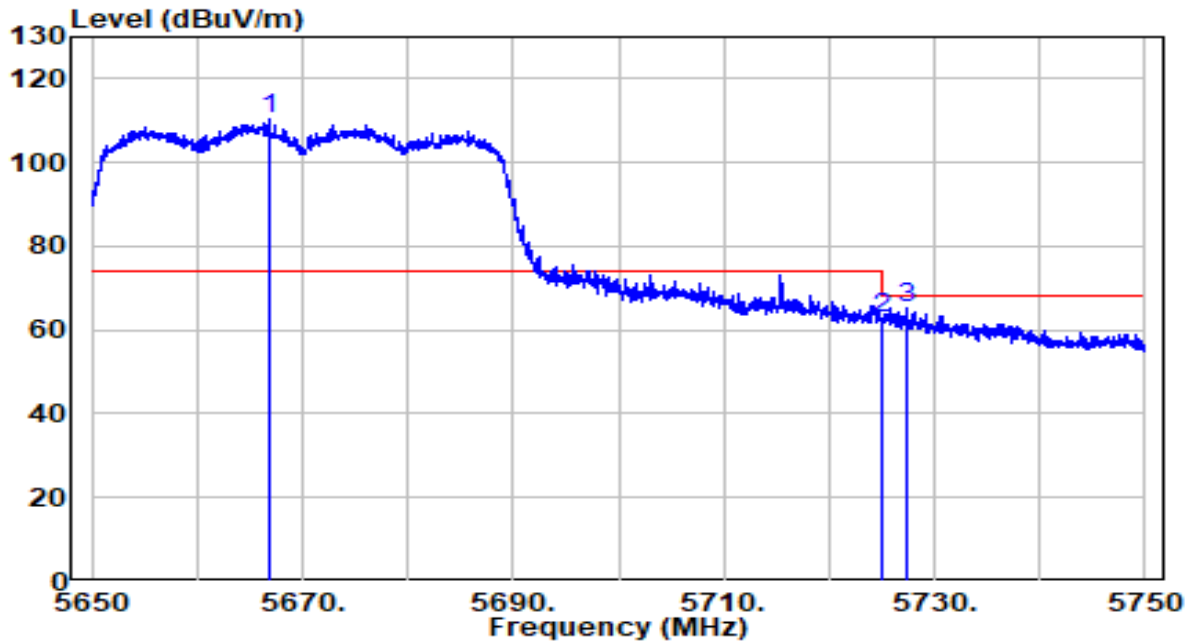

No	Frequency (MHz)	Reading (dBuV)	C.F (dB)	Measurement (dBuV/m)	Margin (dB)	Limit (dBuV/m)	Remark (QP/PK/AV)
1	* 5666.750	89.37	20.81	110.18	N/A	N/A	Peak
2	5725.000	42.02	21.00	63.02	-5.18	68.20	Peak
3	5727.300	44.41	21.01	65.42	-2.78	68.20	Peak

Note:

1. " *", means this data is the worst emission level.
2. C.F (Correction Factor) = Antenna Factor (dB)+ Cable Loss (dB)– Preamplifier(dB)+16db attenuation.
3. Measurement(dBuV/m) = Reading(dBuV) + C.F (Correction Factor).
- 4.The emission levels of other frequencies are very lower than the limit and not show in test report.

EUT	AP311	Date of Test	2020-09-28
Factor	BBHA 9120D (1GHz~18GHz)_2020	Temp. / Humidity	23.2°C/35%
Polarity	Vertical	Site / Test Engineer	AC1 / Hyde Yu
Test Mode	Transmit by 802.11ax-HE40 at Channel 5670MHz	Test Voltage	120V/60Hz

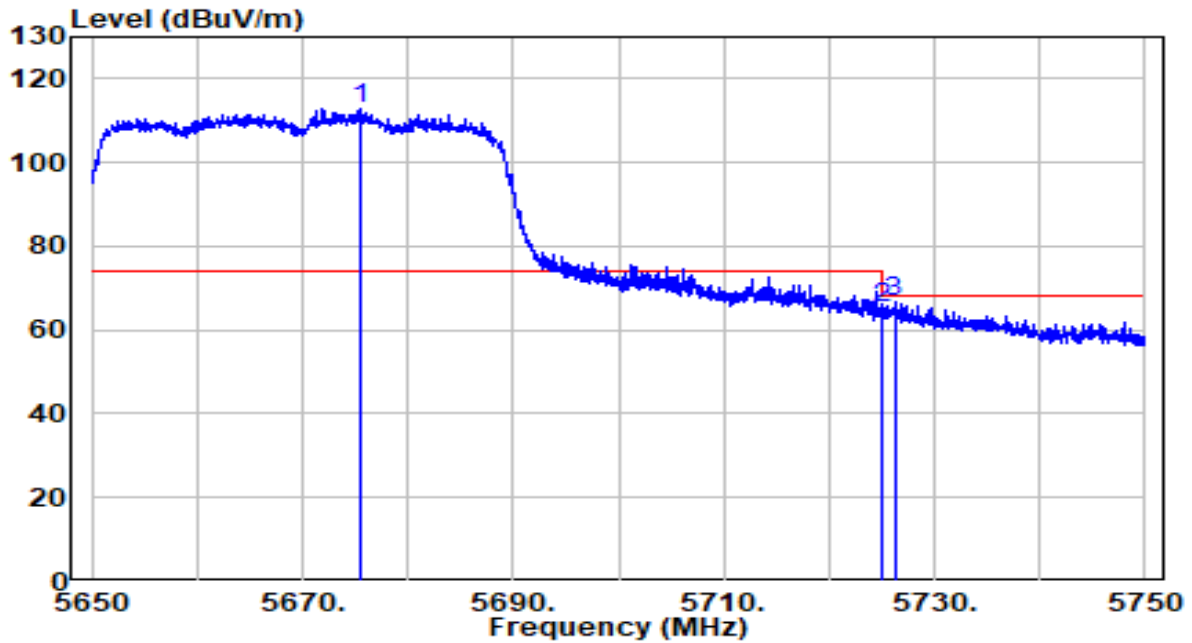

No	Frequency (MHz)	Reading (dBuV)	C.F (dB)	Measurement (dBuV/m)	Margin (dB)	Limit (dBuV/m)	Remark (QP/PK/AV)
1	* 5675.400	92.06	20.84	112.90	N/A	N/A	Peak
2	5725.000	44.30	21.00	65.30	-2.90	68.20	Peak
3	5726.200	45.47	21.00	66.47	-1.73	68.20	Peak

Note:

1. " *", means this data is the worst emission level.
2. C.F (Correction Factor) = Antenna Factor (dB)+ Cable Loss (dB)– Preamplifier(dB)+16db attenuation.
3. Measurement(dBuV/m) = Reading(dBuV) + C.F (Correction Factor).
- 4.The emission levels of other frequencies are very lower than the limit and not show in test report.

EUT	AP311	Date of Test	2020-09-28
Factor	BBHA 9120D (1GHz~18GHz)_2020	Temp. / Humidity	23.2°C/35%
Polarity	Horizontal	Site / Test Engineer	AC1 / Hyde Yu
Test Mode	Transmit by 802.11ax-HE40 at Channel 5755MHz	Test Voltage	120V/60Hz

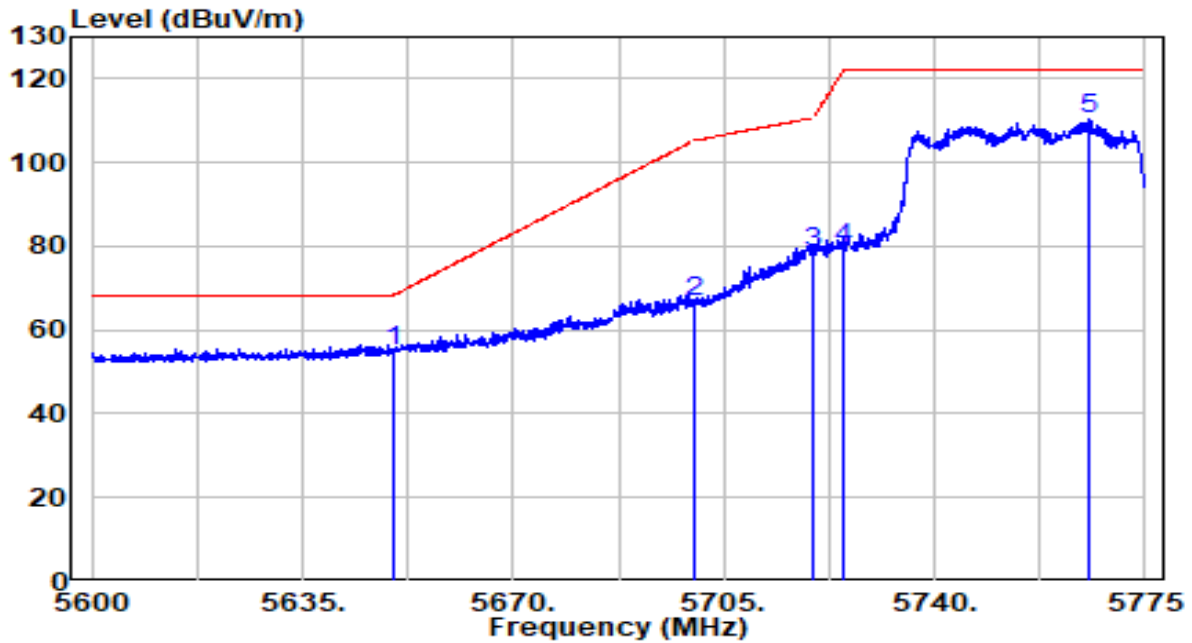

No	Frequency (MHz)	Reading (dBuV)	C.F (dB)	Measurement (dBuV/m)	Margin (dB)	Limit (dBuV/m)	Remark (QP/PK/AV)
1	5650.000	33.98	20.76	54.73	-13.47	68.20	Peak
2	5700.000	45.94	20.92	66.86	-38.34	105.20	Peak
3	5720.000	57.46	20.98	78.44	-32.36	110.80	Peak
4	5725.000	58.35	21.00	79.35	-42.85	122.20	Peak
5	* 5765.725	89.40	21.13	110.54	N/A	N/A	Peak

Note:

1. " *", means this data is the worst emission level.
2. C.F (Correction Factor) = Antenna Factor (dB)+ Cable Loss (dB)– Preamplifier(dB)+16db attenuation.
3. Measurement(dBuV/m) = Reading(dBuV) + C.F (Correction Factor).
- 4.The emission levels of other frequencies are very lower than the limit and not show in test report.

EUT	AP311	Date of Test	2020-09-28
Factor	BBHA 9120D (1GHz~18GHz)_2020	Temp. / Humidity	23.2°C/35%
Polarity	Vertical	Site / Test Engineer	AC1 / Hyde Yu
Test Mode	Transmit by 802.11ax-HE40 at Channel 5755MHz	Test Voltage	120V/60Hz

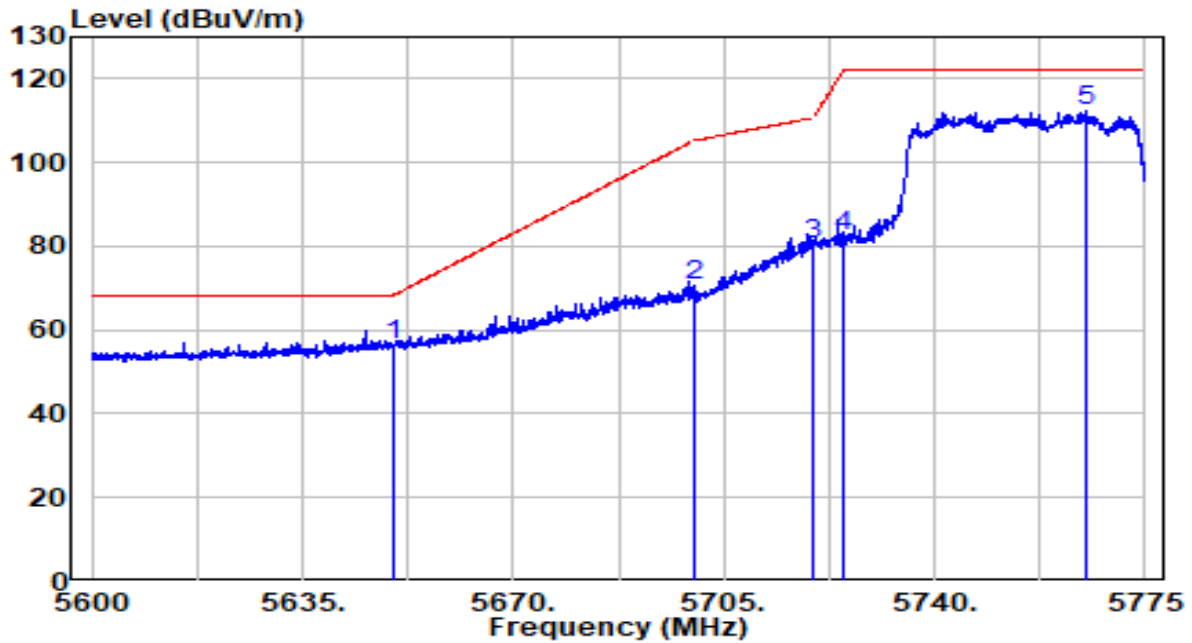

No	Frequency (MHz)	Reading (dBuV)	C.F (dB)	Measurement (dBuV/m)	Margin (dB)	Limit (dBuV/m)	Remark (QP/PK/AV)
1	5650.000	35.82	20.76	56.58	-11.62	68.20	Peak
2	5700.000	49.54	20.92	70.46	-34.74	105.20	Peak
3	5720.000	59.34	20.98	80.32	-30.48	110.80	Peak
4	5725.000	61.32	21.00	82.32	-39.88	122.20	Peak
5	* 5765.112	90.99	21.13	112.12	N/A	N/A	Peak

Note:

1. " *", means this data is the worst emission level.
2. C.F (Correction Factor) = Antenna Factor (dB)+ Cable Loss (dB)– Preamplifier(dB)+16db attenuation.
3. Measurement(dBuV/m) = Reading(dBuV) + C.F (Correction Factor).
- 4.The emission levels of other frequencies are very lower than the limit and not show in test report.

EUT	AP311	Date of Test	2020-09-28
Factor	BBHA 9120D (1GHz~18GHz)_2020	Temp. / Humidity	23.2°C/35%
Polarity	Horizontal	Site / Test Engineer	AC1 / Hyde Yu
Test Mode	Transmit by 802.11ax-HE40 at Channel 5795MHz	Test Voltage	120V/60Hz

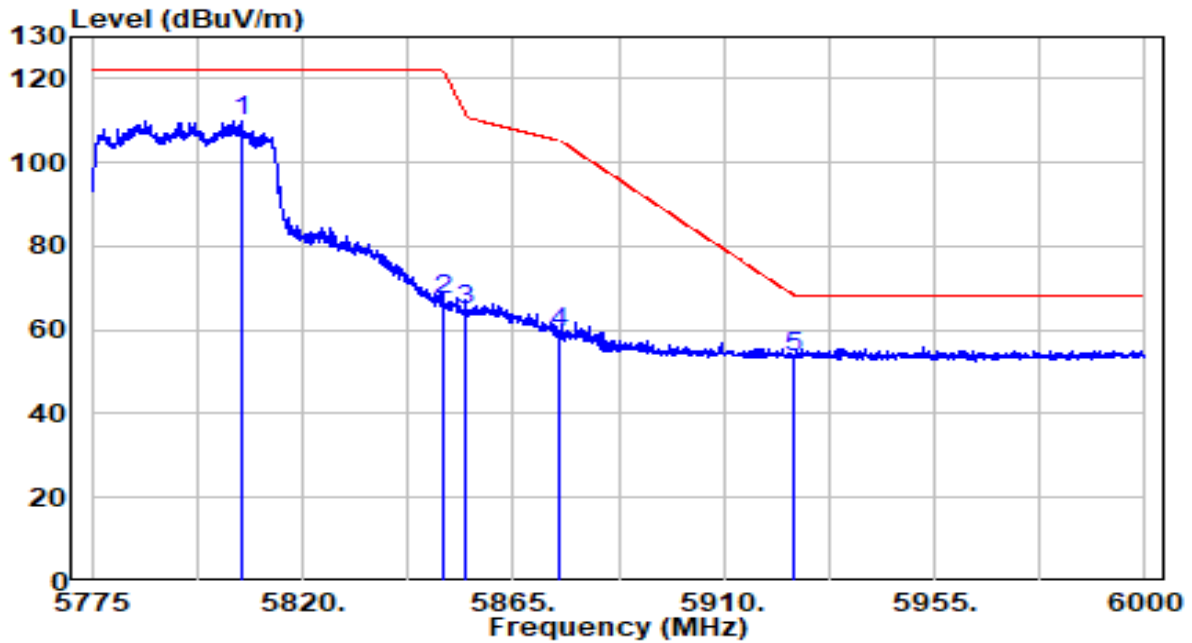

No	Frequency (MHz)	Reading (dBuV)	C.F (dB)	Measurement (dBuV/m)	Margin (dB)	Limit (dBuV/m)	Remark (QP/PK/AV)
1	* 5806.837	88.79	21.26	110.06	N/A	N/A	Peak
2	5850.000	45.85	21.40	67.26	-54.94	122.20	Peak
3	5855.000	43.27	21.42	64.69	-46.11	110.80	Peak
4	5875.000	38.11	21.49	59.60	-45.60	105.20	Peak
5	5925.000	31.95	21.65	53.60	-14.60	68.20	Peak

Note:

1. " *", means this data is the worst emission level.
2. C.F (Correction Factor) = Antenna Factor (dB)+ Cable Loss (dB)– Preamplifier(dB)+16db attenuation.
3. Measurement(dBuV/m) = Reading(dBuV) + C.F (Correction Factor).
- 4.The emission levels of other frequencies are very lower than the limit and not show in test report.

EUT	AP311	Date of Test	2020-09-28
Factor	BBHA 9120D (1GHz~18GHz)_2020	Temp. / Humidity	23.2°C/35%
Polarity	Vertical	Site / Test Engineer	AC1 / Hyde Yu
Test Mode	Transmit by 802.11ax-HE40 at Channel 5795MHz	Test Voltage	120V/60Hz

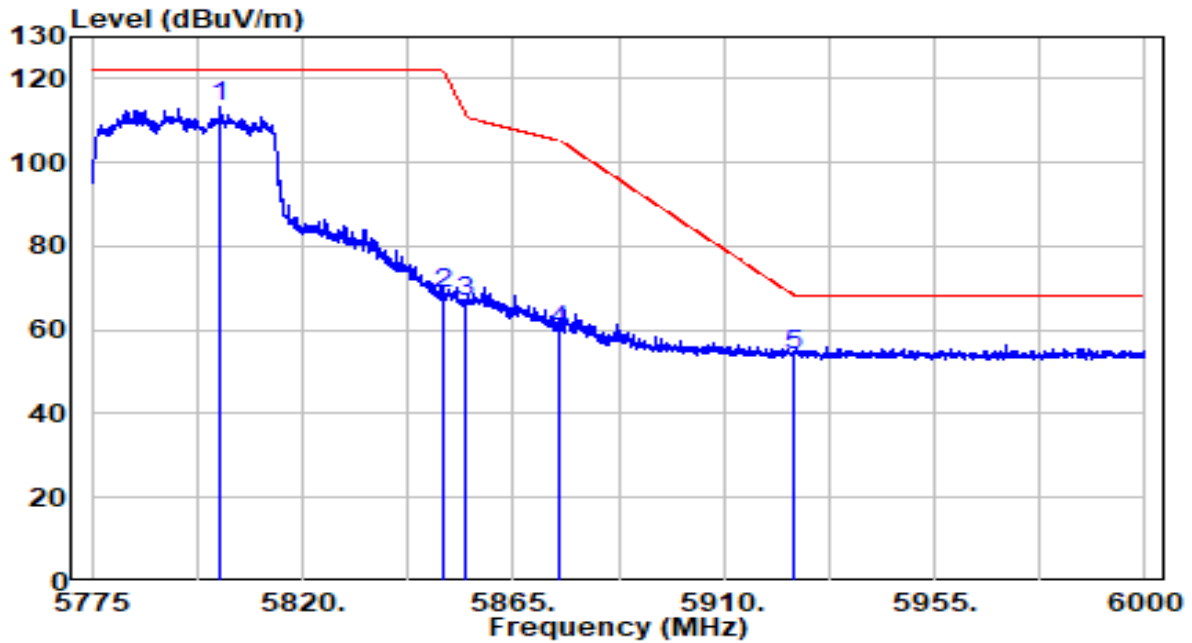

No	Frequency (MHz)	Reading (dBuV)	C.F (dB)	Measurement (dBuV/m)	Margin (dB)	Limit (dBuV/m)	Remark (QP/PK/AV)
1	* 5802.450	91.84	21.25	113.09	N/A	N/A	Peak
2	5850.000	47.20	21.40	68.61	-53.59	122.20	Peak
3	5855.000	45.22	21.42	66.64	-44.16	110.80	Peak
4	5875.000	38.55	21.49	60.04	-45.16	105.20	Peak
5	5925.000	32.27	21.65	53.91	-14.29	68.20	Peak

Note:

- "*" means this data is the worst emission level.
- C.F (Correction Factor) = Antenna Factor (dB)+ Cable Loss (dB)– Preamplifier(dB)+16db attenuation.
- Measurement(dBuV/m) = Reading(dBuV) + C.F (Correction Factor).
- The emission levels of other frequencies are very lower than the limit and not show in test report.

EUT	AP311	Date of Test	2020-09-28
Factor	BBHA 9120D (1GHz~18GHz)_2020	Temp. / Humidity	23.2°C/35%
Polarity	Horizontal	Site / Test Engineer	AC1 / Hyde Yu
Test Mode	Transmit by 802.11ax-HE80 at Channel 5210MHz	Test Voltage	120V/60Hz

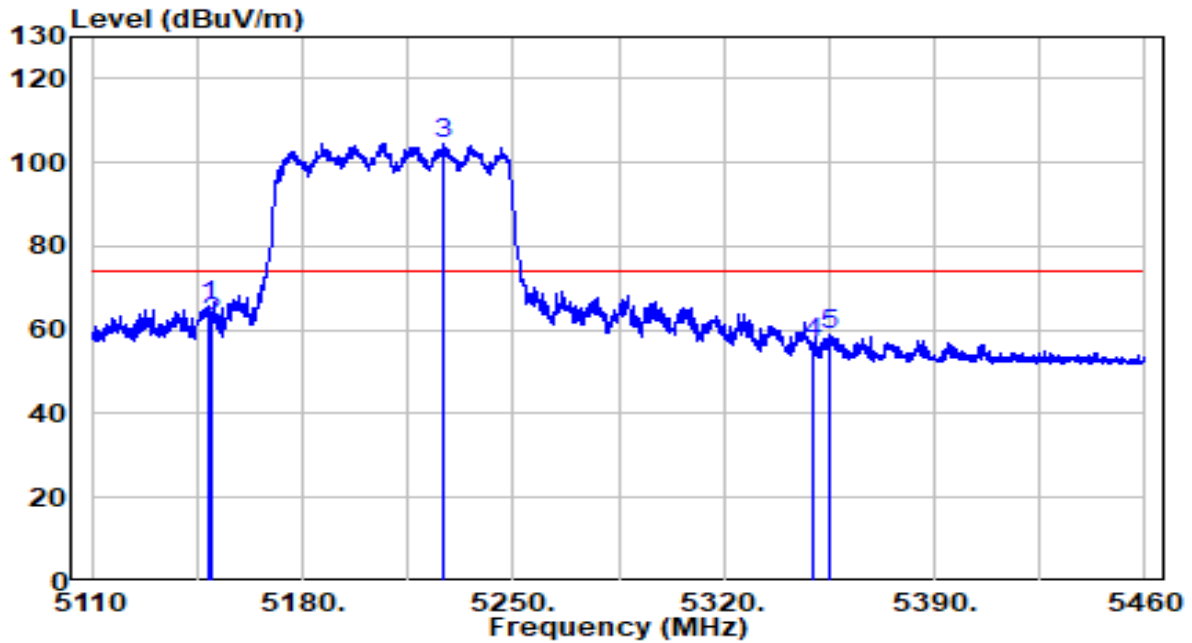

No	Frequency (MHz)	Reading (dBuV)	C.F (dB)	Measurement (dBuV/m)	Margin (dB)	Limit (dBuV/m)	Remark (QP/PK/AV)
1	5149.025	45.99	19.90	65.89	-8.11	74.00	Peak
2	5150.000	42.05	19.91	61.95	-12.05	74.00	Peak
3	* 5226.550	84.67	19.99	104.66	N/A	N/A	Peak
4	5350.000	36.81	20.11	56.93	-17.07	74.00	Peak
5	5354.825	38.94	20.12	59.06	-14.94	74.00	Peak

Note:

1. " *", means this data is the worst emission level.
2. C.F (Correction Factor) = Antenna Factor (dB)+ Cable Loss (dB)– Preamplifier(dB)+16db attenuation.
3. Measurement(dBuV/m) = Reading(dBuV) + C.F (Correction Factor).
- 4.The emission levels of other frequencies are very lower than the limit and not show in test report.

EUT	AP311	Date of Test	2020-09-28
Factor	BBHA 9120D (1GHz~18GHz)_2020	Temp. / Humidity	23.2°C/35%
Polarity	Horizontal	Site / Test Engineer	AC1 / Hyde Yu
Test Mode	Transmit by 802.11ax-HE80 at Channel 5210MHz	Test Voltage	120V/60Hz

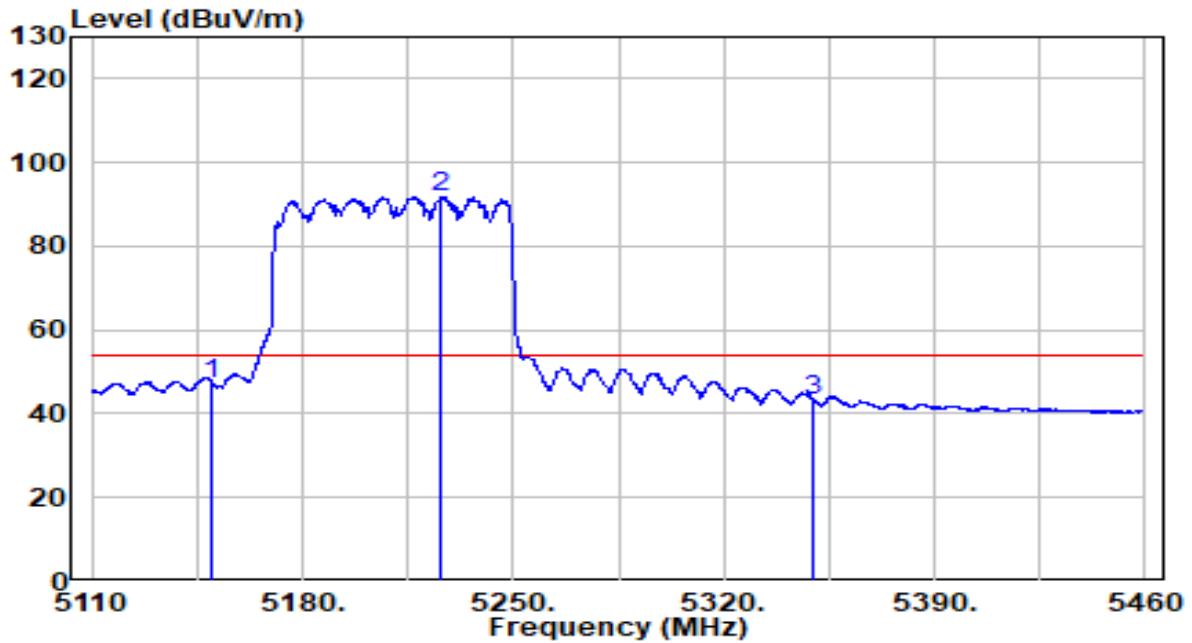

No	Frequency (MHz)	Reading (dBuV)	C.F (dB)	Measurement (dBuV/m)	Margin (dB)	Limit (dBuV/m)	Remark (QP/PK/AV)
1	5150.000	27.40	19.91	47.30	-6.70	54.00	Average
2	* 5226.025	71.92	19.99	91.91	N/A	N/A	Average
3	5350.000	23.19	20.11	43.30	-10.70	54.00	Average

Note:

1. " *", means this data is the worst emission level.
2. C.F (Correction Factor) = Antenna Factor (dB)+ Cable Loss (dB)– Preamplifier(dB)+16db attenuation.
3. Measurement(dBuV/m) = Reading(dBuV) + C.F (Correction Factor).
- 4.The emission levels of other frequencies are very lower than the limit and not show in test report.

EUT	AP311	Date of Test	2020-09-28
Factor	BBHA 9120D (1GHz~18GHz)_2020	Temp. / Humidity	23.2°C/35%
Polarity	Vertical	Site / Test Engineer	AC1 / Hyde Yu
Test Mode	Transmit by 802.11ax-HE80 at Channel 5210MHz	Test Voltage	120V/60Hz

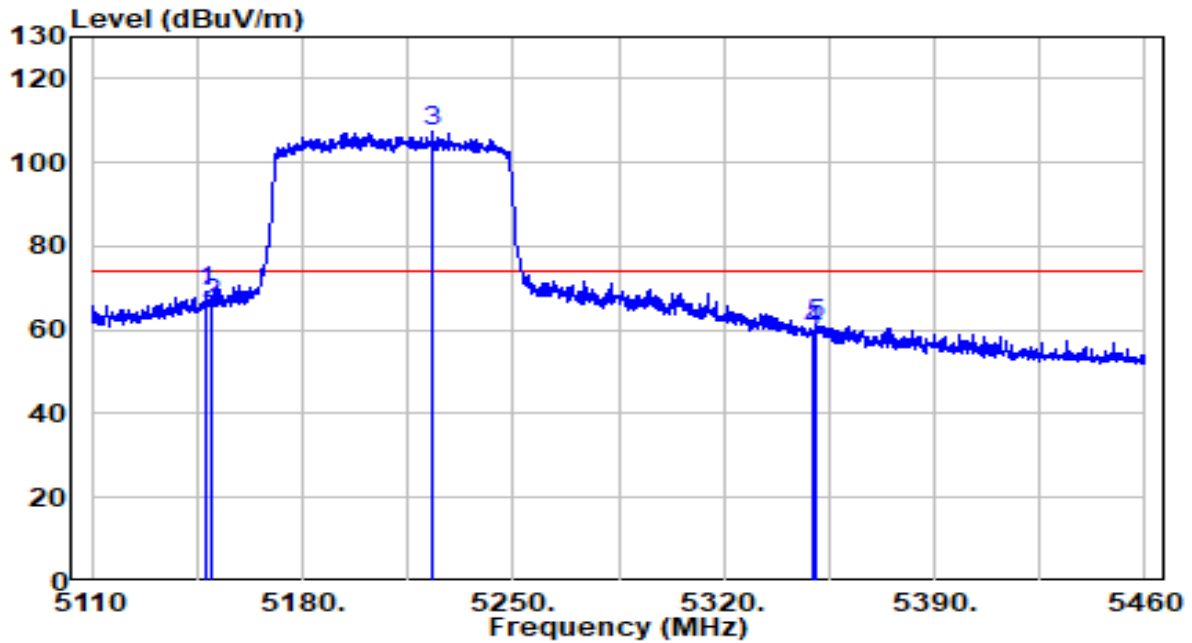

No	Frequency (MHz)	Reading (dBuV)	C.F (dB)	Measurement (dBuV/m)	Margin (dB)	Limit (dBuV/m)	Remark (QP/PK/AV)
1	5147.975	49.21	19.90	69.11	-4.89	74.00	Peak
2	5150.000	46.52	19.91	66.43	-7.57	74.00	Peak
3	* 5222.875	87.63	19.98	107.61	N/A	N/A	Peak
4	5350.000	39.57	20.11	59.68	-14.32	74.00	Peak
5	5350.800	41.08	20.11	61.19	-12.81	74.00	Peak

Note:

1. " *", means this data is the worst emission level.
2. C.F (Correction Factor) = Antenna Factor (dB)+ Cable Loss (dB)– Preamplifier(dB)+16db attenuation.
3. Measurement(dBuV/m) = Reading(dBuV) + C.F (Correction Factor).
- 4.The emission levels of other frequencies are very lower than the limit and not show in test report.

EUT	AP311	Date of Test	2020-09-28
Factor	BBHA 9120D (1GHz~18GHz)_2020	Temp. / Humidity	23.2°C/35%
Polarity	Vertical	Site / Test Engineer	AC1 / Hyde Yu
Test Mode	Transmit by 802.11ax-HE80 at Channel 5210MHz	Test Voltage	120V/60Hz

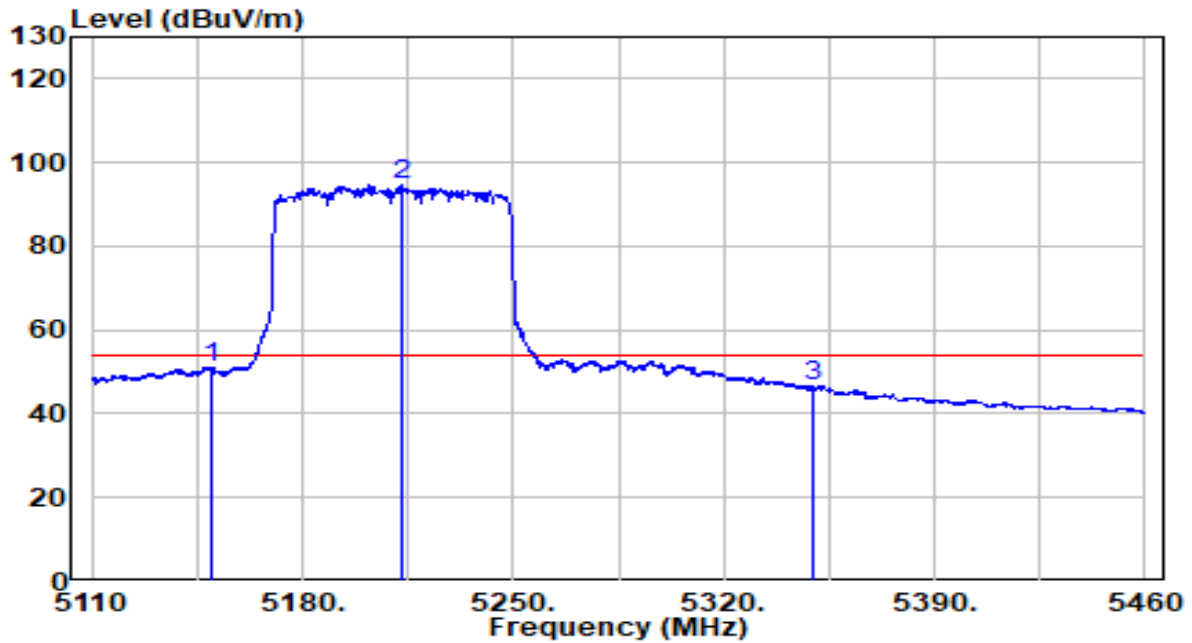

No	Frequency (MHz)	Reading (dBuV)	C.F (dB)	Measurement (dBuV/m)	Margin (dB)	Limit (dBuV/m)	Remark (QP/PK/AV)
1	5150.000	31.08	19.91	50.99	-3.01	54.00	Average
2	* 5212.900	74.65	19.97	94.62	N/A	N/A	Average
3	5350.000	26.31	20.11	46.42	-7.58	54.00	Average

Note:

1. " *", means this data is the worst emission level.
2. C.F (Correction Factor) = Antenna Factor (dB)+ Cable Loss (dB)– Preamplifier(dB)+16db attenuation.
3. Measurement(dBuV/m) = Reading(dBuV) + C.F (Correction Factor).
- 4.The emission levels of other frequencies are very lower than the limit and not show in test report.

EUT	AP311	Date of Test	2020-09-28
Factor	BBHA 9120D (1GHz~18GHz)_2020	Temp. / Humidity	23.2°C/35%
Polarity	Horizontal	Site / Test Engineer	AC1 / Hyde Yu
Test Mode	Transmit by 802.11ax-HE80 at Channel 5290MHz	Test Voltage	120V/60Hz

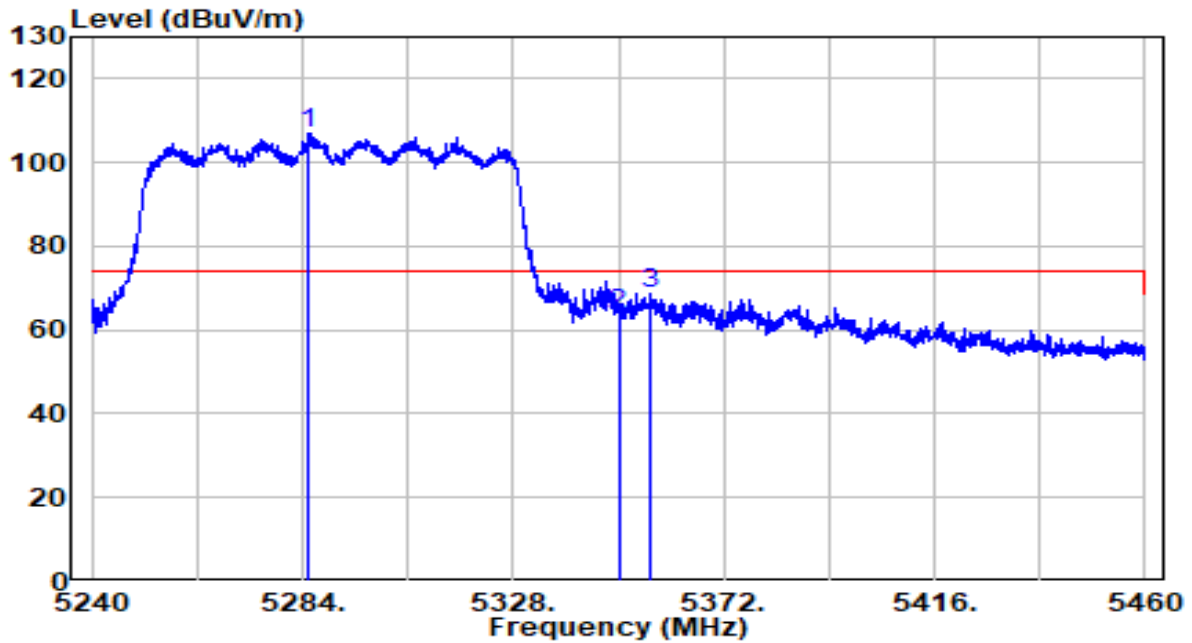

No	Frequency (MHz)	Reading (dBuV)	C.F (dB)	Measurement (dBuV/m)	Margin (dB)	Limit (dBuV/m)	Remark (QP/PK/AV)
1	* 5285.430	86.86	20.05	106.90	N/A	N/A	Peak
2	5350.000	43.76	20.11	63.88	-10.12	74.00	Peak
3	5356.710	48.57	20.12	68.69	-5.31	74.00	Peak

Note:

1. " *", means this data is the worst emission level.
2. C.F (Correction Factor) = Antenna Factor (dB)+ Cable Loss (dB)– Preamplifier(dB)+16db attenuation.
3. Measurement(dBuV/m) = Reading(dBuV) + C.F (Correction Factor).
- 4.The emission levels of other frequencies are very lower than the limit and not show in test report.

EUT	AP311	Date of Test	2020-09-28
Factor	BBHA 9120D (1GHz~18GHz)_2020	Temp. / Humidity	23.2°C/35%
Polarity	Horizontal	Site / Test Engineer	AC1 / Hyde Yu
Test Mode	Transmit by 802.11ax-HE80 at Channel 5290MHz	Test Voltage	120V/60Hz

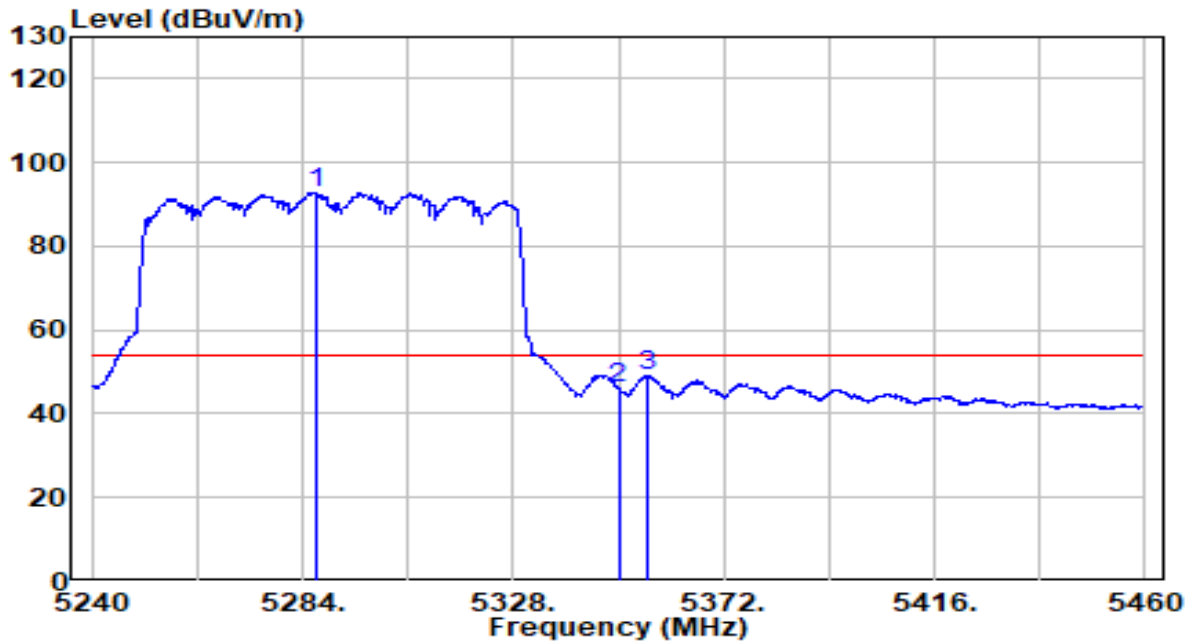

No	Frequency (MHz)	Reading (dBuV)	C.F (dB)	Measurement (dBuV/m)	Margin (dB)	Limit (dBuV/m)	Remark (QP/PK/AV)
1	* 5286.750	72.88	20.05	92.93	N/A	N/A	Average
2	5350.000	26.19	20.11	46.30	-7.70	54.00	Average
3	5355.940	28.88	20.12	49.00	-5.00	54.00	Average

Note:

1. " *", means this data is the worst emission level.
2. C.F (Correction Factor) = Antenna Factor (dB)+ Cable Loss (dB)– Preamplifier(dB)+16db attenuation.
3. Measurement(dBuV/m) = Reading(dBuV) + C.F (Correction Factor).
- 4.The emission levels of other frequencies are very lower than the limit and not show in test report.

EUT	AP311	Date of Test	2020-09-28
Factor	BBHA 9120D (1GHz~18GHz)_2020	Temp. / Humidity	23.2°C/35%
Polarity	Vertical	Site / Test Engineer	AC1 / Hyde Yu
Test Mode	Transmit by 802.11ax-HE80 at Channel 5290MHz	Test Voltage	120V/60Hz

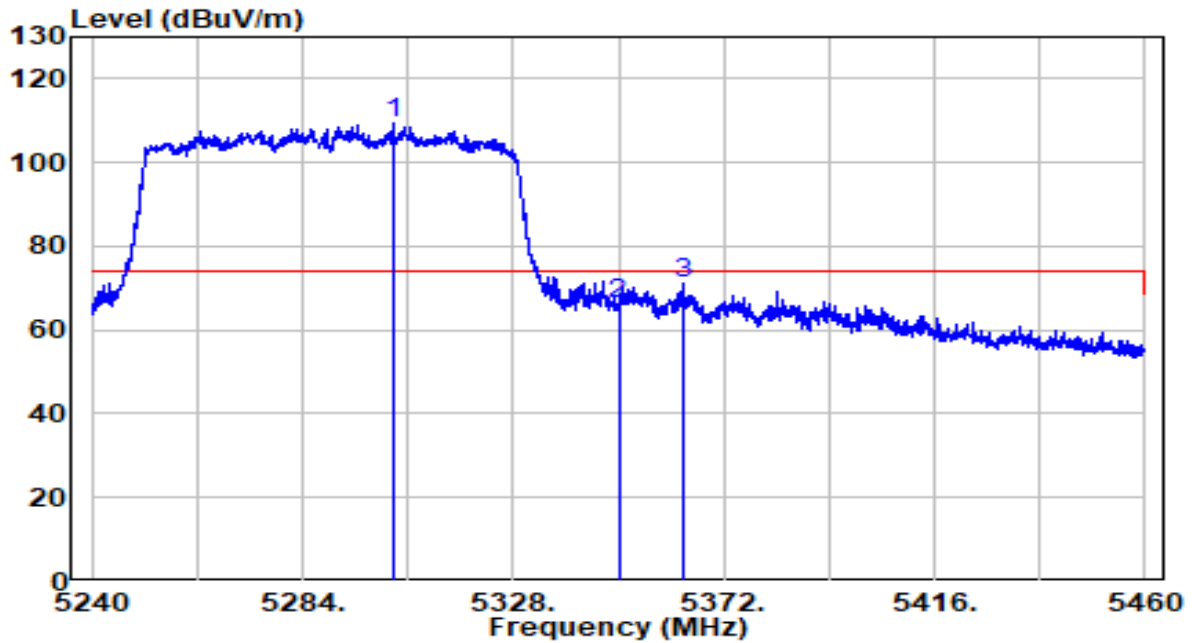

No	Frequency (MHz)	Reading (dBuV)	C.F (dB)	Measurement (dBuV/m)	Margin (dB)	Limit (dBuV/m)	Remark (QP/PK/AV)
1	* 5302.810	89.19	20.06	109.25	N/A	N/A	Peak
2	5350.000	46.21	20.11	66.32	-7.68	74.00	Peak
3	5363.420	50.95	20.13	71.08	-2.92	74.00	Peak

Note:

1. " *", means this data is the worst emission level.
2. C.F (Correction Factor) = Antenna Factor (dB)+ Cable Loss (dB)– Preamplifier(dB)+16db attenuation.
3. Measurement(dBuV/m) = Reading(dBuV) + C.F (Correction Factor).
- 4.The emission levels of other frequencies are very lower than the limit and not show in test report.

EUT	AP311	Date of Test	2020-09-28
Factor	BBHA 9120D (1GHz~18GHz)_2020	Temp. / Humidity	23.2°C/35%
Polarity	Vertical	Site / Test Engineer	AC1 / Hyde Yu
Test Mode	Transmit by 802.11ax-HE80 at Channel 5290MHz	Test Voltage	120V/60Hz

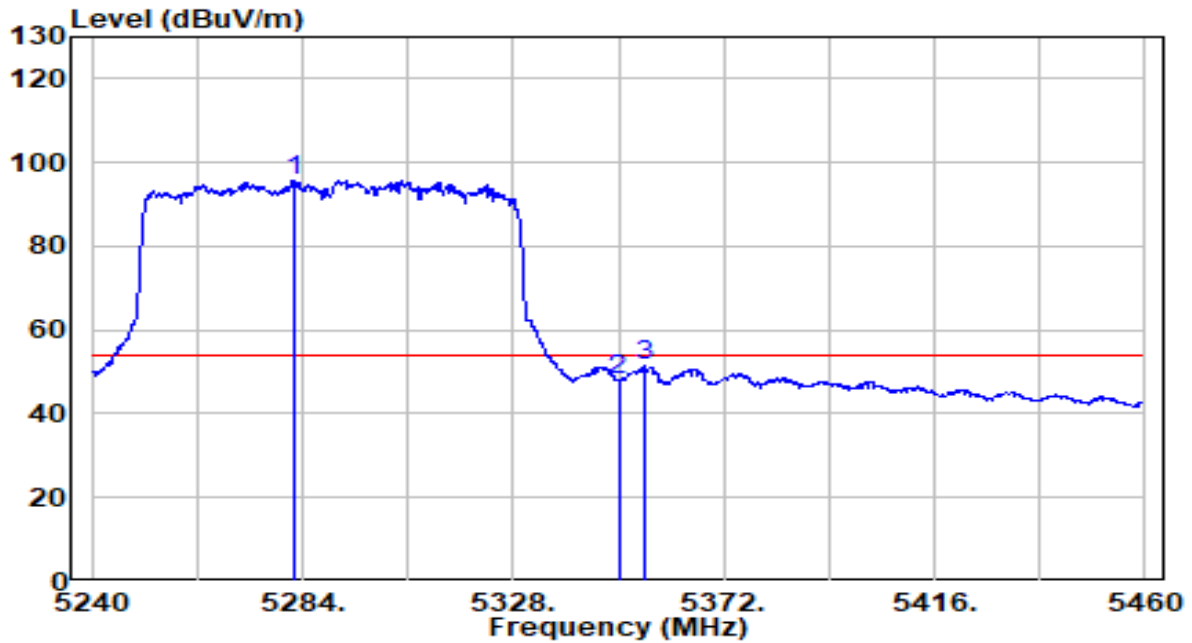

No	Frequency (MHz)	Reading (dBuV)	C.F (dB)	Measurement (dBuV/m)	Margin (dB)	Limit (dBuV/m)	Remark (QP/PK/AV)
1	* 5282.130	75.65	20.04	95.69	N/A	N/A	Average
2	5350.000	27.80	20.11	47.92	-6.08	54.00	Average
3	5355.390	31.24	20.12	51.36	-2.64	54.00	Average

Note:

1. " *", means this data is the worst emission level.
2. C.F (Correction Factor) = Antenna Factor (dB)+ Cable Loss (dB)– Preamplifier(dB)+16db attenuation.
3. Measurement(dBuV/m) = Reading(dBuV) + C.F (Correction Factor).
- 4.The emission levels of other frequencies are very lower than the limit and not show in test report.

EUT	AP311	Date of Test	2020-09-28
Factor	BBHA 9120D (1GHz~18GHz)_2020	Temp. / Humidity	23.2°C/35%
Polarity	Horizontal	Site / Test Engineer	AC1 / Hyde Yu
Test Mode	Transmit by 802.11ax-HE80 at Channel 5530MHz	Test Voltage	120V/60Hz

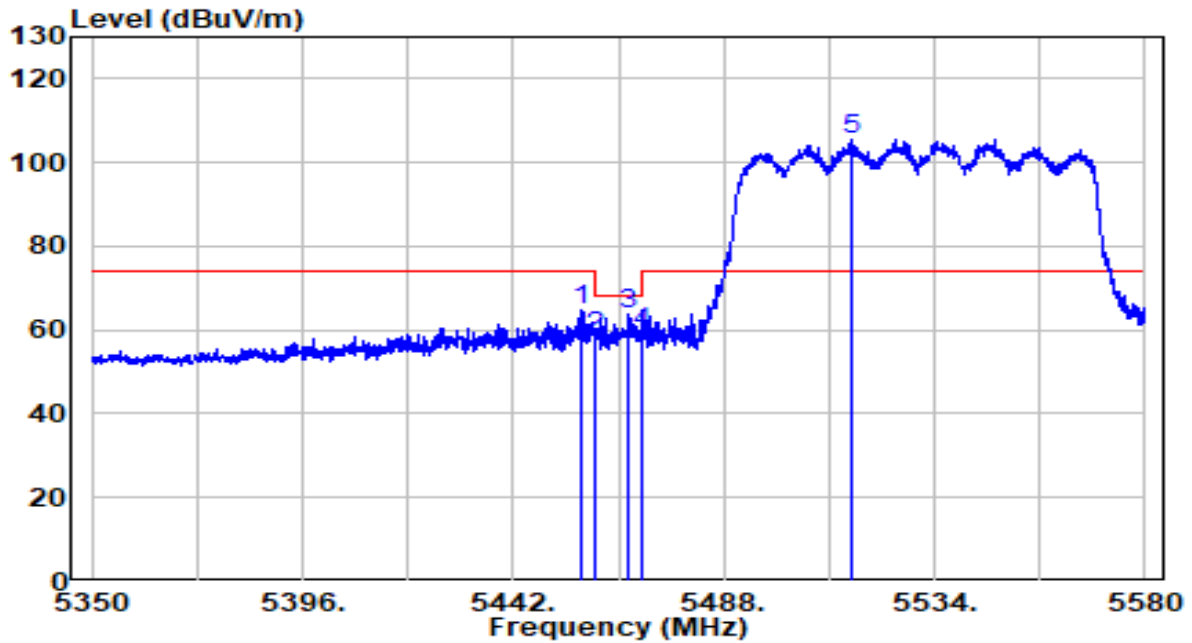

No	Frequency (MHz)	Reading (dBuV)	C.F (dB)	Measurement (dBuV/m)	Margin (dB)	Limit (dBuV/m)	Remark (QP/PK/AV)
1	5456.605	44.55	20.22	64.77	-9.23	74.00	Peak
2	5460.000	38.21	20.23	58.44	-9.76	68.20	Peak
3	5467.300	43.30	20.24	63.54	-4.66	68.20	Peak
4	5470.000	39.17	20.24	59.41	-8.79	68.20	Peak
5	* 5516.060	85.16	20.32	105.48	N/A	N/A	Peak

Note:

1. " *", means this data is the worst emission level.
2. C.F (Correction Factor) = Antenna Factor (dB)+ Cable Loss (dB)– Preamplifier(dB)+16db attenuation.
3. Measurement(dBuV/m) = Reading(dBuV) + C.F (Correction Factor).
- 4.The emission levels of other frequencies are very lower than the limit and not show in test report.

EUT	AP311	Date of Test	2020-09-28
Factor	BBHA 9120D (1GHz~18GHz)_2020	Temp. / Humidity	23.2°C/35%
Polarity	Horizontal	Site / Test Engineer	AC1 / Hyde Yu
Test Mode	Transmit by 802.11ax-HE80 at Channel 5530MHz	Test Voltage	120V/60Hz

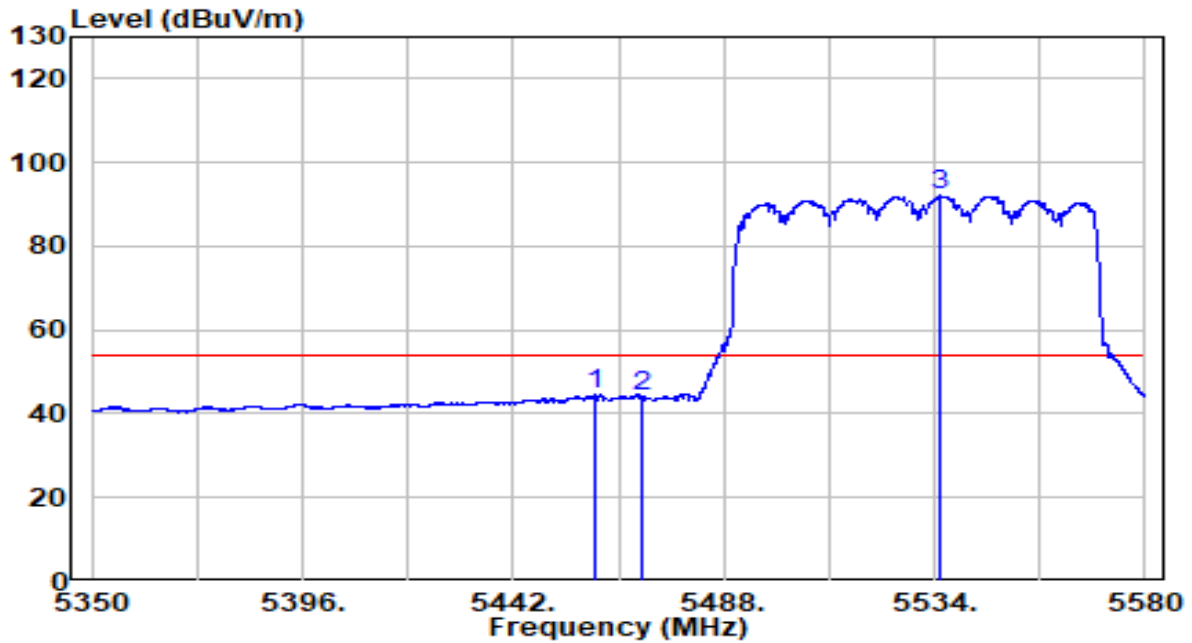

No	Frequency (MHz)	Reading (dBuV)	C.F (dB)	Measurement (dBuV/m)	Margin (dB)	Limit (dBuV/m)	Remark (QP/PK/AV)
1	5460.000	24.34	20.23	44.57	-9.43	54.00	Average
2	5470.000	23.80	20.24	44.04	-9.96	54.00	Average
3	* 5535.380	71.63	20.38	92.01	N/A	N/A	Average

Note:

1. " *", means this data is the worst emission level.
2. C.F (Correction Factor) = Antenna Factor (dB)+ Cable Loss (dB)– Preamplifier(dB)+16db attenuation.
3. Measurement(dBuV/m) = Reading(dBuV) + C.F (Correction Factor).
- 4.The emission levels of other frequencies are very lower than the limit and not show in test report.

EUT	AP311	Date of Test	2020-09-28
Factor	BBHA 9120D (1GHz~18GHz)_2020	Temp. / Humidity	23.2°C/35%
Polarity	Vertical	Site / Test Engineer	AC1 / Hyde Yu
Test Mode	Transmit by 802.11ax-HE80 at Channel 5530MHz	Test Voltage	120V/60Hz

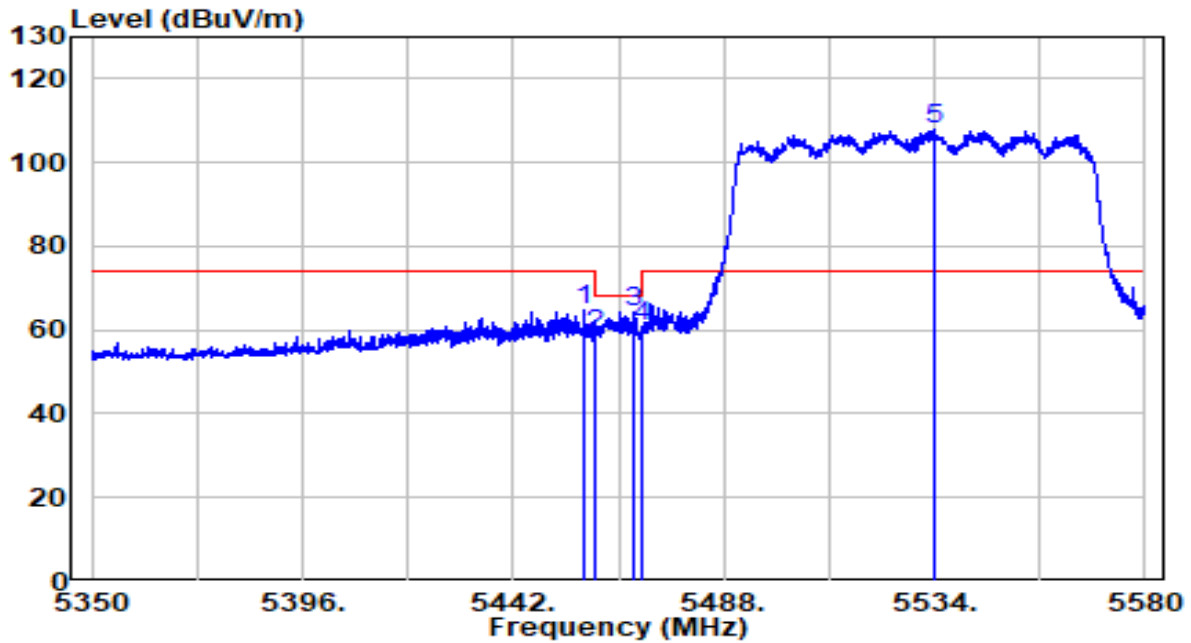

No	Frequency (MHz)	Reading (dBuV)	C.F (dB)	Measurement (dBuV/m)	Margin (dB)	Limit (dBuV/m)	Remark (QP/PK/AV)
1	5457.525	44.32	20.23	64.55	-9.45	74.00	Peak
2	5460.055	38.69	20.23	58.92	-9.28	68.20	Peak
3	5468.105	44.08	20.24	64.32	-3.88	68.20	Peak
4	5470.000	40.47	20.24	60.71	-7.49	68.20	Peak
5	* 5533.770	87.51	20.38	107.89	N/A	N/A	Peak

Note:

1. " *", means this data is the worst emission level.
2. C.F (Correction Factor) = Antenna Factor (dB)+ Cable Loss (dB)– Preamplifier(dB)+16db attenuation.
3. Measurement(dBuV/m) = Reading(dBuV) + C.F (Correction Factor).
- 4.The emission levels of other frequencies are very lower than the limit and not show in test report.

EUT	AP311	Date of Test	2020-09-28
Factor	BBHA 9120D (1GHz~18GHz)_2020	Temp. / Humidity	23.2°C/35%
Polarity	Vertical	Site / Test Engineer	AC1 / Hyde Yu
Test Mode	Transmit by 802.11ax-HE80 at Channel 5530MHz	Test Voltage	120V/60Hz

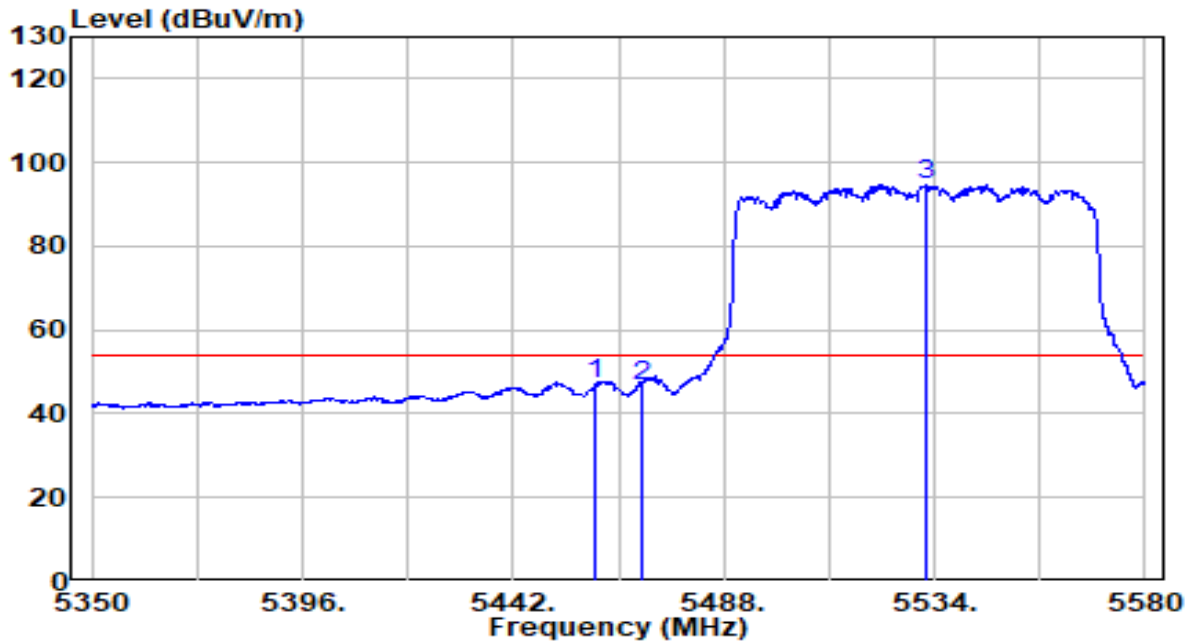

No	Frequency (MHz)	Reading (dBuV)	C.F (dB)	Measurement (dBuV/m)	Margin (dB)	Limit (dBuV/m)	Remark (QP/PK/AV)
1	5460.000	27.00	20.23	47.23	-6.77	54.00	Average
2	5470.000	26.52	20.24	46.76	-7.24	54.00	Average
3	* 5532.275	74.32	20.37	94.69	N/A	N/A	Average

Note:

1. " *", means this data is the worst emission level.
2. C.F (Correction Factor) = Antenna Factor (dB)+ Cable Loss (dB)– Preamplifier(dB)+16db attenuation.
3. Measurement(dBuV/m) = Reading(dBuV) + C.F (Correction Factor).
- 4.The emission levels of other frequencies are very lower than the limit and not show in test report.

EUT	AP311	Date of Test	2020-09-28
Factor	BBHA 9120D (1GHz~18GHz)_2020	Temp. / Humidity	23.2°C/35%
Polarity	Horizontal	Site / Test Engineer	AC1 / Hyde Yu
Test Mode	Transmit by 802.11ax-HE80 at Channel 5610MHz	Test Voltage	120V/60Hz

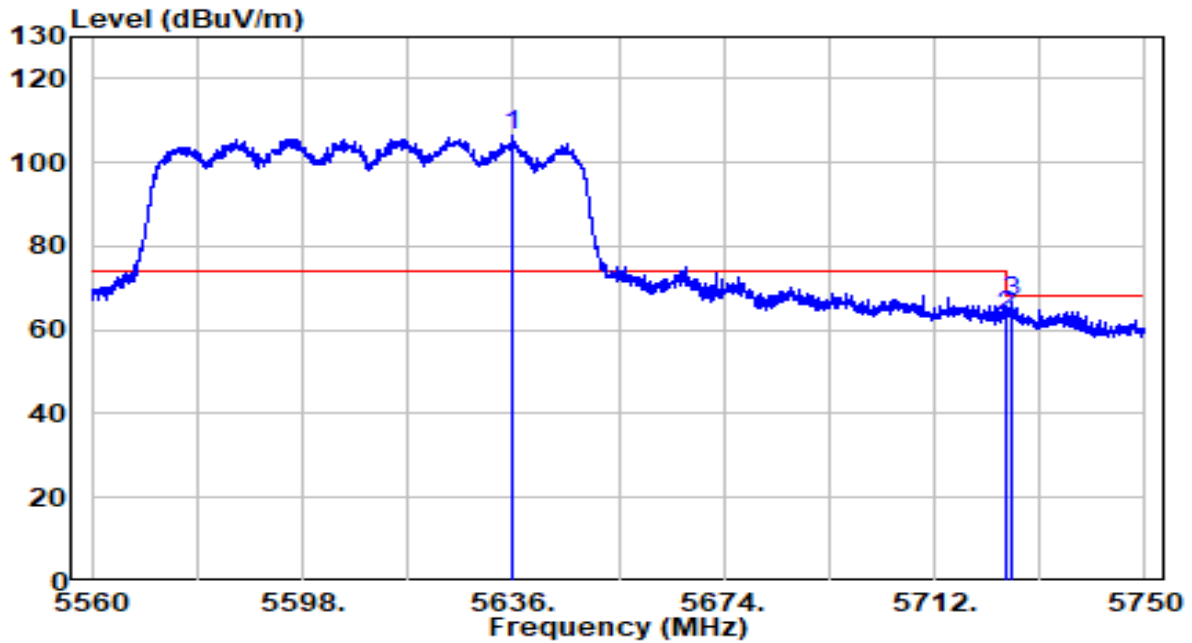

No	Frequency (MHz)	Reading (dBuV)	C.F (dB)	Measurement (dBuV/m)	Margin (dB)	Limit (dBuV/m)	Remark (QP/PK/AV)
1	* 5636.000	85.97	20.71	106.68	N/A	N/A	Peak
2	5725.000	42.52	21.00	63.52	-4.68	68.20	Peak
3	5726.155	45.61	21.00	66.61	-1.59	68.20	Peak

Note:

1. " *", means this data is the worst emission level.
2. C.F (Correction Factor) = Antenna Factor (dB)+ Cable Loss (dB)– Preamplifier(dB)+16db attenuation.
3. Measurement(dBuV/m) = Reading(dBuV) + C.F (Correction Factor).
- 4.The emission levels of other frequencies are very lower than the limit and not show in test report.

EUT	AP311	Date of Test	2020-09-28
Factor	BBHA 9120D (1GHz~18GHz)_2020	Temp. / Humidity	23.2°C/35%
Polarity	Vertical	Site / Test Engineer	AC1 / Hyde Yu
Test Mode	Transmit by 802.11ax-HE80 at Channel 5610MHz	Test Voltage	120V/60Hz

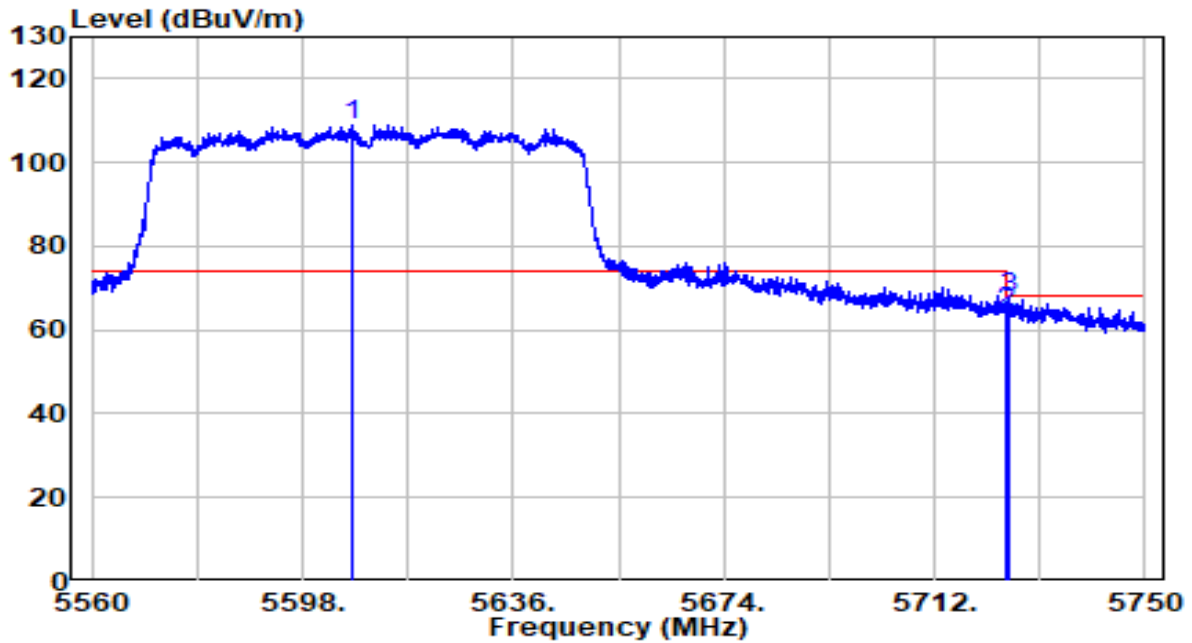

No	Frequency (MHz)	Reading (dBuV)	C.F (dB)	Measurement (dBuV/m)	Margin (dB)	Limit (dBuV/m)	Remark (QP/PK/AV)
1	* 5606.930	88.43	20.62	109.05	N/A	N/A	Peak
2	5725.000	43.03	21.00	64.03	-4.17	68.20	Peak
3	5725.205	46.60	21.00	67.60	-0.60	68.20	Peak

Note:

1. " *", means this data is the worst emission level.
2. C.F (Correction Factor) = Antenna Factor (dB)+ Cable Loss (dB)– Preamplifier(dB)+16db attenuation.
3. Measurement(dBuV/m) = Reading(dBuV) + C.F (Correction Factor).
- 4.The emission levels of other frequencies are very lower than the limit and not show in test report.

EUT	AP311	Date of Test	2020-09-28
Factor	BBHA 9120D (1GHz~18GHz)_2020	Temp. / Humidity	23.2°C/35%
Polarity	Horizontal	Site / Test Engineer	AC1 / Hyde Yu
Test Mode	Transmit by 802.11ax-HE80 at Channel 5775MHz	Test Voltage	120V/60Hz

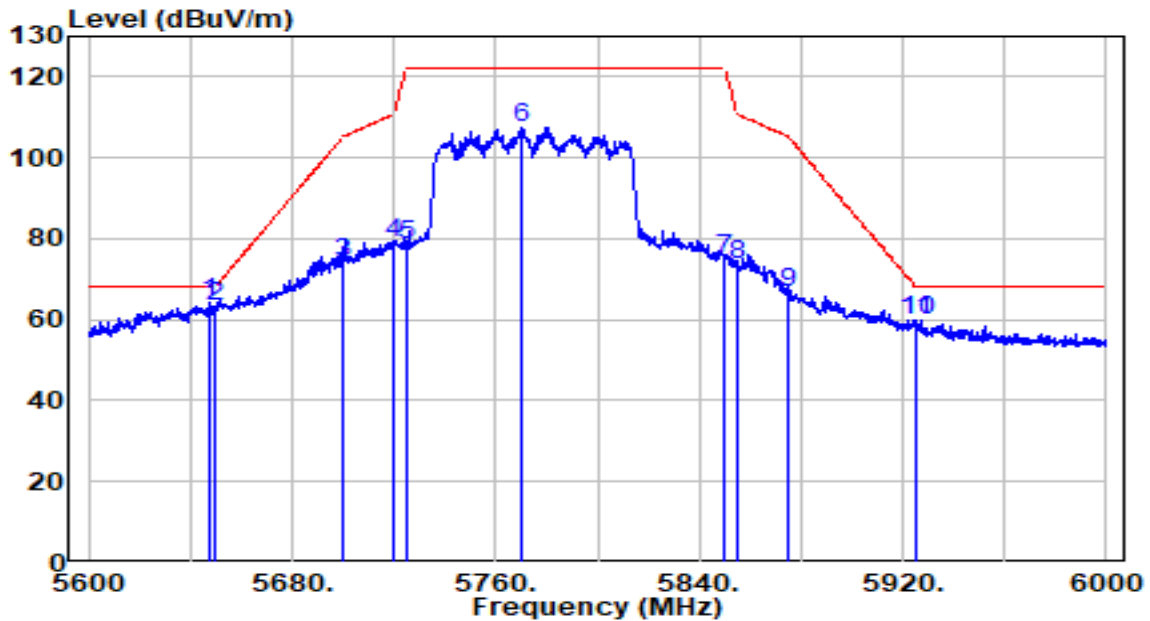

No	Frequency (MHz)	Reading (dBuV)	C.F (dB)	Measurement (dBuV/m)	Margin (dB)	Limit (dBuV/m)	Remark (QP/PK/AV)
1	* 5647.400	43.52	20.75	64.27	-3.93	68.20	Peak
2	5650.000	42.45	20.76	63.20	-5.00	68.20	Peak
3	5700.000	53.19	20.92	74.11	-31.09	105.20	Peak
4	5720.000	57.90	20.98	78.88	-31.92	110.80	Peak
5	5725.000	57.30	21.00	78.29	-43.91	122.20	Peak
6	5770.600	86.52	21.15	107.66	N/A	N/A	Peak
7	5850.000	53.65	21.40	75.05	-47.15	122.20	Peak
8	5855.000	51.94	21.42	73.36	-37.44	110.80	Peak
9	5875.000	45.28	21.49	66.77	-38.43	105.20	Peak
10	5925.000	38.32	21.65	59.97	-8.23	68.20	Peak
11	5925.000	38.32	21.65	59.97	-8.23	68.20	Peak

Note:

1. " *", means this data is the worst emission level.
2. C.F (Correction Factor) = Antenna Factor (dB)+ Cable Loss (dB)– Preamplifier(dB)+16db attenuation.
3. Measurement(dBuV/m) = Reading(dBuV) + C.F (Correction Factor).
- 4.The emission levels of other frequencies are very lower than the limit and not show in test report.

EUT	AP311	Date of Test	2020-09-28
Factor	BBHA 9120D (1GHz~18GHz)_2020	Temp. / Humidity	23.2°C/35%
Polarity	Vertical	Site / Test Engineer	AC1 / Hyde Yu
Test Mode	Transmit by 802.11ax-HE80 at Channel 5775MHz	Test Voltage	120V/60Hz

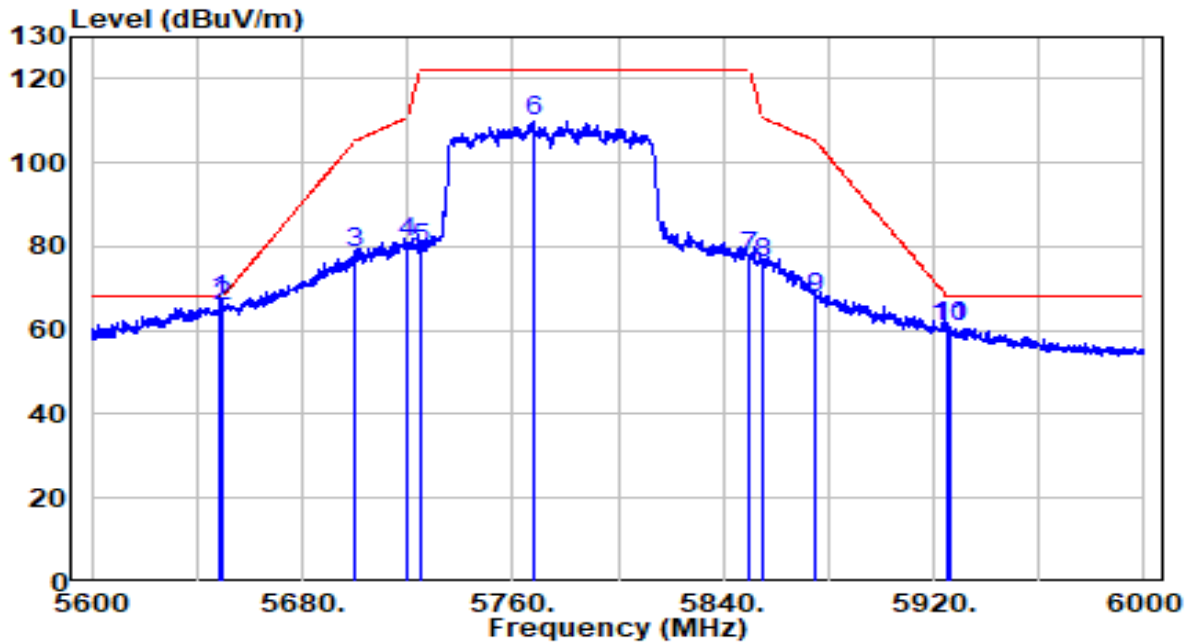

No	Frequency (MHz)	Reading (dBuV)	C.F (dB)	Measurement (dBuV/m)	Margin (dB)	Limit (dBuV/m)	Remark (QP/PK/AV)
1	* 5649.000	46.52	20.75	67.28	-0.92	68.20	Peak
2	5650.000	45.09	20.76	65.85	-2.35	68.20	Peak
3	5700.000	57.53	20.92	78.45	-26.75	105.20	Peak
4	5720.000	59.85	20.98	80.84	-29.96	110.80	Peak
5	5725.000	58.39	21.00	79.39	-42.81	122.20	Peak
6	5767.600	88.99	21.14	110.13	N/A	N/A	Peak
7	5850.000	56.19	21.40	77.59	-44.61	122.20	Peak
8	5855.000	54.44	21.42	75.86	-34.94	110.80	Peak
9	5875.000	46.43	21.49	67.91	-37.29	105.20	Peak
10	5925.000	39.19	21.65	60.84	-7.36	68.20	Peak
11	5926.200	39.40	21.65	61.05	-7.15	68.20	Peak

Note:

1. " *", means this data is the worst emission level.
2. C.F (Correction Factor) = Antenna Factor (dB)+ Cable Loss (dB)– Preamplifier(dB)+16db attenuation.
3. Measurement(dBuV/m) = Reading(dBuV) + C.F (Correction Factor).
- 4.The emission levels of other frequencies are very lower than the limit and not show in test report.

EUT	AP311	Date of Test	2020-09-27
Factor	BBHA 9120D (1GHz~18GHz)_2020	Temp. / Humidity	25.3°C/45.8%
Polarity	Horizontal	Site / Test Engineer	AC1 / Kevin Ker
Test Mode	Transmit by 802.11a at Channel 5180MHz-Scan Antenna	Test Voltage	120V/60Hz

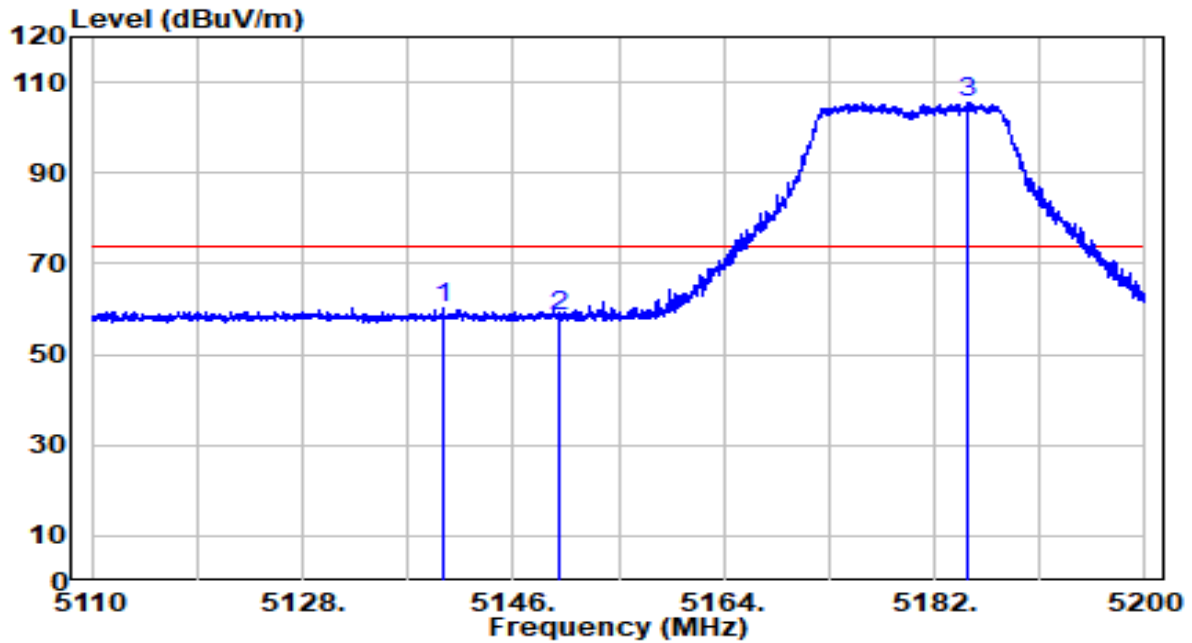

No	Frequency (MHz)	Reading (dBuV)	C.F (dB)	Measurement (dBuV/m)	Margin (dB)	Limit (dBuV/m)	Remark (QP/PK/AV)
1	5139.925	40.17	19.90	60.07	-13.93	74.00	Peak
2	5150.000	38.39	19.91	58.29	-15.71	74.00	Peak
3	* 5184.880	85.73	19.94	105.67	N/A	N/A	Peak

Note:

1. " *", means this data is the worst emission level.
2. C.F (Correction Factor) = Antenna Factor (dB)+ Cable Loss (dB)– Preamplifier(dB)+16db attenuation.
3. Measurement(dBuV/m) = Reading(dBuV) + C.F (Correction Factor).
- 4.The emission levels of other frequencies are very lower than the limit and not show in test report.

EUT	AP311	Date of Test	2020-09-27
Factor	BBHA 9120D (1GHz~18GHz)_2020	Temp. / Humidity	25.3°C/45.8%
Polarity	Horizontal	Site / Test Engineer	AC1 / Kevin Ker
Test Mode	Transmit by 802.11a at Channel 5180MHz-Scan Antenna	Test Voltage	120V/60Hz

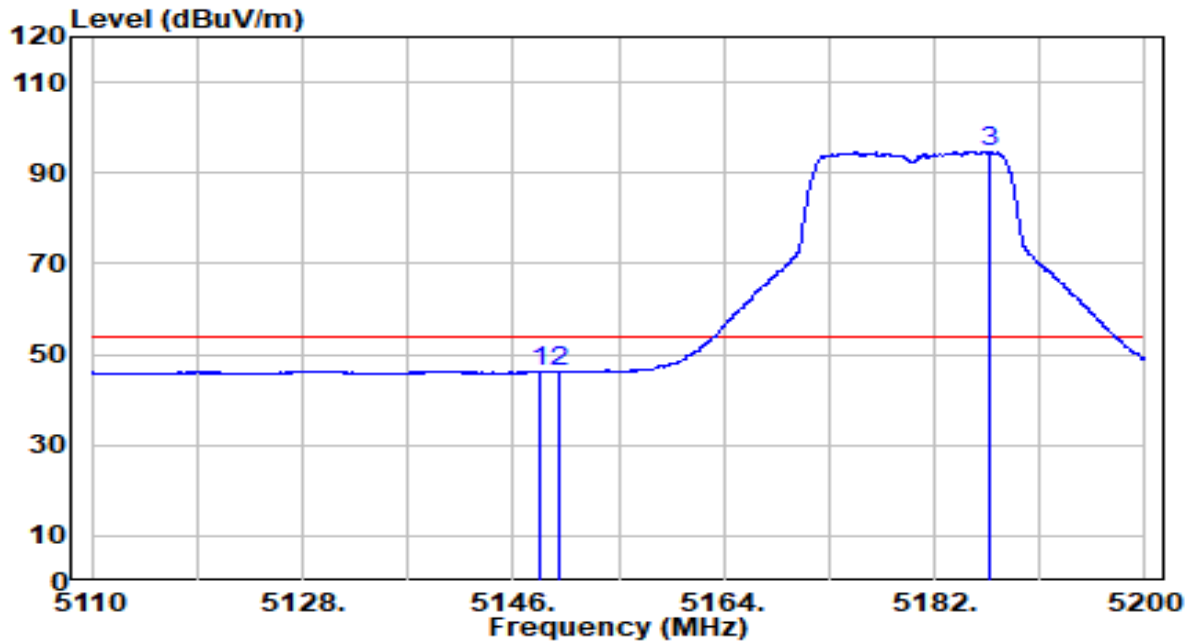

No	Frequency (MHz)	Reading (dBuV)	C.F (dB)	Measurement (dBuV/m)	Margin (dB)	Limit (dBuV/m)	Remark (QP/PK/AV)
1	5148.205	26.41	19.90	46.31	-7.69	54.00	Average
2	5150.000	26.31	19.91	46.22	-7.78	54.00	Average
3	* 5186.725	74.78	19.94	94.72	N/A	N/A	Average

Note:

1. " *", means this data is the worst emission level.
2. C.F (Correction Factor) = Antenna Factor (dB)+ Cable Loss (dB)– Preamplifier(dB)+16db attenuation.
3. Measurement(dBuV/m) = Reading(dBuV) + C.F (Correction Factor).
- 4.The emission levels of other frequencies are very lower than the limit and not show in test report.

EUT	AP311	Date of Test	2020-09-27
Factor	BBHA 9120D (1GHz~18GHz)_2020	Temp. / Humidity	25.3°C/45.8%
Polarity	Vertical	Site / Test Engineer	AC1 / Kevin Ker
Test Mode	Transmit by 802.11a at Channel 5180MHz-Scan Antenna	Test Voltage	120V/60Hz

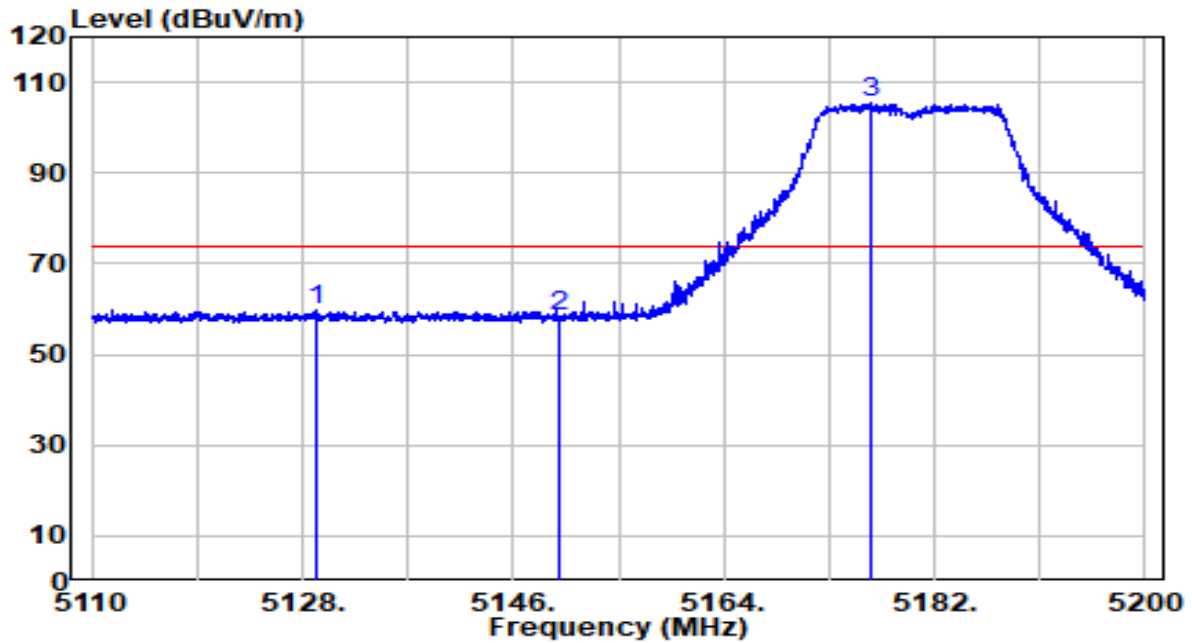

No	Frequency (MHz)	Reading (dBuV)	C.F (dB)	Measurement (dBuV/m)	Margin (dB)	Limit (dBuV/m)	Remark (QP/PK/AV)
1	5129.080	40.09	19.88	59.97	-14.03	74.00	Peak
2	5150.000	38.54	19.91	58.44	-15.56	74.00	Peak
3	* 5176.645	85.51	19.93	105.44	N/A	N/A	Peak

Note:

1. " *", means this data is the worst emission level.
2. C.F (Correction Factor) = Antenna Factor (dB)+ Cable Loss (dB)– Preamplifier(dB)+16db attenuation.
3. Measurement(dBuV/m) = Reading(dBuV) + C.F (Correction Factor).
- 4.The emission levels of other frequencies are very lower than the limit and not show in test report.

EUT	AP311	Date of Test	2020-09-27
Factor	BBHA 9120D (1GHz~18GHz)_2020	Temp. / Humidity	25.3°C/45.8%
Polarity	Vertical	Site / Test Engineer	AC1 / Kevin Ker
Test Mode	Transmit by 802.11a at Channel 5180MHz-Scan Antenna	Test Voltage	120V/60Hz

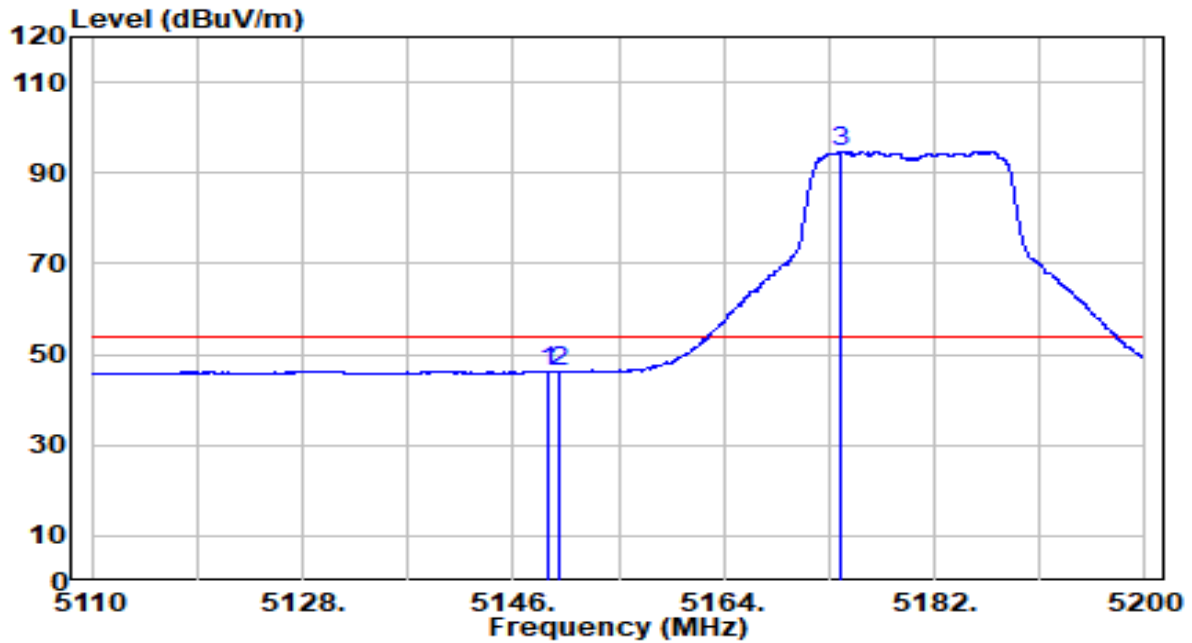

No	Frequency (MHz)	Reading (dBuV)	C.F (dB)	Measurement (dBuV/m)	Margin (dB)	Limit (dBuV/m)	Remark (QP/PK/AV)
1	5148.925	26.39	19.90	46.30	-7.70	54.00	Average
2	5150.000	26.28	19.91	46.18	-7.82	54.00	Average
3	* 5173.900	74.76	19.93	94.69	N/A	N/A	Average

Note:

1. " *", means this data is the worst emission level.
2. C.F (Correction Factor) = Antenna Factor (dB)+ Cable Loss (dB)– Preamplifier(dB)+16db attenuation.
3. Measurement(dBuV/m) = Reading(dBuV) + C.F (Correction Factor).
- 4.The emission levels of other frequencies are very lower than the limit and not show in test report.

EUT	AP311	Date of Test	2020-09-27
Factor	BBHA 9120D (1GHz~18GHz)_2020	Temp. / Humidity	25.3°C/45.8%
Polarity	Horizontal	Site / Test Engineer	AC1 / Kevin Ker
Test Mode	Transmit by 802.11a at Channel 5240MHz-Scan Antenna	Test Voltage	120V/60Hz

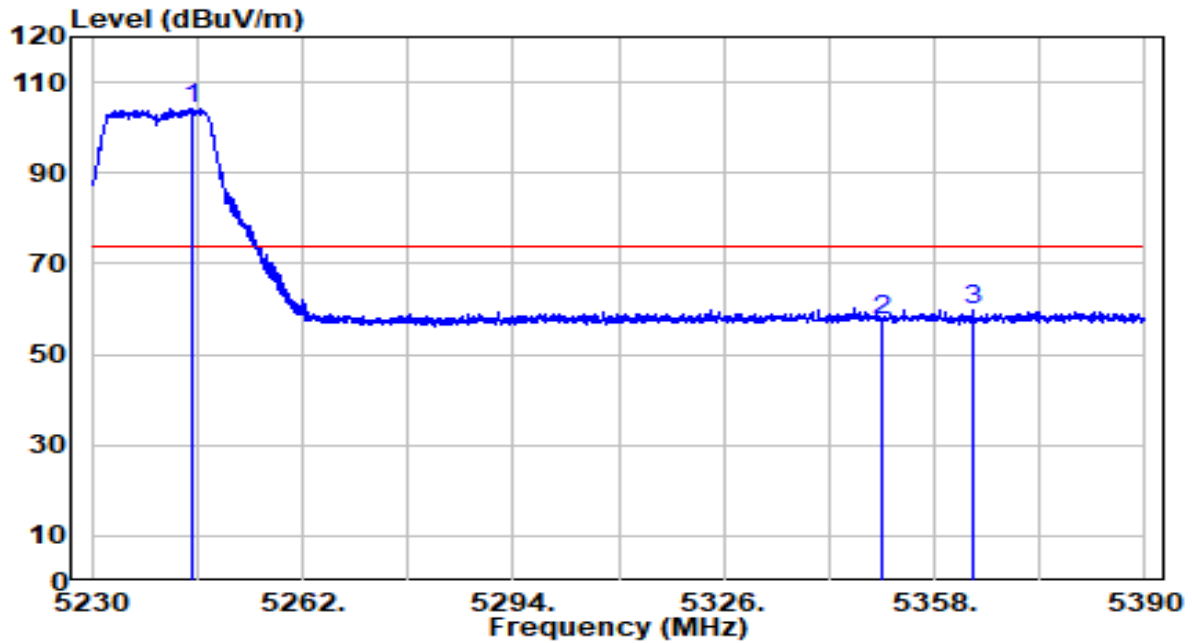

No	Frequency (MHz)	Reading (dBuV)	C.F (dB)	Measurement (dBuV/m)	Margin (dB)	Limit (dBuV/m)	Remark (QP/PK/AV)
1	* 5245.200	84.17	20.01	104.18	N/A	N/A	Peak
2	5350.000	37.59	20.11	57.70	-16.30	74.00	Peak
3	5363.920	39.73	20.13	59.86	-14.14	74.00	Peak

Note:

1. " *", means this data is the worst emission level.
2. C.F (Correction Factor) = Antenna Factor (dB)+ Cable Loss (dB)– Preamplifier(dB)+16db attenuation.
3. Measurement(dBuV/m) = Reading(dBuV) + C.F (Correction Factor).
- 4.The emission levels of other frequencies are very lower than the limit and not show in test report.

EUT	AP311	Date of Test	2020-09-27
Factor	BBHA 9120D (1GHz~18GHz)_2020	Temp. / Humidity	25.3°C/45.8%
Polarity	Horizontal	Site / Test Engineer	AC1 / Kevin Ker
Test Mode	Transmit by 802.11a at Channel 5240MHz-Scan Antenna	Test Voltage	120V/60Hz

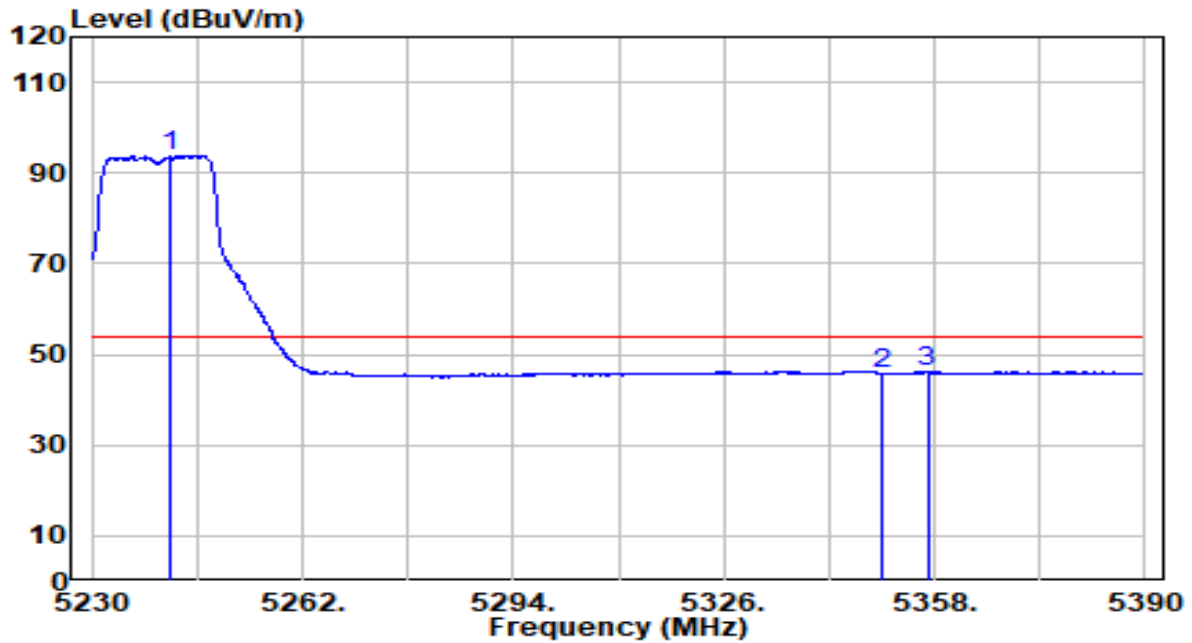

No	Frequency (MHz)	Reading (dBuV)	C.F (dB)	Measurement (dBuV/m)	Margin (dB)	Limit (dBuV/m)	Remark (QP/PK/AV)
1	* 5241.920	73.93	20.00	93.93	N/A	N/A	Average
2	5350.000	25.79	20.11	45.91	-8.09	54.00	Average
3	5356.960	26.10	20.12	46.22	-7.78	54.00	Average

Note:

1. " *", means this data is the worst emission level.
2. C.F (Correction Factor) = Antenna Factor (dB)+ Cable Loss (dB)– Preamplifier(dB)+16db attenuation.
3. Measurement(dBuV/m) = Reading(dBuV) + C.F (Correction Factor).
- 4.The emission levels of other frequencies are very lower than the limit and not show in test report.

EUT	AP311	Date of Test	2020-09-27
Factor	BBHA 9120D (1GHz~18GHz)_2020	Temp. / Humidity	25.3°C/45.8%
Polarity	Vertical	Site / Test Engineer	AC1 / Kevin Ker
Test Mode	Transmit by 802.11a at Channel 5240MHz-Scan Antenna	Test Voltage	120V/60Hz

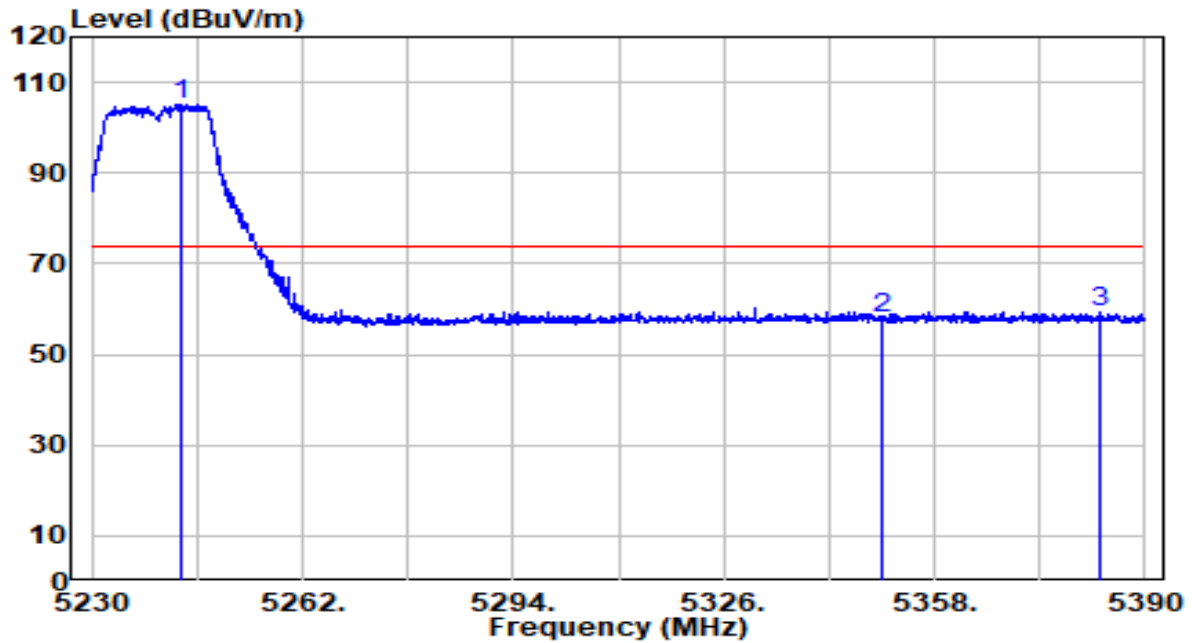

No	Frequency (MHz)	Reading (dBuV)	C.F (dB)	Measurement (dBuV/m)	Margin (dB)	Limit (dBuV/m)	Remark (QP/PK/AV)
1	* 5243.520	85.16	20.00	105.16	N/A	N/A	Peak
2	5350.000	37.94	20.11	58.06	-15.94	74.00	Peak
3	5383.280	39.33	20.15	59.48	-14.52	74.00	Peak

Note:

1. " *", means this data is the worst emission level.
2. C.F (Correction Factor) = Antenna Factor (dB)+ Cable Loss (dB)– Preamplifier(dB)+16db attenuation.
3. Measurement(dBuV/m) = Reading(dBuV) + C.F (Correction Factor).
- 4.The emission levels of other frequencies are very lower than the limit and not show in test report.

EUT	AP311	Date of Test	2020-09-27
Factor	BBHA 9120D (1GHz~18GHz)_2020	Temp. / Humidity	25.3°C/45.8%
Polarity	Vertical	Site / Test Engineer	AC1 / Kevin Ker
Test Mode	Transmit by 802.11a at Channel 5240MHz -Scan Antenna	Test Voltage	120V/60Hz

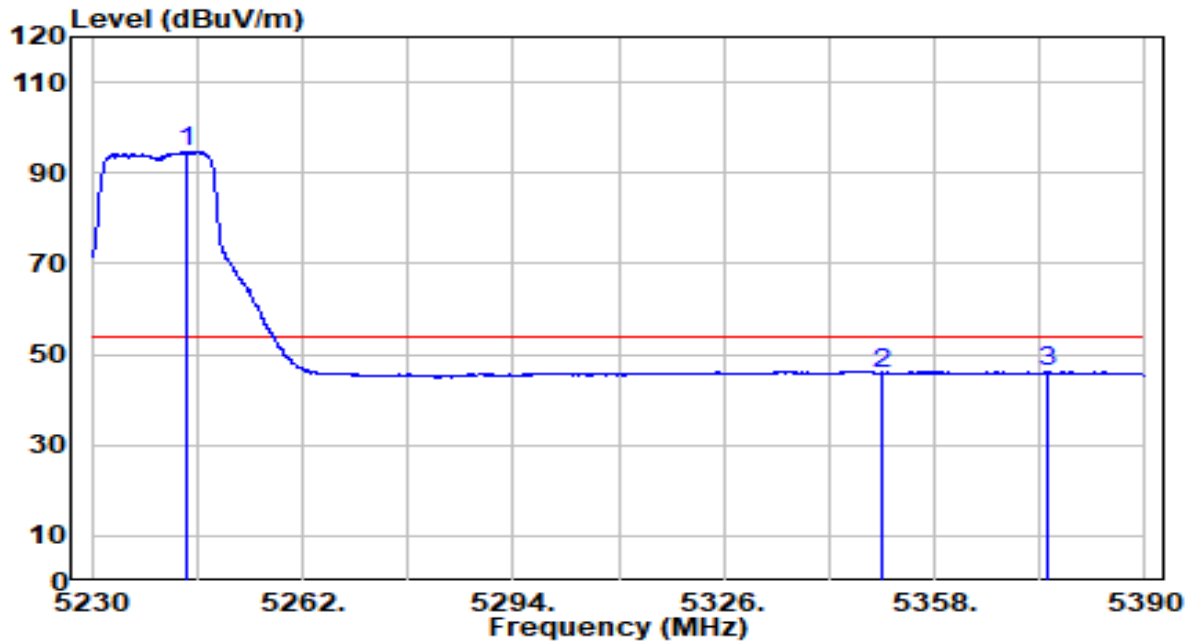

No	Frequency (MHz)	Reading (dBuV)	C.F (dB)	Measurement (dBuV/m)	Margin (dB)	Limit (dBuV/m)	Remark (QP/PK/AV)
1	* 5244.560	74.82	20.00	94.82	N/A	N/A	Average
2	5350.000	25.78	20.11	45.90	-8.10	54.00	Average
3	5375.360	26.02	20.14	46.16	-7.84	54.00	Average

Note:

1. " *", means this data is the worst emission level.
2. C.F (Correction Factor) = Antenna Factor (dB)+ Cable Loss (dB)– Preamplifier(dB)+16db attenuation.
3. Measurement(dBuV/m) = Reading(dBuV) + C.F (Correction Factor).
- 4.The emission levels of other frequencies are very lower than the limit and not show in test report.

EUT	AP311	Date of Test	2020-09-27
Factor	BBHA 9120D (1GHz~18GHz)_2020	Temp. / Humidity	25.3°C/45.8%
Polarity	Horizontal	Site / Test Engineer	AC1 / Kevin Ker
Test Mode	Transmit by 802.11a at Channel 5745MHz-Scan Antenna	Test Voltage	120V/60Hz

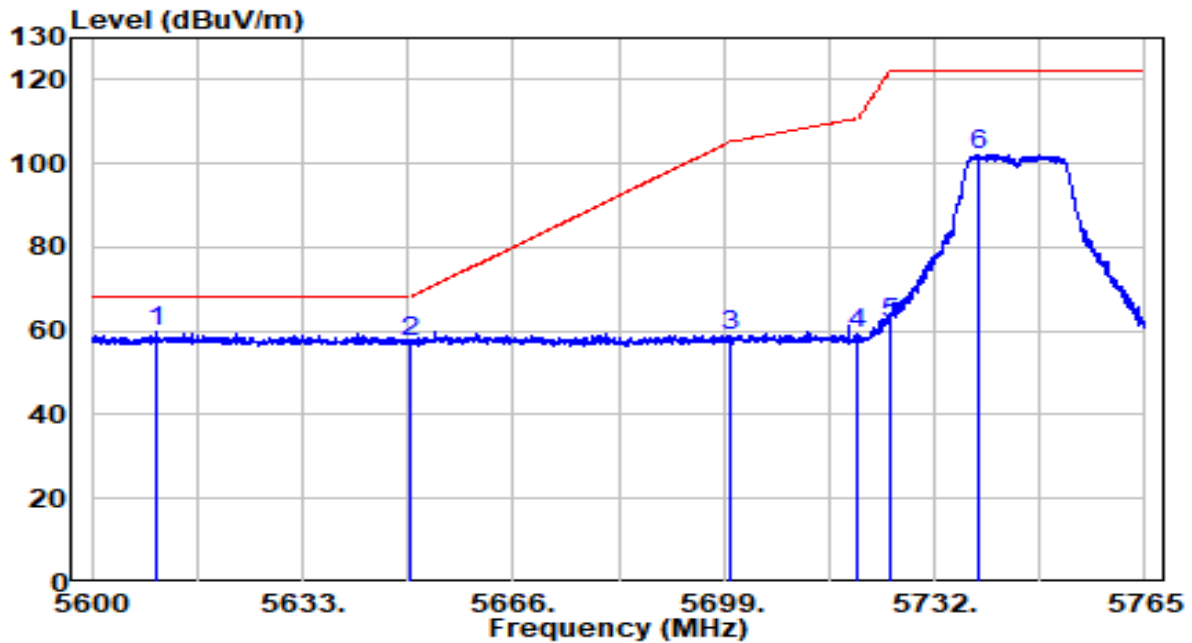

No	Frequency (MHz)	Reading (dBuV)	C.F (dB)	Measurement (dBuV/m)	Margin (dB)	Limit (dBuV/m)	Remark (QP/PK/AV)
1	* 5610.230	39.19	20.63	59.82	-8.38	68.20	Peak
2	5650.000	36.66	20.76	57.41	-10.79	68.20	Peak
3	5700.000	38.05	20.92	58.97	-46.23	105.20	Peak
4	5720.000	38.24	20.98	59.22	-51.58	110.80	Peak
5	5725.000	40.68	21.00	61.68	-60.52	122.20	Peak
6	5739.013	81.24	21.04	102.28	N/A	N/A	Peak

Note:

1. " *", means this data is the worst emission level.
2. C.F (Correction Factor) = Antenna Factor (dB)+ Cable Loss (dB)– Preamplifier(dB)+16db attenuation.
3. Measurement(dBuV/m) = Reading(dBuV) + C.F (Correction Factor).
- 4.The emission levels of other frequencies are very lower than the limit and not show in test report.

EUT	AP311	Date of Test	2020-09-27
Factor	BBHA 9120D (1GHz~18GHz)_2020	Temp. / Humidity	25.3°C/45.8%
Polarity	Vertical	Site / Test Engineer	AC1 / Kevin Ker
Test Mode	Transmit by 802.11a at Channel 5745MHz-Scan Antenna	Test Voltage	120V/60Hz

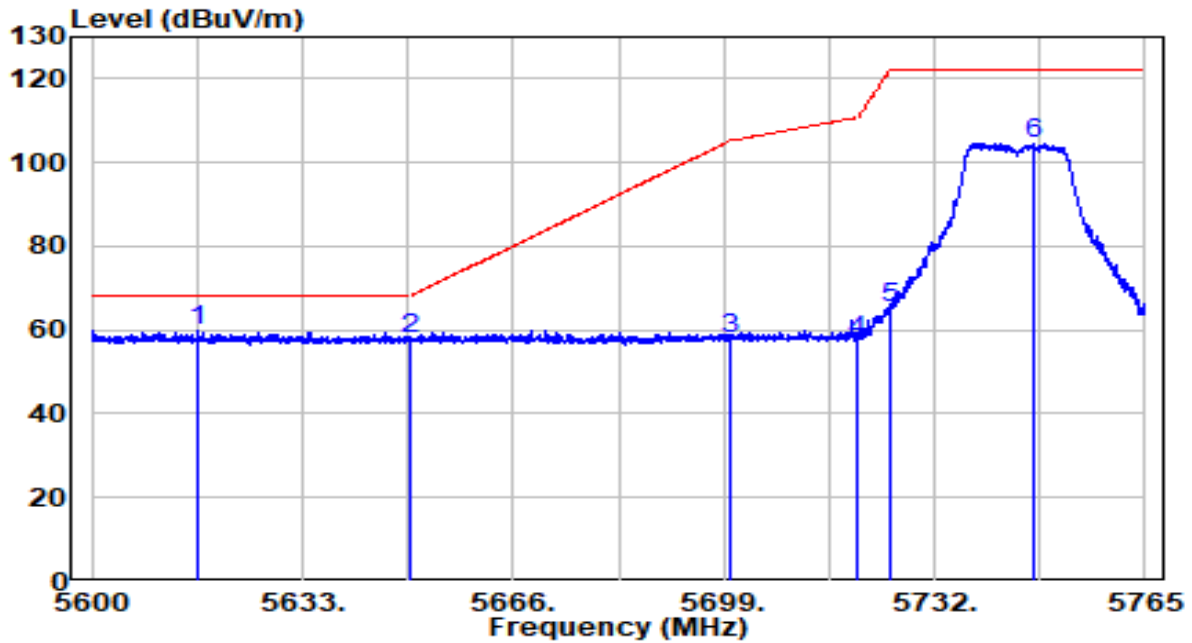

No	Frequency (MHz)	Reading (dBuV)	C.F (dB)	Measurement (dBuV/m)	Margin (dB)	Limit (dBuV/m)	Remark (QP/PK/AV)
1	* 5616.665	39.11	20.65	59.76	-8.44	68.20	Peak
2	5650.000	37.20	20.76	57.96	-10.24	68.20	Peak
3	5700.000	36.84	20.92	57.76	-47.44	105.20	Peak
4	5720.000	36.60	20.98	57.59	-53.21	110.80	Peak
5	5725.000	44.20	21.00	65.20	-57.00	122.20	Peak
6	5747.592	83.61	21.07	104.68	N/A	N/A	Peak

Note:

1. " *", means this data is the worst emission level.
2. C.F (Correction Factor) = Antenna Factor (dB)+ Cable Loss (dB)– Preamplifier(dB)+16db attenuation.
3. Measurement(dBuV/m) = Reading(dBuV) + C.F (Correction Factor).
- 4.The emission levels of other frequencies are very lower than the limit and not show in test report.

EUT	AP311	Date of Test	2020-09-27
Factor	BBHA 9120D (1GHz~18GHz)_2020	Temp. / Humidity	25.3°C/45.8%
Polarity	Horizontal	Site / Test Engineer	AC1 / Kevin Ker
Test Mode	Transmit by 802.11a at Channel 5825MHz-Scan Antenna	Test Voltage	120V/60Hz

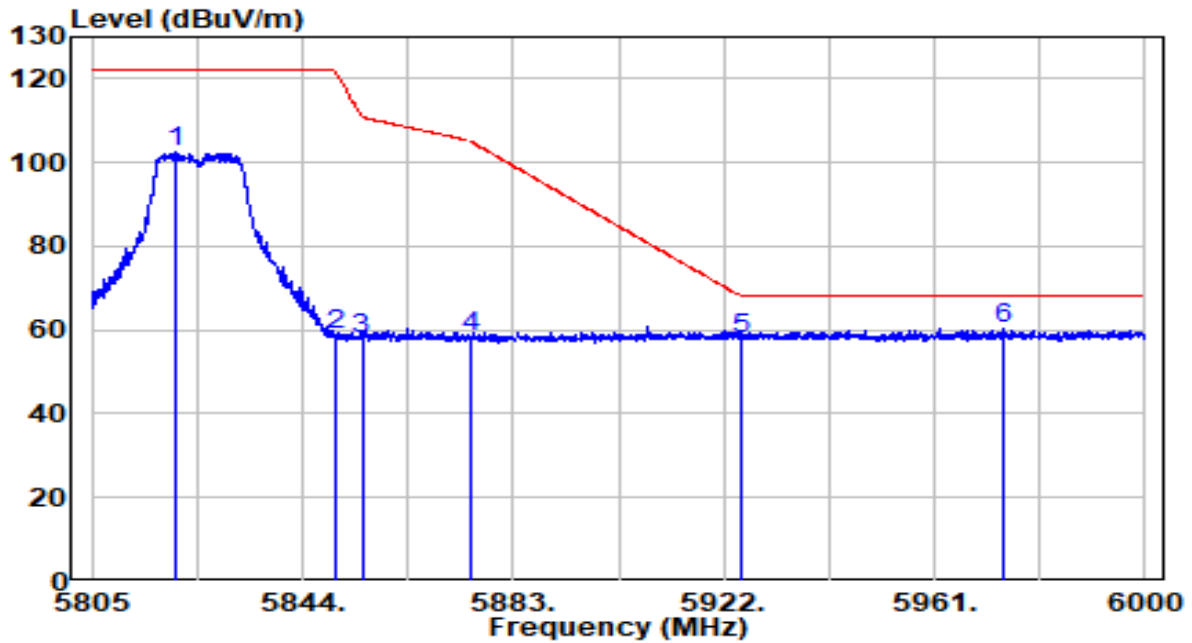

No	Frequency (MHz)	Reading (dBUV)	C.F (dB)	Measurement (dBUV/m)	Margin (dB)	Limit (dBUV/m)	Remark (QP/PK/AV)
1	5820.308	81.02	21.31	102.33	N/A	N/A	Peak
2	5850.000	37.26	21.40	58.67	-63.53	122.20	Peak
3	5855.000	36.68	21.42	58.10	-52.70	110.80	Peak
4	5875.000	36.87	21.49	58.35	-46.85	105.20	Peak
5	5925.000	36.21	21.65	57.86	-10.34	68.20	Peak
6	* 5973.675	38.31	21.80	60.12	-8.08	68.20	Peak

Note:

1. " *", means this data is the worst emission level.
2. C.F (Correction Factor) = Antenna Factor (dB)+ Cable Loss (dB)– Preamplifier(dB)+16db attenuation.
3. Measurement(dBUV/m) = Reading(dBUV) + C.F (Correction Factor).
- 4.The emission levels of other frequencies are very lower than the limit and not show in test report.

EUT	AP311	Date of Test	2020-09-27
Factor	BBHA 9120D (1GHz~18GHz)_2020	Temp. / Humidity	25.3°C/45.8%
Polarity	Vertical	Site / Test Engineer	AC1 / Kevin Ker
Test Mode	Transmit by 802.11a at Channel 5825MHz-Scan Antenna	Test Voltage	120V/60Hz

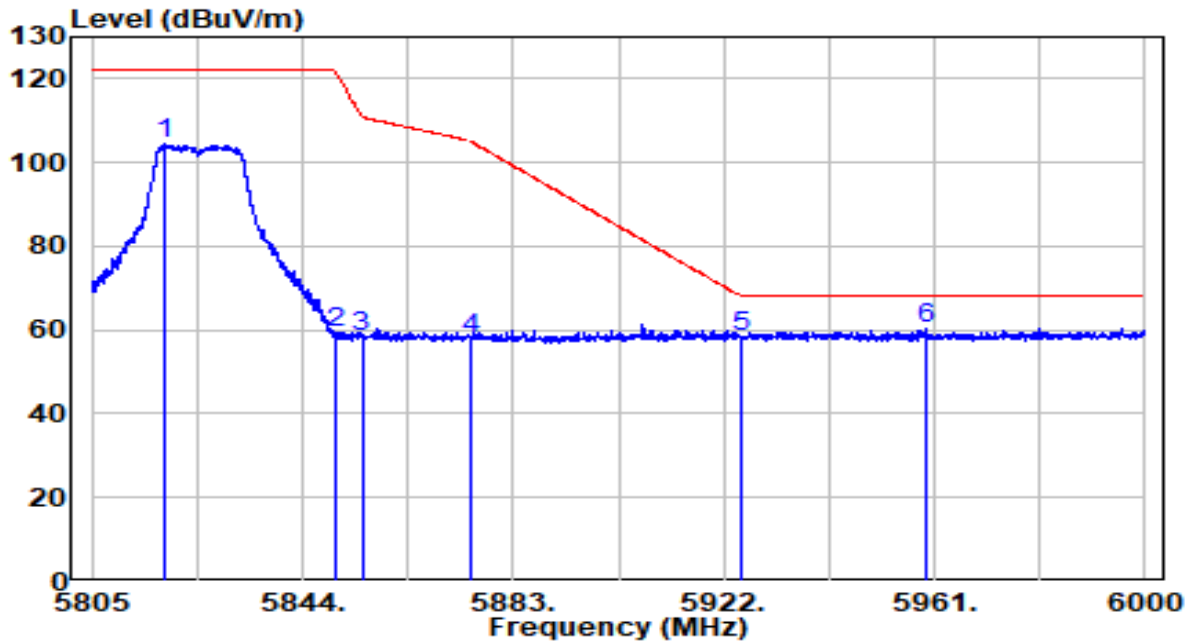

No	Frequency (MHz)	Reading (dBuV)	C.F (dB)	Measurement (dBuV/m)	Margin (dB)	Limit (dBuV/m)	Remark (QP/PK/AV)
1	5818.455	83.17	21.30	104.48	N/A	N/A	Peak
2	5850.000	38.14	21.40	59.55	-62.65	122.20	Peak
3	5855.000	37.01	21.42	58.43	-52.37	110.80	Peak
4	5875.000	36.16	21.49	57.65	-47.55	105.20	Peak
5	5925.000	36.85	21.65	58.49	-9.71	68.20	Peak
6	* 5959.245	38.63	21.76	60.39	-7.81	68.20	Peak

Note:

1. " *", means this data is the worst emission level.
2. C.F (Correction Factor) = Antenna Factor (dB)+ Cable Loss (dB)– Preamplifier(dB)+16db attenuation.
3. Measurement(dBuV/m) = Reading(dBuV) + C.F (Correction Factor).
- 4.The emission levels of other frequencies are very lower than the limit and not show in test report.

6.10. AC Conducted Emissions Measurement

6.10.1. Test Limit

FCC Part 15.207 Limits		
Frequency (MHz)	QP (dB μ V)	AV (dB μ V)
0.15 - 0.50	66 - 56	56 - 46
0.50 - 5.0	56	46
5.0 - 30	60	50

Note 1: The lower limit shall apply at the transition frequencies.

Note 2: The limit decreases linearly with the logarithm of the frequency in the range 0.15MHz to 0.5MHz.

6.10.2. Test Procedure

The EUT was setup according to ANSI C63.4, 2009 and tested according to KDB 789033 for compliance to FCC 47CFR 15.247 requirements. The EUT was placed on a platform of nominal size, 1 m by 1.5 m, raised 80 cm above the conducting ground plane. The vertical conducting plane was located 40 cm to the rear of the EUT. All other surfaces of EUT were at least 80 cm from any other grounded conducting surface. The EUT and simulators are connected to the main power through a line impedance stabilization network (LISN). The LISN provides a 50 ohm /50uH coupling impedance for the measuring equipment. The peripheral devices are also connected to the main power through a LISN. (Please refer to the block diagram of the test setup and photographs) Each current-carrying conductor of the EUT power cord, except the ground (safety) conductor, was individually connected through a LISN to the input power source.

The excess length of the power cord between the EUT and the LISN receptacle were folded back and forth at the center of the lead to form a bundle not exceeding 40 cm in length.

Conducted emissions were investigated over the frequency range from 0.15MHz to 30MHz using a receiver bandwidth of 9kHz.

6.10.3. Test Setup

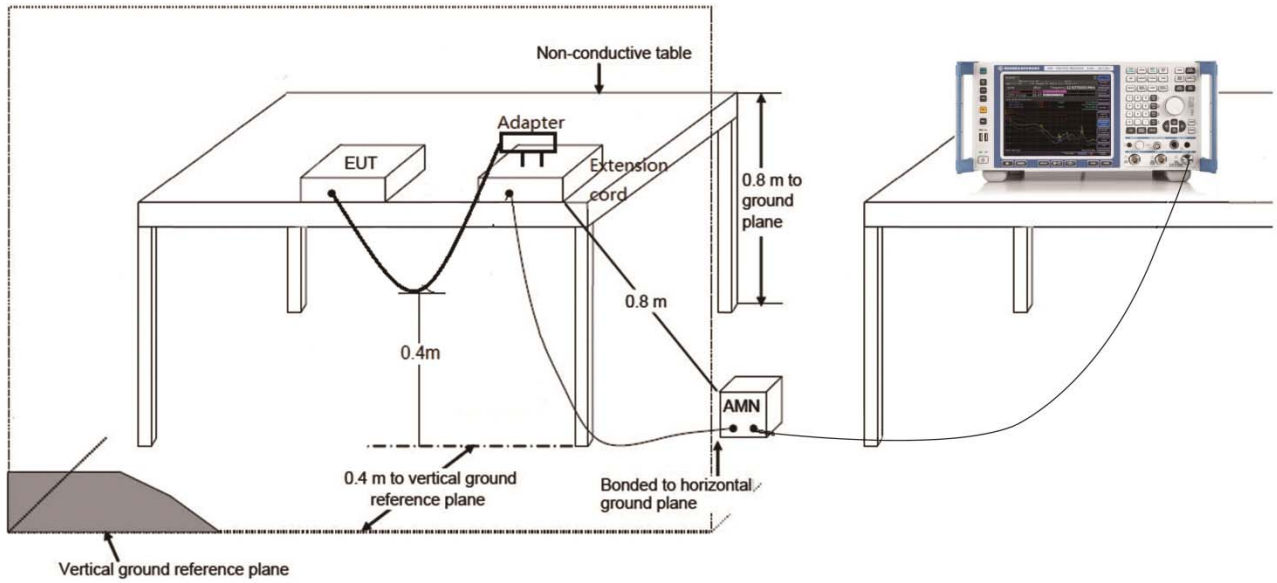

6.10.4. Test Result

EUT	AP311	Date of Test	2020-10-12
Factor	CE_ENV216-L1 (Filter ON)_2020	Temp. / Humidity	23.2°C /51.6%
Polarity	Line1	Site / Test Engineer	SR2 / Kevin Ker
Test Mode	Transmit by 802.11ax-HE20 at channel 5260MHz	Test Voltage	120V/60Hz

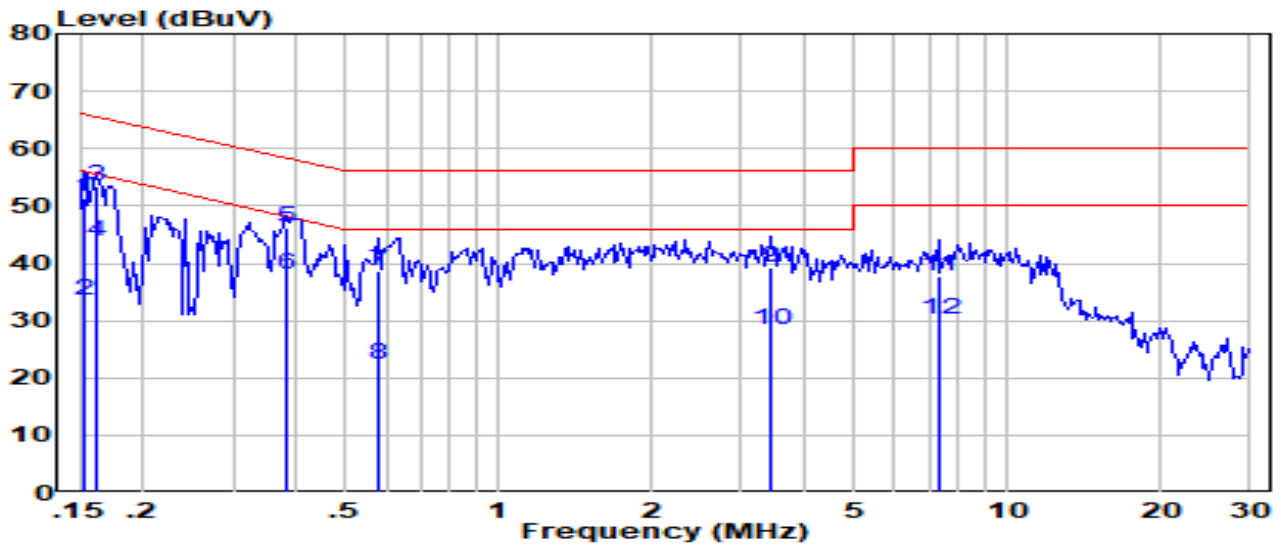

No	Frequency (MHz)	Reading (dBUV)	C.F (dB)	Measurement (dBUV/m)	Margin (dB)	Limit (dBUV/m)	Remark (QP/PK/AV)
1	0.153	41.68	9.61	51.26	-14.57	65.84	QP
2	0.153	23.88	9.61	33.46	-22.37	55.84	AV
3	0.161	43.78	9.61	53.36	-12.05	65.41	QP
4	0.161	34.18	9.61	43.76	-11.65	55.41	AV
5	0.381	36.56	9.62	46.14	-12.12	58.26	QP
6	*	28.46	9.62	38.04	-10.22	48.26	AV
7	0.579	29.19	9.64	38.77	-17.23	56.00	QP
8	0.579	12.88	9.64	22.46	-23.54	46.00	AV
9	3.440	29.64	9.71	39.24	-16.76	56.00	QP
10	3.440	18.84	9.71	28.44	-17.56	46.00	AV
11	7.310	28.11	9.80	37.75	-22.25	60.00	QP
12	7.310	20.61	9.80	30.25	-19.75	50.00	AV

Note:

1. " *", means this data is the worst emission level.
2. C.F (Correction Factor) = Antenna Factor (dB)+ Cable Loss (dB).
3. Measurement(dBUV/m) = Reading(dBUV) + C.F (Correction Factor).

EUT	AP311	Date of Test	2020-10-12
Factor	CE_ENV216-N (Filter ON)_2020	Temp. / Humidity	23.2°C /51.6%
Polarity	Neutral	Site / Test Engineer	SR2 / Kevin Ker
Test Mode	Transmit by 802.11ax-HE20 at channel 5260MHz	Test Voltage	120V/60Hz

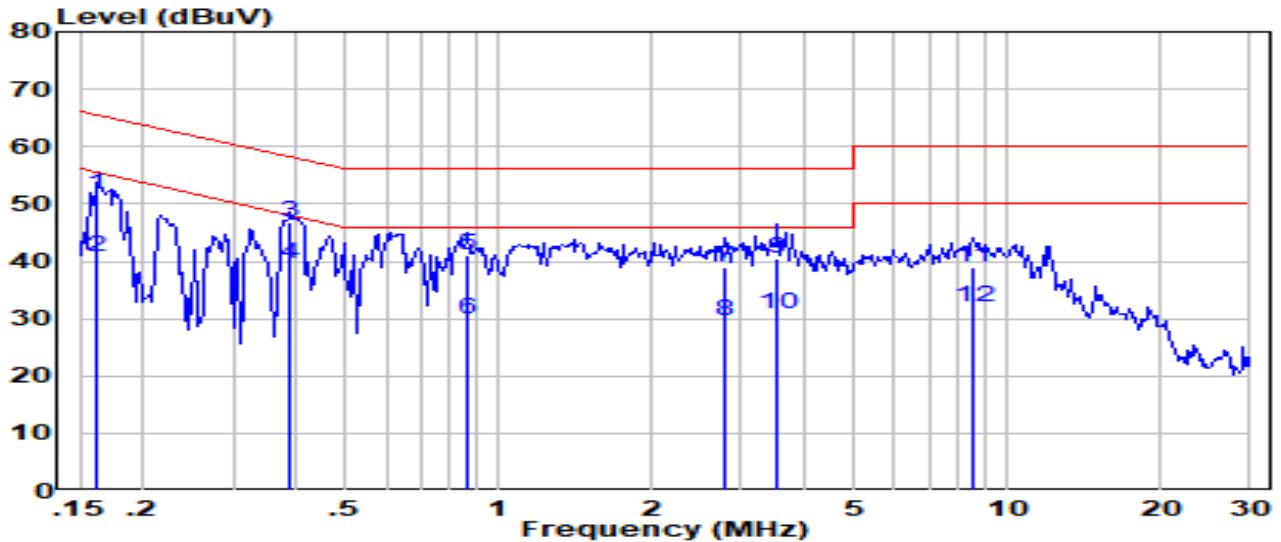

No	Frequency (MHz)	Reading (dBuV)	C.F (dB)	Measurement (dBuV/m)	Margin (dB)	Limit (dBuV/m)	Remark (QP/PK/AV)
1	0.162	41.94	9.62	51.53	-13.83	65.36	QP
2	0.162	31.04	9.62	40.63	-14.73	55.36	AV
3	0.389	37.07	9.63	46.66	-11.43	58.09	QP
4	*	29.87	9.63	39.46	-8.63	48.09	AV
5	0.871	31.49	9.66	41.09	-14.91	56.00	QP
6	0.871	20.19	9.66	29.79	-16.21	46.00	AV
7	2.790	29.39	9.71	38.99	-17.01	56.00	QP
8	2.790	19.89	9.71	29.49	-16.51	46.00	AV
9	3.540	30.88	9.72	40.50	-15.50	56.00	QP
10	3.540	21.18	9.72	30.80	-15.20	46.00	AV
11	8.570	29.22	9.85	38.88	-21.12	60.00	QP
12	8.570	22.42	9.85	32.08	-17.92	50.00	AV

Note:

1. " *", means this data is the worst emission level.
2. C.F (Correction Factor) = Antenna Factor (dB)+ Cable Loss (dB).
3. Measurement(dBuV/m) = Reading(dBuV) + C.F (Correction Factor).

EUT	AP311	Date of Test	2020-10-12
Factor	CE_ENV216-L1 (Filter ON)_2020	Temp. / Humidity	23.2°C /51.6%
Polarity	Line1	Site / Test Engineer	SR2 / Kevin Ker
Test Mode	Transmit by 802.11a at channel 5825MHz -Scan Antenna	Test Voltage	120V/60Hz

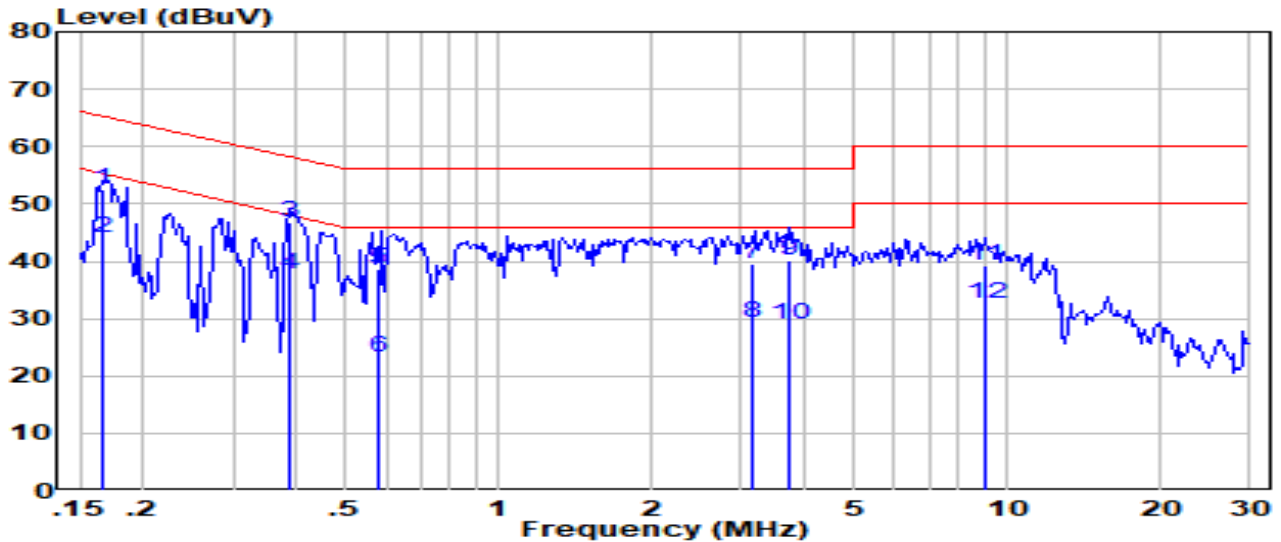

No	Frequency (MHz)	Reading (dBuV)	C.F (dB)	Measurement (dBuV/m)	Margin (dB)	Limit (dBuV/m)	Remark (QP/PK/AV)
1	0.167	42.99	9.61	52.57	-12.54	65.11	QP
2	0.167	34.39	9.61	43.97	-11.14	55.11	AV
3	0.389	37.26	9.62	46.84	-11.25	58.09	QP
4	*	0.389	28.26	37.84	-10.25	48.09	AV
5	0.580	28.99	9.64	38.57	-17.43	56.00	QP
6	0.580	13.79	9.64	23.37	-22.63	46.00	AV
7	3.170	30.07	9.71	39.68	-16.32	56.00	QP
8	3.170	19.67	9.71	29.28	-16.72	46.00	AV
9	3.720	30.40	9.72	40.01	-15.99	56.00	QP
10	3.720	19.50	9.72	29.11	-16.89	46.00	AV
11	9.010	29.62	9.85	39.28	-20.72	60.00	QP
12	9.010	22.92	9.85	32.58	-17.42	50.00	AV

Note:

1. " *", means this data is the worst emission level.
2. C.F (Correction Factor) = Antenna Factor (dB)+ Cable Loss (dB).
3. Measurement(dBuV/m) = Reading(dBuV) + C.F (Correction Factor).

EUT	AP311	Date of Test	2020-10-12
Factor	CE_ENV216-N (Filter ON)_2020	Temp. / Humidity	23.2°C /51.6%
Polarity	Neutral	Site / Test Engineer	SR2 / Kevin Ker
Test Mode	Transmit by 802.11a at channel 5825MHz -Scan Antenna	Test Voltage	120V/60Hz

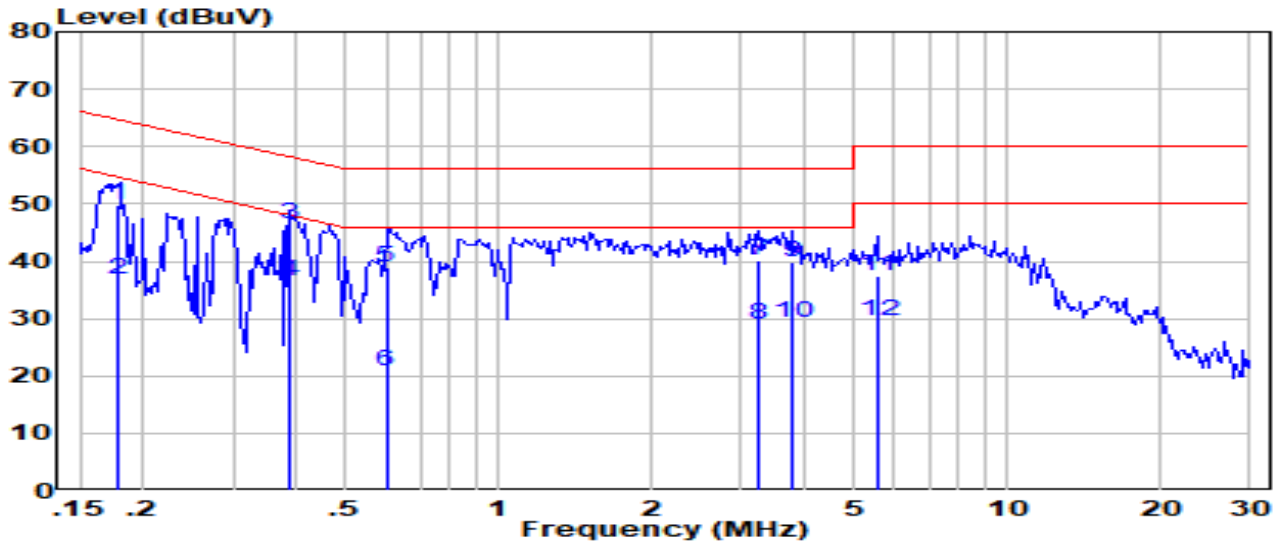

No	Frequency (MHz)	Reading (dBuV)	C.F (dB)	Measurement (dBuV/m)	Margin (dB)	Limit (dBuV/m)	Remark (QP/PK/AV)
1	0.179	40.34	9.62	49.93	-14.60	64.53	QP
2	0.179	27.24	9.62	36.83	-17.70	54.53	AV
3	0.390	36.77	9.63	46.36	-11.70	58.06	QP
4	*	0.390	26.87	36.46	-11.60	48.06	AV
5	0.600	29.38	9.65	38.97	-17.03	56.00	QP
6	0.600	11.28	9.65	20.87	-25.13	46.00	AV
7	3.240	30.44	9.71	40.05	-15.95	56.00	QP
8	3.240	19.44	9.71	29.05	-16.95	46.00	AV
9	3.760	30.14	9.73	39.76	-16.24	56.00	QP
10	3.760	19.64	9.73	29.26	-16.74	46.00	AV
11	5.540	27.80	9.77	37.44	-22.56	60.00	QP
12	5.540	19.90	9.77	29.54	-20.46	50.00	AV

Note:

1. " *", means this data is the worst emission level.
2. C.F (Correction Factor) = Antenna Factor (dB)+ Cable Loss (dB).
3. Measurement(dBuV/m) = Reading(dBuV) + C.F (Correction Factor).

7. CONCLUSION

The data collected relate only the item(s) tested and show that the device is compliance with Part 15E of the FCC Rules.

————— The End —————

Appendix A - Test Setup Photograph

Refer to "2010TW0002-UT" file.

Appendix B-EUT Photograph

Refer to "2010TW0002-UE" file.