

# MEASUREMENT REPORT

## FCC PART 15.407 WLAN 802.11a/n/ac/ax

---

**FCC ID:** 2ALJ3AP30X  
**Applicant:** HAN Networks Co., Ltd.  
**Application Type:** Certification  
**Product:** HAN Access Point  
**Model No.:** AP301  
**Brand Name:** HAN NETWORKS; HANNETWORKS  
**FCC Classification:** Unlicensed National Information Infrastructure (NII)  
**FCC Rule Part(s):** Part15 Subpart E (Section 15.407)  
**Test Procedure(s):** ANSI C63.10-2013  
**Receive Date** August 25, 2020  
**Test Date:** October 17 ~ November 30, 2020

**Tested By** : Fran Chen  
( Fran Chen )

**Reviewed By** : Paddy Chen  
( Paddy Chen )

**Approved By** : Chenz Ker  
( Chenz Ker )



The test results relate only to the samples tested.

This equipment has been shown to be capable of compliance with the applicable technical standards as indicated in the measurement report and was tested in accordance with the measurement procedures specified in ANSI C63.10-2013. Test results reported herein relate only to the item(s) tested.

The test report shall not be reproduced except in full without the written approval of MRT Technology (Taiwan) Co., Ltd.

### Revision History

Report No.	Version	Description	Issue Date	Note
2010TW0002-UF	V1.0	Original Report	2020-12-07	Valid

---

## CONTENTS

Description	Page
<b>1. INTRODUCTION .....</b>	<b>7</b>
1.1. Scope .....	7
1.2. MRT Test Location .....	7
<b>2. PRODUCT INFORMATION .....</b>	<b>8</b>
2.1. Equipment Description.....	8
2.2. Product Specification Subjective to this Report.....	8
2.3. Working Frequencies for this report.....	9
2.4. Description of Available Antennas.....	10
2.5. Description of Antenna RF Port .....	10
2.6. Test Mode .....	10
2.7. Description of Test Software .....	10
2.8. Duty Cycle .....	11
2.9. EMI Suppression Device(s)/Modifications.....	12
2.10. Configuration of Tested System.....	13
2.11. Test System Details.....	13
<b>3. ANTENNA REQUIREMENTS.....</b>	<b>14</b>
<b>4. TEST EQUIPMENT CALIBRATION DATE .....</b>	<b>15</b>
<b>5. MEASUREMENT UNCERTAINTY.....</b>	<b>17</b>
<b>6. TEST RESULT .....</b>	<b>18</b>
6.1. Summary .....	18
6.2. 26dB Bandwidth Measurement.....	19
6.2.1. Test Limit .....	19
6.2.2. Test Procedure used.....	19
6.2.3. Test Setting.....	19
6.2.4. Test Setup .....	19
6.2.5. Test Result.....	20
6.3. 6dB Bandwidth Measurement.....	35
6.3.1. Test Limit .....	35
6.3.2. Test Procedure used.....	35
6.3.3. Test Setting.....	35
6.3.4. Test Setup .....	35
6.3.5. Test Result.....	36
6.4. Output Power Measurement.....	41
6.4.1. Test Limit .....	41

---

6.4.2. Test Procedure Used .....	41
6.4.3. Test Setting.....	41
6.4.4. Test Setup .....	41
6.4.5. TestResult.....	42
6.5. Transmit Power Control .....	45
6.5.1. Test Limit .....	45
6.5.2. Test Procedure Used .....	45
6.5.3. Test Setting.....	45
6.5.4. Test Setup .....	45
6.5.5. TestResult.....	45
6.6. Power Spectral Density Measurement.....	46
6.6.1. TestLimit .....	46
6.6.2. Test Procedure Used .....	46
6.6.3. Test Setting.....	46
6.6.4. Test Setup .....	47
6.6.5. Test Result.....	48
6.7. Frequency Stability Measurement.....	76
6.7.1. TestLimit .....	76
6.7.2. Test Procedure Used .....	76
6.7.3. Test Setup .....	77
6.7.4. Test Result.....	78
6.8. Radiated Spurious Emission Measurement .....	79
6.8.1. Test Limit .....	79
6.8.2. Test Procedure Used .....	79
6.8.3. Test Setting.....	79
6.8.4. Test Setup .....	81
6.8.5. Test Result.....	82
6.9. Radiated RestrictedBand Edge Measurement.....	226
6.9.1. Test Limit .....	226
6.9.2. Test Procedure Used .....	227
6.9.3. Test Setting.....	228
6.9.4. Test Setup .....	229
6.9.5. Test Result.....	230
6.10. AC Conducted Emissions Measurement.....	372
6.10.1. TestLimit .....	372
6.10.2. Test Procedure .....	372
6.10.3. Test Setup .....	373
6.10.4. Test Result.....	374

**7. CONCLUSION..... 378**

**Appendix A - Test Setup Photograph ..... 379**

**Appendix B - EUT Photograph..... 380**

## §2.1033 General Information

<b>Applicant</b>	HAN Networks Co., Ltd.
<b>Applicant Address</b>	101-A16, 1st Floor, Building 3, No.9 compound, Yongfeng Road, Haidian District, Beijing, P.R. China
<b>Manufacturer</b>	HAN Networks Co., Ltd.
<b>Manufacturer Address</b>	101-A16, 1st Floor, Building 3, No.9 compound, Yongfeng Road, Haidian District, Beijing, P.R. China
<b>Test Site</b>	MRT Technology (Taiwan) Co., Ltd
<b>Test Site Address</b>	No. 38, Fuxing Second Rd., Guishan Dist., Taoyuan City 333, Taiwan (R.O.C)
<b>MRT FCC Registration No.</b>	291082
<b>FCC Rule Part(s)</b>	Part 15.407
<b>Model No.</b>	AP301
<b>Test Device Serial No.:</b>	#1 <input type="checkbox"/> Production <input checked="" type="checkbox"/> Pre-Production <input type="checkbox"/> Engineering

### Test Facility / Accreditations

1. MRT facility is an FCC registered (Reg. No. 291082) test facility with the site description report on file and is designated by the FCC as an Accredited Test Firm.
2. MRT facility is an IC registered (MRT Reg. No. 21723) test laboratory with the site description on file at Industry Canada.
3. MRT Lab is accredited to ISO 17025 by the Taiwan Accreditation Foundation (TAF Cert. No. 3261) in EMC, Telecommunications and Radio testing for FCC (Designation Number: TW3261), Industry Taiwan, EU and TELEC Rules.

## 1. INTRODUCTION

### 1.1. Scope

Measurement and determination of electromagnetic emissions (EMC) of radio frequency devices including intentional and/or unintentional radiators for compliance with the technical rules and regulations of the Federal Communications Commission and the Innovation, Science and Economic Development Canada and Certification and Engineering Bureau.

### 1.2. MRT Test Location

The map below shows the location of the MRT LABORATORY, its proximity to the Taoyuan City. These measurement tests were conducted at the MRT Technology (Taiwan) Co., Ltd. Facility located at No.38, Fuxing 2nd Rd., Guishan Dist., Taoyuan City 33377, Taiwan (R.O.C).

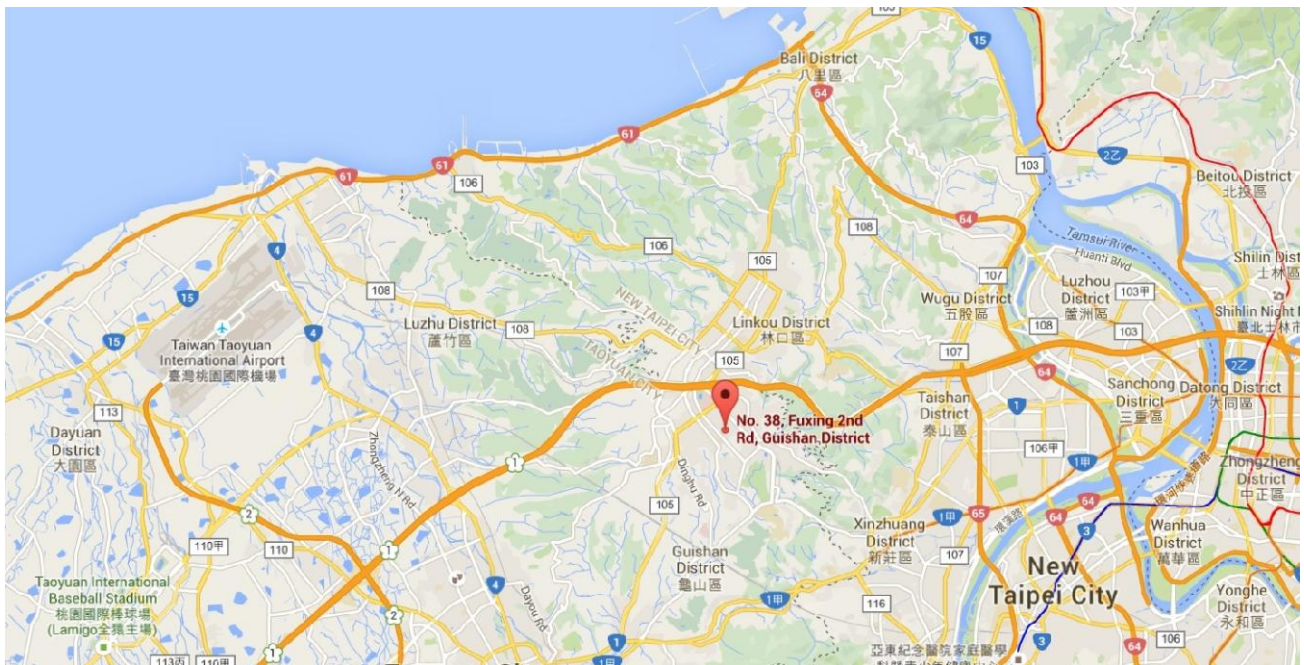

## 2. PRODUCT INFORMATION

### 2.1. Equipment Description

Product Name:	HAN Access Point
Model No.:	AP301
Brand Name:	HAN NETWORKS; HANNETWORKS
Wi-Fi Specification:	802.11a/b/g/n/ac/ax
Operating Temperature:	0 ~ 50 °C
Power Type:	PoE input or AC adapter input
Operating Environment:	Indoor Use

### 2.2. Product Specification Subjective to this Report

Frequency Range:	For 802.11a/n-HT20/ac-VHT20/ax-HE20: 5180~5320MHz, 5500~5720MHz, 5745~5825MHz For 802.11n-HT40/ac-VHT40/ax-HE40: 5190~5310MHz, 5510~5710MHz, 5755~5795MHz For 802.11ac-VHT80/ax-HE80: 5210MHz, 5290MHz, 5530MHz, 5610 MHz,5690 MHz,5775MHz
Type of Modulation:	802.11a/n/ac: OFDM 802.11ax: OFDMA
Data Rate:	802.11a: 6/9/12/18/24/36/48/54Mbps 802.11n: up to 300Mbps 802.11ac: up to 866.6Mbps 802.11ax: up to 1201Mbps

Note: For other features of this EUT, test report will be issued separately.



### 2.3. Working Frequencies for this report

#### 802.11a/n-HT20/ac-VHT20/ax-HE20

Channel	Frequency	Channel	Frequency	Channel	Frequency
36	5180 MHz	40	5200 MHz	44	5220 MHz
48	5240 MHz	52	5260 MHz	56	5280 MHz
60	5300 MHz	64	5320 MHz	100	5500 MHz
104	5520 MHz	108	5540 MHz	112	5560 MHz
116	5580 MHz	120	5600 MHz	124	5620 MHz
128	5640 MHz	132	5660 MHz	136	5680 MHz
140	5700 MHz	144	5720 MHz	149	5745 MHz
153	5765 MHz	157	5785 MHz	161	5805 MHz
165	5825 MHz	--	--	--	--

#### 802.11n-HT40/ac-VHT40/ax-HE40

Channel	Frequency	Channel	Frequency	Channel	Frequency
38	5190 MHz	46	5230 MHz	54	5270 MHz
62	5310 MHz	102	5510 MHz	110	5550MHz
118	5590 MHz	126	5630 MHz	134	5670 MHz
142	5710 MHz	151	5755 MHz	159	5795 MHz

#### 802.11ac-VHT80/ax-HE80

Channel	Frequency	Channel	Frequency	Channel	Frequency
42	5210 MHz	58	5290 MHz	106	5530 MHz
122	5610 MHz	138	5690 MHz	155	5775 MHz

## 2.4. Description of Available Antennas

Antenna Type	Frequency Band (GHz)	T <sub>x</sub> Paths	Bandwidth (MHz)	MaxPeak Gain (dBi)		CDD Directional Gain(dBi)		Beamforming Directional Gain (dBi)
				Ant 0	Ant 1	Power	PSD	
Wi-Fi Internal Antenna List (2.4GHz 2*2 MIMO, 5GHz 2*2 MIMO)								
PIFA Antenna	2412 ~ 2462	2	20, 40	3.20	3.30	3.30	6.31	6.31
	5150 ~ 5850	2	20, 40, 80	3.10	3.30	3.30	6.31	6.31

Note 1: The EUT supports Cyclic Delay Diversity (CDD) technology for 802.11a/b/g/n/ac/ax and it is correlated.

If all antennas have the same gain,  $G_{ANT}$ , Directional gain =  $G_{ANT}$  + Array Gain, where Array Gain is as follows.

- For power spectral density (PSD) measurements on all devices,  
Array Gain =  $10 \log (N_{ANT} / N_{SS})$  dB = 3.01;
- For power measurements on IEEE 802.11 devices,  
Array Gain = 0 dB for  $N_{ANT} \leq 4$ ;

If antenna gains are not equal, Directional gain may be calculated by using the formulas applicable to equal gain antennas with  $G_{ANT}$  set equal to the gain of the antenna having the highest gain.

Note 2: The EUT also supports Beamforming mode, and the Beamforming support 802.11n/ac/ax, not include 802.11a/b/g. The directional gain =  $G_{ANT}$  + Array Gain (3.01dBi).

Note 3: Antenna type and antenna gain are provided by the manufacturer.

## 2.5. Test Mode

Test Mode	Mode 1: Transmit by 802.11a (6Mbps)
	Mode 2: Transmit by 802.11ac-VHT20 (MCS0)
	Mode 3: Transmit by 802.11ac-VHT40 (MCS0)
	Mode 4: Transmit by 802.11ac-VHT80 (MCS0)
	Mode 5: Transmit by 802.11ax-HE20 (MCS0)
	Mode 6: Transmit by 802.11ax-HE40 (MCS0)
	Mode 7: Transmit by 802.11ax-HE80 (MCS0)

Note: Due to the same modulation & power setting between 802.11n and 802.11ac, so 802.11n-HT20 and HT40 are covered by 802.11ac-VHT20 and VHT40 in this report.

## 2.6. Description of Test Software

The test utility software used during testing was "QSPR", and the version was "v50-00186".

## 2.7. Duty Cycle

5GHz (NII) operation is possible in 20MHz, 40MHz, 80MHz channel bandwidths. The maximum achievable duty cycles for all modes were determined based on measurements performed on a spectrum analyzer in zero-span mode with RBW = 8MHz, VBW = 50MHz. The RBW and VBW were both greater than 50/T, where T is the minimum transmission duration, and the number of sweep points across T was greater than 100. The duty cycles are as follows:

Test Mode	Duty Cycle	Test Mode	Duty Cycle
802.11a	93.23 %	802.11ax-HE20	94.99%
802.11ac-VHT20	93.97%	802.11ax-HE40	95.03%
802.11ac-VHT40	95.64%	802.11ax-HE80	94.57%
802.11ac-VHT80	88.73%	--	--

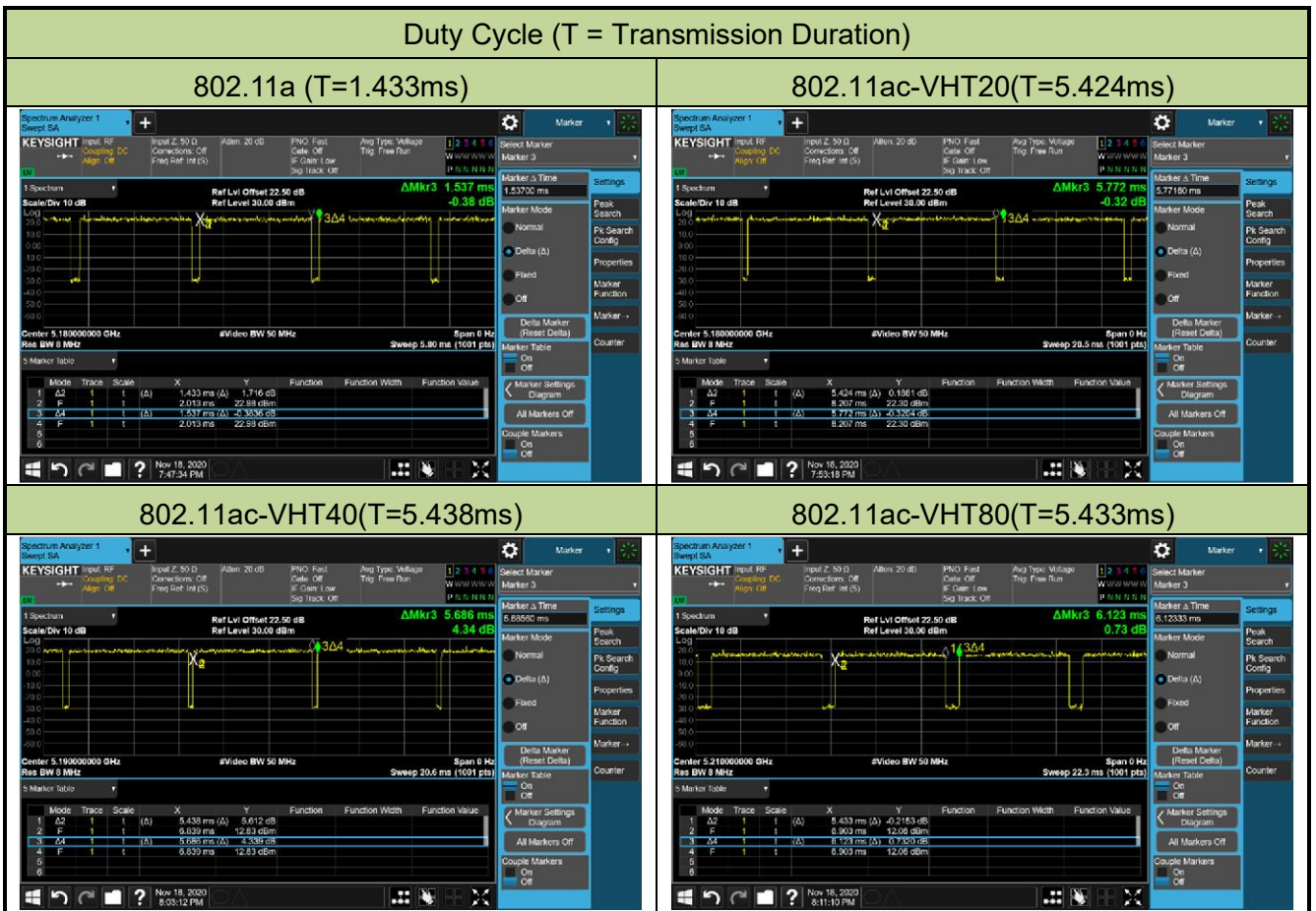

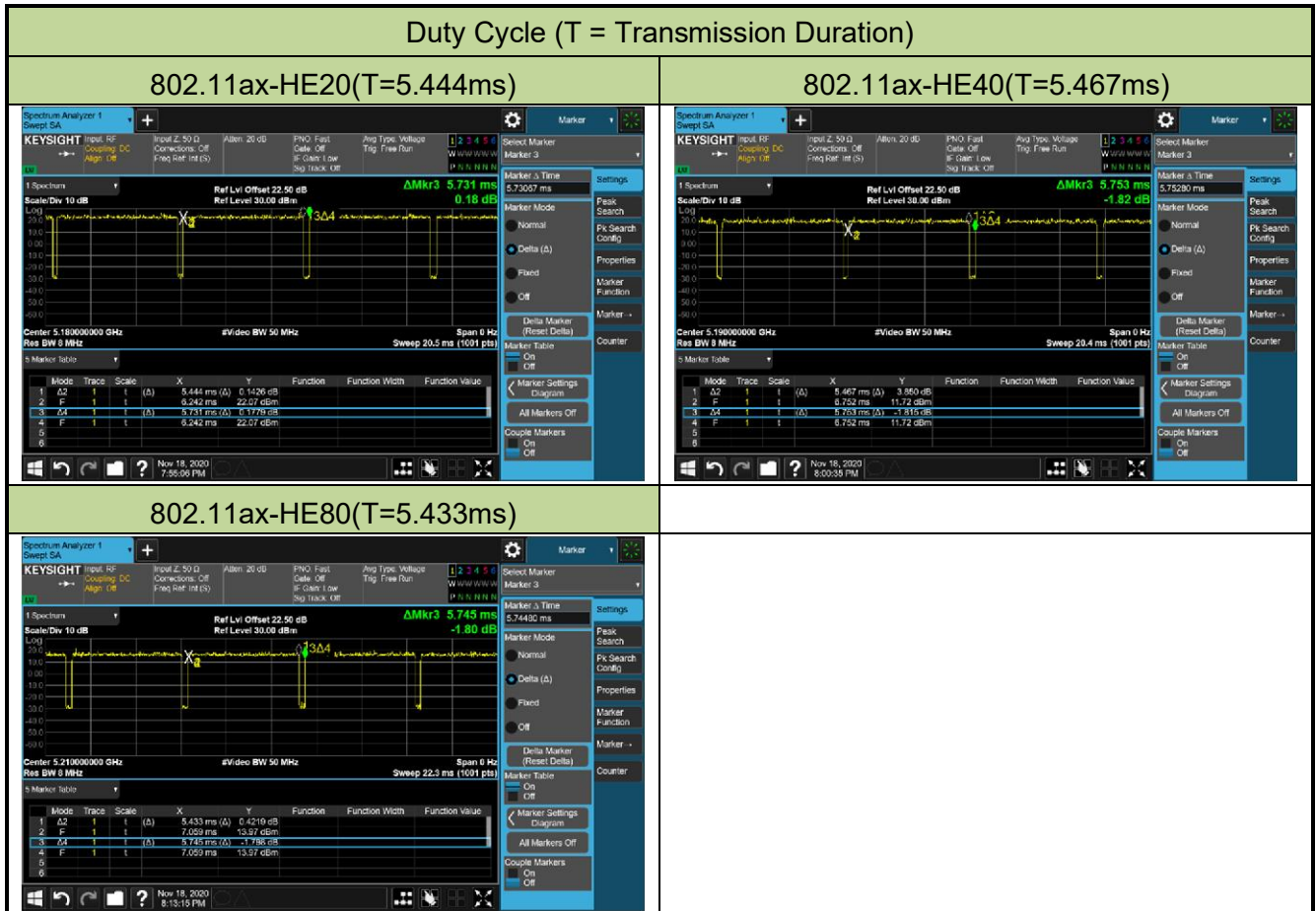

## 2.8. EMI Suppression Device(s)/Modifications

No EMI suppression device(s) were added and/or no modifications were made during testing.

### 2.9. Configuration of Tested System

This device was tested per the guidance ANSI C63.10:2013 was used to reference the appropriate EUT setup for radiated emissions testing and AC line conducted testing.

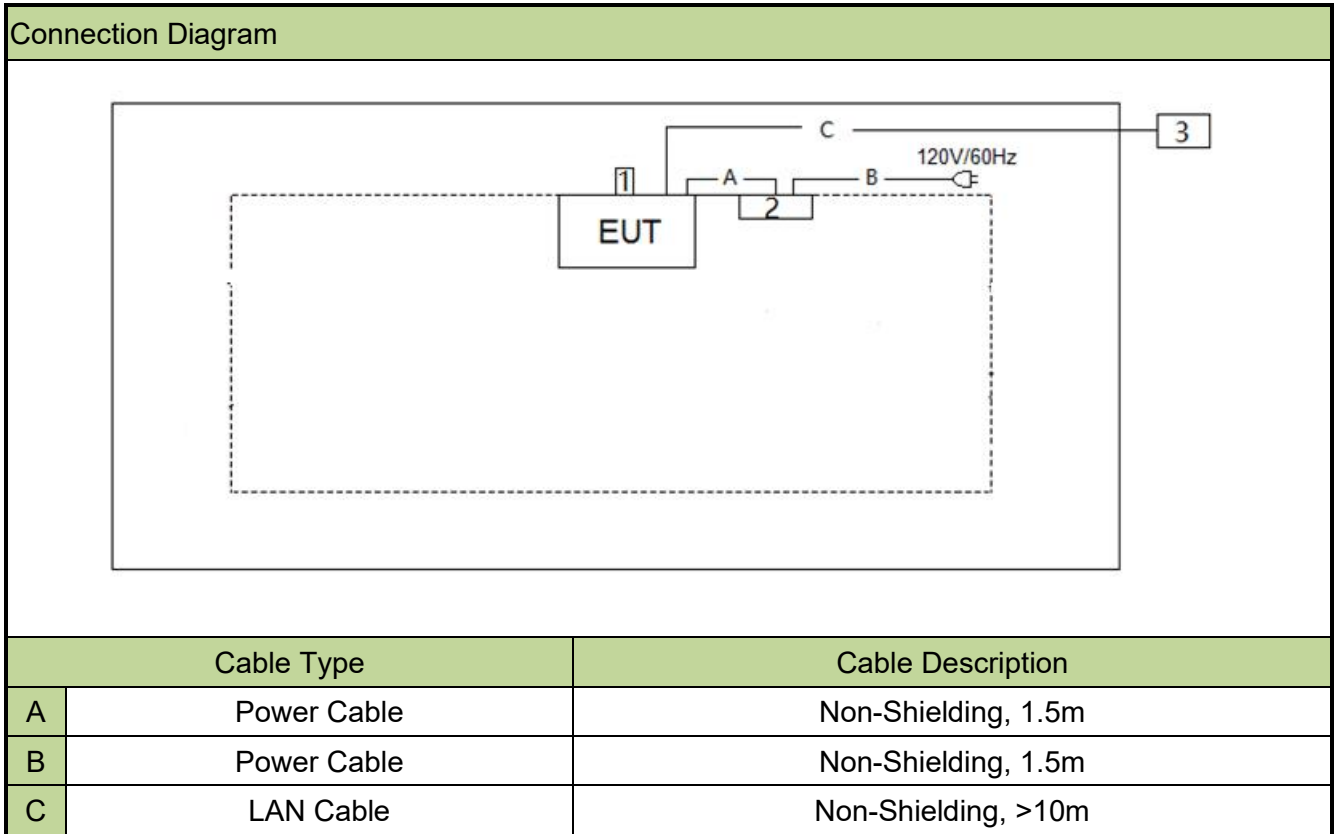

### 2.10. Test System Details

The types for all equipments, plus descriptions of all cables used in the tested system (including inserted cards) are:

Product	Manufacturer	Model No.	Serial No.	
1	USB Dongle	SanDisk	BL161025264V	N/A
2	AC Adapter	DELTA	ADP-30HR B	1WMD05S00T5
3	Notebook	ASUS	PRO45V	N/A

### 3. ANTENNA REQUIREMENTS

**Excerpt from §15.203 of the FCC Rules/Regulations:**

“An intentional radiator antenna shall be designed to ensure that no antenna other than that furnished by the responsible party can be used with the device. The use of a permanently attached antenna or of an antenna that uses a unique coupling to the intentional radiator shall be considered sufficient to comply with the provisions of this section.”

- The antenna of the device is **permanently attached**.
- There are no provisions for connection to an external antenna.

**Conclusion:**

The unit complies with the requirement of §15.203.

#### 4. TEST EQUIPMENT CALIBRATION DATE

##### Radiated Disturbance-AC1 :

Instrument	Manufacturer	Type No.	Asset No.	Cali. Interval	Cali. Due Date
Broadband TRILOG Antenna	SCHWARZBECK	VULB 9162	MRTTWA00001	1 year	2021/10/5
Active Loop Antenna	SCHWARZBECK	FMZB 1519B	MRTTWA00002	1 year	2021/4/27
Broadband Hornantenna	SCHWARZBECK	BBHA 9120D	MRTTWA00003	1 year	2021/4/24
Breitband Hornantenna	SCHWARZBECK	BBHA 9170	MRTTWA00004	1 year	2021/4/24
Broadband Preamplifier	SCHWARZBECK	BBV 9718	MRTTWA00005	1 year	2021/4/24
Broadband Amplifier	SCHWARZBECK	BBV 9721	MRTTWA00006	1 year	2021/4/24
Signal Analyzer	R&S	FSV40	MRTTWA00007	1 year	2021/3/24
EMI Test Receiver	R&S	ESR3	MRTTWA00009	1 year	2021/3/25
EXA Signal Analyzer	KEYSIGHT	N9010A	MRTTWA00012	1 year	2021/10/14
EXA Signal Analyzer	KEYSIGHT	N9010B	MRTTWA00074	1 year	2021/7/14
Antenna Cable	HUBERSUHNER	SF106	MRTTWE00010	1 year	2021/6/16
Temperature/Humidity Meter	TFA	35.1078.10.IT	MRTTWA00032	1 year	2021/5/29
Cable	Rosnol	K1K50-UP0264-K1 K50-4M	MRTTWE00012	1 year	2021/6/21

##### Conducted Emissions-SR2 :

Instrument	Manufacturer	Type No.	Asset No.	Cali. Interval	Cali. Due Date
Two-Line V-Network	R&S	ENV216	MRTTWA00019	1 year	2021/3/26
Two-Line V-Network	R&S	ENV216	MRTTWA00020	1 year	2021/4/24
8-Wire ISN (T8-Cat6)	R&S	ENY81 CA6	MRTTWA00017	1 year	2021/5/25
8-Wire ISN (T8)	R&S	ENY81	MRTTWA00018	1 year	2021/5/25
8-Wire ISN	TESEQ	CDN ST08AS	MRTTWA00083	1 year	2021/9/2
EMI Test Receiver	R&S	ESR3	MRTTWA00045	1 year	2021/5/26
Conducted Cable	Rosnol	N1C50-RG400-B1C 50-500CM	MRTTWE00013	1 year	2021/6/21
Temperature/Humidity Meter	TFA	35.1078.10.IT	MRTTWA00033	1 year	2021/5/28

## Conducted Test Equipment-SR2:

Instrument	Manufacturer	Type No.	Asset No.	Cali. Interval	Cali. Due Date
X-Series USB Peak and Average Power Sensor	KEYSIGHT	U2021XA	MRTTWA00014	1 year	2021/4/24
X-Series USB Peak and Average Power Sensor	KEYSIGHT	U2021XA	MRTTWA00015	1 year	2021/3/26
Wideband Radio Communication Taster	R&S	CMW 500	MRTTWA00041	1 year	2021/1/7
EXA Signal Analyzer	KEYSIGHT	N9010A	MRTTWA00012	1 year	2021/10/14
EXA Signal Analyzer	KEYSIGHT	N9010B	MRTTWA00074	1 year	2021/7/14
Attenuator	MVE	20dB	MRTSUE06547	N/A	N/A
Signal Analyzer	R&S	FSV40	MRTTWA00007	1 year	2021/3/24
Temperature & Humidity Chamber	TEN BILLION	TTH-B3UP	MRTTWA00036	1 year	2021/6/9
Temperature/Humidity Meter	TFA	35.1078.10.IT	MRTTWA00033	1 year	2021/5/28

Software	Version	Function
e3	9.160520a	EMI Test Software



## 5. MEASUREMENT UNCERTAINTY

Where relevant, the following test uncertainty levels have been estimated for tests performed on the EUT as specified in CISPR 16-4-2. This uncertainty represents an expanded uncertainty expressed at approximately the 95% confidence level using a coverage factor of  $k = 2$ .

<b>Conducted Emission- Power Line</b>
Measuring Uncertainty for a Level of Confidence of 95% ( $U=2Uc(y)$ ): 150kHz~30MHz: $\pm 2.53\text{dB}$
<b>Radiated Spurious Emission</b>
Measuring Uncertainty for a Level of Confidence of 95% ( $U=2Uc(y)$ ): 9kHz~30MHz: $\pm 3.92\text{dB}$ 30MHz~1GHz: $\pm 4.25\text{dB}$ 1GHz~18GHz: $\pm 4.40\text{dB}$ 18GHz~40GHz: $\pm 4.45\text{dB}$
<b>Frequency Error</b>
Measuring Uncertainty for a Level of Confidence of 95% ( $U=2Uc(y)$ ): $\pm 78.4\text{Hz}$
<b>Conducted Power</b>
Measuring Uncertainty for a Level of Confidence of 95% ( $U=2Uc(y)$ ): $\pm 0.84\text{dB}$
<b>Conducted Spurious Emission</b>
Measuring Uncertainty for a Level of Confidence of 95% ( $U=2Uc(y)$ ): $\pm 2.65\text{ dB}$
<b>Occupied Bandwidth</b>
Measuring Uncertainty for a Level of Confidence of 95% ( $U=2Uc(y)$ ): 3.3%
<b>Temp. / Humidity</b>
Measuring Uncertainty for a Level of Confidence of 95% ( $U=2Uc(y)$ ): $\pm 0.82^\circ\text{C} / \pm 3\%$
<b>DC Voltage</b>
Measuring Uncertainty for a Level of Confidence of 95% ( $U=2Uc(y)$ ): $\pm 0.3\%$

## 6. TEST RESULT

### 6.1. Summary

FCC Section(s)	Test Description	Test Limit	Test Condition	Test Result	Reference
15.407(a)	26dB Bandwidth	N/A	Conducted	Pass	Section 6.2
15.407(e)	6dB Bandwidth	≥ 500kHz		Pass	Section 6.3
15.407(a)(1)(ii), (2), (3)	Maximum Conducted Output Power	Refer to section 7.4		Pass	Section 6.4
15.407(h)(1)	Transmit Power Control	≤ 24 dBm		Pass	Section 6.5
15.407(a)(1)(ii), (2), (3)	Peak Power Spectral Density	Refer to section 7.6		Pass	Section 6.6
15.407(g)	Frequency Stability	± 20 ppm		Pass	Section 6.7
15.407(b)(1), (2), (3), (4)(i)	Undesirable Emissions	Refer to Section 7.8	Radiated	Pass	Section 6.8 & 6.9
15.205, 15.209 15.407(b)(1), (2), (3), (4)(i)	General Field Strength (Restricted Bands and Radiated Emission)	Emissions in restricted bands must meet the radiated limits detailed in 15.209		Pass	
15.207	AC Conducted Emissions 150kHz - 30MHz	< FCC 15.207 limits	Line Conducted	Pass	Section 6.10

#### Notes:

- The analyzer plots shown in this section were all taken with a correction table loaded into the analyzer. The correction table was used to account for the losses of the cables and attenuators used as part of the system to connect the EUT to the analyzer at all frequencies of interest.
- Output power test was verified over all data rates of each mode, and then choose the maximum power output (low data rate) for final test of each channel.
- Test Items “26dB /6dB Bandwidth” & “Band Edge / Out-of-Band Emissions” have been assessed MIMO transmission, and showed the worst test data in this report.
- The power setting of CDD & Beamforming mode is same. For 802.11n/ac/ax uses worst case beamforming mode in the test report. The test results shown in the following sections represent the worst case emissions.

## 6.2. 26dB Bandwidth Measurement

### 6.2.1. Test Limit

N/A

### 6.2.2. Test Procedure used

KDB 789033 D02v02r01- Section C.1

### 6.2.3. Test Setting

1. The analyzers' automatic bandwidth measurement capability was used to perform the 26dB bandwidth measurement. The "X" dB bandwidth parameter was set to  $X = 26$ . The automatic bandwidth measurement function also has the capability of simultaneously measuring the 99% occupied bandwidth. The bandwidth measurement was not influenced by any intermediated power nulls in the fundamental emission.
2. RBW = approximately 1% of the emission bandwidth.
3. VBW  $\geq 3 \times$  RBW.
4. Detector = Peak.
5. Trace mode = max hold.

### 6.2.4. Test Setup

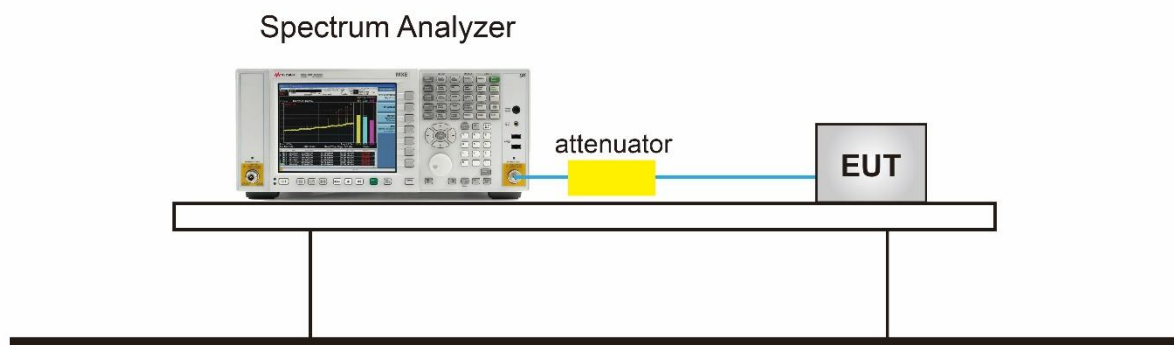

### 6.2.5.Test Result

Product	HAN Access Point, AP301	Test Site	SR2
Test Engineer	Eric Lin	Test Date	2020/11/19
Test Item	26dB Bandwidth		

Test Mode	Data Rate/ MCS	Channel No.	Frequency (MHz)	26dB Bandwidth (MHz)	99% Bandwidth (MHz)
802.11a	6Mbps	36	5180	19.55	16.40
802.11a	6Mbps	44	5220	20.35	16.40
802.11a	6Mbps	48	5240	19.53	16.45
802.11a	6Mbps	52	5260	20.17	16.40
802.11a	6Mbps	60	5300	20.39	16.42
802.11a	6Mbps	64	5320	20.29	16.42
802.11a	6Mbps	100	5500	19.95	16.41
802.11a	6Mbps	116	5580	19.99	16.40
802.11a	6Mbps	140	5700	19.95	16.43
802.11a	6Mbps	144	5720	20.25	16.40
802.11a	6Mbps	149	5745	19.43	16.41
802.11a	6Mbps	157	5785	19.97	16.40
802.11a	6Mbps	165	5825	19.33	16.43
802.11ac-VHT20	MCS0	36	5180	21.22	17.61
802.11ac-VHT20	MCS0	44	5220	20.64	17.60
802.11ac-VHT20	MCS0	48	5240	20.83	17.62
802.11ac-VHT20	MCS0	52	5260	20.63	17.62
802.11ac-VHT20	MCS0	60	5300	20.65	17.63
802.11ac-VHT20	MCS0	64	5320	20.98	17.60
802.11ac-VHT20	MCS0	100	5500	21.16	17.63
802.11ac-VHT20	MCS0	116	5580	20.61	17.60
802.11ac-VHT20	MCS0	140	5700	20.98	17.64
802.11ac-VHT20	MCS0	144	5720	20.40	17.59
802.11ac-VHT20	MCS0	149	5745	20.19	17.67
802.11ac-VHT20	MCS0	157	5785	21.76	17.61
802.11ac-VHT20	MCS0	165	5825	21.07	17.62



Test Mode	Data Rate/ MCS	Channel No.	Frequency (MHz)	26dB Bandwidth (MHz)	99% Bandwidth (MHz)
802.11ac-VHT40	MCS0	38	5190	39.73	36.13
802.11ac-VHT40	MCS0	46	5230	40.83	36.16
802.11ac-VHT40	MCS0	54	5270	40.15	36.19
802.11ac-VHT40	MCS0	62	5310	39.45	36.16
802.11ac-VHT40	MCS0	102	5510	39.60	36.09
802.11ac-VHT40	MCS0	110	5550	40.27	36.04
802.11ac-VHT40	MCS0	134	5670	40.21	36.14
802.11ac-VHT40	MCS0	142	5710	39.22	36.12
802.11ac-VHT40	MCS0	151	5755	39.70	36.07
802.11ac-VHT40	MCS0	159	5795	39.68	36.18
802.11ac-VHT80	MCS0	42	5210	80.91	75.35
802.11ac-VHT80	MCS0	58	5290	80.21	75.41
802.11ac-VHT80	MCS0	106	5530	79.97	75.38
802.11ac-VHT80	MCS0	122	5610	81.55	75.42
802.11ac-VHT80	MCS0	138	5690	81.55	75.65
802.11ac-VHT80	MCS0	155	5775	80.64	75.53
802.11ax-HE20	MCS0	36	5180	20.82	18.88
802.11ax-HE20	MCS0	44	5220	20.74	18.92
802.11ax-HE20	MCS0	48	5240	20.85	18.93
802.11ax-HE20	MCS0	52	5260	21.19	18.91
802.11ax-HE20	MCS0	60	5300	21.25	18.94
802.11ax-HE20	MCS0	64	5320	21.07	18.92
802.11ax-HE20	MCS0	100	5500	20.98	18.95
802.11ax-HE20	MCS0	116	5580	20.49	18.88
802.11ax-HE20	MCS0	140	5700	20.84	18.92
802.11ax-HE20	MCS0	144	5720	20.93	18.93
802.11ax-HE20	MCS0	149	5745	21.38	18.92
802.11ax-HE20	MCS0	157	5785	21.39	18.93
802.11ax-HE20	MCS0	165	5825	21.21	18.98

Test Mode	Data Rate/ MCS	Channel No.	Frequency (MHz)	26dB Bandwidth (MHz)	99% Bandwidth (MHz)
802.11ax-HE40	MCS0	38	5190	40.34	37.82
802.11ax-HE40	MCS0	46	5230	39.79	37.69
802.11ax-HE40	MCS0	54	5270	39.97	37.73
802.11ax-HE40	MCS0	62	5310	40.84	37.70
802.11ax-HE40	MCS0	102	5510	41.15	37.66
802.11ax-HE40	MCS0	110	5550	41.13	37.75
802.11ax-HE40	MCS0	134	5670	40.60	37.71
802.11ax-HE40	MCS0	142	5710	39.88	37.71
802.11ax-HE40	MCS0	151	5755	40.16	37.71
802.11ax-HE40	MCS0	159	5795	41.23	37.79
802.11ax-HE80	MCS0	42	5210	80.38	76.92
802.11ax-HE80	MCS0	58	5290	81.14	77.24
802.11ax-HE80	MCS0	106	5530	80.92	76.98
802.11ax-HE80	MCS0	122	5610	81.35	77.01
802.11ax-HE80	MCS0	138	5690	80.93	77.11
802.11ax-HE80	MCS0	155	5775	80.87	77.02

Note: The Data only show the max power Antenna Port in the test report.

802.11a 26dB Bandwidth & 99% Bandwidth

Channel 36 (5180MHz)

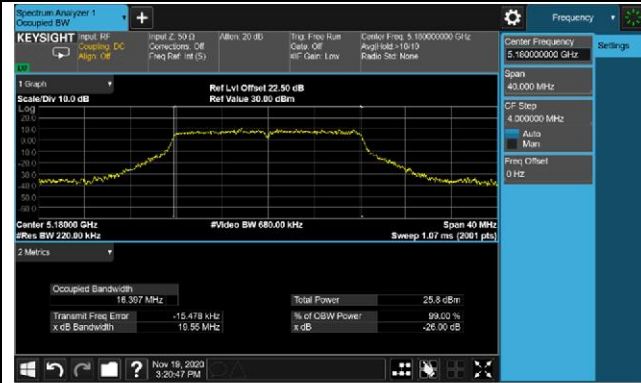

Channel 44 (5220MHz)

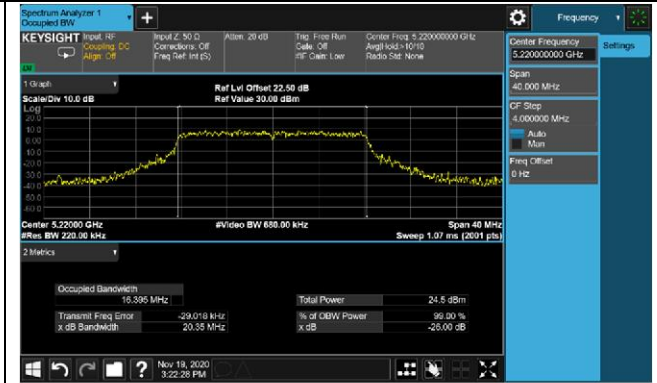

Channel 48 (5240MHz)

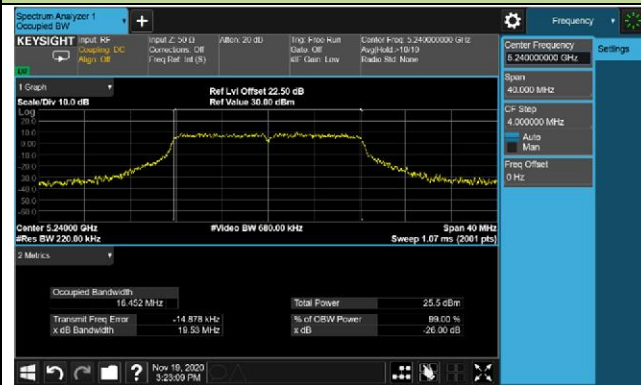

Channel 52 (5260MHz)

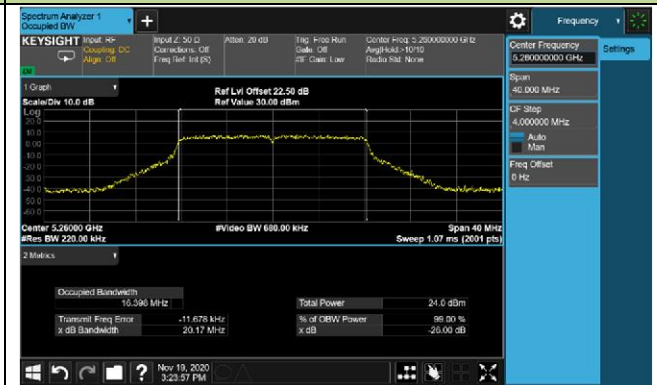

Channel 60 (5300MHz)

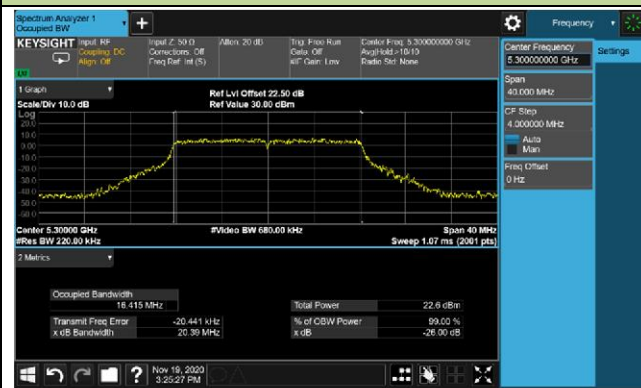

Channel 64 (5320MHz)

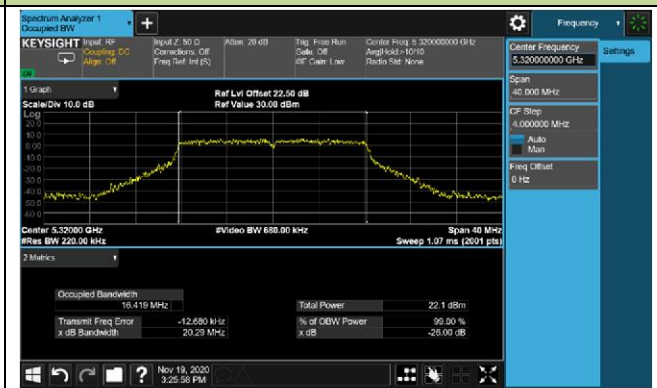

Channel 100 (5500MHz)

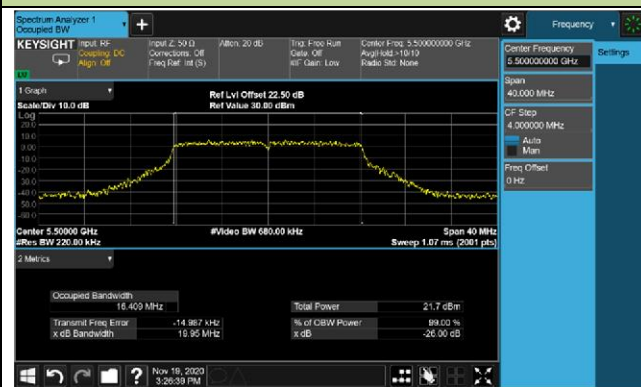

Channel 116 (5580MHz)

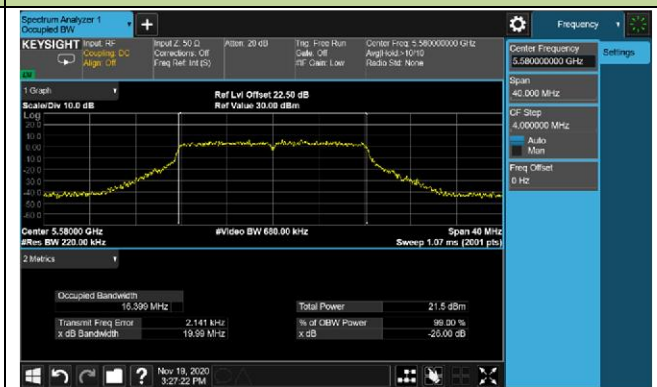

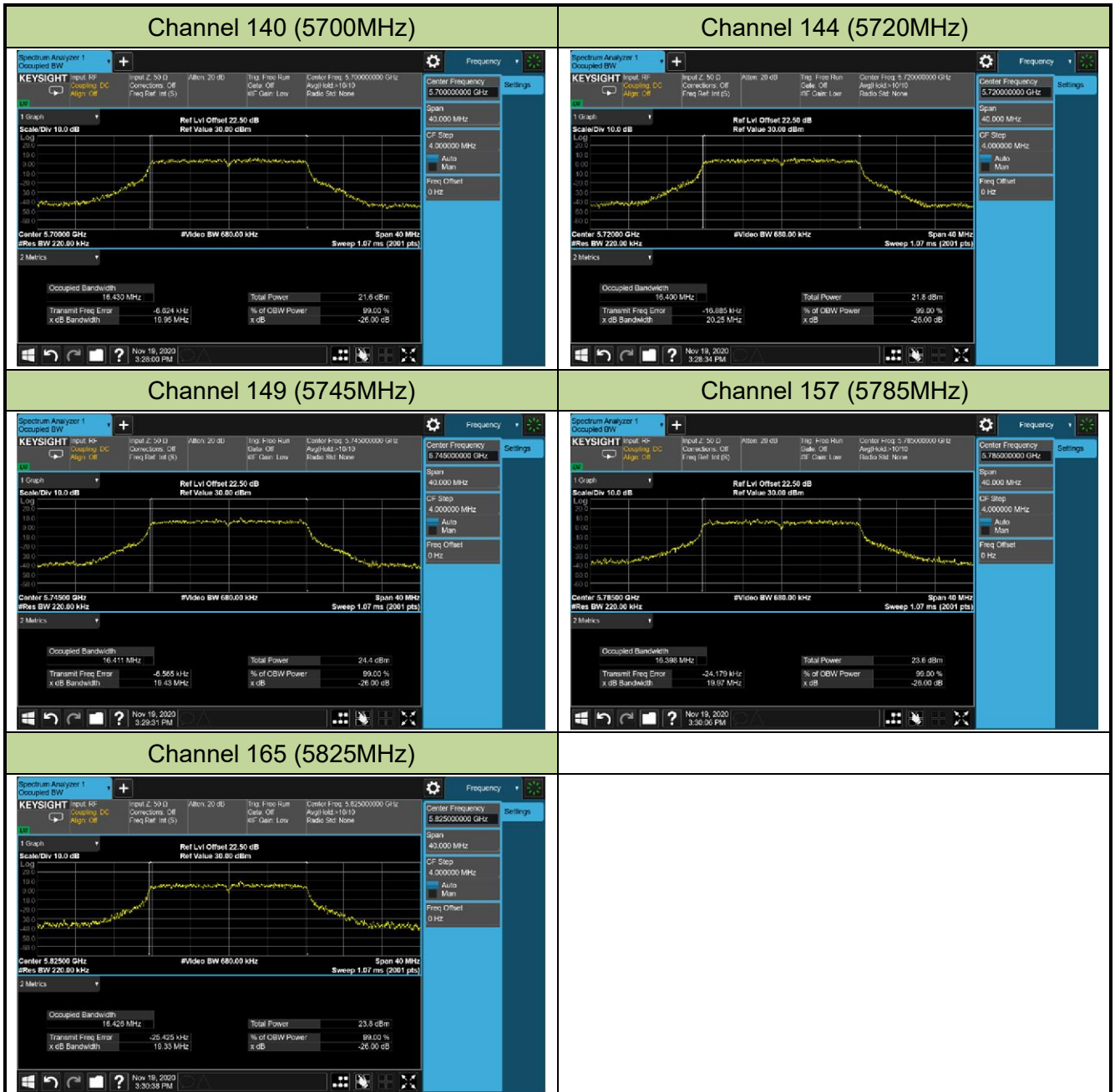



802.11ac-VHT20 26dB Bandwidth & 99% Bandwidth

Channel 36 (5180MHz)

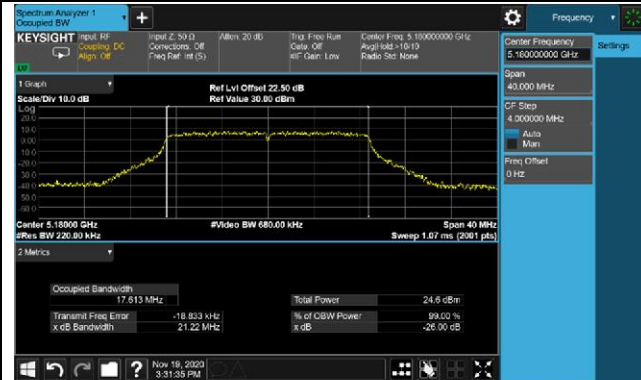

Channel 44 (5220MHz)

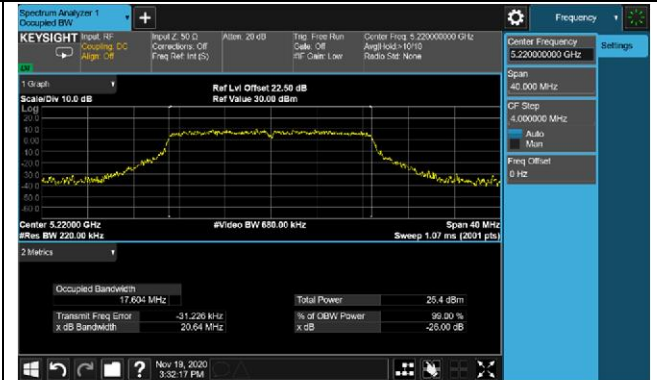

Channel 48 (5240MHz)

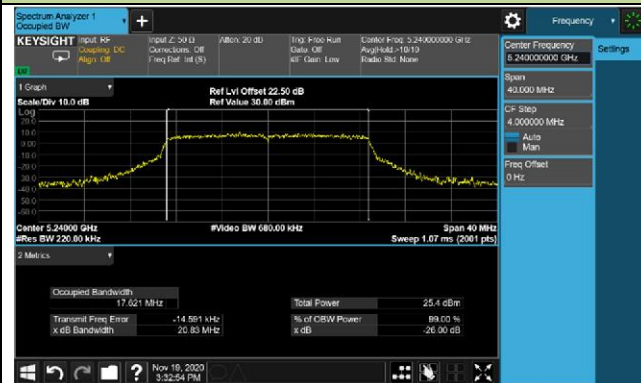

Channel 52 (5260MHz)

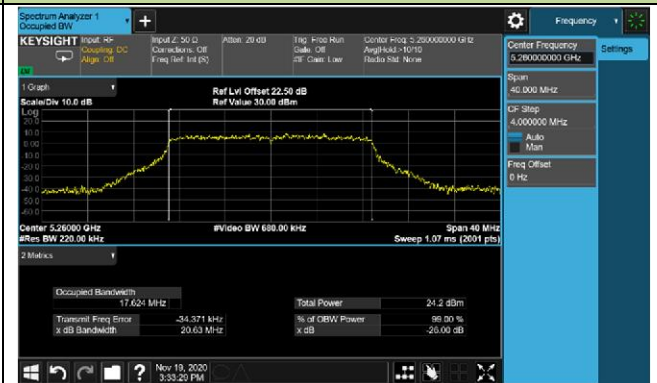

Channel 60 (5300MHz)

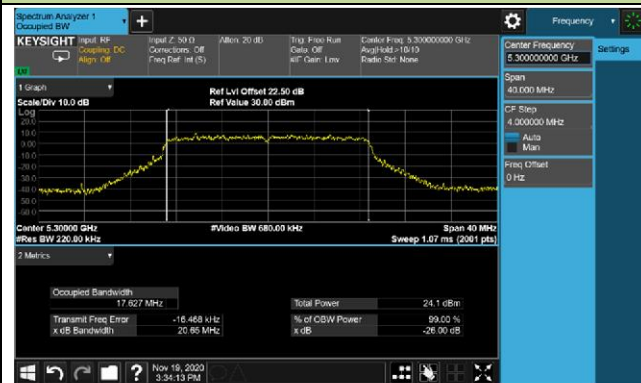

Channel 64 (5320MHz)

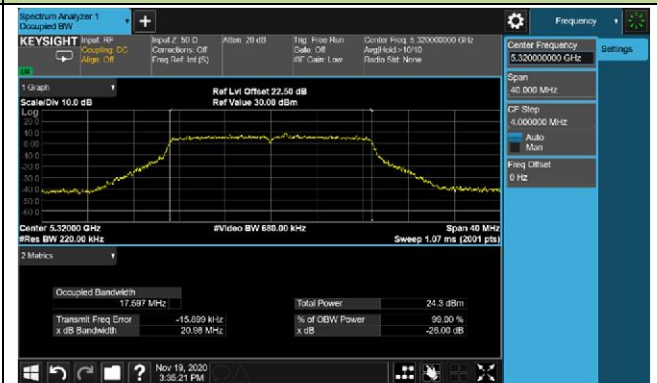

Channel 100 (5500MHz)

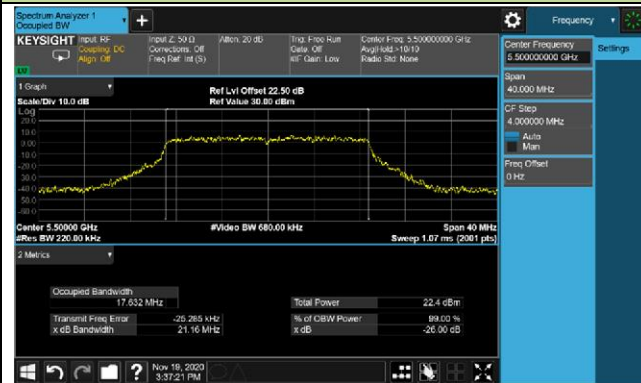

Channel 116 (5580MHz)

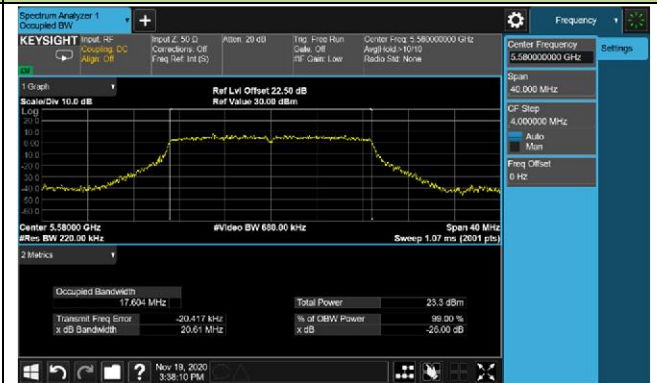

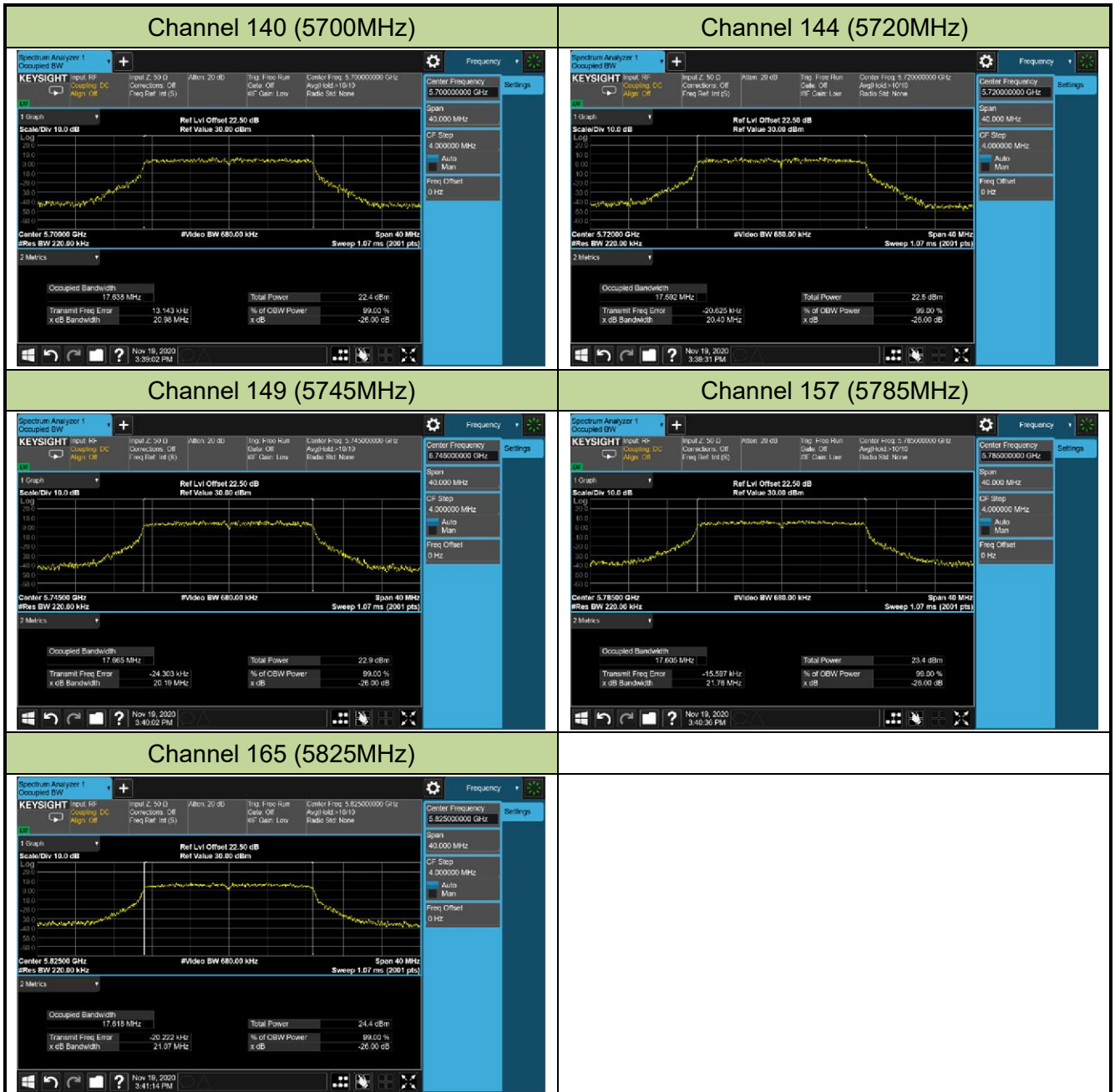

802.11ac-VHT40 26dB Bandwidth & 99% Bandwidth

Channel 38 (5190MHz)

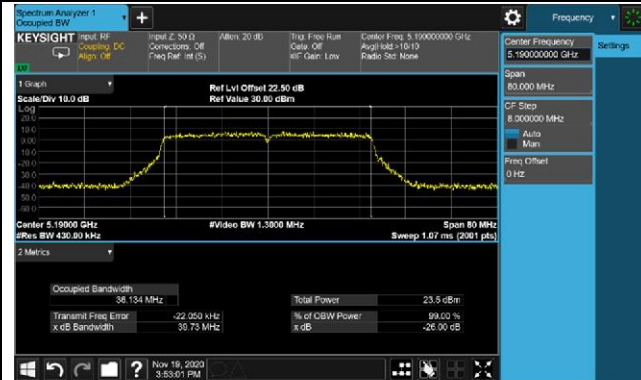

Channel 46 (5230MHz)

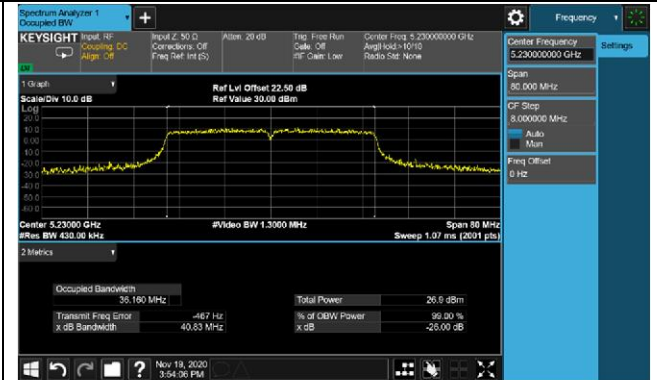

Channel 54 (5270MHz)

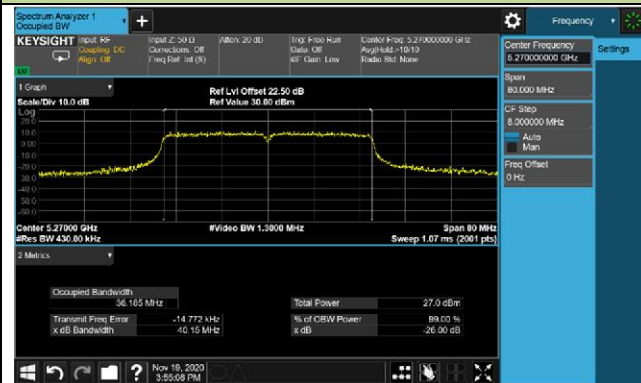

Channel 62 (5310MHz)

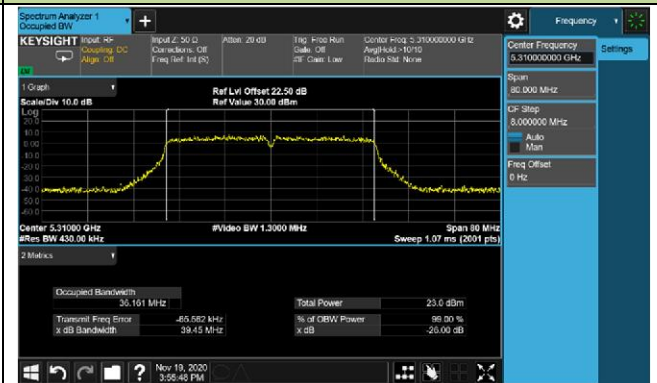

Channel 102 (5510MHz)

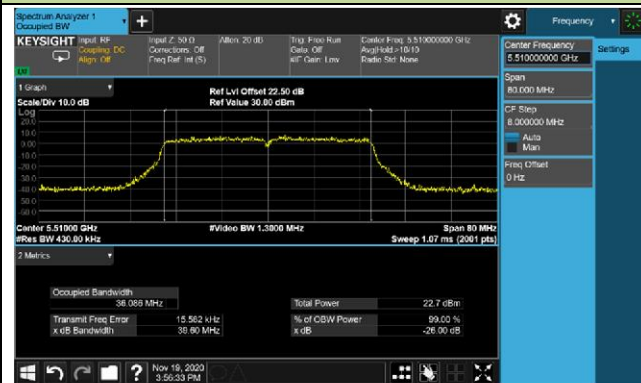

Channel 110 (5550MHz)

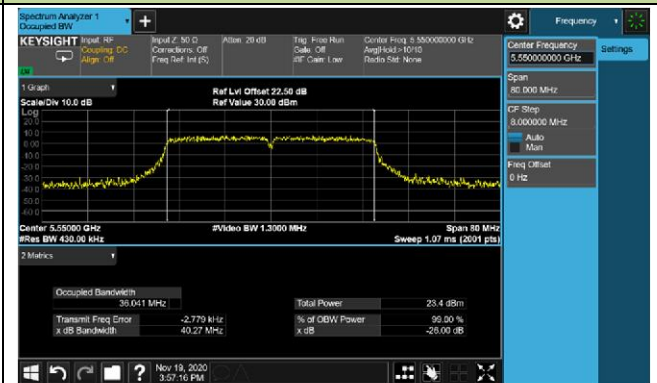

Channel 134 (5670MHz)

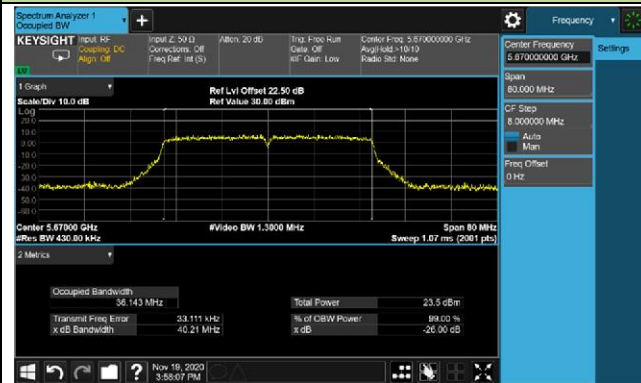

Channel 142 (5710MHz)

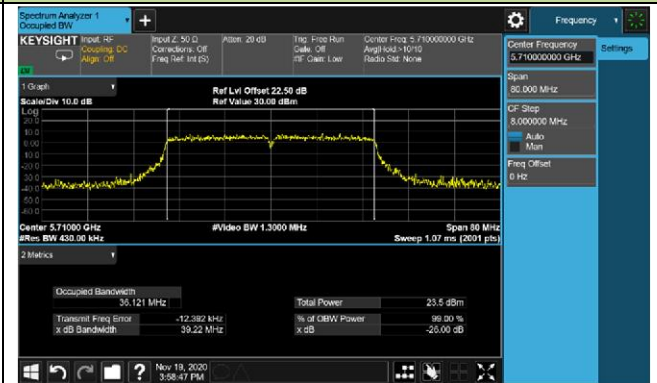

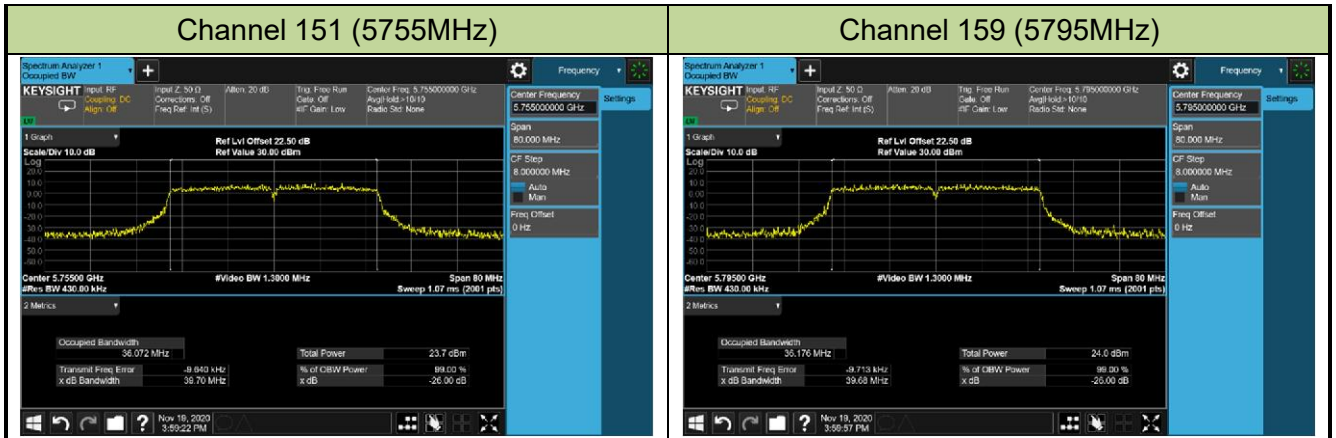

802.11ac-VHT80 26dB Bandwidth & 99% Bandwidth

Channel 42 (5210MHz)

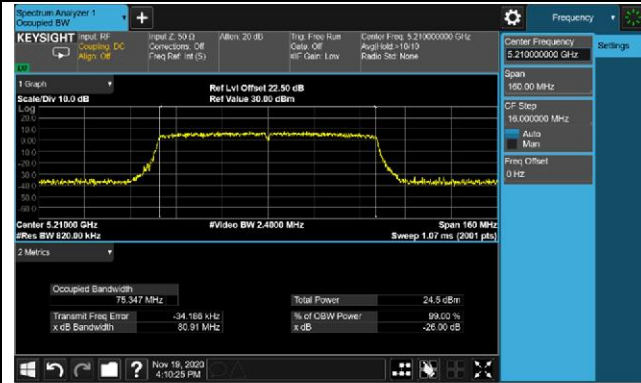

Channel 58 (5290MHz)

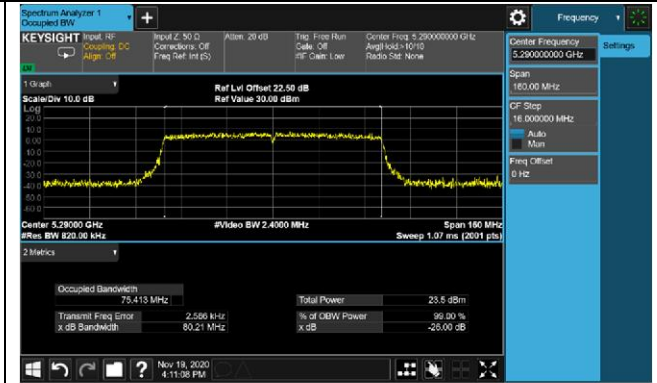

Channel 106 (5530MHz)

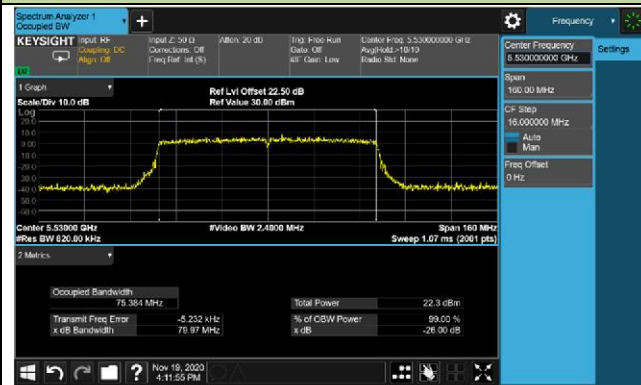

Channel 122 (5610MHz)

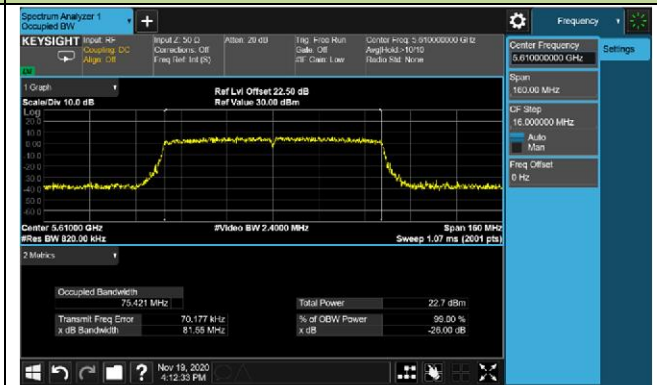

Channel 138 (5690MHz)



Channel 155 (5775MHz)

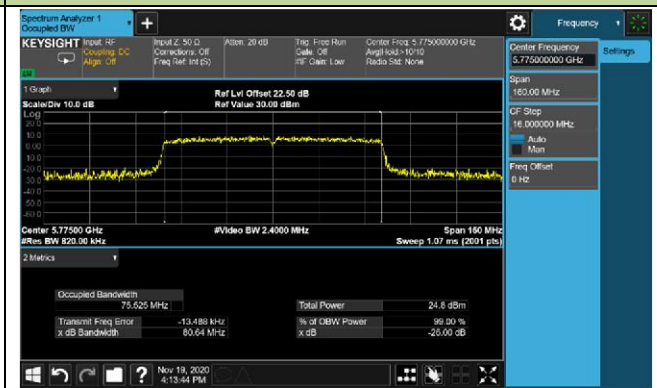

802.11ax-HE20 26dB Bandwidth & 99% Bandwidth

Channel 36 (5180MHz)

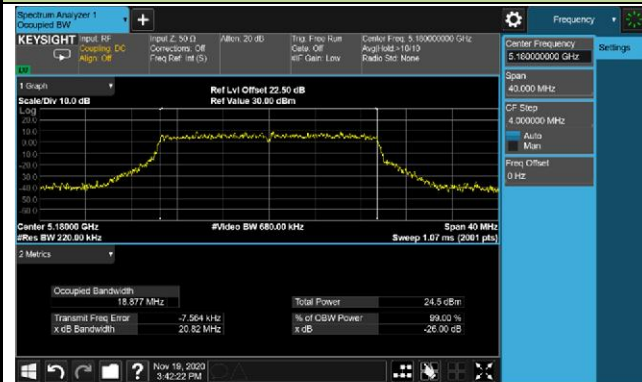

Channel 44 (5220MHz)

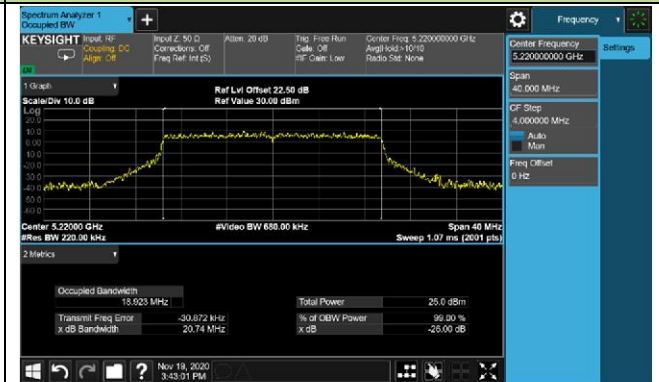

Channel 48 (5240MHz)

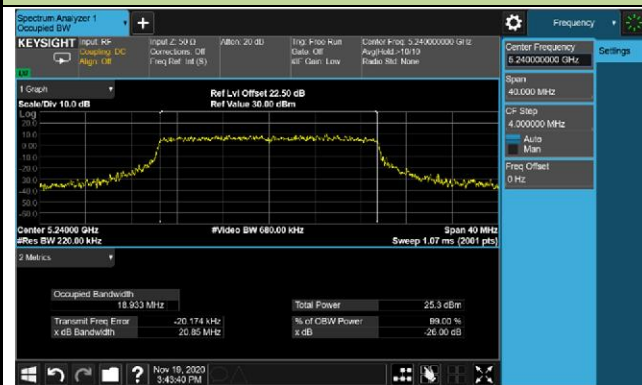

Channel 52 (5260MHz)

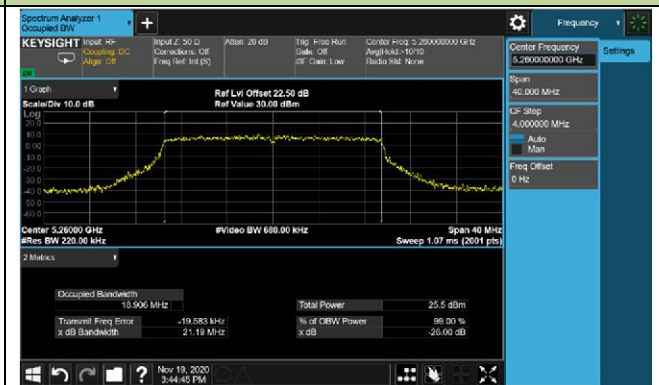

Channel 60 (5300MHz)

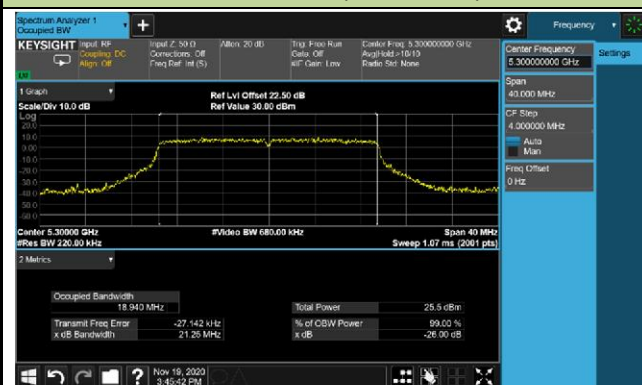

Channel 64 (5320MHz)

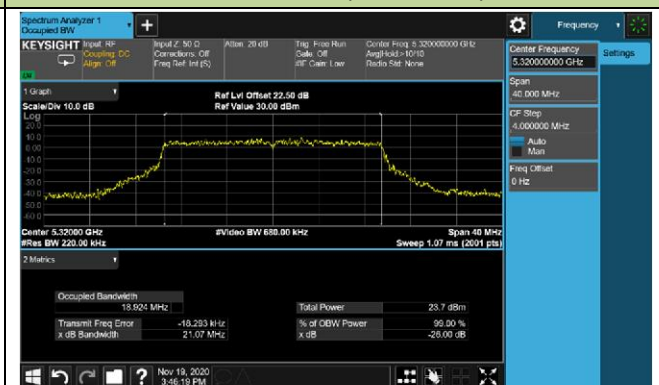

Channel 100 (5500MHz)

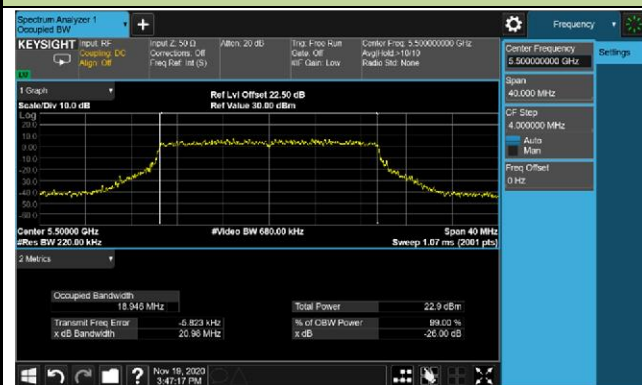

Channel 116 (5580MHz)

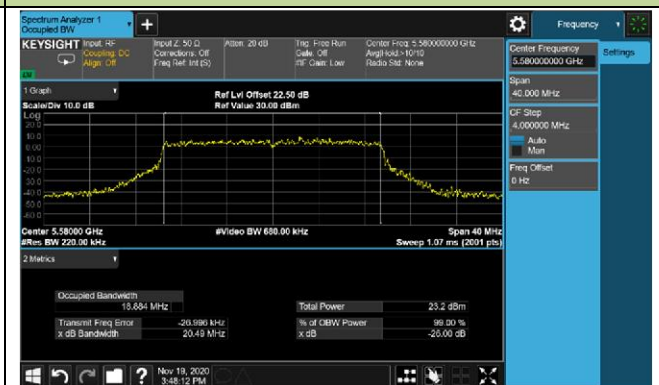

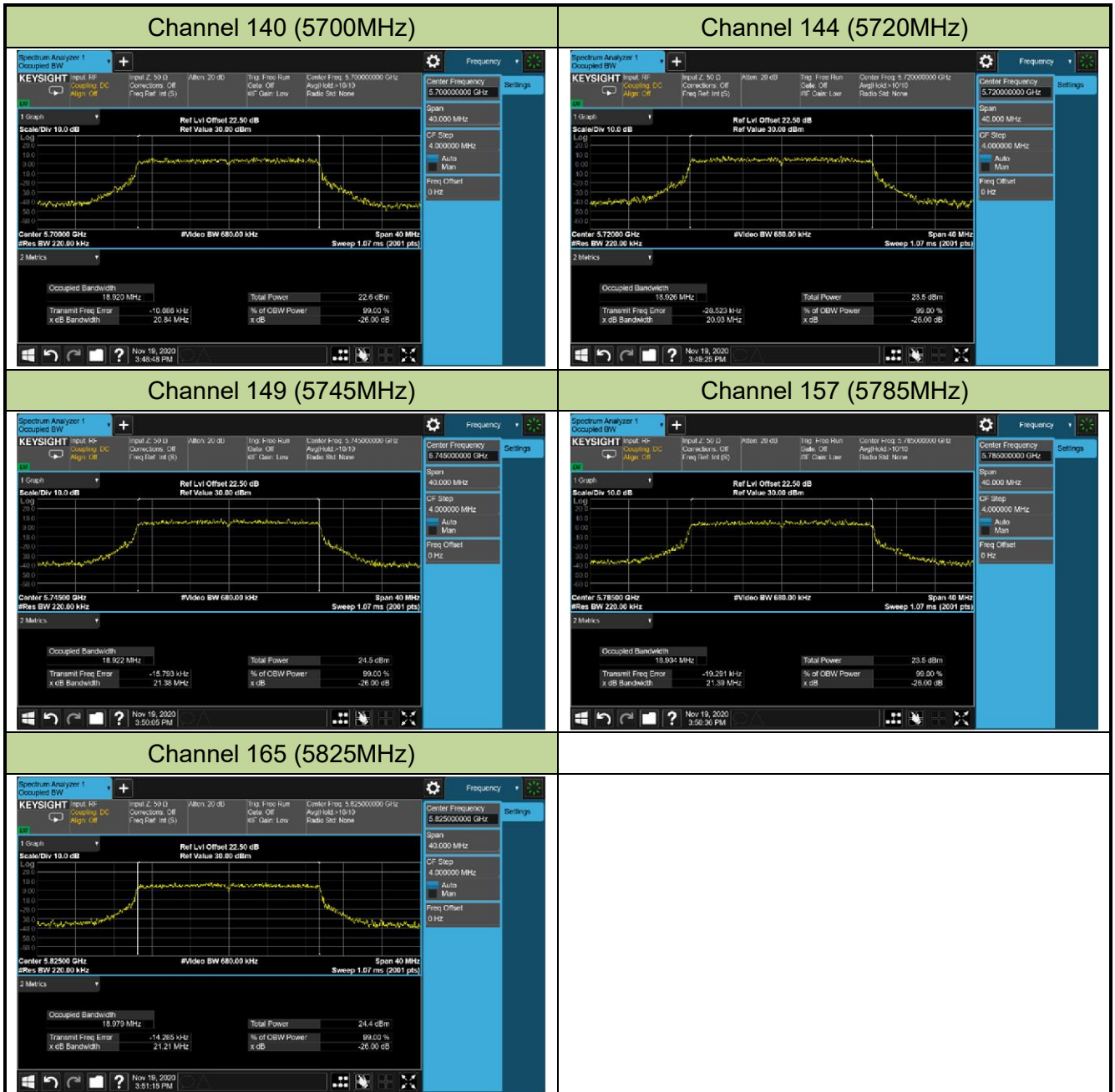

802.11ax-HE40 26dB Bandwidth & 99% Bandwidth

Channel 38 (5190MHz)

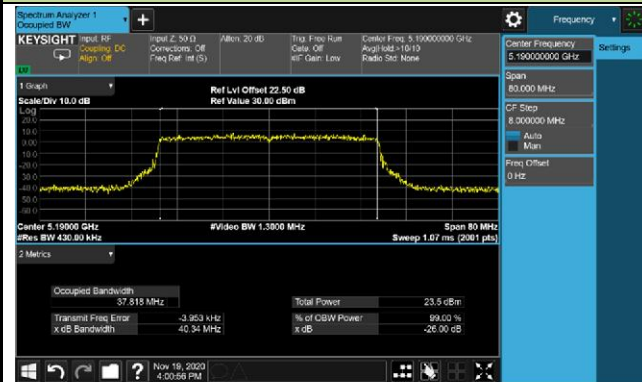

Channel 46 (5230MHz)

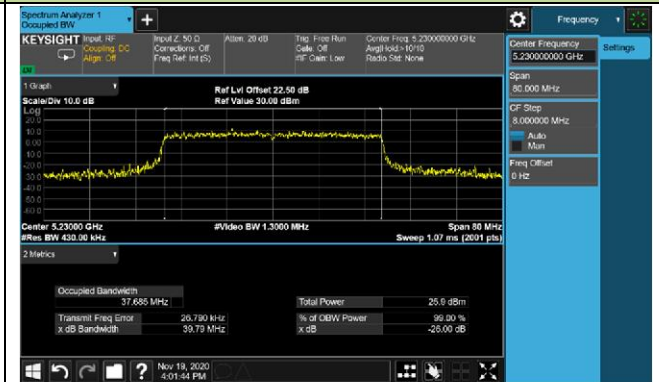

Channel 54 (5270MHz)

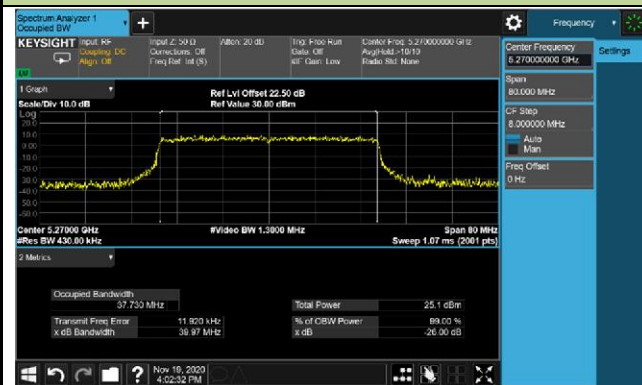

Channel 62 (5310MHz)

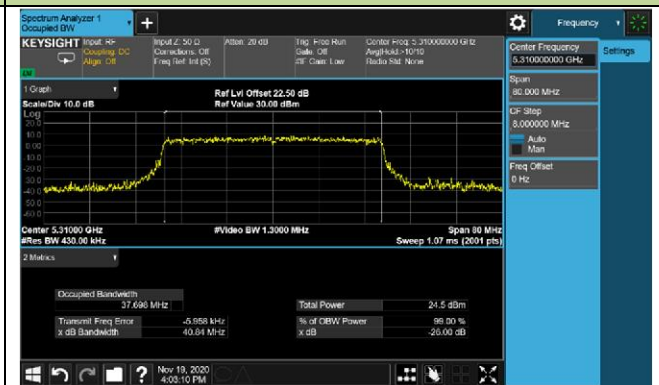

Channel 102 (5510MHz)

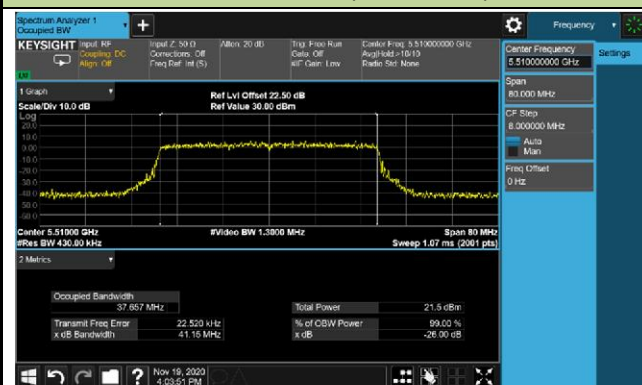

Channel 110 (5550MHz)

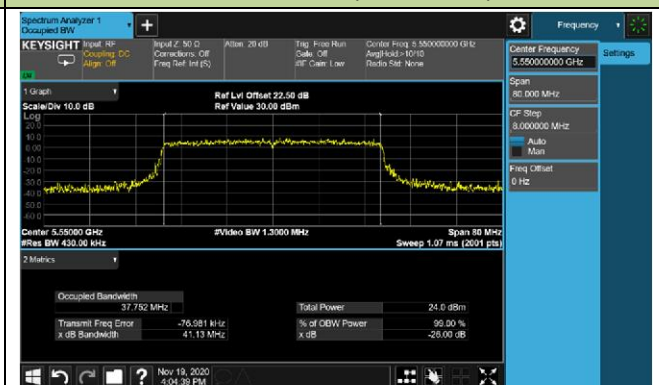

Channel 134 (5670MHz)

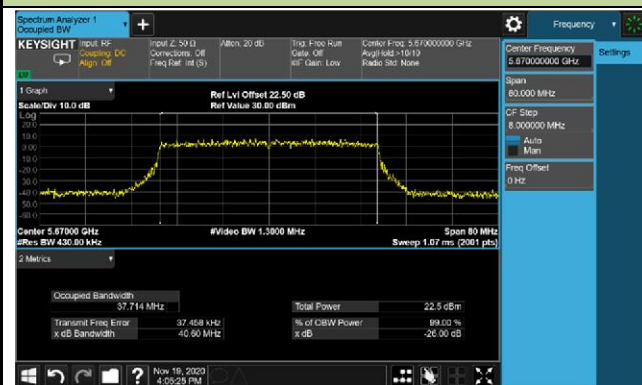

Channel 142 (5710MHz)

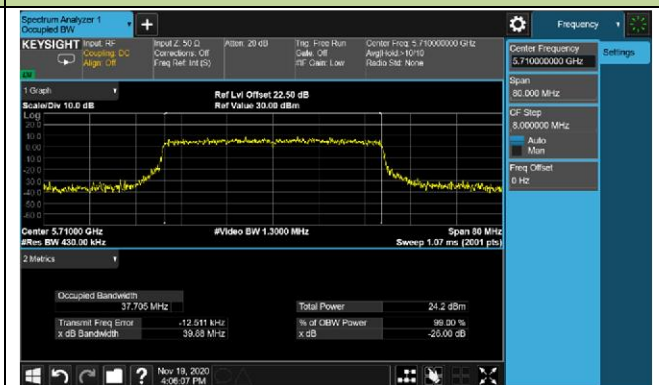



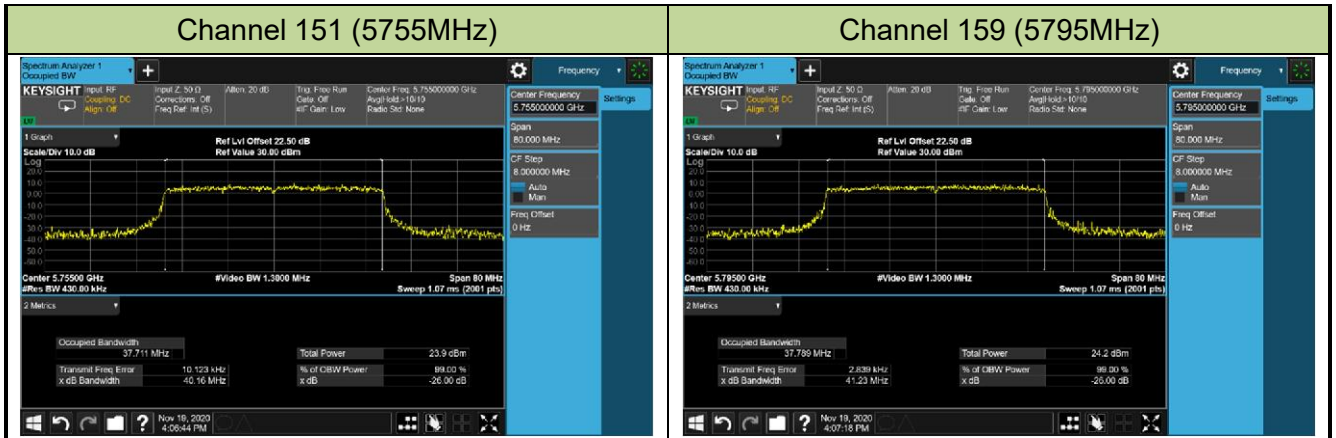

802.11ax-HE80 26dB Bandwidth & 99% Bandwidth

Channel 42 (5210MHz)

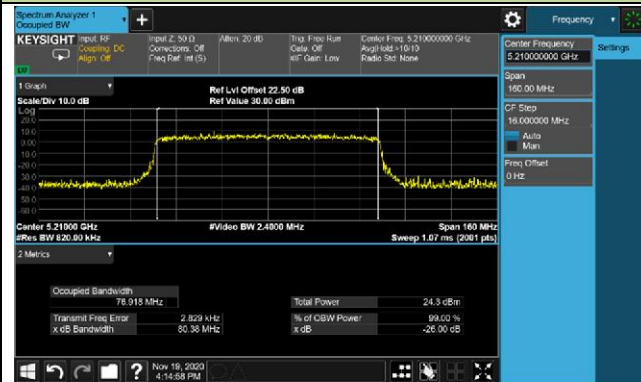

Channel 58 (5290MHz)

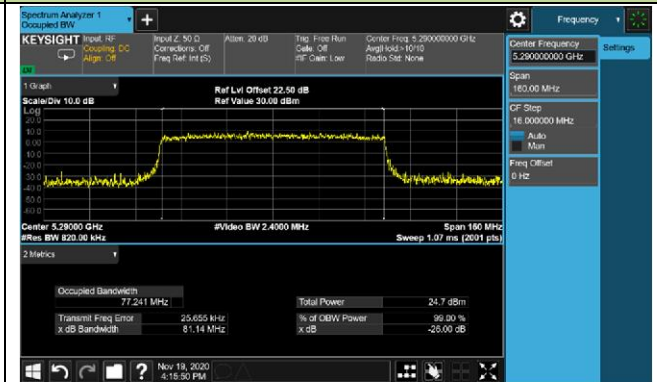

Channel 106 (5530MHz)

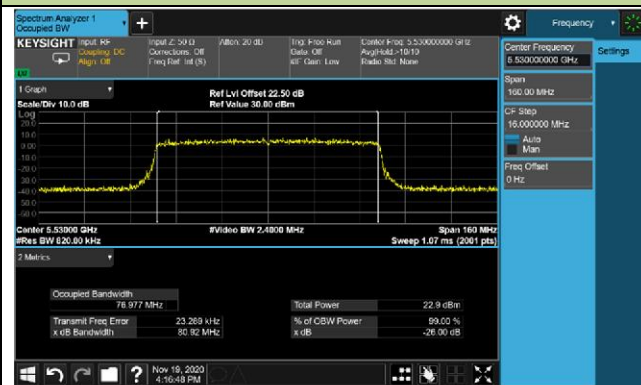

Channel 122 (5610MHz)

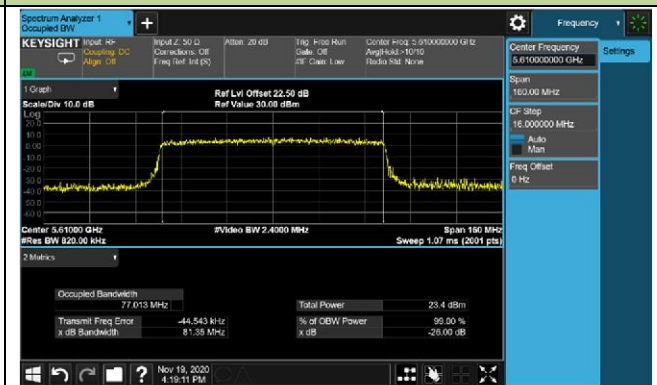

Channel 138 (5690MHz)

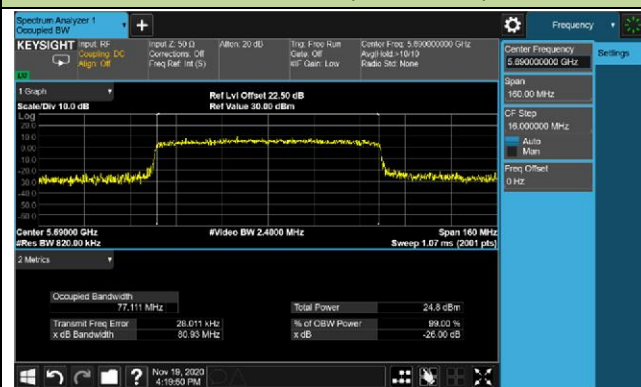

Channel 155 (5775MHz)

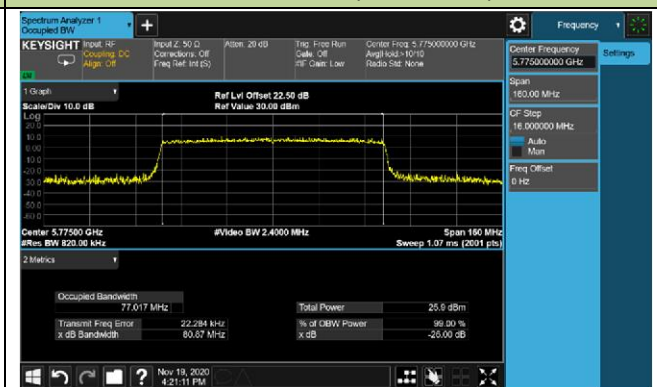

### 6.3. 6dB Bandwidth Measurement

#### 6.3.1. Test Limit

The minimum 6dB bandwidth shall be at least 500 kHz.

#### 6.3.2. Test Procedure used

KDB 789033 D02v02r01- Section C.2

#### 6.3.3. Test Setting

1. Set center frequency to the nominal EUT channel center frequency.
2. RBW = 100 kHz.
3. VBW  $\geq$  3  $\times$  RBW.
4. Detector = Peak.
5. Trace mode = max hold.
6. Sweep = auto couple.
7. Allow the trace to stabilize.
8. Measure the maximum width of the emission that is constrained by the frequencies associated with the two outermost amplitude points (upper and lower frequencies) that are attenuated by 6 dB relative to the maximum level measured in the fundamental emission.

#### 6.3.4. Test Setup

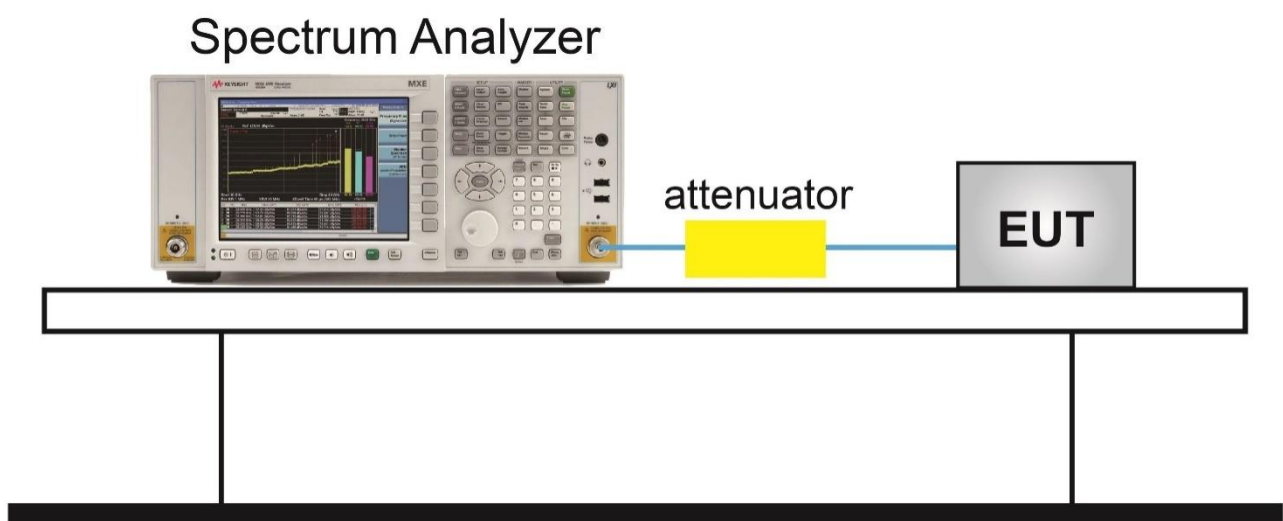

**6.3.5.Test Result**

Product	HAN Access Point, AP301	Test Site	SR2
Test Engineer	Eric Lin	Test Date	2020/11/19
Test item	6dB bandwidth (U-NII-3)		

Test Mode	Data Rate/ MCS	Channel No.	Frequency (MHz)	6dB Bandwidth (MHz)	Limit (MHz)	Result
802.11a	6Mbps	149	5745	15.93	≥ 0.5	Pass
802.11a	6Mbps	157	5785	16.36	≥ 0.5	Pass
802.11a	6Mbps	165	5825	16.38	≥ 0.5	Pass
802.11ac-VHT20	MCS0	149	5745	17.65	≥ 0.5	Pass
802.11ac-VHT20	MCS0	157	5785	17.63	≥ 0.5	Pass
802.11ac-VHT20	MCS0	165	5825	17.60	≥ 0.5	Pass
802.11ac-VHT40	MCS0	151	5755	36.44	≥ 0.5	Pass
802.11ac-VHT40	MCS0	159	5795	36.41	≥ 0.5	Pass
802.11ac-VHT80	MCS0	155	5775	72.89	≥ 0.5	Pass
802.11ax-HE20	MCS0	149	5745	18.06	≥ 0.5	Pass
802.11ax-HE20	MCS0	157	5785	18.19	≥ 0.5	Pass
802.11ax-HE20	MCS0	165	5825	18.54	≥ 0.5	Pass
802.11ax-HE40	MCS0	151	5755	37.79	≥ 0.5	Pass
802.11ax-HE40	MCS0	159	5795	37.85	≥ 0.5	Pass
802.11ax-HE80	MCS0	155	5775	76.34	≥ 0.5	Pass

Note: The Data only show the max power Antenna Port in the test report.

### 802.11a 6dB Bandwidth

#### Channel 149 (5745MHz)

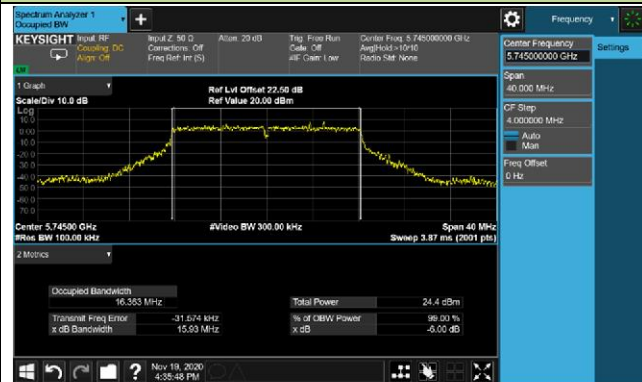

#### Channel 157 (5785MHz)



#### Channel 165 (5825MHz)



### 802.11ac-VHT20 6dB Bandwidth

#### Channel 149 (5745MHz)



#### Channel 157 (5785MHz)



#### Channel 165 (5825MHz)



802.11ac-VHT40 6dB Bandwidth

Channel 151 (5755MHz)



Channel 159 (5795MHz)

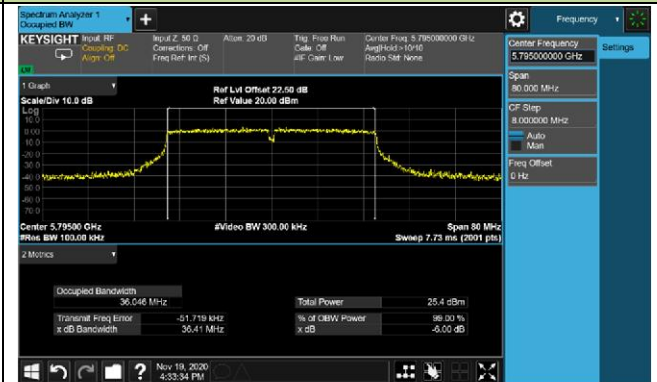

802.11ac-VHT80 6dB Bandwidth

Channel 155 (5775MHz)

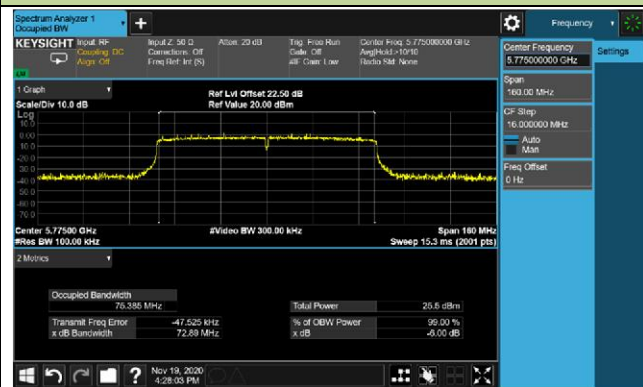

802.11ax-HE20 6dB Bandwidth

Channel 149 (5745MHz)



Channel 157 (5785MHz)



Channel 165 (5825MHz)

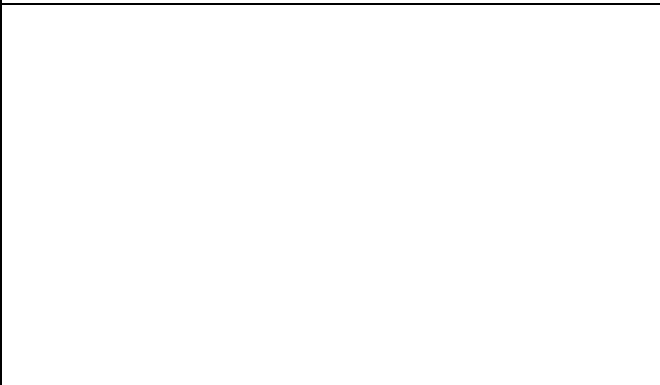

802.11ax-HE40 6dB Bandwidth

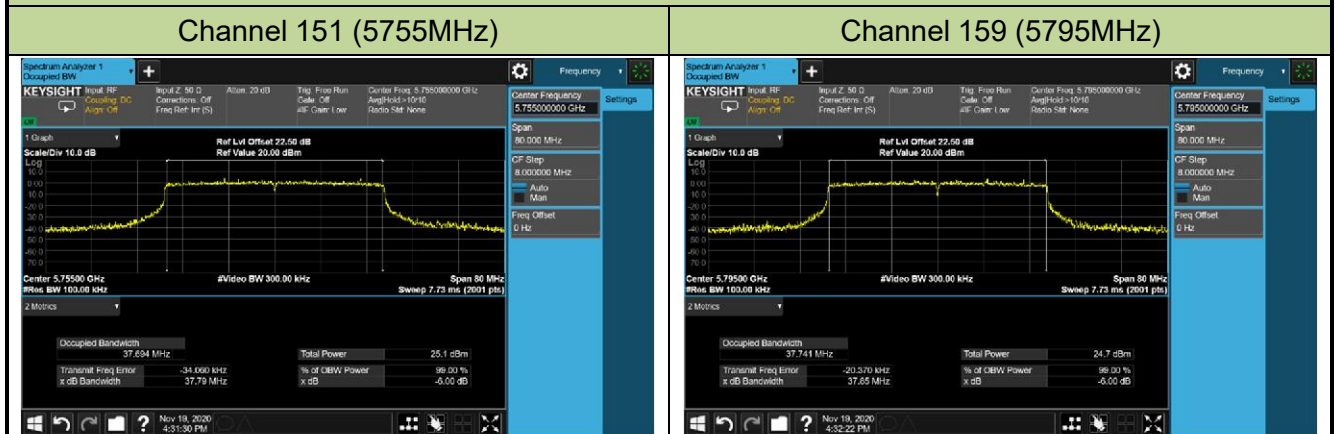

802.11ax-HE80 6dB Bandwidth

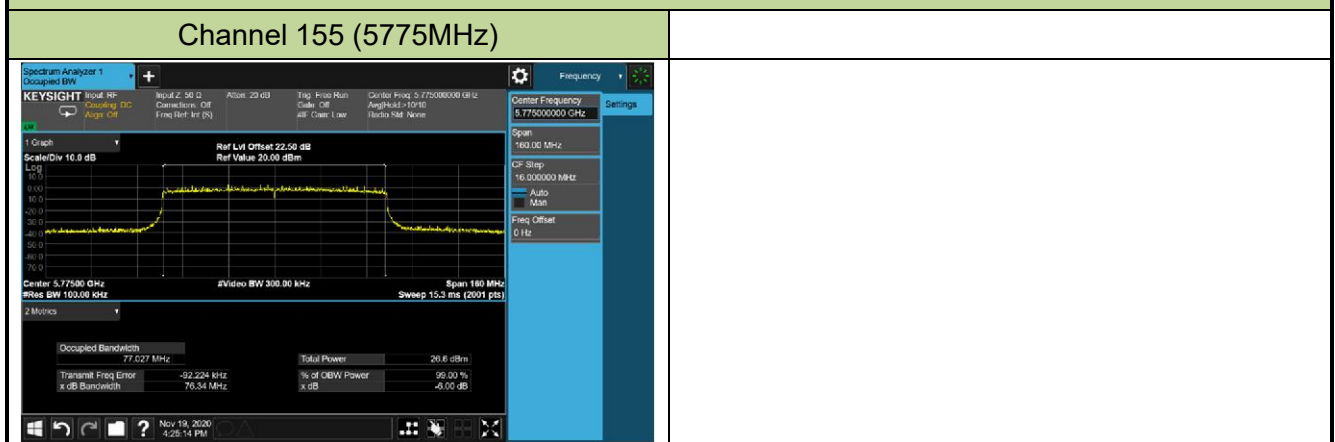



## 6.4. Output Power Measurement

### 6.4.1. Test Limit

For the band 5.15-5.25 GHz, the maximum conducted output power over the frequency band of operation shall not exceed 1 W provided the maximum antenna gain does not exceed 6 dBi.

For the 5.25-5.35 GHz and 5.47-5.725 GHz bands, the maximum conducted output power over the frequency bands of operation shall not exceed the lesser of 250 mW or  $11 \text{ dBm} + 10 \log B$ , where B is the 26 dB emission bandwidth in megahertz.

For the band 5.725-5.85 GHz, the maximum conducted output power over the frequency band of operation shall not exceed 1 W (30dBm).

If transmitting antennas of directional gain greater than 6dBi are used, the maximum conducted output power shall be reduced by the amount in dB that the directional gain of the antenna exceeds 6dBi.

### 6.4.2. Test Procedure Used

KDB 789033D02v02r01- Section E)3) b) Method PM-G

### 6.4.3. Test Setting

Average power measurements were performed only when the EUT was transmitting at its maximum power control level using a broadband power meter with a pulse sensor. The power meter implemented triggering and gating capabilities which were set up such that power measurements were recorded only during the ON time of the transmitter.

### 6.4.4. Test Setup

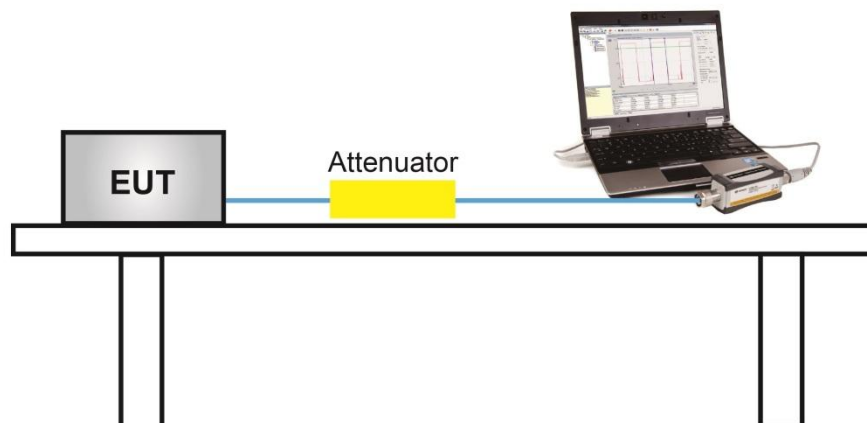

**6.4.5.Test Result**

Product	HAN Access Point, AP301	Test Site	SR2
Test Engineer	Eric Lin	Test Date	2020/11/18
Test item	Output Power		

Test Mode	Data Rate/ MCS	Channel No.	Freq. (MHz)	Ant 0 Average Power (dBm)	Ant 1 Average Power (dBm)	Total Average Power (dBm)	Average Power Limit (dBm)	Result
11a	6Mbps	36	5180	19.41	18.95	22.20	≤ 29.69	Pass
11a	6Mbps	44	5220	19.77	19.59	22.69	≤ 29.69	Pass
11a	6Mbps	48	5240	19.98	19.68	22.84	≤ 29.69	Pass
11a	6Mbps	52	5260	18.31	18.05	21.19	≤ 23.67	Pass
11a	6Mbps	60	5300	18.01	17.76	20.90	≤ 23.67	Pass
11a	6Mbps	64	5320	17.50	17.41	20.47	≤ 23.67	Pass
11a	6Mbps	100	5500	18.07	18.14	21.12	≤ 23.67	Pass
11a	6Mbps	116	5580	17.03	16.94	20.00	≤ 23.67	Pass
11a	6Mbps	140	5700	17.17	17.04	20.12	≤ 23.67	Pass
11a	6Mbps	144	5720	17.02	17.17	20.11	≤ 23.67	Pass
11a	6Mbps	149	5745	19.02	18.94	21.99	≤ 29.69	Pass
11a	6Mbps	157	5785	18.82	19.05	21.95	≤ 29.69	Pass
11a	6Mbps	165	5825	19.04	19.21	22.14	≤ 29.69	Pass
11ac-VHT20	MCS0	36	5180	19.11	18.81	21.97	≤ 29.69	Pass
11ac-VHT20	MCS0	40	5220	19.52	19.38	22.46	≤ 29.69	Pass
11ac-VHT20	MCS0	48	5240	19.85	19.43	22.66	≤ 29.69	Pass
11ac-VHT20	MCS0	52	5260	18.88	18.76	21.83	≤23.67	Pass
11ac-VHT20	MCS0	60	5300	18.82	18.57	21.71	≤23.67	Pass
11ac-VHT20	MCS0	64	5320	17.98	17.47	20.74	≤23.67	Pass
11ac-VHT20	MCS0	100	5500	18.89	18.84	21.88	≤23.67	Pass
11ac-VHT20	MCS0	116	5580	18.66	18.46	21.57	≤23.67	Pass
11ac-VHT20	MCS0	140	5700	18.32	18.53	21.44	≤23.67	Pass
11ac-VHT20	MCS0	144	5720	18.46	18.48	21.48	≤23.67	Pass
11ac-VHT20	MCS0	149	5745	18.62	18.91	21.78	≤ 29.69	Pass
11ac-VHT20	MCS0	157	5785	18.67	18.47	21.58	≤ 29.69	Pass
11ac-VHT20	MCS0	165	5825	18.76	18.64	21.71	≤ 29.69	Pass



Test Mode	Data Rate/ MCS	Channel No.	Freq. (MHz)	Ant 0 Average Power (dBm)	Ant 1 Average Power (dBm)	TotalAverage Power(dBm)	Average Power Limit(dBm)	Result
11ac-VHT40	MCS0	38	5190	17.79	17.63	20.72	≤ 29.69	Pass
11ac-VHT40	MCS0	46	5230	19.97	19.85	22.92	≤ 29.69	Pass
11ac-VHT40	MCS0	54	5270	19.98	19.56	22.79	≤ 23.67	Pass
11ac-VHT40	MCS0	62	5310	17.15	17.31	20.24	≤ 23.67	Pass
11ac-VHT40	MCS0	102	5510	18.11	17.85	20.99	≤ 23.67	Pass
11ac-VHT40	MCS0	110	5550	19.71	19.37	22.55	≤ 23.67	Pass
11ac-VHT40	MCS0	134	5670	18.30	18.44	21.38	≤ 23.67	Pass
11ac-VHT40	MCS0	142	5710	18.95	18.79	21.88	≤ 23.67	Pass
11ac-VHT40	MCS0	151	5755	19.08	18.89	22.00	≤ 29.69	Pass
11ac-VHT40	MCS0	159	5795	19.07	18.92	22.01	≤ 29.69	Pass
11ac-VHT80	MCS0	42	5210	17.71	17.49	20.61	≤ 29.69	Pass
11ac-VHT80	MCS0	58	5290	18.10	17.96	21.04	≤ 29.69	Pass
11ac-VHT80	MCS0	106	5530	17.45	17.68	20.58	≤ 29.69	Pass
11ac-VHT80	MCS0	122	5610	17.61	17.33	20.48	≤ 23.67	Pass
11ac-VHT80	MCS0	138	5690	19.65	19.68	22.68	≤ 23.67	Pass
11ac-VHT80	MCS0	155	5775	19.42	19.09	22.27	≤ 29.69	Pass
11ax-HE20	MCS0	36	5180	18.61	18.58	21.61	≤ 29.69	Pass
11ax-HE20	MCS0	40	5220	19.84	19.51	22.69	≤ 29.69	Pass
11ax-HE20	MCS0	48	5240	19.48	19.38	22.44	≤ 29.69	Pass
11ax-HE20	MCS0	52	5260	19.02	18.98	22.01	≤ 23.67	Pass
11ax-HE20	MCS0	60	5300	18.99	18.93	21.97	≤ 23.67	Pass
11ax-HE20	MCS0	64	5320	18.49	18.36	21.44	≤ 23.67	Pass
11ax-HE20	MCS0	100	5500	18.28	18.19	21.25	≤ 23.67	Pass
11ax-HE20	MCS0	116	5580	18.71	18.55	21.64	≤ 23.67	Pass
11ax-HE20	MCS0	140	5700	18.17	18.35	21.27	≤ 23.67	Pass
11ax-HE20	MCS0	144	5720	18.85	18.95	21.91	≤ 23.67	Pass
11ax-HE20	MCS0	149	5745	18.82	18.56	21.70	≤ 29.69	Pass
11ax-HE20	MCS0	157	5785	18.54	18.71	21.64	≤ 29.69	Pass
11ax-HE20	MCS0	165	5825	18.68	18.92	21.81	≤ 29.69	Pass

Test Mode	Data Rate/ MCS	Channel No.	Freq. (MHz)	Ant 0 Average Power (dBm)	Ant 1 Average Power (dBm)	TotalAverage Power(dBm)	Average Power Limit(dBm)	Result
11ax-HE40	MCS0	38	5190	17.64	17.47	20.57	≤ 29.69	Pass
11ax-HE40	MCS0	46	5230	19.93	19.46	22.71	≤ 29.69	Pass
11ax-HE40	MCS0	54	5270	19.01	18.58	21.81	≤ 23.67	Pass
11ax-HE40	MCS0	62	5310	18.75	18.43	21.60	≤ 23.67	Pass
11ax-HE40	MCS0	102	5510	16.74	17.10	19.93	≤ 23.67	Pass
11ax-HE40	MCS0	110	5550	19.07	19.13	22.11	≤ 23.67	Pass
11ax-HE40	MCS0	134	5670	17.59	17.83	20.72	≤ 23.67	Pass
11ax-HE40	MCS0	142	5710	18.99	19.01	22.01	≤ 23.67	Pass
11ax-HE40	MCS0	151	5755	18.97	18.65	21.82	≤ 29.69	Pass
11ax-HE40	MCS0	159	5795	18.81	18.59	21.71	≤ 29.69	Pass
11ax-HE80	MCS0	42	5210	17.82	17.40	20.63	≤ 29.69	Pass
11ax-HE80	MCS0	58	5290	18.21	18.06	21.15	≤ 29.69	Pass
11ax-HE80	MCS0	106	5530	17.15	17.01	20.09	≤ 23.67	Pass
11ax-HE80	MCS0	122	5610	18.23	18.12	21.19	≤ 23.67	Pass
11ax-HE80	MCS0	138	5690	19.04	19.17	22.12	≤ 23.67	Pass
11ax-HE80	MCS0	155	5775	18.47	18.62	21.56	≤ 29.69	Pass

Note 1:

The Total Average Power (dBm) =  $10 \cdot \log \{10^{(\text{Ant 0 Average Power} / 10)} + 10^{(\text{Ant 1 Average Power} / 10)}\}$ .

Note 2:

For 5150 - 5250MHz: Average Power Limit (dBm) = 30 dBm-(6.31-6) dBi =29.69dBm.

For 5250 - 5350MHz: Average Power Limit (dBm) = 11dBm+10log (20.17) =24.05dBm>23.98dBm, Final Limit=23.98dBm-(6.31-6) dBi=23.67dBm;

For 5470~5725MHz: Average Power Limit (dBm) = 11dBm+10log (19.95) =24.00dBm>23.98dBm; Final Limit=23.98dBm-(6.31-6) dBi=23.67dBm;

For 5725~5850MHz: Average Power Limit (dBm) = 30 dBm-(6.31-6) dBi =29.69dBm.

## 6.5. Transmit Power Control

### 6.5.1. Test Limit

The U-NII device is required to have the capability to operate at least 6 dB below the mean EIRP value of 30 dBm.

### 6.5.2. Test Procedure Used

KDB 789033 D02v01- Section E)3) b) Method PM-G

### 6.5.3. Test Setting

Average power measurements were performed only when the EUT was transmitting at its maximum power control level using a broadband power meter with a pulse sensor. The power meter implemented triggering and gating capabilities which were set up such that power measurements were recorded only during the ON time of the transmitter. The trace was averaged over 100 traces to obtain the final measured average power.

### 6.5.4. Test Setup

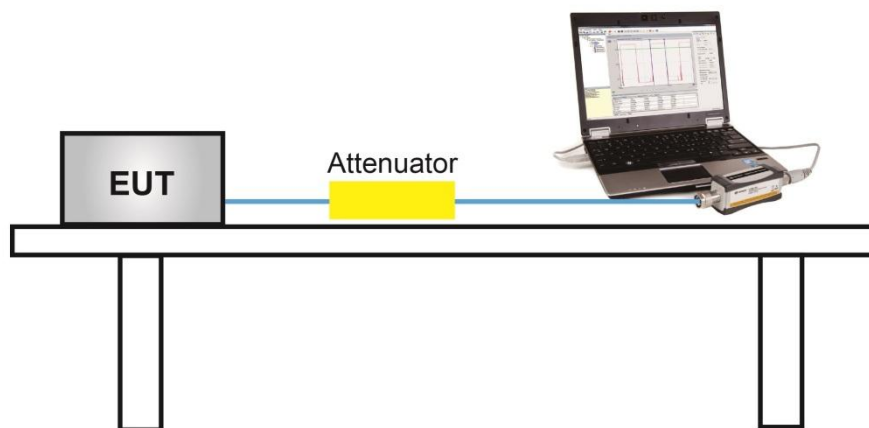

### 6.5.5. Test Result

Manufacturer declared that device support TPC mechanism in the operation description.

## **6.6. Power Spectral Density Measurement**

### **6.6.1. Test Limit**

For the band 5.15-5.25 GHz, the maximum power spectral density shall not exceed 17 dBm in any 1 megahertz band.

For the 5.25-5.35 GHz and 5.47-5.725 GHz bands, the maximum power spectral density shall not exceed 11 dBm in any 1 megahertz band.

For the band 5.725-5.85 GHz, the maximum power spectral density shall not exceed 30 dBm in any 500-kHz band.

If transmitting antennas of directional gain greater than 6dBi are used, the peak power spectral density shall be reduced by the amount in dB that the directional gain of the antenna exceeds 6dBi.

### **6.6.2. Test Procedure Used**

KDB 789033 D02v02r01-SectionF

### **6.6.3. Test Setting**

1. Analyzer was set to the center frequency of the UNII channel under investigation
2. Span was set to encompass the entire 26dB EBW of the signal.
3. RBW = 1MHz, if measurement bandwidth of Maximum PSD is specified in 500 kHz,  
RBW = 100 kHz
4. VBW = 3MHz
5. Number of sweep points  $\geq 2 \times (\text{span} / \text{RBW})$
6. Detector = power averaging (Average)
7. Sweep time = auto
8. Trigger = free run
9. Use the peak search function on the instrument to find the peak of the spectrum and record its value.
10. Add  $10 \cdot \log(1/x)$ , where x is the duty cycle, to the measured power in order to compute the average power during the actual transmission times (because the measurement represents an average over both the on and off times of the transmission). For example, add  $10 \cdot \log(1/0.25) = 6$  dB if the duty cycle is 25 percent.

### 6.6.4. Test Setup

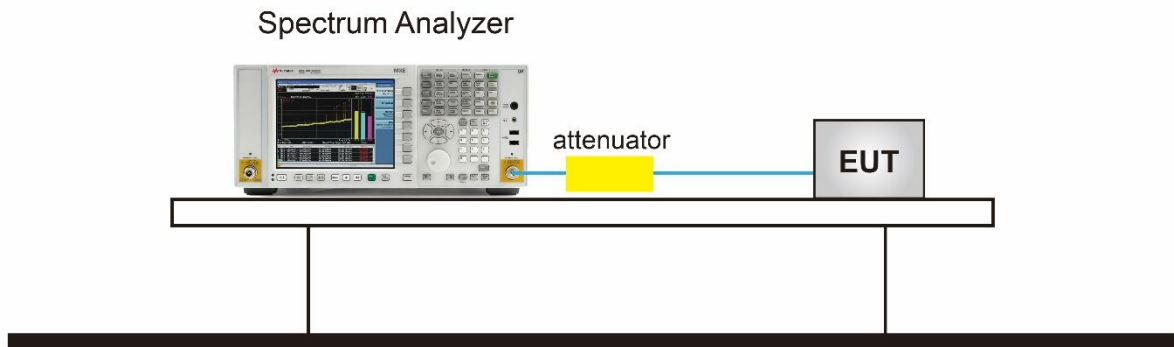

**6.6.5.Test Result**

Product	HAN Access Point, AP301	Test Site	SR2
Test Engineer	Eric Lin	Test Date	2020/11/19
Test Item	Power Spectral Density (U-NII- 1& 2A &2C)		

Test Mode	Data Rate /MCS	Ch. No.	Freq. (MHz)	Ant 0 PSD (dBm/MHz)	Ant 1 PSD (dBm/MHz)	Duty Cycle (%)	Total PSD (dBm/ MHz)	PSD Limit (dBm/MHz)	Result
11a	6Mbps	36	5180	8.62	8.61	93.23	11.93	≤16.69	Pass
11a	6Mbps	44	5220	9.10	8.97	93.23	12.35	≤16.69	Pass
11a	6Mbps	48	5240	9.14	9.04	93.23	12.41	≤16.69	Pass
11a	6Mbps	52	5260	7.12	7.05	93.23	10.40	≤10.69	Pass
11a	6Mbps	60	5300	6.56	6.59	93.23	9.89	≤10.69	Pass
11a	6Mbps	64	5320	6.00	6.14	93.23	9.39	≤10.69	Pass
11a	6Mbps	100	5500	6.07	6.07	93.23	9.39	≤10.69	Pass
11a	6Mbps	116	5580	5.09	5.07	93.23	8.39	≤10.69	Pass
11a	6Mbps	140	5700	5.42	5.56	93.23	8.81	≤10.69	Pass
11a	6Mbps	144	5720	5.56	5.71	93.23	8.95	≤10.69	Pass
11ac-VHT20	MCS0	36	5180	7.69	7.35	93.97	10.80	≤16.69	Pass
11ac-VHT20	MCS0	40	5220	8.15	8.51	93.97	11.61	≤16.69	Pass
11ac-VHT20	MCS0	48	5240	8.64	8.30	93.97	11.75	≤16.69	Pass
11ac-VHT20	MCS0	52	5260	7.41	7.21	93.97	10.59	≤10.69	Pass
11ac-VHT20	MCS0	60	5300	7.32	7.34	93.97	10.61	≤10.69	Pass
11ac-VHT20	MCS0	64	5320	6.31	6.44	93.97	9.66	≤10.69	Pass
11ac-VHT20	MCS0	100	5500	6.66	6.55	93.97	9.89	≤10.69	Pass
11ac-VHT20	MCS0	116	5580	6.69	6.76	93.97	10.00	≤10.69	Pass
11ac-VHT20	MCS0	140	5700	6.48	6.76	93.97	9.90	≤10.69	Pass
11ac-VHT20	MCS0	144	5720	6.58	6.78	93.97	9.96	≤10.69	Pass





Test Mode	Data Rate/ MCS	Ch. No.	Freq. (MHz)	Ant 0 PSD (dBm/MHz)	Ant 1 PSD (dBm/MHz)	Duty Cycle (%)	Total PSD (dBm/ MHz)	PSD Limit (dBm/MHz)	Result
11ac-VHT40	MCS0	38	5190	3.99	3.72	95.64	7.06	≤16.69	Pass
11ac-VHT40	MCS0	46	5230	5.98	6.05	95.64	9.22	≤16.69	Pass
11ac-VHT40	MCS0	54	5270	6.10	6.11	95.64	9.31	≤10.69	Pass
11ac-VHT40	MCS0	62	5310	3.14	3.52	95.64	6.54	≤10.69	Pass
11ac-VHT40	MCS0	102	5510	3.18	3.49	95.64	6.54	≤10.69	Pass
11ac-VHT40	MCS0	110	5550	4.34	4.10	95.64	7.43	≤10.69	Pass
11ac-VHT40	MCS0	134	5670	3.67	3.65	95.64	6.87	≤10.69	Pass
11ac-VHT40	MCS0	142	5710	4.40	4.63	95.64	7.72	≤10.69	Pass
11ac-VHT80	MCS0	42	5210	0.55	0.36	88.73	3.99	≤16.69	Pass
11ac-VHT80	MCS0	58	5290	0.61	0.74	88.73	4.21	≤10.69	Pass
11ac-VHT80	MCS0	106	5530	-1.00	-0.88	88.73	2.59	≤10.69	Pass
11ac-VHT80	MCS0	122	5610	-0.41	-0.03	88.73	3.32	≤10.69	Pass
11ac-VHT80	MCS0	138	5690	1.74	1.97	88.73	5.39	≤10.69	Pass
11ax-HE20	MCS0	36	5180	7.29	7.06	94.99	10.41	≤16.69	Pass
11ax-HE20	MCS0	40	5220	8.19	8.40	94.99	11.53	≤16.69	Pass
11ax-HE20	MCS0	48	5240	8.21	8.46	94.99	11.57	≤16.69	Pass
11ax-HE20	MCS0	52	5260	7.38	7.17	94.99	10.51	≤10.69	Pass
11ax-HE20	MCS0	60	5300	7.26	7.14	94.99	10.43	≤10.69	Pass
11ax-HE20	MCS0	64	5320	6.74	6.64	94.99	9.92	≤10.69	Pass
11ax-HE20	MCS0	100	5500	5.91	6.15	94.99	9.26	≤10.69	Pass
11ax-HE20	MCS0	116	5580	6.39	6.56	94.99	9.71	≤10.69	Pass
11ax-HE20	MCS0	140	5700	6.66	6.70	94.99	9.91	≤10.69	Pass
11ax-HE20	MCS0	144	5720	6.95	6.80	94.99	10.11	≤10.69	Pass

Test Mode	Data Rate/ MCS	Ch. No.	Freq. (MHz)	Ant 0 PSD (dBm/MHz)	Ant 1 PSD (dBm/MHz)	Duty Cycle (%)	Total PSD (dBm/ MHz)	PSD Limit (dBm/MHz)	Result
11ax-HE40	MCS0	38	5190	2.97	2.91	95.03	6.17	≤16.69	Pass
11ax-HE40	MCS0	46	5230	5.72	5.13	95.03	8.67	≤16.69	Pass
11ax-HE40	MCS0	54	5270	4.71	4.70	95.03	7.94	≤10.69	Pass
11ax-HE40	MCS0	62	5310	4.24	4.03	95.03	7.37	≤10.69	Pass
11ax-HE40	MCS0	102	5510	1.43	1.53	95.03	4.71	≤10.69	Pass
11ax-HE40	MCS0	110	5550	3.66	3.71	95.03	6.92	≤10.69	Pass
11ax-HE40	MCS0	134	5670	2.67	2.88	95.03	6.01	≤10.69	Pass
11ax-HE40	MCS0	142	5710	4.06	4.06	95.03	7.29	≤10.69	Pass
11ax-HE80	MCS0	42	5210	0.26	0.28	94.57	3.52	≤16.69	Pass
11ax-HE80	MCS0	58	5290	1.45	1.06	94.57	4.51	≤10.69	Pass
11ax-HE80	MCS0	106	5530	-1.19	-0.95	94.57	2.19	≤10.69	Pass
11ax-HE80	MCS0	122	5610	0.05	0.27	94.57	3.41	≤10.69	Pass
11ax-HE80	MCS0	138	5690	1.59	1.32	94.57	4.71	≤10.69	Pass

Note 1:

When EUT duty cycle < 98%, the total PSD (dBm/MHz) =  $10 \cdot \log \{10^{(\text{Ant 0 PSD}/10)} + 10^{(\text{Ant 1 PSD}/10)}\}$  (dBm/MHz) +  $10 \cdot \log (1/\text{Duty Cycle})$ .

Note 2:

For 5150 - 5250MHz: PSD Limit (dBm/MHz) = 17 dBm/MHz - (6.31 - 6) dBi = 16.69dBm/MHz.

For 5250 - 5350MHz: PSD Limit (dBm/MHz) = 11 dBm/MHz - (6.31 - 6) dBi= 10.69dBm/MHz.

For 5470 - 5725MHz: PSD Limit (dBm/MHz) = 11 dBm/MHz - (6.31 - 6) dBi= 10.69dBm/MHz.

Product	HAN Access Point, AP301	Test Site	SR2
Test Engineer	Eric Lin	Test Date	2020/11/19
Test Item	Power Spectral Density (U-NII-3)		

Test Mode	Data Rate/ MCS	Ch. No.	Freq. (MHz)	Ant 0 PSD (dBm/510KHz)	Ant 1 PSD (dBm/510KHz)	Duty Cycle (%)	Total PSD (dBm/ 510kHz)	Limit (dBm/ 500kHz)	Result
11a	6Mbps	149	5745	4.84	4.54	93.23	8.01	≤29.69	Pass
11a	6Mbps	157	5785	4.40	4.66	93.23	7.85	≤29.69	Pass
11a	6Mbps	165	5825	4.89	4.97	93.23	8.24	≤29.69	Pass
11ac-VHT20	MCS0	149	5745	4.34	4.03	93.97	7.47	≤29.69	Pass
11ac-VHT20	MCS0	157	5785	3.99	4.16	93.97	7.36	≤29.69	Pass
11ac-VHT20	MCS0	165	5825	4.60	4.77	93.97	7.97	≤29.69	Pass
11ac-VHT40	MCS0	151	5755	1.39	1.48	95.64	4.64	≤29.69	Pass
11ac-VHT40	MCS0	159	5795	1.47	1.48	95.64	4.68	≤29.69	Pass
11ac-VHT80	MCS0	155	5775	-1.19	-1.03	88.73	2.42	≤29.69	Pass
11ax-HE20	MCS0	149	5745	3.92	3.78	94.99	7.08	≤29.69	Pass
11ax-HE20	MCS0	157	5785	3.46	3.78	94.99	6.86	≤29.69	Pass
11ax-HE20	MCS0	165	5825	4.17	4.32	94.99	7.48	≤29.69	Pass
11ax-HE40	MCS0	151	5755	1.09	1.05	95.03	4.30	≤29.69	Pass
11ax-HE40	MCS0	159	5795	1.19	0.94	95.03	4.30	≤29.69	Pass
11ax-HE80	MCS0	155	5775	-1.87	-1.63	94.57	1.51	≤29.69	Pass

Note 1:

When EUT duty cycle < 98%, the total PSD (dBm/510kHz) =  $10 \cdot \log \{ 10^{(\text{Ant 0 PSD}/10)} + 10^{(\text{Ant 1 PSD}/10)} \}$  (dBm/510kHz) +  $10 \cdot \log (1/\text{Duty Cycle})$ .

Note 2: PSD Limit (dBm/500kHz) = 30 dBm/500kHz - (6.31 - 6) dBi= 29.69dBm/500kHz.

802.11a Power Spectral Density - Ant 0 / Ant 0 + 1

Channel 36 (5180MHz)



Channel 44 (5220MHz)



Channel 48 (5240MHz)

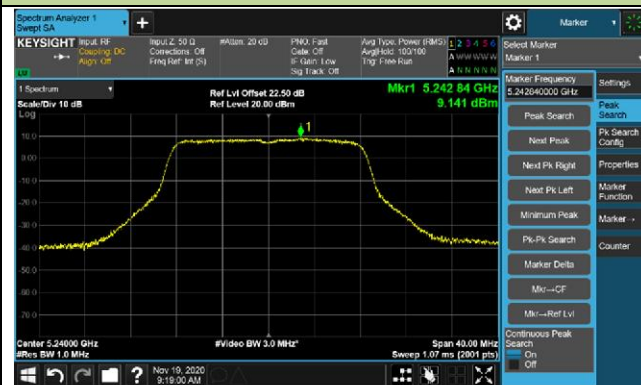

Channel 52 (5260MHz)



Channel 60 (5300MHz)



Channel 64 (5320MHz)



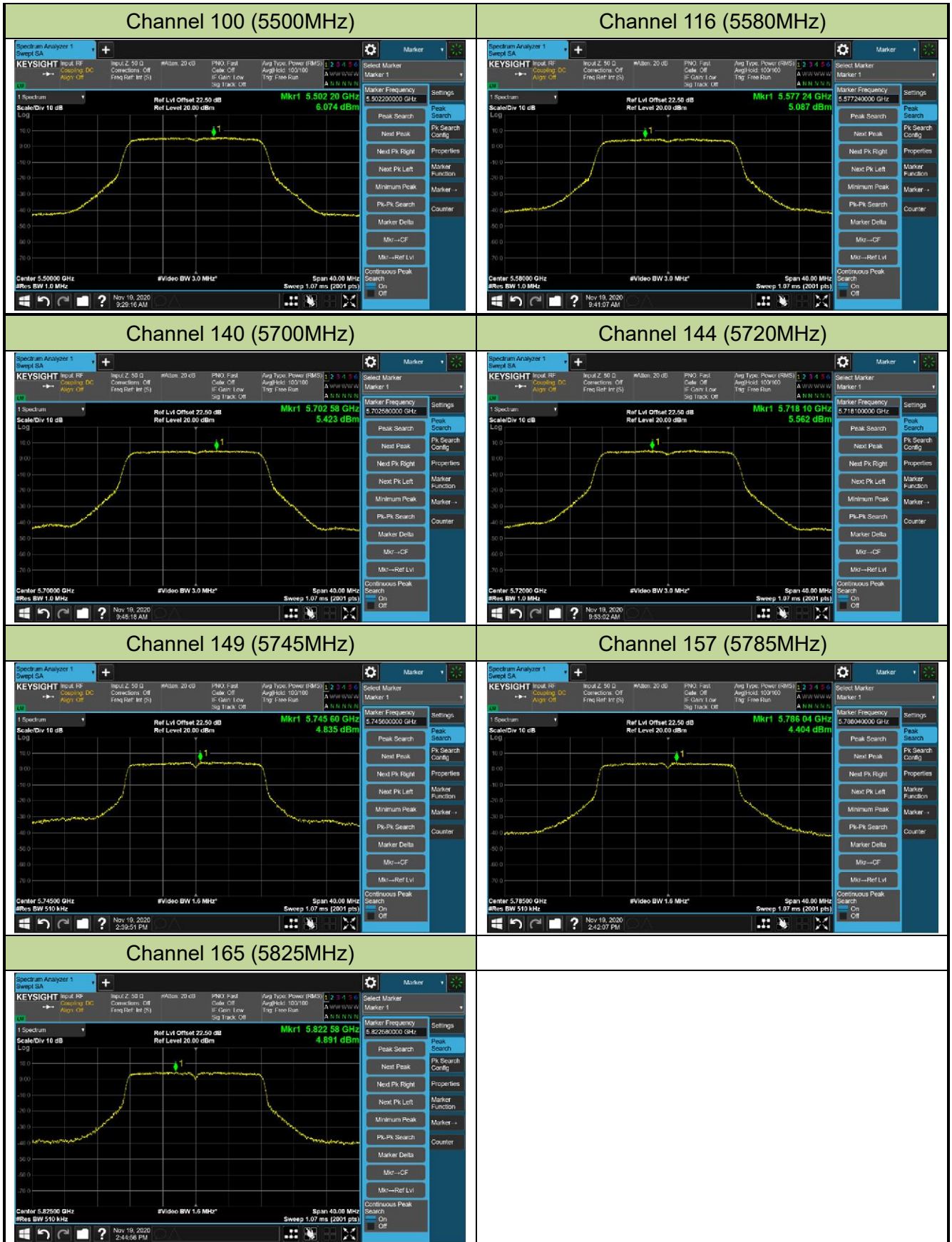

802.11ac-VHT20 Power Spectral Density - Ant 0 / Ant 0 + 1

Channel 36 (5180MHz)

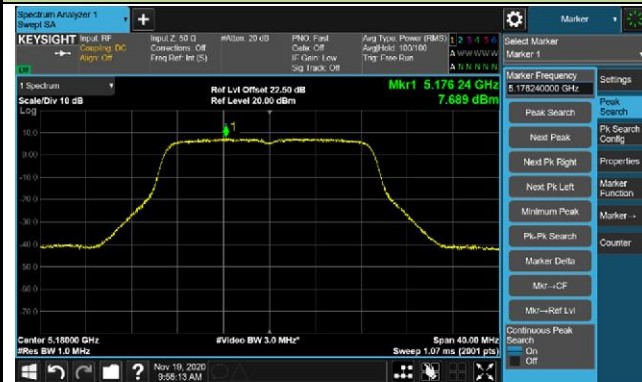

Channel 44 (5220MHz)



Channel 48 (5240MHz)



Channel 52 (5260MHz)



Channel 60 (5300MHz)



Channel 64 (5320MHz)



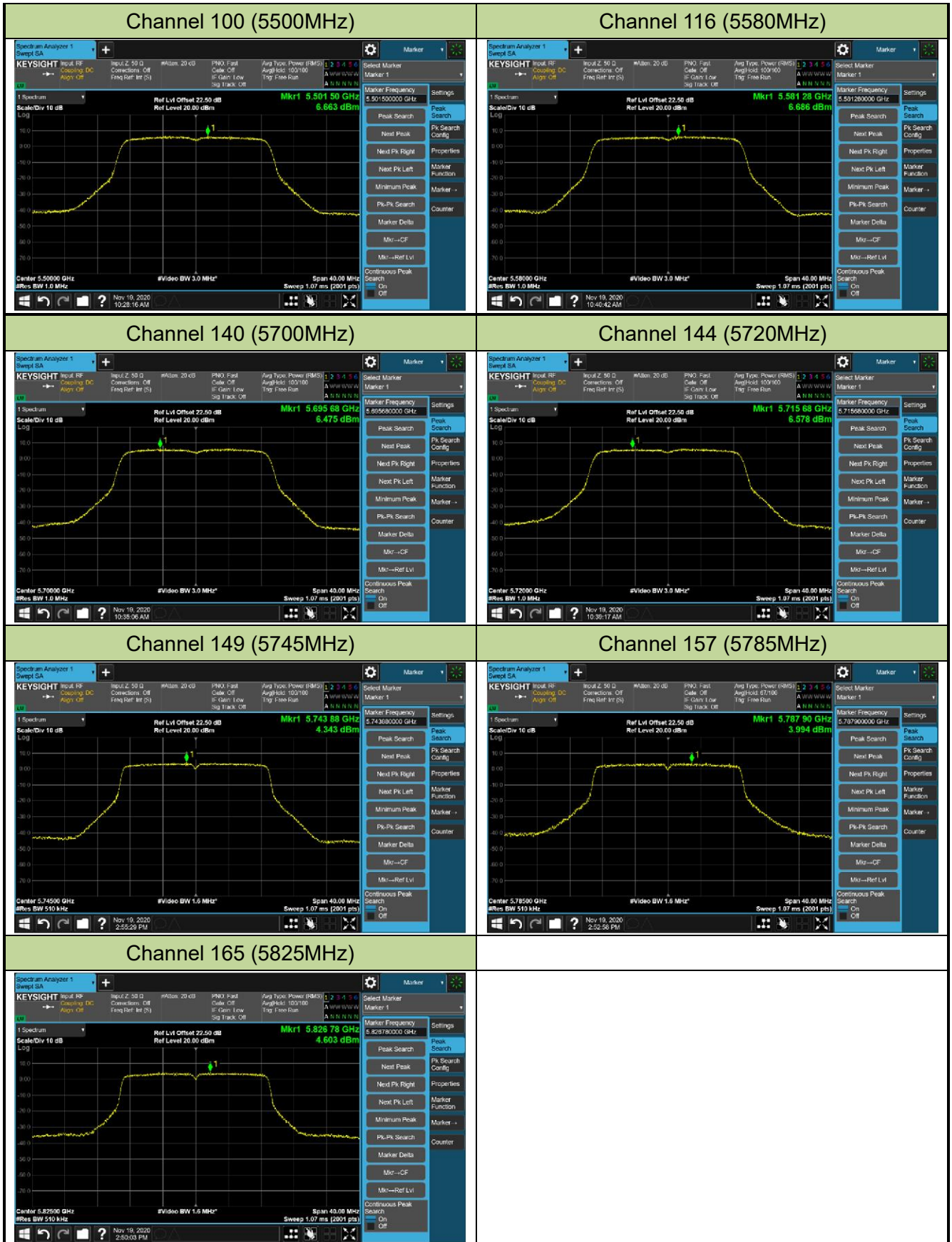

802.11ac-VHT40 Power Spectral Density - Ant 0 / Ant 0 + 1

Channel 38 (5190MHz)



Channel 46 (5230MHz)



Channel 54 (5270MHz)

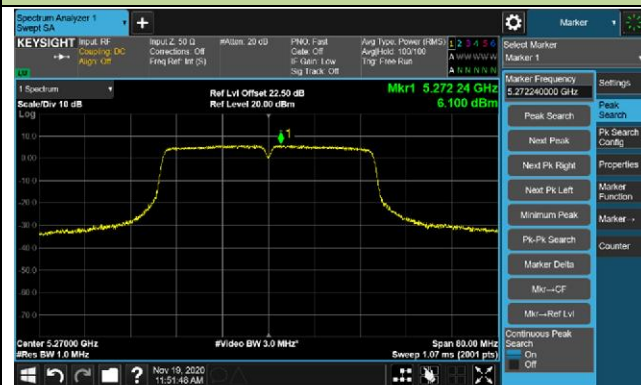

Channel 62 (5310MHz)



Channel 102 (5510MHz)



Channel 110 (5550MHz)

