

DFS Test Report

Report No.: RF170508D01A-1

FCC ID: 2ALJ3AP27X

Test Model: AP271

Received Date: May 08, 2017

Test Date: Nov. 20 ~ Nov. 21, 2017

Issued Date: Nov. 22, 2017

Applicant: HAN Networks Co., Ltd.

Address: 5/F, Building 37, No.8 Dongbeiwang West Road, HaiDian District, Beijing, China

Issued By: Bureau Veritas Consumer Products Services (H.K.) Ltd., Taoyuan Branch

Lab Address: No. 47-2, 14th Ling, Chia Pau Vil., Lin Kou Dist., New Taipei City, Taiwan, R.O.C.

Test Location: No. 19, Hwa Ya 2nd Rd., Wen Hwa Vil., Kwei Shan Dist., Taoyuan City 33383, TAIWAN (R.O.C.)

**FCC Registration/
Designation Number:** 788550 / TW0003



This report is for your exclusive use. Any copying or replication of this report to or for any other person or entity, or use of our name or trademark, is permitted only with our prior written permission. This report sets forth our findings solely with respect to the test samples identified herein. The results set forth in this report are not indicative or representative of the quality or characteristics of the lot from which a test sample was taken or any similar or identical product unless specifically and expressly noted. Our report includes all of the tests requested by you and the results thereof based upon the information that you provided to us. You have 60 days from date of issuance of this report to notify us of any material error or omission caused by our negligence, provided, however, that such notice shall be in writing and shall specifically address the issue you wish to raise. A failure to raise such issue within the prescribed time shall constitute your unqualified acceptance of the completeness of this report, the tests conducted and the correctness of the report contents. Unless specific mention, the uncertainty of measurement has been explicitly taken into account to declare the compliance or non-compliance to the specification. The report must not be used by the client to claim product certification, approval, or endorsement by TAF or any government agencies.

Table of Contents

Release Control Record	3
1 Certificate of Conformity	4
2 EUT Information	5
2.1 Operating Frequency Bands and Mode of EUT.....	5
2.2 EUT Software and Firmware Version.....	5
2.3 Description Of Available Antennas to The EUT	5
2.4 EUT Maximum Conducted Power.....	6
2.5 EUT Maximum E.I.R.P. Power	8
2.6 Transmit Power Control (TPc).....	10
2.7 Statement of Manufacturer.....	10
3. U-NII DFS Rule Requirements	11
3.1 Working Modes and Required Test Items	11
3.2 Test Limits And Radar Signal Parameters	12
4. Test & Support Equipment List	15
4.1 Test Instruments.....	15
4.2 Description of Support Units	15
5. Test Procedure	16
5.1 ADT DFS Measurement System.....	16
5.2 Calibration of DFS Detection Threshold Level.....	17
5.3 Deviation from Test Standard.....	17
5.4 Radiated Test Setup Configuration	18
5.4.1 Master Mode.....	18
6. Test Results	19
6.1 Summary of Test Results	19
6.2 Test Results.....	20
6.2.1 Test Mode	20
6.2.2 U-NII Detection Bandwidth	25
6.2.3 Channel Availability Check Time	31
6.2.4 Channel Closing Transmission and Channel Move Time.....	33
6.2.5 Non- Occupancy Period	42
6.2.6 Uniform Spreading.....	45
7. Information on the Testing Laboratories	46

Release Control Record

Issue No.	Description	Date Issued
RF170508D01A-1	Original release.	Nov. 22, 2017

1 Certificate of Conformity

Product: HAN Access Point

Brand: HAN

Test Model: AP271

Sample Status: ENGINEERING SAMPLE

Applicant: HAN Networks Co., Ltd.

Test Date: Nov. 20 ~ Nov. 21, 2017

Standards: FCC Part 15, Subpart E (Section 15.407)

KDB 905462 D02 UNII DFS Compliance Procedures New Rules v02

The above equipment has been tested by **Bureau Veritas Consumer Products Services (H.K.) Ltd., Taoyuan Branch**, and found compliance with the requirement of the above standards. The test record, data evaluation & Equipment Under Test (EUT) configurations represented herein are true and accurate accounts of the measurements of the sample's RF characteristics under the conditions specified in this report.

Prepared by :  , **Date:** Nov. 22, 2017
Pettie Chen / Senior Specialist

Approved by :  , **Date:** Nov. 22, 2017
Ken Liu / Senior Manager

2 EUT Information

2.1 Operating Frequency Bands and Mode of EUT

Table 1: Operating Frequency Bands and Mode of EUT

Operational Mode	Operating Frequency Range	
	5250~5350MHz	5470~5725MHz
Master	✓	✓

2.2 EUT Software and Firmware Version

Table 2: The Eut Software/Firmware Version

No.	Product	Model No.	Software/Firmware Version
1	HAN Access Point	AP271	3.0.2.4908

2.3 Description of Available Antennas to The EUT

Table 3: Antenna List

Antenna No.	Antenna Type	Operation Frequency Range (MHz)	Gain (dBi)
1	Matrix	5250-5725	6.62
2	Matrix	5250-5725	6.24

Maximum Correlated Directional Gain = $10 \log[(10^{G1/20} + 10^{G2/20} + \dots + 10^{GN/20})^2 / N_{ANT}]$ dBi
 Note: 5250~57250MHz: Directional Gain = 9.44 dBi

2.4 EUT Maximum Conducted Power

Table 4: The Measured Conducted Output Power

CDD Mode

802.11a

Frequency Band (MHz)	MAX. Power		MIN. Power	
	Output Power(dBm)	Output Power(mW)	Output Power(dBm)	Output Power(mW)
5250~5350	15.91	38.994	9.91	9.795
5470~5725	21.12	129.420	15.12	32.509

802.11n HT20

Frequency Band (MHz)	MAX. Power		MIN. Power	
	Output Power(dBm)	Output Power(mW)	Output Power(dBm)	Output Power(mW)
5250~5350	15.90	38.905	9.90	9.77
5470~5725	20.95	124.451	14.95	31.26

802.11n HT40

Frequency Band (MHz)	MAX. Power		MIN. Power	
	Output Power(dBm)	Output Power(mW)	Output Power(dBm)	Output Power(mW)
5250~5350	15.86	38.548	9.86	9.68
5470~5725	22.87	193.642	16.87	48.64

802.11ac VHT80

Frequency Band (MHz)	MAX. Power		MIN. Power	
	Output Power(dBm)	Output Power(mW)	Output Power(dBm)	Output Power(mW)
5250~5350	15.82	38.194	9.82	9.594
5470~5725	22.80	190.546	16.80	47.863

Beamforming Mode

802.11ac VHT20

Frequency Band (MHz)	MAX. Power		MIN. Power	
	Output Power(dBm)	Output Power(mW)	Output Power(dBm)	Output Power(mW)
5250~5350	12.87	19.364	6.87	4.864
5470~5725	20.41	109.901	14.41	27.606

802.11ac VHT40

Frequency Band (MHz)	MAX. Power		MIN. Power	
	Output Power(dBm)	Output Power(mW)	Output Power(dBm)	Output Power(mW)
5250~5350	12.87	19.364	6.87	4.86
5470~5725	20.27	106.414	14.27	26.73

802.11ac VHT80

Frequency Band (MHz)	MAX. Power		MIN. Power	
	Output Power(dBm)	Output Power(mW)	Output Power(dBm)	Output Power(mW)
5250~5350	12.85	19.275	6.85	4.84
5470~5725	20.21	104.954	14.21	26.36

2.5 EUT Maximum E.I.R.P. Power

Table 5: The EIRP Output Power List

CDD Mode

802.11a

Frequency Band (MHz)	MAX. Power		MIN. Power	
	Output Power(dBm)	Output Power(mW)	Output Power(dBm)	Output Power(mW)
5250~5350	22.53	179.061	16.53	44.978
5470~5725	27.74	594.292	21.74	149.279

802.11n HT20

Frequency Band (MHz)	MAX. Power		MIN. Power	
	Output Power(dBm)	Output Power(mW)	Output Power(dBm)	Output Power(mW)
5250~5350	22.52	178.649	16.52	44.87
5470~5725	27.57	571.479	21.57	143.55

802.11n HT40

Frequency Band (MHz)	MAX. Power		MIN. Power	
	Output Power(dBm)	Output Power(mW)	Output Power(dBm)	Output Power(mW)
5250~5350	22.48	177.011	16.48	44.46
5470~5725	29.49	889.201	23.49	223.36

802.11ac VHT80

Frequency Band (MHz)	MAX. Power		MIN. Power	
	Output Power(dBm)	Output Power(mW)	Output Power(dBm)	Output Power(mW)
5250~5350	22.44	175.388	16.44	44.055
5470~5725	29.42	874.984	23.42	219.786

Beamforming Mode

802.11ac VHT20

Frequency Band (MHz)	MAX. Power		MIN. Power	
	Output Power(dBm)	Output Power(mW)	Output Power(dBm)	Output Power(mW)
5250~5350	22.31	170.216	16.31	42.756
5470~5725	29.85	966.051	23.85	242.661

802.11ac VHT40

Frequency Band (MHz)	MAX. Power		MIN. Power	
	Output Power(dBm)	Output Power(mW)	Output Power(dBm)	Output Power(mW)
5250~5350	22.31	170.216	16.31	42.76
5470~5725	29.71	935.406	23.71	234.96

802.11ac VHT80

Frequency Band (MHz)	MAX. Power		MIN. Power	
	Output Power(dBm)	Output Power(mW)	Output Power(dBm)	Output Power(mW)
5250~5350	22.29	169.434	16.29	42.56
5470~5725	29.65	922.571	23.65	231.74

2.6 Transmit Power Control (TPC)

U-NII devices operating in the 5.25-5.35 GHz band and the 5.47-5.725 GHz band shall employ a TPC mechanism. The U-NII device is required to have the capability to operate at least 6 dB below the mean EIRP value of 30 dBm. A TPC mechanism is not required for systems with an e.i.r.p. of less than 500 mW.

Maximum EIRP of this device is 966.051 mW which more than 500mW, therefore it's require TPC function.

2.7 Statement of Manufacturer

Manufacturer statement confirming that information regarding the parameters of the detected Radar Waveforms is not available to the end user.

3. U-NII DFS Rule Requirements

3.1 Working Modes and Required Test Items

The manufacturer shall state whether the UUT is capable of operating as a Master and/or a Client. If the UUT is capable of operating in more than one operating mode then each operating mode shall be tested separately. See tables 6 and 7 for the applicability of DFS requirements for each of the operational modes.

Table 6: Applicability of DFS Requirements Prior To Use a Channel

Requirement	Operational Mode		
	Master	Client without radar detection	Client with radar detection
Non-Occupancy Period	✓	✓ _{note}	✓
DFS Detection Threshold	✓	Not required	✓
Channel Availability Check Time	✓	Not required	Not required
U-NII Detection Bandwidth	✓	Not required	✓

Note: Per KDB 905462 D03 UNII Clients Without Radar Detection New Rules v01r02 section (b)(5/6), If the client moves with the master, the device is considered compliant if nothing appears in the client non-occupancy period test. For devices that shut down (rather than moving channels), no beacons should appear. An analyzer plot that contains a single 30-minute sweep on the original channel.

Table 7: Applicability of DFS Requirements During Normal Operation.

Requirement	Operational Mode	
	Master or Client with radar detection	Client without radar detection
DFS Detection Threshold	✓	Not required
Channel Closing Transmission Time	✓	✓
Channel Move Time	✓	✓
U-NII Detection Bandwidth	✓	Not required

Additional requirements for devices with multiple bandwidth modes	Master or Client with radar detection	Client without radar detection
U-NII Detection Bandwidth and Statistical Performance Check	All BW modes must be tested	Not required
Channel Move Time and Channel Closing Transmission Time	Test using widest BW mode available	Test using the widest BW mode available for the link
All other tests	Any single BW mode	Not required

Note: Frequencies selected for statistical performance check (Section 7.8.4) should include several frequencies within the radar detection bandwidth and frequencies near the edge of the radar detection bandwidth. For 802.11 devices it is suggested to select frequencies in each of the bonded 20 MHz channels and the channel center frequency.

3.2 Test Limits And Radar Signal Parameters

Detection Threshold Values

Table 8: DFS Detection Thresholds For Master Devices And Client Devices With Radar Detection

Maximum Transmit Power	Value (See Notes 1, 2, and 3)
EIRP \geq 200 milliwatt	-64 dBm
EIRP < 200 milliwatt and power spectral density < 10 dBm/MHz	-62 dBm
EIRP < 200 milliwatt that do not meet the power spectral density requirement	-64 dBm

Note 1: This is the level at the input of the receiver assuming a 0 dBi receive antenna.

Note 2: Throughout these test procedures an additional 1 dB has been added to the amplitude of the test transmission waveforms to account for variations in measurement equipment. This will ensure that the test signal is at or above the detection threshold level to trigger a DFS response.

Note3: EIRP is based on the highest antenna gain. For MIMO devices refer to KDB Publication 662911 D01.

Table 9: DFS Response Requirement Values

Parameter	Value
Non-occupancy period	Minimum 30 minutes
Channel Availability Check Time	60 seconds
Channel Move Time	10 seconds See Note 1.
Channel Closing Transmission Time	200 milliseconds + an aggregate of 60 milliseconds over remaining 10 second period. See Notes 1 and 2.
U-NII Detection Bandwidth	Minimum 100% of the U-NII 99% transmission power bandwidth. See Note 3

Note 1: Channel Move Time and the Channel Closing Transmission Time should be performed with Radar Type 0. The measurement timing begins at the end of the Radar Type 0 burst.

Note 2: The Channel Closing Transmission Time is comprised of 200 milliseconds starting at the beginning of the Channel Move Time plus any additional intermittent control signals required to facilitate a Channel move (an aggregate of 60 milliseconds) during the remainder of the 10 second period. The aggregate duration of control signals will not count quiet periods in between transmissions.

Note 3: During the U-NII Detection Bandwidth detection test, radar type 0 should be used. For each frequency step the minimum percentage of detection is 90 percent. Measurements are performed with no data traffic.

Parameters of DFS Test Signals

Step intervals of 0.1 microsecond for Pulse Width, 1 microsecond for PRI, 1 MHz for chirp width and 1 for the number of pulses will be utilized for the random determination of specific test waveforms.

Table 10: Short Pulse Radar Test Waveforms

Radar Type	Pulse Width (μsec)	PRI (μsec)	Number of Pulses	Minimum Percentage of Successful Detection	Minimum Number of Trials
0	1	1428	18	See Note 1	See Note 1
1	1	Test A: 15 unique PRI values randomly selected from the list of 23 PRI values in Table 5a	$\text{Roundup} \left\{ \left(\frac{1}{360} \right) \cdot \left(\frac{19 \cdot 10^6}{\text{PRI}_{\mu\text{sec}}} \right) \right\}$	60%	30
		Test B: 15 unique PRI values randomly selected within the range of 518-3066 μ sec, with a minimum increment of 1 μ sec, excluding PRI values selected in Test A			
2	1-5	150-230	23-29	60%	30
3	6-10	200-500	16-18	60%	30
4	11-20	200-500	12-16	60%	30
Aggregate (Radar Types 1-4)				80%	120
Note 1: Short Pulse Radar Type 0 should be used for the detection bandwidth test, channel move time, and channel closing time tests.					

Table 11: Long Pulse Radar Test Waveform

Radar Type	Pulse Width (μsec)	Chirp Width (MHz)	PRI (μsec)	Number Of Pulses Per Burst	Number Of Bursts	Minimum Percentage Of Successful Detection	Minimum Number Of Trials
5	50-100	5-20	1000-2000	1-3	8-20	80%	30

Three subsets of trials will be performed with a minimum of ten trials per subset. The subset of trials differ in where the Long Pulse Type 5 Signal is tuned in frequency.

- a) the Channel center frequency
- b) tuned frequencies such that 90% of the Long Pulse Type 5 frequency modulation is within the low edge of the UUT Occupied Bandwidth
- c) tuned frequencies such that 90% of the Long Pulse Type 5 frequency modulation is within the high edge of the UUT Occupied Bandwidth

It include 10 trails for every subset, the formula as below,

For subset case 1: the center frequency of the signal generator will remain fixed at the center of the UUT Channel.

For subset case 2: to retain 90% frequency overlap between the radar signal and the UUT Occupied Bandwidth, the center frequency of the signal generator will vary for each of the ten trials in subset case 2. The center frequency of the signal generator for each trial is calculated by:

$$FL+(0.4*Chirp\ Width\ [in\ MHz])$$

For subset case 3: to retain 90% frequency overlap between the radar signal and the UUT Occupied Bandwidth, the center frequency of the signal generator will vary for each of the ten trials in subset case 3. The center frequency of the signal generator for each trial is calculated by:

$$FH-(0.4*Chirp\ Width\ [in\ MHz])$$

Table 12: Frequency Hopping Radar Test Waveform

Radar Type	Pulse Width (μsec)	PRI (μsec)	Pulses per Hop	Hopping Rate (kHz)	Hopping Sequence Length (msec)	Minimum Percentage Of Successful Detection	Minimum Number Of Trials
6	1	333	9	0.333	300	70%	30

4. Test & Support Equipment List

4.1 Test Instruments

Table 13: Test Instruments List

Description	Model No.	Brand	Date Of Calibration	Due Date Of Calibration
Spectrum analyzer	ESR	R&S	2017/02/20	2018/02/19
Signal generator	8645A	Agilent	2017/08/11	2018/08/10
Horn antenna	BBHA 9120 D	Schwarzbeck	2016/12/28	2017/12/27
RF coaxial cable	CA3501-3501-G.90(3m) & CA3501-3501-F.90(2m)	INFINET	2017/08/21	2018/08/20

4.2 Description of Support Units

Table 14: Support Unit Information.

No.	Product	Brand	Model No.	FCC ID
1	WiFi USB Adapter	NETGEAR	A6210	PY313400249

NOTE: This device was functioned as a Master Slave device during the DFS test.

5. Test Procedure

5.1 DFS Measurement System

A complete DFS Measurement System consists of two subsystems: (1) the Radar Signal Generating Subsystem and (2) the Traffic Monitoring Subsystem. The control PC is necessary for generating the Radar waveforms in Table 10, 11 and 12. The traffic monitoring subsystem is specified to the type of unit under test (UUT).

Radiated Setup Configuration of DFS Measurement System

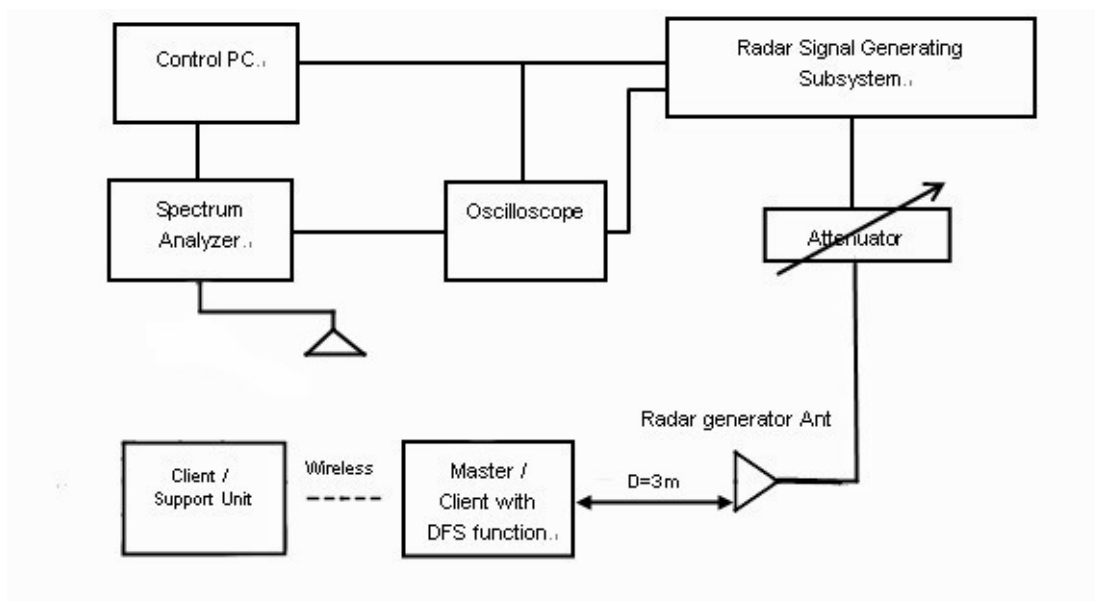

System testing will be performed with channel-loading using means appropriate to the data types that are used by the unlicensed device. The following requirements apply:

	a) The data file must be of a type that is typical for the device (i.e., MPEG-2, MPEG-4, WAV, MP3, MP4, AVI, etc.) and must generally be transmitting in a streaming mode.
	b) Software to ping the client is permitted to simulate data transfer but must have random ping intervals.
v	c) Timing plots are required with calculations demonstrating a minimum channel loading of approximately 17% or greater.
	d) Unicast or Multicast protocols are preferable but other protocols may be used. The appropriate protocol used must be described in the test procedures.

5.2 Calibration of DFS Detection Threshold Level

The measured channel is 5500MHz, 5510MHz and 5530MHz. The radar signal was the same as transmitted channels, and injected into the antenna of AP (master) or Client Device with Radar Detection, measured the channel closing transmission time and channel move time. The calibrated conducted detection threshold level is set to -64dBm. The tested level is lower than required level hence it provides margin to the limit.

Radiated setup configuration of Calibration of DFS Detection Threshold Level

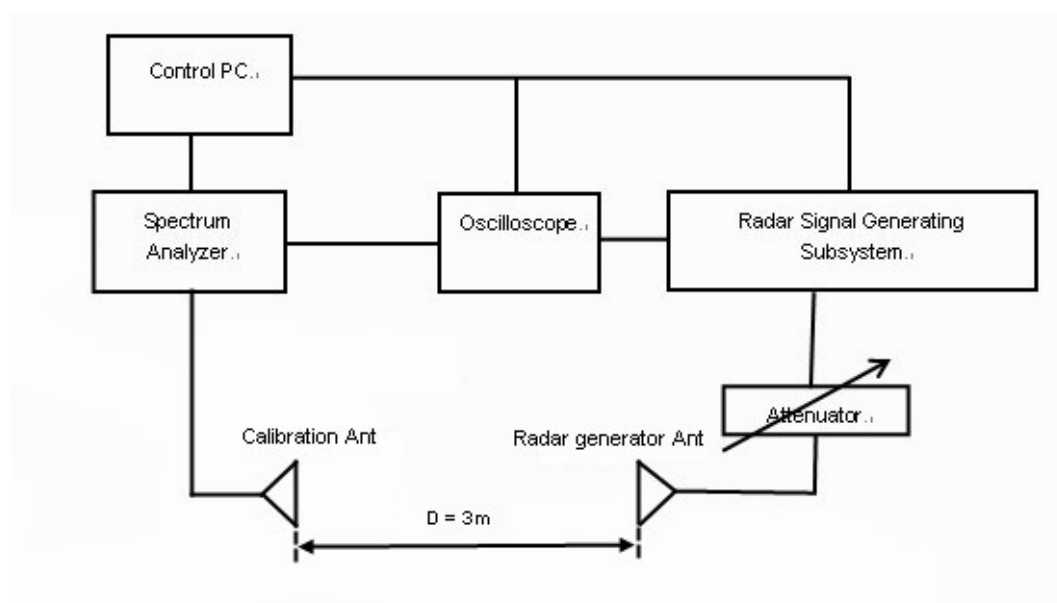

5.3 Deviation from Test Standard

No deviation.

5.4 Radiated Test Setup Configuration

5.4.1 Master Mode

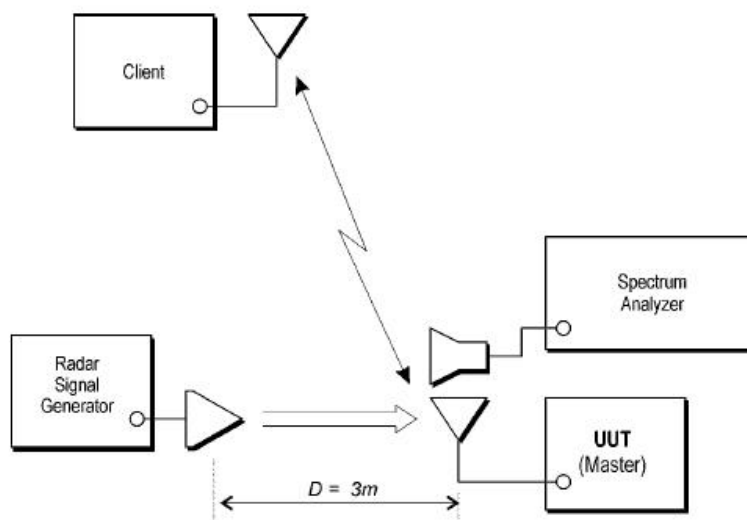

The EUT is a U-NII Device operating in Master mode. The radar test signals are injected into the Master Device.

6. Test Results

6.1 Summary of Test Results

Clause	Test Parameter	Remarks	Pass/Fail
15.407	DFS Detection Threshold	Applicable	Pass
15.407	U-NII Detection Bandwidth	Applicable	Pass
15.407	Channel Availability Check Time	Applicable	Pass
15.407	Channel Move Time	Applicable	Pass
15.407	Channel Closing Transmission Time	Applicable	Pass
15.407	Non- Occupancy Period	Applicable	Pass
15.407	Uniform Spreading	Applicable	Pass

6.2 Test Results

6.2.1 Test Mode

Master with injection at the Master. (Radar Test Waveforms are injected into the Master.)

DFS Detection Threshold

For detection threshold level of -64dBm, the required Radar Signal at antenna port was set to -64dBm. The tested level is lower than required level for 1dB, hence it provides margin to the limit.

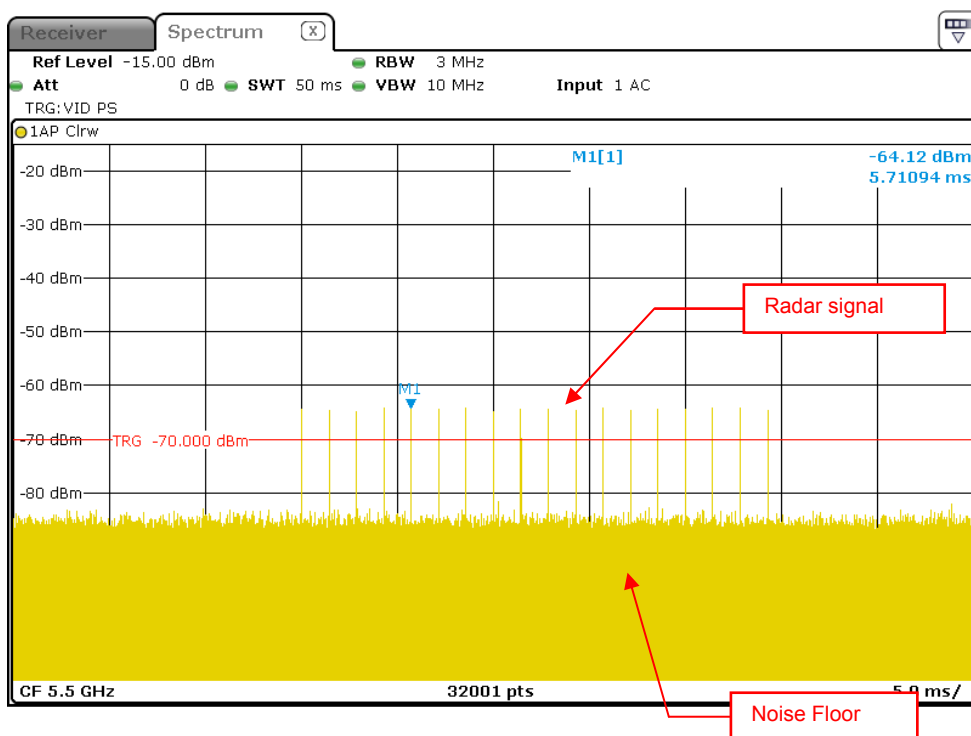

Radar Signal 0

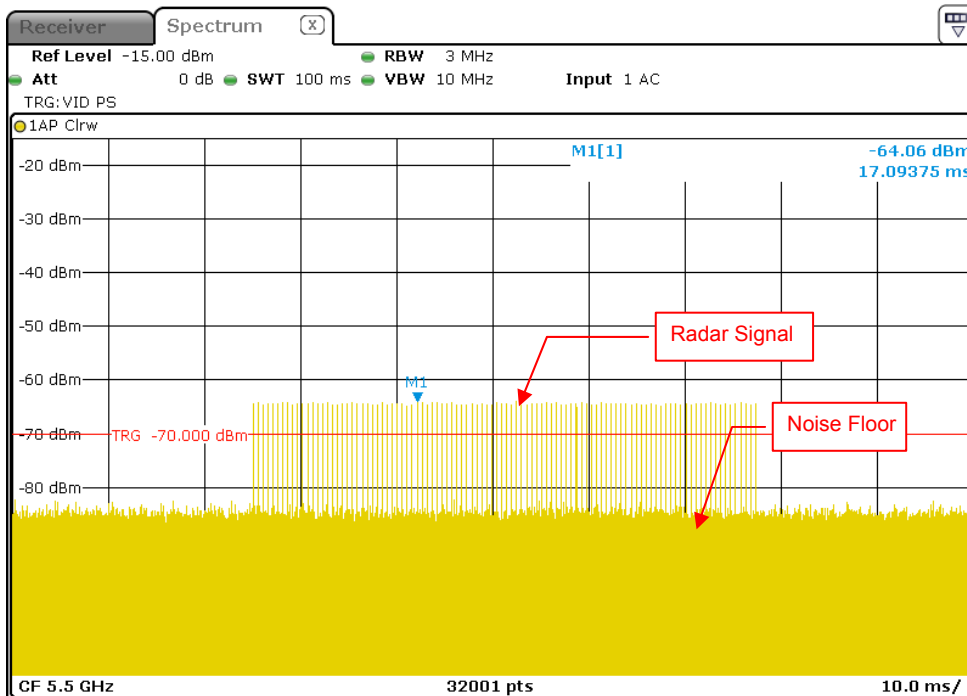

Radar Signal 1 (Test A)

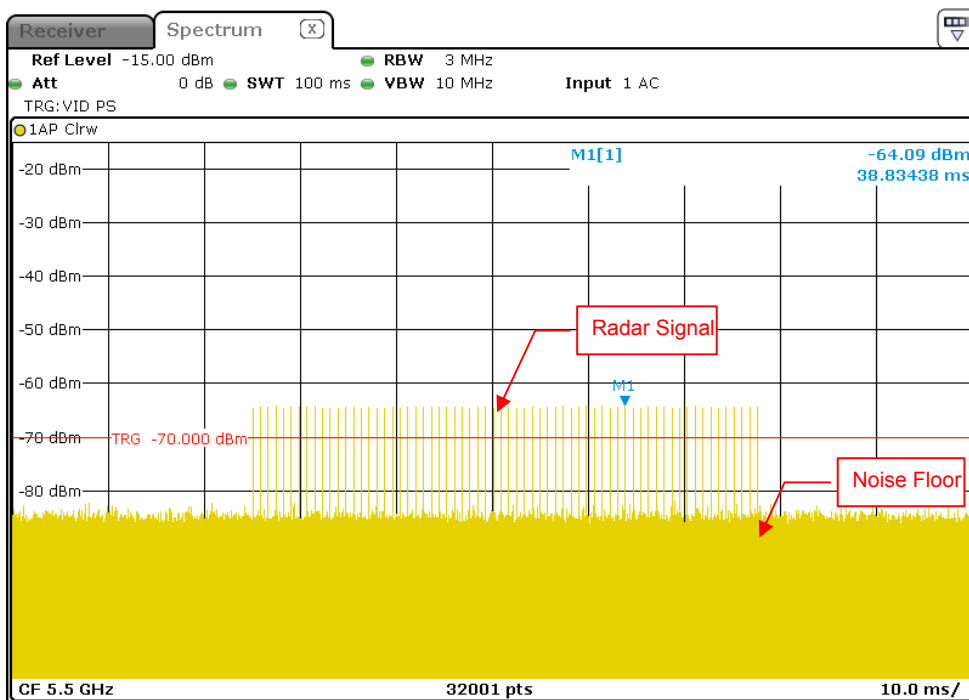

Radar Signal 1 (Test B)

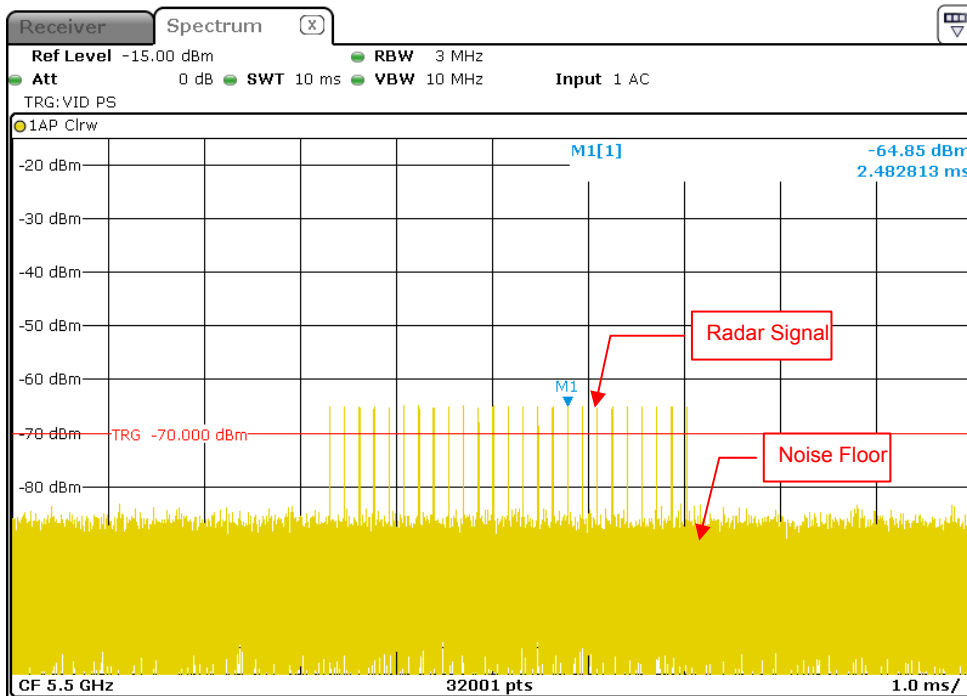

Radar Signal 2

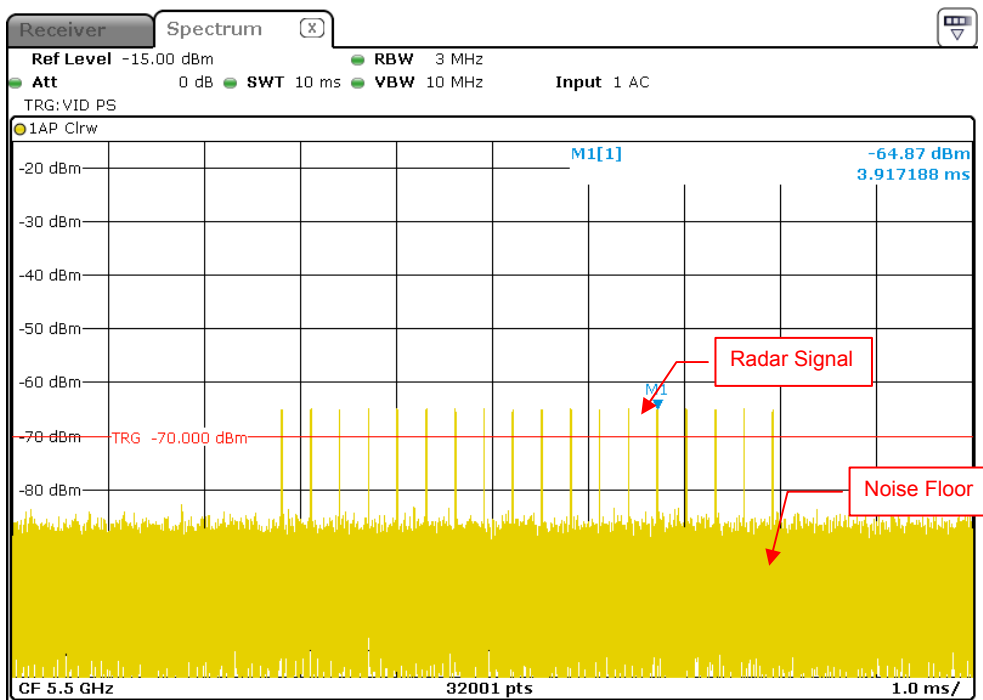

Radar Signal 3

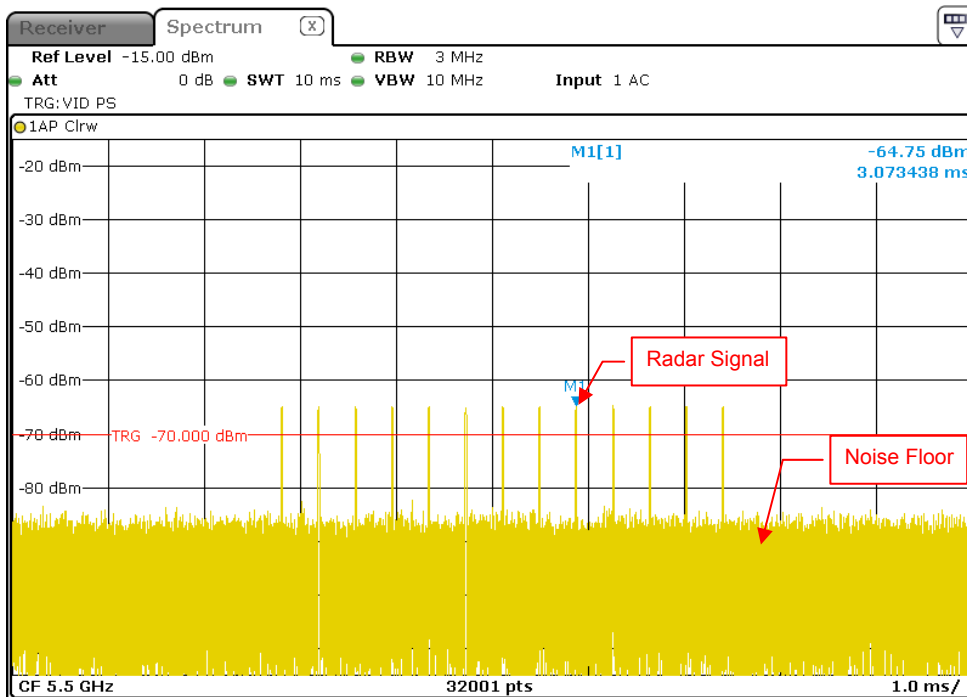

Radar Signal 4

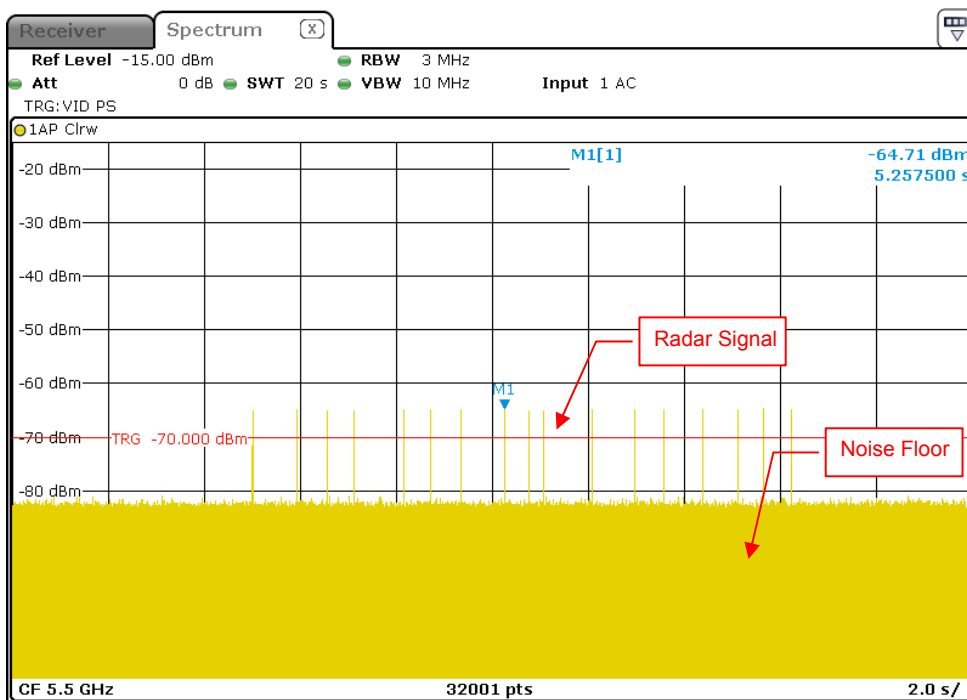

Radar Signal 5

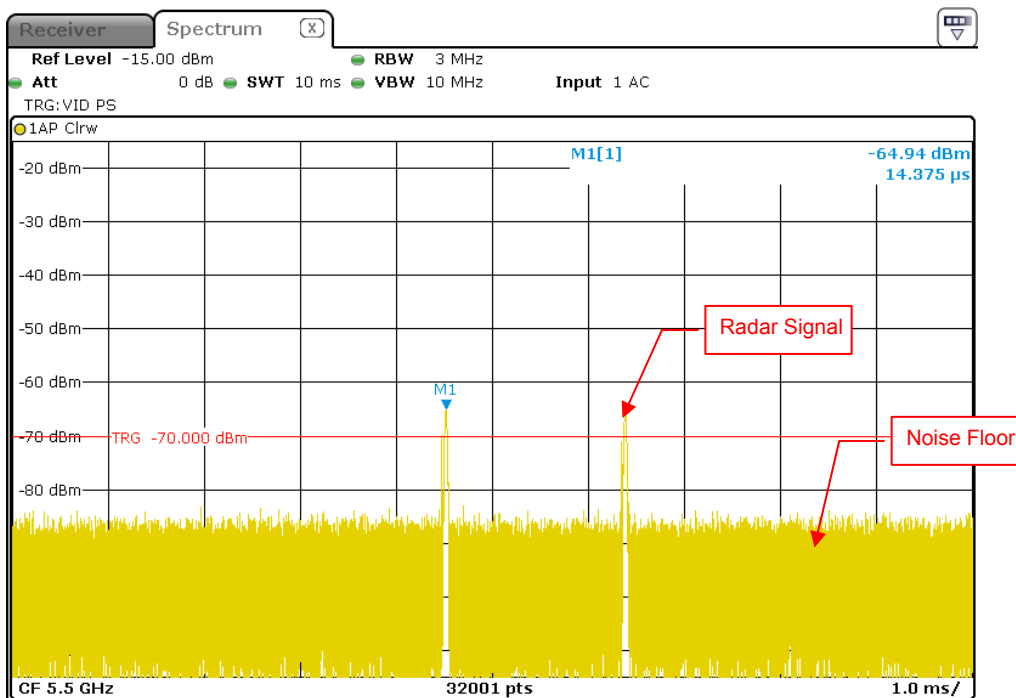

Single Burst of Radar Signal 5

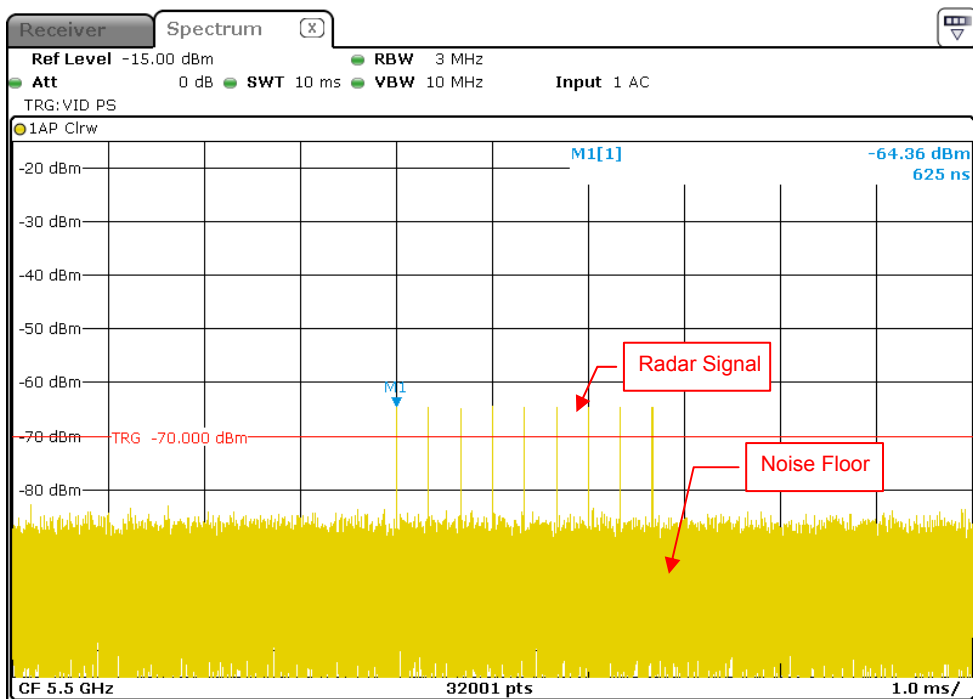

Radar Signal 6

6.2.2 U-NII Detection Bandwidth

IEEE 802.11ac VHT20

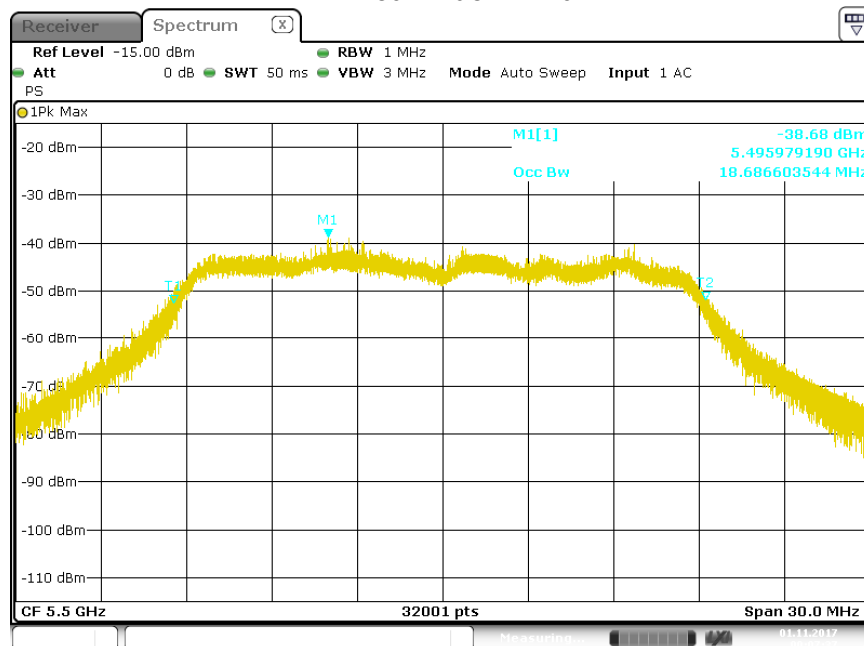

U-NII 99% Channel bandwidth

IEEE 802.11ac VHT40

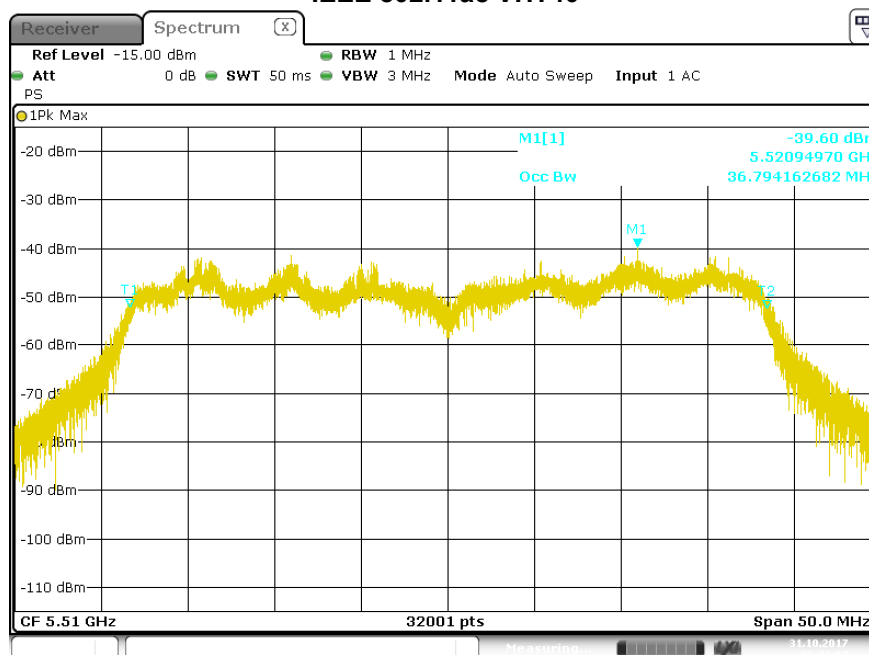

U-NII 99% Channel bandwidth

IEEE 802.11ac VHT80

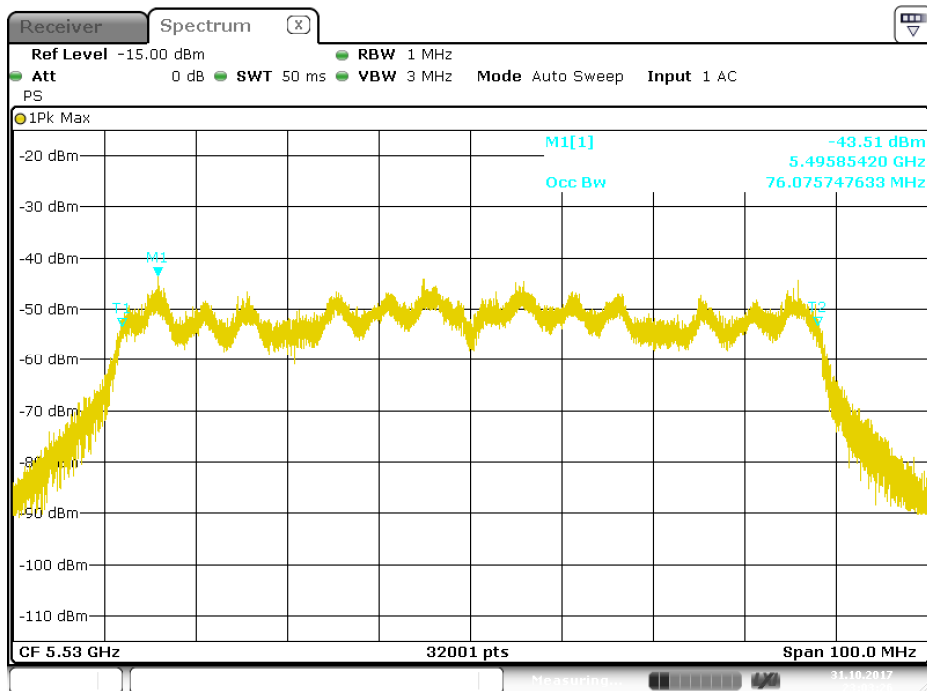

U-NII 99% Channel bandwidth

Detection Bandwidth Test - IEEE 802.11ac VHT20

Radar Type 0

EUT Frequency: 5500MHz

EUT 99% Power bandwidth: 18.68MHz

Detection bandwidth limit (100% of EUT 99% Power bandwidth): 18.68MHz

Detection bandwidth (5510(FH) – 5490(FL)) : 20MHz

Test Result : PASS

Radar Frequency (MHz)	Trial Number / Detection										Detection Rate (%)
	1	2	3	4	5	6	7	8	9	10	
5489	N	N	N	N	N	N	N	N	N	N	0
5490(FL)	Y	Y	Y	Y	Y	Y	Y	Y	Y	Y	100
5491	Y	Y	Y	Y	Y	Y	Y	Y	Y	Y	100
5492	Y	Y	Y	Y	Y	Y	Y	Y	Y	Y	100
5493	Y	Y	Y	Y	Y	Y	Y	Y	Y	Y	100
5494	Y	Y	Y	Y	Y	Y	Y	Y	Y	Y	100
5495	Y	Y	Y	Y	Y	Y	Y	Y	Y	Y	100
5496	Y	Y	Y	Y	Y	Y	Y	Y	Y	Y	100
5497	Y	Y	Y	Y	Y	Y	Y	Y	Y	Y	100
5498	Y	Y	Y	Y	Y	Y	Y	Y	Y	Y	100
5499	Y	Y	Y	Y	Y	Y	Y	Y	Y	Y	100
5500	Y	Y	Y	Y	Y	Y	Y	Y	Y	Y	100
5501	Y	Y	Y	Y	Y	Y	Y	Y	Y	Y	100
5502	Y	Y	Y	Y	Y	Y	Y	Y	Y	Y	100
5503	Y	Y	Y	Y	Y	Y	Y	Y	Y	Y	100
5504	Y	Y	Y	Y	Y	Y	Y	Y	Y	Y	100
5505	Y	Y	Y	Y	Y	Y	Y	Y	Y	Y	100
5506	Y	Y	Y	Y	Y	Y	Y	Y	Y	Y	100
5507	Y	Y	Y	Y	Y	Y	Y	Y	Y	Y	100
5508	Y	Y	Y	Y	Y	Y	Y	Y	Y	Y	100
5509	Y	Y	Y	Y	Y	Y	Y	Y	Y	Y	100
5510(FH)	Y	Y	Y	Y	Y	Y	Y	Y	Y	Y	100
5511	N	N	N	N	N	N	N	N	N	N	0

Detection Bandwidth Test - IEEE 802.11ac VHT40											
Radar Type 0											
EUT Frequency: 5510MHz											
EUT 99% Power bandwidth: 36.79 MHz											
Detection bandwidth limit (100% of EUT 99% Power bandwidth): 36.79 MHz											
Detection bandwidth (5530(FH) – 5490(FL)) : 40MHz											
Test Result : PASS											
Radar Frequency (MHz)	Trial Number / Detection										Detection Rate (%)
	1	2	3	4	5	6	7	8	9	10	
5489	N	N	N	N	N	N	N	N	N	N	0
5490(FL)	Y	Y	Y	Y	Y	Y	Y	Y	Y	Y	100
5491	Y	Y	Y	Y	Y	Y	Y	Y	Y	Y	100
5492	Y	Y	Y	Y	Y	Y	Y	Y	Y	Y	100
5493	Y	Y	Y	Y	Y	Y	Y	Y	Y	Y	100
5494	Y	Y	Y	Y	Y	Y	Y	Y	Y	Y	100
5495	Y	Y	Y	Y	Y	Y	Y	Y	Y	Y	100
5496	Y	Y	Y	Y	Y	Y	Y	Y	Y	Y	100
5497	Y	Y	Y	Y	Y	Y	Y	Y	Y	Y	100
5498	Y	Y	Y	Y	Y	Y	Y	Y	Y	Y	100
5499	Y	Y	Y	Y	Y	Y	Y	Y	Y	Y	100
5500	Y	Y	Y	Y	Y	Y	Y	Y	Y	Y	100
5501	Y	Y	Y	Y	Y	Y	Y	Y	Y	Y	100
5502	Y	Y	Y	Y	Y	Y	Y	Y	Y	Y	100
5503	Y	Y	Y	Y	Y	Y	Y	Y	Y	Y	100
5504	Y	Y	Y	Y	Y	Y	Y	Y	Y	Y	100
5505	Y	Y	Y	Y	Y	Y	Y	Y	Y	Y	100
5506	Y	Y	Y	Y	Y	Y	Y	Y	Y	Y	100
5507	Y	Y	Y	Y	Y	Y	Y	Y	Y	Y	100
5508	Y	Y	Y	Y	Y	Y	Y	Y	Y	Y	100
5509	Y	Y	Y	Y	Y	Y	Y	Y	Y	Y	100
5510	Y	Y	Y	Y	Y	Y	Y	Y	Y	Y	100
5511	Y	Y	Y	Y	Y	Y	Y	Y	Y	Y	100
5512	Y	Y	Y	Y	Y	Y	Y	Y	Y	Y	100
5513	Y	Y	Y	Y	Y	Y	Y	Y	Y	Y	100
5514	Y	Y	Y	Y	Y	Y	Y	Y	Y	Y	100
5515	Y	Y	Y	Y	Y	Y	Y	Y	Y	Y	100
5516	Y	Y	Y	Y	Y	Y	Y	Y	Y	Y	100
5517	Y	Y	Y	Y	Y	Y	Y	Y	Y	Y	100
5518	Y	Y	Y	Y	Y	Y	Y	Y	Y	Y	100
5519	Y	Y	Y	Y	Y	Y	Y	Y	Y	Y	100
5520	Y	Y	Y	Y	Y	Y	Y	Y	Y	Y	100
5521	Y	Y	Y	Y	Y	Y	Y	Y	Y	Y	100
5522	Y	Y	Y	Y	Y	Y	Y	Y	Y	Y	100
5523	Y	Y	Y	Y	Y	Y	Y	Y	Y	Y	100
5524	Y	Y	Y	Y	Y	Y	Y	Y	Y	Y	100
5525	Y	Y	Y	Y	Y	Y	Y	Y	Y	Y	100
5526	Y	Y	Y	Y	Y	Y	Y	Y	Y	Y	100
5527	Y	Y	Y	Y	Y	Y	Y	Y	Y	Y	100
5528	Y	Y	Y	Y	Y	Y	Y	Y	Y	Y	100
5529	Y	Y	Y	Y	Y	Y	Y	Y	Y	Y	100
5530(FH)	Y	Y	Y	Y	Y	Y	Y	Y	Y	Y	100
5531	N	N	N	N	N	N	N	N	N	N	0

Detection Bandwidth Test - IEEE 802.11ac VHT80											
Radar Type 0											
EUT Frequency: 5530MHz											
EUT 99% Power bandwidth: 76.07MHz											
Detection bandwidth limit (100% of EUT 99% Power bandwidth): 76.07MHz											
Detection bandwidth (5570(FH) – 5490(FL)) : 80MHz											
Test Result : PASS											
Radar Frequency (MHz)	Trial Number / Detection										Detection Rate (%)
	1	2	3	4	5	6	7	8	9	10	
5489	N	N	N	N	N	N	N	N	N	N	0
5490(FL)	Y	Y	Y	Y	Y	Y	Y	Y	Y	Y	100
5491	Y	Y	Y	Y	Y	Y	Y	Y	Y	Y	100
5492	Y	Y	Y	Y	Y	Y	Y	Y	Y	Y	100
5493	Y	Y	Y	Y	Y	Y	Y	Y	Y	Y	100
5494	Y	Y	Y	Y	Y	Y	Y	Y	Y	Y	100
5495	Y	Y	Y	Y	Y	Y	Y	Y	Y	Y	100
5496	Y	Y	Y	Y	Y	Y	Y	Y	Y	Y	100
5497	Y	Y	Y	Y	Y	Y	Y	Y	Y	Y	100
5498	Y	Y	Y	Y	Y	Y	Y	Y	Y	Y	100
5499	Y	Y	Y	Y	Y	Y	Y	Y	Y	Y	100
5500	Y	Y	Y	Y	Y	Y	Y	Y	Y	Y	100
5501	Y	Y	Y	Y	Y	Y	Y	Y	Y	Y	100
5502	Y	Y	Y	Y	Y	Y	Y	Y	Y	Y	100
5503	Y	Y	Y	Y	Y	Y	Y	Y	Y	Y	100
5504	Y	Y	Y	Y	Y	Y	Y	Y	Y	Y	100
5505	Y	Y	Y	Y	Y	Y	Y	Y	Y	Y	100
5506	Y	Y	Y	Y	Y	Y	Y	Y	Y	Y	100
5507	Y	Y	Y	Y	Y	Y	Y	Y	Y	Y	100
5508	Y	Y	Y	Y	Y	Y	Y	Y	Y	Y	100
5509	Y	Y	Y	Y	Y	Y	Y	Y	Y	Y	100
5510	Y	Y	Y	Y	Y	Y	Y	Y	Y	Y	100
5511	Y	Y	Y	Y	Y	Y	Y	Y	Y	Y	100
5512	Y	Y	Y	Y	Y	Y	Y	Y	Y	Y	100
5513	Y	Y	Y	Y	Y	Y	Y	Y	Y	Y	100
5514	Y	Y	Y	Y	Y	Y	Y	Y	Y	Y	100
5515	Y	Y	Y	Y	Y	Y	Y	Y	Y	Y	100
5516	Y	Y	Y	Y	Y	Y	Y	Y	Y	Y	100
5517	Y	Y	Y	Y	Y	Y	Y	Y	Y	Y	100
5518	Y	Y	Y	Y	Y	Y	Y	Y	Y	Y	100
5519	Y	Y	Y	Y	Y	Y	Y	Y	Y	Y	100
5520	Y	Y	Y	Y	Y	Y	Y	Y	Y	Y	100
5521	Y	Y	Y	Y	Y	Y	Y	Y	Y	Y	100
5522	Y	Y	Y	Y	Y	Y	Y	Y	Y	Y	100
5523	Y	Y	Y	Y	Y	Y	Y	Y	Y	Y	100
5524	Y	Y	Y	Y	Y	Y	Y	Y	Y	Y	100
5525	Y	Y	Y	Y	Y	Y	Y	Y	Y	Y	100
5526	Y	Y	Y	Y	Y	Y	Y	Y	Y	Y	100
5527	Y	Y	Y	Y	Y	Y	Y	Y	Y	Y	100
5528	Y	Y	Y	Y	Y	Y	Y	Y	Y	Y	100
5529	Y	Y	Y	Y	Y	Y	Y	Y	Y	Y	100
5530	Y	Y	Y	Y	Y	Y	Y	Y	Y	Y	100
5531	Y	Y	Y	Y	Y	Y	Y	Y	Y	Y	100
5532	Y	Y	Y	Y	Y	Y	Y	Y	Y	Y	100
5533	Y	Y	Y	Y	Y	Y	Y	Y	Y	Y	100

5534	Y	Y	Y	Y	Y	Y	Y	Y	Y	Y	100
5535	Y	Y	Y	Y	Y	Y	Y	Y	Y	Y	100
5536	Y	Y	Y	Y	Y	Y	Y	Y	Y	Y	100
5537	Y	Y	Y	Y	Y	Y	Y	Y	Y	Y	100
5538	Y	Y	Y	Y	Y	Y	Y	Y	Y	Y	100
5539	Y	Y	Y	Y	Y	Y	Y	Y	Y	Y	100
5540	Y	Y	Y	Y	Y	Y	Y	Y	Y	Y	100
5541	Y	Y	Y	Y	Y	Y	Y	Y	Y	Y	100
5542	Y	Y	Y	Y	Y	Y	Y	Y	Y	Y	100
5543	Y	Y	Y	Y	Y	Y	Y	Y	Y	Y	100
5544	Y	Y	Y	Y	Y	Y	Y	Y	Y	Y	100
5545	Y	Y	Y	Y	Y	Y	Y	Y	Y	Y	100
5546	Y	Y	Y	Y	Y	Y	Y	Y	Y	Y	100
5547	Y	Y	Y	Y	Y	Y	Y	Y	Y	Y	100
5548	Y	Y	Y	Y	Y	Y	Y	Y	Y	Y	100
5549	Y	Y	Y	Y	Y	Y	Y	Y	Y	Y	100
5550	Y	Y	Y	Y	Y	Y	Y	Y	Y	Y	100
5551	Y	Y	Y	Y	Y	Y	Y	Y	Y	Y	100
5552	Y	Y	Y	Y	Y	Y	Y	Y	Y	Y	100
5553	Y	Y	Y	Y	Y	Y	Y	Y	Y	Y	100
5554	Y	Y	Y	Y	Y	Y	Y	Y	Y	Y	100
5555	Y	Y	Y	Y	Y	Y	Y	Y	Y	Y	100
5556	Y	Y	Y	Y	Y	Y	Y	Y	Y	Y	100
5557	Y	Y	Y	Y	Y	Y	Y	Y	Y	Y	100
5558	Y	Y	Y	Y	Y	Y	Y	Y	Y	Y	100
5559	Y	Y	Y	Y	Y	Y	Y	Y	Y	Y	100
5560	Y	Y	Y	Y	Y	Y	Y	Y	Y	Y	100
5561	Y	Y	Y	Y	Y	Y	Y	Y	Y	Y	100
5562	Y	Y	Y	Y	Y	Y	Y	Y	Y	Y	100
5563	Y	Y	Y	Y	Y	Y	Y	Y	Y	Y	100
5564	Y	Y	Y	Y	Y	Y	Y	Y	Y	Y	100
5565	Y	Y	Y	Y	Y	Y	Y	Y	Y	Y	100
5566	Y	Y	Y	Y	Y	Y	Y	Y	Y	Y	100
5567	Y	Y	Y	Y	Y	Y	Y	Y	Y	Y	100
5568	Y	Y	Y	Y	Y	Y	Y	Y	Y	Y	100
5569	Y	Y	Y	Y	Y	Y	Y	Y	Y	Y	100
5570(FH)	Y	Y	Y	Y	Y	Y	Y	Y	Y	Y	100
5571	N	N	N	N	N	N	N	N	N	N	0

6.2.3 Channel Availability Check Time

If the EUT successfully detected the radar burst, it should be observed as the EUT has no transmissions occurred until the EUT starts transmitting on another channel.

Timing of Radar Signal	Observation	
	EUT	Spectrum Analyzer
Within 1 to 6 second	Detected	No transmissions
Within 54 to 60 second	Detected	No transmissions

Initial Channel Availability Check Time

Channel Availability Check

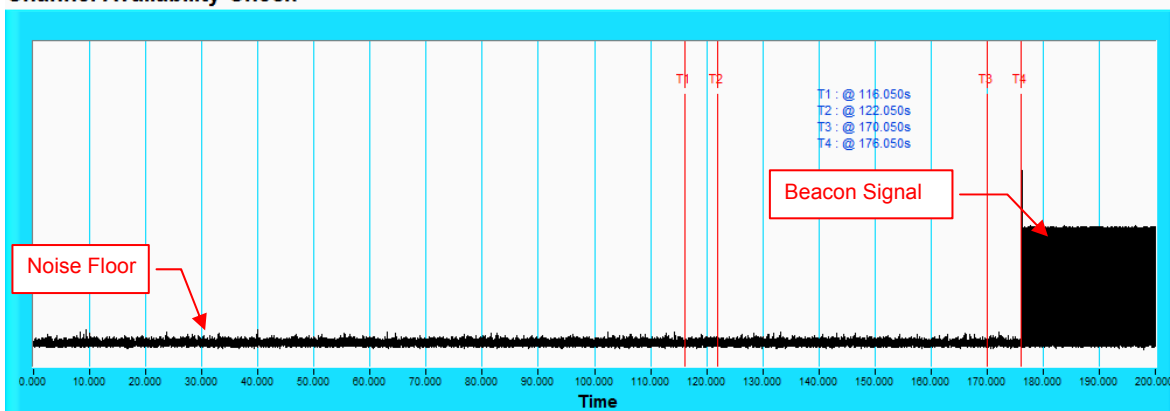

NOTE: T1 denotes the end of power-up time period is 116.05 second. T4 denotes the end of Channel Availability Check time is 176.05 second. Channel Availability Check time is equal to (T4 – T1) 60 seconds.

Radar Burst at the Beginning of the Channel Availability Check Time

Channel Availability Check

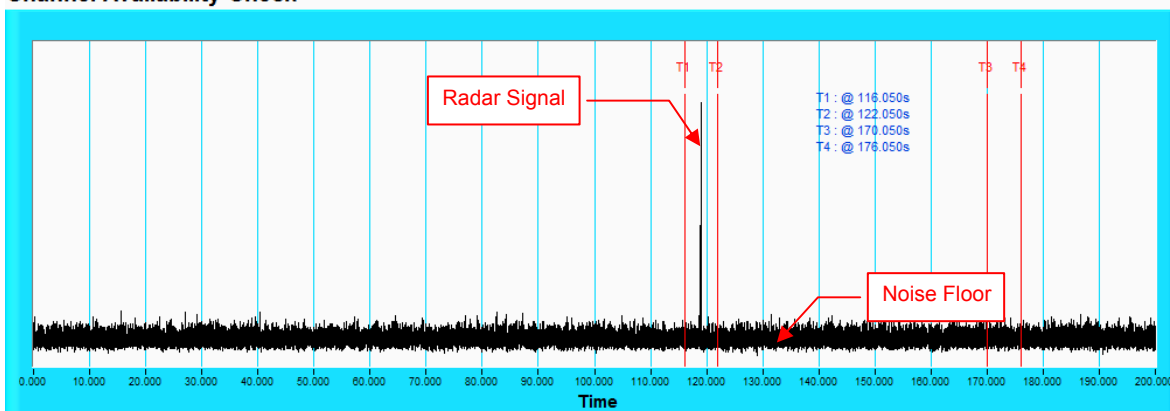

NOTE: T1 denotes the end of power up time period is 116.05 second. T2 denotes 122.05 second, the radar burst was commenced within a 6 second window starting from the end of power-up sequence. T4 denotes the 176.05 second.

Radar Burst at the End of the Channel Availability Check Time Channel Availability Check

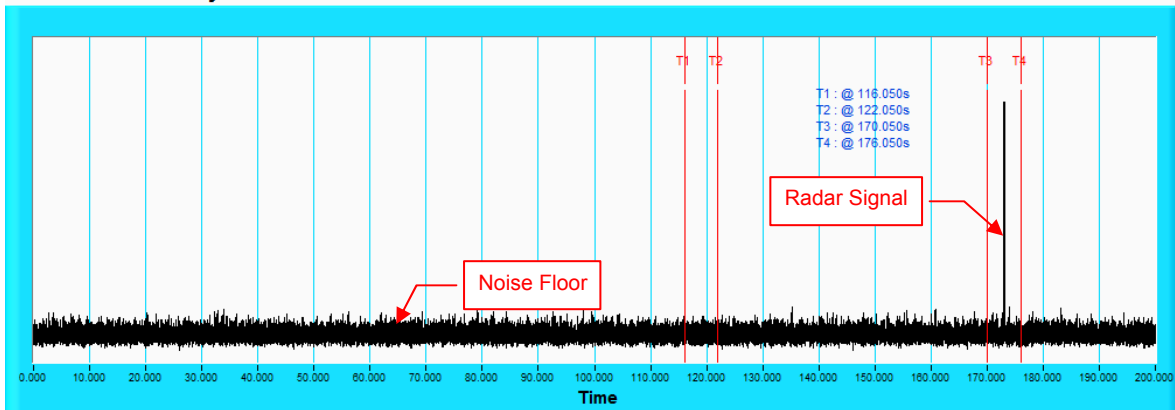

NOTE: T1 denotes the end of power up time period is 116.05 second. T3 denotes 170.05 second and radar burst was commenced within 54th second to 60th second window starting from the end of power-up sequence. T4 denotes the 176.05 second.

6.2.4 Channel Closing Transmission and Channel Move Time

Wireless Traffic Loading IEEE 802.11ac VHT20 Duty Cycle

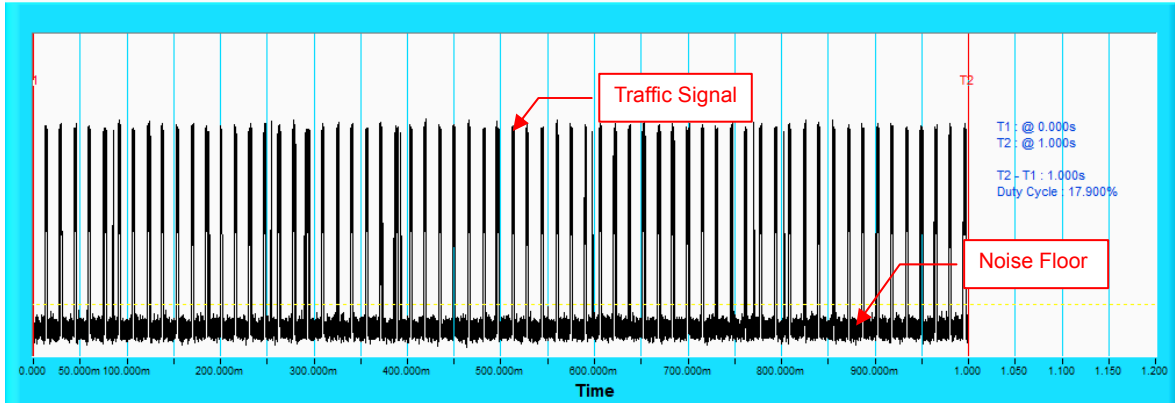

IEEE 802.11ac VHT40 Duty Cycle

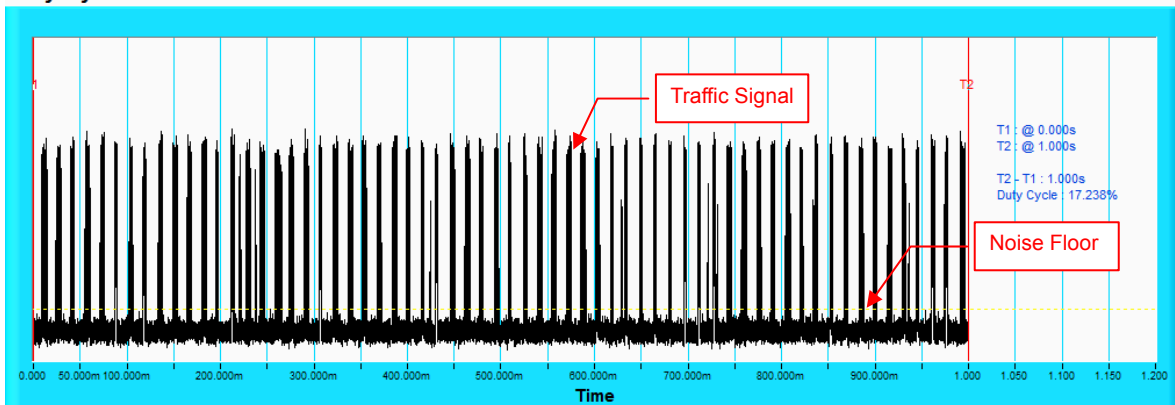

IEEE 802.11ac VHT80 Duty Cycle

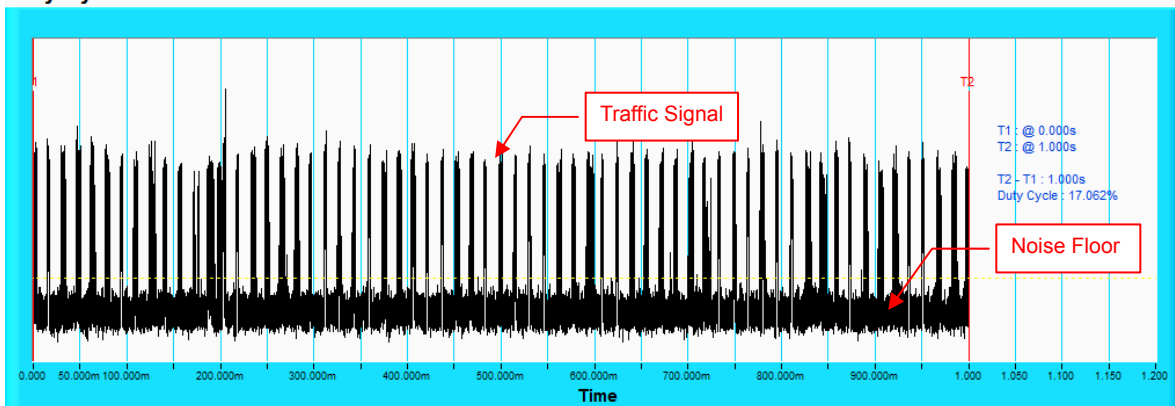

Radar signal 0

IEEE 802.11ac VHT80

Channel Closing Transmission Time & Channel Move Time

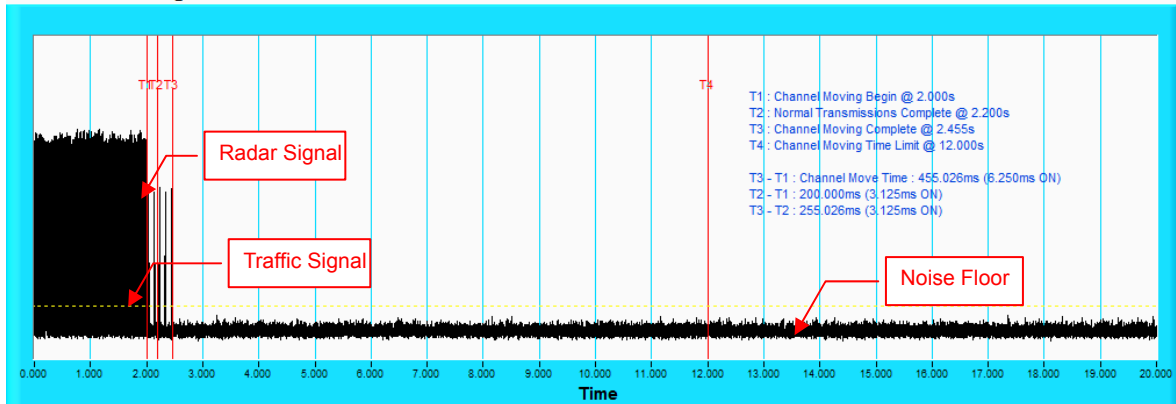

NOTE: T1 denotes the start of Channel Move Time upon the end of the last Radar burst. T2 denotes the data transmission time of 200ms from T1. T3 denotes the end of Channel Move Time. T4 denotes the 10 second from T1 to observe the aggregate duration of transmissions.

Channel Closing Transmission Time & Channel Move Time

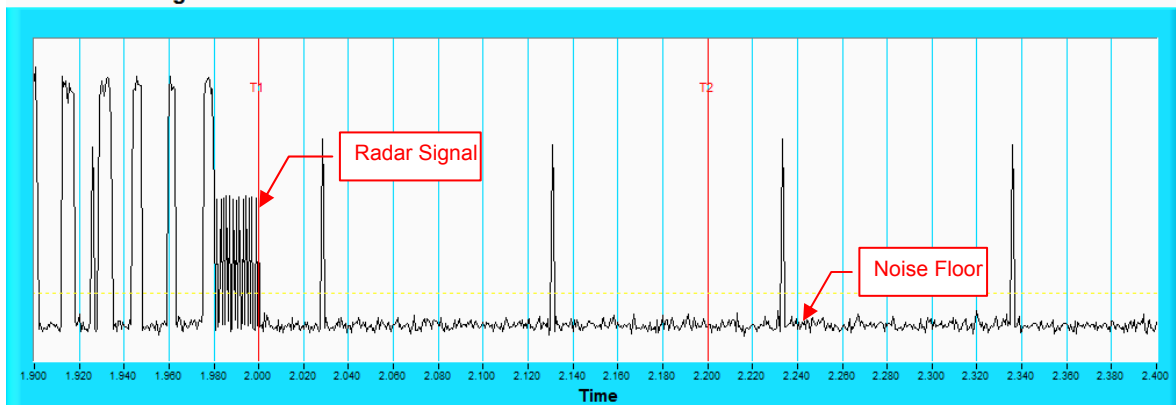

NOTE: Zoom-in of the first 500ms after radar signal applied.

Radar signal 1

IEEE 802.11ac VHT80

Channel Closing Transmission Time & Channel Move Time

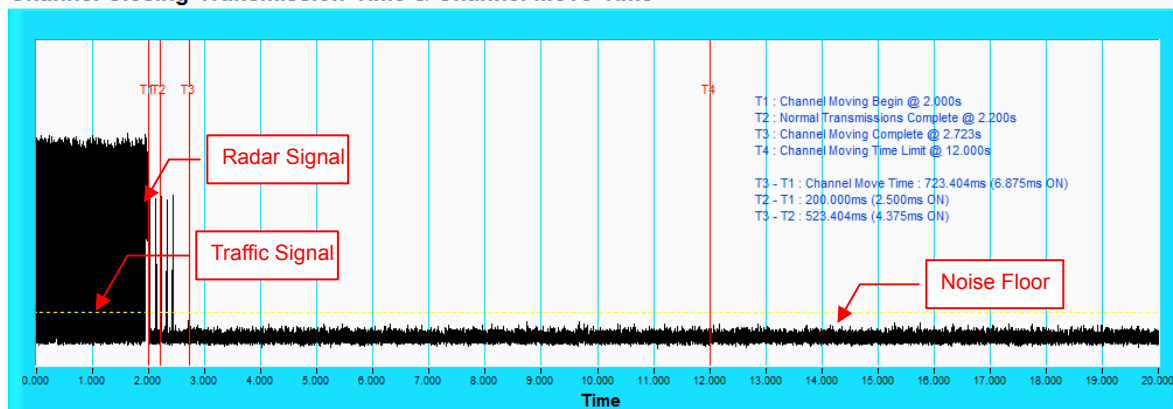

NOTE: T1 denotes the start of Channel Move Time upon the end of the last Radar burst. T2 denotes the data transmission time of 200ms from T1. T3 denotes the end of Channel Move Time. T4 denotes the 10 second from T1 to observe the aggregate duration of transmissions.

Channel Closing Transmission Time & Channel Move Time

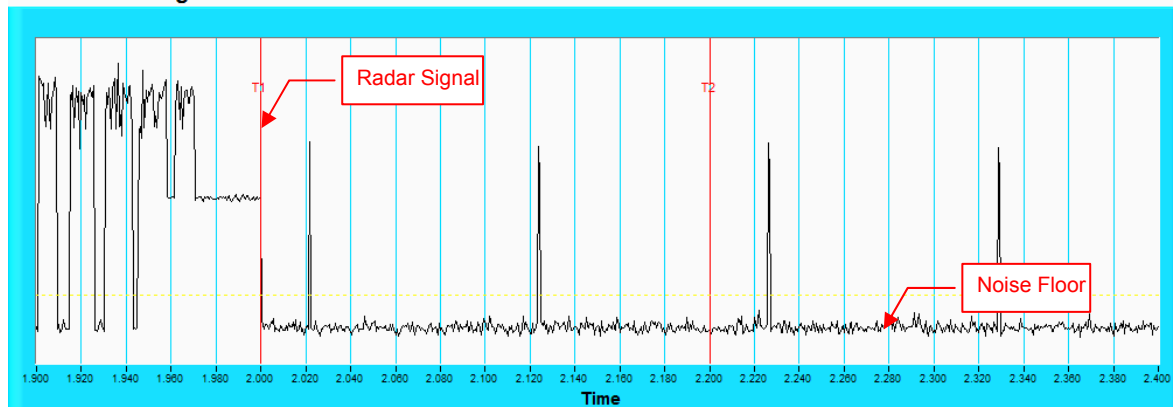

NOTE: Zoom-in of the first 500ms after radar signal applied.

Radar signal 2

IEEE 802.11ac VHT80

Channel Closing Transmission Time & Channel Move Time

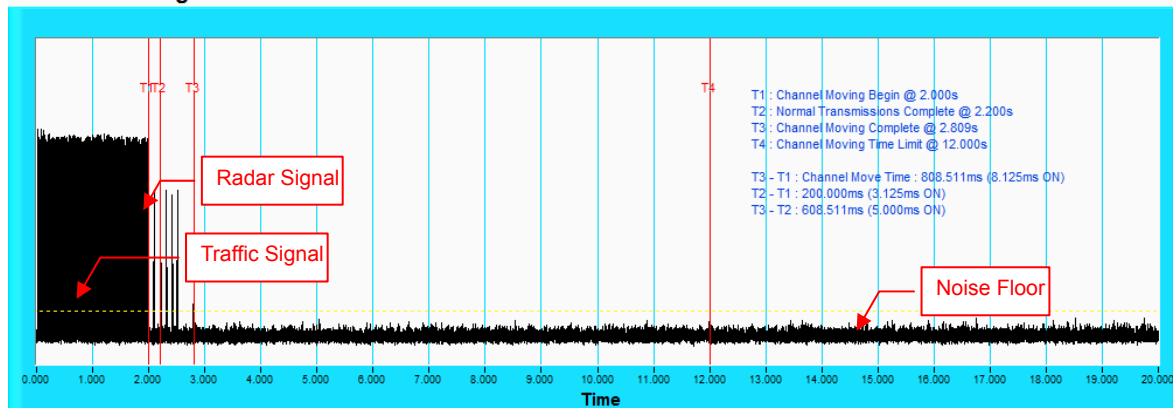

NOTE: T1 denotes the start of Channel Move Time upon the end of the last Radar burst. T2 denotes the data transmission time of 200ms from T1. T3 denotes the end of Channel Move Time. T4 denotes the 10 second from T1 to observe the aggregate duration of transmissions.

Channel Closing Transmission Time & Channel Move Time

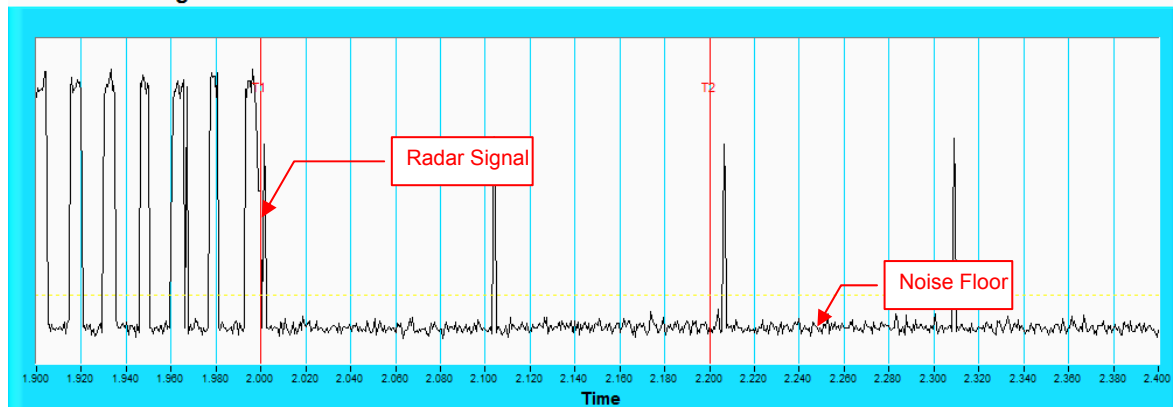

NOTE: Zoom-in of the first 500ms after radar signal applied.

Radar signal 3

IEEE 802.11ac VHT80

Channel Closing Transmission Time & Channel Move Time

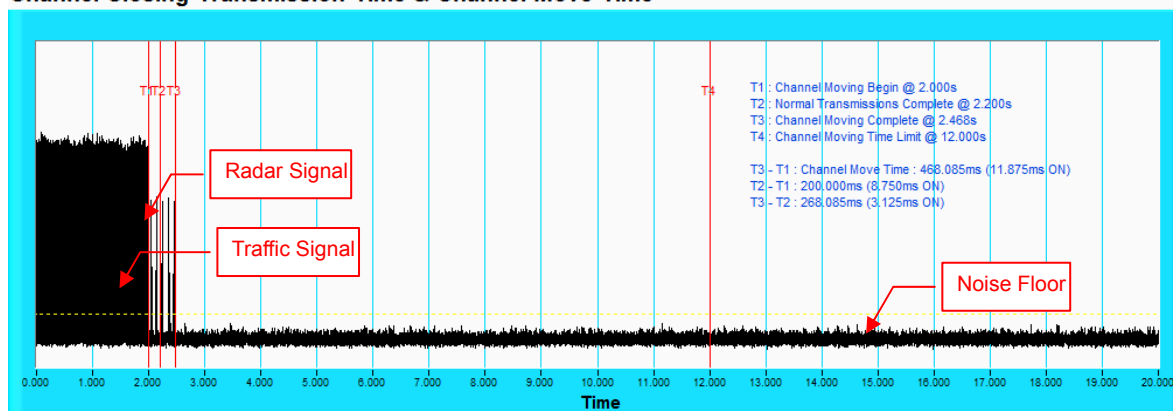

NOTE: T1 denotes the start of Channel Move Time upon the end of the last Radar burst. T2 denotes the data transmission time of 200ms from T1. T3 denotes the end of Channel Move Time. T4 denotes the 10 second from T1 to observe the aggregate duration of transmissions.

Channel Closing Transmission Time & Channel Move Time

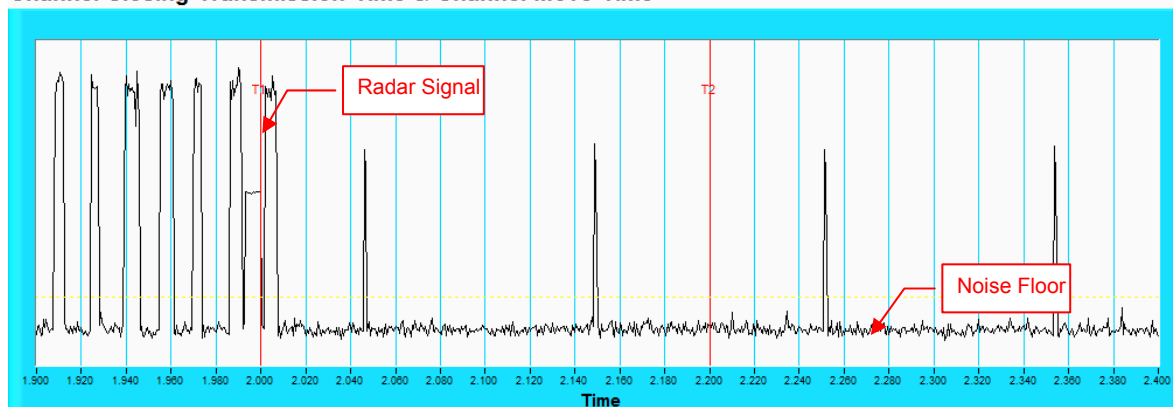

NOTE: Room-in of the first 500ms after radar signal applied.

Radar signal 4

IEEE 802.11ac VHT80

Channel Closing Transmission Time & Channel Move Time

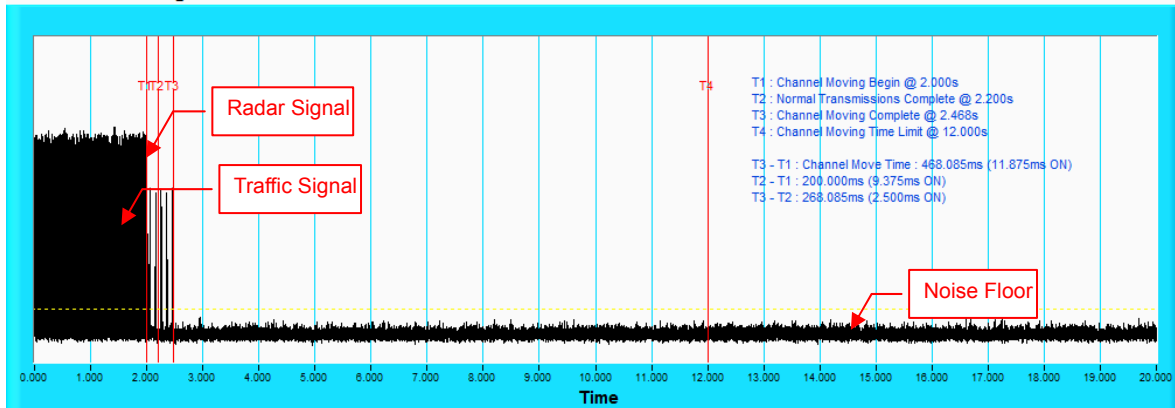

NOTE: T1 denotes the start of Channel Move Time upon the end of the last Radar burst. T2 denotes the data transmission time of 200ms from T1. T3 denotes the end of Channel Move Time. T4 denotes the 10 second from T1 to observe the aggregate duration of transmissions.

Channel Closing Transmission Time & Channel Move Time

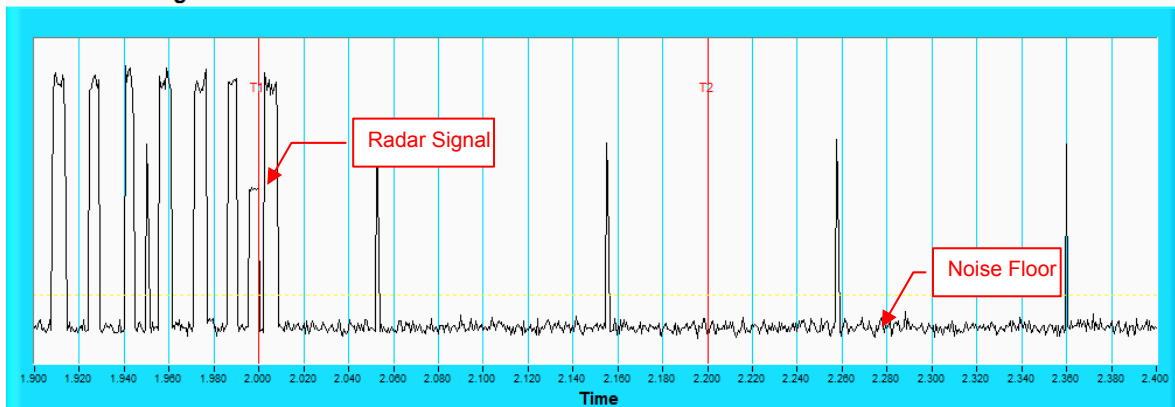

NOTE: Room-in of the first 500ms after radar signal applied.

IEEE 802.11ac VHT20

Table 1: Short Pulse Radar Test Waveforms.

Radar Type	Pulse Width (μsec)	PRI (μsec)	Number of Pulses	Number of Trials(Times)	Percentage of Successful Detection (%)
1	1	Test A: 15 unique PRI values randomly selected from the list of 23 PRI values in Table 5a	Roundup $\left\{ \begin{array}{l} \left(\frac{1}{360} \right) \cdot \\ \left(\frac{19 \cdot 10^6}{PRI_{\mu sec}} \right) \end{array} \right\}$	30	100
		Test B: 15 unique PRI values randomly selected within the range of 518-3066 μ sec, with a minimum increment of 1 μ sec, excluding PRI values selected in Test A			
2	1-5	150-230	23-29	30	76.67
3	6-10	200-500	16-18	30	86.67
4	11-20	200-500	12-16	30	80
Aggregate (Radar Types 1-4)				120	85.83

Table 2: Long Pulse Radar Test Waveform

Radar Type	Pulse Width (μsec)	Chirp Width (MHz)	PRI (μsec)	Number of Pulses per Burst	Number of Bursts	Number of Trials(Times)	Percentage of Successful Detection (%)
5	50-100	5-20	1000-2000	1-3	8-20	30	83.33

Table 3: Frequency Hopping Radar Test Waveform

Radar Type	Pulse Width (μsec)	PRI (μsec)	Pulses per Hop	Hopping Rate (kHz)	Hopping Sequence Length (msec)	Number of Trials(Times)	Percentage of Successful Detection (%)
6	1	333	9	0.333	300	30	100

The Detailed Radar pattern and Statistical Performance showed in Annex A.

IEEE 802.11ac VHT40

Table 1: Short Pulse Radar Test Waveforms.

Radar Type	Pulse Width (μsec)	PRI (μsec)	Number of Pulses	Number of Trials(Times)	Percentage of Successful Detection (%)
1	1	Test A: 15 unique PRI values randomly selected from the list of 23 PRI values in Table 5a	Roundup $\left\{ \begin{array}{l} \left(\frac{1}{360} \right) \cdot \\ \left(\frac{19 \cdot 10^6}{PRI_{\mu sec}} \right) \end{array} \right\}$	30	96.67
		Test B: 15 unique PRI values randomly selected within the range of 518-3066 μ sec, with a minimum increment of 1 μ sec, excluding PRI values selected in Test A			
2	1-5	150-230	23-29	30	90
3	6-10	200-500	16-18	30	90
4	11-20	200-500	12-16	30	80
Aggregate (Radar Types 1-4)				120	89.17

Table 2: Long Pulse Radar Test Waveform

Radar Type	Pulse Width (μsec)	Chirp Width (MHz)	PRI (μsec)	Number of Pulses per Burst	Number of Bursts	Number of Trials(Times)	Percentage of Successful Detection (%)
5	50-100	5-20	1000-2000	1-3	8-20	30	100

Table 3: Frequency Hopping Radar Test Waveform

Radar Type	Pulse Width (μsec)	PRI (μsec)	Pulses per Hop	Hopping Rate (kHz)	Hopping Sequence Length (msec)	Number of Trials(Times)	Percentage of Successful Detection (%)
6	1	333	9	0.333	300	30	100

The Detailed Radar pattern and Statistical Performance showed in Annex A.

IEEE 802.11ac VHT80

Table 1: Short Pulse Radar Test Waveforms.

Radar Type	Pulse Width (μsec)	PRI (μsec)	Number of Pulses	Number of Trials(Times)	Percentage of Successful Detection (%)
1	1	Test A: 15 unique PRI values randomly selected from the list of 23 PRI values in Table 5a	Roundup $\left\{ \begin{array}{l} \left(\frac{1}{360} \right) \cdot \\ \left(\frac{19 \cdot 10^6}{PRI_{\mu sec}} \right) \end{array} \right\}$	30	100
		Test B: 15 unique PRI values randomly selected within the range of 518-3066 μ sec, with a minimum increment of 1 μ sec, excluding PRI values selected in Test A			
2	1-5	150-230	23-29	30	83.33
3	6-10	200-500	16-18	30	90
4	11-20	200-500	12-16	30	83.33
Aggregate (Radar Types 1-4)				120	89.17

Table 2: Long Pulse Radar Test Waveform

Radar Type	Pulse Width (μsec)	Chirp Width (MHz)	PRI (μsec)	Number of Pulses per Burst	Number of Bursts	Number of Trials(Times)	Percentage of Successful Detection (%)
5	50-100	5-20	1000-2000	1-3	8-20	30	100

Table 3: Frequency Hopping Radar Test Waveform

Radar Type	Pulse Width (μsec)	PRI (μsec)	Pulses per Hop	Hopping Rate (kHz)	Hopping Sequence Length (msec)	Number of Trials(Times)	Percentage of Successful Detection (%)
6	1	333	9	0.333	300	30	100

The Detailed Radar pattern and Statistical Performance showed in Annex A.

6.2.5 Non-Occupancy Period

Associate test:

During the 30 minutes observation time, UUT did not make any transmissions on a channel after a radar signal was detected on that channel by either the Channel Availability Check or the In-Service Monitoring.

- 1) Client links with master on 5300MHz.

Waveform of EUT links up with Master

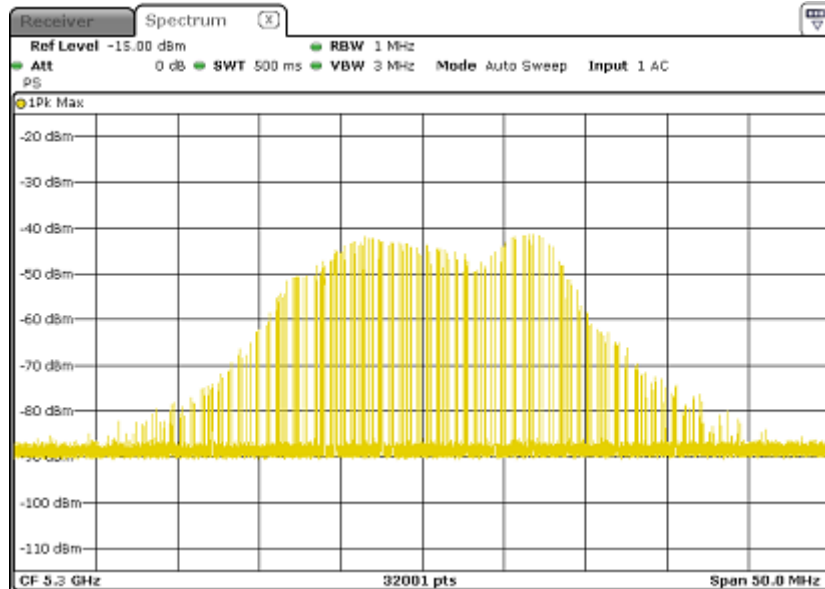

- 2) Client plays specified files via master.

Waveform of transmission

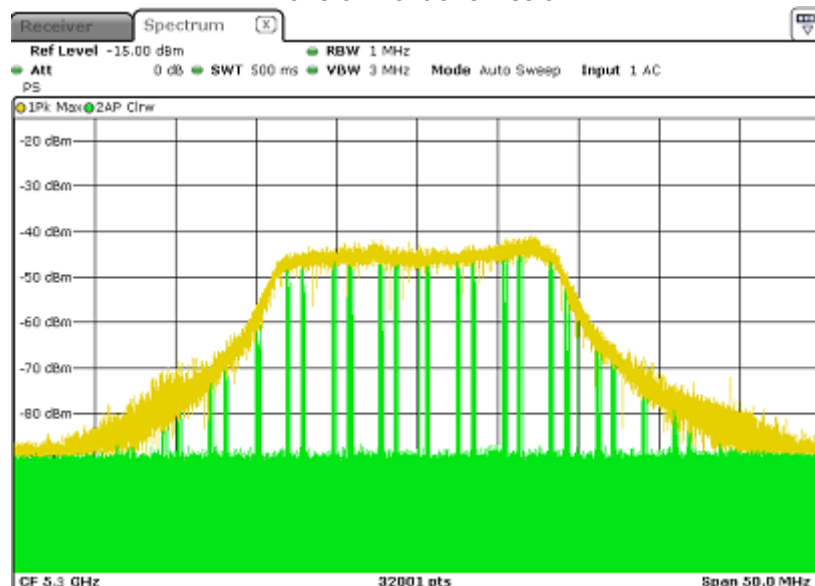

3) Radar signal is applied to the Master device and WiFi traffic signal stop immediately.

Radar 0

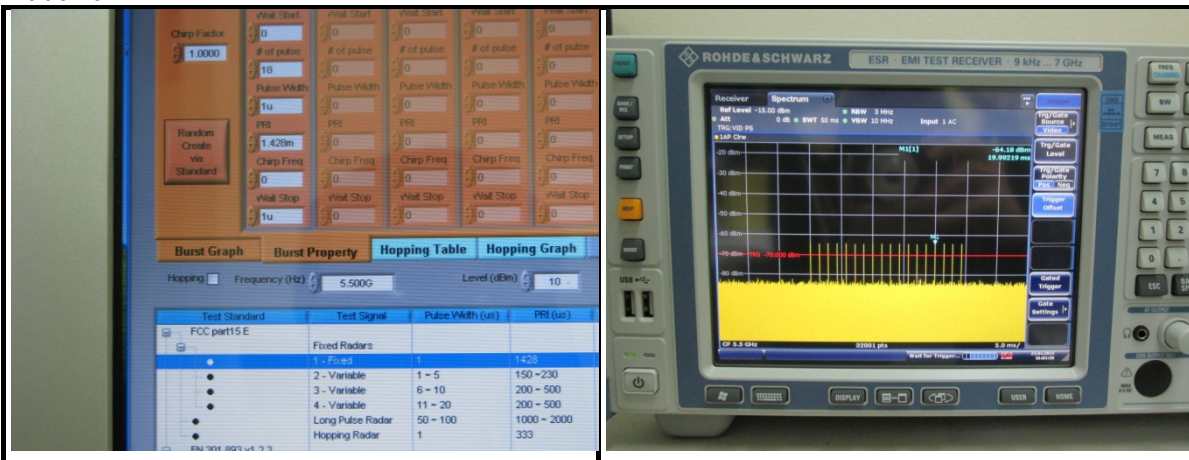

Radar 1

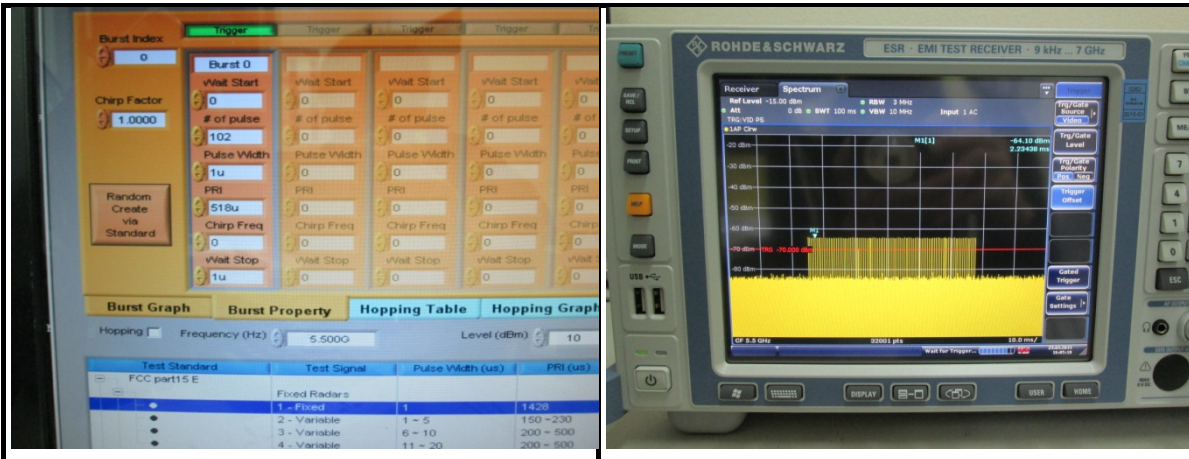

Radar 2



Radar 3

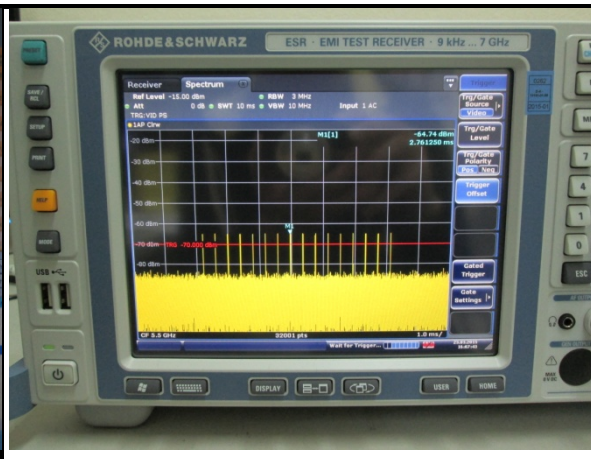

Radar 4

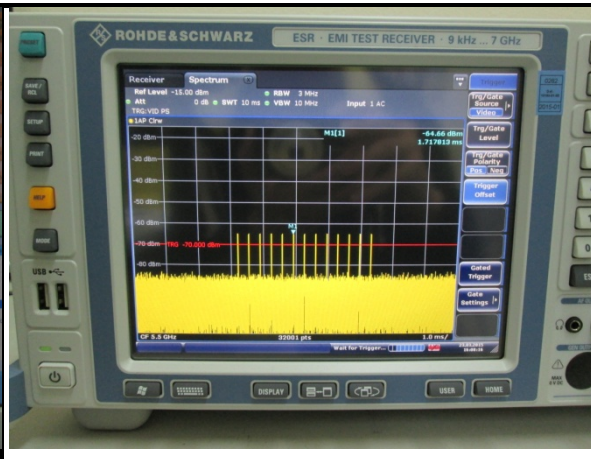
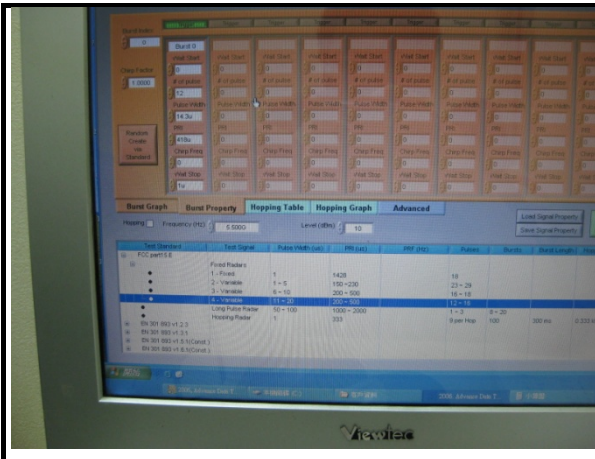

Radar 5

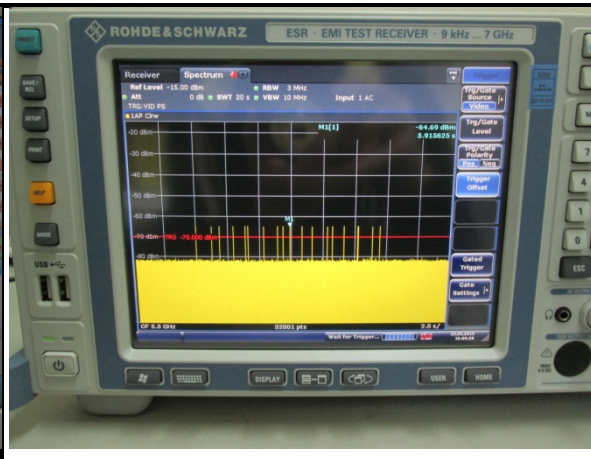
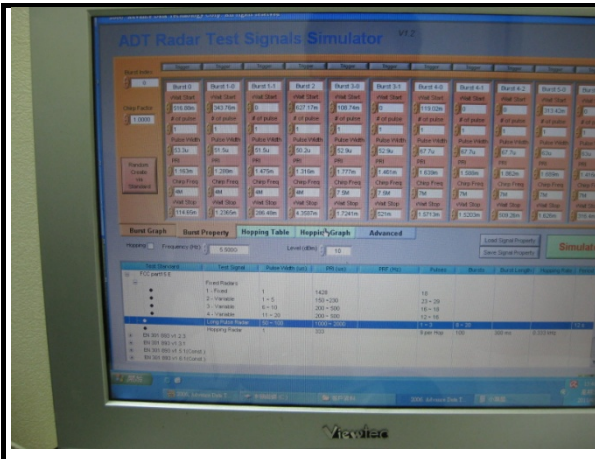

Radar 6



4) 5510MHz has been monitored in 30 minutes period. In this period, no any transmission occurs.

Plot of 30minutes period

802.11an HT20

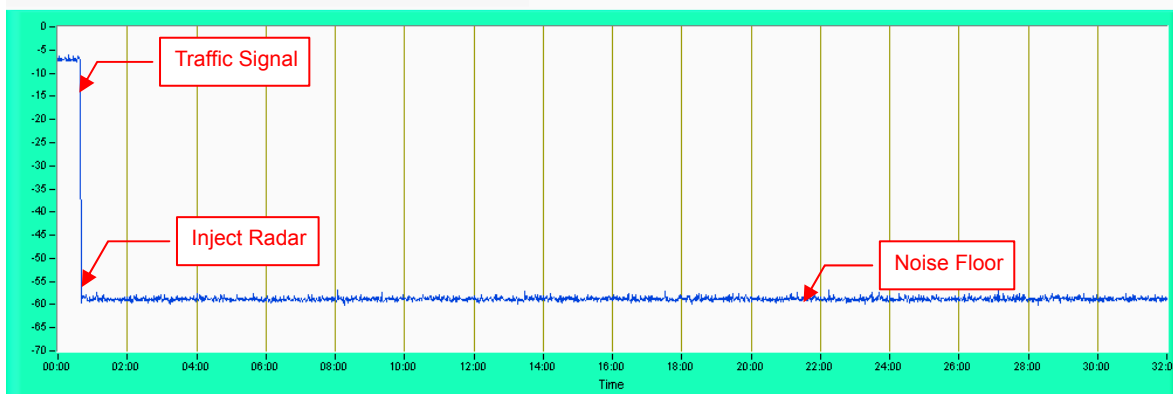

NOTE: Test setup are shown on Test setup photo.pdf

6.2.6 Uniform Spreading

The intention of the uniform spreading is to provide, on aggregate, a uniform loading of the spectrum. The EUT randomly select next output channel without any bias or fixed pattern, so that all channels in DFS bands (5150 MHz to 5725 MHz) will be used equally.

6.2.7 Transmit power control (TPC)

TPC	E.I.R.P	FCC 15.407(h)(1)
√	> 500mW	The TPC mechanism is required for system with an E.I.R.P. of above 500mW
	< 500mW	The TPC mechanism is not required for system with an E.I.R.P. of less 500mW

7. Information on the Testing Laboratories

We, Bureau Veritas Consumer Products Services (H.K.) Ltd., Taoyuan Branch, were founded in 1988 to provide our best service in EMC, Radio, Telecom and Safety consultation. Our laboratories are accredited and approved according to ISO/IEC 17025.

If you have any comments, please feel free to contact us at the following:

Linko EMC/RF Lab
Tel: 886-2-26052180
Fax: 886-2-26051924

Hsin Chu EMC/RF/Telecom Lab
Tel: 886-3-6668565
Fax: 886-3-6668323

Hwa Ya EMC/RF/Safety Lab:
Tel: 886-3-3183232
Fax: 886-3-3270892

Email: service.adt@tw.bureauveritas.com

Web Site: www.bureauveritas-adt.com

The address and road map of all our labs can be found in our web site also.

--- END ---

Annex-A

Annex A.1: The Detailed Radar pattern and Statistical Performance

IEEE 802.11ac VHT20

Type 1 Radar Statistical Performances						
Trial #	Pulse Repetition Frequency Number (1 to 23)	PRF (Pulse per seconds)	Pulses per Burst	PRI (s)	Radar Frequency (MHz)	Detection
1	22	1066.1	57	938u	5506	Yes
2	10	1432.7	76	698u	5495	Yes
3	6	1618.1	86	618u	5505	Yes
4	2	1858.7	99	538u	5501	Yes
5	19	1139.0	61	878u	5491	Yes
6	23	326.2	18	3.066m	5499	Yes
7	7	1567.4	83	638u	5508	Yes
8	21	1089.3	58	918u	5504	Yes
9	17	1193.3	63	838u	5494	Yes
10	18	1165.5	62	858u	5500	Yes
11	15	1253.1	67	798u	5507	Yes
12	11	1392.8	74	718u	5498	Yes
13	4	1730.1	92	578u	5492	Yes
14	5	1672.2	89	598u	5493	Yes
15	3	1792.1	95	558u	5496	Yes
16		394.3	21	2.536m	5497	Yes
17		1035.2	55	966u	5503	Yes
18		1209.2	64	827u	5509	Yes
19		399.8	22	2.501m	5502	Yes
20		385.4	21	2.595m	5507	Yes
21		897.7	48	1.114m	5502	Yes
22		768.0	41	1.302m	5496	Yes
23		328.4	18	3.045m	5501	Yes
24		615.8	33	1.624m	5505	Yes
25		347.5	19	2.878m	5492	Yes
26		973.7	52	1.027m	5500	Yes
27		402.4	22	2.485m	5494	Yes
28		625.0	33	1.600m	5493	Yes
29		853.2	46	1.172m	5498	Yes
30		849.6	45	1.177m	5509	Yes
Detection Rate: 100.0 %						

Type 2 Radar Statistical Performances					
Trial #	Pulses per Burst	Pulse Width (s)	PRI (s)	Radar Frequency (MHz)	Detection
1	26	3.2u	179u	5492	No
2	23	1.1u	207u	5493	Yes
3	24	2.1u	230u	5500	Yes
4	29	4.8u	200u	5496	No
5	28	3.9u	214u	5495	No
6	26	2.9u	222u	5491	Yes
7	26	3.2u	204u	5501	Yes
8	25	2.5u	192u	5498	Yes
9	26	3.1u	164u	5499	Yes
10	23	1.2u	156u	5494	No
11	27	3.9u	210u	5505	Yes
12	29	4.6u	201u	5504	Yes
13	26	3.2u	162u	5503	Yes
14	25	2.2u	197u	5497	Yes
15	29	4.5u	163u	5502	Yes
16	26	3u	203u	5506	Yes
17	29	5u	168u	5507	Yes
18	25	2.4u	217u	5508	Yes
19	26	2.9u	191u	5509	Yes
20	25	2.3u	166u	5499	Yes
21	27	3.7u	150u	5508	No
22	25	2.2u	176u	5504	Yes
23	29	4.9u	195u	5509	Yes
24	26	2.9u	202u	5495	Yes
25	25	2.5u	178u	5502	No
26	23	1.1u	206u	5497	Yes
27	27	3.8u	155u	5500	Yes
28	29	4.7u	157u	5494	Yes
29	25	2.4u	224u	5507	No
30	28	4.2u	159u	5491	Yes
					Detection Rate: 76.67 %

Type 3 Radar Statistical Performances					
Trial #	Pulses per Burst	Pulse Width (s)	PRI (s)	Radar Frequency (MHz)	Detection
1	17	8.2u	355u	5504	No
2	16	6.1u	487u	5494	Yes
3	16	7.1u	344u	5498	Yes
4	18	9.8u	288u	5492	Yes
5	18	8.9u	230u	5495	Yes
6	17	7.9u	432u	5493	Yes
7	17	8.2u	207u	5503	Yes
8	17	7.5u	443u	5497	Yes
9	17	8.1u	439u	5507	Yes
10	16	6.2u	223u	5509	Yes
11	18	8.9u	208u	5501	No
12	18	9.6u	463u	5491	Yes
13	17	8.2u	441u	5496	Yes
14	16	7.2u	323u	5508	No
15	18	9.5u	297u	5506	Yes
16	17	8u	412u	5502	Yes
17	18	10u	324u	5500	Yes
18	17	7.4u	271u	5505	Yes
19	17	7.9u	349u	5499	Yes
20	16	7.3u	409u	5506	Yes
21	18	8.7u	373u	5494	Yes
22	16	7.2u	254u	5501	Yes
23	18	9.9u	274u	5503	Yes
24	17	7.9u	278u	5493	Yes
25	17	7.5u	317u	5499	Yes
26	16	6.1u	260u	5505	Yes
27	18	8.8u	211u	5491	Yes
28	18	9.7u	272u	5509	Yes
29	17	7.4u	264u	5504	No
30	18	9.2u	284u	5492	Yes
					Detection Rate: 86.67 %

Type 4 Radar Statistical Performances					
Trial #	Pulses per Burst	Pulse Width (s)	PRI (s)	Radar Frequency (MHz)	Detection
1	14	16u	355u	5501	Yes
2	12	11.3u	487u	5497	Yes
3	13	13.5u	344u	5493	No
4	16	19.4u	288u	5494	Yes
5	15	17.5u	230u	5495	Yes
6	14	15.3u	432u	5504	Yes
7	14	15.9u	207u	5491	Yes
8	13	14.3u	443u	5508	Yes
9	14	15.8u	439u	5498	Yes
10	12	11.5u	223u	5500	No
11	15	17.4u	208u	5502	Yes
12	16	19u	463u	5492	No
13	14	16u	441u	5499	No
14	13	13.8u	323u	5496	Yes
15	16	18.9u	297u	5503	Yes
16	14	15.5u	412u	5506	Yes
17	16	19.9u	324u	5507	Yes
18	13	14.1u	271u	5505	Yes
19	14	15.2u	349u	5509	Yes
20	13	13.8u	409u	5507	Yes
21	15	17.1u	373u	5509	Yes
22	13	13.8u	254u	5503	Yes
23	16	19.8u	274u	5501	Yes
24	14	15.3u	278u	5495	Yes
25	13	14.5u	317u	5496	Yes
26	12	11.3u	260u	5491	No
27	15	17.3u	211u	5492	No
28	16	19.2u	272u	5506	Yes
29	13	14.2u	264u	5493	Yes
30	15	18.2u	284u	5494	Yes
					Detection Rate: 80 %

Type 5 Radar Statistical Performances		
Trial #	Test Signal Name	Detection
1	LP_Signal_01	Yes
2	LP_Signal_02	No
3	LP_Signal_03	Yes
4	LP_Signal_04	Yes
5	LP_Signal_05	Yes
6	LP_Signal_06	No
7	LP_Signal_07	Yes
8	LP_Signal_08	No
9	LP_Signal_09	No
10	LP_Signal_10	No
11	LP_Signal_11	Yes
12	LP_Signal_12	Yes
13	LP_Signal_13	Yes
14	LP_Signal_14	Yes
15	LP_Signal_15	Yes
16	LP_Signal_16	Yes
17	LP_Signal_17	Yes
18	LP_Signal_18	Yes
19	LP_Signal_19	Yes
20	LP_Signal_20	Yes
21	LP_Signal_21	Yes
22	LP_Signal_22	Yes
23	LP_Signal_23	Yes
24	LP_Signal_24	Yes
25	LP_Signal_25	Yes
26	LP_Signal_26	Yes
27	LP_Signal_27	Yes
28	LP_Signal_28	Yes
29	LP_Signal_29	Yes
30	LP_Signal_30	Yes
		Detection Rate: 83.3 %

Long Pulse Radar Test Signal						
Test Signal Name: LP_Signal_01						
Number of Bursts in Trial: 19						
Chrip Center Frequency: 5493MHz						
Burst	Pulses per Burst	Chrip (Hz)	Pulse Width (s)	Pulse 1 to 2 Spacing (s)	Pulse 2 to 3 Spacing (s)	Start Location (s)
1	2	5M	50.4u	1.916m	-	334.6m
2	2	5M	54.2u	1.760m	-	40.17m
3	2	5M	66.7u	1.591m	-	375.0m
4	1	5M	81.8u	-	-	224.8m
5	3	5M	85.3u	1.562m	1.550m	598.5m
6	2	5M	50.9u	1.097m	-	247.8m
7	3	5M	71.5u	1.403m	1.250m	384.9m
8	1	5M	57.3u	-	-	545.1m
9	1	5M	99.4u	-	-	327.7m
10	2	5M	81.7u	1.762m	-	346.5m
11	3	5M	87.0u	1.625m	1.683m	237.2m
12	2	5M	94.9u	1.522m	-	585.4m
13	2	5M	83.5u	1.529m	-	480.1m
14	2	5M	66.1u	1.677m	-	545.9m
15	2	5M	52.9u	1.709m	-	563.8m
16	3	5M	51.5u	1.865m	1.887m	433.2m
17	1	5M	82.8u	-	-	4.846m
18	2	5M	84.6u	957.4u	-	397.1m
19	3	5M	70.6u	1.247m	1.791m	432.2m

Long Pulse Radar Test Signal						
Test Signal Name: LP_Signal_02						
Number of Bursts in Trial: 19						
Chrip Center Frequency: 5493MHz						
Burst	Pulses per Burst	Chrip (Hz)	Pulse Width (s)	Pulse 1 to 2 Spacing (s)	Pulse 2 to 3 Spacing (s)	Start Location (s)
1	3	5M	61.2u	1.793m	1.857m	398.8m
2	1	5M	53.7u	-	-	300.3m
3	2	5M	82.7u	1.900m	-	154.0m
4	3	5M	98.8u	1.369m	1.879m	7.212m
5	2	5M	54.9u	1.516m	-	475.2m

6	3	5M	57.2u	1.640m	1.396m	427.7m
7	2	5M	91.6u	1.507m	-	435.3m
8	2	5M	69.8u	1.897m	-	349.7m
9	2	5M	58.1u	1.668m	-	584.4m
10	2	5M	81.6u	1.380m	-	184.8m
11	2	5M	57.5u	1.242m	-	221.2m
12	3	5M	92.2u	1.227m	913.8u	353.3m
13	2	5M	81.9u	1.129m	-	486.4m
14	2	5M	66.9u	1.395m	-	235.5m
15	1	5M	67.9u	-	-	415.5m
16	3	5M	99.2u	1.884m	1.803m	462.9m
17	2	5M	71.2u	1.043m	-	214.2m
18	1	5M	70.9u	-	-	379.4m
19	2	5M	68.8u	1.209m	-	322.3m

Long Pulse Radar Test Signal						
Test Signal Name: LP_Signal_03						
Number of Bursts in Trial: 18						
Chrip Center Frequency: 5494MHz						
Burst	Pulses per Burst	Chrip (Hz)	Pulse Width (s)	Pulse 1 to 2 Spacing (s)	Pulse 2 to 3 Spacing (s)	Start Location (s)
1	2	5M	64.8u	1.186m	-	75.79m
2	3	5M	95.3u	1.039m	1.151m	354.7m
3	1	5M	58.2u	-	-	145.6m
4	2	5M	96.2u	1.328m	-	408.6m
5	1	5M	70.0u	-	-	571.7m
6	1	5M	97.0u	-	-	4.469m
7	2	5M	74.8u	1.904m	-	112.1m
8	2	5M	86.3u	1.847m	-	19.29m
9	1	5M	56.7u	-	-	317.3m
10	2	5M	61.0u	956.0u	-	142.0m
11	2	5M	71.0u	935.0u	-	251.8m
12	1	5M	54.2u	-	-	150.7m
13	3	5M	90.1u	1.385m	1.143m	630.6m
14	2	5M	99.6u	1.522m	-	405.1m
15	2	5M	67.1u	1.741m	-	9.165m
16	2	5M	50.8u	1.064m	-	487.1m
17	2	5M	78.9u	1.002m	-	226.8m

18	3	5M	87.7u	1.409m	1.017m	595.7m
----	---	----	-------	--------	--------	--------

Long Pulse Radar Test Signal
Test Signal Name: LP_Signal_04
Number of Bursts in Trial: 16
Chrip Center Frequency: 5495MHz

Burst	Pulses per Burst	Chrip (Hz)	Pulse Width (s)	Pulse 1 to 2 Spacing (s)	Pulse 2 to 3 Spacing (s)	Start Location (s)
1	3	6M	58.3u	1.169m	1.228m	212.0m
2	1	6M	67.9u	-	-	683.3m
3	2	6M	76.5u	1.176m	-	683.9m
4	2	6M	54.8u	1.298m	-	490.2m
5	3	6M	79.2u	1.024m	1.835m	160.4m
6	2	6M	89.3u	1.805m	-	653.3m
7	1	6M	77.2u	-	-	73.40m
8	3	6M	89.4u	1.249m	1.228m	589.4m
9	3	6M	97.7u	1.549m	1.052m	484.7m
10	3	6M	99.5u	1.824m	1.045m	490.8m
11	2	6M	62.4u	1.758m	-	48.28m
12	2	6M	99.1u	1.202m	-	270.9m
13	3	6M	92.6u	1.079m	1.569m	227.5m
14	2	6M	87.4u	1.359m	-	577.4m
15	1	6M	81.1u	-	-	371.3m
16	3	6M	50.5u	1.117m	996.5u	19.19m

Long Pulse Radar Test Signal
Test Signal Name: LP_Signal_05
Number of Bursts in Trial: 16
Chrip Center Frequency: 5495MHz

Burst	Pulses per Burst	Chrip (Hz)	Pulse Width (s)	Pulse 1 to 2 Spacing (s)	Pulse 2 to 3 Spacing (s)	Start Location (s)
1	2	6M	61.5u	1.386m	-	311.0m
2	3	6M	67.1u	1.513m	1.138m	208.0m
3	2	6M	96.6u	1.844m	-	387.8m
4	1	6M	82.7u	-	-	224.5m
5	2	6M	67.8u	1.718m	-	627.0m
6	2	6M	87.2u	1.177m	-	181.9m
7	2	6M	67.9u	1.705m	-	545.1m

8	3	6M	92.8u	1.251m	1.284m	255.7m
9	1	6M	68.4u	-	-	724.0m
10	3	6M	70.6u	1.617m	1.276m	638.6m
11	2	6M	79.2u	1.690m	-	1.461m
12	2	6M	66.8u	1.231m	-	710.1m
13	2	6M	79.3u	1.785m	-	297.6m
14	3	6M	52.6u	1.716m	1.394m	154.1m
15	1	6M	51.5u	-	-	341.0m
16	2	6M	60.8u	1.100m	-	636.3m

Long Pulse Radar Test Signal						
Test Signal Name: LP_Signal_06						
Number of Bursts in Trial: 12						
Chrip Center Frequency: 5495MHz						
Burst	Pulses per Burst	Chrip (Hz)	Pulse Width (s)	Pulse 1 to 2 Spacing (s)	Pulse 2 to 3 Spacing (s)	Start Location (s)
1	1	6M	74.4u	-	-	870.4m
2	2	6M	73.0u	1.799m	-	254.4m
3	1	6M	69.1u	-	-	695.0m
4	2	6M	80.4u	1.729m	-	818.0m
5	2	6M	80.1u	1.222m	-	775.0m
6	3	6M	61.6u	1.022m	1.568m	773.7m
7	2	6M	72.5u	1.562m	-	260.7m
8	3	6M	69.9u	1.863m	1.712m	187.4m
9	2	6M	98.9u	1.750m	-	407.2m
10	1	6M	86.5u	-	-	242.1m
11	2	6M	67.5u	1.178m	-	608.3m
12	3	6M	85.8u	1.665m	1.754m	944.7m

Long Pulse Radar Test Signal						
Test Signal Name: LP_Signal_07						
Number of Bursts in Trial: 13						
Chrip Center Frequency: 5496MHz						
Burst	Pulses per Burst	Chrip (Hz)	Pulse Width (s)	Pulse 1 to 2 Spacing (s)	Pulse 2 to 3 Spacing (s)	Start Location (s)
1	2	7M	52.9u	1.149m	-	459.6m
2	2	7M	72.7u	1.195m	-	749.5m
3	2	7M	84.3u	1.348m	-	820.7m
4	2	7M	77.1u	1.831m	-	696.8m
5	1	7M	99.5u	-	-	365.0m
6	1	7M	81.5u	-	-	821.3m
7	2	7M	66.5u	1.670m	-	10.40m
8	2	7M	94.2u	1.051m	-	450.0m
9	2	7M	54.3u	1.075m	-	892.9m
10	2	7M	97.5u	1.352m	-	129.0m
11	3	7M	66.1u	1.290m	952.9u	70.05m
12	2	7M	64.0u	1.671m	-	229.6m
13	1	7M	50.9u	-	-	132.1m

Long Pulse Radar Test Signal						
Test Signal Name: LP_Signal_08						
Number of Bursts in Trial: 15						
Chrip Center Frequency: 5497MHz						
Burst	Pulses per Burst	Chrip (Hz)	Pulse Width (s)	Pulse 1 to 2 Spacing (s)	Pulse 2 to 3 Spacing (s)	Start Location (s)
1	2	7M	53.0u	969.0u	-	746.8m
2	1	7M	63.4u	-	-	742.3m
3	2	7M	50.2u	1.509m	-	409.2m
4	3	7M	60.1u	1.447m	1.300m	473.9m
5	2	7M	80.0u	1.361m	-	541.6m
6	2	7M	54.0u	1.276m	-	751.9m
7	2	7M	86.4u	1.372m	-	5.669m
8	3	7M	67.1u	1.234m	1.548m	681.3m
9	1	7M	83.2u	-	-	569.4m
10	2	7M	89.6u	1.288m	-	710.9m
11	2	7M	68.4u	1.713m	-	305.7m

12	2	7M	98.4u	1.105m	-	659.4m
13	2	7M	53.8u	1.651m	-	260.7m
14	3	7M	90.7u	971.3u	1.297m	64.39m
15	3	7M	88.5u	1.396m	1.731m	619.3m

Long Pulse Radar Test Signal						
Test Signal Name: LP_Signal_09						
Number of Bursts in Trial: 19						
Chrip Center Frequency: 5498MHz						
Burst	Pulses per Burst	Chrip (Hz)	Pulse Width (s)	Pulse 1 to 2 Spacing (s)	Pulse 2 to 3 Spacing (s)	Start Location (s)
1	1	7M	88.9u	-	-	400.9m
2	2	7M	87.7u	1.749m	-	609.2m
3	2	7M	50.6u	1.085m	-	105.0m
4	3	7M	91.1u	1.614m	1.318m	577.2m
5	2	7M	74.9u	973.1u	-	357.6m
6	3	7M	73.2u	1.725m	1.906m	367.0m
7	3	7M	80.3u	945.7u	1.860m	150.4m
8	2	7M	95.3u	1.286m	-	625.2m
9	2	7M	84.7u	1.685m	-	954.0u
10	2	7M	59.4u	1.472m	-	547.2m
11	2	7M	86.9u	1.657m	-	488.3m
12	2	7M	58.6u	1.575m	-	148.0m
13	1	7M	97.1u	-	-	448.7m
14	1	7M	75.6u	-	-	601.2m
15	3	7M	66.8u	1.457m	1.366m	239.7m
16	2	7M	79.2u	1.394m	-	127.7m
17	2	7M	50.1u	1.763m	-	55.41m
18	1	7M	73.1u	-	-	132.9m
19	1	7M	51.8u	-	-	601.6m

Long Pulse Radar Test Signal						
Test Signal Name: LP_Signal_10						
Number of Bursts in Trial: 9						
Chrip Center Frequency: 5499MHz						
Burst	Pulses per Burst	Chrip (Hz)	Pulse Width (s)	Pulse 1 to 2 Spacing (s)	Pulse 2 to 3 Spacing (s)	Start Location (s)
1	2	8M	93.1u	1.620m	-	499.5m
2	2	8M	90.9u	1.377m	-	1.052
3	3	8M	82.3u	1.050m	941.7u	104.9m
4	2	8M	54.9u	1.127m	-	1.141
5	1	8M	91.9u	-	-	543.0m
6	1	8M	67.1u	-	-	72.55m
7	2	8M	57.6u	1.477m	-	617.0m
8	2	8M	79.3u	922.7u	-	624.9m
9	2	8M	85.0u	1.009m	-	707.7m

Long Pulse Radar Test Signal						
Test Signal Name: LP_Signal_11						
Number of Bursts in Trial: 14						
Chrip Center Frequency: 5500MHz						
Burst	Pulses per Burst	Chrip (Hz)	Pulse Width (s)	Pulse 1 to 2 Spacing (s)	Pulse 2 to 3 Spacing (s)	Start Location (s)
1	1	15M	63.5u	-	-	839.9m
2	3	6M	97.5u	1.416m	925.5u	48.28m
3	1	15M	91.8u	-	-	752.4m
4	1	14M	86.5u	-	-	143.7m
5	2	18M	71.1u	1.545m	-	601.8m
6	1	6M	82.8u	-	-	148.8m
7	1	7M	64.4u	-	-	386.1m
8	1	18M	53.6u	-	-	560.5m
9	1	15M	98.6u	-	-	725.7m
10	3	19M	85.5u	1.115m	1.136m	119.7m
11	1	15M	100.0u	-	-	278.8m
12	3	12M	87.8u	946.2u	1.112m	177.8m
13	2	9M	61.9u	1.555m	-	393.5m
14	3	18M	86.5u	1.084m	1.587m	38.97m

Long Pulse Radar Test Signal						
Test Signal Name: LP_Signal_12						
Number of Bursts in Trial: 9						
Chrip Center Frequency: 5501MHz						
Burst	Pulses per Burst	Chrip (Hz)	Pulse Width (s)	Pulse 1 to 2 Spacing (s)	Pulse 2 to 3 Spacing (s)	Start Location (s)
1	2	8M	58.9u	1.002m	-	989.2m
2	3	8M	79.9u	1.077m	1.801m	660.2m
3	1	8M	66.4u	-	-	769.1m
4	3	8M	62.0u	1.858m	1.539m	163.1m
5	2	8M	60.5u	1.679m	-	587.7m
6	2	8M	73.6u	1.760m	-	712.2m
7	1	8M	98.5u	-	-	501.0m
8	2	8M	78.1u	1.302m	-	756.8m
9	3	8M	99.7u	1.069m	1.783m	557.6m

Long Pulse Radar Test Signal						
Test Signal Name: LP_Signal_13						
Number of Bursts in Trial: 15						
Chrip Center Frequency: 5499MHz						
Burst	Pulses per Burst	Chrip (Hz)	Pulse Width (s)	Pulse 1 to 2 Spacing (s)	Pulse 2 to 3 Spacing (s)	Start Location (s)
1	1	9M	89.4u	-	-	338.0m
2	3	9M	68.3u	1.753m	1.438m	613.1m
3	2	9M	63.6u	1.362m	-	303.8m
4	2	9M	80.5u	993.5u	-	595.4m
5	2	9M	73.6u	1.540m	-	78.46m
6	1	9M	87.3u	-	-	160.7m
7	2	9M	74.5u	1.600m	-	607.5m
8	2	9M	77.4u	1.693m	-	479.2m
9	2	9M	78.4u	989.6u	-	115.9m
10	2	9M	93.1u	1.366m	-	724.2m
11	1	9M	84.2u	-	-	81.00m
12	1	9M	74.9u	-	-	557.2m
13	2	9M	81.2u	1.048m	-	738.1m
14	2	9M	55.9u	1.240m	-	186.3m
15	3	9M	76.3u	1.412m	1.545m	715.8m

Long Pulse Radar Test Signal						
Test Signal Name: LP_Signal_14						
Number of Bursts in Trial: 18						
Chrip Center Frequency: 5498MHz						
Burst	Pulses per Burst	Chrip (Hz)	Pulse Width (s)	Pulse 1 to 2 Spacing (s)	Pulse 2 to 3 Spacing (s)	Start Location (s)
1	1	9M	92.6u	-	-	574.7m
2	3	9M	67.9u	1.272m	1.316m	302.6m
3	1	9M	85.3u	-	-	195.7m
4	2	9M	87.8u	1.863m	-	517.8m
5	2	9M	73.7u	1.364m	-	350.7m
6	1	9M	55.8u	-	-	569.5m
7	3	9M	99.1u	936.9u	1.756m	652.9m
8	2	9M	94.5u	1.889m	-	175.3m
9	2	9M	69.1u	1.741m	-	186.8m
10	2	9M	60.2u	1.826m	-	144.5m
11	2	9M	90.0u	1.419m	-	500.0m
12	2	9M	98.3u	1.336m	-	157.3m
13	2	9M	94.4u	1.660m	-	479.9m
14	3	9M	91.0u	1.788m	1.474m	137.2m
15	1	9M	74.3u	-	-	351.9m
16	2	9M	55.0u	1.665m	-	89.03m
17	3	9M	85.5u	981.5u	1.182m	444.9m
18	2	9M	86.1u	1.623m	-	259.0m

Long Pulse Radar Test Signal						
Test Signal Name: LP_Signal_15						
Number of Bursts in Trial: 20						
Chrip Center Frequency: 5502MHz						
Burst	Pulses per Burst	Chrip (Hz)	Pulse Width (s)	Pulse 1 to 2 Spacing (s)	Pulse 2 to 3 Spacing (s)	Start Location (s)
1	1	9M	94.6u	-	-	541.2m
2	2	9M	94.3u	1.687m	-	300.2m
3	3	9M	67.5u	1.885m	1.052m	314.5m
4	3	9M	51.5u	1.605m	1.393m	582.8m
5	1	9M	96.5u	-	-	281.6m
6	3	9M	93.8u	914.2u	1.809m	93.31m
7	2	9M	52.4u	1.213m	-	451.3m

8	2	9M	89.2u	1.714m	-	513.7m
9	1	9M	78.4u	-	-	498.4m
10	1	9M	81.3u	-	-	245.5m
11	1	9M	76.6u	-	-	633.1m
12	2	9M	98.4u	1.540m	-	80.05m
13	2	9M	72.1u	1.237m	-	256.2m
14	2	9M	73.7u	1.744m	-	548.2m
15	2	9M	66.1u	1.736m	-	408.8m
16	3	9M	84.7u	1.337m	1.034m	251.4m
17	1	9M	85.1u	-	-	332.5m
18	1	9M	52.1u	-	-	142.5m
19	1	9M	85.5u	-	-	0.000
20	2	9M	86.1u	1.623m	-	259.0m

Long Pulse Radar Test Signal						
Test Signal Name: LP_Signal_16						
Number of Bursts in Trial: 14						
Chrip Center Frequency: 5503MHz						
Burst	Pulses per Burst	Chrip (Hz)	Pulse Width (s)	Pulse 1 to 2 Spacing (s)	Pulse 2 to 3 Spacing (s)	Start Location (s)
1	1	11M	71.4u	-	-	617.2m
2	1	11M	61.3u	-	-	743.0m
3	2	11M	50.5u	1.638m	-	406.0m
4	2	11M	98.5u	1.317m	-	487.7m
5	3	11M	55.6u	1.159m	1.086m	759.9m
6	2	11M	84.8u	933.2u	-	641.4m
7	2	11M	66.1u	1.885m	-	68.60m
8	2	11M	54.4u	1.740m	-	286.3m
9	2	11M	82.6u	1.772m	-	664.4m
10	1	11M	93.1u	-	-	801.1m
11	1	11M	56.8u	-	-	546.2m
12	2	11M	95.6u	1.737m	-	93.59m
13	1	11M	59.9u	-	-	705.3m
14	1	11M	56.5u	-	-	714.6m

Long Pulse Radar Test Signal						
Test Signal Name: LP_Signal_17						
Number of Bursts in Trial: 8						
Chrip Center Frequency: 5496MHz						
Burst	Pulses per Burst	Chrip (Hz)	Pulse Width (s)	Pulse 1 to 2 Spacing (s)	Pulse 2 to 3 Spacing (s)	Start Location (s)
1	2	11M	84.4u	1.421m	-	801.3m
2	3	11M	70.4u	1.837m	1.413m	694.8m
3	1	11M	56.8u	-	-	852.3m
4	2	11M	88.3u	1.609m	-	214.6m
5	3	11M	63.4u	1.206m	1.734m	788.8m
6	3	11M	66.9u	942.1u	1.551m	502.0m
7	3	11M	67.8u	938.2u	1.580m	404.8m
8	2	11M	68.5u	1.233m	-	191.0m

Long Pulse Radar Test Signal						
Test Signal Name: LP_Signal_18						
Number of Bursts in Trial: 14						
Chrip Center Frequency: 5495MHz						
Burst	Pulses per Burst	Chrip (Hz)	Pulse Width (s)	Pulse 1 to 2 Spacing (s)	Pulse 2 to 3 Spacing (s)	Start Location (s)
1	2	11M	80.5u	1.232m	-	80.10m
2	3	11M	56.7u	1.751m	1.546m	522.8m
3	2	11M	91.9u	1.088m	-	90.81m
4	1	11M	96.0u	-	-	616.9m
5	3	11M	96.7u	1.860m	1.465m	333.2m
6	1	11M	81.1u	-	-	272.7m
7	2	11M	56.3u	1.563m	-	399.8m
8	1	11M	82.2u	-	-	311.4m
9	3	11M	66.5u	1.751m	1.086m	413.8m
10	1	11M	93.7u	-	-	87.24m
11	3	11M	80.2u	993.8u	1.009m	213.3m
12	1	11M	62.0u	-	-	216.1m
13	2	11M	89.6u	969.4u	-	624.3m
14	2	11M	55.3u	1.157m	-	75.19m

Long Pulse Radar Test Signal						
Test Signal Name: LP_Signal_19						
Number of Bursts in Trial: 15						
Chrip Center Frequency: 5504MHz						
Burst	Pulses per Burst	Chrip (Hz)	Pulse Width (s)	Pulse 1 to 2 Spacing (s)	Pulse 2 to 3 Spacing (s)	Start Location (s)
1	3	13M	72.1u	1.176m	1.245m	711.3m
2	3	13M	66.5u	1.451m	952.5u	689.2m
3	2	13M	97.3u	1.333m	-	62.65m
4	2	13M	67.6u	1.035m	-	387.6m
5	1	13M	51.6u	-	-	26.37m
6	2	13M	87.9u	1.499m	-	438.2m
7	2	13M	88.9u	1.856m	-	606.1m
8	3	13M	76.6u	1.341m	1.440m	646.0m
9	2	13M	65.9u	1.898m	-	262.9m
10	2	13M	65.9u	1.233m	-	530.7m
11	1	13M	56.8u	-	-	94.44m
12	3	13M	95.3u	1.778m	1.437m	485.4m
13	1	13M	89.3u	-	-	384.7m
14	2	13M	77.2u	1.862m	-	516.6m
15	2	13M	67.4u	1.159m	-	275.1m

Long Pulse Radar Test Signal						
Test Signal Name: LP_Signal_20						
Number of Bursts in Trial: 12						
Chrip Center Frequency: 5505MHz						
Burst	Pulses per Burst	Chrip (Hz)	Pulse Width (s)	Pulse 1 to 2 Spacing (s)	Pulse 2 to 3 Spacing (s)	Start Location (s)
1	2	13M	53.7u	1.723m	-	960.3m
2	1	13M	62.9u	-	-	407.9m
3	2	13M	96.2u	1.404m	-	686.3m
4	1	13M	85.8u	-	-	924.7m
5	3	13M	62.8u	1.023m	1.462m	609.4m
6	1	13M	56.3u	-	-	569.8m
7	3	13M	65.9u	1.348m	1.373m	90.93m
8	2	13M	74.4u	962.6u	-	131.7m
9	1	13M	71.5u	-	-	336.0m

10	3	13M	53.7u	1.897m	1.247m	38.16m
11	2	13M	60.4u	1.372m	-	18.91m
12	1	13M	69.1u	-	-	576.4m

Long Pulse Radar Test Signal						
Test Signal Name: LP_Signal_21						
Number of Bursts in Trial: 14						
Chrip Center Frequency: 5506MHz						
Burst	Pulses per Burst	Chrip (Hz)	Pulse Width (s)	Pulse 1 to 2 Spacing (s)	Pulse 2 to 3 Spacing (s)	Start Location (s)
1	2	13M	87.9u	1.555m	-	82.46m
2	2	13M	56.0u	1.119m	-	628.1m
3	2	13M	83.0u	1.298m	-	406.7m
4	2	13M	95.1u	1.626m	-	592.7m
5	2	13M	61.6u	1.456m	-	268.8m
6	3	13M	97.8u	979.2u	1.872m	334.8m
7	3	13M	64.2u	1.202m	1.322m	210.8m
8	3	13M	72.2u	1.247m	1.859m	687.8m
9	2	13M	85.8u	1.236m	-	674.3m
10	2	13M	74.0u	1.168m	-	830.0m
11	3	13M	91.3u	1.337m	1.469m	613.3m
12	2	13M	88.1u	1.095m	-	524.0m
13	2	13M	96.8u	1.490m	-	491.4m
14	1	13M	60.2u	-	-	662.7m

Long Pulse Radar Test Signal						
Test Signal Name: LP_Signal_22						
Number of Bursts in Trial: 20						
Chrip Center Frequency: 5507MHz						
Burst	Pulses per Burst	Chrip (Hz)	Pulse Width (s)	Pulse 1 to 2 Spacing (s)	Pulse 2 to 3 Spacing (s)	Start Location (s)
1	2	16M	90.8u	1.363m	-	359.9m
2	1	16M	79.7u	-	-	257.3m
3	1	16M	95.3u	-	-	222.6m
4	2	16M	75.3u	1.844m	-	346.1m
5	3	16M	50.2u	1.471m	1.870m	214.7m
6	2	16M	74.4u	1.154m	-	236.1m
7	2	16M	97.2u	1.830m	-	295.6m

8	2	16M	97.0u	1.512m	-	235.6m
9	1	16M	58.9u	-	-	567.2m
10	2	16M	74.8u	1.440m	-	15.56m
11	2	16M	76.9u	1.496m	-	29.78m
12	1	16M	69.6u	-	-	469.7m
13	3	16M	96.3u	995.7u	958.7u	279.9m
14	2	16M	56.3u	1.771m	-	13.09m
15	3	16M	98.0u	1.185m	1.284m	482.3m
16	1	16M	50.4u	-	-	333.2m
17	3	16M	79.7u	1.692m	1.393m	356.8m
18	3	16M	72.2u	1.593m	1.459m	192.6m
19	2	16M	83.3u	1.442m	-	429.6m
20	2	16M	97.4u	1.286m	-	69.43m

Long Pulse Radar Test Signal						
Test Signal Name: LP_Signal_23						
Number of Bursts in Trial: 16						
Chrip Center Frequency: 5506MHz						
Burst	Pulses per Burst	Chrip (Hz)	Pulse Width (s)	Pulse 1 to 2 Spacing (s)	Pulse 2 to 3 Spacing (s)	Start Location (s)
1	1	16M	95.3u	-	-	108.6m
2	2	16M	53.1u	1.606m	-	65.83m
3	3	16M	96.8u	1.488m	1.352m	2.636m
4	2	16M	67.5u	1.301m	-	327.5m
5	3	16M	55.6u	1.122m	1.431m	138.8m
6	1	16M	50.8u	-	-	12.03m
7	2	16M	53.4u	1.503m	-	456.4m
8	3	16M	54.8u	1.412m	1.710m	520.5m
9	3	16M	53.7u	1.685m	1.762m	465.8m
10	2	16M	60.3u	1.837m	-	679.9m
11	2	16M	91.2u	1.027m	-	500.3m
12	2	16M	95.7u	1.804m	-	154.5m
13	2	16M	70.0u	1.808m	-	89.20m
14	2	16M	72.9u	1.045m	-	617.0m
15	2	16M	94.5u	1.540m	-	399.1m
16	3	16M	67.8u	1.932m	1.398m	689.5m

Long Pulse Radar Test Signal						
Test Signal Name: LP_Signal_24						
Number of Bursts in Trial: 20						
Chrip Center Frequency: 5505MHz						
Burst	Pulses per Burst	Chrip (Hz)	Pulse Width (s)	Pulse 1 to 2 Spacing (s)	Pulse 2 to 3 Spacing (s)	Start Location (s)
1	1	16M	99.6u	-	-	17.15m
2	2	16M	93.7u	1.550m	-	451.0m
3	2	16M	56.2u	1.695m	-	50.30m
4	2	16M	97.4u	1.595m	-	38.25m
5	3	16M	95.7u	1.758m	1.330m	461.8m
6	2	16M	96.5u	1.594m	-	383.8m
7	2	16M	64.4u	1.496m	-	585.0m
8	2	16M	51.8u	1.463m	-	38.37m
9	2	16M	88.9u	1.014m	-	467.6m
10	2	16M	90.0u	1.787m	-	401.9m
11	2	16M	64.5u	1.632m	-	179.2m
12	2	16M	90.5u	1.865m	-	311.0m
13	2	16M	89.0u	1.668m	-	304.5m
14	3	16M	56.3u	1.495m	1.440m	358.9m
15	2	16M	70.0u	1.613m	-	385.4m
16	2	16M	68.5u	1.071m	-	131.7m
17	1	16M	90.7u	-	-	171.0m
18	3	16M	59.2u	1.357m	1.500m	74.09m
19	2	16M	75.4u	1.259m	-	263.9m
20	2	16M	59.9u	1.439m	-	223.9m

Long Pulse Radar Test Signal						
Test Signal Name: LP_Signal_25						
Number of Bursts in Trial: 17						
Chrip Center Frequency: 5504MHz						
Burst	Pulses per Burst	Chrip (Hz)	Pulse Width (s)	Pulse 1 to 2 Spacing (s)	Pulse 2 to 3 Spacing (s)	Start Location (s)
1	1	18M	72.0u	-	-	413.7m
2	3	18M	76.9u	1.097m	1.376m	354.9m
3	1	18M	75.2u	-	-	599.4m
4	2	18M	93.0u	1.493m	-	250.8m

5	3	18M	57.1u	1.585m	1.588m	420.6m
6	2	18M	50.8u	1.717m	-	539.4m
7	1	18M	65.7u	-	-	28.59m
8	3	18M	77.0u	1.202m	971.0u	391.0m
9	2	18M	68.2u	1.440m	-	564.1m
10	2	18M	82.5u	1.844m	-	422.2m
11	2	18M	73.2u	1.822m	-	136.1m
12	2	18M	63.3u	1.267m	-	319.8m
13	2	18M	99.0u	1.166m	-	656.0m
14	2	18M	90.2u	1.503m	-	202.4m
15	1	18M	83.7u	-	-	579.4m
16	1	18M	74.6u	-	-	461.2m
17	3	18M	80.6u	1.132m	986.4u	29.06m

Long Pulse Radar Test Signal						
Test Signal Name: LP_Signal_26						
Number of Bursts in Trial: 12						
Chrip Center Frequency: 5503MHz						
Burst	Pulses per Burst	Chrip (Hz)	Pulse Width (s)	Pulse 1 to 2 Spacing (s)	Pulse 2 to 3 Spacing (s)	Start Location (s)
1	3	18M	90.4u	1.021m	1.876m	544.8m
2	2	18M	55.2u	1.474m	-	795.9m
3	2	18M	73.1u	1.677m	-	575.1m
4	1	18M	76.9u	-	-	838.4m
5	2	18M	71.7u	1.243m	-	16.19m
6	2	18M	69.6u	1.237m	-	192.7m
7	2	18M	93.1u	1.641m	-	921.6m
8	2	18M	84.6u	1.422m	-	329.5m
9	3	18M	53.7u	1.569m	1.097m	564.7m
10	2	18M	79.1u	1.416m	-	260.3m
11	1	18M	98.6u	-	-	191.5m
12	2	18M	74.9u	1.357m	-	211.0m

Long Pulse Radar Test Signal						
Test Signal Name: LP_Signal_27						
Number of Bursts in Trial: 19						
Chrip Center Frequency: 5502MHz						
Burst	Pulses per Burst	Chrip (Hz)	Pulse Width (s)	Pulse 1 to 2 Spacing (s)	Pulse 2 to 3 Spacing (s)	Start Location (s)
1	2	18M	83.6u	1.855m	-	495.3m
2	3	18M	55.5u	1.448m	1.708m	215.6m
3	2	18M	70.2u	1.478m	-	561.7m
4	2	18M	64.9u	1.288m	-	595.7m
5	2	18M	62.4u	1.276m	-	111.2m
6	2	18M	94.7u	1.555m	-	137.8m
7	3	18M	90.7u	1.210m	909.3u	343.8m
8	2	18M	52.8u	1.222m	-	530.2m
9	1	18M	81.4u	-	-	289.4m
10	3	18M	65.5u	1.063m	1.533m	231.9m
11	2	18M	86.2u	964.8u	-	187.7m
12	2	18M	76.0u	1.754m	-	294.4m
13	2	18M	68.7u	937.3u	-	413.6m
14	2	18M	92.7u	1.176m	-	166.7m
15	3	18M	65.6u	1.000m	1.054m	405.5m
16	2	18M	90.8u	1.227m	-	142.0m
17	3	18M	88.6u	1.603m	1.775m	462.3m
18	1	18M	52.1u	-	-	317.1m
19	2	18M	58.9u	1.918m	-	587.3m

Long Pulse Radar Test Signal						
Test Signal Name: LP_Signal_28						
Number of Bursts in Trial: 20						
Chrip Center Frequency: 5501MHz						
Burst	Pulses per Burst	Chrip (Hz)	Pulse Width (s)	Pulse 1 to 2 Spacing (s)	Pulse 2 to 3 Spacing (s)	Start Location (s)
1	2	20M	63.1u	1.352m	-	165.6m
2	2	20M	58.9u	1.458m	-	231.2m
3	2	20M	77.9u	1.812m	-	578.2m
4	2	20M	55.4u	1.834m	-	493.0m
5	3	20M	93.5u	1.337m	1.895m	207.5m
6	2	20M	92.8u	1.212m	-	161.6m
7	3	20M	60.2u	1.500m	1.299m	450.6m
8	3	20M	92.9u	980.1u	1.224m	70.72m
9	3	20M	68.5u	1.737m	1.169m	263.0m
10	2	20M	85.6u	967.4u	-	128.5m
11	2	20M	85.4u	1.165m	-	495.9m
12	2	20M	68.2u	1.498m	-	88.26m
13	2	20M	66.6u	1.769m	-	10.88m
14	3	20M	56.7u	1.517m	1.056m	393.2m
15	1	20M	61.9u	-	-	488.3m
16	3	20M	92.9u	1.185m	1.163m	309.7m
17	2	20M	59.6u	1.139m	-	243.6m
18	3	20M	71.4u	1.337m	1.026m	381.3m
19	3	20M	66.5u	1.886m	1.669m	75.38m
20	1	20M	99.2u	-	-	205.0m

Long Pulse Radar Test Signal						
Test Signal Name: LP_Signal_29						
Number of Bursts in Trial: 15						
Chrip Center Frequency: 5500MHz						
Burst	Pulses per Burst	Chrip (Hz)	Pulse Width (s)	Pulse 1 to 2 Spacing (s)	Pulse 2 to 3 Spacing (s)	Start Location (s)
1	1	20M	63.9u	-	-	77.33m
2	2	20M	94.7u	1.807m	-	47.69m
3	2	20M	55.2u	1.653m	-	235.8m
4	1	20M	88.6u	-	-	734.4m
5	3	20M	58.9u	1.448m	1.576m	594.5m
6	3	20M	80.2u	1.051m	1.328m	738.1m
7	2	20M	51.8u	1.771m	-	610.0m
8	1	20M	58.2u	-	-	187.6m
9	3	20M	51.5u	1.442m	1.642m	91.17m
10	2	20M	54.6u	1.066m	-	128.0m
11	3	20M	92.5u	1.718m	1.207m	337.4m
12	3	20M	88.1u	1.794m	1.583m	438.5m
13	2	20M	63.5u	1.643m	-	214.3m
14	2	20M	73.1u	959.9u	-	235.5m
15	1	20M	71.4u	-	-	509.1m

Long Pulse Radar Test Signal						
Test Signal Name: LP_Signal_30						
Number of Bursts in Trial: 18						
Chrip Center Frequency: 5499MHz						
Burst	Pulses per Burst	Chrip (Hz)	Pulse Width (s)	Pulse 1 to 2 Spacing (s)	Pulse 2 to 3 Spacing (s)	Start Location (s)
1	1	20M	58.6u	-	-	36.12m
2	2	20M	92.0u	1.831m	-	301.7m
3	2	20M	97.4u	1.173m	-	286.9m
4	2	20M	57.0u	979.0u	-	55.23m
5	1	20M	66.5u	-	-	376.4m
6	2	20M	78.9u	1.100m	-	434.4m
7	2	20M	70.2u	1.681m	-	626.6m
8	3	20M	72.3u	1.233m	1.537m	438.6m
9	2	20M	59.1u	1.565m	-	429.8m
10	1	20M	50.4u	-	-	446.6m
11	2	20M	88.1u	1.050m	-	371.0m
12	2	20M	52.9u	1.220m	-	91.61m
13	1	20M	95.1u	-	-	395.7m
14	1	20M	82.4u	-	-	374.5m
15	2	20M	96.3u	992.7u	-	595.6m
16	2	20M	91.4u	1.793m	-	121.7m
17	2	20M	97.6u	1.191m	-	331.3m
18	2	20M	61.0u	1.695m	-	56.15m

Type 6 Radar Statistical Performances				
Trial #	Pulses per Burst	Pulse Width (s)	PRI (s)	Detection
1	9	1.0u	333.0u	Yes
2	9	1.0u	333.0u	Yes
3	9	1.0u	333.0u	Yes
4	9	1.0u	333.0u	Yes
5	9	1.0u	333.0u	Yes
6	9	1.0u	333.0u	Yes
7	9	1.0u	333.0u	Yes
8	9	1.0u	333.0u	Yes
9	9	1.0u	333.0u	Yes
10	9	1.0u	333.0u	Yes
11	9	1.0u	333.0u	Yes
12	9	1.0u	333.0u	Yes
13	9	1.0u	333.0u	Yes
14	9	1.0u	333.0u	Yes
15	9	1.0u	333.0u	Yes
16	9	1.0u	333.0u	Yes
17	9	1.0u	333.0u	Yes
18	9	1.0u	333.0u	Yes
19	9	1.0u	333.0u	Yes
20	9	1.0u	333.0u	Yes
21	9	1.0u	333.0u	Yes
22	9	1.0u	333.0u	Yes
23	9	1.0u	333.0u	Yes
24	9	1.0u	333.0u	Yes
25	9	1.0u	333.0u	Yes
26	9	1.0u	333.0u	Yes
27	9	1.0u	333.0u	Yes
28	9	1.0u	333.0u	Yes
29	9	1.0u	333.0u	Yes
30	9	1.0u	333.0u	Yes
				Detection Rate: 100.0 %

Type 6 Radar Statistical Performances		
Trial #	Hopping Frequency Sequence Name	Detection
1	HOP_FREQ_SEQ_01	Yes
2	HOP_FREQ_SEQ_02	Yes
3	HOP_FREQ_SEQ_03	Yes
4	HOP_FREQ_SEQ_04	Yes
5	HOP_FREQ_SEQ_05	Yes
6	HOP_FREQ_SEQ_06	Yes
7	HOP_FREQ_SEQ_07	Yes
8	HOP_FREQ_SEQ_08	Yes
9	HOP_FREQ_SEQ_09	Yes
10	HOP_FREQ_SEQ_10	Yes
11	HOP_FREQ_SEQ_11	Yes
12	HOP_FREQ_SEQ_12	Yes
13	HOP_FREQ_SEQ_13	Yes
14	HOP_FREQ_SEQ_14	Yes
15	HOP_FREQ_SEQ_15	Yes
16	HOP_FREQ_SEQ_16	Yes
17	HOP_FREQ_SEQ_17	Yes
18	HOP_FREQ_SEQ_18	Yes
19	HOP_FREQ_SEQ_19	Yes
20	HOP_FREQ_SEQ_20	Yes
21	HOP_FREQ_SEQ_21	Yes
22	HOP_FREQ_SEQ_22	Yes
23	HOP_FREQ_SEQ_23	Yes
24	HOP_FREQ_SEQ_24	Yes
25	HOP_FREQ_SEQ_25	Yes
26	HOP_FREQ_SEQ_26	Yes
27	HOP_FREQ_SEQ_27	Yes
28	HOP_FREQ_SEQ_28	Yes
29	HOP_FREQ_SEQ_29	Yes
30	HOP_FREQ_SEQ_30	Yes
		Detection Rate: 100.0 %

Hopping Frequency Sequence Name: HOP_FREQ_SEQ_01							
SEQ#	Frequency (Hz)	SEQ#	Frequency (Hz)	SEQ#	Frequency (Hz)	SEQ#	Frequency (Hz)
1	5.510G	2	5.494G	3	5.424G	4	5.274G
5	5.671G	6	5.351G	7	5.371G	8	5.616G
9	5.595G	10	5.625G	11	5.483G	12	5.676G
13	5.522G	14	5.400G	15	5.539G	16	5.543G
17	5.465G	18	5.537G	19	5.481G	20	5.325G
21	5.647G	22	5.724G	23	5.436G	24	5.322G
25	5.544G	26	5.476G	27	5.695G	28	5.608G
29	5.634G	30	5.601G	31	5.618G	32	5.433G
33	5.711G	34	5.596G	35	5.485G	36	5.262G
37	5.675G	38	5.570G	39	5.644G	40	5.688G
41	5.300G	42	5.331G	43	5.609G	44	5.637G
45	5.398G	46	5.484G	47	5.366G	48	5.620G
49	5.606G	50	5.604G	51	5.320G	52	5.495G
53	5.552G	54	5.702G	55	5.692G	56	5.673G
57	5.526G	58	5.517G	59	5.698G	60	5.651G
61	5.689G	62	5.343G	63	5.294G	64	5.301G
65	5.271G	66	5.619G	67	5.557G	68	5.615G
69	5.406G	70	5.629G	71	5.653G	72	5.521G
73	5.286G	74	5.461G	75	5.423G	76	5.304G
77	5.460G	78	5.605G	79	5.263G	80	5.643G
81	5.646G	82	5.602G	83	5.431G	84	5.652G
85	5.678G	86	5.452G	87	5.364G	88	5.299G
89	5.356G	90	5.363G	91	5.470G	92	5.359G
93	5.478G	94	5.296G	95	5.257G	96	5.353G
97	5.603G	98	5.697G	99	5.610G	100	5.425G

Hopping Frequency Sequence Name: HOP_FREQ_SEQ_02							
SEQ#	Frequency (Hz)	SEQ#	Frequency (Hz)	SEQ#	Frequency (Hz)	SEQ#	Frequency (Hz)
1	5.588G	2	5.570G	3	5.328G	4	5.311G
5	5.526G	6	5.339G	7	5.264G	8	5.463G
9	5.573G	10	5.527G	11	5.323G	12	5.421G
13	5.543G	14	5.638G	15	5.600G	16	5.404G
17	5.420G	18	5.255G	19	5.278G	20	5.563G

21	5.284G	22	5.713G	23	5.530G	24	5.710G
25	5.385G	26	5.446G	27	5.292G	28	5.510G
29	5.400G	30	5.376G	31	5.590G	32	5.486G
33	5.349G	34	5.585G	35	5.684G	36	5.315G
37	5.361G	38	5.677G	39	5.576G	40	5.412G
41	5.550G	42	5.350G	43	5.580G	44	5.549G
45	5.615G	46	5.341G	47	5.326G	48	5.374G
49	5.279G	50	5.605G	51	5.523G	52	5.724G
53	5.419G	54	5.402G	55	5.534G	56	5.505G
57	5.367G	58	5.720G	59	5.623G	60	5.552G
61	5.274G	62	5.454G	63	5.547G	64	5.397G
65	5.603G	66	5.673G	67	5.475G	68	5.625G
69	5.442G	70	5.307G	71	5.681G	72	5.340G
73	5.618G	74	5.579G	75	5.322G	76	5.662G
77	5.672G	78	5.403G	79	5.539G	80	5.703G
81	5.413G	82	5.501G	83	5.697G	84	5.698G
85	5.608G	86	5.448G	87	5.621G	88	5.572G
89	5.262G	90	5.300G	91	5.405G	92	5.686G
93	5.348G	94	5.515G	95	5.674G	96	5.275G
97	5.619G	98	5.701G	99	5.583G	100	5.496G

Hopping Frequency Sequence Name: HOP_FREQ_SEQ_03							
SEQ#	Frequency (Hz)	SEQ#	Frequency (Hz)	SEQ#	Frequency (Hz)	SEQ#	Frequency (Hz)
1	5.407G	2	5.504G	3	5.568G	4	5.256G
5	5.605G	6	5.317G	7	5.496G	8	5.717G
9	5.267G	10	5.354G	11	5.513G	12	5.373G
13	5.619G	14	5.355G	15	5.696G	16	5.713G
17	5.430G	18	5.506G	19	5.396G	20	5.447G
21	5.632G	22	5.615G	23	5.379G	24	5.663G
25	5.685G	26	5.400G	27	5.287G	28	5.490G
29	5.363G	30	5.654G	31	5.424G	32	5.311G
33	5.581G	34	5.498G	35	5.440G	36	5.329G
37	5.305G	38	5.345G	39	5.252G	40	5.427G
41	5.708G	42	5.607G	43	5.480G	44	5.423G
45	5.375G	46	5.507G	47	5.519G	48	5.408G
49	5.280G	50	5.413G	51	5.380G	52	5.324G
53	5.431G	54	5.399G	55	5.548G	56	5.611G

57	5.319G	58	5.617G	59	5.351G	60	5.658G
61	5.670G	62	5.646G	63	5.524G	64	5.483G
65	5.269G	66	5.320G	67	5.420G	68	5.710G
69	5.718G	70	5.669G	71	5.391G	72	5.641G
73	5.591G	74	5.518G	75	5.692G	76	5.369G
77	5.362G	78	5.636G	79	5.455G	80	5.590G
81	5.462G	82	5.579G	83	5.627G	84	5.676G
85	5.540G	86	5.441G	87	5.262G	88	5.720G
89	5.495G	90	5.494G	91	5.528G	92	5.682G
93	5.628G	94	5.383G	95	5.446G	96	5.390G
97	5.642G	98	5.478G	99	5.545G	100	5.666G

Hopping Frequency Sequence Name: HOP_FREQ_SEQ_04							
SEQ#	Frequency (Hz)	SEQ#	Frequency (Hz)	SEQ#	Frequency (Hz)	SEQ#	Frequency (Hz)
1	5.453G	2	5.369G	3	5.322G	4	5.609G
5	5.685G	6	5.393G	7	5.673G	8	5.362G
9	5.269G	10	5.455G	11	5.551G	12	5.427G
13	5.266G	14	5.510G	15	5.503G	16	5.293G
17	5.374G	18	5.373G	19	5.361G	20	5.283G
21	5.291G	22	5.548G	23	5.454G	24	5.606G
25	5.365G	26	5.445G	27	5.593G	28	5.632G
29	5.535G	30	5.334G	31	5.306G	32	5.693G
33	5.517G	34	5.253G	35	5.642G	36	5.459G
37	5.452G	38	5.653G	39	5.338G	40	5.385G
41	5.325G	42	5.647G	43	5.422G	44	5.313G
45	5.424G	46	5.595G	47	5.368G	48	5.690G
49	5.695G	50	5.371G	51	5.597G	52	5.396G
53	5.522G	54	5.665G	55	5.624G	56	5.442G
57	5.256G	58	5.482G	59	5.608G	60	5.350G
61	5.433G	62	5.678G	63	5.657G	64	5.397G
65	5.528G	66	5.414G	67	5.303G	68	5.315G
69	5.512G	70	5.655G	71	5.611G	72	5.555G
73	5.666G	74	5.530G	75	5.360G	76	5.476G
77	5.618G	78	5.557G	79	5.472G	80	5.500G
81	5.724G	82	5.461G	83	5.447G	84	5.680G
85	5.292G	86	5.316G	87	5.710G	88	5.426G
89	5.570G	90	5.694G	91	5.621G	92	5.536G

93	5.363G	94	5.357G	95	5.501G	96	5.328G
97	5.417G	98	5.504G	99	5.282G	100	5.488G

Hopping Frequency Sequence Name: HOP_FREQ_SEQ_05							
SEQ#	Frequency (Hz)	SEQ#	Frequency (Hz)	SEQ#	Frequency (Hz)	SEQ#	Frequency (Hz)
1	5.631G	2	5.281G	3	5.564G	4	5.645G
5	5.624G	6	5.429G	7	5.618G	8	5.394G
9	5.610G	10	5.558G	11	5.659G	12	5.531G
13	5.521G	14	5.290G	15	5.399G	16	5.609G
17	5.426G	18	5.425G	19	5.299G	20	5.407G
21	5.560G	22	5.438G	23	5.640G	24	5.644G
25	5.415G	26	5.503G	27	5.361G	28	5.572G
29	5.252G	30	5.316G	31	5.402G	32	5.650G
33	5.304G	34	5.646G	35	5.676G	36	5.536G
37	5.614G	38	5.497G	39	5.469G	40	5.571G
41	5.483G	42	5.265G	43	5.439G	44	5.551G
45	5.675G	46	5.620G	47	5.420G	48	5.493G
49	5.414G	50	5.693G	51	5.325G	52	5.616G
53	5.721G	54	5.674G	55	5.528G	56	5.322G
57	5.720G	58	5.334G	59	5.516G	60	5.549G
61	5.627G	62	5.389G	63	5.294G	64	5.641G
65	5.412G	66	5.368G	67	5.345G	68	5.666G
69	5.685G	70	5.583G	71	5.347G	72	5.615G
73	5.251G	74	5.556G	75	5.581G	76	5.502G
77	5.496G	78	5.365G	79	5.340G	80	5.335G
81	5.453G	82	5.459G	83	5.291G	84	5.696G
85	5.348G	86	5.680G	87	5.266G	88	5.655G
89	5.465G	90	5.270G	91	5.449G	92	5.445G
93	5.700G	94	5.452G	95	5.359G	96	5.263G
97	5.704G	98	5.490G	99	5.454G	100	5.603G

Hopping Frequency Sequence Name: HOP_FREQ_SEQ_06							
SEQ#	Frequency (Hz)	SEQ#	Frequency (Hz)	SEQ#	Frequency (Hz)	SEQ#	Frequency (Hz)
1	5.550G	2	5.353G	3	5.409G	4	5.369G
5	5.552G	6	5.715G	7	5.580G	8	5.398G
9	5.253G	10	5.599G	11	5.393G	12	5.634G

13	5.384G	14	5.671G	15	5.507G	16	5.636G
17	5.301G	18	5.525G	19	5.678G	20	5.474G
21	5.260G	22	5.604G	23	5.417G	24	5.401G
25	5.713G	26	5.381G	27	5.378G	28	5.412G
29	5.641G	30	5.421G	31	5.495G	32	5.540G
33	5.511G	34	5.330G	35	5.323G	36	5.305G
37	5.529G	38	5.490G	39	5.710G	40	5.374G
41	5.722G	42	5.592G	43	5.699G	44	5.575G
45	5.723G	46	5.681G	47	5.262G	48	5.716G
49	5.267G	50	5.394G	51	5.586G	52	5.652G
53	5.291G	54	5.344G	55	5.457G	56	5.392G
57	5.689G	58	5.536G	59	5.255G	60	5.288G
61	5.676G	62	5.535G	63	5.461G	64	5.328G
65	5.506G	66	5.403G	67	5.700G	68	5.612G
69	5.555G	70	5.427G	71	5.705G	72	5.402G
73	5.591G	74	5.521G	75	5.597G	76	5.396G
77	5.548G	78	5.579G	79	5.481G	80	5.707G
81	5.542G	82	5.607G	83	5.628G	84	5.355G
85	5.470G	86	5.500G	87	5.547G	88	5.368G
89	5.358G	90	5.711G	91	5.311G	92	5.265G
93	5.303G	94	5.632G	95	5.679G	96	5.589G
97	5.429G	98	5.539G	99	5.364G	100	5.287G

Hopping Frequency Sequence Name: HOP_FREQ_SEQ_07							
SEQ#	Frequency (Hz)	SEQ#	Frequency (Hz)	SEQ#	Frequency (Hz)	SEQ#	Frequency (Hz)
1	5.318G	2	5.264G	3	5.277G	4	5.489G
5	5.577G	6	5.671G	7	5.535G	8	5.372G
9	5.418G	10	5.591G	11	5.285G	12	5.696G
13	5.506G	14	5.360G	15	5.551G	16	5.362G
17	5.536G	18	5.453G	19	5.378G	20	5.279G
21	5.507G	22	5.713G	23	5.662G	24	5.625G
25	5.583G	26	5.705G	27	5.678G	28	5.332G
29	5.553G	30	5.402G	31	5.382G	32	5.533G
33	5.639G	34	5.367G	35	5.364G	36	5.463G
37	5.594G	38	5.425G	39	5.429G	40	5.287G
41	5.373G	42	5.431G	43	5.319G	44	5.628G
45	5.375G	46	5.658G	47	5.430G	48	5.688G

49	5.619G	50	5.697G	51	5.457G	52	5.613G
53	5.647G	54	5.574G	55	5.337G	56	5.304G
57	5.720G	58	5.715G	59	5.603G	60	5.272G
61	5.284G	62	5.602G	63	5.334G	64	5.660G
65	5.683G	66	5.701G	67	5.359G	68	5.470G
69	5.326G	70	5.297G	71	5.673G	72	5.684G
73	5.497G	74	5.548G	75	5.555G	76	5.666G
77	5.379G	78	5.306G	79	5.523G	80	5.575G
81	5.294G	82	5.627G	83	5.623G	84	5.335G
85	5.685G	86	5.472G	87	5.271G	88	5.343G
89	5.442G	90	5.681G	91	5.646G	92	5.710G
93	5.482G	94	5.288G	95	5.394G	96	5.377G
97	5.525G	98	5.629G	99	5.280G	100	5.473G

Hopping Frequency Sequence Name: HOP_FREQ_SEQ_08							
SEQ#	Frequency (Hz)	SEQ#	Frequency (Hz)	SEQ#	Frequency (Hz)	SEQ#	Frequency (Hz)
1	5.511G	2	5.600G	3	5.304G	4	5.459G
5	5.303G	6	5.310G	7	5.514G	8	5.618G
9	5.620G	10	5.405G	11	5.587G	12	5.585G
13	5.294G	14	5.493G	15	5.687G	16	5.460G
17	5.426G	18	5.356G	19	5.584G	20	5.490G
21	5.629G	22	5.453G	23	5.720G	24	5.512G
25	5.575G	26	5.261G	27	5.379G	28	5.311G
29	5.408G	30	5.700G	31	5.409G	32	5.299G
33	5.650G	34	5.422G	35	5.444G	36	5.344G
37	5.393G	38	5.305G	39	5.515G	40	5.383G
41	5.604G	42	5.395G	43	5.588G	44	5.592G
45	5.545G	46	5.293G	47	5.646G	48	5.378G
49	5.266G	50	5.255G	51	5.546G	52	5.342G
53	5.267G	54	5.680G	55	5.702G	56	5.639G
57	5.517G	58	5.323G	59	5.382G	60	5.396G
61	5.335G	62	5.256G	63	5.686G	64	5.614G
65	5.465G	66	5.628G	67	5.276G	68	5.306G
69	5.315G	70	5.627G	71	5.573G	72	5.537G
73	5.704G	74	5.369G	75	5.536G	76	5.653G
77	5.718G	78	5.542G	79	5.318G	80	5.454G
81	5.257G	82	5.504G	83	5.710G	84	5.452G

85	5.486G	86	5.656G	87	5.717G	88	5.282G
89	5.569G	90	5.429G	91	5.494G	92	5.442G
93	5.271G	94	5.624G	95	5.420G	96	5.397G
97	5.562G	98	5.560G	99	5.477G	100	5.470G

Hopping Frequency Sequence Name: HOP_FREQ_SEQ_09							
SEQ#	Frequency (Hz)	SEQ#	Frequency (Hz)	SEQ#	Frequency (Hz)	SEQ#	Frequency (Hz)
1	5.592G	2	5.412G	3	5.677G	4	5.253G
5	5.401G	6	5.529G	7	5.264G	8	5.348G
9	5.312G	10	5.486G	11	5.281G	12	5.420G
13	5.501G	14	5.415G	15	5.651G	16	5.279G
17	5.395G	18	5.434G	19	5.435G	20	5.441G
21	5.670G	22	5.575G	23	5.406G	24	5.616G
25	5.674G	26	5.373G	27	5.596G	28	5.683G
29	5.291G	30	5.469G	31	5.603G	32	5.715G
33	5.477G	34	5.251G	35	5.634G	36	5.484G
37	5.321G	38	5.545G	39	5.490G	40	5.268G
41	5.450G	42	5.513G	43	5.619G	44	5.482G
45	5.571G	46	5.254G	47	5.456G	48	5.717G
49	5.518G	50	5.527G	51	5.495G	52	5.543G
53	5.694G	54	5.578G	55	5.541G	56	5.645G
57	5.639G	58	5.293G	59	5.270G	60	5.337G
61	5.565G	62	5.675G	63	5.389G	64	5.614G
65	5.330G	66	5.414G	67	5.563G	68	5.503G
69	5.442G	70	5.536G	71	5.687G	72	5.390G
73	5.470G	74	5.328G	75	5.704G	76	5.342G
77	5.551G	78	5.252G	79	5.673G	80	5.326G
81	5.534G	82	5.566G	83	5.275G	84	5.340G
85	5.366G	86	5.573G	87	5.399G	88	5.632G
89	5.463G	90	5.402G	91	5.548G	92	5.304G
93	5.341G	94	5.615G	95	5.665G	96	5.471G
97	5.699G	98	5.598G	99	5.445G	100	5.659G

Hopping Frequency Sequence Name: HOP_FREQ_SEQ_10							
SEQ#	Frequency (Hz)	SEQ#	Frequency (Hz)	SEQ#	Frequency (Hz)	SEQ#	Frequency (Hz)
1	5.518G	2	5.496G	3	5.700G	4	5.625G
5	5.534G	6	5.444G	7	5.548G	8	5.501G
9	5.392G	10	5.541G	11	5.450G	12	5.445G
13	5.284G	14	5.722G	15	5.316G	16	5.506G
17	5.660G	18	5.583G	19	5.421G	20	5.338G
21	5.268G	22	5.632G	23	5.591G	24	5.558G
25	5.658G	26	5.547G	27	5.470G	28	5.620G
29	5.261G	30	5.485G	31	5.462G	32	5.554G
33	5.270G	34	5.286G	35	5.640G	36	5.498G
37	5.709G	38	5.606G	39	5.343G	40	5.645G
41	5.653G	42	5.420G	43	5.564G	44	5.277G
45	5.460G	46	5.290G	47	5.358G	48	5.440G
49	5.371G	50	5.276G	51	5.292G	52	5.575G
53	5.577G	54	5.376G	55	5.359G	56	5.517G
57	5.361G	58	5.519G	59	5.447G	60	5.602G
61	5.561G	62	5.335G	63	5.526G	64	5.711G
65	5.366G	66	5.252G	67	5.287G	68	5.585G
69	5.425G	70	5.300G	71	5.663G	72	5.406G
73	5.469G	74	5.555G	75	5.672G	76	5.415G
77	5.638G	78	5.563G	79	5.639G	80	5.368G
81	5.584G	82	5.458G	83	5.278G	84	5.717G
85	5.272G	86	5.308G	87	5.689G	88	5.542G
89	5.253G	90	5.623G	91	5.412G	92	5.313G
93	5.642G	94	5.511G	95	5.677G	96	5.691G
97	5.687G	98	5.516G	99	5.340G	100	5.294G

Hopping Frequency Sequence Name: HOP_FREQ_SEQ_11							
SEQ#	Frequency (Hz)	SEQ#	Frequency (Hz)	SEQ#	Frequency (Hz)	SEQ#	Frequency (Hz)
1	5.437G	2	5.523G	3	5.399G	4	5.597G
5	5.447G	6	5.420G	7	5.524G	8	5.269G
9	5.327G	10	5.314G	11	5.505G	12	5.525G
13	5.574G	14	5.548G	15	5.328G	16	5.588G
17	5.337G	18	5.299G	19	5.501G	20	5.260G

21	5.461G	22	5.662G	23	5.510G	24	5.498G
25	5.427G	26	5.379G	27	5.714G	28	5.626G
29	5.432G	30	5.416G	31	5.497G	32	5.352G
33	5.333G	34	5.603G	35	5.346G	36	5.578G
37	5.568G	38	5.450G	39	5.536G	40	5.264G
41	5.283G	42	5.595G	43	5.385G	44	5.443G
45	5.585G	46	5.694G	47	5.466G	48	5.604G
49	5.451G	50	5.394G	51	5.429G	52	5.359G
53	5.560G	54	5.602G	55	5.567G	56	5.422G
57	5.512G	58	5.477G	59	5.693G	60	5.251G
61	5.607G	62	5.338G	63	5.331G	64	5.355G
65	5.321G	66	5.709G	67	5.290G	68	5.308G
69	5.409G	70	5.468G	71	5.553G	72	5.713G
73	5.669G	74	5.350G	75	5.634G	76	5.423G
77	5.721G	78	5.457G	79	5.596G	80	5.435G
81	5.544G	82	5.672G	83	5.601G	84	5.517G
85	5.638G	86	5.460G	87	5.540G	88	5.258G
89	5.707G	90	5.616G	91	5.388G	92	5.654G
93	5.256G	94	5.459G	95	5.391G	96	5.646G
97	5.452G	98	5.557G	99	5.637G	100	5.504G

Hopping Frequency Sequence Name: HOP_FREQ_SEQ_12							
SEQ#	Frequency (Hz)	SEQ#	Frequency (Hz)	SEQ#	Frequency (Hz)	SEQ#	Frequency (Hz)
1	5.576G	2	5.677G	3	5.261G	4	5.699G
5	5.436G	6	5.457G	7	5.694G	8	5.655G
9	5.348G	10	5.446G	11	5.412G	12	5.562G
13	5.712G	14	5.524G	15	5.701G	16	5.397G
17	5.507G	18	5.419G	19	5.483G	20	5.422G
21	5.351G	22	5.641G	23	5.623G	24	5.709G
25	5.642G	26	5.583G	27	5.566G	28	5.715G
29	5.269G	30	5.453G	31	5.697G	32	5.533G
33	5.579G	34	5.251G	35	5.361G	36	5.643G
37	5.716G	38	5.674G	39	5.449G	40	5.286G
41	5.360G	42	5.259G	43	5.644G	44	5.455G
45	5.567G	46	5.668G	47	5.696G	48	5.607G
49	5.423G	50	5.413G	51	5.705G	52	5.326G
53	5.646G	54	5.329G	55	5.384G	56	5.450G

57	5.680G	58	5.634G	59	5.411G	60	5.632G
61	5.497G	62	5.345G	63	5.647G	64	5.603G
65	5.570G	66	5.266G	67	5.420G	68	5.722G
69	5.353G	70	5.417G	71	5.577G	72	5.618G
73	5.556G	74	5.563G	75	5.297G	76	5.368G
77	5.282G	78	5.529G	79	5.481G	80	5.356G
81	5.530G	82	5.336G	83	5.462G	84	5.302G
85	5.719G	86	5.611G	87	5.506G	88	5.367G
89	5.675G	90	5.586G	91	5.580G	92	5.434G
93	5.541G	94	5.468G	95	5.301G	96	5.593G
97	5.409G	98	5.493G	99	5.723G	100	5.437G

Hopping Frequency Sequence Name: HOP_FREQ_SEQ_13							
SEQ#	Frequency (Hz)	SEQ#	Frequency (Hz)	SEQ#	Frequency (Hz)	SEQ#	Frequency (Hz)
1	5.349G	2	5.395G	3	5.493G	4	5.408G
5	5.322G	6	5.293G	7	5.389G	8	5.563G
9	5.387G	10	5.534G	11	5.704G	12	5.441G
13	5.490G	14	5.366G	15	5.344G	16	5.697G
17	5.450G	18	5.590G	19	5.657G	20	5.410G
21	5.405G	22	5.719G	23	5.423G	24	5.290G
25	5.527G	26	5.304G	27	5.270G	28	5.373G
29	5.267G	30	5.361G	31	5.318G	32	5.331G
33	5.342G	34	5.687G	35	5.391G	36	5.494G
37	5.659G	38	5.313G	39	5.624G	40	5.268G
41	5.487G	42	5.258G	43	5.272G	44	5.406G
45	5.632G	46	5.633G	47	5.443G	48	5.691G
49	5.394G	50	5.345G	51	5.312G	52	5.588G
53	5.418G	54	5.292G	55	5.696G	56	5.428G
57	5.507G	58	5.525G	59	5.380G	60	5.553G
61	5.655G	62	5.481G	63	5.651G	64	5.596G
65	5.512G	66	5.409G	67	5.707G	68	5.397G
69	5.545G	70	5.365G	71	5.375G	72	5.591G
73	5.635G	74	5.445G	75	5.364G	76	5.252G
77	5.629G	78	5.340G	79	5.326G	80	5.502G
81	5.269G	82	5.547G	83	5.336G	84	5.575G
85	5.500G	86	5.585G	87	5.448G	88	5.564G
89	5.653G	90	5.540G	91	5.504G	92	5.539G

93	5.333G	94	5.532G	95	5.438G	96	5.464G
97	5.356G	98	5.666G	99	5.262G	100	5.642G

Hopping Frequency Sequence Name: HOP_FREQ_SEQ_14							
SEQ#	Frequency (Hz)	SEQ#	Frequency (Hz)	SEQ#	Frequency (Hz)	SEQ#	Frequency (Hz)
1	5.563G	2	5.501G	3	5.390G	4	5.261G
5	5.695G	6	5.603G	7	5.335G	8	5.446G
9	5.409G	10	5.419G	11	5.608G	12	5.308G
13	5.337G	14	5.658G	15	5.483G	16	5.510G
17	5.585G	18	5.303G	19	5.605G	20	5.442G
21	5.598G	22	5.254G	23	5.268G	24	5.584G
25	5.666G	26	5.465G	27	5.568G	28	5.629G
29	5.674G	30	5.353G	31	5.488G	32	5.457G
33	5.703G	34	5.467G	35	5.448G	36	5.657G
37	5.413G	38	5.375G	39	5.400G	40	5.429G
41	5.538G	42	5.580G	43	5.265G	44	5.309G
45	5.253G	46	5.562G	47	5.692G	48	5.496G
49	5.489G	50	5.263G	51	5.557G	52	5.315G
53	5.472G	54	5.329G	55	5.545G	56	5.407G
57	5.521G	58	5.357G	59	5.721G	60	5.471G
61	5.717G	62	5.526G	63	5.661G	64	5.259G
65	5.592G	66	5.264G	67	5.513G	68	5.498G
69	5.348G	70	5.522G	71	5.476G	72	5.290G
73	5.461G	74	5.530G	75	5.571G	76	5.543G
77	5.401G	78	5.619G	79	5.597G	80	5.399G
81	5.706G	82	5.275G	83	5.678G	84	5.647G
85	5.367G	86	5.673G	87	5.434G	88	5.338G
89	5.255G	90	5.464G	91	5.553G	92	5.537G
93	5.459G	94	5.428G	95	5.298G	96	5.403G
97	5.424G	98	5.556G	99	5.339G	100	5.506G

Hopping Frequency Sequence Name: HOP_FREQ_SEQ_15							
SEQ#	Frequency (Hz)	SEQ#	Frequency (Hz)	SEQ#	Frequency (Hz)	SEQ#	Frequency (Hz)
1	5.412G	2	5.285G	3	5.358G	4	5.394G
5	5.431G	6	5.710G	7	5.611G	8	5.258G
9	5.455G	10	5.598G	11	5.426G	12	5.364G
13	5.582G	14	5.525G	15	5.299G	16	5.644G
17	5.628G	18	5.337G	19	5.639G	20	5.257G
21	5.390G	22	5.385G	23	5.319G	24	5.633G
25	5.440G	26	5.464G	27	5.403G	28	5.691G
29	5.327G	30	5.372G	31	5.675G	32	5.435G
33	5.532G	34	5.414G	35	5.510G	36	5.667G
37	5.542G	38	5.254G	39	5.678G	40	5.608G
41	5.567G	42	5.459G	43	5.451G	44	5.427G
45	5.622G	46	5.462G	47	5.356G	48	5.297G
49	5.500G	50	5.261G	51	5.555G	52	5.612G
53	5.338G	54	5.590G	55	5.530G	56	5.513G
57	5.569G	58	5.487G	59	5.506G	60	5.404G
61	5.496G	62	5.361G	63	5.328G	64	5.552G
65	5.714G	66	5.528G	67	5.354G	68	5.672G
69	5.368G	70	5.370G	71	5.653G	72	5.686G
73	5.694G	74	5.442G	75	5.682G	76	5.472G
77	5.700G	78	5.556G	79	5.527G	80	5.359G
81	5.267G	82	5.518G	83	5.689G	84	5.519G
85	5.437G	86	5.434G	87	5.419G	88	5.365G
89	5.517G	90	5.709G	91	5.610G	92	5.409G
93	5.671G	94	5.557G	95	5.304G	96	5.585G
97	5.646G	98	5.617G	99	5.563G	100	5.534G

Hopping Frequency Sequence Name: HOP_FREQ_SEQ_16							
SEQ#	Frequency (Hz)	SEQ#	Frequency (Hz)	SEQ#	Frequency (Hz)	SEQ#	Frequency (Hz)
1	5.369G	2	5.288G	3	5.646G	4	5.430G
5	5.671G	6	5.682G	7	5.584G	8	5.541G
9	5.455G	10	5.581G	11	5.478G	12	5.263G
13	5.317G	14	5.287G	15	5.512G	16	5.529G
17	5.395G	18	5.596G	19	5.428G	20	5.459G
21	5.413G	22	5.397G	23	5.567G	24	5.451G
25	5.600G	26	5.664G	27	5.688G	28	5.383G
29	5.468G	30	5.338G	31	5.598G	32	5.416G
33	5.607G	34	5.253G	35	5.448G	36	5.659G
37	5.580G	38	5.382G	39	5.342G	40	5.367G
41	5.466G	42	5.314G	43	5.437G	44	5.546G
45	5.360G	46	5.381G	47	5.573G	48	5.349G
49	5.635G	50	5.294G	51	5.588G	52	5.696G
53	5.669G	54	5.687G	55	5.533G	56	5.434G
57	5.627G	58	5.398G	59	5.605G	60	5.304G
61	5.711G	62	5.553G	63	5.672G	64	5.595G
65	5.524G	66	5.653G	67	5.648G	68	5.623G
69	5.502G	70	5.608G	71	5.707G	72	5.599G
73	5.439G	74	5.632G	75	5.457G	76	5.385G
77	5.668G	78	5.423G	79	5.587G	80	5.561G
81	5.251G	82	5.339G	83	5.436G	84	5.384G
85	5.351G	86	5.638G	87	5.568G	88	5.334G
89	5.261G	90	5.654G	91	5.355G	92	5.673G
93	5.371G	94	5.266G	95	5.556G	96	5.716G
97	5.303G	98	5.391G	99	5.386G	100	5.578G

Hopping Frequency Sequence Name: HOP_FREQ_SEQ_17							
SEQ#	Frequency (Hz)	SEQ#	Frequency (Hz)	SEQ#	Frequency (Hz)	SEQ#	Frequency (Hz)
1	5.397G	2	5.541G	3	5.530G	4	5.288G
5	5.436G	6	5.519G	7	5.627G	8	5.631G
9	5.456G	10	5.452G	11	5.419G	12	5.636G
13	5.327G	14	5.650G	15	5.673G	16	5.396G
17	5.554G	18	5.705G	19	5.328G	20	5.442G

21	5.355G	22	5.475G	23	5.569G	24	5.381G
25	5.365G	26	5.445G	27	5.362G	28	5.719G
29	5.330G	30	5.493G	31	5.459G	32	5.324G
33	5.497G	34	5.722G	35	5.372G	36	5.645G
37	5.581G	38	5.495G	39	5.711G	40	5.678G
41	5.521G	42	5.539G	43	5.298G	44	5.500G
45	5.556G	46	5.542G	47	5.640G	48	5.608G
49	5.523G	50	5.306G	51	5.538G	52	5.723G
53	5.392G	54	5.618G	55	5.462G	56	5.696G
57	5.479G	58	5.574G	59	5.279G	60	5.307G
61	5.375G	62	5.690G	63	5.634G	64	5.384G
65	5.566G	66	5.433G	67	5.363G	68	5.350G
69	5.661G	70	5.265G	71	5.715G	72	5.465G
73	5.582G	74	5.354G	75	5.551G	76	5.287G
77	5.338G	78	5.441G	79	5.273G	80	5.598G
81	5.534G	82	5.468G	83	5.579G	84	5.502G
85	5.257G	86	5.543G	87	5.639G	88	5.577G
89	5.254G	90	5.552G	91	5.425G	92	5.404G
93	5.361G	94	5.352G	95	5.585G	96	5.578G
97	5.376G	98	5.536G	99	5.691G	100	5.432G

Hopping Frequency Sequence Name: HOP_FREQ_SEQ_18							
SEQ#	Frequency (Hz)	SEQ#	Frequency (Hz)	SEQ#	Frequency (Hz)	SEQ#	Frequency (Hz)
1	5.632G	2	5.429G	3	5.484G	4	5.565G
5	5.691G	6	5.560G	7	5.699G	8	5.402G
9	5.313G	10	5.534G	11	5.260G	12	5.389G
13	5.711G	14	5.409G	15	5.496G	16	5.290G
17	5.713G	18	5.487G	19	5.514G	20	5.472G
21	5.468G	22	5.680G	23	5.354G	24	5.312G
25	5.645G	26	5.693G	27	5.536G	28	5.499G
29	5.592G	30	5.380G	31	5.529G	32	5.572G
33	5.304G	34	5.408G	35	5.681G	36	5.308G
37	5.511G	38	5.374G	39	5.515G	40	5.590G
41	5.471G	42	5.294G	43	5.458G	44	5.655G
45	5.270G	46	5.269G	47	5.672G	48	5.498G
49	5.352G	50	5.721G	51	5.422G	52	5.598G
53	5.276G	54	5.390G	55	5.489G	56	5.555G

57	5.651G	58	5.591G	59	5.597G	60	5.442G
61	5.329G	62	5.671G	63	5.634G	64	5.454G
65	5.462G	66	5.355G	67	5.309G	68	5.475G
69	5.559G	70	5.662G	71	5.701G	72	5.459G
73	5.252G	74	5.543G	75	5.395G	76	5.350G
77	5.465G	78	5.463G	79	5.336G	80	5.470G
81	5.426G	82	5.401G	83	5.411G	84	5.452G
85	5.676G	86	5.524G	87	5.719G	88	5.646G
89	5.324G	90	5.626G	91	5.568G	92	5.334G
93	5.385G	94	5.717G	95	5.332G	96	5.694G
97	5.317G	98	5.495G	99	5.523G	100	5.420G

Hopping Frequency Sequence Name: HOP_FREQ_SEQ_19							
SEQ#	Frequency (Hz)	SEQ#	Frequency (Hz)	SEQ#	Frequency (Hz)	SEQ#	Frequency (Hz)
1	5.535G	2	5.336G	3	5.400G	4	5.605G
5	5.563G	6	5.428G	7	5.499G	8	5.602G
9	5.672G	10	5.537G	11	5.714G	12	5.334G
13	5.538G	14	5.633G	15	5.266G	16	5.553G
17	5.707G	18	5.261G	19	5.582G	20	5.667G
21	5.379G	22	5.702G	23	5.573G	24	5.457G
25	5.481G	26	5.510G	27	5.357G	28	5.575G
29	5.618G	30	5.622G	31	5.356G	32	5.596G
33	5.253G	34	5.384G	35	5.314G	36	5.616G
37	5.669G	38	5.340G	39	5.374G	40	5.632G
41	5.686G	42	5.718G	43	5.412G	44	5.506G
45	5.375G	46	5.272G	47	5.611G	48	5.293G
49	5.496G	50	5.305G	51	5.512G	52	5.699G
53	5.401G	54	5.395G	55	5.586G	56	5.373G
57	5.565G	58	5.525G	59	5.694G	60	5.426G
61	5.678G	62	5.579G	63	5.446G	64	5.592G
65	5.474G	66	5.677G	67	5.328G	68	5.556G
69	5.275G	70	5.486G	71	5.561G	72	5.635G
73	5.270G	74	5.703G	75	5.723G	76	5.327G
77	5.668G	78	5.546G	79	5.654G	80	5.560G
81	5.344G	82	5.313G	83	5.378G	84	5.567G
85	5.511G	86	5.629G	87	5.394G	88	5.468G
89	5.488G	90	5.436G	91	5.645G	92	5.465G

93	5.265G	94	5.578G	95	5.442G	96	5.559G
97	5.717G	98	5.441G	99	5.454G	100	5.393G

Hopping Frequency Sequence Name: HOP_FREQ_SEQ_20							
SEQ#	Frequency (Hz)	SEQ#	Frequency (Hz)	SEQ#	Frequency (Hz)	SEQ#	Frequency (Hz)
1	5.659G	2	5.646G	3	5.553G	4	5.544G
5	5.533G	6	5.658G	7	5.667G	8	5.696G
9	5.283G	10	5.574G	11	5.531G	12	5.607G
13	5.430G	14	5.623G	15	5.470G	16	5.385G
17	5.614G	18	5.423G	19	5.411G	20	5.501G
21	5.632G	22	5.536G	23	5.485G	24	5.576G
25	5.449G	26	5.397G	27	5.401G	28	5.606G
29	5.603G	30	5.580G	31	5.629G	32	5.638G
33	5.507G	34	5.688G	35	5.404G	36	5.627G
37	5.316G	38	5.717G	39	5.654G	40	5.384G
41	5.280G	42	5.434G	43	5.513G	44	5.302G
45	5.395G	46	5.613G	47	5.711G	48	5.472G
49	5.566G	50	5.274G	51	5.346G	52	5.388G
53	5.497G	54	5.672G	55	5.657G	56	5.537G
57	5.573G	58	5.479G	59	5.630G	60	5.693G
61	5.292G	62	5.289G	63	5.597G	64	5.315G
65	5.569G	66	5.545G	67	5.321G	68	5.443G
69	5.489G	70	5.429G	71	5.676G	72	5.555G
73	5.275G	74	5.417G	75	5.628G	76	5.565G
77	5.666G	78	5.294G	79	5.298G	80	5.295G
81	5.296G	82	5.557G	83	5.297G	84	5.564G
85	5.530G	86	5.352G	87	5.637G	88	5.377G
89	5.694G	90	5.382G	91	5.350G	92	5.282G
93	5.543G	94	5.550G	95	5.512G	96	5.568G
97	5.323G	98	5.330G	99	5.488G	100	5.490G

Hopping Frequency Sequence Name: HOP_FREQ_SEQ_21							
SEQ#	Frequency (Hz)	SEQ#	Frequency (Hz)	SEQ#	Frequency (Hz)	SEQ#	Frequency (Hz)
1	5.440G	2	5.482G	3	5.715G	4	5.408G
5	5.448G	6	5.512G	7	5.450G	8	5.352G
9	5.329G	10	5.463G	11	5.250G	12	5.293G

13	5.707G	14	5.341G	15	5.467G	16	5.343G
17	5.564G	18	5.444G	19	5.465G	20	5.308G
21	5.711G	22	5.670G	23	5.339G	24	5.709G
25	5.599G	26	5.405G	27	5.334G	28	5.674G
29	5.669G	30	5.671G	31	5.297G	32	5.328G
33	5.652G	34	5.270G	35	5.486G	36	5.396G
37	5.277G	38	5.479G	39	5.407G	40	5.649G
41	5.495G	42	5.611G	43	5.355G	44	5.386G
45	5.399G	46	5.462G	47	5.484G	48	5.310G
49	5.500G	50	5.718G	51	5.472G	52	5.443G
53	5.340G	54	5.503G	55	5.415G	56	5.608G
57	5.342G	58	5.419G	59	5.299G	60	5.547G
61	5.485G	62	5.687G	63	5.321G	64	5.410G
65	5.420G	66	5.376G	67	5.417G	68	5.686G
69	5.523G	70	5.700G	71	5.594G	72	5.557G
73	5.369G	74	5.704G	75	5.385G	76	5.581G
77	5.701G	78	5.453G	79	5.536G	80	5.580G
81	5.717G	82	5.452G	83	5.344G	84	5.251G
85	5.712G	86	5.555G	87	5.632G	88	5.429G
89	5.268G	90	5.604G	91	5.543G	92	5.641G
93	5.647G	94	5.562G	95	5.521G	96	5.446G
97	5.359G	98	5.637G	99	5.576G	100	5.705G

Hopping Frequency Sequence Name: HOP_FREQ_SEQ_22							
SEQ#	Frequency (Hz)	SEQ#	Frequency (Hz)	SEQ#	Frequency (Hz)	SEQ#	Frequency (Hz)
1	5.481G	2	5.623G	3	5.346G	4	5.289G
5	5.487G	6	5.683G	7	5.692G	8	5.649G
9	5.396G	10	5.276G	11	5.592G	12	5.542G
13	5.398G	14	5.682G	15	5.489G	16	5.611G
17	5.624G	18	5.337G	19	5.378G	20	5.695G
21	5.670G	22	5.583G	23	5.502G	24	5.462G
25	5.406G	26	5.700G	27	5.408G	28	5.657G
29	5.540G	30	5.532G	31	5.719G	32	5.299G
33	5.371G	34	5.323G	35	5.418G	36	5.705G
37	5.693G	38	5.524G	39	5.598G	40	5.591G
41	5.669G	42	5.541G	43	5.324G	44	5.426G
45	5.368G	46	5.571G	47	5.668G	48	5.325G

49	5.260G	50	5.416G	51	5.333G	52	5.676G
53	5.383G	54	5.513G	55	5.525G	56	5.255G
57	5.466G	58	5.625G	59	5.400G	60	5.348G
61	5.572G	62	5.638G	63	5.266G	64	5.559G
65	5.468G	66	5.621G	67	5.251G	68	5.265G
69	5.444G	70	5.254G	71	5.622G	72	5.561G
73	5.459G	74	5.717G	75	5.417G	76	5.687G
77	5.551G	78	5.706G	79	5.718G	80	5.336G
81	5.522G	82	5.651G	83	5.671G	84	5.305G
85	5.685G	86	5.640G	87	5.617G	88	5.708G
89	5.347G	90	5.450G	91	5.369G	92	5.318G
93	5.461G	94	5.303G	95	5.660G	96	5.330G
97	5.288G	98	5.379G	99	5.608G	100	5.449G

Hopping Frequency Sequence Name: HOP_FREQ_SEQ_23							
SEQ#	Frequency (Hz)	SEQ#	Frequency (Hz)	SEQ#	Frequency (Hz)	SEQ#	Frequency (Hz)
1	5.716G	2	5.412G	3	5.724G	4	5.649G
5	5.531G	6	5.618G	7	5.534G	8	5.699G
9	5.701G	10	5.525G	11	5.590G	12	5.720G
13	5.340G	14	5.440G	15	5.372G	16	5.461G
17	5.389G	18	5.275G	19	5.452G	20	5.451G
21	5.658G	22	5.483G	23	5.533G	24	5.393G
25	5.642G	26	5.516G	27	5.630G	28	5.471G
29	5.322G	30	5.410G	31	5.485G	32	5.604G
33	5.467G	34	5.304G	35	5.650G	36	5.327G
37	5.586G	38	5.648G	39	5.268G	40	5.257G
41	5.564G	42	5.346G	43	5.593G	44	5.592G
45	5.442G	46	5.626G	47	5.610G	48	5.625G
49	5.373G	50	5.594G	51	5.601G	52	5.441G
53	5.654G	54	5.383G	55	5.271G	56	5.694G
57	5.678G	58	5.405G	59	5.709G	60	5.714G
61	5.526G	62	5.295G	63	5.687G	64	5.579G
65	5.609G	66	5.632G	67	5.319G	68	5.400G
69	5.599G	70	5.547G	71	5.431G	72	5.572G
73	5.598G	74	5.392G	75	5.450G	76	5.365G
77	5.299G	78	5.514G	79	5.635G	80	5.505G
81	5.321G	82	5.426G	83	5.256G	84	5.263G

85	5.634G	86	5.345G	87	5.342G	88	5.669G
89	5.476G	90	5.646G	91	5.251G	92	5.333G
93	5.611G	94	5.445G	95	5.510G	96	5.307G
97	5.448G	98	5.513G	99	5.376G	100	5.464G

Hopping Frequency Sequence Name: HOP_FREQ_SEQ_24							
SEQ#	Frequency (Hz)	SEQ#	Frequency (Hz)	SEQ#	Frequency (Hz)	SEQ#	Frequency (Hz)
1	5.632G	2	5.617G	3	5.551G	4	5.529G
5	5.436G	6	5.571G	7	5.416G	8	5.669G
9	5.506G	10	5.389G	11	5.719G	12	5.679G
13	5.609G	14	5.295G	15	5.367G	16	5.255G
17	5.310G	18	5.531G	19	5.717G	20	5.314G
21	5.655G	22	5.414G	23	5.612G	24	5.479G
25	5.377G	26	5.404G	27	5.336G	28	5.692G
29	5.561G	30	5.319G	31	5.656G	32	5.712G
33	5.549G	34	5.449G	35	5.610G	36	5.579G
37	5.665G	38	5.628G	39	5.553G	40	5.627G
41	5.372G	42	5.587G	43	5.483G	44	5.538G
45	5.433G	46	5.275G	47	5.453G	48	5.671G
49	5.478G	50	5.437G	51	5.370G	52	5.334G
53	5.289G	54	5.403G	55	5.324G	56	5.474G
57	5.535G	58	5.663G	59	5.658G	60	5.446G
61	5.484G	62	5.311G	63	5.591G	64	5.564G
65	5.708G	66	5.526G	67	5.439G	68	5.351G
69	5.357G	70	5.664G	71	5.510G	72	5.567G
73	5.696G	74	5.605G	75	5.557G	76	5.323G
77	5.274G	78	5.555G	79	5.624G	80	5.659G
81	5.384G	82	5.283G	83	5.554G	84	5.445G
85	5.674G	86	5.423G	87	5.651G	88	5.298G
89	5.320G	90	5.316G	91	5.381G	92	5.430G
93	5.566G	94	5.465G	95	5.616G	96	5.405G
97	5.299G	98	5.662G	99	5.512G	100	5.643G

Hopping Frequency Sequence Name: HOP_FREQ_SEQ_25							
SEQ#	Frequency (Hz)	SEQ#	Frequency (Hz)	SEQ#	Frequency (Hz)	SEQ#	Frequency (Hz)
1	5.639G	2	5.344G	3	5.621G	4	5.542G

5	5.525G	6	5.461G	7	5.695G	8	5.358G
9	5.627G	10	5.582G	11	5.449G	12	5.281G
13	5.479G	14	5.357G	15	5.285G	16	5.567G
17	5.484G	18	5.271G	19	5.445G	20	5.571G
21	5.453G	22	5.391G	23	5.341G	24	5.499G
25	5.708G	26	5.361G	27	5.685G	28	5.634G
29	5.383G	30	5.570G	31	5.631G	32	5.515G
33	5.558G	34	5.276G	35	5.526G	36	5.265G
37	5.661G	38	5.687G	39	5.435G	40	5.697G
41	5.296G	42	5.284G	43	5.368G	44	5.309G
45	5.495G	46	5.682G	47	5.345G	48	5.434G
49	5.642G	50	5.275G	51	5.716G	52	5.596G
53	5.707G	54	5.307G	55	5.351G	56	5.295G
57	5.478G	58	5.630G	59	5.269G	60	5.660G
61	5.282G	62	5.486G	63	5.662G	64	5.417G
65	5.444G	66	5.557G	67	5.603G	68	5.333G
69	5.619G	70	5.601G	71	5.314G	72	5.510G
73	5.279G	74	5.645G	75	5.396G	76	5.420G
77	5.584G	78	5.326G	79	5.260G	80	5.659G
81	5.532G	82	5.379G	83	5.431G	84	5.507G
85	5.518G	86	5.467G	87	5.412G	88	5.580G
89	5.372G	90	5.308G	91	5.401G	92	5.537G
93	5.455G	94	5.604G	95	5.393G	96	5.672G
97	5.541G	98	5.643G	99	5.365G	100	5.463G

Hopping Frequency Sequence Name: HOP_FREQ_SEQ_26							
SEQ#	Frequency (Hz)	SEQ#	Frequency (Hz)	SEQ#	Frequency (Hz)	SEQ#	Frequency (Hz)
1	5.428G	2	5.637G	3	5.611G	4	5.704G
5	5.718G	6	5.287G	7	5.644G	8	5.411G
9	5.709G	10	5.493G	11	5.350G	12	5.614G
13	5.257G	14	5.447G	15	5.299G	16	5.294G
17	5.377G	18	5.457G	19	5.609G	20	5.703G
21	5.448G	22	5.417G	23	5.389G	24	5.385G
25	5.357G	26	5.450G	27	5.528G	28	5.536G
29	5.489G	30	5.358G	31	5.712G	32	5.271G
33	5.529G	34	5.264G	35	5.329G	36	5.361G
37	5.320G	38	5.713G	39	5.514G	40	5.583G

41	5.253G	42	5.443G	43	5.484G	44	5.362G
45	5.680G	46	5.283G	47	5.664G	48	5.424G
49	5.569G	50	5.656G	51	5.300G	52	5.373G
53	5.636G	54	5.596G	55	5.434G	56	5.557G
57	5.354G	58	5.627G	59	5.587G	60	5.376G
61	5.655G	62	5.251G	63	5.585G	64	5.695G
65	5.293G	66	5.710G	67	5.367G	68	5.446G
69	5.334G	70	5.435G	71	5.595G	72	5.379G
73	5.398G	74	5.551G	75	5.653G	76	5.401G
77	5.423G	78	5.275G	79	5.510G	80	5.488G
81	5.553G	82	5.254G	83	5.699G	84	5.708G
85	5.280G	86	5.292G	87	5.286G	88	5.544G
89	5.395G	90	5.459G	91	5.487G	92	5.455G
93	5.547G	94	5.391G	95	5.560G	96	5.625G
97	5.501G	98	5.612G	99	5.512G	100	5.556G

Hopping Frequency Sequence Name: HOP_FREQ_SEQ_27							
SEQ#	Frequency (Hz)	SEQ#	Frequency (Hz)	SEQ#	Frequency (Hz)	SEQ#	Frequency (Hz)
1	5.291G	2	5.612G	3	5.548G	4	5.673G
5	5.268G	6	5.410G	7	5.699G	8	5.668G
9	5.600G	10	5.288G	11	5.431G	12	5.470G
13	5.714G	14	5.391G	15	5.651G	16	5.377G
17	5.539G	18	5.253G	19	5.645G	20	5.501G
21	5.684G	22	5.423G	23	5.565G	24	5.561G
25	5.724G	26	5.426G	27	5.681G	28	5.608G
29	5.683G	30	5.328G	31	5.283G	32	5.558G
33	5.589G	34	5.461G	35	5.368G	36	5.659G
37	5.256G	38	5.710G	39	5.322G	40	5.617G
41	5.555G	42	5.522G	43	5.424G	44	5.705G
45	5.304G	46	5.415G	47	5.356G	48	5.469G
49	5.582G	50	5.496G	51	5.513G	52	5.642G
53	5.401G	54	5.272G	55	5.579G	56	5.455G
57	5.385G	58	5.489G	59	5.662G	60	5.716G
61	5.605G	62	5.528G	63	5.347G	64	5.483G
65	5.281G	66	5.263G	67	5.601G	68	5.613G
69	5.417G	70	5.620G	71	5.587G	72	5.351G
73	5.367G	74	5.441G	75	5.418G	76	5.721G

77	5.359G	78	5.557G	79	5.687G	80	5.619G
81	5.708G	82	5.676G	83	5.350G	84	5.704G
85	5.429G	86	5.664G	87	5.419G	88	5.498G
89	5.262G	90	5.698G	91	5.310G	92	5.433G
93	5.422G	94	5.656G	95	5.652G	96	5.494G
97	5.428G	98	5.543G	99	5.518G	100	5.615G

Hopping Frequency Sequence Name: HOP_FREQ_SEQ_28							
SEQ#	Frequency (Hz)	SEQ#	Frequency (Hz)	SEQ#	Frequency (Hz)	SEQ#	Frequency (Hz)
1	5.369G	2	5.605G	3	5.405G	4	5.277G
5	5.613G	6	5.500G	7	5.427G	8	5.490G
9	5.279G	10	5.353G	11	5.579G	12	5.581G
13	5.691G	14	5.377G	15	5.635G	16	5.723G
17	5.662G	18	5.672G	19	5.638G	20	5.435G
21	5.271G	22	5.310G	23	5.325G	24	5.455G
25	5.562G	26	5.419G	27	5.495G	28	5.483G
29	5.504G	30	5.697G	31	5.713G	32	5.587G
33	5.529G	34	5.503G	35	5.481G	36	5.505G
37	5.716G	38	5.453G	39	5.698G	40	5.602G
41	5.364G	42	5.614G	43	5.521G	44	5.418G
45	5.376G	46	5.689G	47	5.251G	48	5.619G
49	5.286G	50	5.686G	51	5.485G	52	5.650G
53	5.415G	54	5.475G	55	5.340G	56	5.371G
57	5.295G	58	5.299G	59	5.688G	60	5.578G
61	5.706G	62	5.551G	63	5.520G	64	5.724G
65	5.588G	66	5.622G	67	5.438G	68	5.319G
69	5.400G	70	5.454G	71	5.265G	72	5.282G
73	5.573G	74	5.432G	75	5.327G	76	5.306G
77	5.667G	78	5.668G	79	5.679G	80	5.300G
81	5.443G	82	5.386G	83	5.368G	84	5.705G
85	5.291G	86	5.555G	87	5.502G	88	5.423G
89	5.701G	90	5.592G	91	5.634G	92	5.285G
93	5.558G	94	5.488G	95	5.337G	96	5.480G
97	5.426G	98	5.390G	99	5.526G	100	5.700G

Hopping Frequency Sequence Name: HOP_FREQ_SEQ_29							
SEQ#	Frequency (Hz)	SEQ#	Frequency (Hz)	SEQ#	Frequency (Hz)	SEQ#	Frequency (Hz)
1	5.276G	2	5.446G	3	5.404G	4	5.334G
5	5.339G	6	5.338G	7	5.693G	8	5.522G
9	5.295G	10	5.653G	11	5.528G	12	5.541G
13	5.464G	14	5.676G	15	5.360G	16	5.629G
17	5.468G	18	5.636G	19	5.624G	20	5.298G
21	5.316G	22	5.651G	23	5.657G	24	5.390G
25	5.521G	26	5.387G	27	5.280G	28	5.534G
29	5.302G	30	5.341G	31	5.342G	32	5.413G
33	5.654G	34	5.275G	35	5.489G	36	5.554G
37	5.459G	38	5.496G	39	5.437G	40	5.444G
41	5.538G	42	5.591G	43	5.304G	44	5.520G
45	5.283G	46	5.325G	47	5.660G	48	5.707G
49	5.677G	50	5.259G	51	5.559G	52	5.386G
53	5.501G	54	5.410G	55	5.441G	56	5.384G
57	5.447G	58	5.337G	59	5.273G	60	5.645G
61	5.429G	62	5.398G	63	5.504G	64	5.291G
65	5.419G	66	5.564G	67	5.354G	68	5.597G
69	5.530G	70	5.411G	71	5.445G	72	5.336G
73	5.627G	74	5.409G	75	5.535G	76	5.292G
77	5.599G	78	5.583G	79	5.359G	80	5.277G
81	5.639G	82	5.697G	83	5.266G	84	5.555G
85	5.422G	86	5.290G	87	5.498G	88	5.692G
89	5.402G	90	5.670G	91	5.718G	92	5.281G
93	5.561G	94	5.366G	95	5.592G	96	5.250G
97	5.450G	98	5.423G	99	5.395G	100	5.678G

Hopping Frequency Sequence Name: HOP_FREQ_SEQ_30							
SEQ#	Frequency (Hz)	SEQ#	Frequency (Hz)	SEQ#	Frequency (Hz)	SEQ#	Frequency (Hz)
1	5.608G	2	5.566G	3	5.636G	4	5.493G
5	5.556G	6	5.536G	7	5.540G	8	5.537G
9	5.391G	10	5.456G	11	5.459G	12	5.597G
13	5.412G	14	5.708G	15	5.702G	16	5.594G
17	5.642G	18	5.612G	19	5.290G	20	5.582G
21	5.294G	22	5.467G	23	5.437G	24	5.285G
25	5.295G	26	5.532G	27	5.541G	28	5.516G
29	5.476G	30	5.505G	31	5.639G	32	5.515G
33	5.551G	34	5.587G	35	5.429G	36	5.514G
37	5.338G	38	5.694G	39	5.458G	40	5.323G
41	5.403G	42	5.625G	43	5.640G	44	5.324G
45	5.469G	46	5.662G	47	5.638G	48	5.308G
49	5.428G	50	5.620G	51	5.377G	52	5.374G
53	5.615G	54	5.670G	55	5.457G	56	5.419G
57	5.682G	58	5.534G	59	5.496G	60	5.663G
61	5.557G	62	5.438G	63	5.288G	64	5.355G
65	5.649G	66	5.253G	67	5.710G	68	5.443G
69	5.721G	70	5.510G	71	5.650G	72	5.359G
73	5.569G	74	5.372G	75	5.574G	76	5.423G
77	5.466G	78	5.688G	79	5.382G	80	5.337G
81	5.533G	82	5.463G	83	5.448G	84	5.401G
85	5.341G	86	5.431G	87	5.722G	88	5.656G
89	5.455G	90	5.538G	91	5.489G	92	5.546G
93	5.585G	94	5.611G	95	5.554G	96	5.309G
97	5.672G	98	5.512G	99	5.396G	100	5.420G

IEEE 802.11ac VHT40

Type 1 Radar Statistical Performances						
Trial #	Pulse Repetition Frequency Number (1 to 23)	PRF (Pulse per seconds)	Pulses per Burst	PRI (s)	Radar Frequency (MHz)	Detection
1	23	326.2	18	3.066m	5495	Yes
2	9	1474.9	78	678u	5501	Yes
3	16	1222.5	65	818u	5497	Yes
4	5	1672.2	89	598u	5511	Yes
5	7	1567.4	83	638u	5503	Yes
6	15	1253.1	67	798u	5499	Yes
7	12	1355.0	72	738u	5496	Yes
8	20	1113.6	59	898u	5517	Yes
9	11	1392.8	74	718u	5519	Yes
10	3	1792.1	95	558u	5509	Yes
11	19	1139.0	61	878u	5523	Yes
12	17	1193.3	63	838u	5514	Yes
13	2	1858.7	99	538u	5507	Yes
14	8	1519.8	81	658u	5500	Yes
15	22	1066.1	57	938u	5524	Yes
16		1065.0	57	939u	5508	Yes
17		499.0	27	2.004m	5498	Yes
18		627.7	34	1.593m	5513	Yes
19		636.5	34	1.571m	5525	Yes
20		1179.2	63	848u	5506	Yes
21		370.8	20	2.697m	5515	Yes
22		590.7	32	1.693m	5522	No
23		557.7	30	1.793m	5510	Yes
24		989.1	53	1.011m	5518	Yes
25		349.4	19	2.862m	5521	Yes
26		997.0	53	1.003m	5516	Yes
27		363.5	20	2.751m	5520	Yes
28		492.9	27	2.029m	5512	Yes
29		1326.3	70	754u	5504	Yes
30		803.2	18	1.245m	5502	Yes
Detection Rate: 96.7 %						

Type 2 Radar Statistical Performances					
Trial #	Pulses per Burst	Pulse Width (s)	PRI (s)	Radar Frequency (MHz)	Detection
1	29	4.9u	210u	5507	Yes
2	24	1.7u	178u	5503	Yes
3	25	2.1u	173u	5500	Yes
4	28	4u	222u	5498	Yes
5	27	3.6u	219u	5499	Yes
6	29	5u	212u	5497	Yes
7	29	4.9u	176u	5518	Yes
8	23	1.1u	199u	5519	Yes
9	23	1.2u	162u	5501	Yes
10	29	4.5u	220u	5512	Yes
11	29	5u	229u	5511	No
12	29	5u	214u	5495	Yes
13	25	2.4u	153u	5517	No
14	28	4.1u	197u	5496	Yes
15	24	2u	211u	5506	Yes
16	29	4.6u	190u	5510	Yes
17	23	1u	213u	5502	Yes
18	25	2.4u	218u	5509	Yes
19	26	3.2u	215u	5513	Yes
20	26	3.1u	157u	5520	Yes
21	25	2.7u	168u	5515	Yes
22	25	2.6u	227u	5516	Yes
23	24	2u	171u	5521	Yes
24	23	1.1u	158u	5525	Yes
25	23	1u	167u	5524	Yes
26	29	4.9u	150u	5514	No
27	29	4.8u	191u	5523	Yes
28	25	2.3u	159u	5522	Yes
29	28	4.3u	226u	5505	Yes
30	26	3.3u	208u	5508	Yes
					Detection Rate: 90 %

Type 3 Radar Statistical Performances					
Trial #	Pulses per Burst	Pulse Width (s)	PRI (s)	Radar Frequency (MHz)	Detection
1	18	9.9u	235u	5510	No
2	16	6.7u	357u	5495	Yes
3	16	7.1u	333u	5507	Yes
4	18	9u	242u	5513	Yes
5	17	8.6u	397u	5509	Yes
6	18	10u	302u	5498	Yes
7	18	9.9u	203u	5501	Yes
8	16	6.1u	428u	5522	Yes
9	16	6.2u	335u	5512	Yes
10	18	9.5u	240u	5503	Yes
11	18	10u	224u	5514	Yes
12	18	10u	410u	5504	Yes
13	17	7.4u	359u	5517	Yes
14	18	9.1u	269u	5524	Yes
15	16	7u	250u	5500	No
16	18	9.6u	247u	5497	Yes
17	16	6u	222u	5511	Yes
18	17	7.4u	424u	5499	Yes
19	17	8.2u	393u	5521	Yes
20	17	8.1u	382u	5505	Yes
21	17	7.7u	486u	5518	Yes
22	17	7.6u	480u	5508	No
23	16	7u	360u	5502	Yes
24	16	6.1u	297u	5515	Yes
25	16	6u	265u	5516	Yes
26	18	9.9u	263u	5496	Yes
27	18	9.8u	324u	5506	Yes
28	17	7.3u	386u	5520	Yes
29	18	9.3u	311u	5523	Yes
30	17	8.3u	378u	5519	Yes
					Detection Rate: 90 %

Type 4 Radar Statistical Performances					
Trial #	Pulses per Burst	Pulse Width (s)	PRI (s)	Radar Frequency (MHz)	Detection
1	16	19.7u	235u	5497	Yes
2	12	12.7u	357u	5496	No
3	13	13.6u	333u	5509	No
4	15	17.7u	242u	5500	Yes
5	15	16.8u	397u	5525	Yes
6	16	20u	302u	5518	Yes
7	16	19.7u	203u	5501	Yes
8	12	11.3u	428u	5512	No
9	12	11.5u	335u	5508	Yes
10	16	18.8u	240u	5505	Yes
11	16	20u	224u	5503	Yes
12	16	20u	410u	5514	Yes
13	13	14.2u	359u	5516	No
14	15	18u	269u	5502	Yes
15	13	13.3u	250u	5521	Yes
16	16	19u	247u	5513	Yes
17	12	11.1u	222u	5511	Yes
18	13	14.2u	424u	5522	Yes
19	14	15.9u	393u	5519	Yes
20	14	15.8u	382u	5498	No
21	14	14.8u	486u	5515	Yes
22	13	14.6u	480u	5507	Yes
23	13	13.2u	360u	5506	Yes
24	12	11.3u	297u	5520	Yes
25	12	11u	265u	5499	Yes
26	16	19.6u	263u	5504	Yes
27	16	19.6u	324u	5510	Yes
28	13	14u	386u	5517	Yes
29	16	18.3u	311u	5523	No
30	14	16.1u	378u	5524	Yes
					Detection Rate: 80 %

Type 5 Radar Statistical Performances		
Trial #	Test Signal Name	Detection
1	LP_Signal_01	Yes
2	LP_Signal_02	Yes
3	LP_Signal_03	Yes
4	LP_Signal_04	Yes
5	LP_Signal_05	Yes
6	LP_Signal_06	Yes
7	LP_Signal_07	Yes
8	LP_Signal_08	Yes
9	LP_Signal_09	Yes
10	LP_Signal_10	Yes
11	LP_Signal_11	Yes
12	LP_Signal_12	Yes
13	LP_Signal_13	Yes
14	LP_Signal_14	Yes
15	LP_Signal_15	Yes
16	LP_Signal_16	Yes
17	LP_Signal_17	Yes
18	LP_Signal_18	Yes
19	LP_Signal_19	Yes
20	LP_Signal_20	Yes
21	LP_Signal_21	Yes
22	LP_Signal_22	Yes
23	LP_Signal_23	Yes
24	LP_Signal_24	Yes
25	LP_Signal_25	Yes
26	LP_Signal_26	Yes
27	LP_Signal_27	Yes
28	LP_Signal_28	Yes
29	LP_Signal_29	Yes
30	LP_Signal_30	Yes
		Detection Rate: 100.0 %

Long Pulse Radar Test Signal						
Test Signal Name: LP_Signal_01						
Number of Bursts in Trial: 16						
Chrip Center Frequency: 5493MHz						
Burst	Pulses per Burst	Chrip (Hz)	Pulse Width (s)	Pulse 1 to 2 Spacing (s)	Pulse 2 to 3 Spacing (s)	Start Location (s)
1	1	5M	59.2u	-	-	243.0m
2	2	5M	94.5u	1.834m	-	299.3m
3	2	5M	95.4u	1.641m	-	566.0m
4	3	5M	59.5u	1.313m	1.332m	354.8m
5	2	5M	62.1u	1.158m	-	618.4m
6	3	5M	73.9u	1.671m	1.534m	629.7m
7	2	5M	50.4u	1.155m	-	384.7m
8	3	5M	62.7u	1.675m	1.571m	94.54m
9	1	5M	52.4u	-	-	45.93m
10	3	5M	55.9u	1.743m	1.537m	37.45m
11	2	5M	62.1u	1.725m	-	173.9m
12	3	5M	65.1u	1.567m	1.369m	549.6m
13	3	5M	80.3u	1.548m	1.117m	530.8m
14	2	5M	85.5u	1.063m	-	265.8m
15	3	5M	54.7u	1.134m	1.657m	49.43m
16	2	5M	85.8u	1.450m	-	382.0m

Long Pulse Radar Test Signal						
Test Signal Name: LP_Signal_02						
Number of Bursts in Trial: 11						
Chrip Center Frequency: 5493MHz						
Burst	Pulses per Burst	Chrip (Hz)	Pulse Width (s)	Pulse 1 to 2 Spacing (s)	Pulse 2 to 3 Spacing (s)	Start Location (s)
1	3	5M	77.4u	928.6u	1.433m	748.0m
2	2	5M	76.8u	1.792m	-	106.4m
3	2	5M	80.6u	1.265m	-	687.9m
4	3	5M	91.4u	1.357m	1.842m	327.9m
5	3	5M	90.0u	1.712m	1.217m	846.9m
6	2	5M	64.2u	1.792m	-	764.9m
7	2	5M	97.3u	1.153m	-	266.8m
8	2	5M	52.9u	952.1u	-	132.9m

9	3	5M	95.0u	1.657m	1.029m	423.4m
10	2	5M	87.7u	1.304m	-	303.7m
11	3	5M	69.8u	1.737m	1.511m	612.5m

Long Pulse Radar Test Signal
Test Signal Name: LP_Signal_03
Number of Bursts in Trial: 18
Chrip Center Frequency: 5494MHz

Burst	Pulses per Burst	Chrip (Hz)	Pulse Width (s)	Pulse 1 to 2 Spacing (s)	Pulse 2 to 3 Spacing (s)	Start Location (s)
1	2	5M	64.8u	1.186m	-	75.79m
2	3	5M	95.3u	1.039m	1.151m	354.7m
3	1	5M	58.2u	-	-	145.6m
4	2	5M	96.2u	1.328m	-	408.6m
5	1	5M	70.0u	-	-	571.7m
6	1	5M	97.0u	-	-	4.469m
7	2	5M	74.8u	1.904m	-	112.1m
8	2	5M	86.3u	1.847m	-	19.29m
9	1	5M	56.7u	-	-	317.3m
10	2	5M	61.0u	956.0u	-	142.0m
11	2	5M	71.0u	935.0u	-	251.8m
12	1	5M	54.2u	-	-	150.7m
13	3	5M	90.1u	1.385m	1.143m	630.6m
14	2	5M	99.6u	1.522m	-	405.1m
15	2	5M	67.1u	1.741m	-	9.165m
16	2	5M	50.8u	1.064m	-	487.1m
17	2	5M	78.9u	1.002m	-	226.8m
18	3	5M	87.7u	1.409m	1.017m	595.7m

Long Pulse Radar Test Signal
Test Signal Name: LP_Signal_04
Number of Bursts in Trial: 16
Chrip Center Frequency: 5495MHz

Burst	Pulses per Burst	Chrip (Hz)	Pulse Width (s)	Pulse 1 to 2 Spacing (s)	Pulse 2 to 3 Spacing (s)	Start Location (s)
1	3	6M	58.3u	1.169m	1.228m	212.0m
2	1	6M	67.9u	-	-	683.3m
3	2	6M	76.5u	1.176m	-	683.9m

4	2	6M	54.8u	1.298m	-	490.2m
5	3	6M	79.2u	1.024m	1.835m	160.4m
6	2	6M	89.3u	1.805m	-	653.3m
7	1	6M	77.2u	-	-	73.40m
8	3	6M	89.4u	1.249m	1.228m	589.4m
9	3	6M	97.7u	1.549m	1.052m	484.7m
10	3	6M	99.5u	1.824m	1.045m	490.8m
11	2	6M	62.4u	1.758m	-	48.28m
12	2	6M	99.1u	1.202m	-	270.9m
13	3	6M	92.6u	1.079m	1.569m	227.5m
14	2	6M	87.4u	1.359m	-	577.4m
15	1	6M	81.1u	-	-	371.3m
16	3	6M	50.5u	1.117m	996.5u	19.19m

Long Pulse Radar Test Signal						
Test Signal Name: LP_Signal_05						
Number of Bursts in Trial: 9						
Chrip Center Frequency: 5495MHz						
Burst	Pulses per Burst	Chrip (Hz)	Pulse Width (s)	Pulse 1 to 2 Spacing (s)	Pulse 2 to 3 Spacing (s)	Start Location (s)
1	1	6M	60.5u	-	-	472.7m
2	1	6M	80.1u	-	-	675.8m
3	2	6M	66.3u	1.548m	-	1.264
4	2	6M	96.6u	1.803m	-	1.141
5	1	6M	81.9u	-	-	946.6m
6	1	6M	80.8u	-	-	104.5m
7	3	6M	55.8u	966.2u	1.307m	288.3m
8	1	6M	61.4u	-	-	551.7m
9	3	6M	88.4u	973.6u	1.741m	76.95m

Long Pulse Radar Test Signal						
Test Signal Name: LP_Signal_06						
Number of Bursts in Trial: 18						
Chrip Center Frequency: 5495MHz						
Burst	Pulses per Burst	Chrip (Hz)	Pulse Width (s)	Pulse 1 to 2 Spacing (s)	Pulse 2 to 3 Spacing (s)	Start Location (s)
1	2	6M	78.8u	1.762m	-	465.6m
2	2	6M	52.8u	1.329m	-	583.2m

3	1	6M	59.6u	-	-	447.7m
4	1	6M	70.0u	-	-	305.9m
5	2	6M	64.5u	1.427m	-	370.3m
6	1	6M	94.0u	-	-	355.4m
7	1	6M	98.4u	-	-	230.2m
8	1	6M	98.8u	-	-	465.8m
9	3	6M	93.1u	936.9u	1.278m	643.2m
10	1	6M	79.3u	-	-	619.5m
11	1	6M	96.8u	-	-	60.72m
12	3	6M	96.8u	1.449m	1.845m	392.2m
13	3	6M	62.4u	1.516m	1.547m	326.3m
14	2	6M	79.7u	1.539m	-	573.3m
15	2	6M	83.8u	1.568m	-	166.7m
16	3	6M	65.1u	1.162m	1.623m	29.54m
17	2	6M	64.0u	1.434m	-	440.0m
18	3	6M	95.5u	1.227m	1.583m	339.8m

Long Pulse Radar Test Signal						
Test Signal Name: LP_Signal_07						
Number of Bursts in Trial: 10						
Chrip Center Frequency: 5496MHz						
Burst	Pulses per Burst	Chrip (Hz)	Pulse Width (s)	Pulse 1 to 2 Spacing (s)	Pulse 2 to 3 Spacing (s)	Start Location (s)
1	2	7M	55.6u	1.308m	-	946.0m
2	2	7M	90.3u	1.109m	-	586.0m
3	3	7M	75.1u	1.179m	1.124m	427.1m
4	3	7M	86.1u	1.371m	1.270m	375.9m
5	2	7M	89.1u	1.058m	-	615.5m
6	2	7M	76.9u	1.774m	-	247.3m
7	2	7M	64.3u	1.929m	-	1.055
8	3	7M	61.7u	1.387m	1.721m	167.4m
9	2	7M	95.7u	1.831m	-	305.4m
10	3	7M	84.7u	1.764m	1.195m	294.9m

Long Pulse Radar Test Signal						
Test Signal Name: LP_Signal_08						
Number of Bursts in Trial: 15						
Chrip Center Frequency: 5497MHz						
Burst	Pulses per Burst	Chrip (Hz)	Pulse Width (s)	Pulse 1 to 2 Spacing (s)	Pulse 2 to 3 Spacing (s)	Start Location (s)
1	2	7M	53.0u	969.0u	-	746.8m
2	1	7M	63.4u	-	-	742.3m
3	2	7M	50.2u	1.509m	-	409.2m
4	3	7M	60.1u	1.447m	1.300m	473.9m
5	2	7M	80.0u	1.361m	-	541.6m
6	2	7M	54.0u	1.276m	-	751.9m
7	2	7M	86.4u	1.372m	-	5.669m
8	3	7M	67.1u	1.234m	1.548m	681.3m
9	1	7M	83.2u	-	-	569.4m
10	2	7M	89.6u	1.288m	-	710.9m
11	2	7M	68.4u	1.713m	-	305.7m
12	2	7M	98.4u	1.105m	-	659.4m
13	2	7M	53.8u	1.651m	-	260.7m
14	3	7M	90.7u	971.3u	1.297m	64.39m
15	3	7M	88.5u	1.396m	1.731m	619.3m

Long Pulse Radar Test Signal						
Test Signal Name: LP_Signal_09						
Number of Bursts in Trial: 12						
Chrip Center Frequency: 5498MHz						
Burst	Pulses per Burst	Chrip (Hz)	Pulse Width (s)	Pulse 1 to 2 Spacing (s)	Pulse 2 to 3 Spacing (s)	Start Location (s)
1	2	7M	80.8u	1.909m	-	739.1m
2	3	7M	72.8u	1.611m	1.582m	706.3m
3	2	7M	90.5u	1.287m	-	462.3m
4	1	7M	63.9u	-	-	784.5m
5	2	7M	88.9u	1.779m	-	930.2m
6	3	7M	62.5u	1.149m	1.301m	45.25m
7	2	7M	80.7u	996.3u	-	723.7m
8	2	7M	53.8u	1.508m	-	526.5m
9	1	7M	60.9u	-	-	969.6m

10	3	7M	70.9u	1.208m	1.123m	654.9m
11	2	7M	60.0u	1.424m	-	233.5m
12	2	7M	80.6u	1.042m	-	8.643m

Long Pulse Radar Test Signal						
Test Signal Name: LP_Signal_10						
Number of Bursts in Trial: 13						
Chrip Center Frequency: 5499MHz						
Burst	Pulses per Burst	Chrip (Hz)	Pulse Width (s)	Pulse 1 to 2 Spacing (s)	Pulse 2 to 3 Spacing (s)	Start Location (s)
1	2	9M	61.5u	955.5u	-	640.4m
2	1	9M	92.5u	-	-	393.8m
3	3	9M	71.1u	1.724m	1.483m	227.5m
4	2	9M	79.5u	1.035m	-	625.6m
5	2	9M	75.3u	1.324m	-	302.7m
6	3	9M	71.1u	1.201m	1.880m	210.6m
7	2	9M	83.2u	1.845m	-	576.6m
8	2	9M	81.1u	1.333m	-	524.0m
9	2	9M	97.7u	1.050m	-	855.4m
10	2	9M	95.7u	1.224m	-	597.8m
11	2	9M	53.5u	1.334m	-	874.0m
12	3	9M	70.8u	1.735m	1.020m	510.2m
13	2	9M	95.7u	1.535m	-	870.2m

Long Pulse Radar Test Signal						
Test Signal Name: LP_Signal_11						
Number of Bursts in Trial: 13						
Chrip Center Frequency: 5500MHz						
Burst	Pulses per Burst	Chrip (Hz)	Pulse Width (s)	Pulse 1 to 2 Spacing (s)	Pulse 2 to 3 Spacing (s)	Start Location (s)
1	2	9M	57.9u	1.841m	-	422.7m
2	1	9M	69.6u	-	-	132.7m
3	3	9M	82.1u	1.128m	1.462m	793.5m
4	2	9M	93.4u	1.042m	-	520.9m
5	1	9M	64.5u	-	-	298.1m
6	3	9M	90.7u	1.633m	1.340m	663.6m
7	2	9M	59.5u	1.173m	-	23.35m
8	2	9M	98.2u	1.173m	-	471.2m

9	3	9M	89.6u	1.013m	999.4u	847.1m
10	2	9M	50.2u	1.240m	-	78.02m
11	1	9M	68.5u	-	-	52.96m
12	3	9M	97.3u	1.125m	1.776m	279.1m
13	3	9M	72.8u	1.805m	1.181m	911.6m

Long Pulse Radar Test Signal						
Test Signal Name: LP_Signal_12						
Number of Bursts in Trial: 15						
Chrip Center Frequency: 5501MHz						
Burst	Pulses per Burst	Chrip (Hz)	Pulse Width (s)	Pulse 1 to 2 Spacing (s)	Pulse 2 to 3 Spacing (s)	Start Location (s)
1	1	9M	89.4u	-	-	338.0m
2	3	9M	68.3u	1.753m	1.438m	613.1m
3	2	9M	63.6u	1.362m	-	303.8m
4	2	9M	80.5u	993.5u	-	595.4m
5	2	9M	73.6u	1.540m	-	78.46m
6	1	9M	87.3u	-	-	160.7m
7	2	9M	74.5u	1.600m	-	607.5m
8	2	9M	77.4u	1.693m	-	479.2m
9	2	9M	78.4u	989.6u	-	115.9m
10	2	9M	93.1u	1.366m	-	724.2m
11	1	9M	84.2u	-	-	81.00m
12	1	9M	74.9u	-	-	557.2m
13	2	9M	81.2u	1.048m	-	738.1m
14	2	9M	55.9u	1.240m	-	186.3m
15	3	9M	76.3u	1.412m	1.545m	715.8m

Long Pulse Radar Test Signal						
Test Signal Name: LP_Signal_13						
Number of Bursts in Trial: 10						
Chrip Center Frequency: 5499MHz						
Burst	Pulses per Burst	Chrip (Hz)	Pulse Width (s)	Pulse 1 to 2 Spacing (s)	Pulse 2 to 3 Spacing (s)	Start Location (s)
1	3	10M	81.8u	1.808m	1.698m	72.39m
2	3	10M	76.6u	1.509m	1.487m	279.1m
3	1	10M	97.8u	-	-	1.124
4	3	10M	91.4u	1.843m	1.006m	24.01m
5	2	10M	74.5u	1.380m	-	1.025
6	2	10M	59.7u	1.379m	-	870.2m
7	2	10M	79.5u	1.094m	-	565.8m
8	2	10M	86.0u	1.148m	-	702.2m
9	2	10M	61.7u	1.400m	-	1.076
10	3	10M	87.5u	1.460m	1.499m	297.4m

Long Pulse Radar Test Signal						
Test Signal Name: LP_Signal_14						
Number of Bursts in Trial: 18						
Chrip Center Frequency: 5498MHz						
Burst	Pulses per Burst	Chrip (Hz)	Pulse Width (s)	Pulse 1 to 2 Spacing (s)	Pulse 2 to 3 Spacing (s)	Start Location (s)
1	3	10M	54.2u	1.942m	1.494m	592.2m
2	3	10M	71.2u	1.558m	1.925m	239.4m
3	2	10M	96.1u	1.640m	-	300.6m
4	3	10M	90.5u	1.811m	1.633m	351.7m
5	2	10M	76.9u	1.123m	-	637.0m
6	3	10M	50.0u	1.335m	1.347m	297.1m
7	1	10M	75.1u	-	-	128.3m
8	1	10M	67.8u	-	-	292.2m
9	2	10M	88.2u	1.658m	-	55.83m
10	2	10M	52.3u	1.229m	-	382.0m
11	1	10M	64.4u	-	-	649.6m
12	2	10M	80.0u	1.813m	-	186.8m
13	3	10M	71.2u	1.625m	1.030m	289.9m
14	3	10M	52.9u	1.884m	1.728m	105.0m

15	3	10M	72.4u	932.6u	1.559m	96.61m
16	2	10M	74.9u	1.418m	-	493.8m
17	1	10M	76.4u	-	-	528.7m
18	2	10M	62.3u	1.001m	-	468.6m

Long Pulse Radar Test Signal						
Test Signal Name: LP_Signal_15						
Number of Bursts in Trial: 9						
Chrip Center Frequency: 5502MHz						
Burst	Pulses per Burst	Chrip (Hz)	Pulse Width (s)	Pulse 1 to 2 Spacing (s)	Pulse 2 to 3 Spacing (s)	Start Location (s)
1	2	10M	71.0u	1.700m	-	593.5m
2	2	10M	88.3u	1.451m	-	88.29m
3	1	10M	85.0u	-	-	525.7m
4	2	10M	79.7u	1.341m	-	774.4m
5	3	10M	79.3u	1.573m	921.7u	729.8m
6	1	10M	66.1u	-	-	928.6m
7	2	10M	54.9u	1.834m	-	366.6m
8	3	10M	55.2u	1.238m	1.195m	1.308
9	2	10M	62.7u	1.728m	-	250.5m

Long Pulse Radar Test Signal						
Test Signal Name: LP_Signal_16						
Number of Bursts in Trial: 14						
Chrip Center Frequency: 5503MHz						
Burst	Pulses per Burst	Chrip (Hz)	Pulse Width (s)	Pulse 1 to 2 Spacing (s)	Pulse 2 to 3 Spacing (s)	Start Location (s)
1	2	13M	89.3u	1.226m	-	698.6m
2	2	13M	62.6u	1.024m	-	618.9m
3	2	13M	92.3u	1.201m	-	707.5m
4	1	13M	59.6u	-	-	50.00m
5	1	13M	96.4u	-	-	8.448m
6	3	13M	69.5u	1.319m	1.753m	62.15m
7	2	13M	89.0u	1.502m	-	190.0m
8	1	13M	70.1u	-	-	855.4m
9	2	13M	82.7u	1.528m	-	481.2m
10	1	13M	84.3u	-	-	770.9m
11	3	13M	60.4u	1.218m	1.468m	138.4m
12	3	13M	53.3u	1.553m	1.265m	163.6m
13	2	13M	56.1u	1.623m	-	373.4m
14	3	13M	58.9u	1.330m	1.283m	306.1m

Long Pulse Radar Test Signal						
Test Signal Name: LP_Signal_17						
Number of Bursts in Trial: 10						
Chrip Center Frequency: 5496MHz						
Burst	Pulses per Burst	Chrip (Hz)	Pulse Width (s)	Pulse 1 to 2 Spacing (s)	Pulse 2 to 3 Spacing (s)	Start Location (s)
1	1	13M	67.5u	-	-	502.0m
2	1	13M	88.4u	-	-	240.1m
3	1	13M	65.8u	-	-	262.9m
4	2	13M	62.4u	1.503m	-	341.2m
5	1	13M	95.6u	-	-	958.2m
6	3	13M	62.0u	1.724m	1.096m	947.7m
7	1	13M	52.1u	-	-	612.1m
8	2	13M	50.7u	1.853m	-	1.171
9	2	13M	88.5u	1.693m	-	992.4m
10	2	13M	51.3u	1.595m	-	447.5m

Long Pulse Radar Test Signal						
Test Signal Name: LP_Signal_18						
Number of Bursts in Trial: 12						
Chrip Center Frequency: 5495MHz						
Burst	Pulses per Burst	Chrip (Hz)	Pulse Width (s)	Pulse 1 to 2 Spacing (s)	Pulse 2 to 3 Spacing (s)	Start Location (s)
1	2	13M	71.5u	982.5u	-	86.36m
2	1	13M	89.8u	-	-	993.6m
3	1	13M	83.2u	-	-	30.83m
4	1	13M	59.2u	-	-	837.0m
5	1	13M	68.7u	-	-	229.0m
6	2	13M	96.4u	1.547m	-	543.5m
7	2	13M	84.2u	1.813m	-	108.2m
8	1	13M	61.5u	-	-	194.1m
9	2	13M	87.9u	1.451m	-	603.2m
10	1	13M	94.3u	-	-	285.9m
11	2	13M	61.6u	1.018m	-	423.4m
12	2	13M	55.8u	1.245m	-	287.7m

Long Pulse Radar Test Signal						
Test Signal Name: LP_Signal_19						
Number of Bursts in Trial: 16						
Chrip Center Frequency: 5504MHz						
Burst	Pulses per Burst	Chrip (Hz)	Pulse Width (s)	Pulse 1 to 2 Spacing (s)	Pulse 2 to 3 Spacing (s)	Start Location (s)
1	2	19M	53.2u	1.577m	-	187.2m
2	2	18M	75.8u	1.649m	-	374.2m
3	1	13M	67.8u	-	-	344.8m
4	3	18M	83.2u	1.471m	1.578m	510.7m
5	1	15M	51.5u	-	-	342.1m
6	2	15M	88.6u	1.773m	-	505.7m
7	2	15M	54.4u	1.276m	-	99.43m
8	2	15M	75.2u	1.702m	-	532.3m
9	3	15M	86.3u	1.467m	1.799m	570.2m
10	2	15M	80.5u	1.836m	-	219.9m
11	1	15M	65.8u	-	-	439.1m
12	1	15M	74.8u	-	-	155.7m
13	2	15M	50.9u	1.797m	-	466.0m
14	1	15M	98.0u	-	-	241.0m
15	1	15M	64.1u	-	-	747.6m
16	3	15M	51.3u	1.279m	1.374m	54.36m

Long Pulse Radar Test Signal						
Test Signal Name: LP_Signal_20						
Number of Bursts in Trial: 8						
Chrip Center Frequency: 5505MHz						
Burst	Pulses per Burst	Chrip (Hz)	Pulse Width (s)	Pulse 1 to 2 Spacing (s)	Pulse 2 to 3 Spacing (s)	Start Location (s)
1	3	15M	86.3u	1.743m	985.7u	297.0m
2	1	15M	66.0u	-	-	1.473
3	3	15M	67.9u	1.531m	1.717m	438.4m
4	3	15M	86.6u	1.433m	1.491m	650.2m
5	2	15M	59.3u	1.648m	-	773.9m
6	2	15M	60.7u	1.384m	-	278.3m
7	2	15M	58.5u	1.114m	-	1.321
8	2	15M	88.9u	920.1u	-	360.9m

Long Pulse Radar Test Signal						
Test Signal Name: LP_Signal_21						
Number of Bursts in Trial: 10						
Chrip Center Frequency: 5527MHz						
Burst	Pulses per Burst	Chrip (Hz)	Pulse Width (s)	Pulse 1 to 2 Spacing (s)	Pulse 2 to 3 Spacing (s)	Start Location (s)
1	2	15M	94.0u	1.223m	-	602.5m
2	1	15M	72.8u	-	-	973.3m
3	1	15M	53.8u	-	-	901.9m
4	2	15M	62.4u	1.292m	-	937.5m
5	2	15M	78.8u	1.014m	-	731.3m
6	2	15M	93.5u	1.149m	-	20.15m
7	1	15M	61.8u	-	-	620.4m
8	3	15M	82.0u	1.788m	1.001m	82.34m
9	1	15M	63.6u	-	-	891.7m
10	2	15M	76.7u	1.229m	-	49.96m

Long Pulse Radar Test Signal						
Test Signal Name: LP_Signal_22						
Number of Bursts in Trial: 11						
Chrip Center Frequency: 5527MHz						
Burst	Pulses per Burst	Chrip (Hz)	Pulse Width (s)	Pulse 1 to 2 Spacing (s)	Pulse 2 to 3 Spacing (s)	Start Location (s)
1	2	17M	74.8u	1.336m	-	732.2m
2	2	17M	64.1u	1.818m	-	719.3m
3	3	17M	98.6u	1.137m	1.023m	239.8m
4	3	17M	65.3u	1.927m	1.272m	816.3m
5	3	17M	93.8u	956.2u	1.471m	59.23m
6	2	17M	90.7u	1.479m	-	258.2m
7	3	17M	88.4u	1.449m	1.878m	326.8m
8	1	17M	65.2u	-	-	922.6m
9	3	17M	80.1u	1.304m	1.086m	879.3m
10	1	17M	98.6u	-	-	108.0m
11	1	17M	90.8u	-	-	26.15m

Long Pulse Radar Test Signal						
Test Signal Name: LP_Signal_23						
Number of Bursts in Trial: 19						
Chrip Center Frequency: 5526MHz						
Burst	Pulses per Burst	Chrip (Hz)	Pulse Width (s)	Pulse 1 to 2 Spacing (s)	Pulse 2 to 3 Spacing (s)	Start Location (s)
1	3	17M	56.6u	1.081m	1.442m	264.5m
2	2	17M	77.0u	1.479m	-	411.6m
3	1	17M	64.7u	-	-	502.4m
4	2	17M	66.3u	1.533m	-	128.2m
5	2	17M	66.5u	1.654m	-	32.33m
6	2	17M	53.9u	1.723m	-	368.5m
7	2	17M	95.4u	1.678m	-	502.6m
8	2	17M	79.6u	1.481m	-	375.6m
9	2	17M	94.7u	1.774m	-	335.2m
10	3	17M	86.7u	1.256m	1.147m	567.5m
11	2	17M	65.2u	1.373m	-	55.52m
12	3	17M	53.6u	1.336m	1.086m	350.4m
13	1	17M	93.6u	-	-	549.5m
14	3	17M	99.9u	1.866m	961.1u	222.0m
15	2	17M	98.7u	1.242m	-	603.9m
16	3	17M	99.5u	992.5u	1.138m	514.9m
17	2	17M	88.7u	1.906m	-	388.1m
18	2	17M	98.4u	1.185m	-	429.7m
19	2	17M	84.8u	1.718m	-	344.7m

Long Pulse Radar Test Signal						
Test Signal Name: LP_Signal_24						
Number of Bursts in Trial: 12						
Chrip Center Frequency: 5525MHz						
Burst	Pulses per Burst	Chrip (Hz)	Pulse Width (s)	Pulse 1 to 2 Spacing (s)	Pulse 2 to 3 Spacing (s)	Start Location (s)
1	2	17M	93.4u	1.791m	-	467.1m
2	2	17M	53.0u	1.331m	-	100.2m
3	2	17M	63.1u	1.017m	-	444.6m
4	2	17M	66.4u	1.835m	-	765.4m
5	2	17M	54.8u	1.828m	-	810.6m

6	3	17M	99.5u	974.5u	1.850m	833.5m
7	1	17M	94.7u	-	-	898.3m
8	3	17M	51.2u	1.184m	1.832m	783.4m
9	3	17M	87.4u	1.279m	1.661m	145.4m
10	3	17M	60.8u	1.353m	1.908m	109.4m
11	2	17M	81.3u	1.689m	-	467.0m
12	2	17M	65.6u	957.4u	-	612.4m

Long Pulse Radar Test Signal						
Test Signal Name: LP_Signal_25						
Number of Bursts in Trial: 14						
Chrip Center Frequency: 5525MHz						
Burst	Pulses per Burst	Chrip (Hz)	Pulse Width (s)	Pulse 1 to 2 Spacing (s)	Pulse 2 to 3 Spacing (s)	Start Location (s)
1	2	19M	57.4u	1.572m	-	817.2m
2	3	19M	74.9u	1.651m	1.525m	728.1m
3	2	19M	61.0u	1.735m	-	456.8m
4	1	19M	51.0u	-	-	705.2m
5	1	19M	70.9u	-	-	416.2m
6	1	19M	74.4u	-	-	137.3m
7	2	19M	96.1u	1.248m	-	252.5m
8	2	19M	62.4u	1.425m	-	346.7m
9	3	19M	83.2u	1.202m	1.002m	4.653m
10	2	19M	75.3u	1.397m	-	392.0m
11	2	19M	59.8u	1.393m	-	455.0m
12	2	19M	59.2u	1.897m	-	349.0m
13	2	19M	84.7u	1.796m	-	755.0m
14	2	19M	61.9u	1.149m	-	413.6m

Long Pulse Radar Test Signal						
Test Signal Name: LP_Signal_26						
Number of Bursts in Trial: 14						
Chrip Center Frequency: 5525MHz						
Burst	Pulses per Burst	Chrip (Hz)	Pulse Width (s)	Pulse 1 to 2 Spacing (s)	Pulse 2 to 3 Spacing (s)	Start Location (s)
1	2	19M	71.7u	1.014m	-	296.4m
2	1	19M	51.3u	-	-	48.96m
3	1	19M	54.9u	-	-	138.5m

4	1	19M	93.5u	-	-	839.3m
5	2	19M	96.3u	1.129m	-	808.4m
6	3	19M	54.8u	1.325m	1.878m	449.8m
7	2	19M	70.4u	1.073m	-	123.0m
8	1	19M	88.9u	-	-	76.81m
9	2	19M	71.3u	1.818m	-	383.6m
10	2	19M	98.0u	1.652m	-	218.1m
11	1	19M	93.4u	-	-	32.10m
12	1	19M	87.3u	-	-	559.1m
13	3	19M	74.2u	1.818m	1.191m	83.98m
14	2	19M	50.0u	1.298m	-	378.9m

Long Pulse Radar Test Signal						
Test Signal Name: LP_Signal_27						
Number of Bursts in Trial: 14						
Chrip Center Frequency: 5524MHz						
Burst	Pulses per Burst	Chrip (Hz)	Pulse Width (s)	Pulse 1 to 2 Spacing (s)	Pulse 2 to 3 Spacing (s)	Start Location (s)
1	1	19M	96.6u	-	-	363.1m
2	1	19M	51.9u	-	-	739.2m
3	1	19M	76.1u	-	-	386.4m
4	2	19M	73.2u	1.121m	-	703.9m
5	2	19M	63.6u	1.058m	-	622.0m
6	1	19M	79.6u	-	-	34.99m
7	3	19M	82.5u	1.213m	1.864m	794.1m
8	3	19M	53.7u	1.356m	1.081m	215.9m
9	1	19M	80.9u	-	-	611.8m
10	2	19M	95.4u	1.890m	-	620.4m
11	2	19M	50.1u	1.778m	-	549.3m
12	1	19M	78.5u	-	-	569.2m
13	2	19M	63.2u	1.648m	-	480.1m
14	2	19M	65.0u	965.0u	-	762.0m

Long Pulse Radar Test Signal						
Test Signal Name: LP_Signal_28						
Number of Bursts in Trial: 15						
Chrip Center Frequency: 5523MHz						
Burst	Pulses per Burst	Chrip (Hz)	Pulse Width (s)	Pulse 1 to 2 Spacing (s)	Pulse 2 to 3 Spacing (s)	Start Location (s)
1	1	20M	63.9u	-	-	77.33m
2	2	20M	94.7u	1.807m	-	47.69m
3	2	20M	55.2u	1.653m	-	235.8m
4	1	20M	88.6u	-	-	734.4m
5	3	20M	58.9u	1.448m	1.576m	594.5m
6	3	20M	80.2u	1.051m	1.328m	738.1m
7	2	20M	51.8u	1.771m	-	610.0m
8	1	20M	58.2u	-	-	187.6m
9	3	20M	51.5u	1.442m	1.642m	91.17m
10	2	20M	54.6u	1.066m	-	128.0m
11	3	20M	92.5u	1.718m	1.207m	337.4m
12	3	20M	88.1u	1.794m	1.583m	438.5m
13	2	20M	63.5u	1.643m	-	214.3m
14	2	20M	73.1u	959.9u	-	235.5m
15	1	20M	71.4u	-	-	509.1m

Long Pulse Radar Test Signal						
Test Signal Name: LP_Signal_29						
Number of Bursts in Trial: 20						
Chrip Center Frequency: 5522MHz						
Burst	Pulses per Burst	Chrip (Hz)	Pulse Width (s)	Pulse 1 to 2 Spacing (s)	Pulse 2 to 3 Spacing (s)	Start Location (s)
1	2	20M	63.1u	1.352m	-	165.6m
2	2	20M	58.9u	1.458m	-	231.2m
3	2	20M	77.9u	1.812m	-	578.2m
4	2	20M	55.4u	1.834m	-	493.0m
5	3	20M	93.5u	1.337m	1.895m	207.5m
6	2	20M	92.8u	1.212m	-	161.6m
7	3	20M	60.2u	1.500m	1.299m	450.6m
8	3	20M	92.9u	980.1u	1.224m	70.72m
9	3	20M	68.5u	1.737m	1.169m	263.0m

10	2	20M	85.6u	967.4u	-	128.5m
11	2	20M	85.4u	1.165m	-	495.9m
12	2	20M	68.2u	1.498m	-	88.26m
13	2	20M	66.6u	1.769m	-	10.88m
14	3	20M	56.7u	1.517m	1.056m	393.2m
15	1	20M	61.9u	-	-	488.3m
16	3	20M	92.9u	1.185m	1.163m	309.7m
17	2	20M	59.6u	1.139m	-	243.6m
18	3	20M	71.4u	1.337m	1.026m	381.3m
19	3	20M	66.5u	1.886m	1.669m	75.38m
20	1	20M	99.2u	-	-	205.0m

Long Pulse Radar Test Signal						
Test Signal Name: LP_Signal_30						
Number of Bursts in Trial: 13						
Chrip Center Frequency: 5521MHz						
Burst	Pulses per Burst	Chrip (Hz)	Pulse Width (s)	Pulse 1 to 2 Spacing (s)	Pulse 2 to 3 Spacing (s)	Start Location (s)
1	3	20M	99.7u	1.511m	1.864m	57.55m
2	2	20M	62.6u	1.651m	-	208.8m
3	2	20M	78.6u	1.897m	-	188.5m
4	3	20M	92.7u	1.075m	1.701m	713.1m
5	2	20M	84.2u	1.551m	-	875.0m
6	2	20M	71.6u	1.165m	-	311.7m
7	1	20M	67.9u	-	-	735.6m
8	3	20M	54.0u	1.098m	1.873m	138.9m
9	1	20M	82.3u	-	-	262.2m
10	2	20M	63.4u	1.368m	-	14.73m
11	2	20M	64.4u	1.845m	-	637.0m
12	2	20M	90.9u	1.294m	-	356.2m
13	1	20M	96.9u	-	-	536.0m

Type 6 Radar Statistical Performances				
Trial #	Pulses per Burst	Pulse Width (s)	PRI (s)	Detection
1	9	1.0u	333.0u	Yes
2	9	1.0u	333.0u	Yes
3	9	1.0u	333.0u	Yes
4	9	1.0u	333.0u	Yes
5	9	1.0u	333.0u	Yes
6	9	1.0u	333.0u	Yes
7	9	1.0u	333.0u	Yes
8	9	1.0u	333.0u	Yes
9	9	1.0u	333.0u	Yes
10	9	1.0u	333.0u	Yes
11	9	1.0u	333.0u	Yes
12	9	1.0u	333.0u	Yes
13	9	1.0u	333.0u	Yes
14	9	1.0u	333.0u	Yes
15	9	1.0u	333.0u	Yes
16	9	1.0u	333.0u	Yes
17	9	1.0u	333.0u	Yes
18	9	1.0u	333.0u	Yes
19	9	1.0u	333.0u	Yes
20	9	1.0u	333.0u	Yes
21	9	1.0u	333.0u	Yes
22	9	1.0u	333.0u	Yes
23	9	1.0u	333.0u	Yes
24	9	1.0u	333.0u	Yes
25	9	1.0u	333.0u	Yes
26	9	1.0u	333.0u	Yes
27	9	1.0u	333.0u	Yes
28	9	1.0u	333.0u	Yes
29	9	1.0u	333.0u	Yes
30	9	1.0u	333.0u	Yes
				Detection Rate: 100.0 %

Type 6 Radar Statistical Performances		
Trial #	Hopping Frequency Sequence Name	Detection
1	HOP_FREQ_SEQ_01	Yes
2	HOP_FREQ_SEQ_02	Yes
3	HOP_FREQ_SEQ_03	Yes
4	HOP_FREQ_SEQ_04	Yes
5	HOP_FREQ_SEQ_05	Yes
6	HOP_FREQ_SEQ_06	Yes
7	HOP_FREQ_SEQ_07	Yes
8	HOP_FREQ_SEQ_08	Yes
9	HOP_FREQ_SEQ_09	Yes
10	HOP_FREQ_SEQ_10	Yes
11	HOP_FREQ_SEQ_11	Yes
12	HOP_FREQ_SEQ_12	Yes
13	HOP_FREQ_SEQ_13	Yes
14	HOP_FREQ_SEQ_14	Yes
15	HOP_FREQ_SEQ_15	Yes
16	HOP_FREQ_SEQ_16	Yes
17	HOP_FREQ_SEQ_17	Yes
18	HOP_FREQ_SEQ_18	Yes
19	HOP_FREQ_SEQ_19	Yes
20	HOP_FREQ_SEQ_20	Yes
21	HOP_FREQ_SEQ_21	Yes
22	HOP_FREQ_SEQ_22	Yes
23	HOP_FREQ_SEQ_23	Yes
24	HOP_FREQ_SEQ_24	Yes
25	HOP_FREQ_SEQ_25	Yes
26	HOP_FREQ_SEQ_26	Yes
27	HOP_FREQ_SEQ_27	Yes
28	HOP_FREQ_SEQ_28	Yes
29	HOP_FREQ_SEQ_29	Yes
30	HOP_FREQ_SEQ_30	Yes
		Detection Rate: 100.0 %

Hopping Frequency Sequence Name: HOP_FREQ_SEQ_01							
SEQ#	Frequency (Hz)	SEQ#	Frequency (Hz)	SEQ#	Frequency (Hz)	SEQ#	Frequency (Hz)
1	5.419G	2	5.701G	3	5.392G	4	5.709G
5	5.506G	6	5.313G	7	5.613G	8	5.415G
9	5.537G	10	5.299G	11	5.283G	12	5.520G
13	5.609G	14	5.422G	15	5.569G	16	5.681G
17	5.480G	18	5.265G	19	5.411G	20	5.587G
21	5.309G	22	5.495G	23	5.530G	24	5.683G
25	5.418G	26	5.654G	27	5.635G	28	5.631G
29	5.524G	30	5.426G	31	5.452G	32	5.294G
33	5.573G	34	5.461G	35	5.267G	36	5.376G
37	5.471G	38	5.685G	39	5.363G	40	5.256G
41	5.278G	42	5.518G	43	5.393G	44	5.396G
45	5.305G	46	5.385G	47	5.272G	48	5.269G
49	5.444G	50	5.712G	51	5.532G	52	5.646G
53	5.623G	54	5.514G	55	5.508G	56	5.328G
57	5.650G	58	5.317G	59	5.581G	60	5.714G
61	5.647G	62	5.534G	63	5.304G	64	5.403G
65	5.715G	66	5.274G	67	5.724G	68	5.673G
69	5.355G	70	5.374G	71	5.507G	72	5.639G
73	5.335G	74	5.442G	75	5.406G	76	5.509G
77	5.590G	78	5.655G	79	5.303G	80	5.459G
81	5.511G	82	5.296G	83	5.572G	84	5.499G
85	5.580G	86	5.548G	87	5.453G	88	5.466G
89	5.567G	90	5.614G	91	5.648G	92	5.323G
93	5.491G	94	5.481G	95	5.318G	96	5.705G
97	5.554G	98	5.372G	99	5.400G	100	5.621G

Hopping Frequency Sequence Name: HOP_FREQ_SEQ_02							
SEQ#	Frequency (Hz)	SEQ#	Frequency (Hz)	SEQ#	Frequency (Hz)	SEQ#	Frequency (Hz)
1	5.509G	2	5.630G	3	5.452G	4	5.692G
5	5.447G	6	5.312G	7	5.566G	8	5.306G
9	5.635G	10	5.674G	11	5.365G	12	5.424G
13	5.594G	14	5.668G	15	5.458G	16	5.676G
17	5.505G	18	5.444G	19	5.706G	20	5.704G

21	5.422G	22	5.528G	23	5.639G	24	5.294G
25	5.552G	26	5.570G	27	5.521G	28	5.545G
29	5.286G	30	5.636G	31	5.687G	32	5.432G
33	5.694G	34	5.641G	35	5.679G	36	5.673G
37	5.323G	38	5.571G	39	5.476G	40	5.722G
41	5.333G	42	5.307G	43	5.279G	44	5.592G
45	5.695G	46	5.638G	47	5.474G	48	5.684G
49	5.622G	50	5.648G	51	5.624G	52	5.559G
53	5.273G	54	5.462G	55	5.518G	56	5.470G
57	5.659G	58	5.669G	59	5.439G	60	5.547G
61	5.328G	62	5.420G	63	5.258G	64	5.602G
65	5.348G	66	5.703G	67	5.361G	68	5.256G
69	5.284G	70	5.723G	71	5.535G	72	5.599G
73	5.608G	74	5.714G	75	5.657G	76	5.561G
77	5.513G	78	5.393G	79	5.554G	80	5.681G
81	5.666G	82	5.285G	83	5.584G	84	5.485G
85	5.301G	86	5.585G	87	5.310G	88	5.555G
89	5.690G	90	5.434G	91	5.421G	92	5.385G
93	5.568G	94	5.548G	95	5.363G	96	5.330G
97	5.386G	98	5.262G	99	5.475G	100	5.562G

Hopping Frequency Sequence Name: HOP_FREQ_SEQ_03							
SEQ#	Frequency (Hz)	SEQ#	Frequency (Hz)	SEQ#	Frequency (Hz)	SEQ#	Frequency (Hz)
1	5.425G	2	5.296G	3	5.541G	4	5.485G
5	5.609G	6	5.550G	7	5.565G	8	5.505G
9	5.270G	10	5.439G	11	5.597G	12	5.632G
13	5.599G	14	5.305G	15	5.454G	16	5.489G
17	5.299G	18	5.272G	19	5.428G	20	5.634G
21	5.562G	22	5.482G	23	5.623G	24	5.620G
25	5.645G	26	5.637G	27	5.646G	28	5.576G
29	5.359G	30	5.386G	31	5.472G	32	5.376G
33	5.548G	34	5.554G	35	5.606G	36	5.508G
37	5.529G	38	5.481G	39	5.350G	40	5.578G
41	5.630G	42	5.354G	43	5.512G	44	5.362G
45	5.448G	46	5.335G	47	5.273G	48	5.311G
49	5.251G	50	5.365G	51	5.266G	52	5.467G
53	5.542G	54	5.569G	55	5.723G	56	5.666G

57	5.414G	58	5.709G	59	5.268G	60	5.547G
61	5.331G	62	5.430G	63	5.461G	64	5.551G
65	5.338G	66	5.343G	67	5.337G	68	5.557G
69	5.644G	70	5.347G	71	5.440G	72	5.378G
73	5.451G	74	5.294G	75	5.342G	76	5.295G
77	5.667G	78	5.699G	79	5.492G	80	5.260G
81	5.465G	82	5.290G	83	5.591G	84	5.250G
85	5.560G	86	5.607G	87	5.507G	88	5.391G
89	5.714G	90	5.476G	91	5.462G	92	5.681G
93	5.544G	94	5.657G	95	5.671G	96	5.315G
97	5.438G	98	5.594G	99	5.694G	100	5.446G

Hopping Frequency Sequence Name: HOP_FREQ_SEQ_04							
SEQ#	Frequency (Hz)	SEQ#	Frequency (Hz)	SEQ#	Frequency (Hz)	SEQ#	Frequency (Hz)
1	5.656G	2	5.317G	3	5.710G	4	5.659G
5	5.320G	6	5.553G	7	5.341G	8	5.424G
9	5.346G	10	5.700G	11	5.295G	12	5.688G
13	5.508G	14	5.433G	15	5.363G	16	5.614G
17	5.357G	18	5.293G	19	5.567G	20	5.489G
21	5.271G	22	5.343G	23	5.380G	24	5.570G
25	5.379G	26	5.305G	27	5.267G	28	5.288G
29	5.371G	30	5.683G	31	5.446G	32	5.311G
33	5.259G	34	5.352G	35	5.270G	36	5.699G
37	5.462G	38	5.501G	39	5.602G	40	5.289G
41	5.684G	42	5.434G	43	5.629G	44	5.715G
45	5.313G	46	5.429G	47	5.253G	48	5.260G
49	5.539G	50	5.717G	51	5.547G	52	5.419G
53	5.596G	54	5.251G	55	5.377G	56	5.531G
57	5.612G	58	5.476G	59	5.403G	60	5.442G
61	5.580G	62	5.663G	63	5.706G	64	5.453G
65	5.461G	66	5.677G	67	5.427G	68	5.518G
69	5.438G	70	5.721G	71	5.587G	72	5.359G
73	5.397G	74	5.304G	75	5.641G	76	5.474G
77	5.537G	78	5.650G	79	5.485G	80	5.696G
81	5.675G	82	5.588G	83	5.389G	84	5.600G
85	5.323G	86	5.516G	87	5.458G	88	5.571G
89	5.319G	90	5.354G	91	5.477G	92	5.291G

93	5.692G	94	5.422G	95	5.425G	96	5.671G
97	5.393G	98	5.497G	99	5.407G	100	5.413G

Hopping Frequency Sequence Name: HOP_FREQ_SEQ_05							
SEQ#	Frequency (Hz)	SEQ#	Frequency (Hz)	SEQ#	Frequency (Hz)	SEQ#	Frequency (Hz)
1	5.433G	2	5.522G	3	5.546G	4	5.617G
5	5.350G	6	5.599G	7	5.588G	8	5.385G
9	5.605G	10	5.484G	11	5.670G	12	5.694G
13	5.352G	14	5.544G	15	5.489G	16	5.677G
17	5.337G	18	5.394G	19	5.625G	20	5.285G
21	5.566G	22	5.435G	23	5.581G	24	5.331G
25	5.474G	26	5.280G	27	5.381G	28	5.400G
29	5.348G	30	5.446G	31	5.282G	32	5.398G
33	5.693G	34	5.336G	35	5.276G	36	5.448G
37	5.638G	38	5.371G	39	5.417G	40	5.587G
41	5.696G	42	5.574G	43	5.314G	44	5.536G
45	5.437G	46	5.405G	47	5.289G	48	5.675G
49	5.553G	50	5.298G	51	5.479G	52	5.263G
53	5.613G	54	5.295G	55	5.712G	56	5.653G
57	5.302G	58	5.538G	59	5.500G	60	5.353G
61	5.368G	62	5.416G	63	5.534G	64	5.711G
65	5.384G	66	5.632G	67	5.426G	68	5.283G
69	5.469G	70	5.418G	71	5.253G	72	5.430G
73	5.572G	74	5.620G	75	5.481G	76	5.668G
77	5.424G	78	5.559G	79	5.511G	80	5.335G
81	5.499G	82	5.319G	83	5.698G	84	5.709G
85	5.649G	86	5.376G	87	5.655G	88	5.383G
89	5.305G	90	5.614G	91	5.718G	92	5.357G
93	5.691G	94	5.409G	95	5.676G	96	5.429G
97	5.505G	98	5.703G	99	5.466G	100	5.389G

Hopping Frequency Sequence Name: HOP_FREQ_SEQ_06							
SEQ#	Frequency (Hz)	SEQ#	Frequency (Hz)	SEQ#	Frequency (Hz)	SEQ#	Frequency (Hz)
1	5.389G	2	5.339G	3	5.605G	4	5.388G
5	5.462G	6	5.676G	7	5.319G	8	5.322G
9	5.639G	10	5.379G	11	5.521G	12	5.371G

13	5.311G	14	5.414G	15	5.252G	16	5.398G
17	5.364G	18	5.723G	19	5.530G	20	5.348G
21	5.474G	22	5.509G	23	5.589G	24	5.574G
25	5.316G	26	5.279G	27	5.271G	28	5.257G
29	5.563G	30	5.699G	31	5.366G	32	5.611G
33	5.384G	34	5.643G	35	5.479G	36	5.579G
37	5.353G	38	5.487G	39	5.571G	40	5.272G
41	5.432G	42	5.422G	43	5.302G	44	5.260G
45	5.508G	46	5.281G	47	5.515G	48	5.400G
49	5.645G	50	5.291G	51	5.706G	52	5.282G
53	5.288G	54	5.453G	55	5.259G	56	5.406G
57	5.674G	58	5.687G	59	5.554G	60	5.710G
61	5.629G	62	5.654G	63	5.449G	64	5.557G
65	5.440G	66	5.323G	67	5.267G	68	5.624G
69	5.256G	70	5.516G	71	5.410G	72	5.581G
73	5.619G	74	5.341G	75	5.627G	76	5.346G
77	5.418G	78	5.625G	79	5.304G	80	5.338G
81	5.481G	82	5.454G	83	5.600G	84	5.365G
85	5.497G	86	5.667G	87	5.537G	88	5.568G
89	5.606G	90	5.287G	91	5.385G	92	5.693G
93	5.548G	94	5.702G	95	5.421G	96	5.513G
97	5.357G	98	5.675G	99	5.583G	100	5.598G

Hopping Frequency Sequence Name: HOP_FREQ_SEQ_07							
SEQ#	Frequency (Hz)	SEQ#	Frequency (Hz)	SEQ#	Frequency (Hz)	SEQ#	Frequency (Hz)
1	5.321G	2	5.701G	3	5.598G	4	5.530G
5	5.459G	6	5.522G	7	5.542G	8	5.543G
9	5.623G	10	5.463G	11	5.326G	12	5.711G
13	5.347G	14	5.674G	15	5.427G	16	5.571G
17	5.639G	18	5.669G	19	5.298G	20	5.304G
21	5.470G	22	5.315G	23	5.709G	24	5.556G
25	5.641G	26	5.299G	27	5.567G	28	5.564G
29	5.405G	30	5.291G	31	5.544G	32	5.262G
33	5.670G	34	5.577G	35	5.314G	36	5.679G
37	5.539G	38	5.387G	39	5.392G	40	5.699G
41	5.562G	42	5.478G	43	5.633G	44	5.502G
45	5.609G	46	5.305G	47	5.710G	48	5.451G

49	5.379G	50	5.707G	51	5.434G	52	5.296G
53	5.651G	54	5.700G	55	5.632G	56	5.663G
57	5.681G	58	5.369G	59	5.320G	60	5.561G
61	5.391G	62	5.307G	63	5.557G	64	5.295G
65	5.510G	66	5.273G	67	5.414G	68	5.662G
69	5.394G	70	5.489G	71	5.403G	72	5.390G
73	5.368G	74	5.601G	75	5.443G	76	5.383G
77	5.688G	78	5.704G	79	5.269G	80	5.327G
81	5.381G	82	5.409G	83	5.480G	84	5.565G
85	5.288G	86	5.250G	87	5.566G	88	5.366G
89	5.724G	90	5.361G	91	5.393G	92	5.375G
93	5.482G	94	5.647G	95	5.666G	96	5.549G
97	5.495G	98	5.593G	99	5.294G	100	5.572G

Hopping Frequency Sequence Name: HOP_FREQ_SEQ_08							
SEQ#	Frequency (Hz)	SEQ#	Frequency (Hz)	SEQ#	Frequency (Hz)	SEQ#	Frequency (Hz)
1	5.291G	2	5.486G	3	5.278G	4	5.310G
5	5.391G	6	5.386G	7	5.669G	8	5.530G
9	5.641G	10	5.490G	11	5.704G	12	5.263G
13	5.687G	14	5.475G	15	5.533G	16	5.538G
17	5.268G	18	5.593G	19	5.438G	20	5.517G
21	5.332G	22	5.683G	23	5.376G	24	5.305G
25	5.539G	26	5.544G	27	5.510G	28	5.255G
29	5.321G	30	5.274G	31	5.442G	32	5.322G
33	5.629G	34	5.661G	35	5.709G	36	5.439G
37	5.648G	38	5.571G	39	5.393G	40	5.257G
41	5.444G	42	5.532G	43	5.498G	44	5.576G
45	5.520G	46	5.597G	47	5.276G	48	5.636G
49	5.330G	50	5.684G	51	5.359G	52	5.483G
53	5.529G	54	5.525G	55	5.504G	56	5.368G
57	5.425G	58	5.303G	59	5.372G	60	5.711G
61	5.329G	62	5.463G	63	5.616G	64	5.289G
65	5.692G	66	5.723G	67	5.551G	68	5.296G
69	5.622G	70	5.251G	71	5.264G	72	5.719G
73	5.561G	74	5.695G	75	5.508G	76	5.375G
77	5.407G	78	5.428G	79	5.344G	80	5.598G
81	5.479G	82	5.617G	83	5.354G	84	5.574G

85	5.286G	86	5.534G	87	5.499G	88	5.547G
89	5.473G	90	5.714G	91	5.706G	92	5.663G
93	5.639G	94	5.273G	95	5.608G	96	5.474G
97	5.720G	98	5.456G	99	5.647G	100	5.250G

Hopping Frequency Sequence Name: HOP_FREQ_SEQ_09							
SEQ#	Frequency (Hz)	SEQ#	Frequency (Hz)	SEQ#	Frequency (Hz)	SEQ#	Frequency (Hz)
1	5.637G	2	5.540G	3	5.619G	4	5.273G
5	5.262G	6	5.537G	7	5.565G	8	5.710G
9	5.510G	10	5.713G	11	5.652G	12	5.549G
13	5.403G	14	5.708G	15	5.469G	16	5.491G
17	5.506G	18	5.444G	19	5.709G	20	5.339G
21	5.640G	22	5.426G	23	5.475G	24	5.482G
25	5.371G	26	5.503G	27	5.282G	28	5.568G
29	5.591G	30	5.563G	31	5.670G	32	5.408G
33	5.451G	34	5.374G	35	5.642G	36	5.586G
37	5.684G	38	5.377G	39	5.553G	40	5.564G
41	5.443G	42	5.466G	43	5.442G	44	5.316G
45	5.301G	46	5.501G	47	5.380G	48	5.257G
49	5.404G	50	5.386G	51	5.327G	52	5.417G
53	5.474G	54	5.416G	55	5.655G	56	5.291G
57	5.434G	58	5.518G	59	5.604G	60	5.592G
61	5.465G	62	5.541G	63	5.322G	64	5.718G
65	5.468G	66	5.588G	67	5.269G	68	5.289G
69	5.346G	70	5.632G	71	5.410G	72	5.362G
73	5.392G	74	5.283G	75	5.561G	76	5.516G
77	5.528G	78	5.650G	79	5.439G	80	5.615G
81	5.486G	82	5.310G	83	5.543G	84	5.626G
85	5.280G	86	5.266G	87	5.368G	88	5.252G
89	5.460G	90	5.400G	91	5.298G	92	5.405G
93	5.420G	94	5.302G	95	5.587G	96	5.329G
97	5.569G	98	5.472G	99	5.263G	100	5.665G

Hopping Frequency Sequence Name: HOP_FREQ_SEQ_10							
SEQ#	Frequency (Hz)	SEQ#	Frequency (Hz)	SEQ#	Frequency (Hz)	SEQ#	Frequency (Hz)
1	5.631G	2	5.465G	3	5.433G	4	5.478G
5	5.398G	6	5.603G	7	5.394G	8	5.490G
9	5.318G	10	5.372G	11	5.646G	12	5.491G
13	5.517G	14	5.384G	15	5.271G	16	5.451G
17	5.685G	18	5.415G	19	5.336G	20	5.470G
21	5.587G	22	5.520G	23	5.508G	24	5.484G
25	5.509G	26	5.629G	27	5.279G	28	5.393G
29	5.266G	30	5.571G	31	5.388G	32	5.298G
33	5.659G	34	5.482G	35	5.467G	36	5.680G
37	5.414G	38	5.281G	39	5.636G	40	5.359G
41	5.427G	42	5.501G	43	5.447G	44	5.573G
45	5.432G	46	5.278G	47	5.689G	48	5.658G
49	5.688G	50	5.519G	51	5.515G	52	5.641G
53	5.309G	54	5.475G	55	5.457G	56	5.317G
57	5.670G	58	5.346G	59	5.581G	60	5.329G
61	5.536G	62	5.604G	63	5.690G	64	5.557G
65	5.331G	66	5.399G	67	5.316G	68	5.650G
69	5.370G	70	5.651G	71	5.322G	72	5.469G
73	5.251G	74	5.714G	75	5.314G	76	5.485G
77	5.489G	78	5.411G	79	5.498G	80	5.376G
81	5.561G	82	5.321G	83	5.453G	84	5.363G
85	5.367G	86	5.455G	87	5.600G	88	5.431G
89	5.459G	90	5.634G	91	5.656G	92	5.254G
93	5.409G	94	5.550G	95	5.313G	96	5.695G
97	5.562G	98	5.534G	99	5.288G	100	5.291G

Hopping Frequency Sequence Name: HOP_FREQ_SEQ_11							
SEQ#	Frequency (Hz)	SEQ#	Frequency (Hz)	SEQ#	Frequency (Hz)	SEQ#	Frequency (Hz)
1	5.377G	2	5.523G	3	5.294G	4	5.434G
5	5.430G	6	5.438G	7	5.625G	8	5.541G
9	5.350G	10	5.311G	11	5.267G	12	5.694G
13	5.537G	14	5.280G	15	5.603G	16	5.315G
17	5.285G	18	5.577G	19	5.333G	20	5.457G
21	5.283G	22	5.633G	23	5.455G	24	5.502G
25	5.668G	26	5.706G	27	5.339G	28	5.321G
29	5.717G	30	5.566G	31	5.604G	32	5.570G
33	5.608G	34	5.270G	35	5.722G	36	5.379G
37	5.391G	38	5.671G	39	5.279G	40	5.378G
41	5.647G	42	5.649G	43	5.677G	44	5.612G
45	5.396G	46	5.300G	47	5.297G	48	5.591G
49	5.319G	50	5.558G	51	5.299G	52	5.495G
53	5.424G	54	5.611G	55	5.351G	56	5.529G
57	5.334G	58	5.629G	59	5.303G	60	5.710G
61	5.641G	62	5.423G	63	5.460G	64	5.593G
65	5.648G	66	5.251G	67	5.583G	68	5.667G
69	5.256G	70	5.621G	71	5.554G	72	5.473G
73	5.341G	74	5.390G	75	5.307G	76	5.400G
77	5.394G	78	5.601G	79	5.492G	80	5.521G
81	5.491G	82	5.560G	83	5.638G	84	5.687G
85	5.620G	86	5.506G	87	5.346G	88	5.269G
89	5.498G	90	5.719G	91	5.622G	92	5.659G
93	5.600G	94	5.695G	95	5.301G	96	5.259G
97	5.658G	98	5.661G	99	5.331G	100	5.553G

Hopping Frequency Sequence Name: HOP_FREQ_SEQ_12							
SEQ#	Frequency (Hz)	SEQ#	Frequency (Hz)	SEQ#	Frequency (Hz)	SEQ#	Frequency (Hz)
1	5.286G	2	5.333G	3	5.361G	4	5.336G
5	5.607G	6	5.500G	7	5.307G	8	5.459G
9	5.544G	10	5.564G	11	5.505G	12	5.400G
13	5.377G	14	5.546G	15	5.589G	16	5.320G
17	5.528G	18	5.387G	19	5.550G	20	5.721G
21	5.557G	22	5.616G	23	5.419G	24	5.502G
25	5.645G	26	5.611G	27	5.629G	28	5.363G
29	5.585G	30	5.474G	31	5.277G	32	5.393G
33	5.430G	34	5.283G	35	5.349G	36	5.327G
37	5.599G	38	5.582G	39	5.624G	40	5.405G
41	5.603G	42	5.296G	43	5.391G	44	5.677G
45	5.347G	46	5.298G	47	5.295G	48	5.406G
49	5.426G	50	5.686G	51	5.492G	52	5.465G
53	5.643G	54	5.628G	55	5.515G	56	5.447G
57	5.511G	58	5.388G	59	5.389G	60	5.495G
61	5.671G	62	5.529G	63	5.415G	64	5.683G
65	5.341G	66	5.446G	67	5.556G	68	5.306G
69	5.670G	70	5.651G	71	5.630G	72	5.707G
73	5.482G	74	5.262G	75	5.655G	76	5.698G
77	5.448G	78	5.553G	79	5.496G	80	5.572G
81	5.609G	82	5.692G	83	5.700G	84	5.463G
85	5.647G	86	5.445G	87	5.576G	88	5.719G
89	5.297G	90	5.650G	91	5.352G	92	5.696G
93	5.408G	94	5.407G	95	5.543G	96	5.704G
97	5.290G	98	5.548G	99	5.285G	100	5.517G

Hopping Frequency Sequence Name: HOP_FREQ_SEQ_13							
SEQ#	Frequency (Hz)	SEQ#	Frequency (Hz)	SEQ#	Frequency (Hz)	SEQ#	Frequency (Hz)
1	5.517G	2	5.619G	3	5.714G	4	5.399G
5	5.516G	6	5.573G	7	5.446G	8	5.341G
9	5.372G	10	5.342G	11	5.507G	12	5.395G
13	5.296G	14	5.256G	15	5.479G	16	5.574G
17	5.599G	18	5.480G	19	5.521G	20	5.321G
21	5.648G	22	5.427G	23	5.269G	24	5.566G
25	5.669G	26	5.358G	27	5.311G	28	5.292G
29	5.605G	30	5.712G	31	5.524G	32	5.400G
33	5.724G	34	5.501G	35	5.609G	36	5.513G
37	5.695G	38	5.649G	39	5.709G	40	5.432G
41	5.646G	42	5.383G	43	5.376G	44	5.684G
45	5.590G	46	5.430G	47	5.413G	48	5.384G
49	5.635G	50	5.716G	51	5.352G	52	5.356G
53	5.487G	54	5.601G	55	5.441G	56	5.622G
57	5.465G	58	5.528G	59	5.417G	60	5.390G
61	5.283G	62	5.674G	63	5.522G	64	5.431G
65	5.401G	66	5.705G	67	5.692G	68	5.408G
69	5.466G	70	5.381G	71	5.488G	72	5.509G
73	5.267G	74	5.661G	75	5.581G	76	5.405G
77	5.469G	78	5.656G	79	5.305G	80	5.549G
81	5.582G	82	5.456G	83	5.259G	84	5.377G
85	5.554G	86	5.319G	87	5.523G	88	5.302G
89	5.594G	90	5.293G	91	5.722G	92	5.641G
93	5.644G	94	5.453G	95	5.470G	96	5.503G
97	5.659G	98	5.330G	99	5.397G	100	5.557G

Hopping Frequency Sequence Name: HOP_FREQ_SEQ_14							
SEQ#	Frequency (Hz)	SEQ#	Frequency (Hz)	SEQ#	Frequency (Hz)	SEQ#	Frequency (Hz)
1	5.293G	2	5.445G	3	5.287G	4	5.497G
5	5.660G	6	5.352G	7	5.637G	8	5.709G
9	5.333G	10	5.427G	11	5.367G	12	5.469G
13	5.577G	14	5.613G	15	5.459G	16	5.372G
17	5.284G	18	5.252G	19	5.521G	20	5.619G
21	5.487G	22	5.379G	23	5.353G	24	5.382G
25	5.433G	26	5.271G	27	5.563G	28	5.695G
29	5.506G	30	5.686G	31	5.565G	32	5.300G
33	5.569G	34	5.568G	35	5.345G	36	5.708G
37	5.283G	38	5.502G	39	5.662G	40	5.260G
41	5.404G	42	5.710G	43	5.674G	44	5.648G
45	5.281G	46	5.610G	47	5.299G	48	5.551G
49	5.474G	50	5.622G	51	5.529G	52	5.458G
53	5.553G	54	5.416G	55	5.638G	56	5.307G
57	5.524G	58	5.491G	59	5.492G	60	5.696G
61	5.693G	62	5.251G	63	5.517G	64	5.470G
65	5.477G	66	5.523G	67	5.667G	68	5.360G
69	5.418G	70	5.533G	71	5.588G	72	5.426G
73	5.349G	74	5.682G	75	5.626G	76	5.324G
77	5.454G	78	5.485G	79	5.348G	80	5.280G
81	5.436G	82	5.659G	83	5.567G	84	5.365G
85	5.268G	86	5.482G	87	5.664G	88	5.376G
89	5.576G	90	5.630G	91	5.699G	92	5.289G
93	5.496G	94	5.547G	95	5.413G	96	5.559G
97	5.311G	98	5.480G	99	5.440G	100	5.295G

Hopping Frequency Sequence Name: HOP_FREQ_SEQ_15							
SEQ#	Frequency (Hz)	SEQ#	Frequency (Hz)	SEQ#	Frequency (Hz)	SEQ#	Frequency (Hz)
1	5.696G	2	5.616G	3	5.724G	4	5.580G
5	5.491G	6	5.647G	7	5.555G	8	5.607G
9	5.489G	10	5.306G	11	5.570G	12	5.255G
13	5.656G	14	5.291G	15	5.664G	16	5.705G
17	5.537G	18	5.376G	19	5.406G	20	5.413G
21	5.550G	22	5.501G	23	5.441G	24	5.443G
25	5.707G	26	5.509G	27	5.366G	28	5.260G
29	5.613G	30	5.536G	31	5.547G	32	5.373G
33	5.637G	34	5.294G	35	5.578G	36	5.556G
37	5.287G	38	5.485G	39	5.602G	40	5.657G
41	5.519G	42	5.606G	43	5.393G	44	5.632G
45	5.381G	46	5.293G	47	5.506G	48	5.722G
49	5.588G	50	5.652G	51	5.292G	52	5.716G
53	5.544G	54	5.363G	55	5.524G	56	5.513G
57	5.454G	58	5.462G	59	5.412G	60	5.521G
61	5.620G	62	5.370G	63	5.511G	64	5.693G
65	5.641G	66	5.666G	67	5.433G	68	5.562G
69	5.690G	70	5.375G	71	5.589G	72	5.688G
73	5.532G	74	5.480G	75	5.364G	76	5.683G
77	5.568G	78	5.402G	79	5.309G	80	5.704G
81	5.259G	82	5.539G	83	5.408G	84	5.540G
85	5.430G	86	5.386G	87	5.391G	88	5.507G
89	5.627G	90	5.416G	91	5.446G	92	5.298G
93	5.551G	94	5.350G	95	5.336G	96	5.362G
97	5.700G	98	5.590G	99	5.343G	100	5.667G

Hopping Frequency Sequence Name: HOP_FREQ_SEQ_16							
SEQ#	Frequency (Hz)	SEQ#	Frequency (Hz)	SEQ#	Frequency (Hz)	SEQ#	Frequency (Hz)
1	5.368G	2	5.373G	3	5.380G	4	5.441G
5	5.322G	6	5.572G	7	5.561G	8	5.281G
9	5.326G	10	5.676G	11	5.674G	12	5.453G
13	5.500G	14	5.485G	15	5.460G	16	5.641G
17	5.617G	18	5.722G	19	5.473G	20	5.423G
21	5.602G	22	5.483G	23	5.635G	24	5.338G
25	5.656G	26	5.298G	27	5.466G	28	5.420G
29	5.411G	30	5.481G	31	5.271G	32	5.402G
33	5.591G	34	5.306G	35	5.666G	36	5.636G
37	5.458G	38	5.261G	39	5.341G	40	5.702G
41	5.324G	42	5.251G	43	5.396G	44	5.518G
45	5.645G	46	5.701G	47	5.550G	48	5.408G
49	5.465G	50	5.643G	51	5.331G	52	5.442G
53	5.625G	54	5.325G	55	5.681G	56	5.355G
57	5.436G	58	5.668G	59	5.434G	60	5.563G
61	5.422G	62	5.557G	63	5.292G	64	5.573G
65	5.496G	66	5.566G	67	5.429G	68	5.445G
69	5.578G	70	5.269G	71	5.686G	72	5.646G
73	5.319G	74	5.632G	75	5.312G	76	5.601G
77	5.377G	78	5.268G	79	5.615G	80	5.477G
81	5.697G	82	5.608G	83	5.502G	84	5.595G
85	5.315G	86	5.522G	87	5.314G	88	5.403G
89	5.535G	90	5.363G	91	5.470G	92	5.538G
93	5.419G	94	5.590G	95	5.447G	96	5.547G
97	5.541G	98	5.564G	99	5.435G	100	5.510G

Hopping Frequency Sequence Name: HOP_FREQ_SEQ_17							
SEQ#	Frequency (Hz)	SEQ#	Frequency (Hz)	SEQ#	Frequency (Hz)	SEQ#	Frequency (Hz)
1	5.712G	2	5.390G	3	5.338G	4	5.702G
5	5.623G	6	5.566G	7	5.531G	8	5.660G
9	5.550G	10	5.264G	11	5.339G	12	5.663G
13	5.533G	14	5.540G	15	5.557G	16	5.475G
17	5.604G	18	5.611G	19	5.593G	20	5.351G
21	5.622G	22	5.386G	23	5.569G	24	5.427G
25	5.689G	26	5.645G	27	5.469G	28	5.654G
29	5.532G	30	5.317G	31	5.587G	32	5.501G
33	5.389G	34	5.643G	35	5.687G	36	5.350G
37	5.251G	38	5.614G	39	5.278G	40	5.268G
41	5.465G	42	5.620G	43	5.497G	44	5.312G
45	5.556G	46	5.592G	47	5.415G	48	5.461G
49	5.254G	50	5.579G	51	5.492G	52	5.496G
53	5.394G	54	5.273G	55	5.699G	56	5.256G
57	5.698G	58	5.286G	59	5.562G	60	5.455G
61	5.537G	62	5.688G	63	5.572G	64	5.674G
65	5.635G	66	5.507G	67	5.709G	68	5.684G
69	5.330G	70	5.680G	71	5.559G	72	5.551G
73	5.505G	74	5.414G	75	5.320G	76	5.483G
77	5.391G	78	5.319G	79	5.411G	80	5.491G
81	5.661G	82	5.677G	83	5.464G	84	5.607G
85	5.334G	86	5.280G	87	5.348G	88	5.650G
89	5.425G	90	5.721G	91	5.573G	92	5.275G
93	5.451G	94	5.499G	95	5.416G	96	5.696G
97	5.715G	98	5.541G	99	5.638G	100	5.681G

Hopping Frequency Sequence Name: HOP_FREQ_SEQ_18							
SEQ#	Frequency (Hz)	SEQ#	Frequency (Hz)	SEQ#	Frequency (Hz)	SEQ#	Frequency (Hz)
1	5.674G	2	5.592G	3	5.699G	4	5.417G
5	5.694G	6	5.256G	7	5.613G	8	5.607G
9	5.313G	10	5.267G	11	5.268G	12	5.655G
13	5.715G	14	5.593G	15	5.326G	16	5.632G
17	5.308G	18	5.711G	19	5.516G	20	5.605G
21	5.393G	22	5.464G	23	5.557G	24	5.587G
25	5.282G	26	5.262G	27	5.333G	28	5.672G
29	5.351G	30	5.582G	31	5.496G	32	5.497G
33	5.665G	34	5.571G	35	5.390G	36	5.271G
37	5.558G	38	5.429G	39	5.590G	40	5.509G
41	5.618G	42	5.514G	43	5.260G	44	5.296G
45	5.611G	46	5.386G	47	5.426G	48	5.483G
49	5.601G	50	5.594G	51	5.329G	52	5.673G
53	5.576G	54	5.336G	55	5.666G	56	5.652G
57	5.690G	58	5.482G	59	5.657G	60	5.722G
61	5.255G	62	5.685G	63	5.395G	64	5.600G
65	5.548G	66	5.498G	67	5.305G	68	5.315G
69	5.658G	70	5.499G	71	5.689G	72	5.476G
73	5.408G	74	5.465G	75	5.595G	76	5.278G
77	5.502G	78	5.444G	79	5.366G	80	5.331G
81	5.653G	82	5.564G	83	5.561G	84	5.347G
85	5.481G	86	5.449G	87	5.705G	88	5.619G
89	5.677G	90	5.570G	91	5.532G	92	5.382G
93	5.602G	94	5.629G	95	5.660G	96	5.698G
97	5.349G	98	5.283G	99	5.562G	100	5.578G

Hopping Frequency Sequence Name: HOP_FREQ_SEQ_19							
SEQ#	Frequency (Hz)	SEQ#	Frequency (Hz)	SEQ#	Frequency (Hz)	SEQ#	Frequency (Hz)
1	5.361G	2	5.418G	3	5.376G	4	5.603G
5	5.346G	6	5.513G	7	5.252G	8	5.397G
9	5.428G	10	5.474G	11	5.465G	12	5.541G
13	5.685G	14	5.681G	15	5.272G	16	5.324G
17	5.521G	18	5.481G	19	5.508G	20	5.472G
21	5.259G	22	5.690G	23	5.548G	24	5.478G
25	5.251G	26	5.682G	27	5.680G	28	5.447G
29	5.488G	30	5.380G	31	5.684G	32	5.514G
33	5.665G	34	5.643G	35	5.565G	36	5.302G
37	5.567G	38	5.381G	39	5.458G	40	5.316G
41	5.419G	42	5.661G	43	5.266G	44	5.285G
45	5.335G	46	5.504G	47	5.559G	48	5.562G
49	5.556G	50	5.612G	51	5.686G	52	5.435G
53	5.271G	54	5.699G	55	5.366G	56	5.384G
57	5.456G	58	5.442G	59	5.515G	60	5.678G
61	5.609G	62	5.640G	63	5.279G	64	5.708G
65	5.572G	66	5.638G	67	5.283G	68	5.590G
69	5.555G	70	5.356G	71	5.579G	72	5.294G
73	5.317G	74	5.278G	75	5.581G	76	5.322G
77	5.352G	78	5.660G	79	5.689G	80	5.360G
81	5.538G	82	5.319G	83	5.427G	84	5.455G
85	5.717G	86	5.657G	87	5.371G	88	5.321G
89	5.280G	90	5.402G	91	5.598G	92	5.483G
93	5.449G	94	5.476G	95	5.518G	96	5.692G
97	5.460G	98	5.524G	99	5.507G	100	5.705G

Hopping Frequency Sequence Name: HOP_FREQ_SEQ_20							
SEQ#	Frequency (Hz)	SEQ#	Frequency (Hz)	SEQ#	Frequency (Hz)	SEQ#	Frequency (Hz)
1	5.316G	2	5.553G	3	5.265G	4	5.389G
5	5.401G	6	5.407G	7	5.357G	8	5.691G
9	5.415G	10	5.416G	11	5.538G	12	5.372G
13	5.539G	14	5.327G	15	5.629G	16	5.605G
17	5.334G	18	5.465G	19	5.380G	20	5.328G
21	5.623G	22	5.491G	23	5.624G	24	5.625G
25	5.523G	26	5.514G	27	5.654G	28	5.584G
29	5.270G	30	5.511G	31	5.681G	32	5.306G
33	5.366G	34	5.703G	35	5.608G	36	5.503G
37	5.458G	38	5.633G	39	5.272G	40	5.345G
41	5.311G	42	5.483G	43	5.405G	44	5.496G
45	5.386G	46	5.643G	47	5.542G	48	5.600G
49	5.300G	50	5.290G	51	5.578G	52	5.268G
53	5.262G	54	5.572G	55	5.370G	56	5.369G
57	5.267G	58	5.621G	59	5.348G	60	5.396G
61	5.392G	62	5.540G	63	5.289G	64	5.517G
65	5.704G	66	5.617G	67	5.448G	68	5.606G
69	5.497G	70	5.495G	71	5.602G	72	5.378G
73	5.417G	74	5.335G	75	5.355G	76	5.271G
77	5.277G	78	5.611G	79	5.414G	80	5.630G
81	5.260G	82	5.699G	83	5.552G	84	5.307G
85	5.663G	86	5.439G	87	5.323G	88	5.471G
89	5.477G	90	5.720G	91	5.648G	92	5.436G
93	5.682G	94	5.604G	95	5.558G	96	5.634G
97	5.567G	98	5.356G	99	5.708G	100	5.652G

Hopping Frequency Sequence Name: HOP_FREQ_SEQ_21							
SEQ#	Frequency (Hz)	SEQ#	Frequency (Hz)	SEQ#	Frequency (Hz)	SEQ#	Frequency (Hz)
1	5.695G	2	5.392G	3	5.546G	4	5.452G
5	5.537G	6	5.523G	7	5.429G	8	5.522G
9	5.454G	10	5.492G	11	5.292G	12	5.328G
13	5.314G	14	5.321G	15	5.538G	16	5.330G
17	5.280G	18	5.533G	19	5.518G	20	5.384G
21	5.263G	22	5.436G	23	5.525G	24	5.590G
25	5.306G	26	5.285G	27	5.605G	28	5.653G
29	5.610G	30	5.458G	31	5.644G	32	5.694G
33	5.723G	34	5.374G	35	5.368G	36	5.565G
37	5.614G	38	5.270G	39	5.683G	40	5.255G
41	5.648G	42	5.634G	43	5.664G	44	5.484G
45	5.548G	46	5.419G	47	5.344G	48	5.371G
49	5.380G	50	5.607G	51	5.573G	52	5.293G
53	5.420G	54	5.567G	55	5.579G	56	5.503G
57	5.445G	58	5.296G	59	5.603G	60	5.414G
61	5.709G	62	5.516G	63	5.651G	64	5.411G
65	5.515G	66	5.432G	67	5.252G	68	5.604G
69	5.589G	70	5.323G	71	5.509G	72	5.671G
73	5.449G	74	5.491G	75	5.710G	76	5.588G
77	5.266G	78	5.622G	79	5.536G	80	5.372G
81	5.615G	82	5.268G	83	5.336G	84	5.471G
85	5.582G	86	5.382G	87	5.381G	88	5.387G
89	5.279G	90	5.264G	91	5.308G	92	5.278G
93	5.496G	94	5.404G	95	5.262G	96	5.322G
97	5.624G	98	5.534G	99	5.399G	100	5.506G

Hopping Frequency Sequence Name: HOP_FREQ_SEQ_22							
SEQ#	Frequency (Hz)	SEQ#	Frequency (Hz)	SEQ#	Frequency (Hz)	SEQ#	Frequency (Hz)
1	5.274G	2	5.442G	3	5.557G	4	5.352G
5	5.424G	6	5.359G	7	5.448G	8	5.518G
9	5.576G	10	5.374G	11	5.313G	12	5.621G
13	5.651G	14	5.574G	15	5.304G	16	5.335G
17	5.549G	18	5.280G	19	5.612G	20	5.567G
21	5.388G	22	5.646G	23	5.472G	24	5.586G
25	5.650G	26	5.553G	27	5.413G	28	5.721G
29	5.287G	30	5.373G	31	5.634G	32	5.435G
33	5.601G	34	5.266G	35	5.316G	36	5.578G
37	5.571G	38	5.301G	39	5.264G	40	5.688G
41	5.581G	42	5.370G	43	5.420G	44	5.291G
45	5.415G	46	5.329G	47	5.332G	48	5.398G
49	5.609G	50	5.295G	51	5.458G	52	5.535G
53	5.632G	54	5.286G	55	5.258G	56	5.391G
57	5.250G	58	5.368G	59	5.643G	60	5.283G
61	5.503G	62	5.540G	63	5.599G	64	5.459G
65	5.439G	66	5.523G	67	5.659G	68	5.319G
69	5.252G	70	5.408G	71	5.440G	72	5.684G
73	5.642G	74	5.666G	75	5.447G	76	5.718G
77	5.454G	78	5.452G	79	5.671G	80	5.279G
81	5.308G	82	5.346G	83	5.284G	84	5.508G
85	5.501G	86	5.560G	87	5.520G	88	5.265G
89	5.652G	90	5.689G	91	5.697G	92	5.479G
93	5.397G	94	5.656G	95	5.685G	96	5.356G
97	5.500G	98	5.660G	99	5.515G	100	5.453G

Hopping Frequency Sequence Name: HOP_FREQ_SEQ_23							
SEQ#	Frequency (Hz)	SEQ#	Frequency (Hz)	SEQ#	Frequency (Hz)	SEQ#	Frequency (Hz)
1	5.536G	2	5.300G	3	5.286G	4	5.432G
5	5.456G	6	5.499G	7	5.486G	8	5.563G
9	5.548G	10	5.703G	11	5.393G	12	5.638G
13	5.713G	14	5.608G	15	5.384G	16	5.711G
17	5.274G	18	5.516G	19	5.335G	20	5.690G
21	5.611G	22	5.424G	23	5.305G	24	5.577G
25	5.594G	26	5.289G	27	5.546G	28	5.592G
29	5.380G	30	5.565G	31	5.629G	32	5.423G
33	5.470G	34	5.372G	35	5.717G	36	5.293G
37	5.451G	38	5.722G	39	5.390G	40	5.588G
41	5.418G	42	5.460G	43	5.463G	44	5.710G
45	5.310G	46	5.675G	47	5.363G	48	5.640G
49	5.630G	50	5.457G	51	5.543G	52	5.537G
53	5.329G	54	5.518G	55	5.567G	56	5.322G
57	5.617G	58	5.450G	59	5.515G	60	5.522G
61	5.323G	62	5.512G	63	5.336G	64	5.263G
65	5.691G	66	5.287G	67	5.441G	68	5.503G
69	5.309G	70	5.283G	71	5.250G	72	5.339G
73	5.487G	74	5.321G	75	5.290G	76	5.381G
77	5.253G	78	5.599G	79	5.268G	80	5.582G
81	5.328G	82	5.532G	83	5.679G	84	5.666G
85	5.539G	86	5.469G	87	5.655G	88	5.443G
89	5.511G	90	5.643G	91	5.285G	92	5.431G
93	5.656G	94	5.535G	95	5.627G	96	5.701G
97	5.438G	98	5.495G	99	5.449G	100	5.591G

Hopping Frequency Sequence Name: HOP_FREQ_SEQ_24							
SEQ#	Frequency (Hz)	SEQ#	Frequency (Hz)	SEQ#	Frequency (Hz)	SEQ#	Frequency (Hz)
1	5.408G	2	5.464G	3	5.693G	4	5.422G
5	5.360G	6	5.659G	7	5.485G	8	5.611G
9	5.317G	10	5.273G	11	5.594G	12	5.661G
13	5.359G	14	5.696G	15	5.518G	16	5.452G
17	5.400G	18	5.324G	19	5.677G	20	5.532G
21	5.407G	22	5.569G	23	5.372G	24	5.723G
25	5.309G	26	5.275G	27	5.637G	28	5.393G
29	5.251G	30	5.614G	31	5.484G	32	5.421G
33	5.262G	34	5.325G	35	5.454G	36	5.612G
37	5.351G	38	5.702G	39	5.604G	40	5.339G
41	5.520G	42	5.314G	43	5.283G	44	5.439G
45	5.682G	46	5.449G	47	5.342G	48	5.334G
49	5.304G	50	5.459G	51	5.675G	52	5.546G
53	5.302G	54	5.419G	55	5.326G	56	5.667G
57	5.411G	58	5.432G	59	5.705G	60	5.433G
61	5.349G	62	5.361G	63	5.668G	64	5.413G
65	5.552G	66	5.328G	67	5.338G	68	5.288G
69	5.694G	70	5.467G	71	5.620G	72	5.250G
73	5.628G	74	5.560G	75	5.582G	76	5.680G
77	5.347G	78	5.298G	79	5.426G	80	5.692G
81	5.458G	82	5.548G	83	5.337G	84	5.265G
85	5.386G	86	5.343G	87	5.424G	88	5.292G
89	5.563G	90	5.539G	91	5.724G	92	5.255G
93	5.365G	94	5.469G	95	5.389G	96	5.492G
97	5.268G	98	5.610G	99	5.438G	100	5.382G

Hopping Frequency Sequence Name: HOP_FREQ_SEQ_25							
SEQ#	Frequency (Hz)	SEQ#	Frequency (Hz)	SEQ#	Frequency (Hz)	SEQ#	Frequency (Hz)
1	5.391G	2	5.724G	3	5.502G	4	5.548G
5	5.703G	6	5.544G	7	5.385G	8	5.676G
9	5.301G	10	5.271G	11	5.665G	12	5.298G
13	5.308G	14	5.504G	15	5.413G	16	5.446G
17	5.401G	18	5.365G	19	5.414G	20	5.430G
21	5.509G	22	5.332G	23	5.389G	24	5.545G
25	5.705G	26	5.624G	27	5.658G	28	5.263G
29	5.568G	30	5.422G	31	5.497G	32	5.341G
33	5.486G	34	5.395G	35	5.329G	36	5.660G
37	5.325G	38	5.477G	39	5.619G	40	5.525G
41	5.297G	42	5.559G	43	5.580G	44	5.590G
45	5.423G	46	5.285G	47	5.720G	48	5.267G
49	5.350G	50	5.706G	51	5.340G	52	5.649G
53	5.338G	54	5.543G	55	5.562G	56	5.687G
57	5.362G	58	5.266G	59	5.524G	60	5.520G
61	5.560G	62	5.355G	63	5.715G	64	5.542G
65	5.487G	66	5.584G	67	5.718G	68	5.269G
69	5.599G	70	5.374G	71	5.260G	72	5.587G
73	5.574G	74	5.384G	75	5.552G	76	5.403G
77	5.351G	78	5.484G	79	5.281G	80	5.259G
81	5.460G	82	5.319G	83	5.330G	84	5.533G
85	5.277G	86	5.626G	87	5.490G	88	5.439G
89	5.613G	90	5.565G	91	5.553G	92	5.561G
93	5.453G	94	5.555G	95	5.608G	96	5.505G
97	5.287G	98	5.506G	99	5.376G	100	5.284G

Hopping Frequency Sequence Name: HOP_FREQ_SEQ_26							
SEQ#	Frequency (Hz)	SEQ#	Frequency (Hz)	SEQ#	Frequency (Hz)	SEQ#	Frequency (Hz)
1	5.518G	2	5.476G	3	5.593G	4	5.256G
5	5.688G	6	5.624G	7	5.579G	8	5.270G
9	5.450G	10	5.639G	11	5.529G	12	5.292G
13	5.607G	14	5.447G	15	5.627G	16	5.544G
17	5.410G	18	5.574G	19	5.671G	20	5.426G
21	5.681G	22	5.595G	23	5.538G	24	5.340G
25	5.708G	26	5.351G	27	5.552G	28	5.380G
29	5.543G	30	5.460G	31	5.568G	32	5.531G
33	5.284G	34	5.492G	35	5.322G	36	5.290G
37	5.375G	38	5.656G	39	5.541G	40	5.516G
41	5.573G	42	5.553G	43	5.417G	44	5.365G
45	5.522G	46	5.327G	47	5.637G	48	5.372G
49	5.266G	50	5.388G	51	5.338G	52	5.514G
53	5.662G	54	5.448G	55	5.703G	56	5.577G
57	5.361G	58	5.261G	59	5.303G	60	5.659G
61	5.696G	62	5.601G	63	5.721G	64	5.524G
65	5.378G	66	5.641G	67	5.480G	68	5.556G
69	5.420G	70	5.615G	71	5.407G	72	5.291G
73	5.631G	74	5.483G	75	5.680G	76	5.720G
77	5.557G	78	5.283G	79	5.633G	80	5.339G
81	5.438G	82	5.623G	83	5.495G	84	5.391G
85	5.702G	86	5.310G	87	5.349G	88	5.602G
89	5.353G	90	5.698G	91	5.473G	92	5.618G
93	5.506G	94	5.486G	95	5.718G	96	5.677G
97	5.534G	98	5.376G	99	5.300G	100	5.487G

Hopping Frequency Sequence Name: HOP_FREQ_SEQ_27							
SEQ#	Frequency (Hz)	SEQ#	Frequency (Hz)	SEQ#	Frequency (Hz)	SEQ#	Frequency (Hz)
1	5.337G	2	5.631G	3	5.477G	4	5.383G
5	5.506G	6	5.710G	7	5.590G	8	5.379G
9	5.455G	10	5.562G	11	5.572G	12	5.411G
13	5.529G	14	5.630G	15	5.671G	16	5.275G
17	5.584G	18	5.441G	19	5.639G	20	5.717G
21	5.452G	22	5.609G	23	5.370G	24	5.286G
25	5.658G	26	5.303G	27	5.610G	28	5.579G
29	5.470G	30	5.660G	31	5.407G	32	5.641G
33	5.560G	34	5.338G	35	5.637G	36	5.667G
37	5.359G	38	5.520G	39	5.306G	40	5.267G
41	5.698G	42	5.277G	43	5.521G	44	5.720G
45	5.665G	46	5.647G	47	5.578G	48	5.668G
49	5.479G	50	5.342G	51	5.372G	52	5.445G
53	5.417G	54	5.487G	55	5.534G	56	5.636G
57	5.376G	58	5.702G	59	5.435G	60	5.516G
61	5.276G	62	5.343G	63	5.393G	64	5.531G
65	5.657G	66	5.567G	67	5.363G	68	5.499G
69	5.361G	70	5.654G	71	5.661G	72	5.282G
73	5.510G	74	5.290G	75	5.335G	76	5.353G
77	5.469G	78	5.349G	79	5.712G	80	5.711G
81	5.524G	82	5.569G	83	5.563G	84	5.389G
85	5.450G	86	5.645G	87	5.608G	88	5.638G
89	5.298G	90	5.691G	91	5.542G	92	5.345G
93	5.308G	94	5.256G	95	5.297G	96	5.623G
97	5.302G	98	5.536G	99	5.440G	100	5.475G

Hopping Frequency Sequence Name: HOP_FREQ_SEQ_28							
SEQ#	Frequency (Hz)	SEQ#	Frequency (Hz)	SEQ#	Frequency (Hz)	SEQ#	Frequency (Hz)
1	5.362G	2	5.677G	3	5.297G	4	5.457G
5	5.421G	6	5.286G	7	5.537G	8	5.697G
9	5.427G	10	5.690G	11	5.436G	12	5.413G
13	5.443G	14	5.492G	15	5.614G	16	5.431G
17	5.558G	18	5.633G	19	5.582G	20	5.477G
21	5.547G	22	5.505G	23	5.433G	24	5.498G
25	5.276G	26	5.630G	27	5.591G	28	5.544G
29	5.356G	30	5.454G	31	5.689G	32	5.639G
33	5.482G	34	5.627G	35	5.308G	36	5.366G
37	5.337G	38	5.523G	39	5.721G	40	5.464G
41	5.682G	42	5.426G	43	5.528G	44	5.719G
45	5.414G	46	5.488G	47	5.535G	48	5.408G
49	5.576G	50	5.456G	51	5.311G	52	5.541G
53	5.476G	54	5.302G	55	5.644G	56	5.376G
57	5.596G	58	5.306G	59	5.471G	60	5.384G
61	5.641G	62	5.461G	63	5.373G	64	5.273G
65	5.536G	66	5.507G	67	5.405G	68	5.266G
69	5.694G	70	5.524G	71	5.466G	72	5.623G
73	5.610G	74	5.451G	75	5.709G	76	5.676G
77	5.365G	78	5.617G	79	5.670G	80	5.696G
81	5.271G	82	5.319G	83	5.636G	84	5.515G
85	5.684G	86	5.517G	87	5.387G	88	5.710G
89	5.314G	90	5.674G	91	5.336G	92	5.317G
93	5.626G	94	5.688G	95	5.521G	96	5.359G
97	5.411G	98	5.574G	99	5.318G	100	5.573G

Hopping Frequency Sequence Name: HOP_FREQ_SEQ_29							
SEQ#	Frequency (Hz)	SEQ#	Frequency (Hz)	SEQ#	Frequency (Hz)	SEQ#	Frequency (Hz)
1	5.609G	2	5.264G	3	5.406G	4	5.637G
5	5.444G	6	5.301G	7	5.708G	8	5.627G
9	5.701G	10	5.420G	11	5.327G	12	5.350G
13	5.586G	14	5.504G	15	5.712G	16	5.439G
17	5.719G	18	5.338G	19	5.345G	20	5.405G
21	5.462G	22	5.260G	23	5.302G	24	5.452G
25	5.544G	26	5.416G	27	5.325G	28	5.470G
29	5.600G	30	5.604G	31	5.455G	32	5.337G
33	5.351G	34	5.402G	35	5.357G	36	5.482G
37	5.537G	38	5.436G	39	5.313G	40	5.318G
41	5.531G	42	5.410G	43	5.511G	44	5.479G
45	5.680G	46	5.709G	47	5.323G	48	5.684G
49	5.415G	50	5.272G	51	5.466G	52	5.581G
53	5.320G	54	5.311G	55	5.542G	56	5.651G
57	5.566G	58	5.317G	59	5.309G	60	5.474G
61	5.477G	62	5.385G	63	5.374G	64	5.268G
65	5.682G	66	5.661G	67	5.567G	68	5.258G
69	5.266G	70	5.534G	71	5.497G	72	5.296G
73	5.557G	74	5.283G	75	5.615G	76	5.450G
77	5.253G	78	5.570G	79	5.471G	80	5.618G
81	5.448G	82	5.549G	83	5.394G	84	5.383G
85	5.523G	86	5.644G	87	5.312G	88	5.691G
89	5.495G	90	5.629G	91	5.306G	92	5.587G
93	5.688G	94	5.356G	95	5.275G	96	5.565G
97	5.365G	98	5.424G	99	5.624G	100	5.395G

Hopping Frequency Sequence Name: HOP_FREQ_SEQ_30							
SEQ#	Frequency (Hz)	SEQ#	Frequency (Hz)	SEQ#	Frequency (Hz)	SEQ#	Frequency (Hz)
1	5.491G	2	5.450G	3	5.454G	4	5.513G
5	5.520G	6	5.308G	7	5.290G	8	5.620G
9	5.275G	10	5.407G	11	5.477G	12	5.637G
13	5.396G	14	5.452G	15	5.686G	16	5.292G
17	5.574G	18	5.553G	19	5.317G	20	5.312G
21	5.457G	22	5.547G	23	5.250G	24	5.435G
25	5.649G	26	5.523G	27	5.682G	28	5.644G
29	5.409G	30	5.595G	31	5.504G	32	5.270G
33	5.286G	34	5.283G	35	5.403G	36	5.583G
37	5.506G	38	5.543G	39	5.360G	40	5.310G
41	5.608G	42	5.387G	43	5.254G	44	5.707G
45	5.269G	46	5.665G	47	5.256G	48	5.341G
49	5.584G	50	5.692G	51	5.560G	52	5.582G
53	5.662G	54	5.324G	55	5.530G	56	5.576G
57	5.712G	58	5.552G	59	5.284G	60	5.388G
61	5.670G	62	5.507G	63	5.279G	64	5.661G
65	5.521G	66	5.402G	67	5.253G	68	5.332G
69	5.510G	70	5.428G	71	5.401G	72	5.624G
73	5.335G	74	5.377G	75	5.695G	76	5.445G
77	5.313G	78	5.531G	79	5.647G	80	5.468G
81	5.316G	82	5.395G	83	5.655G	84	5.404G
85	5.528G	86	5.581G	87	5.307G	88	5.713G
89	5.381G	90	5.328G	91	5.706G	92	5.306G
93	5.674G	94	5.676G	95	5.590G	96	5.366G
97	5.533G	98	5.684G	99	5.463G	100	5.556G

IEEE 802.11ac VHT80

Type 1 Radar Statistical Performances						
Trial #	Pulse Repetition Frequency Number (1 to 23)	PRF (Pulse per seconds)	Pulses per Burst	PRI (s)	Radar Frequency (MHz)	Detection
1	18	1165.5	62	858u	5519	Yes
2	20	1113.6	59	898u	5548	Yes
3	8	1519.8	81	658u	5505	Yes
4	19	1139.0	61	878u	5537	Yes
5	6	1618.1	86	618u	5526	Yes
6	12	1355.0	72	738u	5500	Yes
7	5	1672.2	89	598u	5503	Yes
8	7	1567.4	83	638u	5509	Yes
9	22	1066.1	57	938u	5507	Yes
10	2	1858.7	99	538u	5508	Yes
11	9	1474.9	78	678u	5512	Yes
12	14	1285.3	68	778u	5529	Yes
13	21	1089.3	58	918u	5511	Yes
14	10	1432.7	76	698u	5502	Yes
15	3	1792.1	95	558u	5524	Yes
16		327.8	18	3051m	5499	Yes
17		425.4	23	2351m	5522	Yes
18		1085.8	58	921u	5557	Yes
19		643.1	34	1555m	5514	Yes
20		386.1	21	2590m	5554	Yes
21		635.7	34	1573m	5544	Yes
22		1733.1	92	577u	5542	Yes
23		479.2	26	2087m	5521	Yes
24		1003.0	53	997u	5501	Yes
25		424.1	23	2358m	5523	Yes
26		638.6	34	1566m	5552	Yes
27		412.5	22	2424m	5546	Yes
28		501.5	27	1994m	5534	Yes
29		520.0	28	1923m	5515	Yes
30		803.2	83	708u	5528	Yes
Detection Rate: 100 %						

Type 2 Radar Statistical Performances					
Trial #	Pulses per Burst	Pulse Width (s)	PRI (s)	Radar Frequency (MHz)	Detection
1	23	1.3u	228u	5543	Yes
2	26	3.2u	172u	5553	Yes
3	27	3.9u	212u	5510	Yes
4	24	1.9u	213u	5538	No
5	27	3.6u	150u	5503	No
6	26	3.3u	158u	5526	Yes
7	29	4.9u	210u	5501	Yes
8	23	1.3u	223u	5549	Yes
9	29	4.9u	152u	5511	Yes
10	27	3.3u	190u	5509	Yes
11	25	2.7u	203u	5541	Yes
12	29	5u	227u	5540	Yes
13	26	3.3u	196u	5535	Yes
14	28	4.4u	198u	5547	No
15	24	1.9u	161u	5506	Yes
16	27	3.6u	226u	5560	Yes
17	26	2.8u	181u	5545	Yes
18	25	2.5u	167u	5520	Yes
19	23	1.3u	178u	5525	Yes
20	25	2.4u	187u	5519	No
21	29	4.8u	153u	5531	Yes
22	27	3.5u	201u	5521	Yes
23	23	1.3u	166u	5552	Yes
24	29	4.8u	155u	5514	Yes
25	28	4.3u	221u	5542	Yes
26	26	3.2u	191u	5524	No
27	24	1.7u	192u	5546	Yes
28	23	1.2u	164u	5551	Yes
29	25	2.4u	154u	5507	Yes
30	29	5u	207u	5504	Yes
					Detection Rate: 83.33 %

Type 3 Radar Statistical Performances					
Trial #	Pulses per Burst	Pulse Width (s)	PRI (s)	Radar Frequency (MHz)	Detection
1	16	6.3u	403u	5522	Yes
2	17	8.2u	313u	5546	Yes
3	18	8.9u	214u	5524	Yes
4	16	6.9u	262u	5532	Yes
5	17	8.6u	273u	5545	Yes
6	17	8.3u	470u	5556	Yes
7	18	9.9u	453u	5552	Yes
8	16	6.3u	378u	5515	Yes
9	18	9.9u	483u	5504	Yes
10	17	8.3u	317u	5508	Yes
11	17	7.7u	385u	5518	No
12	18	10u	275u	5525	Yes
13	17	8.3u	497u	5550	Yes
14	18	9.4u	420u	5499	Yes
15	16	6.9u	366u	5502	Yes
16	17	8.6u	414u	5509	Yes
17	17	7.8u	444u	5555	Yes
18	17	7.5u	427u	5560	No
19	16	6.3u	338u	5510	Yes
20	17	7.4u	436u	5558	Yes
21	18	9.8u	265u	5507	Yes
22	17	8.5u	451u	5543	Yes
23	16	6.3u	274u	5547	No
24	18	9.8u	417u	5542	Yes
25	18	9.3u	330u	5561	Yes
26	17	8.2u	472u	5501	Yes
27	16	6.7u	333u	5503	Yes
28	16	6.2u	377u	5526	Yes
29	17	7.4u	394u	5506	Yes
30	18	10u	296u	5523	Yes
					Detection Rate: 90 %

Type 4 Radar Statistical Performances					
Trial #	Pulses per Burst	Pulse Width (s)	PRI (s)	Radar Frequency (MHz)	Detection
1	12	11.7u	403u	5548	Yes
2	14	15.9u	313u	5549	No
3	15	17.4u	214u	5517	Yes
4	13	13.2u	262u	5528	Yes
5	15	16.8u	273u	5557	Yes
6	14	16.1u	470u	5503	Yes
7	16	19.8u	453u	5553	Yes
8	12	11.7u	378u	5558	Yes
9	16	19.8u	483u	5520	Yes
10	14	16.2u	317u	5546	Yes
11	14	14.8u	385u	5531	Yes
12	16	19.9u	275u	5560	Yes
13	14	16.1u	497u	5556	Yes
14	16	18.6u	420u	5512	Yes
15	13	13.2u	366u	5545	Yes
16	15	16.9u	414u	5505	Yes
17	14	15u	444u	5559	Yes
18	13	14.4u	427u	5550	Yes
19	12	11.7u	338u	5511	Yes
20	13	14.2u	436u	5525	Yes
21	16	19.6u	265u	5533	Yes
22	15	16.5u	451u	5509	No
23	12	11.7u	274u	5521	No
24	16	19.4u	417u	5544	Yes
25	16	18.3u	330u	5541	No
26	14	15.9u	472u	5502	Yes
27	12	12.5u	333u	5499	No
28	12	11.5u	377u	5501	Yes
29	13	14.2u	394u	5547	Yes
30	16	19.8u	296u	5518	Yes
					Detection Rate: 83.33 %

Type 5 Radar Statistical Performances		
Trial #	Test Signal Name	Detection
1	LP_Signal_01	Yes
2	LP_Signal_02	Yes
3	LP_Signal_03	Yes
4	LP_Signal_04	Yes
5	LP_Signal_05	Yes
6	LP_Signal_06	Yes
7	LP_Signal_07	Yes
8	LP_Signal_08	Yes
9	LP_Signal_09	Yes
10	LP_Signal_10	Yes
11	LP_Signal_11	Yes
12	LP_Signal_12	Yes
13	LP_Signal_13	Yes
14	LP_Signal_14	Yes
15	LP_Signal_15	Yes
16	LP_Signal_16	Yes
17	LP_Signal_17	Yes
18	LP_Signal_18	Yes
19	LP_Signal_19	Yes
20	LP_Signal_20	Yes
21	LP_Signal_21	Yes
22	LP_Signal_22	Yes
23	LP_Signal_23	Yes
24	LP_Signal_24	Yes
25	LP_Signal_25	Yes
26	LP_Signal_26	Yes
27	LP_Signal_27	Yes
28	LP_Signal_28	Yes
29	LP_Signal_29	Yes
30	LP_Signal_30	Yes
		Detection Rate: 100.0 %

Long Pulse Radar Test Signal						
Test Signal Name: LP_Signal_01						
Number of Bursts in Trial: 14						
Chrip Center Frequency: 5493MHz						
Burst	Pulses per Burst	Chrip (Hz)	Pulse Width (s)	Pulse 1 to 2 Spacing (s)	Pulse 2 to 3 Spacing (s)	Start Location (s)
1	2	20M	89.8u	958.2u	-	146.9m
2	3	20M	93.1u	1.680m	1.399m	602.2m
3	3	20M	99.9u	1.412m	1.104m	382.3m
4	3	20M	81.3u	1.361m	1.357m	826.3m
5	2	20M	58.9u	1.882m	-	678.3m
6	2	20M	62.6u	1.115m	-	41.22m
7	1	20M	59.4u	-	-	168.2m
8	2	20M	58.4u	1.786m	-	810.7m
9	3	20M	93.1u	1.298m	1.212m	651.9m
10	2	20M	50.6u	1.849m	-	168.0m
11	2	20M	82.1u	1.866m	-	296.7m
12	2	20M	89.9u	1.635m	-	266.2m
13	1	20M	92.5u	-	-	540.8m
14	3	20M	92.9u	1.003m	1.034m	233.0m

Long Pulse Radar Test Signal						
Test Signal Name: LP_Signal_02						
Number of Bursts in Trial: 20						
Chrip Center Frequency: 5494MHz						
Burst	Pulses per Burst	Chrip (Hz)	Pulse Width (s)	Pulse 1 to 2 Spacing (s)	Pulse 2 to 3 Spacing (s)	Start Location (s)
1	2	20M	63.1u	1.352m	-	165.6m
2	2	20M	58.9u	1.458m	-	231.2m
3	2	20M	77.9u	1.812m	-	578.2m
4	2	20M	55.4u	1.834m	-	493.0m
5	3	20M	93.5u	1.337m	1.895m	207.5m
6	2	20M	92.8u	1.212m	-	161.6m
7	3	20M	60.2u	1.500m	1.299m	450.6m
8	3	20M	92.9u	980.1u	1.224m	70.72m
9	3	20M	68.5u	1.737m	1.169m	263.0m
10	2	20M	85.6u	967.4u	-	128.5m

11	2	20M	85.4u	1.165m	-	495.9m
12	2	20M	68.2u	1.498m	-	88.26m
13	2	20M	66.6u	1.769m	-	10.88m
14	3	20M	56.7u	1.517m	1.056m	393.2m
15	1	20M	61.9u	-	-	488.3m
16	3	20M	92.9u	1.185m	1.163m	309.7m
17	2	20M	59.6u	1.139m	-	243.6m
18	3	20M	71.4u	1.337m	1.026m	381.3m
19	3	20M	66.5u	1.886m	1.669m	75.38m
20	1	20M	99.2u	-	-	205.0m

Long Pulse Radar Test Signal						
Test Signal Name: LP_Signal_03						
Number of Bursts in Trial: 15						
Chrip Center Frequency: 5495MHz						
Burst	Pulses per Burst	Chrip (Hz)	Pulse Width (s)	Pulse 1 to 2 Spacing (s)	Pulse 2 to 3 Spacing (s)	Start Location (s)
1	1	20M	63.9u	-	-	77.33m
2	2	20M	94.7u	1.807m	-	47.69m
3	2	20M	55.2u	1.653m	-	235.8m
4	1	20M	88.6u	-	-	734.4m
5	3	20M	58.9u	1.448m	1.576m	594.5m
6	3	20M	80.2u	1.051m	1.328m	738.1m
7	2	20M	51.8u	1.771m	-	610.0m
8	1	20M	58.2u	-	-	187.6m
9	3	20M	51.5u	1.442m	1.642m	91.17m
10	2	20M	54.6u	1.066m	-	128.0m
11	3	20M	92.5u	1.718m	1.207m	337.4m
12	3	20M	88.1u	1.794m	1.583m	438.5m
13	2	20M	63.5u	1.643m	-	214.3m
14	2	20M	73.1u	959.9u	-	235.5m
15	1	20M	71.4u	-	-	509.1m

Long Pulse Radar Test Signal						
Test Signal Name: LP_Signal_04						
Number of Bursts in Trial: 17						
Chrip Center Frequency: 5495MHz						
Burst	Pulses per Burst	Chrip (Hz)	Pulse Width (s)	Pulse 1 to 2 Spacing (s)	Pulse 2 to 3 Spacing (s)	Start Location (s)
1	1	18M	99.1u	-	-	365.0m
2	2	18M	80.2u	1.073m	-	218.9m
3	1	18M	98.4u	-	-	62.40m
4	2	18M	79.9u	924.1u	-	28.38m
5	3	18M	85.7u	1.729m	1.103m	59.49m
6	3	18M	83.1u	1.033m	1.823m	360.0m
7	1	18M	93.9u	-	-	207.7m
8	2	18M	92.9u	1.657m	-	307.2m
9	2	18M	93.9u	1.164m	-	269.1m
10	3	18M	71.8u	1.516m	1.207m	433.3m
11	2	18M	60.1u	1.913m	-	334.1m
12	2	18M	65.1u	1.569m	-	471.0m
13	2	18M	70.1u	1.020m	-	403.4m
14	2	18M	54.7u	1.505m	-	537.2m
15	2	18M	71.7u	1.764m	-	569.9m
16	2	18M	98.5u	1.729m	-	505.7m
17	2	18M	90.2u	1.677m	-	644.0m

Long Pulse Radar Test Signal						
Test Signal Name: LP_Signal_05						
Number of Bursts in Trial: 11						
Chrip Center Frequency: 5495MHz						
Burst	Pulses per Burst	Chrip (Hz)	Pulse Width (s)	Pulse 1 to 2 Spacing (s)	Pulse 2 to 3 Spacing (s)	Start Location (s)
1	1	18M	64.2u	-	-	494.2m
2	2	18M	97.0u	1.292m	-	114.8m
3	2	18M	52.3u	1.620m	-	1.064
4	2	18M	60.6u	1.251m	-	410.6m
5	3	18M	84.8u	1.723m	1.288m	300.7m
6	1	18M	50.7u	-	-	53.23m
7	3	18M	89.9u	1.262m	1.445m	710.3m
8	2	18M	97.5u	1.135m	-	685.6m
9	1	18M	64.6u	-	-	299.5m
10	3	18M	54.2u	1.045m	1.103m	829.1m
11	1	18M	71.8u	-	-	490.9m

Long Pulse Radar Test Signal						
Test Signal Name: LP_Signal_06						
Number of Bursts in Trial: 19						
Chrip Center Frequency: 5496MHz						
Burst	Pulses per Burst	Chrip (Hz)	Pulse Width (s)	Pulse 1 to 2 Spacing (s)	Pulse 2 to 3 Spacing (s)	Start Location (s)
1	2	18M	76.9u	1.237m	-	555.7m
2	3	18M	90.6u	1.903m	1.092m	438.1m
3	2	18M	99.3u	1.507m	-	346.0m
4	2	18M	89.9u	1.524m	-	345.9m
5	2	18M	65.6u	1.720m	-	258.9m
6	1	18M	77.2u	-	-	347.7m
7	1	18M	60.5u	-	-	359.7m
8	3	18M	65.1u	1.373m	1.097m	337.8m
9	2	18M	65.7u	1.587m	-	359.4m
10	3	18M	90.6u	1.294m	1.142m	366.8m
11	2	18M	82.4u	1.038m	-	435.3m
12	2	18M	95.2u	980.8u	-	333.7m
13	1	18M	50.2u	-	-	586.5m

14	2	18M	55.7u	1.311m	-	577.6m
15	1	18M	76.5u	-	-	29.99m
16	3	18M	73.2u	1.228m	960.8u	610.8m
17	3	18M	80.8u	1.016m	1.639m	124.7m
18	1	18M	75.1u	-	-	525.7m
19	2	18M	90.5u	1.397m	-	210.0m

Long Pulse Radar Test Signal						
Test Signal Name: LP_Signal_07						
Number of Bursts in Trial: 12						
Chrip Center Frequency: 5496MHz						
Burst	Pulses per Burst	Chrip (Hz)	Pulse Width (s)	Pulse 1 to 2 Spacing (s)	Pulse 2 to 3 Spacing (s)	Start Location (s)
1	2	17M	93.4u	1.791m	-	467.1m
2	2	17M	53.0u	1.331m	-	100.2m
3	2	17M	63.1u	1.017m	-	444.6m
4	2	17M	66.4u	1.835m	-	765.4m
5	2	17M	54.8u	1.828m	-	810.6m
6	3	17M	99.5u	974.5u	1.850m	833.5m
7	1	17M	94.7u	-	-	898.3m
8	3	17M	51.2u	1.184m	1.832m	783.4m
9	3	17M	87.4u	1.279m	1.661m	145.4m
10	3	17M	60.8u	1.353m	1.908m	109.4m
11	2	17M	81.3u	1.689m	-	467.0m
12	2	17M	65.6u	957.4u	-	612.4m

Long Pulse Radar Test Signal						
Test Signal Name: LP_Signal_08						
Number of Bursts in Trial: 15						
Chrip Center Frequency: 5497MHz						
Burst	Pulses per Burst	Chrip (Hz)	Pulse Width (s)	Pulse 1 to 2 Spacing (s)	Pulse 2 to 3 Spacing (s)	Start Location (s)
1	2	17M	74.4u	1.078m	-	405.4m
2	2	17M	64.5u	1.652m	-	642.9m
3	2	17M	60.9u	1.407m	-	702.7m
4	1	17M	93.7u	-	-	738.4m
5	3	17M	73.4u	1.274m	1.171m	600.8m
6	2	17M	65.8u	1.640m	-	566.8m

7	2	17M	67.9u	1.038m	-	561.0m
8	2	17M	75.2u	970.8u	-	25.08m
9	1	17M	58.5u	-	-	667.7m
10	1	17M	97.9u	-	-	176.6m
11	3	17M	87.6u	1.679m	1.187m	730.3m
12	1	17M	94.5u	-	-	720.4m
13	3	17M	56.4u	1.013m	1.776m	274.4m
14	2	17M	84.2u	1.338m	-	186.8m
15	1	17M	67.2u	-	-	223.4m

Long Pulse Radar Test Signal						
Test Signal Name: LP_Signal_09						
Number of Bursts in Trial: 10						
Chrip Center Frequency: 5498MHz						
Burst	Pulses per Burst	Chrip (Hz)	Pulse Width (s)	Pulse 1 to 2 Spacing (s)	Pulse 2 to 3 Spacing (s)	Start Location (s)
1	2	17M	99.1u	1.432m	-	452.6m
2	2	17M	85.7u	1.749m	-	995.1m
3	2	17M	63.1u	1.583m	-	348.2m
4	2	17M	78.7u	1.420m	-	1.184
5	2	17M	82.0u	1.576m	-	745.4m
6	1	17M	52.4u	-	-	410.8m
7	3	17M	79.4u	1.362m	994.6u	206.2m
8	3	17M	90.4u	1.173m	1.671m	534.7m
9	2	17M	92.6u	1.715m	-	1.114
10	2	17M	84.6u	1.254m	-	963.0m

Long Pulse Radar Test Signal						
Test Signal Name: LP_Signal_10						
Number of Bursts in Trial: 12						
Chrip Center Frequency: 5499MHz						
Burst	Pulses per Burst	Chrip (Hz)	Pulse Width (s)	Pulse 1 to 2 Spacing (s)	Pulse 2 to 3 Spacing (s)	Start Location (s)
1	3	15M	91.9u	1.303m	1.089m	773.6m
2	3	15M	60.3u	1.462m	1.450m	919.7m
3	2	15M	67.3u	1.863m	-	541.7m
4	2	15M	81.9u	1.640m	-	615.1m
5	2	15M	86.7u	1.507m	-	774.5m

6	2	15M	79.8u	1.827m	-	615.8m
7	2	15M	94.9u	1.478m	-	145.1m
8	2	15M	77.6u	1.605m	-	650.7m
9	2	15M	88.8u	1.690m	-	806.3m
10	1	15M	89.3u	-	-	451.0m
11	2	15M	80.7u	1.437m	-	12.93m
12	2	15M	80.1u	1.246m	-	6.725m

Long Pulse Radar Test Signal						
Test Signal Name: LP_Signal_11						
Number of Bursts in Trial: 8						
Chrip Center Frequency: 5530MHz						
Burst	Pulses per Burst	Chrip (Hz)	Pulse Width (s)	Pulse 1 to 2 Spacing (s)	Pulse 2 to 3 Spacing (s)	Start Location (s)
1	2	15M	61.9u	1.482m	-	23.65m
2	2	15M	76.8u	1.819m	-	1.274
3	1	15M	93.8u	-	-	1.028
4	3	15M	67.8u	1.480m	1.136m	355.3m
5	2	15M	79.1u	1.648m	-	1.431
6	2	15M	82.1u	1.086m	-	516.9m
7	1	15M	70.6u	-	-	1.348
8	2	15M	77.9u	1.747m	-	1.102

Long Pulse Radar Test Signal						
Test Signal Name: LP_Signal_12						
Number of Bursts in Trial: 13						
Chrip Center Frequency: 5531MHz						
Burst	Pulses per Burst	Chrip (Hz)	Pulse Width (s)	Pulse 1 to 2 Spacing (s)	Pulse 2 to 3 Spacing (s)	Start Location (s)
1	1	15M	58.8u	-	-	24.59m
2	2	15M	70.7u	1.396m	-	679.2m
3	2	15M	73.6u	1.819m	-	117.6m
4	2	15M	61.6u	1.469m	-	619.5m
5	2	15M	94.1u	1.818m	-	334.8m
6	2	15M	75.1u	1.779m	-	356.5m
7	2	15M	72.8u	1.892m	-	109.8m
8	1	15M	60.6u	-	-	347.6m
9	1	15M	78.3u	-	-	296.3m

10	1	15M	92.8u	-	-	611.0m
11	2	15M	87.0u	1.901m	-	64.79m
12	2	15M	98.1u	1.888m	-	304.4m
13	2	15M	53.2u	1.031m	-	667.8m

Long Pulse Radar Test Signal						
Test Signal Name: LP_Signal_13						
Number of Bursts in Trial: 19						
Chrip Center Frequency: 5532MHz						
Burst	Pulses per Burst	Chrip (Hz)	Pulse Width (s)	Pulse 1 to 2 Spacing (s)	Pulse 2 to 3 Spacing (s)	Start Location (s)
1	2	14M	85.7u	1.367m	-	603.6m
2	3	14M	78.6u	1.641m	1.199m	161.4m
3	3	14M	80.1u	1.820m	1.882m	517.0m
4	2	14M	62.7u	979.3u	-	319.0m
5	2	14M	85.2u	1.237m	-	559.3m
6	3	14M	98.1u	1.761m	1.255m	106.3m
7	1	14M	72.0u	-	-	136.6m
8	2	14M	68.4u	1.583m	-	562.6m
9	1	14M	82.6u	-	-	591.2m
10	2	14M	82.9u	1.029m	-	339.8m
11	1	14M	66.1u	-	-	277.3m
12	2	14M	72.6u	1.029m	-	514.5m
13	1	14M	87.3u	-	-	169.0m
14	2	14M	77.9u	1.828m	-	416.6m
15	2	14M	69.3u	1.609m	-	602.9m
16	1	14M	56.2u	-	-	104.6m
17	1	14M	99.7u	-	-	399.8m
18	2	14M	53.6u	1.552m	-	494.2m
19	1	14M	79.0u	-	-	195.2m

Long Pulse Radar Test Signal						
Test Signal Name: LP_Signal_14						
Number of Bursts in Trial: 10						
Chrip Center Frequency: 5533MHz						
Burst	Pulses per Burst	Chrip (Hz)	Pulse Width (s)	Pulse 1 to 2 Spacing (s)	Pulse 2 to 3 Spacing (s)	Start Location (s)
1	1	14M	92.7u	-	-	887.6m
2	3	14M	64.5u	1.123m	1.453m	993.9m
3	3	14M	79.5u	1.032m	1.898m	914.2m
4	2	14M	72.5u	1.066m	-	235.3m
5	3	14M	69.3u	1.795m	1.885m	777.4m
6	2	14M	76.1u	1.019m	-	784.7m
7	3	14M	71.3u	1.083m	1.707m	633.9m
8	3	14M	89.4u	1.194m	1.196m	543.2m
9	2	14M	75.7u	943.3u	-	280.3m
10	3	14M	80.4u	1.683m	1.273m	521.0m

Long Pulse Radar Test Signal						
Test Signal Name: LP_Signal_15						
Number of Bursts in Trial: 11						
Chrip Center Frequency: 5529MHz						
Burst	Pulses per Burst	Chrip (Hz)	Pulse Width (s)	Pulse 1 to 2 Spacing (s)	Pulse 2 to 3 Spacing (s)	Start Location (s)
1	3	14M	51.2u	1.554m	1.600m	938.5m
2	2	14M	62.1u	1.523m	-	66.65m
3	2	14M	84.1u	1.237m	-	333.2m
4	1	14M	83.6u	-	-	226.5m
5	2	14M	94.4u	1.354m	-	662.1m
6	3	14M	73.6u	1.860m	1.455m	990.1m
7	1	14M	72.7u	-	-	690.2m
8	2	14M	84.4u	1.778m	-	809.3m
9	2	14M	72.2u	1.660m	-	636.3m
10	2	14M	95.6u	1.055m	-	474.9m
11	1	14M	70.9u	-	-	98.17m

Long Pulse Radar Test Signal						
Test Signal Name: LP_Signal_16						
Number of Bursts in Trial: 15						
Chrip Center Frequency: 5528MHz						
Burst	Pulses per Burst	Chrip (Hz)	Pulse Width (s)	Pulse 1 to 2 Spacing (s)	Pulse 2 to 3 Spacing (s)	Start Location (s)
1	3	12M	72.1u	1.176m	1.245m	711.3m
2	3	12M	66.5u	1.451m	952.5u	689.2m
3	2	12M	97.3u	1.333m	-	62.65m
4	2	12M	67.6u	1.035m	-	387.6m
5	1	12M	51.6u	-	-	26.37m
6	2	12M	87.9u	1.499m	-	438.2m
7	2	12M	88.9u	1.856m	-	606.1m
8	3	12M	76.6u	1.341m	1.440m	646.0m
9	2	12M	65.9u	1.898m	-	262.9m
10	2	12M	65.9u	1.233m	-	530.7m
11	1	12M	56.8u	-	-	94.44m
12	3	12M	95.3u	1.778m	1.437m	485.4m
13	1	12M	89.3u	-	-	384.7m
14	2	12M	77.2u	1.862m	-	516.6m
15	2	12M	67.4u	1.159m	-	275.1m

Long Pulse Radar Test Signal						
Test Signal Name: LP_Signal_17						
Number of Bursts in Trial: 15						
Chrip Center Frequency: 5527MHz						
Burst	Pulses per Burst	Chrip (Hz)	Pulse Width (s)	Pulse 1 to 2 Spacing (s)	Pulse 2 to 3 Spacing (s)	Start Location (s)
1	2	12M	81.6u	1.612m	-	637.0m
2	3	12M	90.9u	1.408m	1.477m	341.8m
3	3	12M	80.3u	1.062m	1.686m	433.0m
4	2	12M	75.5u	1.727m	-	214.7m
5	1	12M	60.4u	-	-	485.5m
6	2	12M	66.3u	1.927m	-	87.10m
7	2	12M	64.0u	1.316m	-	184.3m
8	1	12M	75.3u	-	-	392.1m
9	2	12M	99.4u	1.005m	-	9.492m

10	2	12M	68.8u	1.053m	-	492.9m
11	2	12M	87.1u	1.357m	-	641.1m
12	2	12M	58.8u	1.074m	-	519.2m
13	2	12M	58.6u	1.788m	-	219.9m
14	3	12M	99.7u	1.593m	1.282m	157.8m
15	3	12M	72.4u	1.515m	1.350m	755.6m

Long Pulse Radar Test Signal						
Test Signal Name: LP_Signal_18						
Number of Bursts in Trial: 19						
Chrip Center Frequency: 5534MHz						
Burst	Pulses per Burst	Chrip (Hz)	Pulse Width (s)	Pulse 1 to 2 Spacing (s)	Pulse 2 to 3 Spacing (s)	Start Location (s)
1	3	12M	81.7u	1.402m	1.721m	48.18m
2	2	12M	59.9u	1.602m	-	424.8m
3	1	12M	89.9u	-	-	534.9m
4	2	12M	71.6u	1.654m	-	77.70m
5	3	12M	91.6u	1.405m	1.096m	136.0m
6	3	12M	72.6u	1.402m	1.899m	322.1m
7	3	12M	94.7u	1.579m	1.078m	281.5m
8	1	12M	78.0u	-	-	111.9m
9	2	12M	53.4u	1.065m	-	496.4m
10	2	12M	58.1u	1.830m	-	74.32m
11	1	12M	65.9u	-	-	145.2m
12	2	12M	79.8u	1.918m	-	336.8m
13	2	12M	87.9u	1.039m	-	229.4m
14	1	12M	50.2u	-	-	138.3m
15	3	12M	59.6u	1.741m	1.366m	142.6m
16	3	12M	86.9u	1.369m	1.489m	448.6m
17	2	12M	78.2u	971.8u	-	615.9m
18	1	12M	80.4u	-	-	442.1m
19	2	12M	59.4u	1.211m	-	129.1m

Long Pulse Radar Test Signal						
Test Signal Name: LP_Signal_19						
Number of Bursts in Trial: 17						
Chrip Center Frequency: 5526MHz						
Burst	Pulses per Burst	Chrip (Hz)	Pulse Width (s)	Pulse 1 to 2 Spacing (s)	Pulse 2 to 3 Spacing (s)	Start Location (s)
1	3	9M	97.1u	1.264m	1.430m	328.8m
2	1	9M	91.0u	-	-	488.2m
3	2	9M	53.0u	1.114m	-	242.3m
4	3	9M	62.2u	1.021m	1.349m	260.4m
5	3	9M	83.4u	999.6u	1.416m	342.1m
6	2	9M	97.3u	1.829m	-	53.44m
7	1	9M	86.6u	-	-	494.1m
8	2	9M	86.3u	1.709m	-	47.12m
9	2	9M	65.9u	1.147m	-	496.4m
10	2	9M	95.9u	1.142m	-	167.4m
11	2	9M	91.3u	1.871m	-	623.7m
12	3	9M	73.8u	1.157m	1.923m	162.0m
13	1	9M	66.7u	-	-	479.4m
14	1	9M	72.0u	-	-	231.6m
15	2	9M	52.7u	1.902m	-	274.7m
16	1	9M	87.5u	-	-	558.9m
17	1	9M	77.3u	-	-	525.9m

Long Pulse Radar Test Signal						
Test Signal Name: LP_Signal_20						
Number of Bursts in Trial: 18						
Chrip Center Frequency: 5525MHz						
Burst	Pulses per Burst	Chrip (Hz)	Pulse Width (s)	Pulse 1 to 2 Spacing (s)	Pulse 2 to 3 Spacing (s)	Start Location (s)
1	1	9M	92.6u	-	-	574.7m
2	3	9M	67.9u	1.272m	1.316m	302.6m
3	1	9M	85.3u	-	-	195.7m
4	2	9M	87.8u	1.863m	-	517.8m
5	2	9M	73.7u	1.364m	-	350.7m
6	1	9M	55.8u	-	-	569.5m
7	3	9M	99.1u	936.9u	1.756m	652.9m

8	2	9M	94.5u	1.889m	-	175.3m
9	2	9M	69.1u	1.741m	-	186.8m
10	2	9M	60.2u	1.826m	-	144.5m
11	2	9M	90.0u	1.419m	-	500.0m
12	2	9M	98.3u	1.336m	-	157.3m
13	2	9M	94.4u	1.660m	-	479.9m
14	3	9M	91.0u	1.788m	1.474m	137.2m
15	1	9M	74.3u	-	-	351.9m
16	2	9M	55.0u	1.665m	-	89.03m
17	3	9M	85.5u	981.5u	1.182m	444.9m
18	2	9M	86.1u	1.623m	-	259.0m

Long Pulse Radar Test Signal						
Test Signal Name: LP_Signal_21						
Number of Bursts in Trial: 15						
Chrip Center Frequency: 5568MHz						
Burst	Pulses per Burst	Chrip (Hz)	Pulse Width (s)	Pulse 1 to 2 Spacing (s)	Pulse 2 to 3 Spacing (s)	Start Location (s)
1	1	9M	89.4u	-	-	338.0m
2	3	9M	68.3u	1.753m	1.438m	613.1m
3	2	9M	63.6u	1.362m	-	303.8m
4	2	9M	80.5u	993.5u	-	595.4m
5	2	9M	73.6u	1.540m	-	78.46m
6	1	9M	87.3u	-	-	160.7m
7	2	9M	74.5u	1.600m	-	607.5m
8	2	9M	77.4u	1.693m	-	479.2m
9	2	9M	78.4u	989.6u	-	115.9m
10	2	9M	93.1u	1.366m	-	724.2m
11	1	9M	84.2u	-	-	81.00m
12	1	9M	74.9u	-	-	557.2m
13	2	9M	81.2u	1.048m	-	738.1m
14	2	9M	55.9u	1.240m	-	186.3m
15	3	9M	76.3u	1.412m	1.545m	715.8m

Long Pulse Radar Test Signal						
Test Signal Name: LP_Signal_22						
Number of Bursts in Trial: 11						
Chrip Center Frequency: 5567MHz						
Burst	Pulses per Burst	Chrip (Hz)	Pulse Width (s)	Pulse 1 to 2 Spacing (s)	Pulse 2 to 3 Spacing (s)	Start Location (s)
1	1	8M	71.1u	-	-	436.6m
2	1	8M	87.7u	-	-	18.39m
3	1	8M	56.2u	-	-	170.2m
4	2	8M	87.7u	1.268m	-	279.7m
5	2	8M	77.9u	1.903m	-	679.5m
6	3	8M	53.6u	969.4u	1.477m	1.068
7	1	8M	69.4u	-	-	447.7m
8	2	8M	93.5u	1.630m	-	178.2m
9	2	8M	52.4u	1.119m	-	320.4m
10	2	8M	76.3u	1.579m	-	806.7m
11	2	8M	72.0u	1.881m	-	90.84m

Long Pulse Radar Test Signal						
Test Signal Name: LP_Signal_23						
Number of Bursts in Trial: 14						
Chrip Center Frequency: 5566MHz						
Burst	Pulses per Burst	Chrip (Hz)	Pulse Width (s)	Pulse 1 to 2 Spacing (s)	Pulse 2 to 3 Spacing (s)	Start Location (s)
1	1	15M	63.5u	-	-	839.9m
2	3	6M	97.5u	1.416m	925.5u	48.28m
3	1	15M	91.8u	-	-	752.4m
4	1	14M	86.5u	-	-	143.7m
5	2	18M	71.1u	1.545m	-	601.8m
6	1	6M	82.8u	-	-	148.8m
7	1	7M	64.4u	-	-	386.1m
8	1	18M	53.6u	-	-	560.5m
9	1	15M	98.6u	-	-	725.7m
10	3	19M	85.5u	1.115m	1.136m	119.7m
11	1	15M	100.0u	-	-	278.8m
12	3	12M	87.8u	946.2u	1.112m	177.8m
13	2	9M	61.9u	1.555m	-	393.5m

14	3	18M	86.5u	1.084m	1.587m	38.97m
----	---	-----	-------	--------	--------	--------

Long Pulse Radar Test Signal						
Test Signal Name: LP_Signal_24						
Number of Bursts in Trial: 9						
Chrip Center Frequency: 5565MHz						
Burst	Pulses per Burst	Chrip (Hz)	Pulse Width (s)	Pulse 1 to 2 Spacing (s)	Pulse 2 to 3 Spacing (s)	Start Location (s)
1	3	8M	71.1u	1.222m	1.413m	444.6m
2	2	8M	59.0u	1.893m	-	289.7m
3	2	8M	60.7u	1.211m	-	933.9m
4	3	8M	68.6u	1.430m	1.751m	827.1m
5	3	8M	78.0u	1.707m	1.351m	65.79m
6	3	8M	95.0u	1.577m	1.175m	1.235
7	2	8M	94.0u	1.043m	-	1.170
8	2	8M	82.2u	1.181m	-	463.7m
9	1	8M	55.8u	-	-	543.3m

Long Pulse Radar Test Signal						
Test Signal Name: LP_Signal_25						
Number of Bursts in Trial: 18						
Chrip Center Frequency: 5565MHz						
Burst	Pulses per Burst	Chrip (Hz)	Pulse Width (s)	Pulse 1 to 2 Spacing (s)	Pulse 2 to 3 Spacing (s)	Start Location (s)
1	2	6M	78.8u	1.762m	-	465.6m
2	2	6M	52.8u	1.329m	-	583.2m
3	1	6M	59.6u	-	-	447.7m
4	1	6M	70.0u	-	-	305.9m
5	2	6M	64.5u	1.427m	-	370.3m
6	1	6M	94.0u	-	-	355.4m
7	1	6M	98.4u	-	-	230.2m
8	1	6M	98.8u	-	-	465.8m
9	3	6M	93.1u	936.9u	1.278m	643.2m
10	1	6M	79.3u	-	-	619.5m
11	1	6M	96.8u	-	-	60.72m
12	3	6M	96.8u	1.449m	1.845m	392.2m
13	3	6M	62.4u	1.516m	1.547m	326.3m
14	2	6M	79.7u	1.539m	-	573.3m

15	2	6M	83.8u	1.568m	-	166.7m
16	3	6M	65.1u	1.162m	1.623m	29.54m
17	2	6M	64.0u	1.434m	-	440.0m
18	3	6M	95.5u	1.227m	1.583m	339.8m

Long Pulse Radar Test Signal						
Test Signal Name: LP_Signal_26						
Number of Bursts in Trial: 16						
Chrip Center Frequency: 5564MHz						
Burst	Pulses per Burst	Chrip (Hz)	Pulse Width (s)	Pulse 1 to 2 Spacing (s)	Pulse 2 to 3 Spacing (s)	Start Location (s)
1	3	6M	58.3u	1.169m	1.228m	212.0m
2	1	6M	67.9u	-	-	683.3m
3	2	6M	76.5u	1.176m	-	683.9m
4	2	6M	54.8u	1.298m	-	490.2m
5	3	6M	79.2u	1.024m	1.835m	160.4m
6	2	6M	89.3u	1.805m	-	653.3m
7	1	6M	77.2u	-	-	73.40m
8	3	6M	89.4u	1.249m	1.228m	589.4m
9	3	6M	97.7u	1.549m	1.052m	484.7m
10	3	6M	99.5u	1.824m	1.045m	490.8m
11	2	6M	62.4u	1.758m	-	48.28m
12	2	6M	99.1u	1.202m	-	270.9m
13	3	6M	92.6u	1.079m	1.569m	227.5m
14	2	6M	87.4u	1.359m	-	577.4m
15	1	6M	81.1u	-	-	371.3m
16	3	6M	50.5u	1.117m	996.5u	19.19m

Long Pulse Radar Test Signal						
Test Signal Name: LP_Signal_27						
Number of Bursts in Trial: 16						
Chrip Center Frequency: 5564MHz						
Burst	Pulses per Burst	Chrip (Hz)	Pulse Width (s)	Pulse 1 to 2 Spacing (s)	Pulse 2 to 3 Spacing (s)	Start Location (s)
1	2	6M	61.5u	1.386m	-	311.0m
2	3	6M	67.1u	1.513m	1.138m	208.0m
3	2	6M	96.6u	1.844m	-	387.8m
4	1	6M	82.7u	-	-	224.5m

5	2	6M	67.8u	1.718m	-	627.0m
6	2	6M	87.2u	1.177m	-	181.9m
7	2	6M	67.9u	1.705m	-	545.1m
8	3	6M	92.8u	1.251m	1.284m	255.7m
9	1	6M	68.4u	-	-	724.0m
10	3	6M	70.6u	1.617m	1.276m	638.6m
11	2	6M	79.2u	1.690m	-	1.461m
12	2	6M	66.8u	1.231m	-	710.1m
13	2	6M	79.3u	1.785m	-	297.6m
14	3	6M	52.6u	1.716m	1.394m	154.1m
15	1	6M	51.5u	-	-	341.0m
16	2	6M	60.8u	1.100m	-	636.3m

Long Pulse Radar Test Signal						
Test Signal Name: LP_Signal_28						
Number of Bursts in Trial: 9						
Chrip Center Frequency: 5563MHz						
Burst	Pulses per Burst	Chrip (Hz)	Pulse Width (s)	Pulse 1 to 2 Spacing (s)	Pulse 2 to 3 Spacing (s)	Start Location (s)
1	3	5M	53.7u	985.3u	1.100m	677.3m
2	2	5M	87.5u	1.371m	-	858.8m
3	2	5M	92.1u	1.415m	-	312.5m
4	2	5M	92.5u	1.790m	-	890.4m
5	1	5M	92.6u	-	-	308.8m
6	2	5M	97.7u	1.644m	-	462.4m
7	2	5M	77.6u	1.302m	-	313.9m
8	2	5M	58.4u	1.411m	-	609.2m
9	3	5M	61.9u	1.171m	1.289m	854.2m

Long Pulse Radar Test Signal						
Test Signal Name: LP_Signal_29						
Number of Bursts in Trial: 19						
Chrip Center Frequency: 5563MHz						
Burst	Pulses per Burst	Chrip (Hz)	Pulse Width (s)	Pulse 1 to 2 Spacing (s)	Pulse 2 to 3 Spacing (s)	Start Location (s)
1	3	5M	61.2u	1.793m	1.857m	398.8m
2	1	5M	53.7u	-	-	300.3m
3	2	5M	82.7u	1.900m	-	154.0m

4	3	5M	98.8u	1.369m	1.879m	7.212m
5	2	5M	54.9u	1.516m	-	475.2m
6	3	5M	57.2u	1.640m	1.396m	427.7m
7	2	5M	91.6u	1.507m	-	435.3m
8	2	5M	69.8u	1.897m	-	349.7m
9	2	5M	58.1u	1.668m	-	584.4m
10	2	5M	81.6u	1.380m	-	184.8m
11	2	5M	57.5u	1.242m	-	221.2m
12	3	5M	92.2u	1.227m	913.8u	353.3m
13	2	5M	81.9u	1.129m	-	486.4m
14	2	5M	66.9u	1.395m	-	235.5m
15	1	5M	67.9u	-	-	415.5m
16	3	5M	99.2u	1.884m	1.803m	462.9m
17	2	5M	71.2u	1.043m	-	214.2m
18	1	5M	70.9u	-	-	379.4m
19	2	5M	68.8u	1.209m	-	322.3m

Long Pulse Radar Test Signal						
Test Signal Name: LP_Signal_30						
Number of Bursts in Trial: 19						
Chrip Center Frequency: 5561MHz						
Burst	Pulses per Burst	Chrip (Hz)	Pulse Width (s)	Pulse 1 to 2 Spacing (s)	Pulse 2 to 3 Spacing (s)	Start Location (s)
1	2	5M	50.4u	1.916m	-	334.6m
2	2	5M	54.2u	1.760m	-	40.17m
3	2	5M	66.7u	1.591m	-	375.0m
4	1	5M	81.8u	-	-	224.8m
5	3	5M	85.3u	1.562m	1.550m	598.5m
6	2	5M	50.9u	1.097m	-	247.8m
7	3	5M	71.5u	1.403m	1.250m	384.9m
8	1	5M	57.3u	-	-	545.1m
9	1	5M	99.4u	-	-	327.7m
10	2	5M	81.7u	1.762m	-	346.5m
11	3	5M	87.0u	1.625m	1.683m	237.2m
12	2	5M	94.9u	1.522m	-	585.4m
13	2	5M	83.5u	1.529m	-	480.1m
14	2	5M	66.1u	1.677m	-	545.9m
15	2	5M	52.9u	1.709m	-	563.8m

16	3	5M	51.5u	1.865m	1.887m	433.2m
17	1	5M	82.8u	-	-	4.846m
18	2	5M	84.6u	957.4u	-	397.1m
19	3	5M	70.6u	1.247m	1.791m	432.2m

Type 6 Radar Statistical Performances				
Trial #	Pulses per Burst	Pulse Width (s)	PRI (s)	Detection
1	9	1.0u	333.0u	Yes
2	9	1.0u	333.0u	Yes
3	9	1.0u	333.0u	Yes
4	9	1.0u	333.0u	Yes
5	9	1.0u	333.0u	Yes
6	9	1.0u	333.0u	Yes
7	9	1.0u	333.0u	Yes
8	9	1.0u	333.0u	Yes
9	9	1.0u	333.0u	Yes
10	9	1.0u	333.0u	Yes
11	9	1.0u	333.0u	Yes
12	9	1.0u	333.0u	Yes
13	9	1.0u	333.0u	Yes
14	9	1.0u	333.0u	Yes
15	9	1.0u	333.0u	Yes
16	9	1.0u	333.0u	Yes
17	9	1.0u	333.0u	Yes
18	9	1.0u	333.0u	Yes
19	9	1.0u	333.0u	Yes
20	9	1.0u	333.0u	Yes
21	9	1.0u	333.0u	Yes
22	9	1.0u	333.0u	Yes
23	9	1.0u	333.0u	Yes
24	9	1.0u	333.0u	Yes
25	9	1.0u	333.0u	Yes
26	9	1.0u	333.0u	Yes
27	9	1.0u	333.0u	Yes
28	9	1.0u	333.0u	Yes
29	9	1.0u	333.0u	Yes
30	9	1.0u	333.0u	Yes
				Detection Rate: 100 %

Type 6 Radar Statistical Performances		
Trial #	Hopping Frequency Sequence Name	Detection
1	HOP_FREQ_SEQ_01	Yes
2	HOP_FREQ_SEQ_02	Yes
3	HOP_FREQ_SEQ_03	Yes
4	HOP_FREQ_SEQ_04	Yes
5	HOP_FREQ_SEQ_05	Yes
6	HOP_FREQ_SEQ_06	Yes
7	HOP_FREQ_SEQ_07	Yes
8	HOP_FREQ_SEQ_08	Yes
9	HOP_FREQ_SEQ_09	Yes
10	HOP_FREQ_SEQ_10	Yes
11	HOP_FREQ_SEQ_11	Yes
12	HOP_FREQ_SEQ_12	Yes
13	HOP_FREQ_SEQ_13	Yes
14	HOP_FREQ_SEQ_14	Yes
15	HOP_FREQ_SEQ_15	Yes
16	HOP_FREQ_SEQ_16	Yes
17	HOP_FREQ_SEQ_17	Yes
18	HOP_FREQ_SEQ_18	Yes
19	HOP_FREQ_SEQ_19	Yes
20	HOP_FREQ_SEQ_20	Yes
21	HOP_FREQ_SEQ_21	Yes
22	HOP_FREQ_SEQ_22	Yes
23	HOP_FREQ_SEQ_23	Yes
24	HOP_FREQ_SEQ_24	Yes
25	HOP_FREQ_SEQ_25	Yes
26	HOP_FREQ_SEQ_26	Yes
27	HOP_FREQ_SEQ_27	Yes
28	HOP_FREQ_SEQ_28	Yes
29	HOP_FREQ_SEQ_29	Yes
30	HOP_FREQ_SEQ_30	Yes
		Detection Rate: 100 %

Hopping Frequency Sequence Name: HOP_FREQ_SEQ_01							
SEQ#	Frequency (Hz)	SEQ#	Frequency (Hz)	SEQ#	Frequency (Hz)	SEQ#	Frequency (Hz)
1	5.584G	2	5.650G	3	5.556G	4	5.372G
5	5.441G	6	5.637G	7	5.635G	8	5.288G
9	5.697G	10	5.412G	11	5.323G	12	5.452G
13	5.659G	14	5.460G	15	5.641G	16	5.681G
17	5.374G	18	5.301G	19	5.510G	20	5.468G
21	5.585G	22	5.486G	23	5.314G	24	5.677G
25	5.655G	26	5.570G	27	5.687G	28	5.675G
29	5.572G	30	5.583G	31	5.505G	32	5.698G
33	5.350G	34	5.551G	35	5.597G	36	5.707G
37	5.333G	38	5.617G	39	5.259G	40	5.663G
41	5.620G	42	5.398G	43	5.366G	44	5.685G
45	5.516G	46	5.630G	47	5.633G	48	5.445G
49	5.458G	50	5.345G	51	5.680G	52	5.592G
53	5.396G	54	5.463G	55	5.469G	56	5.672G
57	5.518G	58	5.648G	59	5.435G	60	5.297G
61	5.332G	62	5.526G	63	5.586G	64	5.609G
65	5.657G	66	5.430G	67	5.274G	68	5.471G
69	5.310G	70	5.504G	71	5.673G	72	5.281G
73	5.682G	74	5.498G	75	5.688G	76	5.544G
77	5.712G	78	5.634G	79	5.608G	80	5.282G
81	5.631G	82	5.415G	83	5.699G	84	5.360G
85	5.283G	86	5.316G	87	5.472G	88	5.449G
89	5.694G	90	5.269G	91	5.700G	92	5.294G
93	5.692G	94	5.286G	95	5.501G	96	5.689G
97	5.324G	98	5.588G	99	5.536G	100	5.579G

Hopping Frequency Sequence Name: HOP_FREQ_SEQ_02							
SEQ#	Frequency (Hz)	SEQ#	Frequency (Hz)	SEQ#	Frequency (Hz)	SEQ#	Frequency (Hz)
1	5.346G	2	5.501G	3	5.272G	4	5.295G
5	5.403G	6	5.712G	7	5.613G	8	5.429G
9	5.263G	10	5.351G	11	5.476G	12	5.323G
13	5.606G	14	5.355G	15	5.603G	16	5.402G
17	5.721G	18	5.330G	19	5.557G	20	5.354G

21	5.315G	22	5.465G	23	5.590G	24	5.704G
25	5.551G	26	5.303G	27	5.638G	28	5.493G
29	5.480G	30	5.709G	31	5.438G	32	5.255G
33	5.344G	34	5.256G	35	5.651G	36	5.460G
37	5.660G	38	5.343G	39	5.277G	40	5.436G
41	5.658G	42	5.370G	43	5.286G	44	5.446G
45	5.655G	46	5.517G	47	5.394G	48	5.360G
49	5.648G	50	5.425G	51	5.612G	52	5.620G
53	5.592G	54	5.570G	55	5.518G	56	5.298G
57	5.632G	58	5.600G	59	5.448G	60	5.258G
61	5.487G	62	5.701G	63	5.297G	64	5.449G
65	5.691G	66	5.450G	67	5.565G	68	5.348G
69	5.679G	70	5.629G	71	5.380G	72	5.453G
73	5.584G	74	5.335G	75	5.591G	76	5.705G
77	5.398G	78	5.270G	79	5.622G	80	5.514G
81	5.434G	82	5.369G	83	5.485G	84	5.301G
85	5.345G	86	5.618G	87	5.452G	88	5.441G
89	5.474G	90	5.250G	91	5.616G	92	5.710G
93	5.468G	94	5.513G	95	5.692G	96	5.334G
97	5.504G	98	5.347G	99	5.280G	100	5.400G

Hopping Frequency Sequence Name: HOP_FREQ_SEQ_03							
SEQ#	Frequency (Hz)	SEQ#	Frequency (Hz)	SEQ#	Frequency (Hz)	SEQ#	Frequency (Hz)
1	5.520G	2	5.463G	3	5.410G	4	5.684G
5	5.482G	6	5.448G	7	5.370G	8	5.610G
9	5.413G	10	5.667G	11	5.326G	12	5.381G
13	5.443G	14	5.583G	15	5.334G	16	5.642G
17	5.414G	18	5.457G	19	5.385G	20	5.412G
21	5.382G	22	5.578G	23	5.670G	24	5.465G
25	5.483G	26	5.257G	27	5.323G	28	5.674G
29	5.536G	30	5.384G	31	5.596G	32	5.722G
33	5.269G	34	5.643G	35	5.560G	36	5.628G
37	5.580G	38	5.415G	39	5.369G	40	5.636G
41	5.660G	42	5.477G	43	5.678G	44	5.492G
45	5.624G	46	5.337G	47	5.400G	48	5.698G
49	5.640G	50	5.260G	51	5.564G	52	5.403G
53	5.427G	54	5.627G	55	5.350G	56	5.611G

57	5.566G	58	5.691G	59	5.358G	60	5.648G
61	5.262G	62	5.429G	63	5.378G	64	5.590G
65	5.393G	66	5.278G	67	5.718G	68	5.312G
69	5.529G	70	5.305G	71	5.552G	72	5.650G
73	5.454G	74	5.330G	75	5.422G	76	5.341G
77	5.356G	78	5.485G	79	5.551G	80	5.588G
81	5.544G	82	5.716G	83	5.304G	84	5.659G
85	5.277G	86	5.703G	87	5.472G	88	5.575G
89	5.537G	90	5.294G	91	5.690G	92	5.380G
93	5.614G	94	5.362G	95	5.423G	96	5.311G
97	5.637G	98	5.540G	99	5.270G	100	5.302G

Hopping Frequency Sequence Name: HOP_FREQ_SEQ_04							
SEQ#	Frequency (Hz)	SEQ#	Frequency (Hz)	SEQ#	Frequency (Hz)	SEQ#	Frequency (Hz)
1	5.397G	2	5.383G	3	5.462G	4	5.338G
5	5.267G	6	5.261G	7	5.454G	8	5.500G
9	5.603G	10	5.568G	11	5.328G	12	5.467G
13	5.629G	14	5.612G	15	5.544G	16	5.375G
17	5.325G	18	5.507G	19	5.514G	20	5.433G
21	5.718G	22	5.526G	23	5.497G	24	5.520G
25	5.555G	26	5.389G	27	5.628G	28	5.511G
29	5.435G	30	5.424G	31	5.319G	32	5.453G
33	5.493G	34	5.311G	35	5.641G	36	5.415G
37	5.547G	38	5.655G	39	5.711G	40	5.579G
41	5.702G	42	5.260G	43	5.336G	44	5.278G
45	5.314G	46	5.587G	47	5.688G	48	5.598G
49	5.443G	50	5.719G	51	5.291G	52	5.428G
53	5.441G	54	5.377G	55	5.385G	56	5.315G
57	5.609G	58	5.274G	59	5.409G	60	5.546G
61	5.431G	62	5.288G	63	5.324G	64	5.341G
65	5.376G	66	5.689G	67	5.541G	68	5.422G
69	5.695G	70	5.679G	71	5.618G	72	5.465G
73	5.255G	74	5.590G	75	5.634G	76	5.388G
77	5.406G	78	5.420G	79	5.309G	80	5.362G
81	5.425G	82	5.605G	83	5.624G	84	5.374G
85	5.366G	86	5.360G	87	5.645G	88	5.297G
89	5.556G	90	5.554G	91	5.351G	92	5.596G

93	5.302G	94	5.470G	95	5.654G	96	5.299G
97	5.481G	98	5.606G	99	5.487G	100	5.343G

Hopping Frequency Sequence Name: HOP_FREQ_SEQ_05							
SEQ#	Frequency (Hz)	SEQ#	Frequency (Hz)	SEQ#	Frequency (Hz)	SEQ#	Frequency (Hz)
1	5.421G	2	5.644G	3	5.275G	4	5.412G
5	5.320G	6	5.350G	7	5.652G	8	5.620G
9	5.548G	10	5.601G	11	5.640G	12	5.450G
13	5.582G	14	5.702G	15	5.311G	16	5.349G
17	5.489G	18	5.605G	19	5.698G	20	5.407G
21	5.478G	22	5.545G	23	5.267G	24	5.658G
25	5.376G	26	5.707G	27	5.592G	28	5.696G
29	5.655G	30	5.504G	31	5.271G	32	5.416G
33	5.667G	34	5.673G	35	5.347G	36	5.700G
37	5.307G	38	5.723G	39	5.357G	40	5.522G
41	5.417G	42	5.257G	43	5.383G	44	5.419G
45	5.714G	46	5.393G	47	5.261G	48	5.508G
49	5.485G	50	5.260G	51	5.318G	52	5.628G
53	5.278G	54	5.430G	55	5.520G	56	5.392G
57	5.358G	58	5.270G	59	5.627G	60	5.557G
61	5.558G	62	5.305G	63	5.526G	64	5.314G
65	5.528G	66	5.555G	67	5.540G	68	5.380G
69	5.573G	70	5.268G	71	5.459G	72	5.482G
73	5.653G	74	5.353G	75	5.306G	76	5.324G
77	5.497G	78	5.693G	79	5.362G	80	5.514G
81	5.581G	82	5.415G	83	5.368G	84	5.599G
85	5.291G	86	5.704G	87	5.503G	88	5.564G
89	5.611G	90	5.634G	91	5.560G	92	5.300G
93	5.646G	94	5.561G	95	5.692G	96	5.633G
97	5.635G	98	5.492G	99	5.312G	100	5.690G

Hopping Frequency Sequence Name: HOP_FREQ_SEQ_06							
SEQ#	Frequency (Hz)	SEQ#	Frequency (Hz)	SEQ#	Frequency (Hz)	SEQ#	Frequency (Hz)
1	5.510G	2	5.475G	3	5.466G	4	5.512G
5	5.665G	6	5.493G	7	5.595G	8	5.412G
9	5.488G	10	5.435G	11	5.408G	12	5.263G

13	5.569G	14	5.713G	15	5.269G	16	5.687G
17	5.554G	18	5.392G	19	5.455G	20	5.592G
21	5.264G	22	5.670G	23	5.660G	24	5.614G
25	5.715G	26	5.560G	27	5.591G	28	5.461G
29	5.290G	30	5.278G	31	5.714G	32	5.365G
33	5.650G	34	5.307G	35	5.432G	36	5.641G
37	5.490G	38	5.417G	39	5.265G	40	5.457G
41	5.367G	42	5.598G	43	5.308G	44	5.669G
45	5.287G	46	5.413G	47	5.312G	48	5.389G
49	5.495G	50	5.530G	51	5.532G	52	5.525G
53	5.697G	54	5.619G	55	5.494G	56	5.577G
57	5.563G	58	5.342G	59	5.288G	60	5.313G
61	5.513G	62	5.636G	63	5.316G	64	5.428G
65	5.304G	66	5.326G	67	5.681G	68	5.584G
69	5.272G	70	5.363G	71	5.460G	72	5.468G
73	5.710G	74	5.362G	75	5.722G	76	5.262G
77	5.385G	78	5.482G	79	5.336G	80	5.390G
81	5.688G	82	5.277G	83	5.407G	84	5.393G
85	5.334G	86	5.372G	87	5.422G	88	5.322G
89	5.581G	90	5.559G	91	5.346G	92	5.380G
93	5.515G	94	5.258G	95	5.606G	96	5.406G
97	5.564G	98	5.444G	99	5.613G	100	5.526G

Hopping Frequency Sequence Name: HOP_FREQ_SEQ_07							
SEQ#	Frequency (Hz)	SEQ#	Frequency (Hz)	SEQ#	Frequency (Hz)	SEQ#	Frequency (Hz)
1	5.551G	2	5.676G	3	5.484G	4	5.572G
5	5.380G	6	5.718G	7	5.660G	8	5.644G
9	5.397G	10	5.438G	11	5.410G	12	5.256G
13	5.538G	14	5.542G	15	5.550G	16	5.480G
17	5.413G	18	5.461G	19	5.463G	20	5.369G
21	5.640G	22	5.383G	23	5.375G	24	5.488G
25	5.570G	26	5.281G	27	5.613G	28	5.282G
29	5.310G	30	5.273G	31	5.724G	32	5.622G
33	5.633G	34	5.267G	35	5.715G	36	5.523G
37	5.632G	38	5.620G	39	5.567G	40	5.589G
41	5.318G	42	5.263G	43	5.378G	44	5.716G
45	5.289G	46	5.568G	47	5.710G	48	5.516G

49	5.606G	50	5.337G	51	5.283G	52	5.717G
53	5.424G	54	5.651G	55	5.711G	56	5.707G
57	5.698G	58	5.462G	59	5.518G	60	5.445G
61	5.360G	62	5.653G	63	5.307G	64	5.341G
65	5.581G	66	5.457G	67	5.601G	68	5.345G
69	5.658G	70	5.431G	71	5.648G	72	5.253G
73	5.683G	74	5.384G	75	5.398G	76	5.459G
77	5.254G	78	5.607G	79	5.301G	80	5.417G
81	5.347G	82	5.643G	83	5.712G	84	5.514G
85	5.576G	86	5.610G	87	5.386G	88	5.381G
89	5.476G	90	5.680G	91	5.272G	92	5.477G
93	5.565G	94	5.450G	95	5.414G	96	5.343G
97	5.497G	98	5.405G	99	5.503G	100	5.577G

Hopping Frequency Sequence Name: HOP_FREQ_SEQ_08							
SEQ#	Frequency (Hz)	SEQ#	Frequency (Hz)	SEQ#	Frequency (Hz)	SEQ#	Frequency (Hz)
1	5.452G	2	5.443G	3	5.458G	4	5.492G
5	5.281G	6	5.280G	7	5.290G	8	5.685G
9	5.655G	10	5.636G	11	5.369G	12	5.320G
13	5.272G	14	5.644G	15	5.250G	16	5.695G
17	5.303G	18	5.268G	19	5.384G	20	5.351G
21	5.620G	22	5.588G	23	5.447G	24	5.283G
25	5.658G	26	5.566G	27	5.457G	28	5.476G
29	5.626G	30	5.325G	31	5.679G	32	5.590G
33	5.282G	34	5.538G	35	5.269G	36	5.539G
37	5.408G	38	5.400G	39	5.604G	40	5.371G
41	5.520G	42	5.499G	43	5.274G	44	5.352G
45	5.436G	46	5.505G	47	5.394G	48	5.617G
49	5.330G	50	5.652G	51	5.700G	52	5.317G
53	5.592G	54	5.473G	55	5.398G	56	5.573G
57	5.393G	58	5.674G	59	5.635G	60	5.546G
61	5.370G	62	5.542G	63	5.376G	64	5.561G
65	5.385G	66	5.606G	67	5.516G	68	5.613G
69	5.701G	70	5.510G	71	5.397G	72	5.332G
73	5.642G	74	5.651G	75	5.430G	76	5.551G
77	5.560G	78	5.316G	79	5.302G	80	5.382G
81	5.714G	82	5.341G	83	5.429G	84	5.693G

85	5.523G	86	5.470G	87	5.252G	88	5.420G
89	5.266G	90	5.563G	91	5.472G	92	5.601G
93	5.273G	94	5.340G	95	5.296G	96	5.333G
97	5.441G	98	5.550G	99	5.475G	100	5.678G

Hopping Frequency Sequence Name: HOP_FREQ_SEQ_09							
SEQ#	Frequency (Hz)	SEQ#	Frequency (Hz)	SEQ#	Frequency (Hz)	SEQ#	Frequency (Hz)
1	5.618G	2	5.628G	3	5.634G	4	5.468G
5	5.711G	6	5.257G	7	5.588G	8	5.445G
9	5.625G	10	5.675G	11	5.527G	12	5.470G
13	5.707G	14	5.438G	15	5.559G	16	5.499G
17	5.388G	18	5.662G	19	5.594G	20	5.394G
21	5.354G	22	5.678G	23	5.418G	24	5.332G
25	5.696G	26	5.716G	27	5.621G	28	5.450G
29	5.348G	30	5.434G	31	5.452G	32	5.368G
33	5.382G	34	5.254G	35	5.578G	36	5.377G
37	5.269G	38	5.554G	39	5.449G	40	5.430G
41	5.383G	42	5.623G	43	5.401G	44	5.399G
45	5.550G	46	5.586G	47	5.581G	48	5.308G
49	5.512G	50	5.275G	51	5.362G	52	5.363G
53	5.576G	54	5.671G	55	5.342G	56	5.381G
57	5.284G	58	5.390G	59	5.605G	60	5.455G
61	5.503G	62	5.547G	63	5.562G	64	5.429G
65	5.704G	66	5.426G	67	5.411G	68	5.613G
69	5.584G	70	5.311G	71	5.501G	72	5.537G
73	5.451G	74	5.717G	75	5.709G	76	5.695G
77	5.303G	78	5.369G	79	5.514G	80	5.570G
81	5.665G	82	5.592G	83	5.631G	84	5.253G
85	5.622G	86	5.463G	87	5.469G	88	5.518G
89	5.437G	90	5.642G	91	5.630G	92	5.398G
93	5.491G	94	5.367G	95	5.346G	96	5.425G
97	5.414G	98	5.640G	99	5.321G	100	5.393G

Hopping Frequency Sequence Name: HOP_FREQ_SEQ_10							
SEQ#	Frequency (Hz)	SEQ#	Frequency (Hz)	SEQ#	Frequency (Hz)	SEQ#	Frequency (Hz)
1	5.314G	2	5.430G	3	5.302G	4	5.313G
5	5.617G	6	5.493G	7	5.598G	8	5.300G
9	5.712G	10	5.573G	11	5.578G	12	5.340G
13	5.359G	14	5.593G	15	5.351G	16	5.451G
17	5.354G	18	5.389G	19	5.275G	20	5.625G
21	5.515G	22	5.574G	23	5.404G	24	5.552G
25	5.426G	26	5.561G	27	5.685G	28	5.555G
29	5.592G	30	5.363G	31	5.717G	32	5.347G
33	5.252G	34	5.701G	35	5.614G	36	5.608G
37	5.671G	38	5.449G	39	5.556G	40	5.371G
41	5.373G	42	5.652G	43	5.365G	44	5.304G
45	5.537G	46	5.634G	47	5.281G	48	5.647G
49	5.324G	50	5.544G	51	5.447G	52	5.437G
53	5.400G	54	5.289G	55	5.325G	56	5.505G
57	5.603G	58	5.279G	59	5.416G	60	5.446G
61	5.326G	62	5.419G	63	5.550G	64	5.409G
65	5.605G	66	5.316G	67	5.360G	68	5.540G
69	5.370G	70	5.495G	71	5.613G	72	5.467G
73	5.362G	74	5.514G	75	5.298G	76	5.559G
77	5.380G	78	5.636G	79	5.589G	80	5.470G
81	5.551G	82	5.428G	83	5.429G	84	5.716G
85	5.361G	86	5.330G	87	5.441G	88	5.402G
89	5.271G	90	5.297G	91	5.696G	92	5.691G
93	5.376G	94	5.424G	95	5.707G	96	5.307G
97	5.435G	98	5.385G	99	5.638G	100	5.563G

Hopping Frequency Sequence Name: HOP_FREQ_SEQ_11							
SEQ#	Frequency (Hz)	SEQ#	Frequency (Hz)	SEQ#	Frequency (Hz)	SEQ#	Frequency (Hz)
1	5.583G	2	5.494G	3	5.698G	4	5.598G
5	5.625G	6	5.370G	7	5.326G	8	5.606G
9	5.498G	10	5.328G	11	5.694G	12	5.709G
13	5.613G	14	5.481G	15	5.418G	16	5.677G
17	5.448G	18	5.343G	19	5.357G	20	5.554G

21	5.659G	22	5.396G	23	5.303G	24	5.419G
25	5.362G	26	5.428G	27	5.469G	28	5.268G
29	5.394G	30	5.492G	31	5.663G	32	5.720G
33	5.567G	34	5.356G	35	5.635G	36	5.372G
37	5.386G	38	5.345G	39	5.600G	40	5.412G
41	5.258G	42	5.411G	43	5.301G	44	5.618G
45	5.699G	46	5.604G	47	5.463G	48	5.542G
49	5.680G	50	5.670G	51	5.368G	52	5.589G
53	5.553G	54	5.515G	55	5.446G	56	5.304G
57	5.441G	58	5.424G	59	5.620G	60	5.263G
61	5.592G	62	5.629G	63	5.466G	64	5.556G
65	5.636G	66	5.722G	67	5.302G	68	5.656G
69	5.252G	70	5.286G	71	5.369G	72	5.723G
73	5.573G	74	5.569G	75	5.558G	76	5.250G
77	5.500G	78	5.457G	79	5.462G	80	5.562G
81	5.716G	82	5.614G	83	5.347G	84	5.565G
85	5.288G	86	5.627G	87	5.342G	88	5.696G
89	5.712G	90	5.337G	91	5.649G	92	5.538G
93	5.688G	94	5.549G	95	5.272G	96	5.447G
97	5.519G	98	5.323G	99	5.314G	100	5.706G

Hopping Frequency Sequence Name: HOP_FREQ_SEQ_12							
SEQ#	Frequency (Hz)	SEQ#	Frequency (Hz)	SEQ#	Frequency (Hz)	SEQ#	Frequency (Hz)
1	5.511G	2	5.597G	3	5.289G	4	5.670G
5	5.617G	6	5.438G	7	5.491G	8	5.682G
9	5.526G	10	5.298G	11	5.352G	12	5.714G
13	5.689G	14	5.688G	15	5.360G	16	5.431G
17	5.530G	18	5.549G	19	5.478G	20	5.411G
21	5.658G	22	5.356G	23	5.265G	24	5.345G
25	5.520G	26	5.624G	27	5.562G	28	5.674G
29	5.284G	30	5.707G	31	5.464G	32	5.502G
33	5.315G	34	5.297G	35	5.639G	36	5.469G
37	5.407G	38	5.353G	39	5.542G	40	5.458G
41	5.545G	42	5.367G	43	5.569G	44	5.687G
45	5.680G	46	5.722G	47	5.312G	48	5.465G
49	5.574G	50	5.319G	51	5.648G	52	5.702G
53	5.664G	54	5.515G	55	5.613G	56	5.504G

57	5.662G	58	5.251G	59	5.322G	60	5.448G
61	5.395G	62	5.582G	63	5.350G	64	5.563G
65	5.508G	66	5.261G	67	5.577G	68	5.393G
69	5.280G	70	5.374G	71	5.380G	72	5.519G
73	5.460G	74	5.587G	75	5.720G	76	5.653G
77	5.611G	78	5.657G	79	5.596G	80	5.642G
81	5.684G	82	5.604G	83	5.538G	84	5.415G
85	5.692G	86	5.423G	87	5.258G	88	5.336G
89	5.436G	90	5.349G	91	5.287G	92	5.427G
93	5.283G	94	5.711G	95	5.316G	96	5.638G
97	5.507G	98	5.691G	99	5.399G	100	5.610G

Hopping Frequency Sequence Name: HOP_FREQ_SEQ_13							
SEQ#	Frequency (Hz)	SEQ#	Frequency (Hz)	SEQ#	Frequency (Hz)	SEQ#	Frequency (Hz)
1	5.524G	2	5.546G	3	5.257G	4	5.323G
5	5.303G	6	5.498G	7	5.585G	8	5.653G
9	5.540G	10	5.413G	11	5.482G	12	5.462G
13	5.296G	14	5.656G	15	5.626G	16	5.631G
17	5.567G	18	5.711G	19	5.418G	20	5.374G
21	5.666G	22	5.623G	23	5.382G	24	5.408G
25	5.615G	26	5.394G	27	5.593G	28	5.657G
29	5.441G	30	5.395G	31	5.714G	32	5.607G
33	5.254G	34	5.612G	35	5.677G	36	5.717G
37	5.684G	38	5.660G	39	5.273G	40	5.415G
41	5.351G	42	5.484G	43	5.673G	44	5.610G
45	5.442G	46	5.478G	47	5.661G	48	5.563G
49	5.560G	50	5.617G	51	5.463G	52	5.459G
53	5.469G	54	5.417G	55	5.525G	56	5.555G
57	5.493G	58	5.371G	59	5.516G	60	5.663G
61	5.347G	62	5.288G	63	5.580G	64	5.350G
65	5.378G	66	5.700G	67	5.597G	68	5.324G
69	5.458G	70	5.471G	71	5.538G	72	5.599G
73	5.426G	74	5.310G	75	5.688G	76	5.333G
77	5.475G	78	5.258G	79	5.419G	80	5.701G
81	5.600G	82	5.590G	83	5.690G	84	5.528G
85	5.362G	86	5.342G	87	5.502G	88	5.414G
89	5.457G	90	5.297G	91	5.357G	92	5.509G

93	5.274G	94	5.451G	95	5.328G	96	5.539G
97	5.596G	98	5.479G	99	5.474G	100	5.284G

Hopping Frequency Sequence Name: HOP_FREQ_SEQ_14							
SEQ#	Frequency (Hz)	SEQ#	Frequency (Hz)	SEQ#	Frequency (Hz)	SEQ#	Frequency (Hz)
1	5.284G	2	5.688G	3	5.520G	4	5.344G
5	5.339G	6	5.657G	7	5.545G	8	5.607G
9	5.538G	10	5.297G	11	5.658G	12	5.600G
13	5.460G	14	5.285G	15	5.398G	16	5.264G
17	5.303G	18	5.465G	19	5.708G	20	5.443G
21	5.421G	22	5.630G	23	5.386G	24	5.357G
25	5.723G	26	5.684G	27	5.483G	28	5.551G
29	5.529G	30	5.275G	31	5.381G	32	5.444G
33	5.639G	34	5.345G	35	5.326G	36	5.506G
37	5.531G	38	5.679G	39	5.355G	40	5.649G
41	5.560G	42	5.377G	43	5.331G	44	5.428G
45	5.575G	46	5.500G	47	5.509G	48	5.656G
49	5.693G	50	5.376G	51	5.434G	52	5.327G
53	5.542G	54	5.368G	55	5.321G	56	5.349G
57	5.389G	58	5.353G	59	5.606G	60	5.494G
61	5.315G	62	5.568G	63	5.559G	64	5.278G
65	5.680G	66	5.288G	67	5.557G	68	5.405G
69	5.589G	70	5.634G	71	5.721G	72	5.350G
73	5.485G	74	5.481G	75	5.433G	76	5.296G
77	5.691G	78	5.544G	79	5.587G	80	5.599G
81	5.713G	82	5.632G	83	5.676G	84	5.307G
85	5.497G	86	5.328G	87	5.653G	88	5.578G
89	5.332G	90	5.608G	91	5.310G	92	5.445G
93	5.419G	94	5.576G	95	5.503G	96	5.549G
97	5.322G	98	5.683G	99	5.707G	100	5.698G

Hopping Frequency Sequence Name: HOP_FREQ_SEQ_15							
SEQ#	Frequency (Hz)	SEQ#	Frequency (Hz)	SEQ#	Frequency (Hz)	SEQ#	Frequency (Hz)
1	5.522G	2	5.425G	3	5.421G	4	5.722G
5	5.369G	6	5.553G	7	5.395G	8	5.265G
9	5.669G	10	5.543G	11	5.266G	12	5.490G
13	5.724G	14	5.250G	15	5.405G	16	5.579G
17	5.520G	18	5.608G	19	5.686G	20	5.404G
21	5.494G	22	5.560G	23	5.446G	24	5.367G
25	5.545G	26	5.388G	27	5.350G	28	5.402G
29	5.640G	30	5.286G	31	5.273G	32	5.680G
33	5.256G	34	5.292G	35	5.308G	36	5.481G
37	5.304G	38	5.600G	39	5.397G	40	5.299G
41	5.386G	42	5.586G	43	5.602G	44	5.444G
45	5.684G	46	5.505G	47	5.723G	48	5.613G
49	5.532G	50	5.319G	51	5.595G	52	5.370G
53	5.318G	54	5.314G	55	5.487G	56	5.531G
57	5.604G	58	5.272G	59	5.572G	60	5.598G
61	5.384G	62	5.591G	63	5.619G	64	5.695G
65	5.372G	66	5.452G	67	5.443G	68	5.269G
69	5.462G	70	5.568G	71	5.346G	72	5.422G
73	5.257G	74	5.523G	75	5.671G	76	5.307G
77	5.361G	78	5.416G	79	5.433G	80	5.617G
81	5.398G	82	5.351G	83	5.485G	84	5.650G
85	5.347G	86	5.334G	87	5.442G	88	5.276G
89	5.392G	90	5.360G	91	5.456G	92	5.468G
93	5.309G	94	5.328G	95	5.497G	96	5.337G
97	5.294G	98	5.261G	99	5.557G	100	5.665G

Hopping Frequency Sequence Name: HOP_FREQ_SEQ_16							
SEQ#	Frequency (Hz)	SEQ#	Frequency (Hz)	SEQ#	Frequency (Hz)	SEQ#	Frequency (Hz)
1	5.587G	2	5.395G	3	5.533G	4	5.319G
5	5.473G	6	5.361G	7	5.697G	8	5.549G
9	5.680G	10	5.507G	11	5.526G	12	5.374G
13	5.377G	14	5.723G	15	5.444G	16	5.457G
17	5.347G	18	5.517G	19	5.313G	20	5.412G
21	5.720G	22	5.719G	23	5.380G	24	5.410G
25	5.692G	26	5.323G	27	5.466G	28	5.506G
29	5.386G	30	5.286G	31	5.643G	32	5.681G
33	5.370G	34	5.333G	35	5.476G	36	5.498G
37	5.655G	38	5.368G	39	5.612G	40	5.254G
41	5.602G	42	5.627G	43	5.335G	44	5.404G
45	5.718G	46	5.656G	47	5.667G	48	5.431G
49	5.686G	50	5.651G	51	5.585G	52	5.649G
53	5.265G	54	5.474G	55	5.268G	56	5.631G
57	5.376G	58	5.260G	59	5.488G	60	5.521G
61	5.672G	62	5.618G	63	5.403G	64	5.610G
65	5.315G	66	5.556G	67	5.659G	68	5.420G
69	5.596G	70	5.270G	71	5.324G	72	5.546G
73	5.358G	74	5.675G	75	5.295G	76	5.568G
77	5.281G	78	5.630G	79	5.499G	80	5.263G
81	5.325G	82	5.541G	83	5.490G	84	5.371G
85	5.634G	86	5.464G	87	5.352G	88	5.326G
89	5.330G	90	5.606G	91	5.711G	92	5.381G
93	5.580G	94	5.280G	95	5.554G	96	5.362G
97	5.626G	98	5.510G	99	5.716G	100	5.441G

Hopping Frequency Sequence Name: HOP_FREQ_SEQ_17							
SEQ#	Frequency (Hz)	SEQ#	Frequency (Hz)	SEQ#	Frequency (Hz)	SEQ#	Frequency (Hz)
1	5.293G	2	5.283G	3	5.433G	4	5.556G
5	5.494G	6	5.344G	7	5.320G	8	5.656G
9	5.405G	10	5.606G	11	5.323G	12	5.358G
13	5.274G	14	5.521G	15	5.434G	16	5.546G
17	5.644G	18	5.487G	19	5.313G	20	5.676G
21	5.609G	22	5.297G	23	5.565G	24	5.377G
25	5.288G	26	5.397G	27	5.470G	28	5.299G
29	5.645G	30	5.292G	31	5.667G	32	5.473G
33	5.615G	34	5.513G	35	5.558G	36	5.447G
37	5.549G	38	5.362G	39	5.365G	40	5.465G
41	5.483G	42	5.370G	43	5.361G	44	5.702G
45	5.369G	46	5.723G	47	5.328G	48	5.278G
49	5.311G	50	5.539G	51	5.419G	52	5.554G
53	5.262G	54	5.379G	55	5.713G	56	5.493G
57	5.294G	58	5.603G	59	5.304G	60	5.340G
61	5.614G	62	5.350G	63	5.551G	64	5.626G
65	5.295G	66	5.671G	67	5.336G	68	5.694G
69	5.621G	70	5.540G	71	5.648G	72	5.391G
73	5.373G	74	5.682G	75	5.463G	76	5.672G
77	5.559G	78	5.477G	79	5.518G	80	5.607G
81	5.647G	82	5.442G	83	5.720G	84	5.590G
85	5.403G	86	5.580G	87	5.591G	88	5.637G
89	5.506G	90	5.411G	91	5.587G	92	5.543G
93	5.601G	94	5.455G	95	5.697G	96	5.668G
97	5.695G	98	5.271G	99	5.430G	100	5.514G

Hopping Frequency Sequence Name: HOP_FREQ_SEQ_18							
SEQ#	Frequency (Hz)	SEQ#	Frequency (Hz)	SEQ#	Frequency (Hz)	SEQ#	Frequency (Hz)
1	5.715G	2	5.594G	3	5.450G	4	5.473G
5	5.287G	6	5.338G	7	5.346G	8	5.288G
9	5.542G	10	5.306G	11	5.333G	12	5.472G
13	5.490G	14	5.551G	15	5.644G	16	5.651G
17	5.618G	18	5.434G	19	5.691G	20	5.666G
21	5.648G	22	5.558G	23	5.397G	24	5.316G
25	5.602G	26	5.545G	27	5.336G	28	5.701G
29	5.401G	30	5.582G	31	5.576G	32	5.429G
33	5.367G	34	5.527G	35	5.344G	36	5.286G
37	5.304G	38	5.660G	39	5.687G	40	5.631G
41	5.622G	42	5.677G	43	5.383G	44	5.296G
45	5.619G	46	5.503G	47	5.708G	48	5.482G
49	5.624G	50	5.599G	51	5.667G	52	5.298G
53	5.414G	54	5.349G	55	5.548G	56	5.615G
57	5.568G	58	5.424G	59	5.720G	60	5.271G
61	5.369G	62	5.559G	63	5.276G	64	5.356G
65	5.256G	66	5.681G	67	5.540G	68	5.263G
69	5.275G	70	5.629G	71	5.303G	72	5.433G
73	5.481G	74	5.523G	75	5.285G	76	5.407G
77	5.378G	78	5.512G	79	5.650G	80	5.278G
81	5.446G	82	5.546G	83	5.486G	84	5.564G
85	5.613G	86	5.390G	87	5.348G	88	5.468G
89	5.565G	90	5.518G	91	5.600G	92	5.311G
93	5.506G	94	5.484G	95	5.438G	96	5.381G
97	5.553G	98	5.364G	99	5.423G	100	5.343G

Hopping Frequency Sequence Name: HOP_FREQ_SEQ_19							
SEQ#	Frequency (Hz)	SEQ#	Frequency (Hz)	SEQ#	Frequency (Hz)	SEQ#	Frequency (Hz)
1	5.666G	2	5.487G	3	5.470G	4	5.359G
5	5.338G	6	5.472G	7	5.390G	8	5.708G
9	5.589G	10	5.366G	11	5.485G	12	5.519G
13	5.337G	14	5.659G	15	5.501G	16	5.405G
17	5.295G	18	5.369G	19	5.284G	20	5.425G
21	5.661G	22	5.447G	23	5.483G	24	5.267G
25	5.285G	26	5.549G	27	5.306G	28	5.473G
29	5.637G	30	5.578G	31	5.513G	32	5.605G
33	5.623G	34	5.573G	35	5.536G	36	5.663G
37	5.511G	38	5.479G	39	5.611G	40	5.510G
41	5.403G	42	5.301G	43	5.711G	44	5.706G
45	5.259G	46	5.554G	47	5.494G	48	5.254G
49	5.250G	50	5.497G	51	5.291G	52	5.543G
53	5.495G	54	5.376G	55	5.481G	56	5.325G
57	5.506G	58	5.697G	59	5.340G	60	5.378G
61	5.579G	62	5.558G	63	5.664G	64	5.364G
65	5.290G	66	5.467G	67	5.446G	68	5.417G
69	5.684G	70	5.700G	71	5.408G	72	5.545G
73	5.316G	74	5.305G	75	5.616G	76	5.329G
77	5.255G	78	5.601G	79	5.455G	80	5.486G
81	5.478G	82	5.383G	83	5.450G	84	5.358G
85	5.678G	86	5.407G	87	5.514G	88	5.718G
89	5.331G	90	5.468G	91	5.698G	92	5.507G
93	5.312G	94	5.719G	95	5.372G	96	5.570G
97	5.271G	98	5.528G	99	5.582G	100	5.644G

Hopping Frequency Sequence Name: HOP_FREQ_SEQ_20							
SEQ#	Frequency (Hz)	SEQ#	Frequency (Hz)	SEQ#	Frequency (Hz)	SEQ#	Frequency (Hz)
1	5.388G	2	5.645G	3	5.618G	4	5.275G
5	5.406G	6	5.363G	7	5.279G	8	5.639G
9	5.665G	10	5.617G	11	5.579G	12	5.691G
13	5.295G	14	5.602G	15	5.372G	16	5.484G
17	5.516G	18	5.345G	19	5.649G	20	5.597G
21	5.394G	22	5.404G	23	5.487G	24	5.483G
25	5.543G	26	5.722G	27	5.574G	28	5.353G
29	5.528G	30	5.522G	31	5.401G	32	5.467G
33	5.325G	34	5.585G	35	5.277G	36	5.264G
37	5.525G	38	5.586G	39	5.430G	40	5.350G
41	5.445G	42	5.635G	43	5.675G	44	5.285G
45	5.674G	46	5.307G	47	5.328G	48	5.338G
49	5.286G	50	5.540G	51	5.657G	52	5.313G
53	5.546G	54	5.370G	55	5.358G	56	5.611G
57	5.495G	58	5.410G	59	5.268G	60	5.640G
61	5.311G	62	5.513G	63	5.584G	64	5.562G
65	5.518G	66	5.572G	67	5.456G	68	5.680G
69	5.461G	70	5.348G	71	5.505G	72	5.340G
73	5.409G	74	5.699G	75	5.362G	76	5.714G
77	5.706G	78	5.684G	79	5.431G	80	5.463G
81	5.288G	82	5.418G	83	5.374G	84	5.270G
85	5.571G	86	5.414G	87	5.266G	88	5.322G
89	5.547G	90	5.272G	91	5.710G	92	5.327G
93	5.331G	94	5.282G	95	5.403G	96	5.560G
97	5.342G	98	5.321G	99	5.701G	100	5.504G

Hopping Frequency Sequence Name: HOP_FREQ_SEQ_21							
SEQ#	Frequency (Hz)	SEQ#	Frequency (Hz)	SEQ#	Frequency (Hz)	SEQ#	Frequency (Hz)
1	5.637G	2	5.337G	3	5.452G	4	5.302G
5	5.278G	6	5.606G	7	5.696G	8	5.579G
9	5.363G	10	5.285G	11	5.275G	12	5.484G
13	5.427G	14	5.468G	15	5.309G	16	5.607G
17	5.494G	18	5.684G	19	5.272G	20	5.697G
21	5.447G	22	5.367G	23	5.338G	24	5.504G
25	5.465G	26	5.381G	27	5.368G	28	5.471G
29	5.310G	30	5.455G	31	5.553G	32	5.626G
33	5.457G	34	5.420G	35	5.362G	36	5.621G
37	5.700G	38	5.599G	39	5.653G	40	5.615G
41	5.402G	42	5.379G	43	5.490G	44	5.715G
45	5.695G	46	5.595G	47	5.421G	48	5.609G
49	5.664G	50	5.642G	51	5.628G	52	5.674G
53	5.507G	54	5.617G	55	5.656G	56	5.493G
57	5.266G	58	5.714G	59	5.319G	60	5.441G
61	5.478G	62	5.444G	63	5.474G	64	5.575G
65	5.294G	66	5.282G	67	5.328G	68	5.462G
69	5.289G	70	5.724G	71	5.454G	72	5.306G
73	5.380G	74	5.332G	75	5.677G	76	5.374G
77	5.712G	78	5.387G	79	5.472G	80	5.542G
81	5.533G	82	5.426G	83	5.254G	84	5.669G
85	5.271G	86	5.577G	87	5.502G	88	5.403G
89	5.543G	90	5.571G	91	5.513G	92	5.479G
93	5.601G	94	5.482G	95	5.428G	96	5.614G
97	5.336G	98	5.372G	99	5.600G	100	5.470G

Hopping Frequency Sequence Name: HOP_FREQ_SEQ_22							
SEQ#	Frequency (Hz)	SEQ#	Frequency (Hz)	SEQ#	Frequency (Hz)	SEQ#	Frequency (Hz)
1	5.335G	2	5.570G	3	5.334G	4	5.433G
5	5.464G	6	5.451G	7	5.687G	8	5.586G
9	5.254G	10	5.634G	11	5.438G	12	5.722G
13	5.386G	14	5.607G	15	5.290G	16	5.262G
17	5.515G	18	5.441G	19	5.636G	20	5.270G
21	5.256G	22	5.279G	23	5.620G	24	5.447G
25	5.471G	26	5.417G	27	5.473G	28	5.708G
29	5.468G	30	5.362G	31	5.572G	32	5.563G
33	5.328G	34	5.601G	35	5.541G	36	5.629G
37	5.393G	38	5.667G	39	5.531G	40	5.313G
41	5.633G	42	5.403G	43	5.613G	44	5.553G
45	5.465G	46	5.716G	47	5.329G	48	5.356G
49	5.320G	50	5.391G	51	5.255G	52	5.276G
53	5.324G	54	5.271G	55	5.500G	56	5.646G
57	5.404G	58	5.265G	59	5.671G	60	5.616G
61	5.371G	62	5.606G	63	5.477G	64	5.467G
65	5.561G	66	5.359G	67	5.603G	68	5.407G
69	5.426G	70	5.715G	71	5.663G	72	5.680G
73	5.463G	74	5.274G	75	5.567G	76	5.721G
77	5.678G	78	5.657G	79	5.443G	80	5.338G
81	5.293G	82	5.325G	83	5.724G	84	5.402G
85	5.581G	86	5.478G	87	5.507G	88	5.669G
89	5.409G	90	5.495G	91	5.627G	92	5.519G
93	5.508G	94	5.322G	95	5.373G	96	5.382G
97	5.530G	98	5.589G	99	5.587G	100	5.580G

Hopping Frequency Sequence Name: HOP_FREQ_SEQ_23							
SEQ#	Frequency (Hz)	SEQ#	Frequency (Hz)	SEQ#	Frequency (Hz)	SEQ#	Frequency (Hz)
1	5.295G	2	5.251G	3	5.536G	4	5.257G
5	5.694G	6	5.615G	7	5.373G	8	5.529G
9	5.255G	10	5.542G	11	5.604G	12	5.280G
13	5.288G	14	5.479G	15	5.706G	16	5.600G
17	5.420G	18	5.640G	19	5.256G	20	5.260G
21	5.605G	22	5.349G	23	5.466G	24	5.576G
25	5.310G	26	5.696G	27	5.658G	28	5.284G
29	5.286G	30	5.651G	31	5.324G	32	5.570G
33	5.627G	34	5.610G	35	5.541G	36	5.505G
37	5.527G	38	5.481G	39	5.270G	40	5.301G
41	5.667G	42	5.516G	43	5.409G	44	5.299G
45	5.348G	46	5.482G	47	5.617G	48	5.586G
49	5.442G	50	5.297G	51	5.470G	52	5.296G
53	5.417G	54	5.282G	55	5.671G	56	5.676G
57	5.506G	58	5.421G	59	5.438G	60	5.345G
61	5.402G	62	5.350G	63	5.483G	64	5.577G
65	5.573G	66	5.537G	67	5.635G	68	5.426G
69	5.278G	70	5.303G	71	5.276G	72	5.591G
73	5.686G	74	5.568G	75	5.559G	76	5.712G
77	5.621G	78	5.414G	79	5.669G	80	5.398G
81	5.630G	82	5.521G	83	5.662G	84	5.619G
85	5.262G	86	5.578G	87	5.335G	88	5.401G
89	5.645G	90	5.312G	91	5.546G	92	5.292G
93	5.654G	94	5.663G	95	5.557G	96	5.628G
97	5.504G	98	5.305G	99	5.632G	100	5.624G

Hopping Frequency Sequence Name: HOP_FREQ_SEQ_24							
SEQ#	Frequency (Hz)	SEQ#	Frequency (Hz)	SEQ#	Frequency (Hz)	SEQ#	Frequency (Hz)
1	5.471G	2	5.508G	3	5.494G	4	5.442G
5	5.648G	6	5.621G	7	5.433G	8	5.405G
9	5.339G	10	5.302G	11	5.546G	12	5.502G
13	5.268G	14	5.607G	15	5.673G	16	5.406G
17	5.669G	18	5.307G	19	5.453G	20	5.670G
21	5.274G	22	5.570G	23	5.636G	24	5.484G
25	5.599G	26	5.458G	27	5.294G	28	5.595G
29	5.308G	30	5.606G	31	5.556G	32	5.402G
33	5.392G	34	5.626G	35	5.603G	36	5.416G
37	5.645G	38	5.709G	39	5.665G	40	5.407G
41	5.290G	42	5.298G	43	5.628G	44	5.314G
45	5.363G	46	5.366G	47	5.557G	48	5.321G
49	5.722G	50	5.525G	51	5.351G	52	5.390G
53	5.309G	54	5.614G	55	5.464G	56	5.281G
57	5.639G	58	5.293G	59	5.424G	60	5.413G
61	5.332G	62	5.478G	63	5.305G	64	5.398G
65	5.619G	66	5.507G	67	5.642G	68	5.299G
69	5.488G	70	5.480G	71	5.396G	72	5.682G
73	5.450G	74	5.592G	75	5.403G	76	5.374G
77	5.538G	78	5.287G	79	5.282G	80	5.537G
81	5.710G	82	5.641G	83	5.615G	84	5.358G
85	5.613G	86	5.438G	87	5.346G	88	5.386G
89	5.680G	90	5.255G	91	5.486G	92	5.379G
93	5.304G	94	5.320G	95	5.446G	96	5.720G
97	5.503G	98	5.690G	99	5.269G	100	5.306G

Hopping Frequency Sequence Name: HOP_FREQ_SEQ_25							
SEQ#	Frequency (Hz)	SEQ#	Frequency (Hz)	SEQ#	Frequency (Hz)	SEQ#	Frequency (Hz)
1	5.545G	2	5.281G	3	5.677G	4	5.635G
5	5.287G	6	5.663G	7	5.632G	8	5.290G
9	5.395G	10	5.614G	11	5.260G	12	5.396G
13	5.646G	14	5.538G	15	5.390G	16	5.611G
17	5.402G	18	5.647G	19	5.561G	20	5.397G
21	5.373G	22	5.444G	23	5.315G	24	5.300G
25	5.501G	26	5.407G	27	5.670G	28	5.514G
29	5.448G	30	5.343G	31	5.294G	32	5.382G
33	5.580G	34	5.606G	35	5.261G	36	5.329G
37	5.334G	38	5.527G	39	5.480G	40	5.666G
41	5.276G	42	5.422G	43	5.301G	44	5.639G
45	5.661G	46	5.684G	47	5.616G	48	5.369G
49	5.385G	50	5.317G	51	5.590G	52	5.253G
53	5.689G	54	5.375G	55	5.714G	56	5.693G
57	5.496G	58	5.596G	59	5.583G	60	5.529G
61	5.340G	62	5.477G	63	5.723G	64	5.656G
65	5.252G	66	5.662G	67	5.629G	68	5.622G
69	5.335G	70	5.592G	71	5.360G	72	5.333G
73	5.391G	74	5.603G	75	5.374G	76	5.665G
77	5.420G	78	5.681G	79	5.674G	80	5.368G
81	5.324G	82	5.312G	83	5.468G	84	5.319G
85	5.559G	86	5.518G	87	5.367G	88	5.275G
89	5.709G	90	5.262G	91	5.692G	92	5.582G
93	5.584G	94	5.473G	95	5.282G	96	5.331G
97	5.298G	98	5.565G	99	5.470G	100	5.626G

Hopping Frequency Sequence Name: HOP_FREQ_SEQ_26							
SEQ#	Frequency (Hz)	SEQ#	Frequency (Hz)	SEQ#	Frequency (Hz)	SEQ#	Frequency (Hz)
1	5.475G	2	5.337G	3	5.544G	4	5.723G
5	5.509G	6	5.506G	7	5.328G	8	5.327G
9	5.260G	10	5.716G	11	5.542G	12	5.256G
13	5.441G	14	5.349G	15	5.634G	16	5.680G
17	5.545G	18	5.661G	19	5.469G	20	5.704G
21	5.478G	22	5.446G	23	5.393G	24	5.521G
25	5.400G	26	5.306G	27	5.295G	28	5.280G
29	5.367G	30	5.557G	31	5.681G	32	5.471G
33	5.573G	34	5.637G	35	5.554G	36	5.444G
37	5.292G	38	5.552G	39	5.413G	40	5.588G
41	5.252G	42	5.447G	43	5.496G	44	5.582G
45	5.502G	46	5.373G	47	5.311G	48	5.415G
49	5.354G	50	5.412G	51	5.418G	52	5.685G
53	5.267G	54	5.483G	55	5.334G	56	5.626G
57	5.368G	58	5.600G	59	5.307G	60	5.498G
61	5.428G	62	5.341G	63	5.693G	64	5.569G
65	5.495G	66	5.647G	67	5.266G	68	5.481G
69	5.624G	70	5.477G	71	5.399G	72	5.422G
73	5.452G	74	5.689G	75	5.282G	76	5.296G
77	5.344G	78	5.333G	79	5.301G	80	5.595G
81	5.503G	82	5.501G	83	5.277G	84	5.358G
85	5.253G	86	5.419G	87	5.593G	88	5.456G
89	5.673G	90	5.629G	91	5.656G	92	5.671G
93	5.375G	94	5.650G	95	5.459G	96	5.678G
97	5.635G	98	5.615G	99	5.434G	100	5.575G

Hopping Frequency Sequence Name: HOP_FREQ_SEQ_27							
SEQ#	Frequency (Hz)	SEQ#	Frequency (Hz)	SEQ#	Frequency (Hz)	SEQ#	Frequency (Hz)
1	5.289G	2	5.560G	3	5.603G	4	5.697G
5	5.449G	6	5.529G	7	5.462G	8	5.262G
9	5.570G	10	5.701G	11	5.340G	12	5.274G
13	5.651G	14	5.673G	15	5.536G	16	5.712G
17	5.411G	18	5.566G	19	5.686G	20	5.376G
21	5.717G	22	5.531G	23	5.692G	24	5.295G
25	5.611G	26	5.719G	27	5.661G	28	5.667G
29	5.311G	30	5.470G	31	5.287G	32	5.561G
33	5.316G	34	5.517G	35	5.286G	36	5.604G
37	5.556G	38	5.398G	39	5.446G	40	5.350G
41	5.282G	42	5.380G	43	5.549G	44	5.480G
45	5.522G	46	5.408G	47	5.623G	48	5.416G
49	5.263G	50	5.352G	51	5.621G	52	5.674G
53	5.714G	54	5.644G	55	5.665G	56	5.412G
57	5.305G	58	5.315G	59	5.710G	60	5.251G
61	5.471G	62	5.302G	63	5.357G	64	5.575G
65	5.432G	66	5.630G	67	5.456G	68	5.720G
69	5.707G	70	5.513G	71	5.303G	72	5.330G
73	5.482G	74	5.296G	75	5.595G	76	5.457G
77	5.297G	78	5.371G	79	5.632G	80	5.643G
81	5.540G	82	5.687G	83	5.310G	84	5.684G
85	5.721G	86	5.658G	87	5.465G	88	5.341G
89	5.553G	90	5.506G	91	5.563G	92	5.463G
93	5.691G	94	5.417G	95	5.481G	96	5.472G
97	5.581G	98	5.500G	99	5.304G	100	5.568G

Hopping Frequency Sequence Name: HOP_FREQ_SEQ_28							
SEQ#	Frequency (Hz)	SEQ#	Frequency (Hz)	SEQ#	Frequency (Hz)	SEQ#	Frequency (Hz)
1	5.388G	2	5.252G	3	5.315G	4	5.290G
5	5.590G	6	5.638G	7	5.636G	8	5.550G
9	5.335G	10	5.642G	11	5.254G	12	5.566G
13	5.549G	14	5.640G	15	5.279G	16	5.499G
17	5.649G	18	5.267G	19	5.491G	20	5.587G
21	5.712G	22	5.309G	23	5.393G	24	5.260G
25	5.416G	26	5.271G	27	5.293G	28	5.366G
29	5.596G	30	5.446G	31	5.594G	32	5.624G
33	5.438G	34	5.343G	35	5.319G	36	5.313G
37	5.310G	38	5.341G	39	5.650G	40	5.263G
41	5.560G	42	5.403G	43	5.580G	44	5.508G
45	5.265G	46	5.272G	47	5.684G	48	5.479G
49	5.456G	50	5.701G	51	5.277G	52	5.620G
53	5.588G	54	5.289G	55	5.258G	56	5.611G
57	5.327G	58	5.300G	59	5.405G	60	5.564G
61	5.628G	62	5.409G	63	5.670G	64	5.255G
65	5.529G	66	5.497G	67	5.326G	68	5.496G
69	5.711G	70	5.717G	71	5.357G	72	5.724G
73	5.526G	74	5.618G	75	5.274G	76	5.441G
77	5.678G	78	5.544G	79	5.614G	80	5.418G
81	5.386G	82	5.721G	83	5.668G	84	5.379G
85	5.463G	86	5.396G	87	5.664G	88	5.353G
89	5.703G	90	5.298G	91	5.644G	92	5.307G
93	5.509G	94	5.553G	95	5.681G	96	5.589G
97	5.513G	98	5.547G	99	5.527G	100	5.295G

Hopping Frequency Sequence Name: HOP_FREQ_SEQ_29							
SEQ#	Frequency (Hz)	SEQ#	Frequency (Hz)	SEQ#	Frequency (Hz)	SEQ#	Frequency (Hz)
1	5.351G	2	5.612G	3	5.484G	4	5.268G
5	5.493G	6	5.636G	7	5.631G	8	5.693G
9	5.284G	10	5.413G	11	5.451G	12	5.706G
13	5.580G	14	5.382G	15	5.683G	16	5.344G
17	5.712G	18	5.288G	19	5.355G	20	5.361G
21	5.460G	22	5.305G	23	5.584G	24	5.594G
25	5.336G	26	5.358G	27	5.633G	28	5.335G
29	5.696G	30	5.386G	31	5.267G	32	5.517G
33	5.289G	34	5.489G	35	5.313G	36	5.568G
37	5.271G	38	5.514G	39	5.605G	40	5.511G
41	5.473G	42	5.270G	43	5.446G	44	5.626G
45	5.596G	46	5.378G	47	5.718G	48	5.582G
49	5.505G	50	5.297G	51	5.573G	52	5.672G
53	5.603G	54	5.639G	55	5.640G	56	5.346G
57	5.688G	58	5.678G	59	5.258G	60	5.657G
61	5.668G	62	5.512G	63	5.450G	64	5.254G
65	5.327G	66	5.308G	67	5.320G	68	5.434G
69	5.454G	70	5.495G	71	5.326G	72	5.457G
73	5.458G	74	5.577G	75	5.667G	76	5.622G
77	5.647G	78	5.274G	79	5.364G	80	5.628G
81	5.585G	82	5.620G	83	5.250G	84	5.609G
85	5.474G	86	5.420G	87	5.390G	88	5.638G
89	5.311G	90	5.463G	91	5.713G	92	5.412G
93	5.499G	94	5.306G	95	5.348G	96	5.279G
97	5.572G	98	5.559G	99	5.275G	100	5.680G

Hopping Frequency Sequence Name: HOP_FREQ_SEQ_30							
SEQ#	Frequency (Hz)	SEQ#	Frequency (Hz)	SEQ#	Frequency (Hz)	SEQ#	Frequency (Hz)
1	5.673G	2	5.315G	3	5.496G	4	5.668G
5	5.371G	6	5.565G	7	5.279G	8	5.577G
9	5.487G	10	5.664G	11	5.641G	12	5.649G
13	5.386G	14	5.545G	15	5.687G	16	5.393G
17	5.455G	18	5.467G	19	5.480G	20	5.642G
21	5.362G	22	5.602G	23	5.704G	24	5.499G
25	5.260G	26	5.591G	27	5.357G	28	5.605G
29	5.459G	30	5.403G	31	5.328G	32	5.586G
33	5.651G	34	5.520G	35	5.684G	36	5.384G
37	5.677G	38	5.601G	39	5.259G	40	5.251G
41	5.502G	42	5.432G	43	5.346G	44	5.648G
45	5.353G	46	5.612G	47	5.283G	48	5.718G
49	5.321G	50	5.349G	51	5.369G	52	5.627G
53	5.524G	54	5.708G	55	5.381G	56	5.274G
57	5.544G	58	5.409G	59	5.611G	60	5.380G
61	5.580G	62	5.498G	63	5.468G	64	5.257G
65	5.584G	66	5.266G	67	5.509G	68	5.629G
69	5.305G	70	5.324G	71	5.395G	72	5.676G
73	5.533G	74	5.688G	75	5.449G	76	5.388G
77	5.703G	78	5.603G	79	5.262G	80	5.686G
81	5.394G	82	5.661G	83	5.450G	84	5.342G
85	5.355G	86	5.483G	87	5.540G	88	5.538G
89	5.401G	90	5.276G	91	5.526G	92	5.400G
93	5.457G	94	5.654G	95	5.559G	96	5.377G
97	5.513G	98	5.678G	99	5.549G	100	5.301G