

## FCC Test Report

**Report No.:** RF170713D01-2

**FCC ID:** 2ALJ3AP24X

**Test Model:** AP241, AP241e

**Received Date:** Jul. 13, 2017

**Test Date:** Aug. 21 ~ Oct. 11, 2017

**Issued Date:** Nov. 14, 2017

**Applicant:** HAN Networks Co., Ltd.

**Address:** 5/F, Building 37, No.8 Dongbeiwang West Road, HaiDian District, Beijing, China

**Issued By:** Bureau Veritas Consumer Products Services (H.K.) Ltd., Taoyuan Branch

**Lab Address:** No. 47-2, 14th Ling, Chia Pau Vil., Lin Kou Dist., New Taipei City, Taiwan, R.O.C.

**FCC Registration /  
Designation Number:** 198487 / TW2021



This report is for your exclusive use. Any copying or replication of this report to or for any other person or entity, or use of our name or trademark, is permitted only with our prior written permission. This report sets forth our findings solely with respect to the test samples identified herein. The results set forth in this report are not indicative or representative of the quality or characteristics of the lot from which a test sample was taken or any similar or identical product unless specifically and expressly noted. Our report includes all of the tests requested by you and the results thereof based upon the information that you provided to us. You have 60 days from date of issuance of this report to notify us of any material error or omission caused by our negligence, provided, however, that such notice shall be in writing and shall specifically address the issue you wish to raise. A failure to raise such issue within the prescribed time shall constitute your unqualified acceptance of the completeness of this report, the tests conducted and the correctness of the report contents. Unless specific mention, the uncertainty of measurement has been explicitly taken into account to declare the compliance or non-compliance to the specification. The report must not be used by the client to claim product certification, approval, or endorsement by TAF or any government agencies.

## Table of Contents

<b>Release Control Record</b> .....	<b>4</b>
<b>1 Certificate of Conformity</b> .....	<b>5</b>
<b>2 Summary of Test Results</b> .....	<b>6</b>
2.1 Measurement Uncertainty .....	6
2.2 Modification Record .....	6
<b>3 General Information</b> .....	<b>7</b>
3.1 General Description of EUT .....	7
3.2 Description of Test Modes .....	9
3.2.1 Test Mode Applicability and Tested Channel Detail .....	10
3.3 Duty Cycle of Test Signal .....	13
3.4 Description of Support Units .....	14
3.4.1 Configuration of System under Test .....	15
3.5 General Description of Applied Standard .....	16
<b>4 Test Types and Results</b> .....	<b>17</b>
4.1 Radiated Emission and Bandedge Measurement.....	17
4.1.1 Limits of Radiated Emission and Bandedge Measurement .....	17
4.1.2 Test Instruments .....	18
4.1.3 Test Procedure .....	19
4.1.4 Deviation from Test Standard .....	19
4.1.5 Test Setup.....	20
4.1.6 EUT Operating Condition .....	21
4.1.7 Test Results .....	22
4.2 Conducted Emission Measurement .....	84
4.2.1 Limits of Conducted Emission Measurement .....	84
4.2.2 Test Instruments .....	84
4.2.3 Test Procedure .....	85
4.2.4 Deviation from Test Standard .....	85
4.2.5 Test Setup.....	85
4.2.6 EUT Operating Condition .....	85
4.2.7 Test Results .....	86
4.3 Transmit Power Measurement .....	94
4.3.1 Limits of Transmit Power Measurement .....	94
4.3.2 Test Setup.....	94
4.3.3 Test Instruments .....	94
4.3.4 Test Procedure .....	95
4.3.5 Deviation from Test Standard .....	95
4.3.6 EUT Operating Condition .....	95
4.3.7 Test Result.....	96
4.4 Occupied Bandwidth Measurement .....	104
4.4.1 Test Setup.....	104
4.4.2 Test Instruments .....	104
4.4.3 Test Procedure .....	104
4.4.4 Test Results .....	105
4.5 Peak Power Spectral Density Measurement.....	109
4.5.1 Limits of Peak Power Spectral Density Measurement .....	109
4.5.2 Test Setup.....	109
4.5.3 Test Instruments .....	109
4.5.4 Test Procedure .....	109
4.5.5 Deviation from Test Standard .....	109
4.5.6 EUT Operating Condition .....	109
4.5.7 Test Results .....	110
4.6 6dB Bandwidth Measurement .....	120

4.6.1	Limits of 6dB Bandwidth Measurement .....	120
4.6.2	Test Setup .....	120
4.6.3	Test Instruments .....	120
4.6.4	Test Procedure .....	120
4.6.5	Deviation from Test Standard .....	120
4.6.6	EUT Operating Condition .....	120
4.6.7	Test Results .....	121
<b>5</b>	<b>Pictures of Test Arrangements .....</b>	<b>125</b>
	<b>Annex A- Radiated Out of Band Emission (OOBE) Measurement (For U-NII-3 band) .....</b>	<b>126</b>
	<b>Appendix – Information on the Testing Laboratories .....</b>	<b>136</b>

### Release Control Record

Issue No.	Description	Date Issued
RF170713D01-2	Original release.	Nov. 14, 2017

## 1 Certificate of Conformity

**Product:** HAN Access Point

**Brand:** HAN

**Test Model:** AP241, AP241e

**Sample Status:** Engineering sample

**Applicant:** HAN Networks Co., Ltd.

**Test Date:** Aug. 21 ~ Oct. 11, 2017

**Standard:** 47 CFR FCC Part 15, Subpart E (Section 15.407)  
ANSI C63.10: 2013

The above equipment has been tested by **Bureau Veritas Consumer Products Services (H.K.) Ltd., Taoyuan Branch**, and found compliance with the requirement of the above standards. The test record, data evaluation & Equipment Under Test (EUT) configurations represented herein are true and accurate accounts of the measurements of the sample's EMC characteristics under the conditions specified in this report.

**Prepared by :** \_\_\_\_\_

*Jessica Cheng*

Jessica Cheng / Senior Specialist

**Date:** \_\_\_\_\_

Nov. 14, 2017

**Approved by :** \_\_\_\_\_

*Rex Lai*

Rex Lai / Associate Technical Manager

**Date:** \_\_\_\_\_

Nov. 14, 2017

## 2 Summary of Test Results

47 CFR FCC Part 15, Subpart E (Section 15.407)			
FCC Clause	Test Item	Result	Remarks
15.407(b)(6)	AC Power Conducted Emissions	Pass	Meet the requirement of limit. Minimum passing margin is -2.31dB at 0.35703MHz.
15.407(b) (1/2/3/4(i/ii)/6)	Radiated Emissions & Band Edge Measurement*	Pass	Meet the requirement of limit. Minimum passing margin is -1.03dB at 5649.88MHz.
15.407(a)(1/2/3)	Max Average Transmit Power	Pass	Meet the requirement of limit.
---	Occupied Bandwidth Measurement	-	Reference only.
15.407(a)(1/2/3)	Peak Power Spectral Density	Pass	Meet the requirement of limit.
15.407(e)	6dB bandwidth	Pass	Meet the requirement of limit. (U-NII-3 Band only)
15.203	Antenna Requirement	Pass	Antenna connector is R-SMA or I-PEX not a standard connector.

\*For U-NII-3 band compliance with rule part 15.407(b)(4)(i), the OOB test plots were recorded in Annex A.

### 2.1 Measurement Uncertainty

Where relevant, the following measurement uncertainty levels have been estimated for tests performed on the EUT as specified in CISPR 16-4-2:

Measurement	Frequency	Expanded Uncertainty (k=2) (±)
Conducted Emissions at mains ports	150kHz ~ 30MHz	2.77 dB
Radiated Emissions up to 1 GHz	9kHz ~ 30MHz	2.38 dB
	30MHz ~ 1000MHz	5.54 dB
Radiated Emissions above 1 GHz	Above 1GHz	5.48 dB

### 2.2 Modification Record

There were no modifications required for compliance.

### 3 General Information

#### 3.1 General Description of EUT

Product	HAN Access Point
Brand	HAN
Test Model	AP241, AP241e
Model Difference	Refer to note as below
Status of EUT	Engineering sample
Power Supply Rating	48Vdc from Adapter or 55Vdc from PoE
Modulation Type	64QAM, 16QAM, QPSK, BPSK 256QAM for OFDM in 11ac mode only.
Modulation Technology	OFDM
Transfer Rate	802.11a: 54/48/36/24/18/12/9/6Mbps 802.11n: up to 800Mbps 802.11ac: up to 1733Mbps
Operating Frequency	5180 ~ 5240MHz 5745 ~ 5825MHz
Number of Channel	<b>5180 ~ 5240MHz</b> 4 for 802.11a, 802.11n (20MHz), 802.11ac (20MHz) 2 for 802.11n (40MHz), 802.11ac (40MHz) 1 for 802.11ac (80MHz) <b>5745 ~ 5825MHz</b> 5 for 802.11a, 802.11n (20MHz) 802.11ac (20MHz) 2 for 802.11n (40MHz) 802.11ac (40MHz) 1 for 802.11ac (80MHz)
Output Power	<b>5180 ~ 5240MHz:</b> 69.756mW <b>5745 ~ 5825MHz:</b> 899.435mW
Antenna Type	Refer to note as below
Antenna Connector	Refer to note as below
Accessory Device	N/A
Data Cable Supplied	N/A

Note:

- The EUT incorporates a MIMO function. Physically, the EUT provides 4 completed transmitters and 4 receivers.

Modulation Mode	TX FUNCTION
802.11a	4TX
802.11n (20MHz)	4TX
802.11n (40MHz)	4TX
802.11ac (20MHz)	4TX
802.11ac (40MHz)	4TX
802.11ac (80MHz)	4TX

\* The modulation and bandwidth are similar for 802.11n mode for 20MHz / 40MHz and 802.11ac mode for 20MHz / 40MHz, therefore investigated worst case to representative mode in test report. (Final test mode refer section 3.2.1)

2. All models are listed as below.

Brand	Model	Difference
HAN	AP241	Internal PIFA antenna for Bluetooth function, and internal PIFA antenna for WLAN function
	AP241e	Internal PIFA antenna for Bluetooth function, and external Dipole antenna for WLAN function

3. The EUT was pre-tested with the following modes:

- ✧ Operating Mode (EUT Powered from Adapter)
- ✧ Operating Mode (EUT Powered from PoE)

The worst emission level was found when the EUT tested under **Operating Mode (EUT + Adapter)**, therefore, only its test data was recorded in this report.

4. The antennas provided to the EUT, please refer to the following table:

Model of EUT	Antenna	Frequency	Chain No.	Antenna Type	Antenna Gain (dBi)	Connector Type
AP241	Internal	5GHz	Chain 0	PIFA	4.46	I-PEX
			Chain 1	PIFA	4.22	I-PEX
			Chain 2	PIFA	4.17	I-PEX
			Chain 3	PIFA	*4.47	I-PEX
			Chain 4	PIFA	4.41	I-PEX
			Chain 5	PIFA	4.30	I-PEX
			Chain 6	PIFA	4.43	I-PEX
			Chain 7	PIFA	4.13	I-PEX
AP241e	External	5GHz	Chain 0	Dipole	6	R-SMA
			Chain 1	Dipole	6	R-SMA
			Chain 2	Dipole	6	R-SMA
			Chain 3	Dipole	6	R-SMA
			Chain 4	Dipole	6	R-SMA
			Chain 5	Dipole	6	R-SMA
			Chain 6	Dipole	6	R-SMA
			Chain 7	Dipole	6	R-SMA

\* As client's request, the 4.47dBi of Internal max. gain is chosen for final tests since it has the maximum gain among Internal antennas.

5. The directional gain table:

Antenna	Max. Gain (dBi)
Internal	10.49
External	12.02

Note:

(i) If transmit signals are *correlated*, then

Directional gain =  $10 \log \left[ \frac{(10^{G_1/20} + 10^{G_2/20} + \dots + 10^{G_N/20})^2}{N_{ANT}} \right]$  dBi [Note the "20"s in the denominator of each exponent and the square of the sum of terms; the object is to combine the signal levels coherently.]

6. The above EUT information is declared by manufacturer and for more detailed features description, please refer to the manufacturer's specifications or user's manual.



### 3.2 Description of Test Modes

#### FOR 5180 ~ 5240MHz

4 channels are provided for 802.11a, 802.11n (20MHz), 802.11ac (20MHz):

Channel	Frequency	Channel	Frequency
36	5180 MHz	44	5220 MHz
40	5200 MHz	48	5240 MHz

2 channels are provided for 802.11n (40MHz), 802.11ac (40MHz):

Channel	Frequency	Channel	Frequency
38	5190 MHz	46	5230 MHz

1 channel is provided for 802.11ac (80MHz):

Channel	Frequency
42	5210MHz

#### FOR 5745 ~ 5825MHz:

5 channels are provided for 802.11a, 802.11n (20MHz), 802.11ac (20MHz):

Channel	Frequency	Channel	Frequency
149	5745MHz	161	5805MHz
153	5765MHz	165	5825MHz
157	5785MHz		

2 channels are provided for 802.11n (40MHz), 802.11ac (40MHz):

Channel	Frequency	Channel	Frequency
151	5755MHz	159	5795MHz

1 channel is provided for 802.11ac (80MHz):

Channel	Frequency
155	5775MHz

### 3.2.1 Test Mode Applicability and Tested Channel Detail

EUT Configure Mode	Applicable To				Description
	RE $\geq$ 1G	RE $<$ 1G	PLC	APCM	
A	√	√	√	√	Model: AP241 (Int. antenna), Powered from Adapter
B	√	√	√	√	Model: AP241e (Ext. antenna), Powered from Adapter
C	-	-	√	-	Model: AP241 (Int. antenna), Powered from PoE
D	-	-	√	-	Model: AP241e (Ext. antenna), Powered from PoE

Where **RE $\geq$ 1G**: Radiated Emission above 1GHz      **RE $<$ 1G**: Radiated Emission below 1GHz  
**PLC**: Power Line Conducted Emission      **APCM**: Antenna Port Conducted Measurement

**NOTE:**

The EUT had been pre-tested on the positioned of each 3 axis. The worst case was found when positioned on **Y-plane**. (Mode A)  
The EUT had been pre-tested on the positioned of each 3 axis. The worst case was found when positioned on **X-plane**. (Mode B)

**Radiated Emission Test (Above 1GHz):**

- Pre-Scan has been conducted to determine the worst-case mode from all possible combinations between available modulations, data rates and antenna ports (if EUT with antenna diversity architecture).
- Following channel(s) was (were) selected for the final test as listed below.

CDD Mode							
EUT Configure Mode	Mode	FREQ. Band (MHz)	Available Channel	Tested Channel	Modulation Technology	Modulation Type	Data Rate (Mbps)
A & B	802.11a	5180-5240	36 to 48	36, 40, 48	OFDM	BPSK	6
A & B	802.11n (20MHz)		36 to 48	36, 40, 48	OFDM	BPSK	6.5
A & B	802.11n (40MHz)		38 to 46	38, 46	OFDM	BPSK	13.5
A & B	802.11ac (80MHz)		42	42	OFDM	BPSK	29.3
A & B	802.11a	5745-5825	149 to 165	149, 157, 165	OFDM	BPSK	6
A & B	802.11n (20MHz)		149 to 165	149, 157, 165	OFDM	BPSK	6.5
A & B	802.11n (40MHz)		151 to 159	151, 159	OFDM	BPSK	13.5
A & B	802.11ac (80MHz)		155	155	OFDM	BPSK	29.3

Beamforming_NSS1 Mode							
EUT Configure Mode	Mode	FREQ. Band (MHz)	Available Channel	Tested Channel	Modulation Technology	Modulation Type	Data Rate (Mbps)
A & B	802.11a	5180-5240	36 to 48	36, 40, 48	OFDM	BPSK	6
A & B	802.11ac (20MHz)		36 to 48	36, 40, 48	OFDM	BPSK	6.5
A & B	802.11ac (40MHz)		38 to 46	38, 46	OFDM	BPSK	13.5
A & B	802.11ac (80MHz)		42	42	OFDM	BPSK	29.3
A & B	802.11a	5745-5825	149 to 165	149, 157, 165	OFDM	BPSK	6
A & B	802.11ac (20MHz)		149 to 165	149, 157, 165	OFDM	BPSK	6.5
A & B	802.11ac (40MHz)		151 to 159	151, 159	OFDM	BPSK	13.5
A & B	802.11ac (80MHz)		155	155	OFDM	BPSK	29.3

### Radiated Emission Test (Below 1GHz):

- Pre-Scan has been conducted to determine the worst-case mode from all possible combinations between available modulations, data rates and antenna ports (if EUT with antenna diversity architecture).
- Following channel(s) was (were) selected for the final test as listed below.

CDD Mode							
EUT Configure Mode	Mode	FREQ. Band (MHz)	Available Channel	Tested Channel	Modulation Technology	Modulation Type	Data Rate (Mbps)
A & B	802.11a	5180-5240	36 to 48	48	OFDM	BPSK	6
	802.11a	5745-5825	149 to 165		OFDM	BPSK	6

### Power Line Conducted Emission Test:

- Pre-Scan has been conducted to determine the worst-case mode from all possible combinations between available modulations, data rates and antenna ports (if EUT with antenna diversity architecture).
- Following channel(s) was (were) selected for the final test as listed below.

CDD Mode							
EUT Configure Mode	Mode	FREQ. Band (MHz)	Available Channel	Tested Channel	Modulation Technology	Modulation Type	Data Rate (Mbps)
A ~ D	802.11a	5180-5240	36 to 48	48	OFDM	BPSK	6
	802.11a	5745-5825	149 to 165		OFDM	BPSK	6

### Antenna Port Conducted Measurement:

- This item includes all test value of each mode, but only includes spectrum plot of worst value of each mode.
- Pre-Scan has been conducted to determine the worst-case mode from all possible combinations between available modulations, data rates and antenna ports (if EUT with antenna diversity architecture).
- Following channel(s) was (were) selected for the final test as listed below.

<b>CDD Mode</b>							
EUT Configure Mode	Mode	FREQ. Band (MHz)	Available Channel	Tested Channel	Modulation Technology	Modulation Type	Data Rate (Mbps)
A & B	802.11a	5180-5240	36 to 48	36, 40, 48	OFDM	BPSK	6
A & B	802.11n (20MHz)		36 to 48	36, 40, 48	OFDM	BPSK	6.5
A & B	802.11n (40MHz)		38 to 46	38, 46	OFDM	BPSK	13.5
A & B	802.11ac (80MHz)		42	42	OFDM	BPSK	29.3
A & B	802.11a	5745-5825	149 to 165	149, 157, 165	OFDM	BPSK	6
A & B	802.11n (20MHz)		149 to 165	149, 157, 165	OFDM	BPSK	6.5
A & B	802.11n (40MHz)		151 to 159	151, 159	OFDM	BPSK	13.5
A & B	802.11ac (80MHz)		155	155	OFDM	BPSK	29.3
<b>Beamforming_NSS1 Mode (Output Power Only)</b>							
EUT Configure Mode	Mode	FREQ. Band (MHz)	Available Channel	Tested Channel	Modulation Technology	Modulation Type	Data Rate (Mbps)
A & B	802.11ac (20MHz)	5180-5240	36 to 48	36, 40, 48	OFDM	BPSK	6.5
A & B	802.11ac (40MHz)		38 to 46	38, 46	OFDM	BPSK	13.5
A & B	802.11ac (80MHz)		42	42	OFDM	BPSK	29.3
A & B	802.11ac (20MHz)	5745-5825	149 to 165	149, 157, 165	OFDM	BPSK	6.5
A & B	802.11ac (40MHz)		151 to 159	151, 159	OFDM	BPSK	13.5
A & B	802.11ac (80MHz)		155	155	OFDM	BPSK	29.3

### Test Condition:

Applicable To	Environmental Conditions	Input Power	Tested By
RE $\geq$ 1G	33deg. C, 64%RH	120Vac, 60Hz	Ian Chang
RE<1G	32deg. C, 66%RH	120Vac, 60Hz	Ian Chang
PLC	27deg. C, 73%RH	120Vac, 60Hz	Ian Chang
APCM	25deg. C, 76%RH	120Vac, 60Hz	Saxon Lee

### 3.3 Duty Cycle of Test Signal

Duty cycle of test signal is < 98 %, duty factor is required

**802.11a:** Duty cycle =  $2/2.09 = 0.957$ , Duty factor =  $10 * \log(1/0.957) = 0.19$

**802.11n (20MHz):** Duty cycle of test signal is 98.2 %.

**802.11n (40MHz):** Duty cycle =  $2.265/2.485 = 0.952$ , Duty factor =  $10 * \log(1/0.952) = 0.21$

**802.11ac (80MHz):** Duty cycle =  $1.116/1.2 = 0.93$ , Duty factor =  $10 * \log(1/0.93) = 0.32$

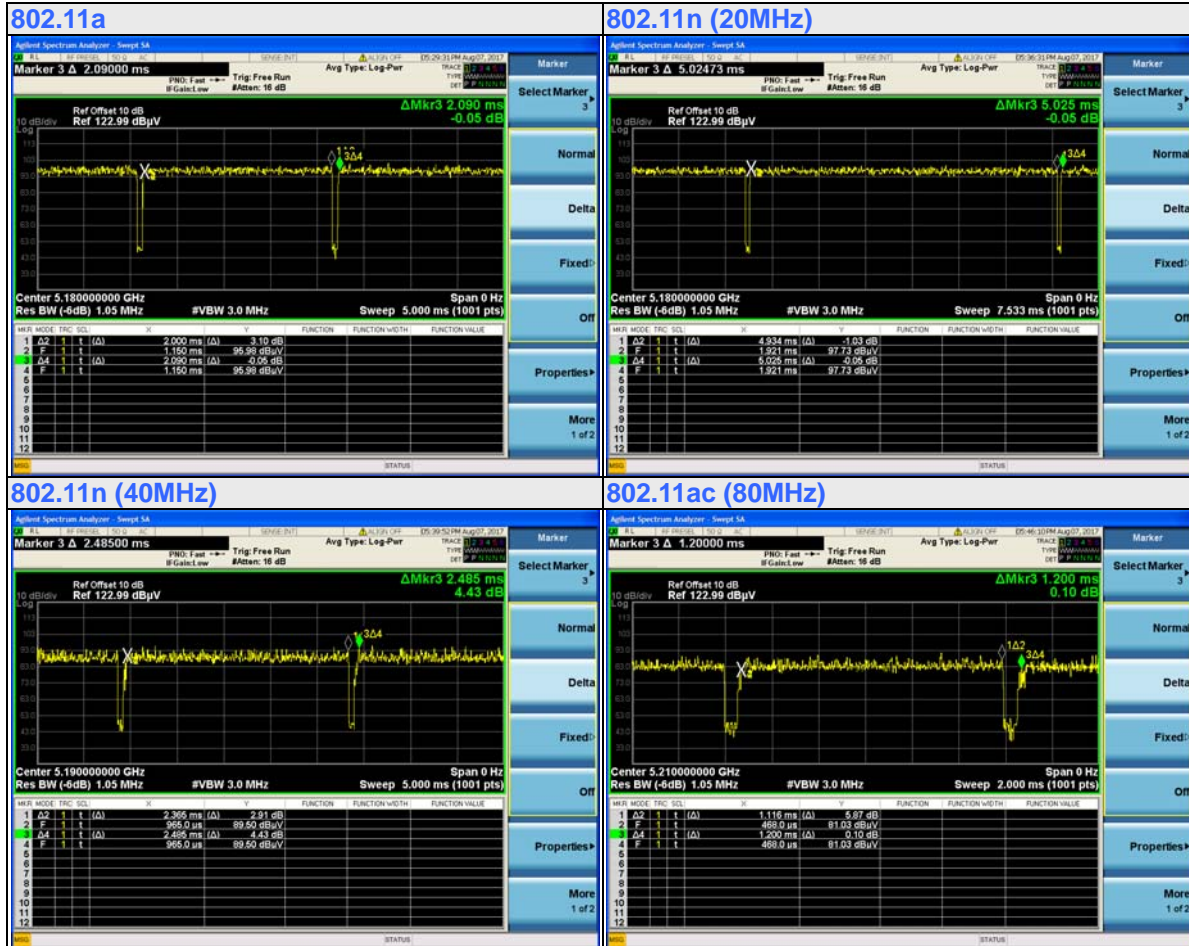

### 3.4 Description of Support Units

The EUT has been tested as an independent unit together with other necessary accessories or support units. The following support units or accessories were used to form a representative test configuration during the tests.

ID	Product	Brand	Model No.	Serial No.	FCC ID	Remarks
A.	Adapter	APD	WB-18D12R	N/A	N/A	Supplied by client
B.	NOTEBOOK PC	DELL	PP27L	8SNZ12S	FCC DoC Approved	Provided by Lab
C.	PoE	Microsemi	PD-9001GR/AT/AC	N/A	N/A	Supplied by client

Note:

1. All power cords of the above support units are non-shielded (1.8m).
2. Item B ~ C acted as communication partners to transfer data.

ID	Descriptions	Qty.	Length (m)	Shielding (Yes/No)	Cores (Qty.)	Remarks
1.	DC cable	1	1.5	N	0	Supplied by client
2.	LAN cable	1	10	N	0	Provided by Lab
3.	LAN cable	1	1.5	N	0	Provided by Lab
4.	AC cable	1	1.8	N	0	Provided by Lab

Note: The core(s) is(are) originally attached to the cable(s).

### 3.4.1 Configuration of System under Test

#### Mode A & B:

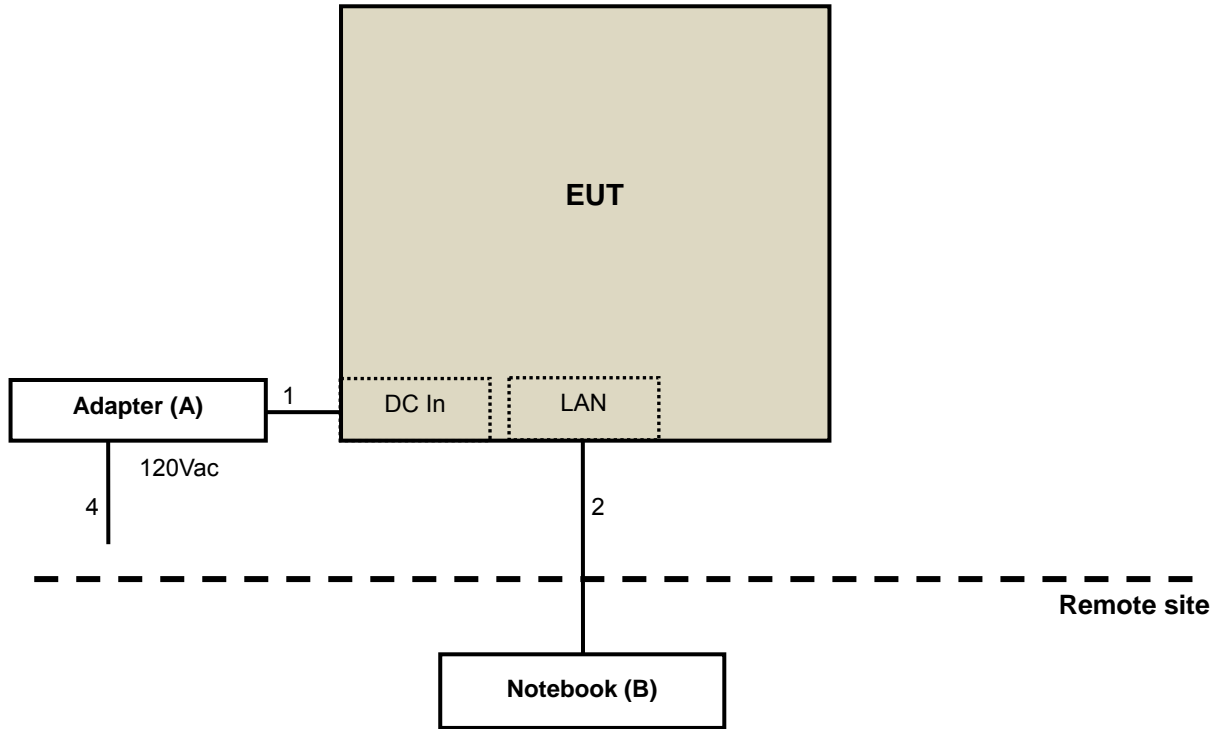

#### Mode C & D:

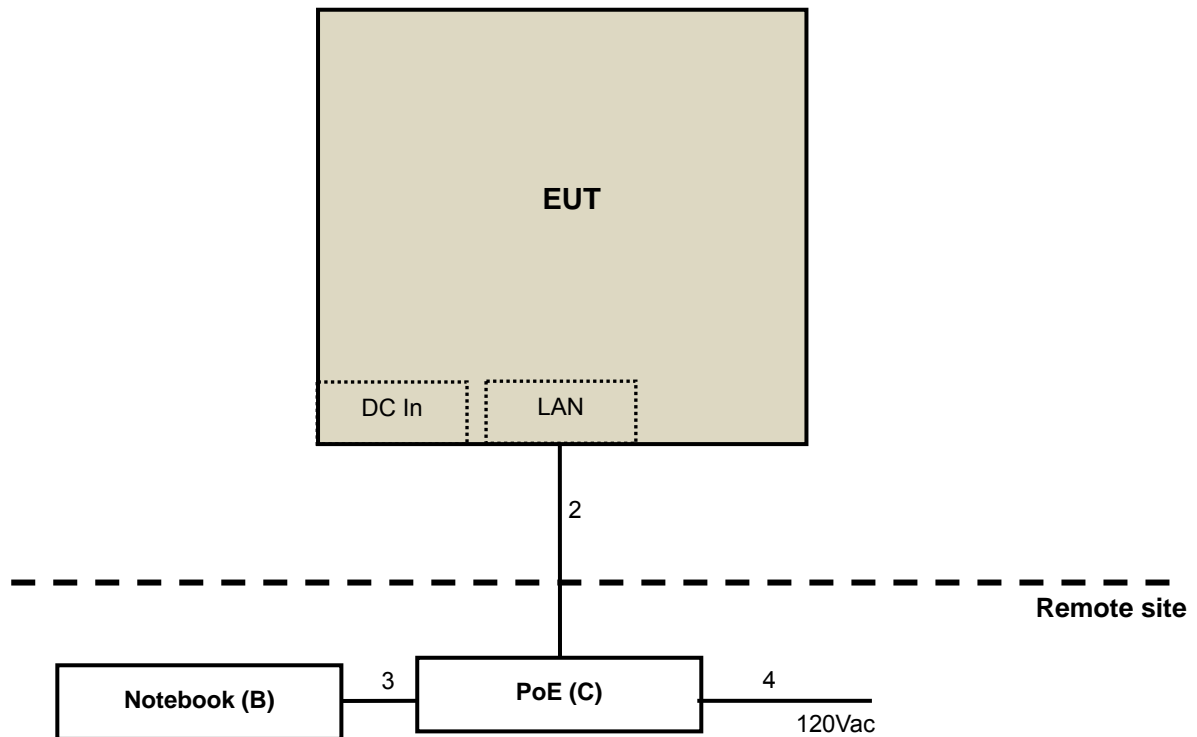

### 3.5 General Description of Applied Standard

The EUT is a RF Product. According to the specifications of the manufacturer, it must comply with the requirements of the following standards:

**FCC Part 15, Subpart E (15.407)**  
**KDB 789033 D02 General UNII Test Procedure New Rules v02r01**  
**KDB 662911 D01 Multiple Transmitter Output v02r01**  
**ANSI C63.10-2013**

All test items have been performed and recorded as per the above standards.



## 4 Test Types and Results

### 4.1 Radiated Emission and Bandedge Measurement

#### 4.1.1 Limits of Radiated Emission and Bandedge Measurement

Radiated emissions which fall in the restricted bands must comply with the radiated emission limits specified as below table.

Frequencies (MHz)	Field Strength (microvolts/meter)	Measurement Distance (meters)
0.009 ~ 0.490	2400/F(kHz)	300
0.490 ~ 1.705	24000/F(kHz)	30
1.705 ~ 30.0	30	30
30 ~ 88	100	3
88 ~ 216	150	3
216 ~ 960	200	3
Above 960	500	3

**NOTE:**

- The lower limit shall apply at the transition frequencies.
- Emission level (dBuV/m) = 20 log Emission level (uV/m).
- For frequencies above 1000MHz, the field strength limits are based on average detector, however, the peak field strength of any emission shall not exceed the maximum permitted average limits, specified above by more than 20dB under any condition of modulation.

Limits of unwanted emission out of the restricted bands

Applicable To		Limit	
789033 D02 General UNII Test Procedure New Rules v01r03		Field Strength at 3m	
		PK:74 (dBµV/m)	AV:54 (dBµV/m)
Frequency Band	Applicable To	EIRP Limit	Equivalent Field Strength at 3m
5150~5250 MHz	15.407(b)(1)	PK:-27 (dBm/MHz)	PK:68.2(dBµV/m)
5250~5350 MHz	15.407(b)(2)		
5470~5725 MHz	15.407(b)(3)		
5725~5850 MHz	<input checked="" type="checkbox"/> 15.407(b)(4)(i)	PK:-27 (dBm/MHz) <sup>*1</sup> PK:10 (dBm/MHz) <sup>*2</sup> PK:15.6 (dBm/MHz) <sup>*3</sup> PK:27 (dBm/MHz) <sup>*4</sup>	PK: 68.2(dBµV/m) <sup>*1</sup> PK:105.2 (dBµV/m) <sup>*2</sup> PK: 110.8(dBµV/m) <sup>*3</sup> PK:122.2 (dBµV/m) <sup>*4</sup>
	<input type="checkbox"/> 15.407(b)(4)(ii)	Emission limits in section 15.247(d)	
<sup>*1</sup> beyond 75 MHz or more above of the band edge. <sup>*3</sup> below the band edge increasing linearly to a level of 15.6 dBm/MHz at 5 MHz above.		<sup>*2</sup> below the band edge increasing linearly to 10 dBm/MHz at 25 MHz above. <sup>*4</sup> from 5 MHz above or below the band edge increasing linearly to a level of 27 dBm/MHz at the band edge.	

**Note:**

The following formula is used to convert the equipment isotropic radiated power (eirp) to field strength:

$$E = \frac{1000000\sqrt{30P}}{3} \mu\text{V/m, where P is the eirp (Watts).}$$

#### 4.1.2 Test Instruments

DESCRIPTION & MANUFACTURER	MODEL NO.	SERIAL NO.	CALIBRATED DATE	CALIBRATED UNTIL
HP Preamplifier	8447D	2432A03504	Feb. 21, 2017	Feb. 20, 2018
HP Preamplifier	8449B	3008A01201	Feb. 22, 2017	Feb. 21, 2018
MITEQ Preamplifier	AMF-6F-260400-33-8P	892164	Feb. 21, 2017	Feb. 20, 2018
Agilent TEST RECEIVER	N9038A	MY51210129	Feb. 08, 2017	Feb. 07, 2018
Schwarzbeck Antenna	VULB 9168	139	Dec. 13, 2016	Dec. 12, 2017
Schwarzbeck Horn Antenna	BBHA-9170	212	Dec. 30, 2016	Dec. 29, 2017
Schwarzbeck Horn Antenna	BBHA 9120-D1	D130	Dec. 27, 2016	Dec. 26, 2017
ADT. Turn Table	TT100	0306	NA	NA
ADT. Tower	AT100	0306	NA	NA
Software	Radiated_V7.6.15.9.5	NA	NA	NA
SUHNER RF cable With 4dB PAD	SF104	CABLE-CH6	Aug. 14, 2017	Aug. 13, 2018
SUHNER RF cable With 3dB PAD	SF102	Cable-CH8-3.6m	Aug. 14, 2017	Aug. 13, 2018
KEYSIGHT MIMO Powermeasurement Test set	U2021XA	U2021XA-001	May 31, 2017	May 30, 2018
KEYSIGHT Spectrum Analyzer	N9030A	MY54490260	Jul. 26, 2017	Jul. 25, 2018
Loop Antenna EMCI	LPA600	270	Aug. 11, 2017	Aug. 10, 2019
EMCO Horn Antenna	3115	00028257	Dec. 15, 2016	Dec. 14, 2017
Highpass filter Wainwright Instruments	WHK 3.1/18G-10SS	SN 8	NA	NA
ROHDE & SCHWARZ Spectrum Analyzer	FSV40	101042	Sep. 30, 2016	Sep. 29, 2017
Anritsu Power Sensor	MA2411B	0738404	Apr. 28, 2016 Apr. 24, 2017	Apr. 27, 2017 Apr. 23, 2018
Anritsu Power Meter	ML2495A	0842014	Apr. 28, 2016 Apr. 24, 2017	Apr. 27, 2017 Apr. 23, 2018

- NOTE:**
1. The calibration interval of the above test instruments is 12/24 months. And the calibrations are traceable to NML/ROC and NIST/USA.
  2. The horn antenna and HP preamplifier (model: 8449B) are used only for the measurement of emission frequency above 1GHz if tested.
  3. The test was performed in Chamber No. 6.
  4. The Industry Canada Reference No. IC 7450E-6.
  5. The FCC Site Registration No. is 447212.
  6. Tested Date: Aug. 21 ~ Sep. 20, 2017

#### 4.1.3 Test Procedure

##### **For Radiated emission below 30MHz**

- a. The EUT was placed on the top of a rotating table 0.8 meters above the ground at a 3 meter chamber room. The table was rotated 360 degrees to determine the position of the highest radiation.
- b. The EUT was set 3 meters away from the interference-receiving antenna, which was mounted on the top of a variable-height antenna tower.
- c. Both X and Y axes of the antenna are set to make the measurement.
- d. For each suspected emission, the EUT was arranged to its worst case and the rotatable table was turned from 0 degrees to 360 degrees to find the maximum reading.
- e. The test-receiver system was set to Quasi-Peak Detect Function and Specified Bandwidth with Maximum Hold Mode.

##### **NOTE:**

1. The resolution bandwidth and video bandwidth of test receiver/spectrum analyzer is 9kHz at frequency below 30MHz.

##### **For Radiated emission above 30MHz**

- a. The EUT was placed on the top of a rotating table 0.8 meters (for 30MHz ~ 1GHz) / 1.5 meters (for above 1GHz) above the ground at 3 meter chamber room for test. The table was rotated 360 degrees to determine the position of the highest radiation.
- b. The EUT was set 3 meters away from the interference-receiving antenna, which was mounted on the top of a variable-height antenna tower.
- c. The height of antenna is varied from one meter to four meters above the ground to determine the maximum value of the field strength. Both horizontal and vertical polarizations of the antenna are set to make the measurement.
- d. For each suspected emission, the EUT was arranged to its worst case and then the antenna was tuned to heights from 1 meter to 4 meters and the rotatable table was turned from 0 degrees to 360 degrees to find the maximum reading.
- e. The test-receiver system was set to quasi-peak detect function and specified bandwidth with maximum hold mode when the test frequency is below 1 GHz.
- f. The test-receiver system was set to peak and average detect function and specified bandwidth with maximum hold mode when the test frequency is above 1 GHz. If the peak reading value also meets average limit, measurement with the average detector is unnecessary.

##### **Note:**

1. The resolution bandwidth and video bandwidth of test receiver/spectrum analyzer is 120kHz for Quasi-peak detection (QP) at frequency below 1GHz.
2. The resolution bandwidth of test receiver/spectrum analyzer is 1 MHz and the video bandwidth is 3 MHz for Peak detection (PK) at frequency above 1GHz.
3. The resolution bandwidth of test receiver/spectrum analyzer is 1MHz and the video bandwidth is  $\geq 1/T$  (Duty cycle < 98%) or 10Hz (Duty cycle  $\geq 98\%$ ) for Average detection (AV) at frequency above 1GHz.
4. All modes of operation were investigated and the worst-case emissions are reported.

#### 4.1.4 Deviation from Test Standard

No deviation.

#### 4.1.5 Test Setup

##### For Radiated emission below 30MHz

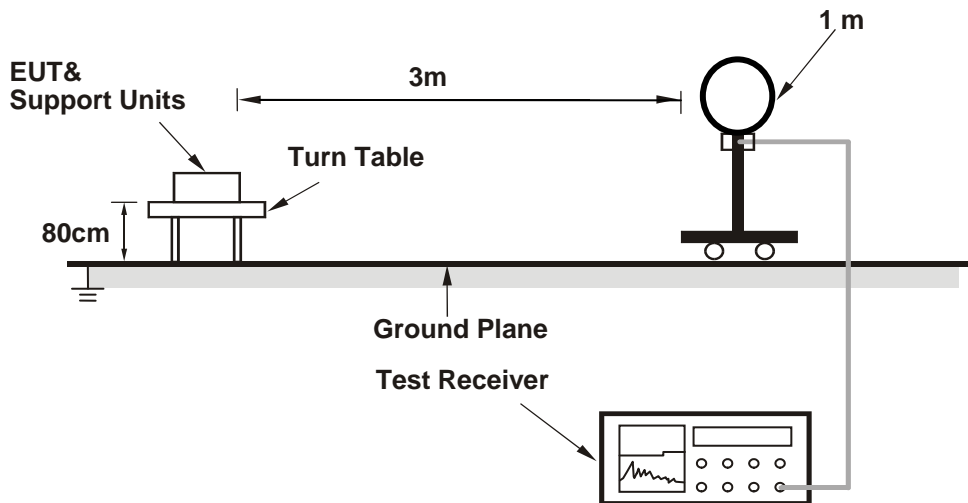

##### For Radiated emission 30MHz to 1GHz

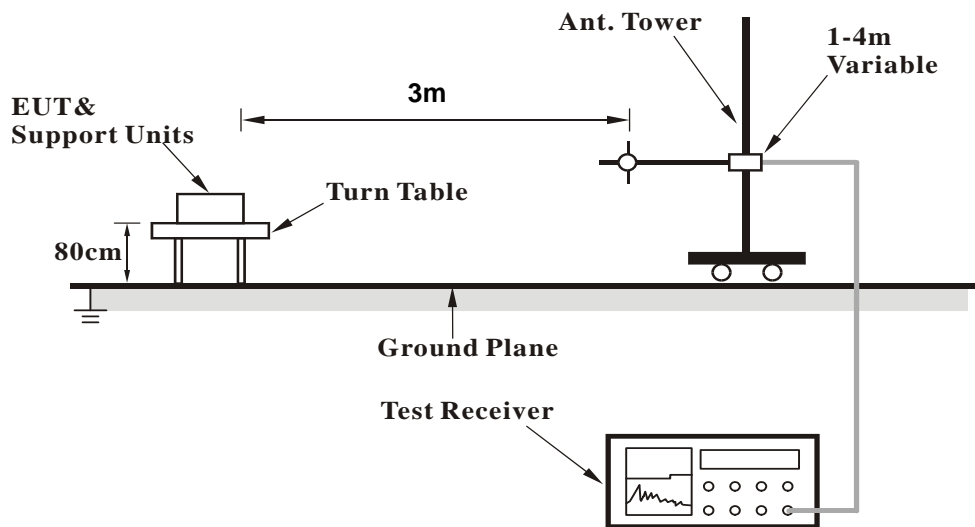

**For Radiated emission above 1GHz**

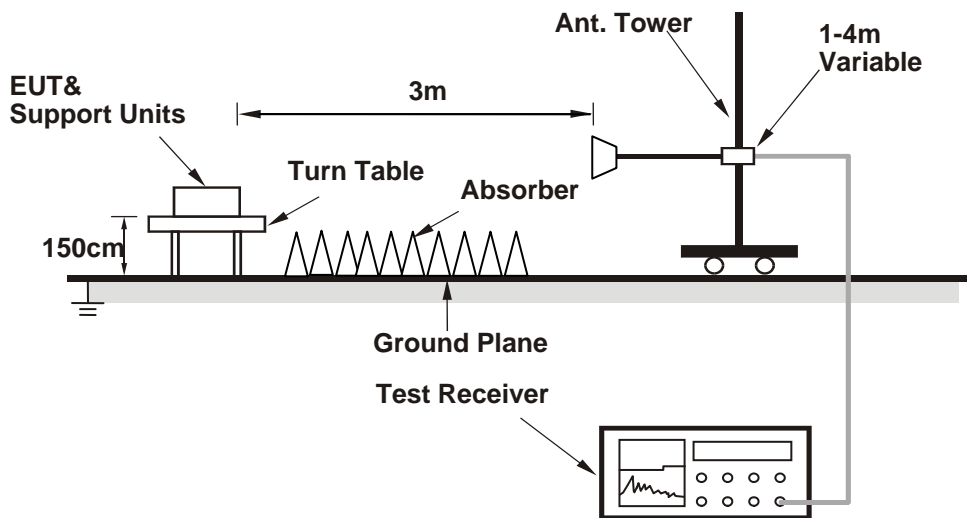

For the actual test configuration, please refer to the attached file (Test Setup Photo).

**4.1.6 EUT Operating Condition**

- a. Connected the EUT with AC adapter placed on testing table.
- b. Set the EUT under transmission condition continuously at specific channel frequency.

#### 4.1.7 Test Results

##### Above 1GHz Data:

##### CDD Mode (Mode A)

##### 802.11a

<b>CHANNEL</b>	TX Channel 36	<b>DETECTOR FUNCTION</b>	Peak (PK)
<b>FREQUENCY RANGE</b>	1GHz ~ 25GHz		Average (AV)

#### ANTENNA POLARITY & TEST DISTANCE: HORIZONTAL AT 3 M

NO.	FREQ. (MHz)	EMISSION LEVEL (dBuV/m)	LIMIT (dBuV/m)	MARGIN (dB)	ANTENNA HEIGHT (m)	TABLE ANGLE (Degree)	RAW VALUE (dBuV)	CORRECTION FACTOR (dB/m)
1	5150.00	57.41 PK	74.00	-16.59	1.65 H	296	52.50	4.91
2	5150.00	42.99 AV	54.00	-11.01	1.65 H	296	38.08	4.91
3	*5180.00	106.87 PK			1.65 H	296	101.93	4.94
4	*5180.00	95.25 AV			1.65 H	296	90.31	4.94
5	#10360.00	55.78 PK	74.00	-18.22	1.58 H	225	40.25	15.53
6	#10360.00	41.89 AV	54.00	-12.11	1.58 H	225	26.36	15.53

#### ANTENNA POLARITY & TEST DISTANCE: VERTICAL AT 3 M

NO.	FREQ. (MHz)	EMISSION LEVEL (dBuV/m)	LIMIT (dBuV/m)	MARGIN (dB)	ANTENNA HEIGHT (m)	TABLE ANGLE (Degree)	RAW VALUE (dBuV)	CORRECTION FACTOR (dB/m)
1	5150.00	56.37 PK	74.00	-17.63	1.57 V	183	51.46	4.91
2	5150.00	42.80 AV	54.00	-11.20	1.57 V	183	37.89	4.91
3	*5180.00	104.63 PK			1.57 V	183	99.69	4.94
4	*5180.00	92.52 AV			1.57 V	183	87.58	4.94
5	#10360.00	55.17 PK	74.00	-18.83	1.99 V	36	39.64	15.53
6	#10360.00	41.37 AV	54.00	-12.63	1.99 V	36	25.84	15.53

#### REMARKS:

1. Emission Level(dBuV/m) = Raw Value(dBuV) + Correction Factor(dB/m)
2. Correction Factor(dB/m) = Antenna Factor(dB/m) + Cable Factor(dB) – Pre-Amplifier Factor(dB)
3. The other emission levels were very low against the limit.
4. Margin value = Emission Level – Limit value
5. " \* ": Fundamental frequency.
6. " # ": The radiated frequency is out of the restricted band.

<b>CHANNEL</b>	TX Channel 40	<b>DETECTOR FUNCTION</b>	Peak (PK)
<b>FREQUENCY RANGE</b>	1GHz ~ 25GHz		Average (AV)

**ANTENNA POLARITY & TEST DISTANCE: HORIZONTAL AT 3 M**

NO.	FREQ. (MHz)	EMISSION LEVEL (dBuV/m)	LIMIT (dBuV/m)	MARGIN (dB)	ANTENNA HEIGHT (m)	TABLE ANGLE (Degree)	RAW VALUE (dBuV)	CORRECTION FACTOR (dB/m)
1	*5200.00	105.66 PK			1.72 H	293	100.69	4.97
2	*5200.00	94.15 AV			1.72 H	293	89.18	4.97
3	#10400.00	56.42 PK	74.00	-17.58	1.67 H	265	40.84	15.58
4	#10400.00	40.86 AV	54.00	-13.14	1.67 H	265	25.28	15.58

**ANTENNA POLARITY & TEST DISTANCE: VERTICAL AT 3 M**

NO.	FREQ. (MHz)	EMISSION LEVEL (dBuV/m)	LIMIT (dBuV/m)	MARGIN (dB)	ANTENNA HEIGHT (m)	TABLE ANGLE (Degree)	RAW VALUE (dBuV)	CORRECTION FACTOR (dB/m)
1	*5200.00	103.86 PK			1.62 V	189	98.89	4.97
2	*5200.00	92.43 AV			1.62 V	189	87.46	4.97
3	#10400.00	54.86 PK	74.00	-19.14	2.36 V	251	39.28	15.58
4	#10400.00	41.22 AV	54.00	-12.78	2.36 V	251	25.64	15.58

**REMARKS:**

1. Emission Level(dBuV/m) = Raw Value(dBuV) + Correction Factor(dB/m)
2. Correction Factor(dB/m) = Antenna Factor(dB/m) + Cable Factor(dB) – Pre-Amplifier Factor(dB)
3. The other emission levels were very low against the limit.
4. Margin value = Emission Level – Limit value
5. " \* ": Fundamental frequency.
6. " # ": The radiated frequency is out of the restricted band.

<b>CHANNEL</b>	TX Channel 48	<b>DETECTOR FUNCTION</b>	Peak (PK)
<b>FREQUENCY RANGE</b>	1GHz ~ 25GHz		Average (AV)

**ANTENNA POLARITY & TEST DISTANCE: HORIZONTAL AT 3 M**

NO.	FREQ. (MHz)	EMISSION LEVEL (dBuV/m)	LIMIT (dBuV/m)	MARGIN (dB)	ANTENNA HEIGHT (m)	TABLE ANGLE (Degree)	RAW VALUE (dBuV)	CORRECTION FACTOR (dB/m)
1	*5240.00	107.41 PK			1.80 H	309	102.37	5.04
2	*5240.00	96.36 AV			1.80 H	309	91.32	5.04
3	5350.00	56.43 PK	74.00	-17.57	1.80 H	309	51.08	5.35
4	5350.00	42.58 AV	54.00	-11.42	1.80 H	309	37.23	5.35
5	#10480.00	56.38 PK	74.00	-17.62	1.94 H	268	40.62	15.76
6	#10480.00	42.42 AV	54.00	-11.58	1.94 H	268	26.66	15.76

**ANTENNA POLARITY & TEST DISTANCE: VERTICAL AT 3 M**

NO.	FREQ. (MHz)	EMISSION LEVEL (dBuV/m)	LIMIT (dBuV/m)	MARGIN (dB)	ANTENNA HEIGHT (m)	TABLE ANGLE (Degree)	RAW VALUE (dBuV)	CORRECTION FACTOR (dB/m)
1	*5240.00	105.30 PK			1.58 V	189	100.26	5.04
2	*5240.00	93.63 AV			1.58 V	189	88.59	5.04
3	5350.00	55.61 PK	74.00	-18.39	1.58 V	189	50.26	5.35
4	5350.00	42.34 AV	54.00	-11.66	1.58 V	189	36.99	5.35
5	#10480.00	55.06 PK	74.00	-18.94	1.68 V	269	39.30	15.76
6	#10480.00	41.61 AV	54.00	-12.39	1.68 V	269	25.85	15.76

**REMARKS:**

1. Emission Level(dBuV/m) = Raw Value(dBuV) + Correction Factor(dB/m)
2. Correction Factor(dB/m) = Antenna Factor(dB/m) + Cable Factor(dB) – Pre-Amplifier Factor(dB)
3. The other emission levels were very low against the limit.
4. Margin value = Emission Level – Limit value
5. " \* ": Fundamental frequency.
6. " # ": The radiated frequency is out of the restricted band.



<b>CHANNEL</b>	TX Channel 149	<b>DETECTOR FUNCTION</b>	Peak (PK)
<b>FREQUENCY RANGE</b>	1GHz ~ 25GHz		Average (AV)

**ANTENNA POLARITY & TEST DISTANCE: HORIZONTAL AT 3 M**

NO.	FREQ. (MHz)	EMISSION LEVEL (dBuV/m)	LIMIT (dBuV/m)	MARGIN (dB)	ANTENNA HEIGHT (m)	TABLE ANGLE (Degree)	RAW VALUE (dBuV)	CORRECTION FACTOR (dB/m)
1	#5629.74	66.96 PK	68.20	-1.24	1.52 H	47	60.37	6.59
2	*5745.00	117.91 PK			1.52 H	47	111.22	6.69
3	*5745.00	106.94 AV			1.52 H	47	100.25	6.69
4	#5929.70	58.11 PK	68.20	-10.09	1.52 H	47	51.07	7.04
5	11490.00	57.09 PK	74.00	-16.91	1.68 H	254	40.19	16.90
6	11490.00	43.28 AV	54.00	-10.72	1.68 H	254	26.38	16.90

**ANTENNA POLARITY & TEST DISTANCE: VERTICAL AT 3 M**

NO.	FREQ. (MHz)	EMISSION LEVEL (dBuV/m)	LIMIT (dBuV/m)	MARGIN (dB)	ANTENNA HEIGHT (m)	TABLE ANGLE (Degree)	RAW VALUE (dBuV)	CORRECTION FACTOR (dB/m)
1	#5629.22	60.34 PK	68.20	-7.86	1.32 V	68	53.75	6.59
2	*5745.00	114.13 PK			1.32 V	68	107.44	6.69
3	*5745.00	103.99 AV			1.32 V	68	97.30	6.69
4	#5990.14	55.86 PK	68.20	-12.34	1.32 V	68	48.57	7.29
5	11490.00	56.15 PK	74.00	-17.85	1.95 V	164	39.25	16.90
6	11490.00	42.06 AV	54.00	-11.94	1.95 V	164	25.16	16.90

**REMARKS:**

1. Emission Level(dBuV/m) = Raw Value(dBuV) + Correction Factor(dB/m)
2. Correction Factor(dB/m) = Antenna Factor(dB/m) + Cable Factor(dB) – Pre-Amplifier Factor(dB)
3. The other emission levels were very low against the limit.
4. Margin value = Emission Level – Limit value
5. " \* ": Fundamental frequency.
6. " # ": The radiated frequency is out of the restricted band.

<b>CHANNEL</b>	TX Channel 157	<b>DETECTOR FUNCTION</b>	Peak (PK)
<b>FREQUENCY RANGE</b>	1GHz ~ 25GHz		Average (AV)

**ANTENNA POLARITY & TEST DISTANCE: HORIZONTAL AT 3 M**

NO.	FREQ. (MHz)	EMISSION LEVEL (dBuV/m)	LIMIT (dBuV/m)	MARGIN (dB)	ANTENNA HEIGHT (m)	TABLE ANGLE (Degree)	RAW VALUE (dBuV)	CORRECTION FACTOR (dB/m)
1	#5646.01	61.39 PK	68.20	-6.81	1.85 H	357	54.78	6.61
2	*5785.00	121.20 PK			1.85 H	357	114.48	6.72
3	*5785.00	109.83 AV			1.85 H	357	103.11	6.72
4	#5930.05	56.87 PK	68.20	-11.33	1.85 H	357	49.83	7.04
5	11570.00	57.63 PK	74.00	-16.37	1.94 H	145	40.84	16.79
6	11570.00	43.42 AV	54.00	-10.58	1.94 H	145	26.63	16.79

**ANTENNA POLARITY & TEST DISTANCE: VERTICAL AT 3 M**

NO.	FREQ. (MHz)	EMISSION LEVEL (dBuV/m)	LIMIT (dBuV/m)	MARGIN (dB)	ANTENNA HEIGHT (m)	TABLE ANGLE (Degree)	RAW VALUE (dBuV)	CORRECTION FACTOR (dB/m)
1	#5645.21	62.51 PK	68.20	-5.69	1.41 V	79	55.90	6.61
2	*5785.00	118.18 PK			1.41 V	79	111.46	6.72
3	*5785.00	106.61 AV			1.41 V	79	99.89	6.72
4	#5934.30	57.55 PK	68.20	-10.65	1.41 V	79	50.50	7.05
5	11570.00	56.33 PK	74.00	-17.67	1.67 V	46	39.54	16.79
6	11570.00	42.73 AV	54.00	-11.27	1.67 V	46	25.94	16.79

**REMARKS:**

1. Emission Level(dBuV/m) = Raw Value(dBuV) + Correction Factor(dB/m)
2. Correction Factor(dB/m) = Antenna Factor(dB/m) + Cable Factor(dB) – Pre-Amplifier Factor(dB)
3. The other emission levels were very low against the limit.
4. Margin value = Emission Level – Limit value
5. " \* ": Fundamental frequency.
6. " # ": The radiated frequency is out of the restricted band.

<b>CHANNEL</b>	TX Channel 165	<b>DETECTOR FUNCTION</b>	Peak (PK)
<b>FREQUENCY RANGE</b>	1GHz ~ 25GHz		Average (AV)

**ANTENNA POLARITY & TEST DISTANCE: HORIZONTAL AT 3 M**

NO.	FREQ. (MHz)	EMISSION LEVEL (dBuV/m)	LIMIT (dBuV/m)	MARGIN (dB)	ANTENNA HEIGHT (m)	TABLE ANGLE (Degree)	RAW VALUE (dBuV)	CORRECTION FACTOR (dB/m)
1	#5645.88	61.26 PK	68.20	-6.94	1.81 H	0	54.65	6.61
2	*5825.00	120.47 PK			1.81 H	0	113.69	6.78
3	*5825.00	109.37 AV			1.81 H	0	102.59	6.78
4	#5928.01	67.00 PK	68.20	-1.20	1.81 H	0	59.98	7.02
5	11650.00	57.60 PK	74.00	-16.40	1.67 H	281	40.84	16.76
6	11650.00	43.65 AV	54.00	-10.35	1.67 H	281	26.89	16.76

**ANTENNA POLARITY & TEST DISTANCE: VERTICAL AT 3 M**

NO.	FREQ. (MHz)	EMISSION LEVEL (dBuV/m)	LIMIT (dBuV/m)	MARGIN (dB)	ANTENNA HEIGHT (m)	TABLE ANGLE (Degree)	RAW VALUE (dBuV)	CORRECTION FACTOR (dB/m)
1	#5644.11	57.73 PK	68.20	-10.47	1.38 V	68	51.11	6.62
2	*5825.00	116.67 PK			1.38 V	38	109.89	6.78
3	*5825.00	105.57 AV			1.38 V	38	98.79	6.78
4	#5961.42	57.39 PK	68.20	-10.81	1.38 V	38	50.21	7.18
5	11650.00	56.40 PK	74.00	-17.60	1.84 V	215	39.64	16.76
6	11650.00	42.57 AV	54.00	-11.43	1.84 V	215	25.81	16.76

**REMARKS:**

1. Emission Level(dBuV/m) = Raw Value(dBuV) + Correction Factor(dB/m)
2. Correction Factor(dB/m) = Antenna Factor(dB/m) + Cable Factor(dB) – Pre-Amplifier Factor(dB)
3. The other emission levels were very low against the limit.
4. Margin value = Emission Level – Limit value
5. " \* ": Fundamental frequency.
6. " # ": The radiated frequency is out of the restricted band.

**802.11n (20MHz)**

<b>CHANNEL</b>	TX Channel 36	<b>DETECTOR FUNCTION</b>	Peak (PK)
<b>FREQUENCY RANGE</b>	1GHz ~ 25GHz		Average (AV)

**ANTENNA POLARITY & TEST DISTANCE: HORIZONTAL AT 3 M**

NO.	FREQ. (MHz)	EMISSION LEVEL (dBuV/m)	LIMIT (dBuV/m)	MARGIN (dB)	ANTENNA HEIGHT (m)	TABLE ANGLE (Degree)	RAW VALUE (dBuV)	CORRECTION FACTOR (dB/m)
1	5150.00	57.04 PK	74.00	-16.96	1.85 H	306	52.13	4.91
2	5150.00	43.17 AV	54.00	-10.83	1.85 H	306	38.26	4.91
3	*5180.00	107.28 PK			1.85 H	306	102.34	4.94
4	*5180.00	94.84 AV			1.85 H	306	89.90	4.94
5	#10360.00	56.15 PK	74.00	-17.85	2.18 H	264	40.62	15.53
6	#10360.00	41.90 AV	54.00	-12.10	2.18 H	264	26.37	15.53

**ANTENNA POLARITY & TEST DISTANCE: VERTICAL AT 3 M**

NO.	FREQ. (MHz)	EMISSION LEVEL (dBuV/m)	LIMIT (dBuV/m)	MARGIN (dB)	ANTENNA HEIGHT (m)	TABLE ANGLE (Degree)	RAW VALUE (dBuV)	CORRECTION FACTOR (dB/m)
1	5150.00	56.17 PK	74.00	-17.83	1.61 V	181	51.26	4.91
2	5150.00	42.46 AV	54.00	-11.54	1.61 V	181	37.55	4.91
3	*5180.00	105.20 PK			1.61 V	181	100.26	4.94
4	*5180.00	92.43 AV			1.61 V	181	87.49	4.94
5	#10360.00	54.90 PK	74.00	-19.10	1.62 V	225	39.37	15.53
6	#10360.00	41.35 AV	54.00	-12.65	1.62 V	225	25.82	15.53

**REMARKS:**

1. Emission Level(dBuV/m) = Raw Value(dBuV) + Correction Factor(dB/m)
2. Correction Factor(dB/m) = Antenna Factor(dB/m) + Cable Factor(dB) – Pre-Amplifier Factor(dB)
3. The other emission levels were very low against the limit.
4. Margin value = Emission Level – Limit value
5. " \* ": Fundamental frequency.
6. " # ": The radiated frequency is out of the restricted band.

<b>CHANNEL</b>	TX Channel 40	<b>DETECTOR FUNCTION</b>	Peak (PK)
<b>FREQUENCY RANGE</b>	1GHz ~ 25GHz		Average (AV)

**ANTENNA POLARITY & TEST DISTANCE: HORIZONTAL AT 3 M**

NO.	FREQ. (MHz)	EMISSION LEVEL (dBuV/m)	LIMIT (dBuV/m)	MARGIN (dB)	ANTENNA HEIGHT (m)	TABLE ANGLE (Degree)	RAW VALUE (dBuV)	CORRECTION FACTOR (dB/m)
1	*5200.00	107.33 PK			1.87 H	307	102.36	4.97
2	*5200.00	95.09 AV			1.87 H	307	90.12	4.97
3	#10400.00	56.12 PK	74.00	-17.88	1.89 H	274	40.54	15.58
4	#10400.00	41.95 AV	54.00	-12.05	1.89 H	274	26.37	15.58

**ANTENNA POLARITY & TEST DISTANCE: VERTICAL AT 3 M**

NO.	FREQ. (MHz)	EMISSION LEVEL (dBuV/m)	LIMIT (dBuV/m)	MARGIN (dB)	ANTENNA HEIGHT (m)	TABLE ANGLE (Degree)	RAW VALUE (dBuV)	CORRECTION FACTOR (dB/m)
1	*5200.00	105.23 PK			1.52 V	189	100.26	4.97
2	*5200.00	93.93 AV			1.52 V	189	88.96	4.97
3	#10400.00	54.68 PK	74.00	-19.32	1.67 V	29	39.10	15.58
4	#10400.00	40.61 AV	54.00	-13.39	1.67 V	29	25.03	15.58

**REMARKS:**

1. Emission Level(dBuV/m) = Raw Value(dBuV) + Correction Factor(dB/m)
2. Correction Factor(dB/m) = Antenna Factor(dB/m) + Cable Factor(dB) – Pre-Amplifier Factor(dB)
3. The other emission levels were very low against the limit.
4. Margin value = Emission Level – Limit value
5. " \* ": Fundamental frequency.
6. " # ": The radiated frequency is out of the restricted band.

<b>CHANNEL</b>	TX Channel 48	<b>DETECTOR FUNCTION</b>	Peak (PK)
<b>FREQUENCY RANGE</b>	1GHz ~ 25GHz		Average (AV)

**ANTENNA POLARITY & TEST DISTANCE: HORIZONTAL AT 3 M**

NO.	FREQ. (MHz)	EMISSION LEVEL (dBuV/m)	LIMIT (dBuV/m)	MARGIN (dB)	ANTENNA HEIGHT (m)	TABLE ANGLE (Degree)	RAW VALUE (dBuV)	CORRECTION FACTOR (dB/m)
1	*5240.00	108.41 PK			1.69 H	308	103.37	5.04
2	*5240.00	96.45 AV			1.69 H	308	91.41	5.04
3	5350.00	55.77 PK	74.00	-18.23	1.69 H	308	50.42	5.35
4	5350.00	43.24 AV	54.00	-10.76	1.69 H	308	37.89	5.35
5	#10480.00	56.61 PK	74.00	-17.39	2.18 H	221	40.85	15.76
6	#10480.00	42.39 AV	54.00	-11.61	2.18 H	221	26.63	15.76

**ANTENNA POLARITY & TEST DISTANCE: VERTICAL AT 3 M**

NO.	FREQ. (MHz)	EMISSION LEVEL (dBuV/m)	LIMIT (dBuV/m)	MARGIN (dB)	ANTENNA HEIGHT (m)	TABLE ANGLE (Degree)	RAW VALUE (dBuV)	CORRECTION FACTOR (dB/m)
1	*5240.00	106.62 PK			1.54 V	182	101.58	5.04
2	*5240.00	94.67 AV			1.54 V	182	89.63	5.04
3	5350.00	55.04 PK	74.00	-18.96	1.54 V	182	49.69	5.35
4	5350.00	42.24 AV	54.00	-11.76	1.54 V	182	36.89	5.35
5	#10480.00	54.97 PK	74.00	-19.03	2.64 V	349	39.21	15.76
6	#10480.00	41.04 AV	54.00	-12.96	2.64 V	349	25.28	15.76

**REMARKS:**

1. Emission Level(dBuV/m) = Raw Value(dBuV) + Correction Factor(dB/m)
2. Correction Factor(dB/m) = Antenna Factor(dB/m) + Cable Factor(dB) – Pre-Amplifier Factor(dB)
3. The other emission levels were very low against the limit.
4. Margin value = Emission Level – Limit value
5. " \* ": Fundamental frequency.
6. " # ": The radiated frequency is out of the restricted band.

<b>CHANNEL</b>	TX Channel 149	<b>DETECTOR FUNCTION</b>	Peak (PK)
<b>FREQUENCY RANGE</b>	1GHz ~ 25GHz		Average (AV)

**ANTENNA POLARITY & TEST DISTANCE: HORIZONTAL AT 3 M**

NO.	FREQ. (MHz)	EMISSION LEVEL (dBuV/m)	LIMIT (dBuV/m)	MARGIN (dB)	ANTENNA HEIGHT (m)	TABLE ANGLE (Degree)	RAW VALUE (dBuV)	CORRECTION FACTOR (dB/m)
1	#5650.65	67.09 PK	68.68	-1.59	1.50 H	47	60.47	6.62
2	*5745.00	118.37 PK			1.50 H	47	111.68	6.69
3	*5745.00	106.84 AV			1.50 H	47	100.15	6.69
4	#5938.16	56.69 PK	68.20	-11.51	1.50 H	47	49.62	7.07
5	11490.00	57.14 PK	74.00	-16.86	1.23 H	226	40.24	16.90
6	11490.00	43.74 AV	54.00	-10.26	1.23 H	226	26.84	16.90

**ANTENNA POLARITY & TEST DISTANCE: VERTICAL AT 3 M**

NO.	FREQ. (MHz)	EMISSION LEVEL (dBuV/m)	LIMIT (dBuV/m)	MARGIN (dB)	ANTENNA HEIGHT (m)	TABLE ANGLE (Degree)	RAW VALUE (dBuV)	CORRECTION FACTOR (dB/m)
1	#5645.17	61.60 PK	68.20	-6.60	1.36 V	41	54.99	6.61
2	*5745.00	114.15 PK			1.36 V	41	107.46	6.69
3	*5745.00	103.54 AV			1.36 V	41	96.85	6.69
4	#5938.31	57.61 PK	68.20	-10.59	1.36 V	41	50.54	7.07
5	11490.00	56.54 PK	74.00	-17.46	1.84 V	263	39.64	16.90
6	11490.00	42.51 AV	54.00	-11.49	1.84 V	263	25.61	16.90

**REMARKS:**

1. Emission Level(dBuV/m) = Raw Value(dBuV) + Correction Factor(dB/m)
2. Correction Factor(dB/m) = Antenna Factor(dB/m) + Cable Factor(dB) – Pre-Amplifier Factor(dB)
3. The other emission levels were very low against the limit.
4. Margin value = Emission Level – Limit value
5. " \* ": Fundamental frequency.
6. " # ": The radiated frequency is out of the restricted band.

<b>CHANNEL</b>	TX Channel 157	<b>DETECTOR FUNCTION</b>	Peak (PK)
<b>FREQUENCY RANGE</b>	1GHz ~ 25GHz		Average (AV)

**ANTENNA POLARITY & TEST DISTANCE: HORIZONTAL AT 3 M**

NO.	FREQ. (MHz)	EMISSION LEVEL (dBuV/m)	LIMIT (dBuV/m)	MARGIN (dB)	ANTENNA HEIGHT (m)	TABLE ANGLE (Degree)	RAW VALUE (dBuV)	CORRECTION FACTOR (dB/m)
1	#5643.59	66.70 PK	68.20	-1.50	1.53 H	47	60.08	6.62
2	*5785.00	117.55 PK			1.53 H	47	110.83	6.72
3	*5785.00	106.52 AV			1.53 H	47	99.80	6.72
4	#5952.79	60.73 PK	68.20	-7.47	1.53 H	47	53.60	7.13
5	11570.00	57.63 PK	74.00	-16.37	1.67 H	69	40.84	16.79
6	11570.00	43.46 AV	54.00	-10.54	1.67 H	69	26.67	16.79

**ANTENNA POLARITY & TEST DISTANCE: VERTICAL AT 3 M**

NO.	FREQ. (MHz)	EMISSION LEVEL (dBuV/m)	LIMIT (dBuV/m)	MARGIN (dB)	ANTENNA HEIGHT (m)	TABLE ANGLE (Degree)	RAW VALUE (dBuV)	CORRECTION FACTOR (dB/m)
1	#5647.08	60.79 PK	68.20	-7.41	1.28 V	32	54.18	6.61
2	*5785.00	112.99 PK			1.28 V	32	106.27	6.72
3	*5785.00	102.39 AV			1.28 V	32	95.67	6.72
4	#5926.21	58.05 PK	68.20	-10.15	1.28 V	32	51.03	7.02
5	11570.00	56.12 PK	74.00	-17.88	1.94 V	236	39.33	16.79
6	11570.00	42.43 AV	54.00	-11.57	1.94 V	236	25.64	16.79

**REMARKS:**

1. Emission Level(dBuV/m) = Raw Value(dBuV) + Correction Factor(dB/m)
2. Correction Factor(dB/m) = Antenna Factor(dB/m) + Cable Factor(dB) – Pre-Amplifier Factor(dB)
3. The other emission levels were very low against the limit.
4. Margin value = Emission Level – Limit value
5. " \* ": Fundamental frequency.
6. " # ": The radiated frequency is out of the restricted band.



<b>CHANNEL</b>	TX Channel 165	<b>DETECTOR FUNCTION</b>	Peak (PK)
<b>FREQUENCY RANGE</b>	1GHz ~ 25GHz		Average (AV)

**ANTENNA POLARITY & TEST DISTANCE: HORIZONTAL AT 3 M**

NO.	FREQ. (MHz)	EMISSION LEVEL (dBuV/m)	LIMIT (dBuV/m)	MARGIN (dB)	ANTENNA HEIGHT (m)	TABLE ANGLE (Degree)	RAW VALUE (dBuV)	CORRECTION FACTOR (dB/m)
1	#5648.95	59.95 PK	68.20	-8.25	1.48 H	50	53.34	6.61
2	*5825.00	118.62 PK			1.48 H	50	111.84	6.78
3	*5825.00	106.43 AV			1.48 H	50	99.65	6.78
4	#5921.47	69.23 PK	70.81	-1.58	1.48 H	57	62.23	7.00
5	11650.00	57.04 PK	74.00	-16.96	2.15 H	284	40.28	16.76
6	11650.00	43.09 AV	54.00	-10.91	2.15 H	284	26.33	16.76

**ANTENNA POLARITY & TEST DISTANCE: VERTICAL AT 3 M**

NO.	FREQ. (MHz)	EMISSION LEVEL (dBuV/m)	LIMIT (dBuV/m)	MARGIN (dB)	ANTENNA HEIGHT (m)	TABLE ANGLE (Degree)	RAW VALUE (dBuV)	CORRECTION FACTOR (dB/m)
1	#5643.95	57.44 PK	68.20	-10.76	1.24 V	85	50.82	6.62
2	*5825.00	114.62 PK			1.24 V	85	107.84	6.78
3	*5825.00	102.47 AV			1.24 V	85	95.69	6.78
4	#5938.97	56.83 PK	68.20	-11.37	1.24 V	85	49.76	7.07
5	11650.00	56.71 PK	74.00	-17.29	1.89 V	259	39.95	16.76
6	11650.00	41.89 AV	54.00	-12.11	1.89 V	259	25.13	16.76

**REMARKS:**

1. Emission Level(dBuV/m) = Raw Value(dBuV) + Correction Factor(dB/m)
2. Correction Factor(dB/m) = Antenna Factor(dB/m) + Cable Factor(dB) – Pre-Amplifier Factor(dB)
3. The other emission levels were very low against the limit.
4. Margin value = Emission Level – Limit value
5. " \* ": Fundamental frequency.
6. " # ": The radiated frequency is out of the restricted band.

802.11n (40MHz)

<b>CHANNEL</b>	TX Channel 38	<b>DETECTOR FUNCTION</b>	Peak (PK)
<b>FREQUENCY RANGE</b>	1GHz ~ 25GHz		Average (AV)

**ANTENNA POLARITY & TEST DISTANCE: HORIZONTAL AT 3 M**

NO.	FREQ. (MHz)	EMISSION LEVEL (dBuV/m)	LIMIT (dBuV/m)	MARGIN (dB)	ANTENNA HEIGHT (m)	TABLE ANGLE (Degree)	RAW VALUE (dBuV)	CORRECTION FACTOR (dB/m)
1	5150.00	56.96 PK	74.00	-17.04	1.88 H	310	52.05	4.91
2	5150.00	43.96 AV	54.00	-10.04	1.88 H	310	39.05	4.91
3	*5190.00	103.01 PK			1.88 H	310	98.05	4.96
4	*5190.00	92.10 AV			1.88 H	310	87.14	4.96
5	#10380.00	56.24 PK	74.00	-17.76	2.18 H	274	40.68	15.56
6	#10380.00	42.50 AV	54.00	-11.50	2.18 H	274	26.94	15.56

**ANTENNA POLARITY & TEST DISTANCE: VERTICAL AT 3 M**

NO.	FREQ. (MHz)	EMISSION LEVEL (dBuV/m)	LIMIT (dBuV/m)	MARGIN (dB)	ANTENNA HEIGHT (m)	TABLE ANGLE (Degree)	RAW VALUE (dBuV)	CORRECTION FACTOR (dB/m)
1	5150.00	56.37 PK	74.00	-17.63	1.58 V	189	51.46	4.91
2	5150.00	43.46 AV	54.00	-10.54	1.58 V	189	38.55	4.91
3	*5190.00	102.42 PK			1.58 V	189	97.46	4.96
4	*5190.00	91.21 AV			1.58 V	189	86.25	4.96
5	#10380.00	55.40 PK	74.00	-18.60	2.34 V	338	39.84	15.56
6	#10380.00	40.74 AV	54.00	-13.26	2.34 V	338	25.18	15.56

**REMARKS:**

1. Emission Level(dBuV/m) = Raw Value(dBuV) + Correction Factor(dB/m)
2. Correction Factor(dB/m) = Antenna Factor(dB/m) + Cable Factor(dB) – Pre-Amplifier Factor(dB)
3. The other emission levels were very low against the limit.
4. Margin value = Emission Level – Limit value
5. " \* ": Fundamental frequency.
6. " # ": The radiated frequency is out of the restricted band.

<b>CHANNEL</b>	TX Channel 46	<b>DETECTOR FUNCTION</b>	Peak (PK)
<b>FREQUENCY RANGE</b>	1GHz ~ 25GHz		Average (AV)

**ANTENNA POLARITY & TEST DISTANCE: HORIZONTAL AT 3 M**

NO.	FREQ. (MHz)	EMISSION LEVEL (dBuV/m)	LIMIT (dBuV/m)	MARGIN (dB)	ANTENNA HEIGHT (m)	TABLE ANGLE (Degree)	RAW VALUE (dBuV)	CORRECTION FACTOR (dB/m)
1	*5230.00	103.18 PK			1.90 H	310	98.16	5.02
2	*5230.00	93.14 AV			1.90 H	310	88.12	5.02
3	5350.00	57.12 PK	74.00	-16.88	1.90 H	310	51.77	5.35
4	5350.00	43.24 AV	54.00	-10.76	1.90 H	310	37.89	5.35
5	#10460.00	56.39 PK	74.00	-17.61	2.95 H	285	40.68	15.71
6	#10460.00	42.08 AV	54.00	-11.92	2.95 H	285	26.37	15.71

**ANTENNA POLARITY & TEST DISTANCE: VERTICAL AT 3 M**

NO.	FREQ. (MHz)	EMISSION LEVEL (dBuV/m)	LIMIT (dBuV/m)	MARGIN (dB)	ANTENNA HEIGHT (m)	TABLE ANGLE (Degree)	RAW VALUE (dBuV)	CORRECTION FACTOR (dB/m)
1	*5230.00	101.70 PK			2.62 V	185	96.68	5.02
2	*5230.00	91.61 AV			2.62 V	185	86.59	5.02
3	5350.00	55.94 PK	74.00	-18.06	2.62 V	185	50.59	5.35
4	5350.00	42.78 AV	54.00	-11.22	2.62 V	185	37.43	5.35
5	#10460.00	55.57 PK	74.00	-18.43	1.78 V	48	39.86	15.71
6	#10460.00	41.39 AV	54.00	-12.61	1.78 V	48	25.68	15.71

**REMARKS:**

1. Emission Level(dBuV/m) = Raw Value(dBuV) + Correction Factor(dB/m)
2. Correction Factor(dB/m) = Antenna Factor(dB/m) + Cable Factor(dB) – Pre-Amplifier Factor(dB)
3. The other emission levels were very low against the limit.
4. Margin value = Emission Level – Limit value
5. " \* ": Fundamental frequency.
6. " # ": The radiated frequency is out of the restricted band.

<b>CHANNEL</b>	TX Channel 151	<b>DETECTOR FUNCTION</b>	Peak (PK)
<b>FREQUENCY RANGE</b>	1GHz ~ 25GHz		Average (AV)

**ANTENNA POLARITY & TEST DISTANCE: HORIZONTAL AT 3 M**

NO.	FREQ. (MHz)	EMISSION LEVEL (dBuV/m)	LIMIT (dBuV/m)	MARGIN (dB)	ANTENNA HEIGHT (m)	TABLE ANGLE (Degree)	RAW VALUE (dBuV)	CORRECTION FACTOR (dB/m)
1	#5648.49	66.25 PK	68.20	-1.95	1.46 H	49	59.64	6.61
2	*5755.00	114.69 PK			1.46 H	49	107.99	6.70
3	*5755.00	104.16 AV			1.46 H	49	97.46	6.70
4	#5927.08	58.05 PK	68.20	-10.15	1.46 H	49	51.03	7.02
5	11510.00	57.51 PK	74.00	-16.49	1.67 H	336	40.64	16.87
6	11510.00	43.51 AV	54.00	-10.49	1.67 H	336	26.64	16.87

**ANTENNA POLARITY & TEST DISTANCE: VERTICAL AT 3 M**

NO.	FREQ. (MHz)	EMISSION LEVEL (dBuV/m)	LIMIT (dBuV/m)	MARGIN (dB)	ANTENNA HEIGHT (m)	TABLE ANGLE (Degree)	RAW VALUE (dBuV)	CORRECTION FACTOR (dB/m)
1	#5641.45	58.96 PK	68.20	-9.24	1.33 V	69	52.36	6.60
2	*5755.00	110.16 PK			1.33 V	69	103.46	6.70
3	*5755.00	99.81 AV			1.33 V	69	93.11	6.70
4	#5958.31	56.19 PK	68.20	-12.01	1.33 V	69	49.03	7.16
5	11510.00	55.99 PK	74.00	-18.01	1.94 V	236	39.12	16.87
6	11510.00	42.51 AV	54.00	-11.49	1.94 V	236	25.64	16.87

**REMARKS:**

1. Emission Level(dBuV/m) = Raw Value(dBuV) + Correction Factor(dB/m)
2. Correction Factor(dB/m) = Antenna Factor(dB/m) + Cable Factor(dB) – Pre-Amplifier Factor(dB)
3. The other emission levels were very low against the limit.
4. Margin value = Emission Level – Limit value
5. " \* ": Fundamental frequency.
6. " # ": The radiated frequency is out of the restricted band.

<b>CHANNEL</b>	TX Channel 159	<b>DETECTOR FUNCTION</b>	Peak (PK)
<b>FREQUENCY RANGE</b>	1GHz ~ 25GHz		Average (AV)

**ANTENNA POLARITY & TEST DISTANCE: HORIZONTAL AT 3 M**

NO.	FREQ. (MHz)	EMISSION LEVEL (dBuV/m)	LIMIT (dBuV/m)	MARGIN (dB)	ANTENNA HEIGHT (m)	TABLE ANGLE (Degree)	RAW VALUE (dBuV)	CORRECTION FACTOR (dB/m)
1	#5645.44	67.13 PK	68.20	-1.07	1.48 H	48	60.52	6.61
2	*5795.00	115.02 PK			1.48 H	48	108.29	6.73
3	*5795.00	104.56 AV			1.48 H	48	97.83	6.73
4	#5929.04	62.32 PK	68.20	-5.88	1.48 H	48	55.29	7.03
5	11590.00	57.69 PK	74.00	-16.31	2.18 H	64	40.94	16.75
6	11590.00	43.43 AV	54.00	-10.57	2.18 H	64	26.68	16.75

**ANTENNA POLARITY & TEST DISTANCE: VERTICAL AT 3 M**

NO.	FREQ. (MHz)	EMISSION LEVEL (dBuV/m)	LIMIT (dBuV/m)	MARGIN (dB)	ANTENNA HEIGHT (m)	TABLE ANGLE (Degree)	RAW VALUE (dBuV)	CORRECTION FACTOR (dB/m)
1	#5641.52	61.66 PK	68.20	-6.54	1.36 V	69	55.06	6.60
2	*5795.00	109.99 PK			1.36 V	69	103.26	6.73
3	*5795.00	100.42 AV			1.36 V	69	93.69	6.73
4	#5924.98	59.38 PK	68.21	-8.83	1.36 V	69	52.36	7.02
5	11590.00	56.13 PK	74.00	-17.87	1.57 V	124	39.38	16.75
6	11590.00	42.43 AV	54.00	-11.57	1.57 V	124	25.68	16.75

**REMARKS:**

1. Emission Level(dBuV/m) = Raw Value(dBuV) + Correction Factor(dB/m)
2. Correction Factor(dB/m) = Antenna Factor(dB/m) + Cable Factor(dB) – Pre-Amplifier Factor(dB)
3. The other emission levels were very low against the limit.
4. Margin value = Emission Level – Limit value
5. " \* ": Fundamental frequency.
6. " # ": The radiated frequency is out of the restricted band.

802.11ac (80MHz)

<b>CHANNEL</b>	TX Channel 42	<b>DETECTOR FUNCTION</b>	Peak (PK)
<b>FREQUENCY RANGE</b>	1GHz ~ 25GHz		Average (AV)

**ANTENNA POLARITY & TEST DISTANCE: HORIZONTAL AT 3 M**

NO.	FREQ. (MHz)	EMISSION LEVEL (dBuV/m)	LIMIT (dBuV/m)	MARGIN (dB)	ANTENNA HEIGHT (m)	TABLE ANGLE (Degree)	RAW VALUE (dBuV)	CORRECTION FACTOR (dB/m)
1	5150.00	58.13 PK	74.00	-15.87	1.75 H	309	53.22	4.91
2	5150.00	44.25 AV	54.00	-9.75	1.75 H	309	39.34	4.91
3	*5210.00	101.36 PK			1.75 H	309	96.38	4.98
4	*5210.00	90.76 AV			1.75 H	309	85.78	4.98
5	5350.00	56.77 PK	74.00	-17.23	1.75 H	309	51.42	5.35
6	5350.00	42.50 AV	54.00	-11.50	1.75 H	309	37.15	5.35
7	#10420.00	56.57 PK	74.00	-17.43	1.94 H	268	40.94	15.63
8	#10420.00	42.31 AV	54.00	-11.69	1.94 H	268	26.68	15.63

**ANTENNA POLARITY & TEST DISTANCE: VERTICAL AT 3 M**

NO.	FREQ. (MHz)	EMISSION LEVEL (dBuV/m)	LIMIT (dBuV/m)	MARGIN (dB)	ANTENNA HEIGHT (m)	TABLE ANGLE (Degree)	RAW VALUE (dBuV)	CORRECTION FACTOR (dB/m)
1	5150.00	57.27 PK	74.00	-16.73	1.58 V	189	52.36	4.91
2	5150.00	43.80 AV	54.00	-10.20	1.58 V	189	38.89	4.91
3	*5210.00	99.56 PK			1.58 V	189	94.58	4.98
4	*5210.00	88.67 AV			1.58 V	189	83.69	4.98
5	5350.00	55.81 PK	74.00	-18.19	1.58 V	189	50.46	5.35
6	5350.00	42.23 AV	54.00	-11.77	1.58 V	189	36.88	5.35
7	#10420.00	55.27 PK	74.00	-18.73	2.69 V	234	39.64	15.63
8	#10420.00	41.25 AV	54.00	-12.75	2.69 V	234	25.62	15.63

**REMARKS:**

1. Emission Level(dBuV/m) = Raw Value(dBuV) + Correction Factor(dB/m)
2. Correction Factor(dB/m) = Antenna Factor(dB/m) + Cable Factor(dB) – Pre-Amplifier Factor(dB)
3. The other emission levels were very low against the limit.
4. Margin value = Emission Level – Limit value
5. " \* ": Fundamental frequency.
6. " # ": The radiated frequency is out of the restricted band.

<b>CHANNEL</b>	TX Channel 155	<b>DETECTOR FUNCTION</b>	Peak (PK)
<b>FREQUENCY RANGE</b>	1GHz ~ 25GHz		Average (AV)

**ANTENNA POLARITY & TEST DISTANCE: HORIZONTAL AT 3 M**

NO.	FREQ. (MHz)	EMISSION LEVEL (dBuV/m)	LIMIT (dBuV/m)	MARGIN (dB)	ANTENNA HEIGHT (m)	TABLE ANGLE (Degree)	RAW VALUE (dBuV)	CORRECTION FACTOR (dB/m)
1	#5641.82	67.16 PK	68.20	-1.04	1.77 H	0	60.56	6.60
2	*5775.00	109.77 PK			1.77 H	0	103.05	6.72
3	*5775.00	99.25 AV			1.77 H	0	92.53	6.72
4	#5926.45	60.16 PK	68.20	-8.04	1.77 H	0	53.14	7.02
5	11550.00	57.39 PK	74.00	-16.61	1.92 H	228	40.58	16.81
6	11550.00	43.46 AV	54.00	-10.54	1.92 H	228	26.65	16.81

**ANTENNA POLARITY & TEST DISTANCE: VERTICAL AT 3 M**

NO.	FREQ. (MHz)	EMISSION LEVEL (dBuV/m)	LIMIT (dBuV/m)	MARGIN (dB)	ANTENNA HEIGHT (m)	TABLE ANGLE (Degree)	RAW VALUE (dBuV)	CORRECTION FACTOR (dB/m)
1	#5642.30	59.57 PK	68.20	-8.63	1.29 V	58	52.97	6.60
2	*5775.00	106.40 PK			1.28 V	58	99.68	6.72
3	*5775.00	95.31 AV			1.28 V	58	88.59	6.72
4	#5938.50	55.17 PK	68.20	-13.03	1.29 V	58	48.10	7.07
5	11550.00	56.66 PK	74.00	-17.34	1.79 V	84	39.85	16.81
6	11550.00	42.49 AV	54.00	-11.51	1.79 V	84	25.68	16.81

**REMARKS:**

1. Emission Level(dBuV/m) = Raw Value(dBuV) + Correction Factor(dB/m)
2. Correction Factor(dB/m) = Antenna Factor(dB/m) + Cable Factor(dB) – Pre-Amplifier Factor(dB)
3. The other emission levels were very low against the limit.
4. Margin value = Emission Level – Limit value
5. " \* ": Fundamental frequency.
6. " # ": The radiated frequency is out of the restricted band.

**CDD Mode (Mode B)**

**802.11a**

<b>CHANNEL</b>	TX Channel 36	<b>DETECTOR FUNCTION</b>	Peak (PK)
<b>FREQUENCY RANGE</b>	1GHz ~ 25GHz		Average (AV)

**ANTENNA POLARITY & TEST DISTANCE: HORIZONTAL AT 3 M**

NO.	FREQ. (MHz)	EMISSION LEVEL (dBuV/m)	LIMIT (dBuV/m)	MARGIN (dB)	ANTENNA HEIGHT (m)	TABLE ANGLE (Degree)	RAW VALUE (dBuV)	CORRECTION FACTOR (dB/m)
1	5150.00	57.42 PK	74.00	-16.58	1.18 H	16	51.48	5.94
2	5150.00	44.04 AV	54.00	-9.96	1.18 H	16	38.10	5.94
3	*5180.00	102.28 PK			1.18 H	16	96.25	6.03
4	*5180.00	89.92 AV			1.18 H	16	83.89	6.03
5	#10360.00	55.74 PK	74.00	-18.26	1.87 H	224	39.64	16.10
6	#10360.00	41.55 AV	54.00	-12.45	1.87 H	224	25.45	16.10

**ANTENNA POLARITY & TEST DISTANCE: VERTICAL AT 3 M**

NO.	FREQ. (MHz)	EMISSION LEVEL (dBuV/m)	LIMIT (dBuV/m)	MARGIN (dB)	ANTENNA HEIGHT (m)	TABLE ANGLE (Degree)	RAW VALUE (dBuV)	CORRECTION FACTOR (dB/m)
1	5150.00	58.19 PK	74.00	-15.81	1.62 V	327	52.25	5.94
2	5150.00	46.61 AV	54.00	-7.39	1.62 V	327	40.67	5.94
3	*5180.00	112.42 PK			1.62 V	327	106.39	6.03
4	*5180.00	102.87 AV			1.62 V	327	96.84	6.03
5	#10360.00	56.36 PK	74.00	-17.64	1.63 V	201	40.26	16.10
6	#10360.00	42.53 AV	54.00	-11.47	1.63 V	201	26.43	16.10

**REMARKS:**

1. Emission Level(dBuV/m) = Raw Value(dBuV) + Correction Factor(dB/m)
2. Correction Factor(dB/m) = Antenna Factor(dB/m) + Cable Factor(dB) – Pre-Amplifier Factor(dB)
3. The other emission levels were very low against the limit.
4. Margin value = Emission Level – Limit value
5. " \* ": Fundamental frequency.
6. " # ": The radiated frequency is out of the restricted band.



<b>CHANNEL</b>	TX Channel 40	<b>DETECTOR FUNCTION</b>	Peak (PK)
<b>FREQUENCY RANGE</b>	1GHz ~ 25GHz		Average (AV)

**ANTENNA POLARITY & TEST DISTANCE: HORIZONTAL AT 3 M**

NO.	FREQ. (MHz)	EMISSION LEVEL (dBuV/m)	LIMIT (dBuV/m)	MARGIN (dB)	ANTENNA HEIGHT (m)	TABLE ANGLE (Degree)	RAW VALUE (dBuV)	CORRECTION FACTOR (dB/m)
1	*5200.00	103.57 PK			1.20 H	23	97.46	6.11
2	*5200.00	92.47 AV			1.20 H	23	86.36	6.11
3	#10400.00	55.60 PK	74.00	-18.40	1.67 H	225	39.34	16.26
4	#10400.00	41.39 AV	54.00	-12.61	1.67 H	225	25.13	16.26

**ANTENNA POLARITY & TEST DISTANCE: VERTICAL AT 3 M**

NO.	FREQ. (MHz)	EMISSION LEVEL (dBuV/m)	LIMIT (dBuV/m)	MARGIN (dB)	ANTENNA HEIGHT (m)	TABLE ANGLE (Degree)	RAW VALUE (dBuV)	CORRECTION FACTOR (dB/m)
1	*5200.00	113.22 PK			1.78 V	319	107.11	6.11
2	*5200.00	101.33 AV			1.78 V	319	95.22	6.11
3	#10400.00	56.42 PK	74.00	-17.58	1.34 V	236	40.16	16.26
4	#10400.00	42.89 AV	54.00	-11.11	1.34 V	236	26.63	16.26

**REMARKS:**

1. Emission Level(dBuV/m) = Raw Value(dBuV) + Correction Factor(dB/m)
2. Correction Factor(dB/m) = Antenna Factor(dB/m) + Cable Factor(dB) – Pre-Amplifier Factor(dB)
3. The other emission levels were very low against the limit.
4. Margin value = Emission Level – Limit value
5. " \* ": Fundamental frequency.
6. " # ": The radiated frequency is out of the restricted band.

<b>CHANNEL</b>	TX Channel 48	<b>DETECTOR FUNCTION</b>	Peak (PK)
<b>FREQUENCY RANGE</b>	1GHz ~ 25GHz		Average (AV)

**ANTENNA POLARITY & TEST DISTANCE: HORIZONTAL AT 3 M**

NO.	FREQ. (MHz)	EMISSION LEVEL (dBuV/m)	LIMIT (dBuV/m)	MARGIN (dB)	ANTENNA HEIGHT (m)	TABLE ANGLE (Degree)	RAW VALUE (dBuV)	CORRECTION FACTOR (dB/m)
1	*5240.00	103.16 PK			1.15 H	20	96.89	6.27
2	*5240.00	91.52 AV			1.15 H	20	85.25	6.27
3	5350.00	56.61 PK	74.00	-17.39	1.15 H	20	49.86	6.75
4	5350.00	43.71 AV	54.00	-10.29	1.15 H	20	36.96	6.75
5	#10480.00	56.09 PK	74.00	-17.91	1.48 H	251	39.62	16.47
6	#10480.00	41.55 AV	54.00	-12.45	1.48 H	251	25.08	16.47

**ANTENNA POLARITY & TEST DISTANCE: VERTICAL AT 3 M**

NO.	FREQ. (MHz)	EMISSION LEVEL (dBuV/m)	LIMIT (dBuV/m)	MARGIN (dB)	ANTENNA HEIGHT (m)	TABLE ANGLE (Degree)	RAW VALUE (dBuV)	CORRECTION FACTOR (dB/m)
1	*5240.00	113.56 PK			1.61 V	320	107.29	6.27
2	*5240.00	101.75 AV			1.61 V	320	95.48	6.27
3	5350.00	57.61 PK	74.00	-16.39	1.61 V	320	50.86	6.75
4	5350.00	44.01 AV	54.00	-9.99	1.61 V	320	37.26	6.75
5	#10480.00	57.01 PK	74.00	-16.99	1.69 V	214	40.54	16.47
6	#10480.00	43.28 AV	54.00	-10.72	1.69 V	214	26.81	16.47

**REMARKS:**

1. Emission Level(dBuV/m) = Raw Value(dBuV) + Correction Factor(dB/m)
2. Correction Factor(dB/m) = Antenna Factor(dB/m) + Cable Factor(dB) – Pre-Amplifier Factor(dB)
3. The other emission levels were very low against the limit.
4. Margin value = Emission Level – Limit value
5. " \* ": Fundamental frequency.
6. " # ": The radiated frequency is out of the restricted band.

<b>CHANNEL</b>	TX Channel 149	<b>DETECTOR FUNCTION</b>	Peak (PK)
<b>FREQUENCY RANGE</b>	1GHz ~ 25GHz		Average (AV)

**ANTENNA POLARITY & TEST DISTANCE: HORIZONTAL AT 3 M**

NO.	FREQ. (MHz)	EMISSION LEVEL (dBuV/m)	LIMIT (dBuV/m)	MARGIN (dB)	ANTENNA HEIGHT (m)	TABLE ANGLE (Degree)	RAW VALUE (dBuV)	CORRECTION FACTOR (dB/m)
1	#5647.70	57.37 PK	68.20	-10.83	2.11 H	310	50.76	6.61
2	*5745.00	111.56 PK			2.11 H	310	104.87	6.69
3	*5745.00	100.56 AV			2.11 H	310	93.87	6.69
4	#5962.17	57.57 PK	68.20	-10.63	2.11 H	310	50.39	7.18
5	11490.00	56.15 PK	74.00	-17.85	1.94 H	181	39.25	16.90
6	11490.00	42.71 AV	54.00	-11.29	1.94 H	181	25.81	16.90

**ANTENNA POLARITY & TEST DISTANCE: VERTICAL AT 3 M**

NO.	FREQ. (MHz)	EMISSION LEVEL (dBuV/m)	LIMIT (dBuV/m)	MARGIN (dB)	ANTENNA HEIGHT (m)	TABLE ANGLE (Degree)	RAW VALUE (dBuV)	CORRECTION FACTOR (dB/m)
1	#5651.33	68.03 PK	69.18	-1.15	1.55 V	267	61.41	6.62
2	*5745.00	126.59 PK			1.55 V	267	119.90	6.69
3	*5745.00	114.39 AV			1.55 V	267	107.70	6.69
4	#5925.25	61.86 PK	68.20	-6.34	1.55 V	267	54.84	7.02
5	11490.00	57.53 PK	74.00	-16.47	1.67 V	225	40.63	16.90
6	11490.00	43.74 AV	54.00	-10.26	1.67 V	225	26.84	16.90

**REMARKS:**

1. Emission Level(dBuV/m) = Raw Value(dBuV) + Correction Factor(dB/m)
2. Correction Factor(dB/m) = Antenna Factor(dB/m) + Cable Factor(dB) – Pre-Amplifier Factor(dB)
3. The other emission levels were very low against the limit.
4. Margin value = Emission Level – Limit value
5. " \* ": Fundamental frequency.
6. " # ": The radiated frequency is out of the restricted band.

<b>CHANNEL</b>	TX Channel 157	<b>DETECTOR FUNCTION</b>	Peak (PK)
<b>FREQUENCY RANGE</b>	1GHz ~ 25GHz		Average (AV)

**ANTENNA POLARITY & TEST DISTANCE: HORIZONTAL AT 3 M**

NO.	FREQ. (MHz)	EMISSION LEVEL (dBuV/m)	LIMIT (dBuV/m)	MARGIN (dB)	ANTENNA HEIGHT (m)	TABLE ANGLE (Degree)	RAW VALUE (dBuV)	CORRECTION FACTOR (dB/m)
1	#5644.03	61.37 PK	68.20	-6.83	2.16 H	332	54.75	6.62
2	*5785.00	110.88 PK			2.16 H	332	104.16	6.72
3	*5785.00	100.56 AV			2.16 H	332	93.84	6.72
4	#5927.67	58.19 PK	68.20	-10.01	2.16 H	332	51.17	7.02
5	11570.00	56.30 PK	74.00	-17.70	1.77 H	46	39.51	16.79
6	11570.00	42.63 AV	54.00	-11.37	1.77 H	46	25.84	16.79

**ANTENNA POLARITY & TEST DISTANCE: VERTICAL AT 3 M**

NO.	FREQ. (MHz)	EMISSION LEVEL (dBuV/m)	LIMIT (dBuV/m)	MARGIN (dB)	ANTENNA HEIGHT (m)	TABLE ANGLE (Degree)	RAW VALUE (dBuV)	CORRECTION FACTOR (dB/m)
1	#5651.58	68.05 PK	69.37	-1.32	1.95 V	287	61.43	6.62
2	*5785.00	126.11 PK			1.95 V	287	119.39	6.72
3	*5785.00	115.15 AV			1.95 V	287	108.43	6.72
4	#5924.53	64.24 PK	68.55	-4.31	1.95 V	287	57.22	7.02
5	11570.00	57.30 PK	74.00	-16.70	2.15 V	201	40.51	16.79
6	11570.00	43.53 AV	54.00	-10.47	2.15 V	201	26.74	16.79

**REMARKS:**

1. Emission Level(dBuV/m) = Raw Value(dBuV) + Correction Factor(dB/m)
2. Correction Factor(dB/m) = Antenna Factor(dB/m) + Cable Factor(dB) – Pre-Amplifier Factor(dB)
3. The other emission levels were very low against the limit.
4. Margin value = Emission Level – Limit value
5. " \* ": Fundamental frequency.
6. " # ": The radiated frequency is out of the restricted band.

<b>CHANNEL</b>	TX Channel 165	<b>DETECTOR FUNCTION</b>	Peak (PK)
<b>FREQUENCY RANGE</b>	1GHz ~ 25GHz		Average (AV)

**ANTENNA POLARITY & TEST DISTANCE: HORIZONTAL AT 3 M**

NO.	FREQ. (MHz)	EMISSION LEVEL (dBuV/m)	LIMIT (dBuV/m)	MARGIN (dB)	ANTENNA HEIGHT (m)	TABLE ANGLE (Degree)	RAW VALUE (dBuV)	CORRECTION FACTOR (dB/m)
1	#5647.74	62.15 PK	68.20	-6.05	2.15 H	316	55.54	6.61
2	*5825.00	109.24 PK			2.15 H	316	102.46	6.78
3	*5825.00	98.34 AV			2.15 H	316	91.56	6.78
4	#5969.70	61.80 PK	68.20	-6.40	2.15 H	316	54.59	7.21
5	11650.00	56.12 PK	74.00	-17.88	1.84 H	241	39.36	16.76
6	11650.00	42.40 AV	54.00	-11.60	1.84 H	241	25.64	16.76

**ANTENNA POLARITY & TEST DISTANCE: VERTICAL AT 3 M**

NO.	FREQ. (MHz)	EMISSION LEVEL (dBuV/m)	LIMIT (dBuV/m)	MARGIN (dB)	ANTENNA HEIGHT (m)	TABLE ANGLE (Degree)	RAW VALUE (dBuV)	CORRECTION FACTOR (dB/m)
1	#5639.98	64.43 PK	68.20	-3.77	2.25 V	289	57.82	6.61
2	*5825.00	124.63 PK			2.25 V	289	117.85	6.78
3	*5825.00	112.62 AV			2.25 V	289	105.84	6.78
4	#5960.67	66.74 PK	68.20	-1.46	2.25 V	289	59.57	7.17
5	11650.00	57.27 PK	74.00	-16.73	1.42 V	258	40.51	16.76
6	11650.00	43.61 AV	54.00	-10.39	1.42 V	258	26.85	16.76

**REMARKS:**

1. Emission Level(dBuV/m) = Raw Value(dBuV) + Correction Factor(dB/m)
2. Correction Factor(dB/m) = Antenna Factor(dB/m) + Cable Factor(dB) – Pre-Amplifier Factor(dB)
3. The other emission levels were very low against the limit.
4. Margin value = Emission Level – Limit value
5. " \* ": Fundamental frequency.
6. " # ": The radiated frequency is out of the restricted band.

802.11n (20MHz)

<b>CHANNEL</b>	TX Channel 36	<b>DETECTOR FUNCTION</b>	Peak (PK)
<b>FREQUENCY RANGE</b>	1GHz ~ 25GHz		Average (AV)

**ANTENNA POLARITY & TEST DISTANCE: HORIZONTAL AT 3 M**

NO.	FREQ. (MHz)	EMISSION LEVEL (dBuV/m)	LIMIT (dBuV/m)	MARGIN (dB)	ANTENNA HEIGHT (m)	TABLE ANGLE (Degree)	RAW VALUE (dBuV)	CORRECTION FACTOR (dB/m)
1	5150.00	56.42 PK	74.00	-17.58	1.26 H	29	50.48	5.94
2	5150.00	44.40 AV	54.00	-9.60	1.26 H	29	38.46	5.94
3	*5180.00	103.49 PK			1.26 H	29	97.46	6.03
4	*5180.00	91.29 AV			1.26 H	29	85.26	6.03
5	#10360.00	55.45 PK	74.00	-18.55	1.88 H	157	39.35	16.10
6	#10360.00	41.74 AV	54.00	-12.26	1.88 H	157	25.64	16.10

**ANTENNA POLARITY & TEST DISTANCE: VERTICAL AT 3 M**

NO.	FREQ. (MHz)	EMISSION LEVEL (dBuV/m)	LIMIT (dBuV/m)	MARGIN (dB)	ANTENNA HEIGHT (m)	TABLE ANGLE (Degree)	RAW VALUE (dBuV)	CORRECTION FACTOR (dB/m)
1	5150.00	57.79 PK	74.00	-16.21	1.90 V	24	51.85	5.94
2	5150.00	44.93 AV	54.00	-9.07	1.90 V	24	38.99	5.94
3	*5180.00	113.42 PK			1.90 V	24	107.39	6.03
4	*5180.00	101.93 AV			1.90 V	24	95.90	6.03
5	#10360.00	56.62 PK	74.00	-17.38	1.85 V	210	40.52	16.10
6	#10360.00	42.72 AV	54.00	-11.28	1.85 V	210	26.62	16.10

**REMARKS:**

1. Emission Level(dBuV/m) = Raw Value(dBuV) + Correction Factor(dB/m)
2. Correction Factor(dB/m) = Antenna Factor(dB/m) + Cable Factor(dB) – Pre-Amplifier Factor(dB)
3. The other emission levels were very low against the limit.
4. Margin value = Emission Level – Limit value
5. " \* ": Fundamental frequency.
6. " # ": The radiated frequency is out of the restricted band.

<b>CHANNEL</b>	TX Channel 40	<b>DETECTOR FUNCTION</b>	Peak (PK)
<b>FREQUENCY RANGE</b>	1GHz ~ 25GHz		Average (AV)

**ANTENNA POLARITY & TEST DISTANCE: HORIZONTAL AT 3 M**

NO.	FREQ. (MHz)	EMISSION LEVEL (dBuV/m)	LIMIT (dBuV/m)	MARGIN (dB)	ANTENNA HEIGHT (m)	TABLE ANGLE (Degree)	RAW VALUE (dBuV)	CORRECTION FACTOR (dB/m)
1	*5200.00	103.80 PK			1.26 H	29	98.79	5.01
2	*5200.00	91.97 AV			1.26 H	29	86.96	5.01
3	#10400.00	55.37 PK	74.00	-18.63	1.98 H	284	39.25	16.12
4	#10400.00	41.20 AV	54.00	-12.80	1.98 H	284	25.08	16.12

**ANTENNA POLARITY & TEST DISTANCE: VERTICAL AT 3 M**

NO.	FREQ. (MHz)	EMISSION LEVEL (dBuV/m)	LIMIT (dBuV/m)	MARGIN (dB)	ANTENNA HEIGHT (m)	TABLE ANGLE (Degree)	RAW VALUE (dBuV)	CORRECTION FACTOR (dB/m)
1	*5200.00	113.06 PK			4.00 V	N/A	108.05	5.01
2	*5200.00	101.54 AV			4.00 V	N/A	96.53	5.01
3	#10400.00	56.38 PK	74.00	-17.62	1.62 V	225	40.26	16.12
4	#10400.00	42.96 AV	54.00	-11.04	1.62 V	225	26.84	16.12

**REMARKS:**

1. Emission Level(dBuV/m) = Raw Value(dBuV) + Correction Factor(dB/m)
2. Correction Factor(dB/m) = Antenna Factor(dB/m) + Cable Factor(dB) – Pre-Amplifier Factor(dB)
3. The other emission levels were very low against the limit.
4. Margin value = Emission Level – Limit value
5. " \* ": Fundamental frequency.
6. " # ": The radiated frequency is out of the restricted band.

<b>CHANNEL</b>	TX Channel 48	<b>DETECTOR FUNCTION</b>	Peak (PK)
<b>FREQUENCY RANGE</b>	1GHz ~ 25GHz		Average (AV)

**ANTENNA POLARITY & TEST DISTANCE: HORIZONTAL AT 3 M**

NO.	FREQ. (MHz)	EMISSION LEVEL (dBuV/m)	LIMIT (dBuV/m)	MARGIN (dB)	ANTENNA HEIGHT (m)	TABLE ANGLE (Degree)	RAW VALUE (dBuV)	CORRECTION FACTOR (dB/m)
1	*5240.00	103.71 PK			1.21 H	36	98.54	5.17
2	*5240.00	90.86 AV			1.21 H	36	85.69	5.17
3	5350.00	55.89 PK	74.00	-18.11	1.21 H	36	50.23	5.66
4	5350.00	43.61 AV	54.00	-10.39	1.21 H	36	37.95	5.66
5	#10480.00	55.59 PK	74.00	-18.41	1.87 H	44	39.25	16.34
6	#10480.00	41.50 AV	54.00	-12.50	1.87 H	44	25.16	16.34

**ANTENNA POLARITY & TEST DISTANCE: VERTICAL AT 3 M**

NO.	FREQ. (MHz)	EMISSION LEVEL (dBuV/m)	LIMIT (dBuV/m)	MARGIN (dB)	ANTENNA HEIGHT (m)	TABLE ANGLE (Degree)	RAW VALUE (dBuV)	CORRECTION FACTOR (dB/m)
1	*5240.00	113.27 PK			1.91 V	25	108.10	5.17
2	*5240.00	101.45 AV			1.91 V	25	96.28	5.17
3	5350.00	56.52 PK	74.00	-17.48	1.91 V	25	50.86	5.66
4	5350.00	44.32 AV	54.00	-9.68	1.91 V	25	38.66	5.66
5	#10480.00	56.88 PK	74.00	-17.12	1.87 V	224	40.54	16.34
6	#10480.00	43.15 AV	54.00	-10.85	1.87 V	224	26.81	16.34

**REMARKS:**

1. Emission Level(dBuV/m) = Raw Value(dBuV) + Correction Factor(dB/m)
2. Correction Factor(dB/m) = Antenna Factor(dB/m) + Cable Factor(dB) – Pre-Amplifier Factor(dB)
3. The other emission levels were very low against the limit.
4. Margin value = Emission Level – Limit value
5. " \* ": Fundamental frequency.
6. " # ": The radiated frequency is out of the restricted band.



<b>CHANNEL</b>	TX Channel 149	<b>DETECTOR FUNCTION</b>	Peak (PK)
<b>FREQUENCY RANGE</b>	1GHz ~ 25GHz		Average (AV)

**ANTENNA POLARITY & TEST DISTANCE: HORIZONTAL AT 3 M**

NO.	FREQ. (MHz)	EMISSION LEVEL (dBuV/m)	LIMIT (dBuV/m)	MARGIN (dB)	ANTENNA HEIGHT (m)	TABLE ANGLE (Degree)	RAW VALUE (dBuV)	CORRECTION FACTOR (dB/m)
1	#5646.09	60.14 PK	68.20	-8.06	2.16 H	316	53.53	6.61
2	*5745.00	109.95 PK			2.16 H	316	103.26	6.69
3	*5745.00	100.34 AV			2.16 H	316	93.65	6.69
4	#5948.98	57.57 PK	68.20	-10.63	2.16 H	316	50.45	7.12
5	11490.00	56.26 PK	74.00	-17.74	1.84 H	218	39.36	16.90
6	11490.00	42.74 AV	54.00	-11.26	1.84 H	218	25.84	16.90

**ANTENNA POLARITY & TEST DISTANCE: VERTICAL AT 3 M**

NO.	FREQ. (MHz)	EMISSION LEVEL (dBuV/m)	LIMIT (dBuV/m)	MARGIN (dB)	ANTENNA HEIGHT (m)	TABLE ANGLE (Degree)	RAW VALUE (dBuV)	CORRECTION FACTOR (dB/m)
1	#5652.33	68.86 PK	69.92	-1.06	1.94 V	298	62.25	6.61
2	*5745.00	125.36 PK			2.16 V	298	118.67	6.69
3	*5745.00	114.67 AV			2.16 V	298	107.98	6.69
4	#5938.18	58.95 PK	68.20	-9.25	1.94 V	298	51.88	7.07
5	11490.00	57.30 PK	74.00	-16.70	1.36 V	239	40.40	16.90
6	11490.00	43.15 AV	54.00	-10.85	1.36 V	239	26.25	16.90

**REMARKS:**

1. Emission Level(dBuV/m) = Raw Value(dBuV) + Correction Factor(dB/m)
2. Correction Factor(dB/m) = Antenna Factor(dB/m) + Cable Factor(dB) – Pre-Amplifier Factor(dB)
3. The other emission levels were very low against the limit.
4. Margin value = Emission Level – Limit value
5. " \* ": Fundamental frequency.
6. " # ": The radiated frequency is out of the restricted band.

<b>CHANNEL</b>	TX Channel 157	<b>DETECTOR FUNCTION</b>	Peak (PK)
<b>FREQUENCY RANGE</b>	1GHz ~ 25GHz		Average (AV)

**ANTENNA POLARITY & TEST DISTANCE: HORIZONTAL AT 3 M**

NO.	FREQ. (MHz)	EMISSION LEVEL (dBuV/m)	LIMIT (dBuV/m)	MARGIN (dB)	ANTENNA HEIGHT (m)	TABLE ANGLE (Degree)	RAW VALUE (dBuV)	CORRECTION FACTOR (dB/m)
1	#5645.72	62.68 PK	68.20	-5.52	2.36 H	325	56.07	6.61
2	*5785.00	111.28 PK			1.00 H	325	104.56	6.72
3	*5785.00	101.57 AV			1.00 H	325	94.85	6.72
4	#5934.31	57.69 PK	68.20	-10.51	2.36 H	325	50.64	7.05
5	11570.00	56.10 PK	74.00	-17.90	1.67 H	84	39.31	16.79
6	11570.00	41.85 AV	54.00	-12.15	1.67 H	84	25.06	16.79

**ANTENNA POLARITY & TEST DISTANCE: VERTICAL AT 3 M**

NO.	FREQ. (MHz)	EMISSION LEVEL (dBuV/m)	LIMIT (dBuV/m)	MARGIN (dB)	ANTENNA HEIGHT (m)	TABLE ANGLE (Degree)	RAW VALUE (dBuV)	CORRECTION FACTOR (dB/m)
1	#5647.90	67.14 PK	68.20	-1.06	1.94 V	297	60.53	6.61
2	*5785.00	126.64 PK			1.94 V	297	119.92	6.72
3	*5785.00	115.63 AV			1.94 V	297	108.91	6.72
4	#5931.99	62.66 PK	68.20	-5.54	1.94 V	297	55.61	7.05
5	11570.00	57.73 PK	74.00	-16.27	1.45 V	88	40.94	16.79
6	11570.00	43.46 AV	54.00	-10.54	1.45 V	88	26.67	16.79

**REMARKS:**

1. Emission Level(dBuV/m) = Raw Value(dBuV) + Correction Factor(dB/m)
2. Correction Factor(dB/m) = Antenna Factor(dB/m) + Cable Factor(dB) – Pre-Amplifier Factor(dB)
3. The other emission levels were very low against the limit.
4. Margin value = Emission Level – Limit value
5. " \* ": Fundamental frequency.
6. " # ": The radiated frequency is out of the restricted band.

<b>CHANNEL</b>	TX Channel 165	<b>DETECTOR FUNCTION</b>	Peak (PK)
<b>FREQUENCY RANGE</b>	1GHz ~ 25GHz		Average (AV)

**ANTENNA POLARITY & TEST DISTANCE: HORIZONTAL AT 3 M**

NO.	FREQ. (MHz)	EMISSION LEVEL (dBuV/m)	LIMIT (dBuV/m)	MARGIN (dB)	ANTENNA HEIGHT (m)	TABLE ANGLE (Degree)	RAW VALUE (dBuV)	CORRECTION FACTOR (dB/m)
1	#5648.82	57.85 PK	68.20	-10.35	2.31 H	330	51.24	6.61
2	*5825.00	109.36 PK			2.31 H	330	102.58	6.78
3	*5825.00	98.44 AV			2.31 H	330	91.66	6.78
4	#5963.33	59.79 PK	68.20	-8.41	2.31 H	330	52.61	7.18
5	11650.00	56.02 PK	74.00	-17.98	1.82 H	225	39.26	16.76
6	11650.00	42.41 AV	54.00	-11.59	1.82 H	225	25.65	16.76

**ANTENNA POLARITY & TEST DISTANCE: VERTICAL AT 3 M**

NO.	FREQ. (MHz)	EMISSION LEVEL (dBuV/m)	LIMIT (dBuV/m)	MARGIN (dB)	ANTENNA HEIGHT (m)	TABLE ANGLE (Degree)	RAW VALUE (dBuV)	CORRECTION FACTOR (dB/m)
1	#5649.31	66.74 PK	68.20	-1.46	2.16 V	297	60.13	6.61
2	*5825.00	124.16 PK			2.16 V	297	117.38	6.78
3	*5825.00	113.37 AV			2.16 V	297	106.59	6.78
4	#5961.96	63.93 PK	68.20	-4.27	2.16 V	297	56.75	7.18
5	11650.00	57.60 PK	74.00	-16.40	1.23 V	214	40.84	16.76
6	11650.00	43.27 AV	54.00	-10.73	1.23 V	214	26.51	16.76

**REMARKS:**

1. Emission Level(dBuV/m) = Raw Value(dBuV) + Correction Factor(dB/m)
2. Correction Factor(dB/m) = Antenna Factor(dB/m) + Cable Factor(dB) – Pre-Amplifier Factor(dB)
3. The other emission levels were very low against the limit.
4. Margin value = Emission Level – Limit value
5. " \* ": Fundamental frequency.
6. " # ": The radiated frequency is out of the restricted band.

802.11n (40MHz)

<b>CHANNEL</b>	TX Channel 38	<b>DETECTOR FUNCTION</b>	Peak (PK)
<b>FREQUENCY RANGE</b>	1GHz ~ 25GHz		Average (AV)

**ANTENNA POLARITY & TEST DISTANCE: HORIZONTAL AT 3 M**

NO.	FREQ. (MHz)	EMISSION LEVEL (dBuV/m)	LIMIT (dBuV/m)	MARGIN (dB)	ANTENNA HEIGHT (m)	TABLE ANGLE (Degree)	RAW VALUE (dBuV)	CORRECTION FACTOR (dB/m)
1	5150.00	57.14 PK	74.00	-16.86	1.28 H	51	52.26	4.88
2	5150.00	45.14 AV	54.00	-8.86	1.28 H	51	40.26	4.88
3	*5190.00	100.24 PK			1.28 H	51	95.26	4.98
4	*5190.00	89.44 AV			1.28 H	51	84.46	4.98
5	#10380.00	55.68 PK	74.00	-18.32	1.57 H	114	39.64	16.04
6	#10380.00	41.43 AV	54.00	-12.57	1.57 H	114	25.39	16.04

**ANTENNA POLARITY & TEST DISTANCE: VERTICAL AT 3 M**

NO.	FREQ. (MHz)	EMISSION LEVEL (dBuV/m)	LIMIT (dBuV/m)	MARGIN (dB)	ANTENNA HEIGHT (m)	TABLE ANGLE (Degree)	RAW VALUE (dBuV)	CORRECTION FACTOR (dB/m)
1	5150.00	60.01 PK	74.00	-13.99	1.66 V	326	55.13	4.88
2	5150.00	47.12 AV	54.00	-6.88	1.66 V	326	42.24	4.88
3	*5190.00	109.19 PK			1.66 V	326	104.21	4.98
4	*5190.00	98.62 AV			1.66 V	326	93.64	4.98
5	#10380.00	56.55 PK	74.00	-17.45	1.52 V	122	40.51	16.04
6	#10380.00	42.36 AV	54.00	-11.64	1.52 V	122	26.32	16.04

**REMARKS:**

1. Emission Level(dBuV/m) = Raw Value(dBuV) + Correction Factor(dB/m)
2. Correction Factor(dB/m) = Antenna Factor(dB/m) + Cable Factor(dB) – Pre-Amplifier Factor(dB)
3. The other emission levels were very low against the limit.
4. Margin value = Emission Level – Limit value
5. " \* ": Fundamental frequency.
6. " # ": The radiated frequency is out of the restricted band.

<b>CHANNEL</b>	TX Channel 46	<b>DETECTOR FUNCTION</b>	Peak (PK)
<b>FREQUENCY RANGE</b>	1GHz ~ 25GHz		Average (AV)

**ANTENNA POLARITY & TEST DISTANCE: HORIZONTAL AT 3 M**

NO.	FREQ. (MHz)	EMISSION LEVEL (dBuV/m)	LIMIT (dBuV/m)	MARGIN (dB)	ANTENNA HEIGHT (m)	TABLE ANGLE (Degree)	RAW VALUE (dBuV)	CORRECTION FACTOR (dB/m)
1	*5230.00	101.71 PK			1.24 H	56	96.58	5.13
2	*5230.00	90.57 AV			1.24 H	56	85.44	5.13
3	5350.00	55.68 PK	74.00	-18.32	1.24 H	56	50.02	5.66
4	5350.00	43.79 AV	54.00	-10.21	1.24 H	56	38.13	5.66
5	#10460.00	55.76 PK	74.00	-18.24	1.88 H	145	39.48	16.28
6	#10460.00	42.09 AV	54.00	-11.91	1.88 H	145	25.81	16.28

**ANTENNA POLARITY & TEST DISTANCE: VERTICAL AT 3 M**

NO.	FREQ. (MHz)	EMISSION LEVEL (dBuV/m)	LIMIT (dBuV/m)	MARGIN (dB)	ANTENNA HEIGHT (m)	TABLE ANGLE (Degree)	RAW VALUE (dBuV)	CORRECTION FACTOR (dB/m)
1	*5230.00	110.68 PK			1.77 V	301	105.55	5.13
2	*5230.00	99.58 AV			1.77 V	301	94.45	5.13
3	5350.00	56.45 PK	74.00	-17.55	1.77 V	301	50.79	5.66
4	5350.00	44.12 AV	54.00	-9.88	1.77 V	301	38.46	5.66
5	#10460.00	56.79 PK	74.00	-17.21	1.55 V	220	40.51	16.28
6	#10460.00	42.79 AV	54.00	-11.21	1.55 V	220	26.51	16.28

**REMARKS:**

1. Emission Level(dBuV/m) = Raw Value(dBuV) + Correction Factor(dB/m)
2. Correction Factor(dB/m) = Antenna Factor(dB/m) + Cable Factor(dB) – Pre-Amplifier Factor(dB)
3. The other emission levels were very low against the limit.
4. Margin value = Emission Level – Limit value
5. " \* ": Fundamental frequency.
6. " # ": The radiated frequency is out of the restricted band.

<b>CHANNEL</b>	TX Channel 151	<b>DETECTOR FUNCTION</b>	Peak (PK)
<b>FREQUENCY RANGE</b>	1GHz ~ 25GHz		Average (AV)

**ANTENNA POLARITY & TEST DISTANCE: HORIZONTAL AT 3 M**

NO.	FREQ. (MHz)	EMISSION LEVEL (dBuV/m)	LIMIT (dBuV/m)	MARGIN (dB)	ANTENNA HEIGHT (m)	TABLE ANGLE (Degree)	RAW VALUE (dBuV)	CORRECTION FACTOR (dB/m)
1	#5644.90	58.67 PK	68.20	-9.53	2.34 H	347	52.06	6.61
2	*5755.00	110.06 PK			2.34 H	347	103.36	6.70
3	*5755.00	98.86 AV			2.34 H	347	92.16	6.70
4	#5935.06	57.60 PK	68.20	-10.60	2.34 H	347	50.53	7.07
5	11510.00	56.19 PK	74.00	-17.81	1.56 H	22	39.32	16.87
6	11510.00	41.93 AV	54.00	-12.07	1.56 H	22	25.06	16.87

**ANTENNA POLARITY & TEST DISTANCE: VERTICAL AT 3 M**

NO.	FREQ. (MHz)	EMISSION LEVEL (dBuV/m)	LIMIT (dBuV/m)	MARGIN (dB)	ANTENNA HEIGHT (m)	TABLE ANGLE (Degree)	RAW VALUE (dBuV)	CORRECTION FACTOR (dB/m)
1	#5649.88	67.17 PK	68.20	-1.03	2.20 V	297	60.56	6.61
2	*5755.00	122.30 PK			2.20 V	297	115.60	6.70
3	*5755.00	111.78 AV			2.20 V	297	105.08	6.70
4	#5924.13	62.81 PK	68.84	-6.03	2.20 V	297	55.80	7.01
5	11510.00	57.38 PK	74.00	-16.62	2.15 V	196	40.51	16.87
6	11510.00	43.51 AV	54.00	-10.49	2.15 V	196	26.64	16.87

**REMARKS:**

1. Emission Level(dBuV/m) = Raw Value(dBuV) + Correction Factor(dB/m)
2. Correction Factor(dB/m) = Antenna Factor(dB/m) + Cable Factor(dB) – Pre-Amplifier Factor(dB)
3. The other emission levels were very low against the limit.
4. Margin value = Emission Level – Limit value
5. " \* ": Fundamental frequency.
6. " # ": The radiated frequency is out of the restricted band.

<b>CHANNEL</b>	TX Channel 159	<b>DETECTOR FUNCTION</b>	Peak (PK)
<b>FREQUENCY RANGE</b>	1GHz ~ 25GHz		Average (AV)

**ANTENNA POLARITY & TEST DISTANCE: HORIZONTAL AT 3 M**

NO.	FREQ. (MHz)	EMISSION LEVEL (dBuV/m)	LIMIT (dBuV/m)	MARGIN (dB)	ANTENNA HEIGHT (m)	TABLE ANGLE (Degree)	RAW VALUE (dBuV)	CORRECTION FACTOR (dB/m)
1	#5640.73	57.32 PK	68.20	-10.88	2.25 H	336	50.72	6.60
2	*5795.00	109.29 PK			2.25 H	336	102.56	6.73
3	*5795.00	99.38 AV			2.25 H	336	92.65	6.73
4	#5938.09	59.24 PK	68.20	-8.96	2.25 H	336	52.17	7.07
5	11590.00	56.64 PK	74.00	-17.36	1.86 H	239	39.89	16.75
6	11590.00	42.45 AV	54.00	-11.55	1.86 H	239	25.70	16.75

**ANTENNA POLARITY & TEST DISTANCE: VERTICAL AT 3 M**

NO.	FREQ. (MHz)	EMISSION LEVEL (dBuV/m)	LIMIT (dBuV/m)	MARGIN (dB)	ANTENNA HEIGHT (m)	TABLE ANGLE (Degree)	RAW VALUE (dBuV)	CORRECTION FACTOR (dB/m)
1	#5646.29	66.99 PK	68.20	-1.21	2.18 V	296	60.38	6.61
2	*5795.00	122.10 PK			2.18 V	296	115.37	6.73
3	*5795.00	112.09 AV			2.18 V	296	105.36	6.73
4	#5949.37	64.26 PK	68.20	-3.94	2.18 V	296	57.14	7.12
5	11590.00	57.00 PK	74.00	-17.00	1.44 V	251	40.25	16.75
6	11590.00	43.07 AV	54.00	-10.93	1.44 V	251	26.32	16.75

**REMARKS:**

1. Emission Level(dBuV/m) = Raw Value(dBuV) + Correction Factor(dB/m)
2. Correction Factor(dB/m) = Antenna Factor(dB/m) + Cable Factor(dB) – Pre-Amplifier Factor(dB)
3. The other emission levels were very low against the limit.
4. Margin value = Emission Level – Limit value
5. " \* ": Fundamental frequency.
6. " # ": The radiated frequency is out of the restricted band.

802.11ac (80MHz)

<b>CHANNEL</b>	TX Channel 42	<b>DETECTOR FUNCTION</b>	Peak (PK)
<b>FREQUENCY RANGE</b>	1GHz ~ 25GHz		Average (AV)

**ANTENNA POLARITY & TEST DISTANCE: HORIZONTAL AT 3 M**

NO.	FREQ. (MHz)	EMISSION LEVEL (dBuV/m)	LIMIT (dBuV/m)	MARGIN (dB)	ANTENNA HEIGHT (m)	TABLE ANGLE (Degree)	RAW VALUE (dBuV)	CORRECTION FACTOR (dB/m)
1	5150.00	57.14 PK	74.00	-16.86	1.32 H	35	52.26	4.88
2	5150.00	45.04 AV	54.00	-8.96	1.32 H	35	40.16	4.88
3	*5210.00	98.61 PK			1.32 H	35	93.56	5.05
4	*5210.00	86.50 AV			1.32 H	35	81.45	5.05
5	5350.00	55.92 PK	74.00	-18.08	1.32 H	35	50.26	5.66
6	5350.00	42.68 AV	54.00	-11.32	1.32 H	35	37.02	5.66
7	#10420.00	55.43 PK	74.00	-18.57	1.25 H	336	39.25	16.18
8	#10420.00	41.34 AV	54.00	-12.66	1.25 H	336	25.16	16.18

**ANTENNA POLARITY & TEST DISTANCE: VERTICAL AT 3 M**

NO.	FREQ. (MHz)	EMISSION LEVEL (dBuV/m)	LIMIT (dBuV/m)	MARGIN (dB)	ANTENNA HEIGHT (m)	TABLE ANGLE (Degree)	RAW VALUE (dBuV)	CORRECTION FACTOR (dB/m)
1	5150.00	60.09 PK	74.00	-13.91	1.81 V	300	55.21	4.88
2	5150.00	45.90 AV	54.00	-8.10	1.81 V	300	41.02	4.88
3	*5210.00	107.07 PK			1.81 V	300	102.02	5.05
4	*5210.00	95.94 AV			1.81 V	300	90.89	5.05
5	5350.00	56.78 PK	74.00	-17.22	1.81 V	300	51.12	5.66
6	5350.00	43.18 AV	54.00	-10.82	1.81 V	300	37.52	5.66
7	#10420.00	56.84 PK	74.00	-17.16	1.84 V	154	40.66	16.18
8	#10420.00	43.03 AV	54.00	-10.97	1.84 V	154	26.85	16.18

**REMARKS:**

1. Emission Level(dBuV/m) = Raw Value(dBuV) + Correction Factor(dB/m)
2. Correction Factor(dB/m) = Antenna Factor(dB/m) + Cable Factor(dB) – Pre-Amplifier Factor(dB)
3. The other emission levels were very low against the limit.
4. Margin value = Emission Level – Limit value
5. " \* ": Fundamental frequency.
6. " # ": The radiated frequency is out of the restricted band.



<b>CHANNEL</b>	TX Channel 155	<b>DETECTOR FUNCTION</b>	Peak (PK)
<b>FREQUENCY RANGE</b>	1GHz ~ 25GHz		Average (AV)

**ANTENNA POLARITY & TEST DISTANCE: HORIZONTAL AT 3 M**

NO.	FREQ. (MHz)	EMISSION LEVEL (dBuV/m)	LIMIT (dBuV/m)	MARGIN (dB)	ANTENNA HEIGHT (m)	TABLE ANGLE (Degree)	RAW VALUE (dBuV)	CORRECTION FACTOR (dB/m)
1	#5630.00	58.80 PK	68.20	-9.40	2.11 H	352	52.20	6.60
2	*5775.00	109.28 PK			2.11 H	352	102.56	6.72
3	*5775.00	98.83 AV			2.11 H	352	92.11	6.72
4	#5936.85	58.74 PK	68.20	-9.46	2.11 H	352	51.67	7.07
5	11550.00	56.65 PK	74.00	-17.35	1.88 H	294	39.84	16.81
6	11550.00	42.57 AV	54.00	-11.43	1.88 H	294	25.76	16.81

**ANTENNA POLARITY & TEST DISTANCE: VERTICAL AT 3 M**

NO.	FREQ. (MHz)	EMISSION LEVEL (dBuV/m)	LIMIT (dBuV/m)	MARGIN (dB)	ANTENNA HEIGHT (m)	TABLE ANGLE (Degree)	RAW VALUE (dBuV)	CORRECTION FACTOR (dB/m)
1	#5647.17	66.64 PK	68.20	-1.56	2.19 V	297	60.03	6.61
2	*5775.00	115.70 PK			2.19 V	297	108.98	6.72
3	*5775.00	105.43 AV			2.19 V	297	98.71	6.72
4	#5935.02	62.20 PK	68.20	-6.00	2.19 V	297	55.13	7.07
5	11550.00	57.45 PK	74.00	-16.55	1.69 V	285	40.64	16.81
6	11550.00	43.68 AV	54.00	-10.32	1.69 V	285	26.87	16.81

**REMARKS:**

1. Emission Level(dBuV/m) = Raw Value(dBuV) + Correction Factor(dB/m)
2. Correction Factor(dB/m) = Antenna Factor(dB/m) + Cable Factor(dB) – Pre-Amplifier Factor(dB)
3. The other emission levels were very low against the limit.
4. Margin value = Emission Level – Limit value
5. " \* ": Fundamental frequency.
6. " # ": The radiated frequency is out of the restricted band.

**Beamforming\_NSS1 Mode (Mode A)**

**802.11ac (20MHz)**

<b>CHANNEL</b>	TX Channel 36	<b>DETECTOR FUNCTION</b>	Peak (PK)
<b>FREQUENCY RANGE</b>	1GHz ~ 40GHz		Average (AV)

**ANTENNA POLARITY & TEST DISTANCE: HORIZONTAL AT 3 M**

NO.	FREQ. (MHz)	EMISSION LEVEL (dBuV/m)	LIMIT (dBuV/m)	MARGIN (dB)	ANTENNA HEIGHT (m)	TABLE ANGLE (Degree)	RAW VALUE (dBuV)	CORRECTION FACTOR (dB/m)
1	5150.00	63.55 PK	74.00	-10.45	1.19 H	294	58.64	4.91
2	5150.00	44.62 AV	54.00	-9.38	1.19 H	294	39.71	4.91
3	*5180.00	112.83 PK			1.19 H	294	107.89	4.94
4	*5180.00	100.71 AV			1.19 H	294	95.77	4.94
5	#10360.00	55.20 PK	74.00	-18.80	1.95 H	268	39.67	15.53
6	#10360.00	41.19 AV	54.00	-12.81	1.95 H	268	25.66	15.53

**ANTENNA POLARITY & TEST DISTANCE: VERTICAL AT 3 M**

NO.	FREQ. (MHz)	EMISSION LEVEL (dBuV/m)	LIMIT (dBuV/m)	MARGIN (dB)	ANTENNA HEIGHT (m)	TABLE ANGLE (Degree)	RAW VALUE (dBuV)	CORRECTION FACTOR (dB/m)
1	5150.00	71.40 PK	74.00	-2.60	1.64 V	231	66.49	4.91
2	5150.00	50.90 AV	54.00	-3.10	1.64 V	231	45.99	4.91
3	*5180.00	113.75 PK			1.64 V	231	108.81	4.94
4	*5180.00	101.82 AV			1.64 V	231	96.88	4.94
5	#10360.00	56.42 PK	74.00	-17.58	1.67 V	254	40.89	15.53
6	#10360.00	42.41 AV	54.00	-11.59	1.67 V	254	26.88	15.53

**REMARKS:**

1. Emission Level(dBuV/m) = Raw Value(dBuV) + Correction Factor(dB/m)
2. Correction Factor(dB/m) = Antenna Factor(dB/m) + Cable Factor(dB) – Pre-Amplifier Factor(dB)
3. The other emission levels were very low against the limit.
4. Margin value = Emission Level – Limit value
5. " \* ": Fundamental frequency.
6. " # ": The radiated frequency is out of the restricted band.

<b>CHANNEL</b>	TX Channel 40	<b>DETECTOR FUNCTION</b>	Peak (PK)
<b>FREQUENCY RANGE</b>	1GHz ~ 40GHz		Average (AV)

**ANTENNA POLARITY & TEST DISTANCE: HORIZONTAL AT 3 M**

NO.	FREQ. (MHz)	EMISSION LEVEL (dBuV/m)	LIMIT (dBuV/m)	MARGIN (dB)	ANTENNA HEIGHT (m)	TABLE ANGLE (Degree)	RAW VALUE (dBuV)	CORRECTION FACTOR (dB/m)
1	*5200.00	112.45 PK			1.00 H	306	107.48	4.97
2	*5200.00	101.32 AV			1.00 H	306	96.35	4.97
3	#10400.00	54.93 PK	74.00	-19.07	1.55 H	202	39.35	15.58
4	#10400.00	41.39 AV	54.00	-12.61	1.55 H	202	25.81	15.58

**ANTENNA POLARITY & TEST DISTANCE: VERTICAL AT 3 M**

NO.	FREQ. (MHz)	EMISSION LEVEL (dBuV/m)	LIMIT (dBuV/m)	MARGIN (dB)	ANTENNA HEIGHT (m)	TABLE ANGLE (Degree)	RAW VALUE (dBuV)	CORRECTION FACTOR (dB/m)
1	*5200.00	113.84 PK			1.64 V	243	108.87	4.97
2	*5200.00	102.34 AV			1.64 V	243	97.37	4.97
3	#10400.00	55.94 PK	74.00	-18.06	1.64 V	243	40.36	15.58
4	#10400.00	42.43 AV	54.00	-11.57	1.64 V	243	26.85	15.58

**REMARKS:**

1. Emission Level(dBuV/m) = Raw Value(dBuV) + Correction Factor(dB/m)
2. Correction Factor(dB/m) = Antenna Factor(dB/m) + Cable Factor(dB) – Pre-Amplifier Factor(dB)
3. The other emission levels were very low against the limit.
4. Margin value = Emission Level – Limit value
5. " \* ": Fundamental frequency.
6. " # ": The radiated frequency is out of the restricted band.

<b>CHANNEL</b>	TX Channel 48	<b>DETECTOR FUNCTION</b>	Peak (PK)
<b>FREQUENCY RANGE</b>	1GHz ~ 40GHz		Average (AV)

**ANTENNA POLARITY & TEST DISTANCE: HORIZONTAL AT 3 M**

NO.	FREQ. (MHz)	EMISSION LEVEL (dBuV/m)	LIMIT (dBuV/m)	MARGIN (dB)	ANTENNA HEIGHT (m)	TABLE ANGLE (Degree)	RAW VALUE (dBuV)	CORRECTION FACTOR (dB/m)
1	*5240.00	113.68 PK			1.23 H	288	108.64	5.04
2	*5240.00	102.93 AV			1.23 H	288	97.89	5.04
3	5350.00	55.91 PK	74.00	-18.09	1.23 H	288	50.56	5.35
4	5350.00	41.68 AV	54.00	-12.32	1.23 H	288	36.33	5.35
5	#10480.00	55.12 PK	74.00	-18.88	1.67 H	145	39.36	15.76
6	#10480.00	41.71 AV	54.00	-12.29	1.67 H	145	25.95	15.76

**ANTENNA POLARITY & TEST DISTANCE: VERTICAL AT 3 M**

NO.	FREQ. (MHz)	EMISSION LEVEL (dBuV/m)	LIMIT (dBuV/m)	MARGIN (dB)	ANTENNA HEIGHT (m)	TABLE ANGLE (Degree)	RAW VALUE (dBuV)	CORRECTION FACTOR (dB/m)
1	*5240.00	114.47 PK			1.70 V	242	109.43	5.04
2	*5240.00	103.76 AV			1.70 V	242	98.72	5.04
3	5350.00	56.42 PK	74.00	-17.58	1.70 V	242	51.07	5.35
4	5350.00	42.28 AV	54.00	-11.72	1.70 V	242	36.93	5.35
5	#10480.00	56.43 PK	74.00	-17.57	1.68 V	36	40.67	15.76
6	#10480.00	42.64 AV	54.00	-11.36	1.68 V	36	26.88	15.76

**REMARKS:**

1. Emission Level(dBuV/m) = Raw Value(dBuV) + Correction Factor(dB/m)
2. Correction Factor(dB/m) = Antenna Factor(dB/m) + Cable Factor(dB) – Pre-Amplifier Factor(dB)
3. The other emission levels were very low against the limit.
4. Margin value = Emission Level – Limit value
5. " \* ": Fundamental frequency.
6. " # ": The radiated frequency is out of the restricted band.

<b>CHANNEL</b>	TX Channel 149	<b>DETECTOR FUNCTION</b>	Peak (PK)
<b>FREQUENCY RANGE</b>	1GHz ~ 40GHz		Average (AV)

**ANTENNA POLARITY & TEST DISTANCE: HORIZONTAL AT 3 M**

NO.	FREQ. (MHz)	EMISSION LEVEL (dBuV/m)	LIMIT (dBuV/m)	MARGIN (dB)	ANTENNA HEIGHT (m)	TABLE ANGLE (Degree)	RAW VALUE (dBuV)	CORRECTION FACTOR (dB/m)
1	#5604.36	61.23 PK	68.20	-6.97	1.65 H	207	54.65	6.58
2	*5745.00	118.96 PK			1.65 H	207	112.27	6.69
3	*5745.00	103.25 AV			1.65 H	207	96.56	6.69
4	#5944.06	57.02 PK	68.20	-11.18	1.65 H	207	49.92	7.10
5	11490.00	58.16 PK	74.00	-15.84	1.63 H	183	41.26	16.90
6	11490.00	44.34 AV	54.00	-9.66	1.63 H	183	27.44	16.90

**ANTENNA POLARITY & TEST DISTANCE: VERTICAL AT 3 M**

NO.	FREQ. (MHz)	EMISSION LEVEL (dBuV/m)	LIMIT (dBuV/m)	MARGIN (dB)	ANTENNA HEIGHT (m)	TABLE ANGLE (Degree)	RAW VALUE (dBuV)	CORRECTION FACTOR (dB/m)
1	#5630.60	58.78 PK	68.20	-9.42	3.99 V	244	52.18	6.60
2	*5745.00	116.64 PK			3.99 V	244	109.95	6.69
3	*5745.00	98.74 AV			3.99 V	244	92.05	6.69
4	#5967.30	56.65 PK	68.20	-11.55	3.99 V	244	49.45	7.20
5	11490.00	57.06 PK	74.00	-16.94	2.15 V	221	40.16	16.90
6	11490.00	43.28 AV	54.00	-10.72	2.15 V	221	26.38	16.90

**REMARKS:**

1. Emission Level(dBuV/m) = Raw Value(dBuV) + Correction Factor(dB/m)
2. Correction Factor(dB/m) = Antenna Factor(dB/m) + Cable Factor(dB) – Pre-Amplifier Factor(dB)
3. The other emission levels were very low against the limit.
4. Margin value = Emission Level – Limit value
5. " \* ": Fundamental frequency.
6. " # ": The radiated frequency is out of the restricted band.

<b>CHANNEL</b>	TX Channel 157	<b>DETECTOR FUNCTION</b>	Peak (PK)
<b>FREQUENCY RANGE</b>	1GHz ~ 40GHz		Average (AV)

**ANTENNA POLARITY & TEST DISTANCE: HORIZONTAL AT 3 M**

NO.	FREQ. (MHz)	EMISSION LEVEL (dBuV/m)	LIMIT (dBuV/m)	MARGIN (dB)	ANTENNA HEIGHT (m)	TABLE ANGLE (Degree)	RAW VALUE (dBuV)	CORRECTION FACTOR (dB/m)
1	#5643.75	61.71 PK	68.20	-6.49	1.59 H	216	55.09	6.62
2	*5785.00	119.13 PK			1.59 H	216	112.41	6.72
3	*5785.00	103.10 AV			1.59 H	216	96.38	6.72
4	#5938.78	58.94 PK	68.20	-9.26	1.59 H	216	51.87	7.07
5	11570.00	57.31 PK	74.00	-16.69	1.47 H	203	40.52	16.79
6	11570.00	43.77 AV	54.00	-10.23	1.47 H	203	26.98	16.79

**ANTENNA POLARITY & TEST DISTANCE: VERTICAL AT 3 M**

NO.	FREQ. (MHz)	EMISSION LEVEL (dBuV/m)	LIMIT (dBuV/m)	MARGIN (dB)	ANTENNA HEIGHT (m)	TABLE ANGLE (Degree)	RAW VALUE (dBuV)	CORRECTION FACTOR (dB/m)
1	#5635.02	57.19 PK	68.20	-11.01	3.97 V	252	50.59	6.60
2	*5785.00	116.08 PK			3.97 V	252	109.36	6.72
3	*5785.00	98.84 AV			3.97 V	252	92.12	6.72
4	#5957.34	56.00 PK	68.20	-12.20	3.97 V	252	48.84	7.16
5	11570.00	56.13 PK	74.00	-17.87	1.24 V	134	39.34	16.79
6	11570.00	42.63 AV	54.00	-11.37	1.24 V	134	25.84	16.79

**REMARKS:**

1. Emission Level(dBuV/m) = Raw Value(dBuV) + Correction Factor(dB/m)
2. Correction Factor(dB/m) = Antenna Factor(dB/m) + Cable Factor(dB) – Pre-Amplifier Factor(dB)
3. The other emission levels were very low against the limit.
4. Margin value = Emission Level – Limit value
5. " \* ": Fundamental frequency.
6. " # ": The radiated frequency is out of the restricted band.

<b>CHANNEL</b>	TX Channel 165	<b>DETECTOR FUNCTION</b>	Peak (PK)
<b>FREQUENCY RANGE</b>	1GHz ~ 40GHz		Average (AV)

**ANTENNA POLARITY & TEST DISTANCE: HORIZONTAL AT 3 M**

NO.	FREQ. (MHz)	EMISSION LEVEL (dBuV/m)	LIMIT (dBuV/m)	MARGIN (dB)	ANTENNA HEIGHT (m)	TABLE ANGLE (Degree)	RAW VALUE (dBuV)	CORRECTION FACTOR (dB/m)
1	#5627.65	57.90 PK	68.20	-10.30	1.69 H	219	51.30	6.60
2	*5825.00	118.66 PK			1.69 H	219	111.88	6.78
3	*5825.00	102.67 AV			1.69 H	219	95.89	6.78
4	#5969.64	60.63 PK	68.20	-7.57	1.69 H	219	53.42	7.21
5	11650.00	57.43 PK	74.00	-16.57	1.48 H	169	40.67	16.76
6	11650.00	43.09 AV	54.00	-10.91	1.48 H	169	26.33	16.76

**ANTENNA POLARITY & TEST DISTANCE: VERTICAL AT 3 M**

NO.	FREQ. (MHz)	EMISSION LEVEL (dBuV/m)	LIMIT (dBuV/m)	MARGIN (dB)	ANTENNA HEIGHT (m)	TABLE ANGLE (Degree)	RAW VALUE (dBuV)	CORRECTION FACTOR (dB/m)
1	#5648.59	57.57 PK	68.20	-10.63	3.88 V	254	50.96	6.61
2	*5825.00	115.67 PK			3.88 V	254	108.89	6.78
3	*5825.00	98.67 AV			3.88 V	254	91.89	6.78
4	#5943.35	57.30 PK	68.20	-10.90	3.88 V	254	50.21	7.09
5	11650.00	56.12 PK	74.00	-17.88	1.39 V	103	39.36	16.76
6	11650.00	42.58 AV	54.00	-11.42	1.39 V	103	25.82	16.76

**REMARKS:**

1. Emission Level(dBuV/m) = Raw Value(dBuV) + Correction Factor(dB/m)
2. Correction Factor(dB/m) = Antenna Factor(dB/m) + Cable Factor(dB) – Pre-Amplifier Factor(dB)
3. The other emission levels were very low against the limit.
4. Margin value = Emission Level – Limit value
5. " \* ": Fundamental frequency.
6. " # ": The radiated frequency is out of the restricted band.

**802.11ac (40MHz)**

<b>CHANNEL</b>	TX Channel 38	<b>DETECTOR FUNCTION</b>	Peak (PK)
<b>FREQUENCY RANGE</b>	1GHz ~ 40GHz		Average (AV)

**ANTENNA POLARITY & TEST DISTANCE: HORIZONTAL AT 3 M**

NO.	FREQ. (MHz)	EMISSION LEVEL (dBuV/m)	LIMIT (dBuV/m)	MARGIN (dB)	ANTENNA HEIGHT (m)	TABLE ANGLE (Degree)	RAW VALUE (dBuV)	CORRECTION FACTOR (dB/m)
1	5150.00	68.17 PK	74.00	-5.83	1.78 H	201	63.26	4.91
2	5150.00	44.60 AV	54.00	-9.40	1.78 H	201	39.69	4.91
3	*5190.00	111.22 PK			1.78 H	201	106.26	4.96
4	*5190.00	95.84 AV			1.78 H	201	90.88	4.96
5	#10380.00	55.18 PK	74.00	-18.82	2.14 H	221	39.62	15.56
6	#10380.00	41.40 AV	54.00	-12.60	2.14 H	221	25.84	15.56

**ANTENNA POLARITY & TEST DISTANCE: VERTICAL AT 3 M**

NO.	FREQ. (MHz)	EMISSION LEVEL (dBuV/m)	LIMIT (dBuV/m)	MARGIN (dB)	ANTENNA HEIGHT (m)	TABLE ANGLE (Degree)	RAW VALUE (dBuV)	CORRECTION FACTOR (dB/m)
1	5150.00	72.83 PK	74.00	-1.17	1.50 V	242	67.92	4.91
2	5150.00	47.01 AV	54.00	-6.99	1.50 V	242	42.10	4.91
3	*5190.00	112.23 PK			1.50 V	242	107.27	4.96
4	*5190.00	96.32 AV			1.50 V	242	91.36	4.96
5	#10380.00	56.14 PK	74.00	-17.86	1.69 V	221	40.58	15.56
6	#10380.00	42.41 AV	54.00	-11.59	1.69 V	221	26.85	15.56

**REMARKS:**

1. Emission Level(dBuV/m) = Raw Value(dBuV) + Correction Factor(dB/m)
2. Correction Factor(dB/m) = Antenna Factor(dB/m) + Cable Factor(dB) – Pre-Amplifier Factor(dB)
3. The other emission levels were very low against the limit.
4. Margin value = Emission Level – Limit value
5. " \* ": Fundamental frequency.
6. " # ": The radiated frequency is out of the restricted band.



<b>CHANNEL</b>	TX Channel 46	<b>DETECTOR FUNCTION</b>	Peak (PK)
<b>FREQUENCY RANGE</b>	1GHz ~ 40GHz		Average (AV)

**ANTENNA POLARITY & TEST DISTANCE: HORIZONTAL AT 3 M**

NO.	FREQ. (MHz)	EMISSION LEVEL (dBuV/m)	LIMIT (dBuV/m)	MARGIN (dB)	ANTENNA HEIGHT (m)	TABLE ANGLE (Degree)	RAW VALUE (dBuV)	CORRECTION FACTOR (dB/m)
1	*5230.00	111.66 PK			1.42 H	239	106.64	5.02
2	*5230.00	95.56 AV			1.42 H	239	90.54	5.02
3	5350.00	55.04 PK	74.00	-18.96	1.42 H	239	49.69	5.35
4	5350.00	41.70 AV	54.00	-12.30	1.42 H	239	36.35	5.35
5	#10460.00	55.06 PK	74.00	-18.94	1.95 H	285	39.35	15.71
6	#10460.00	41.05 AV	54.00	-12.95	1.95 H	285	25.34	15.71

**ANTENNA POLARITY & TEST DISTANCE: VERTICAL AT 3 M**

NO.	FREQ. (MHz)	EMISSION LEVEL (dBuV/m)	LIMIT (dBuV/m)	MARGIN (dB)	ANTENNA HEIGHT (m)	TABLE ANGLE (Degree)	RAW VALUE (dBuV)	CORRECTION FACTOR (dB/m)
1	*5230.00	112.47 PK			4.00 V	201	107.45	5.02
2	*5230.00	96.80 AV			4.00 V	201	91.78	5.02
3	5350.00	55.60 PK	74.00	-18.40	1.35 V	201	50.25	5.35
4	5350.00	42.60 AV	54.00	-11.40	1.35 V	201	37.25	5.35
5	#10460.00	56.35 PK	74.00	-17.65	2.19 V	241	40.64	15.71
6	#10460.00	42.08 AV	54.00	-11.92	2.19 V	241	26.37	15.71

**REMARKS:**

1. Emission Level(dBuV/m) = Raw Value(dBuV) + Correction Factor(dB/m)
2. Correction Factor(dB/m) = Antenna Factor(dB/m) + Cable Factor(dB) – Pre-Amplifier Factor(dB)
3. The other emission levels were very low against the limit.
4. Margin value = Emission Level – Limit value
5. " \* ": Fundamental frequency.
6. " # ": The radiated frequency is out of the restricted band.

<b>CHANNEL</b>	TX Channel 151	<b>DETECTOR FUNCTION</b>	Peak (PK)
<b>FREQUENCY RANGE</b>	1GHz ~ 40GHz		Average (AV)

**ANTENNA POLARITY & TEST DISTANCE: HORIZONTAL AT 3 M**

NO.	FREQ. (MHz)	EMISSION LEVEL (dBuV/m)	LIMIT (dBuV/m)	MARGIN (dB)	ANTENNA HEIGHT (m)	TABLE ANGLE (Degree)	RAW VALUE (dBuV)	CORRECTION FACTOR (dB/m)
1	#5609.34	61.13 PK	68.20	-7.07	1.58 H	203	54.55	6.58
2	*5755.00	119.54 PK			1.58 H	203	112.84	6.70
3	*5755.00	103.39 AV			1.58 H	203	96.69	6.70
4	#5932.05	56.83 PK	68.20	-11.37	1.58 H	203	49.78	7.05
5	11510.00	57.71 PK	74.00	-16.29	2.19 H	218	40.84	16.87
6	11510.00	43.61 AV	54.00	-10.39	2.19 H	218	26.74	16.87

**ANTENNA POLARITY & TEST DISTANCE: VERTICAL AT 3 M**

NO.	FREQ. (MHz)	EMISSION LEVEL (dBuV/m)	LIMIT (dBuV/m)	MARGIN (dB)	ANTENNA HEIGHT (m)	TABLE ANGLE (Degree)	RAW VALUE (dBuV)	CORRECTION FACTOR (dB/m)
1	#5625.09	58.88 PK	68.20	-9.32	2.84 V	267	52.29	6.59
2	*5755.00	116.06 PK			2.84 V	267	109.36	6.70
3	*5755.00	100.06 AV			2.84 V	267	93.36	6.70
4	#5948.94	55.29 PK	68.20	-12.91	2.84 V	267	48.17	7.12
5	11510.00	56.55 PK	74.00	-17.45	2.18 V	41	39.68	16.87
6	11510.00	42.71 AV	54.00	-11.29	2.18 V	41	25.84	16.87

**REMARKS:**

1. Emission Level(dBuV/m) = Raw Value(dBuV) + Correction Factor(dB/m)
2. Correction Factor(dB/m) = Antenna Factor(dB/m) + Cable Factor(dB) – Pre-Amplifier Factor(dB)
3. The other emission levels were very low against the limit.
4. Margin value = Emission Level – Limit value
5. " \* ": Fundamental frequency.
6. " # ": The radiated frequency is out of the restricted band.

<b>CHANNEL</b>	TX Channel 159	<b>DETECTOR FUNCTION</b>	Peak (PK)
<b>FREQUENCY RANGE</b>	1GHz ~ 40GHz		Average (AV)

**ANTENNA POLARITY & TEST DISTANCE: HORIZONTAL AT 3 M**

NO.	FREQ. (MHz)	EMISSION LEVEL (dBuV/m)	LIMIT (dBuV/m)	MARGIN (dB)	ANTENNA HEIGHT (m)	TABLE ANGLE (Degree)	RAW VALUE (dBuV)	CORRECTION FACTOR (dB/m)
1	#5610.32	61.20 PK	68.20	-7.00	1.54 H	212	54.62	6.58
2	*5795.00	120.51 PK			1.54 H	212	113.78	6.73
3	*5795.00	103.62 AV			1.54 H	212	96.89	6.73
4	#5925.20	57.18 PK	68.20	-11.02	1.54 H	212	50.16	7.02
5	11590.00	57.43 PK	74.00	-16.57	2.39 H	352	40.68	16.75
6	11590.00	43.37 AV	54.00	-10.63	2.39 H	352	26.62	16.75

**ANTENNA POLARITY & TEST DISTANCE: VERTICAL AT 3 M**

NO.	FREQ. (MHz)	EMISSION LEVEL (dBuV/m)	LIMIT (dBuV/m)	MARGIN (dB)	ANTENNA HEIGHT (m)	TABLE ANGLE (Degree)	RAW VALUE (dBuV)	CORRECTION FACTOR (dB/m)
1	#5601.31	59.82 PK	68.20	-8.38	2.63 V	230	53.25	6.57
2	*5795.00	115.62 PK			2.63 V	230	108.89	6.73
3	*5795.00	100.40 AV			2.63 V	230	93.67	6.73
4	#5933.55	55.39 PK	68.20	-12.81	2.63 V	230	48.34	7.05
5	11590.00	56.39 PK	74.00	-17.61	1.78 V	247	39.64	16.75
6	11590.00	42.44 AV	54.00	-11.56	1.78 V	247	25.69	16.75

**REMARKS:**

1. Emission Level(dBuV/m) = Raw Value(dBuV) + Correction Factor(dB/m)
2. Correction Factor(dB/m) = Antenna Factor(dB/m) + Cable Factor(dB) – Pre-Amplifier Factor(dB)
3. The other emission levels were very low against the limit.
4. Margin value = Emission Level – Limit value
5. " \* ": Fundamental frequency.
6. " # ": The radiated frequency is out of the restricted band.

802.11ac (80MHz)

<b>CHANNEL</b>	TX Channel 42	<b>DETECTOR FUNCTION</b>	Peak (PK)
<b>FREQUENCY RANGE</b>	1GHz ~ 40GHz		Average (AV)

**ANTENNA POLARITY & TEST DISTANCE: HORIZONTAL AT 3 M**

NO.	FREQ. (MHz)	EMISSION LEVEL (dBuV/m)	LIMIT (dBuV/m)	MARGIN (dB)	ANTENNA HEIGHT (m)	TABLE ANGLE (Degree)	RAW VALUE (dBuV)	CORRECTION FACTOR (dB/m)
1	5150.00	69.17 PK	74.00	-4.83	1.44 H	285	64.26	4.91
2	5150.00	44.57 AV	54.00	-9.43	1.44 H	285	39.66	4.91
3	*5210.00	109.21 PK			1.44 H	285	104.23	4.98
4	*5210.00	95.31 AV			1.44 H	285	90.33	4.98
5	5350.00	55.01 PK	74.00	-18.99	1.44 H	285	49.66	5.35
6	5350.00	42.21 AV	54.00	-11.79	1.44 H	285	36.86	5.35
7	#10420.00	54.96 PK	74.00	-19.04	1.69 H	239	39.33	15.63
8	#10420.00	41.48 AV	54.00	-12.52	1.69 H	239	25.85	15.63

**ANTENNA POLARITY & TEST DISTANCE: VERTICAL AT 3 M**

NO.	FREQ. (MHz)	EMISSION LEVEL (dBuV/m)	LIMIT (dBuV/m)	MARGIN (dB)	ANTENNA HEIGHT (m)	TABLE ANGLE (Degree)	RAW VALUE (dBuV)	CORRECTION FACTOR (dB/m)
1	5150.00	72.77 PK	74.00	-1.23	1.59 V	222	67.86	4.91
2	5150.00	46.74 AV	54.00	-7.26	1.59 V	222	41.83	4.91
3	*5210.00	110.13 PK			1.59 V	222	105.15	4.98
4	*5210.00	96.00 AV			1.59 V	222	91.02	4.98
5	5350.00	56.29 PK	74.00	-17.71	1.59 V	222	50.94	5.35
6	5350.00	43.06 AV	54.00	-10.94	1.59 V	222	37.71	5.35
7	#10420.00	56.47 PK	74.00	-17.53	1.82 V	221	40.84	15.63
8	#10420.00	42.00 AV	54.00	-12.00	1.82 V	221	26.37	15.63

**REMARKS:**

1. Emission Level(dBuV/m) = Raw Value(dBuV) + Correction Factor(dB/m)
2. Correction Factor(dB/m) = Antenna Factor(dB/m) + Cable Factor(dB) – Pre-Amplifier Factor(dB)
3. The other emission levels were very low against the limit.
4. Margin value = Emission Level – Limit value
5. " \* ": Fundamental frequency.
6. " # ": The radiated frequency is out of the restricted band.

<b>CHANNEL</b>	TX Channel 155	<b>DETECTOR FUNCTION</b>	Peak (PK)
<b>FREQUENCY RANGE</b>	1GHz ~ 40GHz		Average (AV)

**ANTENNA POLARITY & TEST DISTANCE: HORIZONTAL AT 3 M**

NO.	FREQ. (MHz)	EMISSION LEVEL (dBuV/m)	LIMIT (dBuV/m)	MARGIN (dB)	ANTENNA HEIGHT (m)	TABLE ANGLE (Degree)	RAW VALUE (dBuV)	CORRECTION FACTOR (dB/m)
1	#5641.82	67.09 PK	68.20	-1.11	1.53 H	206	60.49	6.60
2	*5775.00	118.97 PK			1.53 H	206	112.25	6.72
3	*5775.00	103.24 AV			1.53 H	206	96.52	6.72
4	#5931.51	58.95 PK	68.20	-9.25	1.53 H	206	51.90	7.05
5	11550.00	57.12 PK	74.00	-16.88	1.82 H	204	40.31	16.81
6	11550.00	42.90 AV	54.00	-11.10	1.82 H	204	26.09	16.81

**ANTENNA POLARITY & TEST DISTANCE: VERTICAL AT 3 M**

NO.	FREQ. (MHz)	EMISSION LEVEL (dBuV/m)	LIMIT (dBuV/m)	MARGIN (dB)	ANTENNA HEIGHT (m)	TABLE ANGLE (Degree)	RAW VALUE (dBuV)	CORRECTION FACTOR (dB/m)
1	#5625.44	59.51 PK	68.20	-8.69	2.89 V	269	52.92	6.59
2	*5775.00	115.61 PK			2.89 V	269	108.89	6.72
3	*5775.00	100.27 AV			2.89 V	269	93.55	6.72
4	#5932.89	56.54 PK	68.20	-11.66	2.89 V	269	49.49	7.05
5	11550.00	56.17 PK	74.00	-17.83	1.32 V	152	39.36	16.81
6	11550.00	42.65 AV	54.00	-11.35	1.32 V	152	25.84	16.81

**REMARKS:**

1. Emission Level(dBuV/m) = Raw Value(dBuV) + Correction Factor(dB/m)
2. Correction Factor(dB/m) = Antenna Factor(dB/m) + Cable Factor(dB) – Pre-Amplifier Factor(dB)
3. The other emission levels were very low against the limit.
4. Margin value = Emission Level – Limit value
5. " \* ": Fundamental frequency.
6. " # ": The radiated frequency is out of the restricted band.

**Beamforming\_NSS1 Mode (Mode B)**

**802.11ac (20MHz)**

<b>CHANNEL</b>	TX Channel 36	<b>DETECTOR FUNCTION</b>	Peak (PK)
<b>FREQUENCY RANGE</b>	1GHz ~ 40GHz		Average (AV)

**ANTENNA POLARITY & TEST DISTANCE: HORIZONTAL AT 3 M**

NO.	FREQ. (MHz)	EMISSION LEVEL (dBuV/m)	LIMIT (dBuV/m)	MARGIN (dB)	ANTENNA HEIGHT (m)	TABLE ANGLE (Degree)	RAW VALUE (dBuV)	CORRECTION FACTOR (dB/m)
1	5150.00	56.99 PK	74.00	-17.01	1.65 H	68	52.08	4.91
2	5150.00	43.11 AV	54.00	-10.89	1.65 H	68	38.20	4.91
3	*5180.00	105.17PK			1.65 H	68	100.23	4.94
4	*5180.00	90.41 AV			1.65 H	68	85.47	4.94
5	#10360.00	55.19 PK	74.00	-18.81	2.36 H	103	39.66	15.53
6	#10360.00	40.92 AV	54.00	-13.08	2.36 H	103	25.39	15.53

**ANTENNA POLARITY & TEST DISTANCE: VERTICAL AT 3 M**

NO.	FREQ. (MHz)	EMISSION LEVEL (dBuV/m)	LIMIT (dBuV/m)	MARGIN (dB)	ANTENNA HEIGHT (m)	TABLE ANGLE (Degree)	RAW VALUE (dBuV)	CORRECTION FACTOR (dB/m)
1	5150.00	64.76 PK	74.00	-9.24	1.72 V	33	59.85	4.91
2	5150.00	45.41 AV	54.00	-8.59	1.72 V	33	40.50	4.91
3	*5180.00	119.42 PK			1.72 V	33	114.48	4.94
4	*5180.00	104.47 AV			1.72 V	33	99.53	4.94
5	#10360.00	55.56 PK	74.00	-18.44	1.48 V	201	40.03	15.53
6	#10360.00	41.66 AV	54.00	-12.34	1.48 V	201	26.13	15.53

**REMARKS:**

1. Emission Level(dBuV/m) = Raw Value(dBuV) + Correction Factor(dB/m)
2. Correction Factor(dB/m) = Antenna Factor(dB/m) + Cable Factor(dB) – Pre-Amplifier Factor(dB)
3. The other emission levels were very low against the limit.
4. Margin value = Emission Level – Limit value
5. " \* ": Fundamental frequency.
6. " # ": The radiated frequency is out of the restricted band.

<b>CHANNEL</b>	TX Channel 40	<b>DETECTOR FUNCTION</b>	Peak (PK)
<b>FREQUENCY RANGE</b>	1GHz ~ 40GHz		Average (AV)

**ANTENNA POLARITY & TEST DISTANCE: HORIZONTAL AT 3 M**

NO.	FREQ. (MHz)	EMISSION LEVEL (dBuV/m)	LIMIT (dBuV/m)	MARGIN (dB)	ANTENNA HEIGHT (m)	TABLE ANGLE (Degree)	RAW VALUE (dBuV)	CORRECTION FACTOR (dB/m)
1	*5200.00	105.17 PK			1.58 H	78	100.20	4.97
2	*5200.00	90.43 AV			1.58 H	78	85.46	4.97
3	#10400.00	54.92 PK	74.00	-19.08	2.18 H	100	39.34	15.58
4	#10400.00	40.87 AV	54.00	-13.13	2.18 H	100	25.29	15.58

**ANTENNA POLARITY & TEST DISTANCE: VERTICAL AT 3 M**

NO.	FREQ. (MHz)	EMISSION LEVEL (dBuV/m)	LIMIT (dBuV/m)	MARGIN (dB)	ANTENNA HEIGHT (m)	TABLE ANGLE (Degree)	RAW VALUE (dBuV)	CORRECTION FACTOR (dB/m)
1	*5200.00	118.64 PK			1.72 V	225	113.67	4.97
2	*5200.00	104.47 AV			1.72 V	225	99.50	4.97
3	#10400.00	56.03 PK	74.00	-17.97	1.87 V	124	40.45	15.58
4	#10400.00	42.25 AV	54.00	-11.75	1.87 V	124	26.67	15.58

**REMARKS:**

1. Emission Level(dBuV/m) = Raw Value(dBuV) + Correction Factor(dB/m)
2. Correction Factor(dB/m) = Antenna Factor(dB/m) + Cable Factor(dB) – Pre-Amplifier Factor(dB)
3. The other emission levels were very low against the limit.
4. Margin value = Emission Level – Limit value
5. " \* ": Fundamental frequency.
6. " # ": The radiated frequency is out of the restricted band.

<b>CHANNEL</b>	TX Channel 48	<b>DETECTOR FUNCTION</b>	Peak (PK)
<b>FREQUENCY RANGE</b>	1GHz ~ 40GHz		Average (AV)

**ANTENNA POLARITY & TEST DISTANCE: HORIZONTAL AT 3 M**

NO.	FREQ. (MHz)	EMISSION LEVEL (dBuV/m)	LIMIT (dBuV/m)	MARGIN (dB)	ANTENNA HEIGHT (m)	TABLE ANGLE (Degree)	RAW VALUE (dBuV)	CORRECTION FACTOR (dB/m)
1	*5240.00	105.29 PK			1.69 H	79	100.25	5.04
2	*5240.00	90.73 AV			1.69 H	79	85.69	5.04
3	5350.00	55.80 PK	74.00	-18.20	1.69 H	79	50.45	5.35
4	5350.00	42.33 AV	54.00	-11.67	1.69 H	79	36.98	5.35
5	#10480.00	55.14 PK	74.00	-18.86	1.78 H	225	39.38	15.76
6	#10480.00	40.86 AV	54.00	-13.14	1.78 H	225	25.10	15.76

**ANTENNA POLARITY & TEST DISTANCE: VERTICAL AT 3 M**

NO.	FREQ. (MHz)	EMISSION LEVEL (dBuV/m)	LIMIT (dBuV/m)	MARGIN (dB)	ANTENNA HEIGHT (m)	TABLE ANGLE (Degree)	RAW VALUE (dBuV)	CORRECTION FACTOR (dB/m)
1	*5240.00	119.07 PK			1.82 V	222	114.03	5.04
2	*5240.00	104.63 AV			1.82 V	222	99.59	5.04
3	5350.00	56.77 PK	74.00	-17.23	1.82 V	222	51.42	5.35
4	5350.00	43.10 AV	54.00	-10.90	1.82 V	222	37.75	5.35
5	#10480.00	56.34 PK	74.00	-17.66	1.95 V	341	40.58	15.76
6	#10480.00	42.39 AV	54.00	-11.61	1.95 V	341	26.63	15.76

**REMARKS:**

1. Emission Level(dBuV/m) = Raw Value(dBuV) + Correction Factor(dB/m)
2. Correction Factor(dB/m) = Antenna Factor(dB/m) + Cable Factor(dB) – Pre-Amplifier Factor(dB)
3. The other emission levels were very low against the limit.
4. Margin value = Emission Level – Limit value
5. " \* ": Fundamental frequency.
6. " # ": The radiated frequency is out of the restricted band.



<b>CHANNEL</b>	TX Channel 149	<b>DETECTOR FUNCTION</b>	Peak (PK)
<b>FREQUENCY RANGE</b>	1GHz ~ 40GHz		Average (AV)

**ANTENNA POLARITY & TEST DISTANCE: HORIZONTAL AT 3 M**

NO.	FREQ. (MHz)	EMISSION LEVEL (dBuV/m)	LIMIT (dBuV/m)	MARGIN (dB)	ANTENNA HEIGHT (m)	TABLE ANGLE (Degree)	RAW VALUE (dBuV)	CORRECTION FACTOR (dB/m)
1	#5618.29	58.45 PK	68.20	-9.75	1.69 H	89	51.86	6.59
2	*5745.00	107.42 PK			1.69 H	89	100.73	6.69
3	*5745.00	96.78 AV			1.69 H	89	90.09	6.69
4	#5932.33	57.46 PK	68.20	-10.74	1.69 H	69	50.41	7.05
5	11490.00	56.56 PK	74.00	-17.44	1.54 H	284	39.66	16.90
6	11490.00	42.72 AV	54.00	-11.28	1.54 H	284	25.82	16.90

**ANTENNA POLARITY & TEST DISTANCE: VERTICAL AT 3 M**

NO.	FREQ. (MHz)	EMISSION LEVEL (dBuV/m)	LIMIT (dBuV/m)	MARGIN (dB)	ANTENNA HEIGHT (m)	TABLE ANGLE (Degree)	RAW VALUE (dBuV)	CORRECTION FACTOR (dB/m)
1	#5613.34	60.92 PK	68.20	-7.28	1.19 V	87	54.33	6.59
2	*5745.00	116.38 PK			1.19 V	87	109.69	6.69
3	*5745.00	105.34 AV			1.19 V	87	98.65	6.69
4	#5945.18	57.97 PK	68.20	-10.23	1.19 V	87	50.87	7.10
5	11490.00	57.41 PK	74.00	-16.59	1.74 V	194	40.51	16.90
6	11490.00	43.26 AV	54.00	-10.74	1.74 V	194	26.36	16.90

**REMARKS:**

1. Emission Level(dBuV/m) = Raw Value(dBuV) + Correction Factor(dB/m)
2. Correction Factor(dB/m) = Antenna Factor(dB/m) + Cable Factor(dB) – Pre-Amplifier Factor(dB)
3. The other emission levels were very low against the limit.
4. Margin value = Emission Level – Limit value
5. " \* ": Fundamental frequency.
6. " # ": The radiated frequency is out of the restricted band.

<b>CHANNEL</b>	TX Channel 157	<b>DETECTOR FUNCTION</b>	Peak (PK)
<b>FREQUENCY RANGE</b>	1GHz ~ 40GHz		Average (AV)

**ANTENNA POLARITY & TEST DISTANCE: HORIZONTAL AT 3 M**

NO.	FREQ. (MHz)	EMISSION LEVEL (dBuV/m)	LIMIT (dBuV/m)	MARGIN (dB)	ANTENNA HEIGHT (m)	TABLE ANGLE (Degree)	RAW VALUE (dBuV)	CORRECTION FACTOR (dB/m)
1	#5648.08	58.06 PK	68.20	-10.14	1.75 H	99	51.46	6.60
2	*5785.00	106.61 PK			1.75 H	99	99.89	6.72
3	*5785.00	96.60 AV			1.75 H	99	89.88	6.72
4	#5929.05	57.93 PK	68.20	-10.27	1.75 H	99	50.90	7.03
5	11570.00	56.41 PK	74.00	-17.59	1.69 H	228	39.62	16.79
6	11570.00	42.43 AV	54.00	-11.57	1.69 H	228	25.64	16.79

**ANTENNA POLARITY & TEST DISTANCE: VERTICAL AT 3 M**

NO.	FREQ. (MHz)	EMISSION LEVEL (dBuV/m)	LIMIT (dBuV/m)	MARGIN (dB)	ANTENNA HEIGHT (m)	TABLE ANGLE (Degree)	RAW VALUE (dBuV)	CORRECTION FACTOR (dB/m)
1	#5639.82	60.73 PK	68.20	-7.47	1.23 V	75	54.12	6.61
2	*5785.00	116.60 PK			1.23 V	75	109.88	6.72
3	*5785.00	97.36 AV			1.23 V	75	90.64	6.72
4	#5935.34	61.11 PK	68.20	-7.09	1.23 V	75	54.04	7.07
5	11570.00	57.51 PK	74.00	-16.49	1.84 V	59	40.72	16.79
6	11570.00	43.13 AV	54.00	-10.87	1.84 V	59	26.34	16.79

**REMARKS:**

1. Emission Level(dBuV/m) = Raw Value(dBuV) + Correction Factor(dB/m)
2. Correction Factor(dB/m) = Antenna Factor(dB/m) + Cable Factor(dB) – Pre-Amplifier Factor(dB)
3. The other emission levels were very low against the limit.
4. Margin value = Emission Level – Limit value
5. " \* ": Fundamental frequency.
6. " # ": The radiated frequency is out of the restricted band.

<b>CHANNEL</b>	TX Channel 165	<b>DETECTOR FUNCTION</b>	Peak (PK)
<b>FREQUENCY RANGE</b>	1GHz ~ 40GHz		Average (AV)

**ANTENNA POLARITY & TEST DISTANCE: HORIZONTAL AT 3 M**

NO.	FREQ. (MHz)	EMISSION LEVEL (dBuV/m)	LIMIT (dBuV/m)	MARGIN (dB)	ANTENNA HEIGHT (m)	TABLE ANGLE (Degree)	RAW VALUE (dBuV)	CORRECTION FACTOR (dB/m)
1	#5644.69	56.75 PK	68.20	-11.45	1.66 H	95	50.14	6.61
2	*5825.00	107.23 PK			1.66 H	95	100.45	6.78
3	*5825.00	97.46 AV			1.66 H	95	90.68	6.78
4	#5960.29	59.72 PK	68.20	-8.48	1.66 H	95	52.55	7.17
5	11650.00	56.58 PK	74.00	-17.42	1.45 H	23	39.82	16.76
6	11650.00	41.88 AV	54.00	-12.12	1.45 H	23	25.12	16.76

**ANTENNA POLARITY & TEST DISTANCE: VERTICAL AT 3 M**

NO.	FREQ. (MHz)	EMISSION LEVEL (dBuV/m)	LIMIT (dBuV/m)	MARGIN (dB)	ANTENNA HEIGHT (m)	TABLE ANGLE (Degree)	RAW VALUE (dBuV)	CORRECTION FACTOR (dB/m)
1	#5641.33	58.22 PK	68.20	-9.98	1.17 V	80	51.62	6.60
2	*5825.00	116.56 PK			1.17 V	80	109.78	6.78
3	*5825.00	105.67 AV			1.17 V	80	98.89	6.78
4	#5955.36	61.19 PK	68.20	-7.01	1.17 V	80	54.05	7.14
5	11650.00	57.12 PK	74.00	-16.88	1.25 V	201	40.36	16.76
6	11650.00	43.09 AV	54.00	-10.91	1.25 V	201	26.33	16.76

**REMARKS:**

1. Emission Level(dBuV/m) = Raw Value(dBuV) + Correction Factor(dB/m)
2. Correction Factor(dB/m) = Antenna Factor(dB/m) + Cable Factor(dB) – Pre-Amplifier Factor(dB)
3. The other emission levels were very low against the limit.
4. Margin value = Emission Level – Limit value
5. " \* ": Fundamental frequency.
6. " # ": The radiated frequency is out of the restricted band.

802.11ac (40MHz)

<b>CHANNEL</b>	TX Channel 38	<b>DETECTOR FUNCTION</b>	Peak (PK)
<b>FREQUENCY RANGE</b>	1GHz ~ 40GHz		Average (AV)

**ANTENNA POLARITY & TEST DISTANCE: HORIZONTAL AT 3 M**

NO.	FREQ. (MHz)	EMISSION LEVEL (dBuV/m)	LIMIT (dBuV/m)	MARGIN (dB)	ANTENNA HEIGHT (m)	TABLE ANGLE (Degree)	RAW VALUE (dBuV)	CORRECTION FACTOR (dB/m)
1	5150.00	67.27 PK	74.00	-6.73	1.62 H	79	62.36	4.91
2	5150.00	45.93 AV	54.00	-8.07	1.62 H	79	41.02	4.91
3	*5190.00	103.52 PK			1.62 H	79	98.56	4.96
4	*5190.00	90.65 AV			1.62 H	79	85.69	4.96
5	#10380.00	55.37 PK	74.00	-18.63	1.00 H	81	39.81	15.56
6	#10380.00	40.64 AV	54.00	-13.36	1.00 H	81	25.08	15.56

**ANTENNA POLARITY & TEST DISTANCE: VERTICAL AT 3 M**

NO.	FREQ. (MHz)	EMISSION LEVEL (dBuV/m)	LIMIT (dBuV/m)	MARGIN (dB)	ANTENNA HEIGHT (m)	TABLE ANGLE (Degree)	RAW VALUE (dBuV)	CORRECTION FACTOR (dB/m)
1	5150.00	72.22 PK	74.00	-1.78	1.92 V	220	67.31	4.91
2	5150.00	50.11 AV	54.00	-3.89	1.92 V	220	45.20	4.91
3	*5190.00	116.79 PK			1.92 V	220	111.83	4.96
4	*5190.00	102.05 AV			1.92 V	220	97.09	4.96
5	#10380.00	56.41 PK	74.00	-17.59	1.92 V	129	40.85	15.56
6	#10380.00	41.95 AV	54.00	-12.05	1.92 V	129	26.39	15.56

**REMARKS:**

1. Emission Level(dBuV/m) = Raw Value(dBuV) + Correction Factor(dB/m)
2. Correction Factor(dB/m) = Antenna Factor(dB/m) + Cable Factor(dB) – Pre-Amplifier Factor(dB)
3. The other emission levels were very low against the limit.
4. Margin value = Emission Level – Limit value
5. " \* ": Fundamental frequency.
6. " # ": The radiated frequency is out of the restricted band.

<b>CHANNEL</b>	TX Channel 46	<b>DETECTOR FUNCTION</b>	Peak (PK)
<b>FREQUENCY RANGE</b>	1GHz ~ 40GHz		Average (AV)

**ANTENNA POLARITY & TEST DISTANCE: HORIZONTAL AT 3 M**

NO.	FREQ. (MHz)	EMISSION LEVEL (dBuV/m)	LIMIT (dBuV/m)	MARGIN (dB)	ANTENNA HEIGHT (m)	TABLE ANGLE (Degree)	RAW VALUE (dBuV)	CORRECTION FACTOR (dB/m)
1	*5230.00	104.71 PK			1.78 H	64	99.69	5.02
2	*5230.00	91.37 AV			1.78 H	64	86.35	5.02
3	5350.00	55.38 PK	74.00	-18.62	1.78 H	64	50.03	5.35
4	5350.00	42.02 AV	54.00	-11.98	1.78 H	64	36.67	5.35
5	#10460.00	55.03 PK	74.00	-18.97	1.26 H	315	39.32	15.71
6	#10460.00	41.06 AV	54.00	-12.94	1.26 H	315	25.35	15.71

**ANTENNA POLARITY & TEST DISTANCE: VERTICAL AT 3 M**

NO.	FREQ. (MHz)	EMISSION LEVEL (dBuV/m)	LIMIT (dBuV/m)	MARGIN (dB)	ANTENNA HEIGHT (m)	TABLE ANGLE (Degree)	RAW VALUE (dBuV)	CORRECTION FACTOR (dB/m)
1	*5230.00	117.18 PK			1.93 V	181	112.16	5.02
2	*5230.00	100.75 AV			1.93 V	181	95.73	5.02
3	5350.00	56.16 PK	74.00	-17.84	1.93 V	181	50.81	5.35
4	5350.00	43.23 AV	54.00	-10.77	1.93 V	181	37.88	5.35
5	#10460.00	56.31 PK	74.00	-17.69	1.15 V	200	40.60	15.71
6	#10460.00	42.40 AV	54.00	-11.60	1.15 V	200	26.69	15.71

**REMARKS:**

1. Emission Level(dBuV/m) = Raw Value(dBuV) + Correction Factor(dB/m)
2. Correction Factor(dB/m) = Antenna Factor(dB/m) + Cable Factor(dB) – Pre-Amplifier Factor(dB)
3. The other emission levels were very low against the limit.
4. Margin value = Emission Level – Limit value
5. " \* ": Fundamental frequency.
6. " # ": The radiated frequency is out of the restricted band.

<b>CHANNEL</b>	TX Channel 151	<b>DETECTOR FUNCTION</b>	Peak (PK)
<b>FREQUENCY RANGE</b>	1GHz ~ 40GHz		Average (AV)

**ANTENNA POLARITY & TEST DISTANCE: HORIZONTAL AT 3 M**

NO.	FREQ. (MHz)	EMISSION LEVEL (dBuV/m)	LIMIT (dBuV/m)	MARGIN (dB)	ANTENNA HEIGHT (m)	TABLE ANGLE (Degree)	RAW VALUE (dBuV)	CORRECTION FACTOR (dB/m)
1	#5624.86	58.82 PK	68.20	-9.38	1.98 H	231	52.22	6.60
2	*5755.00	107.96 PK			1.98 H	231	101.26	6.70
3	*5755.00	89.96 AV			1.98 H	231	83.26	6.70
4	#5928.09	56.83 PK	68.20	-11.37	1.98 H	231	49.81	7.02
5	11510.00	56.52 PK	74.00	-17.48	1.85 H	251	39.65	16.87
6	11510.00	42.38 AV	54.00	-11.62	1.85 H	251	25.51	16.87

**ANTENNA POLARITY & TEST DISTANCE: VERTICAL AT 3 M**

NO.	FREQ. (MHz)	EMISSION LEVEL (dBuV/m)	LIMIT (dBuV/m)	MARGIN (dB)	ANTENNA HEIGHT (m)	TABLE ANGLE (Degree)	RAW VALUE (dBuV)	CORRECTION FACTOR (dB/m)
1	#5621.14	60.76 PK	68.20	-7.44	1.90 V	197	54.17	6.59
2	*5755.00	116.73 PK			1.90 V	197	110.03	6.70
3	*5755.00	101.35 AV			1.90 V	197	94.65	6.70
4	#5927.70	58.79 PK	68.20	-9.41	1.90 V	197	51.77	7.02
5	11510.00	57.51 PK	74.00	-16.49	1.87 V	45	40.64	16.87
6	11510.00	43.40 AV	54.00	-10.60	1.87 V	45	26.53	16.87

**REMARKS:**

1. Emission Level(dBuV/m) = Raw Value(dBuV) + Correction Factor(dB/m)
2. Correction Factor(dB/m) = Antenna Factor(dB/m) + Cable Factor(dB) – Pre-Amplifier Factor(dB)
3. The other emission levels were very low against the limit.
4. Margin value = Emission Level – Limit value
5. " \* ": Fundamental frequency.
6. " # ": The radiated frequency is out of the restricted band.

<b>CHANNEL</b>	TX Channel 159	<b>DETECTOR FUNCTION</b>	Peak (PK)
<b>FREQUENCY RANGE</b>	1GHz ~ 40GHz		Average (AV)

**ANTENNA POLARITY & TEST DISTANCE: HORIZONTAL AT 3 M**

NO.	FREQ. (MHz)	EMISSION LEVEL (dBuV/m)	LIMIT (dBuV/m)	MARGIN (dB)	ANTENNA HEIGHT (m)	TABLE ANGLE (Degree)	RAW VALUE (dBuV)	CORRECTION FACTOR (dB/m)
1	#5641.48	58.58 PK	68.20	-9.62	2.16 H	245	51.98	6.60
2	*5795.00	108.96 PK			2.16 H	245	102.23	6.73
3	*5795.00	91.29 AV			2.16 H	245	84.56	6.73
4	#5928.42	58.30 PK	68.20	-9.90	2.16 H	245	51.27	7.03
5	11590.00	56.40 PK	74.00	-17.60	1.66 H	252	39.65	16.75
6	11590.00	42.57 AV	54.00	-11.43	1.66 H	252	25.82	16.75

**ANTENNA POLARITY & TEST DISTANCE: VERTICAL AT 3 M**

NO.	FREQ. (MHz)	EMISSION LEVEL (dBuV/m)	LIMIT (dBuV/m)	MARGIN (dB)	ANTENNA HEIGHT (m)	TABLE ANGLE (Degree)	RAW VALUE (dBuV)	CORRECTION FACTOR (dB/m)
1	#5643.78	60.02 PK	68.20	-8.18	1.97 V	201	53.40	6.62
2	*5795.00	117.76 PK			1.97 V	201	111.03	6.73
3	*5795.00	101.99 AV			1.97 V	201	95.26	6.73
4	#5946.61	59.79 PK	68.20	-8.41	1.97 V	201	52.68	7.11
5	11590.00	57.11 PK	74.00	-16.89	1.87 V	164	40.36	16.75
6	11590.00	43.14 AV	54.00	-10.86	1.87 V	164	26.39	16.75

**REMARKS:**

1. Emission Level(dBuV/m) = Raw Value(dBuV) + Correction Factor(dB/m)
2. Correction Factor(dB/m) = Antenna Factor(dB/m) + Cable Factor(dB) – Pre-Amplifier Factor(dB)
3. The other emission levels were very low against the limit.
4. Margin value = Emission Level – Limit value
5. " \* ": Fundamental frequency.
6. " # ": The radiated frequency is out of the restricted band.

**802.11ac (80MHz)**

<b>CHANNEL</b>	TX Channel 42	<b>DETECTOR FUNCTION</b>	Peak (PK)
<b>FREQUENCY RANGE</b>	1GHz ~ 40GHz		Average (AV)

**ANTENNA POLARITY & TEST DISTANCE: HORIZONTAL AT 3 M**

NO.	FREQ. (MHz)	EMISSION LEVEL (dBuV/m)	LIMIT (dBuV/m)	MARGIN (dB)	ANTENNA HEIGHT (m)	TABLE ANGLE (Degree)	RAW VALUE (dBuV)	CORRECTION FACTOR (dB/m)
1	5150.00	69.07 PK	74.00	-4.93	1.58 H	68	64.16	4.91
2	5150.00	47.17 AV	54.00	-6.83	1.58 H	68	42.26	4.91
3	*5210.00	104.87 PK			1.58 H	68	99.89	4.98
4	*5210.00	92.47 AV			1.58 H	68	87.49	4.98
5	5350.00	55.77 PK	74.00	-18.23	1.58 H	68	50.42	5.35
6	5350.00	42.77 AV	54.00	-11.23	1.58 H	68	37.42	5.35
7	#10420.00	54.95 PK	74.00	-19.05	2.09 H	126	39.32	15.63
8	#10420.00	40.88 AV	54.00	-13.12	2.09 H	126	25.25	15.63

**ANTENNA POLARITY & TEST DISTANCE: VERTICAL AT 3 M**

NO.	FREQ. (MHz)	EMISSION LEVEL (dBuV/m)	LIMIT (dBuV/m)	MARGIN (dB)	ANTENNA HEIGHT (m)	TABLE ANGLE (Degree)	RAW VALUE (dBuV)	CORRECTION FACTOR (dB/m)
1	5150.00	72.96 PK	74.00	-1.04	1.95 V	221	68.05	4.91
2	5150.00	51.00 AV	54.00	-3.00	1.95 V	221	46.09	4.91
3	*5210.00	114.32 PK			1.95 V	221	109.34	4.98
4	*5210.00	98.59 AV			1.95 V	221	93.61	4.98
5	5350.00	56.32 PK	74.00	-17.68	1.95 V	221	50.97	5.35
6	5350.00	43.27 AV	54.00	-10.73	1.95 V	221	37.92	5.35
7	#10420.00	56.47 PK	74.00	-17.53	1.84 V	221	40.84	15.63
8	#10420.00	41.82 AV	54.00	-12.18	1.84 V	221	26.19	15.63

**REMARKS:**

1. Emission Level(dBuV/m) = Raw Value(dBuV) + Correction Factor(dB/m)
2. Correction Factor(dB/m) = Antenna Factor(dB/m) + Cable Factor(dB) – Pre-Amplifier Factor(dB)
3. The other emission levels were very low against the limit.
4. Margin value = Emission Level – Limit value
5. " \* ": Fundamental frequency.
6. " # ": The radiated frequency is out of the restricted band.



<b>CHANNEL</b>	TX Channel 155	<b>DETECTOR FUNCTION</b>	Peak (PK)
<b>FREQUENCY RANGE</b>	1GHz ~ 40GHz		Average (AV)

**ANTENNA POLARITY & TEST DISTANCE: HORIZONTAL AT 3 M**

NO.	FREQ. (MHz)	EMISSION LEVEL (dBuV/m)	LIMIT (dBuV/m)	MARGIN (dB)	ANTENNA HEIGHT (m)	TABLE ANGLE (Degree)	RAW VALUE (dBuV)	CORRECTION FACTOR (dB/m)
1	#5631.93	65.77 PK	68.20	-2.43	1.62 H	39	59.17	6.60
2	*5775.00	108.88 PK			1.62 H	39	102.16	6.72
3	*5775.00	96.28 AV			1.62 H	39	89.56	6.72
4	#5931.67	58.40 PK	68.20	-9.80	1.62 H	39	51.35	7.05
5	11550.00	56.13 PK	74.00	-17.87	1.84 H	251	39.32	16.81
6	11550.00	42.32 AV	54.00	-11.68	1.84 H	251	25.51	16.81

**ANTENNA POLARITY & TEST DISTANCE: VERTICAL AT 3 M**

NO.	FREQ. (MHz)	EMISSION LEVEL (dBuV/m)	LIMIT (dBuV/m)	MARGIN (dB)	ANTENNA HEIGHT (m)	TABLE ANGLE (Degree)	RAW VALUE (dBuV)	CORRECTION FACTOR (dB/m)
1	#5647.17	66.61 PK	68.20	-1.59	1.92 V	61	60.00	6.61
2	*5775.00	117.97 PK			1.92 V	61	111.25	6.72
3	*5775.00	104.75 AV			1.92 V	61	98.03	6.72
4	#5942.31	62.67 PK	68.20	-5.53	1.92 V	61	55.58	7.09
5	11550.00	57.37 PK	74.00	-16.63	1.87 V	163	40.56	16.81
6	11550.00	43.37 AV	54.00	-10.63	1.87 V	163	26.56	16.81

**REMARKS:**

1. Emission Level(dBuV/m) = Raw Value(dBuV) + Correction Factor(dB/m)
2. Correction Factor(dB/m) = Antenna Factor(dB/m) + Cable Factor(dB) – Pre-Amplifier Factor(dB)
3. The other emission levels were very low against the limit.
4. Margin value = Emission Level – Limit value
5. " \* ": Fundamental frequency.
6. " # ": The radiated frequency is out of the restricted band.

**BELOW 1GHz WORST-CASE DATA:**
**CDD Mode (Mode A)**
**802.11a**

<b>CHANNEL</b>	TX Channel 48	<b>DETECTOR FUNCTION</b>	Quasi-Peak (QP)
<b>FREQUENCY RANGE</b>	9kHz ~ 1GHz		

**ANTENNA POLARITY & TEST DISTANCE: HORIZONTAL AT 3 M**

NO.	FREQ. (MHz)	EMISSION LEVEL (dBuV/m)	LIMIT (dBuV/m)	MARGIN (dB)	ANTENNA HEIGHT (m)	TABLE ANGLE (Degree)	RAW VALUE (dBuV)	CORRECTION FACTOR (dB/m)
1	36.74	29.70 QP	40.00	-10.30	1.88 H	54	39.85	-10.15
2	148.29	24.98 QP	43.50	-18.52	2.74 H	256	34.14	-9.16
3	215.66	32.10 QP	43.50	-11.40	1.45 H	79	43.21	-11.11
4	293.89	27.06 QP	46.00	-18.94	2.63 H	313	34.66	-7.60
5	400.01	37.62 QP	46.00	-8.38	2.54 H	117	42.94	-5.32
6	473.24	29.69 QP	46.00	-16.31	1.29 H	243	33.16	-3.47

**ANTENNA POLARITY & TEST DISTANCE: VERTICAL AT 3 M**

NO.	FREQ. (MHz)	EMISSION LEVEL (dBuV/m)	LIMIT (dBuV/m)	MARGIN (dB)	ANTENNA HEIGHT (m)	TABLE ANGLE (Degree)	RAW VALUE (dBuV)	CORRECTION FACTOR (dB/m)
1	33.20	34.11 QP	40.00	-5.89	1.64 V	182	44.79	-10.68
2	148.15	26.28 QP	43.50	-17.22	1.29 V	74	35.45	-9.17
3	217.55	26.92 QP	46.00	-19.08	1.82 V	340	38.01	-11.09
4	279.97	26.38 QP	46.00	-19.62	1.08 V	158	34.31	-7.93
5	409.42	33.94 QP	46.00	-12.06	1.42 V	166	39.14	-5.20
6	474.79	33.26 QP	46.00	-12.74	1.78 V	166	36.74	-3.48

**REMARKS:**

1. Emission Level(dBuV/m) = Raw Value(dBuV) + Correction Factor(dB/m)
2. Correction Factor(dB/m) = Antenna Factor(dB/m) + Cable Factor(dB) – Pre-Amplifier Factor(dB)
3. The other emission levels were very low against the limit.
4. Margin value = Emission Level – Limit value

**CDD Mode (Mode B)**

**802.11a**

<b>CHANNEL</b>	TX Channel 48	<b>DETECTOR FUNCTION</b>	Quasi-Peak (QP)
<b>FREQUENCY RANGE</b>	9kHz ~ 1GHz		

**ANTENNA POLARITY & TEST DISTANCE: HORIZONTAL AT 3 M**

NO.	FREQ. (MHz)	EMISSION LEVEL (dBuV/m)	LIMIT (dBuV/m)	MARGIN (dB)	ANTENNA HEIGHT (m)	TABLE ANGLE (Degree)	RAW VALUE (dBuV)	CORRECTION FACTOR (dB/m)
1	36.45	30.27 QP	40.00	-9.73	2.14 H	225	40.44	-10.17
2	146.59	23.63 QP	43.50	-19.87	1.69 H	252	32.78	-9.15
3	223.32	32.18 QP	46.00	-13.82	2.63 H	277	43.40	-11.22
4	302.04	26.17 QP	46.00	-19.83	2.29 H	310	33.51	-7.34
5	412.47	39.33 QP	46.00	-6.67	2.88 H	252	44.43	-5.10
6	471.40	29.99 QP	46.00	-16.01	1.52 H	124	33.47	-3.48

**ANTENNA POLARITY & TEST DISTANCE: VERTICAL AT 3 M**

NO.	FREQ. (MHz)	EMISSION LEVEL (dBuV/m)	LIMIT (dBuV/m)	MARGIN (dB)	ANTENNA HEIGHT (m)	TABLE ANGLE (Degree)	RAW VALUE (dBuV)	CORRECTION FACTOR (dB/m)
1	34.03	35.04 QP	40.00	-4.96	1.34 V	207	45.61	-10.57
2	147.03	25.09 QP	43.50	-18.41	1.28 V	114	34.26	-9.17
3	225.46	28.29 QP	46.00	-17.71	1.96 V	202	39.58	-11.29
4	410.63	35.14 QP	46.00	-10.86	2.20 V	147	40.32	-5.18
5	474.99	31.74 QP	46.00	-14.26	1.57 V	188	35.22	-3.48
6	606.52	37.70 QP	46.00	-8.30	1.42 V	56	38.15	-0.45

**REMARKS:**

1. Emission Level(dBuV/m) = Raw Value(dBuV) + Correction Factor(dB/m)
2. Correction Factor(dB/m) = Antenna Factor(dB/m) + Cable Factor(dB) – Pre-Amplifier Factor(dB)
3. The other emission levels were very low against the limit.
4. Margin value = Emission Level – Limit value

## 4.2 Conducted Emission Measurement

### 4.2.1 Limits of Conducted Emission Measurement

Frequency (MHz)	Conducted Limit (dBuV)	
	Quasi-peak	Average
0.15 - 0.5	66 - 56	56 - 46
0.50 - 5.0	56	46
5.0 - 30.0	60	50

Note: 1. The lower limit shall apply at the transition frequencies.

2. The limit decreases in line with the logarithm of the frequency in the range of 0.15 to 0.50MHz.

### 4.2.2 Test Instruments

Description & Manufacturer	Model No.	Serial No.	Cal. Date	Cal. Due
ROHDE & SCHWARZ TEST RECEIVER	ESCS 30	100276	Apr. 10, 2017	Apr. 09, 2018
ROHDE & SCHWARZ Artificial Mains Network (for EUT)	ENV216	101197	May 22, 2017	May 21, 2018
LISN With Adapter (for EUT)	AD10	C10Ada-002	May 22, 2017	May 21, 2018
ROHDE & SCHWARZ Artificial Mains Network (for peripherals)	ESH3-Z5	100218	Nov. 23, 2016	Nov. 22, 2017
SCHWARZBECK Artificial Mains Network (For EUT)	NNLK8129	8129229	May 09, 2017	May 08, 2018
Software	Cond_V7.3.7.4	NA	NA	NA
RF cable (JYEBAO) With 10dB PAD	5D-FB	Cable-C10.01	Feb. 14, 2017	Feb. 13, 2018
SUHNER Terminator (For ROHDE & SCHWARZ LISN)	65BNC-5001	E1-011484	May 18, 2017	May 17, 2018
ROHDE & SCHWARZ Artificial Mains Network (For TV EUT)	ESH3-Z5	100220	Nov. 08, 2016	Nov. 07, 2017
LISN With Adapter (for TV EUT)	100220	N/A	Nov. 08, 2016	Nov. 07, 2017

Notes: 1. The calibration interval of the above test instruments is 12 months and the calibrations are traceable to NML/ROC and NIST/USA.

2. The test was performed in Shielded Room No. 10.

3. The VCCI Site Registration No. C-1852.

4. The FCC Designation Number is TW2021.

5. Tested Date: Sep. 7 ~ 18, 2017

#### 4.2.3 Test Procedure

- The EUT was placed 0.4 meters from the conducting wall of the shielded room with EUT being connected to the power mains through a line impedance stabilization network (LISN). Other support units were connected to the power mains through another LISN. The two LISNs provide 50 ohm/ 50uH of coupling impedance for the measuring instrument.
- Both lines of the power mains connected to the EUT were checked for maximum conducted interference.
- The frequency range from 150kHz to 30MHz was searched. Emission levels under (Limit - 20dB) was not recorded.

**NOTE:** All modes of operation were investigated and the worst-case emissions are reported.

#### 4.2.4 Deviation from Test Standard

No deviation.

#### 4.2.5 Test Setup

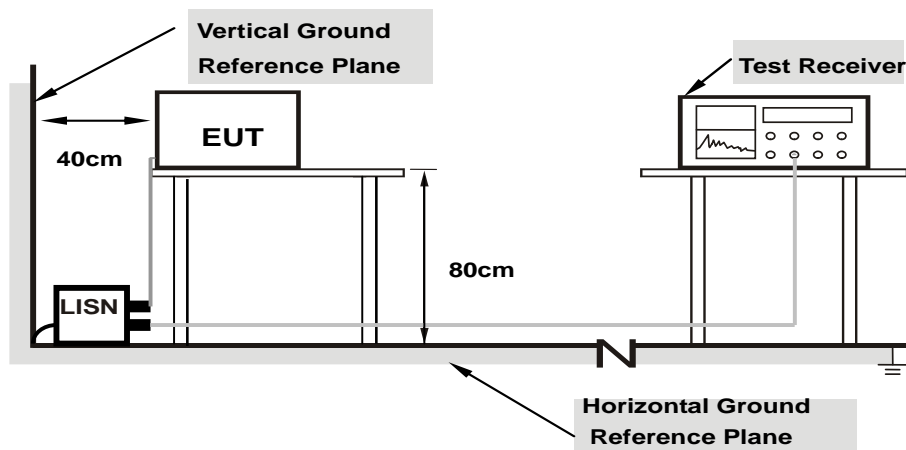

**Note: 1.Support units were connected to second LISN.**

For the actual test configuration, please refer to the attached file (Test Setup Photo).

#### 4.2.6 EUT Operating Condition

- Connected the EUT with AC adapter or PoE placed on testing table.
- Set the EUT under transmission condition continuously at specific channel frequency.

4.2.7 Test Results

**CDD Mode (Mode A)**

Phase	Line (L)	Detector Function	Quasi-Peak (QP) / Average (AV)
-------	----------	-------------------	--------------------------------

No	Freq. [MHz]	Corr.	Reading Value		Emission Level		Limit		Margin	
		Factor	[dB (uV)]		[dB (uV)]		[dB (uV)]		(dB)	
		(dB)	Q.P.	AV.	Q.P.	AV.	Q.P.	AV.	Q.P.	AV.
1	0.15000	9.65	33.32	24.03	42.97	33.68	66.00	56.00	-23.03	-22.32
<b>2</b>	<b>0.35703</b>	<b>9.66</b>	<b>36.96</b>	<b>36.83</b>	<b>46.62</b>	<b>46.49</b>	<b>58.80</b>	<b>48.80</b>	<b>-12.18</b>	<b>-2.31</b>
3	0.63828	9.68	19.92	18.22	29.60	27.90	56.00	46.00	-26.40	-18.10
4	4.09766	9.84	20.05	13.08	29.89	22.92	56.00	46.00	-26.11	-23.08
5	9.97656	9.93	26.26	21.70	36.19	31.63	60.00	50.00	-23.81	-18.37
6	21.87500	10.02	28.12	26.55	38.14	36.57	60.00	50.00	-21.86	-13.43

**REMARKS:**

1. Q.P. and AV. are abbreviations of quasi-peak and average individually.
2. The emission levels of other frequencies were very low against the limit.
3. Margin value = Emission level - Limit value
4. Correction factor = Insertion loss + Cable loss
5. Emission Level = Correction Factor + Reading Value.

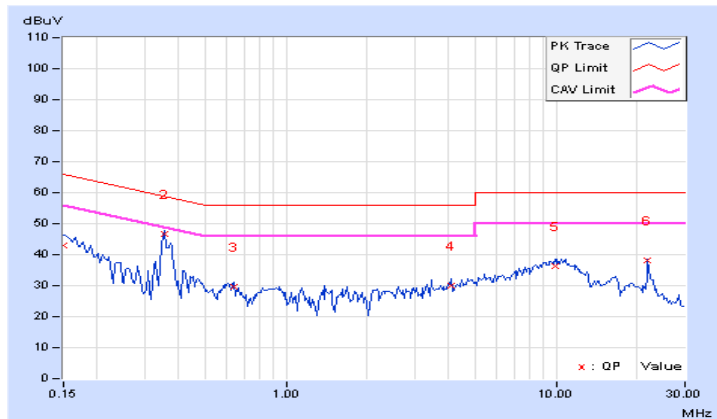

Phase	Neutral (N)	Detector Function	Quasi-Peak (QP) / Average (AV)
-------	-------------	-------------------	--------------------------------

No	Freq. [MHz]	Corr.	Reading Value		Emission Level		Limit		Margin	
		Factor	[dB (uV)]		[dB (uV)]		[dB (uV)]		(dB)	
		(dB)	Q.P.	AV.	Q.P.	AV.	Q.P.	AV.	Q.P.	AV.
1	0.15391	9.67	37.26	24.53	46.93	34.20	65.79	55.79	-18.86	-21.59
2	0.35313	9.68	38.20	36.66	47.88	46.34	58.89	48.89	-11.01	-2.55
3	0.63828	9.69	20.62	19.02	30.31	28.71	56.00	46.00	-25.69	-17.29
4	2.62891	9.78	17.93	11.07	27.71	20.85	56.00	46.00	-28.29	-25.15
5	10.91016	9.96	25.99	21.34	35.95	31.30	60.00	50.00	-24.05	-18.70
6	21.87500	10.08	29.12	28.49	39.20	38.57	60.00	50.00	-20.80	-11.43

**REMARKS:**

1. Q.P. and AV. are abbreviations of quasi-peak and average individually.
2. The emission levels of other frequencies were very low against the limit.
3. Margin value = Emission level - Limit value
4. Correction factor = Insertion loss + Cable loss
5. Emission Level = Correction Factor + Reading Value.

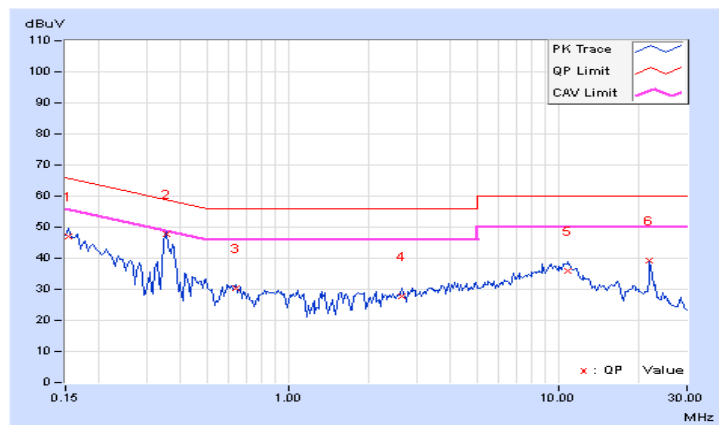

### CDD Mode (Mode B)

Phase	Line (L)	Detector Function	Quasi-Peak (QP) / Average (AV)
-------	----------	-------------------	--------------------------------

No	Freq. [MHz]	Corr.	Reading Value		Emission Level		Limit		Margin	
		Factor (dB)	[dB (uV)]		[dB (uV)]		[dB (uV)]		(dB)	
		Q.P.	AV.	Q.P.	AV.	Q.P.	AV.	Q.P.	AV.	
1	0.15000	9.65	38.75	27.44	48.40	37.09	66.00	56.00	-17.60	-18.91
2	0.17344	9.65	37.85	25.33	47.50	34.98	64.79	54.79	-17.29	-19.81
3	0.33750	9.66	28.43	20.89	38.09	30.55	59.26	49.26	-21.17	-18.71
4	0.50156	9.67	33.64	28.14	43.31	37.81	56.00	46.00	-12.69	-8.19
5	0.82188	9.69	14.46	8.39	24.15	18.08	56.00	46.00	-31.85	-27.92
6	10.13672	9.93	15.80	11.09	25.73	21.02	60.00	50.00	-34.27	-28.98

### REMARKS:

1. Q.P. and AV. are abbreviations of quasi-peak and average individually.
2. The emission levels of other frequencies were very low against the limit.
3. Margin value = Emission level - Limit value
4. Correction factor = Insertion loss + Cable loss
5. Emission Level = Correction Factor + Reading Value.

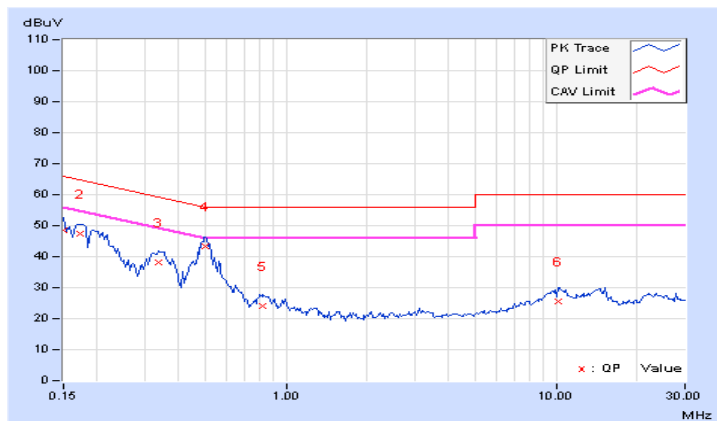



Phase	Neutral (N)	Detector Function	Quasi-Peak (QP) / Average (AV)
-------	-------------	-------------------	--------------------------------

No	Freq. [MHz]	Corr.	Reading Value		Emission Level		Limit		Margin	
		Factor	[dB (uV)]		[dB (uV)]		[dB (uV)]		(dB)	
		(dB)	Q.P.	AV.	Q.P.	AV.	Q.P.	AV.	Q.P.	AV.
1	0.15000	9.68	39.20	20.96	48.88	30.64	66.00	56.00	-17.12	-25.36
2	0.32969	9.68	27.58	20.99	37.26	30.67	59.46	49.46	-22.20	-18.79
3	0.50000	9.68	33.29	27.60	42.97	37.28	56.00	46.00	-13.03	-8.72
4	0.81797	9.70	13.95	8.33	23.65	18.03	56.00	46.00	-32.35	-27.97
5	2.75391	9.79	6.28	2.65	16.07	12.44	56.00	46.00	-39.93	-33.56
6	10.15625	9.95	16.76	11.72	26.71	21.67	60.00	50.00	-33.29	-28.33

**REMARKS:**

1. Q.P. and AV. are abbreviations of quasi-peak and average individually.
2. The emission levels of other frequencies were very low against the limit.
3. Margin value = Emission level - Limit value
4. Correction factor = Insertion loss + Cable loss
5. Emission Level = Correction Factor + Reading Value.

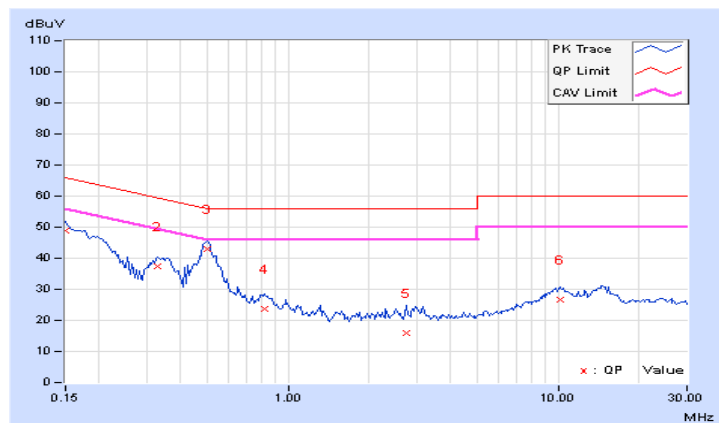

**CDD Mode (Mode C)**

Phase	Line (L)	Detector Function	Quasi-Peak (QP) / Average (AV)
-------	----------	-------------------	--------------------------------

No	Freq. [MHz]	Corr.	Reading Value		Emission Level		Limit		Margin	
		Factor (dB)	[dB (uV)]		[dB (uV)]		[dB (uV)]		(dB)	
		Q.P.	AV.	Q.P.	AV.	Q.P.	AV.	Q.P.	AV.	
1	0.15000	9.65	29.03	15.95	38.68	25.60	66.00	56.00	-27.32	-30.40
2	0.41563	9.66	26.60	18.71	36.26	28.37	57.54	47.54	-21.28	-19.17
3	0.72031	9.68	14.55	6.73	24.23	16.41	56.00	46.00	-31.77	-29.59
4	1.66406	9.73	9.33	1.32	19.06	11.05	56.00	46.00	-36.94	-34.95
5	3.47266	9.81	7.63	1.53	17.44	11.34	56.00	46.00	-38.56	-34.66
6	13.31250	9.95	8.70	0.83	18.65	10.78	60.00	50.00	-41.35	-39.22

**REMARKS:**

1. Q.P. and AV. are abbreviations of quasi-peak and average individually.
2. The emission levels of other frequencies were very low against the limit.
3. Margin value = Emission level - Limit value
4. Correction factor = Insertion loss + Cable loss
5. Emission Level = Correction Factor + Reading Value.

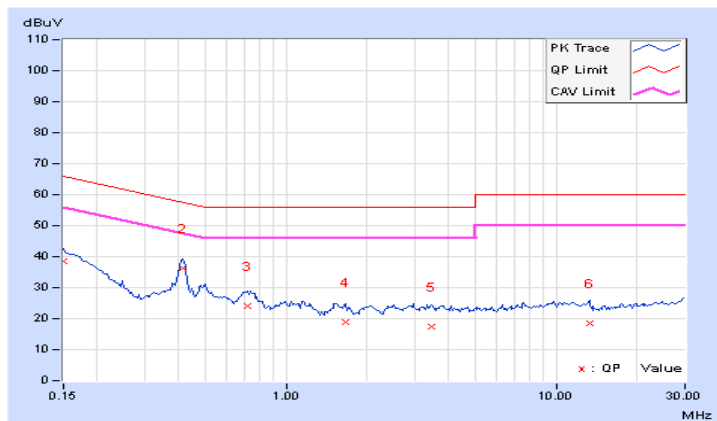

Phase	Neutral (N)	Detector Function	Quasi-Peak (QP) / Average (AV)
-------	-------------	-------------------	--------------------------------

No	Freq. [MHz]	Corr.	Reading Value		Emission Level		Limit		Margin	
		Factor	[dB (uV)]		[dB (uV)]		[dB (uV)]		(dB)	
		(dB)	Q.P.	AV.	Q.P.	AV.	Q.P.	AV.	Q.P.	AV.
1	0.15391	9.67	25.72	12.33	35.39	22.00	65.79	55.79	-30.40	-33.79
2	0.41172	9.68	25.76	17.90	35.44	27.58	57.61	47.61	-22.17	-20.03
3	0.50156	9.69	14.69	6.35	24.38	16.04	56.00	46.00	-31.62	-29.96
4	1.07813	9.71	10.28	2.74	19.99	12.45	56.00	46.00	-36.01	-33.55
5	4.62500	9.87	5.52	1.99	15.39	11.86	56.00	46.00	-40.61	-34.14
6	13.27734	9.99	10.42	2.35	20.41	12.34	60.00	50.00	-39.59	-37.66

**REMARKS:**

1. Q.P. and AV. are abbreviations of quasi-peak and average individually.
2. The emission levels of other frequencies were very low against the limit.
3. Margin value = Emission level - Limit value
4. Correction factor = Insertion loss + Cable loss
5. Emission Level = Correction Factor + Reading Value.

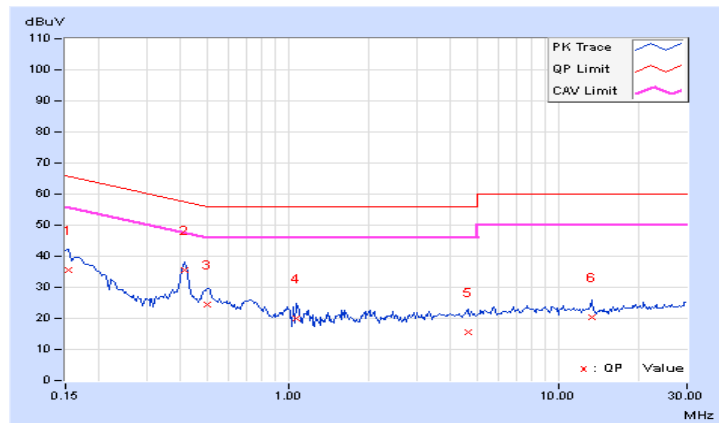

### CDD Mode (Mode D)

Phase	Line (L)	Detector Function	Quasi-Peak (QP) / Average (AV)
-------	----------	-------------------	--------------------------------

No	Freq. [MHz]	Corr.	Reading Value		Emission Level		Limit		Margin	
		Factor (dB)	[dB (uV)]		[dB (uV)]		[dB (uV)]		(dB)	
			Q.P.	AV.	Q.P.	AV.	Q.P.	AV.	Q.P.	AV.
1	0.16172	9.65	40.50	27.12	50.15	36.77	65.38	55.38	-15.23	-18.61
2	0.20469	9.65	34.32	22.74	43.97	32.39	63.42	53.42	-19.45	-21.03
3	0.44297	9.66	27.95	18.35	37.61	28.01	57.01	47.01	-19.40	-19.00
4	1.22266	9.71	19.81	11.43	29.52	21.14	56.00	46.00	-26.48	-24.86
5	18.29688	9.98	21.27	15.46	31.25	25.44	60.00	50.00	-28.75	-24.56
6	29.93750	10.15	25.97	20.25	36.12	30.40	60.00	50.00	-23.88	-19.60

### REMARKS:

1. Q.P. and AV. are abbreviations of quasi-peak and average individually.
2. The emission levels of other frequencies were very low against the limit.
3. Margin value = Emission level - Limit value
4. Correction factor = Insertion loss + Cable loss
5. Emission Level = Correction Factor + Reading Value.

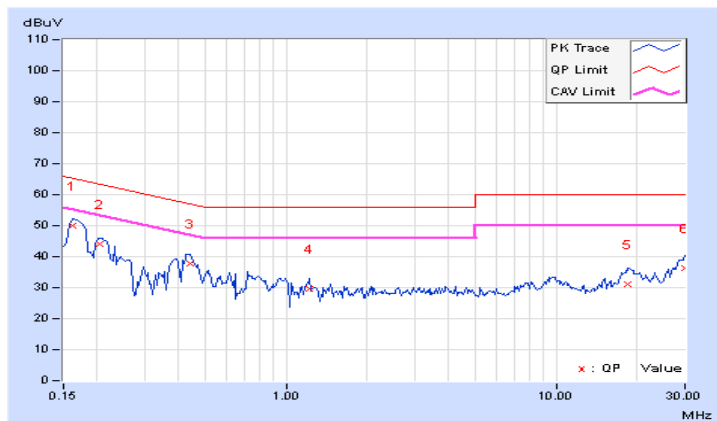

Phase	Neutral (N)	Detector Function	Quasi-Peak (QP) / Average (AV)
-------	-------------	-------------------	--------------------------------

No	Freq. [MHz]	Corr.	Reading Value		Emission Level		Limit		Margin	
		Factor	[dB (uV)]		[dB (uV)]		[dB (uV)]		(dB)	
		(dB)	Q.P.	AV.	Q.P.	AV.	Q.P.	AV.	Q.P.	AV.
1	0.15000	9.68	26.31	6.19	35.99	15.87	66.00	56.00	-30.01	-40.13
2	0.16860	9.67	39.57	28.79	49.24	38.46	65.03	55.03	-15.79	-16.57
3	0.40781	9.68	20.64	15.35	30.32	25.03	57.69	47.69	-27.37	-22.66
4	0.85313	9.70	11.03	2.38	20.73	12.08	56.00	46.00	-35.27	-33.92
5	4.11328	9.86	10.33	2.74	20.19	12.60	56.00	46.00	-35.81	-33.40
6	18.97656	10.05	22.80	17.01	32.85	27.06	60.00	50.00	-27.15	-22.94
7	29.77344	10.12	27.35	22.73	37.47	32.85	60.00	50.00	-22.53	-17.15

**REMARKS:**

1. Q.P. and AV. are abbreviations of quasi-peak and average individually.
2. The emission levels of other frequencies were very low against the limit.
3. Margin value = Emission level - Limit value
4. Correction factor = Insertion loss + Cable loss
5. Emission Level = Correction Factor + Reading Value.

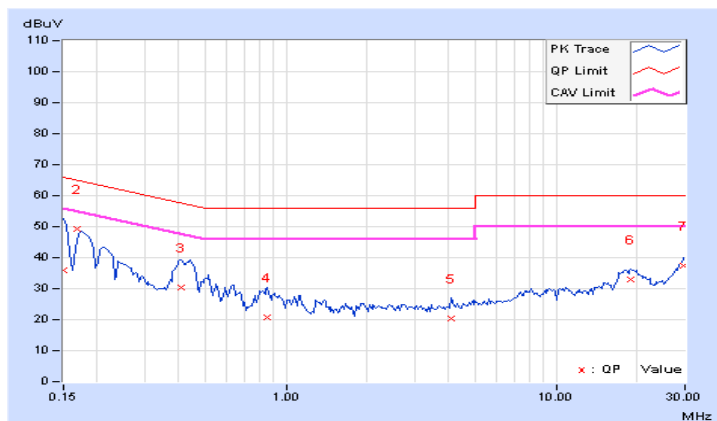

### 4.3 Transmit Power Measurement

#### 4.3.1 Limits of Transmit Power Measurement

Operation Band	EUT Category		Limit
U-NII-1		Outdoor Access Point	1 Watt (30 dBm) (Max. e.i.r.p $\leq$ 125mW(21 dBm) at any elevation angle above 30 degrees as measured from the horizon)
		Fixed point-to-point Access Point	1 Watt (30 dBm)
	√	Indoor Access Point	1 Watt (30 dBm)
		Mobile and Portable client device	250mW (24 dBm)
U-NII-2A	---		250mW (24 dBm) or 11 dBm+10 log B*
U-NII-2C	---		250mW (24 dBm) or 11 dBm+10 log B*
U-NII-3	√		1 Watt (30 dBm)

\*B is the 26 dB emission bandwidth in megahertz

Per KDB 662911 Method of conducted output power measurement on IEEE 802.11 devices,

Array Gain = 0 dB (i.e., no array gain) for  $N_{ANT} \leq 4$ ;

Array Gain = 0 dB (i.e., no array gain) for channel widths  $\geq 40$  MHz for any  $N_{ANT}$ ;

Array Gain =  $5 \log(N_{ANT}/N_{SS})$  dB or 3 dB, whichever is less for 20-MHz channel widths with  $N_{ANT} \geq 5$ .

For power measurements on all other devices: Array Gain =  $10 \log(N_{ANT}/N_{SS})$  dB.

#### 4.3.2 Test Setup

##### FOR POWER OUTPUT MEASUREMENT

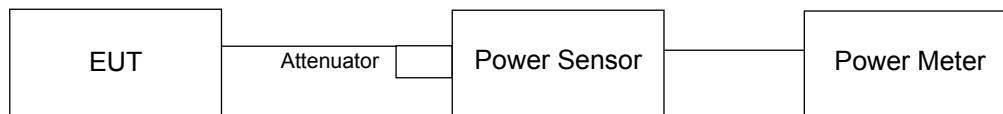

##### FOR 26dB OCCUPIED BANDWIDTH

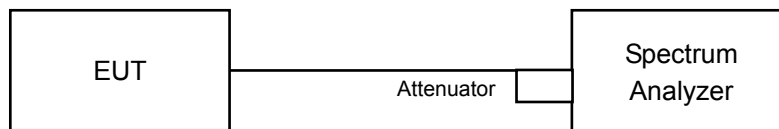

#### 4.3.3 Test Instruments

Refer to section 4.1.2 to get information of above instrument.

#### 4.3.4 Test Procedure

##### For Average Power Measurement

###### For 802.11a, 802.11ac (20MHz), 802.11ac (40MHz)

Method PM is used to perform output power measurement, trigger and gating function of wide band power meter is enabled to measure max output power of TX on burst. Duty factor is not added to measured value.

###### For 802.11ac (80MHz)

- 1) Set span to encompass the entire 26 dB EBW (or, alternatively, the entire 99% occupied bandwidth) of the signal.
- 2) Set sweep trigger to "free run".
- 3) Set RBW = 1 MHz.
- 4) Set VBW  $\geq$  3 MHz
- 5) Number of points in sweep  $\geq$  2 Span / RBW.
- 6) Sweep time  $\leq$  (number of points in sweep) \* T
- 7) Using emission bandwidth to determine the frequency span for integration the channel bandwidth.
- 8) Detector = RMS.
- 9) Trace mode = max hold.
- 10) Allow max hold to run for at least 60 seconds, or longer as needed to allow the trace to stabilize.

###### For 26dB Occupied Bandwidth

- 1) Set RBW = approximately 1% of the emission bandwidth.
- 2) Set the VBW > RBW.
- 3) Detector = Peak.
- 4) Trace mode = max hold.
- 5) Measure the maximum width of the emission that is 26 dB down from the peak of the emission. Compare this with the RBW setting of the analyzer. Readjust RBW and repeat measurement as needed until the RBW/EBW ratio is approximately 1%.

#### 4.3.5 Deviation from Test Standard

No deviation.

#### 4.3.6 EUT Operating Condition

The software provided by client to enable the EUT under transmission condition continuously at lowest, middle and highest channel frequencies individually.

#### 4.3.7 Test Result

##### CDD Mode (Mode A)

##### Power Output:

##### 802.11a

Chan.	Chan. Freq. (MHz)	Maximum Conducted Power (dBm)				Total Power (mW)	Total Power (dBm)	Power Limit (dBm)	Pass/Fail
		Chain 0	Chain 1	Chain 2	Chain 3				
36	5180	11.45	11.68	11.20	12.00	57.719	17.61	30.00	Pass
40	5200	11.34	11.75	11.14	12.15	57.984	17.63	30.00	Pass
48	5240	11.23	11.64	10.81	12.42	57.37	17.59	30.00	Pass
149	5745	21.68	21.54	21.32	21.78	575.972	27.60	30.00	Pass
157	5785	23.81	23.44	23.71	23.08	<b>899.435</b>	29.54	30.00	Pass
165	5825	21.65	20.32	21.37	20.72	508.985	27.07	30.00	Pass

##### 802.11n (20MHz)

Chan.	Chan. Freq. (MHz)	Maximum Conducted Power (dBm)				Total Power (mW)	Total Power (dBm)	Power Limit (dBm)	Pass/Fail
		Chain 0	Chain 1	Chain 2	Chain 3				
36	5180	11.87	12.11	11.44	12.08	61.713	17.90	30.00	Pass
40	5200	11.74	12.01	11.15	12.58	61.958	17.92	30.00	Pass
48	5240	11.69	11.77	11.10	12.96	62.44	17.95	30.00	Pass
149	5745	21.42	20.53	20.83	20.72	490.748	26.91	30.00	Pass
157	5785	20.23	20.46	20.98	20.13	444.965	26.48	30.00	Pass
165	5825	22.08	21.54	22.42	22.53	657.64	28.18	30.00	Pass

##### 802.11n (40MHz)

Chan.	Chan. Freq. (MHz)	Maximum Conducted Power (dBm)				Total Power (mW)	Total Power (dBm)	Power Limit (dBm)	Pass/Fail
		Chain 0	Chain 1	Chain 2	Chain 3				
38	5190	12.01	12.62	11.89	13.04	<b>69.756</b>	18.44	30.00	Pass
46	5230	12.12	12.40	11.66	13.26	69.51	18.42	30.00	Pass
151	5755	20.05	20.08	19.65	19.77	390.116	25.91	30.00	Pass
159	5795	20.89	20.11	20.87	20.23	452.928	26.56	30.00	Pass

##### 802.11ac (80MHz)

Chan.	Chan. Freq. (MHz)	Maximum Conducted Power (dBm)				Total Power (mW)	Total Power (dBm)	Power Limit (dBm)	Pass/Fail
		Chain 0	Chain 1	Chain 2	Chain 3				
42	5210	12.05	12.52	11.62	13.26	69.602	18.43	30.00	Pass
155	5775	17.46	17.85	16.24	16.53	203.724	23.09	30.00	Pass



**26dB Bandwidth:**

**802.11a**

Channel	Channel Frequency (MHz)	26dBc Bandwidth (MHz)				Pass/Fail
		Chain 0	Chain 1	Chain 2	Chain 3	
36	5180	20.15	20.03	19.98	20.03	Pass
40	5200	20.28	20.13	19.94	20.09	Pass
48	5240	20.34	20.12	20.34	20.16	Pass

**802.11n (20MHz)**

Channel	Channel Frequency (MHz)	26dBc Bandwidth (MHz)				Pass/Fail
		Chain 0	Chain 1	Chain 2	Chain 3	
36	5180	20.92	21.01	20.75	21.09	Pass
40	5200	20.71	20.96	20.97	20.64	Pass
48	5240	20.83	20.91	20.88	20.84	Pass

**802.11n (40MHz)**

Channel	Channel Frequency (MHz)	26dBc Bandwidth (MHz)				Pass/Fail
		Chain 0	Chain 1	Chain 2	Chain 3	
38	5190	40.16	40.13	40.15	40.13	Pass
46	5230	40.23	40.14	40.28	40.28	Pass

**802.11ac (80MHz)**

Channel	Channel Frequency (MHz)	26dBc Bandwidth (MHz)				Pass/Fail
		Chain 0	Chain 1	Chain 2	Chain 3	
42	5210	83.51	84.03	84.06	84.52	Pass

### Spectrum Plot of Worst Value

**802.11a / Chain 0: CH48**

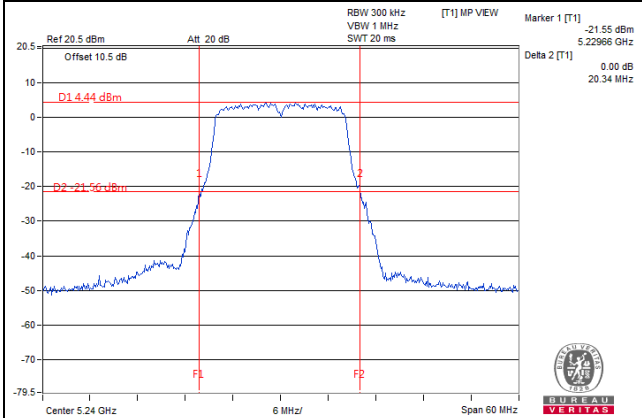

**802.11n (20MHz) / Chain 3: CH36**

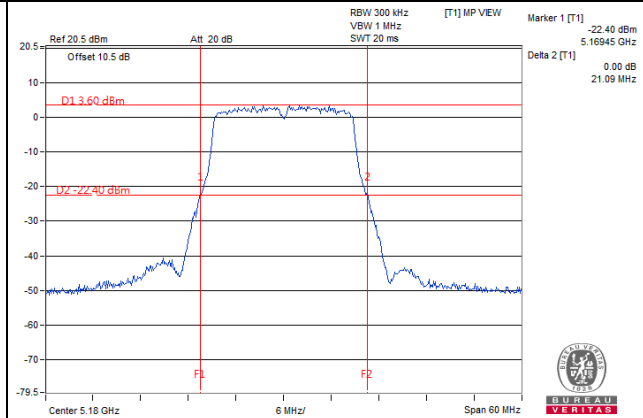

**802.11n (40MHz) / Chain 2:CH46**

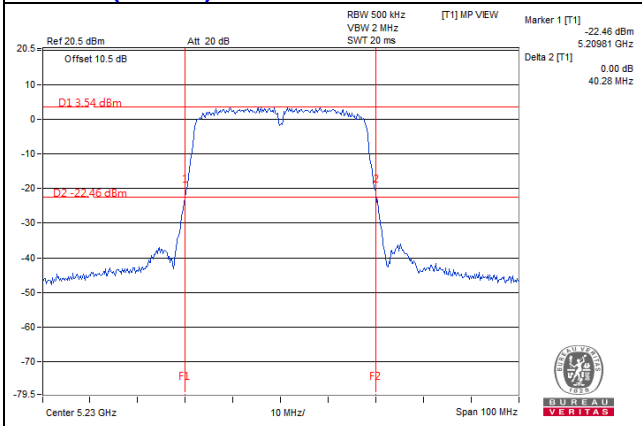

**802.11ac (80MHz) / Chain 3:CH42**

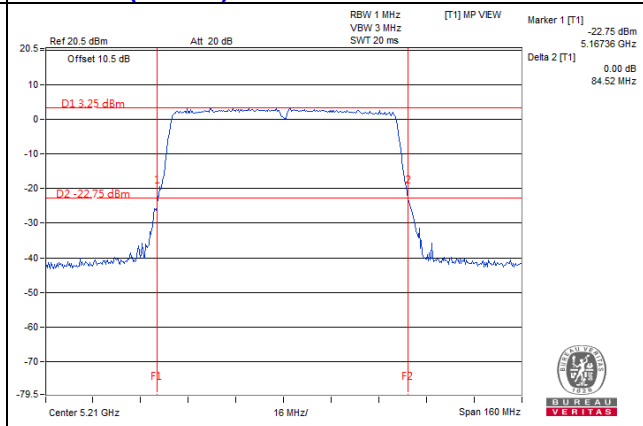

**CDD Mode (Mode B)**
**Power Output:**
**802.11a**

Chan.	Chan. Freq. (MHz)	Maximum Conducted Power (dBm)				Total Power (mW)	Total Power (dBm)	Power Limit (dBm)	Pass/Fail
		Chain 0	Chain 1	Chain 2	Chain 3				
36	5180	9.95	10.22	9.66	10.44	40.719	16.10	30.00	Pass
40	5200	9.89	10.20	9.60	10.63	40.902	16.12	30.00	Pass
48	5240	9.71	10.13	9.33	10.92	40.587	16.08	30.00	Pass
149	5745	22.73	22.57	22.35	22.73	727.506	28.62	30.00	Pass
157	5785	23.01	22.45	22.67	22.16	725.142	28.60	30.00	Pass
165	5825	21.65	20.32	21.37	20.72	508.985	27.07	30.00	Pass

**802.11n (20MHz)**

Chan.	Chan. Freq. (MHz)	Maximum Conducted Power (dBm)				Total Power (mW)	Total Power (dBm)	Power Limit (dBm)	Pass/Fail
		Chain 0	Chain 1	Chain 2	Chain 3				
36	5180	10.36	10.60	9.95	10.64	43.82	16.42	30.00	Pass
40	5200	10.19	10.55	9.66	11.02	43.691	16.40	30.00	Pass
48	5240	10.10	10.27	9.54	11.34	43.483	16.38	30.00	Pass
149	5745	22.37	21.48	21.79	21.70	612.108	27.87	30.00	Pass
157	5785	21.74	21.94	22.50	21.64	629.303	27.99	30.00	Pass
165	5825	20.59	20.09	20.98	21.01	468.142	26.70	30.00	Pass

**802.11n (40MHz)**

Chan.	Chan. Freq. (MHz)	Maximum Conducted Power (dBm)				Total Power (mW)	Total Power (dBm)	Power Limit (dBm)	Pass/Fail
		Chain 0	Chain 1	Chain 2	Chain 3				
38	5190	10.51	11.11	10.37	11.55	49.336	16.93	30.00	Pass
46	5230	10.50	10.90	10.12	11.76	48.8	16.88	30.00	Pass
151	5755	20.05	20.08	19.65	19.77	390.116	25.91	30.00	Pass
159	5795	20.37	19.57	20.36	19.72	401.865	26.04	30.00	Pass

**802.11ac (80MHz)**

Chan.	Chan. Freq. (MHz)	Maximum Conducted Power (dBm)				Total Power (mW)	Total Power (dBm)	Power Limit (dBm)	Pass/Fail
		Chain 0	Chain 1	Chain 2	Chain 3				
42	5210	10.56	10.95	10.14	11.76	49.146	16.91	30.00	Pass
155	5775	15.97	16.37	14.70	15.00	144.023	21.58	30.00	Pass

### 26dB Bandwidth:

#### 802.11a

Channel	Channel Frequency (MHz)	26dBc Bandwidth (MHz)				Pass/Fail
		Chain 0	Chain 1	Chain 2	Chain 3	
36	5180	20.02	20.10	20.11	20.05	Pass
40	5200	20.11	20.04	20.09	20.18	Pass
48	5240	20.15	20.04	20.26	20.38	Pass

#### 802.11n (20MHz)

Channel	Channel Frequency (MHz)	26dBc Bandwidth (MHz)				Pass/Fail
		Chain 0	Chain 1	Chain 2	Chain 3	
36	5180	20.77	20.86	20.81	21.11	Pass
40	5200	20.91	21.12	20.82	20.79	Pass
48	5240	20.83	20.87	20.76	21.07	Pass

#### 802.11n (40MHz)

Channel	Channel Frequency (MHz)	26dBc Bandwidth (MHz)				Pass/Fail
		Chain 0	Chain 1	Chain 2	Chain 3	
38	5190	40.19	40.05	40.05	40.04	Pass
46	5230	39.98	39.96	40.02	40.06	Pass

#### 802.11ac (80MHz)

Channel	Channel Frequency (MHz)	26dBc Bandwidth (MHz)				Pass/Fail
		Chain 0	Chain 1	Chain 2	Chain 3	
42	5210	84.05	83.81	83.94	84.74	Pass

### Spectrum Plot of Worst Value

**802.11a / Chain 3: CH48**

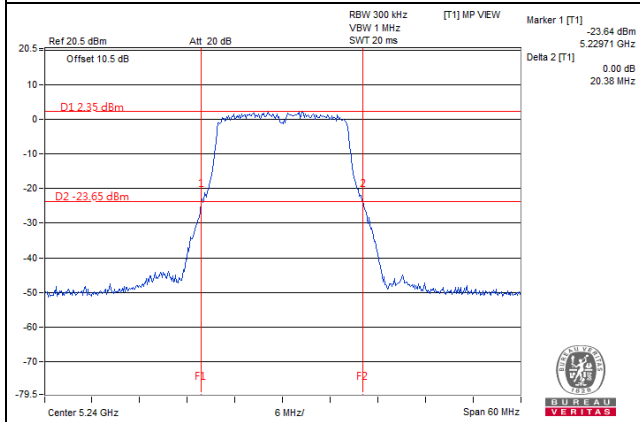

**802.11n (20MHz) / Chain 1: CH40**

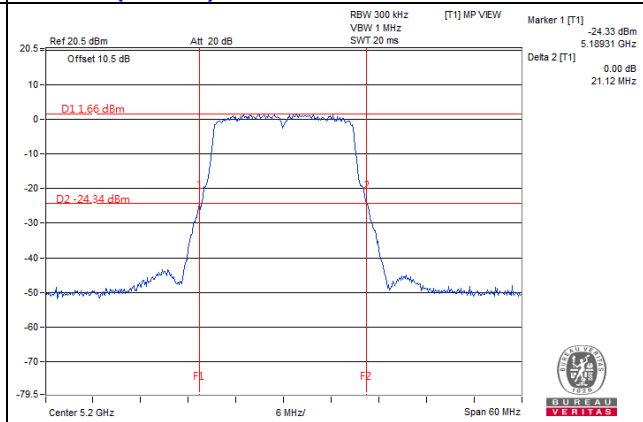

**802.11n (40MHz) / Chain 0: CH38**

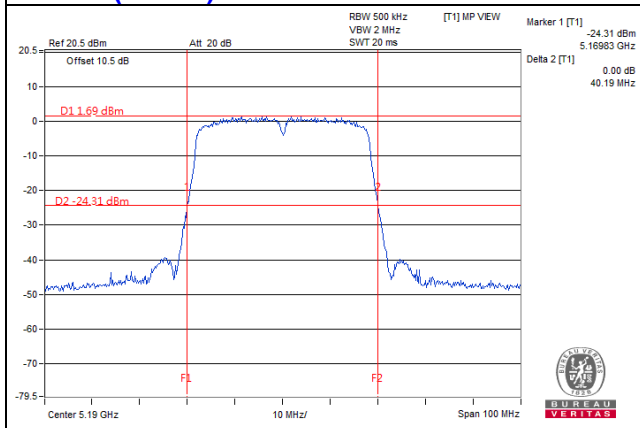

**802.11ac (80MHz) / Chain 3: CH42**

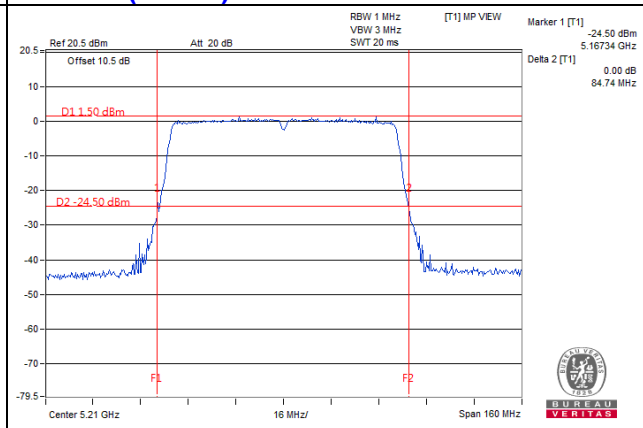

### Beamforming\_NSS1 Mode (Mode A)

#### Power Output:

#### 802.11ac (20MHz)

Chan.	Chan. Freq. (MHz)	Maximum Conducted Power (dBm)				Total Power (mW)	Total Power (dBm)	Power Limit (dBm)	Pass/Fail
		Chain 0	Chain 1	Chain 2	Chain 3				
36	5180	6.89	7.15	6.41	7.10	19.579	12.92	25.51	Pass
40	5200	6.72	7.06	6.18	7.56	19.633	12.93	25.51	Pass
48	5240	6.68	6.75	6.12	7.95	19.718	12.95	25.51	Pass
149	5745	19.96	19.05	19.32	19.24	348.889	25.43	25.51	Pass
157	5785	19.28	19.42	19.87	19.12	350.93	25.45	25.51	Pass
165	5825	19.26	18.89	19.65	19.82	349.976	25.44	25.51	Pass

**NOTE:** Directional gain =  $10 \log[(10^{G1/20} + 10^{G2/20} + \dots + 10^{GN/20})^2 / 4] = 10.49\text{dBi} > 6\text{dBi}$ , so the Conducted Power limit shall be reduced to  $30 - (10.49 - 6) = 25.51\text{dBm}$

#### 802.11ac (40MHz)

Chan.	Chan. Freq. (MHz)	Maximum Conducted Power (dBm)				Total Power (mW)	Total Power (dBm)	Power Limit (dBm)	Pass/Fail
		Chain 0	Chain 1	Chain 2	Chain 3				
38	5190	7.04	7.58	6.85	8.10	22.085	13.44	25.51	Pass
46	5230	7.14	7.38	6.64	8.32	22.051	13.43	25.51	Pass
151	5755	19.52	19.63	19.13	19.29	348.133	25.42	25.51	Pass
159	5795	19.78	19.04	19.69	19.22	351.899	25.46	25.51	Pass

**NOTE:** Directional gain =  $10 \log[(10^{G1/20} + 10^{G2/20} + \dots + 10^{GN/20})^2 / 4] = 10.49\text{dBi} > 6\text{dBi}$ , so the Conducted Power limit shall be reduced to  $30 - (10.49 - 6) = 25.51\text{dBm}$

#### 802.11ac (80MHz)

Chan.	Chan. Freq. (MHz)	Maximum Conducted Power (dBm)				Total Power (mW)	Total Power (dBm)	Power Limit (dBm)	Pass/Fail
		Chain 0	Chain 1	Chain 2	Chain 3				
42	5210	7.08	7.49	6.61	8.23	21.949	13.41	25.51	Pass
155	5775	17.18	17.49	15.88	16.08	187.622	22.73	25.51	Pass

**NOTE:** Directional gain =  $10 \log[(10^{G1/20} + 10^{G2/20} + \dots + 10^{GN/20})^2 / 4] = 10.49\text{dBi} > 6\text{dBi}$ , so the Conducted Power limit shall be reduced to  $30 - (10.49 - 6) = 25.51\text{dBm}$

### Beamforming\_NSS1 Mode (Mode B)

#### Power Output:

#### 802.11ac (20MHz)

Chan.	Chan. Freq. (MHz)	Maximum Conducted Power (dBm)				Total Power (mW)	Total Power (dBm)	Power Limit (dBm)	Pass/Fail
		Chain 0	Chain 1	Chain 2	Chain 3				
36	5180	5.32	5.61	4.98	5.61	13.83	11.41	23.98	Pass
40	5200	5.22	5.52	4.71	5.98	13.813	11.40	23.98	Pass
48	5240	5.11	5.29	4.56	6.35	13.797	11.40	23.98	Pass
149	5745	18.39	17.52	17.81	17.72	245.069	23.89	23.98	Pass
157	5785	18.38	17.64	17.72	17.62	243.907	23.87	23.98	Pass
165	5825	17.75	17.32	18.16	18.22	245.355	23.90	23.98	Pass

**NOTE:** Directional gain =  $10 \log[(10^{G1/20} + 10^{G2/20} + \dots + 10^{GN/20})^2 / 4] = 12.02\text{dBi} > 6\text{dBi}$ , so the Conducted Power limit shall be reduced to  $30 - (12.02 - 6) = 23.98\text{dBm}$

#### 802.11ac (40MHz)

Chan.	Chan. Freq. (MHz)	Maximum Conducted Power (dBm)				Total Power (mW)	Total Power (dBm)	Power Limit (dBm)	Pass/Fail
		Chain 0	Chain 1	Chain 2	Chain 3				
38	5190	5.52	6.08	5.42	6.52	15.59	11.93	23.98	Pass
46	5230	5.49	5.93	5.28	6.75	15.562	11.92	23.98	Pass
151	5755	17.95	18.02	17.56	17.63	240.719	23.82	23.98	Pass
159	5795	17.98	18.04	17.52	17.58	240.26	23.81	23.98	Pass

**NOTE:** Directional gain =  $10 \log[(10^{G1/20} + 10^{G2/20} + \dots + 10^{GN/20})^2 / 4] = 12.02\text{dBi} > 6\text{dBi}$ , so the Conducted Power limit shall be reduced to  $30 - (12.02 - 6) = 23.98\text{dBm}$

#### 802.11ac (80MHz)

Chan.	Chan. Freq. (MHz)	Maximum Conducted Power (dBm)				Total Power (mW)	Total Power (dBm)	Power Limit (dBm)	Pass/Fail
		Chain 0	Chain 1	Chain 2	Chain 3				
42	5210	5.58	5.94	5.16	6.73	15.531	11.91	23.98	Pass
155	5775	15.83	16.28	14.71	14.95	141.585	21.51	23.98	Pass

**NOTE:** Directional gain =  $10 \log[(10^{G1/20} + 10^{G2/20} + \dots + 10^{GN/20})^2 / 4] = 12.02\text{dBi} > 6\text{dBi}$ , so the Conducted Power limit shall be reduced to  $30 - (12.02 - 6) = 23.98\text{dBm}$

## 4.4 Occupied Bandwidth Measurement

### 4.4.1 Test Setup

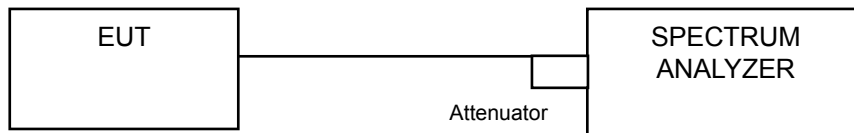

### 4.4.2 Test Instruments

Refer to section 4.1.2 to get information of above instrument.

### 4.4.3 Test Procedure

The transmitter output was connected to the spectrum analyzer through an attenuator. The bandwidth of the fundamental frequency was measured by spectrum analyzer with resolution bandwidth in the range of 1% to 5% of the anticipated emission bandwidth, and a video bandwidth at least 3x the resolution bandwidth and set the detector to SAMPLE. The width of a frequency band such that, below the lower and above the upper frequency limits, the mean powers emitted are each equal to a specified percentage 0.5 %of the total mean power of a given emission.



#### 4.4.4 Test Results

##### CDD Mode (Mode A)

##### 802.11a

Channel	Channel Frequency (MHz)	Occupied Bandwidth (Mhz)				Pass / Fail
		Chain 0	Chain 1	Chain 2	Chain 3	
36	5180	16.44	16.44	16.44	16.44	Pass
40	5200	16.44	16.44	16.44	16.44	Pass
48	5240	16.44	16.44	16.44	16.44	Pass
149	5745	16.60	16.70	16.70	16.60	Pass
157	5785	42.10	41.90	42.00	42.17	Pass
165	5825	28.08	28.50	28.50	28.60	Pass

##### 802.11n (20MHz)

Channel	Channel Frequency (MHz)	Occupied Bandwidth (Mhz)				Pass / Fail
		Chain 0	Chain 1	Chain 2	Chain 3	
36	5180	17.64	17.64	17.64	17.64	Pass
40	5200	17.64	17.64	17.64	17.64	Pass
48	5240	17.64	17.64	17.64	17.64	Pass
149	5745	17.65	17.70	17.70	17.70	Pass
157	5785	17.80	17.80	17.90	17.70	Pass
165	5825	28.10	26.00	25.40	26.10	Pass

##### 802.11n (40MHz)

Channel	Channel Frequency (MHz)	Occupied Bandwidth (Mhz)				Pass / Fail
		Chain 0	Chain 1	Chain 2	Chain 3	
38	5190	36.00	36.00	36.00	36.00	Pass
46	5230	35.80	36.20	36.00	36.20	Pass
151	5755	36.08	36.16	36.16	36.16	Pass
159	5795	36.50	36.50	36.50	36.33	Pass

##### 802.11ac (80MHz)

Channel	Channel Frequency (MHz)	Occupied Bandwidth (Mhz)				Pass / Fail
		Chain 0	Chain 1	Chain 2	Chain 3	
42	5210	75.84	76.08	75.84	75.84	Pass
155	5775	75.88	75.88	76.16	75.88	Pass

### Spectrum Plot of Worst Value

**802.11a / Chain 3: CH157**

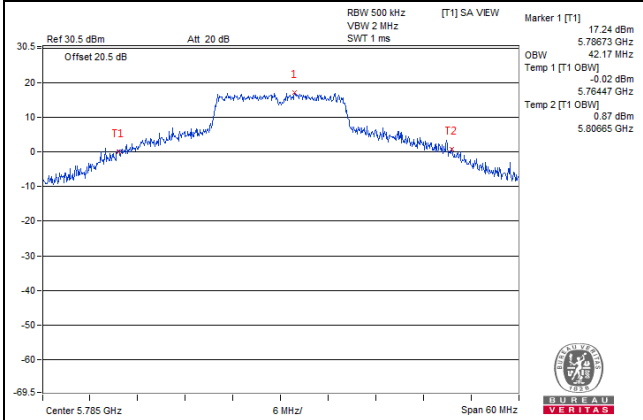

**802.11n (20MHz) / Chain 0: CH165**

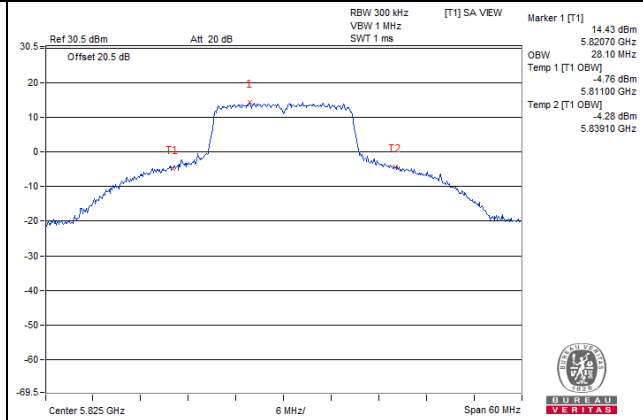

**802.11n (40MHz) / Chain 0: CH159**

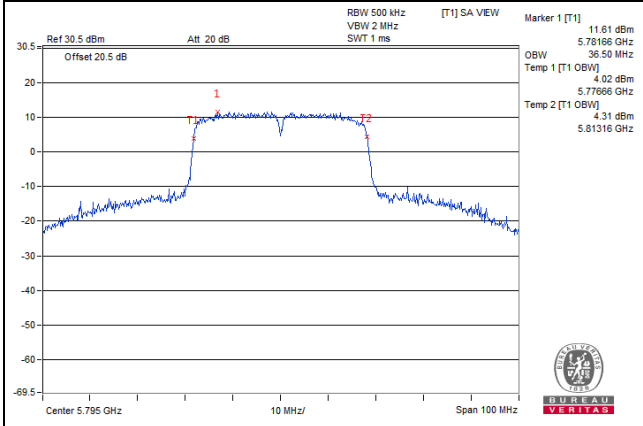

**802.11ac (80MHz) / Chain 2: CH155**

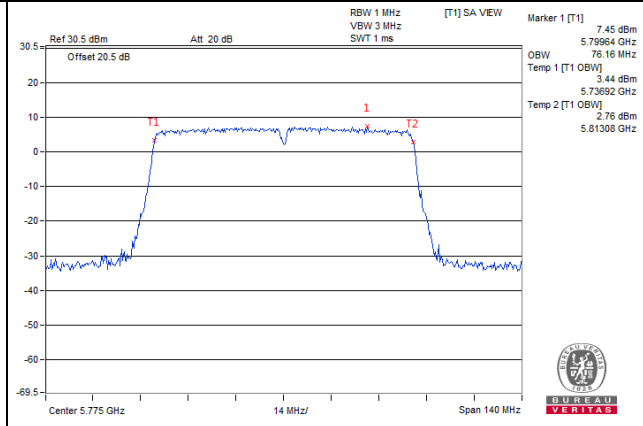

**CDD Mode (Mode B)**

**802.11a**

Channel	Channel Frequency (MHz)	Occupied Bandwidth (Mhz)				Pass / Fail
		Chain 0	Chain 1	Chain 2	Chain 3	
36	5180	16.44	16.44	16.44	16.44	Pass
40	5200	16.44	16.44	16.44	16.44	Pass
48	5240	16.44	16.44	16.44	16.44	Pass
149	5745	17.30	17.60	17.70	17.70	Pass
157	5785	32.60	32.90	32.20	31.40	Pass
165	5825	28.08	28.50	28.50	28.60	Pass

**802.11n (20MHz)**

Channel	Channel Frequency (MHz)	Occupied Bandwidth (Mhz)				Pass / Fail
		Chain 0	Chain 1	Chain 2	Chain 3	
36	5180	17.64	17.64	17.64	17.64	Pass
40	5200	17.64	17.64	17.64	17.64	Pass
48	5240	17.64	17.64	17.64	17.64	Pass
149	5745	17.82	17.90	17.90	17.90	Pass
157	5785	22.00	22.30	22.20	21.20	Pass
165	5825	20.10	20.40	20.50	20.60	Pass

**802.11n (40MHz)**

Channel	Channel Frequency (MHz)	Occupied Bandwidth (Mhz)				Pass / Fail
		Chain 0	Chain 1	Chain 2	Chain 3	
38	5190	36.00	36.20	36.00	36.00	Pass
46	5230	36.00	36.20	35.80	36.20	Pass
151	5755	36.08	36.16	36.16	36.16	Pass
159	5795	36.16	36.16	36.16	36.23	Pass

**802.11ac (80MHz)**

Channel	Channel Frequency (MHz)	Occupied Bandwidth (Mhz)				Pass / Fail
		Chain 0	Chain 1	Chain 2	Chain 3	
42	5210	75.84	76.08	75.84	75.84	Pass
155	5775	75.88	75.88	75.88	75.88	Pass

### Spectrum Plot of Worst Value

**802.11a / Chain 1: CH157**

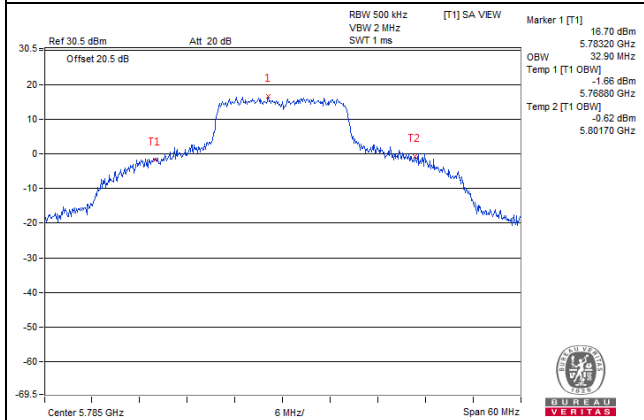

**802.11n (20MHz) / Chain 1: CH157**

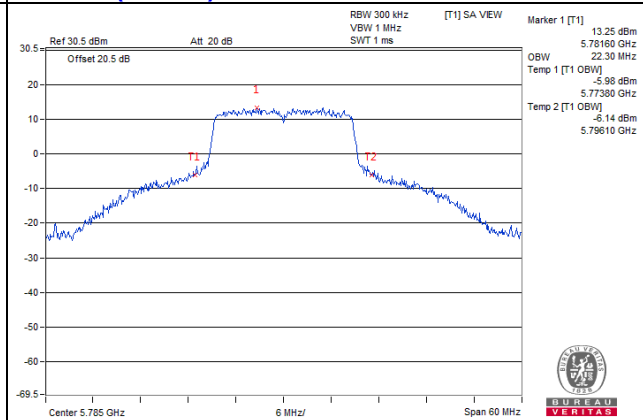

**802.11n (40MHz) / Chain 3: CH159**

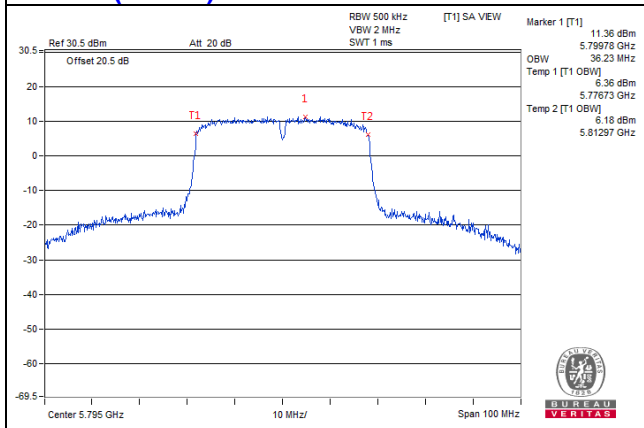

**802.11ac (80MHz) / Chain 1: CH42**

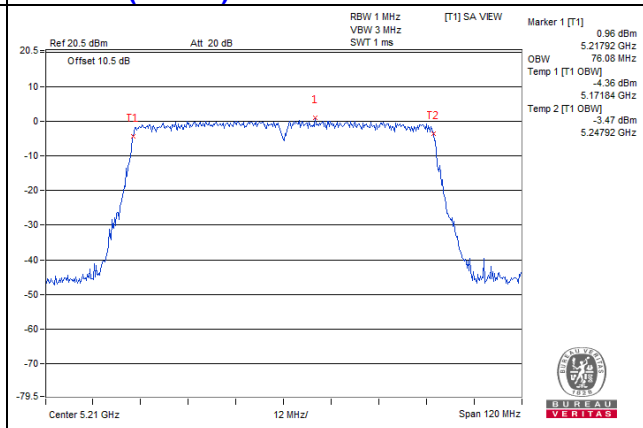

## 4.5 Peak Power Spectral Density Measurement

### 4.5.1 Limits of Peak Power Spectral Density Measurement

Operation Band	EUT Category		Limit
U-NII-1		Outdoor Access Point	17dBm/ MHz
		Fixed point-to-point Access Point	
	√	Indoor Access Point	
		Mobile and Portable client device	11dBm/ MHz
U-NII-2A	---		11dBm/ MHz
U-NII-2C	---		11dBm/ MHz
U-NII-3	√		30dBm/ 500kHz

### 4.5.2 Test Setup

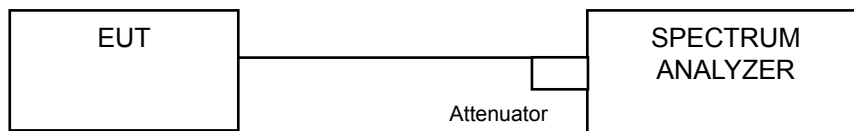

### 4.5.3 Test Instruments

Refer to section 4.1.2 to get information of above instrument.

### 4.5.4 Test Procedure

#### For U-NII-1 band:

##### Using method SA-1

1. Set span to encompass the entire emission bandwidth (EBW) of the signal.
2. Set RBW = 1 MHz, Set VBW ≥ 3 MHz, Detector = RMS
3. Sweep time = auto, trigger set to "free run".
4. Trace average at least 100 traces in power averaging mode.
5. Record the max value

#### ※For U-NII-3:

- 1) Set span to encompass the entire emission bandwidth (EBW) of the signal.
- 2) Set RBW = 500 kHz, Set VBW ≥ 3 RBW, Detector = RMS
- 3) Sweep time = auto, trigger set to "free run".
- 4) Trace average at least 100 traces in power averaging mode.
- 5) Record the max value and add 10 log (1/duty cycle)

### 4.5.5 Deviation from Test Standard

No deviation.

### 4.5.6 EUT Operating Condition

Same as Item 4.3.6.

#### 4.5.7 Test Results

#### CDD Mode (Mode A) For U-NII-1 band 802.11a

Chan.	Chan. Freq. (MHz)	PSD (dBm)				Duty Factor	Total PSD WITH Duty Factor (dBm)	MAX. Limit (dBm)	Pass / Fail
		Chain 0	Chain 1	Chain 2	Chain 3				
36	5180	-0.88	-0.88	-0.90	-0.85	0.19	5.33	12.51	Pass
40	5200	-1.11	-1.14	-1.13	-1.12	0.19	5.09	12.51	Pass
48	5240	-1.12	-1.13	-1.12	-1.11	0.19	5.09	12.51	Pass

**NOTE:**

- Method 1 of power density measurement of KDB 662911 is using for calculating total power density. Total power density is summing entire spectra across corresponding frequency bins on the various outputs by computer.
- Directional gain =  $10 \log[(10^{G1/20} + 10^{G2/20} + \dots + 10^{GN/20})^2 / 4] = 10.49\text{dBi} > 6\text{dBi}$ , so the PSD limit shall be reduced to  $17 - (10.49 - 6) = 12.51\text{dBm}$
- Refer to section 3.3 for duty cycle spectrum plot.

#### 802.11n (20MHz)

Chan.	Chan. Freq. (MHz)	PSD (dBm)				Total PSD (dBm)	MAX. Limit (dBm)	Pass / Fail
		Chain 0	Chain 1	Chain 2	Chain 3			
36	5180	-1.45	-1.43	-1.41	-1.43	4.59	12.51	Pass
40	5200	-1.15	-1.13	-1.17	-1.11	4.88	12.51	Pass
48	5240	-0.60	-0.61	-0.59	-0.59	5.42	12.51	Pass

**NOTE:**

- Method 1 of power density measurement of KDB 662911 is using for calculating total power density. Total power density is summing entire spectra across corresponding frequency bins on the various outputs by computer.
- Directional gain =  $10 \log[(10^{G1/20} + 10^{G2/20} + \dots + 10^{GN/20})^2 / 4] = 10.49\text{dBi} > 6\text{dBi}$ , so the PSD limit shall be reduced to  $17 - (10.49 - 6) = 12.51\text{dBm}$
- Refer to section 3.3 for duty cycle spectrum plot.

#### 802.11n (40MHz)

Chan.	Chan. Freq. (MHz)	PSD (dBm)				Duty Factor	Total PSD WITH Duty Factor (dBm)	MAX. Limit (dBm)	Pass / Fail
		Chain 0	Chain 1	Chain 2	Chain 3				
38	5190	-4.03	-4.03	-4.08	-4.06	0.21	2.18	12.51	Pass
46	5230	-3.65	-3.63	-3.66	-3.60	0.21	2.60	12.51	Pass

**NOTE:**

- Method 1 of power density measurement of KDB 662911 is using for calculating total power density. Total power density is summing entire spectra across corresponding frequency bins on the various outputs by computer.
- Directional gain =  $10 \log[(10^{G1/20} + 10^{G2/20} + \dots + 10^{GN/20})^2 / 4] = 10.49\text{dBi} > 6\text{dBi}$ , so the PSD limit shall be reduced to  $17 - (10.49 - 6) = 12.51\text{dBm}$
- Refer to section 3.3 for duty cycle spectrum plot.

**802.11ac (80MHz)**

Chan.	Chan. Freq. (MHz)	PSD (dBm)				Duty Factor	Total PSD WITH Duty Factor (dBm)	MAX. Limit (dBm)	Pass / Fail
		Chain 0	Chain 1	Chain 2	Chain 3				
42	5210	-7.34	-7.30	-7.29	-7.27	0.32	-0.96	12.51	Pass

**NOTE:**

- Method 1 of power density measurement of KDB 662911 is using for calculating total power density. Total power density is summing entire spectra across corresponding frequency bins on the various outputs by computer.
- Directional gain =  $10 \log[(10^{G1/20} + 10^{G2/20} + \dots + 10^{GN/20})^2 / 4]$  = 10.49dBi >6dBi, so the PSD limit shall be reduced to 17-(10.49-6) = 12.51dBm
- Refer to section 3.3 for duty cycle spectrum plot.

**Spectrum Plot of Worst Value**

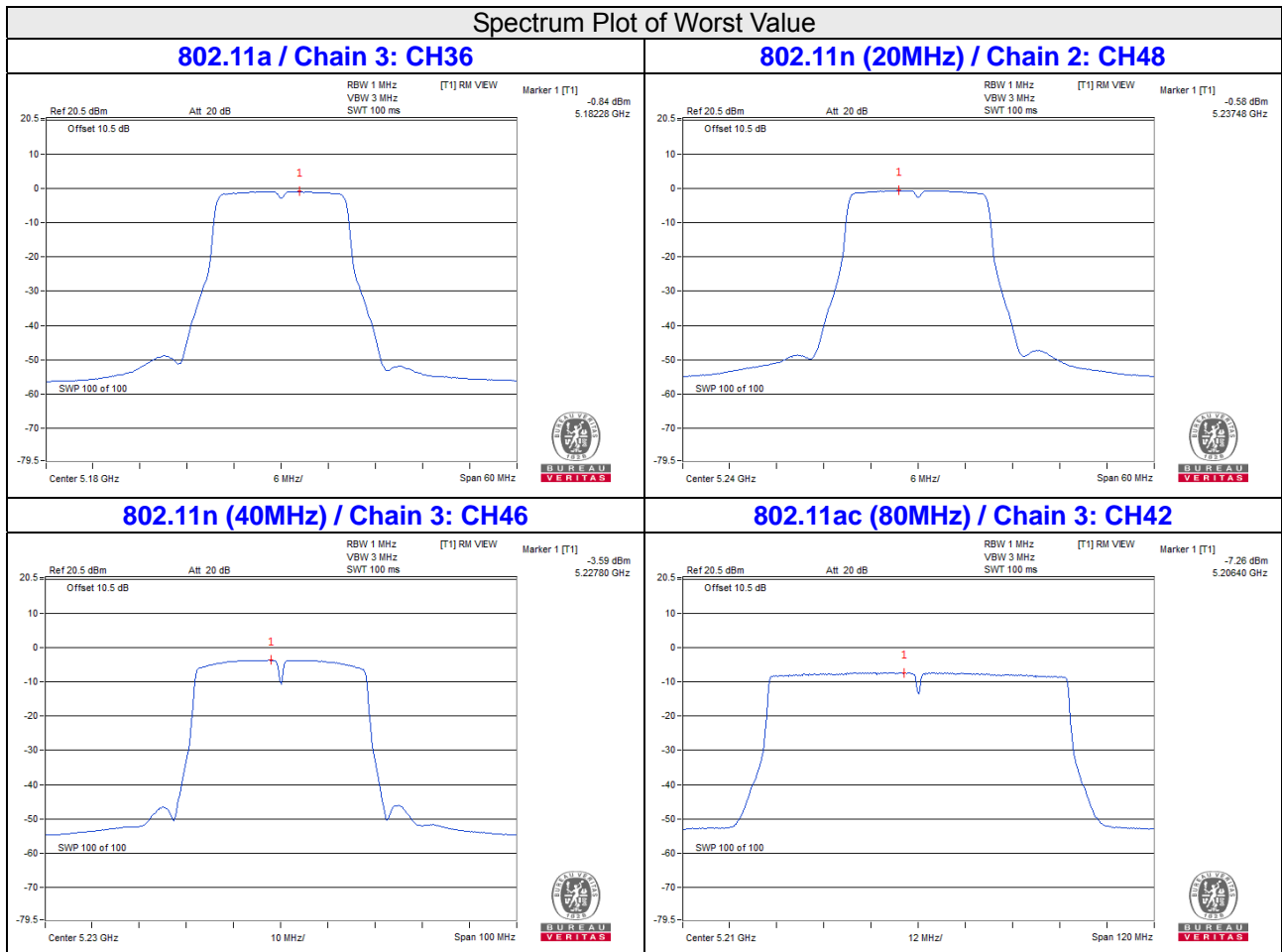

**CDD Mode (Mode B)**  
**For U-NII-1 band**  
**802.11a**

Chan.	Chan. Freq. (MHz)	PSD (dBm)				Duty Factor	Total PSD WITH Duty Factor (dBm)	MAX. Limit (dBm)	Pass / Fail
		Chain 0	Chain 1	Chain 2	Chain 3				
36	5180	-2.92	-2.97	-2.94	-2.97	0.19	3.26	10.98	Pass
40	5200	-3.08	-3.08	-3.08	-3.00	0.19	3.15	10.98	Pass
48	5240	-2.80	-2.77	-2.76	-2.80	0.19	3.43	10.98	Pass

**NOTE:**

- Method 1 of power density measurement of KDB 662911 is using for calculating total power density. Total power density is summing entire spectra across corresponding frequency bins on the various outputs by computer.
- Directional gain =  $10 \log[(10^{G1/20} + 10^{G2/20} + \dots + 10^{GN/20})^2 / 4] = 12.02\text{dBi} > 6\text{dBi}$ , so the PSD limit shall be reduced to  $17 - (12.02 - 6) = 10.98\text{dBm}$
- Refer to section 3.3 for duty cycle spectrum plot.

**802.11n (20MHz)**

Chan.	Chan. Freq. (MHz)	PSD (dBm)				Total PSD (dBm)	MAX. Limit (dBm)	Pass / Fail
		Chain 0	Chain 1	Chain 2	Chain 3			
36	5180	-2.95	-2.99	-2.98	-2.99	3.04	10.98	Pass
40	5200	-3.05	-3.11	-3.09	-3.09	2.94	10.98	Pass
48	5240	-2.72	-2.70	-2.73	-2.66	3.32	10.98	Pass

**NOTE:**

- Method 1 of power density measurement of KDB 662911 is using for calculating total power density. Total power density is summing entire spectra across corresponding frequency bins on the various outputs by computer.
- Directional gain =  $10 \log[(10^{G1/20} + 10^{G2/20} + \dots + 10^{GN/20})^2 / 4] = 12.02\text{dBi} > 6\text{dBi}$ , so the PSD limit shall be reduced to  $17 - (12.02 - 6) = 10.98\text{dBm}$
- Refer to section 3.3 for duty cycle spectrum plot.

**802.11n (40MHz)**

Chan.	Chan. Freq. (MHz)	PSD (dBm)				Duty Factor	Total PSD WITH Duty Factor (dBm)	MAX. Limit (dBm)	Pass / Fail
		Chain 0	Chain 1	Chain 2	Chain 3				
38	5190	-5.72	-5.73	-5.76	-5.77	0.21	0.49	10.98	Pass
46	5230	-5.57	-5.60	-5.62	-5.58	0.21	0.64	10.98	Pass

**NOTE:**

- Method 1 of power density measurement of KDB 662911 is using for calculating total power density. Total power density is summing entire spectra across corresponding frequency bins on the various outputs by computer.
- Directional gain =  $10 \log[(10^{G1/20} + 10^{G2/20} + \dots + 10^{GN/20})^2 / 4] = 12.02\text{dBi} > 6\text{dBi}$ , so the PSD limit shall be reduced to  $17 - (12.02 - 6) = 10.98\text{dBm}$
- Refer to section 3.3 for duty cycle spectrum plot.



### 802.11ac (80MHz)

Chan.	Chan. Freq. (MHz)	PSD (dBm)				Duty Factor	Total PSD WITH Duty Factor (dBm)	MAX. Limit (dBm)	Pass / Fail
		Chain 0	Chain 1	Chain 2	Chain 3				
42	5210	-9.55	-9.60	-9.56	-9.52	0.32	-3.22	10.98	Pass

**NOTE:**

- Method 1 of power density measurement of KDB 662911 is using for calculating total power density. Total power density is summing entire spectra across corresponding frequency bins on the various outputs by computer.
- Directional gain =  $10 \log[(10^{G1/20} + 10^{G2/20} + \dots + 10^{GN/20})^2 / 4] = 12.02\text{dBi} > 6\text{dBi}$ , so the PSD limit shall be reduced to  $17 - (12.02 - 6) = 10.98\text{dBm}$
- Refer to section 3.3 for duty cycle spectrum plot.

### Spectrum Plot of Worst Value

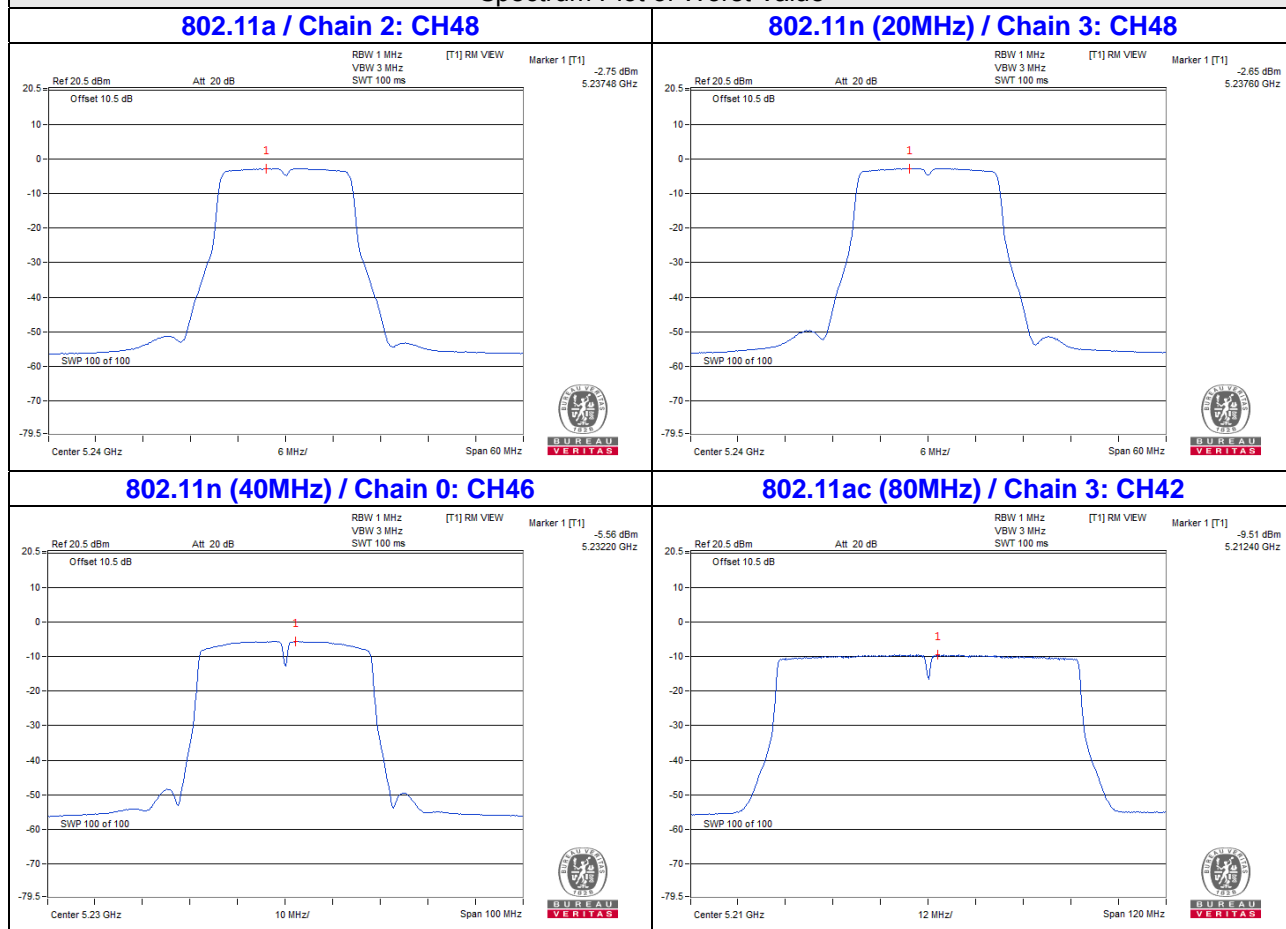

**CDD Mode (Mode A)**

For U-NII-3:  
802.11a

TX chain	Channel	Freq. (MHz)	PSD (dBm/500kHz)	10 log (N=4) dB	Duty Factor	Total PSD (dBm/500kHz)	Limit (dBm/500kHz)	Pass /Fail
0	149	5745	16.05	6.02	0.19	22.26	25.51	Pass
	157	5785	18.90	6.02	0.19	25.11	25.51	Pass
	165	5825	17.04	6.02	0.19	23.25	25.51	Pass
1	149	5745	15.98	6.02	0.19	22.19	25.51	Pass
	157	5785	18.88	6.02	0.19	25.09	25.51	Pass
	165	5825	17.44	6.02	0.19	23.65	25.51	Pass
2	149	5745	16.06	6.02	0.19	22.27	25.51	Pass
	157	5785	18.81	6.02	0.19	25.02	25.51	Pass
	165	5825	17.40	6.02	0.19	23.61	25.51	Pass
3	149	5745	16.23	6.02	0.19	22.44	25.51	Pass
	157	5785	18.98	6.02	0.19	25.19	25.51	Pass
	165	5825	17.36	6.02	0.19	23.57	25.51	Pass

**NOTE:**

1. Directional gain =  $10 \log[(10^{G1/20} + 10^{G2/20} + \dots + 10^{GN/20})^2 / 4] = 10.49\text{dBi} > 6\text{dBi}$ , so the PSD limit shall be reduced to  $30 - (10.49 - 6) = 25.51\text{dBm}$
2. Refer to section 3.3 for duty cycle spectrum plot.

**802.11n (20MHz)**

TX chain	Channel	Freq. (MHz)	PSD (dBm/500kHz)	10 log (N=4) dB	Total PSD (dBm/500kHz)	Limit (dBm/500kHz)	Pass /Fail
0	149	5745	15.44	6.02	21.46	25.51	Pass
	157	5785	16.12	6.02	22.14	25.51	Pass
	165	5825	17.05	6.02	23.07	25.51	Pass
1	149	5745	15.76	6.02	21.78	25.51	Pass
	157	5785	15.86	6.02	21.88	25.51	Pass
	165	5825	16.78	6.02	22.80	25.51	Pass
2	149	5745	15.92	6.02	21.94	25.51	Pass
	157	5785	15.83	6.02	21.85	25.51	Pass
	165	5825	17.07	6.02	23.09	25.51	Pass
3	149	5745	15.34	6.02	21.36	25.51	Pass
	157	5785	16.00	6.02	22.02	25.51	Pass
	165	5825	16.86	6.02	22.88	25.51	Pass

**NOTE:**

1. Directional gain =  $10 \log[(10^{G1/20} + 10^{G2/20} + \dots + 10^{GN/20})^2 / 4] = 10.49\text{dBi} > 6\text{dBi}$ , so the PSD limit shall be reduced to  $30 - (10.49 - 6) = 25.51\text{dBm}$
2. Refer to section 3.3 for duty cycle spectrum plot.

### 802.11n (40MHz)

TX chain	Channel	Freq. (MHz)	PSD (dBm/500kHz)	10 log (N=4) dB	Duty Factor	Total PSD (dBm/500kHz)	Limit (dBm/500kHz)	Pass /Fail
0	151	5755	11.50	6.02	0.21	17.73	25.51	Pass
	159	5795	12.61	6.02	0.21	18.84	25.51	Pass
1	151	5755	11.46	6.02	0.21	17.69	25.51	Pass
	159	5795	12.39	6.02	0.21	18.62	25.51	Pass
2	151	5755	11.41	6.02	0.21	17.64	25.51	Pass
	159	5795	12.57	6.02	0.21	18.80	25.51	Pass
3	151	5755	11.22	6.02	0.21	17.45	25.51	Pass
	159	5795	12.50	6.02	0.21	18.73	25.51	Pass

**NOTE:**

- Directional gain =  $10 \log[(10^{G1/20} + 10^{G2/20} + \dots + 10^{GN/20})^2 / 4] = 10.49\text{dBi} > 6\text{dBi}$ , so the PSD limit shall be reduced to  $30 - (10.49 - 6) = 25.51\text{dBm}$
- Refer to section 3.3 for duty cycle spectrum plot.

### 802.11ac (80MHz)

TX chain	Channel	Freq. (MHz)	PSD (dBm/500kHz)	10 log (N=4) dB	Duty Factor	Total PSD (dBm/500kHz)	Limit (dBm/500kHz)	Pass /Fail
0	155	5775	4.59	6.02	0.32	10.93	25.51	Pass
1	155	5775	5.65	6.02	0.32	11.99	25.51	Pass
2	155	5775	5.01	6.02	0.32	11.35	25.51	Pass
3	155	5775	4.82	6.02	0.32	11.16	25.51	Pass

**NOTE:**

- Directional gain =  $10 \log[(10^{G1/20} + 10^{G2/20} + \dots + 10^{GN/20})^2 / 4] = 10.49\text{dBi} > 6\text{dBi}$ , so the PSD limit shall be reduced to  $30 - (10.49 - 6) = 25.51\text{dBm}$
- Refer to section 3.3 for duty cycle spectrum plot.

Spectrum Plot of Worst Value

802.11a / Chain 3: CH157

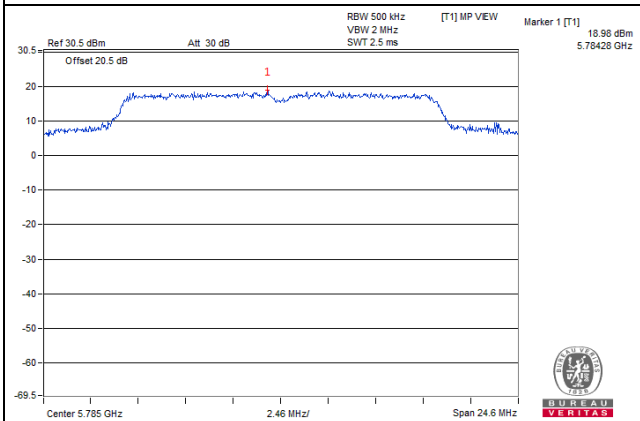

802.11n (20MHz) / Chain 2: CH165

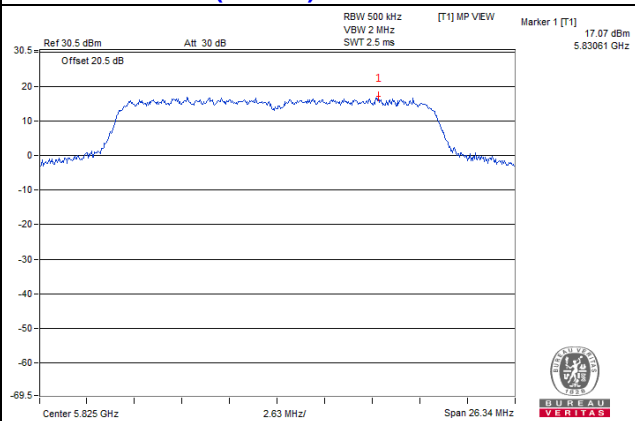

802.11n (40MHz) / Chain 0: CH159

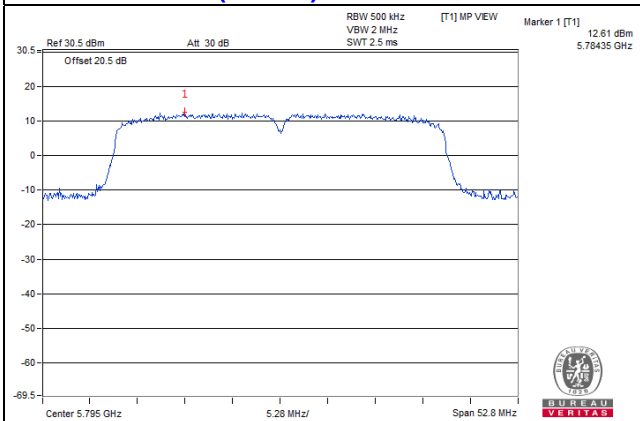

802.11ac (80MHz) / Chain 1: CH155

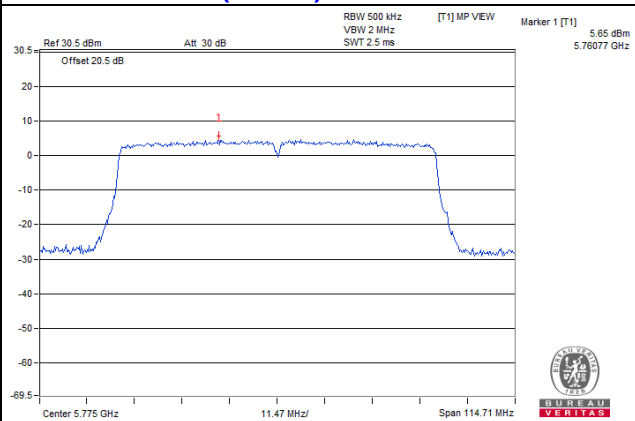

### CDD Mode (Mode B)

For U-NII-3:  
802.11a

TX chain	Channel	Freq. (MHz)	PSD (dBm/500kHz)	10 log (N=4) dB	Duty Factor	Total PSD (dBm/500kHz)	Limit (dBm/500kHz)	Pass /Fail
0	149	5745	16.75	6.02	0.19	22.96	23.98	Pass
	157	5785	17.45	6.02	0.19	23.66	23.98	Pass
	165	5825	17.04	6.02	0.19	23.25	23.98	Pass
1	149	5745	16.62	6.02	0.19	22.83	23.98	Pass
	157	5785	17.39	6.02	0.19	23.60	23.98	Pass
	165	5825	17.44	6.02	0.19	23.65	23.98	Pass
2	149	5745	16.80	6.02	0.19	23.01	23.98	Pass
	157	5785	17.48	6.02	0.19	23.69	23.98	Pass
	165	5825	17.40	6.02	0.19	23.61	23.98	Pass
3	149	5745	16.77	6.02	0.19	22.98	23.98	Pass
	157	5785	17.53	6.02	0.19	23.74	23.98	Pass
	165	5825	17.36	6.02	0.19	23.57	23.98	Pass

**NOTE:**

1. Directional gain =  $10 \log[(10^{G1/20} + 10^{G2/20} + \dots + 10^{GN/20})^2 / 4] = 12.02\text{dBi} > 6\text{dBi}$ , so the PSD limit shall be reduced to  $30 - (12.02 - 6) = 23.98\text{dBm}$
2. Refer to section 3.3 for duty cycle spectrum plot.

### 802.11n (20MHz)

TX chain	Channel	Freq. (MHz)	PSD (dBm/500kHz)	10 log (N=4) dB	Total PSD (dBm/500kHz)	Limit (dBm/500kHz)	Pass /Fail
0	149	5745	16.43	6.02	22.45	23.98	Pass
	157	5785	17.12	6.02	23.14	23.98	Pass
	165	5825	16.61	6.02	22.63	23.98	Pass
1	149	5745	16.23	6.02	22.25	23.98	Pass
	157	5785	16.97	6.02	22.99	23.98	Pass
	165	5825	16.48	6.02	22.50	23.98	Pass
2	149	5745	16.00	6.02	22.02	23.98	Pass
	157	5785	16.89	6.02	22.91	23.98	Pass
	165	5825	16.87	6.02	22.89	23.98	Pass
3	149	5745	16.76	6.02	22.78	23.98	Pass
	157	5785	16.90	6.02	22.92	23.98	Pass
	165	5825	16.78	6.02	22.80	23.98	Pass

**NOTE:**

1. Directional gain =  $10 \log[(10^{G1/20} + 10^{G2/20} + \dots + 10^{GN/20})^2 / 4] = 12.02\text{dBi} > 6\text{dBi}$ , so the PSD limit shall be reduced to  $30 - (12.02 - 6) = 23.98\text{dBm}$
2. Refer to section 3.3 for duty cycle spectrum plot.

### 802.11n (40MHz)

TX chain	Channel	Freq. (MHz)	PSD (dBm/500kHz)	10 log (N=4) dB	Duty Factor	Total PSD (dBm/500kHz)	Limit (dBm/500kHz)	Pass /Fail
0	151	5755	11.50	6.02	0.21	17.73	23.98	Pass
	159	5795	12.11	6.02	0.21	18.34	23.98	Pass
1	151	5755	11.46	6.02	0.21	17.69	23.98	Pass
	159	5795	12.24	6.02	0.21	18.47	23.98	Pass
2	151	5755	11.41	6.02	0.21	17.64	23.98	Pass
	159	5795	12.14	6.02	0.21	18.37	23.98	Pass
3	151	5755	11.22	6.02	0.21	17.45	23.98	Pass
	159	5795	12.32	6.02	0.21	18.55	23.98	Pass

**NOTE:**

- Directional gain =  $10 \log[(10^{G1/20} + 10^{G2/20} + \dots + 10^{GN/20})^2 / 4] = 12.02\text{dBi} > 6\text{dBi}$ , so the PSD limit shall be reduced to  $30 - (12.02 - 6) = 23.98\text{dBm}$
- Refer to section 3.3 for duty cycle spectrum plot.

### 802.11ac (80MHz)

TX chain	Channel	Freq. (MHz)	PSD (dBm/500kHz)	10 log (N=4) dB	Duty Factor	Total PSD (dBm/500kHz)	Limit (dBm/500kHz)	Pass /Fail
0	155	5775	3.31	6.02	0.32	9.65	23.98	Pass
1	155	5775	3.74	6.02	0.32	10.08	23.98	Pass
2	155	5775	3.24	6.02	0.32	9.58	23.98	Pass
3	155	5775	4.08	6.02	0.32	10.42	23.98	Pass

**NOTE:**

- Directional gain =  $10 \log[(10^{G1/20} + 10^{G2/20} + \dots + 10^{GN/20})^2 / 4] = 12.02\text{dBi} > 6\text{dBi}$ , so the PSD limit shall be reduced to  $30 - (12.02 - 6) = 23.98\text{dBm}$
- Refer to section 3.3 for duty cycle spectrum plot.

Spectrum Plot of Worst Value

802.11a / Chain 3: CH157

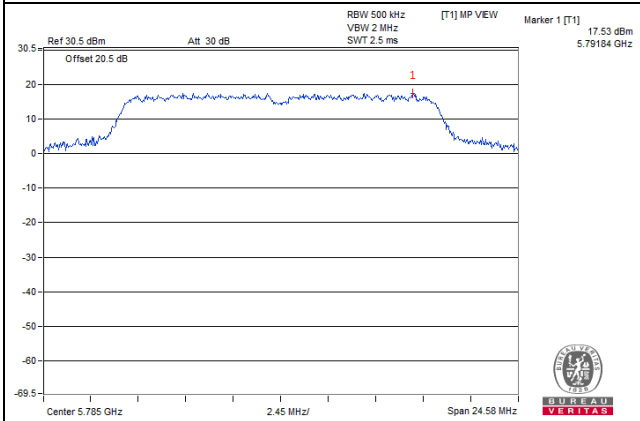

802.11n (20MHz) / Chain 0: CH157

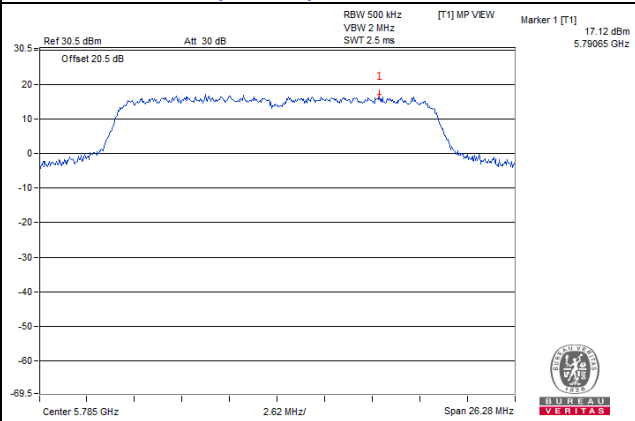

802.11n (40MHz) / Chain 3: CH159

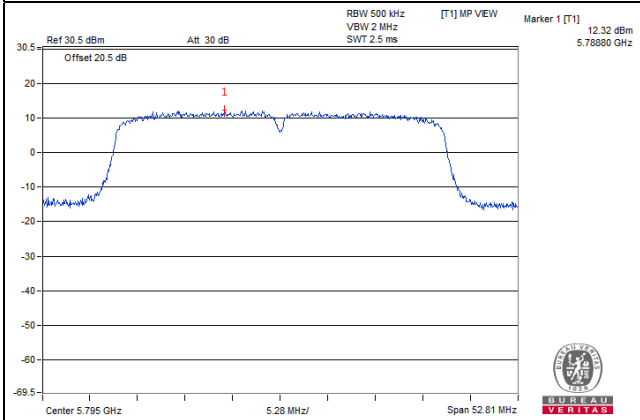

802.11ac (80MHz) / Chain 3: CH155

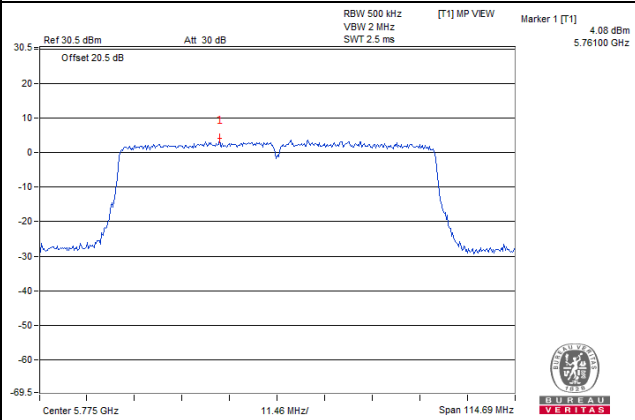

## 4.6 6dB Bandwidth Measurement

### 4.6.1 Limits of 6dB Bandwidth Measurement

The minimum of 6dB Bandwidth Measurement is 0.5MHz.

### 4.6.2 Test Setup

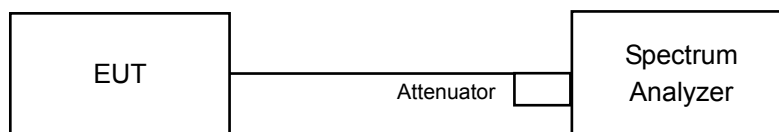

### 4.6.3 Test Instruments

Refer to section 4.1.2 to get information of above instrument.

### 4.6.4 Test Procedure

#### MEASUREMENT PROCEDURE REF

- a. Set resolution bandwidth (RBW) = 100kHz
- b. Set the video bandwidth (VBW)  $\geq 3 \times$  RBW, Detector = Peak.
- c. Trace mode = max hold.
- d. Sweep = auto couple.
- e. Measure the maximum width of the emission that is constrained by the frequencies associated with the two amplitude points (upper and lower) that are attenuated by 6 dB relative to the maximum level measured in the fundamental emission

### 4.6.5 Deviation from Test Standard

No deviation.

### 4.6.6 EUT Operating Condition

The software provided by client to enable the EUT under transmission condition continuously at lowest, middle and highest channel frequencies individually.



## 4.6.7 Test Results

**CDD Mode (Mode A)**
**802.11a**

Channel	Frequency (MHz)	6dB Bandwidth (MHz)				Minimum Limit (MHz)	Pass / Fail
		Chain 0	Chain 1	Chain 2	Chain 3		
149	5745	16.36	16.39	16.38	16.38	0.5	Pass
157	5785	16.39	16.40	16.40	16.40	0.5	Pass
165	5825	16.36	16.38	16.37	16.38	0.5	Pass

**802.11n (20MHz)**

Channel	Frequency (MHz)	6dB Bandwidth (MHz)				Minimum Limit (MHz)	Pass / Fail
		Chain 0	Chain 1	Chain 2	Chain 3		
149	5745	17.56	17.61	17.58	17.59	0.5	Pass
157	5785	17.59	17.59	17.59	17.58	0.5	Pass
165	5825	17.60	17.60	17.56	17.60	0.5	Pass

**802.11n (40MHz)**

Channel	Frequency (MHz)	6dB Bandwidth (MHz)				Minimum Limit (MHz)	Pass / Fail
		Chain 0	Chain 1	Chain 2	Chain 3		
151	5755	35.17	35.18	35.24	35.16	0.5	Pass
159	5795	35.20	35.23	35.15	35.20	0.5	Pass

**802.11ac (80MHz)**

Channel	Frequency (MHz)	6dB Bandwidth (MHz)				Minimum Limit (MHz)	Pass / Fail
		Chain 0	Chain 1	Chain 2	Chain 3		
155	5775	76.39	76.47	76.45	76.47	0.5	Pass

Spectrum Plot of Worst Value

802.11a / Chain 1: CH157

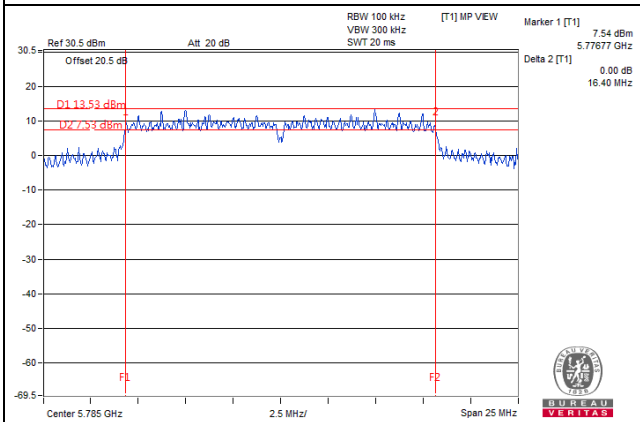

802.11n (20MHz) / Chain 1: CH149

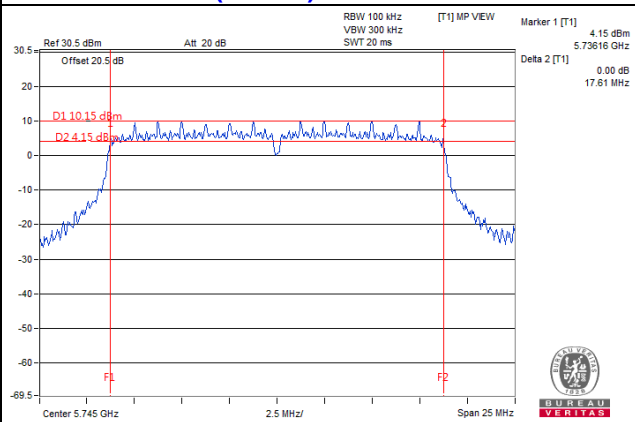

802.11n (40MHz) / Chain 2: CH151

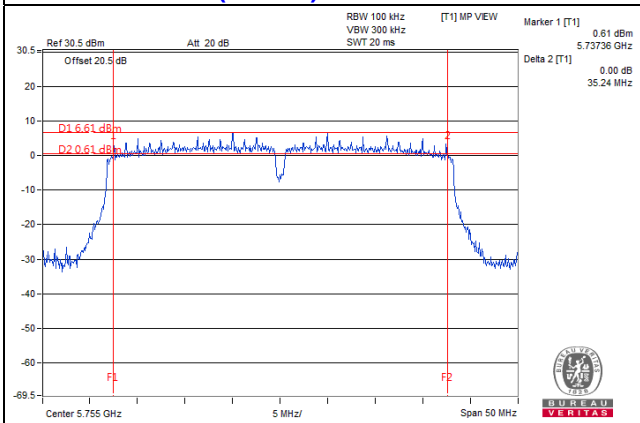

802.11ac (80MHz) / Chain 1: CH155

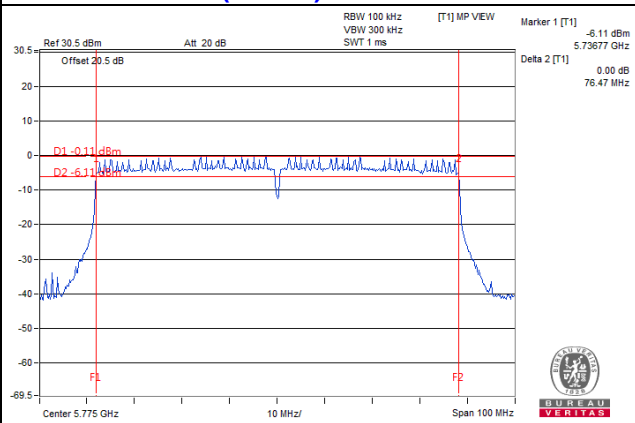

**CDD Mode (Mode B)**
**802.11a**

Channel	Frequency (MHz)	6dB Bandwidth (MHz)				Minimum Limit (MHz)	Pass / Fail
		Chain 0	Chain 1	Chain 2	Chain 3		
149	5745	16.37	16.36	16.38	16.38	0.5	Pass
157	5785	16.38	16.36	16.39	16.39	0.5	Pass
165	5825	16.36	16.38	16.37	16.38	0.5	Pass

**802.11n (20MHz)**

Channel	Frequency (MHz)	6dB Bandwidth (MHz)				Minimum Limit (MHz)	Pass / Fail
		Chain 0	Chain 1	Chain 2	Chain 3		
149	5745	17.58	17.57	17.57	17.57	0.5	Pass
157	5785	17.52	17.61	17.58	17.60	0.5	Pass
165	5825	17.58	17.58	17.56	17.59	0.5	Pass

**802.11n (40MHz)**

Channel	Frequency (MHz)	6dB Bandwidth (MHz)				Minimum Limit (MHz)	Pass / Fail
		Chain 0	Chain 1	Chain 2	Chain 3		
151	5755	35.17	35.18	35.24	35.16	0.5	Pass
159	5795	35.12	35.18	35.22	35.21	0.5	Pass

**802.11ac (80MHz)**

Channel	Frequency (MHz)	6dB Bandwidth (MHz)				Minimum Limit (MHz)	Pass / Fail
		Chain 0	Chain 1	Chain 2	Chain 3		
155	5775	76.42	76.48	76.47	76.46	0.5	Pass



### Spectrum Plot of Worst Value

#### 802.11a / Chain 2: CH157

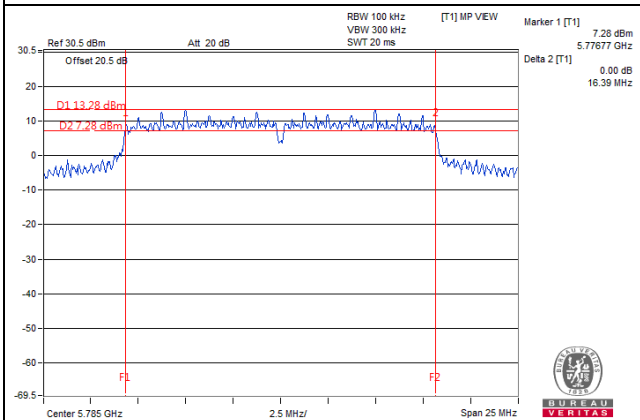

#### 802.11n (20MHz) / Chain 1: CH157

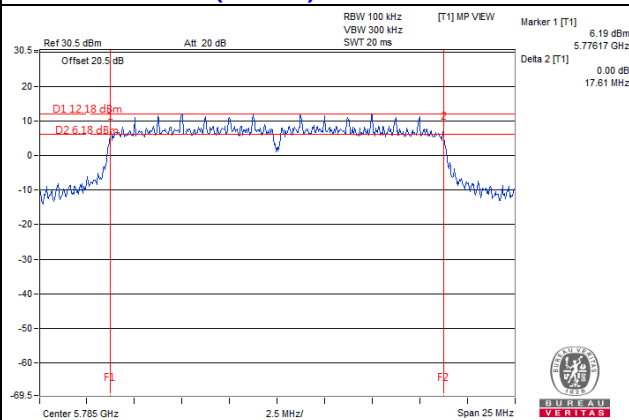

#### 802.11n (40MHz) / Chain 2: CH151

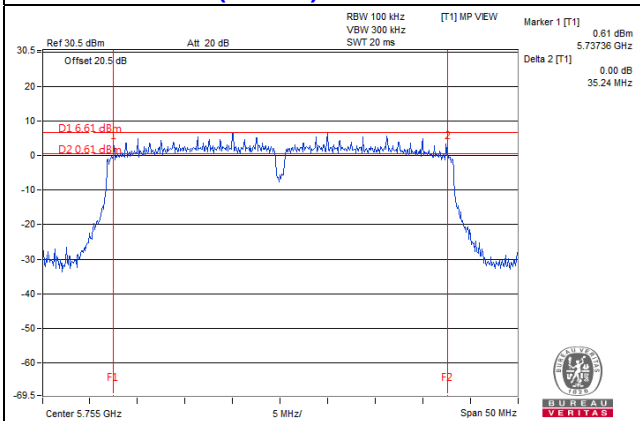

#### 802.11ac (80MHz) / Chain 1: CH155

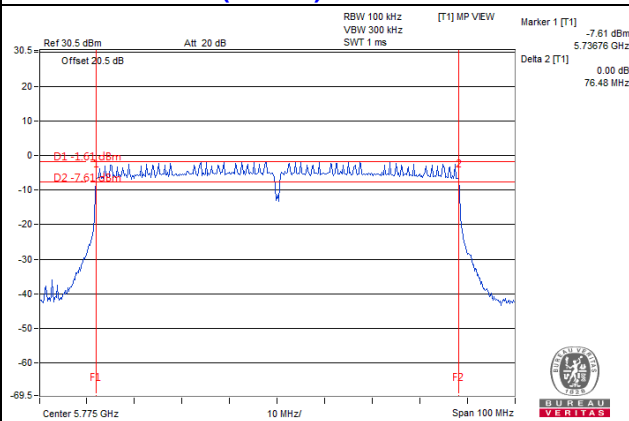

## 5 Pictures of Test Arrangements

Please refer to the attached file (Test Setup Photo).

## Annex A- Radiated Out of Band Emission (OOBE) Measurement (For U-NII-3 band)

**CDD Mode (Mode A)**

**802.11a**

**CH149**

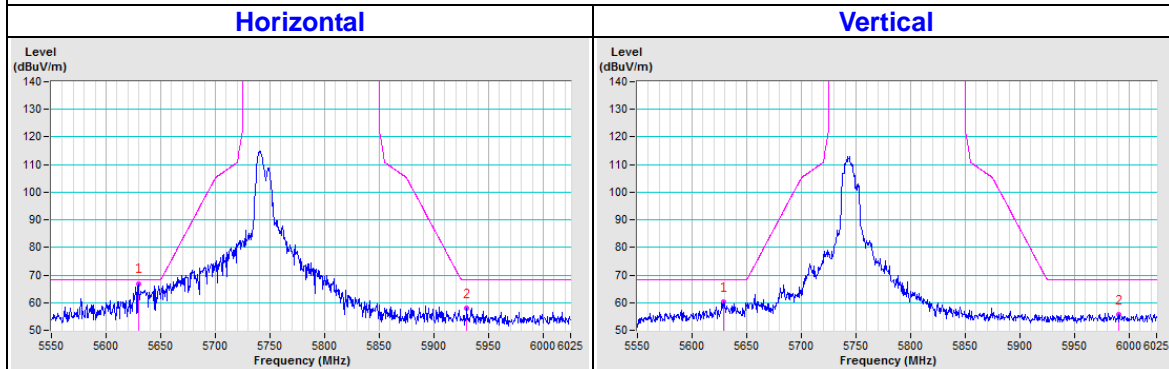

**CH157**

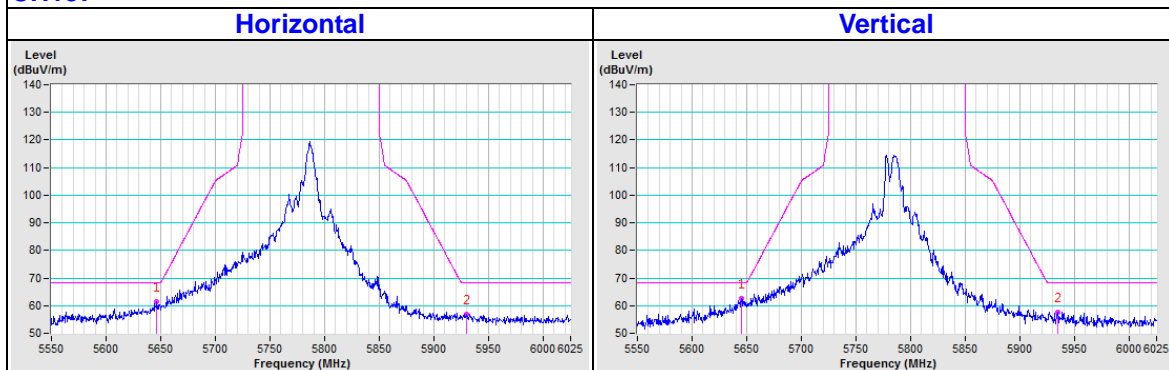

**CH165**

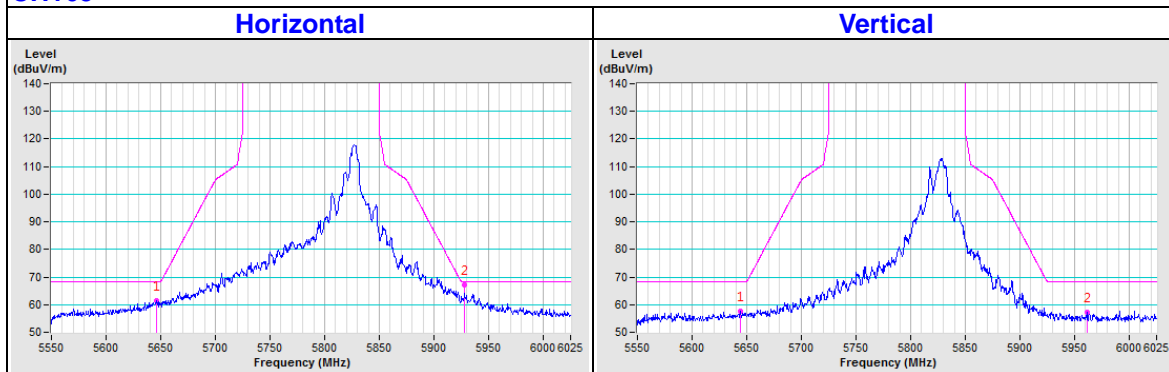

### 802.11n (20MHz)

#### CH149

**Horizontal**

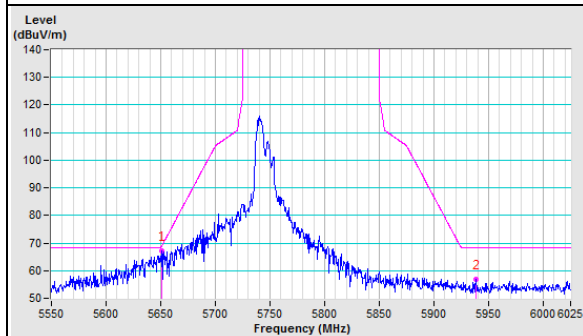

**Vertical**

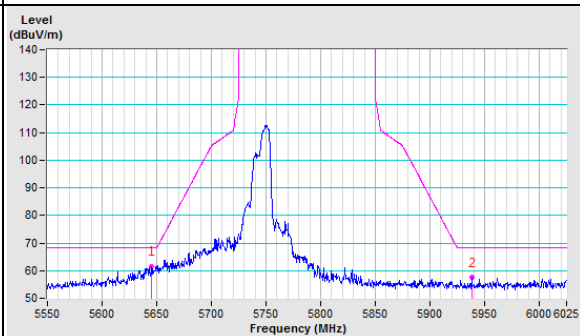

#### CH157

**Horizontal**

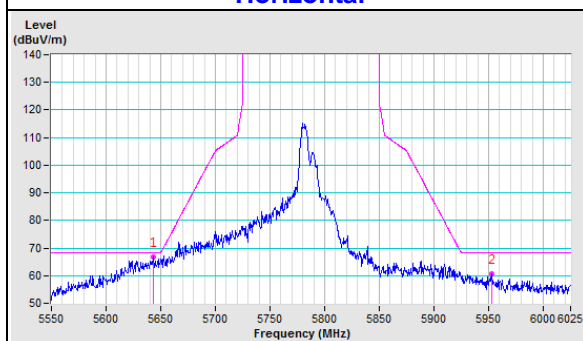

**Vertical**

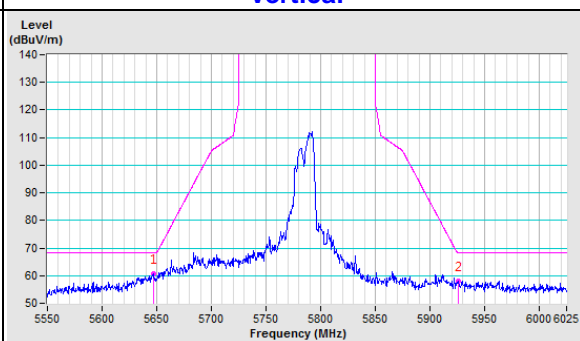

#### CH165

**Horizontal**

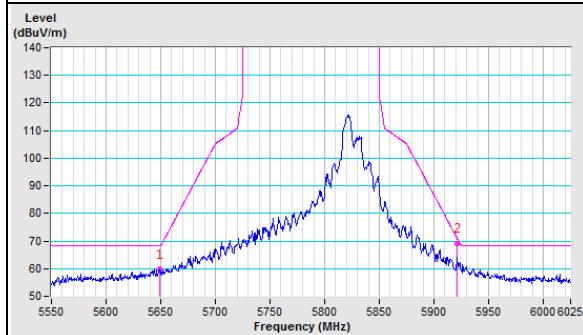

**Vertical**

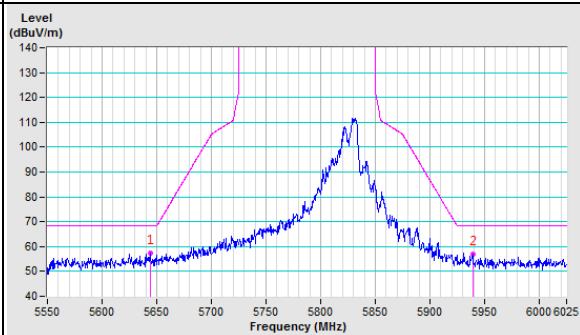

**802.11n (40MHz)**

**CH151**

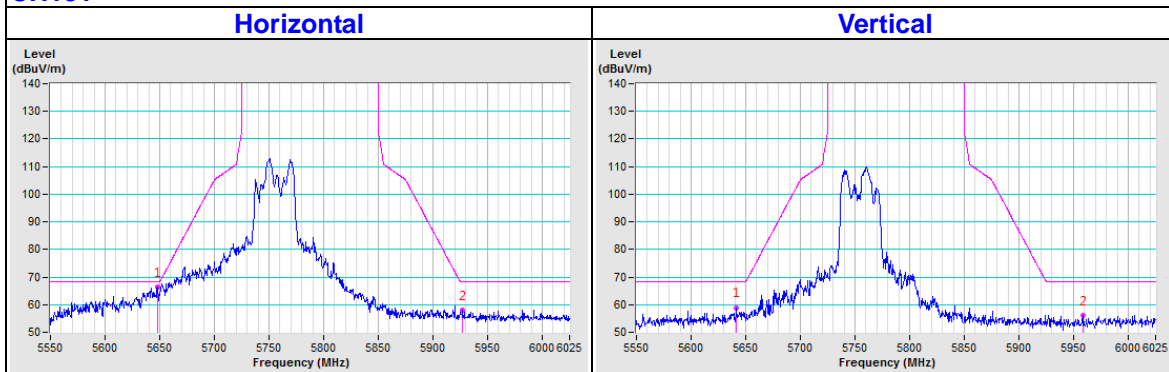

**CH159**

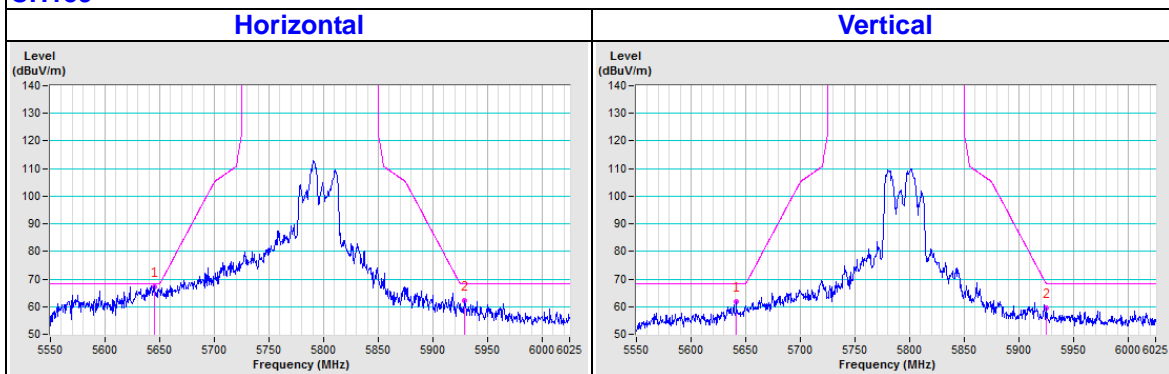

**802.11ac (80MHz)**

**CH155**

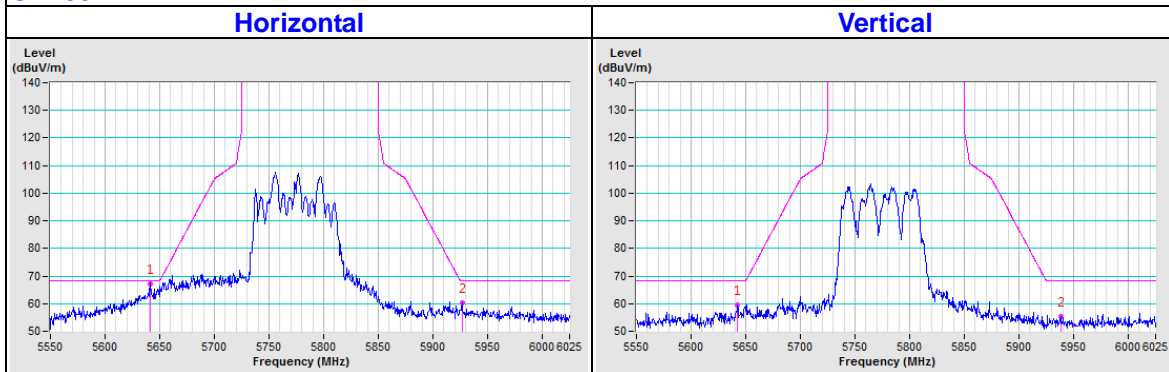



**CDD Mode (Mode B)**

**802.11a**

**CH149**

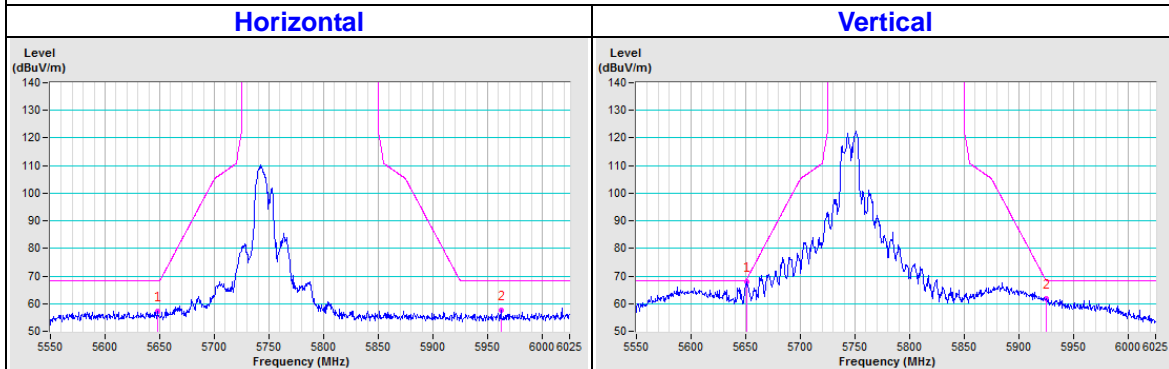

**CH157**

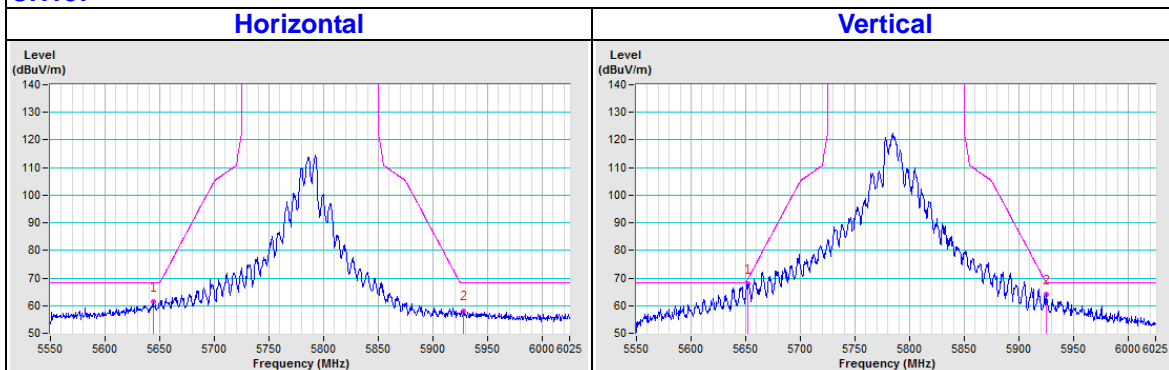

**CH165**

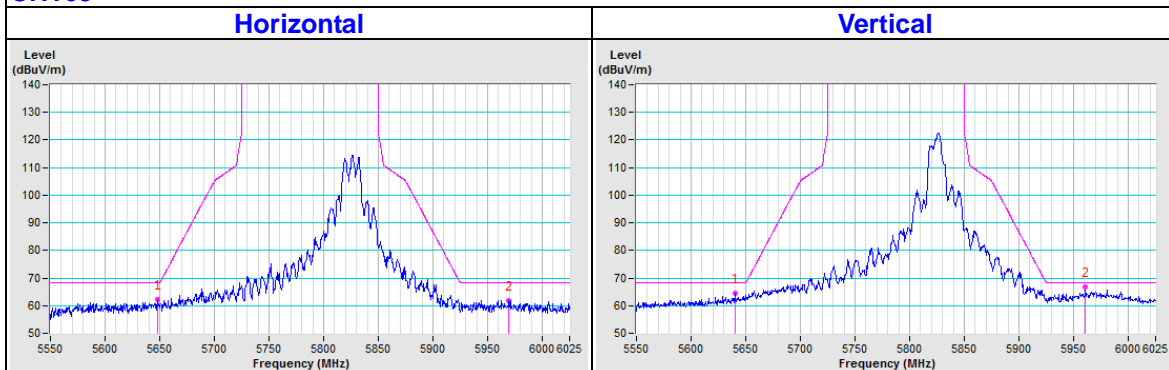

**802.11n (20MHz)  
CH149**

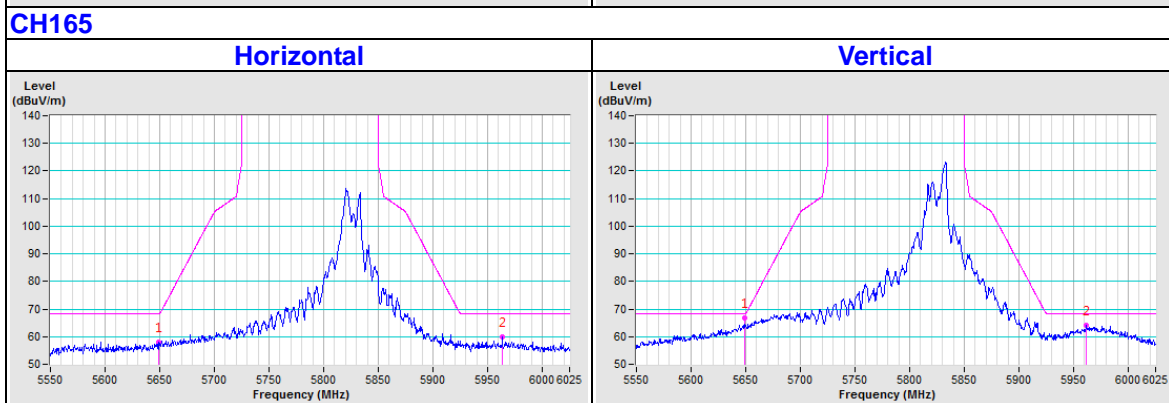
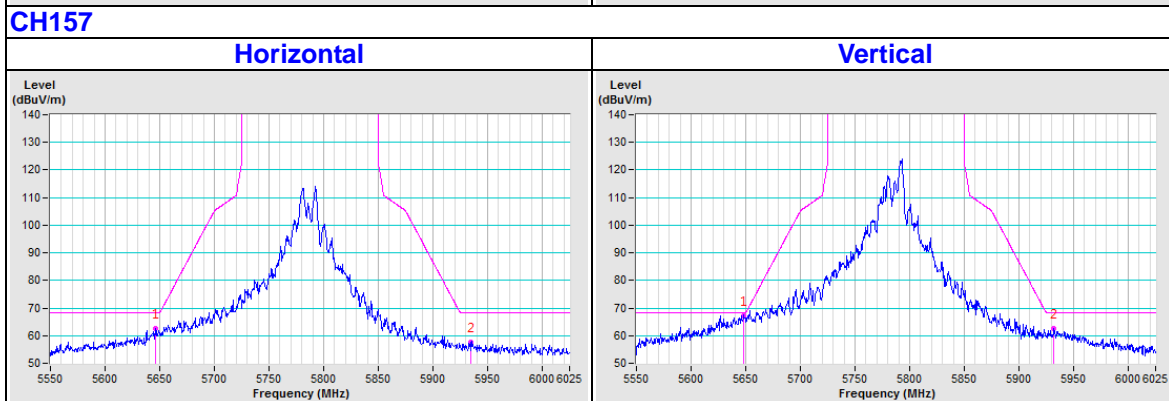
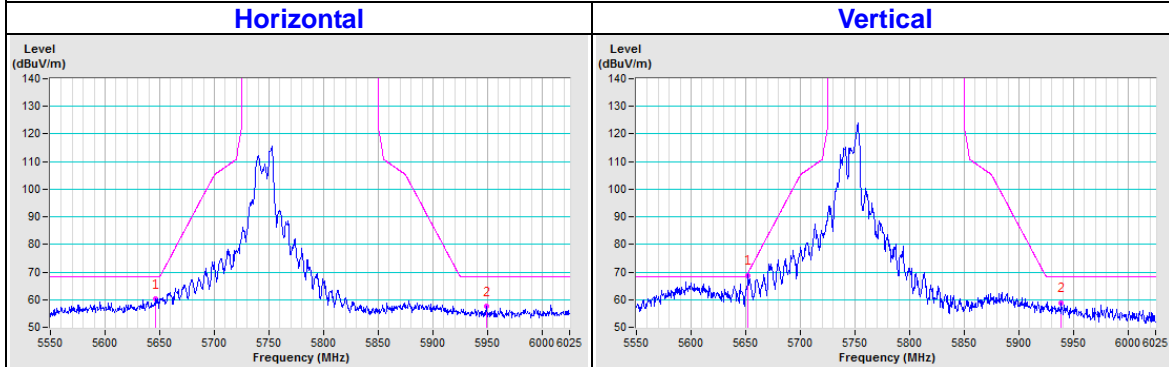

### 802.11n (40MHz)

#### CH151

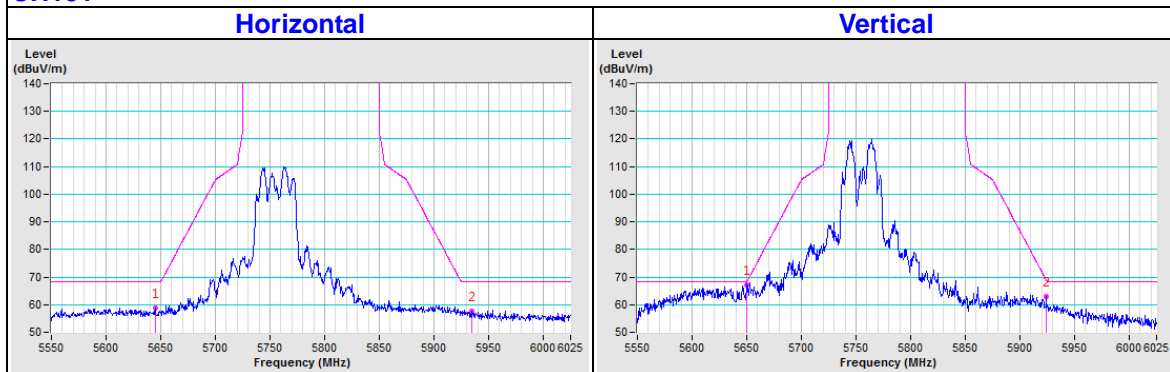

#### CH159

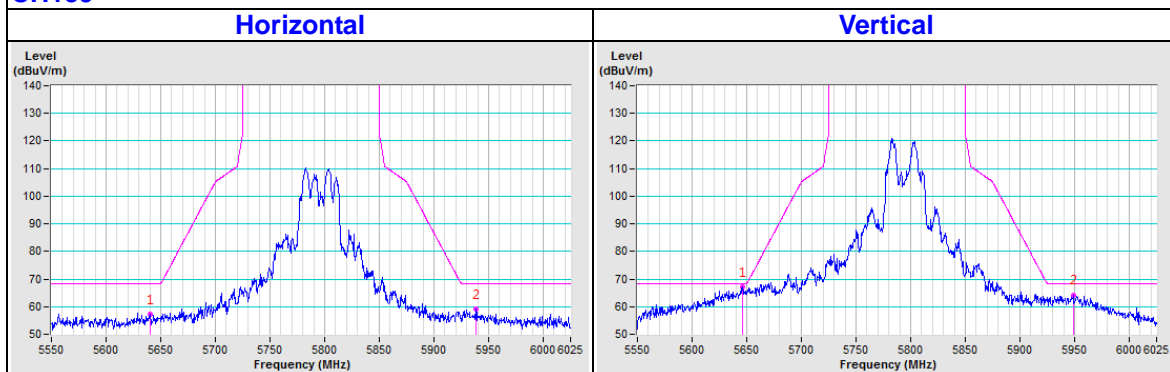

### 802.11ac (80MHz)

#### CH155

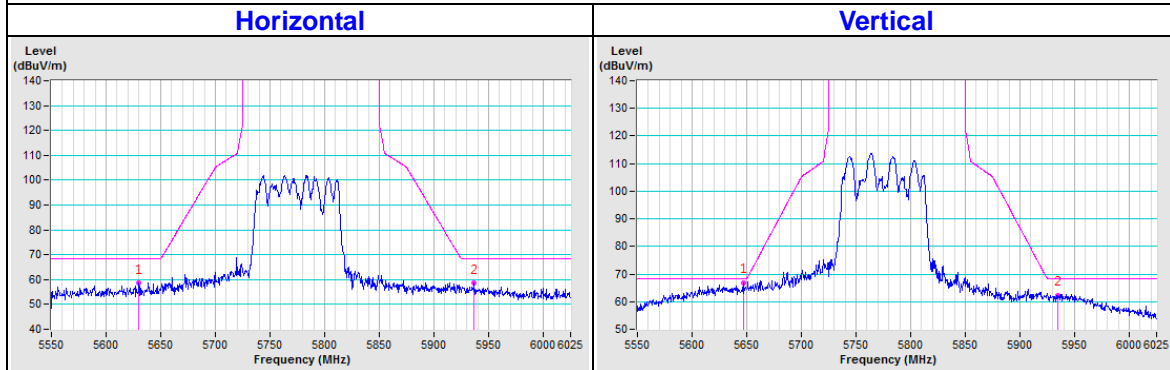

**Beamforming\_NSS1 Mode (Mode A)**

**802.11ac (20MHz)**

**CH149**

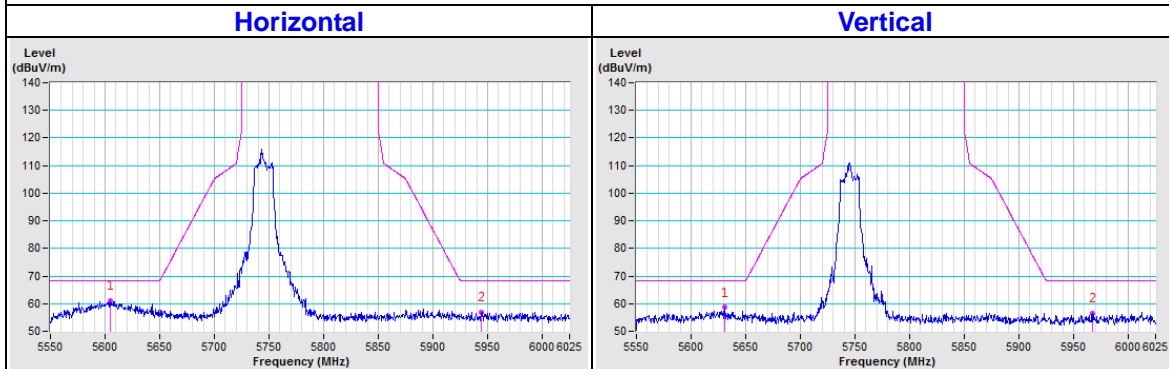

**CH157**

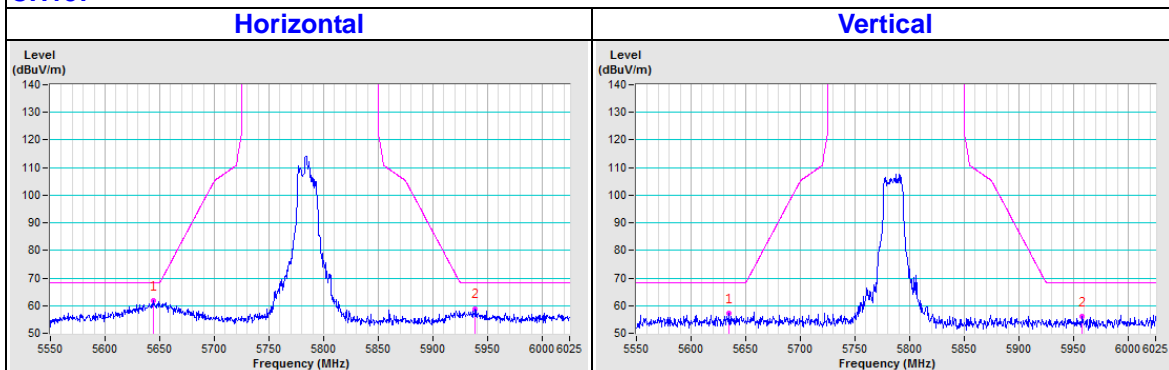

**CH165**

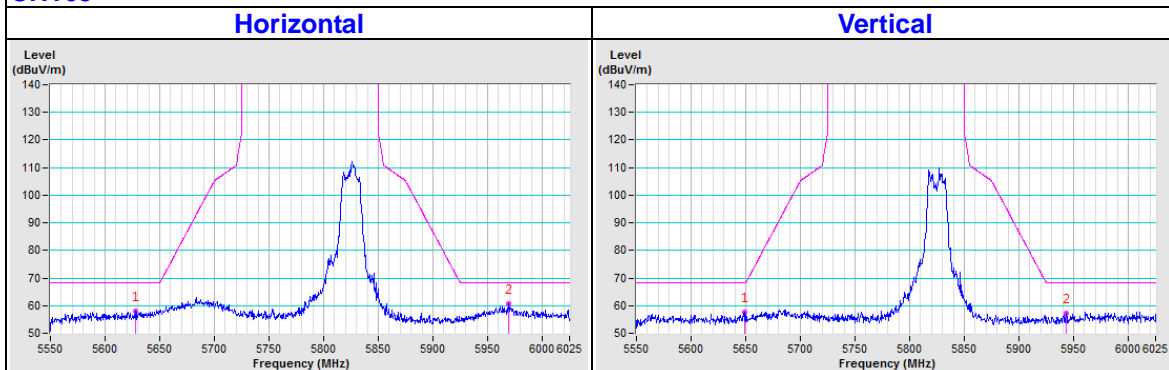

### 802.11ac (40MHz)

CH151

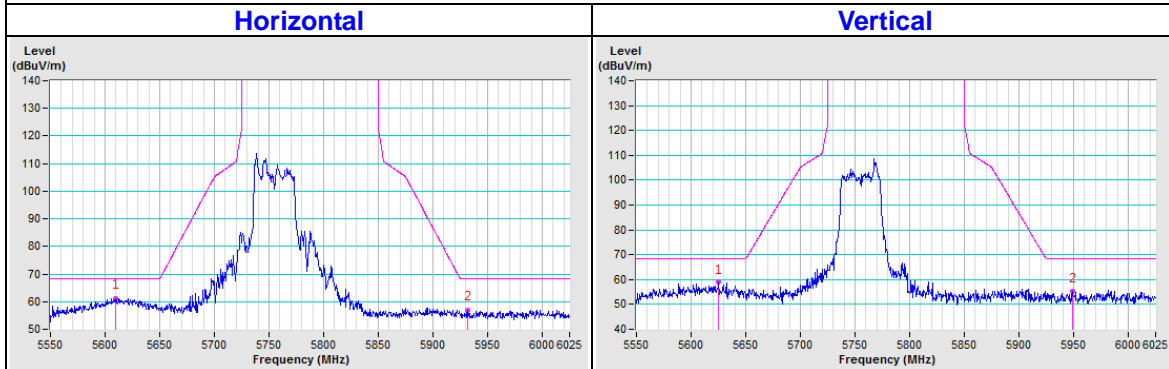

CH159

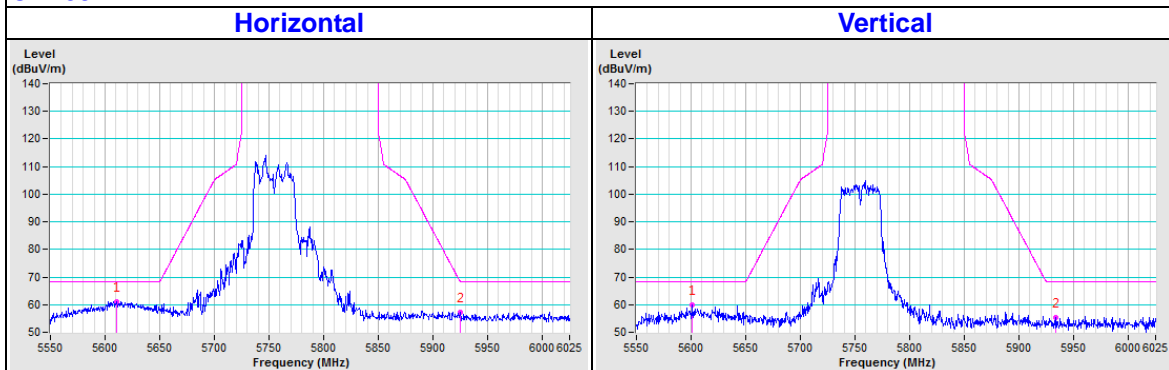

### 802.11ac (80MHz)

CH155

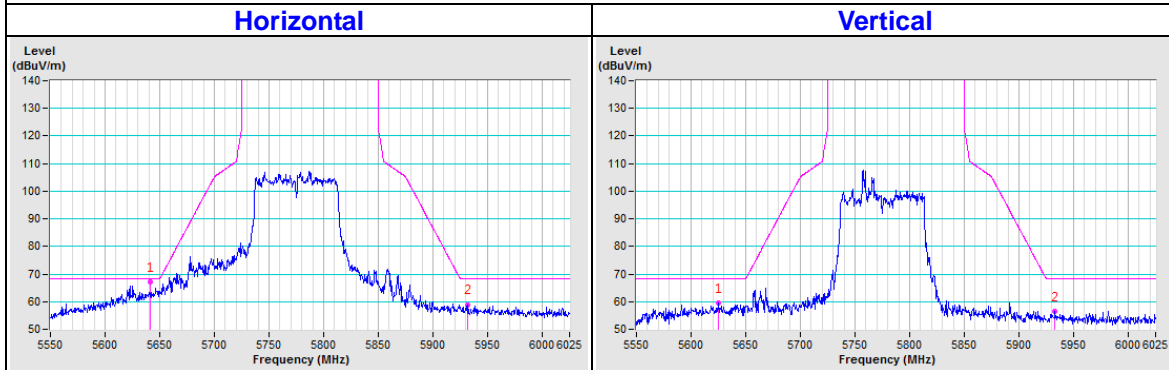

**Beamforming\_NSS1 Mode (Mode B)**

**802.11ac (20MHz)**

**CH149**

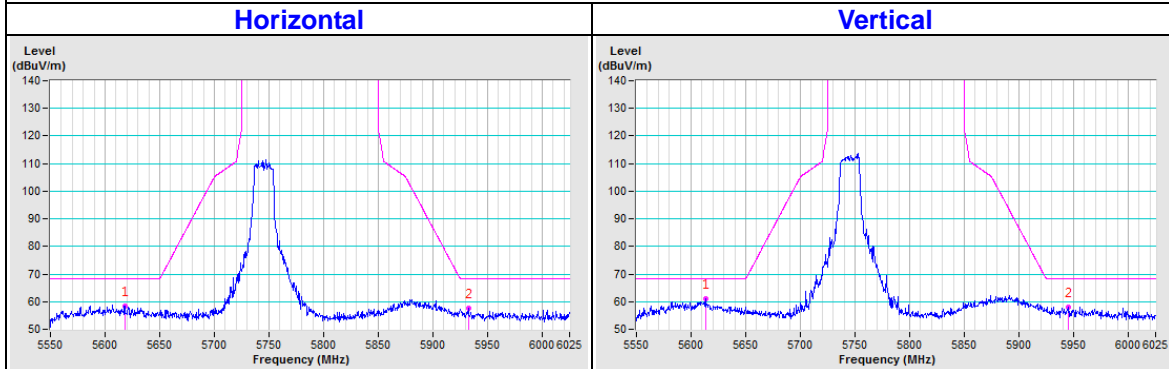

**CH157**

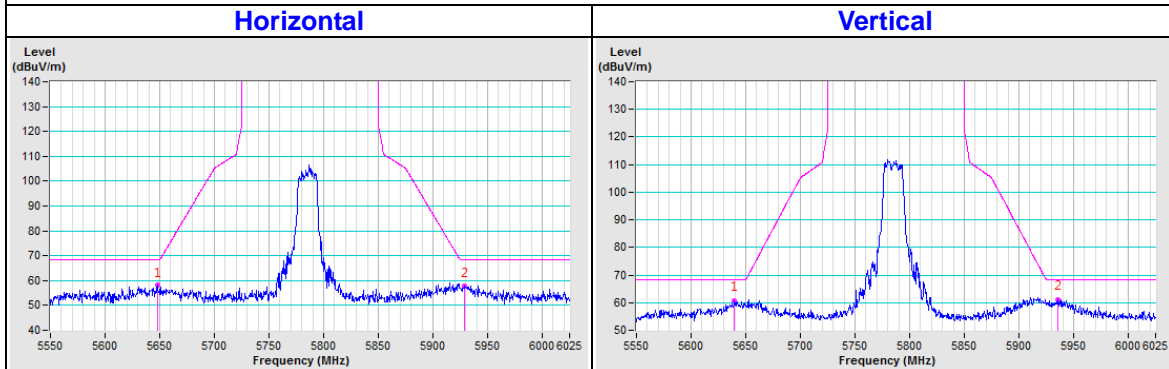

**CH165**

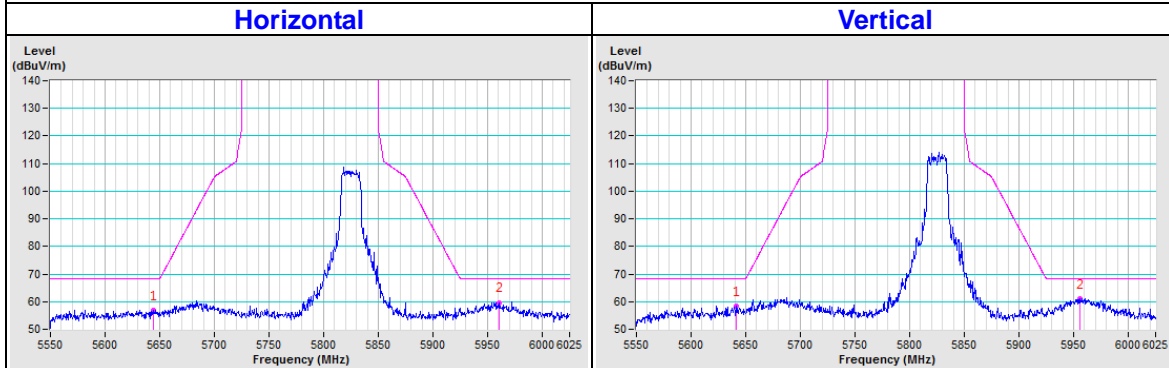

### 802.11ac (40MHz)

#### CH151

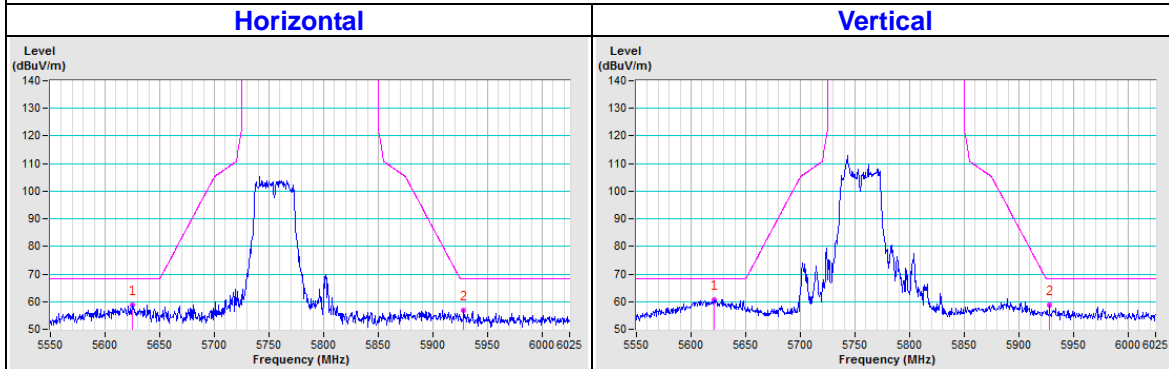

#### CH159

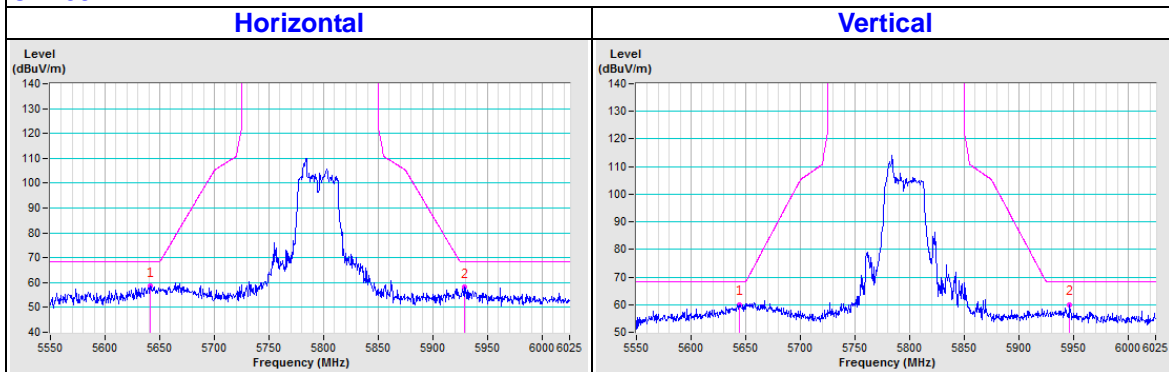

### 802.11ac (80MHz)

#### CH155

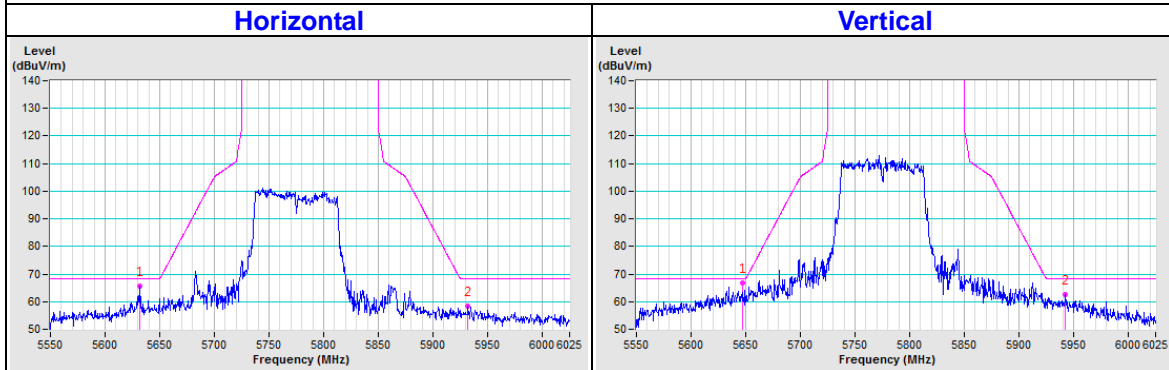

## Appendix – Information on the Testing Laboratories

We, Bureau Veritas Consumer Products Services (H.K.) Ltd., Taoyuan Branch, were founded in 1988 to provide our best service in EMC, Radio, Telecom and Safety consultation. Our laboratories are accredited and approved according to ISO/IEC 17025.

If you have any comments, please feel free to contact us at the following:

**Linko EMC/RF Lab**

Tel: 886-2-26052180

Fax: 886-2-26051924

**Hsin Chu EMC/RF/Telecom Lab**

Tel: 886-3-6668565

Fax: 886-3-6668323

**Hwa Ya EMC/RF/Safety Lab**

Tel: 886-3-3183232

Fax: 886-3-3270892

**Email:** [service.adt@tw.bureauveritas.com](mailto:service.adt@tw.bureauveritas.com)

**Web Site:** [www.bureauveritas-adt.com](http://www.bureauveritas-adt.com)

The address and road map of all our labs can be found in our web site also.

--- END ---