

FCC Test Report

Report No.: RF170713D01

FCC ID: 2ALJ3AP24X

Test Model: AP241, AP241e

Received Date: Jul. 13, 2017

Test Date: Jul. 17 ~ Sep. 20, 2017

Issued Date: Nov. 14, 2017

Applicant: HAN Networks Co., Ltd.

Address: 5/F, Building 37, No.8 Dongbeiwang West Road, HaiDian District, Beijing, China

Issued By: Bureau Veritas Consumer Products Services (H.K.) Ltd., Taoyuan Branch

Lab Address: No. 47-2, 14th Ling, Chia Pau Vil., Lin Kou Dist., New Taipei City, Taiwan, R.O.C.

**FCC Registration /
Designation Number:** 198487 / TW2021



This report is for your exclusive use. Any copying or replication of this report to or for any other person or entity, or use of our name or trademark, is permitted only with our prior written permission. This report sets forth our findings solely with respect to the test samples identified herein. The results set forth in this report are not indicative or representative of the quality or characteristics of the lot from which a test sample was taken or any similar or identical product unless specifically and expressly noted. Our report includes all of the tests requested by you and the results thereof based upon the information that you provided to us. You have 60 days from date of issuance of this report to notify us of any material error or omission caused by our negligence, provided, however, that such notice shall be in writing and shall specifically address the issue you wish to raise. A failure to raise such issue within the prescribed time shall constitute your unqualified acceptance of the completeness of this report, the tests conducted and the correctness of the report contents. Unless specific mention, the uncertainty of measurement has been explicitly taken into account to declare the compliance or non-compliance to the specification. The report must not be used by the client to claim product certification, approval, or endorsement by TAF or any government agencies.

Table of Contents

Release Control Record	4
1 Certificate of Conformity	5
2 Summary of Test Results	6
2.1 Measurement Uncertainty	6
2.2 Modification Record	6
3 General Information	7
3.1 General Description of EUT	7
3.2 Description of Test Modes	9
3.2.1 Test Mode Applicability and Tested Channel Detail	10
3.3 Duty Cycle of Test Signal	12
3.4 Description of Support Units	13
3.4.1 Configuration of System under Test	14
3.5 General Description of Applied Standards	15
4 Test Types and Results	16
4.1 Radiated Emission and Bandedge Measurement.....	16
4.1.1 Limits of Radiated Emission and Bandedge Measurement	16
4.1.2 Test Instruments	17
4.1.3 Test Procedures.....	18
4.1.4 Deviation from Test Standard	18
4.1.5 Test Setup.....	19
4.1.6 EUT Operating Conditions.....	20
4.1.7 Test Results	21
4.2 Conducted Emission Measurement	59
4.2.1 Limits of Conducted Emission Measurement	59
4.2.2 Test Instruments	59
4.2.3 Test Procedures.....	60
4.2.4 Deviation from Test Standard	60
4.2.5 Test Setup.....	60
4.2.6 EUT Operating Conditions.....	60
4.2.7 Test Results	61
4.3 6dB Bandwidth Measurement	69
4.3.1 Limits of 6dB Bandwidth Measurement	69
4.3.2 Test Setup.....	69
4.3.3 Test Instruments	69
4.3.4 Test Procedure	69
4.3.5 Deviation from Test Standard	69
4.3.6 EUT Operating Conditions.....	69
4.3.7 Test Result.....	70
4.4 Conducted Output Power Measurement.....	74
4.4.1 Limits of Conducted Output Power Measurement	74
4.4.2 Test Setup.....	74
4.4.3 Test Instruments	74
4.4.4 Test Procedures.....	74
4.4.5 Deviation from Test Standard	74
4.4.6 EUT Operating Conditions.....	74
4.4.7 Test Results	75
4.5 Power Spectral Density Measurement.....	79
4.5.1 Limits of Power Spectral Density Measurement.....	79
4.5.2 Test Setup.....	79
4.5.3 Test Instruments	79
4.5.4 Test Procedure	79
4.5.5 Deviation from Test Standard	79

4.5.6 EUT Operating Condition	79
4.5.7 Test Results	80
4.6 Conducted Out of Band Emission Measurement.....	86
4.6.1 Limits of Conducted Out of Band Emission Measurement.....	86
4.6.2 Test Setup.....	86
4.6.3 Test Instruments	86
4.6.4 Test Procedure	86
4.6.5 Deviation from Test Standard	86
4.6.6 EUT Operating Condition	86
4.6.7 Test Results	86
5 Pictures of Test Arrangements.....	119
Appendix – Information on the Testing Laboratories	120

Release Control Record

Issue No.	Description	Date Issued
RF170713D01	Original release.	Nov. 14, 2017

2 Summary of Test Results

47 CFR FCC Part 15, Subpart C (SECTION 15.247)			
FCC Clause	Test Item	Result	Remarks
15.207	AC Power Conducted Emission	PASS	Meet the requirement of limit. Minimum passing margin is -2.84dB at 0.35313MHz.
15.205 / 15.209 / 15.247(d)	Radiated Emissions and Band Edge Measurement	PASS	Meet the requirement of limit. Minimum passing margin is -1.02dB at 2483.50 MHz.
15.247(d)	Antenna Port Emission	PASS	Meet the requirement of limit.
15.247(a)(2)	6dB bandwidth	PASS	Meet the requirement of limit.
15.247(b)	Conducted power	PASS	Meet the requirement of limit.
15.247(e)	Power Spectral Density	PASS	Meet the requirement of limit.
15.203	Antenna Requirement	PASS	Antenna connector is R-SMA or I-PEX not a standard connector.

2.1 Measurement Uncertainty

Where relevant, the following measurement uncertainty levels have been estimated for tests performed on the EUT as specified in CISPR 16-4-2:

Measurement	Frequency	Expanded Uncertainty (k=2) (\pm)
Conducted Emissions at mains ports	150kHz ~ 30MHz	2.77 dB
Radiated Emissions up to 1 GHz	9kHz ~ 30MHz	2.38 dB
	30MHz ~ 1000MHz	5.54 dB
Radiated Emissions above 1 GHz	Above 1GHz	5.48 dB

2.2 Modification Record

There were no modifications required for compliance.

3 General Information

3.1 General Description of EUT

Product	HAN Access Point
Brand	HAN
Test Model	AP241, AP241e
Model Difference	Refer to note as below
Status of EUT	Engineering sample
Power Supply Rating	48Vdc from Adapter or 55Vdc from PoE
Modulation Type	CCK, DQPSK, DBPSK for DSSS 64QAM, 16QAM, QPSK, BPSK for OFDM 256QAM for OFDM in VHT20/40 mode
Modulation Technology	DSSS, OFDM
Transfer Rate	802.11b: 11.0/ 5.5/ 2.0/ 1.0Mbps 802.11g: 54.0/ 48.0/ 36.0/ 24.0/ 18.0/ 12.0/ 9.0/ 6.0Mbps 802.11n: up to 800Mbps
Operating Frequency	2.412 ~ 2.462GHz
Number of Channel	11 for 802.11b, 802.11g, 802.11n (20MHz), VHT20, 7 for 802.11n (40MHz), VHT40
Output Power	685.443mW
Antenna Type	Refer to note as below
Antenna Connector	Refer to note as below
Accessory Device	N/A
Data Cable Supplied	N/A

Note:

- The EUT incorporates a MIMO function. Physically, the EUT provides 4 completed transmitters and 4 receivers.

Modulation Mode	TX Function
802.11b	4TX
802.11g	4TX
802.11n (20MHz)	4TX
802.11n (40MHz)	4TX
VHT20	4TX
VHT40	4TX

* The modulation and bandwidth are similar for 802.11n mode for 20MHz / 40MHz and VHT20, VHT40, therefore investigated worst case to representative mode in test report. (Final test mode refer section 3.2.1)

- All models are listed as below.

Brand	Model	Difference
HAN	AP241	Internal PIFA antenna for Bluetooth function, and internal PIFA antenna for WLAN function
	AP241e	Internal PIFA antenna for Bluetooth function, and external Dipole antenna for WLAN function

- The EUT was pre-tested with the following modes:

- ✧ Operating Mode (EUT Powered from Adapter)
- ✧ Operating Mode (EUT Powered from PoE)

The worst emission level was found when the EUT tested under **Operating Mode (EUT + Adapter)**, therefore, only its test data was recorded in this report.

4. The antennas provided to the EUT, please refer to the following table:

Model of EUT	Antenna	Frequency	Chain No.	Antenna Type	Antenna Gain (dBi)	Connector Type
AP241	Internal	2.4GHz	Chain 0	PIFA	4.27	I-PEX
			Chain 1	PIFA	*4.38	I-PEX
			Chain 2	PIFA	4.25	I-PEX
			Chain 3	PIFA	4.08	I-PEX
AP241e	External	2.4GHz	Chain 0	Dipole	4	R-SMA
			Chain 1	Dipole	4	R-SMA
			Chain 2	Dipole	4	R-SMA
			Chain 3	Dipole	4	R-SMA

* As client's request, the 4.38dBi of Internal max. gain is chosen for final tests since it has the maximum gain among Internal antennas.

5. The directional gain table:

Antenna	Max. Gain (dBi)
Internal	10.4
External	10.02

Note:

(i) If transmit signals are *correlated*, then

Directional gain = $10 \log[(10^{G_1/20} + 10^{G_2/20} + \dots + 10^{G_N/20})^2 / N_{ANT}]$ dBi [Note the "20"s in the denominator of each exponent and the square of the sum of terms; the object is to combine the signal levels coherently.]

6. The above EUT information is declared by manufacturer and for more detailed features description, please refer to the manufacturer's specifications or user's manual.

3.2 Description of Test Modes

11 channels are provided for 802.11b, 802.11g and 802.11n (20MHz), VHT20:

Channel	Frequency	Channel	Frequency
1	2412MHz	7	2442MHz
2	2417MHz	8	2447MHz
3	2422MHz	9	2452MHz
4	2427MHz	10	2457MHz
5	2432MHz	11	2462MHz
6	2437MHz		

7 channels are provided for 802.11n (40MHz), VHT40::

Channel	Frequency	Channel	Frequency
3	2422MHz	7	2442MHz
4	2427MHz	8	2447MHz
5	2432MHz	9	2452MHz
6	2437MHz		

3.2.1 Test Mode Applicability and Tested Channel Detail

EUT CONFIGURE MODE	APPLICABLE TO				DESCRIPTION
	RE \geq 1G	RE $<$ 1G	PLC	APCM	
A	√	√	√	√	Model: AP241 (Int. antenna), Powered from Adapter
B	√	√	√	√	Model: AP241e (Ext. antenna), Powered from Adapter
C	-	-	√	-	Model: AP241 (Int. antenna), Powered from PoE
D	-	-	√	-	Model: AP241e (Ext. antenna), Powered from PoE

Where **RE \geq 1G**: Radiated Emission above 1GHz & Bandedge Measurement
RE $<$ 1G: Radiated Emission below 1GHz
PLC: Power Line Conducted Emission
APCM: Antenna Port Conducted Measurement

NOTE:

The EUT had been pre-tested on the positioned of each 2 axis. The worst case was found when positioned on **Y-plane**. (Mode A)
The EUT had been pre-tested on the positioned of each 2 axis. The worst case was found when positioned on **X-plane**. (Mode B)

Radiated Emission Test (Above 1GHz):

- Pre-Scan has been conducted to determine the worst-case mode from all possible combinations between available modulations, data rates and antenna ports (if EUT with antenna diversity architecture).
- Following channel(s) was (were) selected for the final test as listed below.

CDD Mode						
EUT CONFIGURE MODE	MODE	AVAILABLE CHANNEL	TESTED CHANNEL	MODULATION TECHNOLOGY	MODULATION TYPE	DATA RATE (Mbps)
A & B	802.11b	1 to 11	1, 6, 11	DSSS	DBPSK	1
A & B	802.11g	1 to 11	1, 6, 11	OFDM	BPSK	6
A & B	802.11n (20MHz)	1 to 11	1, 6, 11	OFDM	BPSK	6.5
A & B	802.11n (40MHz)	3 to 9	3, 6, 9	OFDM	BPSK	13.5
Beamforming_NSS1 Mode						
EUT CONFIGURE MODE	MODE	AVAILABLE CHANNEL	TESTED CHANNEL	MODULATION TECHNOLOGY	MODULATION TYPE	DATA RATE (Mbps)
A & B	802.11n (20MHz)	1 to 11	1, 6, 11	OFDM	BPSK	6.5
A & B	802.11n (40MHz)	3 to 9	3, 6, 9	OFDM	BPSK	13.5

Radiated Emission Test (Below 1GHz):

- Pre-Scan has been conducted to determine the worst-case mode from all possible combinations between available modulations, data rates and antenna ports (if EUT with antenna diversity architecture).
- Following channel(s) was (were) selected for the final test as listed below.

CDD Mode						
EUT CONFIGURE MODE	MODE	AVAILABLE CHANNEL	TESTED CHANNEL	MODULATION TECHNOLOGY	MODULATION TYPE	DATA RATE (Mbps)
A	802.11g	1 to 11	6	OFDM	BPSK	6
B	802.11n (20MHz)	1 to 11	6	OFDM	BPSK	6.5

Power Line Conducted Emission Test:

- Pre-Scan has been conducted to determine the worst-case mode from all possible combinations between available modulations, data rates and antenna ports (if EUT with antenna diversity architecture).
- Following channel(s) was (were) selected for the final test as listed below.

CDD Mode						
EUT CONFIGURE MODE	MODE	AVAILABLE CHANNEL	TESTED CHANNEL	MODULATION TECHNOLOGY	MODULATION TYPE	DATA RATE (Mbps)
A & C	802.11g	1 to 11	6	OFDM	BPSK	6
B & D	802.11n (20MHz)	1 to 11	6	OFDM	BPSK	6.5

Antenna Port Conducted Measurement:

- This item includes all test value of each mode, but only includes spectrum plot of worst value of each mode.
- Pre-Scan has been conducted to determine the worst-case mode from all possible combinations between available modulations, data rates and antenna ports (if EUT with antenna diversity architecture).
- Following channel(s) was (were) selected for the final test as listed below.

CDD Mode						
EUT CONFIGURE MODE	MODE	AVAILABLE CHANNEL	TESTED CHANNEL	MODULATION TECHNOLOGY	MODULATION TYPE	DATA RATE (Mbps)
A & B	802.11b	1 to 11	1, 6, 11	DSSS	DBPSK	1
A & B	802.11g	1 to 11	1, 6, 11	OFDM	BPSK	6
A & B	802.11n (20MHz)	1 to 11	1, 6, 11	OFDM	BPSK	6.5
A & B	802.11n (40MHz)	3 to 9	3, 6, 9	OFDM	BPSK	13.5
Beamforming_NSS1 Mode (Output Power Only)						
EUT CONFIGURE MODE	MODE	AVAILABLE CHANNEL	TESTED CHANNEL	MODULATION TECHNOLOGY	MODULATION TYPE	DATA RATE (Mbps)
A & B	802.11n (20MHz)	1 to 11	1, 6, 11	OFDM	BPSK	6.5
A & B	802.11n (40MHz)	3 to 9	3, 6, 9	OFDM	BPSK	13.5

Test Condition:

APPLICABLE TO	ENVIRONMENTAL CONDITIONS	INPUT POWER	TESTED BY
RE \geq 1G	33deg. C, 64%RH	120Vac, 60Hz	Ian Chang
RE<1G	32deg. C, 66%RH	120Vac, 60Hz	Ian Chang
PLC	27deg. C, 73%RH	120Vac, 60Hz	Ian Chang
APCM	25deg. C, 76%RH	120Vac, 60Hz	Saxon Lee

3.3 Duty Cycle of Test Signal

If duty cycle of test signal is > 98%, duty factor is not required.
 If duty cycle of test signal is < 98%, duty factor shall be considered.

802.11b: Duty cycle = Duty cycle of test signal is 99.2 %.

802.11g: Duty cycle = $2.011/2.094 = 0.96$, Duty factor = $10 * \log(1/0.96) = 0.17$

802.11n (20MHz): Duty cycle of test signal is 98.2 %.

802.11n (40MHz): Duty cycle = $2.365/2.48 = 0.954$, Duty factor = $10 * \log(1/0.954) = 0.20$

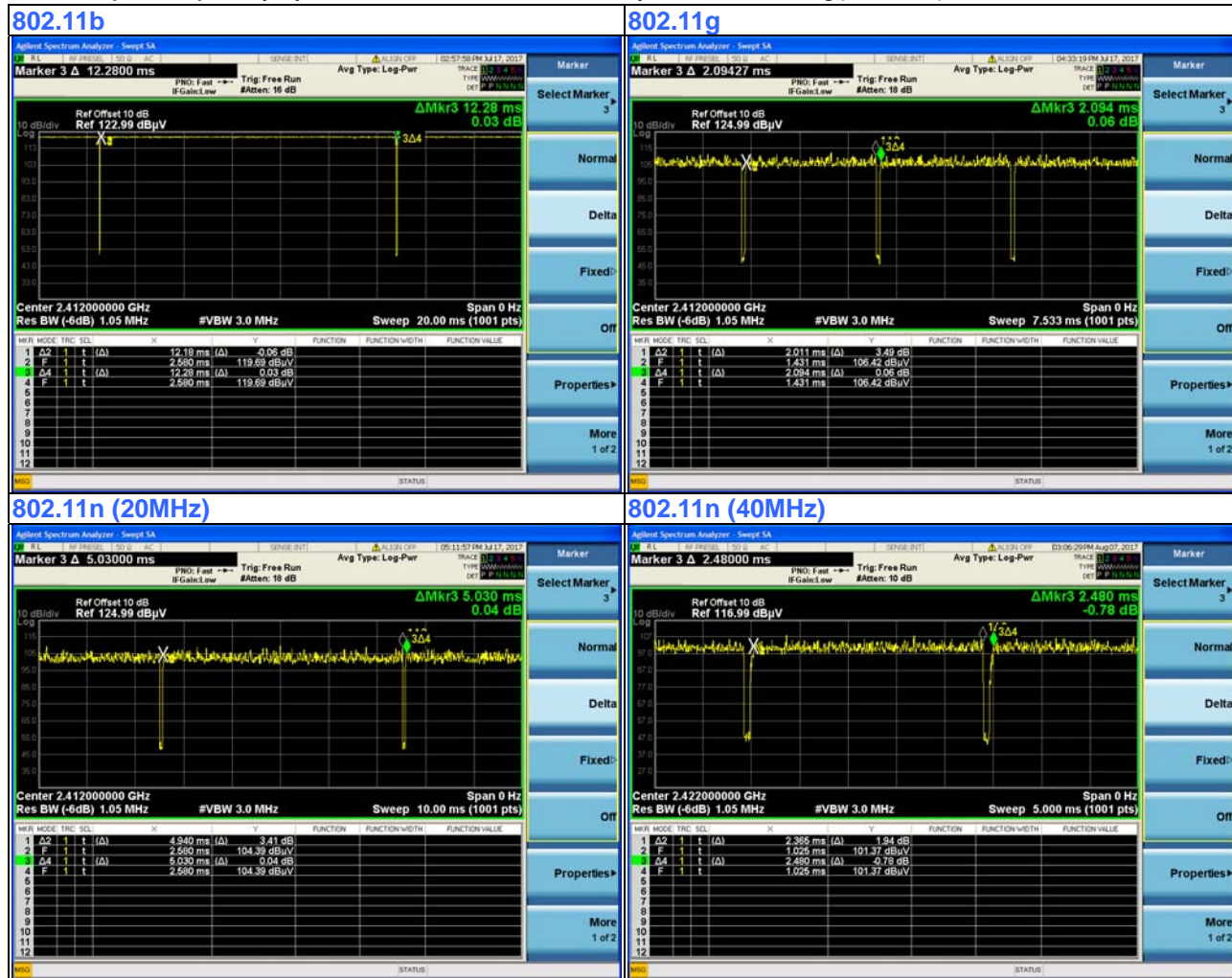

3.4 Description of Support Units

The EUT has been tested as an independent unit together with other necessary accessories or support units. The following support units or accessories were used to form a representative test configuration during the tests.

ID	Product	Brand	Model No.	Serial No.	FCC ID	Remarks
A.	Adapter	APD	WB-18D12R	N/A	N/A	Supplied by client
B.	NOTEBOOK PC	DELL	PP27L	8SNZ12S	FCC DoC Approved	Provided by Lab
C.	PoE	Microsemi	PD-9001GR/AT/AC	N/A	N/A	Supplied by client

Note:

1. All power cords of the above support units are non-shielded (1.8m).
2. Item B ~ C acted as communication partners to transfer data.

ID	Descriptions	Qty.	Length (m)	Shielding (Yes/No)	Cores (Qty.)	Remarks
1.	DC cable	1	1.5	N	0	Supplied by client
2.	LAN cable	1	10	N	0	Provided by Lab
3.	LAN cable	1	1.5	N	0	Provided by Lab
4.	AC cable	1	1.8	N	0	Provided by Lab

Note: The core(s) is(are) originally attached to the cable(s).

3.4.1 Configuration of System under Test

Mode A & B:

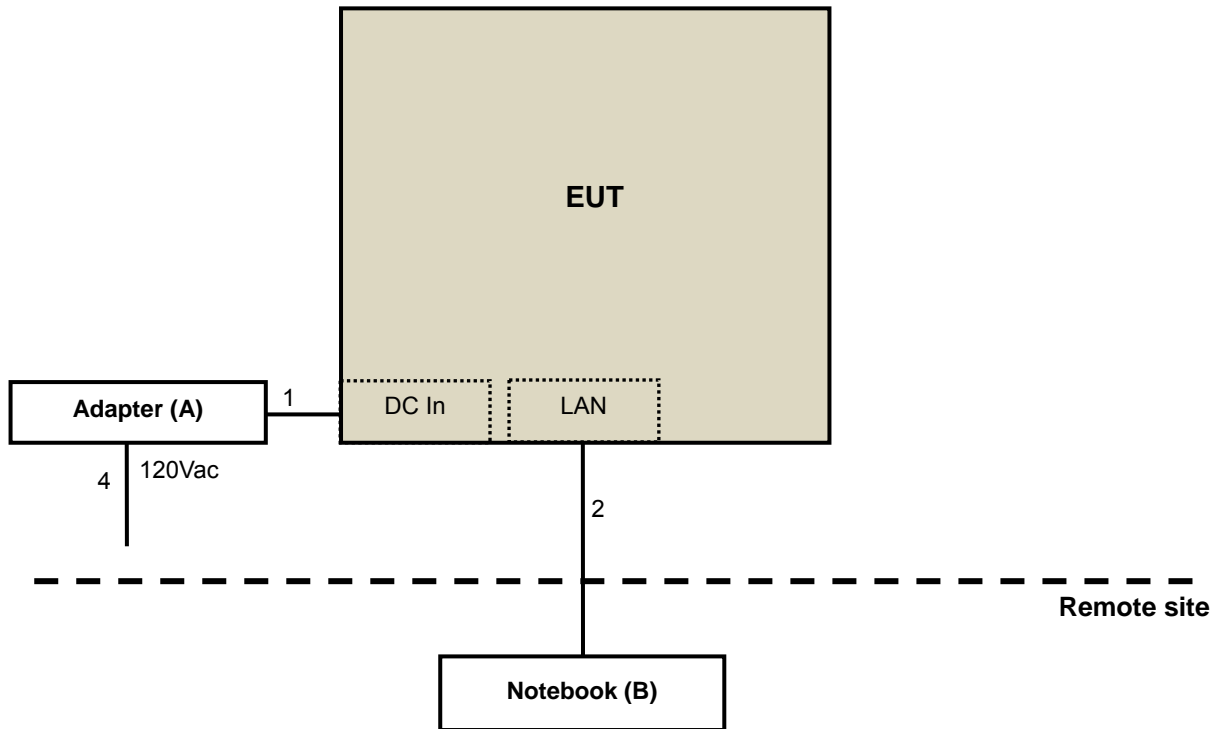

Mode C & D:

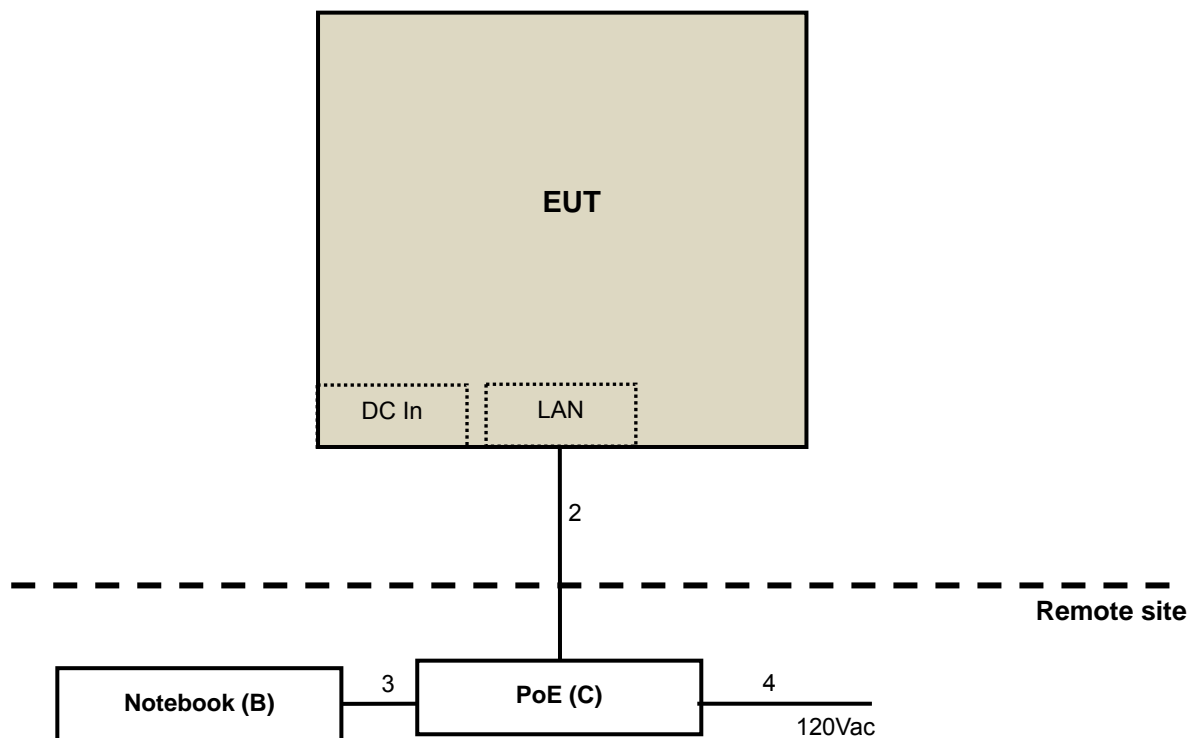

3.5 General Description of Applied Standards

The EUT is a RF Product. According to the specifications of the manufacturer, it must comply with the requirements of the following standards:

FCC Part 15, Subpart C (15.247)
KDB 558074 D01 DTS Meas Guidance v04
KDB 662911 D01 Multiple Transmitter Output v02r01
ANSI C63.10-2013

All test items have been performed and recorded as per the above standards.

4 Test Types and Results

4.1 Radiated Emission and Bandedge Measurement

4.1.1 Limits of Radiated Emission and Bandedge Measurement

Radiated emissions which fall in the restricted bands must comply with the radiated emission limits specified as below table. Other emissions shall be at least 30dB below the highest level of the desired power:

Frequencies (MHz)	Field Strength (microvolts/meter)	Measurement Distance (meters)
0.009 ~ 0.490	2400/F(kHz)	300
0.490 ~ 1.705	24000/F(kHz)	30
1.705 ~ 30.0	30	30
30 ~ 88	100	3
88 ~ 216	150	3
216 ~ 960	200	3
Above 960	500	3

NOTE:

1. The lower limit shall apply at the transition frequencies.
2. Emission level (dBuV/m) = 20 log Emission level (uV/m).
3. For frequencies above 1000MHz, the field strength limits are based on average detector, however, the peak field strength of any emission shall not exceed the maximum permitted average limits, specified above by more than 20dB under any condition of modulation.

4.1.2 Test Instruments

DESCRIPTION & MANUFACTURER	MODEL NO.	SERIAL NO.	CALIBRATED DATE	CALIBRATED UNTIL
HP Preamplifier	8447D	2432A03504	Feb. 21, 2017	Feb. 20, 2018
HP Preamplifier	8449B	3008A01201	Feb. 22, 2017	Feb. 21, 2018
MITEQ Preamplifier	AMF-6F-260400-33-8P	892164	Feb. 21, 2017	Feb. 20, 2018
Agilent TEST RECEIVER	N9038A	MY51210129	Feb. 8, 2017	Feb. 7, 2018
Schwarzbeck Antenna	VULB 9168	139	Dec. 13, 2016	Dec. 12, 2017
Schwarzbeck Antenna	VHBA 9123	480	May 19, 2017	May 18, 2019
Schwarzbeck Horn Antenna	BBHA-9170	212	Dec. 30, 2016	Dec. 29, 2017
Schwarzbeck Horn Antenna	BBHA 9120-D1	D130	Dec. 27, 2016	Dec. 26, 2017
ADT. Turn Table	TT100	0306	NA	NA
ADT. Tower	AT100	0306	NA	NA
Software	Radiated_V7.6.15.9.5	NA	NA	NA
SUHNER RF cable With 4dB PAD	SF104	CABLE-CH6	Aug. 15, 2016	Aug. 14, 2017
			Aug. 14, 2017	Aug. 13, 2018
SUHNER RF cable With 3dB PAD	SF102	Cable-CH8-3.6m	Aug. 15, 2016	Aug. 14, 2017
			Aug. 14, 2017	Aug. 13, 2018
KEYSIGHT MIMO Powermeasurement Test set	U2021XA	U2021XA-001	May 31, 2017	May 30, 2018
KEYSIGHT Spectrum Analyzer	N9030A	MY54490260	Jul. 26, 2016	Jul. 25, 2017
			Jul. 26, 2017	Jul. 25, 2018
Loop Antenna EMCI	LPA600	270	Aug. 20, 2015	Aug. 19, 2017
			Aug. 11, 2017	Aug. 10, 2019
EMCO Horn Antenna	3115	00028257	Dec. 15, 2016	Dec. 14, 2017
Highpass filter Wainwright Instruments	WHK 3.1/18G-10SS	SN 8	NA	NA
ROHDE & SCHWARZ Spectrum Analyzer	FSV40	101042	Sep. 30, 2016	Sep. 29, 2017
Anritsu Power Sensor	MA2411B	0738404	Apr. 24, 2017	Apr. 23, 2018
Anritsu Power Meter	ML2495A	0842014	Apr. 24, 2017	Apr. 23, 2018

- NOTE:**
1. The calibration interval of the above test instruments is 12/24 months. And the calibrations are traceable to NML/ROC and NIST/USA.
 2. The horn antenna and HP preamplifier (model: 8449B) are used only for the measurement of emission frequency above 1GHz if tested.
 3. The test was performed in Chamber No. 6.
 4. The Industry Canada Reference No. IC 7450E-6.
 5. The FCC Designation Number is TW2021.
 6. Tested Date: Jul. 17 ~ Sep. 15, 2017

4.1.3 Test Procedures

For Radiated emission below 30MHz

- a. The EUT was placed on the top of a rotating table 0.8 meters above the ground at a 3 meter chamber room. The table was rotated 360 degrees to determine the position of the highest radiation.
- b. The EUT was set 3 meters away from the interference-receiving antenna, which was mounted on the top of a variable-height antenna tower.
- c. Both X and Y axes of the antenna are set to make the measurement.
- d. For each suspected emission, the EUT was arranged to its worst case and the rotatable table was turned from 0 degrees to 360 degrees to find the maximum reading.
- e. The test-receiver system was set to Quasi-Peak Detect Function and Specified Bandwidth with Maximum Hold Mode.

Note:

1. The resolution bandwidth and video bandwidth of test receiver/spectrum analyzer is 9kHz at frequency below 30MHz.

For Radiated emission above 30MHz

- a. The EUT was placed on the top of a rotating table 0.8 meters (for 30MHz ~ 1GHz) / 1.5 meters (for above 1GHz) above the ground at 3 meter chamber room for test. The table was rotated 360 degrees to determine the position of the highest radiation.
- b. The EUT was set 3 meters away from the interference-receiving antenna, which was mounted on the top of a variable-height antenna tower.
- c. The height of antenna is varied from one meter to four meters above the ground to determine the maximum value of the field strength. Both horizontal and vertical polarizations of the antenna are set to make the measurement.
- d. For each suspected emission, the EUT was arranged to its worst case and then the antenna was tuned to heights from 1 meter to 4 meters and the rotatable table was turned from 0 degrees to 360 degrees to find the maximum reading.
- e. The test-receiver system was set to quasi-peak detect function and specified bandwidth with maximum hold mode when the test frequency is below 1 GHz.
- f. The test-receiver system was set to peak and average detect function and specified bandwidth with maximum hold mode when the test frequency is above 1 GHz. If the peak reading value also meets average limit, measurement with the average detector is unnecessary.

Note:

1. The resolution bandwidth and video bandwidth of test receiver/spectrum analyzer is 120kHz for Quasi-peak detection (QP) at frequency below 1GHz.
2. The resolution bandwidth of test receiver/spectrum analyzer is 1 MHz and the video bandwidth is 3 MHz for Peak detection (PK) at frequency above 1GHz.
3. The resolution bandwidth of test receiver/spectrum analyzer is 1MHz and the video bandwidth is $\geq 1/T$ (Duty cycle < 98%) for Average detection (AV) at frequency above 1GHz.
4. All modes of operation were investigated and the worst-case emissions are reported.

4.1.4 Deviation from Test Standard

No deviation.

4.1.5 Test Setup

For Radiated emission below 30MHz

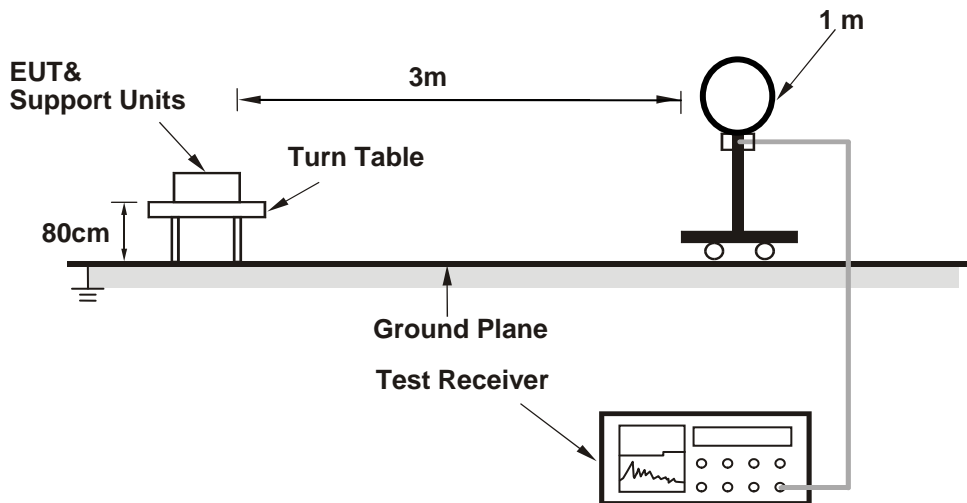

For Radiated emission 30MHz to 1GHz

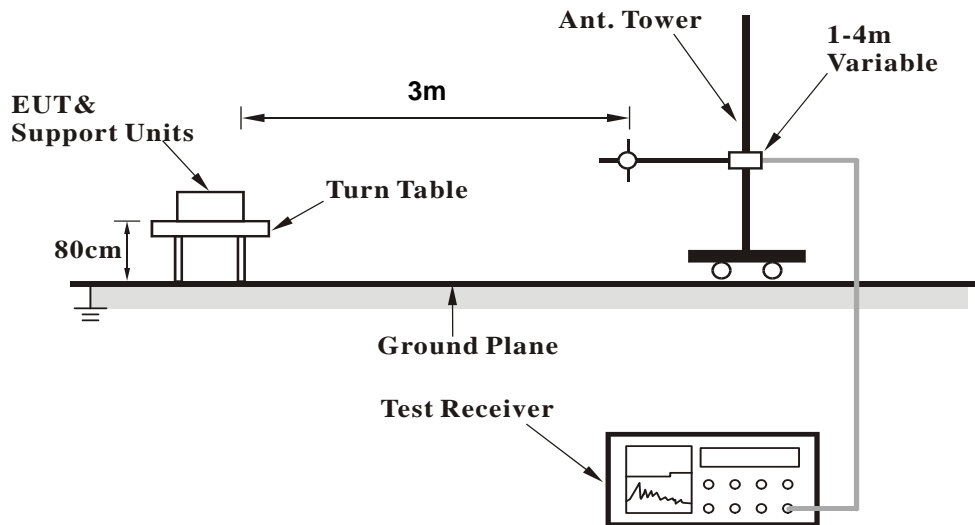

For Radiated emission above 1GHz

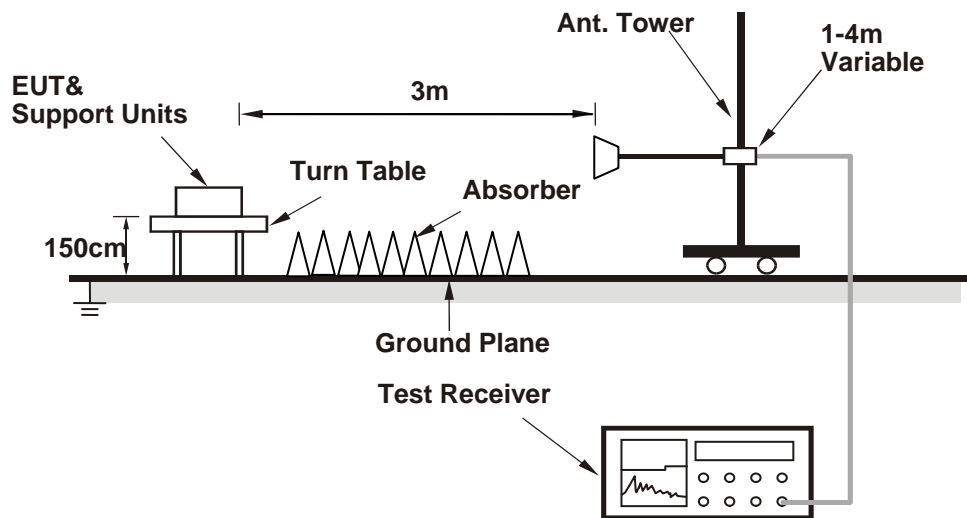

For the actual test configuration, please refer to the attached file (Test Setup Photo).

4.1.6 EUT Operating Conditions

- a. Connected the EUT with AC adapter placed on testing table.
- b. Set the EUT under transmission condition continuously at specific channel frequency.

4.1.7 Test Results

ABOVE 1GHz DATA

CDD Mode (Mode A)

802.11b

CHANNEL	TX Channel 1	DETECTOR FUNCTION	Peak (PK)
FREQUENCY RANGE	1GHz ~ 25GHz		Average (AV)

ANTENNA POLARITY & TEST DISTANCE: HORIZONTAL AT 3 M

NO.	FREQ. (MHz)	EMISSION LEVEL (dBuV/m)	LIMIT (dBuV/m)	MARGIN (dB)	ANTENNA HEIGHT (m)	TABLE ANGLE (Degree)	RAW VALUE (dBuV)	CORRECTION FACTOR (dB/m)
1	2390.00	60.73 PK	74.00	-13.27	1.69 H	47	63.04	-2.31
2	2390.00	52.68 AV	54.00	-1.32	1.69 H	47	54.99	-2.31
3	*2412.00	116.96 PK			1.69 H	47	119.13	-2.17
4	*2412.00	114.06 AV			1.69 H	47	116.23	-2.17
5	4824.00	53.97 PK	74.00	-20.03	1.66 H	16	49.81	4.16
6	4824.00	51.30 AV	54.00	-2.70	1.66 H	16	47.14	4.16

ANTENNA POLARITY & TEST DISTANCE: VERTICAL AT 3 M

NO.	FREQ. (MHz)	EMISSION LEVEL (dBuV/m)	LIMIT (dBuV/m)	MARGIN (dB)	ANTENNA HEIGHT (m)	TABLE ANGLE (Degree)	RAW VALUE (dBuV)	CORRECTION FACTOR (dB/m)
1	2390.00	57.44 PK	74.00	-16.56	1.97 V	31	59.75	-2.31
2	2390.00	48.40 AV	54.00	-5.60	1.97 V	31	50.71	-2.31
3	*2412.00	112.40 PK			1.97 V	31	114.57	-2.17
4	*2412.00	109.56 AV			1.97 V	31	111.73	-2.17
5	4824.00	47.11 PK	74.00	-26.89	1.80 V	71	42.95	4.16
6	4824.00	40.66 AV	54.00	-13.34	1.80 V	71	36.50	4.16

REMARKS:

1. Emission Level(dBuV/m) = Raw Value(dBuV) + Correction Factor(dB/m)
2. Correction Factor(dB/m) = Antenna Factor(dB/m) + Cable Factor(dB) – Pre-Amplifier Factor(dB)
3. The other emission levels were very low against the limit.
4. Margin value = Emission Level – Limit value
5. " * ": Fundamental frequency.

CHANNEL	TX Channel 6	DETECTOR FUNCTION	Peak (PK)
FREQUENCY RANGE	1GHz ~ 25GHz		Average (AV)

ANTENNA POLARITY & TEST DISTANCE: HORIZONTAL AT 3 M

NO.	FREQ. (MHz)	EMISSION LEVEL (dBuV/m)	LIMIT (dBuV/m)	MARGIN (dB)	ANTENNA HEIGHT (m)	TABLE ANGLE (Degree)	RAW VALUE (dBuV)	CORRECTION FACTOR (dB/m)
1	*2437.00	116.83 PK			2.28 H	41	118.84	-2.01
2	*2437.00	114.28 AV			2.28 H	41	116.29	-2.01
3	4874.00	54.98 PK	74.00	-19.02	1.69 H	15	50.73	4.25
4	4874.00	52.28 AV	54.00	-1.72	1.69 H	15	48.03	4.25

ANTENNA POLARITY & TEST DISTANCE: VERTICAL AT 3 M

NO.	FREQ. (MHz)	EMISSION LEVEL (dBuV/m)	LIMIT (dBuV/m)	MARGIN (dB)	ANTENNA HEIGHT (m)	TABLE ANGLE (Degree)	RAW VALUE (dBuV)	CORRECTION FACTOR (dB/m)
1	*2437.00	111.63 PK			2.02 V	26	113.64	-2.01
2	*2437.00	109.27 AV			2.02 V	26	111.28	-2.01
3	4874.00	47.80 PK	74.00	-26.20	1.91 V	63	43.55	4.25
4	4874.00	42.14 AV	54.00	-11.86	1.91 V	63	37.89	4.25

REMARKS:

1. Emission Level(dBuV/m) = Raw Value(dBuV) + Correction Factor(dB/m)
2. Correction Factor(dB/m) = Antenna Factor(dB/m) + Cable Factor(dB) – Pre-Amplifier Factor(dB)
3. The other emission levels were very low against the limit.
4. Margin value = Emission Level – Limit value
5. " * ": Fundamental frequency.

CHANNEL	TX Channel 11	DETECTOR FUNCTION	Peak (PK)
FREQUENCY RANGE	1GHz ~ 25GHz		Average (AV)

ANTENNA POLARITY & TEST DISTANCE: HORIZONTAL AT 3 M

NO.	FREQ. (MHz)	EMISSION LEVEL (dBuV/m)	LIMIT (dBuV/m)	MARGIN (dB)	ANTENNA HEIGHT (m)	TABLE ANGLE (Degree)	RAW VALUE (dBuV)	CORRECTION FACTOR (dB/m)
1	*2462.00	115.85 PK			1.99 H	42	117.70	-1.85
2	*2462.00	113.11 AV			1.99 H	42	114.96	-1.85
3	2483.50	64.86 PK	74.00	-9.14	1.99 H	42	66.57	-1.71
4	2483.50	52.42 AV	54.00	-1.58	1.99 H	42	54.13	-1.71
5	4924.00	54.04 PK	74.00	-19.96	1.76 H	39	49.74	4.30
6	4924.00	51.03 AV	54.00	-2.97	1.76 H	39	46.73	4.30

ANTENNA POLARITY & TEST DISTANCE: VERTICAL AT 3 M

NO.	FREQ. (MHz)	EMISSION LEVEL (dBuV/m)	LIMIT (dBuV/m)	MARGIN (dB)	ANTENNA HEIGHT (m)	TABLE ANGLE (Degree)	RAW VALUE (dBuV)	CORRECTION FACTOR (dB/m)
1	*2462.00	110.61 PK			1.94 V	35	112.46	-1.85
2	*2462.00	108.04 AV			1.94 V	35	109.89	-1.85
3	2483.50	60.65 PK	74.00	-13.35	1.94 V	35	62.36	-1.71
4	2483.50	49.45 AV	54.00	-4.55	1.94 V	35	51.16	-1.71
5	4924.00	46.92 PK	74.00	-27.08	1.91 V	66	42.62	4.30
6	4924.00	40.81 AV	54.00	-13.19	1.91 V	66	36.51	4.30

REMARKS:

1. Emission Level(dBuV/m) = Raw Value(dBuV) + Correction Factor(dB/m)
2. Correction Factor(dB/m) = Antenna Factor(dB/m) + Cable Factor(dB) – Pre-Amplifier Factor(dB)
3. The other emission levels were very low against the limit.
4. Margin value = Emission Level – Limit value
5. " * ": Fundamental frequency.

802.11g

CHANNEL	TX Channel 1	DETECTOR FUNCTION	Peak (PK)
FREQUENCY RANGE	1GHz ~ 25GHz		Average (AV)

ANTENNA POLARITY & TEST DISTANCE: HORIZONTAL AT 3 M

NO.	FREQ. (MHz)	EMISSION LEVEL (dBuV/m)	LIMIT (dBuV/m)	MARGIN (dB)	ANTENNA HEIGHT (m)	TABLE ANGLE (Degree)	RAW VALUE (dBuV)	CORRECTION FACTOR (dB/m)
1	2390.00	67.98 PK	74.00	-6.02	1.51 H	135	70.29	-2.31
2	2390.00	52.67 AV	54.00	-1.33	1.51 H	135	54.98	-2.31
3	*2412.00	117.54 PK			1.51 H	135	119.71	-2.17
4	*2412.00	104.27 AV			1.51 H	135	106.44	-2.17
5	4824.00	47.72 PK	74.00	-26.28	1.93 H	76	43.56	4.16
6	4824.00	32.81 AV	54.00	-21.19	1.93 H	76	28.65	4.16

ANTENNA POLARITY & TEST DISTANCE: VERTICAL AT 3 M

NO.	FREQ. (MHz)	EMISSION LEVEL (dBuV/m)	LIMIT (dBuV/m)	MARGIN (dB)	ANTENNA HEIGHT (m)	TABLE ANGLE (Degree)	RAW VALUE (dBuV)	CORRECTION FACTOR (dB/m)
1	2390.00	63.92 PK	74.00	-10.08	2.03 V	89	66.23	-2.31
2	2390.00	48.10 AV	54.00	-5.90	2.03 V	89	50.41	-2.31
3	*2412.00	111.98 PK			2.03 V	89	114.15	-2.17
4	*2412.00	99.09 AV			2.03 V	89	101.26	-2.17
5	4824.00	44.31 PK	74.00	-29.69	1.69 V	25	40.15	4.16
6	4824.00	29.82 AV	54.00	-24.18	1.69 V	25	25.66	4.16

REMARKS:

1. Emission Level(dBuV/m) = Raw Value(dBuV) + Correction Factor(dB/m)
2. Correction Factor(dB/m) = Antenna Factor(dB/m) + Cable Factor(dB) – Pre-Amplifier Factor(dB)
3. The other emission levels were very low against the limit.
4. Margin value = Emission Level – Limit value
5. " * ": Fundamental frequency.

CHANNEL	TX Channel 6	DETECTOR FUNCTION	Peak (PK)
FREQUENCY RANGE	1GHz ~ 25GHz		Average (AV)

ANTENNA POLARITY & TEST DISTANCE: HORIZONTAL AT 3 M

NO.	FREQ. (MHz)	EMISSION LEVEL (dBuV/m)	LIMIT (dBuV/m)	MARGIN (dB)	ANTENNA HEIGHT (m)	TABLE ANGLE (Degree)	RAW VALUE (dBuV)	CORRECTION FACTOR (dB/m)
1	2390.00	70.81 PK	74.00	-3.19	1.50 H	139	73.12	-2.31
2	2390.00	52.42 AV	54.00	-1.58	1.50 H	139	54.73	-2.31
3	*2437.00	120.88 PK			1.50 H	139	122.89	-2.01
4	*2437.00	109.81 AV			1.50 H	139	111.82	-2.01
5	2483.50	64.82 PK	74.00	-9.18	1.50 H	139	66.53	-1.71
6	2483.50	48.03 AV	54.00	-5.97	1.50 H	139	49.74	-1.71
7	4874.00	47.51 PK	74.00	-26.49	1.54 H	164	43.26	4.25
8	4874.00	33.20 AV	54.00	-20.80	1.54 H	164	28.95	4.25

ANTENNA POLARITY & TEST DISTANCE: VERTICAL AT 3 M

NO.	FREQ. (MHz)	EMISSION LEVEL (dBuV/m)	LIMIT (dBuV/m)	MARGIN (dB)	ANTENNA HEIGHT (m)	TABLE ANGLE (Degree)	RAW VALUE (dBuV)	CORRECTION FACTOR (dB/m)
1	2390.00	67.32 PK	74.00	-6.68	2.11 V	92	69.63	-2.31
2	2390.00	48.10 AV	54.00	-5.90	2.11 V	92	50.41	-2.31
3	*2437.00	115.44 PK			2.11 V	92	117.45	-2.01
4	*2437.00	104.94 AV			2.11 V	92	106.95	-2.01
5	2483.50	60.42 PK	74.00	-13.58	2.11 V	92	62.13	-1.71
6	2483.50	43.48 AV	54.00	-10.52	2.11 V	92	45.19	-1.71
7	4874.00	44.44 PK	74.00	-29.56	1.26 V	65	40.19	4.25
8	4874.00	29.89 AV	54.00	-24.11	1.26 V	65	25.64	4.25

REMARKS:

1. Emission Level(dBuV/m) = Raw Value(dBuV) + Correction Factor(dB/m)
2. Correction Factor(dB/m) = Antenna Factor(dB/m) + Cable Factor(dB) – Pre-Amplifier Factor(dB)
3. The other emission levels were very low against the limit.
4. Margin value = Emission Level – Limit value
5. " * ": Fundamental frequency.

CHANNEL	TX Channel 11	DETECTOR FUNCTION	Peak (PK)
FREQUENCY RANGE	1GHz ~ 25GHz		Average (AV)

ANTENNA POLARITY & TEST DISTANCE: HORIZONTAL AT 3 M

NO.	FREQ. (MHz)	EMISSION LEVEL (dBuV/m)	LIMIT (dBuV/m)	MARGIN (dB)	ANTENNA HEIGHT (m)	TABLE ANGLE (Degree)	RAW VALUE (dBuV)	CORRECTION FACTOR (dB/m)
1	*2462.00	115.57 PK			1.65 H	51	117.42	-1.85
2	*2462.00	104.40 AV			1.65 H	51	106.25	-1.85
3	2483.50	67.75 PK	74.00	-6.25	1.00 H	51	69.46	-1.71
4	2483.50	52.92 AV	54.00	-1.08	1.00 H	51	54.63	-1.71
5	4924.00	47.49 PK	74.00	-26.51	1.57 H	221	43.19	4.30
6	4924.00	32.94 AV	54.00	-21.06	1.57 H	221	28.64	4.30

ANTENNA POLARITY & TEST DISTANCE: VERTICAL AT 3 M

NO.	FREQ. (MHz)	EMISSION LEVEL (dBuV/m)	LIMIT (dBuV/m)	MARGIN (dB)	ANTENNA HEIGHT (m)	TABLE ANGLE (Degree)	RAW VALUE (dBuV)	CORRECTION FACTOR (dB/m)
1	*2462.00	110.79 PK			2.15 V	84	112.64	-1.85
2	*2462.00	100.10 AV			2.15 V	84	101.95	-1.85
3	2483.50	63.70 PK	74.00	-10.30	2.15 V	84	65.41	-1.71
4	2483.50	48.55 AV	54.00	-5.45	2.15 V	84	50.26	-1.71
5	4924.00	44.87 PK	74.00	-29.13	1.29 V	33	40.57	4.30
6	4924.00	29.98 AV	54.00	-24.02	1.29 V	33	25.68	4.30

REMARKS:

1. Emission Level(dBuV/m) = Raw Value(dBuV) + Correction Factor(dB/m)
2. Correction Factor(dB/m) = Antenna Factor(dB/m) + Cable Factor(dB) – Pre-Amplifier Factor(dB)
3. The other emission levels were very low against the limit.
4. Margin value = Emission Level – Limit value
5. " * ": Fundamental frequency.

802.11n (20MHz)

CHANNEL	TX Channel 1	DETECTOR FUNCTION	Peak (PK)
FREQUENCY RANGE	1GHz ~ 25GHz		Average (AV)

ANTENNA POLARITY & TEST DISTANCE: HORIZONTAL AT 3 M

NO.	FREQ. (MHz)	EMISSION LEVEL (dBuV/m)	LIMIT (dBuV/m)	MARGIN (dB)	ANTENNA HEIGHT (m)	TABLE ANGLE (Degree)	RAW VALUE (dBuV)	CORRECTION FACTOR (dB/m)
1	2390.00	68.34 PK	74.00	-5.66	1.64 H	137	70.65	-2.31
2	2390.00	52.96 AV	54.00	-1.04	1.64 H	137	55.27	-2.31
3	*2412.00	118.39 PK			1.64 H	137	120.56	-2.17
4	*2412.00	103.24 AV			1.64 H	137	105.41	-2.17
5	4824.00	48.31 PK	74.00	-25.69	1.53 H	32	44.15	4.16
6	4824.00	33.78 AV	54.00	-20.22	1.53 H	32	29.62	4.16

ANTENNA POLARITY & TEST DISTANCE: VERTICAL AT 3 M

NO.	FREQ. (MHz)	EMISSION LEVEL (dBuV/m)	LIMIT (dBuV/m)	MARGIN (dB)	ANTENNA HEIGHT (m)	TABLE ANGLE (Degree)	RAW VALUE (dBuV)	CORRECTION FACTOR (dB/m)
1	2390.00	64.23 PK	74.00	-9.77	2.21 V	75	66.54	-2.31
2	2390.00	48.93 AV	54.00	-5.07	2.21 V	75	51.24	-2.31
3	*2412.00	113.67 PK			2.21 V	75	115.84	-2.17
4	*2412.00	98.19 AV			2.21 V	75	100.36	-2.17
5	4824.00	45.71 PK	74.00	-28.29	1.87 V	79	41.55	4.16
6	4824.00	31.12 AV	54.00	-22.88	1.87 V	79	26.96	4.16

REMARKS:

1. Emission Level(dBuV/m) = Raw Value(dBuV) + Correction Factor(dB/m)
2. Correction Factor(dB/m) = Antenna Factor(dB/m) + Cable Factor(dB) – Pre-Amplifier Factor(dB)
3. The other emission levels were very low against the limit.
4. Margin value = Emission Level – Limit value
5. " * ": Fundamental frequency.

CHANNEL	TX Channel 6	DETECTOR FUNCTION	Peak (PK)
FREQUENCY RANGE	1GHz ~ 25GHz		Average (AV)

ANTENNA POLARITY & TEST DISTANCE: HORIZONTAL AT 3 M

NO.	FREQ. (MHz)	EMISSION LEVEL (dBuV/m)	LIMIT (dBuV/m)	MARGIN (dB)	ANTENNA HEIGHT (m)	TABLE ANGLE (Degree)	RAW VALUE (dBuV)	CORRECTION FACTOR (dB/m)
1	2390.00	68.98 PK	74.00	-5.02	1.64 H	137	71.29	-2.31
2	2390.00	52.93 AV	54.00	-1.07	1.64 H	137	55.24	-2.31
3	*2437.00	121.44 PK			1.64 H	137	123.45	-2.01
4	*2437.00	105.91 AV			1.64 H	137	107.92	-2.01
5	2483.50	65.19 PK	74.00	-8.81	1.64 H	137	66.90	-1.71
6	2483.50	50.52 AV	54.00	-3.48	1.64 H	137	52.23	-1.71
7	4874.00	49.10 PK	74.00	-24.90	1.68 H	225	44.85	4.25
8	4874.00	33.89 AV	54.00	-20.11	1.68 H	225	29.64	4.25

ANTENNA POLARITY & TEST DISTANCE: VERTICAL AT 3 M

NO.	FREQ. (MHz)	EMISSION LEVEL (dBuV/m)	LIMIT (dBuV/m)	MARGIN (dB)	ANTENNA HEIGHT (m)	TABLE ANGLE (Degree)	RAW VALUE (dBuV)	CORRECTION FACTOR (dB/m)
1	2390.00	65.15 PK	74.00	-8.85	2.10 V	46	67.46	-2.31
2	2390.00	48.13 AV	54.00	-5.87	2.10 V	46	50.44	-2.31
3	*2437.00	116.45 PK			2.10 V	46	118.46	-2.01
4	*2437.00	100.68 AV			2.10 V	46	102.69	-2.01
5	2483.50	60.44 PK	74.00	-13.56	2.10 V	46	62.15	-1.71
6	2483.50	46.94 AV	54.00	-7.06	2.10 V	46	48.65	-1.71
7	4874.00	45.40 PK	74.00	-28.60	1.28 V	15	41.15	4.25
8	4874.00	30.59 AV	54.00	-23.41	1.28 V	15	26.34	4.25

REMARKS:

1. Emission Level(dBuV/m) = Raw Value(dBuV) + Correction Factor(dB/m)
2. Correction Factor(dB/m) = Antenna Factor(dB/m) + Cable Factor(dB) – Pre-Amplifier Factor(dB)
3. The other emission levels were very low against the limit.
4. Margin value = Emission Level – Limit value
5. " * ": Fundamental frequency.

CHANNEL	TX Channel 11	DETECTOR FUNCTION	Peak (PK)
FREQUENCY RANGE	1GHz ~ 25GHz		Average (AV)

ANTENNA POLARITY & TEST DISTANCE: HORIZONTAL AT 3 M

NO.	FREQ. (MHz)	EMISSION LEVEL (dBuV/m)	LIMIT (dBuV/m)	MARGIN (dB)	ANTENNA HEIGHT (m)	TABLE ANGLE (Degree)	RAW VALUE (dBuV)	CORRECTION FACTOR (dB/m)
1	*2462.00	116.68 PK			1.78 H	139	118.53	-1.85
2	*2462.00	101.72 AV			1.78 H	139	103.57	-1.85
3	2483.50	67.70 PK	74.00	-6.30	1.78 H	139	69.41	-1.71
4	2483.50	52.98 AV	54.00	-1.02	1.78 H	139	54.69	-1.71
5	4924.00	48.88 PK	74.00	-25.12	1.58 H	49	44.58	4.30
6	4924.00	34.29 AV	54.00	-19.71	1.58 H	49	29.99	4.30

ANTENNA POLARITY & TEST DISTANCE: VERTICAL AT 3 M

NO.	FREQ. (MHz)	EMISSION LEVEL (dBuV/m)	LIMIT (dBuV/m)	MARGIN (dB)	ANTENNA HEIGHT (m)	TABLE ANGLE (Degree)	RAW VALUE (dBuV)	CORRECTION FACTOR (dB/m)
1	*2462.00	111.60 PK			2.09 V	69	113.45	-1.85
2	*2462.00	96.84 AV			2.09 V	69	98.69	-1.85
3	2483.50	63.51 PK	74.00	-10.49	2.09 V	69	65.22	-1.71
4	2483.50	48.42 AV	54.00	-5.58	2.09 V	69	50.13	-1.71
5	4924.00	44.49 PK	74.00	-29.51	1.98 V	55	40.19	4.30
6	4924.00	30.19 AV	54.00	-23.81	1.98 V	55	25.89	4.30

REMARKS:

1. Emission Level(dBuV/m) = Raw Value(dBuV) + Correction Factor(dB/m)
2. Correction Factor(dB/m) = Antenna Factor(dB/m) + Cable Factor(dB) – Pre-Amplifier Factor(dB)
3. The other emission levels were very low against the limit.
4. Margin value = Emission Level – Limit value
5. " * ": Fundamental frequency.

802.11n (40MHz)

CHANNEL	TX Channel 3	DETECTOR FUNCTION	Peak (PK)
FREQUENCY RANGE	1GHz ~ 25GHz		Average (AV)

ANTENNA POLARITY & TEST DISTANCE: HORIZONTAL AT 3 M

NO.	FREQ. (MHz)	EMISSION LEVEL (dBuV/m)	LIMIT (dBuV/m)	MARGIN (dB)	ANTENNA HEIGHT (m)	TABLE ANGLE (Degree)	RAW VALUE (dBuV)	CORRECTION FACTOR (dB/m)
1	2390.00	67.19 PK	74.00	-6.81	1.48 H	38	69.50	-2.31
2	2390.00	52.77 AV	54.00	-1.23	1.48 H	38	55.08	-2.31
3	*2422.00	110.41 PK			1.48 H	38	112.52	-2.11
4	*2422.00	98.95 AV			1.48 H	38	101.06	-2.11
5	4844.00	46.36 PK	74.00	-27.64	1.57 H	64	42.16	4.20
6	4844.00	31.69 AV	54.00	-22.31	1.57 H	64	27.49	4.20

ANTENNA POLARITY & TEST DISTANCE: VERTICAL AT 3 M

NO.	FREQ. (MHz)	EMISSION LEVEL (dBuV/m)	LIMIT (dBuV/m)	MARGIN (dB)	ANTENNA HEIGHT (m)	TABLE ANGLE (Degree)	RAW VALUE (dBuV)	CORRECTION FACTOR (dB/m)
1	2390.00	62.95 PK	74.00	-11.05	2.17 V	85	65.26	-2.31
2	2390.00	47.85 AV	54.00	-6.15	2.17 V	85	50.16	-2.31
3	*2422.00	105.73 PK			2.17 V	85	107.84	-2.11
4	*2422.00	94.78 AV			2.17 V	85	96.89	-2.11
5	4844.00	45.16 PK	74.00	-28.84	2.19 V	123	40.96	4.20
6	4844.00	30.56 AV	54.00	-23.44	2.19 V	123	26.36	4.20

REMARKS:

1. Emission Level(dBuV/m) = Raw Value(dBuV) + Correction Factor(dB/m)
2. Correction Factor(dB/m) = Antenna Factor(dB/m) + Cable Factor(dB) – Pre-Amplifier Factor(dB)
3. The other emission levels were very low against the limit.
4. Margin value = Emission Level – Limit value
5. " * ": Fundamental frequency.

CHANNEL	TX Channel 6	DETECTOR FUNCTION	Peak (PK)
FREQUENCY RANGE	1GHz ~ 25GHz		Average (AV)

ANTENNA POLARITY & TEST DISTANCE: HORIZONTAL AT 3 M

NO.	FREQ. (MHz)	EMISSION LEVEL (dBuV/m)	LIMIT (dBuV/m)	MARGIN (dB)	ANTENNA HEIGHT (m)	TABLE ANGLE (Degree)	RAW VALUE (dBuV)	CORRECTION FACTOR (dB/m)
1	2390.00	69.89 PK	74.00	-4.11	1.48 H	36	72.20	-2.31
2	2390.00	52.15 AV	54.00	-1.85	1.48 H	36	54.46	-2.31
3	*2437.00	113.63 PK			1.48 H	36	115.64	-2.01
4	*2437.00	102.62 AV			1.48 H	36	104.63	-2.01
5	2483.50	64.48 PK	74.00	-9.52	1.48 H	36	66.19	-1.71
6	2483.50	48.44 AV	54.00	-5.56	1.48 H	36	50.15	-1.71
7	4874.00	49.12 PK	74.00	-24.88	1.82 H	55	44.87	4.25
8	4874.00	33.90 AV	54.00	-20.10	1.82 H	55	29.65	4.25

ANTENNA POLARITY & TEST DISTANCE: VERTICAL AT 3 M

NO.	FREQ. (MHz)	EMISSION LEVEL (dBuV/m)	LIMIT (dBuV/m)	MARGIN (dB)	ANTENNA HEIGHT (m)	TABLE ANGLE (Degree)	RAW VALUE (dBuV)	CORRECTION FACTOR (dB/m)
1	2390.00	66.28 PK	74.00	-7.72	2.16 V	96	68.59	-2.31
2	2390.00	47.90 AV	54.00	-6.10	2.16 V	96	50.21	-2.31
3	*2437.00	108.47 PK			2.16 V	96	110.48	-2.01
4	*2437.00	97.88 AV			2.16 V	96	99.89	-2.01
5	2483.50	60.44 PK	74.00	-13.56	2.16 V	96	62.15	-1.71
6	2483.50	44.55 AV	54.00	-9.45	2.16 V	96	46.26	-1.71
7	4874.00	44.84 PK	74.00	-29.16	1.84 V	166	40.59	4.25
8	4874.00	29.94 AV	54.00	-24.06	1.84 V	166	25.69	4.25

REMARKS:

1. Emission Level(dBuV/m) = Raw Value(dBuV) + Correction Factor(dB/m)
2. Correction Factor(dB/m) = Antenna Factor(dB/m) + Cable Factor(dB) – Pre-Amplifier Factor(dB)
3. The other emission levels were very low against the limit.
4. Margin value = Emission Level – Limit value
5. " * ": Fundamental frequency.

CHANNEL	TX Channel 9	DETECTOR FUNCTION	Peak (PK)
FREQUENCY RANGE	1GHz ~ 25GHz		Average (AV)

ANTENNA POLARITY & TEST DISTANCE: HORIZONTAL AT 3 M

NO.	FREQ. (MHz)	EMISSION LEVEL (dBuV/m)	LIMIT (dBuV/m)	MARGIN (dB)	ANTENNA HEIGHT (m)	TABLE ANGLE (Degree)	RAW VALUE (dBuV)	CORRECTION FACTOR (dB/m)
1	*2452.00	107.02 PK			1.60 H	37	108.93	-1.91
2	*2452.00	96.25 AV			1.60 H	37	98.16	-1.91
3	2483.50	68.21 PK	74.00	-5.79	1.60 H	37	69.92	-1.71
4	2483.50	52.74 AV	54.00	-1.26	1.60 H	37	54.45	-1.71
5	4904.00	48.46 PK	74.00	-25.54	1.77 H	288	44.16	4.30
6	4904.00	33.93 AV	54.00	-20.07	1.77 H	288	29.63	4.30

ANTENNA POLARITY & TEST DISTANCE: VERTICAL AT 3 M

NO.	FREQ. (MHz)	EMISSION LEVEL (dBuV/m)	LIMIT (dBuV/m)	MARGIN (dB)	ANTENNA HEIGHT (m)	TABLE ANGLE (Degree)	RAW VALUE (dBuV)	CORRECTION FACTOR (dB/m)
1	*2452.00	101.37 PK			2.16 V	49	103.28	-1.91
2	*2452.00	91.75 AV			2.16 V	49	93.66	-1.91
3	2483.50	63.56 PK	74.00	-10.44	2.16 V	49	65.27	-1.71
4	2483.50	48.98 AV	54.00	-5.02	2.16 V	49	50.69	-1.71
5	4904.00	44.49 PK	74.00	-29.51	2.11 V	134	40.19	4.30
6	4904.00	30.15 AV	54.00	-23.85	2.11 V	134	25.85	4.30

REMARKS:

1. Emission Level(dBuV/m) = Raw Value(dBuV) + Correction Factor(dB/m)
2. Correction Factor(dB/m) = Antenna Factor(dB/m) + Cable Factor(dB) – Pre-Amplifier Factor(dB)
3. The other emission levels were very low against the limit.
4. Margin value = Emission Level – Limit value
5. " * ": Fundamental frequency.

CDD Mode (Mode B)

802.11b

CHANNEL	TX Channel 1	DETECTOR FUNCTION	Peak (PK)
FREQUENCY RANGE	1GHz ~ 25GHz		Average (AV)

ANTENNA POLARITY & TEST DISTANCE: HORIZONTAL AT 3 M

NO.	FREQ. (MHz)	EMISSION LEVEL (dBuV/m)	LIMIT (dBuV/m)	MARGIN (dB)	ANTENNA HEIGHT (m)	TABLE ANGLE (Degree)	RAW VALUE (dBuV)	CORRECTION FACTOR (dB/m)
1	2390.00	58.32 PK	74.00	-15.68	1.48 H	51	60.22	-1.90
2	2390.00	48.35 AV	54.00	-5.65	1.48 H	51	50.25	-1.90
3	*2412.00	111.21 PK			1.48 H	51	112.97	-1.76
4	*2412.00	108.42 AV			1.48 H	51	110.18	-1.76
5	4804.00	45.73 PK	74.00	-28.27	3.82 H	221	40.57	5.16
6	4804.00	35.81 AV	54.00	-18.19	3.82 H	221	30.65	5.16

ANTENNA POLARITY & TEST DISTANCE: VERTICAL AT 3 M

NO.	FREQ. (MHz)	EMISSION LEVEL (dBuV/m)	LIMIT (dBuV/m)	MARGIN (dB)	ANTENNA HEIGHT (m)	TABLE ANGLE (Degree)	RAW VALUE (dBuV)	CORRECTION FACTOR (dB/m)
1	2390.00	61.36 PK	74.00	-12.64	1.50 V	74	63.26	-1.90
2	2390.00	52.91 AV	54.00	-1.09	1.50 V	74	54.81	-1.90
3	*2412.00	118.62 PK			1.50 V	74	120.38	-1.76
4	*2412.00	115.65 AV			1.50 V	74	117.41	-1.76
5	4824.00	47.42 PK	74.00	-26.58	1.51 V	75	42.25	5.17
6	4824.00	40.05 AV	54.00	-13.95	1.51 V	75	34.88	5.17

REMARKS:

1. Emission Level(dBuV/m) = Raw Value(dBuV) + Correction Factor(dB/m)
2. Correction Factor(dB/m) = Antenna Factor(dB/m) + Cable Factor(dB) – Pre-Amplifier Factor(dB)
3. The other emission levels were very low against the limit.
4. Margin value = Emission Level – Limit value
5. " * ": Fundamental frequency.

CHANNEL	TX Channel 6	DETECTOR FUNCTION	Peak (PK)
FREQUENCY RANGE	1GHz ~ 25GHz		Average (AV)

ANTENNA POLARITY & TEST DISTANCE: HORIZONTAL AT 3 M

NO.	FREQ. (MHz)	EMISSION LEVEL (dBuV/m)	LIMIT (dBuV/m)	MARGIN (dB)	ANTENNA HEIGHT (m)	TABLE ANGLE (Degree)	RAW VALUE (dBuV)	CORRECTION FACTOR (dB/m)
1	2390.00	54.05 PK	74.00	-19.95	1.43 H	61	56.36	-2.31
2	2390.00	44.85 AV	54.00	-9.15	1.43 H	61	47.16	-2.31
3	*2437.00	111.63 PK			1.43 H	61	113.64	-2.01
4	*2437.00	108.21 AV			1.43 H	61	110.22	-2.01
5	2483.50	56.54 PK	74.00	-17.46	1.43 H	61	58.25	-1.71
6	2483.50	48.65 AV	54.00	-5.35	1.43 H	61	50.36	-1.71
7	4874.00	51.17 PK	74.00	-22.83	1.21 H	309	46.88	4.29
8	4874.00	48.05 AV	54.00	-5.95	1.21 H	309	43.76	4.29

ANTENNA POLARITY & TEST DISTANCE: VERTICAL AT 3 M

NO.	FREQ. (MHz)	EMISSION LEVEL (dBuV/m)	LIMIT (dBuV/m)	MARGIN (dB)	ANTENNA HEIGHT (m)	TABLE ANGLE (Degree)	RAW VALUE (dBuV)	CORRECTION FACTOR (dB/m)
1	2390.00	58.67 PK	74.00	-15.33	1.60 V	0	60.98	-2.31
2	2390.00	49.04 AV	54.00	-4.96	1.60 V	0	51.35	-2.31
3	*2437.00	119.60 PK			1.60 V	0	121.61	-2.01
4	*2437.00	116.12 AV			1.60 V	0	118.13	-2.01
5	2483.50	60.50 PK	74.00	-13.50	1.60 V	0	62.21	-1.71
6	2483.50	52.70 AV	54.00	-1.30	1.60 V	0	54.41	-1.71
7	4874.00	52.89 PK	74.00	-21.11	1.58 V	10	48.60	4.29
8	4874.00	50.35 AV	54.00	-3.65	1.58 V	10	46.06	4.29

REMARKS:

1. Emission Level(dBuV/m) = Raw Value(dBuV) + Correction Factor(dB/m)
2. Correction Factor(dB/m) = Antenna Factor(dB/m) + Cable Factor(dB) – Pre-Amplifier Factor(dB)
3. The other emission levels were very low against the limit.
4. Margin value = Emission Level – Limit value
5. " * ": Fundamental frequency.

CHANNEL	TX Channel 11	DETECTOR FUNCTION	Peak (PK)
FREQUENCY RANGE	1GHz ~ 25GHz		Average (AV)

ANTENNA POLARITY & TEST DISTANCE: HORIZONTAL AT 3 M

NO.	FREQ. (MHz)	EMISSION LEVEL (dBuV/m)	LIMIT (dBuV/m)	MARGIN (dB)	ANTENNA HEIGHT (m)	TABLE ANGLE (Degree)	RAW VALUE (dBuV)	CORRECTION FACTOR (dB/m)
1	*2462.00	108.97 PK			1.42 H	43	110.43	-1.46
2	*2462.00	106.36 AV			1.42 H	43	107.82	-1.46
3	2483.50	59.01 PK	74.00	-14.99	1.42 H	43	60.34	-1.33
4	2483.50	50.83 AV	54.00	-3.17	1.42 H	43	52.16	-1.33
5	4924.00	45.96 PK	74.00	-28.04	3.77 H	231	40.66	5.30
6	4924.00	35.94 AV	54.00	-18.06	3.77 H	231	30.64	5.30

ANTENNA POLARITY & TEST DISTANCE: VERTICAL AT 3 M

NO.	FREQ. (MHz)	EMISSION LEVEL (dBuV/m)	LIMIT (dBuV/m)	MARGIN (dB)	ANTENNA HEIGHT (m)	TABLE ANGLE (Degree)	RAW VALUE (dBuV)	CORRECTION FACTOR (dB/m)
1	*2462.00	117.41 PK			1.66 V	79	118.87	-1.46
2	*2462.00	114.51 AV			1.66 V	79	115.97	-1.46
3	2483.50	63.40 PK	74.00	-10.60	1.66 V	79	64.73	-1.33
4	2483.50	52.81 AV	54.00	-1.19	1.66 V	79	54.14	-1.33
5	4924.00	48.14 PK	74.00	-25.86	1.52 V	81	42.84	5.30
6	4924.00	39.53 AV	54.00	-14.47	1.52 V	81	34.23	5.30

REMARKS:

1. Emission Level(dBuV/m) = Raw Value(dBuV) + Correction Factor(dB/m)
2. Correction Factor(dB/m) = Antenna Factor(dB/m) + Cable Factor(dB) – Pre-Amplifier Factor(dB)
3. The other emission levels were very low against the limit.
4. Margin value = Emission Level – Limit value
5. " * ": Fundamental frequency.

802.11g

CHANNEL	TX Channel 1	DETECTOR FUNCTION	Peak (PK)
FREQUENCY RANGE	1GHz ~ 25GHz		Average (AV)

ANTENNA POLARITY & TEST DISTANCE: HORIZONTAL AT 3 M

NO.	FREQ. (MHz)	EMISSION LEVEL (dBuV/m)	LIMIT (dBuV/m)	MARGIN (dB)	ANTENNA HEIGHT (m)	TABLE ANGLE (Degree)	RAW VALUE (dBuV)	CORRECTION FACTOR (dB/m)
1	2390.00	62.19 PK	74.00	-11.81	1.32 H	50	64.09	-1.90
2	2390.00	46.88 AV	54.00	-7.12	1.32 H	50	48.78	-1.90
3	*2412.00	111.22 PK			1.32 H	50	112.98	-1.76
4	*2412.00	100.34 AV			1.32 H	50	102.10	-1.76
5	4824.00	44.83 PK	74.00	-29.17	1.87 H	201	39.66	5.17
6	4824.00	30.58 AV	54.00	-23.42	1.87 H	201	25.41	5.17

ANTENNA POLARITY & TEST DISTANCE: VERTICAL AT 3 M

NO.	FREQ. (MHz)	EMISSION LEVEL (dBuV/m)	LIMIT (dBuV/m)	MARGIN (dB)	ANTENNA HEIGHT (m)	TABLE ANGLE (Degree)	RAW VALUE (dBuV)	CORRECTION FACTOR (dB/m)
1	2390.00	67.72 PK	74.00	-6.28	1.49 V	254	69.62	-1.90
2	2390.00	52.87 AV	54.00	-1.13	1.49 V	254	54.77	-1.90
3	*2412.00	120.14 PK			1.49 V	254	121.90	-1.76
4	*2412.00	108.92 AV			1.49 V	254	110.68	-1.76
5	4824.00	45.82 PK	74.00	-28.18	1.69 V	224	40.65	5.17
6	4824.00	31.52 AV	54.00	-22.48	1.69 V	224	26.35	5.17

REMARKS:

1. Emission Level(dBuV/m) = Raw Value(dBuV) + Correction Factor(dB/m)
2. Correction Factor(dB/m) = Antenna Factor(dB/m) + Cable Factor(dB) – Pre-Amplifier Factor(dB)
3. The other emission levels were very low against the limit.
4. Margin value = Emission Level – Limit value
5. " * ": Fundamental frequency.

CHANNEL	TX Channel 6	DETECTOR FUNCTION	Peak (PK)
FREQUENCY RANGE	1GHz ~ 25GHz		Average (AV)

ANTENNA POLARITY & TEST DISTANCE: HORIZONTAL AT 3 M

NO.	FREQ. (MHz)	EMISSION LEVEL (dBuV/m)	LIMIT (dBuV/m)	MARGIN (dB)	ANTENNA HEIGHT (m)	TABLE ANGLE (Degree)	RAW VALUE (dBuV)	CORRECTION FACTOR (dB/m)
1	2390.00	64.01 PK	74.00	-9.99	1.36 H	62	66.32	-2.31
2	2390.00	48.71 AV	54.00	-5.29	1.36 H	62	51.02	-2.31
3	*2437.00	115.45 PK			1.36 H	62	117.46	-2.01
4	*2437.00	102.50 AV			1.36 H	62	104.51	-2.01
5	2483.50	67.94 PK	74.00	-6.06	1.36 H	62	69.65	-1.71
6	2483.50	48.45 AV	54.00	-5.55	1.36 H	62	50.16	-1.71
7	4874.00	43.62 PK	74.00	-30.38	1.19 H	233	39.33	4.29
8	4874.00	29.42 AV	54.00	-24.58	1.19 H	233	25.13	4.29

ANTENNA POLARITY & TEST DISTANCE: VERTICAL AT 3 M

NO.	FREQ. (MHz)	EMISSION LEVEL (dBuV/m)	LIMIT (dBuV/m)	MARGIN (dB)	ANTENNA HEIGHT (m)	TABLE ANGLE (Degree)	RAW VALUE (dBuV)	CORRECTION FACTOR (dB/m)
1	2390.00	68.10 PK	74.00	-5.90	1.74 V	14	70.41	-2.31
2	2390.00	52.69 AV	54.00	-1.31	1.74 V	14	55.00	-2.31
3	*2437.00	123.54 PK			1.74 V	14	125.55	-2.01
4	*2437.00	110.42 AV			1.74 V	14	112.43	-2.01
5	2483.50	71.30 PK	74.00	-2.70	1.74 V	14	73.01	-1.71
6	2483.50	52.98 AV	54.00	-1.02	1.74 V	14	54.69	-1.71
7	4874.00	44.45 PK	74.00	-29.55	1.78 V	216	40.16	4.29
8	4874.00	30.83 AV	54.00	-23.17	1.78 V	216	26.54	4.29

REMARKS:

1. Emission Level(dBuV/m) = Raw Value(dBuV) + Correction Factor(dB/m)
2. Correction Factor(dB/m) = Antenna Factor(dB/m) + Cable Factor(dB) – Pre-Amplifier Factor(dB)
3. The other emission levels were very low against the limit.
4. Margin value = Emission Level – Limit value
5. " * ": Fundamental frequency.

CHANNEL	TX Channel 11	DETECTOR FUNCTION	Peak (PK)
FREQUENCY RANGE	1GHz ~ 25GHz		Average (AV)

ANTENNA POLARITY & TEST DISTANCE: HORIZONTAL AT 3 M

NO.	FREQ. (MHz)	EMISSION LEVEL (dBuV/m)	LIMIT (dBuV/m)	MARGIN (dB)	ANTENNA HEIGHT (m)	TABLE ANGLE (Degree)	RAW VALUE (dBuV)	CORRECTION FACTOR (dB/m)
1	*2462.00	111.38 PK			1.31 H	42	112.84	-1.46
2	*2462.00	100.40 AV			1.31 H	42	101.86	-1.46
3	2483.50	59.80 PK	74.00	-14.20	1.31 H	42	61.13	-1.33
4	2483.50	42.86 AV	54.00	-11.14	1.31 H	42	44.19	-1.33
5	4924.00	44.94 PK	74.00	-29.06	1.93 H	187	39.64	5.30
6	4924.00	31.12 AV	54.00	-22.88	1.93 H	187	25.82	5.30

ANTENNA POLARITY & TEST DISTANCE: VERTICAL AT 3 M

NO.	FREQ. (MHz)	EMISSION LEVEL (dBuV/m)	LIMIT (dBuV/m)	MARGIN (dB)	ANTENNA HEIGHT (m)	TABLE ANGLE (Degree)	RAW VALUE (dBuV)	CORRECTION FACTOR (dB/m)
1	*2462.00	119.85 PK			1.81 V	19	121.31	-1.46
2	*2462.00	108.20 AV			1.81 V	19	109.66	-1.46
3	2483.50	67.96 PK	74.00	-6.04	1.81 V	19	69.29	-1.33
4	2483.50	52.87 AV	54.00	-1.13	1.81 V	19	54.20	-1.33
5	4924.00	46.14 PK	74.00	-27.86	1.88 V	209	40.84	5.30
6	4924.00	32.14 AV	54.00	-21.86	1.88 V	209	26.84	5.30

REMARKS:

1. Emission Level(dBuV/m) = Raw Value(dBuV) + Correction Factor(dB/m)
2. Correction Factor(dB/m) = Antenna Factor(dB/m) + Cable Factor(dB) – Pre-Amplifier Factor(dB)
3. The other emission levels were very low against the limit.
4. Margin value = Emission Level – Limit value
5. " * ": Fundamental frequency.

802.11n (20MHz)

CHANNEL	TX Channel 1	DETECTOR FUNCTION	Peak (PK)
FREQUENCY RANGE	1GHz ~ 25GHz		Average (AV)

ANTENNA POLARITY & TEST DISTANCE: HORIZONTAL AT 3 M

NO.	FREQ. (MHz)	EMISSION LEVEL (dBuV/m)	LIMIT (dBuV/m)	MARGIN (dB)	ANTENNA HEIGHT (m)	TABLE ANGLE (Degree)	RAW VALUE (dBuV)	CORRECTION FACTOR (dB/m)
1	2390.00	62.13 PK	74.00	-11.87	1.33 H	50	64.03	-1.90
2	2390.00	46.63 AV	54.00	-7.37	1.33 H	50	48.53	-1.90
3	*2412.00	110.67 PK			1.33 H	50	112.43	-1.76
4	*2412.00	98.71 AV			1.33 H	50	100.47	-1.76
5	4824.00	44.81 PK	74.00	-29.19	1.34 H	221	39.64	5.17
6	4824.00	30.25 AV	54.00	-23.75	1.34 H	221	25.08	5.17

ANTENNA POLARITY & TEST DISTANCE: VERTICAL AT 3 M

NO.	FREQ. (MHz)	EMISSION LEVEL (dBuV/m)	LIMIT (dBuV/m)	MARGIN (dB)	ANTENNA HEIGHT (m)	TABLE ANGLE (Degree)	RAW VALUE (dBuV)	CORRECTION FACTOR (dB/m)
1	2390.00	66.74 PK	74.00	-7.26	1.51 V	250	68.64	-1.90
2	2390.00	52.73 AV	54.00	-1.27	1.51 V	250	54.63	-1.90
3	*2412.00	120.32 PK			1.51 V	250	122.08	-1.76
4	*2412.00	107.87 AV			1.51 V	250	109.63	-1.76
5	4824.00	46.06 PK	74.00	-27.94	2.14 V	263	40.89	5.17
6	4824.00	31.81 AV	54.00	-22.19	2.14 V	263	26.64	5.17

REMARKS:

1. Emission Level(dBuV/m) = Raw Value(dBuV) + Correction Factor(dB/m)
2. Correction Factor(dB/m) = Antenna Factor(dB/m) + Cable Factor(dB) – Pre-Amplifier Factor(dB)
3. The other emission levels were very low against the limit.
4. Margin value = Emission Level – Limit value
5. " * ": Fundamental frequency.

CHANNEL	TX Channel 6	DETECTOR FUNCTION	Peak (PK)
FREQUENCY RANGE	1GHz ~ 25GHz		Average (AV)

ANTENNA POLARITY & TEST DISTANCE: HORIZONTAL AT 3 M

NO.	FREQ. (MHz)	EMISSION LEVEL (dBuV/m)	LIMIT (dBuV/m)	MARGIN (dB)	ANTENNA HEIGHT (m)	TABLE ANGLE (Degree)	RAW VALUE (dBuV)	CORRECTION FACTOR (dB/m)
1	2390.00	62.82 PK	74.00	-11.18	1.32 H	42	65.13	-2.31
2	2390.00	48.90 AV	54.00	-5.10	1.32 H	42	51.21	-2.31
3	*2437.00	114.35 PK			1.32 H	42	116.36	-2.01
4	*2437.00	102.24 AV			1.32 H	42	104.25	-2.01
5	2483.50	66.18 PK	74.00	-7.82	1.32 H	42	67.89	-1.71
6	2483.50	48.52 AV	54.00	-5.48	1.32 H	42	50.23	-1.71
7	4874.00	43.93 PK	74.00	-30.07	1.94 H	141	39.64	4.29
8	4874.00	29.63 AV	54.00	-24.37	1.94 H	141	25.34	4.29

ANTENNA POLARITY & TEST DISTANCE: VERTICAL AT 3 M

NO.	FREQ. (MHz)	EMISSION LEVEL (dBuV/m)	LIMIT (dBuV/m)	MARGIN (dB)	ANTENNA HEIGHT (m)	TABLE ANGLE (Degree)	RAW VALUE (dBuV)	CORRECTION FACTOR (dB/m)
1	2390.00	67.60 PK	74.00	-6.40	1.65 V	11	69.91	-2.31
2	2390.00	52.79 AV	54.00	-1.21	1.65 V	11	55.10	-2.31
3	*2437.00	123.48 PK			1.65 V	11	125.49	-2.01
4	*2437.00	111.28 AV			1.65 V	11	113.29	-2.01
5	2483.50	69.57 PK	74.00	-4.43	1.65 V	11	71.28	-1.71
6	2483.50	52.49 AV	54.00	-1.51	1.65 V	11	54.20	-1.71
7	4874.00	44.80 PK	74.00	-29.20	1.66 V	23	40.51	4.29
8	4874.00	31.13 AV	54.00	-22.87	1.66 V	23	26.84	4.29

REMARKS:

1. Emission Level(dBuV/m) = Raw Value(dBuV) + Correction Factor(dB/m)
2. Correction Factor(dB/m) = Antenna Factor(dB/m) + Cable Factor(dB) – Pre-Amplifier Factor(dB)
3. The other emission levels were very low against the limit.
4. Margin value = Emission Level – Limit value
5. " * ": Fundamental frequency.

CHANNEL	TX Channel 11	DETECTOR FUNCTION	Peak (PK)
FREQUENCY RANGE	1GHz ~ 25GHz		Average (AV)

ANTENNA POLARITY & TEST DISTANCE: HORIZONTAL AT 3 M

NO.	FREQ. (MHz)	EMISSION LEVEL (dBuV/m)	LIMIT (dBuV/m)	MARGIN (dB)	ANTENNA HEIGHT (m)	TABLE ANGLE (Degree)	RAW VALUE (dBuV)	CORRECTION FACTOR (dB/m)
1	*2462.00	109.09 PK			1.39 H	56	110.55	-1.46
2	*2462.00	97.30 AV			1.39 H	56	98.76	-1.46
3	2483.50	62.03 PK	74.00	-11.97	1.39 H	56	63.36	-1.33
4	2483.50	48.53 AV	54.00	-5.47	1.39 H	56	49.86	-1.33
5	4924.00	44.94 PK	74.00	-29.06	1.74 H	104	39.64	5.30
6	4924.00	30.53 AV	54.00	-23.47	1.74 H	104	25.23	5.30

ANTENNA POLARITY & TEST DISTANCE: VERTICAL AT 3 M

NO.	FREQ. (MHz)	EMISSION LEVEL (dBuV/m)	LIMIT (dBuV/m)	MARGIN (dB)	ANTENNA HEIGHT (m)	TABLE ANGLE (Degree)	RAW VALUE (dBuV)	CORRECTION FACTOR (dB/m)
1	*2462.00	118.82 PK			1.67 V	20	120.28	-1.46
2	*2462.00	105.47 AV			1.67 V	20	106.93	-1.46
3	2483.50	66.40 PK	74.00	-7.60	1.67 V	20	67.73	-1.33
4	2483.50	52.59 AV	54.00	-1.41	1.67 V	20	53.92	-1.33
5	4924.00	46.14 PK	74.00	-27.86	1.66 V	208	40.84	5.30
6	4924.00	32.12 AV	54.00	-21.88	1.66 V	208	26.82	5.30

REMARKS:

1. Emission Level(dBuV/m) = Raw Value(dBuV) + Correction Factor(dB/m)
2. Correction Factor(dB/m) = Antenna Factor(dB/m) + Cable Factor(dB) – Pre-Amplifier Factor(dB)
3. The other emission levels were very low against the limit.
4. Margin value = Emission Level – Limit value
5. " * ": Fundamental frequency.

802.11n (40MHz)

CHANNEL	TX Channel 3	DETECTOR FUNCTION	Peak (PK)
FREQUENCY RANGE	1GHz ~ 25GHz		Average (AV)

ANTENNA POLARITY & TEST DISTANCE: HORIZONTAL AT 3 M

NO.	FREQ. (MHz)	EMISSION LEVEL (dBuV/m)	LIMIT (dBuV/m)	MARGIN (dB)	ANTENNA HEIGHT (m)	TABLE ANGLE (Degree)	RAW VALUE (dBuV)	CORRECTION FACTOR (dB/m)
1	2390.00	66.56 PK	74.00	-7.44	1.38 H	67	68.46	-1.90
2	2390.00	48.46 AV	54.00	-5.54	1.38 H	67	50.36	-1.90
3	*2422.00	107.25 PK			1.38 H	67	108.96	-1.71
4	*2422.00	96.15 AV			1.38 H	67	97.86	-1.71
5	4844.00	44.83 PK	74.00	-29.17	1.94 H	251	39.64	5.19
6	4844.00	31.00 AV	54.00	-23.00	1.94 H	251	25.81	5.19

ANTENNA POLARITY & TEST DISTANCE: VERTICAL AT 3 M

NO.	FREQ. (MHz)	EMISSION LEVEL (dBuV/m)	LIMIT (dBuV/m)	MARGIN (dB)	ANTENNA HEIGHT (m)	TABLE ANGLE (Degree)	RAW VALUE (dBuV)	CORRECTION FACTOR (dB/m)
1	2390.00	70.90 PK	74.00	-3.10	1.51 V	180	72.80	-1.90
2	2390.00	52.96 AV	54.00	-1.04	1.51 V	180	54.86	-1.90
3	*2422.00	116.93 PK			1.51 V	180	118.64	-1.71
4	*2422.00	106.24 AV			1.51 V	180	107.95	-1.71
5	4844.00	45.77 PK	74.00	-28.23	1.84 V	251	40.58	5.19
6	4844.00	32.03 AV	54.00	-21.97	1.84 V	251	26.84	5.19

REMARKS:

1. Emission Level(dBuV/m) = Raw Value(dBuV) + Correction Factor(dB/m)
2. Correction Factor(dB/m) = Antenna Factor(dB/m) + Cable Factor(dB) – Pre-Amplifier Factor(dB)
3. The other emission levels were very low against the limit.
4. Margin value = Emission Level – Limit value
5. " * ": Fundamental frequency.

CHANNEL	TX Channel 6	DETECTOR FUNCTION	Peak (PK)
FREQUENCY RANGE	1GHz ~ 25GHz		Average (AV)

ANTENNA POLARITY & TEST DISTANCE: HORIZONTAL AT 3 M

NO.	FREQ. (MHz)	EMISSION LEVEL (dBuV/m)	LIMIT (dBuV/m)	MARGIN (dB)	ANTENNA HEIGHT (m)	TABLE ANGLE (Degree)	RAW VALUE (dBuV)	CORRECTION FACTOR (dB/m)
1	2390.00	61.23 PK	74.00	-12.77	1.33 H	79	63.54	-2.31
2	2390.00	46.20 AV	54.00	-7.80	1.33 H	79	48.51	-2.31
3	*2437.00	106.54 PK			1.33 H	79	108.55	-2.01
4	*2437.00	94.37 AV			1.33 H	79	96.38	-2.01
5	2483.50	66.54 PK	74.00	-7.46	1.33 H	79	68.25	-1.71
6	2483.50	48.65 AV	54.00	-5.35	1.33 H	79	50.36	-1.71
7	4874.00	43.65 PK	74.00	-30.35	1.94 H	127	39.36	4.29
8	4874.00	29.93 AV	54.00	-24.07	1.94 H	127	25.64	4.29

ANTENNA POLARITY & TEST DISTANCE: VERTICAL AT 3 M

NO.	FREQ. (MHz)	EMISSION LEVEL (dBuV/m)	LIMIT (dBuV/m)	MARGIN (dB)	ANTENNA HEIGHT (m)	TABLE ANGLE (Degree)	RAW VALUE (dBuV)	CORRECTION FACTOR (dB/m)
1	2390.00	65.27 PK	74.00	-8.73	1.61 V	11	67.58	-2.31
2	2390.00	49.85 AV	54.00	-4.15	1.61 V	11	52.16	-2.31
3	*2437.00	116.19 PK			1.61 V	11	118.20	-2.01
4	*2437.00	103.85 AV			1.61 V	11	105.86	-2.01
5	2483.50	71.05 PK	74.00	-2.95	1.61 V	11	72.76	-1.71
6	2483.50	52.94 AV	54.00	-1.06	1.61 V	11	54.65	-1.71
7	4874.00	44.57 PK	74.00	-29.43	1.52 V	22	40.28	4.29
8	4874.00	31.10 AV	54.00	-22.90	1.52 V	22	26.81	4.29

REMARKS:

1. Emission Level(dBuV/m) = Raw Value(dBuV) + Correction Factor(dB/m)
2. Correction Factor(dB/m) = Antenna Factor(dB/m) + Cable Factor(dB) – Pre-Amplifier Factor(dB)
3. The other emission levels were very low against the limit.
4. Margin value = Emission Level – Limit value
5. " * ": Fundamental frequency.

CHANNEL	TX Channel 9	DETECTOR FUNCTION	Peak (PK)
FREQUENCY RANGE	1GHz ~ 25GHz		Average (AV)

ANTENNA POLARITY & TEST DISTANCE: HORIZONTAL AT 3 M

NO.	FREQ. (MHz)	EMISSION LEVEL (dBuV/m)	LIMIT (dBuV/m)	MARGIN (dB)	ANTENNA HEIGHT (m)	TABLE ANGLE (Degree)	RAW VALUE (dBuV)	CORRECTION FACTOR (dB/m)
1	*2452.00	104.33 PK			1.39 H	63	105.84	-1.51
2	*2452.00	94.12 AV			1.39 H	63	95.63	-1.51
3	2483.50	66.92 PK	74.00	-7.08	1.39 H	63	68.25	-1.33
4	2483.50	49.08 AV	54.00	-4.92	1.39 H	63	50.41	-1.33
5	4904.00	44.69 PK	74.00	-29.31	1.84 H	229	39.45	5.24
6	4904.00	30.86 AV	54.00	-23.14	1.84 H	229	25.62	5.24

ANTENNA POLARITY & TEST DISTANCE: VERTICAL AT 3 M

NO.	FREQ. (MHz)	EMISSION LEVEL (dBuV/m)	LIMIT (dBuV/m)	MARGIN (dB)	ANTENNA HEIGHT (m)	TABLE ANGLE (Degree)	RAW VALUE (dBuV)	CORRECTION FACTOR (dB/m)
1	*2452.00	114.30 PK			1.60 V	254	115.81	-1.51
2	*2452.00	103.52 AV			1.60 V	254	105.03	-1.51
3	2483.50	71.63 PK	74.00	-2.37	1.60 V	254	72.96	-1.33
4	2483.50	52.96 AV	54.00	-1.04	1.60 V	254	54.29	-1.33
5	4904.00	46.08 PK	74.00	-27.92	4.00 V	211	40.84	5.24
6	4904.00	31.88 AV	54.00	-22.12	4.00 V	211	26.64	5.24

REMARKS:

1. Emission Level(dBuV/m) = Raw Value(dBuV) + Correction Factor(dB/m)
2. Correction Factor(dB/m) = Antenna Factor(dB/m) + Cable Factor(dB) – Pre-Amplifier Factor(dB)
3. The other emission levels were very low against the limit.
4. Margin value = Emission Level – Limit value
5. " * ": Fundamental frequency.

Beamforming_NSS1 Mode (Mode A)

802.11n (20MHz)

CHANNEL	TX Channel 1	DETECTOR FUNCTION	Peak (PK)
FREQUENCY RANGE	1GHz ~ 25GHz		Average (AV)

ANTENNA POLARITY & TEST DISTANCE: HORIZONTAL AT 3 M

NO.	FREQ. (MHz)	EMISSION LEVEL (dBuV/m)	LIMIT (dBuV/m)	MARGIN (dB)	ANTENNA HEIGHT (m)	TABLE ANGLE (Degree)	RAW VALUE (dBuV)	CORRECTION FACTOR (dB/m)
1	2390.00	72.96 PK	74.00	-1.04	3.06 H	307	75.27	-2.31
2	2390.00	50.58 AV	54.00	-3.42	3.06 H	307	52.89	-2.31
3	*2412.00	116.36 PK			3.06 H	307	118.53	-2.17
4	*2412.00	105.16 AV			3.06 H	307	107.33	-2.17
5	4824.00	44.31 PK	74.00	-29.69	1.68 H	264	40.15	4.16
6	4824.00	30.52 AV	54.00	-23.48	1.68 H	264	26.36	4.16

ANTENNA POLARITY & TEST DISTANCE: VERTICAL AT 3 M

NO.	FREQ. (MHz)	EMISSION LEVEL (dBuV/m)	LIMIT (dBuV/m)	MARGIN (dB)	ANTENNA HEIGHT (m)	TABLE ANGLE (Degree)	RAW VALUE (dBuV)	CORRECTION FACTOR (dB/m)
1	2390.00	71.06 PK	74.00	-2.94	3.66 V	221	73.37	-2.31
2	2390.00	48.03 AV	54.00	-5.97	3.66 V	221	50.34	-2.31
3	*2412.00	114.52 PK			3.66 V	221	116.69	-2.17
4	*2412.00	99.66 AV			3.66 V	221	101.83	-2.17
5	4824.00	44.01 PK	74.00	-29.99	1.85 V	36	39.85	4.16
6	4824.00	29.54 AV	54.00	-24.46	1.85 V	36	25.38	4.16

REMARKS:

1. Emission Level(dBuV/m) = Raw Value(dBuV) + Correction Factor(dB/m)
2. Correction Factor(dB/m) = Antenna Factor(dB/m) + Cable Factor(dB) – Pre-Amplifier Factor(dB)
3. The other emission levels were very low against the limit.
4. Margin value = Emission Level – Limit value
5. " * ": Fundamental frequency.

CHANNEL	TX Channel 6	DETECTOR FUNCTION	Peak (PK)
FREQUENCY RANGE	1GHz ~ 25GHz		Average (AV)

ANTENNA POLARITY & TEST DISTANCE: HORIZONTAL AT 3 M

NO.	FREQ. (MHz)	EMISSION LEVEL (dBuV/m)	LIMIT (dBuV/m)	MARGIN (dB)	ANTENNA HEIGHT (m)	TABLE ANGLE (Degree)	RAW VALUE (dBuV)	CORRECTION FACTOR (dB/m)
1	*2437.00	117.05 PK			2.45 H	314	119.06	-2.01
2	*2437.00	102.85 AV			2.45 H	314	104.86	-2.01
3	4874.00	44.94 PK	74.00	-29.06	1.28 H	269	40.69	4.25
4	4874.00	31.10 AV	54.00	-22.90	1.28 H	269	26.85	4.25

ANTENNA POLARITY & TEST DISTANCE: VERTICAL AT 3 M

NO.	FREQ. (MHz)	EMISSION LEVEL (dBuV/m)	LIMIT (dBuV/m)	MARGIN (dB)	ANTENNA HEIGHT (m)	TABLE ANGLE (Degree)	RAW VALUE (dBuV)	CORRECTION FACTOR (dB/m)
1	*2437.00	115.25 PK			3.59 V	231	117.26	-2.01
2	*2437.00	100.25 AV			3.59 V	231	102.26	-2.01
3	4874.00	43.51 PK	74.00	-30.49	1.98 V	88	39.26	4.25
4	4874.00	29.59 AV	54.00	-24.41	1.98 V	88	25.34	4.25

REMARKS:

1. Emission Level(dBuV/m) = Raw Value(dBuV) + Correction Factor(dB/m)
2. Correction Factor(dB/m) = Antenna Factor(dB/m) + Cable Factor(dB) – Pre-Amplifier Factor(dB)
3. The other emission levels were very low against the limit.
4. Margin value = Emission Level – Limit value
5. " * ": Fundamental frequency.

CHANNEL	TX Channel 11	DETECTOR FUNCTION	Peak (PK)
FREQUENCY RANGE	1GHz ~ 25GHz		Average (AV)

ANTENNA POLARITY & TEST DISTANCE: HORIZONTAL AT 3 M

NO.	FREQ. (MHz)	EMISSION LEVEL (dBuV/m)	LIMIT (dBuV/m)	MARGIN (dB)	ANTENNA HEIGHT (m)	TABLE ANGLE (Degree)	RAW VALUE (dBuV)	CORRECTION FACTOR (dB/m)
1	*2462.00	112.49 PK			2.96 H	329	114.34	-1.85
2	*2462.00	103.33 AV			2.96 H	329	105.18	-1.85
3	2483.50	72.79 PK	74.00	-1.21	2.96 H	329	74.50	-1.71
4	2483.50	48.87 AV	54.00	-5.13	2.96 H	329	50.58	-1.71
5	4924.00	44.65 PK	74.00	-29.35	1.64 H	226	40.35	4.30
6	4924.00	31.11 AV	54.00	-22.89	1.64 H	226	26.81	4.30

ANTENNA POLARITY & TEST DISTANCE: VERTICAL AT 3 M

NO.	FREQ. (MHz)	EMISSION LEVEL (dBuV/m)	LIMIT (dBuV/m)	MARGIN (dB)	ANTENNA HEIGHT (m)	TABLE ANGLE (Degree)	RAW VALUE (dBuV)	CORRECTION FACTOR (dB/m)
1	*2462.00	110.61 PK			3.32 V	216	112.46	-1.85
2	*2462.00	101.41 AV			3.32 V	216	103.26	-1.85
3	2483.50	69.45 PK	74.00	-4.55	3.32 V	216	71.16	-1.71
4	2483.50	46.94 AV	54.00	-7.06	3.32 V	216	48.65	-1.71
5	4924.00	43.68 PK	74.00	-30.32	1.84 V	227	39.38	4.30
6	4924.00	30.12 AV	54.00	-23.88	1.84 V	227	25.82	4.30

REMARKS:

1. Emission Level(dBuV/m) = Raw Value(dBuV) + Correction Factor(dB/m)
2. Correction Factor(dB/m) = Antenna Factor(dB/m) + Cable Factor(dB) – Pre-Amplifier Factor(dB)
3. The other emission levels were very low against the limit.
4. Margin value = Emission Level – Limit value
5. " * ": Fundamental frequency.

802.11n (40MHz)

CHANNEL	TX Channel 3	DETECTOR FUNCTION	Peak (PK)
FREQUENCY RANGE	1GHz ~ 25GHz		Average (AV)

ANTENNA POLARITY & TEST DISTANCE: HORIZONTAL AT 3 M

NO.	FREQ. (MHz)	EMISSION LEVEL (dBuV/m)	LIMIT (dBuV/m)	MARGIN (dB)	ANTENNA HEIGHT (m)	TABLE ANGLE (Degree)	RAW VALUE (dBuV)	CORRECTION FACTOR (dB/m)
1	2390.00	72.91 PK	74.00	-1.09	2.00 H	213	75.22	-2.31
2	2390.00	52.53 AV	54.00	-1.47	2.00 H	213	54.84	-2.31
3	*2422.00	116.57 PK			2.00 H	213	118.68	-2.11
4	*2422.00	108.13 AV			2.00 H	213	110.24	-2.11
5	4844.00	45.04 PK	74.00	-28.96	1.58 H	205	40.84	4.20
6	4844.00	30.84 AV	54.00	-23.16	1.58 H	205	26.64	4.20

ANTENNA POLARITY & TEST DISTANCE: VERTICAL AT 3 M

NO.	FREQ. (MHz)	EMISSION LEVEL (dBuV/m)	LIMIT (dBuV/m)	MARGIN (dB)	ANTENNA HEIGHT (m)	TABLE ANGLE (Degree)	RAW VALUE (dBuV)	CORRECTION FACTOR (dB/m)
1	2390.00	70.33 PK	74.00	-3.67	3.12 V	208	72.64	-2.31
2	2390.00	49.05 AV	54.00	-4.95	3.12 V	208	51.36	-2.31
3	*2422.00	114.23 PK			3.12 V	208	116.34	-2.11
4	*2422.00	106.23 AV			3.12 V	208	108.34	-2.11
5	4844.00	43.58 PK	74.00	-30.42	1.97 V	241	39.38	4.20
6	4844.00	29.29 AV	54.00	-24.71	1.97 V	241	25.09	4.20

REMARKS:

1. Emission Level(dBuV/m) = Raw Value(dBuV) + Correction Factor(dB/m)
2. Correction Factor(dB/m) = Antenna Factor(dB/m) + Cable Factor(dB) – Pre-Amplifier Factor(dB)
3. The other emission levels were very low against the limit.
4. Margin value = Emission Level – Limit value
5. " * ": Fundamental frequency.

CHANNEL	TX Channel 6	DETECTOR FUNCTION	Peak (PK)
FREQUENCY RANGE	1GHz ~ 25GHz		Average (AV)

ANTENNA POLARITY & TEST DISTANCE: HORIZONTAL AT 3 M

NO.	FREQ. (MHz)	EMISSION LEVEL (dBuV/m)	LIMIT (dBuV/m)	MARGIN (dB)	ANTENNA HEIGHT (m)	TABLE ANGLE (Degree)	RAW VALUE (dBuV)	CORRECTION FACTOR (dB/m)
1	2390.00	71.03 PK	74.00	-2.97	2.29 H	210	73.34	-2.31
2	2390.00	52.00 AV	54.00	-2.00	2.29 H	210	54.31	-2.31
3	*2437.00	117.35 PK			2.29 H	210	119.36	-2.01
4	*2437.00	106.95 AV			2.29 H	210	108.96	-2.01
5	2483.50	72.11 PK	74.00	-1.89	2.29 H	210	73.82	-1.71
6	2483.50	52.03 AV	54.00	-1.97	2.29 H	210	53.74	-1.71
7	4874.00	44.90 PK	74.00	-29.10	1.68 H	204	40.65	4.25
8	4874.00	31.09 AV	54.00	-22.91	1.68 H	204	26.84	4.25

ANTENNA POLARITY & TEST DISTANCE: VERTICAL AT 3 M

NO.	FREQ. (MHz)	EMISSION LEVEL (dBuV/m)	LIMIT (dBuV/m)	MARGIN (dB)	ANTENNA HEIGHT (m)	TABLE ANGLE (Degree)	RAW VALUE (dBuV)	CORRECTION FACTOR (dB/m)
1	2390.00	60.32 PK	74.00	-13.68	3.26 V	254	62.63	-2.31
2	2390.00	46.85 AV	54.00	-7.15	3.26 V	254	49.16	-2.31
3	*2437.00	115.53 PK			3.26 V	254	117.54	-2.01
4	*2437.00	104.93 AV			3.26 V	254	106.94	-2.01
5	2483.50	69.36 PK	74.00	-4.64	3.26 V	254	71.07	-1.71
6	2483.50	48.85 AV	54.00	-5.15	3.26 V	254	50.56	-1.71
7	4874.00	43.93 PK	74.00	-30.07	1.87 V	105	39.68	4.25
8	4874.00	30.07 AV	54.00	-23.93	1.87 V	105	25.82	4.25

REMARKS:

1. Emission Level(dBuV/m) = Raw Value(dBuV) + Correction Factor(dB/m)
2. Correction Factor(dB/m) = Antenna Factor(dB/m) + Cable Factor(dB) – Pre-Amplifier Factor(dB)
3. The other emission levels were very low against the limit.
4. Margin value = Emission Level – Limit value
5. " * ": Fundamental frequency.

CHANNEL	TX Channel 9	DETECTOR FUNCTION	Peak (PK)
FREQUENCY RANGE	1GHz ~ 25GHz		Average (AV)

ANTENNA POLARITY & TEST DISTANCE: HORIZONTAL AT 3 M

NO.	FREQ. (MHz)	EMISSION LEVEL (dBuV/m)	LIMIT (dBuV/m)	MARGIN (dB)	ANTENNA HEIGHT (m)	TABLE ANGLE (Degree)	RAW VALUE (dBuV)	CORRECTION FACTOR (dB/m)
1	*2452.00	118.18 PK			2.31 H	222	120.09	-1.91
2	*2452.00	105.31 AV			2.31 H	222	107.22	-1.91
3	2483.50	72.68 PK	74.00	-1.32	2.31 H	222	74.39	-1.71
4	2483.50	51.66 AV	54.00	-2.34	2.31 H	222	53.37	-1.71
5	4904.00	44.89 PK	74.00	-29.11	2.31 H	222	40.59	4.30
6	4904.00	31.24 AV	54.00	-22.76	2.31 H	222	26.94	4.30

ANTENNA POLARITY & TEST DISTANCE: VERTICAL AT 3 M

NO.	FREQ. (MHz)	EMISSION LEVEL (dBuV/m)	LIMIT (dBuV/m)	MARGIN (dB)	ANTENNA HEIGHT (m)	TABLE ANGLE (Degree)	RAW VALUE (dBuV)	CORRECTION FACTOR (dB/m)
1	*2452.00	116.34 PK			3.16 V	269	118.25	-1.91
2	*2452.00	103.78 AV			3.16 V	269	105.69	-1.91
3	2483.50	57.65 PK	74.00	-16.35	3.16 V	269	59.36	-1.71
4	2483.50	42.63 AV	54.00	-11.37	3.16 V	269	44.34	-1.71
5	4904.00	43.65 PK	74.00	-30.35	1.64 V	251	39.35	4.30
6	4904.00	30.15 AV	54.00	-23.85	1.64 V	251	25.85	4.30

REMARKS:

1. Emission Level(dBuV/m) = Raw Value(dBuV) + Correction Factor(dB/m)
2. Correction Factor(dB/m) = Antenna Factor(dB/m) + Cable Factor(dB) – Pre-Amplifier Factor(dB)
3. The other emission levels were very low against the limit.
4. Margin value = Emission Level – Limit value
5. " * ": Fundamental frequency.

Beamforming_NSS1 Mode (Mode B)

802.11n (20MHz)

CHANNEL	TX Channel 1	DETECTOR FUNCTION	Peak (PK)
FREQUENCY RANGE	1GHz ~ 25GHz		Average (AV)

ANTENNA POLARITY & TEST DISTANCE: HORIZONTAL AT 3 M

NO.	FREQ. (MHz)	EMISSION LEVEL (dBuV/m)	LIMIT (dBuV/m)	MARGIN (dB)	ANTENNA HEIGHT (m)	TABLE ANGLE (Degree)	RAW VALUE (dBuV)	CORRECTION FACTOR (dB/m)
1	2390.00	68.73 PK	74.00	-5.27	1.89 H	300	71.04	-2.31
2	2390.00	46.78 AV	54.00	-7.22	1.89 H	300	49.09	-2.31
3	*2412.00	105.11 PK			1.89 H	300	107.28	-2.17
4	*2412.00	95.08 AV			1.89 H	300	97.25	-2.17
5	4824.00	44.28 PK	74.00	-29.72	1.67 H	205	40.12	4.16
6	4824.00	30.39 AV	54.00	-23.61	1.67 H	205	26.23	4.16

ANTENNA POLARITY & TEST DISTANCE: VERTICAL AT 3 M

NO.	FREQ. (MHz)	EMISSION LEVEL (dBuV/m)	LIMIT (dBuV/m)	MARGIN (dB)	ANTENNA HEIGHT (m)	TABLE ANGLE (Degree)	RAW VALUE (dBuV)	CORRECTION FACTOR (dB/m)
1	2390.00	72.57 PK	74.00	-1.43	1.53 V	69	74.88	-2.31
2	2390.00	47.30 AV	54.00	-6.70	1.53 V	69	49.61	-2.31
3	*2412.00	114.28 PK			1.53 V	69	116.45	-2.17
4	*2412.00	105.27 AV			1.53 V	69	107.44	-2.17
5	4824.00	44.62 PK	74.00	-29.38	1.64 V	220	40.46	4.16
6	4824.00	31.02 AV	54.00	-22.98	1.64 V	220	26.86	4.16

REMARKS:

1. Emission Level(dBuV/m) = Raw Value(dBuV) + Correction Factor(dB/m)
2. Correction Factor(dB/m) = Antenna Factor(dB/m) + Cable Factor(dB) – Pre-Amplifier Factor(dB)
3. The other emission levels were very low against the limit.
4. Margin value = Emission Level – Limit value
5. " * ": Fundamental frequency.

CHANNEL	TX Channel 6	DETECTOR FUNCTION	Peak (PK)
FREQUENCY RANGE	1GHz ~ 25GHz		Average (AV)

ANTENNA POLARITY & TEST DISTANCE: HORIZONTAL AT 3 M

NO.	FREQ. (MHz)	EMISSION LEVEL (dBuV/m)	LIMIT (dBuV/m)	MARGIN (dB)	ANTENNA HEIGHT (m)	TABLE ANGLE (Degree)	RAW VALUE (dBuV)	CORRECTION FACTOR (dB/m)
1	*2437.00	107.67 PK			1.91 H	298	109.68	-2.01
2	*2437.00	98.25 AV			1.91 H	298	100.26	-2.01
3	4874.00	43.90 PK	74.00	-30.10	1.88 H	241	39.65	4.25
4	4874.00	30.09 AV	54.00	-23.91	1.88 H	241	25.84	4.25

ANTENNA POLARITY & TEST DISTANCE: VERTICAL AT 3 M

NO.	FREQ. (MHz)	EMISSION LEVEL (dBuV/m)	LIMIT (dBuV/m)	MARGIN (dB)	ANTENNA HEIGHT (m)	TABLE ANGLE (Degree)	RAW VALUE (dBuV)	CORRECTION FACTOR (dB/m)
1	*2437.00	118.70 PK			1.50 V	77	120.71	-2.01
2	*2437.00	110.73 AV			1.50 V	77	112.74	-2.01
3	4874.00	44.76 PK	74.00	-29.24	1.64 V	239	40.51	4.25
4	4874.00	31.09 AV	54.00	-22.91	1.64 V	239	26.84	4.25

REMARKS:

1. Emission Level(dBuV/m) = Raw Value(dBuV) + Correction Factor(dB/m)
2. Correction Factor(dB/m) = Antenna Factor(dB/m) + Cable Factor(dB) – Pre-Amplifier Factor(dB)
3. The other emission levels were very low against the limit.
4. Margin value = Emission Level – Limit value
5. " * ": Fundamental frequency.

CHANNEL	TX Channel 11	DETECTOR FUNCTION	Peak (PK)
FREQUENCY RANGE	1GHz ~ 25GHz		Average (AV)

ANTENNA POLARITY & TEST DISTANCE: HORIZONTAL AT 3 M

NO.	FREQ. (MHz)	EMISSION LEVEL (dBuV/m)	LIMIT (dBuV/m)	MARGIN (dB)	ANTENNA HEIGHT (m)	TABLE ANGLE (Degree)	RAW VALUE (dBuV)	CORRECTION FACTOR (dB/m)
1	*2462.00	102.74 PK			1.82 H	312	104.59	-1.85
2	*2462.00	91.84 AV			1.82 H	312	93.69	-1.85
3	2483.50	68.83 PK	74.00	-5.17	1.82 H	312	70.54	-1.71
4	2483.50	43.55 AV	54.00	-10.45	1.82 H	312	45.26	-1.71
5	4924.00	43.75 PK	74.00	-30.25	1.88 H	114	39.45	4.30
6	4924.00	29.58 AV	54.00	-24.42	1.88 H	114	25.28	4.30

ANTENNA POLARITY & TEST DISTANCE: VERTICAL AT 3 M

NO.	FREQ. (MHz)	EMISSION LEVEL (dBuV/m)	LIMIT (dBuV/m)	MARGIN (dB)	ANTENNA HEIGHT (m)	TABLE ANGLE (Degree)	RAW VALUE (dBuV)	CORRECTION FACTOR (dB/m)
1	*2462.00	111.88 PK			1.50 V	97	113.73	-1.85
2	*2462.00	101.08 AV			1.50 V	97	102.93	-1.85
3	2483.50	72.81 PK	74.00	-1.19	1.50 V	97	74.52	-1.71
4	2483.50	47.33 AV	54.00	-6.67	1.50 V	97	49.04	-1.71
5	4924.00	44.66 PK	74.00	-29.34	1.88 V	201	40.36	4.30
6	4924.00	31.24 AV	54.00	-22.76	1.88 V	201	26.94	4.30

REMARKS:

1. Emission Level(dBuV/m) = Raw Value(dBuV) + Correction Factor(dB/m)
2. Correction Factor(dB/m) = Antenna Factor(dB/m) + Cable Factor(dB) – Pre-Amplifier Factor(dB)
3. The other emission levels were very low against the limit.
4. Margin value = Emission Level – Limit value
5. " * ": Fundamental frequency.

802.11n (40MHz)

CHANNEL	TX Channel 3	DETECTOR FUNCTION	Peak (PK)
FREQUENCY RANGE	1GHz ~ 25GHz		Average (AV)

ANTENNA POLARITY & TEST DISTANCE: HORIZONTAL AT 3 M

NO.	FREQ. (MHz)	EMISSION LEVEL (dBuV/m)	LIMIT (dBuV/m)	MARGIN (dB)	ANTENNA HEIGHT (m)	TABLE ANGLE (Degree)	RAW VALUE (dBuV)	CORRECTION FACTOR (dB/m)
1	2390.00	69.95 PK	74.00	-4.05	1.89 H	312	72.26	-2.31
2	2390.00	48.05 AV	54.00	-5.95	1.89 H	312	50.36	-2.31
3	*2422.00	105.87 PK			1.89 H	312	107.98	-2.11
4	*2422.00	96.58 AV			1.89 H	312	98.69	-2.11
5	4844.00	43.58 PK	74.00	-30.42	1.99 H	20	39.38	4.20
6	4844.00	29.39 AV	54.00	-24.61	1.99 H	20	25.19	4.20

ANTENNA POLARITY & TEST DISTANCE: VERTICAL AT 3 M

NO.	FREQ. (MHz)	EMISSION LEVEL (dBuV/m)	LIMIT (dBuV/m)	MARGIN (dB)	ANTENNA HEIGHT (m)	TABLE ANGLE (Degree)	RAW VALUE (dBuV)	CORRECTION FACTOR (dB/m)
1	2390.00	72.87 PK	74.00	-1.13	1.50 V	107	75.18	-2.31
2	2390.00	50.69 AV	54.00	-3.31	1.50 V	107	53.00	-2.31
3	*2422.00	114.63 PK			1.50 V	107	116.74	-2.11
4	*2422.00	105.64 AV			1.50 V	107	107.75	-2.11
5	4844.00	45.18 PK	74.00	-28.82	1.68 V	269	40.98	4.20
6	4844.00	30.87 AV	54.00	-23.13	1.68 V	269	26.67	4.20

REMARKS:

1. Emission Level(dBuV/m) = Raw Value(dBuV) + Correction Factor(dB/m)
2. Correction Factor(dB/m) = Antenna Factor(dB/m) + Cable Factor(dB) – Pre-Amplifier Factor(dB)
3. The other emission levels were very low against the limit.
4. Margin value = Emission Level – Limit value
5. " * ": Fundamental frequency.

CHANNEL	TX Channel 6	DETECTOR FUNCTION	Peak (PK)
FREQUENCY RANGE	1GHz ~ 25GHz		Average (AV)

ANTENNA POLARITY & TEST DISTANCE: HORIZONTAL AT 3 M

NO.	FREQ. (MHz)	EMISSION LEVEL (dBuV/m)	LIMIT (dBuV/m)	MARGIN (dB)	ANTENNA HEIGHT (m)	TABLE ANGLE (Degree)	RAW VALUE (dBuV)	CORRECTION FACTOR (dB/m)
1	2390.00	69.85 PK	74.00	-4.15	1.88 H	320	72.16	-2.31
2	2390.00	47.95 AV	54.00	-6.05	1.88 H	320	50.26	-2.31
3	*2437.00	108.24 PK			1.88 H	320	110.25	-2.01
4	*2437.00	99.25 AV			1.88 H	320	101.26	-2.01
5	2483.50	69.30 PK	74.00	-4.70	1.88 H	320	71.01	-1.71
6	2483.50	48.25 AV	54.00	-5.75	1.88 H	320	49.96	-1.71
7	4874.00	43.89 PK	74.00	-30.11	1.96 H	32	39.64	4.25
8	4874.00	30.06 AV	54.00	-23.94	1.96 H	32	25.81	4.25

ANTENNA POLARITY & TEST DISTANCE: VERTICAL AT 3 M

NO.	FREQ. (MHz)	EMISSION LEVEL (dBuV/m)	LIMIT (dBuV/m)	MARGIN (dB)	ANTENNA HEIGHT (m)	TABLE ANGLE (Degree)	RAW VALUE (dBuV)	CORRECTION FACTOR (dB/m)
1	2390.00	72.82 PK	74.00	-1.18	1.54 V	65	75.13	-2.31
2	2390.00	51.78 AV	54.00	-2.22	1.54 V	65	54.09	-2.31
3	*2437.00	117.37 PK			1.54 V	65	119.38	-2.01
4	*2437.00	108.32 AV			1.54 V	65	110.33	-2.01
5	2483.50	72.98 PK	74.00	-1.02	1.54 V	65	74.69	-1.71
6	2483.50	51.79 AV	54.00	-2.21	1.54 V	65	53.50	-1.71
7	4874.00	44.59 PK	74.00	-29.41	1.55 V	124	40.34	4.25
8	4874.00	30.92 AV	54.00	-23.08	1.55 V	124	26.67	4.25

REMARKS:

1. Emission Level(dBuV/m) = Raw Value(dBuV) + Correction Factor(dB/m)
2. Correction Factor(dB/m) = Antenna Factor(dB/m) + Cable Factor(dB) – Pre-Amplifier Factor(dB)
3. The other emission levels were very low against the limit.
4. Margin value = Emission Level – Limit value
5. " * ": Fundamental frequency.

CHANNEL	TX Channel 9	DETECTOR FUNCTION	Peak (PK)
FREQUENCY RANGE	1GHz ~ 25GHz		Average (AV)

ANTENNA POLARITY & TEST DISTANCE: HORIZONTAL AT 3 M

NO.	FREQ. (MHz)	EMISSION LEVEL (dBuV/m)	LIMIT (dBuV/m)	MARGIN (dB)	ANTENNA HEIGHT (m)	TABLE ANGLE (Degree)	RAW VALUE (dBuV)	CORRECTION FACTOR (dB/m)
1	*2452.00	103.57 PK			1.79 H	311	105.48	-1.91
2	*2452.00	92.97 AV			1.79 H	311	94.88	-1.91
3	2483.50	68.44 PK	74.00	-5.56	1.79 H	311	70.15	-1.71
4	2483.50	48.95 AV	54.00	-5.05	1.79 H	311	50.66	-1.71
5	4904.00	44.14 PK	74.00	-29.86	2.19 H	104	39.84	4.30
6	4904.00	29.38 AV	54.00	-24.62	2.19 H	104	25.08	4.30

ANTENNA POLARITY & TEST DISTANCE: VERTICAL AT 3 M

NO.	FREQ. (MHz)	EMISSION LEVEL (dBuV/m)	LIMIT (dBuV/m)	MARGIN (dB)	ANTENNA HEIGHT (m)	TABLE ANGLE (Degree)	RAW VALUE (dBuV)	CORRECTION FACTOR (dB/m)
1	*2452.00	113.08 PK			1.37 V	69	114.99	-1.91
2	*2452.00	101.91 AV			1.37 V	69	103.82	-1.91
3	2483.50	72.58 PK	74.00	-1.42	1.37 V	69	74.29	-1.71
4	2483.50	52.98 AV	54.00	-1.02	1.37 V	69	54.69	-1.71
5	4904.00	45.14 PK	74.00	-28.86	1.28 V	284	40.84	4.30
6	4904.00	31.12 AV	54.00	-22.88	1.28 V	284	26.82	4.30

REMARKS:

1. Emission Level(dBuV/m) = Raw Value(dBuV) + Correction Factor(dB/m)
2. Correction Factor(dB/m) = Antenna Factor(dB/m) + Cable Factor(dB) – Pre-Amplifier Factor(dB)
3. The other emission levels were very low against the limit.
4. Margin value = Emission Level – Limit value
5. " * ": Fundamental frequency.

BELOW 1GHz WORST-CASE DATA:
CDD Mode (Mode A)
802.11g

CHANNEL	TX Channel 6	DETECTOR FUNCTION	Quasi-Peak (QP)
FREQUENCY RANGE	9kHz ~ 1GHz		

ANTENNA POLARITY & TEST DISTANCE: HORIZONTAL AT 3 M

NO.	FREQ. (MHz)	EMISSION LEVEL (dBuV/m)	LIMIT (dBuV/m)	MARGIN (dB)	ANTENNA HEIGHT (m)	TABLE ANGLE (Degree)	RAW VALUE (dBuV)	CORRECTION FACTOR (dB/m)
1	36.06	29.82 QP	40.00	-10.18	1.89 H	163	40.03	-10.21
2	153.43	22.41 QP	43.50	-21.09	2.37 H	250	31.35	-8.94
3	224.29	32.05 QP	46.00	-13.95	2.04 H	291	43.27	-11.22
4	294.47	27.52 QP	46.00	-18.48	1.64 H	310	35.10	-7.58
5	400.01	38.62 QP	46.00	-7.38	1.55 H	131	43.94	-5.32
6	472.85	31.61 QP	46.00	-14.39	1.75 H	234	35.10	-3.49

ANTENNA POLARITY & TEST DISTANCE: VERTICAL AT 3 M

NO.	FREQ. (MHz)	EMISSION LEVEL (dBuV/m)	LIMIT (dBuV/m)	MARGIN (dB)	ANTENNA HEIGHT (m)	TABLE ANGLE (Degree)	RAW VALUE (dBuV)	CORRECTION FACTOR (dB/m)
1	33.01	35.15 QP	40.00	-4.85	1.68 V	229	45.85	-10.70
2	147.37	25.72 QP	43.50	-17.78	1.88 V	7	34.90	-9.18
3	224.63	28.93 QP	46.00	-17.07	1.25 V	174	40.17	-11.24
4	400.06	33.77 QP	46.00	-12.23	1.63 V	161	39.09	-5.32
5	474.60	31.18 QP	46.00	-14.82	2.16 V	185	34.66	-3.48
6	608.02	32.99 QP	46.00	-13.01	1.95 V	50	33.42	-0.43

REMARKS:

1. Emission Level(dBuV/m) = Raw Value(dBuV) + Correction Factor(dB/m)
2. Correction Factor(dB/m) = Antenna Factor(dB/m) + Cable Factor(dB) – Pre-Amplifier Factor(dB)
3. The other emission levels were very low against the limit.
4. Margin value = Emission Level – Limit value

CDD Mode (Mode B)

802.11n (20MHz)

CHANNEL	TX Channel 6	DETECTOR FUNCTION	Quasi-Peak (QP)
FREQUENCY RANGE	9kHz ~ 1GHz		

ANTENNA POLARITY & TEST DISTANCE: HORIZONTAL AT 3 M

NO.	FREQ. (MHz)	EMISSION LEVEL (dBuV/m)	LIMIT (dBuV/m)	MARGIN (dB)	ANTENNA HEIGHT (m)	TABLE ANGLE (Degree)	RAW VALUE (dBuV)	CORRECTION FACTOR (dB/m)
1	35.97	31.38 QP	40.00	-8.62	2.63 H	318	41.60	-10.22
2	77.63	22.10 QP	40.00	-17.90	2.10 H	266	35.42	-13.32
3	224.68	32.54 QP	46.00	-13.46	1.68 H	288	43.78	-11.24
4	288.75	27.87 QP	46.00	-18.13	1.46 H	302	35.57	-7.70
5	413.44	38.61 QP	46.00	-7.39	1.92 H	218	43.69	-5.08
6	472.13	31.95 QP	46.00	-14.05	2.28 H	122	35.43	-3.48

ANTENNA POLARITY & TEST DISTANCE: VERTICAL AT 3 M

NO.	FREQ. (MHz)	EMISSION LEVEL (dBuV/m)	LIMIT (dBuV/m)	MARGIN (dB)	ANTENNA HEIGHT (m)	TABLE ANGLE (Degree)	RAW VALUE (dBuV)	CORRECTION FACTOR (dB/m)
1	33.19	34.81 QP	40.00	-5.19	1.63 V	89	45.49	-10.68
2	146.79	25.91 QP	43.50	-17.59	1.55 V	61	35.07	-9.16
3	224.73	28.19 QP	46.00	-17.81	1.47 V	201	39.43	-11.24
4	411.02	38.29 QP	46.00	-7.71	2.36 V	138	43.44	-5.15
5	476.64	33.89 QP	46.00	-12.11	1.55 V	135	37.37	-3.48
6	615.15	40.52 QP	46.00	-5.48	1.85 V	58	40.83	-0.31

REMARKS:

1. Emission Level(dBuV/m) = Raw Value(dBuV) + Correction Factor(dB/m)
2. Correction Factor(dB/m) = Antenna Factor(dB/m) + Cable Factor(dB) – Pre-Amplifier Factor(dB)
3. The other emission levels were very low against the limit.
4. Margin value = Emission Level – Limit value

4.2 Conducted Emission Measurement

4.2.1 Limits of Conducted Emission Measurement

Frequency (MHz)	Conducted Limit (dBuV)	
	Quasi-peak	Average
0.15 - 0.5	66 - 56	56 - 46
0.50 - 5.0	56	46
5.0 - 30.0	60	50

Note: 1. The lower limit shall apply at the transition frequencies.

2. The limit decreases in line with the logarithm of the frequency in the range of 0.15 to 0.50MHz.

4.2.2 Test Instruments

Description & Manufacturer	Model No.	Serial No.	Cal. Date	Cal. Due
ROHDE & SCHWARZ TEST RECEIVER	ESCS 30	100276	Apr. 10, 2017	Apr. 09, 2018
ROHDE & SCHWARZ Artificial Mains Network (for EUT)	ENV216	101197	May 22, 2017	May 21, 2018
LISN With Adapter (for EUT)	AD10	C10Ada-002	May 22, 2017	May 21, 2018
ROHDE & SCHWARZ Artificial Mains Network (for peripherals)	ESH3-Z5	100218	Nov. 23, 2016	Nov. 22, 2017
SCHWARZBECK Artificial Mains Network (For EUT)	NNLK8129	8129229	May 09, 2017	May 08, 2018
Software	Cond_V7.3.7.4	NA	NA	NA
RF cable (JYEBAO) With 10dB PAD	5D-FB	Cable-C10.01	Feb. 14, 2017	Feb. 13, 2018
SUHNER Terminator (For ROHDE & SCHWARZ LISN)	65BNC-5001	E1-011484	May 18, 2017	May 17, 2018
ROHDE & SCHWARZ Artificial Mains Network (For TV EUT)	ESH3-Z5	100220	Nov. 08, 2016	Nov. 07, 2017
LISN With Adapter (for TV EUT)	100220	N/A	Nov. 08, 2016	Nov. 07, 2017

Notes: 1. The calibration interval of the above test instruments is 12 months and the calibrations are traceable to NML/ROC and NIST/USA.

2. The test was performed in Shielded Room No. 10.

3. The VCCI Site Registration No. C-1852.

4. The FCC Designation Number is TW2021.

5. Tested Date: Sep. 7 ~ 18, 2017

4.2.3 Test Procedures

- The EUT was placed 0.4 meters from the conducting wall of the shielded room with EUT being connected to the power mains through a line impedance stabilization network (LISN). Other support units were connected to the power mains through another LISN. The two LISNs provide 50 ohm/ 50uH of coupling impedance for the measuring instrument.
- Both lines of the power mains connected to the EUT were checked for maximum conducted interference.
- The frequency range from 150kHz to 30MHz was searched. Emission levels under (Limit - 20dB) was not recorded.

NOTE: The resolution bandwidth and video bandwidth of test receiver is 9kHz for quasi-peak detection (QP) and average detection (AV) at frequency 0.15MHz-30MHz.

4.2.4 Deviation from Test Standard

No deviation.

4.2.5 Test Setup

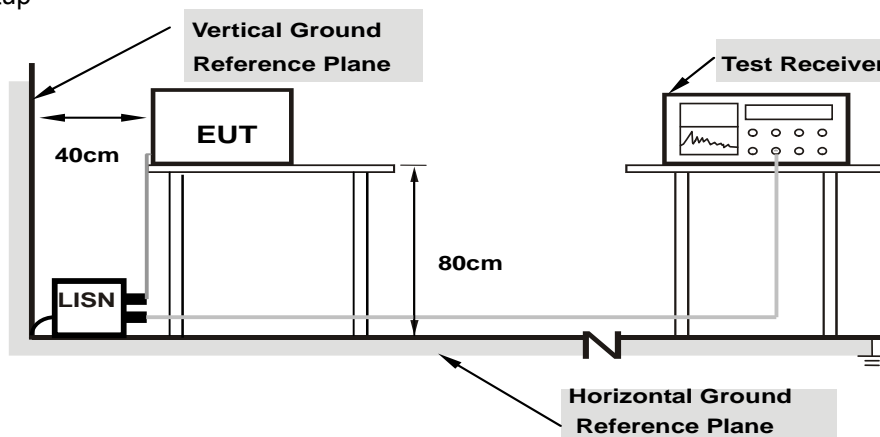

Note: 1.Support units were connected to second LISN.

For the actual test configuration, please refer to the attached file (Test Setup Photo).

4.2.6 EUT Operating Conditions

- Connected the EUT with AC adapter or PoE placed on testing table.
- Set the EUT under transmission condition continuously at specific channel frequency.

4.2.7 Test Results

CDD Mode (Mode A)

Phase	Line (L)	Detector Function	Quasi-Peak (QP) / Average (AV)
-------	----------	-------------------	--------------------------------

No	Freq. [MHz]	Corr.	Reading Value		Emission Level		Limit		Margin	
		Factor	[dB (uV)]		[dB (uV)]		[dB (uV)]		(dB)	
		(dB)	Q.P.	AV.	Q.P.	AV.	Q.P.	AV.	Q.P.	AV.
1	0.15391	9.65	35.83	23.72	45.48	33.37	65.79	55.79	-20.31	-22.42
2	0.35313	9.66	37.01	36.39	46.67	46.05	58.89	48.89	-12.22	-2.84
3	0.63828	9.68	19.88	17.53	29.56	27.21	56.00	46.00	-26.44	-18.79
4	3.96484	9.84	19.99	12.34	29.83	22.18	56.00	46.00	-26.17	-23.82
5	10.21094	9.93	26.52	21.82	36.45	31.75	60.00	50.00	-23.55	-18.25
6	21.87500	10.02	29.20	28.95	39.22	38.97	60.00	50.00	-20.78	-11.03

REMARKS:

1. Q.P. and AV. are abbreviations of quasi-peak and average individually.
2. The emission levels of other frequencies were very low against the limit.
3. Margin value = Emission level - Limit value
4. Correction factor = Insertion loss + Cable loss
5. Emission Level = Correction Factor + Reading Value.

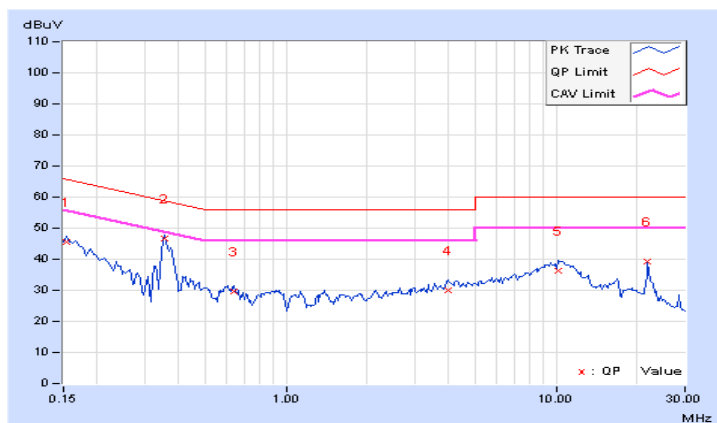

Phase	Neutral (N)	Detector Function	Quasi-Peak (QP) / Average (AV)
-------	-------------	-------------------	--------------------------------

No	Freq. [MHz]	Corr.	Reading Value		Emission Level		Limit		Margin	
		Factor	[dB (uV)]		[dB (uV)]		[dB (uV)]		(dB)	
		(dB)	Q.P.	AV.	Q.P.	AV.	Q.P.	AV.	Q.P.	AV.
1	0.15391	9.67	37.26	24.49	46.93	34.16	65.79	55.79	-18.86	-21.63
2	0.35703	9.68	37.89	35.50	47.57	45.18	58.80	48.80	-11.23	-3.62
3	0.61484	9.69	20.62	18.82	30.31	28.51	56.00	46.00	-25.69	-17.49
4	3.73438	9.85	19.60	12.96	29.45	22.81	56.00	46.00	-26.55	-23.19
5	10.21484	9.95	26.30	21.64	36.25	31.59	60.00	50.00	-23.75	-18.41
6	21.87500	10.08	29.18	28.73	39.26	38.81	60.00	50.00	-20.74	-11.19

REMARKS:

1. Q.P. and AV. are abbreviations of quasi-peak and average individually.
2. The emission levels of other frequencies were very low against the limit.
3. Margin value = Emission level - Limit value
4. Correction factor = Insertion loss + Cable loss
5. Emission Level = Correction Factor + Reading Value.

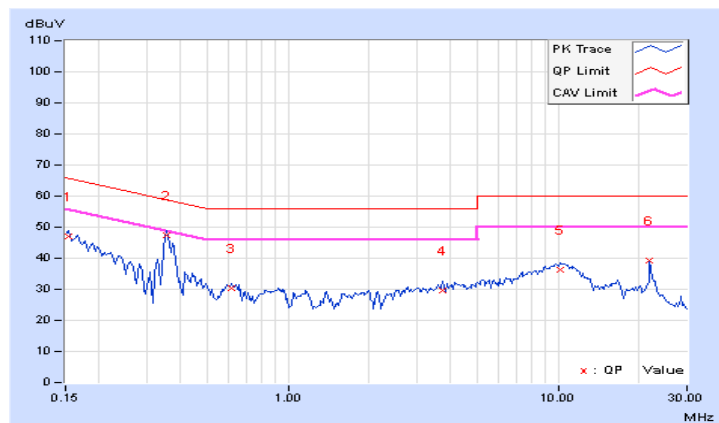

CDD Mode (Mode B)

Phase	Line (L)	Detector Function	Quasi-Peak (QP) / Average (AV)
-------	----------	-------------------	--------------------------------

No	Freq. [MHz]	Corr.	Reading Value		Emission Level		Limit		Margin	
		Factor (dB)	[dB (uV)]		[dB (uV)]		[dB (uV)]		(dB)	
			Q.P.	AV.	Q.P.	AV.	Q.P.	AV.	Q.P.	AV.
1	0.16562	9.65	39.22	29.17	48.87	38.82	65.18	55.18	-16.31	-16.36
2	0.31797	9.66	28.35	20.01	38.01	29.67	59.76	49.76	-21.75	-20.09
3	0.50156	9.67	33.54	27.92	43.21	37.59	56.00	46.00	-12.79	-8.41
4	0.81016	9.69	14.72	8.41	24.41	18.10	56.00	46.00	-31.59	-27.90
5	3.17969	9.80	8.66	4.39	18.46	14.19	56.00	46.00	-37.54	-31.81
6	10.29297	9.93	15.74	11.03	25.67	20.96	60.00	50.00	-34.33	-29.04

REMARKS:

1. Q.P. and AV. are abbreviations of quasi-peak and average individually.
2. The emission levels of other frequencies were very low against the limit.
3. Margin value = Emission level - Limit value
4. Correction factor = Insertion loss + Cable loss
5. Emission Level = Correction Factor + Reading Value.

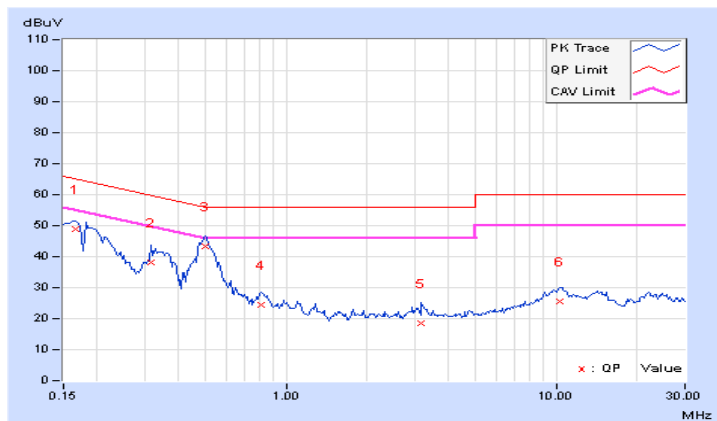

Phase	Neutral (N)	Detector Function	Quasi-Peak (QP) / Average (AV)
-------	-------------	-------------------	--------------------------------

No	Freq. [MHz]	Corr.	Reading Value		Emission Level		Limit		Margin	
		Factor	[dB (uV)]		[dB (uV)]		[dB (uV)]		(dB)	
		(dB)	Q.P.	AV.	Q.P.	AV.	Q.P.	AV.	Q.P.	AV.
1	0.15000	9.68	34.87	24.06	44.55	33.74	66.00	56.00	-21.45	-22.26
2	0.18906	9.67	35.71	28.83	45.38	38.50	64.08	54.08	-18.70	-15.58
3	0.33359	9.68	27.85	20.56	37.53	30.24	59.36	49.36	-21.83	-19.12
4	0.50000	9.68	33.19	27.42	42.87	37.10	56.00	46.00	-13.13	-8.90
5	0.80625	9.70	14.17	7.94	23.87	17.64	56.00	46.00	-32.13	-28.36
6	2.95703	9.80	8.05	2.07	17.85	11.87	56.00	46.00	-38.15	-34.13
7	10.38672	9.95	16.39	11.33	26.34	21.28	60.00	50.00	-33.66	-28.72

REMARKS:

1. Q.P. and AV. are abbreviations of quasi-peak and average individually.
2. The emission levels of other frequencies were very low against the limit.
3. Margin value = Emission level - Limit value
4. Correction factor = Insertion loss + Cable loss
5. Emission Level = Correction Factor + Reading Value.

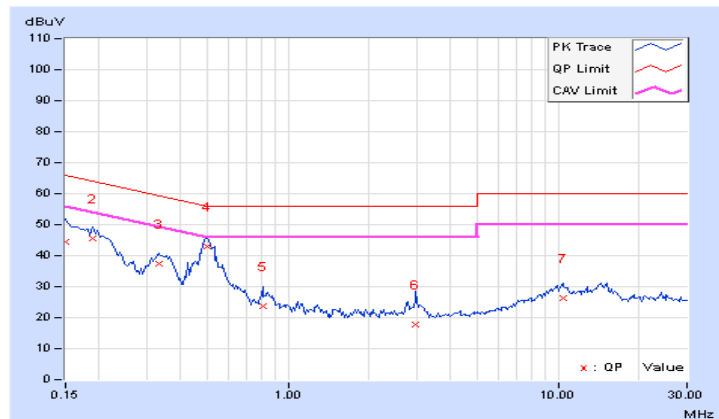

CDD Mode (Mode C)

Phase	Line (L)	Detector Function	Quasi-Peak (QP) / Average (AV)
-------	----------	-------------------	--------------------------------

No	Freq. [MHz]	Corr.	Reading Value		Emission Level		Limit		Margin	
		Factor (dB)	[dB (uV)]		[dB (uV)]		[dB (uV)]		(dB)	
			Q.P.	AV.	Q.P.	AV.	Q.P.	AV.	Q.P.	AV.
1	0.15000	9.65	29.07	15.97	38.72	25.62	66.00	56.00	-27.28	-30.38
2	0.41172	9.66	26.70	18.89	36.36	28.55	57.61	47.61	-21.25	-19.06
3	0.48203	9.67	14.73	6.59	24.40	16.26	56.30	46.30	-31.90	-30.04
4	0.98203	9.70	14.90	10.42	24.60	20.12	56.00	46.00	-31.40	-25.88
5	2.40625	9.76	15.20	10.90	24.96	20.66	56.00	46.00	-31.04	-25.34
6	17.51172	9.98	9.95	2.54	19.93	12.52	60.00	50.00	-40.07	-37.48

REMARKS:

1. Q.P. and AV. are abbreviations of quasi-peak and average individually.
2. The emission levels of other frequencies were very low against the limit.
3. Margin value = Emission level - Limit value
4. Correction factor = Insertion loss + Cable loss
5. Emission Level = Correction Factor + Reading Value.

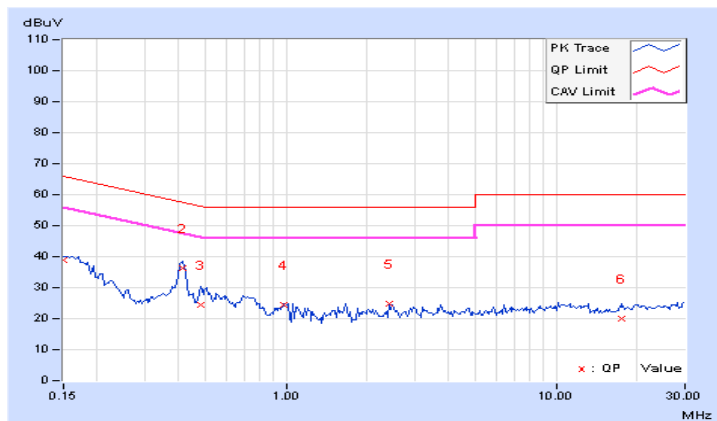

Phase	Neutral (N)	Detector Function	Quasi-Peak (QP) / Average (AV)
-------	-------------	-------------------	--------------------------------

No	Freq. [MHz]	Corr.	Reading Value		Emission Level		Limit		Margin	
		Factor	[dB (uV)]		[dB (uV)]		[dB (uV)]		(dB)	
		(dB)	Q.P.	AV.	Q.P.	AV.	Q.P.	AV.	Q.P.	AV.
1	0.15000	9.68	28.16	14.56	37.84	24.24	66.00	56.00	-28.16	-31.76
2	0.41172	9.68	25.80	17.96	35.48	27.64	57.61	47.61	-22.13	-19.97
3	0.50938	9.69	13.72	4.74	23.41	14.43	56.00	46.00	-32.59	-31.57
4	1.08594	9.71	10.22	2.52	19.93	12.23	56.00	46.00	-36.07	-33.77
5	3.24609	9.82	12.56	1.62	22.38	11.44	56.00	46.00	-33.62	-34.56
6	13.29297	9.99	11.70	1.66	21.69	11.65	60.00	50.00	-38.31	-38.35

REMARKS:

1. Q.P. and AV. are abbreviations of quasi-peak and average individually.
2. The emission levels of other frequencies were very low against the limit.
3. Margin value = Emission level - Limit value
4. Correction factor = Insertion loss + Cable loss
5. Emission Level = Correction Factor + Reading Value.

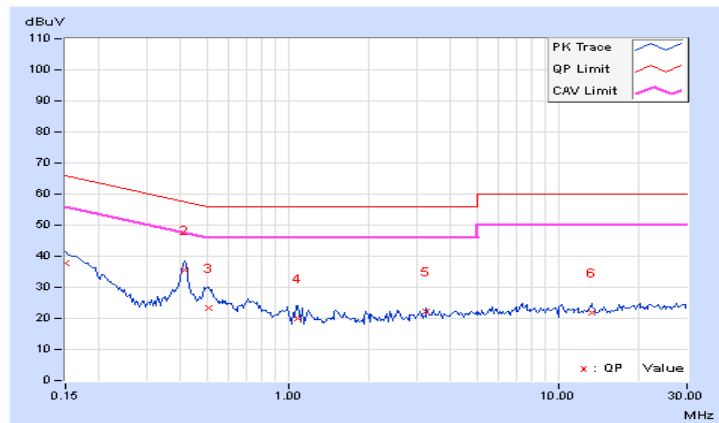

CDD Mode (Mode D)

Phase	Line (L)	Detector Function	Quasi-Peak (QP) / Average (AV)
-------	----------	-------------------	--------------------------------

No	Freq. [MHz]	Corr.	Reading Value		Emission Level		Limit		Margin	
		Factor (dB)	[dB (uV)]		[dB (uV)]		[dB (uV)]		(dB)	
			Q.P.	AV.	Q.P.	AV.	Q.P.	AV.	Q.P.	AV.
1	0.15000	9.65	35.66	11.09	45.31	20.74	66.00	56.00	-20.69	-35.26
2	0.16562	9.65	39.82	29.24	49.47	38.89	65.18	55.18	-15.71	-16.29
3	0.21250	9.65	33.06	23.92	42.71	33.57	63.11	53.11	-20.40	-19.54
4	0.43906	9.66	28.61	15.48	38.27	25.14	57.08	47.08	-18.81	-21.94
5	0.99375	9.70	20.81	12.24	30.51	21.94	56.00	46.00	-25.49	-24.06
6	9.91406	9.93	19.70	12.20	29.63	22.13	60.00	50.00	-30.37	-27.87
7	29.64453	10.15	24.67	20.06	34.82	30.21	60.00	50.00	-25.18	-19.79

REMARKS:

1. Q.P. and AV. are abbreviations of quasi-peak and average individually.
2. The emission levels of other frequencies were very low against the limit.
3. Margin value = Emission level - Limit value
4. Correction factor = Insertion loss + Cable loss
5. Emission Level = Correction Factor + Reading Value.

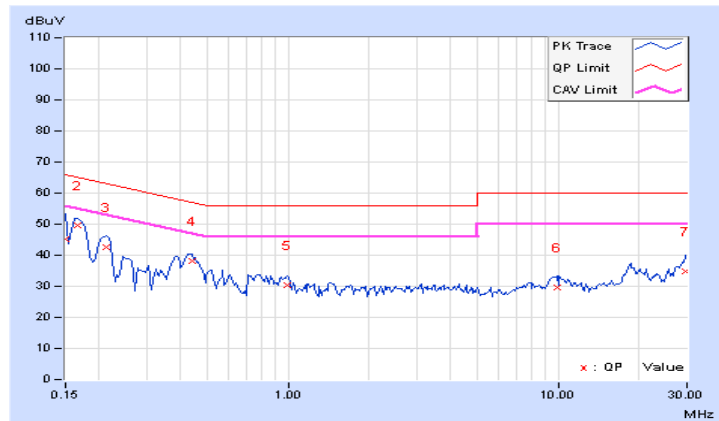

Phase	Neutral (N)	Detector Function	Quasi-Peak (QP) / Average (AV)
-------	-------------	-------------------	--------------------------------

No	Freq. [MHz]	Corr.	Reading Value		Emission Level		Limit		Margin	
		Factor	[dB (uV)]		[dB (uV)]		[dB (uV)]		(dB)	
		(dB)	Q.P.	AV.	Q.P.	AV.	Q.P.	AV.	Q.P.	AV.
1	0.16562	9.67	39.60	28.70	49.27	38.37	65.18	55.18	-15.91	-16.81
2	0.20859	9.67	33.01	22.05	42.68	31.72	63.26	53.26	-20.58	-21.54
3	0.42344	9.68	27.97	20.35	37.65	30.03	57.38	47.38	-19.73	-17.35
4	2.58203	9.78	13.02	3.41	22.80	13.19	56.00	46.00	-33.20	-32.81
5	18.30859	10.04	23.41	18.01	33.45	28.05	60.00	50.00	-26.55	-21.95
6	29.84766	10.12	26.61	21.43	36.73	31.55	60.00	50.00	-23.27	-18.45

REMARKS:

1. Q.P. and AV. are abbreviations of quasi-peak and average individually.
2. The emission levels of other frequencies were very low against the limit.
3. Margin value = Emission level - Limit value
4. Correction factor = Insertion loss + Cable loss
5. Emission Level = Correction Factor + Reading Value.

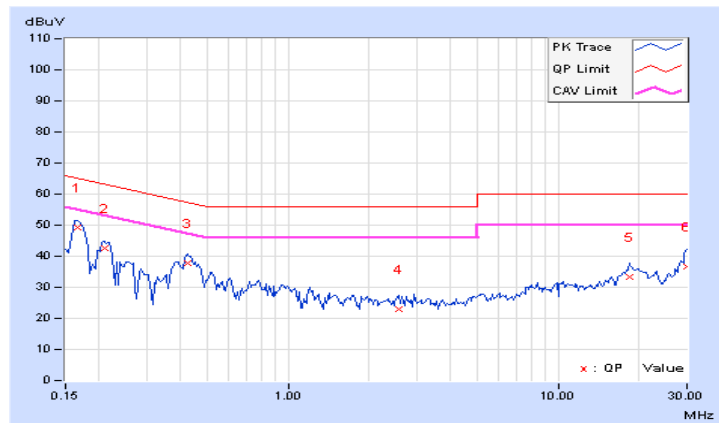

4.3 6dB Bandwidth Measurement

4.3.1 Limits of 6dB Bandwidth Measurement

The minimum of 6dB Bandwidth Measurement is 0.5 MHz.

4.3.2 Test Setup

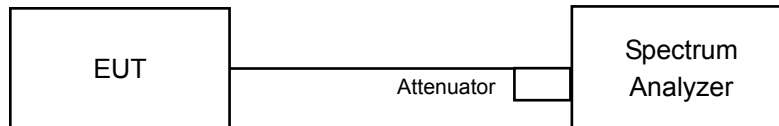

4.3.3 Test Instruments

Refer to section 4.1.2 to get information of above instrument.

4.3.4 Test Procedure

- a. Set resolution bandwidth (RBW) = 100kHz
- b. Set the video bandwidth (VBW) $\geq 3 \times$ RBW, Detector = Peak.
- c. Trace mode = max hold.
- d. Sweep = auto couple.
- e. Measure the maximum width of the emission that is constrained by the frequencies associated with the two amplitude points (upper and lower) that are attenuated by 6 dB relative to the maximum level measured in the fundamental emission

4.3.5 Deviation from Test Standard

No deviation.

4.3.6 EUT Operating Conditions

The software provided by client to enable the EUT under transmission condition continuously at lowest, middle and highest channel frequencies individually.

4.3.7 Test Result

CDD Mode (Mode A)

802.11b

Channel	Frequency (MHz)	6dB Bandwidth (MHz)				Minimum Limit (MHz)	Pass / Fail
		Chain 0	Chain 1	Chain 2	Chain 3		
1	2412	8.56	8.09	8.57	8.09	0.5	PASS
6	2437	8.55	9.05	8.59	8.58	0.5	PASS
11	2462	8.08	9.05	8.57	9.05	0.5	PASS

802.11g

Channel	Frequency (MHz)	6dB Bandwidth (MHz)				Minimum Limit (MHz)	Pass / Fail
		Chain 0	Chain 1	Chain 2	Chain 3		
1	2412	16.37	16.35	16.35	16.37	0.5	PASS
6	2437	16.36	16.39	16.38	16.37	0.5	PASS
11	2462	16.36	16.33	16.35	16.36	0.5	PASS

802.11n (20MHz)

Channel	Frequency (MHz)	6dB Bandwidth (MHz)				Minimum Limit (MHz)	Pass / Fail
		Chain 0	Chain 1	Chain 2	Chain 3		
1	2412	17.17	17.19	17.54	17.57	0.5	PASS
6	2437	17.59	17.59	17.58	17.57	0.5	PASS
11	2462	17.05	17.55	16.96	17.55	0.5	PASS

802.11n (40MHz)

Channel	Frequency (MHz)	6dB Bandwidth (MHz)				Minimum Limit (MHz)	Pass / Fail
		Chain 0	Chain 1	Chain 2	Chain 3		
3	2422	35.11	35.06	35.18	33.88	0.5	PASS
6	2437	35.22	35.23	35.20	35.23	0.5	PASS
9	2452	35.20	35.19	35.14	33.94	0.5	PASS

Spectrum Plot of Worst Value

802.11b / Chain 1: CH6

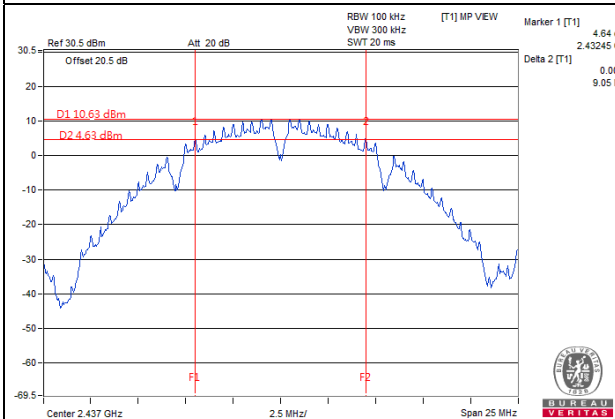

802.11g / Chain 1: CH6

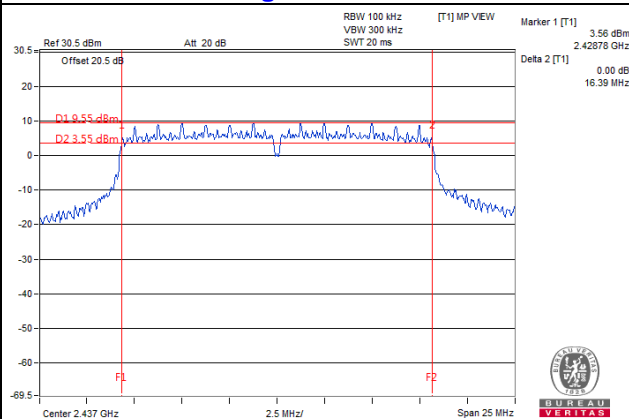

802.11n (20MHz) / Chain 0: CH6

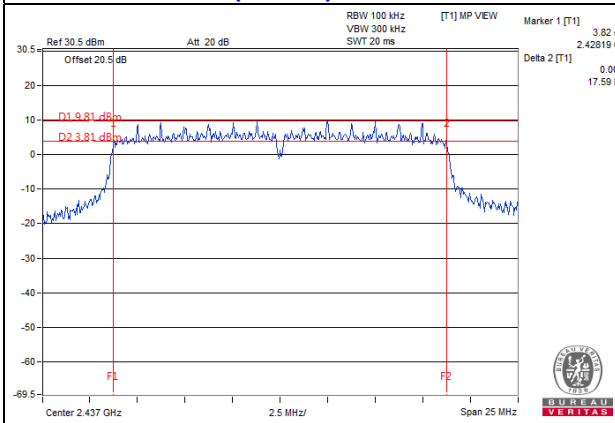

802.11n (40MHz) / Chain 1: CH6

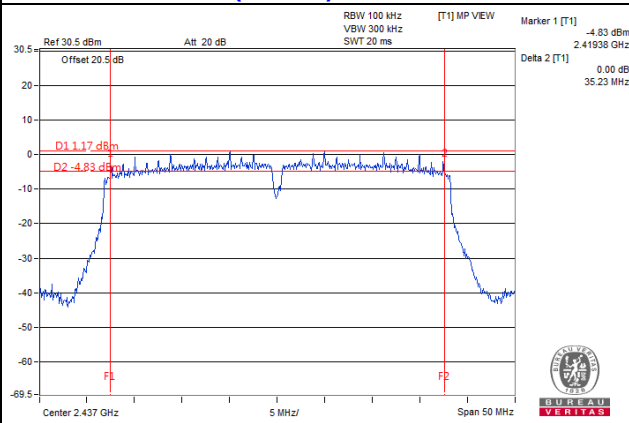

CDD Mode (Mode B)
802.11b

Channel	Frequency (MHz)	6dB Bandwidth (MHz)				Minimum Limit (MHz)	Pass / Fail
		Chain 0	Chain 1	Chain 2	Chain 3		
1	2412	8.56	8.57	9.05	9.04	0.5	PASS
6	2437	8.58	9.07	9.06	8.59	0.5	PASS
11	2462	8.57	8.57	9.04	8.58	0.5	PASS

802.11g

Channel	Frequency (MHz)	6dB Bandwidth (MHz)				Minimum Limit (MHz)	Pass / Fail
		Chain 0	Chain 1	Chain 2	Chain 3		
1	2412	16.36	16.34	16.36	16.36	0.5	PASS
6	2437	16.37	16.36	16.36	16.38	0.5	PASS
11	2462	16.34	16.35	16.36	16.35	0.5	PASS

802.11n (20MHz)

Channel	Frequency (MHz)	6dB Bandwidth (MHz)				Minimum Limit (MHz)	Pass / Fail
		Chain 0	Chain 1	Chain 2	Chain 3		
1	2412	17.57	17.56	17.31	17.51	0.5	PASS
6	2437	17.59	17.59	17.58	17.57	0.5	PASS
11	2462	17.55	16.83	17.56	17.07	0.5	PASS

802.11n (40MHz)

Channel	Frequency (MHz)	6dB Bandwidth (MHz)				Minimum Limit (MHz)	Pass / Fail
		Chain 0	Chain 1	Chain 2	Chain 3		
3	2422	35.11	35.06	35.18	33.88	0.5	PASS
6	2437	35.22	35.23	35.20	35.23	0.5	PASS
9	2452	35.20	35.19	35.14	33.94	0.5	PASS

Spectrum Plot of Worst Value

802.11b / Chain 1: CH6

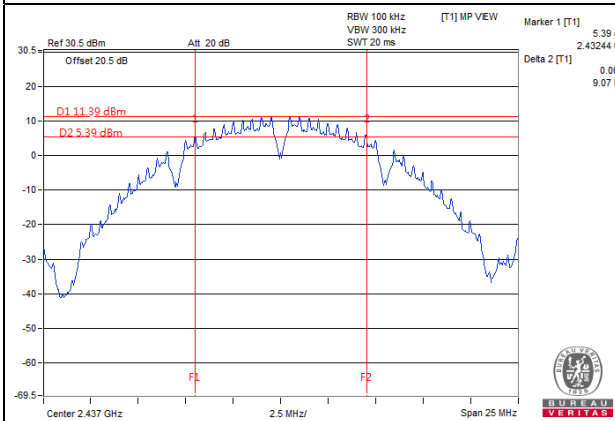

802.11g / Chain 3: CH6

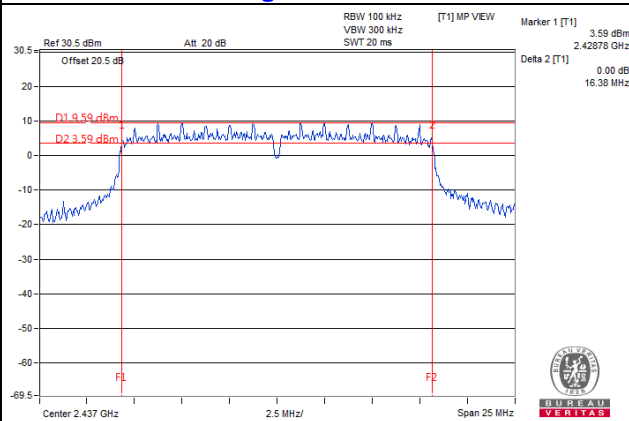

802.11n (20MHz) / Chain 0: CH6

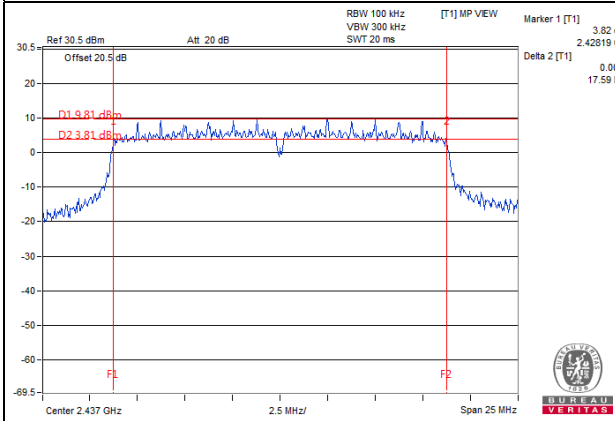

802.11n (40MHz) / Chain 1: CH6

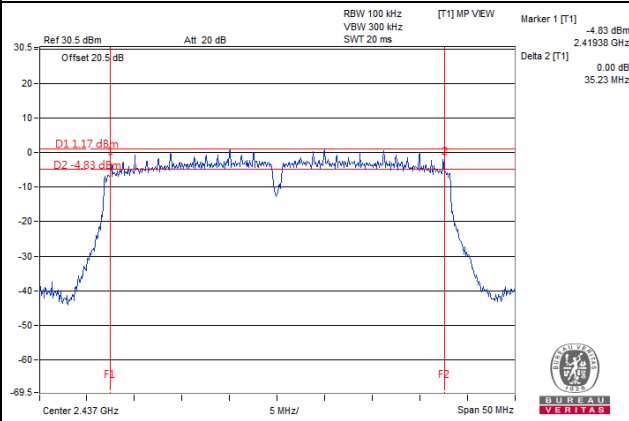

4.4 Conducted Output Power Measurement

4.4.1 Limits of Conducted Output Power Measurement

For systems using digital modulation in the 2400–2483.5 MHz bands: 1 Watt (30dBm)

Per KDB 662911 D01 Multiple Transmitter Output Method of conducted output power measurement on IEEE 802.11 devices,

Array Gain = 0 dB (i.e., no array gain) for $N_{ANT} \leq 4$;

Array Gain = 0 dB (i.e., no array gain) for channel widths ≥ 40 MHz for any N_{ANT} ;

Array Gain = $5 \log(N_{ANT}/N_{SS})$ dB or 3 dB, whichever is less for 20-MHz channel widths with $N_{ANT} \geq 5$.

For power measurements on all other devices: Array Gain = $10 \log(N_{ANT}/N_{SS})$ dB.

4.4.2 Test Setup

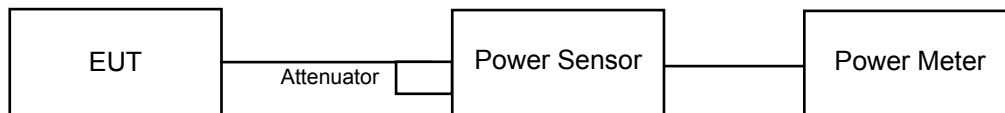

4.4.3 Test Instruments

Refer to section 4.1.2 to get information of above instrument.

4.4.4 Test Procedures

A average power sensor was used on the output port of the EUT. A power meter was used to read the response of the average power sensor. Record the power level.

4.4.5 Deviation from Test Standard

No deviation.

4.4.6 EUT Operating Conditions

Same as Item 4.3.6.

4.4.7 Test Results

CDD Mode (Mode A)

802.11b

Chan.	Chan. Freq. (MHz)	Average Power (dBm)				Total Power (mW)	Total Power (dBm)	Limit (dBm)	Pass / Fail
		Chain 0	Chain 1	Chain 2	Chain 3				
1	2412	20.23	19.88	19.02	17.88	343.889	25.36	30	Pass
6	2437	20.24	19.91	18.98	17.93	344.786	25.38	30	Pass
11	2462	20.13	19.87	18.96	17.92	340.739	25.32	30	Pass

802.11g

Chan.	Chan. Freq. (MHz)	Average Power (dBm)				Total Power (mW)	Total Power (dBm)	Limit (dBm)	Pass / Fail
		Chain 0	Chain 1	Chain 2	Chain 3				
1	2412	18.16	17.88	17.78	18.11	251.533	24.01	30	Pass
6	2437	21.59	21.18	21.69	21.09	551.532	27.42	30	Pass
11	2462	14.89	14.78	14.69	14.88	121.098	20.83	30	Pass

802.11n (20MHz)

Chan.	Chan. Freq. (MHz)	Average Power (dBm)				Total Power (mW)	Total Power (dBm)	Limit (dBm)	Pass / Fail
		Chain 0	Chain 1	Chain 2	Chain 3				
1	2412	18.59	18.17	17.99	18.26	267.831	24.28	30	Pass
6	2437	20.36	19.49	19.56	21.52	429.834	26.33	30	Pass
11	2462	16.22	15.74	15.96	16.21	160.605	22.06	30	Pass

802.11n (40MHz)

Chan.	Chan. Freq. (MHz)	Average Power (dBm)				Total Power (mW)	Total Power (dBm)	Limit (dBm)	Pass / Fail
		Chain 0	Chain 1	Chain 2	Chain 3				
3	2422	12.89	12.78	12.38	12.55	73.708	18.68	30	Pass
6	2437	11.12	10.58	10.45	10.88	47.709	16.79	30	Pass
9	2452	10.89	10.62	10.25	10.98	46.933	16.71	30	Pass

CDD Mode (Mode B)
802.11b

Chan.	Chan. Freq. (MHz)	Average Power (dBm)				Total Power (mW)	Total Power (dBm)	Limit (dBm)	Pass / Fail
		Chain 0	Chain 1	Chain 2	Chain 3				
1	2412	20.74	20.37	19.54	18.38	386.285	25.87	30	Pass
6	2437	20.71	20.39	19.51	18.41	385.831	25.86	30	Pass
11	2462	19.55	19.10	18.32	18.28	306.658	24.87	30	Pass

802.11g

Chan.	Chan. Freq. (MHz)	Average Power (dBm)				Total Power (mW)	Total Power (dBm)	Limit (dBm)	Pass / Fail
		Chain 0	Chain 1	Chain 2	Chain 3				
1	2412	17.12	16.84	16.63	17.03	196.321	22.93	30	Pass
6	2437	22.03	21.50	22.12	21.61	608.649	27.84	30	Pass
11	2462	15.92	15.74	15.75	15.92	153.249	21.85	30	Pass

802.11n (20MHz)

Chan.	Chan. Freq. (MHz)	Average Power (dBm)				Total Power (mW)	Total Power (dBm)	Limit (dBm)	Pass / Fail
		Chain 0	Chain 1	Chain 2	Chain 3				
1	2412	16.98	16.67	16.43	16.75	187.609	22.73	30	Pass
6	2437	22.43	21.55	21.59	23.49	685.443	28.36	30	Pass
11	2462	15.21	14.81	14.92	15.23	127.847	21.07	30	Pass

802.11n (40MHz)

Chan.	Chan. Freq. (MHz)	Average Power (dBm)				Total Power (mW)	Total Power (dBm)	Limit (dBm)	Pass / Fail
		Chain 0	Chain 1	Chain 2	Chain 3				
3	2422	12.89	12.78	12.38	12.55	73.708	18.68	30	Pass
6	2437	11.12	10.58	10.45	10.88	47.709	16.79	30	Pass
9	2452	10.89	10.62	10.25	10.98	46.933	16.71	30	Pass

Beamforming_NSS1 Mode (Mode A)

802.11n (20MHz)

Chan.	Chan. Freq. (MHz)	Average Power (dBm)				Total Power (mW)	Total Power (dBm)	Limit (dBm)	Pass / Fail
		Chain 0	Chain 1	Chain 2	Chain 3				
1	2412	18.07	17.68	17.50	17.72	238.125	23.77	25.6	Pass
6	2437	19.34	18.46	18.54	20.52	340.217	25.32	25.6	Pass
11	2462	15.72	15.28	15.49	15.75	144.038	21.58	25.6	Pass

NOTE:

Directional gain = $10 \log[(10^{G1/20} + 10^{G2/20} + \dots + 10^{GN/20})^2 / 4]$ = 10.4dBi >6dBi, so the Conducted Power limit shall be reduced to $30-(10.4-6) = 25.6\text{dBm}$

802.11n (40MHz)

Chan.	Chan. Freq. (MHz)	Average Power (dBm)				Total Power (mW)	Total Power (dBm)	Limit (dBm)	Pass / Fail
		Chain 0	Chain 1	Chain 2	Chain 3				
3	2422	12.84	12.76	12.39	12.48	73.150	18.64	25.6	Pass
6	2437	11.09	10.52	10.46	10.82	47.320	16.75	25.6	Pass
9	2452	10.91	10.57	10.12	10.89	46.287	16.65	25.6	Pass

NOTE:

Directional gain = $10 \log[(10^{G1/20} + 10^{G2/20} + \dots + 10^{GN/20})^2 / 4]$ = 10.4dBi >6dBi, so the Conducted Power limit shall be reduced to $30-(10.4-6) = 25.6\text{dBm}$

Beamforming_NSS1 Mode (Mode B)

802.11n (20MHz)

Chan.	Chan. Freq. (MHz)	Average Power (dBm)				Total Power (mW)	Total Power (dBm)	Limit (dBm)	Pass / Fail
		Chain 0	Chain 1	Chain 2	Chain 3				
1	2412	16.45	16.23	16.02	16.22	168.006	22.25	25.98	Pass
6	2437	19.72	19.37	19.28	19.95	363.831	25.61	25.98	Pass
11	2462	15.13	14.98	14.85	15.12	127.119	21.04	25.98	Pass

NOTE:

Directional gain = $10 \log[(10^{G1/20} + 10^{G2/20} + \dots + 10^{GN/20})^2 / 4]$ = 10.02dBi >6dBi, so the Conducted Power limit shall be reduced to $30-(10.02-6) = 25.98\text{dBm}$

802.11n (40MHz)

Chan.	Chan. Freq. (MHz)	Average Power (dBm)				Total Power (mW)	Total Power (dBm)	Limit (dBm)	Pass / Fail
		Chain 0	Chain 1	Chain 2	Chain 3				
3	2422	12.84	12.76	12.39	12.48	73.150	18.64	25.98	Pass
6	2437	11.09	10.52	10.46	10.82	47.320	16.75	25.98	Pass
9	2452	10.91	10.57	10.12	10.89	46.287	16.65	25.98	Pass

NOTE:

Directional gain = $10 \log[(10^{G1/20} + 10^{G2/20} + \dots + 10^{GN/20})^2 / 4]$ = 10.02dBi >6dBi, so the Conducted Power limit shall be reduced to $30-(10.02-6) = 25.98\text{dBm}$

4.5 Power Spectral Density Measurement

4.5.1 Limits of Power Spectral Density Measurement

The Maximum of Power Spectral Density Measurement is 8dBm.

4.5.2 Test Setup

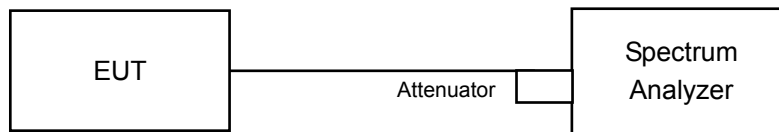

4.5.3 Test Instruments

Refer to section 4.1.2 to get information of above instrument.

4.5.4 Test Procedure

- a. Set analyzer center frequency to DTS channel center frequency.
- b. Set the span to 1.5 times the DTS bandwidth.
- c. Set the RBW to: $3 \text{ kHz} \leq \text{RBW} \leq 10 \text{ kHz}$.
- d. Set the VBW $\geq 3 \times \text{RBW}$.
- e. Detector = peak.
- f. Sweep time = auto couple.
- g. Trace mode = max hold.
- h. Allow trace to fully stabilize.
- i. Use the peak marker function to determine the maximum amplitude level within the RBW.

4.5.5 Deviation from Test Standard

No deviation.

4.5.6 EUT Operating Condition

Same as Item 4.3.6

4.5.7 Test Results

CDD Mode (Mode A) 802.11b

TX chain	Channel	Freq. (MHz)	PSD (dBm)	10 log (N=4) dB	Total PSD (dBm)	Limit (dBm)	Pass /Fail
0	1	2412	-2.72	6.02	3.30	3.60	Pass
	6	2437	-2.84	6.02	3.18	3.60	Pass
	11	2462	-2.51	6.02	3.51	3.60	Pass
1	1	2412	-2.81	6.02	3.21	3.60	Pass
	6	2437	-2.98	6.02	3.04	3.60	Pass
	11	2462	-2.54	6.02	3.48	3.60	Pass
2	1	2412	-2.89	6.02	3.13	3.60	Pass
	6	2437	-2.55	6.02	3.47	3.60	Pass
	11	2462	-2.59	6.02	3.43	3.60	Pass
3	1	2412	-2.63	6.02	3.39	3.60	Pass
	6	2437	-2.53	6.02	3.49	3.60	Pass
	11	2462	-2.57	6.02	3.45	3.60	Pass

NOTE:

Directional gain = $10 \log[(10^{G1/20} + 10^{G2/20} + \dots + 10^{GN/20})^2 / 4] = 10.4\text{dBi} > 6\text{dBi}$, so the PSD limit shall be reduced to $8 - (10.4 - 6) = 3.60\text{dBm}$

802.11g

TX chain	Channel	Freq. (MHz)	PSD (dBm)	10 log (N=4) dB	Total PSD (dBm)	Limit (dBm)	Pass /Fail
0	1	2412	-6.53	6.02	-0.51	3.60	Pass
	6	2437	-3.86	6.02	2.16	3.60	Pass
	11	2462	-8.01	6.02	-1.99	3.60	Pass
1	1	2412	-6.22	6.02	-0.20	3.60	Pass
	6	2437	-3.96	6.02	2.06	3.60	Pass
	11	2462	-8.79	6.02	-2.77	3.60	Pass
2	1	2412	-7.03	6.02	-1.01	3.60	Pass
	6	2437	-4.79	6.02	1.23	3.60	Pass
	11	2462	-7.95	6.02	-1.93	3.60	Pass
3	1	2412	-6.57	6.02	-0.55	3.60	Pass
	6	2437	-5.37	6.02	0.65	3.60	Pass
	11	2462	-8.68	6.02	-2.66	3.60	Pass

NOTE:

Directional gain = $10 \log[(10^{G1/20} + 10^{G2/20} + \dots + 10^{GN/20})^2 / 4] = 10.4\text{dBi} > 6\text{dBi}$, so the PSD limit shall be reduced to $8 - (10.4 - 6) = 3.60\text{dBm}$

802.11n (20MHz)

TX chain	Channel	Freq. (MHz)	PSD (dBm)	10 log (N=4) dB	Total PSD (dBm)	Limit (dBm)	Pass /Fail
0	1	2412	-6.94	6.02	-0.92	3.60	Pass
	6	2437	-5.66	6.02	0.36	3.60	Pass
	11	2462	-9.98	6.02	-3.96	3.60	Pass
1	1	2412	-7.22	6.02	-1.20	3.60	Pass
	6	2437	-5.78	6.02	0.24	3.60	Pass
	11	2462	-10.06	6.02	-4.04	3.60	Pass
2	1	2412	-7.86	6.02	-1.84	3.60	Pass
	6	2437	-5.25	6.02	0.77	3.60	Pass
	11	2462	-9.26	6.02	-3.24	3.60	Pass
3	1	2412	-7.18	6.02	-1.16	3.60	Pass
	6	2437	-4.73	6.02	1.29	3.60	Pass
	11	2462	-9.29	6.02	-3.27	3.60	Pass

NOTE:

Directional gain = $10 \log[(10^{G1/20} + 10^{G2/20} + \dots + 10^{GN/20})^2 / 4] = 10.4\text{dBi} > 6\text{dBi}$, so the PSD limit shall be reduced to $8 - (10.4 - 6) = 3.60\text{dBm}$

802.11n (40MHz)

TX chain	Channel	Freq. (MHz)	PSD (dBm)	10 log (N=4) dB	Total PSD (dBm)	Limit (dBm)	Pass /Fail
0	3	2422	-16.27	6.02	-10.25	3.60	Pass
	6	2437	-13.93	6.02	-7.91	3.60	Pass
	9	2452	-18.11	6.02	-12.09	3.60	Pass
1	3	2422	-16.91	6.02	-10.89	3.60	Pass
	6	2437	-13.85	6.02	-7.83	3.60	Pass
	9	2452	-18.40	6.02	-12.38	3.60	Pass
2	3	2422	-16.58	6.02	-10.56	3.60	Pass
	6	2437	-13.26	6.02	-7.24	3.60	Pass
	9	2452	-18.57	6.02	-12.55	3.60	Pass
3	3	2422	-16.56	6.02	-10.54	3.60	Pass
	6	2437	-13.95	6.02	-7.93	3.60	Pass
	9	2452	-17.92	6.02	-11.90	3.60	Pass

NOTE:

Directional gain = $10 \log[(10^{G1/20} + 10^{G2/20} + \dots + 10^{GN/20})^2 / 4] = 10.4\text{dBi} > 6\text{dBi}$, so the PSD limit shall be reduced to $8 - (10.4 - 6) = 3.60\text{dBm}$

Spectrum Plot of Worst Value

802.11b / Chain 0: CH11

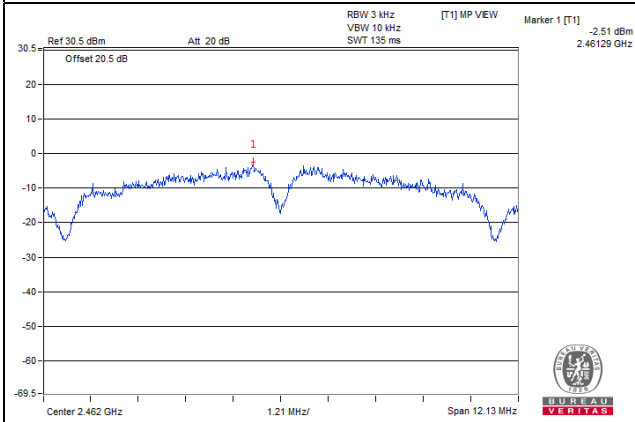

802.11g / Chain 0: CH6

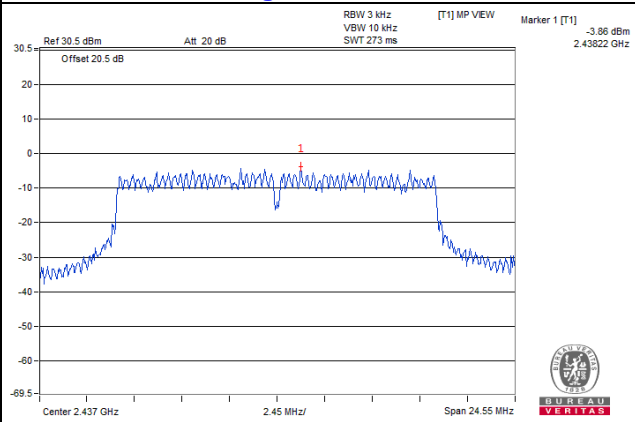

802.11n (20MHz) / Chain 3: CH6

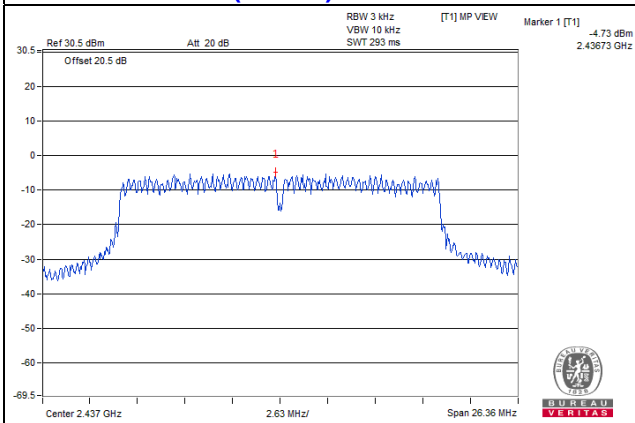

802.11n (40MHz) / Chain 2: CH6

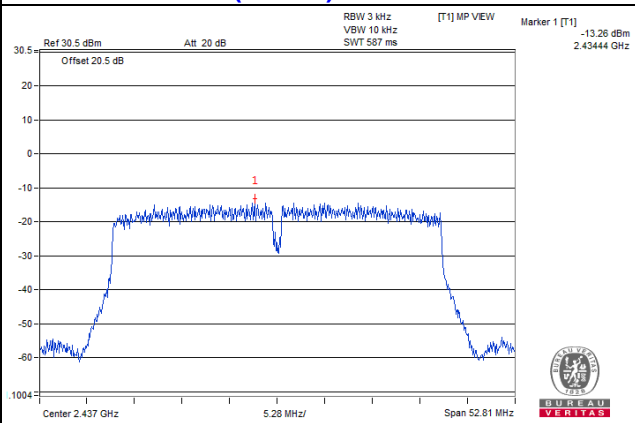

CDD Mode (Mode B)

802.11b

TX chain	Channel	Freq. (MHz)	PSD (dBm)	10 log (N=4) dB	Total PSD (dBm)	Limit (dBm)	Pass /Fail
0	1	2412	-2.10	6.02	3.92	3.98	Pass
	6	2437	-2.27	6.02	3.75	3.98	Pass
	11	2462	-3.15	6.02	2.87	3.98	Pass
1	1	2412	-2.27	6.02	3.75	3.98	Pass
	6	2437	-2.18	6.02	3.84	3.98	Pass
	11	2462	-3.05	6.02	2.97	3.98	Pass
2	1	2412	-2.17	6.02	3.85	3.98	Pass
	6	2437	-2.25	6.02	3.77	3.98	Pass
	11	2462	-3.06	6.02	2.96	3.98	Pass
3	1	2412	-2.20	6.02	3.82	3.98	Pass
	6	2437	-2.35	6.02	3.67	3.98	Pass
	11	2462	-3.07	6.02	2.95	3.98	Pass

NOTE:

Directional gain = $10 \log[(10^{G1/20} + 10^{G2/20} + \dots + 10^{GN/20})^2 / 4] = 10.02\text{dBi} > 6\text{dBi}$, so the PSD limit shall be reduced to $8 - (10.02 - 6) = 3.98\text{dBm}$

802.11g

TX chain	Channel	Freq. (MHz)	PSD (dBm)	10 log (N=4) dB	Total PSD (dBm)	Limit (dBm)	Pass /Fail
0	1	2412	-8.46	6.02	-2.44	3.98	Pass
	6	2437	-4.12	6.02	1.90	3.98	Pass
	11	2462	-9.39	6.02	-3.37	3.98	Pass
1	1	2412	-8.42	6.02	-2.40	3.98	Pass
	6	2437	-5.36	6.02	0.66	3.98	Pass
	11	2462	-9.88	6.02	-3.86	3.98	Pass
2	1	2412	-8.15	6.02	-2.13	3.98	Pass
	6	2437	-3.03	6.02	2.99	3.98	Pass
	11	2462	-8.21	6.02	-2.19	3.98	Pass
3	1	2412	-8.08	6.02	-2.06	3.98	Pass
	6	2437	-4.82	6.02	1.20	3.98	Pass
	11	2462	-8.52	6.02	-2.50	3.98	Pass

NOTE:

Directional gain = $10 \log[(10^{G1/20} + 10^{G2/20} + \dots + 10^{GN/20})^2 / 4] = 10.02\text{dBi} > 6\text{dBi}$, so the PSD limit shall be reduced to $8 - (10.02 - 6) = 3.98\text{dBm}$

802.11n (20MHz)

TX chain	Channel	Freq. (MHz)	PSD (dBm)	10 log (N=4) dB	Total PSD (dBm)	Limit (dBm)	Pass /Fail
0	1	2412	-8.87	6.02	-2.85	3.98	Pass
	6	2437	-5.66	6.02	0.36	3.98	Pass
	11	2462	-10.76	6.02	-4.74	3.98	Pass
1	1	2412	-9.56	6.02	-3.54	3.98	Pass
	6	2437	-5.78	6.02	0.24	3.98	Pass
	11	2462	-11.23	6.02	-5.21	3.98	Pass
2	1	2412	-8.44	6.02	-2.42	3.98	Pass
	6	2437	-5.25	6.02	0.77	3.98	Pass
	11	2462	-10.09	6.02	-4.07	3.98	Pass
3	1	2412	-9.16	6.02	-3.14	3.98	Pass
	6	2437	-4.73	6.02	1.29	3.98	Pass
	11	2462	-10.77	6.02	-4.75	3.98	Pass

NOTE:

Directional gain = $10 \log[(10^{G1/20} + 10^{G2/20} + \dots + 10^{GN/20})^2 / 4] = 10.02\text{dBi} > 6\text{dBi}$, so the PSD limit shall be reduced to $8 - (10.02 - 6) = 3.98\text{dBm}$

802.11n (40MHz)

TX chain	Channel	Freq. (MHz)	PSD (dBm)	10 log (N=4) dB	Total PSD (dBm)	Limit (dBm)	Pass /Fail
0	3	2422	-16.27	6.02	-10.25	3.98	Pass
	6	2437	-13.93	6.02	-7.91	3.98	Pass
	9	2452	-18.11	6.02	-12.09	3.98	Pass
1	3	2422	-16.91	6.02	-10.89	3.98	Pass
	6	2437	-13.85	6.02	-7.83	3.98	Pass
	9	2452	-18.40	6.02	-12.38	3.98	Pass
2	3	2422	-16.58	6.02	-10.56	3.98	Pass
	6	2437	-13.26	6.02	-7.24	3.98	Pass
	9	2452	-18.57	6.02	-12.55	3.98	Pass
3	3	2422	-16.56	6.02	-10.54	3.98	Pass
	6	2437	-13.95	6.02	-7.93	3.98	Pass
	9	2452	-17.92	6.02	-11.90	3.98	Pass

NOTE:

Directional gain = $10 \log[(10^{G1/20} + 10^{G2/20} + \dots + 10^{GN/20})^2 / 4] = 10.02\text{dBi} > 6\text{dBi}$, so the PSD limit shall be reduced to $8 - (10.02 - 6) = 3.98\text{dBm}$

Spectrum Plot of Worst Value

802.11b / Chain 0: CH1

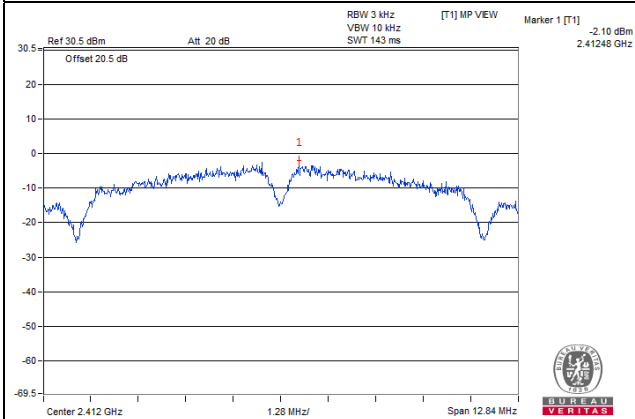

802.11g / Chain 2: CH6

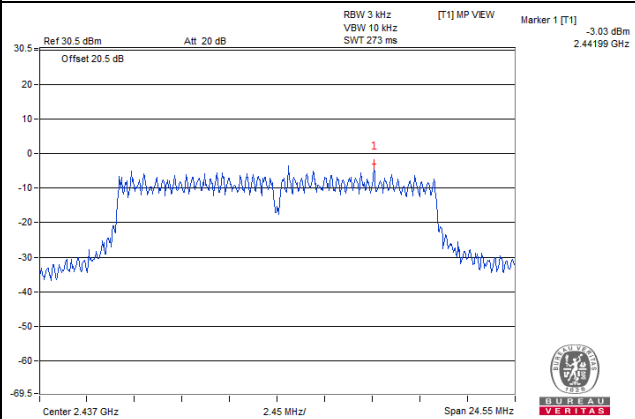

802.11n (20MHz) / Chain 3: CH6

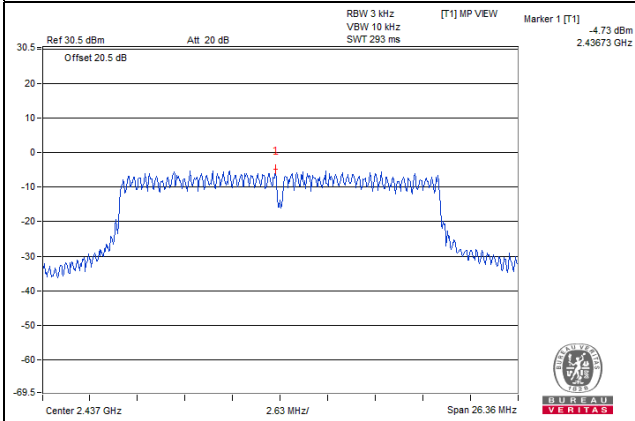

802.11n (40MHz) / Chain 2: CH6

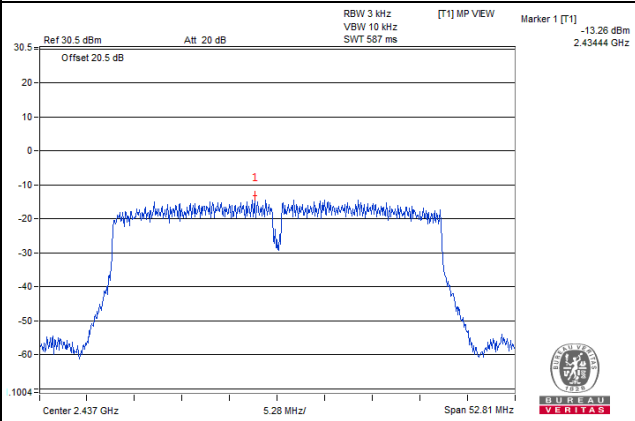

4.6 Conducted Out of Band Emission Measurement

4.6.1 Limits of Conducted Out of Band Emission Measurement

Below 30dB of the highest emission level of operating band (in 100kHz Resolution Bandwidth).

4.6.2 Test Setup

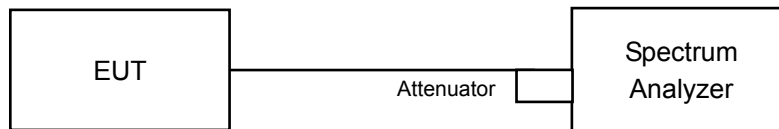

4.6.3 Test Instruments

Refer to section 4.1.2 to get information of above instrument.

4.6.4 Test Procedure

MEASUREMENT PROCEDURE REF

1. Set the RBW = 100 kHz.
2. Set the VBW \geq 300 kHz.
3. Detector = peak.
4. Sweep time = auto couple.
5. Trace mode = max hold.
6. Allow trace to fully stabilize.
7. Use the peak marker function to determine the maximum power level in any 100 kHz band segment within the fundamental EBW.

MEASUREMENT PROCEDURE OOB

1. Set RBW = 100 kHz.
2. Set VBW \geq 300 kHz.
3. Detector = peak.
4. Sweep = auto couple.
5. Trace Mode = max hold.
6. Allow trace to fully stabilize.
7. Use the peak marker function to determine the maximum amplitude level.

4.6.5 Deviation from Test Standard

No deviation.

4.6.6 EUT Operating Condition

Same as Item 4.3.6

4.6.7 Test Results

The spectrum plots are attached on the following pages. D1 line indicates the highest level, and D2 line indicates the 30dB offset below D1. It shows compliance with the requirement.

CDD Mode (Mode A)
802.11b: CHAIN 0

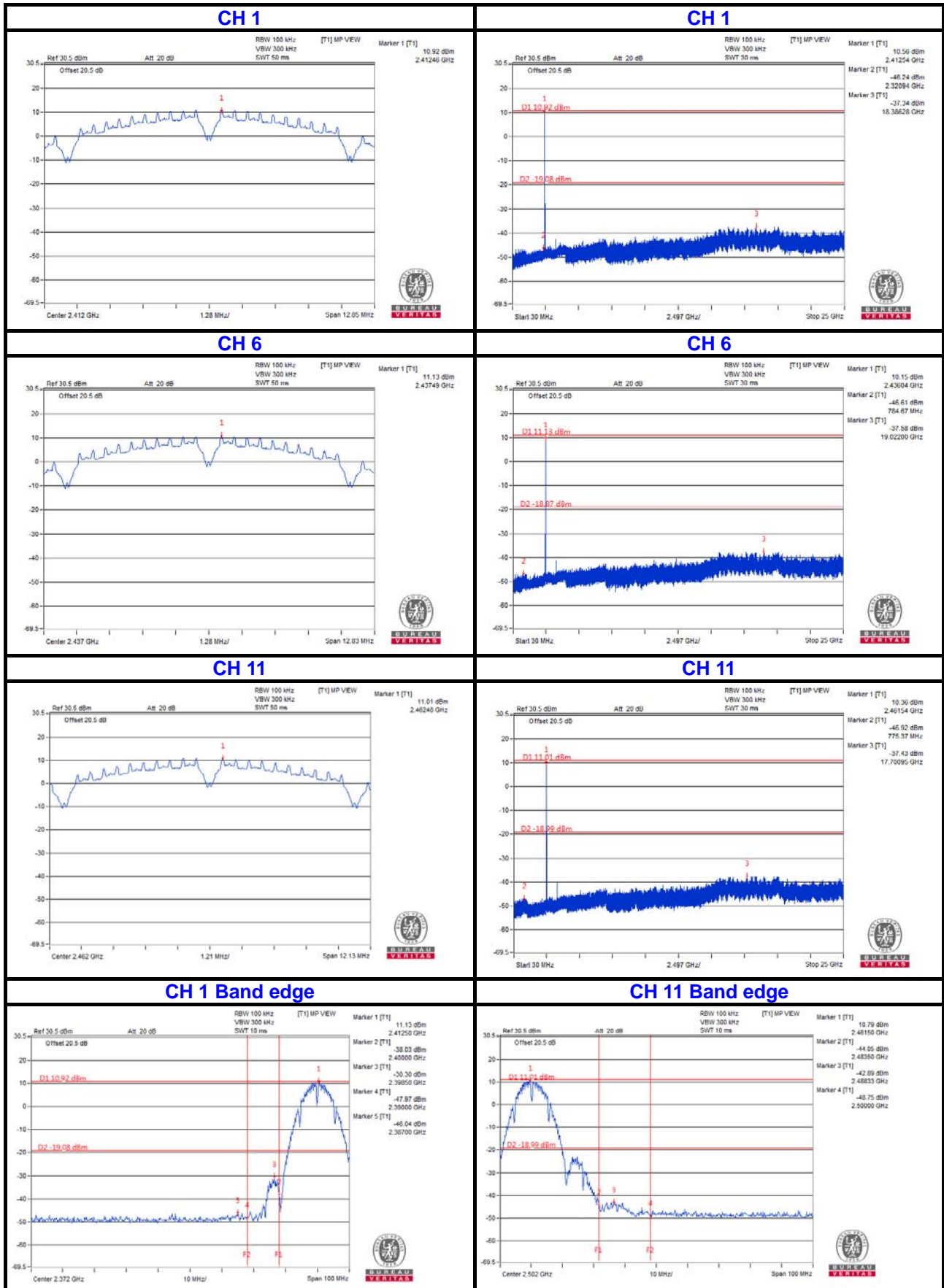

CHAIN 1

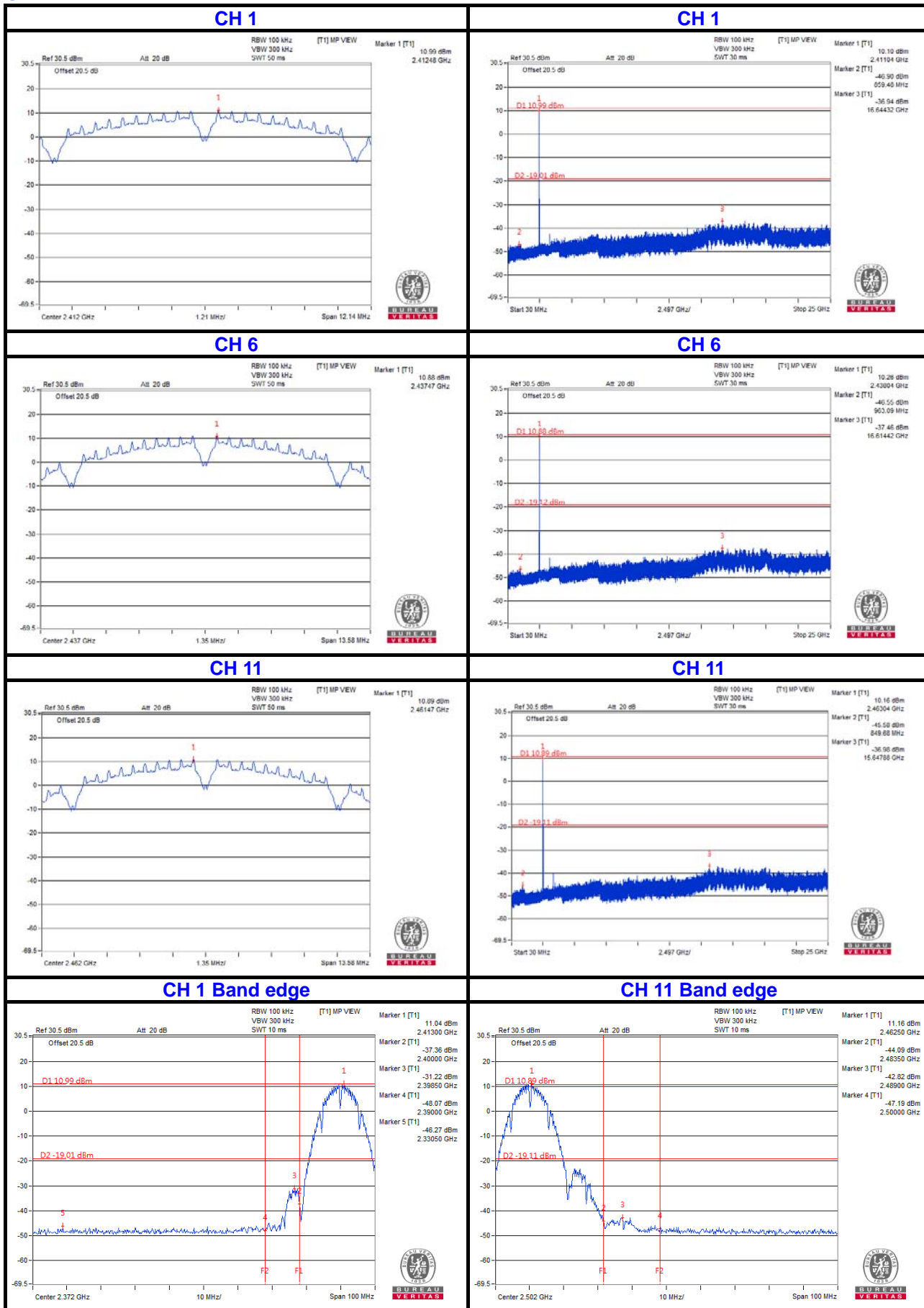

CHAIN 2

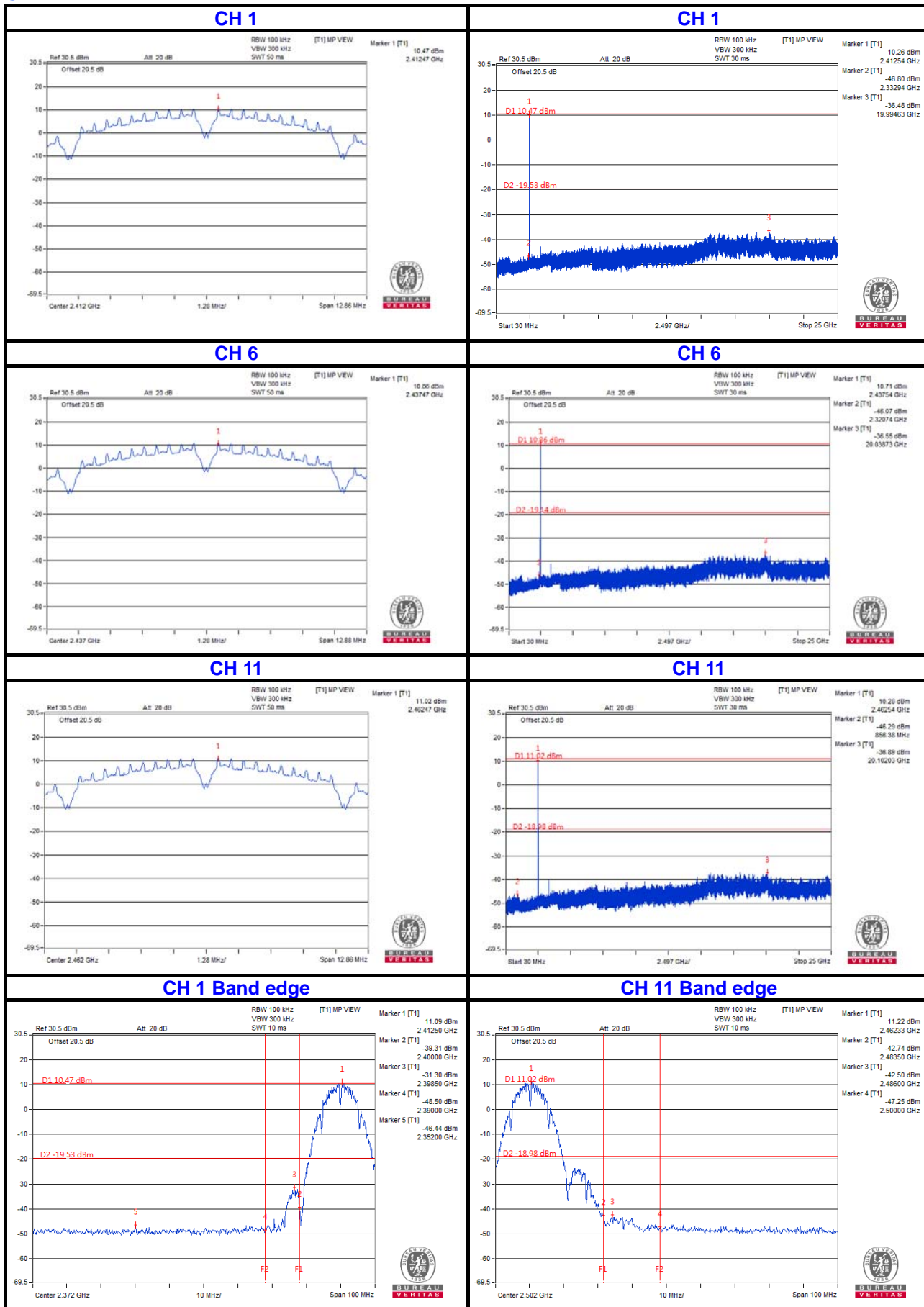

CHAIN 3

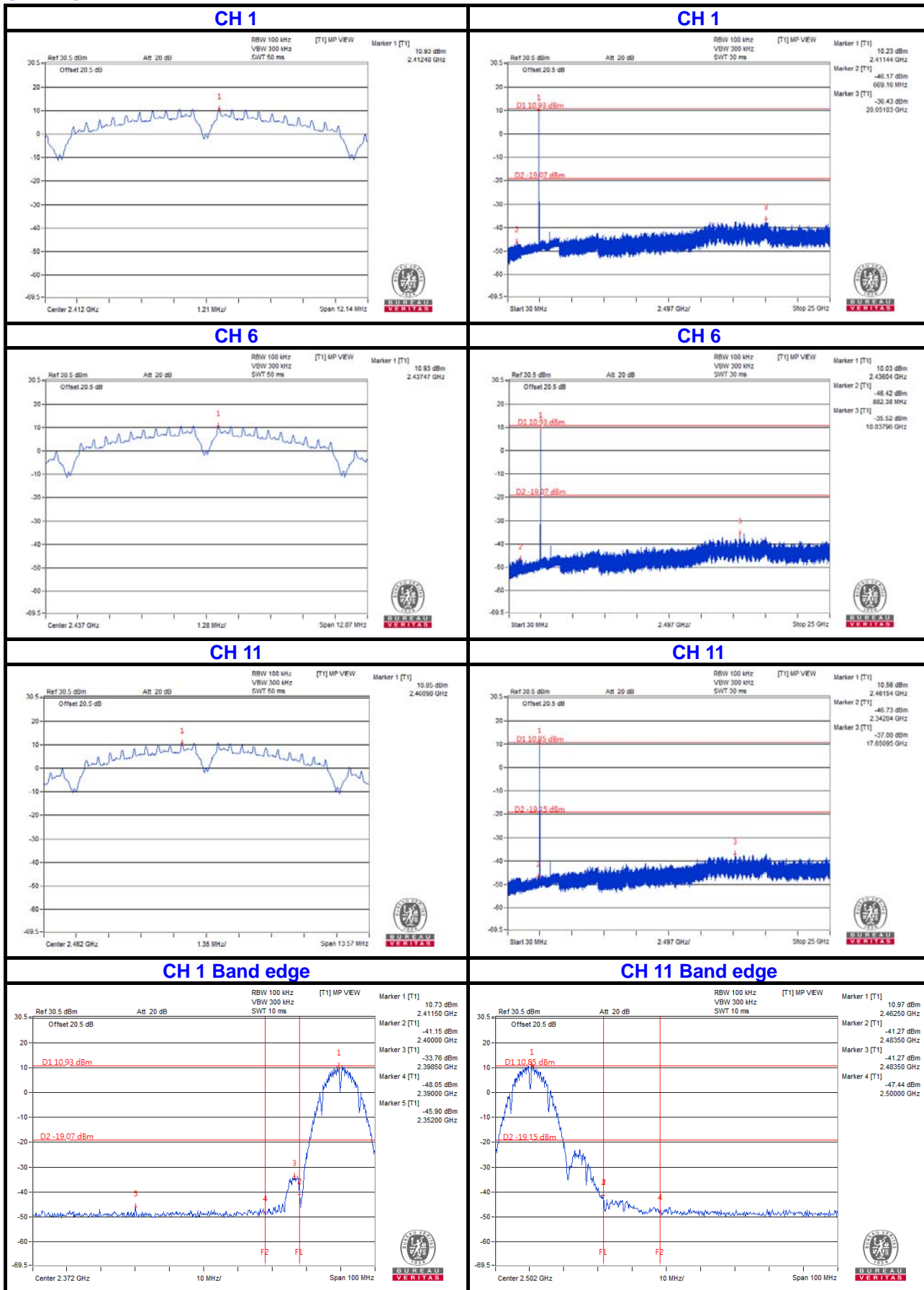

802.11g CHAIN 0

CH 1

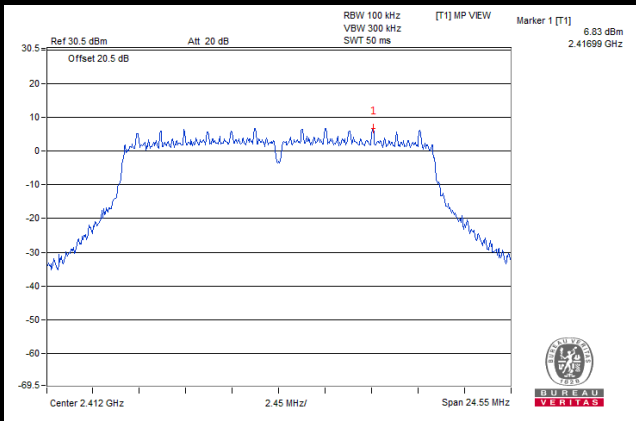

CH 1

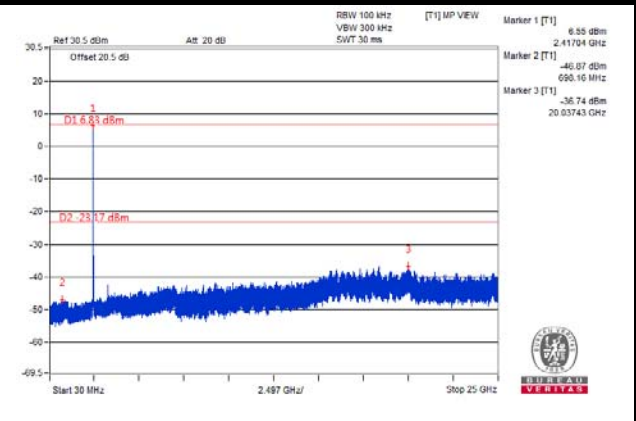

CH 6

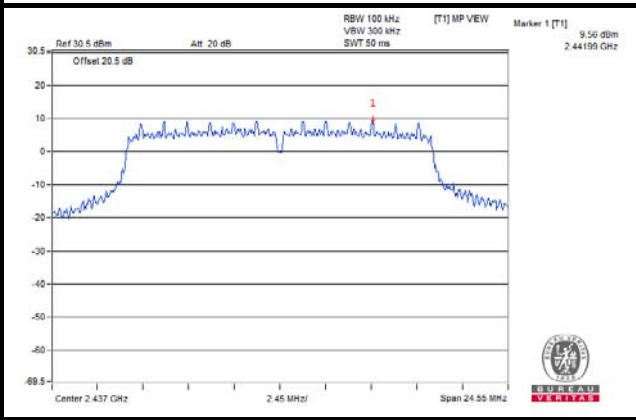

CH 6

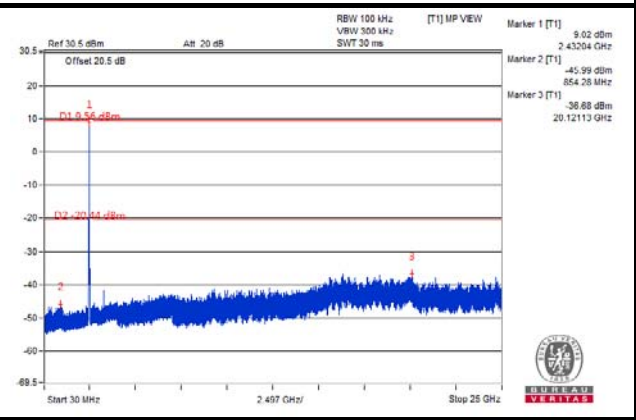

CH 11

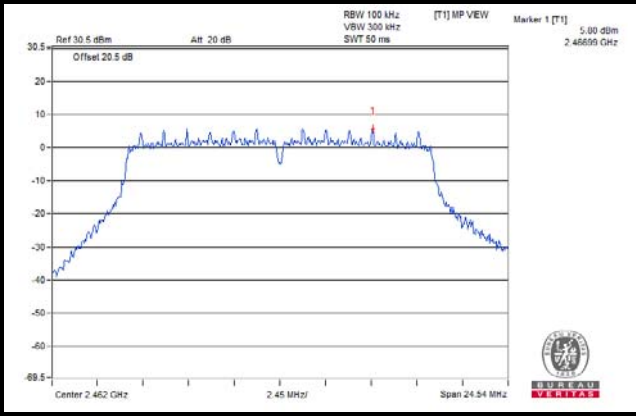

CH 11

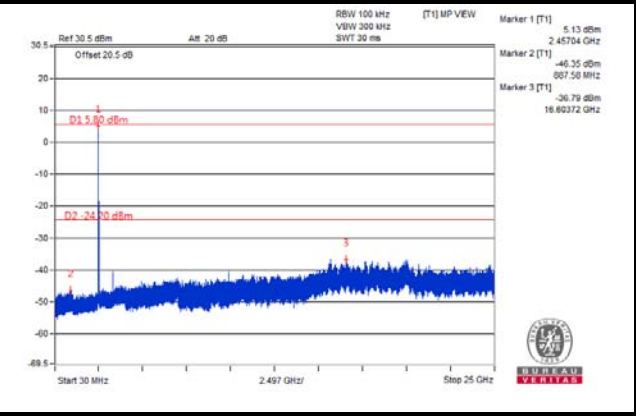

CH 1 Band edge

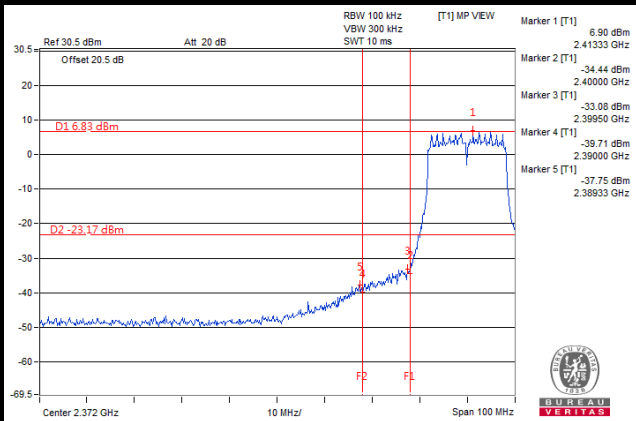

CH 11 Band edge

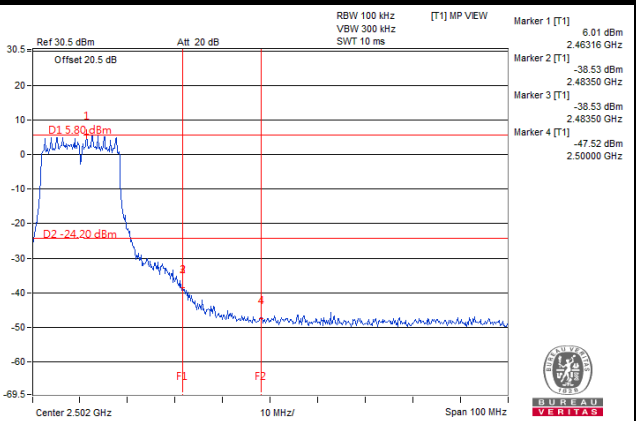

CHAIN 1

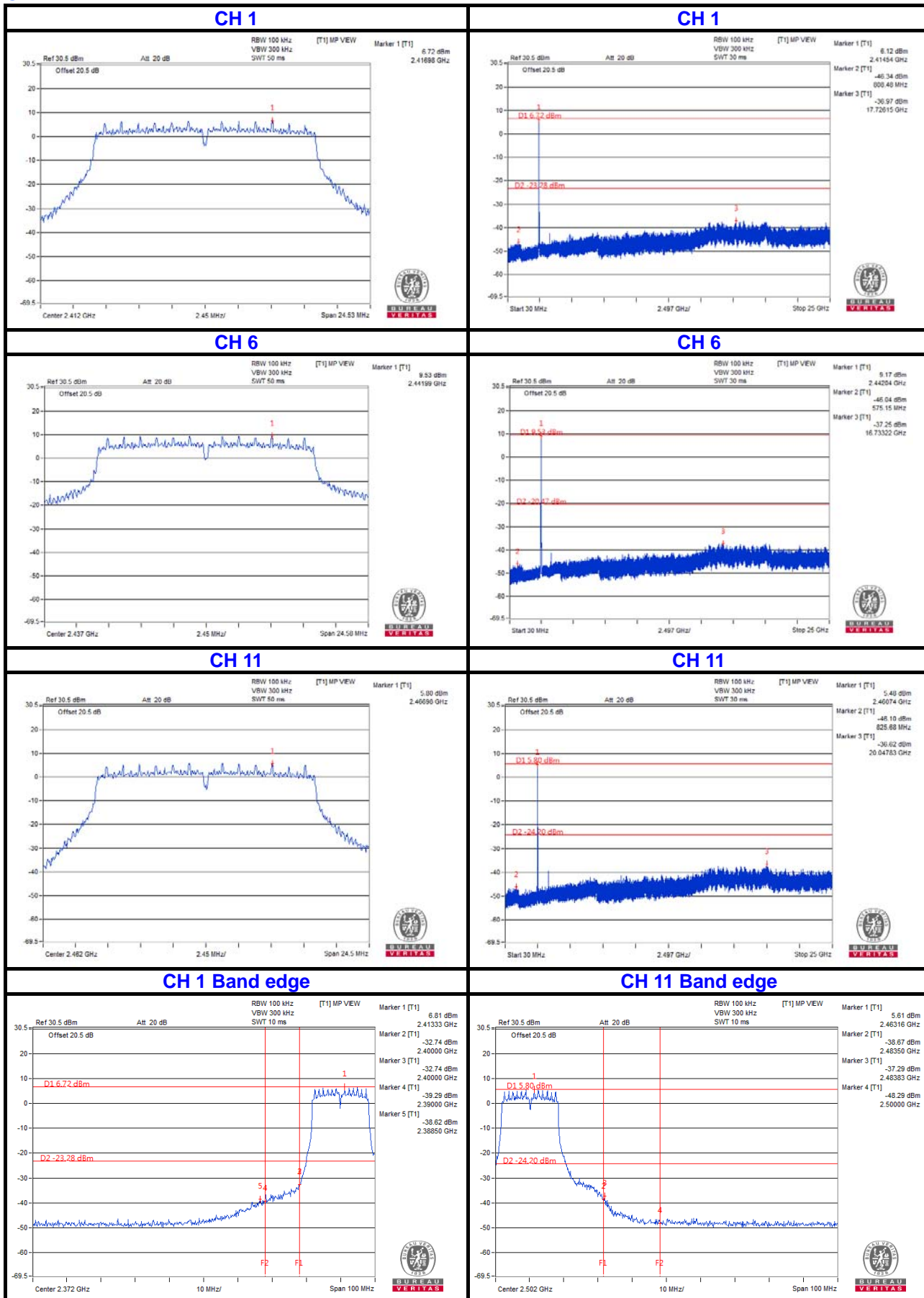

CHAIN 2

CH 1

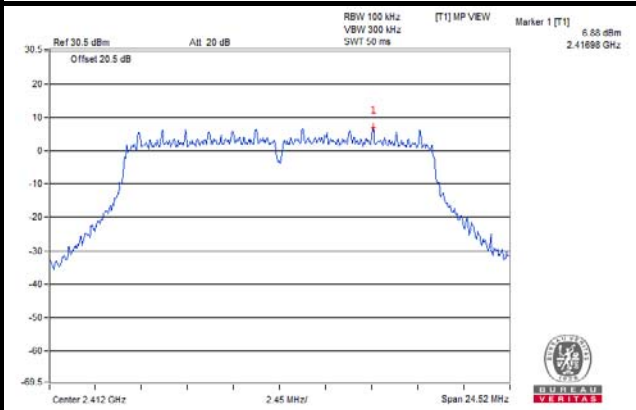

CH 1

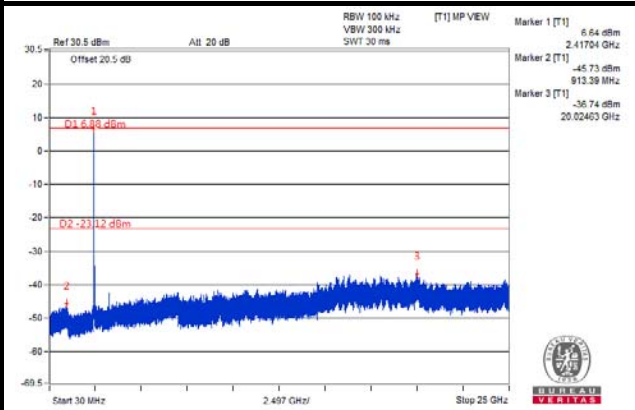

CH 6

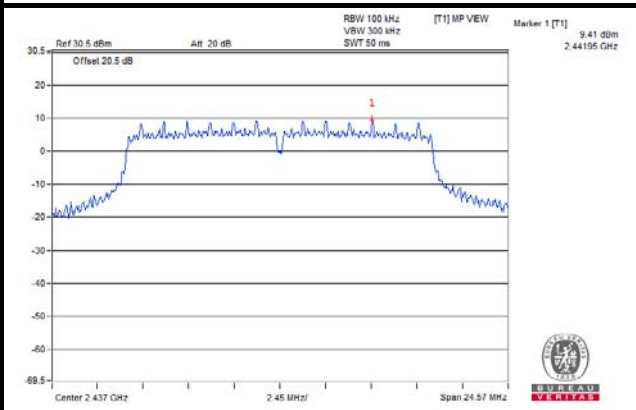

CH 6

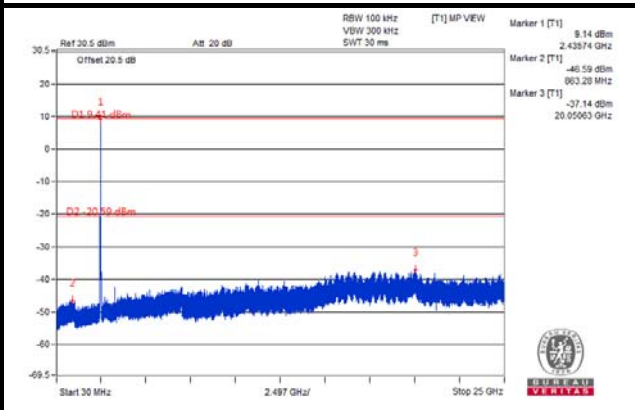

CH 11

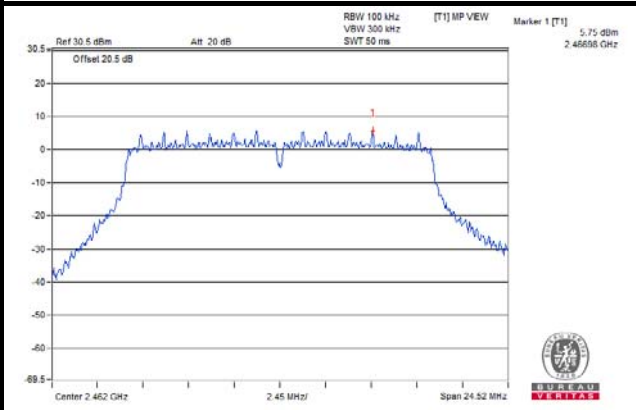

CH 11

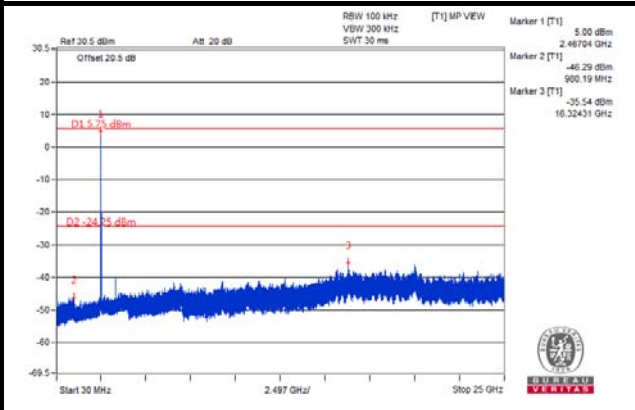

CH 1 Band edge

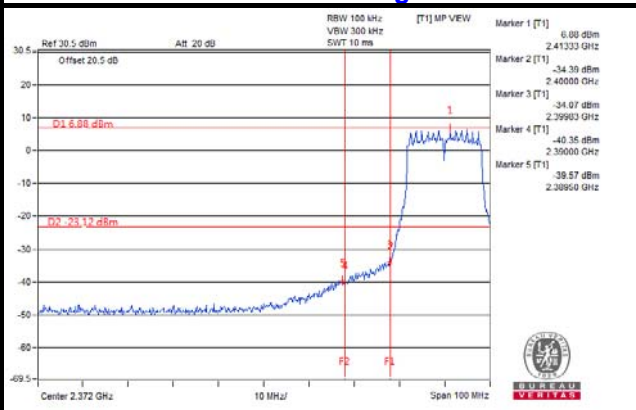

CH 11 Band edge

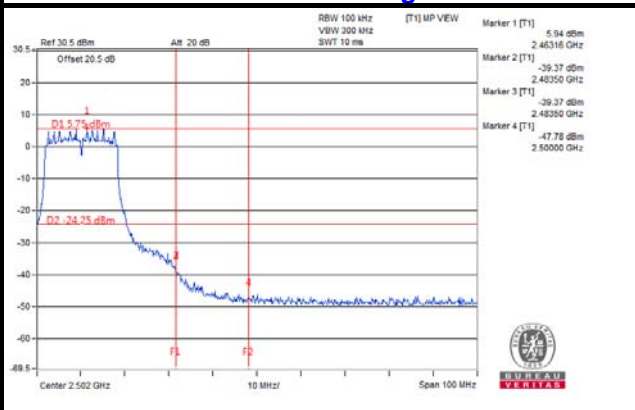

CHAIN 3

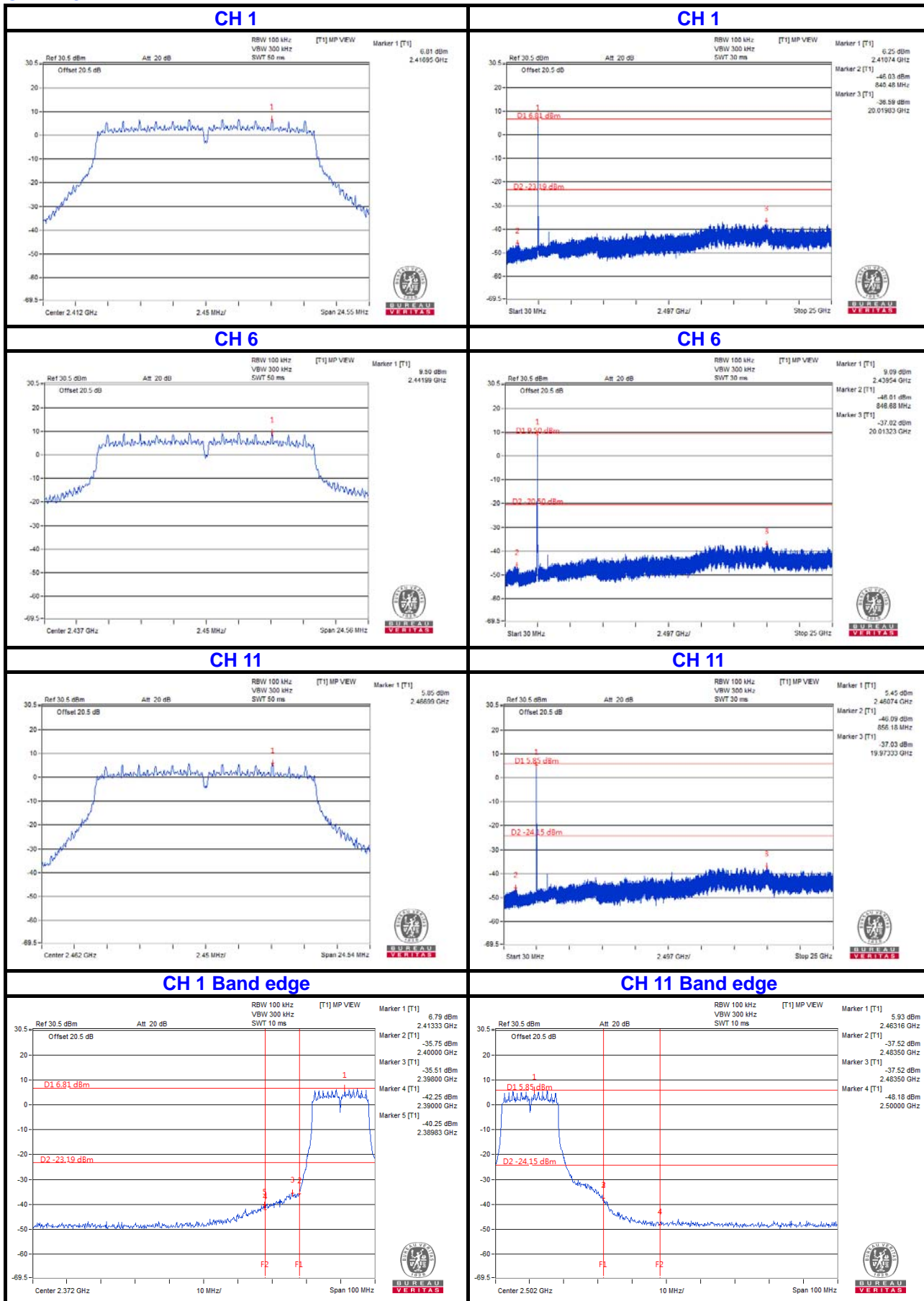

802.11n (20MHz): CHAIN 0

CH 1

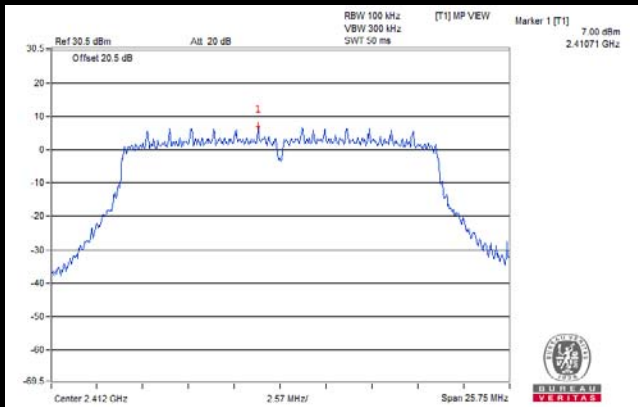

CH 1

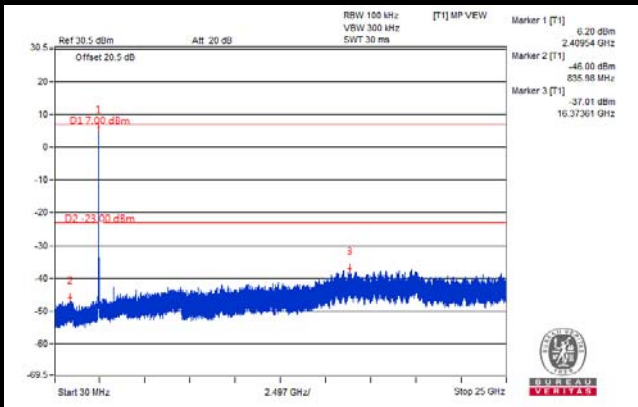

CH 6

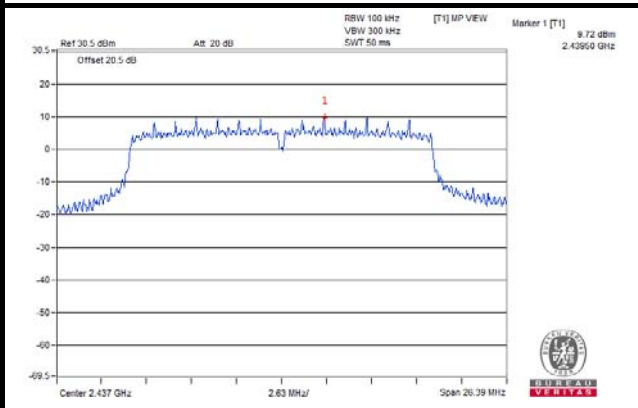

CH 6

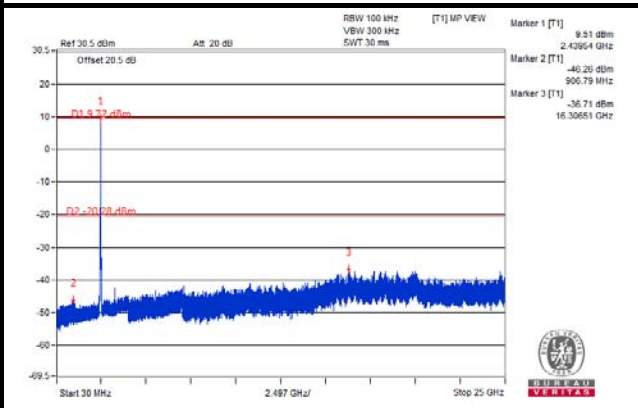

CH 11

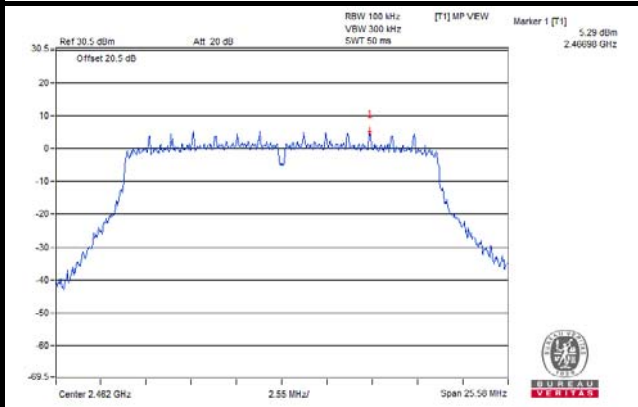

CH 11

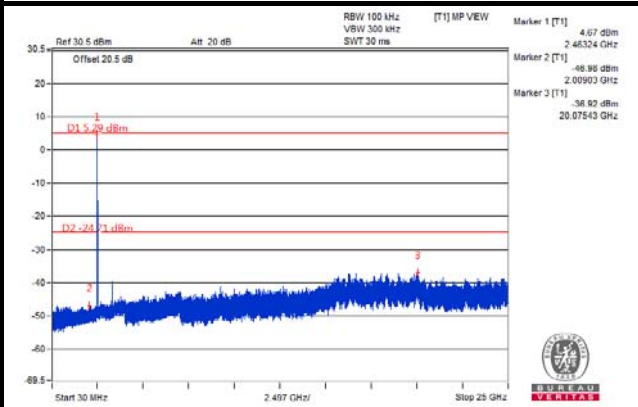

CH 1 Band edge

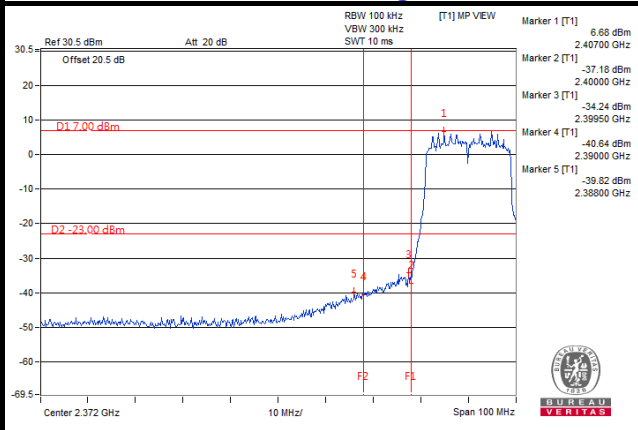

CH 11 Band edge

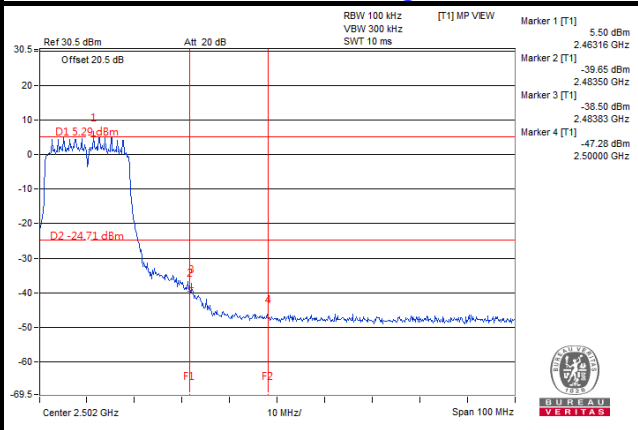

CHAIN 1

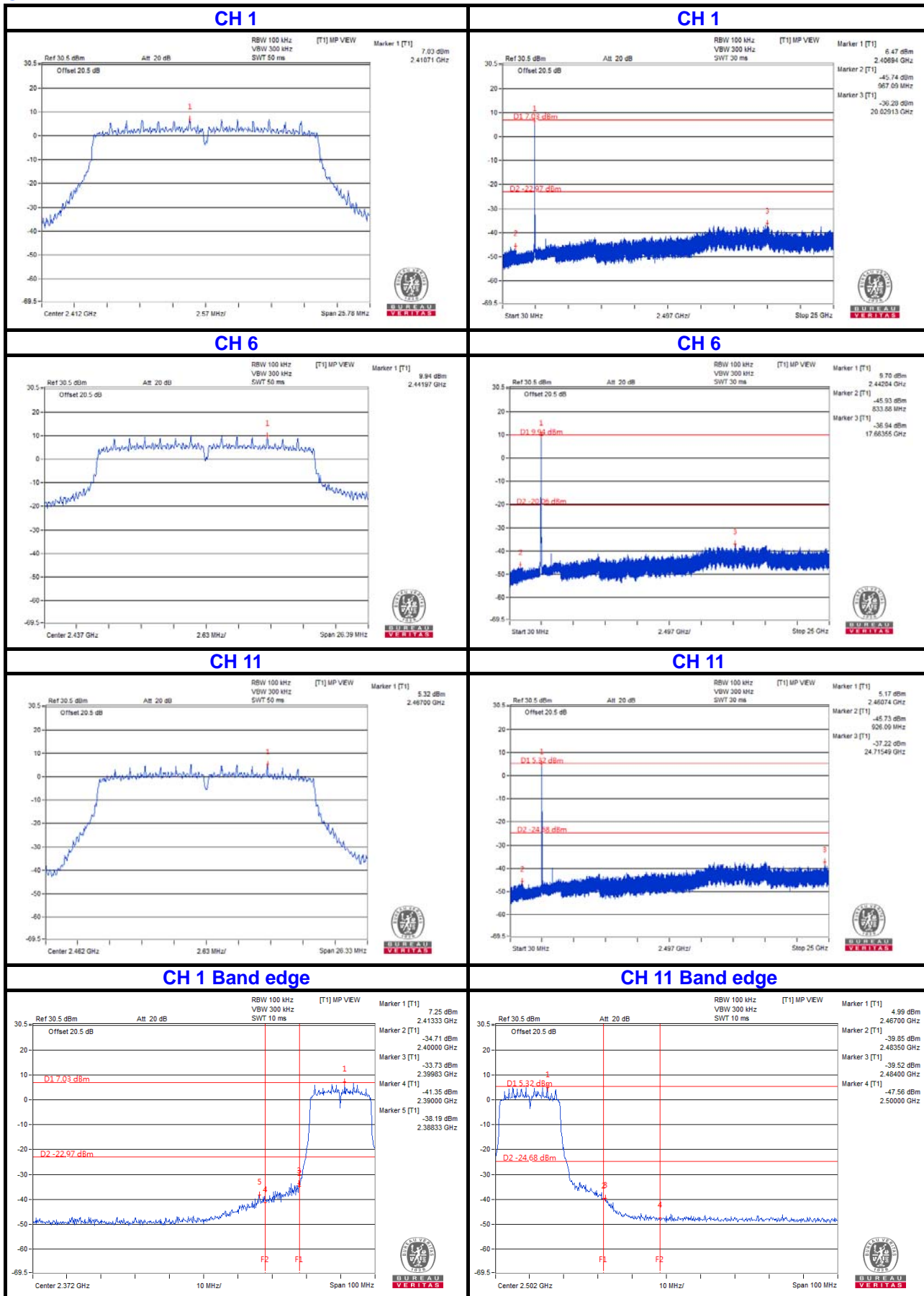

CHAIN 2

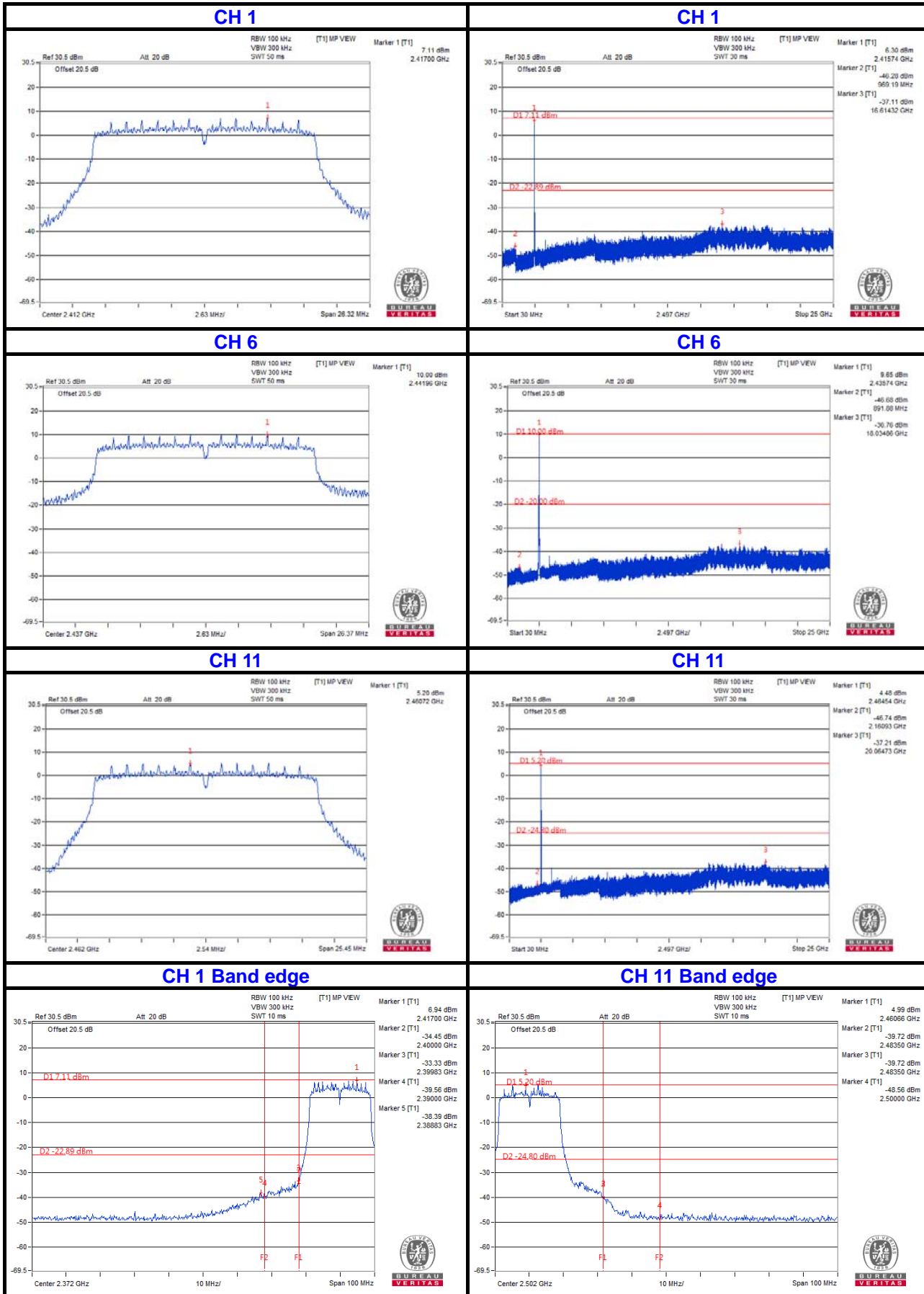

CHAIN 3

CH 1

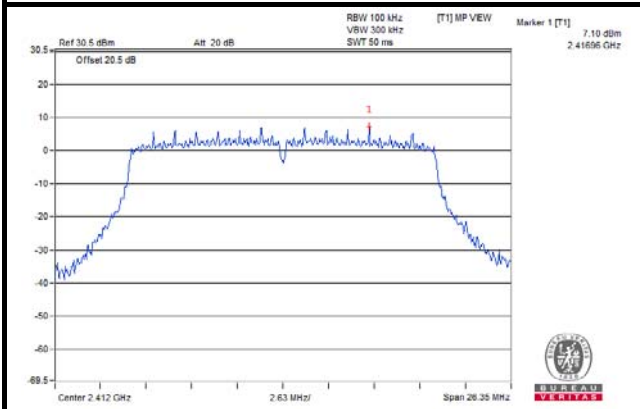

CH 1

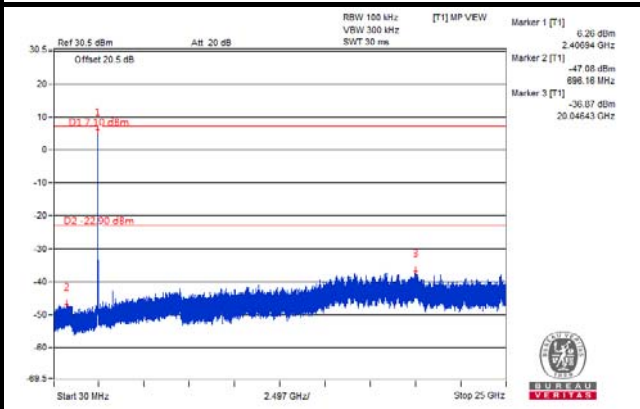

CH 6

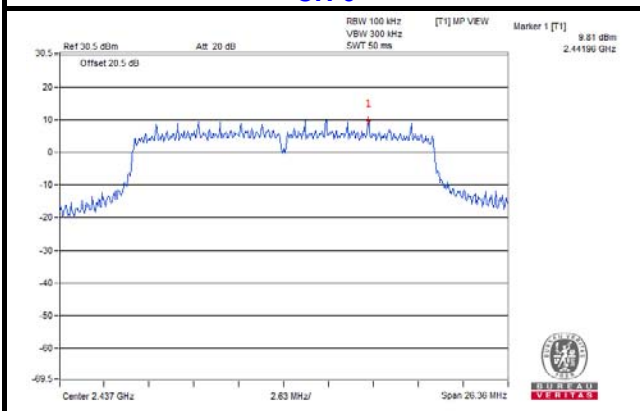

CH 6

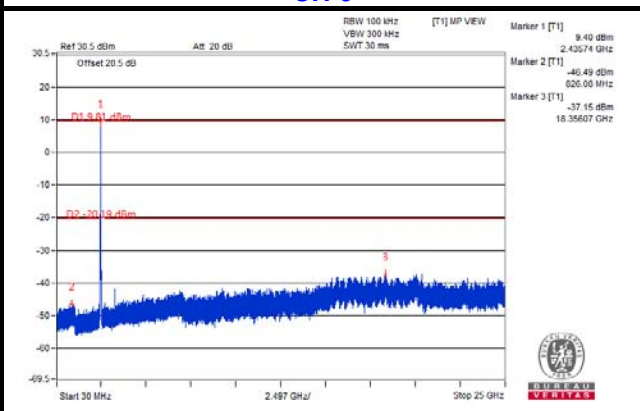

CH 11

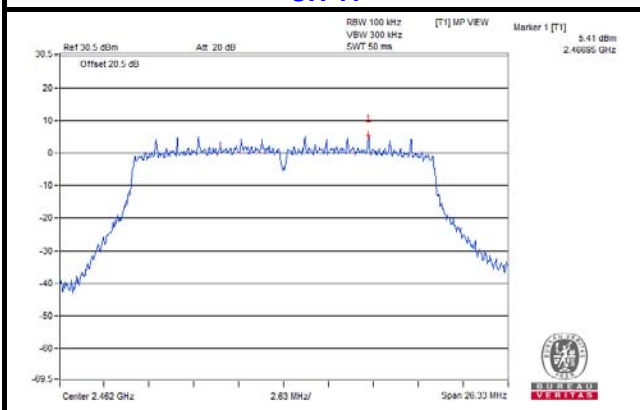

CH 11

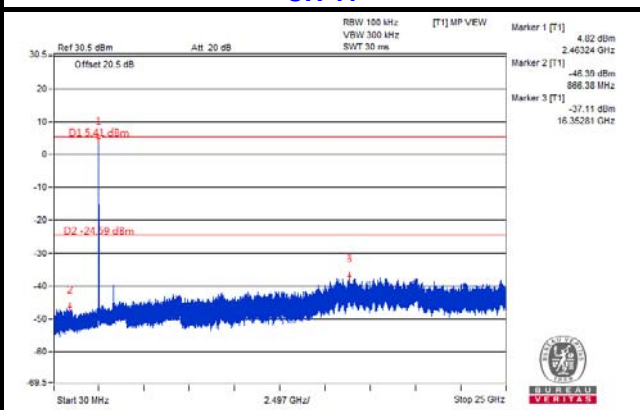

CH 1 Band edge

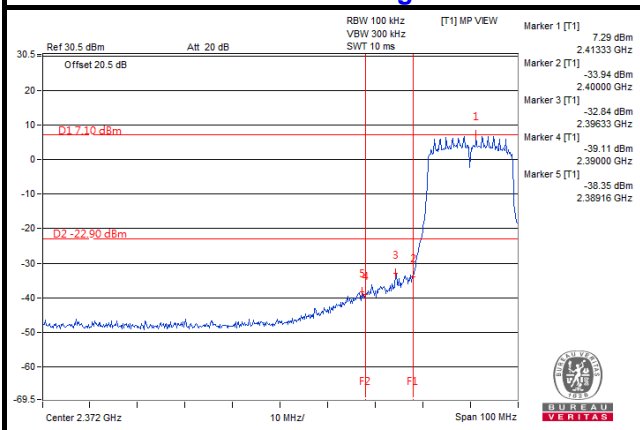

CH 11 Band edge

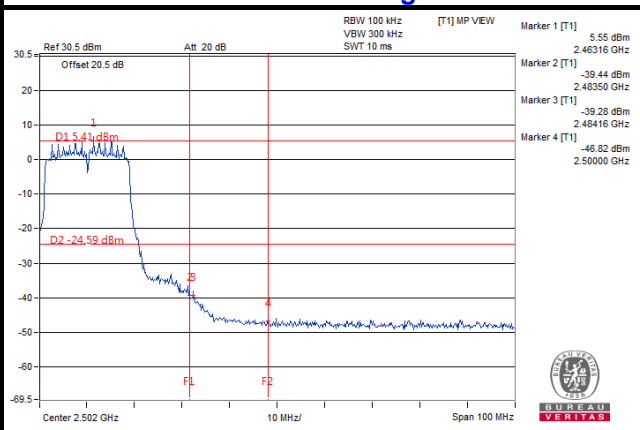

802.11n (40MHz): CHAIN 0

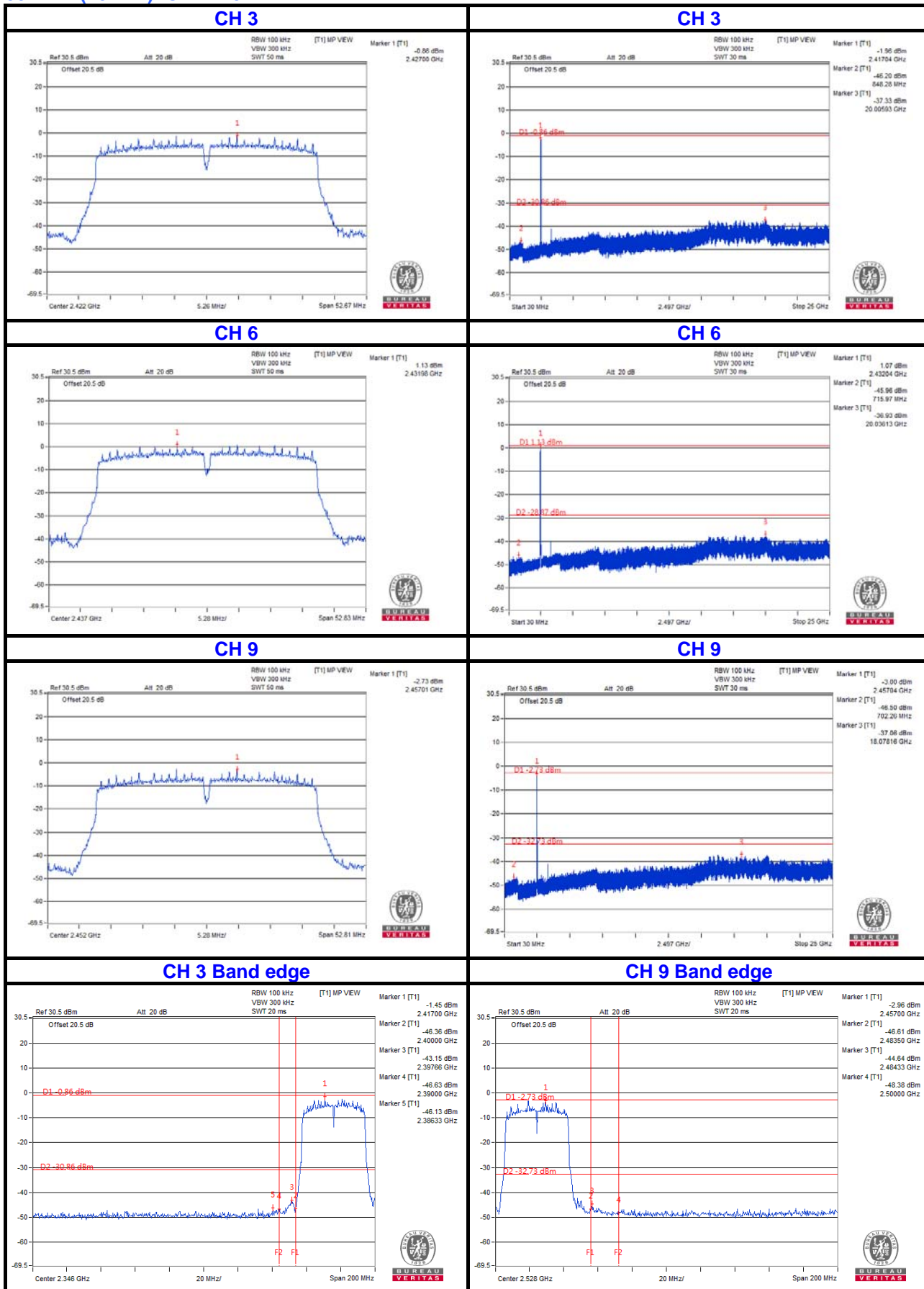

CHAIN 1

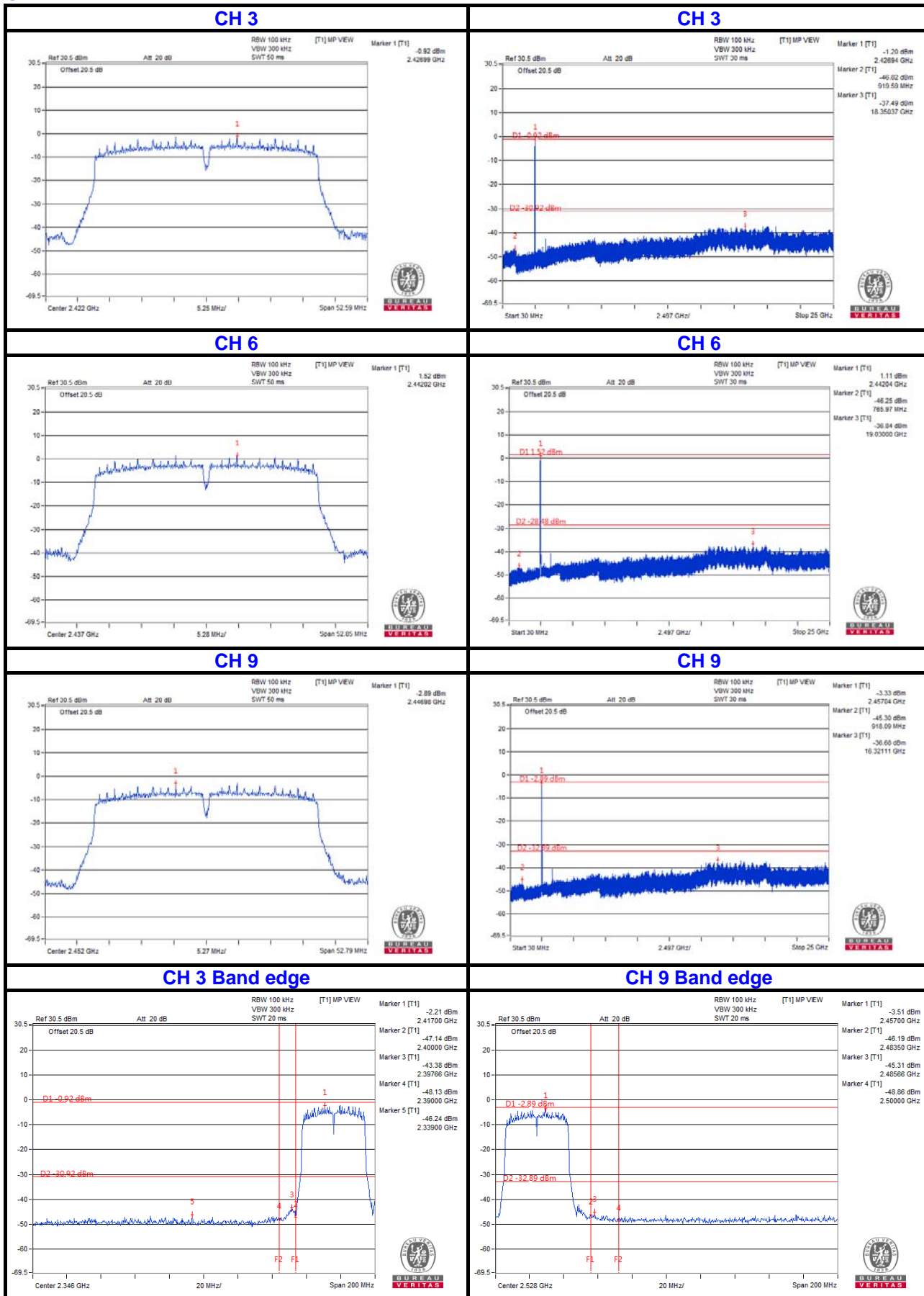

CHAIN 2

CH 3

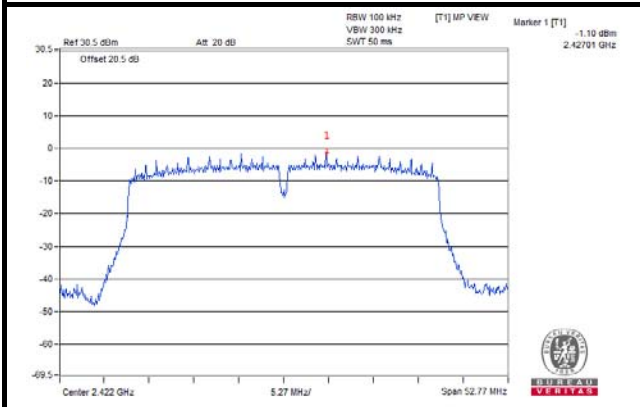

CH 3

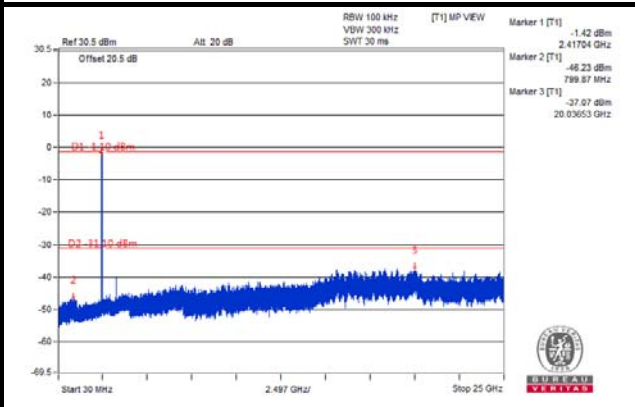

CH 6

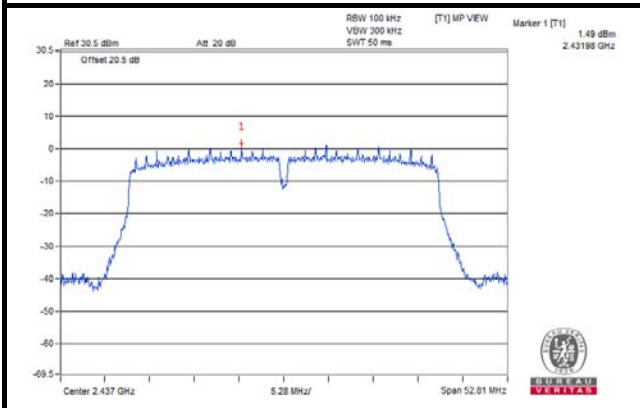

CH 6

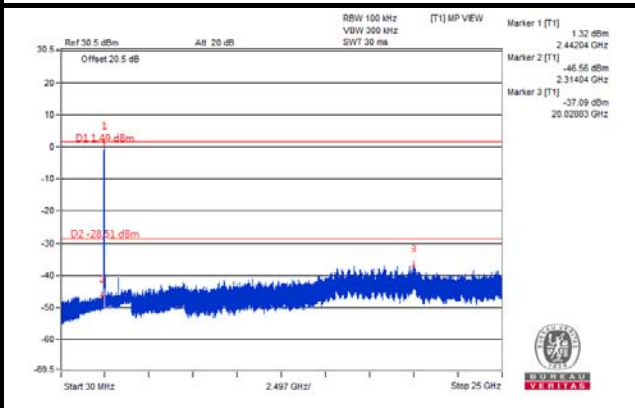

CH 9

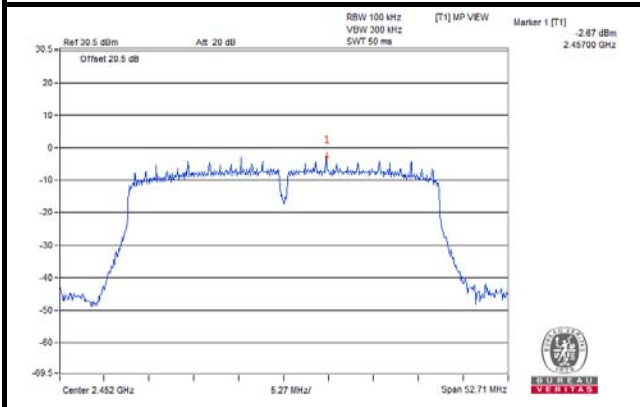

CH 9

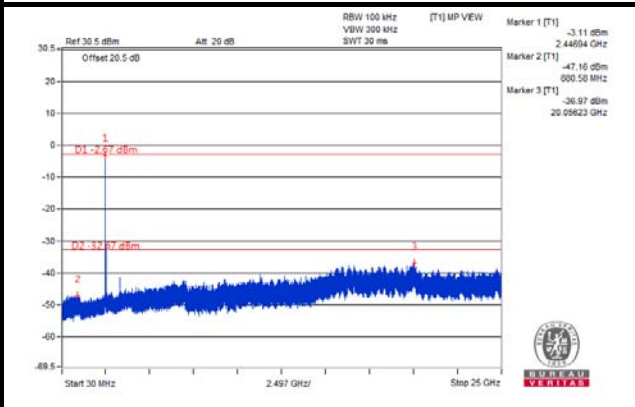

CH 3 Band edge

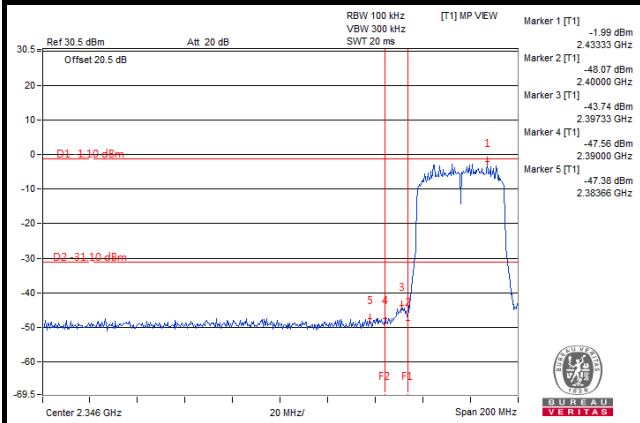

CH 9 Band edge

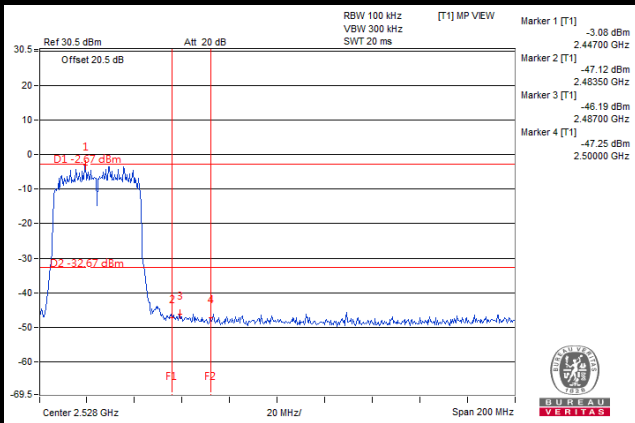

CHAIN 3

CH 3

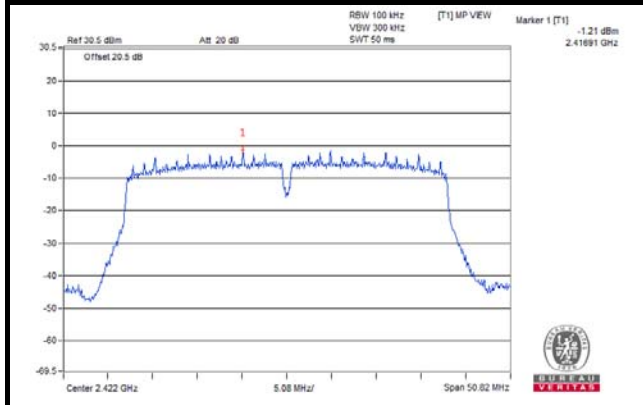

CH 3

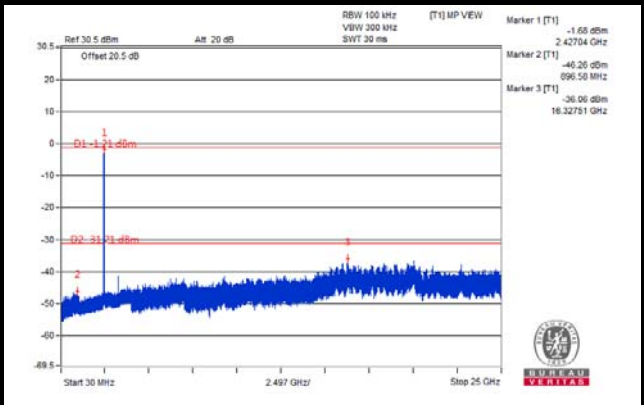

CH 6

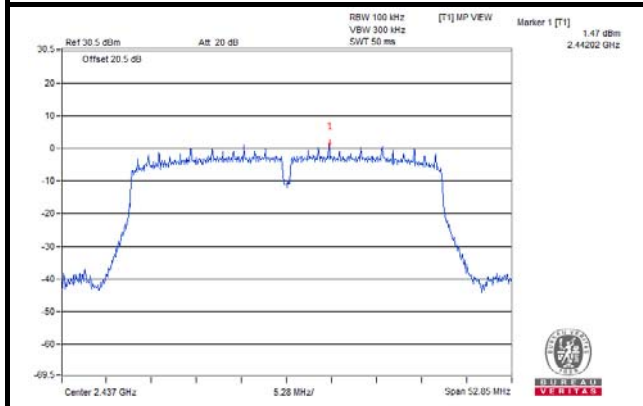

CH 6

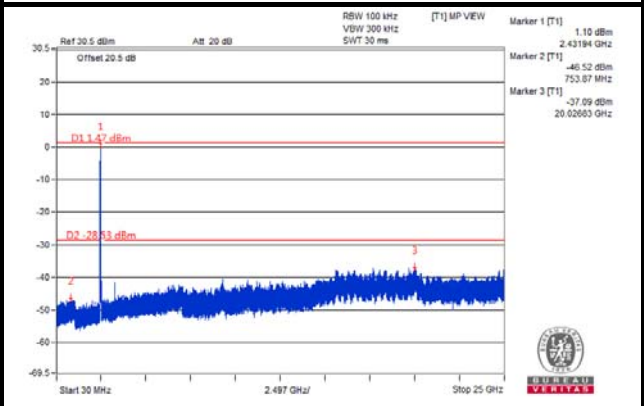

CH 9

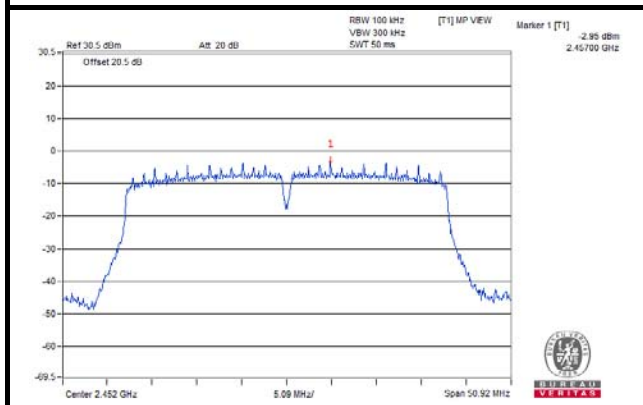

CH 9

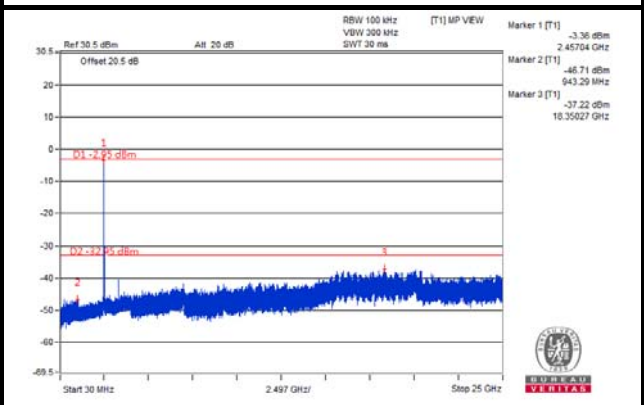

CH 3 Band edge

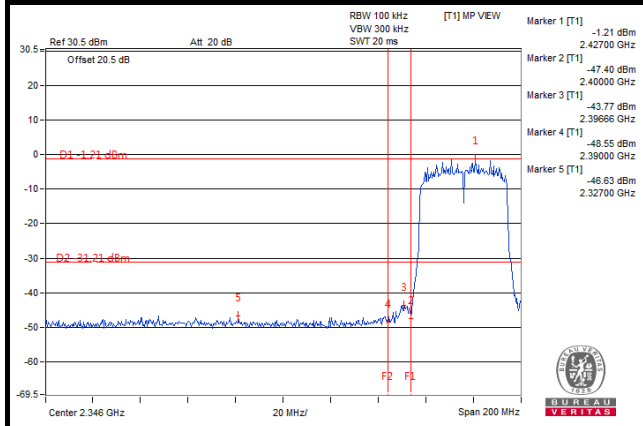

CH 9 Band edge

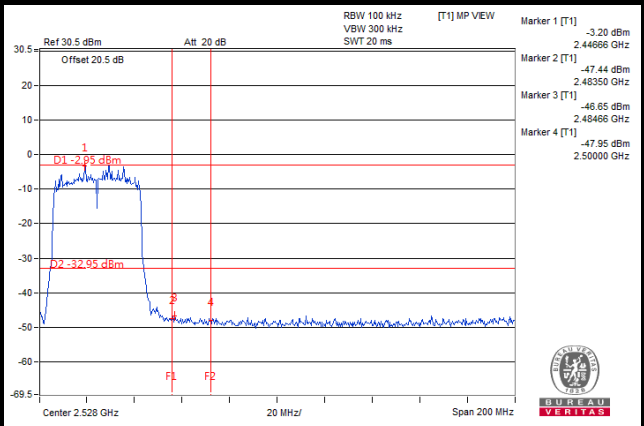

CDD Mode (Mode B)
802.11b: CHAIN 0

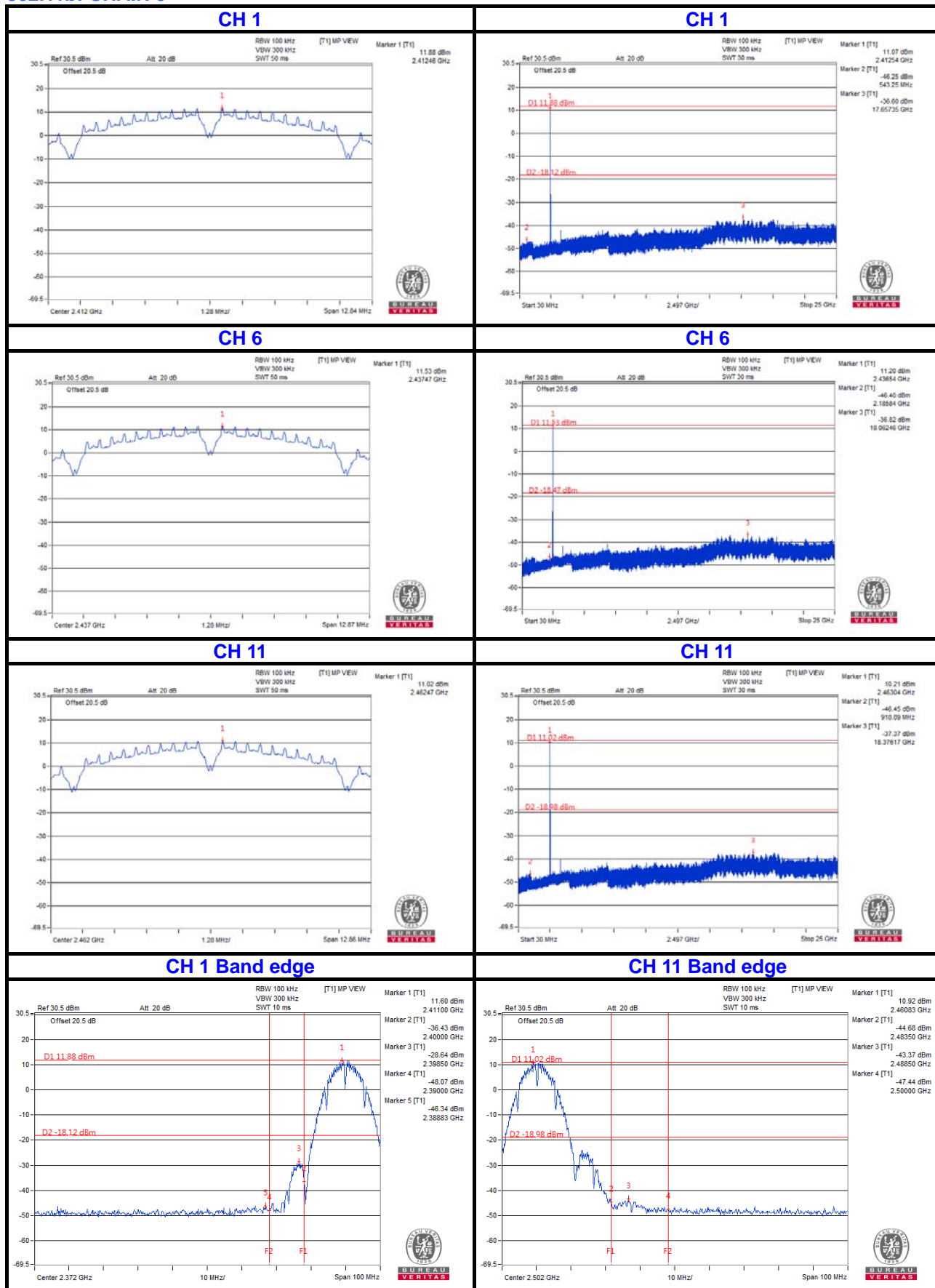

CHAIN 1

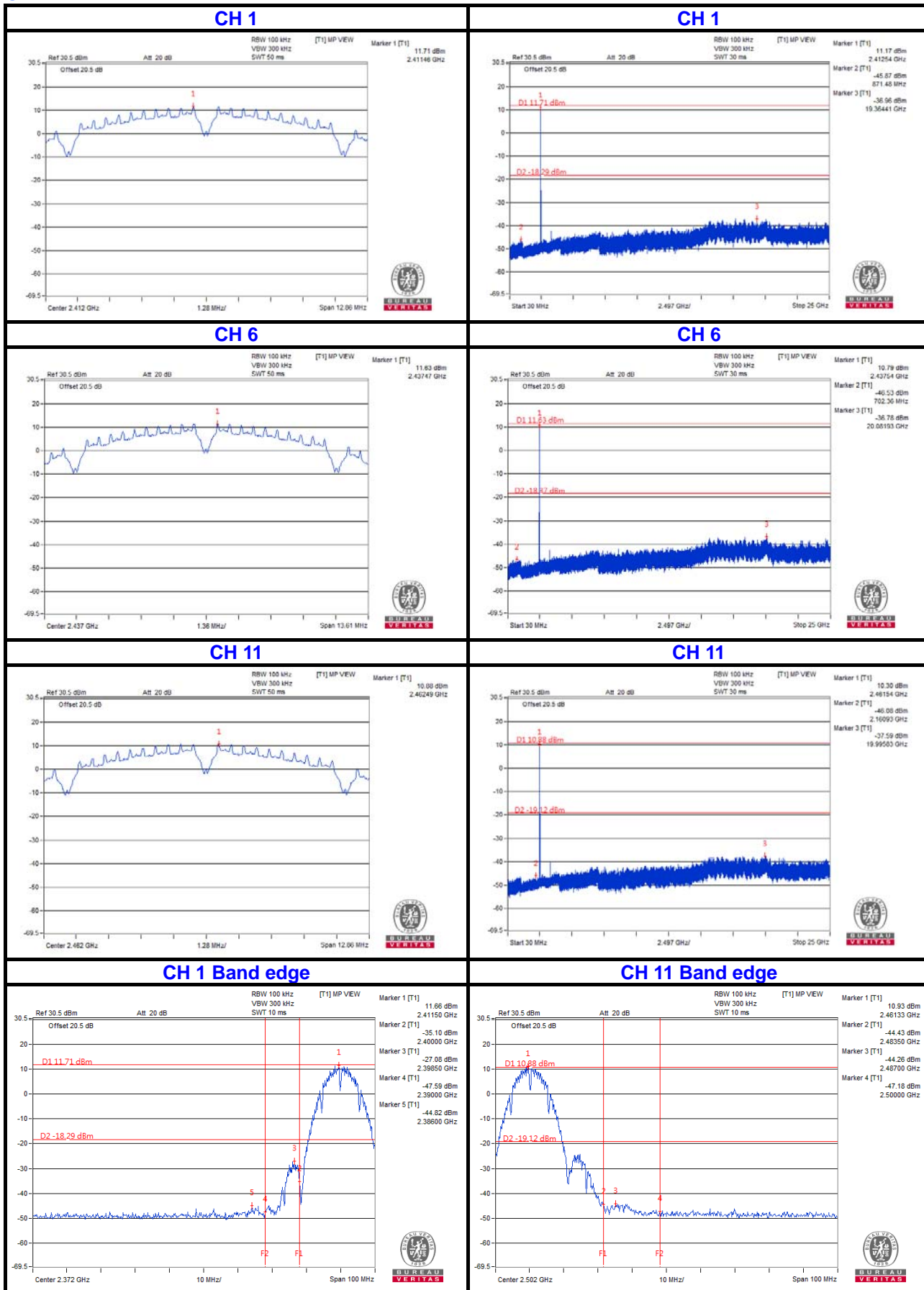

CHAIN 2

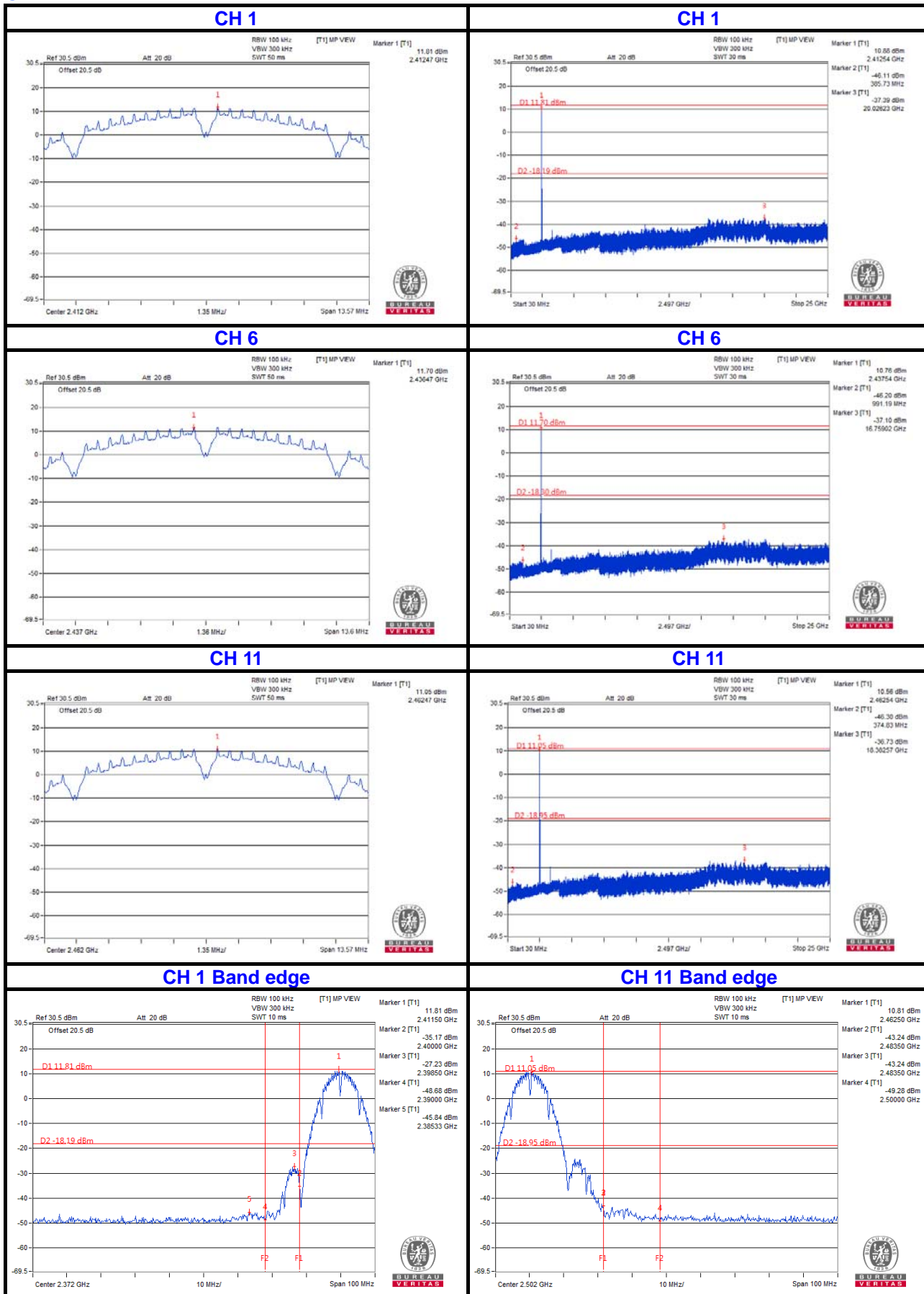

CHAIN 3

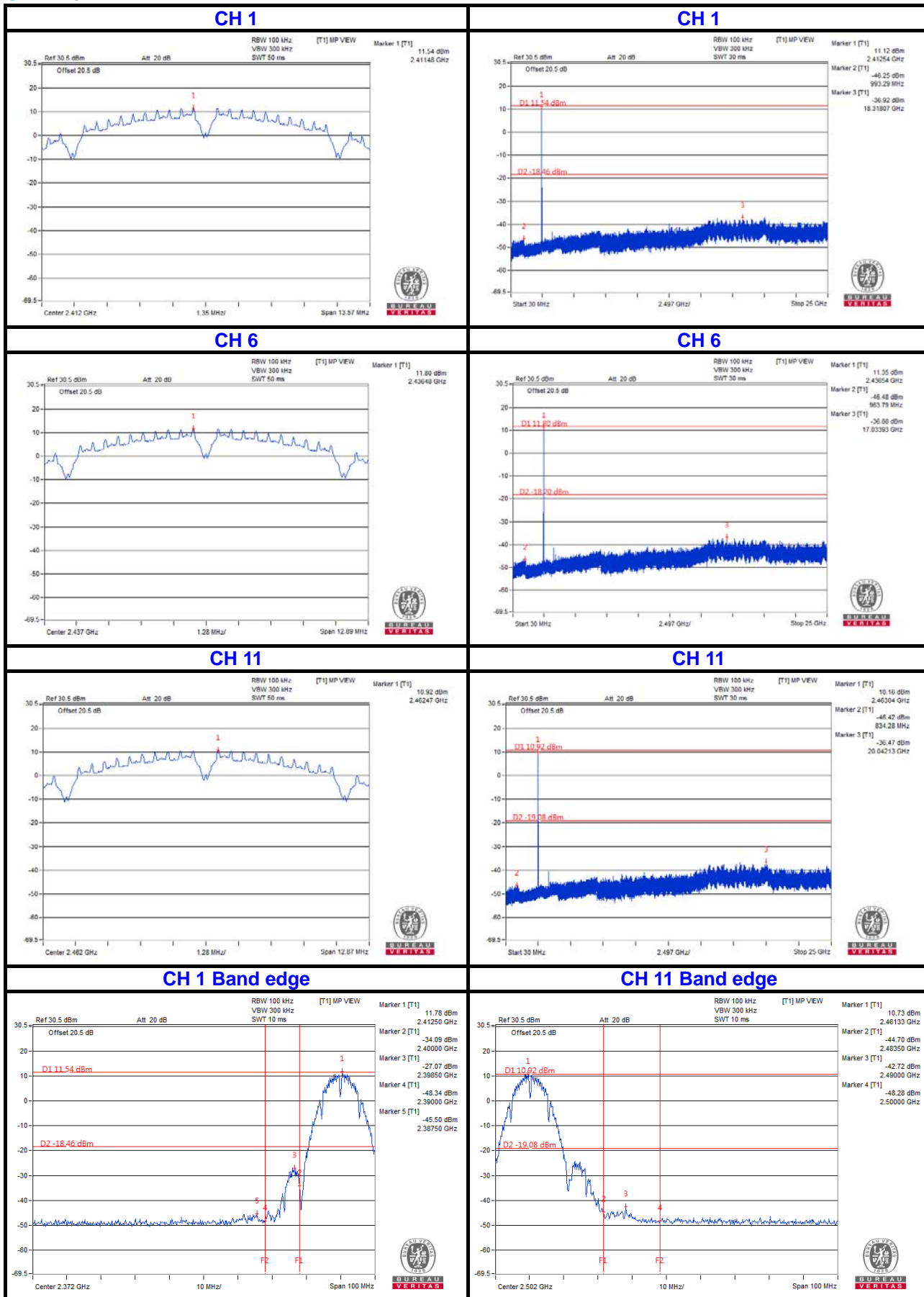

802.11g: CHAIN 0

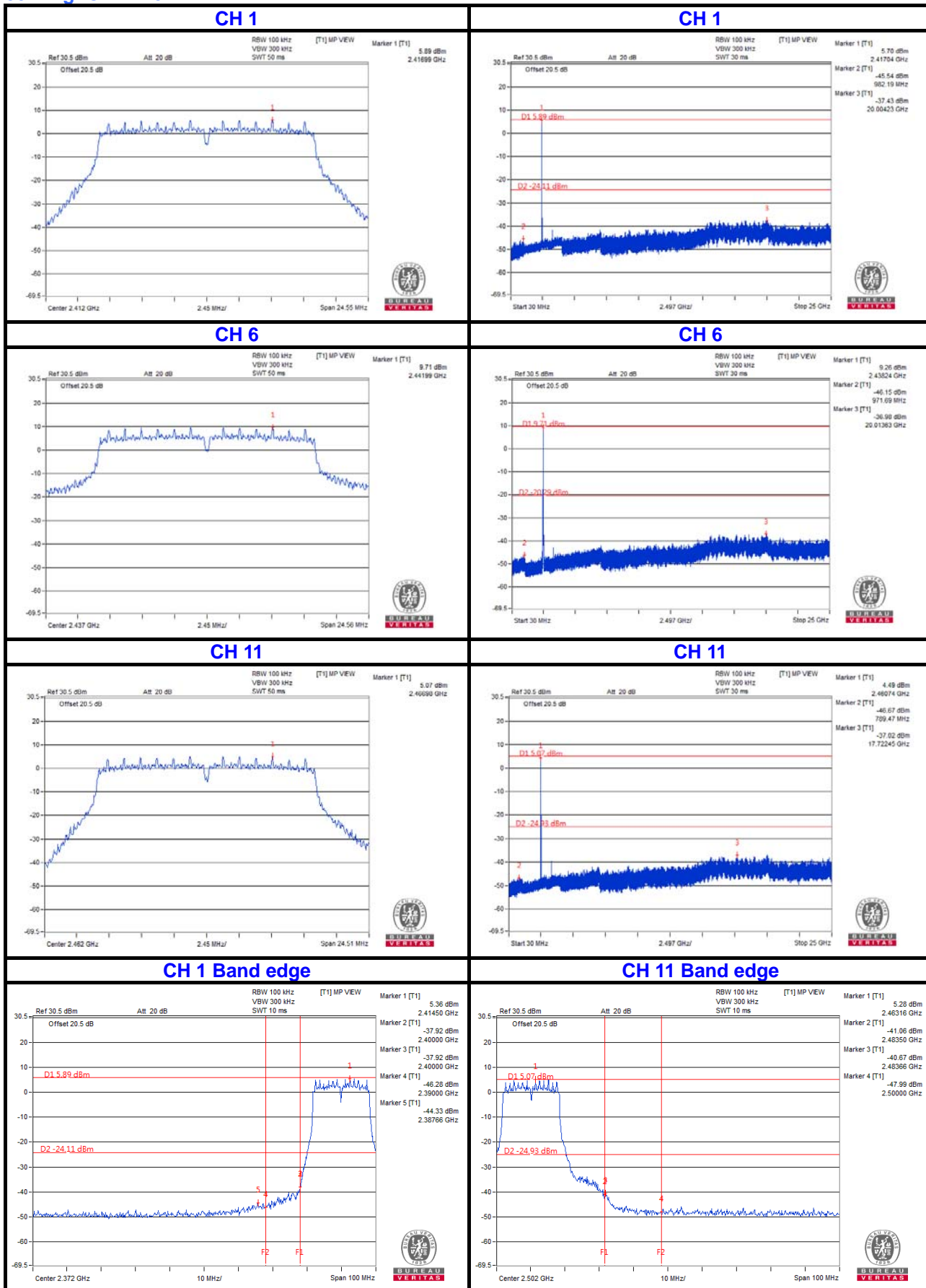

CHAIN 1

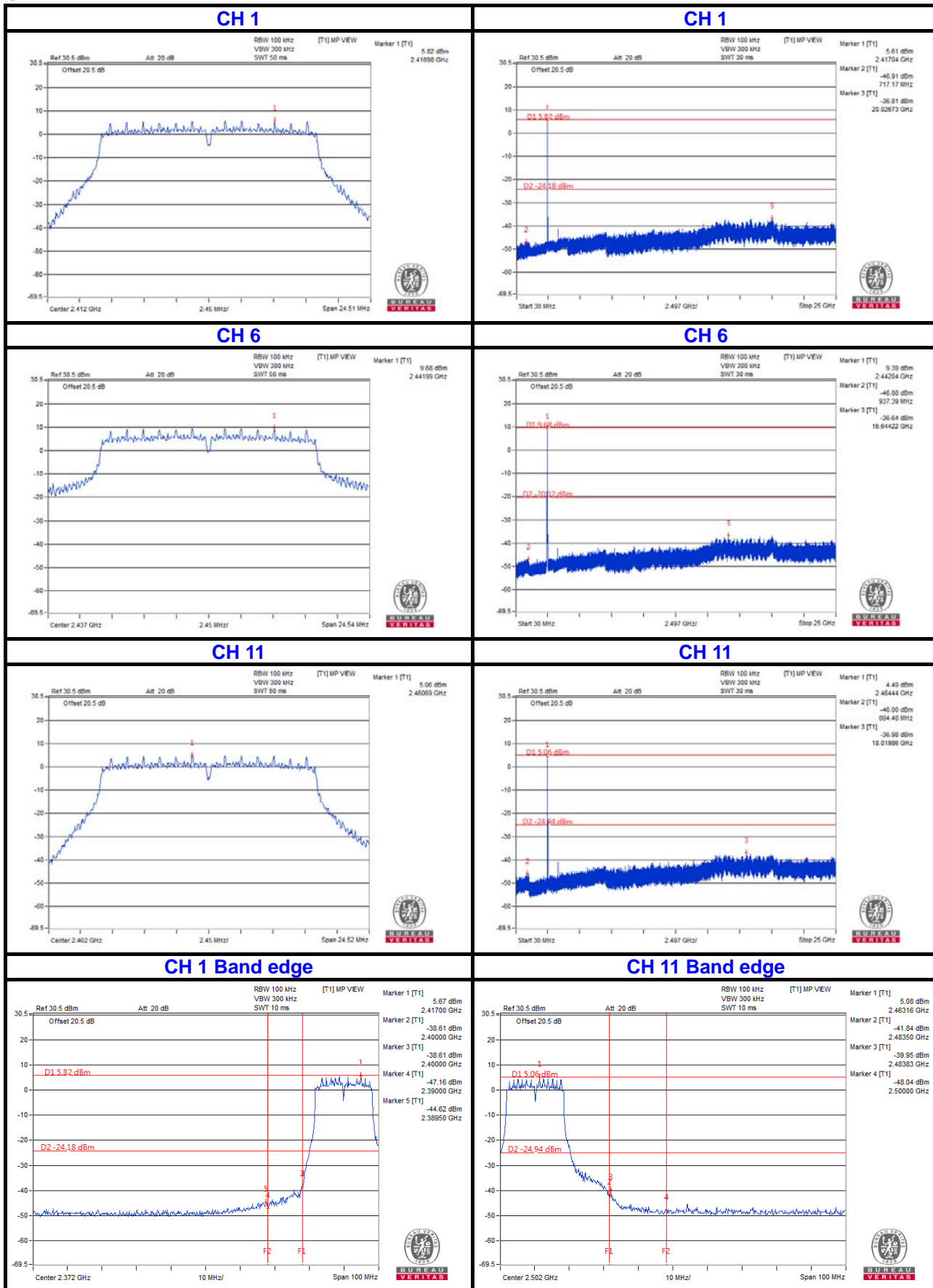

CHAIN 2

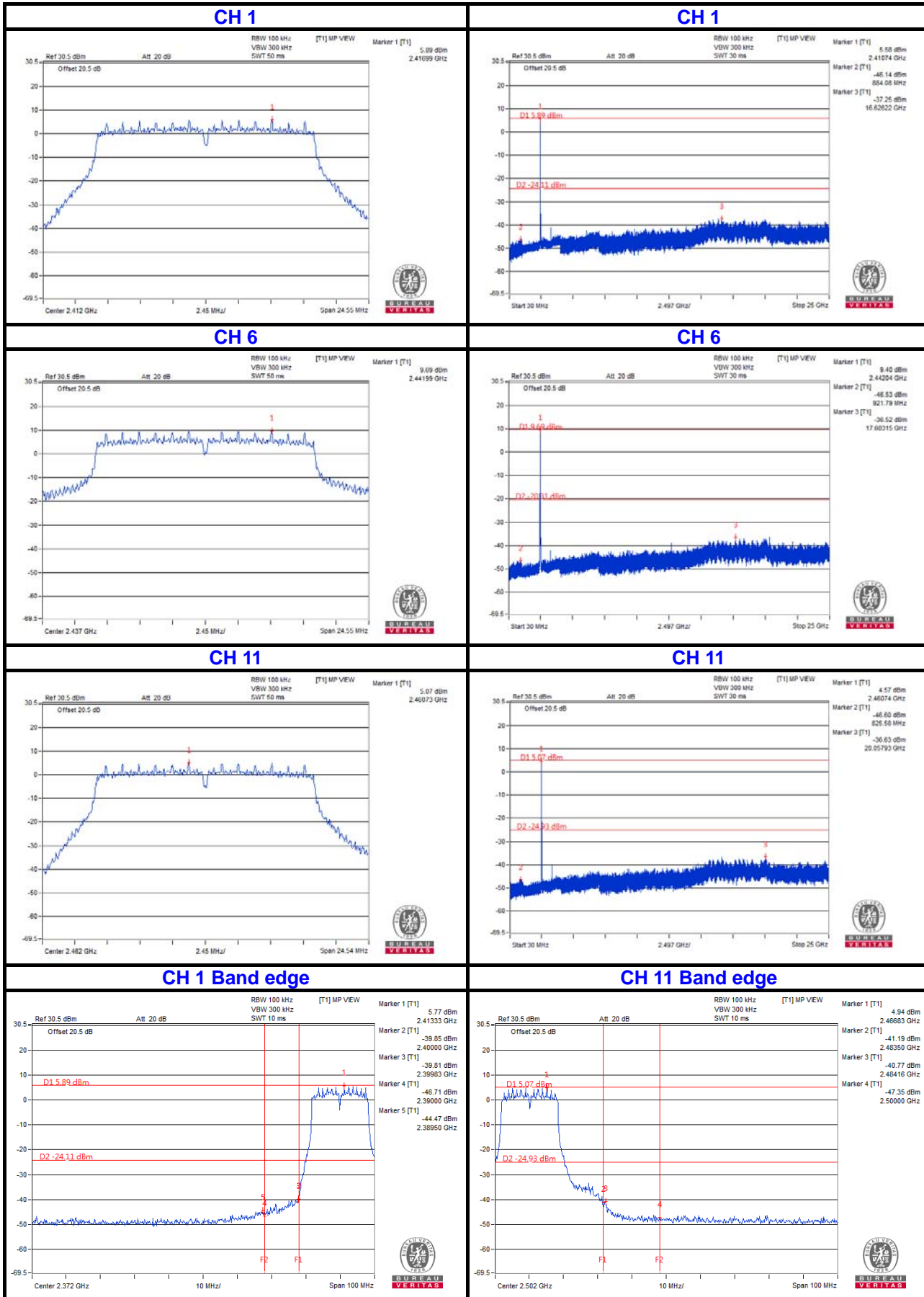

CHAIN 3

CH 1

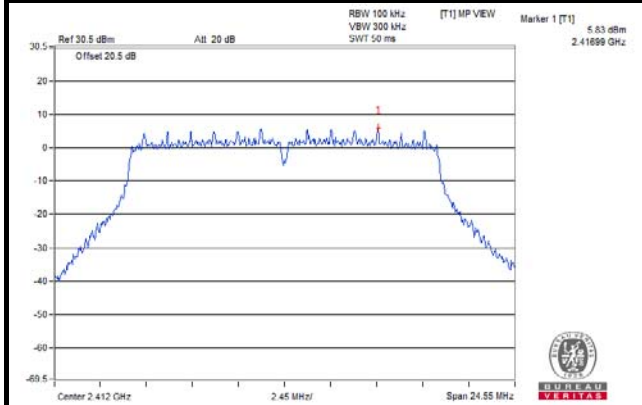

CH 1

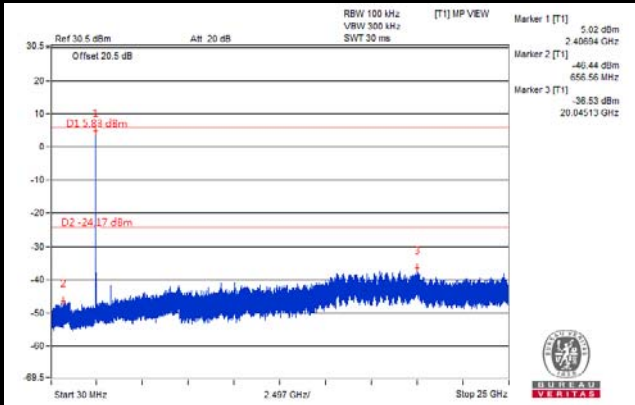

CH 6

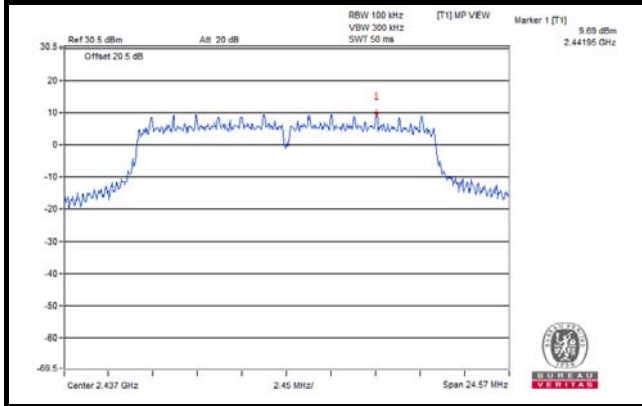

CH 6

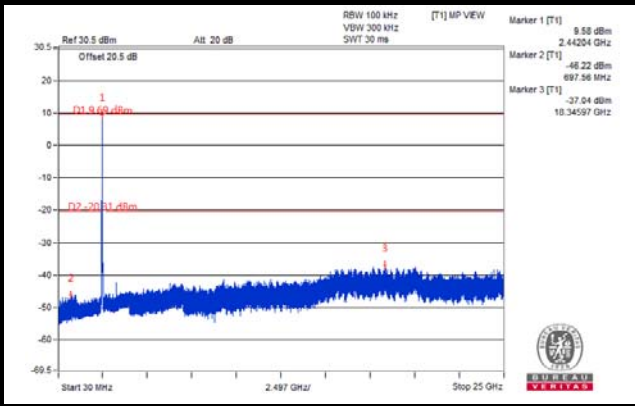

CH 11

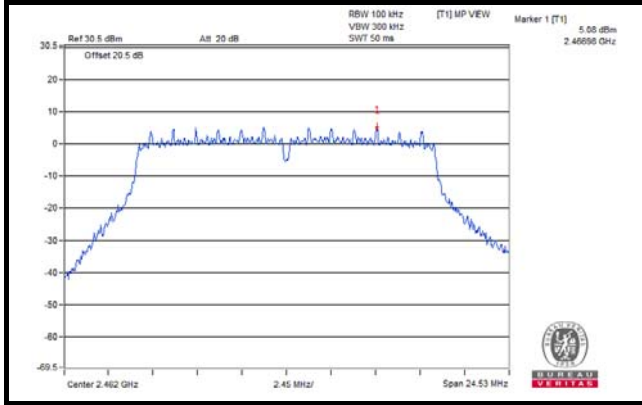

CH 11

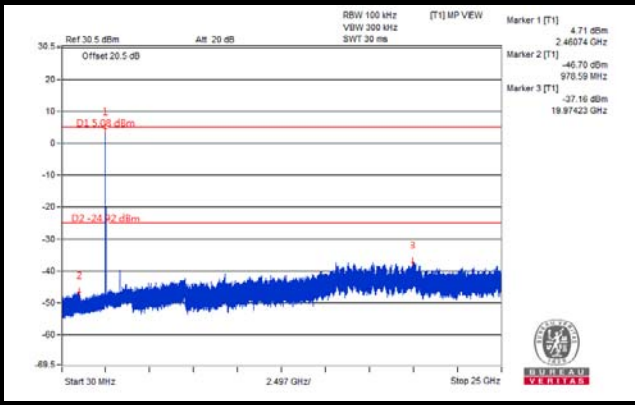

CH 1 Band edge

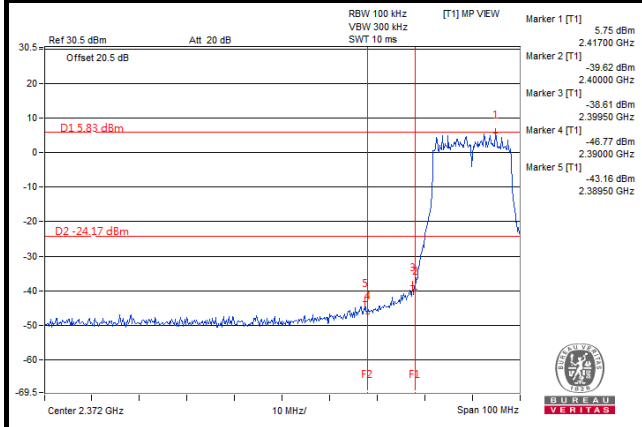

CH 11 Band edge

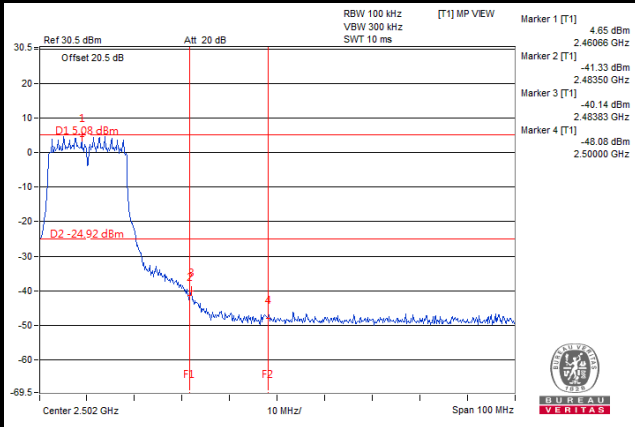

802.11n (20MHz) CHAIN 0

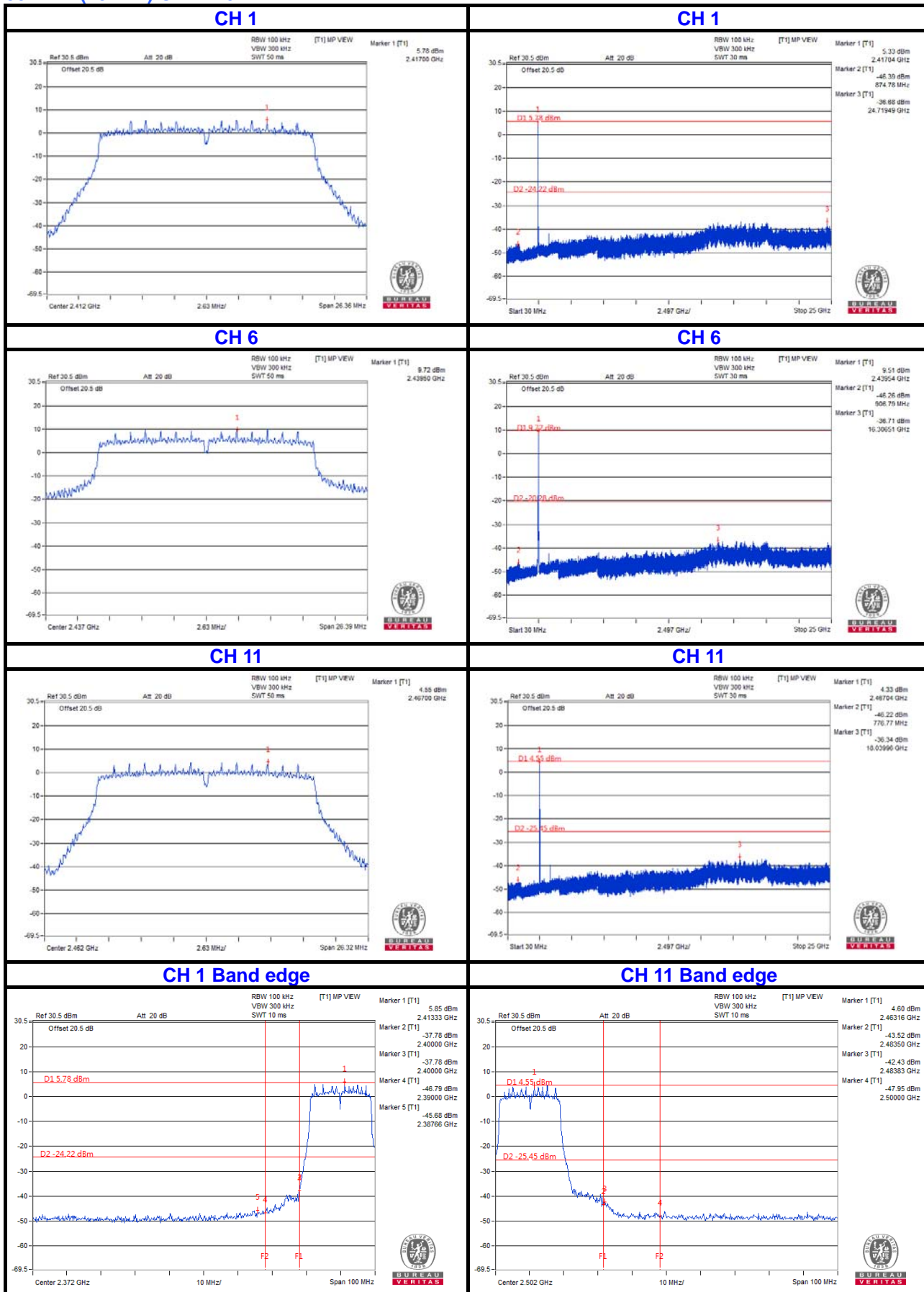

CHAIN 1

CH 1

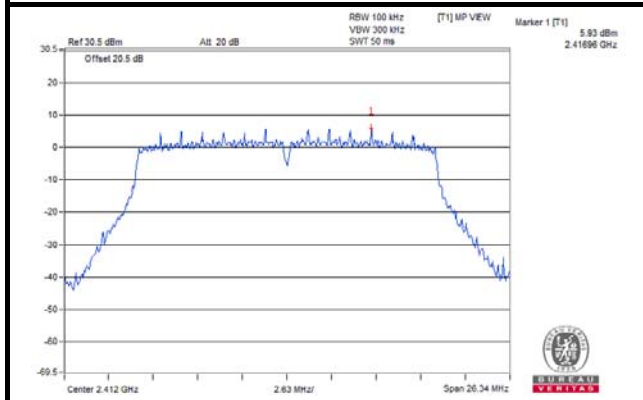

CH 1

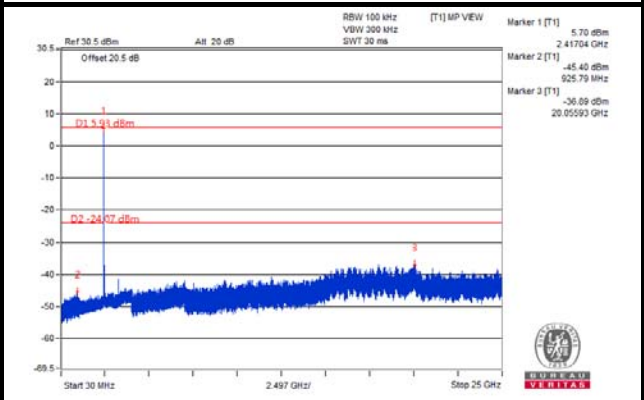

CH 6

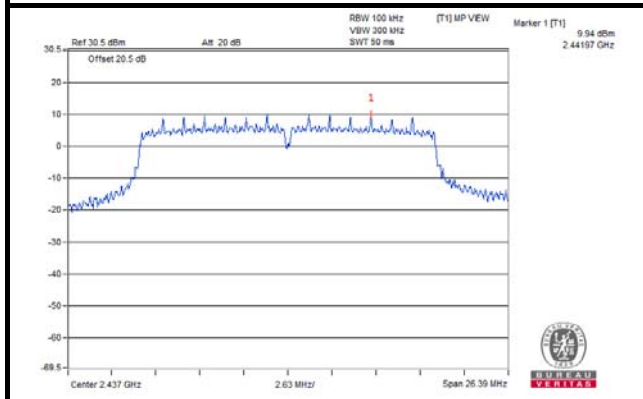

CH 6

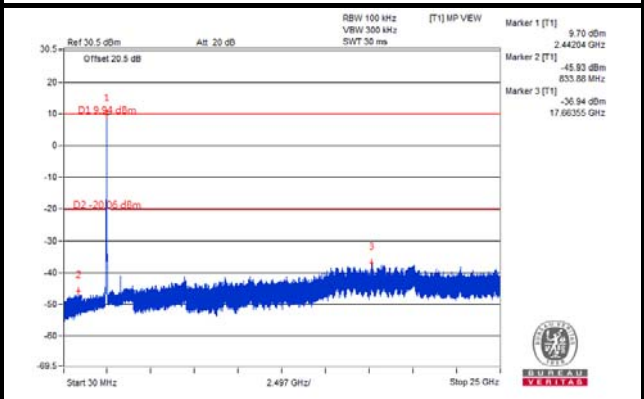

CH 11

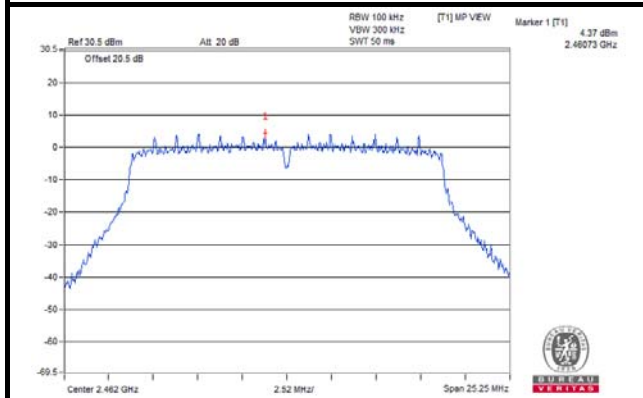

CH 11

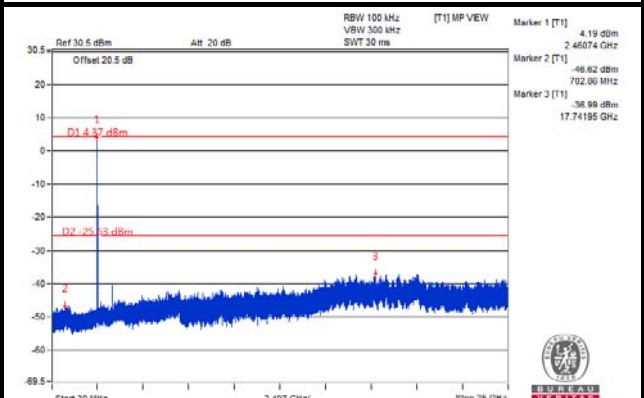

CH 1 Band edge

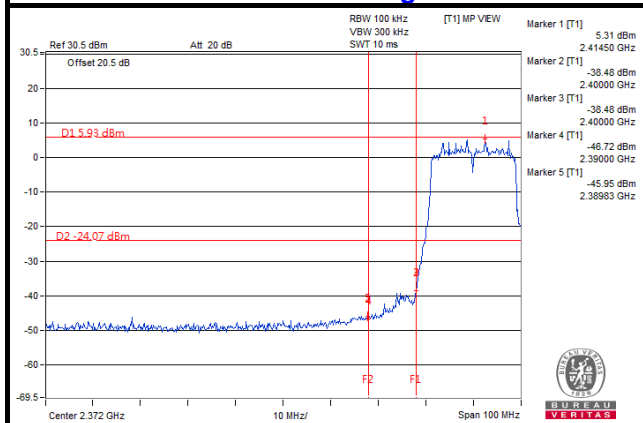

CH 11 Band edge

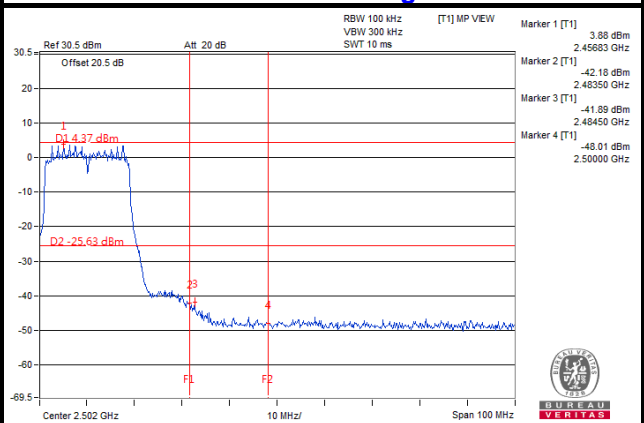

CHAIN 2

CH 1

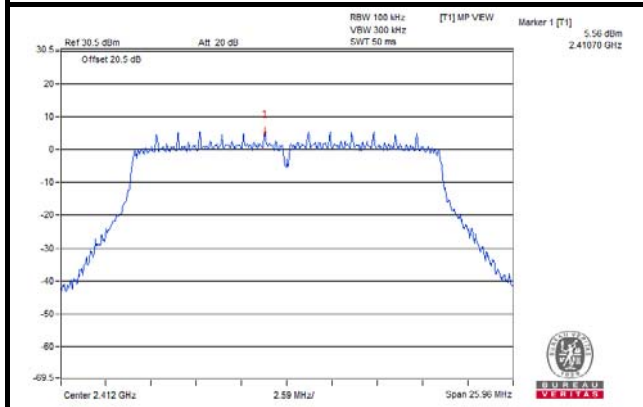

CH 1

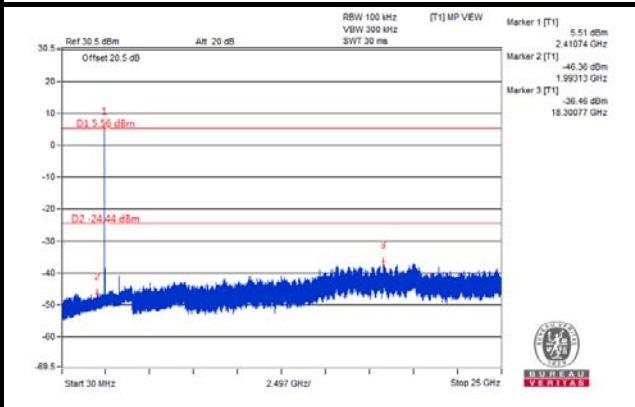

CH 6

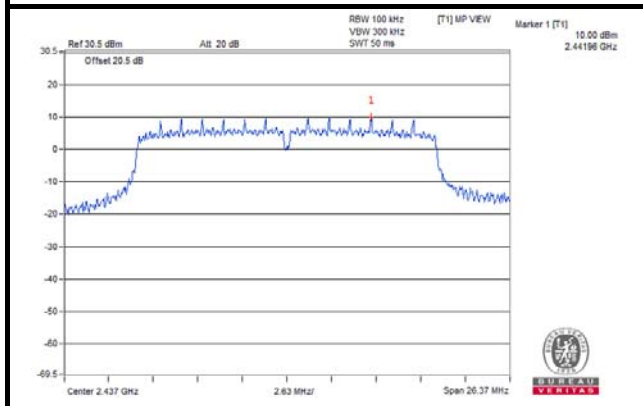

CH 6

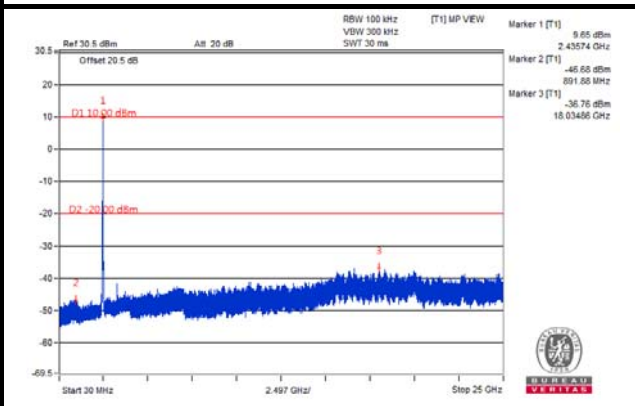

CH 11

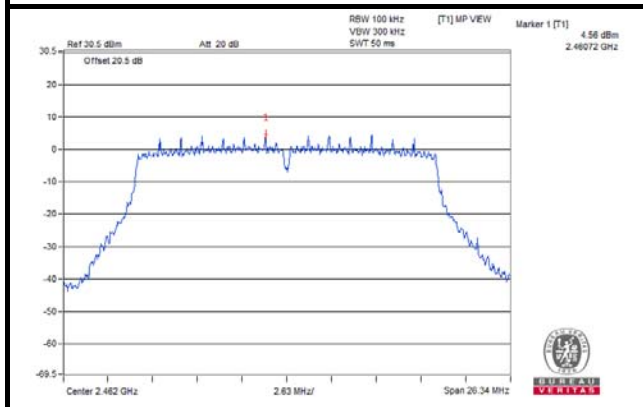

CH 11

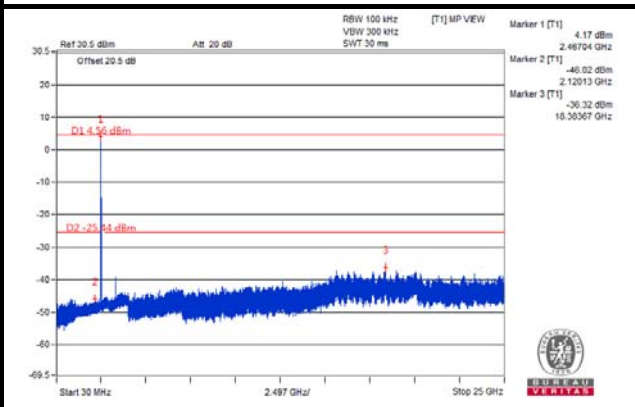

CH 1 Band edge

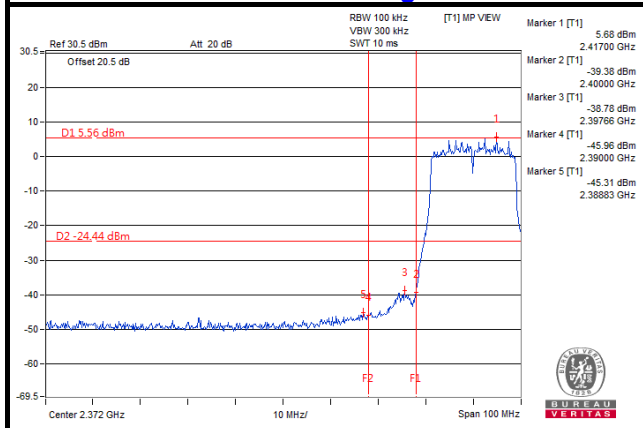

CH 11 Band edge

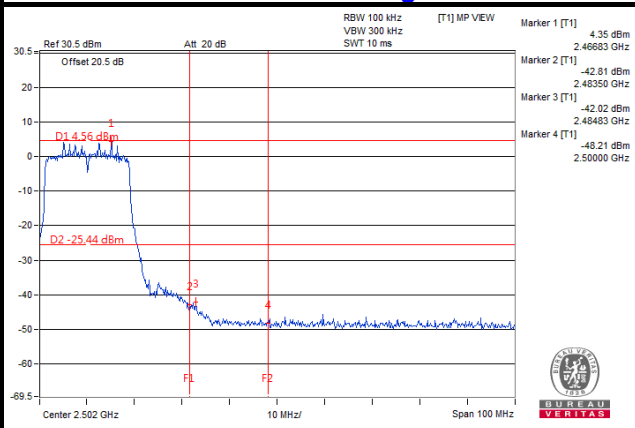

CHAIN 3

CH 1

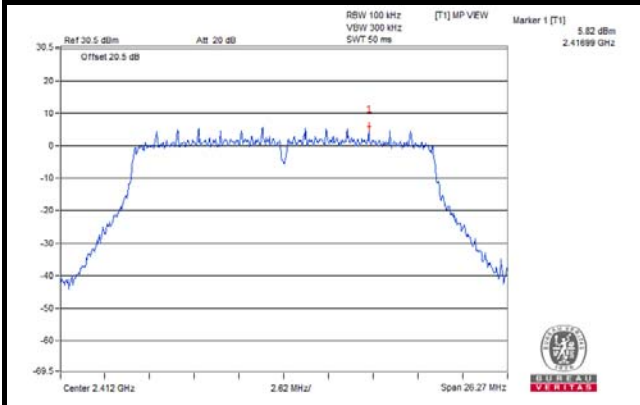

CH 1

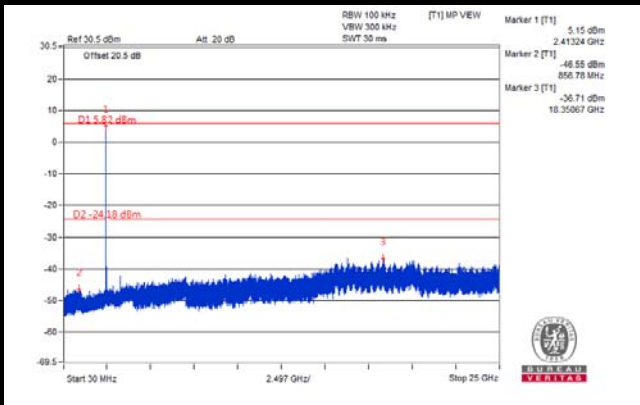

CH 6

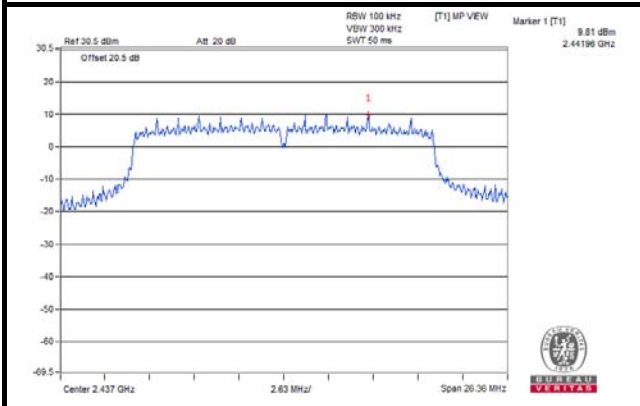

CH 6

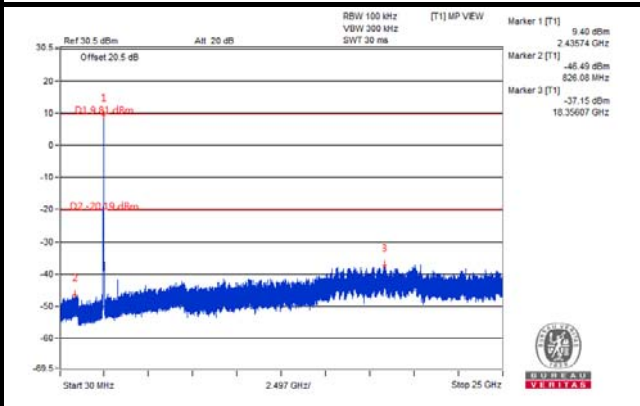

CH 11

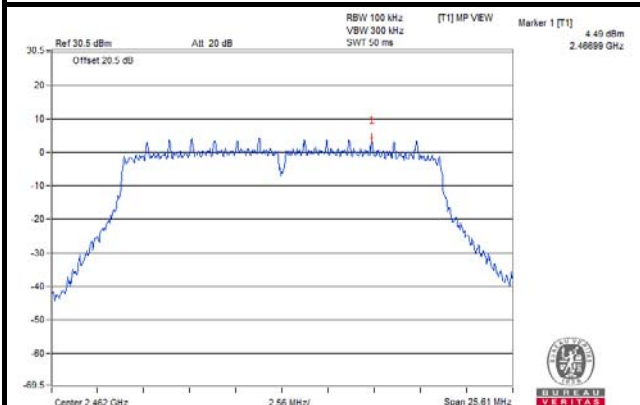

CH 11

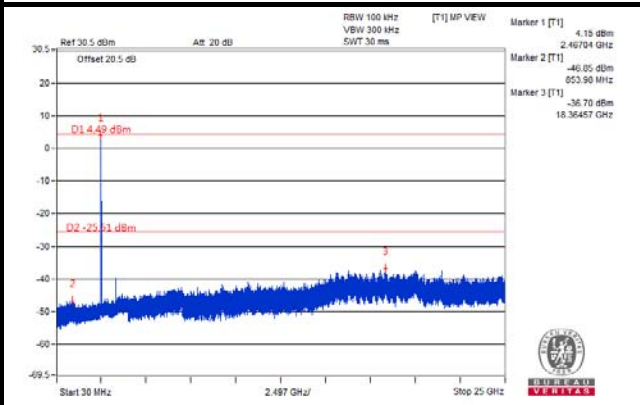

CH 1 Band edge

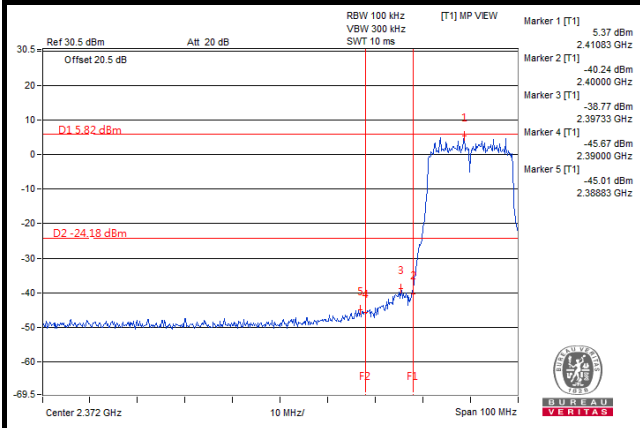

CH 11 Band edge

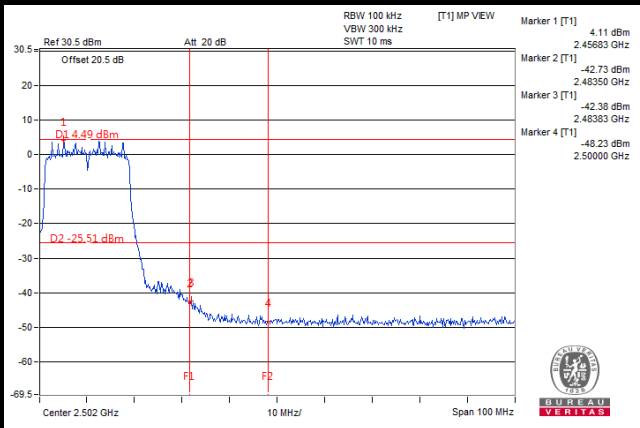

802.11n (40MHz): CHAIN 0

CH 3

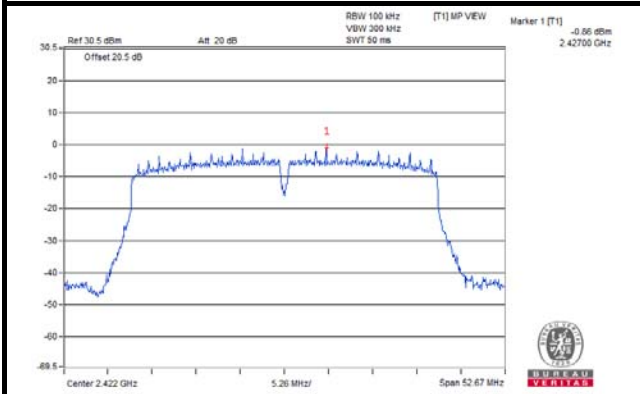

CH 3

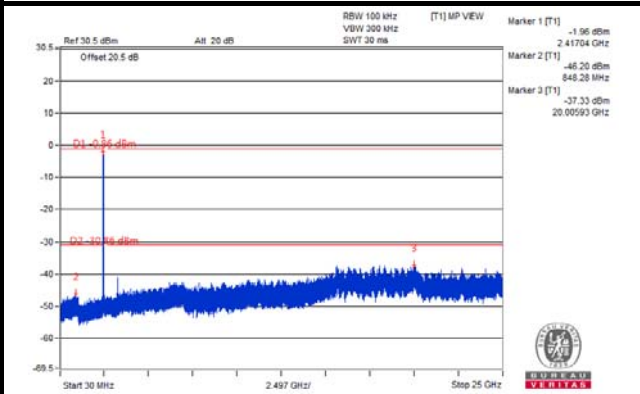

CH 6

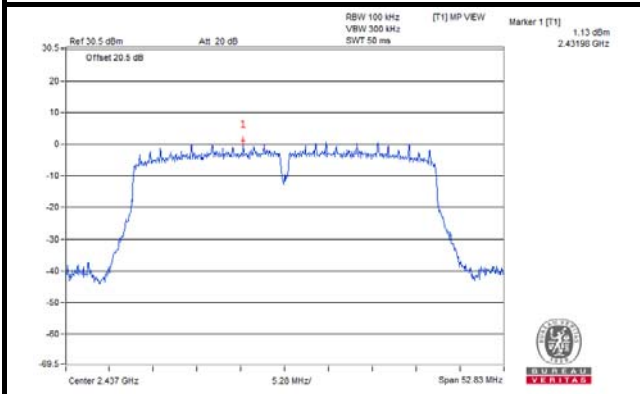

CH 6

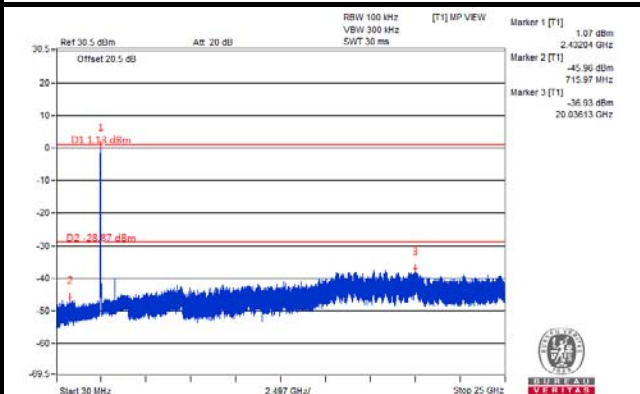

CH 9

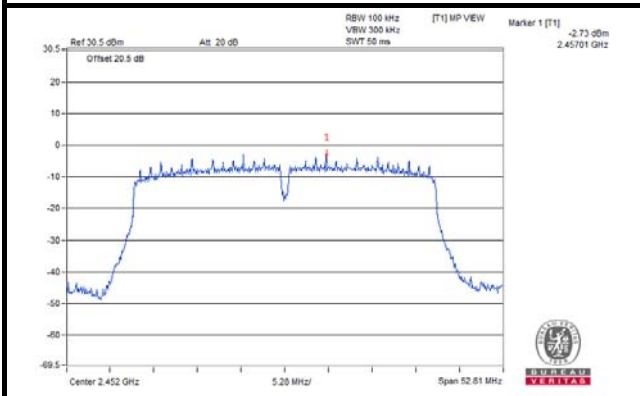

CH 9

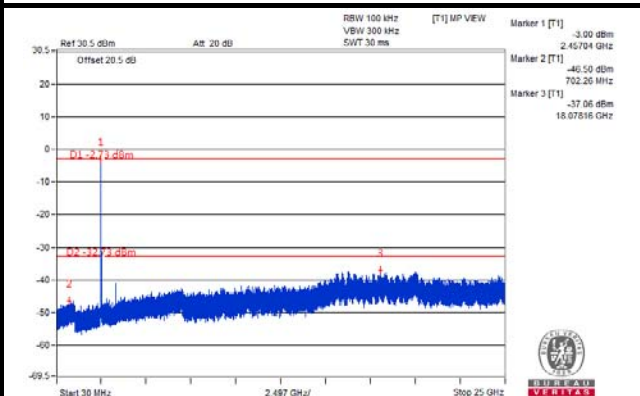

CH 3 Band edge

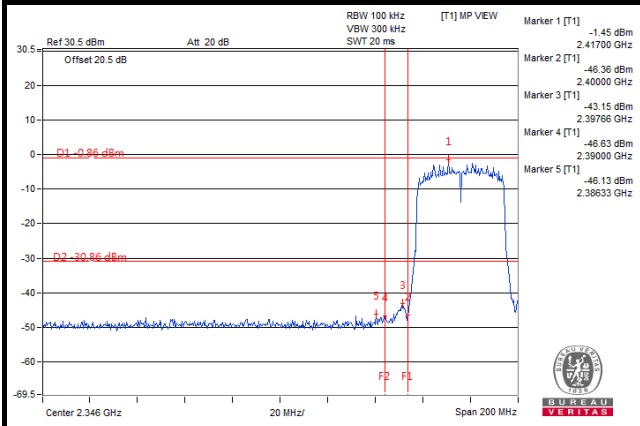

CH 9 Band edge

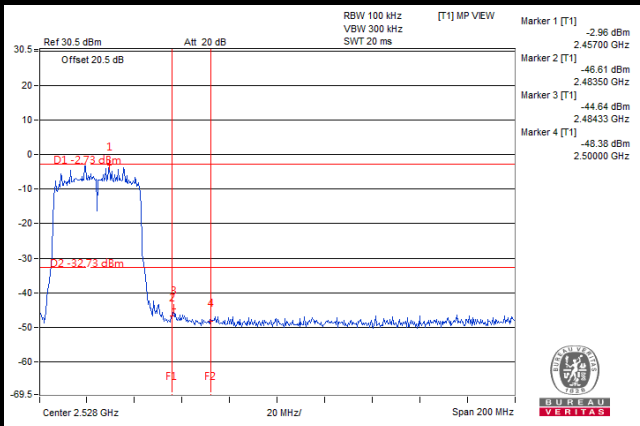

CHAIN 1

CH 3

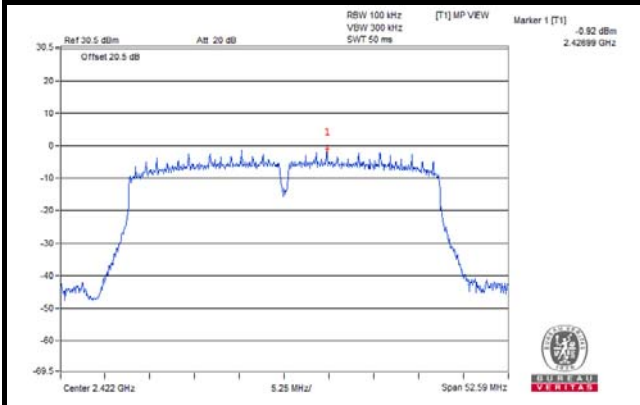

CH 3

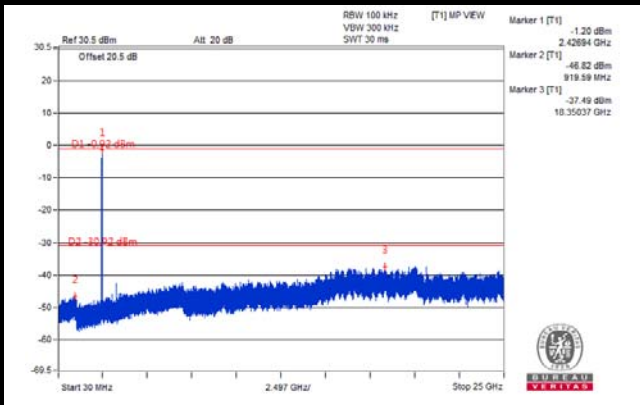

CH 6

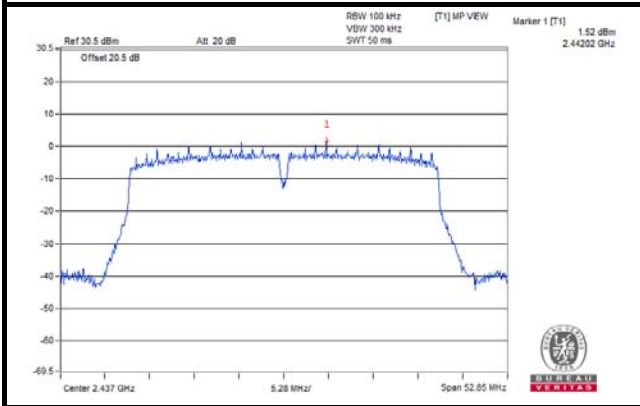

CH 6

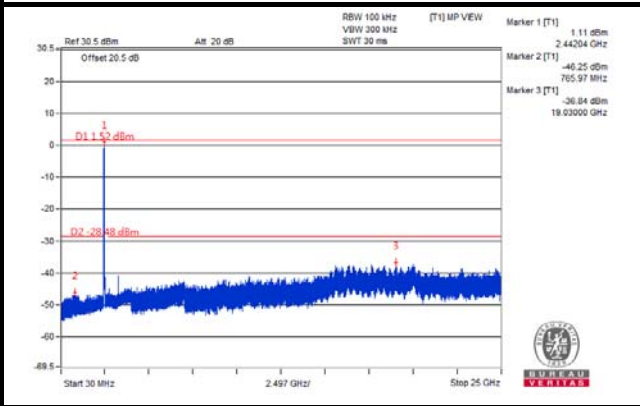

CH 9

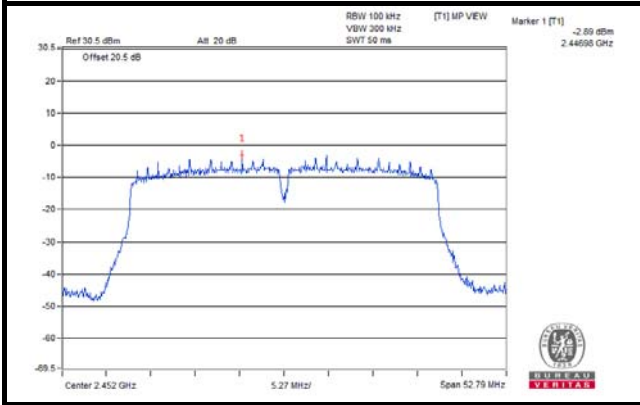

CH 9

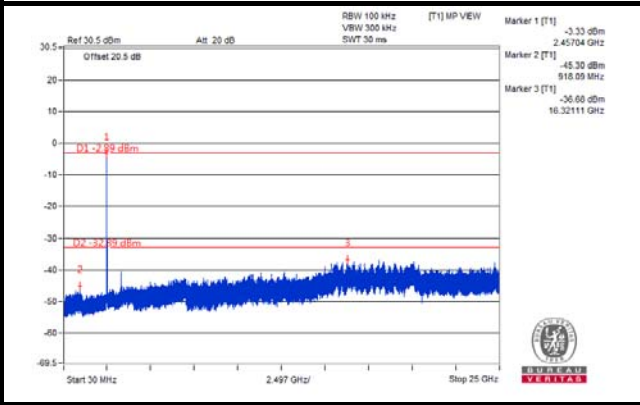

CH 3 Band edge

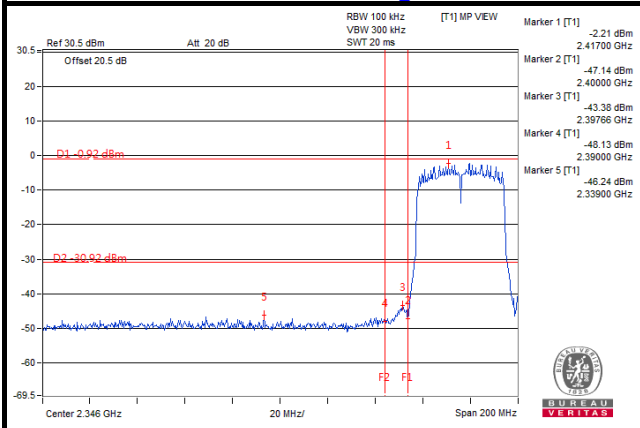

CH 9 Band edge

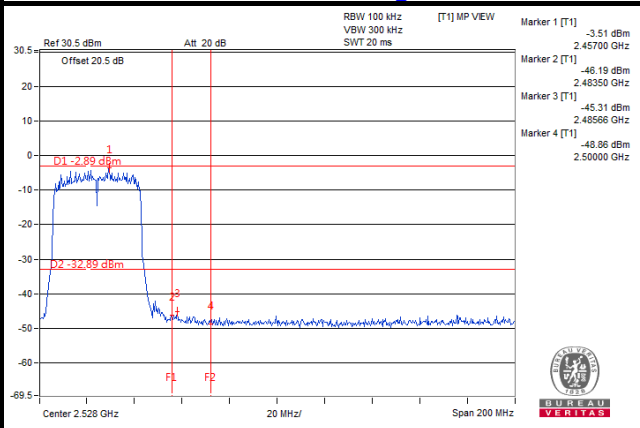

CHAIN 2

CH 3

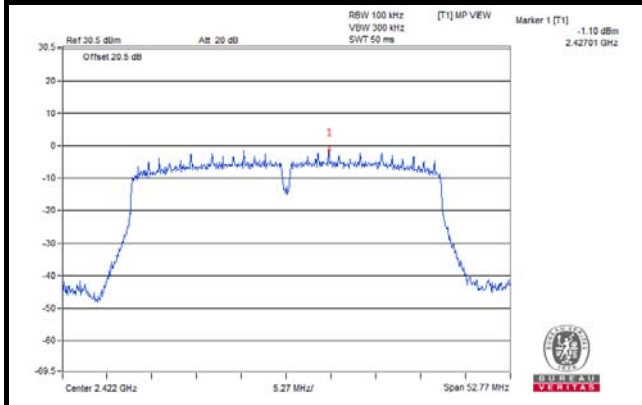

CH 3

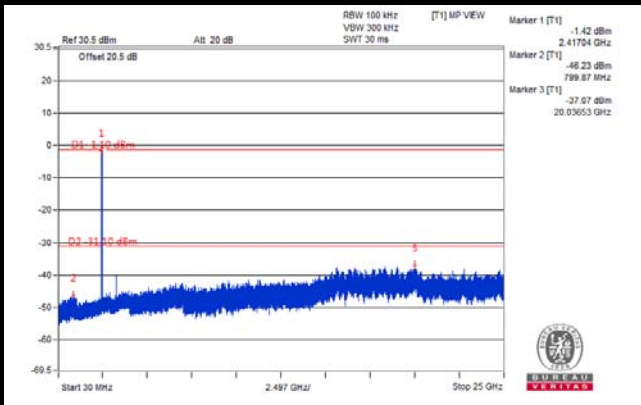

CH 6

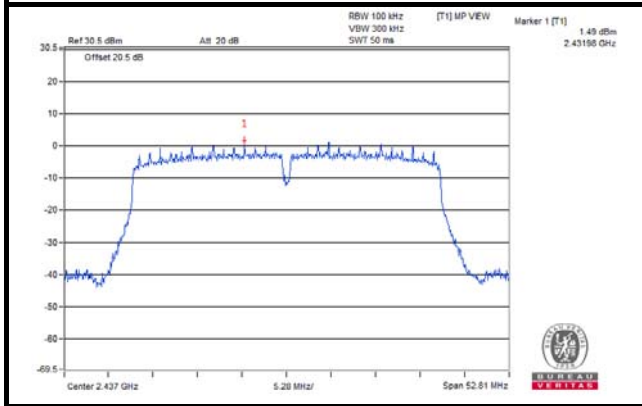

CH 6

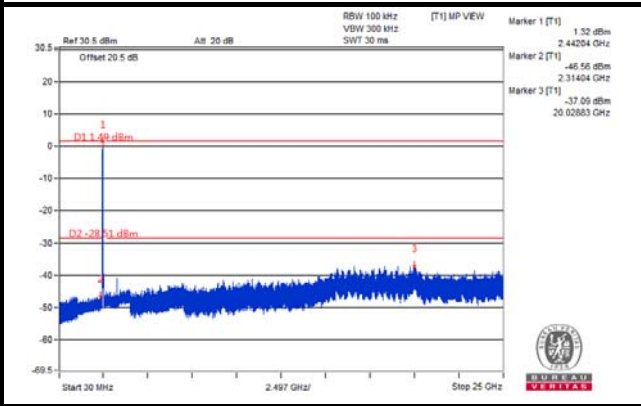

CH 9

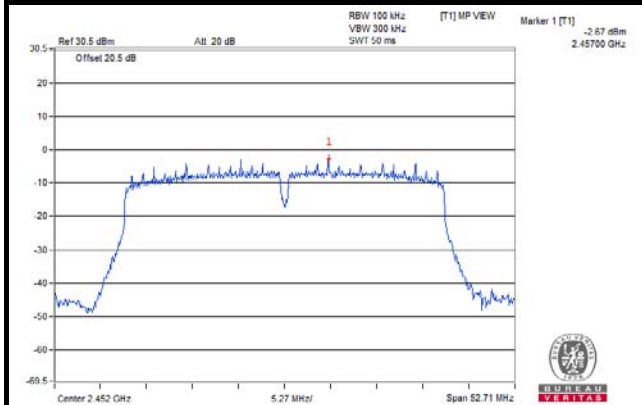

CH 9

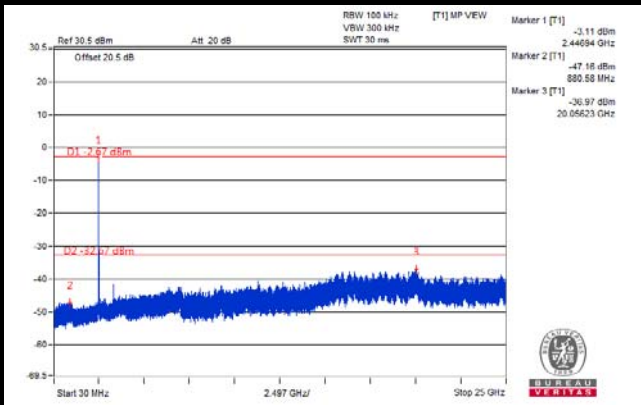

CH 3 Band edge

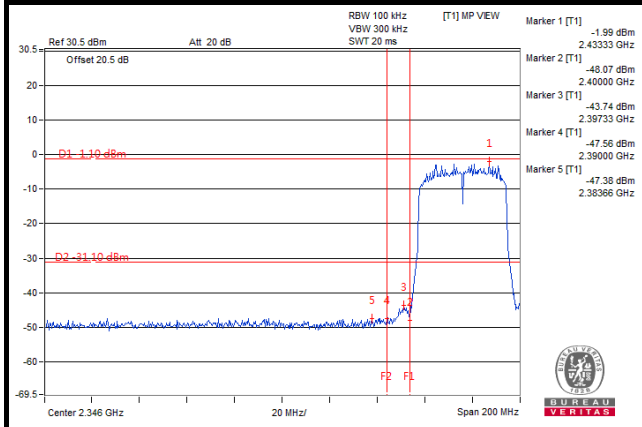

CH 9 Band edge

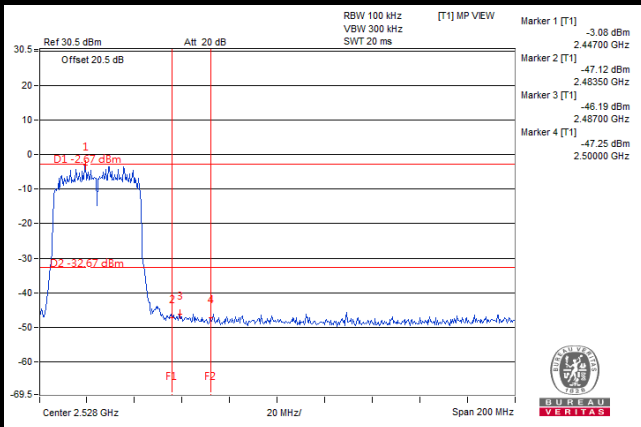

CHAIN 3

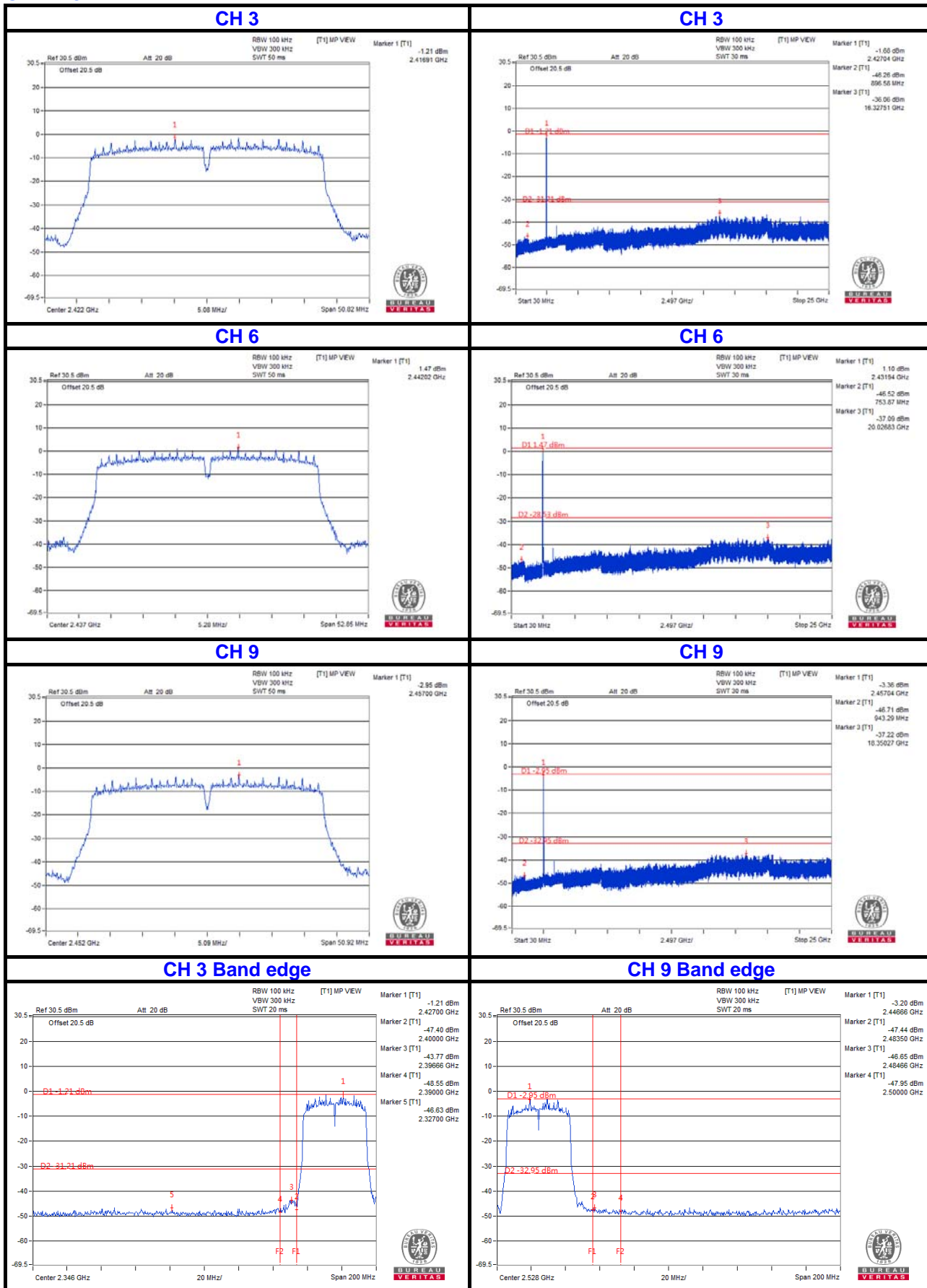

5 Pictures of Test Arrangements

Please refer to the attached file (Test Setup Photo).

Appendix – Information on the Testing Laboratories

We, Bureau Veritas Consumer Products Services (H.K.) Ltd., Taoyuan Branch, were founded in 1988 to provide our best service in EMC, Radio, Telecom and Safety consultation. Our laboratories are accredited and approved according to ISO/IEC 17025.

If you have any comments, please feel free to contact us at the following:

Linko EMC/RF Lab

Tel: 886-2-26052180

Fax: 886-2-26051924

Hsin Chu EMC/RF/Telecom Lab

Tel: 886-3-6668565

Fax: 886-3-6668323

Hwa Ya EMC/RF/Safety Lab

Tel: 886-3-3183232

Fax: 886-3-3270892

Email: service.adt@tw.bureauveritas.com

Web Site: www.bureauveritas-adt.com

The address and road map of all our labs can be found in our web site also.

--- END ---