

FCC Test Report

Report No.: RF170323D03A-1

FCC ID: 2ALJ3AP23X

Test Model: AP231, AP231e

Received Date: Mar. 23, 2017

Test Date: Jul. 12 ~ Sep. 19, 2017

Issued Date: Oct. 2, 2017

Applicant: HAN Networks Co., Ltd.

Address: 5/F, Building 37, No.8 Dongbeiwang West Road, HaiDian District, Beijing, China

Issued By: Bureau Veritas Consumer Products Services (H.K.) Ltd., Taoyuan Branch

Lab Address: No. 47-2, 14th Ling, Chia Pau Vil., Lin Kou Dist., New Taipei City, Taiwan (R.O.C.)

**FCC Registration /
Designation Number:** 198487 / TW2021



This report is for your exclusive use. Any copying or replication of this report to or for any other person or entity, or use of our name or trademark, is permitted only with our prior written permission. This report sets forth our findings solely with respect to the test samples identified herein. The results set forth in this report are not indicative or representative of the quality or characteristics of the lot from which a test sample was taken or any similar or identical product unless specifically and expressly noted. Our report includes all of the tests requested by you and the results thereof based upon the information that you provided to us. You have 60 days from date of issuance of this report to notify us of any material error or omission caused by our negligence, provided, however, that such notice shall be in writing and shall specifically address the issue you wish to raise. A failure to raise such issue within the prescribed time shall constitute your unqualified acceptance of the completeness of this report, the tests conducted and the correctness of the report contents. Unless specific mention, the uncertainty of measurement has been explicitly taken into account to declare the compliance or non-compliance to the specification. The report must not be used by the client to claim product certification, approval, or endorsement by TAF or any government agencies.

Table of Contents

Release Control Record	4
1 Certificate of Conformity	5
2 Summary of Test Results	6
2.1 Measurement Uncertainty	6
2.2 Modification Record	6
3 General Information	7
3.1 General Description of EUT	7
3.2 Description of Test Modes	9
3.2.1 Test Mode Applicability and Tested Channel Detail	10
3.3 Duty Cycle of Test Signal	12
3.4 Description of Support Units	13
3.4.1 Configuration of System under Test	13
3.5 General Description of Applied Standard	14
4 Test Types and Results	15
4.1 Radiated Emission and Bandedge Measurement.....	15
4.1.1 Limits of Radiated Emission and Bandedge Measurement	15
4.1.2 Test Instruments	16
4.1.3 Test Procedure	17
4.1.4 Deviation from Test Standard	18
4.1.5 Test Setup.....	18
4.1.6 EUT Operating Condition	19
4.1.7 Test Results	20
4.2 Conducted Emission Measurement	96
4.2.1 Limits of Conducted Emission Measurement	96
4.2.2 Test Instruments	96
4.2.3 Test Procedure	97
4.2.4 Deviation from Test Standard	97
4.2.5 Test Setup.....	97
4.2.6 EUT Operating Condition	97
4.2.7 Test Results	98
4.3 Transmit Power Measurement	100
4.3.1 Limits of Transmit Power Measurement	100
4.3.2 Test Setup.....	101
4.3.3 Test Instruments	101
4.3.4 Test Procedure	102
4.3.5 Deviation from Test Standard	102
4.3.6 EUT Operating Condition	102
4.3.7 Test Result.....	103
4.4 Occupied Bandwidth Measurement	119
4.4.1 Test Setup.....	119
4.4.2 Test Instruments	119
4.4.3 Test Procedure	119
4.4.4 Test Results	120
4.5 Peak Power Spectral Density Measurement.....	124
4.5.1 Limits of Peak Power Spectral Density Measurement	124
4.5.2 Test Setup.....	124
4.5.3 Test Instruments	124
4.5.4 Test Procedure	124
4.5.5 Deviation from Test Standard	124
4.5.6 EUT Operating Condition	124
4.5.7 Test Results	125

4.6	Frequency Stability Measurement.....	131
4.6.1	Limits of Frequency Stability Measurement.....	131
4.6.2	Test Setup.....	131
4.6.3	Test Instruments	131
4.6.4	Test Procedure	131
4.6.5	Deviation from Test Standard	131
4.6.6	EUT Operating Condition	131
4.6.7	Test Results	132
5	Pictures of Test Arrangements.....	133
	Appendix – Information on the Testing Laboratories	134

Release Control Record

Issue No.	Description	Date Issued
RF170323D03A-1	Original release.	Oct. 2, 2017

1 Certificate of Conformity

Product: HAN Access Point

Brand: HAN

Test Model: AP231, AP231e

Sample Status: Engineering sample

Applicant: HAN Networks Co., Ltd.

Test Date: Jul. 12 ~ Sep. 19, 2017

Standard: 47 CFR FCC Part 15, Subpart E (Section 15.407)
ANSI C63.10: 2013

The above equipment has been tested by **Bureau Veritas Consumer Products Services (H.K.) Ltd., Taoyuan Branch**, and found compliance with the requirement of the above standards. The test record, data evaluation & Equipment Under Test (EUT) configurations represented herein are true and accurate accounts of the measurements of the sample's EMC characteristics under the conditions specified in this report.

Prepared by : Annie Chang , **Date:** Oct. 2, 2017
Annie Chang / Senior Specialist

Approved by : Rex Lai , **Date:** Oct. 2, 2017
Rex Lai / Assistant Manager

2 Summary of Test Results

47 CFR FCC Part 15, Subpart E (Section 15.407)			
FCC Clause	Test Item	Result	Remarks
15.407(b)(6)	AC Power Conducted Emissions	Pass	Meet the requirement of limit. Minimum passing margin is -2.31dB at 0.35703MHz.
15.407(b) (1/2/3/4(i/ii)/6)	Radiated Emissions & Band Edge Measurement	Pass	Meet the requirement of limit. Minimum passing margin is -1.05dB at 5470.00MHz.
15.407(a)(1/2/3)	Max Average Transmit Power	Pass	Meet the requirement of limit.
---	Occupied Bandwidth Measurement	-	Reference only.
15.407(a)(1/2/3)	Peak Power Spectral Density	Pass	Meet the requirement of limit.
15.407(g)	Frequency Stability	Pass	Meet the requirement of limit.
15.203	Antenna Requirement	Pass	Antenna connector is R-SMA or I-PEX not a standard connector.

2.1 Measurement Uncertainty

Where relevant, the following measurement uncertainty levels have been estimated for tests performed on the EUT as specified in CISPR 16-4-2:

Measurement	Frequency	Expanded Uncertainty (k=2) (\pm)
Conducted Emissions at mains ports	150kHz ~ 30MHz	2.77 dB
Radiated Emissions up to 1 GHz	9kHz ~ 30MHz	2.38 dB
	30MHz ~ 1000MHz	5.54 dB
Radiated Emissions above 1 GHz	1GHz ~ 6GHz	4.77 dB
	6GHz ~ 18GHz	5.48 dB

2.2 Modification Record

There were no modifications required for compliance.

3 General Information

3.1 General Description of EUT

Product	HAN Access Point
Brand	HAN
Test Model	AP231, AP231e
Model Difference	Refer to note as below
Status of EUT	Engineering sample
Power Supply Rating	48Vdc from Adapter or 55Vdc from PoE
Modulation Type	64QAM, 16QAM, QPSK, BPSK 256QAM for OFDM in 11ac mode only.
Modulation Technology	OFDM
Transfer Rate	802.11a: 54/48/36/24/18/12/9/6Mbps 802.11n: up to 800Mbps 802.11ac: up to 1733Mbps
Operating Frequency	5260 ~ 5320MHz, 5500 ~ 5700MHz
Number of Channel	5260 ~ 5320MHz: 4 for 802.11a, 802.11n (20MHz), 802.11ac (20MHz) 2 for 802.11n (40MHz), 802.11ac (40MHz) 1 for 802.11ac (80MHz) 5500 ~ 5700MHz 11 for 802.11a, 802.11n (20MHz), 802.11ac (20MHz) 5 for 802.11n (40MHz), 802.11ac (40MHz) 2 for 802.11ac (80MHz)
Output Power	5260 ~ 5320MHz: 70.617mW 5500 ~ 5700MHz: 229.689mW
Antenna Type	Refer to note as below
Antenna Connector	Refer to note as below
Accessory Device	N/A
Data Cable Supplied	N/A

Note:

1. This report is issued as a supplementary report to BV CPS report no. RF130323D03-1. The difference compared with original report is adding U-NII-2A, U-NII-2C band, therefore the EUT is re-tested in this report.
2. This report is prepared for FCC class II permissive change.
3. All models are listed as below.

Brand	Model	Difference
HAN	AP231	Internal antenna
	AP231e	External antenna

4. The EUT incorporates a MIMO function. Physically, the EUT provides four completed transmitters and four receivers.

Modulation Mode	TX FUNCTION
802.11a	4TX
802.11n (20MHz)	4TX
802.11n (40MHz)	4TX
802.11ac (20MHz)	4TX
802.11ac (40MHz)	4TX
802.11ac (80MHz)	4TX

* The modulation and bandwidth are similar for 802.11n mode for 20MHz / 40MHz and 802.11ac mode for 20MHz / 40MHz, therefore investigated worst case to representative mode in test report. (Final test mode refer section 3.2.1)

5. For Radiated test, the EUT was pre-tested with the following modes:

- ✧ Operating Mode, Powered from Adapter
- ✧ Operating Mode, Powered from PoE

The worst emission level was found when the EUT tested under **Operating Mode, Powered from Adapter**, therefore, only its test data was recorded in this report.

6. For Conducted test, the EUT was pre-tested with the following modes:

- ✧ Operating Mode, Model: AP231, Powered from Adapter
- ✧ Operating Mode, Model: AP231e, Powered from Adapter
- ✧ Operating Mode, Model: AP231, Powered from PoE
- ✧ Operating Mode, Model: AP231e, Powered from PoE

The worst emission level was found when the EUT tested under **Operating Mode, Model: AP231, Powered from Adapter**, therefore, only its test data was recorded in this report.

7. The antennas provided to the EUT, please refer to the following table:

Antenna	Chain No.	Antenna Type	Antenna Gain (dBi)	Connector Type
Internal	Chain 0	PIFA	4.39	I-PEX
	Chain 1	PIFA	4.38	I-PEX
	Chain 2	PIFA	4.19	I-PEX
	Chain 3	PIFA	4.45	I-PEX
External	Chain 0	Dipole	6	R-SMA
	Chain 1	Dipole	6	R-SMA
	Chain 2	Dipole	6	R-SMA
	Chain 3	Dipole	6	R-SMA

8. The directional gain table:

Antenna	Max. Gain (dBi)
Internal	10.37
External	12.02

Note:

- (i) If transmit signals are *correlated*, then

Directional gain = $10 \log[(10^{G_1/20} + 10^{G_2/20} + \dots + 10^{G_N/20})^2 / N_{ANT}]$ dBi [Note the "20"s in the denominator of each exponent and the square of the sum of terms; the object is to combine the signal levels coherently.]

9. The above EUT information is declared by manufacturer and for more detailed features description, please refer to the manufacturer's specifications or user's manual.

3.2 Description of Test Modes

FOR 5260 ~ 5320MHz

4 channels are provided for 802.11a, 802.11n (20MHz), 802.11ac (20MHz):

Channel	Frequency	Channel	Frequency
52	5260 MHz	60	5300 MHz
56	5280 MHz	64	5320 MHz

2 channels are provided for 802.11n (40MHz), 802.11ac (40MHz):

Channel	Frequency	Channel	Frequency
54	5270 MHz	62	5310 MHz

1 channel is provided for 802.11ac (80MHz):

Channel	Frequency
58	5290MHz

FOR 5500 ~ 5700MHz

11 channels are provided for 802.11a, 802.11n (20MHz), 802.11ac (20MHz):

Channel	Frequency	Channel	Frequency
100	5500 MHz	124	5620 MHz
104	5520 MHz	128	5640 MHz
108	5540 MHz	132	5660 MHz
112	5560 MHz	136	5680 MHz
116	5580 MHz	140	5700 MHz
120	5600 MHz		

5 channels are provided for 802.11n (40MHz), 802.11ac (40MHz):

Channel	Frequency	Channel	Frequency
102	5510 MHz	126	5630 MHz
110	5550 MHz	134	5670 MHz
118	5590 MHz		

2 channels are provided for 802.11ac (80MHz):

Channel	Frequency	Channel	Frequency
106	5530MHz	122	5610 MHz

3.2.1 Test Mode Applicability and Tested Channel Detail

EUT Configure Mode	Applicable To				Description
	RE \geq 1G	RE $<$ 1G	PLC	APCM	
A	√	√	√	√	Model: AP231 (Int. antenna), Powered from Adapter
B	√	√	-	√	Model: AP231e (Ext. antenna), Powered from Adapter

Where **RE \geq 1G**: Radiated Emission above 1GHz **RE $<$ 1G**: Radiated Emission below 1GHz
PLC: Power Line Conducted Emission **APCM**: Antenna Port Conducted Measurement

NOTE:

The EUT had been pre-tested on the positioned of each 3 axis. The worst case was found when positioned on **X-plane**. (Mode A)
The EUT had been pre-tested on the positioned of each 2 axis. The worst case was found when positioned on **X-plane**. (Mode B)

Radiated Emission Test (Above 1GHz):

- Pre-Scan has been conducted to determine the worst-case mode from all possible combinations between available modulations, data rates and antenna ports (if EUT with antenna diversity architecture).
- Following channel(s) was (were) selected for the final test as listed below.

CDD Mode							
EUT Configure Mode	Mode	FREQ. Band (MHz)	Available Channel	Tested Channel	Modulation Technology	Modulation Type	Data Rate (Mbps)
A & B	802.11a	5260-5320	52 to 64	52, 60, 64	OFDM	BPSK	6
A & B	802.11ac (20MHz)		52 to 64	52, 60, 64	OFDM	BPSK	6.5
A & B	802.11ac (40MHz)		54 to 62	54, 62	OFDM	BPSK	13.5
A & B	802.11ac (80MHz)		58	58	OFDM	BPSK	29.3
A & B	802.11a	5500-5700	100 to 140	100, 116, 132, 140	OFDM	BPSK	6
A & B	802.11ac (20MHz)		100 to 140	100, 116, 132, 140	OFDM	BPSK	6.5
A & B	802.11ac (40MHz)		102 to 134	102, 110, 134	OFDM	BPSK	13.5
A & B	802.11ac (80MHz)		106 to 122	106, 122	OFDM	BPSK	29.3
Beamforming_NSS1 Mode							
EUT Configure Mode	Mode	FREQ. Band (MHz)	Available Channel	Tested Channel	Modulation Technology	Modulation Type	Data Rate (Mbps)
A & B	802.11ac (20MHz)	5260-5320	52 to 64	52, 60, 64	OFDM	BPSK	6.5
A & B	802.11ac (40MHz)		54 to 62	54, 62	OFDM	BPSK	13.5
A & B	802.11ac (80MHz)		58	58	OFDM	BPSK	29.3
A & B	802.11ac (20MHz)	5500-5700	100 to 140	100, 116, 132, 140	OFDM	BPSK	6.5
A & B	802.11ac (40MHz)		102 to 134	102, 110, 134	OFDM	BPSK	13.5
A & B	802.11ac (80MHz)		106 to 122	106, 122	OFDM	BPSK	29.3

Radiated Emission Test (Below 1GHz):

- Pre-Scan has been conducted to determine the worst-case mode from all possible combinations between available modulations, data rates and antenna ports (if EUT with antenna diversity architecture).
- Following channel(s) was (were) selected for the final test as listed below.

CDD Mode							
EUT Configure Mode	Mode	FREQ. Band (MHz)	Available Channel	Tested Channel	Modulation Technology	Modulation Type	Data Rate (Mbps)
A & B	802.11a	5260-5320	52 to 64	52	OFDM	BPSK	6
	802.11a	5500-5700	100 to 140		OFDM	BPSK	6

Power Line Conducted Emission Test:

- Pre-Scan has been conducted to determine the worst-case mode from all possible combinations between available modulations, data rates and antenna ports (if EUT with antenna diversity architecture).
- Following channel(s) was (were) selected for the final test as listed below.

CDD Mode							
EUT Configure Mode	Mode	FREQ. Band (MHz)	Available Channel	Tested Channel	Modulation Technology	Modulation Type	Data Rate (Mbps)
A	802.11a	5260-5320	52 to 64	52	OFDM	BPSK	6
	802.11a	5500-5700	100 to 140		OFDM	BPSK	6

Antenna Port Conducted Measurement:

- This item includes all test value of each mode, but only includes spectrum plot of worst value of each mode.
- Pre-Scan has been conducted to determine the worst-case mode from all possible combinations between available modulations, data rates and antenna ports (if EUT with antenna diversity architecture).
- Following channel(s) was (were) selected for the final test as listed below.
- The EUT was tested with CDD MODE & Beamforming_NSS1 MODE for Maximum Peak Output Power test. The worst case was found when the EUT was tested with CDD MODE. Therefore, other test items were tested with CDD MODE only.

CDD Mode							
EUT Configure Mode	Mode	FREQ. Band (MHz)	Available Channel	Tested Channel	Modulation Technology	Modulation Type	Data Rate (Mbps)
A & B	802.11a	5260-5320	52 to 64	52, 60, 64	OFDM	BPSK	6
A & B	802.11ac (20MHz)		52 to 64	52, 60, 64	OFDM	BPSK	6.5
A & B	802.11ac (40MHz)		54 to 62	54, 62	OFDM	BPSK	13.5
A & B	802.11ac (80MHz)		58	58	OFDM	BPSK	29.3
A & B	802.11a	5500-5700	100 to 140	100, 116, 132, 140	OFDM	BPSK	6
A & B	802.11ac (20MHz)		100 to 140	100, 116, 132, 140	OFDM	BPSK	6.5
A & B	802.11ac (40MHz)		102 to 134	102, 110, 134	OFDM	BPSK	13.5
A & B	802.11ac (80MHz)		106 to 122	106, 122	OFDM	BPSK	29.3

Beamforming_NSS1 Mode (Output Power Only)

EUT Configure Mode	Mode	FREQ. Band (MHz)	Available Channel	Tested Channel	Modulation Technology	Modulation Type	Data Rate (Mbps)
A & B	802.11ac (20MHz)	5260-5320	52 to 64	52, 60, 64	OFDM	BPSK	6.5
A & B	802.11ac (40MHz)		54 to 62	54, 62	OFDM	BPSK	13.5
A & B	802.11ac (80MHz)		58	58	OFDM	BPSK	29.3
A & B	802.11ac (20MHz)	5500-5700	100 to 140	100, 116, 132, 140	OFDM	BPSK	6.5
A & B	802.11ac (40MHz)		102 to 134	102, 110, 134	OFDM	BPSK	13.5
A & B	802.11ac (80MHz)		106 to 122	106, 122	OFDM	BPSK	29.3

Test Condition:

Applicable To	Environmental Conditions	Input Power	Tested By
RE≥1G	33deg. C, 64%RH	120Vac, 60Hz	Ian Chang
RE<1G	30deg. C, 48%RH	120Vac, 60Hz	Ian Chang
PLC	25deg. C, 75%RH	120Vac, 60Hz	Ian Chang
APCM	25deg. C, 76%RH	120Vac, 60Hz	Saxon Lee

3.3 Duty Cycle of Test Signal

Duty cycle of test signal is < 98 %, duty factor is required

802.11a: Duty cycle = 2/2.101 = 0.952, Duty factor = $10 * \log(1/0.952) = 0.21$

802.11ac (20MHz): Duty cycle = 4.927/5.087 = 0.969, Duty factor = $10 * \log(1/0.969) = 0.14$

802.11ac (40MHz): Duty cycle = 2.333/2.463 = 0.947, Duty factor = $10 * \log(1/0.947) = 0.24$

802.11ac (80MHz): Duty cycle = 1.094/1.201 = 0.911, Duty factor = $10 * \log(1/0.911) = 0.41$



3.4 Description of Support Units

The EUT has been tested as an independent unit together with other necessary accessories or support units. The following support units or accessories were used to form a representative test configuration during the tests.

ID	Product	Brand	Model No.	Serial No.	FCC ID	Remarks
A.	Adapter	APD	WB-18D12R	N/A	N/A	Supplied by client
B.	NOTEBOOK PC	DELL	PP27L	8SNZ12S	FCC DoC Approved	Provided by Lab
C.	USB 3.0 Flash Drive	HP	v250w	N/A	FCC DoC Approved	Provided by Lab
D.	Load	N/A	N/A	N/A	N/A	Provided by Lab

Note:

1. All power cords of the above support units are non-shielded (1.8m).
2. Item B acted as communication partners to transfer data.

ID	Descriptions	Qty.	Length (m)	Shielding (Yes/No)	Cores (Qty.)	Remarks
1.	DC cable	1	1.5	N	0	Supplied by client
2.	LAN cable	1	10	N	0	Provided by Lab
3.	LAN cable	1	1.8	N	0	Provided by Lab

Note: The core(s) is(are) originally attached to the cable(s).

3.4.1 Configuration of System under Test

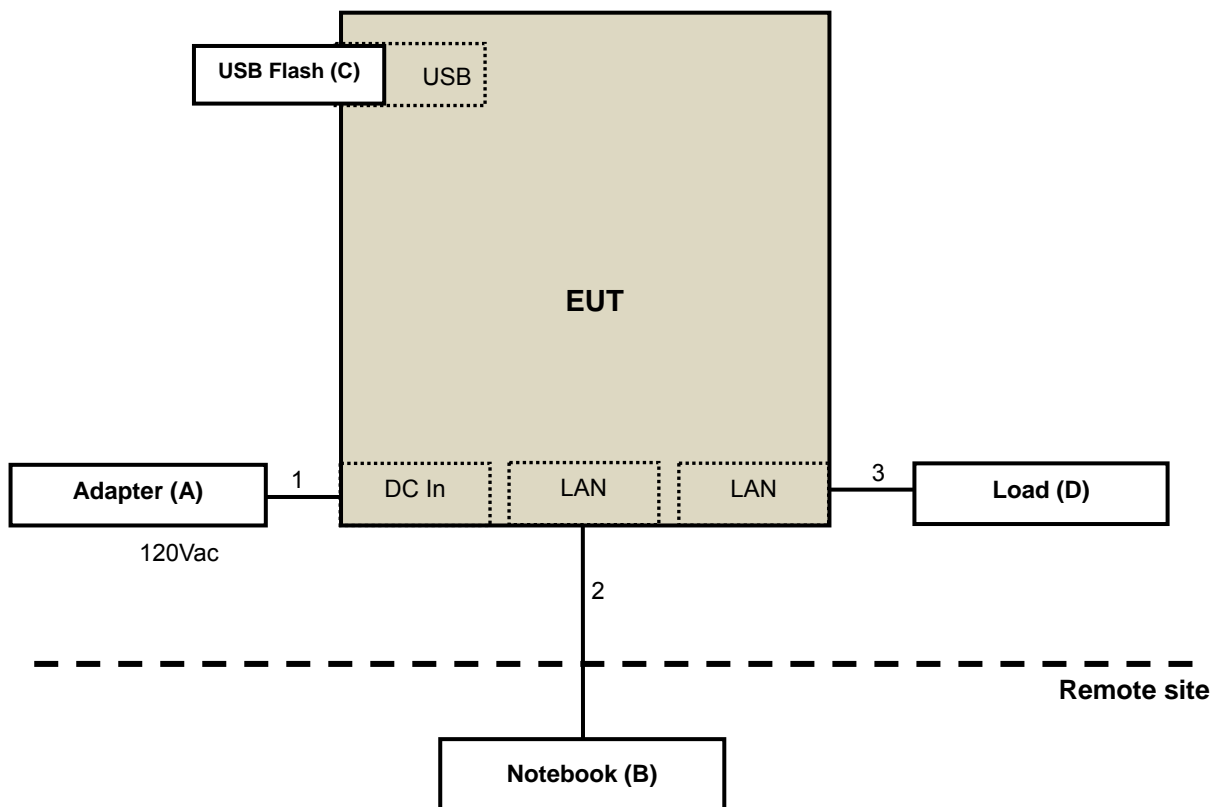

3.5 General Description of Applied Standard

The EUT is a RF Product. According to the specifications of the manufacturer, it must comply with the requirements of the following standards:

FCC Part 15, Subpart E (15.407)
KDB 789033 D02 General UNII Test Procedure New Rules v02r01
KDB 662911 D01 Multiple Transmitter Output v02r01
ANSI C63.10-2013

All test items have been performed and recorded as per the above standards.

4 Test Types and Results

4.1 Radiated Emission and Bandedge Measurement

4.1.1 Limits of Radiated Emission and Bandedge Measurement

Radiated emissions which fall in the restricted bands must comply with the radiated emission limits specified as below table.

Frequencies (MHz)	Field Strength (microvolts/meter)	Measurement Distance (meters)
0.009 ~ 0.490	2400/F(kHz)	300
0.490 ~ 1.705	24000/F(kHz)	30
1.705 ~ 30.0	30	30
30 ~ 88	100	3
88 ~ 216	150	3
216 ~ 960	200	3
Above 960	500	3

NOTE:

- The lower limit shall apply at the transition frequencies.
- Emission level (dBuV/m) = 20 log Emission level (uV/m).
- For frequencies above 1000MHz, the field strength limits are based on average detector, however, the peak field strength of any emission shall not exceed the maximum permitted average limits, specified above by more than 20dB under any condition of modulation.

Limits of unwanted emission out of the restricted bands

Applicable To		Limit	
KDB 789033 D02 General UNII Test Procedure New Rules v02r01		Field Strength at 3m	
		PK:74 (dBuV/m)	AV:54 (dBuV/m)
Frequency Band	Applicable To	EIRP Limit	Equivalent Field Strength at 3m
5150~5250 MHz	15.407(b)(1)	PK:-27 (dBm/MHz)	PK:68.2(dBuV/m)
5250~5350 MHz	15.407(b)(2)		
5470~5725 MHz	15.407(b)(3)		
5725~5850 MHz	<input type="checkbox"/> 15.407(b)(4)(i)	PK:-27 (dBm/MHz) ^{*1} PK:10 (dBm/MHz) ^{*2} PK:15.6 (dBm/MHz) ^{*3} PK:27 (dBm/MHz) ^{*4}	PK: 68.2(dBuV/m) ^{*1} PK:105.2 (dBuV/m) ^{*2} PK: 110.8(dBuV/m) ^{*3} PK:122.2 (dBuV/m) ^{*4}
	<input checked="" type="checkbox"/> 15.407(b)(4)(ii)	Emission limits in section 15.247(d)	
^{*1} beyond 75 MHz or more above of the band edge. ^{*3} below the band edge increasing linearly to a level of 15.6 dBm/MHz at 5 MHz above.		^{*2} below the band edge increasing linearly to 10 dBm/MHz at 25 MHz above. ^{*4} from 5 MHz above or below the band edge increasing linearly to a level of 27 dBm/MHz at the band edge.	

Note:

The following formula is used to convert the equipment isotropic radiated power (eirp) to field strength:

$$E = \frac{1000000\sqrt{30P}}{3} \mu\text{V/m, where P is the eirp (Watts).}$$

4.1.2 Test Instruments

DESCRIPTION & MANUFACTURER	MODEL NO.	SERIAL NO.	CALIBRATED DATE	CALIBRATED UNTIL
HP Preamplifier	8447D	2432A03504	Feb. 21, 2017	Feb. 20, 2018
HP Preamplifier	8449B	3008A01201	Feb. 22, 2017	Feb. 21, 2018
MITEQ Preamplifier	AMF-6F-260400-33-8P	892164	Feb. 21, 2017	Feb. 20, 2018
Agilent TEST RECEIVER	N9038A	MY51210129	Feb. 08, 2017	Feb. 07, 2018
Schwarzbeck Antenna	VULB 9168	139	Dec. 13, 2016	Dec. 12, 2017
Schwarzbeck Horn Antenna	BBHA-9170	212	Dec. 30, 2016	Dec. 29, 2017
Schwarzbeck Horn Antenna	BBHA 9120-D1	D130	Dec. 27, 2016	Dec. 26, 2017
ADT. Turn Table	TT100	0306	NA	NA
ADT. Tower	AT100	0306	NA	NA
Software	Radiated_V7.6.15.9.5	NA	NA	NA
SUHNER RF cable With 4dB PAD	SF104	CABLE-CH6	Aug. 15, 2016	Aug. 14, 2017
			Aug. 14, 2017	Aug. 13, 2018
SUHNER RF cable With 3dB PAD	SF102	Cable-CH8-3.6m	Aug. 15, 2016	Aug. 14, 2017
			Aug. 14, 2017	Aug. 13, 2018
KEYSIGHT MIMO Powermeasurement Test set	U2021XA	U2021XA-001	May 31, 2017	May 30, 2018
KEYSIGHT Spectrum Analyzer	N9030A	MY54490260	Jul. 26, 2016	Jul. 25, 2017
			Jul. 26, 2017	Jul. 25, 2018
Loop Antenna EMCI	LPA600	270	Aug. 20, 2015	Aug. 19, 2017
			Aug. 11, 2017	Aug. 10, 2019
EMCO Horn Antenna	3115	00028257	Dec. 15, 2016	Dec. 14, 2017
Highpass filter Wainwright Instruments	WHK 3.1/18G-10SS	SN 8	NA	NA
ROHDE & SCHWARZ Spectrum Analyzer	FSV40	101042	Sep. 30, 2016	Sep. 29, 2017
Anritsu Power Sensor	MA2411B	0738404	Apr. 24, 2017	Apr. 23, 2018
Anritsu Power Meter	ML2495A	0842014	Apr. 24, 2017	Apr. 23, 2018
Temperature & Humidity Chamber	MHU-225AU	920409	May 25, 2017	May 24, 2018
DIGITAL POWER METER IDRC	CP-240	240515	Sep. 9, 2016	Sep. 8, 2017
			Sep. 8, 2017	Sep. 7, 2018
AC Power Source ExTech	CFW-105	E000603	Sep. 8, 2017	Sep. 7, 2018

- NOTE:**
1. The calibration interval of the above test instruments is 12/24 months. And the calibrations are traceable to NML/ROC and NIST/USA.
 2. The horn antenna and HP preamplifier (model: 8449B) are used only for the measurement of emission frequency above 1GHz if tested.
 3. The test was performed in Chamber No. 6.
 4. The Industry Canada Reference No. IC 7450E-6.
 5. Tested Date: Jul. 12 ~ Sep. 19, 2017

4.1.3 Test Procedure

For Radiated emission below 30MHz

- a. The EUT was placed on the top of a rotating table 0.8 meters above the ground at a 3 meter chamber room. The table was rotated 360 degrees to determine the position of the highest radiation.
- b. The EUT was set 3 meters away from the interference-receiving antenna, which was mounted on the top of a variable-height antenna tower.
- c. Both X and Y axes of the antenna are set to make the measurement.
- d. For each suspected emission, the EUT was arranged to its worst case and the rotatable table was turned from 0 degrees to 360 degrees to find the maximum reading.
- e. The test-receiver system was set to Quasi-Peak Detect Function and Specified Bandwidth with Maximum Hold Mode.

NOTE:

1. The resolution bandwidth and video bandwidth of test receiver/spectrum analyzer is 9kHz at frequency below 30MHz.

For Radiated emission above 30MHz

- a. The EUT was placed on the top of a rotating table 0.8 meters (for 30MHz ~ 1GHz) / 1.5 meters (for above 1GHz) above the ground at 3 meter chamber room for test. The table was rotated 360 degrees to determine the position of the highest radiation.
- b. The EUT was set 3 meters away from the interference-receiving antenna, which was mounted on the top of a variable-height antenna tower.
- c. The height of antenna is varied from one meter to four meters above the ground to determine the maximum value of the field strength. Both horizontal and vertical polarizations of the antenna are set to make the measurement.
- d. For each suspected emission, the EUT was arranged to its worst case and then the antenna was tuned to heights from 1 meter to 4 meters and the rotatable table was turned from 0 degrees to 360 degrees to find the maximum reading.
- e. The test-receiver system was set to quasi-peak detect function and specified bandwidth with maximum hold mode when the test frequency is below 1 GHz.
- f. The test-receiver system was set to peak and average detect function and specified bandwidth with maximum hold mode when the test frequency is above 1 GHz. If the peak reading value also meets average limit, measurement with the average detector is unnecessary.

Note:

1. The resolution bandwidth and video bandwidth of test receiver/spectrum analyzer is 120kHz for Quasi-peak detection (QP) at frequency below 1GHz.
2. The resolution bandwidth of test receiver/spectrum analyzer is 1 MHz and the video bandwidth is 3 MHz for Peak detection (PK) at frequency above 1GHz.
3. The resolution bandwidth of test receiver/spectrum analyzer is 1MHz and the video bandwidth is $\geq 1/T$ (Duty cycle < 98%) or 10Hz (Duty cycle $\geq 98\%$) for Average detection (AV) at frequency above 1GHz.
4. All modes of operation were investigated and the worst-case emissions are reported.

4.1.4 Deviation from Test Standard

No deviation.

4.1.5 Test Setup

For Radiated emission below 30MHz

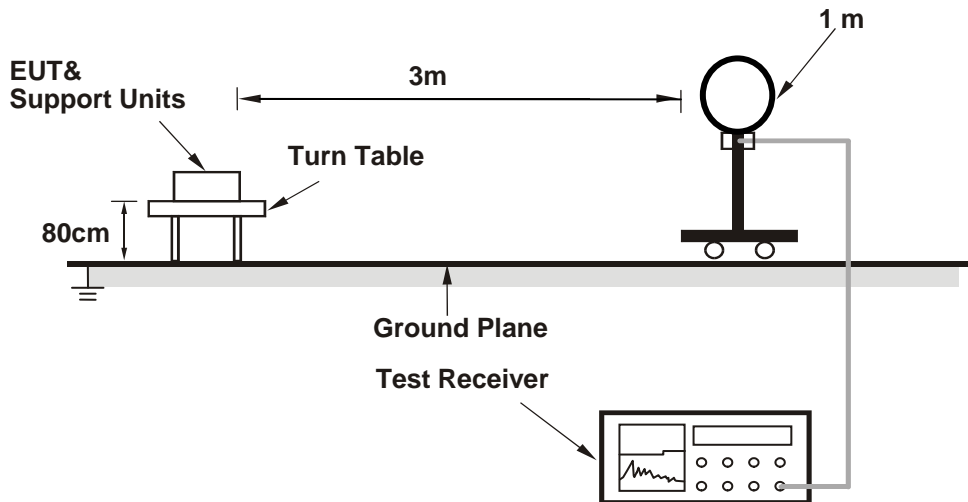

For Radiated emission 30MHz to 1GHz

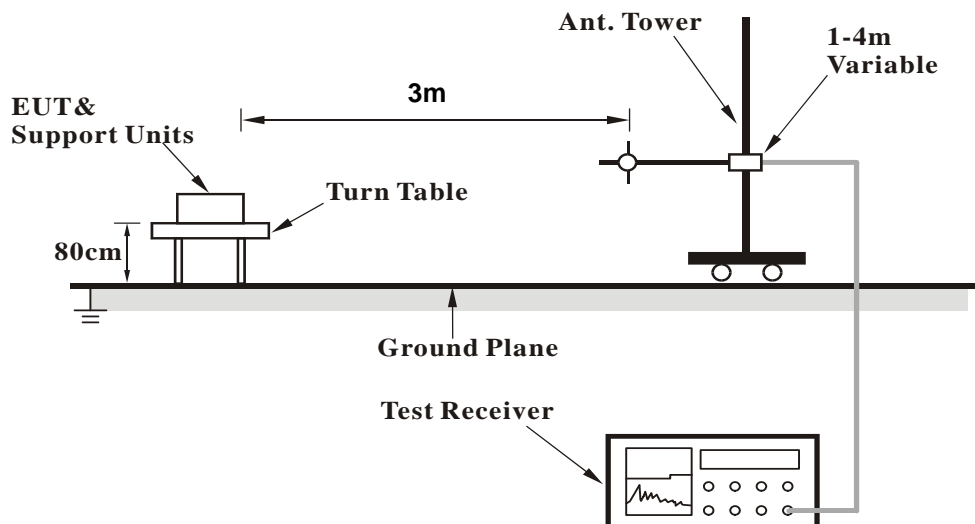

For Radiated emission above 1GHz

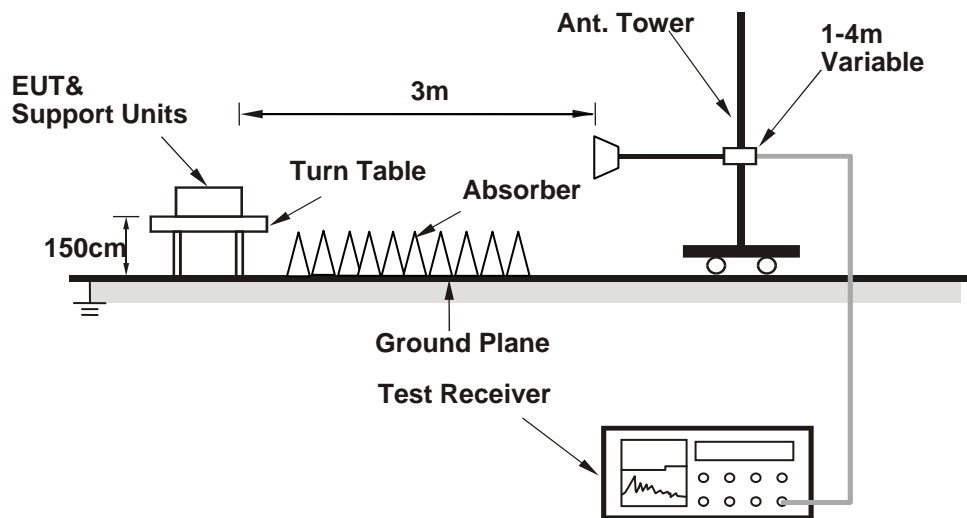

For the actual test configuration, please refer to the attached file (Test Setup Photo).

4.1.6 EUT Operating Condition

- Connected the EUT with AC adapter placed on testing table.
- The EUT perform R/W function with USB HDD from AE notebooks via LAN cables.
- Set the EUT under transmission condition continuously at specific channel frequency.

4.1.7 Test Results

CDD MODE (Mode A)

Above 1GHz Data:

802.11a

CHANNEL	TX Channel 52	DETECTOR FUNCTION	Peak (PK)
FREQUENCY RANGE	1GHz ~ 40GHz		Average (AV)

ANTENNA POLARITY & TEST DISTANCE: HORIZONTAL AT 3 M

NO.	FREQ. (MHz)	EMISSION LEVEL (dBuV/m)	LIMIT (dBuV/m)	MARGIN (dB)	ANTENNA HEIGHT (m)	TABLE ANGLE (Degree)	RAW VALUE (dBuV)	CORRECTION FACTOR (dB/m)
1	5150.00	56.35 PK	74.00	-17.65	1.91 H	215	50.41	5.94
2	5150.00	43.79 AV	54.00	-10.21	1.91 H	215	37.85	5.94
3	*5260.00	104.18 PK			1.91 H	215	97.82	6.36
4	*5260.00	92.61 AV			1.91 H	215	86.25	6.36
5	#10520.00	56.22 PK	74.00	-17.78	2.34 H	154	39.64	16.58
6	#10520.00	41.71 AV	54.00	-12.29	2.34 H	154	25.13	16.58

ANTENNA POLARITY & TEST DISTANCE: VERTICAL AT 3 M

NO.	FREQ. (MHz)	EMISSION LEVEL (dBuV/m)	LIMIT (dBuV/m)	MARGIN (dB)	ANTENNA HEIGHT (m)	TABLE ANGLE (Degree)	RAW VALUE (dBuV)	CORRECTION FACTOR (dB/m)
1	5150.00	57.69 PK	74.00	-16.31	2.50 V	128	51.75	5.94
2	5150.00	44.05 AV	54.00	-9.95	2.50 V	128	38.11	5.94
3	*5260.00	115.24 PK			2.50 V	128	108.88	6.36
4	*5260.00	103.97 AV			2.50 V	128	97.61	6.36
5	#10520.00	57.42 PK	74.00	-16.58	1.67 V	238	40.84	16.58
6	#10520.00	42.70 AV	54.00	-11.30	1.67 V	238	26.12	16.58

REMARKS:

1. Emission Level(dBuV/m) = Raw Value(dBuV) + Correction Factor(dB/m)
2. Correction Factor(dB/m) = Antenna Factor(dB/m) + Cable Factor(dB) – Pre-Amplifier Factor(dB)
3. The other emission levels were very low against the limit.
4. Margin value = Emission Level – Limit value
5. " * ": Fundamental frequency.
6. " # ": The radiated frequency is out of the restricted band.

CHANNEL	TX Channel 60	DETECTOR FUNCTION	Peak (PK)
FREQUENCY RANGE	1GHz ~ 40GHz		Average (AV)

ANTENNA POLARITY & TEST DISTANCE: HORIZONTAL AT 3 M

NO.	FREQ. (MHz)	EMISSION LEVEL (dBuV/m)	LIMIT (dBuV/m)	MARGIN (dB)	ANTENNA HEIGHT (m)	TABLE ANGLE (Degree)	RAW VALUE (dBuV)	CORRECTION FACTOR (dB/m)
1	*5300.00	105.28 PK			1.87 H	220	98.76	6.52
2	*5300.00	94.67 AV			1.87 H	220	88.15	6.52
3	10600.00	56.49 PK	74.00	-17.51	1.36 H	221	39.63	16.86
4	10600.00	42.31 AV	54.00	-11.69	1.36 H	221	25.45	16.86

ANTENNA POLARITY & TEST DISTANCE: VERTICAL AT 3 M

NO.	FREQ. (MHz)	EMISSION LEVEL (dBuV/m)	LIMIT (dBuV/m)	MARGIN (dB)	ANTENNA HEIGHT (m)	TABLE ANGLE (Degree)	RAW VALUE (dBuV)	CORRECTION FACTOR (dB/m)
1	*5300.00	115.30 PK			2.58 V	128	108.78	6.52
2	*5300.00	104.63 AV			2.58 V	128	98.11	6.52
3	10600.00	57.70 PK	74.00	-16.30	1.87 V	264	40.84	16.86
4	10600.00	43.84 AV	54.00	-10.16	1.87 V	264	26.98	16.86

REMARKS:

1. Emission Level(dBuV/m) = Raw Value(dBuV) + Correction Factor(dB/m)
2. Correction Factor(dB/m) = Antenna Factor(dB/m) + Cable Factor(dB) – Pre-Amplifier Factor(dB)
3. The other emission levels were very low against the limit.
4. Margin value = Emission Level – Limit value
5. " * ": Fundamental frequency.

CHANNEL	TX Channel 64	DETECTOR FUNCTION	Peak (PK)
FREQUENCY RANGE	1GHz ~ 40GHz		Average (AV)

ANTENNA POLARITY & TEST DISTANCE: HORIZONTAL AT 3 M

NO.	FREQ. (MHz)	EMISSION LEVEL (dBuV/m)	LIMIT (dBuV/m)	MARGIN (dB)	ANTENNA HEIGHT (m)	TABLE ANGLE (Degree)	RAW VALUE (dBuV)	CORRECTION FACTOR (dB/m)
1	*5320.00	104.46 PK			1.85 H	216	97.84	6.62
2	*5320.00	93.26 AV			1.85 H	216	86.64	6.62
3	5350.00	56.89 PK	74.00	-17.11	1.85 H	216	50.14	6.75
4	5350.00	43.91 AV	54.00	-10.09	1.85 H	216	37.16	6.75
5	10640.00	56.32 PK	74.00	-17.68	2.14 H	144	39.46	16.86
6	10640.00	42.02 AV	54.00	-11.98	2.14 H	144	25.16	16.86

ANTENNA POLARITY & TEST DISTANCE: VERTICAL AT 3 M

NO.	FREQ. (MHz)	EMISSION LEVEL (dBuV/m)	LIMIT (dBuV/m)	MARGIN (dB)	ANTENNA HEIGHT (m)	TABLE ANGLE (Degree)	RAW VALUE (dBuV)	CORRECTION FACTOR (dB/m)
1	*5320.00	114.81 PK			2.61 V	129	108.19	6.62
2	*5320.00	103.72 AV			2.61 V	129	97.10	6.62
3	5350.00	57.64 PK	74.00	-16.36	2.61 V	129	50.89	6.75
4	5350.00	44.48 AV	54.00	-9.52	2.61 V	129	37.73	6.75
5	10640.00	57.38 PK	74.00	-16.62	1.58 V	226	40.52	16.86
6	10640.00	43.05 AV	54.00	-10.95	1.58 V	226	26.19	16.86

REMARKS:

1. Emission Level(dBuV/m) = Raw Value(dBuV) + Correction Factor(dB/m)
2. Correction Factor(dB/m) = Antenna Factor(dB/m) + Cable Factor(dB) – Pre-Amplifier Factor(dB)
3. The other emission levels were very low against the limit.
4. Margin value = Emission Level – Limit value
5. " * ": Fundamental frequency.

CHANNEL	TX Channel 100	DETECTOR FUNCTION	Peak (PK)
FREQUENCY RANGE	1GHz ~ 40GHz		Average (AV)

ANTENNA POLARITY & TEST DISTANCE: HORIZONTAL AT 3 M

NO.	FREQ. (MHz)	EMISSION LEVEL (dBuV/m)	LIMIT (dBuV/m)	MARGIN (dB)	ANTENNA HEIGHT (m)	TABLE ANGLE (Degree)	RAW VALUE (dBuV)	CORRECTION FACTOR (dB/m)
1	5460.00	58.31 PK	74.00	-15.69	2.34 H	151	51.13	7.18
2	5460.00	44.66 AV	54.00	-9.34	2.34 H	151	37.48	7.18
3	5470.00	58.24 PK	68.20	-9.96	2.34 H	151	51.03	7.21
4	*5500.00	105.20 PK			2.34 H	151	97.89	7.31
5	*5500.00	93.99 AV			2.34 H	151	86.68	7.31
6	11000.00	57.68 PK	74.00	-16.32	1.42 H	229	39.44	18.24
7	11000.00	43.33 AV	54.00	-10.67	1.42 H	229	25.09	18.24

ANTENNA POLARITY & TEST DISTANCE: VERTICAL AT 3 M

NO.	FREQ. (MHz)	EMISSION LEVEL (dBuV/m)	LIMIT (dBuV/m)	MARGIN (dB)	ANTENNA HEIGHT (m)	TABLE ANGLE (Degree)	RAW VALUE (dBuV)	CORRECTION FACTOR (dB/m)
1	5460.00	58.98 PK	74.00	-15.02	3.27 V	299	51.80	7.18
2	5460.00	45.27 AV	54.00	-8.73	3.27 V	299	38.09	7.18
3	5470.00	60.04 PK	68.20	-8.16	3.27 V	299	52.83	7.21
4	*5500.00	118.29 PK			3.27 V	299	110.98	7.31
5	*5500.00	106.70 AV			3.27 V	299	99.39	7.31
6	11000.00	59.06 PK	74.00	-14.94	1.87 V	201	40.82	18.24
7	11000.00	44.40 AV	54.00	-9.60	1.87 V	201	26.16	18.24

REMARKS:

1. Emission Level(dBuV/m) = Raw Value(dBuV) + Correction Factor(dB/m)
2. Correction Factor(dB/m) = Antenna Factor(dB/m) + Cable Factor(dB) – Pre-Amplifier Factor(dB)
3. The other emission levels were very low against the limit.
4. Margin value = Emission Level – Limit value
5. " * ": Fundamental frequency.

CHANNEL	TX Channel 116	DETECTOR FUNCTION	Peak (PK)
FREQUENCY RANGE	1GHz ~ 40GHz		Average (AV)

ANTENNA POLARITY & TEST DISTANCE: HORIZONTAL AT 3 M

NO.	FREQ. (MHz)	EMISSION LEVEL (dBuV/m)	LIMIT (dBuV/m)	MARGIN (dB)	ANTENNA HEIGHT (m)	TABLE ANGLE (Degree)	RAW VALUE (dBuV)	CORRECTION FACTOR (dB/m)
1	*5580.00	105.17 PK			2.28 H	162	97.81	7.36
2	*5580.00	92.38 AV			2.28 H	162	85.02	7.36
3	11160.00	56.79 PK	74.00	-17.21	2.86 H	220	39.16	17.63
4	11160.00	42.71 AV	54.00	-11.29	2.86 H	220	25.08	17.63

ANTENNA POLARITY & TEST DISTANCE: VERTICAL AT 3 M

NO.	FREQ. (MHz)	EMISSION LEVEL (dBuV/m)	LIMIT (dBuV/m)	MARGIN (dB)	ANTENNA HEIGHT (m)	TABLE ANGLE (Degree)	RAW VALUE (dBuV)	CORRECTION FACTOR (dB/m)
1	*5580.00	118.00 PK			3.06 V	298	110.64	7.36
2	*5580.00	104.80 AV			3.06 V	298	97.44	7.36
3	11160.00	58.14 PK	74.00	-15.86	1.38 V	224	40.51	17.63
4	11160.00	43.93 AV	54.00	-10.07	1.38 V	224	26.30	17.63

REMARKS:

1. Emission Level(dBuV/m) = Raw Value(dBuV) + Correction Factor(dB/m)
2. Correction Factor(dB/m) = Antenna Factor(dB/m) + Cable Factor(dB) – Pre-Amplifier Factor(dB)
3. The other emission levels were very low against the limit.
4. Margin value = Emission Level – Limit value
5. " * ": Fundamental frequency.

CHANNEL	TX Channel 132	DETECTOR FUNCTION	Peak (PK)
FREQUENCY RANGE	1GHz ~ 40GHz		Average (AV)

ANTENNA POLARITY & TEST DISTANCE: HORIZONTAL AT 3 M

NO.	FREQ. (MHz)	EMISSION LEVEL (dBuV/m)	LIMIT (dBuV/m)	MARGIN (dB)	ANTENNA HEIGHT (m)	TABLE ANGLE (Degree)	RAW VALUE (dBuV)	CORRECTION FACTOR (dB/m)
1	*5660.00	104.91 PK			2.30 H	147	97.55	7.36
2	*5660.00	93.68 AV			2.30 H	147	86.32	7.36
3	11320.00	56.34 PK	74.00	-17.66	1.88 H	298	39.21	17.13
4	11320.00	42.21 AV	54.00	-11.79	1.88 H	298	25.08	17.13

ANTENNA POLARITY & TEST DISTANCE: VERTICAL AT 3 M

NO.	FREQ. (MHz)	EMISSION LEVEL (dBuV/m)	LIMIT (dBuV/m)	MARGIN (dB)	ANTENNA HEIGHT (m)	TABLE ANGLE (Degree)	RAW VALUE (dBuV)	CORRECTION FACTOR (dB/m)
1	*5660.00	118.00 PK			2.98 V	301	110.64	7.36
2	*5660.00	106.82 AV			2.98 V	301	99.46	7.36
3	11320.00	57.47 PK	74.00	-16.53	1.68 V	143	40.34	17.13
4	11320.00	43.94 AV	54.00	-10.06	1.68 V	143	26.81	17.13

REMARKS:

1. Emission Level(dBuV/m) = Raw Value(dBuV) + Correction Factor(dB/m)
2. Correction Factor(dB/m) = Antenna Factor(dB/m) + Cable Factor(dB) – Pre-Amplifier Factor(dB)
3. The other emission levels were very low against the limit.
4. Margin value = Emission Level – Limit value
5. " * ": Fundamental frequency.

CHANNEL	TX Channel 140	DETECTOR FUNCTION	Peak (PK)
FREQUENCY RANGE	1GHz ~ 40GHz		Average (AV)

ANTENNA POLARITY & TEST DISTANCE: HORIZONTAL AT 3 M

NO.	FREQ. (MHz)	EMISSION LEVEL (dBuV/m)	LIMIT (dBuV/m)	MARGIN (dB)	ANTENNA HEIGHT (m)	TABLE ANGLE (Degree)	RAW VALUE (dBuV)	CORRECTION FACTOR (dB/m)
1	*5700.00	105.19 PK			2.33 H	158	97.85	7.34
2	*5700.00	93.33 AV			2.33 H	158	85.99	7.34
3	5725.00	58.87 PK	68.20	-9.33	2.33 H	158	51.50	7.37
4	11400.00	56.64 PK	74.00	-17.36	1.66 H	41	39.41	17.23
5	11400.00	42.71 AV	54.00	-11.29	1.66 H	41	25.48	17.23

ANTENNA POLARITY & TEST DISTANCE: VERTICAL AT 3 M

NO.	FREQ. (MHz)	EMISSION LEVEL (dBuV/m)	LIMIT (dBuV/m)	MARGIN (dB)	ANTENNA HEIGHT (m)	TABLE ANGLE (Degree)	RAW VALUE (dBuV)	CORRECTION FACTOR (dB/m)
1	*5700.00	117.59 PK			3.49 V	302	110.25	7.34
2	*5700.00	106.13 AV			3.49 V	302	98.79	7.34
3	5725.00	60.40 PK	68.20	-7.80	3.49 V	302	53.03	7.37
4	11400.00	57.90 PK	74.00	-16.1	1.54 V	241	40.67	17.23
5	11400.00	43.98 AV	54.00	-10.0	1.54 V	241	26.75	17.23

REMARKS:

1. Emission Level(dBuV/m) = Raw Value(dBuV) + Correction Factor(dB/m)
2. Correction Factor(dB/m) = Antenna Factor(dB/m) + Cable Factor(dB) – Pre-Amplifier Factor(dB)
3. The other emission levels were very low against the limit.
4. Margin value = Emission Level – Limit value
5. " * ": Fundamental frequency.

802.11ac (20MHz)

CHANNEL	TX Channel 52	DETECTOR FUNCTION	Peak (PK)
FREQUENCY RANGE	1GHz ~ 40GHz		Average (AV)

ANTENNA POLARITY & TEST DISTANCE: HORIZONTAL AT 3 M

NO.	FREQ. (MHz)	EMISSION LEVEL (dBuV/m)	LIMIT (dBuV/m)	MARGIN (dB)	ANTENNA HEIGHT (m)	TABLE ANGLE (Degree)	RAW VALUE (dBuV)	CORRECTION FACTOR (dB/m)
1	5150.00	56.42 PK	74.00	-17.58	1.79 H	142	50.48	5.94
2	5150.00	43.83 AV	54.00	-10.17	1.79 H	142	37.89	5.94
3	*5260.00	104.21 PK			1.79 H	142	97.85	6.36
4	*5260.00	91.21 AV			1.79 H	142	84.85	6.36
5	#10520.00	56.22 PK	74.00	-17.78	2.19 H	251	39.64	16.58
6	#10520.00	42.00 AV	54.00	-12.00	2.19 H	251	25.42	16.58

ANTENNA POLARITY & TEST DISTANCE: VERTICAL AT 3 M

NO.	FREQ. (MHz)	EMISSION LEVEL (dBuV/m)	LIMIT (dBuV/m)	MARGIN (dB)	ANTENNA HEIGHT (m)	TABLE ANGLE (Degree)	RAW VALUE (dBuV)	CORRECTION FACTOR (dB/m)
1	5150.00	57.54 PK	74.00	-16.46	2.75 V	128	51.60	5.94
2	5150.00	44.03 AV	54.00	-9.97	2.75 V	128	38.09	5.94
3	*5260.00	115.04 PK			2.75 V	128	108.68	6.36
4	*5260.00	101.67 AV			2.75 V	128	95.31	6.36
5	#10520.00	57.42 PK	74.00	-16.58	1.87 V	224	40.84	16.58
6	#10520.00	43.21 AV	54.00	-10.79	1.87 V	224	26.63	16.58

REMARKS:

1. Emission Level(dBuV/m) = Raw Value(dBuV) + Correction Factor(dB/m)
2. Correction Factor(dB/m) = Antenna Factor(dB/m) + Cable Factor(dB) – Pre-Amplifier Factor(dB)
3. The other emission levels were very low against the limit.
4. Margin value = Emission Level – Limit value
5. " * ": Fundamental frequency.
6. " # ": The radiated frequency is out of the restricted band.

CHANNEL	TX Channel 60	DETECTOR FUNCTION	Peak (PK)
FREQUENCY RANGE	1GHz ~ 40GHz		Average (AV)

ANTENNA POLARITY & TEST DISTANCE: HORIZONTAL AT 3 M

NO.	FREQ. (MHz)	EMISSION LEVEL (dBuV/m)	LIMIT (dBuV/m)	MARGIN (dB)	ANTENNA HEIGHT (m)	TABLE ANGLE (Degree)	RAW VALUE (dBuV)	CORRECTION FACTOR (dB/m)
1	*5300.00	105.24 PK			1.84 H	151	98.72	6.52
2	*5300.00	91.81 AV			1.84 H	151	85.29	6.52
3	10600.00	56.24 PK	74.00	-17.76	2.19 H	145	39.38	16.86
4	10600.00	42.14 AV	54.00	-11.86	2.19 H	145	25.28	16.86

ANTENNA POLARITY & TEST DISTANCE: VERTICAL AT 3 M

NO.	FREQ. (MHz)	EMISSION LEVEL (dBuV/m)	LIMIT (dBuV/m)	MARGIN (dB)	ANTENNA HEIGHT (m)	TABLE ANGLE (Degree)	RAW VALUE (dBuV)	CORRECTION FACTOR (dB/m)
1	*5300.00	115.93 PK			4.00 V	130	109.41	6.52
2	*5300.00	104.68 AV			4.00 V	130	98.16	6.52
3	10600.00	57.70 PK	74.00	-16.30	1.58 V	298	40.84	16.86
4	10600.00	43.20 AV	54.00	-10.80	1.58 V	298	26.34	16.86

REMARKS:

1. Emission Level(dBuV/m) = Raw Value(dBuV) + Correction Factor(dB/m)
2. Correction Factor(dB/m) = Antenna Factor(dB/m) + Cable Factor(dB) – Pre-Amplifier Factor(dB)
3. The other emission levels were very low against the limit.
4. Margin value = Emission Level – Limit value
5. " * ": Fundamental frequency.

CHANNEL	TX Channel 64	DETECTOR FUNCTION	Peak (PK)
FREQUENCY RANGE	1GHz ~ 40GHz		Average (AV)

ANTENNA POLARITY & TEST DISTANCE: HORIZONTAL AT 3 M

NO.	FREQ. (MHz)	EMISSION LEVEL (dBuV/m)	LIMIT (dBuV/m)	MARGIN (dB)	ANTENNA HEIGHT (m)	TABLE ANGLE (Degree)	RAW VALUE (dBuV)	CORRECTION FACTOR (dB/m)
1	*5320.00	104.46 PK			1.82 H	155	97.84	6.62
2	*5320.00	90.87 AV			1.82 H	155	84.25	6.62
3	5350.00	57.62 PK	74.00	-16.38	1.82 H	155	50.87	6.75
4	5350.00	43.88 AV	54.00	-10.12	1.82 H	155	37.13	6.75
5	10640.00	56.33 PK	74.00	-17.67	2.39 H	102	39.47	16.86
6	10640.00	41.94 AV	54.00	-12.06	2.39 H	102	25.08	16.86

ANTENNA POLARITY & TEST DISTANCE: VERTICAL AT 3 M

NO.	FREQ. (MHz)	EMISSION LEVEL (dBuV/m)	LIMIT (dBuV/m)	MARGIN (dB)	ANTENNA HEIGHT (m)	TABLE ANGLE (Degree)	RAW VALUE (dBuV)	CORRECTION FACTOR (dB/m)
1	*5320.00	115.45 PK			2.95 V	131	108.83	6.62
2	*5320.00	102.65 AV			2.95 V	131	96.03	6.62
3	5350.00	57.81 PK	74.00	-16.19	2.95 V	131	51.06	6.75
4	5350.00	44.67 AV	54.00	-9.33	2.95 V	131	37.92	6.75
5	10640.00	57.70 PK	74.00	-16.30	1.57 V	241	40.84	16.86
6	10640.00	43.69 AV	54.00	-10.31	1.57 V	241	26.83	16.86

REMARKS:

1. Emission Level(dBuV/m) = Raw Value(dBuV) + Correction Factor(dB/m)
2. Correction Factor(dB/m) = Antenna Factor(dB/m) + Cable Factor(dB) – Pre-Amplifier Factor(dB)
3. The other emission levels were very low against the limit.
4. Margin value = Emission Level – Limit value
5. " * ": Fundamental frequency.

CHANNEL	TX Channel 100	DETECTOR FUNCTION	Peak (PK)
FREQUENCY RANGE	1GHz ~ 40GHz		Average (AV)

ANTENNA POLARITY & TEST DISTANCE: HORIZONTAL AT 3 M

NO.	FREQ. (MHz)	EMISSION LEVEL (dBuV/m)	LIMIT (dBuV/m)	MARGIN (dB)	ANTENNA HEIGHT (m)	TABLE ANGLE (Degree)	RAW VALUE (dBuV)	CORRECTION FACTOR (dB/m)
1	5460.00	58.61 PK	74.00	-15.39	2.41 H	134	51.43	7.18
2	5460.00	45.17 AV	54.00	-8.83	2.41 H	134	37.99	7.18
3	5470.00	58.23 PK	68.20	-9.97	2.41 H	134	51.02	7.21
4	*5500.00	107.20 PK			2.41 H	134	99.89	7.31
5	*5500.00	93.19 AV			2.41 H	134	85.88	7.31
6	11000.00	57.72 PK	74.00	-16.28	1.52 H	100	39.48	18.24
7	11000.00	44.08 AV	54.00	-9.92	1.52 H	100	25.84	18.24

ANTENNA POLARITY & TEST DISTANCE: VERTICAL AT 3 M

NO.	FREQ. (MHz)	EMISSION LEVEL (dBuV/m)	LIMIT (dBuV/m)	MARGIN (dB)	ANTENNA HEIGHT (m)	TABLE ANGLE (Degree)	RAW VALUE (dBuV)	CORRECTION FACTOR (dB/m)
1	5460.00	59.10 PK	74.00	-14.90	2.76 V	232	51.92	7.18
2	5460.00	45.85 AV	54.00	-8.15	2.76 V	232	38.67	7.18
3	5470.00	59.96 PK	68.20	-8.24	2.76 V	232	52.75	7.21
4	*5500.00	117.32 PK			2.76 V	232	110.01	7.31
5	*5500.00	104.21 AV			2.76 V	232	96.90	7.31
6	11000.00	58.76 PK	74.00	-15.24	1.87 V	194	40.52	18.24
7	11000.00	45.10 AV	54.00	-8.90	1.87 V	194	26.86	18.24

REMARKS:

1. Emission Level(dBuV/m) = Raw Value(dBuV) + Correction Factor(dB/m)
2. Correction Factor(dB/m) = Antenna Factor(dB/m) + Cable Factor(dB) – Pre-Amplifier Factor(dB)
3. The other emission levels were very low against the limit.
4. Margin value = Emission Level – Limit value
5. " * ": Fundamental frequency.

CHANNEL	TX Channel 116	DETECTOR FUNCTION	Peak (PK)
FREQUENCY RANGE	1GHz ~ 40GHz		Average (AV)

ANTENNA POLARITY & TEST DISTANCE: HORIZONTAL AT 3 M

NO.	FREQ. (MHz)	EMISSION LEVEL (dBuV/m)	LIMIT (dBuV/m)	MARGIN (dB)	ANTENNA HEIGHT (m)	TABLE ANGLE (Degree)	RAW VALUE (dBuV)	CORRECTION FACTOR (dB/m)
1	*5580.00	106.03 PK			2.29 H	144	98.67	7.36
2	*5580.00	92.65 AV			2.29 H	144	85.29	7.36
3	11160.00	56.97 PK	74.00	-17.03	2.00 H	211	39.34	17.63
4	11160.00	42.82 AV	54.00	-11.18	2.00 H	211	25.19	17.63

ANTENNA POLARITY & TEST DISTANCE: VERTICAL AT 3 M

NO.	FREQ. (MHz)	EMISSION LEVEL (dBuV/m)	LIMIT (dBuV/m)	MARGIN (dB)	ANTENNA HEIGHT (m)	TABLE ANGLE (Degree)	RAW VALUE (dBuV)	CORRECTION FACTOR (dB/m)
1	*5580.00	117.30 PK			2.89 V	281	109.94	7.36
2	*5580.00	104.18 AV			2.89 V	281	96.82	7.36
3	11160.00	58.30 PK	74.00	-15.70	1.78 V	269	40.67	17.63
4	11160.00	43.99 AV	54.00	-10.01	1.78 V	269	26.36	17.63

REMARKS:

1. Emission Level(dBuV/m) = Raw Value(dBuV) + Correction Factor(dB/m)
2. Correction Factor(dB/m) = Antenna Factor(dB/m) + Cable Factor(dB) – Pre-Amplifier Factor(dB)
3. The other emission levels were very low against the limit.
4. Margin value = Emission Level – Limit value
5. " * ": Fundamental frequency.

CHANNEL	TX Channel 132	DETECTOR FUNCTION	Peak (PK)
FREQUENCY RANGE	1GHz ~ 40GHz		Average (AV)

ANTENNA POLARITY & TEST DISTANCE: HORIZONTAL AT 3 M

NO.	FREQ. (MHz)	EMISSION LEVEL (dBuV/m)	LIMIT (dBuV/m)	MARGIN (dB)	ANTENNA HEIGHT (m)	TABLE ANGLE (Degree)	RAW VALUE (dBuV)	CORRECTION FACTOR (dB/m)
1	*5660.00	106.12 PK			2.29 H	150	98.76	7.36
2	*5660.00	93.91 AV			2.29 H	150	86.55	7.36
3	11320.00	56.68 PK	74.00	-17.32	2.36 H	336	39.55	17.13
4	11320.00	42.82 AV	54.00	-11.18	2.36 H	336	25.69	17.13

ANTENNA POLARITY & TEST DISTANCE: VERTICAL AT 3 M

NO.	FREQ. (MHz)	EMISSION LEVEL (dBuV/m)	LIMIT (dBuV/m)	MARGIN (dB)	ANTENNA HEIGHT (m)	TABLE ANGLE (Degree)	RAW VALUE (dBuV)	CORRECTION FACTOR (dB/m)
1	*5660.00	116.87 PK			3.43 V	280	109.51	7.36
2	*5660.00	104.57 AV			3.43 V	280	97.21	7.36
3	11320.00	57.80 PK	74.00	-16.20	1.61 V	218	40.67	17.13
4	11320.00	43.26 AV	54.00	-10.74	1.61 V	218	26.13	17.13

REMARKS:

1. Emission Level(dBuV/m) = Raw Value(dBuV) + Correction Factor(dB/m)
2. Correction Factor(dB/m) = Antenna Factor(dB/m) + Cable Factor(dB) – Pre-Amplifier Factor(dB)
3. The other emission levels were very low against the limit.
4. Margin value = Emission Level – Limit value
5. " # ": The radiated frequency is out of the restricted band.

CHANNEL	TX Channel 140	DETECTOR FUNCTION	Peak (PK)
FREQUENCY RANGE	1GHz ~ 40GHz		Average (AV)

ANTENNA POLARITY & TEST DISTANCE: HORIZONTAL AT 3 M

NO.	FREQ. (MHz)	EMISSION LEVEL (dBuV/m)	LIMIT (dBuV/m)	MARGIN (dB)	ANTENNA HEIGHT (m)	TABLE ANGLE (Degree)	RAW VALUE (dBuV)	CORRECTION FACTOR (dB/m)
1	*5700.00	104.99 PK			2.42 H	265	97.65	7.34
2	*5700.00	93.03 AV			2.42 H	265	85.69	7.34
3	5725.00	58.83 PK	68.20	-9.37	2.42 H	265	51.46	7.37
4	11400.00	56.32 PK	74.00	-17.68	1.69 H	36	39.09	17.23
5	11400.00	42.59 AV	54.00	-11.41	1.69 H	36	25.36	17.23

ANTENNA POLARITY & TEST DISTANCE: VERTICAL AT 3 M

NO.	FREQ. (MHz)	EMISSION LEVEL (dBuV/m)	LIMIT (dBuV/m)	MARGIN (dB)	ANTENNA HEIGHT (m)	TABLE ANGLE (Degree)	RAW VALUE (dBuV)	CORRECTION FACTOR (dB/m)
1	*5700.00	117.23 PK			2.75 V	187	109.89	7.34
2	*5700.00	103.89 AV			2.75 V	187	96.55	7.34
3	5725.00	60.23 PK	68.20	-7.97	2.75 V	187	52.86	7.37
4	11400.00	57.96 PK	74.00	-16.04	1.37 V	44	40.73	17.23
5	11400.00	43.86 AV	54.00	-10.14	1.37 V	44	26.63	17.23

REMARKS:

1. Emission Level(dBuV/m) = Raw Value(dBuV) + Correction Factor(dB/m)
2. Correction Factor(dB/m) = Antenna Factor(dB/m) + Cable Factor(dB) – Pre-Amplifier Factor(dB)
3. The other emission levels were very low against the limit.
4. Margin value = Emission Level – Limit value
5. " * ": Fundamental frequency.

802.11ac (40MHz)

CHANNEL	TX Channel 54	DETECTOR FUNCTION	Peak (PK)
FREQUENCY RANGE	1GHz ~ 40GHz		Average (AV)

ANTENNA POLARITY & TEST DISTANCE: HORIZONTAL AT 3 M

NO.	FREQ. (MHz)	EMISSION LEVEL (dBuV/m)	LIMIT (dBuV/m)	MARGIN (dB)	ANTENNA HEIGHT (m)	TABLE ANGLE (Degree)	RAW VALUE (dBuV)	CORRECTION FACTOR (dB/m)
1	5150.00	57.39 PK	74.00	-16.61	1.94 H	203	51.45	5.94
2	5150.00	43.80 AV	54.00	-10.20	1.94 H	203	37.86	5.94
3	*5270.00	101.27 PK			1.94 H	203	94.87	6.40
4	*5270.00	90.25 AV			1.94 H	203	83.85	6.40
5	#10540.00	56.29 PK	74.00	-17.71	1.58 H	258	39.64	16.65
6	#10540.00	41.84 AV	54.00	-12.16	1.58 H	258	25.19	16.65

ANTENNA POLARITY & TEST DISTANCE: VERTICAL AT 3 M

NO.	FREQ. (MHz)	EMISSION LEVEL (dBuV/m)	LIMIT (dBuV/m)	MARGIN (dB)	ANTENNA HEIGHT (m)	TABLE ANGLE (Degree)	RAW VALUE (dBuV)	CORRECTION FACTOR (dB/m)
1	5150.00	58.57 PK	74.00	-15.43	2.70 V	128	52.63	5.94
2	5150.00	44.24 AV	54.00	-9.76	2.70 V	128	38.30	5.94
3	*5270.00	112.14 PK			2.70 V	128	105.74	6.40
4	*5270.00	101.13 AV			2.70 V	128	94.73	6.40
5	#10540.00	57.39 PK	74.00	-16.61	2.34 V	15	40.74	16.65
6	#10540.00	43.32 AV	54.00	-10.68	2.34 V	15	26.67	16.65

REMARKS:

1. Emission Level(dBuV/m) = Raw Value(dBuV) + Correction Factor(dB/m)
2. Correction Factor(dB/m) = Antenna Factor(dB/m) + Cable Factor(dB) – Pre-Amplifier Factor(dB)
3. The other emission levels were very low against the limit.
4. Margin value = Emission Level – Limit value
5. " * ": Fundamental frequency.
6. " # ": The radiated frequency is out of the restricted band.

CHANNEL	TX Channel 62	DETECTOR FUNCTION	Peak (PK)
FREQUENCY RANGE	1GHz ~ 40GHz		Average (AV)

ANTENNA POLARITY & TEST DISTANCE: HORIZONTAL AT 3 M

NO.	FREQ. (MHz)	EMISSION LEVEL (dBuV/m)	LIMIT (dBuV/m)	MARGIN (dB)	ANTENNA HEIGHT (m)	TABLE ANGLE (Degree)	RAW VALUE (dBuV)	CORRECTION FACTOR (dB/m)
1	*5310.00	101.35 PK			1.90 H	197	94.78	6.57
2	*5310.00	90.06 AV			1.90 H	197	83.49	6.57
3	5350.00	59.11 PK	74.00	-14.89	1.90 H	197	52.36	6.75
4	5350.00	46.94 AV	54.00	-7.06	1.90 H	197	40.19	6.75
5	10620.00	56.21 PK	74.00	-17.79	1.34 H	115	39.35	16.86
6	10620.00	41.95 AV	54.00	-12.05	1.34 H	115	25.09	16.86

ANTENNA POLARITY & TEST DISTANCE: VERTICAL AT 3 M

NO.	FREQ. (MHz)	EMISSION LEVEL (dBuV/m)	LIMIT (dBuV/m)	MARGIN (dB)	ANTENNA HEIGHT (m)	TABLE ANGLE (Degree)	RAW VALUE (dBuV)	CORRECTION FACTOR (dB/m)
1	*5310.00	112.44 PK			2.58 V	134	105.87	6.57
2	*5310.00	101.11 AV			2.58 V	134	94.54	6.57
3	5350.00	62.67 PK	74.00	-11.33	2.58 V	134	55.92	6.75
4	5350.00	47.82 AV	54.00	-6.18	2.58 V	134	41.07	6.75
5	10620.00	57.50 PK	74.00	-16.50	1.69 V	238	40.64	16.86
6	10620.00	43.70 AV	54.00	-10.30	1.69 V	238	26.84	16.86

REMARKS:

1. Emission Level(dBuV/m) = Raw Value(dBuV) + Correction Factor(dB/m)
2. Correction Factor(dB/m) = Antenna Factor(dB/m) + Cable Factor(dB) – Pre-Amplifier Factor(dB)
3. The other emission levels were very low against the limit.
4. Margin value = Emission Level – Limit value
5. " * ": Fundamental frequency.

CHANNEL	TX Channel 102	DETECTOR FUNCTION	Peak (PK)
FREQUENCY RANGE	1GHz ~ 40GHz		Average (AV)

ANTENNA POLARITY & TEST DISTANCE: HORIZONTAL AT 3 M

NO.	FREQ. (MHz)	EMISSION LEVEL (dBuV/m)	LIMIT (dBuV/m)	MARGIN (dB)	ANTENNA HEIGHT (m)	TABLE ANGLE (Degree)	RAW VALUE (dBuV)	CORRECTION FACTOR (dB/m)
1	5460.00	58.64 PK	74.00	-15.36	1.68 H	199	51.46	7.18
2	5460.00	44.17 AV	54.00	-9.83	1.68 H	199	36.99	7.18
3	5470.00	59.35 PK	68.20	-8.85	1.68 H	199	52.14	7.21
4	*5510.00	103.16 PK			1.68 H	199	95.84	7.32
5	*5510.00	92.51 AV			1.68 H	199	85.19	7.32
6	11020.00	58.07 PK	74.00	-15.93	2.50 H	100	39.89	18.18
7	11020.00	43.86 AV	54.00	-10.14	2.50 H	100	25.68	18.18

ANTENNA POLARITY & TEST DISTANCE: VERTICAL AT 3 M

NO.	FREQ. (MHz)	EMISSION LEVEL (dBuV/m)	LIMIT (dBuV/m)	MARGIN (dB)	ANTENNA HEIGHT (m)	TABLE ANGLE (Degree)	RAW VALUE (dBuV)	CORRECTION FACTOR (dB/m)
1	5460.00	60.83 PK	74.00	-13.17	2.75 V	43	53.65	7.18
2	5460.00	44.36 AV	54.00	-9.64	2.75 V	43	37.18	7.18
3	5470.00	60.66 PK	68.20	-7.54	2.75 V	43	53.45	7.21
4	*5510.00	113.36 PK			2.75 V	43	106.04	7.32
5	*5510.00	103.33 AV			2.75 V	43	96.01	7.32
6	11020.00	58.82 PK	74.00	-15.18	1.48 V	281	40.64	18.18
7	11020.00	44.49 AV	54.00	-9.51	1.48 V	281	26.31	18.18

REMARKS:

1. Emission Level(dBuV/m) = Raw Value(dBuV) + Correction Factor(dB/m)
2. Correction Factor(dB/m) = Antenna Factor(dB/m) + Cable Factor(dB) – Pre-Amplifier Factor(dB)
3. The other emission levels were very low against the limit.
4. Margin value = Emission Level – Limit value
5. " * ": Fundamental frequency.

CHANNEL	TX Channel 110	DETECTOR FUNCTION	Peak (PK)
FREQUENCY RANGE	1GHz ~ 40GHz		Average (AV)

ANTENNA POLARITY & TEST DISTANCE: HORIZONTAL AT 3 M

NO.	FREQ. (MHz)	EMISSION LEVEL (dBuV/m)	LIMIT (dBuV/m)	MARGIN (dB)	ANTENNA HEIGHT (m)	TABLE ANGLE (Degree)	RAW VALUE (dBuV)	CORRECTION FACTOR (dB/m)
1	*5550.00	104.23 PK			1.67 H	212	96.89	7.34
2	*5550.00	93.23 AV			1.67 H	212	85.89	7.34
3	11100.00	57.35 PK	74.00	-16.65	1.87 H	247	39.46	17.89
4	11100.00	43.53 AV	54.00	-10.47	1.87 H	247	25.64	17.89

ANTENNA POLARITY & TEST DISTANCE: VERTICAL AT 3 M

NO.	FREQ. (MHz)	EMISSION LEVEL (dBuV/m)	LIMIT (dBuV/m)	MARGIN (dB)	ANTENNA HEIGHT (m)	TABLE ANGLE (Degree)	RAW VALUE (dBuV)	CORRECTION FACTOR (dB/m)
1	*5550.00	114.81 PK			3.11 V	85	107.47	7.34
2	*5550.00	103.82 AV			3.11 V	85	96.48	7.34
3	11100.00	58.67 PK	74.00	-15.33	1.59 V	201	40.78	17.89
4	11100.00	44.58 AV	54.00	-9.42	1.59 V	201	26.69	17.89

REMARKS:

1. Emission Level(dBuV/m) = Raw Value(dBuV) + Correction Factor(dB/m)
2. Correction Factor(dB/m) = Antenna Factor(dB/m) + Cable Factor(dB) – Pre-Amplifier Factor(dB)
3. The other emission levels were very low against the limit.
4. Margin value = Emission Level – Limit value
5. " * ": Fundamental frequency.

CHANNEL	TX Channel 134	DETECTOR FUNCTION	Peak (PK)
FREQUENCY RANGE	1GHz ~ 40GHz		Average (AV)

ANTENNA POLARITY & TEST DISTANCE: HORIZONTAL AT 3 M

NO.	FREQ. (MHz)	EMISSION LEVEL (dBuV/m)	LIMIT (dBuV/m)	MARGIN (dB)	ANTENNA HEIGHT (m)	TABLE ANGLE (Degree)	RAW VALUE (dBuV)	CORRECTION FACTOR (dB/m)
1	*5670.00	103.94 PK			1.66 H	210	96.58	7.36
2	*5670.00	93.82 AV			1.66 H	210	86.46	7.36
3	5725.00	59.25 PK	68.20	-8.95	1.66 H	210	51.88	7.37
4	11340.00	56.58 PK	74.00	-17.42	1.80 H	25	39.42	17.16
5	11340.00	42.59 AV	54.00	-11.41	1.80 H	25	25.43	17.16

ANTENNA POLARITY & TEST DISTANCE: VERTICAL AT 3 M

NO.	FREQ. (MHz)	EMISSION LEVEL (dBuV/m)	LIMIT (dBuV/m)	MARGIN (dB)	ANTENNA HEIGHT (m)	TABLE ANGLE (Degree)	RAW VALUE (dBuV)	CORRECTION FACTOR (dB/m)
1	*5670.00	114.74 PK			2.88 V	88	107.38	7.36
2	*5670.00	103.70 AV			2.88 V	88	96.34	7.36
3	5725.00	60.34 PK	68.20	-7.82	2.88 V	88	52.97	7.37
4	11340.00	58.05 PK	74.00	-15.95	1.59 V	46	40.89	17.16
5	11340.00	43.77 AV	54.00	-10.23	1.59 V	46	26.61	17.16

REMARKS:

1. Emission Level(dBuV/m) = Raw Value(dBuV) + Correction Factor(dB/m)
2. Correction Factor(dB/m) = Antenna Factor(dB/m) + Cable Factor(dB) – Pre-Amplifier Factor(dB)
3. The other emission levels were very low against the limit.
4. Margin value = Emission Level – Limit value
5. " * ": Fundamental frequency.
6. " # ": The radiated frequency is out of the restricted band.

802.11ac (80MHz)

CHANNEL	TX Channel 58	DETECTOR FUNCTION	Peak (PK)
FREQUENCY RANGE	1GHz ~ 40GHz		Average (AV)

ANTENNA POLARITY & TEST DISTANCE: HORIZONTAL AT 3 M

NO.	FREQ. (MHz)	EMISSION LEVEL (dBuV/m)	LIMIT (dBuV/m)	MARGIN (dB)	ANTENNA HEIGHT (m)	TABLE ANGLE (Degree)	RAW VALUE (dBuV)	CORRECTION FACTOR (dB/m)
1	5150.00	57.38 PK	74.00	-16.62	1.82 H	203	51.44	5.94
2	5150.00	43.97 AV	54.00	-10.03	1.82 H	203	38.03	5.94
3	*5290.00	98.32 PK			1.82 H	203	91.84	6.48
4	*5290.00	87.36 AV			1.82 H	203	80.88	6.48
5	5350.00	66.78 PK	74.00	-7.22	1.82 H	203	60.03	6.75
6	5350.00	48.91 AV	54.00	-5.09	1.82 H	203	42.16	6.75
7	#10580.00	56.15 PK	74.00	-17.85	2.51 H	221	39.36	16.79
8	#10580.00	41.85 AV	54.00	-12.15	2.51 H	221	25.06	16.79

ANTENNA POLARITY & TEST DISTANCE: VERTICAL AT 3 M

NO.	FREQ. (MHz)	EMISSION LEVEL (dBuV/m)	LIMIT (dBuV/m)	MARGIN (dB)	ANTENNA HEIGHT (m)	TABLE ANGLE (Degree)	RAW VALUE (dBuV)	CORRECTION FACTOR (dB/m)
1	5150.00	59.01 PK	74.00	-14.99	2.87 V	139	53.07	5.94
2	5150.00	44.79 AV	54.00	-9.21	2.87 V	139	38.85	5.94
3	*5290.00	109.02 PK			2.87 V	139	102.54	6.48
4	*5290.00	98.02 AV			2.87 V	139	91.54	6.48
5	5350.00	69.58 PK	74.00	-4.42	2.87 V	139	62.83	6.75
6	5350.00	52.91 AV	54.00	-1.09	2.87 V	139	46.16	6.75
7	#10580.00	57.66 PK	74.00	-16.34	1.78 V	251	40.87	16.79
8	#10580.00	43.47 AV	54.00	-10.53	1.78 V	251	26.68	16.79

REMARKS:

1. Emission Level(dBuV/m) = Raw Value(dBuV) + Correction Factor(dB/m)
2. Correction Factor(dB/m) = Antenna Factor(dB/m) + Cable Factor(dB) – Pre-Amplifier Factor(dB)
3. The other emission levels were very low against the limit.
4. Margin value = Emission Level – Limit value
5. " * ": Fundamental frequency.
6. " # ": The radiated frequency is out of the restricted band.

CHANNEL	TX Channel 106	DETECTOR FUNCTION	Peak (PK)
FREQUENCY RANGE	1GHz ~ 40GHz		Average (AV)

ANTENNA POLARITY & TEST DISTANCE: HORIZONTAL AT 3 M

NO.	FREQ. (MHz)	EMISSION LEVEL (dBuV/m)	LIMIT (dBuV/m)	MARGIN (dB)	ANTENNA HEIGHT (m)	TABLE ANGLE (Degree)	RAW VALUE (dBuV)	CORRECTION FACTOR (dB/m)
1	5460.00	63.63 PK	74.00	-10.37	1.84 H	152	56.45	7.18
2	5460.00	49.30 AV	54.00	-4.70	1.84 H	152	42.12	7.18
3	5470.00	63.07 PK	68.20	-5.13	1.84 H	152	55.86	7.21
4	*5530.00	99.78 PK			1.84 H	152	92.45	7.33
5	*5530.00	89.78 AV			1.84 H	152	82.45	7.33
6	11060.00	57.50 PK	74.00	-16.50	2.13 H	145	39.46	18.04
7	11060.00	43.68 AV	54.00	-10.32	2.13 H	145	25.64	18.04

ANTENNA POLARITY & TEST DISTANCE: VERTICAL AT 3 M

NO.	FREQ. (MHz)	EMISSION LEVEL (dBuV/m)	LIMIT (dBuV/m)	MARGIN (dB)	ANTENNA HEIGHT (m)	TABLE ANGLE (Degree)	RAW VALUE (dBuV)	CORRECTION FACTOR (dB/m)
1	5460.00	66.21 PK	74.00	-7.79	3.01 V	118	59.03	7.18
2	5460.00	51.35 AV	54.00	-2.65	3.01 V	118	44.17	7.18
3	5470.00	67.10 PK	68.20	-1.10	3.01 V	118	59.89	7.21
4	*5530.00	111.07 PK			3.01 V	118	103.74	7.33
5	*5530.00	100.60 AV			3.01 V	118	93.27	7.33
6	11060.00	59.01 PK	74.00	-14.99	1.56 V	354	40.97	18.04
7	11060.00	44.88 AV	54.00	-9.12	1.56 V	354	26.84	18.04

REMARKS:

1. Emission Level(dBuV/m) = Raw Value(dBuV) + Correction Factor(dB/m)
2. Correction Factor(dB/m) = Antenna Factor(dB/m) + Cable Factor(dB) – Pre-Amplifier Factor(dB)
3. The other emission levels were very low against the limit.
4. Margin value = Emission Level – Limit value
5. " * ": Fundamental frequency.

CHANNEL	TX Channel 122	DETECTOR FUNCTION	Peak (PK)
FREQUENCY RANGE	1GHz ~ 40GHz		Average (AV)

ANTENNA POLARITY & TEST DISTANCE: HORIZONTAL AT 3 M

NO.	FREQ. (MHz)	EMISSION LEVEL (dBuV/m)	LIMIT (dBuV/m)	MARGIN (dB)	ANTENNA HEIGHT (m)	TABLE ANGLE (Degree)	RAW VALUE (dBuV)	CORRECTION FACTOR (dB/m)
1	*5610.00	101.03 PK			1.58 H	132	93.66	7.37
2	*5610.00	90.48 AV			1.58 H	132	83.11	7.37
3	5725.00	62.24 PK	68.20	-5.96	1.58 H	132	54.87	7.37
4	11220.00	56.81 PK	74.00	-17.19	2.69 H	65	39.41	17.40
5	11220.00	42.78 AV	54.00	-11.22	2.69 H	65	25.38	17.40

ANTENNA POLARITY & TEST DISTANCE: VERTICAL AT 3 M

NO.	FREQ. (MHz)	EMISSION LEVEL (dBuV/m)	LIMIT (dBuV/m)	MARGIN (dB)	ANTENNA HEIGHT (m)	TABLE ANGLE (Degree)	RAW VALUE (dBuV)	CORRECTION FACTOR (dB/m)
1	*5610.00	111.65 PK			2.56 V	40	104.28	7.37
2	*5610.00	100.70 AV			2.56 V	40	93.33	7.37
3	5725.00	63.88 PK	68.20	-4.32	2.56 V	40	56.51	7.37
4	11220.00	58.07 PK	74.00	-15.93	1.83 V	281	40.67	17.40
5	11220.00	43.94 AV	54.00	-10.06	1.83 V	281	26.54	17.40

REMARKS:

1. Emission Level(dBuV/m) = Raw Value(dBuV) + Correction Factor(dB/m)
2. Correction Factor(dB/m) = Antenna Factor(dB/m) + Cable Factor(dB) – Pre-Amplifier Factor(dB)
3. The other emission levels were very low against the limit.
4. Margin value = Emission Level – Limit value
5. " * ": Fundamental frequency.

CDD Mode (Mode B)

802.11a

CHANNEL	TX Channel 52	DETECTOR FUNCTION	Peak (PK)
FREQUENCY RANGE	1GHz ~ 40GHz		Average (AV)

ANTENNA POLARITY & TEST DISTANCE: HORIZONTAL AT 3 M

NO.	FREQ. (MHz)	EMISSION LEVEL (dBuV/m)	LIMIT (dBuV/m)	MARGIN (dB)	ANTENNA HEIGHT (m)	TABLE ANGLE (Degree)	RAW VALUE (dBuV)	CORRECTION FACTOR (dB/m)
1	5150.00	56.88 PK	74.00	-17.12	2.17 H	8	50.94	5.94
2	5150.00	43.20 AV	54.00	-10.80	2.17 H	8	37.26	5.94
3	*5260.00	104.51 PK			2.17 H	8	98.15	6.36
4	*5260.00	93.74 AV			2.17 H	8	87.38	6.36
5	#10520.00	57.46 PK	74.00	-16.54	1.79 H	227	40.88	16.58
6	#10520.00	43.12 AV	54.00	-10.88	1.79 H	227	26.54	16.58

ANTENNA POLARITY & TEST DISTANCE: VERTICAL AT 3 M

NO.	FREQ. (MHz)	EMISSION LEVEL (dBuV/m)	LIMIT (dBuV/m)	MARGIN (dB)	ANTENNA HEIGHT (m)	TABLE ANGLE (Degree)	RAW VALUE (dBuV)	CORRECTION FACTOR (dB/m)
1	5150.00	58.16 PK	74.00	-15.84	1.69 V	174	52.22	5.94
2	5150.00	44.51 AV	54.00	-9.49	1.69 V	174	38.57	5.94
3	*5260.00	119.45 PK			1.69 V	174	113.09	6.36
4	*5260.00	108.52 AV			1.69 V	174	102.16	6.36
5	#10520.00	58.52 PK	74.00	-15.48	1.37 V	251	41.94	16.58
6	#10520.00	44.41 AV	54.00	-9.59	1.37 V	251	27.83	16.58

REMARKS:

1. Emission Level(dBuV/m) = Raw Value(dBuV) + Correction Factor(dB/m)
2. Correction Factor(dB/m) = Antenna Factor(dB/m) + Cable Factor(dB) – Pre-Amplifier Factor(dB)
3. The other emission levels were very low against the limit.
4. Margin value = Emission Level – Limit value
5. " * ": Fundamental frequency.
6. " # ": The radiated frequency is out of the restricted band.

CHANNEL	TX Channel 60	DETECTOR FUNCTION	Peak (PK)
FREQUENCY RANGE	1GHz ~ 40GHz		Average (AV)

ANTENNA POLARITY & TEST DISTANCE: HORIZONTAL AT 3 M

NO.	FREQ. (MHz)	EMISSION LEVEL (dBuV/m)	LIMIT (dBuV/m)	MARGIN (dB)	ANTENNA HEIGHT (m)	TABLE ANGLE (Degree)	RAW VALUE (dBuV)	CORRECTION FACTOR (dB/m)
1	*5300.00	104.81 PK			2.20 H	11	98.29	6.52
2	*5300.00	93.86 AV			2.20 H	11	87.34	6.52
3	10600.00	57.48 PK	74.00	-16.52	1.68 H	223	40.62	16.86
4	10600.00	43.25 AV	54.00	-10.75	1.68 H	223	26.39	16.86

ANTENNA POLARITY & TEST DISTANCE: VERTICAL AT 3 M

NO.	FREQ. (MHz)	EMISSION LEVEL (dBuV/m)	LIMIT (dBuV/m)	MARGIN (dB)	ANTENNA HEIGHT (m)	TABLE ANGLE (Degree)	RAW VALUE (dBuV)	CORRECTION FACTOR (dB/m)
1	*5300.00	120.30 PK			1.74 V	172	113.78	6.52
2	*5300.00	108.93 AV			1.74 V	172	102.41	6.52
3	10600.00	58.72 PK	74.00	-15.28	1.42 V	248	41.86	16.86
4	10600.00	44.77 AV	54.00	-9.23	1.42 V	248	27.91	16.86

REMARKS:

1. Emission Level(dBuV/m) = Raw Value(dBuV) + Correction Factor(dB/m)
2. Correction Factor(dB/m) = Antenna Factor(dB/m) + Cable Factor(dB) – Pre-Amplifier Factor(dB)
3. The other emission levels were very low against the limit.
4. Margin value = Emission Level – Limit value
5. " * ": Fundamental frequency.

CHANNEL	TX Channel 64	DETECTOR FUNCTION	Peak (PK)
FREQUENCY RANGE	1GHz ~ 40GHz		Average (AV)

ANTENNA POLARITY & TEST DISTANCE: HORIZONTAL AT 3 M

NO.	FREQ. (MHz)	EMISSION LEVEL (dBuV/m)	LIMIT (dBuV/m)	MARGIN (dB)	ANTENNA HEIGHT (m)	TABLE ANGLE (Degree)	RAW VALUE (dBuV)	CORRECTION FACTOR (dB/m)
1	*5320.00	104.96 PK			2.15 H	9	98.34	6.62
2	*5320.00	94.13 AV			2.15 H	9	87.51	6.62
3	5350.00	57.88 PK	74.00	-16.12	2.15 H	9	51.13	6.75
4	5350.00	46.17 AV	54.00	-7.83	2.15 H	9	39.42	6.75
5	10640.00	57.45 PK	74.00	-16.55	1.80 H	217	40.59	16.86
6	10640.00	43.32 AV	54.00	-10.68	1.80 H	217	26.46	16.86

ANTENNA POLARITY & TEST DISTANCE: VERTICAL AT 3 M

NO.	FREQ. (MHz)	EMISSION LEVEL (dBuV/m)	LIMIT (dBuV/m)	MARGIN (dB)	ANTENNA HEIGHT (m)	TABLE ANGLE (Degree)	RAW VALUE (dBuV)	CORRECTION FACTOR (dB/m)
1	*5320.00	120.10 PK			1.83 V	175	113.48	6.62
2	*5320.00	108.89 AV			1.83 V	175	102.27	6.62
3	5350.00	58.20 PK	74.00	-15.80	1.83 V	175	51.45	6.75
4	5350.00	46.86 AV	54.00	-7.14	1.83 V	175	40.11	6.75
5	10640.00	58.52 PK	74.00	-15.48	1.38 V	253	41.66	16.86
6	10640.00	44.77 AV	54.00	-9.23	1.38 V	253	27.91	16.86

REMARKS:

1. Emission Level(dBuV/m) = Raw Value(dBuV) + Correction Factor(dB/m)
2. Correction Factor(dB/m) = Antenna Factor(dB/m) + Cable Factor(dB) – Pre-Amplifier Factor(dB)
3. The other emission levels were very low against the limit.
4. Margin value = Emission Level – Limit value
5. " * ": Fundamental frequency.

CHANNEL	TX Channel 100	DETECTOR FUNCTION	Peak (PK)
FREQUENCY RANGE	1GHz ~ 40GHz		Average (AV)

ANTENNA POLARITY & TEST DISTANCE: HORIZONTAL AT 3 M

NO.	FREQ. (MHz)	EMISSION LEVEL (dBuV/m)	LIMIT (dBuV/m)	MARGIN (dB)	ANTENNA HEIGHT (m)	TABLE ANGLE (Degree)	RAW VALUE (dBuV)	CORRECTION FACTOR (dB/m)
1	5460.00	59.12 PK	74.00	-14.88	2.17 H	12	51.94	7.18
2	5460.00	45.59 AV	54.00	-8.41	2.17 H	12	38.41	7.18
3	5470.00	59.40 PK	68.20	-8.8	2.17 H	12	52.19	7.21
4	*5500.00	106.25 PK			2.17 H	12	98.94	7.31
5	*5500.00	95.27 AV			2.17 H	12	87.96	7.31
6	11000.00	58.32 PK	74.00	-15.68	1.69 H	208	40.08	18.24
7	11000.00	44.01 AV	54.00	-9.99	1.69 H	208	25.77	18.24

ANTENNA POLARITY & TEST DISTANCE: VERTICAL AT 3 M

NO.	FREQ. (MHz)	EMISSION LEVEL (dBuV/m)	LIMIT (dBuV/m)	MARGIN (dB)	ANTENNA HEIGHT (m)	TABLE ANGLE (Degree)	RAW VALUE (dBuV)	CORRECTION FACTOR (dB/m)
1	5460.00	60.30 PK	74.00	-13.70	1.80 V	173	53.12	7.18
2	5460.00	47.45 AV	54.00	-6.55	1.80 V	173	40.27	7.18
3	5470.00	61.04 PK	68.20	-7.16	1.80 V	173	53.83	7.21
4	*5500.00	122.49 PK			1.80 V	173	115.18	7.31
5	*5500.00	111.25 AV			1.80 V	173	103.94	7.31
6	11000.00	59.50 PK	74.00	-14.50	1.40 V	256	41.26	18.24
7	11000.00	45.18 AV	54.00	-8.82	1.40 V	256	26.94	18.24

REMARKS:

1. Emission Level(dBuV/m) = Raw Value(dBuV) + Correction Factor(dB/m)
2. Correction Factor(dB/m) = Antenna Factor(dB/m) + Cable Factor(dB) – Pre-Amplifier Factor(dB)
3. The other emission levels were very low against the limit.
4. Margin value = Emission Level – Limit value
5. " * ": Fundamental frequency.

CHANNEL	TX Channel 116	DETECTOR FUNCTION	Peak (PK)
FREQUENCY RANGE	1GHz ~ 40GHz		Average (AV)

ANTENNA POLARITY & TEST DISTANCE: HORIZONTAL AT 3 M

NO.	FREQ. (MHz)	EMISSION LEVEL (dBuV/m)	LIMIT (dBuV/m)	MARGIN (dB)	ANTENNA HEIGHT (m)	TABLE ANGLE (Degree)	RAW VALUE (dBuV)	CORRECTION FACTOR (dB/m)
1	*5580.00	106.08 PK			2.09 H	7	98.72	7.36
2	*5580.00	95.02 AV			2.09 H	7	87.66	7.36
3	11160.00	57.56 PK	74.00	-16.44	1.71 H	200	39.93	17.63
4	11160.00	43.44 AV	54.00	-10.56	1.71 H	200	25.81	17.63

ANTENNA POLARITY & TEST DISTANCE: VERTICAL AT 3 M

NO.	FREQ. (MHz)	EMISSION LEVEL (dBuV/m)	LIMIT (dBuV/m)	MARGIN (dB)	ANTENNA HEIGHT (m)	TABLE ANGLE (Degree)	RAW VALUE (dBuV)	CORRECTION FACTOR (dB/m)
1	*5580.00	122.30 PK			1.78 V	175	114.94	7.36
2	*5580.00	111.18 AV			1.78 V	175	103.82	7.36
3	11160.00	58.71 PK	74.00	-15.29	1.45 V	261	41.08	17.63
4	11160.00	44.34 AV	54.00	-9.66	1.45 V	261	26.71	17.63

REMARKS:

1. Emission Level(dBuV/m) = Raw Value(dBuV) + Correction Factor(dB/m)
2. Correction Factor(dB/m) = Antenna Factor(dB/m) + Cable Factor(dB) – Pre-Amplifier Factor(dB)
3. The other emission levels were very low against the limit.
4. Margin value = Emission Level – Limit value
5. " * ": Fundamental frequency.

CHANNEL	TX Channel 132	DETECTOR FUNCTION	Peak (PK)
FREQUENCY RANGE	1GHz ~ 40GHz		Average (AV)

ANTENNA POLARITY & TEST DISTANCE: HORIZONTAL AT 3 M

NO.	FREQ. (MHz)	EMISSION LEVEL (dBuV/m)	LIMIT (dBuV/m)	MARGIN (dB)	ANTENNA HEIGHT (m)	TABLE ANGLE (Degree)	RAW VALUE (dBuV)	CORRECTION FACTOR (dB/m)
1	*5660.00	106.16 PK			2.11 H	9	98.80	7.36
2	*5660.00	95.29 AV			2.11 H	9	87.93	7.36
3	11320.00	56.84 PK	74.00	-17.16	1.75 H	206	39.71	17.13
4	11320.00	42.71 AV	54.00	-11.29	1.75 H	206	25.58	17.13

ANTENNA POLARITY & TEST DISTANCE: VERTICAL AT 3 M

NO.	FREQ. (MHz)	EMISSION LEVEL (dBuV/m)	LIMIT (dBuV/m)	MARGIN (dB)	ANTENNA HEIGHT (m)	TABLE ANGLE (Degree)	RAW VALUE (dBuV)	CORRECTION FACTOR (dB/m)
1	*5660.00	122.41 PK			1.82 V	171	115.05	7.36
2	*5660.00	110.92 AV			1.82 V	171	103.56	7.36
3	11320.00	58.28 PK	74.00	-15.72	1.36 V	248	41.15	17.13
4	11320.00	43.93 AV	54.00	-10.07	1.36 V	248	26.80	17.13

REMARKS:

1. Emission Level(dBuV/m) = Raw Value(dBuV) + Correction Factor(dB/m)
2. Correction Factor(dB/m) = Antenna Factor(dB/m) + Cable Factor(dB) – Pre-Amplifier Factor(dB)
3. The other emission levels were very low against the limit.
4. Margin value = Emission Level – Limit value
5. " * ": Fundamental frequency.

CHANNEL	TX Channel 140	DETECTOR FUNCTION	Peak (PK)
FREQUENCY RANGE	1GHz ~ 40GHz		Average (AV)

ANTENNA POLARITY & TEST DISTANCE: HORIZONTAL AT 3 M

NO.	FREQ. (MHz)	EMISSION LEVEL (dBuV/m)	LIMIT (dBuV/m)	MARGIN (dB)	ANTENNA HEIGHT (m)	TABLE ANGLE (Degree)	RAW VALUE (dBuV)	CORRECTION FACTOR (dB/m)
1	*5700.00	106.47 PK			2.14 H	10	99.13	7.34
2	*5700.00	95.58 AV			2.14 H	10	88.24	7.34
3	5725.00	60.55 PK	68.20	-7.65	2.14 H	10	53.18	7.37
4	11400.00	57.21 PK	74.00	-16.79	1.64 H	217	39.98	17.23
5	11400.00	42.77 AV	54.00	-11.23	1.64 H	217	25.54	17.23

ANTENNA POLARITY & TEST DISTANCE: VERTICAL AT 3 M

NO.	FREQ. (MHz)	EMISSION LEVEL (dBuV/m)	LIMIT (dBuV/m)	MARGIN (dB)	ANTENNA HEIGHT (m)	TABLE ANGLE (Degree)	RAW VALUE (dBuV)	CORRECTION FACTOR (dB/m)
1	*5700.00	122.27 PK			1.76 V	174	114.93	7.34
2	*5700.00	111.21 AV			1.76 V	174	103.87	7.34
3	5725.00	63.90 PK	68.20	-4.30	1.76 V	174	56.53	7.37
4	11400.00	58.46 PK	74.00	-15.54	1.40 V	269	41.23	17.23
5	11400.00	44.17 AV	54.00	-9.83	1.40 V	269	26.94	17.23

REMARKS:

1. Emission Level(dBuV/m) = Raw Value(dBuV) + Correction Factor(dB/m)
2. Correction Factor(dB/m) = Antenna Factor(dB/m) + Cable Factor(dB) – Pre-Amplifier Factor(dB)
3. The other emission levels were very low against the limit.
4. Margin value = Emission Level – Limit value
5. " * ": Fundamental frequency.

802.11ac (20MHz)

CHANNEL	TX Channel 52	DETECTOR FUNCTION	Peak (PK)
FREQUENCY RANGE	1GHz ~ 40GHz		Average (AV)

ANTENNA POLARITY & TEST DISTANCE: HORIZONTAL AT 3 M

NO.	FREQ. (MHz)	EMISSION LEVEL (dBuV/m)	LIMIT (dBuV/m)	MARGIN (dB)	ANTENNA HEIGHT (m)	TABLE ANGLE (Degree)	RAW VALUE (dBuV)	CORRECTION FACTOR (dB/m)
1	5150.00	56.32 PK	74.00	-17.68	2.09 H	10	50.38	5.94
2	5150.00	43.96 AV	54.00	-10.04	2.09 H	10	38.02	5.94
3	*5260.00	105.11 PK			2.09 H	10	98.75	6.36
4	*5260.00	91.88 AV			2.09 H	10	85.52	6.36
5	#10520.00	56.81 PK	74.00	-17.19	1.62 H	204	40.23	16.58
6	#10520.00	42.66 AV	54.00	-11.34	1.62 H	204	26.08	16.58

ANTENNA POLARITY & TEST DISTANCE: VERTICAL AT 3 M

NO.	FREQ. (MHz)	EMISSION LEVEL (dBuV/m)	LIMIT (dBuV/m)	MARGIN (dB)	ANTENNA HEIGHT (m)	TABLE ANGLE (Degree)	RAW VALUE (dBuV)	CORRECTION FACTOR (dB/m)
1	5150.00	57.60 PK	74.00	-16.40	1.77 V	171	51.66	5.94
2	5150.00	44.73 AV	54.00	-9.27	1.77 V	171	38.79	5.94
3	*5260.00	121.20 PK			1.77 V	171	114.84	6.36
4	*5260.00	108.05 AV			1.77 V	171	101.69	6.36
5	#10520.00	58.09 PK	74.00	-15.91	1.49 V	237	41.51	16.58
6	#10520.00	44.22 AV	54.00	-9.78	1.49 V	237	27.64	16.58

REMARKS:

1. Emission Level(dBuV/m) = Raw Value(dBuV) + Correction Factor(dB/m)
2. Correction Factor(dB/m) = Antenna Factor(dB/m) + Cable Factor(dB) – Pre-Amplifier Factor(dB)
3. The other emission levels were very low against the limit.
4. Margin value = Emission Level – Limit value
5. " * ": Fundamental frequency.
6. " # ": The radiated frequency is out of the restricted band.

CHANNEL	TX Channel 60	DETECTOR FUNCTION	Peak (PK)
FREQUENCY RANGE	1GHz ~ 40GHz		Average (AV)

ANTENNA POLARITY & TEST DISTANCE: HORIZONTAL AT 3 M

NO.	FREQ. (MHz)	EMISSION LEVEL (dBuV/m)	LIMIT (dBuV/m)	MARGIN (dB)	ANTENNA HEIGHT (m)	TABLE ANGLE (Degree)	RAW VALUE (dBuV)	CORRECTION FACTOR (dB/m)
1	*5300.00	106.36 PK			2.11 H	7	99.84	6.52
2	*5300.00	93.19 AV			2.11 H	7	86.67	6.52
3	10600.00	57.17 PK	74.00	-16.83	1.55 H	217	40.31	16.86
4	10600.00	42.80 AV	54.00	-11.20	1.55 H	217	25.94	16.86

ANTENNA POLARITY & TEST DISTANCE: VERTICAL AT 3 M

NO.	FREQ. (MHz)	EMISSION LEVEL (dBuV/m)	LIMIT (dBuV/m)	MARGIN (dB)	ANTENNA HEIGHT (m)	TABLE ANGLE (Degree)	RAW VALUE (dBuV)	CORRECTION FACTOR (dB/m)
1	*5300.00	120.74 PK			1.80 V	174	114.22	6.52
2	*5300.00	107.79 AV			1.80 V	174	101.27	6.52
3	10600.00	58.44 PK	74.00	-15.56	1.36 V	230	41.58	16.86
4	10600.00	44.20 AV	54.00	-9.80	1.36 V	230	27.34	16.86

REMARKS:

1. Emission Level(dBuV/m) = Raw Value(dBuV) + Correction Factor(dB/m)
2. Correction Factor(dB/m) = Antenna Factor(dB/m) + Cable Factor(dB) – Pre-Amplifier Factor(dB)
3. The other emission levels were very low against the limit.
4. Margin value = Emission Level – Limit value
5. " * ": Fundamental frequency.

CHANNEL	TX Channel 64	DETECTOR FUNCTION	Peak (PK)
FREQUENCY RANGE	1GHz ~ 40GHz		Average (AV)

ANTENNA POLARITY & TEST DISTANCE: HORIZONTAL AT 3 M

NO.	FREQ. (MHz)	EMISSION LEVEL (dBuV/m)	LIMIT (dBuV/m)	MARGIN (dB)	ANTENNA HEIGHT (m)	TABLE ANGLE (Degree)	RAW VALUE (dBuV)	CORRECTION FACTOR (dB/m)
1	*5320.00	106.29 PK			2.06 H	9	99.67	6.62
2	*5320.00	93.32 AV			2.06 H	9	86.70	6.62
3	5350.00	57.69 PK	74.00	-16.31	2.06 H	9	50.94	6.75
4	5350.00	44.27 AV	54.00	-9.73	2.06 H	9	37.52	6.75
5	10640.00	57.04 PK	74.00	-16.96	1.63 H	209	40.18	16.86
6	10640.00	42.83 AV	54.00	-11.17	1.63 H	209	25.97	16.86

ANTENNA POLARITY & TEST DISTANCE: VERTICAL AT 3 M

NO.	FREQ. (MHz)	EMISSION LEVEL (dBuV/m)	LIMIT (dBuV/m)	MARGIN (dB)	ANTENNA HEIGHT (m)	TABLE ANGLE (Degree)	RAW VALUE (dBuV)	CORRECTION FACTOR (dB/m)
1	*5320.00	121.27 PK			1.74 V	172	114.65	6.62
2	*5320.00	108.02 AV			1.74 V	172	101.40	6.62
3	5350.00	58.50 PK	74.00	-15.50	1.74 V	172	51.75	6.75
4	5350.00	45.41 AV	54.00	-8.59	1.74 V	172	38.66	6.75
5	10640.00	57.73 PK	74.00	-16.27	1.42 V	227	40.87	16.86
6	10640.00	43.95 AV	54.00	-10.05	1.42 V	227	27.09	16.86

REMARKS:

1. Emission Level(dBuV/m) = Raw Value(dBuV) + Correction Factor(dB/m)
2. Correction Factor(dB/m) = Antenna Factor(dB/m) + Cable Factor(dB) – Pre-Amplifier Factor(dB)
3. The other emission levels were very low against the limit.
4. Margin value = Emission Level – Limit value
5. " * ": Fundamental frequency.

CHANNEL	TX Channel 100	DETECTOR FUNCTION	Peak (PK)
FREQUENCY RANGE	1GHz ~ 40GHz		Average (AV)

ANTENNA POLARITY & TEST DISTANCE: HORIZONTAL AT 3 M

NO.	FREQ. (MHz)	EMISSION LEVEL (dBuV/m)	LIMIT (dBuV/m)	MARGIN (dB)	ANTENNA HEIGHT (m)	TABLE ANGLE (Degree)	RAW VALUE (dBuV)	CORRECTION FACTOR (dB/m)
1	5460.00	58.81 PK	74.00	-15.19	2.09 H	17	51.63	7.18
2	5460.00	45.38 AV	54.00	-8.62	2.09 H	17	38.20	7.18
3	5470.00	59.15 PK	68.20	-9.05	2.09 H	17	51.94	7.21
4	*5500.00	105.95 PK			2.09 H	17	98.64	7.31
5	*5500.00	94.89 AV			2.09 H	17	87.58	7.31
6	11000.00	58.08 PK	74.00	-15.92	1.70 H	222	39.84	18.24
7	11000.00	43.87 AV	54.00	-10.13	1.70 H	222	25.63	18.24

ANTENNA POLARITY & TEST DISTANCE: VERTICAL AT 3 M

NO.	FREQ. (MHz)	EMISSION LEVEL (dBuV/m)	LIMIT (dBuV/m)	MARGIN (dB)	ANTENNA HEIGHT (m)	TABLE ANGLE (Degree)	RAW VALUE (dBuV)	CORRECTION FACTOR (dB/m)
1	5460.00	60.40 PK	74.00	-13.60	1.82 V	171	53.22	7.18
2	5460.00	47.49 AV	54.00	-6.51	1.82 V	171	40.31	7.18
3	5470.00	61.39 PK	68.20	-6.81	1.82 V	171	54.18	7.21
4	*5500.00	122.27 PK			1.82 V	171	114.96	7.31
5	*5500.00	109.12 AV			1.82 V	171	101.81	7.31
6	11000.00	59.33 PK	74.00	-14.67	1.33 V	261	41.09	18.24
7	11000.00	45.12 AV	54.00	-8.88	1.33 V	261	26.88	18.24

REMARKS:

1. Emission Level(dBuV/m) = Raw Value(dBuV) + Correction Factor(dB/m)
2. Correction Factor(dB/m) = Antenna Factor(dB/m) + Cable Factor(dB) – Pre-Amplifier Factor(dB)
3. The other emission levels were very low against the limit.
4. Margin value = Emission Level – Limit value
5. " * ": Fundamental frequency.
6. " # ": The radiated frequency is out of the restricted band.

CHANNEL	TX Channel 116	DETECTOR FUNCTION	Peak (PK)
FREQUENCY RANGE	1GHz ~ 40GHz		Average (AV)

ANTENNA POLARITY & TEST DISTANCE: HORIZONTAL AT 3 M

NO.	FREQ. (MHz)	EMISSION LEVEL (dBuV/m)	LIMIT (dBuV/m)	MARGIN (dB)	ANTENNA HEIGHT (m)	TABLE ANGLE (Degree)	RAW VALUE (dBuV)	CORRECTION FACTOR (dB/m)
1	*5580.00	106.30 PK			2.15 H	9	98.94	7.36
2	*5580.00	95.19 AV			2.15 H	9	87.83	7.36
3	11160.00	57.44 PK	74.00	-16.56	1.68 H	212	39.81	17.63
4	11160.00	43.35 AV	54.00	-10.65	1.68 H	212	25.72	17.63

ANTENNA POLARITY & TEST DISTANCE: VERTICAL AT 3 M

NO.	FREQ. (MHz)	EMISSION LEVEL (dBuV/m)	LIMIT (dBuV/m)	MARGIN (dB)	ANTENNA HEIGHT (m)	TABLE ANGLE (Degree)	RAW VALUE (dBuV)	CORRECTION FACTOR (dB/m)
1	*5580.00	122.52 PK			1.80 V	173	115.16	7.36
2	*5580.00	109.39 AV			1.80 V	173	102.03	7.36
3	11160.00	58.59 PK	74.00	-15.41	1.37 V	250	40.96	17.63
4	11160.00	44.37 AV	54.00	-9.63	1.37 V	250	26.74	17.63

REMARKS:

1. Emission Level(dBuV/m) = Raw Value(dBuV) + Correction Factor(dB/m)
2. Correction Factor(dB/m) = Antenna Factor(dB/m) + Cable Factor(dB) – Pre-Amplifier Factor(dB)
3. The other emission levels were very low against the limit.
4. Margin value = Emission Level – Limit value
5. " * ": Fundamental frequency.

CHANNEL	TX Channel 132	DETECTOR FUNCTION	Peak (PK)
FREQUENCY RANGE	1GHz ~ 40GHz		Average (AV)

ANTENNA POLARITY & TEST DISTANCE: HORIZONTAL AT 3 M

NO.	FREQ. (MHz)	EMISSION LEVEL (dBuV/m)	LIMIT (dBuV/m)	MARGIN (dB)	ANTENNA HEIGHT (m)	TABLE ANGLE (Degree)	RAW VALUE (dBuV)	CORRECTION FACTOR (dB/m)
1	*5660.00	107.17 PK			2.20 H	13	99.81	7.36
2	*5660.00	96.30 AV			2.20 H	13	88.94	7.36
3	11320.00	57.08 PK	74.00	-16.92	1.62 H	210	39.95	17.13
4	11320.00	42.96 AV	54.00	-11.04	1.62 H	210	25.83	17.13

ANTENNA POLARITY & TEST DISTANCE: VERTICAL AT 3 M

NO.	FREQ. (MHz)	EMISSION LEVEL (dBuV/m)	LIMIT (dBuV/m)	MARGIN (dB)	ANTENNA HEIGHT (m)	TABLE ANGLE (Degree)	RAW VALUE (dBuV)	CORRECTION FACTOR (dB/m)
1	*5660.00	122.34 PK			1.77 V	175	114.98	7.36
2	*5660.00	109.13 AV			1.77 V	175	101.77	7.36
3	11320.00	58.01 PK	74.00	-15.99	1.41 V	243	40.88	17.13
4	11320.00	43.93 AV	54.00	-10.07	1.41 V	243	26.80	17.13

REMARKS:

1. Emission Level(dBuV/m) = Raw Value(dBuV) + Correction Factor(dB/m)
2. Correction Factor(dB/m) = Antenna Factor(dB/m) + Cable Factor(dB) – Pre-Amplifier Factor(dB)
3. The other emission levels were very low against the limit.
4. Margin value = Emission Level – Limit value
5. " * ": Fundamental frequency.

CHANNEL	TX Channel 140	DETECTOR FUNCTION	Peak (PK)
FREQUENCY RANGE	1GHz ~ 40GHz		Average (AV)

ANTENNA POLARITY & TEST DISTANCE: HORIZONTAL AT 3 M

NO.	FREQ. (MHz)	EMISSION LEVEL (dBuV/m)	LIMIT (dBuV/m)	MARGIN (dB)	ANTENNA HEIGHT (m)	TABLE ANGLE (Degree)	RAW VALUE (dBuV)	CORRECTION FACTOR (dB/m)
1	*5700.00	106.99 PK			2.17 H	17	99.65	7.34
2	*5700.00	95.85 AV			2.17 H	17	88.51	7.34
3	5725.00	61.05 PK	68.20	-7.15	2.17 H	17	53.68	7.37
4	11400.00	57.28 PK	74.00	-16.72	1.66 H	208	40.05	17.23
5	11400.00	43.17 AV	54.00	-10.83	1.66 H	208	25.94	17.23

ANTENNA POLARITY & TEST DISTANCE: VERTICAL AT 3 M

NO.	FREQ. (MHz)	EMISSION LEVEL (dBuV/m)	LIMIT (dBuV/m)	MARGIN (dB)	ANTENNA HEIGHT (m)	TABLE ANGLE (Degree)	RAW VALUE (dBuV)	CORRECTION FACTOR (dB/m)
1	*5700.00	122.52 PK			1.83 V	176	115.18	7.34
2	*5700.00	109.40 AV			1.83 V	176	102.06	7.34
3	5725.00	64.59 PK	68.20	-3.61	1.83 V	176	57.22	7.37
4	11400.00	58.29 PK	74.00	-15.71	1.35 V	244	41.06	17.23
5	11400.00	44.34 AV	54.00	-9.66	1.35 V	244	27.11	17.23

REMARKS:

1. Emission Level(dBuV/m) = Raw Value(dBuV) + Correction Factor(dB/m)
2. Correction Factor(dB/m) = Antenna Factor(dB/m) + Cable Factor(dB) – Pre-Amplifier Factor(dB)
3. The other emission levels were very low against the limit.
4. Margin value = Emission Level – Limit value
5. " * ": Fundamental frequency.

802.11ac (40MHz)

CHANNEL	TX Channel 54	DETECTOR FUNCTION	Peak (PK)
FREQUENCY RANGE	1GHz ~ 40GHz		Average (AV)

ANTENNA POLARITY & TEST DISTANCE: HORIZONTAL AT 3 M

NO.	FREQ. (MHz)	EMISSION LEVEL (dBuV/m)	LIMIT (dBuV/m)	MARGIN (dB)	ANTENNA HEIGHT (m)	TABLE ANGLE (Degree)	RAW VALUE (dBuV)	CORRECTION FACTOR (dB/m)
1	5150.00	56.98 PK	74.00	-17.02	2.20 H	10	51.04	5.94
2	5150.00	43.46 AV	54.00	-10.54	2.20 H	10	37.52	5.94
3	*5270.00	104.29 PK			2.20 H	10	97.89	6.40
4	*5270.00	93.33 AV			2.20 H	10	86.93	6.40
5	#10540.00	56.57 PK	74.00	-17.43	1.65 H	218	39.92	16.65
6	#10540.00	42.48 AV	54.00	-11.52	1.65 H	218	25.83	16.65

ANTENNA POLARITY & TEST DISTANCE: VERTICAL AT 3 M

NO.	FREQ. (MHz)	EMISSION LEVEL (dBuV/m)	LIMIT (dBuV/m)	MARGIN (dB)	ANTENNA HEIGHT (m)	TABLE ANGLE (Degree)	RAW VALUE (dBuV)	CORRECTION FACTOR (dB/m)
1	5150.00	58.21 PK	74.00	-15.79	1.81 V	174	52.27	5.94
2	5150.00	44.54 AV	54.00	-9.46	1.81 V	174	38.60	5.94
3	*5270.00	119.02 PK			1.81 V	174	112.62	6.40
4	*5270.00	107.98 AV			1.81 V	174	101.58	6.40
5	#10540.00	57.58 PK	74.00	-16.42	1.50 V	239	40.93	16.65
6	#10540.00	43.40 AV	54.00	-10.60	1.50 V	239	26.75	16.65

REMARKS:

1. Emission Level(dBuV/m) = Raw Value(dBuV) + Correction Factor(dB/m)
2. Correction Factor(dB/m) = Antenna Factor(dB/m) + Cable Factor(dB) – Pre-Amplifier Factor(dB)
3. The other emission levels were very low against the limit.
4. Margin value = Emission Level – Limit value
5. " * ": Fundamental frequency.
6. " # ": The radiated frequency is out of the restricted band.

CHANNEL	TX Channel 62	DETECTOR FUNCTION	Peak (PK)
FREQUENCY RANGE	1GHz ~ 40GHz		Average (AV)

ANTENNA POLARITY & TEST DISTANCE: HORIZONTAL AT 3 M

NO.	FREQ. (MHz)	EMISSION LEVEL (dBuV/m)	LIMIT (dBuV/m)	MARGIN (dB)	ANTENNA HEIGHT (m)	TABLE ANGLE (Degree)	RAW VALUE (dBuV)	CORRECTION FACTOR (dB/m)
1	*5310.00	104.60 PK			2.07 H	8	98.03	6.57
2	*5310.00	93.51 AV			2.07 H	8	86.94	6.57
3	5350.00	60.09 PK	74.00	-13.91	2.07 H	8	53.34	6.75
4	5350.00	47.42 AV	54.00	-6.58	2.07 H	8	40.67	6.75
5	10620.00	56.71 PK	74.00	-17.29	1.70 H	221	39.85	16.86
6	10620.00	42.65 AV	54.00	-11.35	1.70 H	221	25.79	16.86

ANTENNA POLARITY & TEST DISTANCE: VERTICAL AT 3 M

NO.	FREQ. (MHz)	EMISSION LEVEL (dBuV/m)	LIMIT (dBuV/m)	MARGIN (dB)	ANTENNA HEIGHT (m)	TABLE ANGLE (Degree)	RAW VALUE (dBuV)	CORRECTION FACTOR (dB/m)
1	*5310.00	118.99 PK			1.81 V	173	112.42	6.57
2	*5310.00	107.94 AV			1.81 V	173	101.37	6.57
3	5350.00	62.37 PK	74.00	-11.63	1.81 V	173	55.62	6.75
4	5350.00	49.46 AV	54.00	-4.54	1.81 V	173	42.71	6.75
5	10620.00	57.71 PK	74.00	-16.29	1.46 V	245	40.85	16.86
6	10620.00	43.68 AV	54.00	-10.32	1.46 V	245	26.82	16.86

REMARKS:

1. Emission Level(dBuV/m) = Raw Value(dBuV) + Correction Factor(dB/m)
2. Correction Factor(dB/m) = Antenna Factor(dB/m) + Cable Factor(dB) – Pre-Amplifier Factor(dB)
3. The other emission levels were very low against the limit.
4. Margin value = Emission Level – Limit value
5. " * ": Fundamental frequency.

CHANNEL	TX Channel 102	DETECTOR FUNCTION	Peak (PK)
FREQUENCY RANGE	1GHz ~ 40GHz		Average (AV)

ANTENNA POLARITY & TEST DISTANCE: HORIZONTAL AT 3 M

NO.	FREQ. (MHz)	EMISSION LEVEL (dBuV/m)	LIMIT (dBuV/m)	MARGIN (dB)	ANTENNA HEIGHT (m)	TABLE ANGLE (Degree)	RAW VALUE (dBuV)	CORRECTION FACTOR (dB/m)
1	5460.00	59.51 PK	74.00	-14.49	2.21 H	7	52.33	7.18
2	5460.00	46.25 AV	54.00	-7.75	2.21 H	7	39.07	7.18
3	5470.00	61.77 PK	68.20	-6.43	2.21 H	7	54.56	7.21
4	*5510.00	106.24 PK			2.21 H	7	98.92	7.32
5	*5510.00	95.38 AV			2.21 H	7	88.06	7.32
6	11020.00	58.26 PK	74.00	-15.74	1.72 H	200	40.08	18.18
7	11020.00	44.12 AV	54.00	-9.88	1.72 H	200	25.94	18.18

ANTENNA POLARITY & TEST DISTANCE: VERTICAL AT 3 M

NO.	FREQ. (MHz)	EMISSION LEVEL (dBuV/m)	LIMIT (dBuV/m)	MARGIN (dB)	ANTENNA HEIGHT (m)	TABLE ANGLE (Degree)	RAW VALUE (dBuV)	CORRECTION FACTOR (dB/m)
1	5460.00	62.61 PK	74.00	-11.39	1.80 V	174	55.43	7.18
2	5460.00	49.47 AV	54.00	-4.53	1.80 V	174	42.29	7.18
3	5470.00	65.70 PK	68.20	-2.50	1.80 V	174	58.49	7.21
4	*5510.00	118.94 PK			1.80 V	174	111.62	7.32
5	*5510.00	108.06 AV			1.80 V	174	100.74	7.32
6	11020.00	59.49 PK	74.00	-14.51	1.31 V	266	41.31	18.18
7	11020.00	45.00 AV	54.00	-9.00	1.31 V	266	26.82	18.18

REMARKS:

1. Emission Level(dBuV/m) = Raw Value(dBuV) + Correction Factor(dB/m)
2. Correction Factor(dB/m) = Antenna Factor(dB/m) + Cable Factor(dB) – Pre-Amplifier Factor(dB)
3. The other emission levels were very low against the limit.
4. Margin value = Emission Level – Limit value
5. " * ": Fundamental frequency.

CHANNEL	TX Channel 110	DETECTOR FUNCTION	Peak (PK)
FREQUENCY RANGE	1GHz ~ 40GHz		Average (AV)

ANTENNA POLARITY & TEST DISTANCE: HORIZONTAL AT 3 M

NO.	FREQ. (MHz)	EMISSION LEVEL (dBuV/m)	LIMIT (dBuV/m)	MARGIN (dB)	ANTENNA HEIGHT (m)	TABLE ANGLE (Degree)	RAW VALUE (dBuV)	CORRECTION FACTOR (dB/m)
1	*5550.00	106.37 PK			2.17 H	9	99.03	7.34
2	*5550.00	96.28 AV			2.17 H	9	88.94	7.34
3	11100.00	57.91 PK	74.00	-16.09	1.67 H	205	40.02	17.89
4	11100.00	43.77 AV	54.00	-10.23	1.67 H	205	25.88	17.89

ANTENNA POLARITY & TEST DISTANCE: VERTICAL AT 3 M

NO.	FREQ. (MHz)	EMISSION LEVEL (dBuV/m)	LIMIT (dBuV/m)	MARGIN (dB)	ANTENNA HEIGHT (m)	TABLE ANGLE (Degree)	RAW VALUE (dBuV)	CORRECTION FACTOR (dB/m)
1	*5550.00	119.55 PK			1.76 V	172	112.21	7.34
2	*5550.00	108.47 AV			1.76 V	172	101.13	7.34
3	11100.00	58.87 PK	74.00	-15.13	1.39 V	253	40.98	17.89
4	11100.00	44.48 AV	54.00	-9.52	1.39 V	253	26.59	17.89

REMARKS:

1. Emission Level(dBuV/m) = Raw Value(dBuV) + Correction Factor(dB/m)
2. Correction Factor(dB/m) = Antenna Factor(dB/m) + Cable Factor(dB) – Pre-Amplifier Factor(dB)
3. The other emission levels were very low against the limit.
4. Margin value = Emission Level – Limit value
5. " * ": Fundamental frequency.

CHANNEL	TX Channel 134	DETECTOR FUNCTION	Peak (PK)
FREQUENCY RANGE	1GHz ~ 40GHz		Average (AV)

ANTENNA POLARITY & TEST DISTANCE: HORIZONTAL AT 3 M

NO.	FREQ. (MHz)	EMISSION LEVEL (dBuV/m)	LIMIT (dBuV/m)	MARGIN (dB)	ANTENNA HEIGHT (m)	TABLE ANGLE (Degree)	RAW VALUE (dBuV)	CORRECTION FACTOR (dB/m)
1	*5670.00	106.17 PK			2.10 H	11	98.81	7.36
2	*5670.00	95.05 AV			2.10 H	11	87.69	7.36
3	5725.00	60.79 PK	68.20	-7.41	2.10 H	11	53.42	7.37
4	11340.00	57.08 PK	74.00	-16.92	1.65 H	214	39.92	17.16
5	11340.00	42.89 AV	54.00	-11.11	1.65 H	214	25.73	17.16

ANTENNA POLARITY & TEST DISTANCE: VERTICAL AT 3 M

NO.	FREQ. (MHz)	EMISSION LEVEL (dBuV/m)	LIMIT (dBuV/m)	MARGIN (dB)	ANTENNA HEIGHT (m)	TABLE ANGLE (Degree)	RAW VALUE (dBuV)	CORRECTION FACTOR (dB/m)
1	*5670.00	119.24 PK			1.82 V	177	111.88	7.36
2	*5670.00	108.10 AV			1.82 V	177	100.74	7.36
3	5725.00	64.56 PK	68.20	-3.64	1.82 V	177	57.19	7.37
4	11340.00	57.98 PK	74.00	-16.02	1.33 V	257	40.82	17.16
5	11340.00	43.86 AV	54.00	-10.14	1.33 V	257	26.70	17.16

REMARKS:

1. Emission Level(dBuV/m) = Raw Value(dBuV) + Correction Factor(dB/m)
2. Correction Factor(dB/m) = Antenna Factor(dB/m) + Cable Factor(dB) – Pre-Amplifier Factor(dB)
3. The other emission levels were very low against the limit.
4. Margin value = Emission Level – Limit value
5. " * ": Fundamental frequency.
6. " # ": The radiated frequency is out of the restricted band.

802.11ac (80MHz)

CHANNEL	TX Channel 58	DETECTOR FUNCTION	Peak (PK)
FREQUENCY RANGE	1GHz ~ 40GHz		Average (AV)

ANTENNA POLARITY & TEST DISTANCE: HORIZONTAL AT 3 M

NO.	FREQ. (MHz)	EMISSION LEVEL (dBuV/m)	LIMIT (dBuV/m)	MARGIN (dB)	ANTENNA HEIGHT (m)	TABLE ANGLE (Degree)	RAW VALUE (dBuV)	CORRECTION FACTOR (dB/m)
1	5150.00	58.60 PK	74.00	-15.40	2.13 H	11	52.66	5.94
2	5150.00	45.08 AV	54.00	-8.92	2.13 H	11	39.14	5.94
3	*5290.00	101.31 PK			2.13 H	11	94.83	6.48
4	*5290.00	91.15 AV			2.13 H	11	84.67	6.48
5	5350.00	67.92 PK	74.00	-6.08	2.13 H	11	61.17	6.75
6	5350.00	49.02 AV	54.00	-4.98	2.13 H	11	42.27	6.75
7	#10580.00	56.75 PK	74.00	-17.25	1.77 H	206	39.96	16.79
8	#10580.00	42.94 AV	54.00	-11.06	1.77 H	206	26.15	16.79

ANTENNA POLARITY & TEST DISTANCE: VERTICAL AT 3 M

NO.	FREQ. (MHz)	EMISSION LEVEL (dBuV/m)	LIMIT (dBuV/m)	MARGIN (dB)	ANTENNA HEIGHT (m)	TABLE ANGLE (Degree)	RAW VALUE (dBuV)	CORRECTION FACTOR (dB/m)
1	5150.00	58.27 PK	74.00	-15.73	1.73 V	168	52.33	5.94
2	5150.00	45.77 AV	54.00	-8.23	1.73 V	168	39.83	5.94
3	*5290.00	112.00 PK			1.73 V	168	105.52	6.48
4	*5290.00	101.62 AV			1.73 V	168	95.14	6.48
5	5350.00	69.63 PK	74.00	-4.37	1.73 V	168	62.88	6.75
6	5350.00	52.83 AV	54.00	-1.17	1.73 V	168	46.08	6.75
7	#10580.00	58.01 PK	74.00	-15.99	1.42 V	237	41.22	16.79
8	#10580.00	43.82 AV	54.00	-10.18	1.42 V	237	27.03	16.79

REMARKS:

1. Emission Level(dBuV/m) = Raw Value(dBuV) + Correction Factor(dB/m)
2. Correction Factor(dB/m) = Antenna Factor(dB/m) + Cable Factor(dB) – Pre-Amplifier Factor(dB)
3. The other emission levels were very low against the limit.
4. Margin value = Emission Level – Limit value
5. " * ": Fundamental frequency.
6. " # ": The radiated frequency is out of the restricted band.

CHANNEL	TX Channel 106	DETECTOR FUNCTION	Peak (PK)
FREQUENCY RANGE	1GHz ~ 40GHz		Average (AV)

ANTENNA POLARITY & TEST DISTANCE: HORIZONTAL AT 3 M

NO.	FREQ. (MHz)	EMISSION LEVEL (dBuV/m)	LIMIT (dBuV/m)	MARGIN (dB)	ANTENNA HEIGHT (m)	TABLE ANGLE (Degree)	RAW VALUE (dBuV)	CORRECTION FACTOR (dB/m)
1	5460.00	62.52 PK	74.00	-11.48	2.06 H	6	55.34	7.18
2	5460.00	49.76 AV	54.00	-4.24	2.06 H	6	42.58	7.18
3	5470.00	63.32 PK	68.20	-4.88	2.06 H	6	56.11	7.21
4	*5530.00	104.07 PK			2.06 H	6	96.74	7.33
5	*5530.00	93.85 AV			2.06 H	6	86.52	7.33
6	11060.00	57.96 PK	74.00	-16.04	1.58 H	193	39.92	18.04
7	11060.00	43.54 AV	54.00	-10.46	1.58 H	193	25.50	18.04

ANTENNA POLARITY & TEST DISTANCE: VERTICAL AT 3 M

NO.	FREQ. (MHz)	EMISSION LEVEL (dBuV/m)	LIMIT (dBuV/m)	MARGIN (dB)	ANTENNA HEIGHT (m)	TABLE ANGLE (Degree)	RAW VALUE (dBuV)	CORRECTION FACTOR (dB/m)
1	5460.00	64.36 PK	74.00	-9.64	1.84 V	177	57.18	7.18
2	5460.00	51.56 AV	54.00	-2.44	1.84 V	177	44.38	7.18
3	5470.00	67.15 PK	68.20	-1.05	1.84 V	177	59.94	7.21
4	*5530.00	113.56 PK			1.84 V	177	106.23	7.33
5	*5530.00	103.50 AV			1.84 V	177	96.17	7.33
6	11060.00	59.12 PK	74.00	-14.88	1.33 V	261	41.08	18.04
7	11060.00	44.83 AV	54.00	-9.17	1.33 V	261	26.79	18.04

REMARKS:

1. Emission Level(dBuV/m) = Raw Value(dBuV) + Correction Factor(dB/m)
2. Correction Factor(dB/m) = Antenna Factor(dB/m) + Cable Factor(dB) – Pre-Amplifier Factor(dB)
3. The other emission levels were very low against the limit.
4. Margin value = Emission Level – Limit value
5. " * ": Fundamental frequency.

CHANNEL	TX Channel 122	DETECTOR FUNCTION	Peak (PK)
FREQUENCY RANGE	1GHz ~ 40GHz		Average (AV)

ANTENNA POLARITY & TEST DISTANCE: HORIZONTAL AT 3 M

NO.	FREQ. (MHz)	EMISSION LEVEL (dBuV/m)	LIMIT (dBuV/m)	MARGIN (dB)	ANTENNA HEIGHT (m)	TABLE ANGLE (Degree)	RAW VALUE (dBuV)	CORRECTION FACTOR (dB/m)
1	*5610.00	104.92 PK			2.12 H	8	97.55	7.37
2	*5610.00	94.64 AV			2.12 H	8	87.27	7.37
3	5725.00	63.54 PK	68.20	-4.66	2.12 H	8	56.17	7.37
4	11220.00	57.28 PK	74.00	-16.72	1.52 H	189	39.88	17.40
5	11220.00	42.81 AV	54.00	-11.19	1.52 H	189	25.41	17.40

ANTENNA POLARITY & TEST DISTANCE: VERTICAL AT 3 M

NO.	FREQ. (MHz)	EMISSION LEVEL (dBuV/m)	LIMIT (dBuV/m)	MARGIN (dB)	ANTENNA HEIGHT (m)	TABLE ANGLE (Degree)	RAW VALUE (dBuV)	CORRECTION FACTOR (dB/m)
1	*5610.00	115.29 PK			1.79 V	173	107.92	7.37
2	*5610.00	104.43 AV			1.79 V	173	97.06	7.37
3	5725.00	66.64 PK	68.20	-1.56	1.79 V	173	59.27	7.37
4	11220.00	58.36 PK	74.00	-15.64	1.40 V	258	40.96	17.40
5	11220.00	44.03 AV	54.00	-9.97	1.40 V	258	26.63	17.40

REMARKS:

1. Emission Level(dBuV/m) = Raw Value(dBuV) + Correction Factor(dB/m)
2. Correction Factor(dB/m) = Antenna Factor(dB/m) + Cable Factor(dB) – Pre-Amplifier Factor(dB)
3. The other emission levels were very low against the limit.
4. Margin value = Emission Level – Limit value
5. " * ": Fundamental frequency.

Beamforming_NSS1 Mode (Mode A)

802.11ac (20MHz)

CHANNEL	TX Channel 52	DETECTOR FUNCTION	Peak (PK)
FREQUENCY RANGE	1GHz ~ 40GHz		Average (AV)

ANTENNA POLARITY & TEST DISTANCE: HORIZONTAL AT 3 M

NO.	FREQ. (MHz)	EMISSION LEVEL (dBuV/m)	LIMIT (dBuV/m)	MARGIN (dB)	ANTENNA HEIGHT (m)	TABLE ANGLE (Degree)	RAW VALUE (dBuV)	CORRECTION FACTOR (dB/m)
1	5150.00	57.43 PK	74.00	-16.57	1.78 H	164	51.49	5.94
2	5150.00	43.79 AV	54.00	-10.21	1.78 H	164	37.85	5.94
3	*5260.00	106.82 PK			1.78 H	164	100.46	6.36
4	*5260.00	94.82 AV			1.78 H	164	88.46	6.36
5	#10520.00	56.25 PK	74.00	-17.75	2.14 H	214	39.67	16.58
6	#10520.00	42.42 AV	54.00	-11.58	2.14 H	214	25.84	16.58

ANTENNA POLARITY & TEST DISTANCE: VERTICAL AT 3 M

NO.	FREQ. (MHz)	EMISSION LEVEL (dBuV/m)	LIMIT (dBuV/m)	MARGIN (dB)	ANTENNA HEIGHT (m)	TABLE ANGLE (Degree)	RAW VALUE (dBuV)	CORRECTION FACTOR (dB/m)
1	5150.00	58.48 PK	74.00	-15.52	2.72 V	39	52.54	5.94
2	5150.00	44.21 AV	54.00	-9.79	2.72 V	39	38.27	5.94
3	*5260.00	117.77 PK			2.72 V	39	111.41	6.36
4	*5260.00	104.05 AV			2.72 V	39	97.69	6.36
5	#10520.00	57.45 PK	74.00	-16.55	1.56 V	225	40.87	16.58
6	#10520.00	43.27 AV	54.00	-10.73	1.56 V	225	26.69	16.58

REMARKS:

1. Emission Level(dBuV/m) = Raw Value(dBuV) + Correction Factor(dB/m)
2. Correction Factor(dB/m) = Antenna Factor(dB/m) + Cable Factor(dB) – Pre-Amplifier Factor(dB)
3. The other emission levels were very low against the limit.
4. Margin value = Emission Level – Limit value
5. " * ": Fundamental frequency.
6. " # ": The radiated frequency is out of the restricted band.

CHANNEL	TX Channel 60	DETECTOR FUNCTION	Peak (PK)
FREQUENCY RANGE	1GHz ~ 40GHz		Average (AV)

ANTENNA POLARITY & TEST DISTANCE: HORIZONTAL AT 3 M

NO.	FREQ. (MHz)	EMISSION LEVEL (dBuV/m)	LIMIT (dBuV/m)	MARGIN (dB)	ANTENNA HEIGHT (m)	TABLE ANGLE (Degree)	RAW VALUE (dBuV)	CORRECTION FACTOR (dB/m)
1	*5300.00	106.68 PK			1.84 H	158	100.16	6.52
2	*5300.00	94.86 AV			1.84 H	158	88.34	6.52
3	10600.00	56.53 PK	74.00	-17.47	2.67 H	141	39.67	16.86
4	10600.00	42.29 AV	54.00	-11.71	2.67 H	141	25.43	16.86

ANTENNA POLARITY & TEST DISTANCE: VERTICAL AT 3 M

NO.	FREQ. (MHz)	EMISSION LEVEL (dBuV/m)	LIMIT (dBuV/m)	MARGIN (dB)	ANTENNA HEIGHT (m)	TABLE ANGLE (Degree)	RAW VALUE (dBuV)	CORRECTION FACTOR (dB/m)
1	*5300.00	117.99 PK			2.68 V	43	111.47	6.52
2	*5300.00	105.38 AV			2.68 V	43	98.86	6.52
3	10600.00	57.83 PK	74.00	-16.17	1.38 V	46	40.97	16.86
4	10600.00	43.84 AV	54.00	-10.16	1.38 V	46	26.98	16.86

REMARKS:

1. Emission Level(dBuV/m) = Raw Value(dBuV) + Correction Factor(dB/m)
2. Correction Factor(dB/m) = Antenna Factor(dB/m) + Cable Factor(dB) – Pre-Amplifier Factor(dB)
3. The other emission levels were very low against the limit.
4. Margin value = Emission Level – Limit value
5. " * ": Fundamental frequency.

CHANNEL	TX Channel 64	DETECTOR FUNCTION	Peak (PK)
FREQUENCY RANGE	1GHz ~ 40GHz		Average (AV)

ANTENNA POLARITY & TEST DISTANCE: HORIZONTAL AT 3 M

NO.	FREQ. (MHz)	EMISSION LEVEL (dBuV/m)	LIMIT (dBuV/m)	MARGIN (dB)	ANTENNA HEIGHT (m)	TABLE ANGLE (Degree)	RAW VALUE (dBuV)	CORRECTION FACTOR (dB/m)
1	*5320.00	106.76 PK			1.84 H	153	100.14	6.62
2	*5320.00	94.87 AV			1.84 H	153	88.25	6.62
3	5350.00	57.78 PK	74.00	-16.22	1.84 H	153	51.03	6.75
4	5350.00	44.23 AV	54.00	-9.77	1.84 H	153	37.48	6.75
5	10640.00	56.70 PK	74.00	-17.30	1.23 H	108	39.84	16.86
6	10640.00	42.74 AV	54.00	-11.26	1.23 H	108	25.88	16.86

ANTENNA POLARITY & TEST DISTANCE: VERTICAL AT 3 M

NO.	FREQ. (MHz)	EMISSION LEVEL (dBuV/m)	LIMIT (dBuV/m)	MARGIN (dB)	ANTENNA HEIGHT (m)	TABLE ANGLE (Degree)	RAW VALUE (dBuV)	CORRECTION FACTOR (dB/m)
1	*5320.00	118.09 PK			2.66 V	45	111.47	6.62
2	*5320.00	105.05 AV			2.66 V	45	98.43	6.62
3	5350.00	58.21 PK	74.00	-15.79	2.66 V	45	51.46	6.75
4	5350.00	45.71 AV	54.00	-8.29	2.66 V	45	38.96	6.75
5	10640.00	57.73 PK	74.00	-16.27	2.18 V	259	40.87	16.86
6	10640.00	43.83 AV	54.00	-10.17	2.18 V	259	26.97	16.86

REMARKS:

1. Emission Level(dBuV/m) = Raw Value(dBuV) + Correction Factor(dB/m)
2. Correction Factor(dB/m) = Antenna Factor(dB/m) + Cable Factor(dB) – Pre-Amplifier Factor(dB)
3. The other emission levels were very low against the limit.
4. Margin value = Emission Level – Limit value
5. " * ": Fundamental frequency.

CHANNEL	TX Channel 100	DETECTOR FUNCTION	Peak (PK)
FREQUENCY RANGE	1GHz ~ 40GHz		Average (AV)

ANTENNA POLARITY & TEST DISTANCE: HORIZONTAL AT 3 M

NO.	FREQ. (MHz)	EMISSION LEVEL (dBuV/m)	LIMIT (dBuV/m)	MARGIN (dB)	ANTENNA HEIGHT (m)	TABLE ANGLE (Degree)	RAW VALUE (dBuV)	CORRECTION FACTOR (dB/m)
1	5460.00	58.59 PK	74.00	-15.41	1.78 H	160	51.41	7.18
2	5460.00	44.82 AV	54.00	-9.18	1.78 H	160	37.64	7.18
3	5470.00	62.67 PK	68.20	-5.53	1.78 H	160	55.46	7.21
4	*5500.00	107.32 PK			1.78 H	160	100.01	7.31
5	*5500.00	95.87 AV			1.78 H	160	88.56	7.31
6	11000.00	57.82 PK	74.00	-16.18	2.51 H	247	39.58	18.24
7	11000.00	43.33 AV	54.00	-10.67	2.51 H	247	25.09	18.24

ANTENNA POLARITY & TEST DISTANCE: VERTICAL AT 3 M

NO.	FREQ. (MHz)	EMISSION LEVEL (dBuV/m)	LIMIT (dBuV/m)	MARGIN (dB)	ANTENNA HEIGHT (m)	TABLE ANGLE (Degree)	RAW VALUE (dBuV)	CORRECTION FACTOR (dB/m)
1	5460.00	59.88 PK	74.00	-14.12	2.79 V	147	52.70	7.18
2	5460.00	46.06 AV	54.00	-7.94	2.79 V	147	38.88	7.18
3	5470.00	64.33 PK	68.20	-3.87	2.79 V	147	57.12	7.21
4	*5500.00	116.83 PK			2.79 V	147	109.52	7.31
5	*5500.00	104.31 AV			2.79 V	147	97.00	7.31
6	11000.00	59.08 PK	74.00	-14.92	1.84 V	241	40.84	18.24
7	11000.00	44.88 AV	54.00	-9.12	1.84 V	241	26.64	18.24

REMARKS:

1. Emission Level(dBuV/m) = Raw Value(dBuV) + Correction Factor(dB/m)
2. Correction Factor(dB/m) = Antenna Factor(dB/m) + Cable Factor(dB) – Pre-Amplifier Factor(dB)
3. The other emission levels were very low against the limit.
4. Margin value = Emission Level – Limit value
5. " * ": Fundamental frequency.

CHANNEL	TX Channel 116	DETECTOR FUNCTION	Peak (PK)
FREQUENCY RANGE	1GHz ~ 40GHz		Average (AV)

ANTENNA POLARITY & TEST DISTANCE: HORIZONTAL AT 3 M

NO.	FREQ. (MHz)	EMISSION LEVEL (dBuV/m)	LIMIT (dBuV/m)	MARGIN (dB)	ANTENNA HEIGHT (m)	TABLE ANGLE (Degree)	RAW VALUE (dBuV)	CORRECTION FACTOR (dB/m)
1	*5580.00	107.20 PK			1.81 H	159	99.84	7.36
2	*5580.00	95.05 AV			1.81 H	159	87.69	7.36
3	11160.00	56.86 PK	74.00	-17.14	1.52 H	236	39.23	17.63
4	11160.00	43.49 AV	54.00	-10.51	1.52 H	236	25.86	17.63

ANTENNA POLARITY & TEST DISTANCE: VERTICAL AT 3 M

NO.	FREQ. (MHz)	EMISSION LEVEL (dBuV/m)	LIMIT (dBuV/m)	MARGIN (dB)	ANTENNA HEIGHT (m)	TABLE ANGLE (Degree)	RAW VALUE (dBuV)	CORRECTION FACTOR (dB/m)
1	*5580.00	117.23 PK			2.82 V	154	109.87	7.36
2	*5580.00	104.48 AV			2.82 V	154	97.12	7.36
3	11160.00	58.52 PK	74.00	-15.48	2.51 V	226	40.89	17.63
4	11160.00	44.44 AV	54.00	-9.56	2.51 V	226	26.81	17.63

REMARKS:

1. Emission Level(dBuV/m) = Raw Value(dBuV) + Correction Factor(dB/m)
2. Correction Factor(dB/m) = Antenna Factor(dB/m) + Cable Factor(dB) – Pre-Amplifier Factor(dB)
3. The other emission levels were very low against the limit.
4. Margin value = Emission Level – Limit value
5. " * ": Fundamental frequency.

CHANNEL	TX Channel 132	DETECTOR FUNCTION	Peak (PK)
FREQUENCY RANGE	1GHz ~ 40GHz		Average (AV)

ANTENNA POLARITY & TEST DISTANCE: HORIZONTAL AT 3 M

NO.	FREQ. (MHz)	EMISSION LEVEL (dBuV/m)	LIMIT (dBuV/m)	MARGIN (dB)	ANTENNA HEIGHT (m)	TABLE ANGLE (Degree)	RAW VALUE (dBuV)	CORRECTION FACTOR (dB/m)
1	*5660.00	107.12 PK			1.76 H	163	99.76	7.36
2	*5660.00	94.61 AV			1.76 H	163	87.25	7.36
3	11320.00	56.29 PK	74.00	-17.71	1.67 H	142	39.16	17.13
4	11320.00	42.16 AV	54.00	-11.84	1.67 H	142	25.03	17.13

ANTENNA POLARITY & TEST DISTANCE: VERTICAL AT 3 M

NO.	FREQ. (MHz)	EMISSION LEVEL (dBuV/m)	LIMIT (dBuV/m)	MARGIN (dB)	ANTENNA HEIGHT (m)	TABLE ANGLE (Degree)	RAW VALUE (dBuV)	CORRECTION FACTOR (dB/m)
1	*5660.00	117.20 PK			2.83 V	144	109.84	7.36
2	*5660.00	104.80 AV			2.83 V	144	97.44	7.36
3	11320.00	57.77 PK	74.00	-16.23	2.10 V	64	40.64	17.13
4	11320.00	44.11 AV	54.00	-9.89	2.10 V	64	26.98	17.13

REMARKS:

1. Emission Level(dBuV/m) = Raw Value(dBuV) + Correction Factor(dB/m)
2. Correction Factor(dB/m) = Antenna Factor(dB/m) + Cable Factor(dB) – Pre-Amplifier Factor(dB)
3. The other emission levels were very low against the limit.
4. Margin value = Emission Level – Limit value
5. " * ": Fundamental frequency.

CHANNEL	TX Channel 140	DETECTOR FUNCTION	Peak (PK)
FREQUENCY RANGE	1GHz ~ 40GHz		Average (AV)

ANTENNA POLARITY & TEST DISTANCE: HORIZONTAL AT 3 M

NO.	FREQ. (MHz)	EMISSION LEVEL (dBuV/m)	LIMIT (dBuV/m)	MARGIN (dB)	ANTENNA HEIGHT (m)	TABLE ANGLE (Degree)	RAW VALUE (dBuV)	CORRECTION FACTOR (dB/m)
1	*5700.00	108.18 PK			1.82 H	160	100.84	7.34
2	*5700.00	95.93 AV			1.82 H	160	88.59	7.34
3	5725.00	58.87 PK	68.20	-9.33	1.82 H	160	51.50	7.37
4	11400.00	56.70 PK	74.00	-17.30	1.55 H	221	39.47	17.23
5	11400.00	42.58 AV	54.00	-11.42	1.55 H	221	25.35	17.23

ANTENNA POLARITY & TEST DISTANCE: VERTICAL AT 3 M

NO.	FREQ. (MHz)	EMISSION LEVEL (dBuV/m)	LIMIT (dBuV/m)	MARGIN (dB)	ANTENNA HEIGHT (m)	TABLE ANGLE (Degree)	RAW VALUE (dBuV)	CORRECTION FACTOR (dB/m)
1	*5700.00	117.65 PK			2.33 V	34	110.31	7.34
2	*5700.00	105.58 AV			2.33 V	34	98.24	7.34
3	5725.00	59.60 PK	68.20	-8.60	2.33 V	34	52.23	7.37
4	11400.00	57.76 PK	74.00	-16.24	1.82 V	205	40.53	17.23
5	11400.00	43.56 AV	54.00	-10.44	1.82 V	205	26.33	17.23

REMARKS:

1. Emission Level(dBuV/m) = Raw Value(dBuV) + Correction Factor(dB/m)
2. Correction Factor(dB/m) = Antenna Factor(dB/m) + Cable Factor(dB) – Pre-Amplifier Factor(dB)
3. The other emission levels were very low against the limit.
4. Margin value = Emission Level – Limit value
5. " * ": Fundamental frequency.

802.11ac (40MHz)

CHANNEL	TX Channel 54	DETECTOR FUNCTION	Peak (PK)
FREQUENCY RANGE	1GHz ~ 40GHz		Average (AV)

ANTENNA POLARITY & TEST DISTANCE: HORIZONTAL AT 3 M

NO.	FREQ. (MHz)	EMISSION LEVEL (dBuV/m)	LIMIT (dBuV/m)	MARGIN (dB)	ANTENNA HEIGHT (m)	TABLE ANGLE (Degree)	RAW VALUE (dBuV)	CORRECTION FACTOR (dB/m)
1	5150.00	57.42 PK	74.00	-16.58	1.84 H	152	51.48	5.94
2	5150.00	43.40 AV	54.00	-10.60	1.84 H	152	37.46	5.94
3	*5270.00	106.29 PK			1.84 H	152	99.89	6.40
4	*5270.00	92.98 AV			1.84 H	152	86.58	6.40
5	#10540.00	56.49 PK	74.00	-17.51	1.87 H	55	39.84	16.65
6	#10540.00	42.49 AV	54.00	-11.51	1.87 H	55	25.84	16.65

ANTENNA POLARITY & TEST DISTANCE: VERTICAL AT 3 M

NO.	FREQ. (MHz)	EMISSION LEVEL (dBuV/m)	LIMIT (dBuV/m)	MARGIN (dB)	ANTENNA HEIGHT (m)	TABLE ANGLE (Degree)	RAW VALUE (dBuV)	CORRECTION FACTOR (dB/m)
1	5150.00	58.40 PK	74.00	-15.60	2.58 V	38	52.46	5.94
2	5150.00	44.63 AV	54.00	-9.37	2.58 V	38	38.69	5.94
3	*5270.00	116.39 PK			2.58 V	38	109.99	6.40
4	*5270.00	101.51 AV			2.58 V	38	95.11	6.40
5	#10540.00	57.52 PK	74.00	-16.48	1.69 V	265	40.87	16.65
6	#10540.00	43.07 AV	54.00	-10.93	1.69 V	265	26.42	16.65

REMARKS:

1. Emission Level(dBuV/m) = Raw Value(dBuV) + Correction Factor(dB/m)
2. Correction Factor(dB/m) = Antenna Factor(dB/m) + Cable Factor(dB) – Pre-Amplifier Factor(dB)
3. The other emission levels were very low against the limit.
4. Margin value = Emission Level – Limit value
5. " * ": Fundamental frequency.
6. " # ": The radiated frequency is out of the restricted band.

CHANNEL	TX Channel 62	DETECTOR FUNCTION	Peak (PK)
FREQUENCY RANGE	1GHz ~ 40GHz		Average (AV)

ANTENNA POLARITY & TEST DISTANCE: HORIZONTAL AT 3 M

NO.	FREQ. (MHz)	EMISSION LEVEL (dBuV/m)	LIMIT (dBuV/m)	MARGIN (dB)	ANTENNA HEIGHT (m)	TABLE ANGLE (Degree)	RAW VALUE (dBuV)	CORRECTION FACTOR (dB/m)
1	*5310.00	106.42 PK			1.78 H	155	99.85	6.57
2	*5310.00	91.35 AV			1.78 H	155	84.78	6.57
3	5350.00	65.00 PK	74.00	-9.00	1.78 H	155	58.25	6.75
4	5350.00	46.91 AV	54.00	-7.09	1.78 H	155	40.16	6.75
5	10620.00	56.48 PK	74.00	-17.52	1.82 H	210	39.62	16.86
6	10620.00	41.91 AV	54.00	-12.09	1.82 H	210	25.05	16.86

ANTENNA POLARITY & TEST DISTANCE: VERTICAL AT 3 M

NO.	FREQ. (MHz)	EMISSION LEVEL (dBuV/m)	LIMIT (dBuV/m)	MARGIN (dB)	ANTENNA HEIGHT (m)	TABLE ANGLE (Degree)	RAW VALUE (dBuV)	CORRECTION FACTOR (dB/m)
1	*5310.00	116.45 PK			2.57 V	39	109.88	6.57
2	*5310.00	101.24 AV			2.57 V	39	94.67	6.57
3	5350.00	67.44 PK	74.00	-6.56	2.57 V	39	60.69	6.75
4	5350.00	48.15 AV	54.00	-5.85	2.57 V	39	41.40	6.75
5	10620.00	57.71 PK	74.00	-16.29	1.89 V	226	40.85	16.86
6	10620.00	43.23 AV	54.00	-10.77	1.89 V	226	26.37	16.86

REMARKS:

1. Emission Level(dBuV/m) = Raw Value(dBuV) + Correction Factor(dB/m)
2. Correction Factor(dB/m) = Antenna Factor(dB/m) + Cable Factor(dB) – Pre-Amplifier Factor(dB)
3. The other emission levels were very low against the limit.
4. Margin value = Emission Level – Limit value
5. " * ": Fundamental frequency.

CHANNEL	TX Channel 102	DETECTOR FUNCTION	Peak (PK)
FREQUENCY RANGE	1GHz ~ 40GHz		Average (AV)

ANTENNA POLARITY & TEST DISTANCE: HORIZONTAL AT 3 M

NO.	FREQ. (MHz)	EMISSION LEVEL (dBuV/m)	LIMIT (dBuV/m)	MARGIN (dB)	ANTENNA HEIGHT (m)	TABLE ANGLE (Degree)	RAW VALUE (dBuV)	CORRECTION FACTOR (dB/m)
1	5460.00	58.32 PK	74.00	-15.68	1.82 H	143	51.14	7.18
2	5460.00	44.87 AV	54.00	-9.13	1.82 H	143	37.69	7.18
3	5470.00	59.37 PK	68.20	-8.83	1.82 H	143	52.16	7.21
4	*5510.00	105.48 PK			1.82 H	143	98.16	7.32
5	*5510.00	92.11 AV			1.82 H	143	84.79	7.32
6	11020.00	57.42 PK	74.00	-16.58	2.36 H	225	39.24	18.18
7	11020.00	43.34 AV	54.00	-10.66	2.36 H	225	25.16	18.18

ANTENNA POLARITY & TEST DISTANCE: VERTICAL AT 3 M

NO.	FREQ. (MHz)	EMISSION LEVEL (dBuV/m)	LIMIT (dBuV/m)	MARGIN (dB)	ANTENNA HEIGHT (m)	TABLE ANGLE (Degree)	RAW VALUE (dBuV)	CORRECTION FACTOR (dB/m)
1	5460.00	59.34 PK	74.00	-14.66	2.05 V	26	52.16	7.18
2	5460.00	46.17 AV	54.00	-7.83	2.05 V	26	38.99	7.18
3	5470.00	63.06 PK	68.20	-5.14	2.05 V	26	55.85	7.21
4	*5510.00	115.82 PK			2.05 V	26	108.50	7.32
5	*5510.00	102.15 AV			2.05 V	26	94.83	7.32
6	11020.00	59.02 PK	74.00	-14.98	1.62 V	297	40.84	18.18
7	11020.00	44.82 AV	54.00	-9.18	1.62 V	297	26.64	18.18

REMARKS:

1. Emission Level(dBuV/m) = Raw Value(dBuV) + Correction Factor(dB/m)
2. Correction Factor(dB/m) = Antenna Factor(dB/m) + Cable Factor(dB) – Pre-Amplifier Factor(dB)
3. The other emission levels were very low against the limit.
4. Margin value = Emission Level – Limit value
5. " * ": Fundamental frequency.

CHANNEL	TX Channel 110	DETECTOR FUNCTION	Peak (PK)
FREQUENCY RANGE	1GHz ~ 40GHz		Average (AV)

ANTENNA POLARITY & TEST DISTANCE: HORIZONTAL AT 3 M

NO.	FREQ. (MHz)	EMISSION LEVEL (dBuV/m)	LIMIT (dBuV/m)	MARGIN (dB)	ANTENNA HEIGHT (m)	TABLE ANGLE (Degree)	RAW VALUE (dBuV)	CORRECTION FACTOR (dB/m)
1	*5550.00	106.90 PK			1.78 H	153	99.56	7.34
2	*5550.00	92.80 AV			1.78 H	153	85.46	7.34
3	11100.00	57.41 PK	74.00	-16.59	1.74 H	205	39.52	17.89
4	11100.00	43.50 AV	54.00	-10.50	1.74 H	205	25.61	17.89

ANTENNA POLARITY & TEST DISTANCE: VERTICAL AT 3 M

NO.	FREQ. (MHz)	EMISSION LEVEL (dBuV/m)	LIMIT (dBuV/m)	MARGIN (dB)	ANTENNA HEIGHT (m)	TABLE ANGLE (Degree)	RAW VALUE (dBuV)	CORRECTION FACTOR (dB/m)
1	*5550.00	117.18 PK			2.15 V	45	109.84	7.34
2	*5550.00	103.03 AV			2.15 V	45	95.69	7.34
3	11100.00	58.77 PK	74.00	-15.23	2.25 V	12	40.88	17.89
4	11100.00	44.27 AV	54.00	-9.73	2.25 V	12	26.38	17.89

REMARKS:

1. Emission Level(dBuV/m) = Raw Value(dBuV) + Correction Factor(dB/m)
2. Correction Factor(dB/m) = Antenna Factor(dB/m) + Cable Factor(dB) – Pre-Amplifier Factor(dB)
3. The other emission levels were very low against the limit.
4. Margin value = Emission Level – Limit value
5. " * ": Fundamental frequency.

CHANNEL	TX Channel 134	DETECTOR FUNCTION	Peak (PK)
FREQUENCY RANGE	1GHz ~ 40GHz		Average (AV)

ANTENNA POLARITY & TEST DISTANCE: HORIZONTAL AT 3 M

NO.	FREQ. (MHz)	EMISSION LEVEL (dBuV/m)	LIMIT (dBuV/m)	MARGIN (dB)	ANTENNA HEIGHT (m)	TABLE ANGLE (Degree)	RAW VALUE (dBuV)	CORRECTION FACTOR (dB/m)
1	*5670.00	104.81 PK			1.75 H	169	97.45	7.36
2	*5670.00	90.72 AV			1.75 H	169	83.36	7.36
3	5725.00	59.83 PK	68.20	-8.37	1.75 H	169	52.46	7.37
4	11340.00	56.58 PK	74.00	-17.42	1.36 H	195	39.42	17.16
5	11340.00	42.59 AV	54.00	-11.41	1.36 H	195	25.43	17.16

ANTENNA POLARITY & TEST DISTANCE: VERTICAL AT 3 M

NO.	FREQ. (MHz)	EMISSION LEVEL (dBuV/m)	LIMIT (dBuV/m)	MARGIN (dB)	ANTENNA HEIGHT (m)	TABLE ANGLE (Degree)	RAW VALUE (dBuV)	CORRECTION FACTOR (dB/m)
1	*5670.00	114.98 PK			2.24 V	78	107.62	7.36
2	*5670.00	99.95 AV			2.24 V	78	92.59	7.36
3	5725.00	61.98 PK	68.20	-6.22	2.24 V	78	54.61	7.37
4	11340.00	57.85 PK	74.00	-16.15	1.89 V	132	40.69	17.16
5	11340.00	44.14 AV	54.00	-9.86	1.89 V	132	26.98	17.16

REMARKS:

1. Emission Level(dBuV/m) = Raw Value(dBuV) + Correction Factor(dB/m)
2. Correction Factor(dB/m) = Antenna Factor(dB/m) + Cable Factor(dB) – Pre-Amplifier Factor(dB)
3. The other emission levels were very low against the limit.
4. Margin value = Emission Level – Limit value
5. " * ": Fundamental frequency.
6. " # ": The radiated frequency is out of the restricted band.

802.11ac (80MHz)

CHANNEL	TX Channel 58	DETECTOR FUNCTION	Peak (PK)
FREQUENCY RANGE	1GHz ~ 40GHz		Average (AV)

ANTENNA POLARITY & TEST DISTANCE: HORIZONTAL AT 3 M

NO.	FREQ. (MHz)	EMISSION LEVEL (dBuV/m)	LIMIT (dBuV/m)	MARGIN (dB)	ANTENNA HEIGHT (m)	TABLE ANGLE (Degree)	RAW VALUE (dBuV)	CORRECTION FACTOR (dB/m)
1	5150.00	57.95 PK	74.00	-16.05	1.91 H	157	52.01	5.94
2	5150.00	43.82 AV	54.00	-10.18	1.91 H	157	37.88	5.94
3	*5290.00	106.12 PK			1.91 H	157	99.64	6.48
4	*5290.00	94.64 AV			1.91 H	157	88.16	6.48
5	5350.00	66.49 PK	74.00	-7.51	1.91 H	157	59.74	6.75
6	5350.00	48.91 AV	54.00	-5.09	1.91 H	157	42.16	6.75
7	#10580.00	39.16 PK	74.00	-34.84	2.84 H	157	22.37	16.79
8	#10580.00	25.37 AV	54.00	-28.63	2.84 H	157	8.58	16.79

ANTENNA POLARITY & TEST DISTANCE: VERTICAL AT 3 M

NO.	FREQ. (MHz)	EMISSION LEVEL (dBuV/m)	LIMIT (dBuV/m)	MARGIN (dB)	ANTENNA HEIGHT (m)	TABLE ANGLE (Degree)	RAW VALUE (dBuV)	CORRECTION FACTOR (dB/m)
1	5150.00	59.63 PK	74.00	-14.37	2.69 V	38	53.69	5.94
2	5150.00	44.86 AV	54.00	-9.14	2.69 V	38	38.92	5.94
3	*5290.00	115.55 PK			2.96 V	38	109.07	6.48
4	*5290.00	98.27 AV			2.96 V	38	91.79	6.48
5	5350.00	69.49 PK	74.00	-4.51	4.00 V	N/A	62.74	6.75
6	5350.00	51.57 AV	54.00	-2.43	4.00 V	N/A	44.82	6.75
7	#10580.00	57.43 PK	74.00	-16.57	1.96 V	230	40.64	16.79
8	#10580.00	43.42 AV	54.00	-10.58	1.96 V	230	26.63	16.79

REMARKS:

1. Emission Level(dBuV/m) = Raw Value(dBuV) + Correction Factor(dB/m)
2. Correction Factor(dB/m) = Antenna Factor(dB/m) + Cable Factor(dB) – Pre-Amplifier Factor(dB)
3. The other emission levels were very low against the limit.
4. Margin value = Emission Level – Limit value
5. " * ": Fundamental frequency.
6. " # ": The radiated frequency is out of the restricted band.

CHANNEL	TX Channel 106	DETECTOR FUNCTION	Peak (PK)
FREQUENCY RANGE	1GHz ~ 40GHz		Average (AV)

ANTENNA POLARITY & TEST DISTANCE: HORIZONTAL AT 3 M

NO.	FREQ. (MHz)	EMISSION LEVEL (dBuV/m)	LIMIT (dBuV/m)	MARGIN (dB)	ANTENNA HEIGHT (m)	TABLE ANGLE (Degree)	RAW VALUE (dBuV)	CORRECTION FACTOR (dB/m)
1	5460.00	61.34 PK	74.00	-12.66	1.84 H	159	54.16	7.18
2	5460.00	45.34 AV	54.00	-8.66	1.84 H	159	38.16	7.18
3	5470.00	61.37 PK	68.20	-6.83	1.84 H	159	54.16	7.21
4	*5530.00	102.17 PK			1.84 H	159	94.84	7.33
5	*5530.00	88.79 AV			1.84 H	159	81.46	7.33
6	11060.00	57.45 PK	74.00	-16.55	1.77 H	100	39.41	18.04
7	11060.00	43.93 AV	54.00	-10.07	1.77 H	100	25.89	18.04

ANTENNA POLARITY & TEST DISTANCE: VERTICAL AT 3 M

NO.	FREQ. (MHz)	EMISSION LEVEL (dBuV/m)	LIMIT (dBuV/m)	MARGIN (dB)	ANTENNA HEIGHT (m)	TABLE ANGLE (Degree)	RAW VALUE (dBuV)	CORRECTION FACTOR (dB/m)
1	5460.00	64.56 PK	74.00	-9.44	2.39 V	141	57.38	7.18
2	5460.00	46.45 AV	54.00	-7.55	2.39 V	141	39.27	7.18
3	5470.00	67.10 PK	68.20	-1.10	2.39 V	141	59.89	7.21
4	*5530.00	111.38 PK			2.39 V	141	104.05	7.33
5	*5530.00	93.59 AV			2.39 V	141	86.26	7.33
6	11060.00	58.88 PK	74.00	-15.12	1.84 V	214	40.84	18.04
7	11060.00	44.85 AV	54.00	-9.15	1.84 V	214	26.81	18.04

REMARKS:

1. Emission Level(dBuV/m) = Raw Value(dBuV) + Correction Factor(dB/m)
2. Correction Factor(dB/m) = Antenna Factor(dB/m) + Cable Factor(dB) – Pre-Amplifier Factor(dB)
3. The other emission levels were very low against the limit.
4. Margin value = Emission Level – Limit value
5. " * ": Fundamental frequency.

CHANNEL	TX Channel 122	DETECTOR FUNCTION	Peak (PK)
FREQUENCY RANGE	1GHz ~ 40GHz		Average (AV)

ANTENNA POLARITY & TEST DISTANCE: HORIZONTAL AT 3 M

NO.	FREQ. (MHz)	EMISSION LEVEL (dBuV/m)	LIMIT (dBuV/m)	MARGIN (dB)	ANTENNA HEIGHT (m)	TABLE ANGLE (Degree)	RAW VALUE (dBuV)	CORRECTION FACTOR (dB/m)
1	*5610.00	102.85 PK			1.79 H	158	95.48	7.37
2	*5610.00	89.25 AV			1.79 H	158	81.88	7.37
3	5725.00	58.40 PK	68.20	-9.80	1.79 H	158	51.03	7.37
4	11220.00	56.86 PK	74.00	-17.14	2.18 H	295	39.46	17.40
5	11220.00	43.34 AV	54.00	-10.66	2.18 H	295	25.94	17.40

ANTENNA POLARITY & TEST DISTANCE: VERTICAL AT 3 M

NO.	FREQ. (MHz)	EMISSION LEVEL (dBuV/m)	LIMIT (dBuV/m)	MARGIN (dB)	ANTENNA HEIGHT (m)	TABLE ANGLE (Degree)	RAW VALUE (dBuV)	CORRECTION FACTOR (dB/m)
1	*5610.00	109.03 PK			2.58 V	177	101.66	7.37
2	*5610.00	97.31 AV			2.58 V	177	89.94	7.37
3	5725.00	60.36 PK	68.20	-7.84	2.58 V	177	52.99	7.37
4	11220.00	57.58 PK	74.00	-16.42	1.84 V	120	40.18	17.40
5	11220.00	43.89 AV	54.00	-10.11	1.84 V	120	26.49	17.40

REMARKS:

1. Emission Level(dBuV/m) = Raw Value(dBuV) + Correction Factor(dB/m)
2. Correction Factor(dB/m) = Antenna Factor(dB/m) + Cable Factor(dB) – Pre-Amplifier Factor(dB)
3. The other emission levels were very low against the limit.
4. Margin value = Emission Level – Limit value
5. " * ": Fundamental frequency.

Beamforming_NSS1 Mode (Mode B)

802.11ac (20MHz)

CHANNEL	TX Channel 52	DETECTOR FUNCTION	Peak (PK)
FREQUENCY RANGE	1GHz ~ 40GHz		Average (AV)

ANTENNA POLARITY & TEST DISTANCE: HORIZONTAL AT 3 M

NO.	FREQ. (MHz)	EMISSION LEVEL (dBuV/m)	LIMIT (dBuV/m)	MARGIN (dB)	ANTENNA HEIGHT (m)	TABLE ANGLE (Degree)	RAW VALUE (dBuV)	CORRECTION FACTOR (dB/m)
1	5150.00	57.43 PK	74.00	-16.57	1.75 H	192	51.49	5.94
2	5150.00	43.63 AV	54.00	-10.37	1.75 H	192	37.69	5.94
3	*5260.00	104.82 PK			1.75 H	192	98.46	6.36
4	*5260.00	91.15 AV			1.75 H	192	84.79	6.36
5	#10520.00	55.86 PK	74.00	-18.14	1.49 H	210	39.28	16.58
6	#10520.00	41.78 AV	54.00	-12.22	1.49 H	210	25.20	16.58

ANTENNA POLARITY & TEST DISTANCE: VERTICAL AT 3 M

NO.	FREQ. (MHz)	EMISSION LEVEL (dBuV/m)	LIMIT (dBuV/m)	MARGIN (dB)	ANTENNA HEIGHT (m)	TABLE ANGLE (Degree)	RAW VALUE (dBuV)	CORRECTION FACTOR (dB/m)
1	5150.00	58.58 PK	74.00	-15.42	2.28 V	190	52.64	5.94
2	5150.00	44.69 AV	54.00	-9.31	2.28 V	190	38.75	5.94
3	*5260.00	120.65 PK			4.00 V	190	114.29	6.36
4	*5260.00	106.83 AV			4.00 V	190	100.47	6.36
5	#10520.00	57.22 PK	74.00	-16.78	1.67 V	234	40.64	16.58
6	#10520.00	43.01 AV	54.00	-10.99	1.67 V	234	26.43	16.58

REMARKS:

1. Emission Level(dBuV/m) = Raw Value(dBuV) + Correction Factor(dB/m)
2. Correction Factor(dB/m) = Antenna Factor(dB/m) + Cable Factor(dB) – Pre-Amplifier Factor(dB)
3. The other emission levels were very low against the limit.
4. Margin value = Emission Level – Limit value
5. " * ": Fundamental frequency.
6. " # ": The radiated frequency is out of the restricted band.

CHANNEL	TX Channel 60	DETECTOR FUNCTION	Peak (PK)
FREQUENCY RANGE	1GHz ~ 40GHz		Average (AV)

ANTENNA POLARITY & TEST DISTANCE: HORIZONTAL AT 3 M

NO.	FREQ. (MHz)	EMISSION LEVEL (dBuV/m)	LIMIT (dBuV/m)	MARGIN (dB)	ANTENNA HEIGHT (m)	TABLE ANGLE (Degree)	RAW VALUE (dBuV)	CORRECTION FACTOR (dB/m)
1	*5300.00	106.30 PK			1.71 H	187	99.78	6.52
2	*5300.00	92.21 AV			1.71 H	187	85.69	6.52
3	10600.00	56.51 PK	74.00	-17.49	1.87 H	221	39.65	16.86
4	10600.00	42.15 AV	54.00	-11.85	1.87 H	221	25.29	16.86

ANTENNA POLARITY & TEST DISTANCE: VERTICAL AT 3 M

NO.	FREQ. (MHz)	EMISSION LEVEL (dBuV/m)	LIMIT (dBuV/m)	MARGIN (dB)	ANTENNA HEIGHT (m)	TABLE ANGLE (Degree)	RAW VALUE (dBuV)	CORRECTION FACTOR (dB/m)
1	*5300.00	121.65 PK			2.36 V	187	115.13	6.52
2	*5300.00	107.78 AV			2.36 V	187	101.26	6.52
3	10600.00	57.83 PK	74.00	-16.17	2.36 V	284	40.97	16.86
4	10600.00	43.61 AV	54.00	-10.39	2.36 V	284	26.75	16.86

REMARKS:

1. Emission Level(dBuV/m) = Raw Value(dBuV) + Correction Factor(dB/m)
2. Correction Factor(dB/m) = Antenna Factor(dB/m) + Cable Factor(dB) – Pre-Amplifier Factor(dB)
3. The other emission levels were very low against the limit.
4. Margin value = Emission Level – Limit value
5. " * ": Fundamental frequency.

CHANNEL	TX Channel 64	DETECTOR FUNCTION	Peak (PK)
FREQUENCY RANGE	1GHz ~ 40GHz		Average (AV)

ANTENNA POLARITY & TEST DISTANCE: HORIZONTAL AT 3 M

NO.	FREQ. (MHz)	EMISSION LEVEL (dBuV/m)	LIMIT (dBuV/m)	MARGIN (dB)	ANTENNA HEIGHT (m)	TABLE ANGLE (Degree)	RAW VALUE (dBuV)	CORRECTION FACTOR (dB/m)
1	*5320.00	105.41 PK			1.73 H	178	98.79	6.62
2	*5320.00	91.31 AV			1.73 H	178	84.69	6.62
3	5350.00	59.22 PK	74.00	-14.78	1.73 H	178	52.47	6.75
4	5350.00	44.88 AV	54.00	-9.12	1.73 H	178	38.13	6.75
5	10640.00	56.34 PK	74.00	-17.66	1.57 H	2	39.48	16.86
6	10640.00	41.95 AV	54.00	-12.05	1.57 H	2	25.09	16.86

ANTENNA POLARITY & TEST DISTANCE: VERTICAL AT 3 M

NO.	FREQ. (MHz)	EMISSION LEVEL (dBuV/m)	LIMIT (dBuV/m)	MARGIN (dB)	ANTENNA HEIGHT (m)	TABLE ANGLE (Degree)	RAW VALUE (dBuV)	CORRECTION FACTOR (dB/m)
1	*5320.00	121.19 PK			2.34 V	196	114.57	6.62
2	*5320.00	107.47 AV			2.34 V	196	100.85	6.62
3	5350.00	64.21 PK	74.00	-9.79	2.34 V	196	57.46	6.75
4	5350.00	46.61 AV	54.00	-7.39	2.34 V	196	39.86	6.75
5	10640.00	57.75 PK	74.00	-16.25	1.94 V	214	40.89	16.86
6	10640.00	43.23 AV	54.00	-10.77	1.94 V	214	26.37	16.86

REMARKS:

1. Emission Level(dBuV/m) = Raw Value(dBuV) + Correction Factor(dB/m)
2. Correction Factor(dB/m) = Antenna Factor(dB/m) + Cable Factor(dB) – Pre-Amplifier Factor(dB)
3. The other emission levels were very low against the limit.
4. Margin value = Emission Level – Limit value
5. " * ": Fundamental frequency.

CHANNEL	TX Channel 100	DETECTOR FUNCTION	Peak (PK)
FREQUENCY RANGE	1GHz ~ 40GHz		Average (AV)

ANTENNA POLARITY & TEST DISTANCE: HORIZONTAL AT 3 M

NO.	FREQ. (MHz)	EMISSION LEVEL (dBuV/m)	LIMIT (dBuV/m)	MARGIN (dB)	ANTENNA HEIGHT (m)	TABLE ANGLE (Degree)	RAW VALUE (dBuV)	CORRECTION FACTOR (dB/m)
1	5460.00	58.96 PK	74.00	-15.04	1.82 H	134	51.78	7.18
2	5460.00	44.84 AV	54.00	-9.16	1.82 H	134	37.66	7.18
3	5470.00	60.84 PK	68.20	-7.36	1.82 H	134	53.63	7.21
4	*5500.00	110.77 PK			1.82 H	134	103.46	7.31
5	*5500.00	97.20 AV			1.82 H	134	89.89	7.31
6	11000.00	57.50 PK	74.00	-16.50	1.84 H	120	39.26	18.24
7	11000.00	43.88 AV	54.00	-10.12	1.84 H	120	25.64	18.24

ANTENNA POLARITY & TEST DISTANCE: VERTICAL AT 3 M

NO.	FREQ. (MHz)	EMISSION LEVEL (dBuV/m)	LIMIT (dBuV/m)	MARGIN (dB)	ANTENNA HEIGHT (m)	TABLE ANGLE (Degree)	RAW VALUE (dBuV)	CORRECTION FACTOR (dB/m)
1	5460.00	59.89 PK	74.00	-14.11	1.99 V	298	52.71	7.18
2	5460.00	45.43 AV	54.00	-8.57	1.99 V	298	38.25	7.18
3	5470.00	63.48 PK	68.20	-4.72	1.99 V	298	56.27	7.21
4	*5500.00	121.73 PK			1.99 V	298	114.42	7.31
5	*5500.00	107.67 AV			1.99 V	298	100.36	7.31
6	11000.00	58.92 PK	74.00	-15.08	1.57 V	264	40.68	18.24
7	11000.00	44.62 AV	54.00	-9.38	1.57 V	264	26.38	18.24

REMARKS:

1. Emission Level(dBuV/m) = Raw Value(dBuV) + Correction Factor(dB/m)
2. Correction Factor(dB/m) = Antenna Factor(dB/m) + Cable Factor(dB) – Pre-Amplifier Factor(dB)
3. The other emission levels were very low against the limit.
4. Margin value = Emission Level – Limit value
5. " * ": Fundamental frequency.

CHANNEL	TX Channel 116	DETECTOR FUNCTION	Peak (PK)
FREQUENCY RANGE	1GHz ~ 40GHz		Average (AV)

ANTENNA POLARITY & TEST DISTANCE: HORIZONTAL AT 3 M

NO.	FREQ. (MHz)	EMISSION LEVEL (dBuV/m)	LIMIT (dBuV/m)	MARGIN (dB)	ANTENNA HEIGHT (m)	TABLE ANGLE (Degree)	RAW VALUE (dBuV)	CORRECTION FACTOR (dB/m)
1	*5580.00	110.90 PK			1.79 H	164	103.54	7.36
2	*5580.00	97.01 AV			1.79 H	164	89.65	7.36
3	11160.00	57.05 PK	74.00	-16.95	1.57 H	88	39.42	17.63
4	11160.00	43.01 AV	54.00	-10.99	1.57 H	88	25.38	17.63

ANTENNA POLARITY & TEST DISTANCE: VERTICAL AT 3 M

NO.	FREQ. (MHz)	EMISSION LEVEL (dBuV/m)	LIMIT (dBuV/m)	MARGIN (dB)	ANTENNA HEIGHT (m)	TABLE ANGLE (Degree)	RAW VALUE (dBuV)	CORRECTION FACTOR (dB/m)
1	*5580.00	122.20 PK			2.08 V	232	114.84	7.36
2	*5580.00	108.20 AV			2.08 V	232	100.84	7.36
3	11160.00	58.27 PK	74.00	-15.73	1.37 V	269	40.64	17.63
4	11160.00	44.15 AV	54.00	-9.85	1.37 V	269	26.52	17.63

REMARKS:

1. Emission Level(dBuV/m) = Raw Value(dBuV) + Correction Factor(dB/m)
2. Correction Factor(dB/m) = Antenna Factor(dB/m) + Cable Factor(dB) – Pre-Amplifier Factor(dB)
3. The other emission levels were very low against the limit.
4. Margin value = Emission Level – Limit value
5. " * ": Fundamental frequency.

CHANNEL	TX Channel 132	DETECTOR FUNCTION	Peak (PK)
FREQUENCY RANGE	1GHz ~ 40GHz		Average (AV)

ANTENNA POLARITY & TEST DISTANCE: HORIZONTAL AT 3 M

NO.	FREQ. (MHz)	EMISSION LEVEL (dBuV/m)	LIMIT (dBuV/m)	MARGIN (dB)	ANTENNA HEIGHT (m)	TABLE ANGLE (Degree)	RAW VALUE (dBuV)	CORRECTION FACTOR (dB/m)
1	*5660.00	111.51 PK			1.72 H	159	104.15	7.36
2	*5660.00	97.60 AV			1.72 H	159	90.24	7.36
3	11320.00	56.55 PK	74.00	-17.45	2.28 H	104	39.42	17.13
4	11320.00	42.32 AV	54.00	-11.68	2.28 H	104	25.19	17.13

ANTENNA POLARITY & TEST DISTANCE: VERTICAL AT 3 M

NO.	FREQ. (MHz)	EMISSION LEVEL (dBuV/m)	LIMIT (dBuV/m)	MARGIN (dB)	ANTENNA HEIGHT (m)	TABLE ANGLE (Degree)	RAW VALUE (dBuV)	CORRECTION FACTOR (dB/m)
1	*5660.00	122.60 PK			2.16 V	241	115.24	7.36
2	*5660.00	108.67 AV			2.16 V	241	101.31	7.36
3	11320.00	57.97 PK	74.00	-16.03	1.26 V	284	40.84	17.13
4	11320.00	43.84 AV	54.00	-10.16	1.26 V	284	26.71	17.13

REMARKS:

1. Emission Level(dBuV/m) = Raw Value(dBuV) + Correction Factor(dB/m)
2. Correction Factor(dB/m) = Antenna Factor(dB/m) + Cable Factor(dB) – Pre-Amplifier Factor(dB)
3. The other emission levels were very low against the limit.
4. Margin value = Emission Level – Limit value
5. " * ": Fundamental frequency.

CHANNEL	TX Channel 140	DETECTOR FUNCTION	Peak (PK)
FREQUENCY RANGE	1GHz ~ 40GHz		Average (AV)

ANTENNA POLARITY & TEST DISTANCE: HORIZONTAL AT 3 M

NO.	FREQ. (MHz)	EMISSION LEVEL (dBuV/m)	LIMIT (dBuV/m)	MARGIN (dB)	ANTENNA HEIGHT (m)	TABLE ANGLE (Degree)	RAW VALUE (dBuV)	CORRECTION FACTOR (dB/m)
1	*5700.00	109.88 PK			1.85 H	188	102.54	7.34
2	*5700.00	96.13 AV			1.85 H	188	88.79	7.34
3	5725.00	62.96 PK	68.20	-5.24	1.85 H	188	55.59	7.37
4	11400.00	56.67 PK	74.00	-17.33	1.94 H	135	39.44	17.23
5	11400.00	42.28 AV	54.00	-11.72	1.94 H	135	25.05	17.23

ANTENNA POLARITY & TEST DISTANCE: VERTICAL AT 3 M

NO.	FREQ. (MHz)	EMISSION LEVEL (dBuV/m)	LIMIT (dBuV/m)	MARGIN (dB)	ANTENNA HEIGHT (m)	TABLE ANGLE (Degree)	RAW VALUE (dBuV)	CORRECTION FACTOR (dB/m)
1	*5700.00	121.04 PK			1.99 V	178	113.70	7.34
2	*5700.00	106.86 AV			1.99 V	178	99.52	7.34
3	5725.00	66.96 PK	68.20	-1.24	1.99 V	178	59.59	7.37
4	11400.00	57.74 PK	74.00	-16.26	2.37 V	158	40.51	17.23
5	11400.00	43.45 AV	54.00	-10.55	2.37 V	158	26.22	17.23

REMARKS:

1. Emission Level(dBuV/m) = Raw Value(dBuV) + Correction Factor(dB/m)
2. Correction Factor(dB/m) = Antenna Factor(dB/m) + Cable Factor(dB) – Pre-Amplifier Factor(dB)
3. The other emission levels were very low against the limit.
4. Margin value = Emission Level – Limit value
5. " * ": Fundamental frequency.

802.11ac (40MHz)

CHANNEL	TX Channel 54	DETECTOR FUNCTION	Peak (PK)
FREQUENCY RANGE	1GHz ~ 40GHz		Average (AV)

ANTENNA POLARITY & TEST DISTANCE: HORIZONTAL AT 3 M

NO.	FREQ. (MHz)	EMISSION LEVEL (dBuV/m)	LIMIT (dBuV/m)	MARGIN (dB)	ANTENNA HEIGHT (m)	TABLE ANGLE (Degree)	RAW VALUE (dBuV)	CORRECTION FACTOR (dB/m)
1	5150.00	57.68 PK	74.00	-16.32	1.82 H	188	51.74	5.94
2	5150.00	44.40 AV	54.00	-9.60	1.82 H	188	38.46	5.94
3	*5270.00	106.28 PK			1.82 H	188	99.88	6.40
4	*5270.00	92.09 AV			1.82 H	188	85.69	6.40
5	#10540.00	56.12 PK	74.00	-17.88	1.23 H	178	39.47	16.65
6	#10540.00	41.73 AV	54.00	-12.27	1.23 H	178	25.08	16.65

ANTENNA POLARITY & TEST DISTANCE: VERTICAL AT 3 M

NO.	FREQ. (MHz)	EMISSION LEVEL (dBuV/m)	LIMIT (dBuV/m)	MARGIN (dB)	ANTENNA HEIGHT (m)	TABLE ANGLE (Degree)	RAW VALUE (dBuV)	CORRECTION FACTOR (dB/m)
1	5150.00	58.80 PK	74.00	-15.20	2.04 V	183	52.86	5.94
2	5150.00	44.94 AV	54.00	-9.06	2.04 V	183	39.00	5.94
3	*5270.00	120.58 PK			2.04 V	183	114.18	6.40
4	*5270.00	104.40 AV			2.04 V	183	98.00	6.40
5	#10540.00	57.32 PK	74.00	-16.68	1.28 V	24	40.67	16.65
6	#10540.00	43.23 AV	54.00	-10.77	1.28 V	24	26.58	16.65

REMARKS:

1. Emission Level(dBuV/m) = Raw Value(dBuV) + Correction Factor(dB/m)
2. Correction Factor(dB/m) = Antenna Factor(dB/m) + Cable Factor(dB) – Pre-Amplifier Factor(dB)
3. The other emission levels were very low against the limit.
4. Margin value = Emission Level – Limit value
5. " * ": Fundamental frequency.
6. " # ": The radiated frequency is out of the restricted band.

CHANNEL	TX Channel 62	DETECTOR FUNCTION	Peak (PK)
FREQUENCY RANGE	1GHz ~ 40GHz		Average (AV)

ANTENNA POLARITY & TEST DISTANCE: HORIZONTAL AT 3 M

NO.	FREQ. (MHz)	EMISSION LEVEL (dBuV/m)	LIMIT (dBuV/m)	MARGIN (dB)	ANTENNA HEIGHT (m)	TABLE ANGLE (Degree)	RAW VALUE (dBuV)	CORRECTION FACTOR (dB/m)
1	*5310.00	106.05 PK			1.78 H	156	99.48	6.57
2	*5310.00	92.36 AV			1.78 H	156	85.79	6.57
3	5350.00	66.62 PK	74.00	-7.38	1.78 H	156	59.87	6.75
4	5350.00	48.91 AV	54.00	-5.09	1.78 H	156	42.16	6.75
5	10620.00	56.27 PK	74.00	-17.73	2.69 H	102	39.41	16.86
6	10620.00	42.70 AV	54.00	-11.30	2.69 H	102	25.84	16.86

ANTENNA POLARITY & TEST DISTANCE: VERTICAL AT 3 M

NO.	FREQ. (MHz)	EMISSION LEVEL (dBuV/m)	LIMIT (dBuV/m)	MARGIN (dB)	ANTENNA HEIGHT (m)	TABLE ANGLE (Degree)	RAW VALUE (dBuV)	CORRECTION FACTOR (dB/m)
1	*5310.00	120.73 PK			2.15 V	186	114.16	6.57
2	*5310.00	104.26 AV			2.15 V	186	97.69	6.57
3	5350.00	69.77 PK	74.00	-4.23	2.15 V	186	63.02	6.75
4	5350.00	52.74 AV	54.00	-1.26	2.15 V	186	45.99	6.75
5	10620.00	57.19 PK	74.00	-16.81	1.87 V	142	40.33	16.86
6	10620.00	43.62 AV	54.00	-10.38	1.87 V	142	26.76	16.86

REMARKS:

1. Emission Level(dBuV/m) = Raw Value(dBuV) + Correction Factor(dB/m)
2. Correction Factor(dB/m) = Antenna Factor(dB/m) + Cable Factor(dB) – Pre-Amplifier Factor(dB)
3. The other emission levels were very low against the limit.
4. Margin value = Emission Level – Limit value
5. " * ": Fundamental frequency.

CHANNEL	TX Channel 102	DETECTOR FUNCTION	Peak (PK)
FREQUENCY RANGE	1GHz ~ 40GHz		Average (AV)

ANTENNA POLARITY & TEST DISTANCE: HORIZONTAL AT 3 M

NO.	FREQ. (MHz)	EMISSION LEVEL (dBuV/m)	LIMIT (dBuV/m)	MARGIN (dB)	ANTENNA HEIGHT (m)	TABLE ANGLE (Degree)	RAW VALUE (dBuV)	CORRECTION FACTOR (dB/m)
1	5460.00	59.34 PK	74.00	-14.66	1.74 H	158	52.16	7.18
2	5460.00	45.64 AV	54.00	-8.36	1.74 H	158	38.46	7.18
3	5470.00	61.37 PK	68.20	-6.83	1.74 H	158	54.16	7.21
4	*5510.00	105.99 PK			1.74 H	158	98.67	7.32
5	*5510.00	91.01 AV			1.74 H	158	83.69	7.32
6	11020.00	57.64 PK	74.00	-16.36	1.20 H	229	39.46	18.18
7	11020.00	44.02 AV	54.00	-9.98	1.20 H	229	25.84	18.18

ANTENNA POLARITY & TEST DISTANCE: VERTICAL AT 3 M

NO.	FREQ. (MHz)	EMISSION LEVEL (dBuV/m)	LIMIT (dBuV/m)	MARGIN (dB)	ANTENNA HEIGHT (m)	TABLE ANGLE (Degree)	RAW VALUE (dBuV)	CORRECTION FACTOR (dB/m)
1	5460.00	62.62 PK	74.00	-11.38	2.35 V	230	55.44	7.18
2	5460.00	46.43 AV	54.00	-7.57	2.35 V	230	39.25	7.18
3	5470.00	67.04 PK	68.20	-1.16	2.35 V	230	59.83	7.21
4	*5510.00	116.77 PK			2.35 V	230	109.45	7.32
5	*5510.00	100.43 AV			2.35 V	230	93.11	7.32
6	11020.00	58.69 PK	74.00	-15.31	1.57 V	163	40.51	18.18
7	11020.00	45.17 AV	54.00	-8.83	1.57 V	163	26.99	18.18

REMARKS:

1. Emission Level(dBuV/m) = Raw Value(dBuV) + Correction Factor(dB/m)
2. Correction Factor(dB/m) = Antenna Factor(dB/m) + Cable Factor(dB) – Pre-Amplifier Factor(dB)
3. The other emission levels were very low against the limit.
4. Margin value = Emission Level – Limit value
5. " * ": Fundamental frequency.

CHANNEL	TX Channel 110	DETECTOR FUNCTION	Peak (PK)
FREQUENCY RANGE	1GHz ~ 40GHz		Average (AV)

ANTENNA POLARITY & TEST DISTANCE: HORIZONTAL AT 3 M

NO.	FREQ. (MHz)	EMISSION LEVEL (dBuV/m)	LIMIT (dBuV/m)	MARGIN (dB)	ANTENNA HEIGHT (m)	TABLE ANGLE (Degree)	RAW VALUE (dBuV)	CORRECTION FACTOR (dB/m)
1	*5550.00	107.46 PK			1.83 H	155	100.12	7.34
2	*5550.00	92.80 AV			1.83 H	155	85.46	7.34
3	11100.00	57.54 PK	74.00	-16.46	2.28 H	295	39.65	17.89
4	11100.00	43.53 AV	54.00	-10.47	2.28 H	295	25.64	17.89

ANTENNA POLARITY & TEST DISTANCE: VERTICAL AT 3 M

NO.	FREQ. (MHz)	EMISSION LEVEL (dBuV/m)	LIMIT (dBuV/m)	MARGIN (dB)	ANTENNA HEIGHT (m)	TABLE ANGLE (Degree)	RAW VALUE (dBuV)	CORRECTION FACTOR (dB/m)
1	*5550.00	119.90 PK			2.41 V	223	112.56	7.34
2	*5550.00	103.93 AV			2.41 V	223	96.59	7.34
3	11100.00	58.76 PK	74.00	-15.24	1.69 V	233	40.87	17.89
4	11100.00	44.37 AV	54.00	-9.63	1.69 V	233	26.48	17.89

REMARKS:

1. Emission Level(dBuV/m) = Raw Value(dBuV) + Correction Factor(dB/m)
2. Correction Factor(dB/m) = Antenna Factor(dB/m) + Cable Factor(dB) – Pre-Amplifier Factor(dB)
3. The other emission levels were very low against the limit.
4. Margin value = Emission Level – Limit value
5. " * ": Fundamental frequency.

CHANNEL	TX Channel 134	DETECTOR FUNCTION	Peak (PK)
FREQUENCY RANGE	1GHz ~ 40GHz		Average (AV)

ANTENNA POLARITY & TEST DISTANCE: HORIZONTAL AT 3 M

NO.	FREQ. (MHz)	EMISSION LEVEL (dBuV/m)	LIMIT (dBuV/m)	MARGIN (dB)	ANTENNA HEIGHT (m)	TABLE ANGLE (Degree)	RAW VALUE (dBuV)	CORRECTION FACTOR (dB/m)
1	*5670.00	107.51 PK			1.78 H	269	100.15	7.36
2	*5670.00	93.32 AV			1.78 H	269	85.96	7.36
3	5725.00	60.63 PK	68.20	-7.57	1.78 H	269	53.26	7.37
4	11340.00	56.59 PK	74.00	-17.41	1.18 H	197	39.43	17.16
5	11340.00	42.83 AV	54.00	-11.17	1.18 H	197	25.67	17.16

ANTENNA POLARITY & TEST DISTANCE: VERTICAL AT 3 M

NO.	FREQ. (MHz)	EMISSION LEVEL (dBuV/m)	LIMIT (dBuV/m)	MARGIN (dB)	ANTENNA HEIGHT (m)	TABLE ANGLE (Degree)	RAW VALUE (dBuV)	CORRECTION FACTOR (dB/m)
1	*5670.00	119.33 PK			2.25 V	207	111.97	7.36
2	*5670.00	103.60 AV			2.25 V	207	96.24	7.36
3	5725.00	63.13 PK	68.20	-5.07	2.25 V	207	55.76	7.37
4	11340.00	57.74 PK	74.00	-16.26	1.97 V	224	40.58	17.16
5	11340.00	44.02 AV	54.00	-9.98	1.97 V	224	26.86	17.16

REMARKS:

1. Emission Level(dBuV/m) = Raw Value(dBuV) + Correction Factor(dB/m)
2. Correction Factor(dB/m) = Antenna Factor(dB/m) + Cable Factor(dB) – Pre-Amplifier Factor(dB)
3. The other emission levels were very low against the limit.
4. Margin value = Emission Level – Limit value
5. " * ": Fundamental frequency.

802.11ac (80MHz)

CHANNEL	TX Channel 58	DETECTOR FUNCTION	Peak (PK)
FREQUENCY RANGE	1GHz ~ 40GHz		Average (AV)

ANTENNA POLARITY & TEST DISTANCE: HORIZONTAL AT 3 M

NO.	FREQ. (MHz)	EMISSION LEVEL (dBuV/m)	LIMIT (dBuV/m)	MARGIN (dB)	ANTENNA HEIGHT (m)	TABLE ANGLE (Degree)	RAW VALUE (dBuV)	CORRECTION FACTOR (dB/m)
1	5150.00	57.40 PK	74.00	-16.60	1.78 H	164	51.46	5.94
2	5150.00	43.96 AV	54.00	-10.04	1.78 H	164	38.02	5.94
3	*5290.00	101.26 PK			1.78 H	164	94.78	6.48
4	*5290.00	94.37 AV			1.78 H	164	87.89	6.48
5	5350.00	66.89 PK	74.00	-7.11	1.78 H	164	60.14	6.75
6	5350.00	47.59 AV	54.00	-6.41	1.78 H	164	40.84	6.75
7	#10580.00	56.20 PK	74.00	-17.80	1.69 H	284	39.41	16.79
8	#10580.00	42.74 AV	54.00	-11.26	1.69 H	284	25.95	16.79

ANTENNA POLARITY & TEST DISTANCE: VERTICAL AT 3 M

NO.	FREQ. (MHz)	EMISSION LEVEL (dBuV/m)	LIMIT (dBuV/m)	MARGIN (dB)	ANTENNA HEIGHT (m)	TABLE ANGLE (Degree)	RAW VALUE (dBuV)	CORRECTION FACTOR (dB/m)
1	5150.00	59.50 PK	74.00	-14.50	2.06 V	184	53.56	5.94
2	5150.00	45.64 AV	54.00	-8.36	2.06 V	184	39.70	5.94
3	*5290.00	115.86 PK			2.06 V	184	109.38	6.48
4	*5290.00	98.83 AV			2.06 V	184	92.35	6.48
5	5350.00	72.36 PK	74.00	-1.64	2.06 V	184	65.61	6.75
6	5350.00	51.70 AV	54.00	-2.30	2.06 V	184	44.95	6.75
7	#10580.00	57.67 PK	74.00	-16.33	1.67 V	224	40.88	16.79
8	#10580.00	43.63 AV	54.00	-10.37	1.67 V	224	26.84	16.79

REMARKS:

1. Emission Level(dBuV/m) = Raw Value(dBuV) + Correction Factor(dB/m)
2. Correction Factor(dB/m) = Antenna Factor(dB/m) + Cable Factor(dB) – Pre-Amplifier Factor(dB)
3. The other emission levels were very low against the limit.
4. Margin value = Emission Level – Limit value
5. " * ": Fundamental frequency.
6. " # ": The radiated frequency is out of the restricted band.

CHANNEL	TX Channel 106	DETECTOR FUNCTION	Peak (PK)
FREQUENCY RANGE	1GHz ~ 40GHz		Average (AV)

ANTENNA POLARITY & TEST DISTANCE: HORIZONTAL AT 3 M

NO.	FREQ. (MHz)	EMISSION LEVEL (dBuV/m)	LIMIT (dBuV/m)	MARGIN (dB)	ANTENNA HEIGHT (m)	TABLE ANGLE (Degree)	RAW VALUE (dBuV)	CORRECTION FACTOR (dB/m)
1	5460.00	59.34 PK	74.00	-14.66	1.69 H	148	52.16	7.18
2	5460.00	45.73 AV	54.00	-8.27	1.69 H	148	38.55	7.18
3	5470.00	65.90 PK	68.20	-2.30	1.69 H	148	58.69	7.21
4	*5530.00	102.77 PK			1.69 H	148	95.44	7.33
5	*5530.00	88.59 AV			1.69 H	148	81.26	7.33
6	11060.00	57.49 PK	74.00	-16.51	2.95 H	225	39.45	18.04
7	11060.00	43.85 AV	54.00	-10.15	2.95 H	225	25.81	18.04

ANTENNA POLARITY & TEST DISTANCE: VERTICAL AT 3 M

NO.	FREQ. (MHz)	EMISSION LEVEL (dBuV/m)	LIMIT (dBuV/m)	MARGIN (dB)	ANTENNA HEIGHT (m)	TABLE ANGLE (Degree)	RAW VALUE (dBuV)	CORRECTION FACTOR (dB/m)
1	5460.00	61.03 PK	74.00	-12.97	2.34 V	233	53.85	7.18
2	5460.00	47.30 AV	54.00	-6.70	2.34 V	233	40.12	7.18
3	5470.00	67.08 PK	68.20	-1.12	2.34 V	233	59.87	7.21
4	*5530.00	113.96 PK			2.34 V	233	106.63	7.33
5	*5530.00	97.53 AV			2.34 V	233	90.20	7.33
6	11060.00	58.71 PK	74.00	-15.29	2.14 V	225	40.67	18.04
7	11060.00	44.93 AV	54.00	-9.07	2.14 V	225	26.89	18.04

REMARKS:

1. Emission Level(dBuV/m) = Raw Value(dBuV) + Correction Factor(dB/m)
2. Correction Factor(dB/m) = Antenna Factor(dB/m) + Cable Factor(dB) – Pre-Amplifier Factor(dB)
3. The other emission levels were very low against the limit.
4. Margin value = Emission Level – Limit value
5. " * ": Fundamental frequency.

CHANNEL	TX Channel 122	DETECTOR FUNCTION	Peak (PK)
FREQUENCY RANGE	1GHz ~ 40GHz		Average (AV)

ANTENNA POLARITY & TEST DISTANCE: HORIZONTAL AT 3 M

NO.	FREQ. (MHz)	EMISSION LEVEL (dBuV/m)	LIMIT (dBuV/m)	MARGIN (dB)	ANTENNA HEIGHT (m)	TABLE ANGLE (Degree)	RAW VALUE (dBuV)	CORRECTION FACTOR (dB/m)
1	*5610.00	103.26 PK			1.85 H	167	95.89	7.37
2	*5610.00	91.53 AV			1.85 H	167	84.16	7.37
3	5725.00	59.53 PK	68.20	-8.67	1.85 H	167	52.16	7.37
4	11220.00	56.86 PK	74.00	-17.14	2.06 H	336	39.46	17.40
5	11220.00	43.21 AV	54.00	-10.79	2.06 H	336	25.81	17.40

ANTENNA POLARITY & TEST DISTANCE: VERTICAL AT 3 M

NO.	FREQ. (MHz)	EMISSION LEVEL (dBuV/m)	LIMIT (dBuV/m)	MARGIN (dB)	ANTENNA HEIGHT (m)	TABLE ANGLE (Degree)	RAW VALUE (dBuV)	CORRECTION FACTOR (dB/m)
1	*5610.00	117.53 PK			2.29 V	214	110.16	7.37
2	*5610.00	102.83 AV			2.29 V	214	95.46	7.37
3	5725.00	61.83 PK	68.20	-6.37	2.29 V	214	54.46	7.37
4	11220.00	58.29 PK	74.00	-15.71	1.67 V	48	40.89	17.40
5	11220.00	44.06 AV	54.00	-9.94	1.67 V	48	26.66	17.40

REMARKS:

1. Emission Level(dBuV/m) = Raw Value(dBuV) + Correction Factor(dB/m)
2. Correction Factor(dB/m) = Antenna Factor(dB/m) + Cable Factor(dB) – Pre-Amplifier Factor(dB)
3. The other emission levels were very low against the limit.
4. Margin value = Emission Level – Limit value
5. " * ": Fundamental frequency.

Below 1GHz Data:

CDD Mode (Mode A)

802.11a

CHANNEL	TX Channel 52	DETECTOR FUNCTION	Quasi-Peak (QP)
FREQUENCY RANGE	9kHz ~ 1GHz		

ANTENNA POLARITY & TEST DISTANCE: HORIZONTAL AT 3 M

NO.	FREQ. (MHz)	EMISSION LEVEL (dBuV/m)	LIMIT (dBuV/m)	MARGIN (dB)	ANTENNA HEIGHT (m)	TABLE ANGLE (Degree)	RAW VALUE (dBuV)	CORRECTION FACTOR (dB/m)
1	52.16	20.19 QP	40.00	-19.81	2.34 H	360	29.16	-8.97
2	151.49	19.02 QP	43.50	-24.48	1.52 H	360	28.13	-9.11
3	233.55	27.28 QP	46.00	-18.72	1.81 H	189	38.14	-10.86
4	289.67	23.31 QP	46.00	-22.69	1.66 H	257	30.94	-7.63
5	391.76	32.01 QP	46.00	-13.99	2.35 H	205	37.52	-5.51
6	503.55	28.39 QP	46.00	-17.61	1.17 H	197	31.29	-2.90

ANTENNA POLARITY & TEST DISTANCE: VERTICAL AT 3 M

NO.	FREQ. (MHz)	EMISSION LEVEL (dBuV/m)	LIMIT (dBuV/m)	MARGIN (dB)	ANTENNA HEIGHT (m)	TABLE ANGLE (Degree)	RAW VALUE (dBuV)	CORRECTION FACTOR (dB/m)
1	36.55	31.48 QP	40.00	-8.52	1.16 V	207	41.88	-10.40
2	51.97	30.59 QP	40.00	-9.41	1.63 V	145	39.55	-8.96
3	101.54	21.46 QP	43.50	-22.04	1.57 V	290	35.18	-13.72
4	244.95	26.53 QP	46.00	-19.47	1.84 V	189	36.18	-9.65
5	391.28	30.65 QP	46.00	-15.35	1.57 V	194	36.18	-5.53
6	516.46	28.44 QP	46.00	-17.56	1.66 V	272	31.11	-2.67

REMARKS:

1. Emission Level(dBuV/m) = Raw Value(dBuV) + Correction Factor(dB/m)
2. Correction Factor(dB/m) = Antenna Factor(dB/m) + Cable Factor(dB) – Pre-Amplifier Factor(dB)
3. The other emission levels were very low against the limit.
4. Margin value = Emission Level – Limit value

CDD Mode (Mode B)

802.11a

CHANNEL	TX Channel 52	DETECTOR FUNCTION	Quasi-Peak (QP)
FREQUENCY RANGE	9kHz ~ 1GHz		

ANTENNA POLARITY & TEST DISTANCE: HORIZONTAL AT 3 M

NO.	FREQ. (MHz)	EMISSION LEVEL (dBuV/m)	LIMIT (dBuV/m)	MARGIN (dB)	ANTENNA HEIGHT (m)	TABLE ANGLE (Degree)	RAW VALUE (dBuV)	CORRECTION FACTOR (dB/m)
1	52.60	18.84 QP	40.00	-21.16	2.28 H	133	27.85	-9.01
2	114.54	18.41 QP	43.50	-25.09	1.94 H	122	30.66	-12.25
3	150.72	18.39 QP	43.50	-25.11	2.04 H	141	27.50	-9.11
4	225.02	17.48 QP	46.00	-28.52	1.85 H	29	28.81	-11.33
5	274.49	30.68 QP	46.00	-15.32	2.64 H	277	38.68	-8.00
6	409.56	34.32 QP	46.00	-11.68	1.00 H	37	39.52	-5.20

ANTENNA POLARITY & TEST DISTANCE: VERTICAL AT 3 M

NO.	FREQ. (MHz)	EMISSION LEVEL (dBuV/m)	LIMIT (dBuV/m)	MARGIN (dB)	ANTENNA HEIGHT (m)	TABLE ANGLE (Degree)	RAW VALUE (dBuV)	CORRECTION FACTOR (dB/m)
1	39.94	30.77 QP	40.00	-9.23	2.16 V	157	40.69	-9.92
2	52.31	28.00 QP	40.00	-12.00	1.23 V	152	36.98	-8.98
3	105.22	22.69 QP	43.50	-20.81	1.18 V	56	35.87	-13.18
4	150.91	20.18 QP	43.50	-23.32	1.45 V	105	29.29	-9.11
5	275.07	28.51 QP	46.00	-17.49	1.58 V	140	36.50	-7.99
6	408.79	34.64 QP	46.00	-11.36	1.44 V	179	39.85	-5.21

REMARKS:

1. Emission Level(dBuV/m) = Raw Value(dBuV) + Correction Factor(dB/m)
2. Correction Factor(dB/m) = Antenna Factor(dB/m) + Cable Factor(dB) – Pre-Amplifier Factor(dB)
3. The other emission levels were very low against the limit.
4. Margin value = Emission Level – Limit value

4.2 Conducted Emission Measurement

4.2.1 Limits of Conducted Emission Measurement

Frequency (MHz)	Conducted Limit (dBuV)	
	Quasi-peak	Average
0.15 - 0.5	66 - 56	56 - 46
0.50 - 5.0	56	46
5.0 - 30.0	60	50

Note: 1. The lower limit shall apply at the transition frequencies.

2. The limit decreases in line with the logarithm of the frequency in the range of 0.15 to 0.50MHz.

4.2.2 Test Instruments

Description & Manufacturer	Model No.	Serial No.	Cal. Date	Cal. Due
ROHDE & SCHWARZ TEST RECEIVER	ESCS 30	100276	Apr. 10, 2017	Apr. 09, 2018
ROHDE & SCHWARZ Artificial Mains Network (for EUT)	ENV216	101197	May 22, 2017	May 21, 2018
LISN With Adapter (for EUT)	AD10	C10Ada-002	May 22, 2017	May 21, 2018
ROHDE & SCHWARZ Artificial Mains Network (for peripherals)	ESH3-Z5	100218	Nov. 23, 2016	Nov. 22, 2017
SCHWARZBECK Artificial Mains Network (For EUT)	NNLK8129	8129229	May 09, 2017	May 08, 2018
Software	Cond_V7.3.7.4	NA	NA	NA
RF cable (JYEBAO) With 10dB PAD	5D-FB	Cable-C10.01	Feb. 14, 2017	Feb. 13, 2018
SUHNER Terminator (For ROHDE & SCHWARZ LISN)	65BNC-5001	E1-011484	May 18, 2017	May 17, 2018
ROHDE & SCHWARZ Artificial Mains Network (For TV EUT)	ESH3-Z5	100220	Nov. 08, 2016	Nov. 07, 2017
LISN With Adapter (for TV EUT)	100220	N/A	Nov. 08, 2016	Nov. 07, 2017

Notes: 1. The calibration interval of the above test instruments is 12 months and the calibrations are traceable to NML/ROC and NIST/USA.

2. The test was performed in Shielded Room No. 10.

3. The FCC Designation Number is TW2021.

4. Tested Date: Jul. 13, 2017

4.2.3 Test Procedure

- The EUT was placed 0.4 meters from the conducting wall of the shielded room with EUT being connected to the power mains through a line impedance stabilization network (LISN). Other support units were connected to the power mains through another LISN. The two LISNs provide 50 ohm/ 50uH of coupling impedance for the measuring instrument.
- Both lines of the power mains connected to the EUT were checked for maximum conducted interference.
- The frequency range from 150kHz to 30MHz was searched. Emission levels under (Limit - 20dB) was not recorded.

NOTE: All modes of operation were investigated and the worst-case emissions are reported.

4.2.4 Deviation from Test Standard

No deviation.

4.2.5 Test Setup

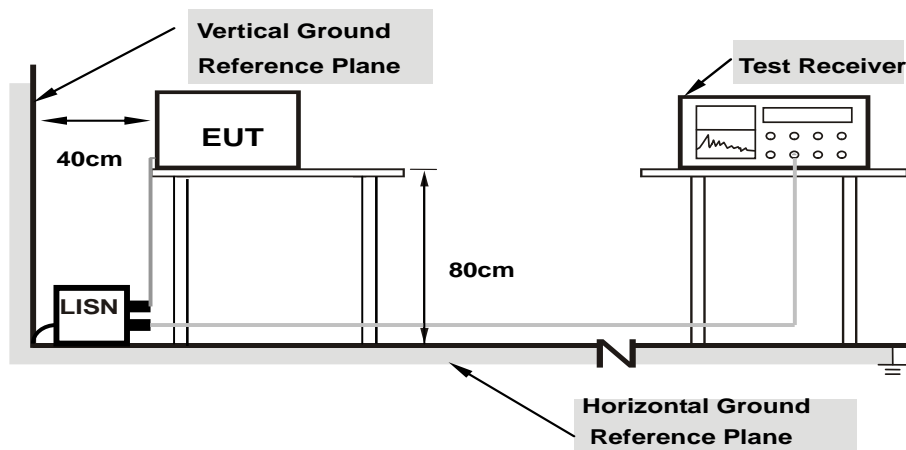

Note: 1.Support units were connected to second LISN.

For the actual test configuration, please refer to the attached file (Test Setup Photo).

4.2.6 EUT Operating Condition

Same as 4.1.6.

4.2.7 Test Results

CDD MODE

Phase	Line (L)	Detector Function	Quasi-Peak (QP) / Average (AV)
-------	----------	-------------------	--------------------------------

No	Freq. [MHz]	Corr.	Reading Value		Emission Level		Limit		Margin	
		Factor	[dB (uV)]		[dB (uV)]		[dB (uV)]		(dB)	
		(dB)	Q.P.	AV.	Q.P.	AV.	Q.P.	AV.	Q.P.	AV.
1	0.15000	9.65	33.32	24.03	42.97	33.68	66.00	56.00	-23.03	-22.32
2	0.35703	9.66	36.96	36.83	46.62	46.49	58.80	48.80	-12.18	-2.31
3	0.63828	9.68	19.92	18.22	29.60	27.90	56.00	46.00	-26.40	-18.10
4	4.09766	9.84	20.05	13.08	29.89	22.92	56.00	46.00	-26.11	-23.08
5	9.97656	9.93	26.26	21.70	36.19	31.63	60.00	50.00	-23.81	-18.37
6	21.87500	10.02	28.12	26.55	38.14	36.57	60.00	50.00	-21.86	-13.43

REMARKS:

1. Q.P. and AV. are abbreviations of quasi-peak and average individually.
2. The emission levels of other frequencies were very low against the limit.
3. Margin value = Emission level - Limit value
4. Correction factor = Insertion loss + Cable loss
5. Emission Level = Correction Factor + Reading Value.

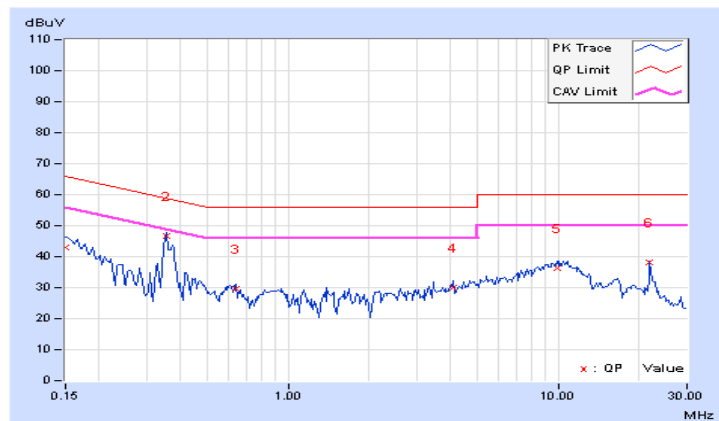

Phase	Neutral (N)	Detector Function	Quasi-Peak (QP) / Average (AV)
-------	-------------	-------------------	--------------------------------

No	Freq. [MHz]	Corr.	Reading Value		Emission Level		Limit		Margin	
		Factor	[dB (uV)]		[dB (uV)]		[dB (uV)]		(dB)	
		(dB)	Q.P.	AV.	Q.P.	AV.	Q.P.	AV.	Q.P.	AV.
1	0.15391	9.67	37.26	24.53	46.93	34.20	65.79	55.79	-18.86	-21.59
2	0.35313	9.68	38.20	36.66	47.88	46.34	58.89	48.89	-11.01	-2.55
3	0.63828	9.69	20.62	19.02	30.31	28.71	56.00	46.00	-25.69	-17.29
4	2.62891	9.78	17.93	11.07	27.71	20.85	56.00	46.00	-28.29	-25.15
5	10.91016	9.96	25.99	21.34	35.95	31.30	60.00	50.00	-24.05	-18.70
6	21.87500	10.08	29.12	28.49	39.20	38.57	60.00	50.00	-20.80	-11.43

REMARKS:

1. Q.P. and AV. are abbreviations of quasi-peak and average individually.
2. The emission levels of other frequencies were very low against the limit.
3. Margin value = Emission level - Limit value
4. Correction factor = Insertion loss + Cable loss
5. Emission Level = Correction Factor + Reading Value.

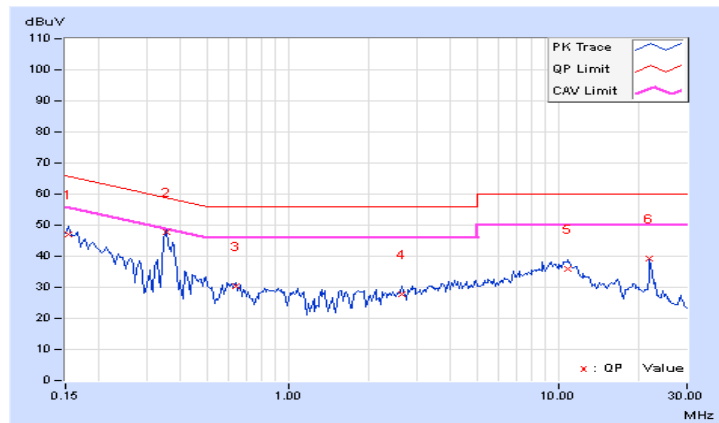

4.3 Transmit Power Measurement

4.3.1 Limits of Transmit Power Measurement

Operation Band	EUT Category		Limit
U-NII-1	---	Outdoor Access Point	1 Watt (30 dBm) (Max. e.i.r.p \leq 125mW(21 dBm) at any elevation angle above 30 degrees as measured from the horizon)
	---	Fixed point-to-point Access Point	1 Watt (30 dBm)
	---	Indoor Access Point	1 Watt (30 dBm)
	---	Mobile and Portable client device	250mW (24 dBm)
U-NII-2A	√		250mW (24 dBm) or 11 dBm+10 log B*
U-NII-2C	√		250mW (24 dBm) or 11 dBm+10 log B*
U-NII-3	---		1 Watt (30 dBm)

*B is the 26 dB emission bandwidth in megahertz

Per KDB 662911 Method of conducted output power measurement on IEEE 802.11 devices,

Array Gain = 0 dB (i.e., no array gain) for $N_{ANT} \leq 4$;

Array Gain = 0 dB (i.e., no array gain) for channel widths ≥ 40 MHz for any N_{ANT} ;

Array Gain = $5 \log(N_{ANT}/N_{SS})$ dB or 3 dB, whichever is less for 20-MHz channel widths with $N_{ANT} \geq 5$.

For power measurements on all other devices: Array Gain = $10 \log(N_{ANT}/N_{SS})$ dB.

4.3.2 Test Setup

For Power Output Measurement

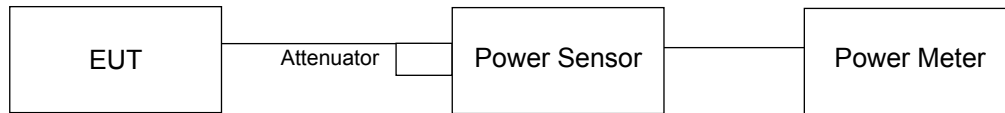

For 26dB Occupied Bandwidth

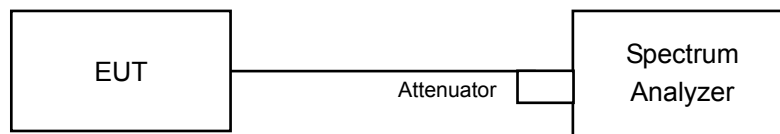

4.3.3 Test Instruments

Refer to section 4.1.2 to get information of above instrument.

4.3.4 Test Procedure

For Average Power Measurement

For 802.11a, 802.11ac (20MHz), 802.11ac (40MHz)

Method PM is used to perform output power measurement, trigger and gating function of wide band power meter is enabled to measure max output power of TX on burst. Duty factor is not added to measured value.

For 802.11ac (80MHz)

- 1) Set span to encompass the entire 26 dB EBW (or, alternatively, the entire 99% occupied bandwidth) of the signal.
- 2) Set sweep trigger to "free run".
- 3) Set RBW = 1 MHz.
- 4) Set VBW \geq 3 MHz
- 5) Number of points in sweep \geq 2 Span / RBW.
- 6) Sweep time \leq (number of points in sweep) * T
- 7) Using emission bandwidth to determine the frequency span for integration the channel bandwidth.
- 8) Detector = RMS.
- 9) Trace mode = max hold.
- 10) Allow max hold to run for at least 60 seconds, or longer as needed to allow the trace to stabilize.

For 26dB Occupied Bandwidth

- 1) Set RBW = approximately 1% of the emission bandwidth.
- 2) Set the VBW > RBW.
- 3) Detector = Peak.
- 4) Trace mode = max hold.
- 5) Measure the maximum width of the emission that is 26 dB down from the peak of the emission. Compare this with the RBW setting of the analyzer. Readjust RBW and repeat measurement as needed until the RBW/EBW ratio is approximately 1%.

4.3.5 Deviation from Test Standard

No deviation.

4.3.6 EUT Operating Condition

The software provided by client to enable the EUT under transmission condition continuously at lowest, middle and highest channel frequencies individually.

4.3.7 Test Result

CDD Mode (Mode A)

Power Output:

802.11a

Chan.	Chan. Freq. (MHz)	Maximum Conducted Power (dBm)				Total Power (mW)	Total Power (dBm)	Power Limit (dBm)	Pass/Fail
		Chain 0	Chain 1	Chain 2	Chain 3				
52	5260	12.79	12.55	12.24	12.07	69.855	18.44	24.00	PASS
60	5300	12.84	12.51	12.41	12.01	70.358	18.47	24.00	PASS
64	5320	12.85	12.52	12.41	12.02	70.480	18.48	23.99	PASS
100	5500	13.96	13.51	13.45	13.19	90.304	19.56	24.00	PASS
116	5580	13.69	13.43	13.52	13.28	89.189	19.50	24.00	PASS
132	5660	13.75	13.64	13.32	13.26	89.497	19.52	24.00	PASS
140	5700	13.95	13.57	13.39	13.24	90.495	19.57	24.00	PASS

NOTE:

Chain 0:

1. $11\text{dBm} + 10\log (20.05) = 24.02 > 24\text{dBm}$
2. $11\text{dBm} + 10\log (20.01) = 24.01 > 24\text{dBm}$
3. $11\text{dBm} + 10\log (20.01) = 24.01 > 24\text{dBm}$
4. $11\text{dBm} + 10\log (20.42) = 24.10 > 24\text{dBm}$
5. $11\text{dBm} + 10\log (20.15) = 24.04 > 24\text{dBm}$
6. $11\text{dBm} + 10\log (20.19) = 24.05 > 24\text{dBm}$
7. $11\text{dBm} + 10\log (20.32) = 24.08 > 24\text{dBm}$

Chain 2:

1. $11\text{dBm} + 10\log (20.11) = 24.03 > 24\text{dBm}$
2. $11\text{dBm} + 10\log (19.98) = 24.01 > 24\text{dBm}$
3. $11\text{dBm} + 10\log (19.91) = 23.99 < 24\text{dBm}$
4. $11\text{dBm} + 10\log (20.20) = 24.05 > 24\text{dBm}$
5. $11\text{dBm} + 10\log (20.11) = 24.03 > 24\text{dBm}$
6. $11\text{dBm} + 10\log (20.16) = 24.04 > 24\text{dBm}$
7. $11\text{dBm} + 10\log (20.05) = 24.02 > 24\text{dBm}$

Chain 1:

1. $11\text{dBm} + 10\log (20.09) = 24.03 > 24\text{dBm}$
2. $11\text{dBm} + 10\log (20.19) = 24.05 > 24\text{dBm}$
3. $11\text{dBm} + 10\log (19.98) = 24.01 > 24\text{dBm}$
4. $11\text{dBm} + 10\log (20.01) = 24.01 > 24\text{dBm}$
5. $11\text{dBm} + 10\log (19.97) = 24.00 > 24\text{dBm}$
6. $11\text{dBm} + 10\log (20.14) = 24.04 > 24\text{dBm}$
7. $11\text{dBm} + 10\log (20.16) = 24.04 > 24\text{dBm}$

Chain 3:

1. $11\text{dBm} + 10\log (20.22) = 24.06 > 24\text{dBm}$
2. $11\text{dBm} + 10\log (20.00) = 24.01 > 24\text{dBm}$
3. $11\text{dBm} + 10\log (20.32) = 24.08 > 24\text{dBm}$
4. $11\text{dBm} + 10\log (20.00) = 24.01 > 24\text{dBm}$
5. $11\text{dBm} + 10\log (20.39) = 24.09 > 24\text{dBm}$
6. $11\text{dBm} + 10\log (20.20) = 24.05 > 24\text{dBm}$
7. $11\text{dBm} + 10\log (20.15) = 24.04 > 24\text{dBm}$

802.11ac (20MHz)

Chan.	Chan. Freq. (MHz)	Maximum Conducted Power (dBm)				Total Power (mW)	Total Power (dBm)	Power Limit (dBm)	Pass/Fail
		Chain 0	Chain 1	Chain 2	Chain 3				
52	5260	12.82	12.54	12.29	12.12	70.326	18.47	24.00	PASS
60	5300	12.78	12.49	12.39	12.08	70.191	18.46	24.00	PASS
64	5320	12.79	12.52	12.51	12.00	70.549	18.48	24.00	PASS
100	5500	13.79	13.72	13.62	13.16	91.198	19.60	24.00	PASS
116	5580	13.74	13.59	13.52	13.18	89.803	19.53	24.00	PASS
132	5660	13.94	13.63	13.52	13.28	91.613	19.62	24.00	PASS
140	5700	13.92	13.68	13.52	13.32	91.964	19.64	24.00	PASS

NOTE:

Chain 0:

1. 11dBm + 10log (21.13) = 24.25 > 24dBm
2. 11dBm + 10log (20.82) = 24.18 > 24dBm
3. 11dBm + 10log (20.86) = 24.19 > 24dBm
4. 11dBm + 10log (20.84) = 24.19 > 24dBm
5. 11dBm + 10log (21.13) = 24.25 > 24dBm
6. 11dBm + 10log (21.01) = 24.22 > 24dBm
7. 11dBm + 10log (20.74) = 24.17 > 24dBm

Chain 2:

1. 11dBm + 10log (20.77) = 24.17 > 24dBm
2. 11dBm + 10log (20.99) = 24.22 > 24dBm
3. 11dBm + 10log (20.82) = 24.18 > 24dBm
4. 11dBm + 10log (20.89) = 24.20 > 24dBm
5. 11dBm + 10log (20.97) = 24.22 > 24dBm
6. 11dBm + 10log (20.95) = 24.21 > 24dBm
7. 11dBm + 10log (21.12) = 24.25 > 24dBm

Chain 1:

1. 11dBm + 10log (20.80) = 24.18 > 24dBm
2. 11dBm + 10log (20.71) = 24.16 > 24dBm
3. 11dBm + 10log (20.68) = 24.16 > 24dBm
4. 11dBm + 10log (20.61) = 24.14 > 24dBm
5. 11dBm + 10log (20.71) = 24.16 > 24dBm
6. 11dBm + 10log (20.91) = 24.20 > 24dBm
7. 11dBm + 10log (20.96) = 24.21 > 24dBm

Chain 3:

1. 11dBm + 10log (21.08) = 24.24 > 24dBm
2. 11dBm + 10log (20.84) = 24.19 > 24dBm
3. 11dBm + 10log (20.74) = 24.17 > 24dBm
4. 11dBm + 10log (20.73) = 24.17 > 24dBm
5. 11dBm + 10log (20.99) = 24.22 > 24dBm
6. 11dBm + 10log (21.01) = 24.22 > 24dBm
7. 11dBm + 10log (21.25) = 24.27 > 24dBm

802.11ac (40MHz)

Chan.	Chan. Freq. (MHz)	Maximum Conducted Power (dBm)				Total Power (mW)	Total Power (dBm)	Power Limit (dBm)	Pass/Fail
		Chain 0	Chain 1	Chain 2	Chain 3				
54	5270	12.75	12.48	12.38	12.22	70.507	18.48	24.00	PASS
62	5310	12.72	12.45	12.36	12.24	70.254	18.47	24.00	PASS
102	5510	16.79	16.73	16.82	16.14	184.050	22.65	24.00	PASS
110	5550	16.78	16.62	16.69	16.15	181.439	22.59	24.00	PASS
134	5670	16.71	16.75	16.81	16.19	183.760	22.64	24.00	PASS

NOTE:

Chain 0:

1. $11\text{dBm} + 10\log (40.18) = 27.04 > 24\text{dBm}$
2. $11\text{dBm} + 10\log (40.18) = 27.04 > 24\text{dBm}$
3. $11\text{dBm} + 10\log (40.17) = 27.04 > 24\text{dBm}$
4. $11\text{dBm} + 10\log (40.23) = 27.05 > 24\text{dBm}$
5. $11\text{dBm} + 10\log (40.15) = 27.04 > 24\text{dBm}$

Chain 2:

1. $11\text{dBm} + 10\log (40.12) = 27.03 > 24\text{dBm}$
2. $11\text{dBm} + 10\log (39.99) = 27.02 > 24\text{dBm}$
3. $11\text{dBm} + 10\log (40.02) = 27.02 > 24\text{dBm}$
4. $11\text{dBm} + 10\log (40.08) = 27.03 > 24\text{dBm}$
5. $11\text{dBm} + 10\log (40.04) = 27.02 > 24\text{dBm}$

Chain 1:

1. $11\text{dBm} + 10\log (40.26) = 27.05 > 24\text{dBm}$
2. $11\text{dBm} + 10\log (40.11) = 27.03 > 24\text{dBm}$
3. $11\text{dBm} + 10\log (40.15) = 27.04 > 24\text{dBm}$
4. $11\text{dBm} + 10\log (40.21) = 27.04 > 24\text{dBm}$
5. $11\text{dBm} + 10\log (39.80) = 27.00 > 24\text{dBm}$

Chain 3:

1. $11\text{dBm} + 10\log (39.93) = 27.01 > 24\text{dBm}$
2. $11\text{dBm} + 10\log (40.00) = 27.02 > 24\text{dBm}$
3. $11\text{dBm} + 10\log (40.05) = 27.03 > 24\text{dBm}$
4. $11\text{dBm} + 10\log (40.17) = 27.04 > 24\text{dBm}$
5. $11\text{dBm} + 10\log (40.13) = 27.03 > 24\text{dBm}$

802.11ac (80MHz)

Chan.	Chan. Freq. (MHz)	Maximum Conducted Power (dBm)				Total Power (mW)	Total Power (dBm)	Power Limit (dBm)	Pass/Fail
		Chain 0	Chain 1	Chain 2	Chain 3				
58	5290	12.73	12.51	12.33	12.29	70.617	18.49	24.00	PASS
106	5530	17.94	17.72	17.45	17.00	227.095	23.56	24.00	PASS
122	5610	17.69	17.81	17.63	17.21	229.689	23.61	24.00	PASS

NOTE:

Chain 0:

1. $11\text{dBm} + 10\log (84.20) = 30.25 > 24\text{dBm}$
2. $11\text{dBm} + 10\log (84.07) = 30.25 > 24\text{dBm}$
3. $11\text{dBm} + 10\log (84.06) = 30.25 > 24\text{dBm}$

Chain 2:

1. $11\text{dBm} + 10\log (84.26) = 30.26 > 24\text{dBm}$
2. $11\text{dBm} + 10\log (83.86) = 30.24 > 24\text{dBm}$
3. $11\text{dBm} + 10\log (84.06) = 30.25 > 24\text{dBm}$

Chain 1:

1. $11\text{dBm} + 10\log (84.43) = 30.26 > 24\text{dBm}$
2. $11\text{dBm} + 10\log (84.13) = 30.25 > 24\text{dBm}$
3. $11\text{dBm} + 10\log (84.34) = 30.26 > 24\text{dBm}$

Chain 3:

1. $11\text{dBm} + 10\log (83.68) = 30.23 > 24\text{dBm}$
2. $11\text{dBm} + 10\log (84.12) = 30.25 > 24\text{dBm}$
3. $11\text{dBm} + 10\log (84.93) = 30.29 > 24\text{dBm}$

26dB BANDWIDTH:

802.11a

Channel	Channel Frequency (MHz)	26dBc Bandwidth (MHz)				Pass/Fail
		Chain 0	Chain 1	Chain 2	Chain 3	
52	5260	20.05	20.09	20.11	20.22	Pass
60	5300	20.01	20.19	19.98	20.00	Pass
64	5320	20.01	19.98	19.91	20.32	Pass
100	5500	20.42	20.01	20.20	20.00	Pass
116	5580	20.15	19.97	20.11	20.39	Pass
132	5660	20.19	20.14	20.16	20.20	Pass
140	5700	20.32	20.16	20.05	20.15	Pass

802.11ac (20MHz)

Channel	Channel Frequency (MHz)	26dBc Bandwidth (MHz)				Pass/Fail
		Chain 0	Chain 1	Chain 2	Chain 3	
52	5260	21.13	20.80	20.77	21.08	Pass
60	5300	20.82	20.71	20.99	20.84	Pass
64	5320	20.86	20.68	20.82	20.74	Pass
100	5500	20.84	20.61	20.89	20.73	Pass
116	5580	21.13	20.71	20.97	20.99	Pass
132	5660	21.01	20.91	20.95	21.01	Pass
140	5700	20.74	20.96	21.12	21.25	Pass

802.11ac (40MHz)

Channel	Channel Frequency (MHz)	26dBc Bandwidth (MHz)				Pass/Fail
		Chain 0	Chain 1	Chain 2	Chain 3	
54	5270	40.18	40.26	40.12	39.93	Pass
62	5310	40.18	40.11	39.99	40.00	Pass
102	5510	40.17	40.15	40.02	40.05	Pass
110	5550	40.23	40.21	40.08	40.17	Pass
134	5670	40.15	39.80	40.04	40.13	Pass

802.11ac (80MHz)

Channel	Channel Frequency (MHz)	26dBc Bandwidth (MHz)				Pass/Fail
		Chain 0	Chain 1	Chain 2	Chain 3	
58	5290	84.20	84.43	84.26	83.68	Pass
106	5530	84.07	84.13	83.86	84.12	Pass
122	5610	84.06	84.34	84.06	84.93	Pass

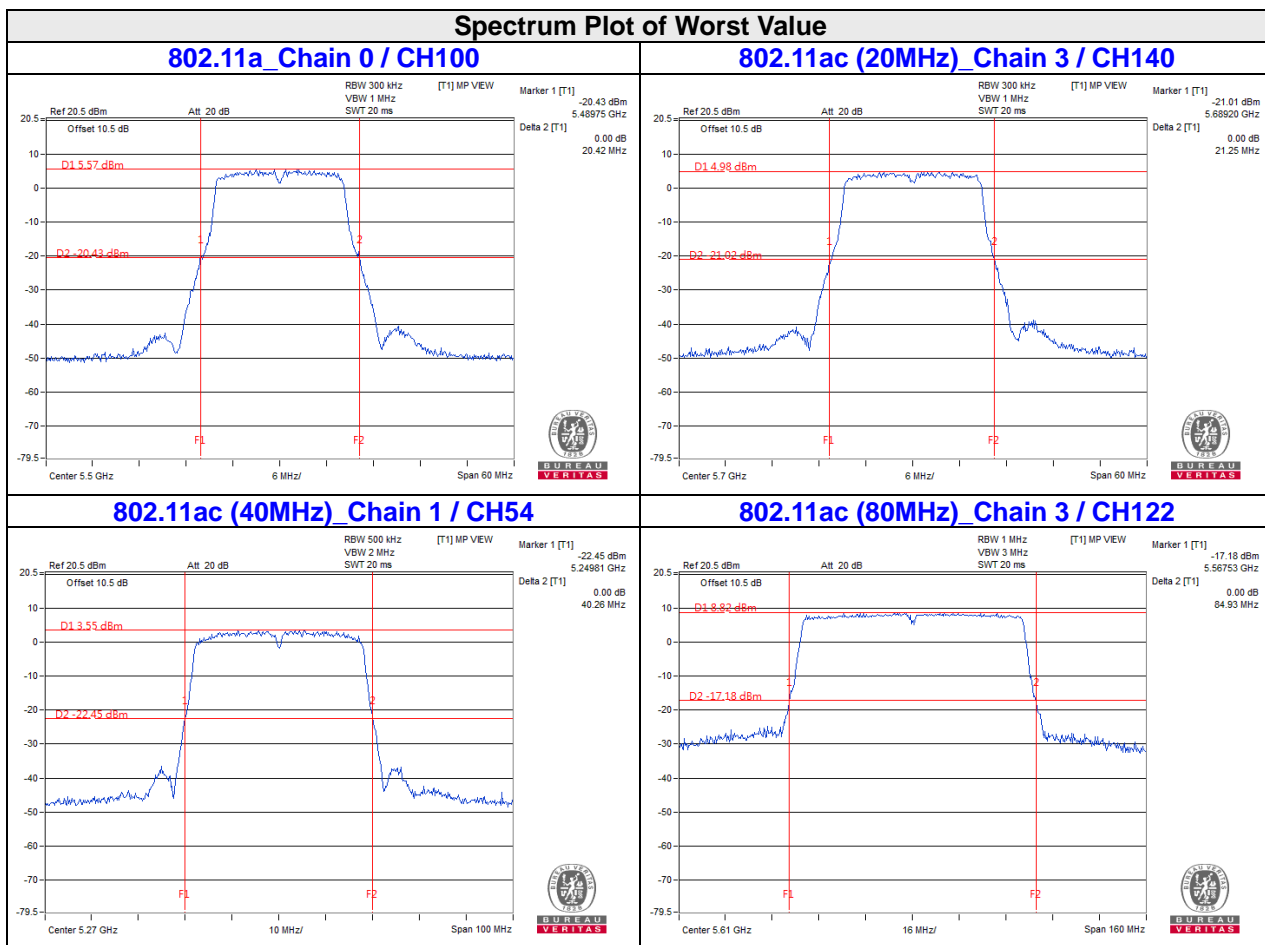

EUT MAXIMUM CONDUCTED POWER

802.11a

FREQUENCY BAND (MHz)	MAX. POWER	
	OUTPUT POWER (mW)	OUTPUT POWER (dBm)
5250~5350	70.480	18.48
5470~5725	90.495	19.57

NOTE: Manufacturer provides Transmit Power Control description to meet this requirement.

802.11ac (20MHz)

FREQUENCY BAND (MHz)	MAX. POWER	
	OUTPUT POWER (mW)	OUTPUT POWER (dBm)
5250~5350	70.549	18.48
5470~5725	91.964	19.64

NOTE: Manufacturer provides Transmit Power Control description to meet this requirement.

802.11ac (40MHz)

FREQUENCY BAND (MHz)	MAX. POWER	
	OUTPUT POWER (mW)	OUTPUT POWER (dBm)
5250~5350	70.507	18.48
5470~5725	184.050	22.65

NOTE: Manufacturer provides Transmit Power Control description to meet this requirement.

802.11ac (80MHz)

FREQUENCY BAND (MHz)	MAX. POWER	
	OUTPUT POWER (mW)	OUTPUT POWER (dBm)
5250~5350	70.617	18.49
5470~5725	229.689	23.61

NOTE: Manufacturer provides Transmit Power Control description to meet this requirement.

CDD Mode (Mode B)

Power Output:

802.11a

Chan.	Chan. Freq. (MHz)	Maximum Conducted Power (dBm)				Total Power (mW)	Total Power (dBm)	Power Limit (dBm)	Pass/Fail
		Chain 0	Chain 1	Chain 2	Chain 3				
52	5260	11.29	10.73	10.74	10.57	48.549	16.86	23.99	PASS
60	5300	11.32	10.71	10.88	10.42	48.589	16.87	24.00	PASS
64	5320	11.25	10.85	10.81	10.48	48.716	16.88	23.98	PASS
100	5500	12.31	12.04	11.98	11.68	63.517	18.03	23.99	PASS
116	5580	12.21	12.00	12.02	11.78	63.471	18.03	24.00	PASS
132	5660	12.25	12.15	11.87	11.79	63.677	18.04	24.00	PASS
140	5700	12.35	12.02	11.94	11.76	63.729	18.04	24.00	PASS

NOTE:

Chain 0:

1. $11\text{dBm} + 10\log (20.09) = 24.03 > 24\text{dBm}$
2. $11\text{dBm} + 10\log (20.08) = 24.03 > 24\text{dBm}$
3. $11\text{dBm} + 10\log (20.30) = 24.07 > 24\text{dBm}$
4. $11\text{dBm} + 10\log (19.91) = 23.99 < 24\text{dBm}$
5. $11\text{dBm} + 10\log (20.20) = 24.05 > 24\text{dBm}$
6. $11\text{dBm} + 10\log (20.06) = 24.02 > 24\text{dBm}$
7. $11\text{dBm} + 10\log (20.01) = 24.01 > 24\text{dBm}$

Chain 2:

1. $11\text{dBm} + 10\log (19.90) = 23.99 < 24\text{dBm}$
2. $11\text{dBm} + 10\log (20.21) = 24.06 > 24\text{dBm}$
3. $11\text{dBm} + 10\log (20.04) = 24.02 > 24\text{dBm}$
4. $11\text{dBm} + 10\log (20.31) = 24.08 > 24\text{dBm}$
5. $11\text{dBm} + 10\log (20.07) = 24.03 > 24\text{dBm}$
6. $11\text{dBm} + 10\log (20.14) = 24.04 > 24\text{dBm}$
7. $11\text{dBm} + 10\log (19.99) = 24.01 > 24\text{dBm}$

Chain 1:

1. $11\text{dBm} + 10\log (20.36) = 24.09 > 24\text{dBm}$
2. $11\text{dBm} + 10\log (20.05) = 24.02 > 24\text{dBm}$
3. $11\text{dBm} + 10\log (20.18) = 24.05 > 24\text{dBm}$
4. $11\text{dBm} + 10\log (20.26) = 24.07 > 24\text{dBm}$
5. $11\text{dBm} + 10\log (20.34) = 24.08 > 24\text{dBm}$
6. $11\text{dBm} + 10\log (20.36) = 24.09 > 24\text{dBm}$
7. $11\text{dBm} + 10\log (20.25) = 24.06 > 24\text{dBm}$

Chain 3:

1. $11\text{dBm} + 10\log (20.12) = 24.04 > 24\text{dBm}$
2. $11\text{dBm} + 10\log (20.08) = 24.03 > 24\text{dBm}$
3. $11\text{dBm} + 10\log (19.86) = 23.98 < 24\text{dBm}$
4. $11\text{dBm} + 10\log (20.09) = 24.03 > 24\text{dBm}$
5. $11\text{dBm} + 10\log (20.34) = 24.08 > 24\text{dBm}$
6. $11\text{dBm} + 10\log (20.09) = 24.03 > 24\text{dBm}$
7. $11\text{dBm} + 10\log (20.18) = 24.05 > 24\text{dBm}$

802.11ac (20MHz)

Chan.	Chan. Freq. (MHz)	Maximum Conducted Power (dBm)				Total Power (mW)	Total Power (dBm)	Power Limit (dBm)	Pass/Fail
		Chain 0	Chain 1	Chain 2	Chain 3				
52	5260	11.33	10.84	10.69	10.52	48.711	16.88	24.00	PASS
60	5300	11.21	10.75	10.79	10.44	48.159	16.83	24.00	PASS
64	5320	11.28	10.78	10.82	10.40	48.438	16.85	24.00	PASS
100	5500	12.31	12.21	12.08	11.68	64.523	18.10	24.00	PASS
116	5580	12.32	12.18	12.11	11.65	64.458	18.09	24.00	PASS
132	5660	12.43	12.09	12.02	11.71	64.426	18.09	24.00	PASS
140	5700	12.45	12.17	12.05	11.66	64.748	18.11	24.00	PASS

NOTE:

Chain 0:

1. $11\text{dBm} + 10\log (20.76) = 24.17 > 24\text{dBm}$
2. $11\text{dBm} + 10\log (20.65) = 24.15 > 24\text{dBm}$
3. $11\text{dBm} + 10\log (20.76) = 24.17 > 24\text{dBm}$
4. $11\text{dBm} + 10\log (20.71) = 24.16 > 24\text{dBm}$
5. $11\text{dBm} + 10\log (21.00) = 24.22 > 24\text{dBm}$
6. $11\text{dBm} + 10\log (21.09) = 24.24 > 24\text{dBm}$
7. $11\text{dBm} + 10\log (21.09) = 24.24 > 24\text{dBm}$

Chain 2:

1. $11\text{dBm} + 10\log (20.64) = 24.15 > 24\text{dBm}$
2. $11\text{dBm} + 10\log (21.10) = 24.24 > 24\text{dBm}$
3. $11\text{dBm} + 10\log (20.76) = 24.17 > 24\text{dBm}$
4. $11\text{dBm} + 10\log (20.74) = 24.17 > 24\text{dBm}$
5. $11\text{dBm} + 10\log (20.91) = 24.20 > 24\text{dBm}$
6. $11\text{dBm} + 10\log (20.94) = 24.21 > 24\text{dBm}$
7. $11\text{dBm} + 10\log (21.04) = 24.23 > 24\text{dBm}$

Chain 1:

1. $11\text{dBm} + 10\log (20.72) = 24.16 > 24\text{dBm}$
2. $11\text{dBm} + 10\log (20.72) = 24.16 > 24\text{dBm}$
3. $11\text{dBm} + 10\log (20.89) = 24.20 > 24\text{dBm}$
4. $11\text{dBm} + 10\log (20.68) = 24.16 > 24\text{dBm}$
5. $11\text{dBm} + 10\log (20.61) = 24.14 > 24\text{dBm}$
6. $11\text{dBm} + 10\log (20.99) = 24.22 > 24\text{dBm}$
7. $11\text{dBm} + 10\log (20.88) = 24.20 > 24\text{dBm}$

Chain 3:

1. $11\text{dBm} + 10\log (20.80) = 24.18 > 24\text{dBm}$
2. $11\text{dBm} + 10\log (20.55) = 24.13 > 24\text{dBm}$
3. $11\text{dBm} + 10\log (20.75) = 24.17 > 24\text{dBm}$
4. $11\text{dBm} + 10\log (21.00) = 24.22 > 24\text{dBm}$
5. $11\text{dBm} + 10\log (20.95) = 24.21 > 24\text{dBm}$
6. $11\text{dBm} + 10\log (21.02) = 24.23 > 24\text{dBm}$
7. $11\text{dBm} + 10\log (21.28) = 24.28 > 24\text{dBm}$

802.11ac (40MHz)

Chan.	Chan. Freq. (MHz)	Maximum Conducted Power (dBm)				Total Power (mW)	Total Power (dBm)	Power Limit (dBm)	Pass/Fail
		Chain 0	Chain 1	Chain 2	Chain 3				
54	5270	11.26	10.88	10.75	10.57	48.899	16.89	24.00	PASS
62	5310	11.19	10.92	11.07	10.52	49.577	16.95	24.00	PASS
102	5510	15.28	15.18	15.24	14.65	129.284	21.12	24.00	PASS
110	5550	15.31	15.16	15.26	14.68	129.723	21.13	24.00	PASS
134	5670	15.22	15.22	15.30	14.62	129.389	21.12	24.00	PASS

NOTE:

Chain 0:

1. $11\text{dBm} + 10\log (39.99) = 27.02 > 24\text{dBm}$
2. $11\text{dBm} + 10\log (40.32) = 27.06 > 24\text{dBm}$
3. $11\text{dBm} + 10\log (40.10) = 27.03 > 24\text{dBm}$
4. $11\text{dBm} + 10\log (40.22) = 27.04 > 24\text{dBm}$
5. $11\text{dBm} + 10\log (40.32) = 27.06 > 24\text{dBm}$

Chain 2:

1. $11\text{dBm} + 10\log (40.23) = 27.05 > 24\text{dBm}$
2. $11\text{dBm} + 10\log (39.99) = 27.02 > 24\text{dBm}$
3. $11\text{dBm} + 10\log (39.94) = 27.01 > 24\text{dBm}$
4. $11\text{dBm} + 10\log (40.13) = 27.03 > 24\text{dBm}$
5. $11\text{dBm} + 10\log (40.21) = 27.04 > 24\text{dBm}$

Chain 1:

1. $11\text{dBm} + 10\log (40.05) = 27.03 > 24\text{dBm}$
2. $11\text{dBm} + 10\log (40.03) = 27.02 > 24\text{dBm}$
3. $11\text{dBm} + 10\log (40.25) = 27.05 > 24\text{dBm}$
4. $11\text{dBm} + 10\log (40.14) = 27.04 > 24\text{dBm}$
5. $11\text{dBm} + 10\log (40.00) = 27.02 > 24\text{dBm}$

Chain 3:

1. $11\text{dBm} + 10\log (40.03) = 27.02 > 24\text{dBm}$
2. $11\text{dBm} + 10\log (40.21) = 27.04 > 24\text{dBm}$
3. $11\text{dBm} + 10\log (40.05) = 27.03 > 24\text{dBm}$
4. $11\text{dBm} + 10\log (40.00) = 27.02 > 24\text{dBm}$
5. $11\text{dBm} + 10\log (40.38) = 27.06 > 24\text{dBm}$

802.11ac (80MHz)

Chan.	Chan. Freq. (MHz)	Maximum Conducted Power (dBm)				Total Power (mW)	Total Power (dBm)	Power Limit (dBm)	Pass/Fail
		Chain 0	Chain 1	Chain 2	Chain 3				
58	5290	11.18	11.04	10.91	10.48	49.328	16.93	24.00	PASS
106	5530	14.94	14.72	14.45	14.00	113.817	20.56	24.00	PASS
122	5610	16.69	16.81	16.63	16.21	182.448	22.61	24.00	PASS

NOTE:

Chain 0:

1. $11\text{dBm} + 10\log (84.17) = 30.25 > 24\text{dBm}$
2. $11\text{dBm} + 10\log (84.54) = 30.27 > 24\text{dBm}$
3. $11\text{dBm} + 10\log (84.43) = 30.26 > 24\text{dBm}$

Chain 2:

1. $11\text{dBm} + 10\log (84.59) = 30.27 > 24\text{dBm}$
2. $11\text{dBm} + 10\log (83.22) = 30.20 > 24\text{dBm}$
3. $11\text{dBm} + 10\log (84.78) = 30.28 > 24\text{dBm}$

Chain 1:

1. $11\text{dBm} + 10\log (83.94) = 30.24 > 24\text{dBm}$
2. $11\text{dBm} + 10\log (83.64) = 30.22 > 24\text{dBm}$
3. $11\text{dBm} + 10\log (84.90) = 30.29 > 24\text{dBm}$

Chain 3:

1. $11\text{dBm} + 10\log (83.65) = 30.22 > 24\text{dBm}$
2. $11\text{dBm} + 10\log (84.41) = 30.26 > 24\text{dBm}$
3. $11\text{dBm} + 10\log (83.82) = 30.23 > 24\text{dBm}$

26dB BANDWIDTH:

802.11a

Channel	Channel Frequency (MHz)	26dBc Bandwidth (MHz)				Pass/Fail
		Chain 0	Chain 1	Chain 2	Chain 3	
52	5260	20.09	20.36	19.90	20.12	Pass
60	5300	20.08	20.05	20.21	20.08	Pass
64	5320	20.30	20.18	20.04	19.86	Pass
100	5500	19.91	20.26	20.31	20.09	Pass
116	5580	20.20	20.34	20.07	20.34	Pass
132	5660	20.06	20.36	20.14	20.09	Pass
140	5700	20.01	20.25	19.99	20.18	Pass

802.11ac (20MHz)

Channel	Channel Frequency (MHz)	26dBc Bandwidth (MHz)				Pass/Fail
		Chain 0	Chain 1	Chain 2	Chain 3	
52	5260	20.76	20.72	20.64	20.80	Pass
60	5300	20.65	20.72	21.10	20.55	Pass
64	5320	20.76	20.89	20.76	20.75	Pass
100	5500	20.71	20.68	20.74	21.00	Pass
116	5580	21.00	20.61	20.91	20.95	Pass
132	5660	21.09	20.99	20.94	21.02	Pass
140	5700	21.09	20.88	21.04	21.28	Pass

802.11ac (40MHz)

Channel	Channel Frequency (MHz)	26dBc Bandwidth (MHz)				Pass/Fail
		Chain 0	Chain 1	Chain 2	Chain 3	
54	5270	39.99	40.05	40.23	40.03	Pass
62	5310	40.32	40.03	39.99	40.21	Pass
102	5510	40.10	40.25	39.94	40.05	Pass
110	5550	40.22	40.14	40.13	40.00	Pass
134	5670	40.32	40.00	40.21	40.38	Pass

802.11ac (80MHz)

Channel	Channel Frequency (MHz)	26dBc Bandwidth (MHz)				Pass/Fail
		Chain 0	Chain 1	Chain 2	Chain 3	
58	5290	84.17	83.94	84.59	83.65	Pass
106	5530	84.54	83.64	83.22	84.41	Pass
122	5610	84.43	84.90	84.78	83.82	Pass

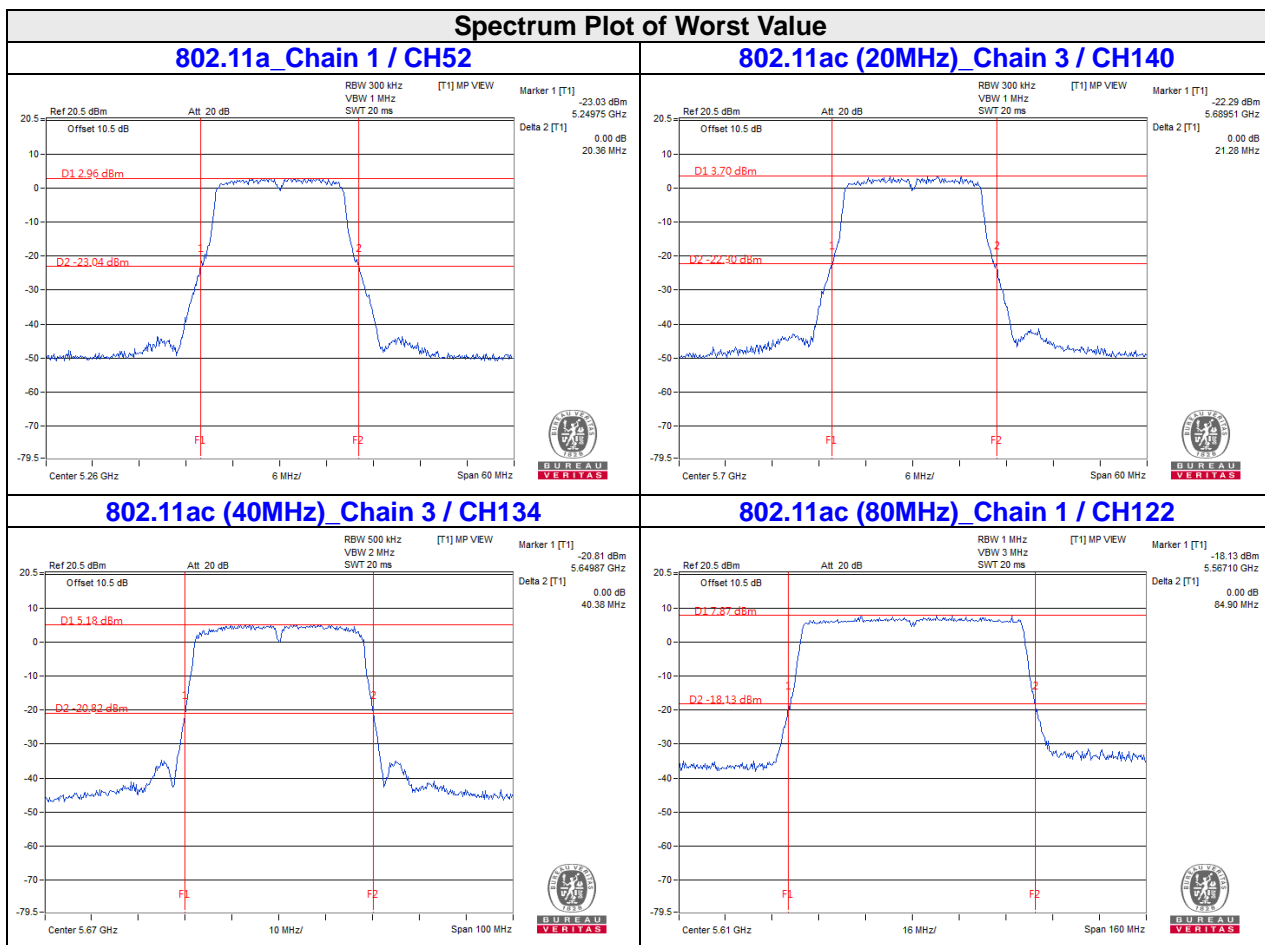

EUT MAXIMUM CONDUCTED POWER

802.11a

FREQUENCY BAND (MHz)	MAX. POWER	
	OUTPUT POWER (mW)	OUTPUT POWER (dBm)
5250~5350	48.716	16.88
5470~5725	63.729	18.04

NOTE: Manufacturer provides Transmit Power Control description to meet this requirement.

802.11ac (20MHz)

FREQUENCY BAND (MHz)	MAX. POWER	
	OUTPUT POWER (mW)	OUTPUT POWER (dBm)
5250~5350	48.711	16.88
5470~5725	64.748	18.11

NOTE: Manufacturer provides Transmit Power Control description to meet this requirement.

802.11ac (40MHz)

FREQUENCY BAND (MHz)	MAX. POWER	
	OUTPUT POWER (mW)	OUTPUT POWER (dBm)
5250~5350	49.577	16.95
5470~5725	129.723	21.13

NOTE: Manufacturer provides Transmit Power Control description to meet this requirement.

802.11ac (80MHz)

FREQUENCY BAND (MHz)	MAX. POWER	
	OUTPUT POWER (mW)	OUTPUT POWER (dBm)
5250~5350	49.328	16.93
5470~5725	182.448	22.61

NOTE: Manufacturer provides Transmit Power Control description to meet this requirement.

Beamforming_NSS1 Mode (Mode A)

Power Output:

802.11ac (20MHz)

Chan.	Chan. Freq. (MHz)	Maximum Conducted Power (dBm)				Total Power (mW)	Total Power (dBm)	Power Limit (dBm)	Pass/Fail
		Chain 0	Chain 1	Chain 2	Chain 3				
52	5260	6.77	6.50	6.29	6.12	17.569	12.45	19.63	PASS
60	5300	6.73	6.48	6.27	6.14	17.503	12.43	19.63	PASS
64	5320	6.74	6.54	6.52	6.04	17.734	12.49	19.63	PASS
100	5500	13.27	13.23	13.17	12.65	81.427	19.11	19.63	PASS
116	5580	13.31	13.14	13.08	12.79	81.370	19.10	19.63	PASS
132	5660	13.45	13.11	12.98	12.78	81.423	19.11	19.63	PASS
140	5700	13.48	13.21	13.04	12.81	82.461	19.16	19.63	PASS

NOTE: Directional gain = $10 \log[(10^{G1/20} + 10^{G2/20} + \dots + 10^{GN/20})^2 / 4] = 10.37\text{dBi} > 6\text{dBi}$, so the Power limit shall be reduced to $24 - (10.37 - 6) = 19.63\text{dBm}$

Chain 0:

1. $11\text{dBm} + 10\log (21.13) = 24.25 > 24\text{dBm}$
2. $11\text{dBm} + 10\log (20.82) = 24.18 > 24\text{dBm}$
3. $11\text{dBm} + 10\log (20.86) = 24.19 > 24\text{dBm}$
4. $11\text{dBm} + 10\log (20.84) = 24.19 > 24\text{dBm}$
5. $11\text{dBm} + 10\log (21.13) = 24.25 > 24\text{dBm}$
6. $11\text{dBm} + 10\log (21.01) = 24.22 > 24\text{dBm}$
7. $11\text{dBm} + 10\log (20.74) = 24.17 > 24\text{dBm}$

Chain 2:

1. $11\text{dBm} + 10\log (20.77) = 24.17 > 24\text{dBm}$
2. $11\text{dBm} + 10\log (20.99) = 24.22 > 24\text{dBm}$
3. $11\text{dBm} + 10\log (20.82) = 24.18 > 24\text{dBm}$
4. $11\text{dBm} + 10\log (20.89) = 24.20 > 24\text{dBm}$
5. $11\text{dBm} + 10\log (20.97) = 24.22 > 24\text{dBm}$
6. $11\text{dBm} + 10\log (20.95) = 24.21 > 24\text{dBm}$
7. $11\text{dBm} + 10\log (21.12) = 24.25 > 24\text{dBm}$

Chain 1:

1. $11\text{dBm} + 10\log (20.80) = 24.18 > 24\text{dBm}$
2. $11\text{dBm} + 10\log (20.71) = 24.16 > 24\text{dBm}$
3. $11\text{dBm} + 10\log (20.68) = 24.16 > 24\text{dBm}$
4. $11\text{dBm} + 10\log (20.61) = 24.14 > 24\text{dBm}$
5. $11\text{dBm} + 10\log (20.71) = 24.16 > 24\text{dBm}$
6. $11\text{dBm} + 10\log (20.91) = 24.20 > 24\text{dBm}$
7. $11\text{dBm} + 10\log (20.96) = 24.21 > 24\text{dBm}$

Chain 3:

1. $11\text{dBm} + 10\log (21.08) = 24.24 > 24\text{dBm}$
2. $11\text{dBm} + 10\log (20.84) = 24.19 > 24\text{dBm}$
3. $11\text{dBm} + 10\log (20.74) = 24.17 > 24\text{dBm}$
4. $11\text{dBm} + 10\log (20.73) = 24.17 > 24\text{dBm}$
5. $11\text{dBm} + 10\log (20.99) = 24.22 > 24\text{dBm}$
6. $11\text{dBm} + 10\log (21.01) = 24.22 > 24\text{dBm}$
7. $11\text{dBm} + 10\log (21.25) = 24.27 > 24\text{dBm}$

802.11ac (40MHz)

Chan.	Chan. Freq. (MHz)	Maximum Conducted Power (dBm)				Total Power (mW)	Total Power (dBm)	Power Limit (dBm)	Pass/Fail
		Chain 0	Chain 1	Chain 2	Chain 3				
54	5270	6.77	6.50	6.32	6.22	17.693	12.48	19.63	PASS
62	5310	6.80	6.47	6.62	6.17	17.954	12.54	19.63	PASS
102	5510	13.35	13.24	13.28	12.64	82.359	19.16	19.63	PASS
110	5550	13.32	13.18	13.22	12.67	81.757	19.13	19.63	PASS
134	5670	13.22	13.22	13.25	12.69	81.691	19.12	19.63	PASS

NOTE: Directional gain = $10 \log[(10^{G1/20} + 10^{G2/20} + \dots + 10^{GN/20})^2 / 4] = 10.37\text{dBi} > 6\text{dBi}$, so the Power limit shall be reduced to $24 - (10.37 - 6) = 19.63\text{dBm}$

Chain 0:

1. $11\text{dBm} + 10\log (40.18) = 27.04 > 24\text{dBm}$
2. $11\text{dBm} + 10\log (40.18) = 27.04 > 24\text{dBm}$
3. $11\text{dBm} + 10\log (40.17) = 27.04 > 24\text{dBm}$
4. $11\text{dBm} + 10\log (40.23) = 27.05 > 24\text{dBm}$
5. $11\text{dBm} + 10\log (40.15) = 27.04 > 24\text{dBm}$

Chain 2:

1. $11\text{dBm} + 10\log (40.12) = 27.03 > 24\text{dBm}$
2. $11\text{dBm} + 10\log (39.99) = 27.02 > 24\text{dBm}$
3. $11\text{dBm} + 10\log (40.02) = 27.02 > 24\text{dBm}$
4. $11\text{dBm} + 10\log (40.08) = 27.03 > 24\text{dBm}$
5. $11\text{dBm} + 10\log (40.04) = 27.02 > 24\text{dBm}$

Chain 1:

1. $11\text{dBm} + 10\log (40.26) = 27.05 > 24\text{dBm}$
2. $11\text{dBm} + 10\log (40.11) = 27.03 > 24\text{dBm}$
3. $11\text{dBm} + 10\log (40.15) = 27.04 > 24\text{dBm}$
4. $11\text{dBm} + 10\log (40.21) = 27.04 > 24\text{dBm}$
5. $11\text{dBm} + 10\log (39.80) = 27.00 > 24\text{dBm}$

Chain 3:

1. $11\text{dBm} + 10\log (39.93) = 27.01 > 24\text{dBm}$
2. $11\text{dBm} + 10\log (40.00) = 27.02 > 24\text{dBm}$
3. $11\text{dBm} + 10\log (40.05) = 27.03 > 24\text{dBm}$
4. $11\text{dBm} + 10\log (40.17) = 27.04 > 24\text{dBm}$
5. $11\text{dBm} + 10\log (40.13) = 27.03 > 24\text{dBm}$

802.11ac (80MHz)

Chan.	Chan. Freq. (MHz)	Maximum Conducted Power (dBm)				Total Power (mW)	Total Power (dBm)	Power Limit (dBm)	Pass/Fail
		Chain 0	Chain 1	Chain 2	Chain 3				
58	5290	6.76	6.48	6.57	6.15	17.848	12.52	19.63	PASS
106	5530	13.26	13.21	13.06	12.67	80.848	19.08	19.63	PASS
122	5610	13.25	13.33	13.07	12.64	81.305	19.10	19.63	PASS

NOTE: Directional gain = $10 \log[(10^{G1/20} + 10^{G2/20} + \dots + 10^{GN/20})^2 / 4] = 10.37\text{dBi} > 6\text{dBi}$, so the Power limit shall be reduced to $24 - (10.37 - 6) = 19.63\text{dBm}$

Chain 0:

1. $11\text{dBm} + 10\log (84.20) = 30.25 > 24\text{dBm}$
2. $11\text{dBm} + 10\log (84.07) = 30.25 > 24\text{dBm}$
3. $11\text{dBm} + 10\log (84.06) = 30.25 > 24\text{dBm}$

Chain 2:

1. $11\text{dBm} + 10\log (84.26) = 30.26 > 24\text{dBm}$
2. $11\text{dBm} + 10\log (83.86) = 30.24 > 24\text{dBm}$
3. $11\text{dBm} + 10\log (84.06) = 30.25 > 24\text{dBm}$

Chain 1:

1. $11\text{dBm} + 10\log (84.43) = 30.26 > 24\text{dBm}$
2. $11\text{dBm} + 10\log (84.13) = 30.25 > 24\text{dBm}$
3. $11\text{dBm} + 10\log (84.34) = 30.26 > 24\text{dBm}$

Chain 3:

1. $11\text{dBm} + 10\log (83.68) = 30.23 > 24\text{dBm}$
2. $11\text{dBm} + 10\log (84.12) = 30.25 > 24\text{dBm}$
3. $11\text{dBm} + 10\log (84.93) = 30.29 > 24\text{dBm}$

Beamforming_NSS1 Mode (Mode B)

Power Output:

802.11ac (20MHz)

Chan.	Chan. Freq. (MHz)	Maximum Conducted Power (dBm)				Total Power (mW)	Total Power (dBm)	Power Limit (dBm)	Pass/Fail
		Chain 0	Chain 1	Chain 2	Chain 3				
52	5260	5.32	4.79	4.65	4.44	12.114	10.83	17.98	PASS
60	5300	5.23	4.71	4.69	4.45	12.022	10.80	17.98	PASS
64	5320	5.28	4.76	4.62	4.48	12.067	10.82	17.98	PASS
100	5500	11.79	11.72	11.69	11.15	57.749	17.62	17.98	PASS
116	5580	11.84	11.58	11.52	11.18	56.977	17.56	17.98	PASS
132	5660	11.95	11.67	11.48	11.24	57.722	17.61	17.98	PASS
140	5700	11.96	11.72	11.52	11.27	58.151	17.65	17.98	PASS

NOTE: Directional gain = $10 \log[(10^{G1/20} + 10^{G2/20} + \dots + 10^{GN/20})^2 / 4]$ = 12.02dBi > 6dBi, so the Power limit shall be reduced to 24-(12.02-6) = 17.98dBm

Chain 0:

1. 11dBm + 10log (20.76) = 24.17 > 24dBm
2. 11dBm + 10log (20.65) = 24.15 > 24dBm
3. 11dBm + 10log (20.76) = 24.17 > 24dBm
4. 11dBm + 10log (20.71) = 24.16 > 24dBm
5. 11dBm + 10log (21.00) = 24.22 > 24dBm
6. 11dBm + 10log (21.09) = 24.24 > 24dBm
7. 11dBm + 10log (21.09) = 24.24 > 24dBm

Chain 2:

1. 11dBm + 10log (20.64) = 24.15 > 24dBm
2. 11dBm + 10log (21.10) = 24.24 > 24dBm
3. 11dBm + 10log (20.76) = 24.17 > 24dBm
4. 11dBm + 10log (20.74) = 24.17 > 24dBm
5. 11dBm + 10log (20.91) = 24.20 > 24dBm
6. 11dBm + 10log (20.94) = 24.21 > 24dBm
7. 11dBm + 10log (21.04) = 24.23 > 24dBm

Chain 1:

1. 11dBm + 10log (20.72) = 24.16 > 24dBm
2. 11dBm + 10log (20.72) = 24.16 > 24dBm
3. 11dBm + 10log (20.89) = 24.20 > 24dBm
4. 11dBm + 10log (20.68) = 24.16 > 24dBm
5. 11dBm + 10log (20.61) = 24.14 > 24dBm
6. 11dBm + 10log (20.99) = 24.22 > 24dBm
7. 11dBm + 10log (20.88) = 24.20 > 24dBm

Chain 3:

1. 11dBm + 10log (20.80) = 24.18 > 24dBm
2. 11dBm + 10log (20.55) = 24.13 > 24dBm
3. 11dBm + 10log (20.75) = 24.17 > 24dBm
4. 11dBm + 10log (21.00) = 24.22 > 24dBm
5. 11dBm + 10log (20.95) = 24.21 > 24dBm
6. 11dBm + 10log (21.02) = 24.23 > 24dBm
7. 11dBm + 10log (21.28) = 24.28 > 24dBm

802.11ac (40MHz)

Chan.	Chan. Freq. (MHz)	Maximum Conducted Power (dBm)				Total Power (mW)	Total Power (dBm)	Power Limit (dBm)	Pass/Fail
		Chain 0	Chain 1	Chain 2	Chain 3				
54	5270	5.23	4.77	4.68	4.50	12.089	10.82	17.98	PASS
62	5310	5.24	4.79	4.66	4.42	12.046	10.81	17.98	PASS
102	5510	11.88	11.75	11.87	11.16	58.823	17.70	17.98	PASS
110	5550	11.83	11.68	11.73	11.15	57.890	17.63	17.98	PASS
134	5670	11.76	11.72	11.70	11.23	57.921	17.63	17.98	PASS

NOTE: Directional gain = $10 \log[(10^{G1/20} + 10^{G2/20} + \dots + 10^{GN/20})^2 / 4] = 12.02\text{dBi} > 6\text{dBi}$, so the Power limit shall be reduced to $24 - (12.02 - 6) = 17.98\text{dBm}$

Chain 0:

1. $11\text{dBm} + 10\log (39.99) = 27.02 > 24\text{dBm}$
2. $11\text{dBm} + 10\log (40.32) = 27.06 > 24\text{dBm}$
3. $11\text{dBm} + 10\log (40.10) = 27.03 > 24\text{dBm}$
4. $11\text{dBm} + 10\log (40.22) = 27.04 > 24\text{dBm}$
5. $11\text{dBm} + 10\log (40.32) = 27.06 > 24\text{dBm}$

Chain 2:

1. $11\text{dBm} + 10\log (40.23) = 27.05 > 24\text{dBm}$
2. $11\text{dBm} + 10\log (39.99) = 27.02 > 24\text{dBm}$
3. $11\text{dBm} + 10\log (39.94) = 27.01 > 24\text{dBm}$
4. $11\text{dBm} + 10\log (40.13) = 27.03 > 24\text{dBm}$
5. $11\text{dBm} + 10\log (40.21) = 27.04 > 24\text{dBm}$

Chain 1:

1. $11\text{dBm} + 10\log (40.05) = 27.03 > 24\text{dBm}$
2. $11\text{dBm} + 10\log (40.03) = 27.02 > 24\text{dBm}$
3. $11\text{dBm} + 10\log (40.25) = 27.05 > 24\text{dBm}$
4. $11\text{dBm} + 10\log (40.14) = 27.04 > 24\text{dBm}$
5. $11\text{dBm} + 10\log (40.00) = 27.02 > 24\text{dBm}$

Chain 3:

1. $11\text{dBm} + 10\log (40.03) = 27.02 > 24\text{dBm}$
2. $11\text{dBm} + 10\log (40.21) = 27.04 > 24\text{dBm}$
3. $11\text{dBm} + 10\log (40.05) = 27.03 > 24\text{dBm}$
4. $11\text{dBm} + 10\log (40.00) = 27.02 > 24\text{dBm}$
5. $11\text{dBm} + 10\log (40.38) = 27.06 > 24\text{dBm}$

802.11ac (80MHz)

Chan.	Chan. Freq. (MHz)	Maximum Conducted Power (dBm)				Total Power (mW)	Total Power (dBm)	Power Limit (dBm)	Pass/Fail
		Chain 0	Chain 1	Chain 2	Chain 3				
58	5290	5.25	4.81	4.59	4.46	12.047	10.81	17.98	PASS
106	5530	11.95	11.78	11.49	11.12	57.769	17.62	17.98	PASS
122	5610	11.96	11.81	11.42	11.08	57.566	17.60	17.98	PASS

NOTE: Directional gain = $10 \log[(10^{G1/20} + 10^{G2/20} + \dots + 10^{GN/20})^2 / 4] = 12.02\text{dBi} > 6\text{dBi}$, so the Power limit shall be reduced to $24 - (12.02 - 6) = 17.98\text{dBm}$

Chain 0:

1. $11\text{dBm} + 10\log (84.17) = 30.25 > 24\text{dBm}$
2. $11\text{dBm} + 10\log (84.54) = 30.27 > 24\text{dBm}$
3. $11\text{dBm} + 10\log (84.43) = 30.26 > 24\text{dBm}$

Chain 2:

1. $11\text{dBm} + 10\log (84.59) = 30.27 > 24\text{dBm}$
2. $11\text{dBm} + 10\log (83.22) = 30.20 > 24\text{dBm}$
3. $11\text{dBm} + 10\log (84.78) = 30.28 > 24\text{dBm}$

Chain 1:

1. $11\text{dBm} + 10\log (83.94) = 30.24 > 24\text{dBm}$
2. $11\text{dBm} + 10\log (83.64) = 30.22 > 24\text{dBm}$
3. $11\text{dBm} + 10\log (84.90) = 30.29 > 24\text{dBm}$

Chain 3:

1. $11\text{dBm} + 10\log (83.65) = 30.22 > 24\text{dBm}$
2. $11\text{dBm} + 10\log (84.41) = 30.26 > 24\text{dBm}$
3. $11\text{dBm} + 10\log (83.82) = 30.23 > 24\text{dBm}$

4.4 Occupied Bandwidth Measurement

4.4.1 Test Setup



4.4.2 Test Instruments

Refer to section 4.1.2 to get information of above instrument.

4.4.3 Test Procedure

The transmitter output was connected to the spectrum analyzer through an attenuator. The bandwidth of the fundamental frequency was measured by spectrum analyzer with resolution bandwidth in the range of 1% to 5% of the anticipated emission bandwidth, and a video bandwidth at least 3x the resolution bandwidth and set the detector to SAMPLE. The width of a frequency band such that, below the lower and above the upper frequency limits, the mean powers emitted are each equal to a specified percentage 0.5 %of the total mean power of a given emission.

4.4.4 Test Results

CDD Mode (Mode A)

802.11a

Channel	Channel Frequency (MHz)	Occupied Bandwidth (MHz)				Pass/Fail
		Chain 0	Chain 1	Chain 2	Chain 3	
52	5260	16.44	16.44	16.44	16.44	Pass
60	5300	16.44	16.44	16.44	16.44	Pass
64	5320	16.44	16.44	16.44	16.44	Pass
100	5500	16.44	16.44	16.44	16.44	Pass
116	5580	16.44	16.44	16.44	16.44	Pass
132	5660	16.44	16.44	16.44	16.44	Pass
140	5700	16.44	16.44	16.44	16.44	Pass

802.11ac (20MHz)

Channel	Channel Frequency (MHz)	Occupied Bandwidth (MHz)				Pass/Fail
		Chain 0	Chain 1	Chain 2	Chain 3	
52	5260	17.64	17.64	17.64	17.64	Pass
60	5300	17.64	17.64	17.64	17.64	Pass
64	5320	17.64	17.64	17.64	17.64	Pass
100	5500	17.64	17.64	17.64	17.64	Pass
116	5580	17.64	17.64	17.64	17.64	Pass
132	5660	17.64	17.64	17.64	17.64	Pass
140	5700	17.64	17.64	17.64	17.64	Pass

802.11ac (40MHz)

Channel	Channel Frequency (MHz)	Occupied Bandwidth (MHz)				Pass/Fail
		Chain 0	Chain 1	Chain 2	Chain 3	
54	5270	36.00	36.00	36.00	36.00	Pass
62	5310	36.00	36.00	36.00	36.20	Pass
102	5510	36.00	36.00	36.00	36.00	Pass
110	5550	36.00	36.20	36.00	36.00	Pass
134	5670	36.00	36.00	36.00	36.00	Pass

802.11ac (80MHz)

Channel	Channel Frequency (MHz)	Occupied Bandwidth (MHz)				Pass/Fail
		Chain 0	Chain 1	Chain 2	Chain 3	
58	5290	75.84	75.84	75.84	75.84	Pass
106	5530	75.84	75.84	75.84	75.84	Pass
122	5610	76.08	75.84	75.84	75.84	Pass

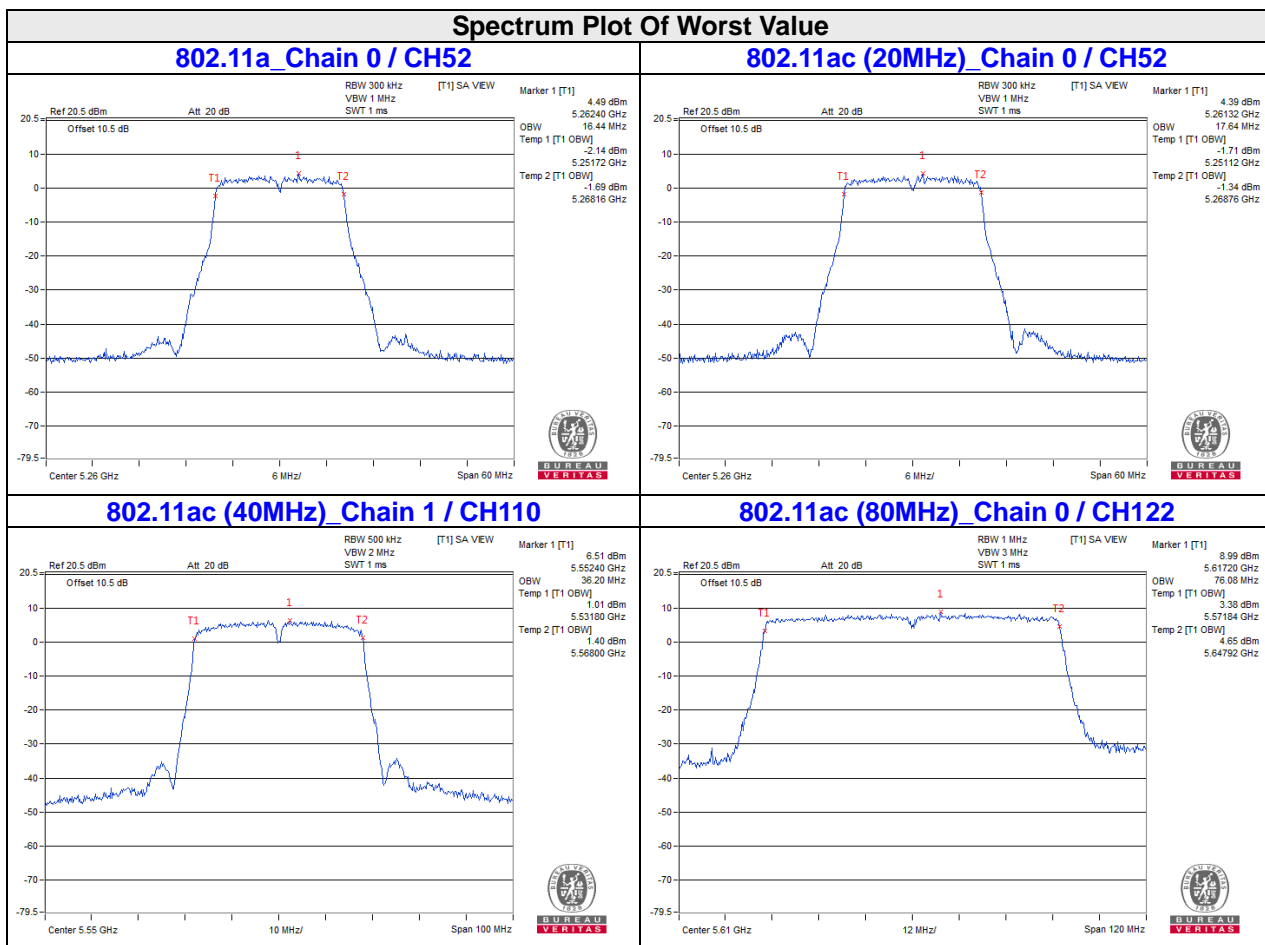

CDD Mode (Mode B)

802.11a

Channel	Channel Frequency (MHz)	Occupied Bandwidth (MHz)				Pass/Fail
		Chain 0	Chain 1	Chain 2	Chain 3	
52	5260	16.44	16.44	16.44	16.44	Pass
60	5300	16.44	16.44	16.44	16.44	Pass
64	5320	16.44	16.44	16.44	16.44	Pass
100	5500	16.44	16.44	16.44	16.56	Pass
116	5580	16.44	16.44	16.44	16.44	Pass
132	5660	16.44	16.44	16.44	16.44	Pass
140	5700	16.44	16.44	16.44	16.44	Pass

802.11ac (20MHz)

Channel	Channel Frequency (MHz)	Occupied Bandwidth (MHz)				Pass/Fail
		Chain 0	Chain 1	Chain 2	Chain 3	
52	5260	17.64	17.64	17.64	17.64	Pass
60	5300	17.64	17.64	17.64	17.64	Pass
64	5320	17.64	17.64	17.64	17.64	Pass
100	5500	17.64	17.64	17.64	17.64	Pass
116	5580	17.64	17.64	17.64	17.64	Pass
132	5660	17.64	17.64	17.64	17.64	Pass
140	5700	17.64	17.64	17.64	17.64	Pass

802.11ac (40MHz)

Channel	Channel Frequency (MHz)	Occupied Bandwidth (MHz)				Pass/Fail
		Chain 0	Chain 1	Chain 2	Chain 3	
54	5270	36.00	36.00	36.00	36.00	Pass
62	5310	36.00	36.00	36.00	36.00	Pass
102	5510	36.00	36.00	36.00	36.00	Pass
110	5550	36.20	36.00	36.00	36.00	Pass
134	5670	36.00	36.00	36.00	36.00	Pass

802.11ac (80MHz)

Channel	Channel Frequency (MHz)	Occupied Bandwidth (MHz)				Pass/Fail
		Chain 0	Chain 1	Chain 2	Chain 3	
58	5290	75.84	75.84	75.84	75.84	Pass
106	5530	75.84	75.84	75.84	76.08	Pass
122	5610	75.84	75.84	75.84	76.08	Pass

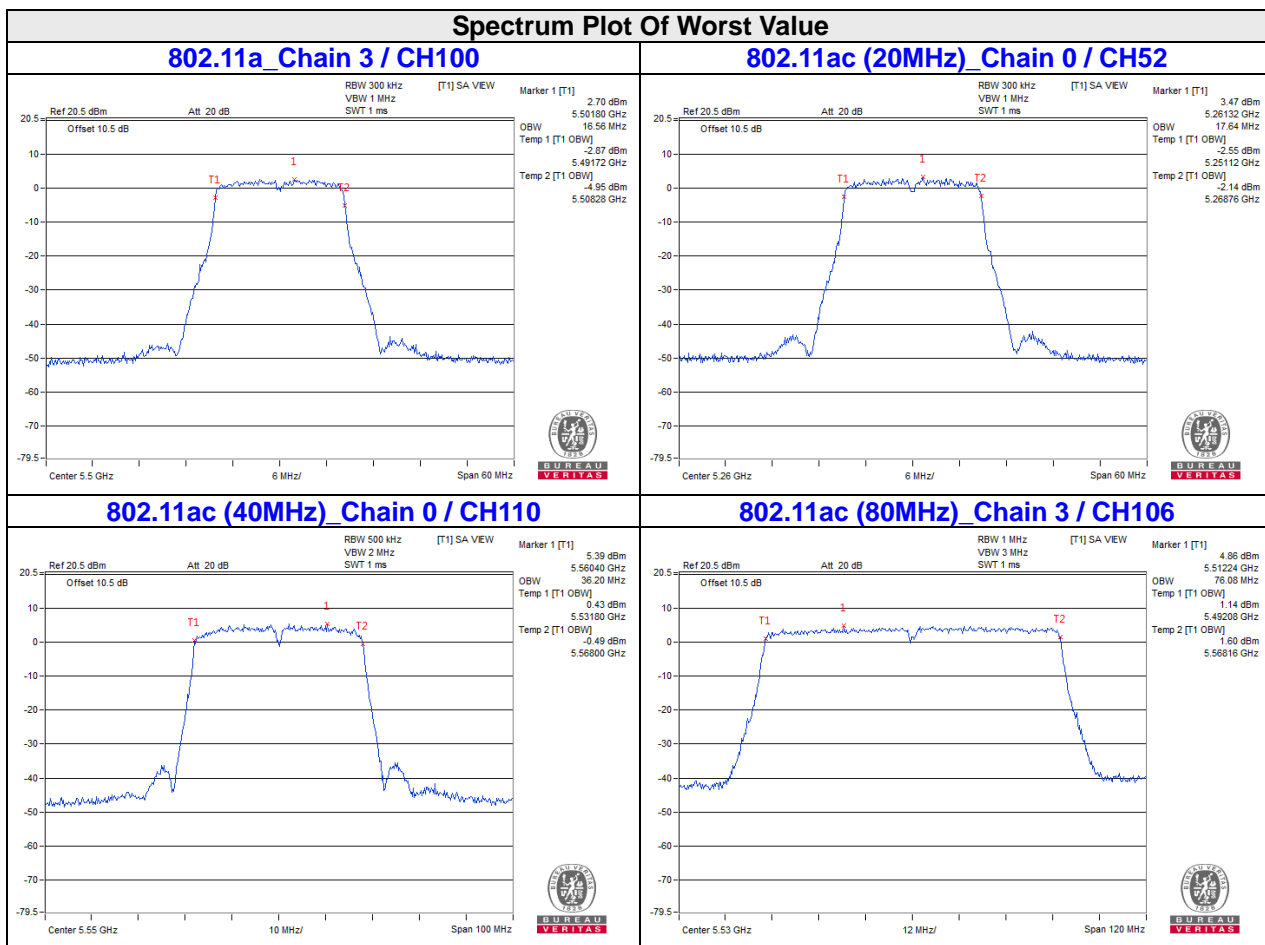

4.5 Peak Power Spectral Density Measurement

4.5.1 Limits of Peak Power Spectral Density Measurement

Operation Band	EUT Category		Limit
U-NII-1	---	Outdoor Access Point	17dBm/ MHz
	---	Fixed point-to-point Access Point	
	---	Indoor Access Point	
	---	Mobile and Portable client device	11dBm/ MHz
U-NII-2A	√		11dBm/ MHz
U-NII-2C	√		11dBm/ MHz
U-NII-3	---		30dBm/ 500kHz

4.5.2 Test Setup

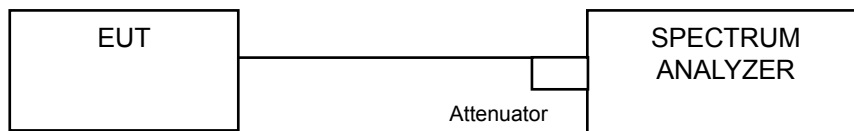

4.5.3 Test Instruments

Refer to section 4.1.2 to get information of above instrument.

4.5.4 Test Procedure

For U-NII-2A, U-NII-2C band:

Using method SA-1

- 1) Set span to encompass the entire emission bandwidth (EBW) of the signal.
- 2) Set RBW = 1 MHz, Set VBW ≥ 3 MHz, Detector = RMS
- 3) Sweep time = auto, trigger set to "free run".
- 4) Trace average at least 100 traces in power averaging mode.
- 5) Record the max value

4.5.5 Deviation from Test Standard

No deviation.

4.5.6 EUT Operating Condition

Same as Item 4.3.6.

4.5.7 Test Results

CDD Mode (Mode A)

802.11a

Chan.	Chan. Freq. (MHz)	PSD (dBm/MHz)				Duty Factor	Total Power Density (dBm/MHz)	MAX. Limit (dBm/MHz)	Pass / Fail
		Chain 0	Chain 1	Chain 2	Chain 3				
52	5260	-0.83	-0.78	-0.78	-0.78	0.21	5.44	6.63	Pass
60	5300	-0.87	-0.95	-0.86	-0.90	0.21	5.34	6.63	Pass
64	5320	-1.34	-1.38	-1.34	-1.34	0.21	4.88	6.63	Pass
100	5500	0.40	0.45	0.23	0.21	0.21	6.56	6.63	Pass
120	5600	0.30	0.28	0.24	0.25	0.21	6.50	6.63	Pass
132	5660	0.27	0.30	0.27	0.30	0.21	6.52	6.63	Pass
140	5700	0.37	0.41	0.25	0.31	0.21	6.57	6.63	Pass

- Note:**
- Method a) of power density measurement of KDB 662911 is using for calculating total power density. Total power density is summing entire spectra across corresponding frequency bins on the various outputs by computer.
 - Directional gain = $10 \log[(10^{G1/20} + 10^{G2/20} + \dots + 10^{GN/20})^2 / 4] = 10.37\text{dBi} > 6\text{dBi}$, so the PSD limit shall be reduced to $11 - (10.37 - 6) = 6.63\text{dBm}$
 - Refer to section 3.3 for duty cycle spectrum plot.

802.11ac (20MHz)

Chan.	Chan. Freq. (MHz)	PSD (dBm/MHz)				Duty Factor	Total Power Density (dBm/MHz)	MAX. Limit (dBm/MHz)	Pass / Fail
		Chain 0	Chain 1	Chain 2	Chain 3				
52	5260	-0.82	-0.81	-0.84	-0.81	0.14	5.34	6.63	Pass
60	5300	-0.88	-0.90	-0.89	-0.89	0.14	5.27	6.63	Pass
64	5320	-1.11	-1.07	-1.08	-1.00	0.14	5.09	6.63	Pass
100	5500	-0.03	0.00	0.06	0.07	0.14	6.18	6.63	Pass
120	5600	-0.25	-0.32	-0.31	-0.24	0.14	5.88	6.63	Pass
132	5660	-0.25	-0.21	-0.16	-0.18	0.14	5.96	6.63	Pass
140	5700	0.00	0.01	0.02	0.07	0.14	6.18	6.63	Pass

- Note:**
- Method a) of power density measurement of KDB 662911 is using for calculating total power density. Total power density is summing entire spectra across corresponding frequency bins on the various outputs by computer.
 - Directional gain = $10 \log[(10^{G1/20} + 10^{G2/20} + \dots + 10^{GN/20})^2 / 4] = 10.37\text{dBi} > 6\text{dBi}$, so the PSD limit shall be reduced to $11 - (10.37 - 6) = 6.63\text{dBm}$
 - Refer to section 3.3 for duty cycle spectrum plot.

802.11ac (40MHz)

Chan.	Chan. Freq. (MHz)	PSD (dBm/MHz)				Duty Factor	Total Power Density (dBm/MHz)	MAX. Limit (dBm/MHz)	Pass / Fail
		Chain 0	Chain 1	Chain 2	Chain 3				
54	5270	-3.60	-3.55	-3.61	-3.56	0.24	2.68	6.63	Pass
62	5310	-3.65	-3.64	-3.65	-3.61	0.24	2.62	6.63	Pass
102	5510	-0.05	-0.06	-0.04	-0.05	0.24	6.21	6.63	Pass
110	5550	-0.26	-0.23	-0.22	-0.22	0.24	6.02	6.63	Pass
134	5670	-0.20	-0.14	-0.16	-0.11	0.24	6.10	6.63	Pass

- Note:**
- Method a) of power density measurement of KDB 662911 is using for calculating total power density. Total power density is summing entire spectra across corresponding frequency bins on the various outputs by computer.
 - Directional gain = $10 \log[(10^{G1/20} + 10^{G2/20} + \dots + 10^{GN/20})^2 / 4] = 10.37\text{dBi} > 6\text{dBi}$, so the PSD limit shall be reduced to $11 - (10.37 - 6) = 6.63\text{dBm}$
 - Refer to section 3.3 for duty cycle spectrum plot.

802.11ac (80MHz)

Chan.	Chan. Freq. (MHz)	PSD (dBm/MHz)				Duty Factor	Total Power Density (dBm/MHz)	MAX. Limit (dBm/MHz)	Pass / Fail
		Chain 0	Chain 1	Chain 2	Chain 3				
58	5290	-6.87	-6.76	-6.78	-6.75	0.41	-0.36	6.63	Pass
106	5530	-1.82	-1.81	-1.46	-1.44	0.41	4.80	6.63	Pass
122	5610	-1.81	-1.87	-1.90	-1.92	0.41	4.56	6.63	Pass

- Note:**
- Method a) of power density measurement of KDB 662911 is using for calculating total power density. Total power density is summing entire spectra across corresponding frequency bins on the various outputs by computer.
 - Directional gain = $10 \log[(10^{G1/20} + 10^{G2/20} + \dots + 10^{GN/20})^2 / 4] = 10.37\text{dBi} > 6\text{dBi}$, so the PSD limit shall be reduced to $11 - (10.37 - 6) = 6.63\text{dBm}$
 - Refer to section 3.3 for duty cycle spectrum plot.

Spectrum Plot of Worst Value

802.11a_Chain 1 / CH140

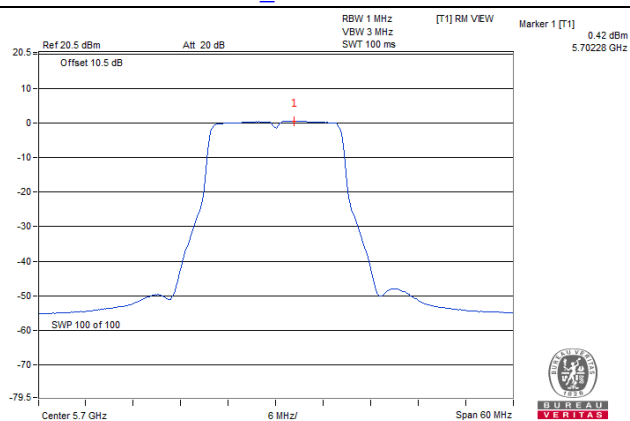

802.11ac (20MHz)_Chain 3 / CH100

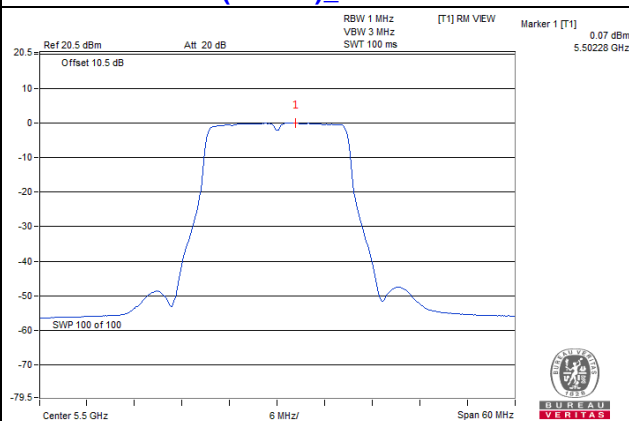

802.11ac (40MHz)_Chain 2 / CH102

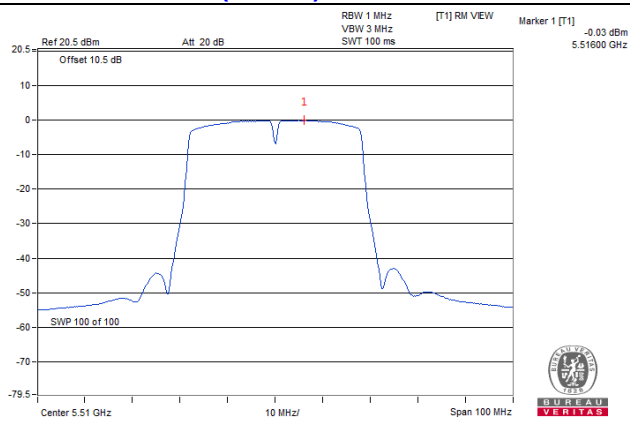

802.11ac (80MHz)_Chain 3 / CH106

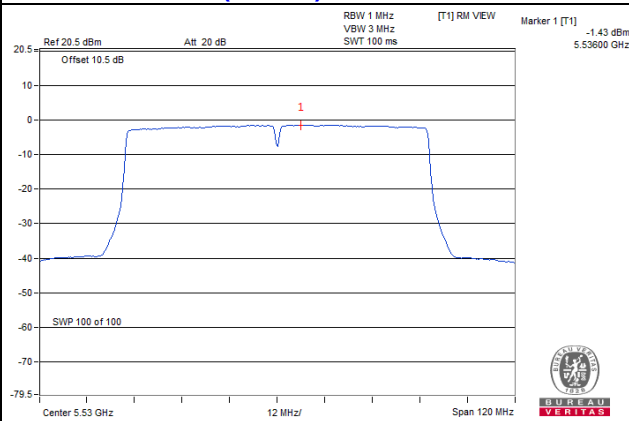

CDD Mode (Mode B)

802.11a

Chan.	Chan. Freq. (MHz)	PSD (dBm/MHz)				Duty Factor	Total Power Density (dBm/MHz)	MAX. Limit (dBm/MHz)	Pass / Fail
		Chain 0	Chain 1	Chain 2	Chain 3				
52	5260	-1.66	-1.62	-1.61	-1.62	0.21	4.61	4.98	Pass
60	5300	-1.66	-1.68	-1.61	-1.62	0.21	4.59	4.98	Pass
64	5320	-1.85	-1.87	-1.87	-1.75	0.21	4.40	4.98	Pass
100	5500	-1.66	-1.67	-1.66	-1.68	0.21	4.57	4.98	Pass
120	5600	-1.81	-1.88	-1.86	-1.88	0.21	4.38	4.98	Pass
132	5660	-1.60	-1.44	-1.55	-1.59	0.21	4.69	4.98	Pass
140	5700	-1.78	-1.73	-1.70	-1.72	0.21	4.50	4.98	Pass

- Note:**
- Method a) of power density measurement of KDB 662911 is using for calculating total power density. Total power density is summing entire spectra across corresponding frequency bins on the various outputs by computer.
 - Directional gain = $10 \log[(10^{G1/20} + 10^{G2/20} + \dots + 10^{GN/20})^2 / 4] = 12.02\text{dBi} > 6\text{dBi}$, so the PSD limit shall be reduced to $11 - (12.02 - 6) = 4.98\text{dBm}$
 - Refer to section 3.3 for duty cycle spectrum plot.

802.11ac (20MHz)

Chan.	Chan. Freq. (MHz)	PSD (dBm/MHz)				Duty Factor	Total Power Density (dBm/MHz)	MAX. Limit (dBm/MHz)	Pass / Fail
		Chain 0	Chain 1	Chain 2	Chain 3				
52	5260	-1.72	-1.63	-1.65	-1.60	0.14	4.51	4.98	Pass
60	5300	-1.76	-1.80	-1.72	-1.74	0.14	4.40	4.98	Pass
64	5320	-1.75	-1.80	-1.75	-1.76	0.14	4.39	4.98	Pass
100	5500	-1.77	-1.77	-1.76	-1.78	0.14	4.39	4.98	Pass
120	5600	-1.68	-1.69	-1.70	-1.71	0.14	4.46	4.98	Pass
132	5660	-1.64	-1.65	-1.64	-1.66	0.14	4.51	4.98	Pass
140	5700	-1.67	-1.68	-1.69	-1.65	0.14	4.48	4.98	Pass

- Note:**
- Method a) of power density measurement of KDB 662911 is using for calculating total power density. Total power density is summing entire spectra across corresponding frequency bins on the various outputs by computer.
 - Directional gain = $10 \log[(10^{G1/20} + 10^{G2/20} + \dots + 10^{GN/20})^2 / 4] = 12.02\text{dBi} > 6\text{dBi}$, so the PSD limit shall be reduced to $11 - (12.02 - 6) = 4.98\text{dBm}$
 - Refer to section 3.3 for duty cycle spectrum plot.

802.11ac (40MHz)

Chan.	Chan. Freq. (MHz)	PSD (dBm/MHz)				Duty Factor	Total Power Density (dBm/MHz)	MAX. Limit (dBm/MHz)	Pass / Fail
		Chain 0	Chain 1	Chain 2	Chain 3				
54	5270	-4.32	-4.38	-4.37	-4.36	0.24	1.90	4.98	Pass
62	5310	-4.44	-4.47	-4.46	-4.48	0.24	1.79	4.98	Pass
102	5510	-1.69	-1.64	-1.65	-1.75	0.24	4.57	4.98	Pass
110	5550	-1.57	-1.59	-1.60	-1.54	0.24	4.68	4.98	Pass
134	5670	-1.74	-1.69	-1.71	-1.68	0.24	4.55	4.98	Pass

- Note:**
- Method a) of power density measurement of KDB 662911 is using for calculating total power density. Total power density is summing entire spectra across corresponding frequency bins on the various outputs by computer.
 - Directional gain = $10 \log[(10^{G1/20} + 10^{G2/20} + \dots + 10^{GN/20})^2 / 4] = 12.02\text{dBi} > 6\text{dBi}$, so the PSD limit shall be reduced to $11 - (12.02 - 6) = 4.98\text{dBm}$
 - Refer to section 3.3 for duty cycle spectrum plot.

802.11ac (80MHz)

Chan.	Chan. Freq. (MHz)	PSD (dBm/MHz)				Duty Factor	Total Power Density (dBm/MHz)	MAX. Limit (dBm/MHz)	Pass / Fail
		Chain 0	Chain 1	Chain 2	Chain 3				
58	5290	-7.65	-7.56	-7.61	-7.61	0.41	-1.18	4.98	Pass
106	5530	-5.49	-5.53	-5.52	-7.53	0.41	0.49	4.98	Pass
122	5610	-3.34	-3.32	-3.36	-3.35	0.41	3.09	4.98	Pass

- Note:**
- Method a) of power density measurement of KDB 662911 is using for calculating total power density. Total power density is summing entire spectra across corresponding frequency bins on the various outputs by computer.
 - Directional gain = $10 \log[(10^{G1/20} + 10^{G2/20} + \dots + 10^{GN/20})^2 / 4] = 12.02\text{dBi} > 6\text{dBi}$, so the PSD limit shall be reduced to $11 - (12.02 - 6) = 4.98\text{dBm}$
 - Refer to section 3.3 for duty cycle spectrum plot.

Spectrum Plot of Worst Value

802.11a_Chain 1 / CH132

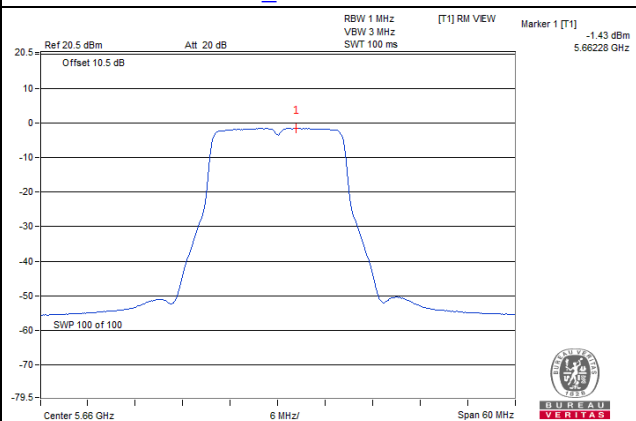

802.11ac (20MHz)_Chain 3 / CH52

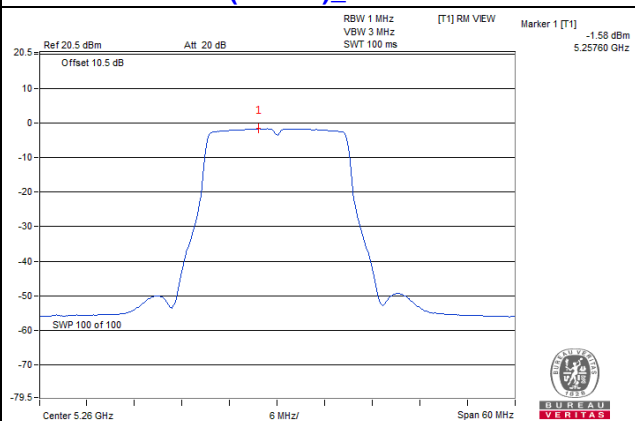

802.11ac (40MHz)_Chain 3 / CH110

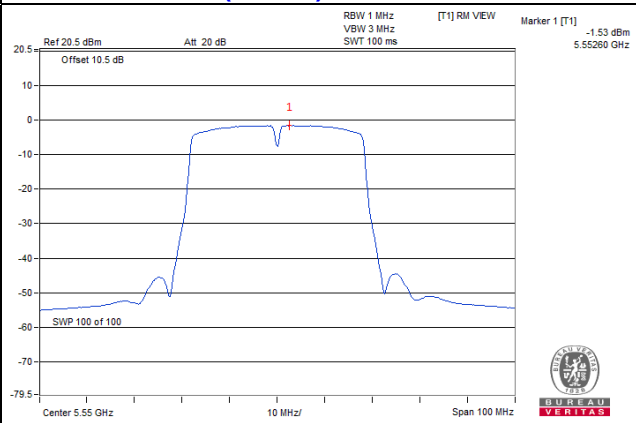

802.11ac (80MHz)_Chain 1 / CH122

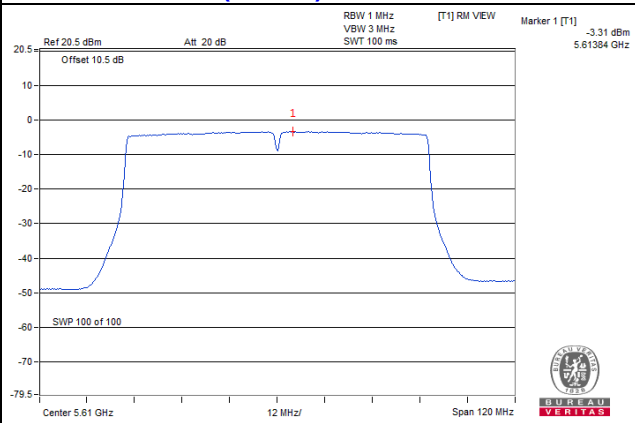

4.6 Frequency Stability Measurement

4.6.1 Limits of Frequency Stability Measurement

The frequency of the carrier signal shall be maintained within band of operation

4.6.2 Test Setup

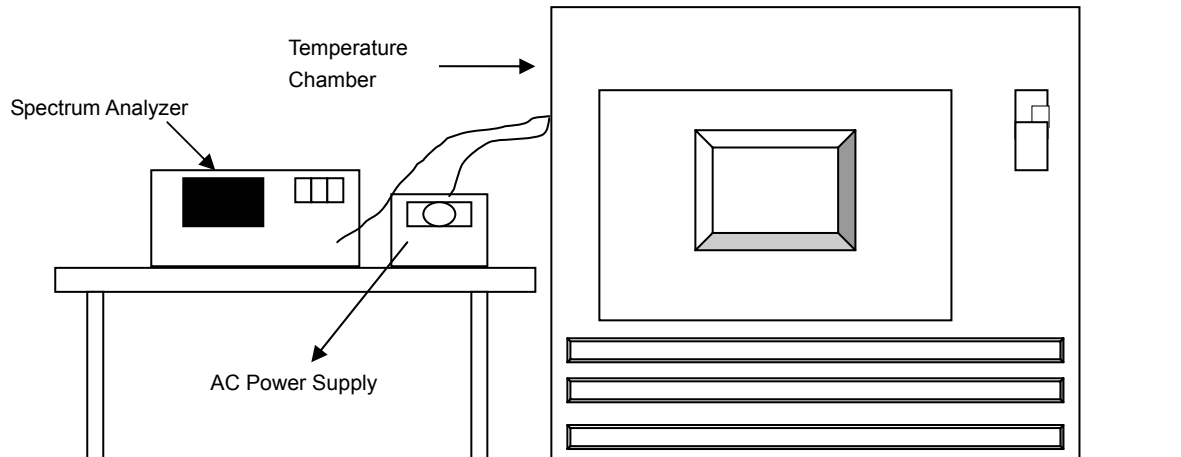

4.6.3 Test Instruments

Refer to section 4.1.2 to get information of above instrument.

4.6.4 Test Procedure

- The EUT was placed inside the environmental test chamber and powered by nominal AC voltage.
- Turn the EUT on and couple its output to a spectrum analyzer.
- Turn the EUT off and set the chamber to the highest temperature specified.
- Allow sufficient time (approximately 30 min) for the temperature of the chamber to stabilize, turn the EUT on and measure the operating frequency after 2, 5, and 10 Minutes.
- Repeat step 2 and 3 with the temperature chamber set to the lowest temperature.
- The test chamber was allowed to stabilize at +20 degree C for a minimum of 30 Minutes. The supply voltage was then adjusted on the EUT from 85% to 115% and the frequency record.

4.6.5 Deviation from Test Standard

No deviation.

4.6.6 EUT Operating Condition

Set the EUT transmit at un-modulation mode to test frequency stability.

4.6.7 Test Results

CDD Mode (Mode A)

Frequency Stability Versus Temp.									
Operating Frequency: 5260 MHz									
TEMP. (°C)	Power Supply (Vac)	0 Minute		2 Minute		5 Minute		10 Minute	
		Measured Frequency (MHz)	Pass/Fail	Measured Frequency (MHz)	Pass/Fail	Measured Frequency (MHz)	Pass/Fail	Measured Frequency (MHz)	Pass/Fail
50	120	5260.043261	Pass	5260.043142	Pass	5260.043222	Pass	5260.043047	Pass
40	120	5260.043915	Pass	5260.043934	Pass	5260.043944	Pass	5260.043709	Pass
30	120	5260.042233	Pass	5260.042115	Pass	5260.042047	Pass	5260.041881	Pass
20	120	5260.043268	Pass	5260.043207	Pass	5260.043343	Pass	5260.043181	Pass
10	120	5260.043652	Pass	5260.043452	Pass	5260.043656	Pass	5260.043866	Pass
0	120	5260.042685	Pass	5260.042644	Pass	5260.042608	Pass	5260.042674	Pass
-10	120	5260.04308	Pass	5260.043203	Pass	5260.043221	Pass	5260.043044	Pass
-20	120	5260.043642	Pass	5260.0436	Pass	5260.043528	Pass	5260.043484	Pass

Frequency Stability Versus Voltage									
Operating Frequency: 5260 MHz									
TEMP. (°C)	Power Supply (Vac)	0 Minute		2 Minute		5 Minute		10 Minute	
		Measured Frequency(MHz)	Pass/Fail	Measured Frequency(M Hz)	Pass/Fail	Measured Frequency(MHz)	Pass/Fail	Measured Frequency(M Hz)	Pass/Fail
20	138	5260.042766	Pass	5260.042651	Pass	5260.042703	Pass	5260.042489	Pass
	120	5260.043268	Pass	5260.043207	Pass	5260.043343	Pass	5260.043181	Pass
	102	5260.043231	Pass	5260.042618	Pass	5260.042857	Pass	5260.042972	Pass

5 Pictures of Test Arrangements

Please refer to the attached file (Test Setup Photo).

Appendix – Information on the Testing Laboratories

We, Bureau Veritas Consumer Products Services (H.K.) Ltd., Taoyuan Branch, were founded in 1988 to provide our best service in EMC, Radio, Telecom and Safety consultation. Our laboratories are accredited and approved according to ISO/IEC 17025.

If you have any comments, please feel free to contact us at the following:

Linko EMC/RF Lab

Tel: 886-2-26052180

Fax: 886-2-26051924

Hsin Chu EMC/RF/Telecom Lab

Tel: 886-3-6668565

Fax: 886-3-6668323

Hwa Ya EMC/RF/Safety Lab

Tel: 886-3-3183232

Fax: 886-3-3270892

Email: service.adt@tw.bureauveritas.com

Web Site: www.bureauveritas-adt.com

The address and road map of all our labs can be found in our web site also.

--- END ---