

FCC Test Report

Report No.: RF170323D03-1

FCC ID: 2ALJ3AP23X

Test Model: AP231, AP231e

Received Date: Oct. 28, 2016

Test Date: Mar. 29 ~ Jul. 13, 2017

Issued Date: Aug. 3, 2017

Applicant: HAN Networks Co., Ltd.

Address: 5/F, Building 37, No.8 Dongbeiwang West Road, HaiDian District, Beijing, China

Issued By: Bureau Veritas Consumer Products Services (H.K.) Ltd., Taoyuan Branch

Lab Address: No. 47-2, 14th Ling, Chia Pau Vil., Lin Kou Dist., New Taipei City, Taiwan, R.O.C.



This report is for your exclusive use. Any copying or replication of this report to or for any other person or entity, or use of our name or trademark, is permitted only with our prior written permission. This report sets forth our findings solely with respect to the test samples identified herein. The results set forth in this report are not indicative or representative of the quality or characteristics of the lot from which a test sample was taken or any similar or identical product unless specifically and expressly noted. Our report includes all of the tests requested by you and the results thereof based upon the information that you provided to us. You have 60 days from date of issuance of this report to notify us of any material error or omission caused by our negligence, provided, however, that such notice shall be in writing and shall specifically address the issue you wish to raise. A failure to raise such issue within the prescribed time shall constitute your unqualified acceptance of the completeness of this report, the tests conducted and the correctness of the report contents. Unless specific mention, the uncertainty of measurement has been explicitly taken into account to declare the compliance or non-compliance to the specification. The report must not be used by the client to claim product certification, approval, or endorsement by TAF or any government agencies.

Table of Contents

Release Control Record	4
1 Certificate of Conformity	5
2 Summary of Test Results	6
2.1 Measurement Uncertainty	6
2.2 Modification Record	6
3 General Information	7
3.1 General Description of EUT	7
3.2 Description of Test Modes	9
3.2.1 Test Mode Applicability and Tested Channel Detail	10
3.3 Duty Cycle of Test Signal	13
3.4 Description of Support Units	14
3.4.1 Configuration of System under Test	15
3.5 General Description of Applied Standard	17
4 Test Types and Results	18
4.1 Radiated Emission and Bandedge Measurement.....	18
4.1.1 Limits of Radiated Emission and Bandedge Measurement	18
4.1.2 Test Instruments	19
4.1.3 Test Procedure	20
4.1.4 Deviation from Test Standard	20
4.1.5 Test Setup.....	21
4.1.6 EUT Operating Condition	22
4.1.7 Test Results	23
4.2 Conducted Emission Measurement	85
4.2.1 Limits of Conducted Emission Measurement	85
4.2.2 Test Instruments	85
4.2.3 Test Procedure	86
4.2.4 Deviation from Test Standard	86
4.2.5 Test Setup.....	86
4.2.6 EUT Operating Condition	86
4.2.7 Test Results	87
4.3 Transmit Power Measurement	95
4.3.1 Limits of Transmit Power Measurement	95
4.3.2 Test Setup.....	95
4.3.3 Test Instruments	95
4.3.4 Test Procedure	96
4.3.5 Deviation from Test Standard	96
4.3.6 EUT Operating Condition	96
4.3.7 Test Result.....	97
4.4 Occupied Bandwidth Measurement	105
4.4.1 Test Setup.....	105
4.4.2 Test Instruments	105
4.4.3 Test Procedure	105
4.4.4 Test Results	106
4.5 Peak Power Spectral Density Measurement.....	110
4.5.1 Limits of Peak Power Spectral Density Measurement	110
4.5.2 Test Setup.....	110
4.5.3 Test Instruments	110
4.5.4 Test Procedure	110
4.5.5 Deviation from Test Standard	110
4.5.6 EUT Operating Condition	110
4.5.7 Test Results	111
4.6 Frequency Stability Measurement.....	121

4.6.1	Limits of Frequency Stability Measurement.....	121
4.6.2	Test Setup.....	121
4.6.3	Test Instruments	121
4.6.4	Test Procedure	121
4.6.5	Deviation from Test Standard	121
4.6.6	EUT Operating Condition	121
4.6.7	Test Results	122
4.7	6dB Bandwidth Measurement.....	123
4.7.1	Limits of 6dB Bandwidth Measurement.....	123
4.7.2	Test Setup.....	123
4.7.3	Test Instruments	123
4.7.4	Test Procedure	123
4.7.5	Deviation from Test Standard	123
4.7.6	EUT Operating Condition	123
4.7.7	Test Results	124
5	Pictures of Test Arrangements.....	128
	Annex A- Radiated Out of Band Emission (OOBE) Measurement (For U-NII-3 band).....	129
	Appendix – Information on the Testing Laboratories	139

Release Control Record

Issue No.	Description	Date Issued
RF170323D03-1	Original release.	Aug. 3, 2017

1 Certificate of Conformity

Product: HAN Access Point

Brand: HAN

Test Model: AP231, AP231e

Sample Status: Engineering sample

Applicant: HAN Networks Co., Ltd.

Test Date: Mar. 29 ~ Jul. 13, 2017

Standard: 47 CFR FCC Part 15, Subpart E (Section 15.407)
ANSI C63.10: 2013

The above equipment has been tested by **Bureau Veritas Consumer Products Services (H.K.) Ltd., Taoyuan Branch**, and found compliance with the requirement of the above standards. The test record, data evaluation & Equipment Under Test (EUT) configurations represented herein are true and accurate accounts of the measurements of the sample's EMC characteristics under the conditions specified in this report.

Prepared by : Annie Chang , **Date:** Aug. 3, 2017
Annie Chang / Senior Specialist

Approved by : Rex Lai , **Date:** Aug. 3, 2017
Rex Lai / Assistant Manager

2 Summary of Test Results

47 CFR FCC Part 15, Subpart E (Section 15.407)			
FCC Clause	Test Item	Result	Remarks
15.407(b)(6)	AC Power Conducted Emissions	Pass	Meet the requirement of limit. Minimum passing margin is -2.31dB at 0.35703MHz.
15.407(b) (1/2/3/4(i/ii)/6)	Radiated Emissions & Band Edge Measurement*	Pass	Meet the requirement of limit. Minimum passing margin is -1.02dB at 5150.00MHz.
15.407(a)(1/2/3)	Max Average Transmit Power	Pass	Meet the requirement of limit.
---	Occupied Bandwidth Measurement	-	Reference only.
15.407(a)(1/2/3)	Peak Power Spectral Density	Pass	Meet the requirement of limit.
15.407(e)	6dB bandwidth	Pass	Meet the requirement of limit. (U-NII-3 Band only)
15.407(g)	Frequency Stability	Pass	Meet the requirement of limit.
15.203	Antenna Requirement	Pass	Antenna connector is R-SMA or I-PEX not a standard connector.

*For U-NII-3 band compliance with rule part 15.407(b)(4)(i), the OOB test plots were recorded in Annex A.

2.1 Measurement Uncertainty

Where relevant, the following measurement uncertainty levels have been estimated for tests performed on the EUT as specified in CISPR 16-4-2:

Measurement	Frequency	Expanded Uncertainty (k=2) (\pm)
Conducted Emissions at mains ports	150kHz ~ 30MHz	2.77 dB
Radiated Emissions up to 1 GHz	9kHz ~ 30MHz	2.38 dB
	30MHz ~ 1000MHz	5.54 dB
Radiated Emissions above 1 GHz	Above 1GHz	5.48 dB

2.2 Modification Record

There were no modifications required for compliance.

3 General Information

3.1 General Description of EUT

Product	HAN Access Point
Brand	HAN
Test Model	AP231, AP231e
Model Difference	Refer to note as below
Status of EUT	Engineering sample
Power Supply Rating	48Vdc from Adapter or 54Vdc from PoE
Modulation Type	64QAM, 16QAM, QPSK, BPSK 256QAM for OFDM in 11ac mode only.
Modulation Technology	OFDM
Transfer Rate	802.11a: 54/48/36/24/18/12/9/6Mbps 802.11n: up to 800Mbps 802.11ac: up to 1733Mbps
Operating Frequency	5180 ~ 5240MHz 5745 ~ 5825MHz
Number of Channel	5180 ~ 5240MHz 4 for 802.11a, 802.11n (20MHz), 802.11ac (20MHz) 2 for 802.11n (40MHz), 802.11ac (40MHz) 1 for 802.11ac (80MHz) 5745 ~ 5825MHz 5 for 802.11a, 802.11n (20MHz) 802.11ac (20MHz) 2 for 802.11n (40MHz) 802.11ac (40MHz) 1 for 802.11ac (80MHz)
Output Power	5180 ~ 5240MHz: 65.794mW 5745 ~ 5825MHz: 951.939mW
Antenna Type	Refer to note as below
Antenna Connector	Refer to note as below
Accessory Device	N/A
Data Cable Supplied	N/A

Note:

- The EUT incorporates a MIMO function. Physically, the EUT provides 4 completed transmitters and 4 receivers.

Modulation Mode	TX FUNCTION
802.11a	4TX
802.11n (20MHz)	4TX
802.11n (40MHz)	4TX
802.11ac (20MHz)	4TX
802.11ac (40MHz)	4TX
802.11ac (80MHz)	4TX

* The modulation and bandwidth are similar for 802.11n mode for 20MHz / 40MHz and 802.11ac mode for 20MHz / 40MHz, therefore investigated worst case to representative mode in test report. (Final test mode refer section 3.2.1)

2. All models are listed as below.

Brand	Model	Difference
HAN	AP231	Internal antenna
	AP231e	External antenna

3. The EUT was pre-tested with the following modes:

- ✧ Operating Mode (EUT Powered from Adapter)
- ✧ Operating Mode (EUT Powered from PoE)

The worst emission level was found when the EUT tested under **Operating Mode (EUT + Adapter)**, therefore, only its test data was recorded in this report.

4. The antennas provided to the EUT, please refer to the following table:

Antenna	Chain No.	Antenna Type	Antenna Gain (dBi)	Connector Type
Internal	Chain 0	PIFA	4.39	I-PEX
	Chain 1	PIFA	4.38	I-PEX
	Chain 2	PIFA	4.19	I-PEX
	Chain 3	PIFA	4.45	I-PEX
External	Chain 0	Dipole	6	R-SMA
	Chain 1	Dipole	6	R-SMA
	Chain 2	Dipole	6	R-SMA
	Chain 3	Dipole	6	R-SMA

5. The Beamforming gain table:

Antenna	Max. Gain (dBi)
Internal	4.87
External	4.76

6. The directional gain table:

Antenna	Max. Gain (dBi)
Internal	10.37
External	12.02

Note:

(i) If transmit signals are *correlated*, then

Directional gain = $10 \log[(10^{G_1/20} + 10^{G_2/20} + \dots + 10^{G_N/20})^2 / N_{ANT}]$ dBi [Note the "20"s in the denominator of each exponent and the square of the sum of terms; the object is to combine the signal levels coherently.]

7. The above EUT information is declared by manufacturer and for more detailed features description, please refer to the manufacturer's specifications or user's manual.

3.2 Description of Test Modes

FOR 5180 ~ 5240MHz

4 channels are provided for 802.11a, 802.11n (20MHz), 802.11ac (20MHz):

Channel	Frequency	Channel	Frequency
36	5180 MHz	44	5220 MHz
40	5200 MHz	48	5240 MHz

2 channels are provided for 802.11n (40MHz), 802.11ac (40MHz):

Channel	Frequency	Channel	Frequency
38	5190 MHz	46	5230 MHz

1 channel is provided for 802.11ac (80MHz):

Channel	Frequency
42	5210MHz

FOR 5745 ~ 5825MHz:

5 channels are provided for 802.11a, 802.11n (20MHz), 802.11ac (20MHz):

Channel	Frequency	Channel	Frequency
149	5745MHz	161	5805MHz
153	5765MHz	165	5825MHz
157	5785MHz		

2 channels are provided for 802.11n (40MHz), 802.11ac (40MHz):

Channel	Frequency	Channel	Frequency
151	5755MHz	159	5795MHz

1 channel is provided for 802.11ac (80MHz):

Channel	Frequency
155	5775MHz

3.2.1 Test Mode Applicability and Tested Channel Detail

EUT Configure Mode	Applicable To				Description
	RE \geq 1G	RE $<$ 1G	PLC	APCM	
A	√	√	√	√	Model: AP231 (Int. antenna), Powered from Adapter
B	√	√	√	√	Model: AP231e (Ext. antenna), Powered from Adapter
C	-	-	√	-	Model: AP231 (Int. antenna), Powered from PoE
D	-	-	√	-	Model: AP231e (Ext. antenna), Powered from PoE

Where **RE \geq 1G**: Radiated Emission above 1GHz **RE $<$ 1G**: Radiated Emission below 1GHz
PLC: Power Line Conducted Emission **APCM**: Antenna Port Conducted Measurement

NOTE:

The EUT had been pre-tested on the positioned of each 3 axis. The worst case was found when positioned on **X-plane**. (Mode A)
 The EUT had been pre-tested on the positioned of each 2 axis. The worst case was found when positioned on **X-plane**. (Mode B)

Radiated Emission Test (Above 1GHz):

- Pre-Scan has been conducted to determine the worst-case mode from all possible combinations between available modulations, data rates and antenna ports (if EUT with antenna diversity architecture).
- Following channel(s) was (were) selected for the final test as listed below.

CDD Mode							
EUT Configure Mode	Mode	FREQ. Band (MHz)	Available Channel	Tested Channel	Modulation Technology	Modulation Type	Data Rate (Mbps)
A & B	802.11a	5180-5240	36 to 48	36, 40, 48	OFDM	BPSK	6
A & B	802.11n (20MHz)		36 to 48	36, 40, 48	OFDM	BPSK	6.5
A & B	802.11n (40MHz)		38 to 46	38, 46	OFDM	BPSK	13.5
A & B	802.11ac (80MHz)		42	42	OFDM	BPSK	29.3
A & B	802.11a	5745-5825	149 to 165	149, 157, 165	OFDM	BPSK	6
A & B	802.11n (20MHz)		149 to 165	149, 157, 165	OFDM	BPSK	6.5
A & B	802.11n (40MHz)		151 to 159	151, 159	OFDM	BPSK	13.5
A & B	802.11ac (80MHz)		155	155	OFDM	BPSK	29.3
Beamforming_NSS1 Mode							
EUT Configure Mode	Mode	FREQ. Band (MHz)	Available Channel	Tested Channel	Modulation Technology	Modulation Type	Data Rate (Mbps)
A & B	802.11a	5180-5240	36 to 48	36, 40, 48	OFDM	BPSK	6
A & B	802.11ac (20MHz)		36 to 48	36, 40, 48	OFDM	BPSK	6.5
A & B	802.11ac (40MHz)		38 to 46	38, 46	OFDM	BPSK	13.5
A & B	802.11ac (80MHz)		42	42	OFDM	BPSK	29.3
A & B	802.11a	5745-5825	149 to 165	149, 157, 165	OFDM	BPSK	6
A & B	802.11ac (20MHz)		149 to 165	149, 157, 165	OFDM	BPSK	6.5
A & B	802.11ac (40MHz)		151 to 159	151, 159	OFDM	BPSK	13.5
A & B	802.11ac (80MHz)		155	155	OFDM	BPSK	29.3

Radiated Emission Test (Below 1GHz):

- Pre-Scan has been conducted to determine the worst-case mode from all possible combinations between available modulations, data rates and antenna ports (if EUT with antenna diversity architecture).
- Following channel(s) was (were) selected for the final test as listed below.

CDD Mode							
EUT Configure Mode	Mode	FREQ. Band (MHz)	Available Channel	Tested Channel	Modulation Technology	Modulation Type	Data Rate (Mbps)
A & B	802.11a	5180-5240	36 to 48	48	OFDM	BPSK	6
	802.11a	5745-5825	149 to 165		OFDM	BPSK	6

Power Line Conducted Emission Test:

- Pre-Scan has been conducted to determine the worst-case mode from all possible combinations between available modulations, data rates and antenna ports (if EUT with antenna diversity architecture).
- Following channel(s) was (were) selected for the final test as listed below.

CDD Mode							
EUT Configure Mode	Mode	FREQ. Band (MHz)	Available Channel	Tested Channel	Modulation Technology	Modulation Type	Data Rate (Mbps)
A ~ D	802.11a	5180-5240	36 to 48	48	OFDM	BPSK	6
	802.11a	5745-5825	149 to 165		OFDM	BPSK	6

Antenna Port Conducted Measurement:

- This item includes all test value of each mode, but only includes spectrum plot of worst value of each mode.
- Pre-Scan has been conducted to determine the worst-case mode from all possible combinations between available modulations, data rates and antenna ports (if EUT with antenna diversity architecture).
- Following channel(s) was (were) selected for the final test as listed below.

CDD Mode							
EUT Configure Mode	Mode	FREQ. Band (MHz)	Available Channel	Tested Channel	Modulation Technology	Modulation Type	Data Rate (Mbps)
A & B	802.11a	5180-5240	36 to 48	36, 40, 48	OFDM	BPSK	6
A & B	802.11n (20MHz)		36 to 48	36, 40, 48	OFDM	BPSK	6.5
A & B	802.11n (40MHz)		38 to 46	38, 46	OFDM	BPSK	13.5
A & B	802.11ac (80MHz)		42	42	OFDM	BPSK	29.3
A & B	802.11a	5745-5825	149 to 165	149, 157, 165	OFDM	BPSK	6
A & B	802.11n (20MHz)		149 to 165	149, 157, 165	OFDM	BPSK	6.5
A & B	802.11n (40MHz)		151 to 159	151, 159	OFDM	BPSK	13.5
A & B	802.11ac (80MHz)		155	155	OFDM	BPSK	29.3
Beamforming_NSS1 Mode (Output Power Only)							
EUT Configure Mode	Mode	FREQ. Band (MHz)	Available Channel	Tested Channel	Modulation Technology	Modulation Type	Data Rate (Mbps)
A & B	802.11ac (20MHz)	5180-5240	36 to 48	36, 40, 48	OFDM	BPSK	6.5
A & B	802.11ac (40MHz)		38 to 46	38, 46	OFDM	BPSK	13.5
A & B	802.11ac (80MHz)		42	42	OFDM	BPSK	29.3
A & B	802.11ac (20MHz)	5745-5825	149 to 165	149, 157, 165	OFDM	BPSK	6.5
A & B	802.11ac (40MHz)		151 to 159	151, 159	OFDM	BPSK	13.5
A & B	802.11ac (80MHz)		155	155	OFDM	BPSK	29.3

Test Condition:

Applicable To	Environmental Conditions	Input Power	Tested By
RE≥1G	20deg. C, 67%RH	120Vac, 60Hz	Ian Chang
RE<1G	30deg. C, 48%RH	120Vac, 60Hz	Ian Chang
PLC	25deg. C, 75%RH	120Vac, 60Hz	Ian Chang
APCM	25deg. C, 76%RH	120Vac, 60Hz	Saxon Lee

3.3 Duty Cycle of Test Signal

Duty cycle of test signal is < 98 %, duty factor is required

802.11a: Duty cycle = $2/2.101 = 0.952$, Duty factor = $10 * \log(1/0.952) = 0.21$

802.11n (20MHz): Duty cycle = $4.927/5.087 = 0.969$, Duty factor = $10 * \log(1/0.969) = 0.14$

802.11n (40MHz): Duty cycle = $2.333/2.463 = 0.947$, Duty factor = $10 * \log(1/0.947) = 0.24$

802.11ac (80MHz): Duty cycle = $1.094/1.201 = 0.911$, Duty factor = $10 * \log(1/0.911) = 0.41$



3.4 Description of Support Units

The EUT has been tested as an independent unit together with other necessary accessories or support units. The following support units or accessories were used to form a representative test configuration during the tests.

ID	Product	Brand	Model No.	Serial No.	FCC ID	Remarks
A.	Adapter	APD	WB-18D12R	N/A	N/A	Supplied by client
B.	NOTEBOOK PC	DELL	PP27L	8SNZ12S	FCC DoC Approved	Provided by Lab
C.	USB 3.0 Flash Drive	HP	v250w	N/A	FCC DoC Approved	Provided by Lab
D.	Load	N/A	N/A	N/A	N/A	Provided by Lab
E.	PoE	Microsemi	PD-9001GR/AT/AC	N/A	N/A	Supplied by client

Note:

1. All power cords of the above support units are non-shielded (1.8m).
2. Item B acted as communication partners to transfer data.

ID	Descriptions	Qty.	Length (m)	Shielding (Yes/No)	Cores (Qty.)	Remarks
1.	DC cable	1	1.5	N	0	Supplied by client
2.	LAN cable	1	10	N	0	Provided by Lab
3.	LAN cable	1	1.8	N	0	Provided by Lab
4.	LAN cable	1	1.8	N	0	Provided by Lab
5.	AC Power Cord	1	1.8	N	0	Supplied by client

Note: The core(s) is(are) originally attached to the cable(s).

3.4.1 Configuration of System under Test

Mode A & B:

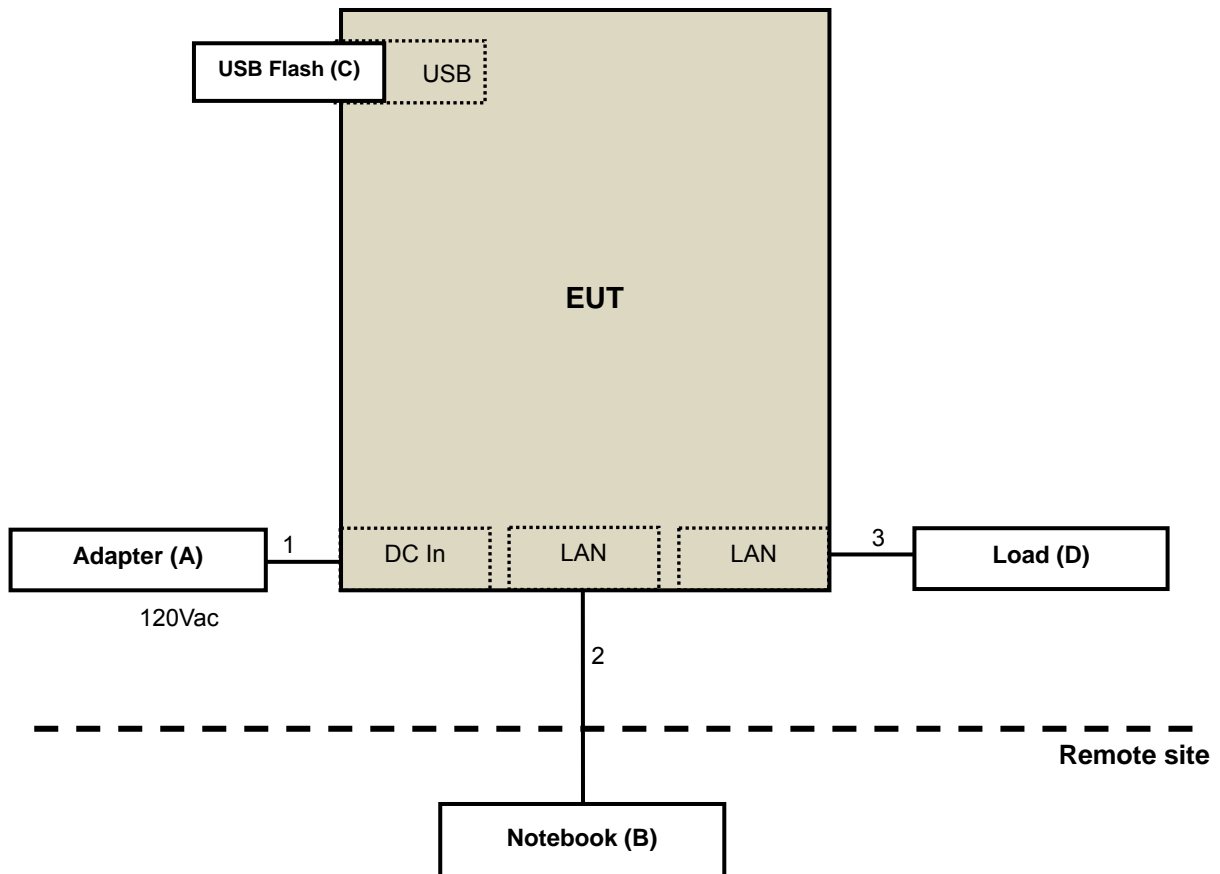

Mode C & D:

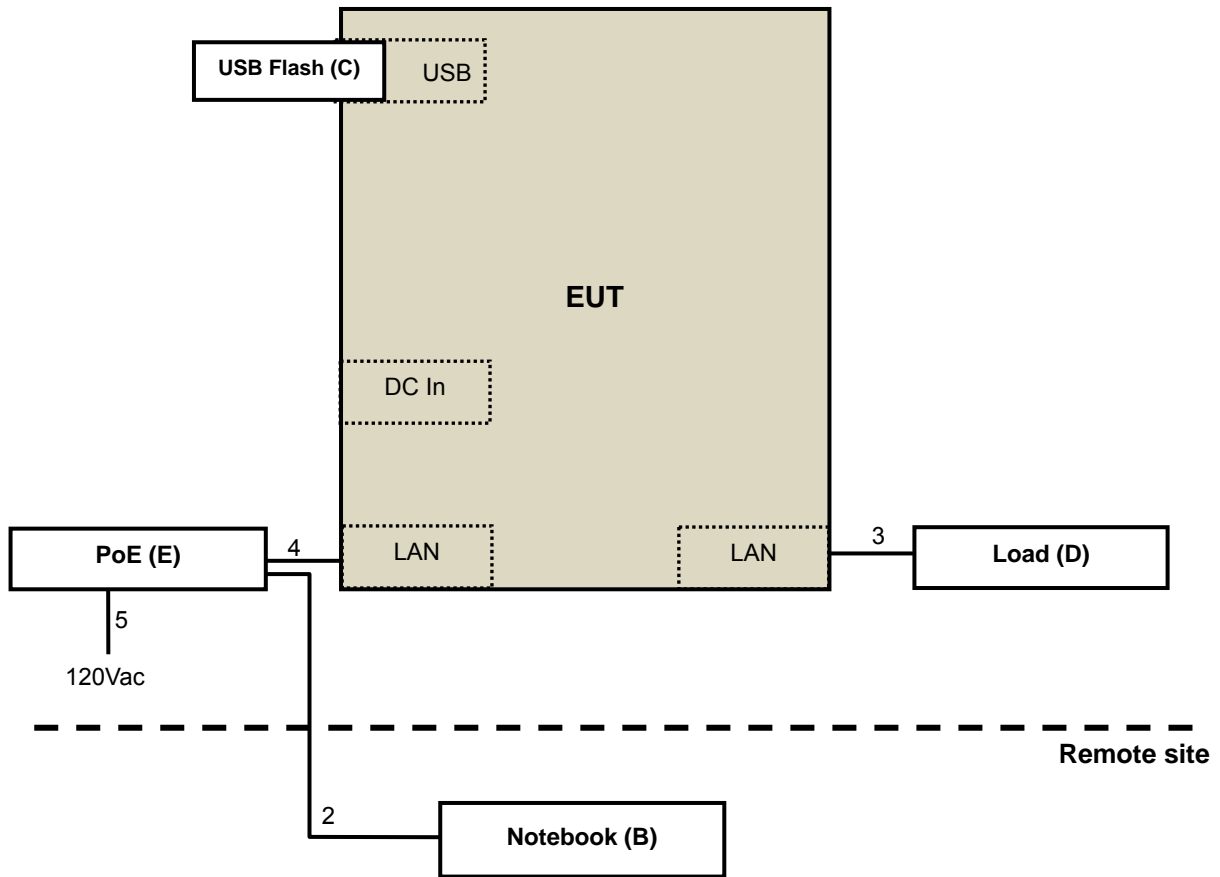

3.5 General Description of Applied Standard

The EUT is a RF Product. According to the specifications of the manufacturer, it must comply with the requirements of the following standards:

FCC Part 15, Subpart E (15.407)
KDB 789033 D02 General UNII Test Procedure New Rules v04
KDB 662911 D01 Multiple Transmitter Output v02r01
ANSI C63.10-2013

All test items have been performed and recorded as per the above standards.

4 Test Types and Results

4.1 Radiated Emission and Bandedge Measurement

4.1.1 Limits of Radiated Emission and Bandedge Measurement

Radiated emissions which fall in the restricted bands must comply with the radiated emission limits specified as below table.

Frequencies (MHz)	Field Strength (microvolts/meter)	Measurement Distance (meters)
0.009 ~ 0.490	2400/F(kHz)	300
0.490 ~ 1.705	24000/F(kHz)	30
1.705 ~ 30.0	30	30
30 ~ 88	100	3
88 ~ 216	150	3
216 ~ 960	200	3
Above 960	500	3

NOTE:

1. The lower limit shall apply at the transition frequencies.
2. Emission level (dBuV/m) = 20 log Emission level (uV/m).
3. For frequencies above 1000MHz, the field strength limits are based on average detector, however, the peak field strength of any emission shall not exceed the maximum permitted average limits, specified above by more than 20dB under any condition of modulation.

Limits of unwanted emission out of the restricted bands

Applicable To		Limit	
789033 D02 General UNII Test Procedure New Rules v01r03		Field Strength at 3m	
		PK:74 (dBµV/m)	AV:54 (dBµV/m)
Frequency Band	Applicable To	EIRP Limit	Equivalent Field Strength at 3m
5150~5250 MHz	15.407(b)(1)	PK:-27 (dBm/MHz)	PK:68.2(dBµV/m)
5250~5350 MHz	15.407(b)(2)		
5470~5725 MHz	15.407(b)(3)		
5725~5850 MHz	<input checked="" type="checkbox"/> 15.407(b)(4)(i)	PK:-27 (dBm/MHz) ^{*1} PK:10 (dBm/MHz) ^{*2} PK:15.6 (dBm/MHz) ^{*3} PK:27 (dBm/MHz) ^{*4}	PK: 68.2(dBµV/m) ^{*1} PK:105.2 (dBµV/m) ^{*2} PK: 110.8(dBµV/m) ^{*3} PK:122.2 (dBµV/m) ^{*4}
	<input type="checkbox"/> 15.407(b)(4)(ii)	Emission limits in section 15.247(d)	
^{*1} beyond 75 MHz or more above of the band edge. ^{*3} below the band edge increasing linearly to a level of 15.6 dBm/MHz at 5 MHz above.		^{*2} below the band edge increasing linearly to 10 dBm/MHz at 25 MHz above. ^{*4} from 5 MHz above or below the band edge increasing linearly to a level of 27 dBm/MHz at the band edge.	

Note:

The following formula is used to convert the equipment isotropic radiated power (eirp) to field strength:

$$E = \frac{1000000\sqrt{30P}}{3} \mu\text{V/m, where P is the eirp (Watts).}$$

4.1.2 Test Instruments

DESCRIPTION & MANUFACTURER	MODEL NO.	SERIAL NO.	CALIBRATED DATE	CALIBRATED UNTIL
HP Preamplifier	8447D	2432A03504	Feb. 21, 2017	Feb. 20, 2018
HP Preamplifier	8449B	3008A01201	Feb. 22, 2017	Feb. 21, 2018
MITEQ Preamplifier	AMF-6F-260400-33-8P	892164	Feb. 21, 2017	Feb. 20, 2018
Agilent TEST RECEIVER	N9038A	MY51210129	Feb. 08, 2017	Feb. 07, 2018
Schwarzbeck Antenna	VULB 9168	139	Dec. 13, 2016	Dec. 12, 2017
Schwarzbeck Horn Antenna	BBHA-9170	212	Dec. 30, 2016	Dec. 29, 2017
Schwarzbeck Horn Antenna	BBHA 9120-D1	D130	Dec. 27, 2016	Dec. 26, 2017
ADT. Turn Table	TT100	0306	NA	NA
ADT. Tower	AT100	0306	NA	NA
Software	Radiated_V7.6.15.9.5	NA	NA	NA
SUHNER RF cable With 4dB PAD	SF104	CABLE-CH6	Aug. 15, 2016	Aug. 14, 2017
SUHNER RF cable With 3dB PAD	SF102	Cable-CH8-3.6m	Aug. 15, 2016	Aug. 14, 2017
KEYSIGHT MIMO Powermeasurement Test set	U2021XA	U2021XA-001	May 25, 2016	May 24, 2017
			May 31, 2017	May 30, 2018
KEYSIGHT Spectrum Analyzer	N9030A	MY54490260	Jul. 26, 2016	Jul. 25, 2017
Loop Antenna EMCI	LPA600	270	Aug. 20, 2015	Aug. 19, 2017
EMCO Horn Antenna	3115	00028257	Dec. 15, 2016	Dec. 14, 2017
Highpass filter Wainwright Instruments	WHK 3.1/18G-10SS	SN 8	NA	NA
ROHDE & SCHWARZ Spectrum Analyzer	FSV40	101042	Sep. 30, 2016	Sep. 29, 2017
Anritsu Power Sensor	MA2411B	0738404	Apr. 28, 2016	Apr. 27, 2017
			Apr. 24, 2017	Apr. 23, 2018
Anritsu Power Meter	ML2495A	0842014	Apr. 28, 2016	Apr. 27, 2017
			Apr. 24, 2017	Apr. 23, 2018
DIGITAL POWER METER IDRC	CP-240	240515	Sep. 9, 2016	Sep. 8, 2017
AC Power Source ExTech	CFW-105	E000603	NA	NA

- NOTE:**
1. The calibration interval of the above test instruments is 12/24 months. And the calibrations are traceable to NML/ROC and NIST/USA.
 2. The horn antenna and HP preamplifier (model: 8449B) are used only for the measurement of emission frequency above 1GHz if tested.
 3. The test was performed in Chamber No. 6.
 4. The Industry Canada Reference No. IC 7450E-6.
 5. The FCC Site Registration No. is 447212.

4.1.3 Test Procedure

For Radiated emission below 30MHz

- a. The EUT was placed on the top of a rotating table 0.8 meters above the ground at a 3 meter chamber room. The table was rotated 360 degrees to determine the position of the highest radiation.
- b. The EUT was set 3 meters away from the interference-receiving antenna, which was mounted on the top of a variable-height antenna tower.
- c. Both X and Y axes of the antenna are set to make the measurement.
- d. For each suspected emission, the EUT was arranged to its worst case and the rotatable table was turned from 0 degrees to 360 degrees to find the maximum reading.
- e. The test-receiver system was set to Quasi-Peak Detect Function and Specified Bandwidth with Maximum Hold Mode.

NOTE:

1. The resolution bandwidth and video bandwidth of test receiver/spectrum analyzer is 9kHz at frequency below 30MHz.

For Radiated emission above 30MHz

- a. The EUT was placed on the top of a rotating table 0.8 meters (for 30MHz ~ 1GHz) / 1.5 meters (for above 1GHz) above the ground at 3 meter chamber room for test. The table was rotated 360 degrees to determine the position of the highest radiation.
- b. The EUT was set 3 meters away from the interference-receiving antenna, which was mounted on the top of a variable-height antenna tower.
- c. The height of antenna is varied from one meter to four meters above the ground to determine the maximum value of the field strength. Both horizontal and vertical polarizations of the antenna are set to make the measurement.
- d. For each suspected emission, the EUT was arranged to its worst case and then the antenna was tuned to heights from 1 meter to 4 meters and the rotatable table was turned from 0 degrees to 360 degrees to find the maximum reading.
- e. The test-receiver system was set to quasi-peak detect function and specified bandwidth with maximum hold mode when the test frequency is below 1 GHz.
- f. The test-receiver system was set to peak and average detect function and specified bandwidth with maximum hold mode when the test frequency is above 1 GHz. If the peak reading value also meets average limit, measurement with the average detector is unnecessary.

Note:

1. The resolution bandwidth and video bandwidth of test receiver/spectrum analyzer is 120kHz for Quasi-peak detection (QP) at frequency below 1GHz.
2. The resolution bandwidth of test receiver/spectrum analyzer is 1 MHz and the video bandwidth is 3 MHz for Peak detection (PK) at frequency above 1GHz.
3. The resolution bandwidth of test receiver/spectrum analyzer is 1MHz and the video bandwidth is $\geq 1/T$ (Duty cycle < 98%) or 10Hz (Duty cycle $\geq 98\%$) for Average detection (AV) at frequency above 1GHz.
4. All modes of operation were investigated and the worst-case emissions are reported.

4.1.4 Deviation from Test Standard

No deviation.

4.1.5 Test Setup

For Radiated emission below 30MHz

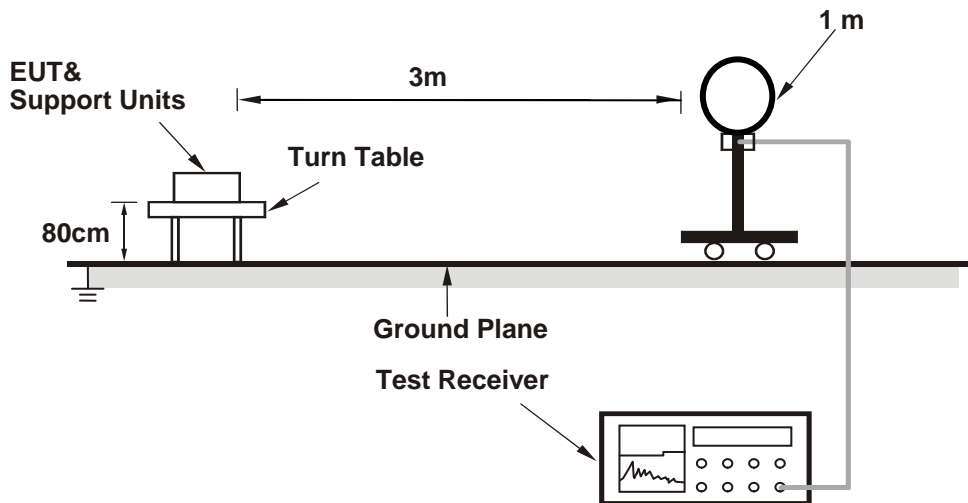

For Radiated emission 30MHz to 1GHz

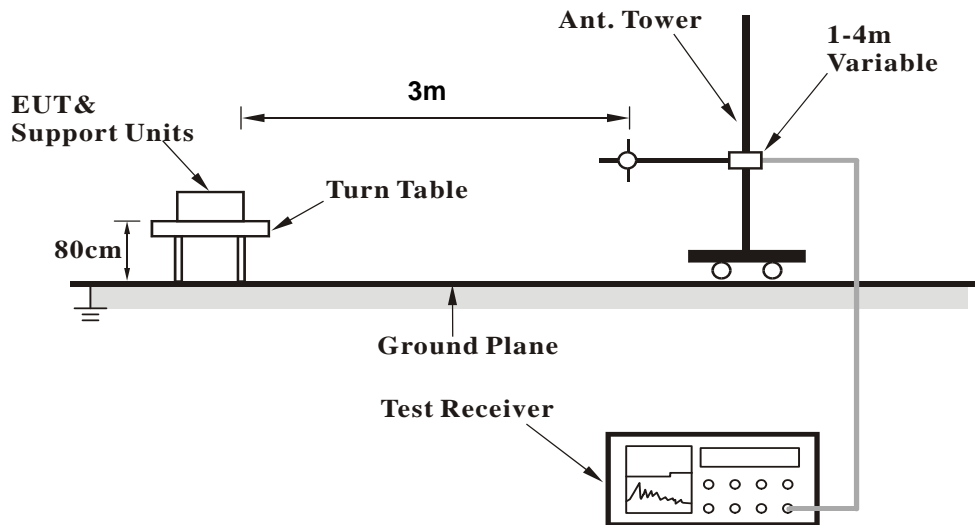

For Radiated emission above 1GHz

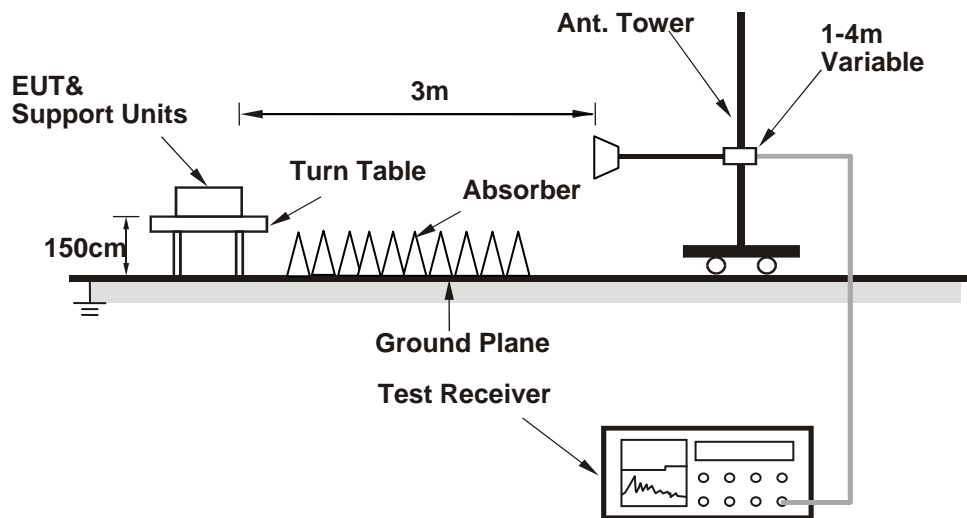

For the actual test configuration, please refer to the attached file (Test Setup Photo).

4.1.6 EUT Operating Condition

- a. Connected the EUT with AC adapter placed on testing table.
- b. The EUT perform R/W function with USB flash from AE notebooks via LAN cables.
- c. Set the EUT under transmission condition continuously at specific channel frequency.

4.1.7 Test Results

Above 1GHz Data:

CDD Mode (Mode A)

802.11a

CHANNEL	TX Channel 36	DETECTOR FUNCTION	Peak (PK)
FREQUENCY RANGE	1GHz ~ 40GHz		Average (AV)

ANTENNA POLARITY & TEST DISTANCE: HORIZONTAL AT 3 M

NO.	FREQ. (MHz)	EMISSION LEVEL (dBuV/m)	LIMIT (dBuV/m)	MARGIN (dB)	ANTENNA HEIGHT (m)	TABLE ANGLE (Degree)	RAW VALUE (dBuV)	CORRECTION FACTOR (dB/m)
1	5150.00	66.59 PK	74.00	-7.41	1.88 H	201	58.79	7.80
2	5150.00	49.06 AV	54.00	-4.94	1.88 H	201	41.26	7.80
3	*5180.00	108.20 PK			1.88 H	201	100.27	7.93
4	*5180.00	97.61 AV			1.88 H	201	89.68	7.93
5	#10360.00	58.33 PK	74.00	-15.67	1.54 H	32	39.86	18.47
6	#10360.00	44.08 AV	54.00	-9.92	1.54 H	32	25.61	18.47

ANTENNA POLARITY & TEST DISTANCE: VERTICAL AT 3 M

NO.	FREQ. (MHz)	EMISSION LEVEL (dBuV/m)	LIMIT (dBuV/m)	MARGIN (dB)	ANTENNA HEIGHT (m)	TABLE ANGLE (Degree)	RAW VALUE (dBuV)	CORRECTION FACTOR (dB/m)
1	5150.00	69.50 PK	74.00	-4.50	2.51 V	129	61.70	7.80
2	5150.00	52.92 AV	54.00	-1.08	2.51 V	129	45.12	7.80
3	*5180.00	119.25 PK			2.51 V	129	111.32	7.93
4	*5180.00	107.99 AV			2.51 V	129	100.06	7.93
5	#10360.00	58.62 PK	74.00	-15.38	1.38 V	241	40.15	18.47
6	#10360.00	44.81 AV	54.00	-9.19	1.38 V	241	26.34	18.47

REMARKS:

1. Emission Level(dBuV/m) = Raw Value(dBuV) + Correction Factor(dB/m)
2. Correction Factor(dB/m) = Antenna Factor(dB/m) + Cable Factor(dB) – Pre-Amplifier Factor(dB)
3. The other emission levels were very low against the limit.
4. Margin value = Emission Level – Limit value
5. " * ": Fundamental frequency.
6. " # ": The radiated frequency is out of the restricted band.

CHANNEL	TX Channel 40	DETECTOR FUNCTION	Peak (PK)
FREQUENCY RANGE	1GHz ~ 40GHz		Average (AV)

ANTENNA POLARITY & TEST DISTANCE: HORIZONTAL AT 3 M

NO.	FREQ. (MHz)	EMISSION LEVEL (dBuV/m)	LIMIT (dBuV/m)	MARGIN (dB)	ANTENNA HEIGHT (m)	TABLE ANGLE (Degree)	RAW VALUE (dBuV)	CORRECTION FACTOR (dB/m)
1	*5200.00	108.57 PK			1.92 H	185	100.55	8.02
2	*5200.00	97.71 AV			1.92 H	185	89.69	8.02
3	#10400.00	57.91 PK	74.00	-16.09	2.13 H	229	39.27	18.64
4	#10400.00	43.72 AV	54.00	-10.28	2.13 H	229	25.08	18.64

ANTENNA POLARITY & TEST DISTANCE: VERTICAL AT 3 M

NO.	FREQ. (MHz)	EMISSION LEVEL (dBuV/m)	LIMIT (dBuV/m)	MARGIN (dB)	ANTENNA HEIGHT (m)	TABLE ANGLE (Degree)	RAW VALUE (dBuV)	CORRECTION FACTOR (dB/m)
1	*5200.00	119.72 PK			2.47 V	258	111.70	8.02
2	*5200.00	108.19 AV			2.47 V	258	100.17	8.02
3	#10400.00	59.00 PK	74.00	-15.00	1.84 V	174	40.36	18.64
4	#10400.00	45.48 AV	54.00	-8.52	1.84 V	174	26.84	18.64

REMARKS:

1. Emission Level(dBuV/m) = Raw Value(dBuV) + Correction Factor(dB/m)
2. Correction Factor(dB/m) = Antenna Factor(dB/m) + Cable Factor(dB) – Pre-Amplifier Factor(dB)
3. The other emission levels were very low against the limit.
4. Margin value = Emission Level – Limit value
5. " * ": Fundamental frequency.
6. " # ": The radiated frequency is out of the restricted band.

CHANNEL	TX Channel 48	DETECTOR FUNCTION	Peak (PK)
FREQUENCY RANGE	1GHz ~ 40GHz		Average (AV)

ANTENNA POLARITY & TEST DISTANCE: HORIZONTAL AT 3 M

NO.	FREQ. (MHz)	EMISSION LEVEL (dBuV/m)	LIMIT (dBuV/m)	MARGIN (dB)	ANTENNA HEIGHT (m)	TABLE ANGLE (Degree)	RAW VALUE (dBuV)	CORRECTION FACTOR (dB/m)
1	*5240.00	110.63 PK			1.87 H	174	102.48	8.15
2	*5240.00	99.71 AV			1.87 H	174	91.56	8.15
3	5350.00	59.07 PK	74.00	-14.93	1.87 H	174	50.49	8.58
4	5350.00	45.70 AV	54.00	-8.30	1.87 H	174	37.12	8.58
5	#10480.00	58.65 PK	74.00	-15.35	2.35 H	142	39.69	18.96
6	#10480.00	44.06 AV	54.00	-9.94	2.35 H	142	25.10	18.96

ANTENNA POLARITY & TEST DISTANCE: VERTICAL AT 3 M

NO.	FREQ. (MHz)	EMISSION LEVEL (dBuV/m)	LIMIT (dBuV/m)	MARGIN (dB)	ANTENNA HEIGHT (m)	TABLE ANGLE (Degree)	RAW VALUE (dBuV)	CORRECTION FACTOR (dB/m)
1	*5240.00	121.76 PK			2.66 V	141	113.61	8.15
2	*5240.00	111.39 AV			2.66 V	141	103.24	8.15
3	5350.00	59.91 PK	74.00	-14.09	2.66 V	141	51.33	8.58
4	5350.00	46.47 AV	54.00	-7.53	2.66 V	141	37.89	8.58
5	#10480.00	59.80 PK	74.00	-14.20	2.18 V	334	40.84	18.96
6	#10480.00	45.09 AV	54.00	-8.91	2.18 V	334	26.13	18.96

REMARKS:

1. Emission Level(dBuV/m) = Raw Value(dBuV) + Correction Factor(dB/m)
2. Correction Factor(dB/m) = Antenna Factor(dB/m) + Cable Factor(dB) – Pre-Amplifier Factor(dB)
3. The other emission levels were very low against the limit.
4. Margin value = Emission Level – Limit value
5. " * ": Fundamental frequency.
6. " # ": The radiated frequency is out of the restricted band.

CHANNEL	TX Channel 149	DETECTOR FUNCTION	Peak (PK)
FREQUENCY RANGE	1GHz ~ 40GHz		Average (AV)

ANTENNA POLARITY & TEST DISTANCE: HORIZONTAL AT 3 M

NO.	FREQ. (MHz)	EMISSION LEVEL (dBuV/m)	LIMIT (dBuV/m)	MARGIN (dB)	ANTENNA HEIGHT (m)	TABLE ANGLE (Degree)	RAW VALUE (dBuV)	CORRECTION FACTOR (dB/m)
1	#5622.47	63.42 PK	68.20	-4.78	1.88 H	197	54.07	9.35
2	*5745.00	109.52 PK			1.88 H	197	100.13	9.39
3	*5745.00	99.03 AV			1.88 H	197	89.64	9.39
4	#5939.63	62.63 PK	68.20	-5.57	1.88 H	197	52.83	9.80
5	11490.00	59.43 PK	74.00	-14.57	2.23 H	197	39.34	20.09
6	11490.00	45.12 AV	54.00	-8.88	2.23 H	197	25.03	20.09

ANTENNA POLARITY & TEST DISTANCE: VERTICAL AT 3 M

NO.	FREQ. (MHz)	EMISSION LEVEL (dBuV/m)	LIMIT (dBuV/m)	MARGIN (dB)	ANTENNA HEIGHT (m)	TABLE ANGLE (Degree)	RAW VALUE (dBuV)	CORRECTION FACTOR (dB/m)
1	#5565.58	64.38 PK	68.20	-3.82	2.33 V	333	55.05	9.33
2	*5745.00	120.54 PK			2.33 V	333	111.15	9.39
3	*5745.00	109.55 AV			2.33 V	333	100.16	9.39
4	#5965.49	63.46 PK	68.20	-4.74	2.33 V	333	53.56	9.90
5	11490.00	60.90 PK	74.00	-13.10	1.38 V	105	40.81	20.09
6	11490.00	46.47 AV	54.00	-7.53	1.38 V	105	26.38	20.09

REMARKS:

1. Emission Level(dBuV/m) = Raw Value(dBuV) + Correction Factor(dB/m)
2. Correction Factor(dB/m) = Antenna Factor(dB/m) + Cable Factor(dB) – Pre-Amplifier Factor(dB)
3. The other emission levels were very low against the limit.
4. Margin value = Emission Level – Limit value
5. " * ": Fundamental frequency.
6. " # ": The radiated frequency is out of the restricted band.

CHANNEL	TX Channel 157	DETECTOR FUNCTION	Peak (PK)
FREQUENCY RANGE	1GHz ~ 40GHz		Average (AV)

ANTENNA POLARITY & TEST DISTANCE: HORIZONTAL AT 3 M

NO.	FREQ. (MHz)	EMISSION LEVEL (dBuV/m)	LIMIT (dBuV/m)	MARGIN (dB)	ANTENNA HEIGHT (m)	TABLE ANGLE (Degree)	RAW VALUE (dBuV)	CORRECTION FACTOR (dB/m)
1	#5612.87	63.72 PK	68.20	-4.48	1.67 H	209	54.37	9.35
2	*5785.00	109.86 PK			1.67 H	209	100.45	9.41
3	*5785.00	99.17 AV			1.67 H	209	89.76	9.41
4	#5972.47	63.77 PK	68.20	-4.43	1.67 H	209	53.84	9.93
5	11570.00	59.98 PK	74.00	-14.02	2.79 H	348	39.69	20.29
6	11570.00	46.10 AV	54.00	-7.90	2.79 H	348	25.81	20.29

ANTENNA POLARITY & TEST DISTANCE: VERTICAL AT 3 M

NO.	FREQ. (MHz)	EMISSION LEVEL (dBuV/m)	LIMIT (dBuV/m)	MARGIN (dB)	ANTENNA HEIGHT (m)	TABLE ANGLE (Degree)	RAW VALUE (dBuV)	CORRECTION FACTOR (dB/m)
1	#5587.11	65.03 PK	68.20	-3.17	2.43 V	335	55.69	9.34
2	*5785.00	121.16 PK			2.43 V	335	111.75	9.41
3	*5785.00	110.06 AV			2.43 V	335	100.65	9.41
4	#5984.61	64.08 PK	68.20	-4.12	2.43 V	335	54.11	9.97
5	11570.00	60.94 PK	74.00	-13.06	2.04 V	317	40.65	20.29
6	11570.00	46.51 AV	54.00	-7.49	2.04 V	317	26.22	20.29

REMARKS:

1. Emission Level(dBuV/m) = Raw Value(dBuV) + Correction Factor(dB/m)
2. Correction Factor(dB/m) = Antenna Factor(dB/m) + Cable Factor(dB) – Pre-Amplifier Factor(dB)
3. The other emission levels were very low against the limit.
4. Margin value = Emission Level – Limit value
5. " * ": Fundamental frequency.
6. " # ": The radiated frequency is out of the restricted band.

CHANNEL	TX Channel 165	DETECTOR FUNCTION	Peak (PK)
FREQUENCY RANGE	1GHz ~ 40GHz		Average (AV)

ANTENNA POLARITY & TEST DISTANCE: HORIZONTAL AT 3 M

NO.	FREQ. (MHz)	EMISSION LEVEL (dBuV/m)	LIMIT (dBuV/m)	MARGIN (dB)	ANTENNA HEIGHT (m)	TABLE ANGLE (Degree)	RAW VALUE (dBuV)	CORRECTION FACTOR (dB/m)
1	#5645.11	63.29 PK	68.20	-4.91	1.78 H	201	53.94	9.35
2	*5825.00	109.16 PK			1.78 H	201	99.69	9.47
3	*5825.00	98.23 AV			1.78 H	201	88.76	9.47
4	#5940.79	63.51 PK	68.20	-4.69	1.78 H	201	53.70	9.81
5	11650.00	59.46 PK	74.00	-14.54	1.27 H	199	39.14	20.32
6	11650.00	45.58 AV	54.00	-8.42	1.27 H	199	25.26	20.32

ANTENNA POLARITY & TEST DISTANCE: VERTICAL AT 3 M

NO.	FREQ. (MHz)	EMISSION LEVEL (dBuV/m)	LIMIT (dBuV/m)	MARGIN (dB)	ANTENNA HEIGHT (m)	TABLE ANGLE (Degree)	RAW VALUE (dBuV)	CORRECTION FACTOR (dB/m)
1	#5623.22	63.41 PK	68.20	-4.79	2.17 V	336	54.06	9.35
2	*5825.00	119.95 PK			2.17 V	336	110.48	9.47
3	*5825.00	109.34 AV			2.17 V	336	99.87	9.47
4	#6022.26	63.63 PK	68.20	-4.57	2.17 V	336	53.45	10.18
5	11650.00	61.01 PK	74.00	-12.99	1.89 V	150	40.69	20.32
6	11650.00	47.28 AV	54.00	-6.72	1.89 V	150	26.96	20.32

REMARKS:

1. Emission Level(dBuV/m) = Raw Value(dBuV) + Correction Factor(dB/m)
2. Correction Factor(dB/m) = Antenna Factor(dB/m) + Cable Factor(dB) – Pre-Amplifier Factor(dB)
3. The other emission levels were very low against the limit.
4. Margin value = Emission Level – Limit value
5. " * ": Fundamental frequency.
6. " # ": The radiated frequency is out of the restricted band.

802.11n (20MHz)

CHANNEL	TX Channel 36	DETECTOR FUNCTION	Peak (PK)
FREQUENCY RANGE	1GHz ~ 40GHz		Average (AV)

ANTENNA POLARITY & TEST DISTANCE: HORIZONTAL AT 3 M

NO.	FREQ. (MHz)	EMISSION LEVEL (dBuV/m)	LIMIT (dBuV/m)	MARGIN (dB)	ANTENNA HEIGHT (m)	TABLE ANGLE (Degree)	RAW VALUE (dBuV)	CORRECTION FACTOR (dB/m)
1	5150.00	66.54 PK	74.00	-7.46	1.77 H	139	58.74	7.80
2	5150.00	49.14 AV	54.00	-4.86	1.77 H	139	41.34	7.80
3	*5180.00	106.82 PK			1.77 H	139	98.89	7.93
4	*5180.00	94.82 AV			1.77 H	139	86.89	7.93
5	#10360.00	57.70 PK	74.00	-16.30	2.17 H	335	39.23	18.47
6	#10360.00	43.52 AV	54.00	-10.48	2.17 H	335	25.05	18.47

ANTENNA POLARITY & TEST DISTANCE: VERTICAL AT 3 M

NO.	FREQ. (MHz)	EMISSION LEVEL (dBuV/m)	LIMIT (dBuV/m)	MARGIN (dB)	ANTENNA HEIGHT (m)	TABLE ANGLE (Degree)	RAW VALUE (dBuV)	CORRECTION FACTOR (dB/m)
1	5150.00	68.91 PK	74.00	-5.09	2.37 V	128	61.11	7.80
2	5150.00	52.91 AV	54.00	-1.09	2.37 V	128	45.11	7.80
3	*5180.00	117.52 PK			2.37 V	128	109.59	7.93
4	*5180.00	105.02 AV			2.37 V	128	97.09	7.93
5	#10360.00	59.34 PK	74.00	-14.66	1.22 V	207	40.87	18.47
6	#10360.00	44.85 AV	54.00	-9.15	1.22 V	207	26.38	18.47

REMARKS:

1. Emission Level(dBuV/m) = Raw Value(dBuV) + Correction Factor(dB/m)
2. Correction Factor(dB/m) = Antenna Factor(dB/m) + Cable Factor(dB) – Pre-Amplifier Factor(dB)
3. The other emission levels were very low against the limit.
4. Margin value = Emission Level – Limit value
5. " * ": Fundamental frequency.
6. " # ": The radiated frequency is out of the restricted band.

CHANNEL	TX Channel 40	DETECTOR FUNCTION	Peak (PK)
FREQUENCY RANGE	1GHz ~ 40GHz		Average (AV)

ANTENNA POLARITY & TEST DISTANCE: HORIZONTAL AT 3 M

NO.	FREQ. (MHz)	EMISSION LEVEL (dBuV/m)	LIMIT (dBuV/m)	MARGIN (dB)	ANTENNA HEIGHT (m)	TABLE ANGLE (Degree)	RAW VALUE (dBuV)	CORRECTION FACTOR (dB/m)
1	*5200.00	109.77 PK			1.91 H	200	101.75	8.02
2	*5200.00	97.91 AV			1.91 H	200	89.89	8.02
3	#10400.00	58.53 PK	74.00	-15.47	1.44 H	288	39.89	18.64
4	#10400.00	43.64 AV	54.00	-10.36	1.44 H	288	25.00	18.64

ANTENNA POLARITY & TEST DISTANCE: VERTICAL AT 3 M

NO.	FREQ. (MHz)	EMISSION LEVEL (dBuV/m)	LIMIT (dBuV/m)	MARGIN (dB)	ANTENNA HEIGHT (m)	TABLE ANGLE (Degree)	RAW VALUE (dBuV)	CORRECTION FACTOR (dB/m)
1	*5200.00	120.39 PK			2.64 V	143	112.37	8.02
2	*5200.00	108.07 AV			2.64 V	143	100.05	8.02
3	#10400.00	58.91 PK	74.00	-15.09	2.11 V	104	40.27	18.64
4	#10400.00	45.52 AV	54.00	-8.48	2.11 V	104	26.88	18.64

REMARKS:

1. Emission Level(dBuV/m) = Raw Value(dBuV) + Correction Factor(dB/m)
2. Correction Factor(dB/m) = Antenna Factor(dB/m) + Cable Factor(dB) – Pre-Amplifier Factor(dB)
3. The other emission levels were very low against the limit.
4. Margin value = Emission Level – Limit value
5. " * ": Fundamental frequency.
6. " # ": The radiated frequency is out of the restricted band.

CHANNEL	TX Channel 48	DETECTOR FUNCTION	Peak (PK)
FREQUENCY RANGE	1GHz ~ 40GHz		Average (AV)

ANTENNA POLARITY & TEST DISTANCE: HORIZONTAL AT 3 M

NO.	FREQ. (MHz)	EMISSION LEVEL (dBuV/m)	LIMIT (dBuV/m)	MARGIN (dB)	ANTENNA HEIGHT (m)	TABLE ANGLE (Degree)	RAW VALUE (dBuV)	CORRECTION FACTOR (dB/m)
1	*5240.00	110.71 PK			1.89 H	178	102.56	8.15
2	*5240.00	99.16 AV			1.89 H	178	91.01	8.15
3	5350.00	57.87 PK	74.00	-16.13	1.89 H	178	49.29	8.58
4	5350.00	45.36 AV	54.00	-8.64	1.89 H	178	36.78	8.58
5	#10480.00	58.39 PK	74.00	-15.61	1.03 H	251	39.43	18.96
6	#10480.00	44.21 AV	54.00	-9.79	1.03 H	251	25.25	18.96

ANTENNA POLARITY & TEST DISTANCE: VERTICAL AT 3 M

NO.	FREQ. (MHz)	EMISSION LEVEL (dBuV/m)	LIMIT (dBuV/m)	MARGIN (dB)	ANTENNA HEIGHT (m)	TABLE ANGLE (Degree)	RAW VALUE (dBuV)	CORRECTION FACTOR (dB/m)
1	*5240.00	121.21 PK			2.74 V	141	113.06	8.15
2	*5240.00	108.76 AV			2.74 V	141	100.61	8.15
3	5350.00	59.10 PK	74.00	-14.90	2.74 V	141	50.52	8.58
4	5350.00	45.86 AV	54.00	-8.14	2.74 V	141	37.28	8.58
5	#10480.00	59.14 PK	74.00	-14.86	2.51 V	347	40.18	18.96
6	#10480.00	44.97 AV	54.00	-9.03	2.51 V	347	26.01	18.96

REMARKS:

1. Emission Level(dBuV/m) = Raw Value(dBuV) + Correction Factor(dB/m)
2. Correction Factor(dB/m) = Antenna Factor(dB/m) + Cable Factor(dB) – Pre-Amplifier Factor(dB)
3. The other emission levels were very low against the limit.
4. Margin value = Emission Level – Limit value
5. " * ": Fundamental frequency.
6. " # ": The radiated frequency is out of the restricted band.

CHANNEL	TX Channel 149	DETECTOR FUNCTION	Peak (PK)
FREQUENCY RANGE	1GHz ~ 40GHz		Average (AV)

ANTENNA POLARITY & TEST DISTANCE: HORIZONTAL AT 3 M

NO.	FREQ. (MHz)	EMISSION LEVEL (dBuV/m)	LIMIT (dBuV/m)	MARGIN (dB)	ANTENNA HEIGHT (m)	TABLE ANGLE (Degree)	RAW VALUE (dBuV)	CORRECTION FACTOR (dB/m)
1	#5596.84	63.49 PK	68.20	-4.71	1.72 H	196	54.14	9.35
2	*5745.00	108.18 PK			1.72 H	196	98.79	9.39
3	*5745.00	97.08 AV			1.72 H	196	87.69	9.39
4	#5956.79	63.28 PK	68.20	-4.92	1.72 H	196	53.40	9.88
5	11490.00	59.93 PK	74.00	-14.07	2.33 H	98	39.84	20.09
6	11490.00	45.27 AV	54.00	-8.73	2.33 H	98	25.18	20.09

ANTENNA POLARITY & TEST DISTANCE: VERTICAL AT 3 M

NO.	FREQ. (MHz)	EMISSION LEVEL (dBuV/m)	LIMIT (dBuV/m)	MARGIN (dB)	ANTENNA HEIGHT (m)	TABLE ANGLE (Degree)	RAW VALUE (dBuV)	CORRECTION FACTOR (dB/m)
1	#5615.38	63.46 PK	68.20	-4.74	2.77 V	334	54.12	9.34
2	*5745.00	119.65 PK			2.77 V	334	110.26	9.39
3	*5745.00	108.54 AV			2.77 V	334	99.15	9.39
4	#6018.56	63.98 PK	68.20	-4.22	2.77 V	334	53.83	10.15
5	11490.00	60.67 PK	74.00	-13.33	1.88 V	78	40.58	20.09
6	11490.00	46.43 AV	54.00	-7.57	1.88 V	78	26.34	20.09

REMARKS:

1. Emission Level(dBuV/m) = Raw Value(dBuV) + Correction Factor(dB/m)
2. Correction Factor(dB/m) = Antenna Factor(dB/m) + Cable Factor(dB) – Pre-Amplifier Factor(dB)
3. The other emission levels were very low against the limit.
4. Margin value = Emission Level – Limit value
5. " * ": Fundamental frequency.
6. " # ": The radiated frequency is out of the restricted band.

CHANNEL	TX Channel 157	DETECTOR FUNCTION	Peak (PK)
FREQUENCY RANGE	1GHz ~ 40GHz		Average (AV)

ANTENNA POLARITY & TEST DISTANCE: HORIZONTAL AT 3 M

NO.	FREQ. (MHz)	EMISSION LEVEL (dBuV/m)	LIMIT (dBuV/m)	MARGIN (dB)	ANTENNA HEIGHT (m)	TABLE ANGLE (Degree)	RAW VALUE (dBuV)	CORRECTION FACTOR (dB/m)
1	#5609.22	63.47 PK	68.20	-4.73	1.69 H	201	54.13	9.34
2	*5785.00	109.10 PK			1.69 H	201	99.69	9.41
3	*5785.00	98.17 AV			1.69 H	201	88.76	9.41
4	#5969.88	63.60 PK	68.20	-4.60	1.69 H	201	53.68	9.92
5	11570.00	60.13 PK	74.00	-13.87	2.09 H	178	39.84	20.29
6	11570.00	45.29 AV	54.00	-8.71	2.09 H	178	25.00	20.29

ANTENNA POLARITY & TEST DISTANCE: VERTICAL AT 3 M

NO.	FREQ. (MHz)	EMISSION LEVEL (dBuV/m)	LIMIT (dBuV/m)	MARGIN (dB)	ANTENNA HEIGHT (m)	TABLE ANGLE (Degree)	RAW VALUE (dBuV)	CORRECTION FACTOR (dB/m)
1	#5604.34	65.34 PK	68.20	-2.86	2.17 V	338	55.99	9.35
2	*5785.00	119.69 PK			2.17 V	338	110.28	9.41
3	*5785.00	110.25 AV			2.17 V	338	100.84	9.41
4	#5967.00	64.49 PK	68.20	-3.71	2.17 V	338	54.58	9.91
5	11570.00	60.80 PK	74.00	-13.20	2.58 V	339	40.51	20.29
6	11570.00	46.98 AV	54.00	-7.02	2.58 V	339	26.69	20.29

REMARKS:

1. Emission Level(dBuV/m) = Raw Value(dBuV) + Correction Factor(dB/m)
2. Correction Factor(dB/m) = Antenna Factor(dB/m) + Cable Factor(dB) – Pre-Amplifier Factor(dB)
3. The other emission levels were very low against the limit.
4. Margin value = Emission Level – Limit value
5. " * ": Fundamental frequency.
6. " # ": The radiated frequency is out of the restricted band.

CHANNEL	TX Channel 165	DETECTOR FUNCTION	Peak (PK)
FREQUENCY RANGE	1GHz ~ 40GHz		Average (AV)

ANTENNA POLARITY & TEST DISTANCE: HORIZONTAL AT 3 M

NO.	FREQ. (MHz)	EMISSION LEVEL (dBuV/m)	LIMIT (dBuV/m)	MARGIN (dB)	ANTENNA HEIGHT (m)	TABLE ANGLE (Degree)	RAW VALUE (dBuV)	CORRECTION FACTOR (dB/m)
1	#5595.30	62.41 PK	68.20	-5.79	1.79 H	180	53.07	9.34
2	*5825.00	109.70 PK			1.79 H	180	100.23	9.47
3	*5825.00	99.79 AV			1.79 H	180	90.32	9.47
4	#5982.82	63.39 PK	68.20	-4.81	1.79 H	180	53.42	9.97
5	11650.00	59.66 PK	74.00	-14.34	1.29 H	15	39.34	20.32
6	11650.00	45.39 AV	54.00	-8.61	1.29 H	15	25.07	20.32

ANTENNA POLARITY & TEST DISTANCE: VERTICAL AT 3 M

NO.	FREQ. (MHz)	EMISSION LEVEL (dBuV/m)	LIMIT (dBuV/m)	MARGIN (dB)	ANTENNA HEIGHT (m)	TABLE ANGLE (Degree)	RAW VALUE (dBuV)	CORRECTION FACTOR (dB/m)
1	#5608.92	63.93 PK	68.20	-4.27	2.20 V	331	54.59	9.34
2	*5825.00	119.98 PK			2.20 V	331	110.51	9.47
3	*5825.00	109.16 AV			2.20 V	331	99.69	9.47
4	#5956.18	63.82 PK	68.20	-4.38	2.20 V	331	53.95	9.87
5	11650.00	61.13 PK	74.00	-12.87	2.33 V	49	40.81	20.32
6	11650.00	46.43 AV	54.00	-7.57	2.33 V	49	26.11	20.32

REMARKS:

1. Emission Level(dBuV/m) = Raw Value(dBuV) + Correction Factor(dB/m)
2. Correction Factor(dB/m) = Antenna Factor(dB/m) + Cable Factor(dB) – Pre-Amplifier Factor(dB)
3. The other emission levels were very low against the limit.
4. Margin value = Emission Level – Limit value
5. " * ": Fundamental frequency.
6. " # ": The radiated frequency is out of the restricted band.

802.11n (40MHz)

CHANNEL	TX Channel 38	DETECTOR FUNCTION	Peak (PK)
FREQUENCY RANGE	1GHz ~ 40GHz		Average (AV)

ANTENNA POLARITY & TEST DISTANCE: HORIZONTAL AT 3 M

NO.	FREQ. (MHz)	EMISSION LEVEL (dBuV/m)	LIMIT (dBuV/m)	MARGIN (dB)	ANTENNA HEIGHT (m)	TABLE ANGLE (Degree)	RAW VALUE (dBuV)	CORRECTION FACTOR (dB/m)
1	5150.00	66.26 PK	74.00	-7.74	1.86 H	194	58.46	7.80
2	5150.00	47.96 AV	54.00	-6.04	1.86 H	194	40.16	7.80
3	*5190.00	101.86 PK			1.86 H	194	93.89	7.97
4	*5190.00	91.55 AV			1.86 H	194	83.58	7.97
5	#10380.00	58.01 PK	74.00	-15.99	2.71 H	351	39.45	18.56
6	#10380.00	44.11 AV	54.00	-9.89	2.71 H	351	25.55	18.56

ANTENNA POLARITY & TEST DISTANCE: VERTICAL AT 3 M

NO.	FREQ. (MHz)	EMISSION LEVEL (dBuV/m)	LIMIT (dBuV/m)	MARGIN (dB)	ANTENNA HEIGHT (m)	TABLE ANGLE (Degree)	RAW VALUE (dBuV)	CORRECTION FACTOR (dB/m)
1	5150.00	69.62 PK	74.00	-4.38	2.41 V	143	61.82	7.80
2	5150.00	52.97 AV	54.00	-1.03	2.41 V	143	45.17	7.80
3	*5190.00	112.73 PK			2.41 V	143	104.76	7.97
4	*5190.00	102.41 AV			2.41 V	143	94.44	7.97
5	#10380.00	59.43 PK	74.00	-14.57	1.23 V	324	40.87	18.56
6	#10380.00	45.22 AV	54.00	-8.78	1.23 V	324	26.66	18.56

REMARKS:

1. Emission Level(dBuV/m) = Raw Value(dBuV) + Correction Factor(dB/m)
2. Correction Factor(dB/m) = Antenna Factor(dB/m) + Cable Factor(dB) – Pre-Amplifier Factor(dB)
3. The other emission levels were very low against the limit.
4. Margin value = Emission Level – Limit value
5. " * ": Fundamental frequency.
6. " # ": The radiated frequency is out of the restricted band.

CHANNEL	TX Channel 46	DETECTOR FUNCTION	Peak (PK)
FREQUENCY RANGE	1GHz ~ 40GHz		Average (AV)

ANTENNA POLARITY & TEST DISTANCE: HORIZONTAL AT 3 M

NO.	FREQ. (MHz)	EMISSION LEVEL (dBuV/m)	LIMIT (dBuV/m)	MARGIN (dB)	ANTENNA HEIGHT (m)	TABLE ANGLE (Degree)	RAW VALUE (dBuV)	CORRECTION FACTOR (dB/m)
1	*5230.00	107.99 PK			1.85 H	191	99.87	8.12
2	*5230.00	96.81 AV			1.85 H	191	88.69	8.12
3	5350.00	58.70 PK	74.00	-15.30	1.85 H	191	50.12	8.58
4	5350.00	46.81 AV	54.00	-7.19	1.85 H	191	38.23	8.58
5	#10460.00	58.33 PK	74.00	-15.67	1.40 H	100	39.46	18.87
6	#10460.00	44.23 AV	54.00	-9.77	1.40 H	100	25.36	18.87

ANTENNA POLARITY & TEST DISTANCE: VERTICAL AT 3 M

NO.	FREQ. (MHz)	EMISSION LEVEL (dBuV/m)	LIMIT (dBuV/m)	MARGIN (dB)	ANTENNA HEIGHT (m)	TABLE ANGLE (Degree)	RAW VALUE (dBuV)	CORRECTION FACTOR (dB/m)
1	*5230.00	118.83 PK			3.16 V	114	110.71	8.12
2	*5230.00	107.45 AV			3.16 V	114	99.33	8.12
3	5350.00	60.29 PK	74.00	-13.71	3.16 V	114	51.71	8.58
4	5350.00	47.67 AV	54.00	-6.33	3.16 V	114	39.09	8.58
5	#10460.00	59.50 PK	74.00	-14.50	2.03 V	238	40.63	18.87
6	#10460.00	45.09 AV	54.00	-8.91	2.03 V	238	26.22	18.87

REMARKS:

1. Emission Level(dBuV/m) = Raw Value(dBuV) + Correction Factor(dB/m)
2. Correction Factor(dB/m) = Antenna Factor(dB/m) + Cable Factor(dB) – Pre-Amplifier Factor(dB)
3. The other emission levels were very low against the limit.
4. Margin value = Emission Level – Limit value
5. " * ": Fundamental frequency.
6. " # ": The radiated frequency is out of the restricted band.

CHANNEL	TX Channel 151	DETECTOR FUNCTION	Peak (PK)
FREQUENCY RANGE	1GHz ~ 40GHz		Average (AV)

ANTENNA POLARITY & TEST DISTANCE: HORIZONTAL AT 3 M

NO.	FREQ. (MHz)	EMISSION LEVEL (dBuV/m)	LIMIT (dBuV/m)	MARGIN (dB)	ANTENNA HEIGHT (m)	TABLE ANGLE (Degree)	RAW VALUE (dBuV)	CORRECTION FACTOR (dB/m)
1	#5648.23	63.38 PK	68.20	-4.82	1.66 H	174	54.02	9.36
2	*5755.00	109.17 PK			1.66 H	174	99.77	9.40
3	*5755.00	97.74 AV			1.66 H	174	88.34	9.40
4	#5997.73	63.07 PK	68.20	-5.13	1.66 H	174	53.04	10.03
5	11510.00	59.44 PK	74.00	-14.56	2.64 H	114	39.33	20.11
6	11510.00	45.37 AV	54.00	-8.63	2.64 H	114	25.26	20.11

ANTENNA POLARITY & TEST DISTANCE: VERTICAL AT 3 M

NO.	FREQ. (MHz)	EMISSION LEVEL (dBuV/m)	LIMIT (dBuV/m)	MARGIN (dB)	ANTENNA HEIGHT (m)	TABLE ANGLE (Degree)	RAW VALUE (dBuV)	CORRECTION FACTOR (dB/m)
1	#5646.05	66.52 PK	68.20	-1.68	2.83 V	359	57.17	9.35
2	*5755.00	118.72 PK			2.83 V	359	109.32	9.40
3	*5755.00	107.81 AV			2.83 V	359	98.41	9.40
4	#5967.48	63.48 PK	68.20	-4.72	2.83 V	359	53.57	9.91
5	11510.00	60.99 PK	74.00	-13.01	2.25 V	45	40.88	20.11
6	11510.00	46.42 AV	54.00	-7.58	2.25 V	45	26.31	20.11

REMARKS:

1. Emission Level(dBuV/m) = Raw Value(dBuV) + Correction Factor(dB/m)
2. Correction Factor(dB/m) = Antenna Factor(dB/m) + Cable Factor(dB) – Pre-Amplifier Factor(dB)
3. The other emission levels were very low against the limit.
4. Margin value = Emission Level – Limit value
5. " * ": Fundamental frequency.
6. " # ": The radiated frequency is out of the restricted band.

CHANNEL	TX Channel 159	DETECTOR FUNCTION	Peak (PK)
FREQUENCY RANGE	1GHz ~ 40GHz		Average (AV)

ANTENNA POLARITY & TEST DISTANCE: HORIZONTAL AT 3 M

NO.	FREQ. (MHz)	EMISSION LEVEL (dBuV/m)	LIMIT (dBuV/m)	MARGIN (dB)	ANTENNA HEIGHT (m)	TABLE ANGLE (Degree)	RAW VALUE (dBuV)	CORRECTION FACTOR (dB/m)
1	#5610.50	63.45 PK	68.20	-4.75	1.73 H	184	54.11	9.34
2	*5795.00	106.88 PK			1.73 H	184	97.46	9.42
3	*5795.00	95.64 AV			1.73 H	184	86.22	9.42
4	#5990.43	64.07 PK	68.20	-4.13	1.73 H	184	54.08	9.99
5	11590.00	59.60 PK	74.00	-14.40	1.31 H	114	39.26	20.34
6	11590.00	45.68 AV	54.00	-8.32	1.31 H	114	25.34	20.34

ANTENNA POLARITY & TEST DISTANCE: VERTICAL AT 3 M

NO.	FREQ. (MHz)	EMISSION LEVEL (dBuV/m)	LIMIT (dBuV/m)	MARGIN (dB)	ANTENNA HEIGHT (m)	TABLE ANGLE (Degree)	RAW VALUE (dBuV)	CORRECTION FACTOR (dB/m)
1	#5632.12	64.39 PK	68.20	-3.81	2.12 V	358	55.05	9.34
2	*5795.00	117.78 PK			2.12 V	358	108.36	9.42
3	*5795.00	106.68 AV			2.12 V	358	97.26	9.42
4	#5990.73	64.30 PK	68.20	-3.90	2.12 V	358	54.31	9.99
5	11590.00	61.18 PK	74.00	-12.82	2.48 V	110	40.84	20.34
6	11590.00	46.62 AV	54.00	-7.38	2.48 V	110	26.28	20.34

REMARKS:

1. Emission Level(dBuV/m) = Raw Value(dBuV) + Correction Factor(dB/m)
2. Correction Factor(dB/m) = Antenna Factor(dB/m) + Cable Factor(dB) – Pre-Amplifier Factor(dB)
3. The other emission levels were very low against the limit.
4. Margin value = Emission Level – Limit value
5. " * ": Fundamental frequency.
6. " # ": The radiated frequency is out of the restricted band.

802.11ac (80MHz)

CHANNEL	TX Channel 42	DETECTOR FUNCTION	Peak (PK)
FREQUENCY RANGE	1GHz ~ 40GHz		Average (AV)

ANTENNA POLARITY & TEST DISTANCE: HORIZONTAL AT 3 M

NO.	FREQ. (MHz)	EMISSION LEVEL (dBuV/m)	LIMIT (dBuV/m)	MARGIN (dB)	ANTENNA HEIGHT (m)	TABLE ANGLE (Degree)	RAW VALUE (dBuV)	CORRECTION FACTOR (dB/m)
1	5150.00	65.26 PK	74.00	-8.74	1.88 H	199	57.46	7.80
2	5150.00	49.06 AV	54.00	-4.94	1.88 H	199	41.26	7.80
3	*5210.00	99.50 PK			1.88 H	199	91.45	8.05
4	*5210.00	88.43 AV			1.88 H	199	80.38	8.05
5	5350.00	59.05 PK	74.00	-14.95	1.88 H	199	50.47	8.58
6	5350.00	45.97 AV	54.00	-8.03	1.88 H	199	37.39	8.58
7	#10420.00	58.36 PK	74.00	-15.64	1.11 H	348	39.64	18.72
8	#10420.00	43.79 AV	54.00	-10.21	1.11 H	348	25.07	18.72

ANTENNA POLARITY & TEST DISTANCE: VERTICAL AT 3 M

NO.	FREQ. (MHz)	EMISSION LEVEL (dBuV/m)	LIMIT (dBuV/m)	MARGIN (dB)	ANTENNA HEIGHT (m)	TABLE ANGLE (Degree)	RAW VALUE (dBuV)	CORRECTION FACTOR (dB/m)
1	5150.00	67.05 PK	74.00	-6.95	3.32 V	118	59.25	7.80
2	5150.00	52.93 AV	54.00	-1.07	3.32 V	118	45.13	7.80
3	*5210.00	110.63 PK			3.32 V	118	102.58	8.05
4	*5210.00	100.02 AV			3.32 V	118	91.97	8.05
5	5350.00	60.28 PK	74.00	-13.72	3.32 V	118	51.70	8.58
6	5350.00	46.70 AV	54.00	-7.30	3.32 V	118	38.12	8.58
7	#10420.00	59.56 PK	74.00	-14.44	1.88 V	308	40.84	18.72
8	#10420.00	45.23 AV	54.00	-8.77	1.88 V	308	26.51	18.72

REMARKS:

- Emission Level(dBuV/m) = Raw Value(dBuV) + Correction Factor(dB/m)
- Correction Factor(dB/m) = Antenna Factor(dB/m) + Cable Factor(dB) – Pre-Amplifier Factor(dB)
- The other emission levels were very low against the limit.
- Margin value = Emission Level – Limit value
- " * ": Fundamental frequency.
- " # ": The radiated frequency is out of the restricted band.

CHANNEL	TX Channel 155	DETECTOR FUNCTION	Peak (PK)
FREQUENCY RANGE	1GHz ~ 40GHz		Average (AV)

ANTENNA POLARITY & TEST DISTANCE: HORIZONTAL AT 3 M

NO.	FREQ. (MHz)	EMISSION LEVEL (dBuV/m)	LIMIT (dBuV/m)	MARGIN (dB)	ANTENNA HEIGHT (m)	TABLE ANGLE (Degree)	RAW VALUE (dBuV)	CORRECTION FACTOR (dB/m)
1	#5597.86	64.14 PK	68.20	-4.06	1.00 H	18	54.79	9.35
2	*5775.00	100.55 PK			1.00 H	18	91.14	9.41
3	*5775.00	88.77 AV			1.00 H	18	79.36	9.41
4	#5929.48	63.33 PK	68.20	-4.87	1.00 H	18	53.57	9.76
5	11550.00	59.34 PK	74.00	-14.66	1.71 H	119	39.12	20.22
6	11550.00	45.56 AV	54.00	-8.44	1.71 H	119	25.34	20.22

ANTENNA POLARITY & TEST DISTANCE: VERTICAL AT 3 M

NO.	FREQ. (MHz)	EMISSION LEVEL (dBuV/m)	LIMIT (dBuV/m)	MARGIN (dB)	ANTENNA HEIGHT (m)	TABLE ANGLE (Degree)	RAW VALUE (dBuV)	CORRECTION FACTOR (dB/m)
1	#5648.79	67.14 PK	68.20	-1.06	2.39 V	34	57.78	9.36
2	*5775.00	111.58 PK			2.39 V	34	102.17	9.41
3	*5775.00	100.77 AV			2.39 V	34	91.36	9.41
4	#5928.03	65.27 PK	68.20	-2.93	2.39 V	34	55.51	9.76
5	11550.00	60.87 PK	74.00	-13.13	1.39 V	178	40.65	20.22
6	11550.00	47.19 AV	54.00	-6.81	1.39 V	178	26.97	20.22

REMARKS:

1. Emission Level(dBuV/m) = Raw Value(dBuV) + Correction Factor(dB/m)
2. Correction Factor(dB/m) = Antenna Factor(dB/m) + Cable Factor(dB) – Pre-Amplifier Factor(dB)
3. The other emission levels were very low against the limit.
4. Margin value = Emission Level – Limit value
5. " * ": Fundamental frequency.
6. " # ": The radiated frequency is out of the restricted band.

CDD Mode (Mode B)

802.11a

CHANNEL	TX Channel 36	DETECTOR FUNCTION	Peak (PK)
FREQUENCY RANGE	1GHz ~ 40GHz		Average (AV)

ANTENNA POLARITY & TEST DISTANCE: HORIZONTAL AT 3 M

NO.	FREQ. (MHz)	EMISSION LEVEL (dBuV/m)	LIMIT (dBuV/m)	MARGIN (dB)	ANTENNA HEIGHT (m)	TABLE ANGLE (Degree)	RAW VALUE (dBuV)	CORRECTION FACTOR (dB/m)
1	5150.00	59.23 PK	74.00	-14.77	1.00 H	21	51.43	7.80
2	5150.00	45.90 AV	54.00	-8.10	1.00 H	21	38.10	7.80
3	*5180.00	108.35 PK			1.00 H	21	100.42	7.93
4	*5180.00	95.48 AV			1.00 H	21	87.55	7.93
5	#10360.00	57.26 PK	74.00	-16.74	1.62 H	205	38.79	18.47
6	#10360.00	42.69 AV	54.00	-11.31	1.62 H	205	24.22	18.47

ANTENNA POLARITY & TEST DISTANCE: VERTICAL AT 3 M

NO.	FREQ. (MHz)	EMISSION LEVEL (dBuV/m)	LIMIT (dBuV/m)	MARGIN (dB)	ANTENNA HEIGHT (m)	TABLE ANGLE (Degree)	RAW VALUE (dBuV)	CORRECTION FACTOR (dB/m)
1	5150.00	66.85 PK	74.00	-7.15	1.89 V	0	59.05	7.80
2	5150.00	52.90 AV	54.00	-1.10	1.89 V	0	45.10	7.80
3	*5180.00	122.69 PK			1.89 V	0	114.76	7.93
4	*5180.00	109.40 AV			1.89 V	0	101.47	7.93
5	#10360.00	57.60 PK	74.00	-16.40	1.64 V	221	39.13	18.47
6	#10360.00	44.11 AV	54.00	-9.89	1.64 V	221	25.64	18.47

REMARKS:

1. Emission Level(dBuV/m) = Raw Value(dBuV) + Correction Factor(dB/m)
2. Correction Factor(dB/m) = Antenna Factor(dB/m) + Cable Factor(dB) – Pre-Amplifier Factor(dB)
3. The other emission levels were very low against the limit.
4. Margin value = Emission Level – Limit value
5. " * ": Fundamental frequency.
6. " # ": The radiated frequency is out of the restricted band.

CHANNEL	TX Channel 40	DETECTOR FUNCTION	Peak (PK)
FREQUENCY RANGE	1GHz ~ 40GHz		Average (AV)

ANTENNA POLARITY & TEST DISTANCE: HORIZONTAL AT 3 M

NO.	FREQ. (MHz)	EMISSION LEVEL (dBuV/m)	LIMIT (dBuV/m)	MARGIN (dB)	ANTENNA HEIGHT (m)	TABLE ANGLE (Degree)	RAW VALUE (dBuV)	CORRECTION FACTOR (dB/m)
1	*5200.00	109.51 PK			1.02 H	23	101.49	8.02
2	*5200.00	96.72 AV			1.02 H	23	88.70	8.02
3	#10400.00	57.40 PK	74.00	-16.60	2.30 H	196	38.76	18.64
4	#10400.00	43.49 AV	54.00	-10.51	2.30 H	196	24.85	18.64

ANTENNA POLARITY & TEST DISTANCE: VERTICAL AT 3 M

NO.	FREQ. (MHz)	EMISSION LEVEL (dBuV/m)	LIMIT (dBuV/m)	MARGIN (dB)	ANTENNA HEIGHT (m)	TABLE ANGLE (Degree)	RAW VALUE (dBuV)	CORRECTION FACTOR (dB/m)
1	*5200.00	123.49 PK			1.71 V	0	115.47	8.02
2	*5200.00	110.27 AV			1.71 V	0	102.25	8.02
3	#10400.00	58.27 PK	74.00	-15.73	1.84 V	241	39.63	18.64
4	#10400.00	44.10 AV	54.00	-9.90	1.84 V	241	25.46	18.64

REMARKS:

1. Emission Level(dBuV/m) = Raw Value(dBuV) + Correction Factor(dB/m)
2. Correction Factor(dB/m) = Antenna Factor(dB/m) + Cable Factor(dB) – Pre-Amplifier Factor(dB)
3. The other emission levels were very low against the limit.
4. Margin value = Emission Level – Limit value
5. " * ": Fundamental frequency.
6. " # ": The radiated frequency is out of the restricted band.

CHANNEL	TX Channel 48	DETECTOR FUNCTION	Peak (PK)
FREQUENCY RANGE	1GHz ~ 40GHz		Average (AV)

ANTENNA POLARITY & TEST DISTANCE: HORIZONTAL AT 3 M

NO.	FREQ. (MHz)	EMISSION LEVEL (dBuV/m)	LIMIT (dBuV/m)	MARGIN (dB)	ANTENNA HEIGHT (m)	TABLE ANGLE (Degree)	RAW VALUE (dBuV)	CORRECTION FACTOR (dB/m)
1	*5240.00	109.61 PK			1.04 H	30	101.46	8.15
2	*5240.00	96.93 AV			1.04 H	30	88.78	8.15
3	5350.00	58.59 PK	74.00	-15.41	1.04 H	30	50.01	8.58
4	5350.00	45.14 AV	54.00	-8.86	1.04 H	30	36.56	8.58
5	#10480.00	57.61 PK	74.00	-16.39	1.71 H	154	38.65	18.96
6	#10480.00	43.59 AV	54.00	-10.41	1.71 H	154	24.63	18.96

ANTENNA POLARITY & TEST DISTANCE: VERTICAL AT 3 M

NO.	FREQ. (MHz)	EMISSION LEVEL (dBuV/m)	LIMIT (dBuV/m)	MARGIN (dB)	ANTENNA HEIGHT (m)	TABLE ANGLE (Degree)	RAW VALUE (dBuV)	CORRECTION FACTOR (dB/m)
1	*5240.00	124.04 PK			1.78 V	0	115.89	8.15
2	*5240.00	110.71 AV			1.78 V	0	102.56	8.15
3	5350.00	59.13 PK	74.00	-14.87	1.78 V	0	50.55	8.58
4	5350.00	45.64 AV	54.00	-8.36	1.78 V	0	37.06	8.58
5	#10480.00	58.61 PK	74.00	-15.39	1.58 V	206	39.65	18.96
6	#10480.00	44.22 AV	54.00	-9.78	1.58 V	206	25.26	18.96

REMARKS:

1. Emission Level(dBuV/m) = Raw Value(dBuV) + Correction Factor(dB/m)
2. Correction Factor(dB/m) = Antenna Factor(dB/m) + Cable Factor(dB) – Pre-Amplifier Factor(dB)
3. The other emission levels were very low against the limit.
4. Margin value = Emission Level – Limit value
5. " * ": Fundamental frequency.
6. " # ": The radiated frequency is out of the restricted band.

CHANNEL	TX Channel 149	DETECTOR FUNCTION	Peak (PK)
FREQUENCY RANGE	1GHz ~ 40GHz		Average (AV)

ANTENNA POLARITY & TEST DISTANCE: HORIZONTAL AT 3 M

NO.	FREQ. (MHz)	EMISSION LEVEL (dBuV/m)	LIMIT (dBuV/m)	MARGIN (dB)	ANTENNA HEIGHT (m)	TABLE ANGLE (Degree)	RAW VALUE (dBuV)	CORRECTION FACTOR (dB/m)
1	#5613.23	63.14 PK	68.20	-5.06	1.06 H	30	53.79	9.35
2	*5745.00	102.29 PK			1.06 H	30	92.90	9.39
3	*5745.00	91.39 AV			1.06 H	30	82.00	9.39
4	#5925.74	64.27 PK	68.20	-3.93	1.06 H	30	54.51	9.76
5	11490.00	58.55 PK	74.00	-15.45	1.94 H	167	38.46	20.09
6	11490.00	44.65 AV	54.00	-9.35	1.94 H	167	24.56	20.09

ANTENNA POLARITY & TEST DISTANCE: VERTICAL AT 3 M

NO.	FREQ. (MHz)	EMISSION LEVEL (dBuV/m)	LIMIT (dBuV/m)	MARGIN (dB)	ANTENNA HEIGHT (m)	TABLE ANGLE (Degree)	RAW VALUE (dBuV)	CORRECTION FACTOR (dB/m)
1	#5631.69	63.91 PK	68.20	-4.29	1.80 V	353	54.57	9.34
2	*5745.00	119.59 PK			1.80 V	353	110.20	9.39
3	*5745.00	108.48 AV			1.80 V	353	99.09	9.39
4	#5929.72	64.08 PK	68.20	-4.12	1.80 V	353	54.31	9.77
5	11490.00	59.34 PK	74.00	-14.66	1.67 V	246	39.25	20.09
6	11490.00	45.69 AV	54.00	-8.31	1.67 V	246	25.60	20.09

REMARKS:

1. Emission Level(dBuV/m) = Raw Value(dBuV) + Correction Factor(dB/m)
2. Correction Factor(dB/m) = Antenna Factor(dB/m) + Cable Factor(dB) – Pre-Amplifier Factor(dB)
3. The other emission levels were very low against the limit.
4. Margin value = Emission Level – Limit value
5. " * ": Fundamental frequency.
6. " # ": The radiated frequency is out of the restricted band.

CHANNEL	TX Channel 157	DETECTOR FUNCTION	Peak (PK)
FREQUENCY RANGE	1GHz ~ 40GHz		Average (AV)

ANTENNA POLARITY & TEST DISTANCE: HORIZONTAL AT 3 M

NO.	FREQ. (MHz)	EMISSION LEVEL (dBuV/m)	LIMIT (dBuV/m)	MARGIN (dB)	ANTENNA HEIGHT (m)	TABLE ANGLE (Degree)	RAW VALUE (dBuV)	CORRECTION FACTOR (dB/m)
1	#5615.36	63.44 PK	68.20	-4.76	1.02 H	29	54.10	9.34
2	*5785.00	100.91 PK			1.02 H	29	91.50	9.41
3	*5785.00	90.87 AV			1.02 H	29	81.46	9.41
4	#6020.04	64.74 PK	68.20	-3.46	1.02 H	29	54.57	10.17
5	11570.00	58.70 PK	74.00	-15.30	2.15 H	187	38.41	20.29
6	11570.00	44.47 AV	54.00	-9.53	2.15 H	187	24.18	20.29

ANTENNA POLARITY & TEST DISTANCE: VERTICAL AT 3 M

NO.	FREQ. (MHz)	EMISSION LEVEL (dBuV/m)	LIMIT (dBuV/m)	MARGIN (dB)	ANTENNA HEIGHT (m)	TABLE ANGLE (Degree)	RAW VALUE (dBuV)	CORRECTION FACTOR (dB/m)
1	#5650.19	63.89 PK	68.34	-4.45	1.86 V	17	54.53	9.36
2	*5785.00	119.48 PK			1.86 V	17	110.07	9.41
3	*5785.00	108.42 AV			1.86 V	17	99.01	9.41
4	#5969.96	63.95 PK	68.20	-4.25	1.86 V	17	54.03	9.92
5	11570.00	59.95 PK	74.00	-14.05	1.92 V	102	39.66	20.29
6	11570.00	45.45 AV	54.00	-8.55	1.92 V	102	25.16	20.29

REMARKS:

1. Emission Level(dBuV/m) = Raw Value(dBuV) + Correction Factor(dB/m)
2. Correction Factor(dB/m) = Antenna Factor(dB/m) + Cable Factor(dB) – Pre-Amplifier Factor(dB)
3. The other emission levels were very low against the limit.
4. Margin value = Emission Level – Limit value
5. " * ": Fundamental frequency.
6. " # ": The radiated frequency is out of the restricted band.

CHANNEL	TX Channel 165	DETECTOR FUNCTION	Peak (PK)
FREQUENCY RANGE	1GHz ~ 40GHz		Average (AV)

ANTENNA POLARITY & TEST DISTANCE: HORIZONTAL AT 3 M

NO.	FREQ. (MHz)	EMISSION LEVEL (dBuV/m)	LIMIT (dBuV/m)	MARGIN (dB)	ANTENNA HEIGHT (m)	TABLE ANGLE (Degree)	RAW VALUE (dBuV)	CORRECTION FACTOR (dB/m)
1	#5640.08	63.00 PK	68.20	-5.20	1.00 H	23	53.64	9.36
2	*5825.00	102.63 PK			1.00 H	23	93.16	9.47
3	*5825.00	92.61 AV			1.00 H	23	83.14	9.47
4	#5972.42	63.12 PK	68.20	-5.08	1.00 H	23	53.19	9.93
5	11650.00	58.73 PK	74.00	-15.27	1.82 H	144	38.41	20.32
6	11650.00	44.94 AV	54.00	-9.06	1.82 H	144	24.62	20.32

ANTENNA POLARITY & TEST DISTANCE: VERTICAL AT 3 M

NO.	FREQ. (MHz)	EMISSION LEVEL (dBuV/m)	LIMIT (dBuV/m)	MARGIN (dB)	ANTENNA HEIGHT (m)	TABLE ANGLE (Degree)	RAW VALUE (dBuV)	CORRECTION FACTOR (dB/m)
1	#5610.99	63.59 PK	68.20	-4.61	1.94 V	4	54.24	9.35
2	*5825.00	120.15 PK			1.94 V	4	110.68	9.47
3	*5825.00	109.48 AV			1.94 V	4	100.01	9.47
4	#5946.87	64.01 PK	68.20	-4.19	1.94 V	4	54.17	9.84
5	11650.00	60.00 PK	74.00	-14.00	1.33 V	254	39.68	20.32
6	11650.00	45.32 AV	54.00	-8.68	1.33 V	254	25.00	20.32

REMARKS:

1. Emission Level(dBuV/m) = Raw Value(dBuV) + Correction Factor(dB/m)
2. Correction Factor(dB/m) = Antenna Factor(dB/m) + Cable Factor(dB) – Pre-Amplifier Factor(dB)
3. The other emission levels were very low against the limit.
4. Margin value = Emission Level – Limit value
5. " * ": Fundamental frequency.
6. " # ": The radiated frequency is out of the restricted band.

802.11n (20MHz)

CHANNEL	TX Channel 36	DETECTOR FUNCTION	Peak (PK)
FREQUENCY RANGE	1GHz ~ 40GHz		Average (AV)

ANTENNA POLARITY & TEST DISTANCE: HORIZONTAL AT 3 M

NO.	FREQ. (MHz)	EMISSION LEVEL (dBuV/m)	LIMIT (dBuV/m)	MARGIN (dB)	ANTENNA HEIGHT (m)	TABLE ANGLE (Degree)	RAW VALUE (dBuV)	CORRECTION FACTOR (dB/m)
1	5150.00	59.24 PK	74.00	-14.76	1.00 H	21	51.44	7.80
2	5150.00	46.08 AV	54.00	-7.92	1.00 H	21	38.28	7.80
3	*5180.00	109.24 PK			1.00 H	21	101.31	7.93
4	*5180.00	96.65 AV			1.00 H	21	88.72	7.93
5	#10360.00	56.93 PK	74.00	-17.07	1.57 H	242	38.46	18.47
6	#10360.00	43.32 AV	54.00	-10.68	1.57 H	242	24.85	18.47

ANTENNA POLARITY & TEST DISTANCE: VERTICAL AT 3 M

NO.	FREQ. (MHz)	EMISSION LEVEL (dBuV/m)	LIMIT (dBuV/m)	MARGIN (dB)	ANTENNA HEIGHT (m)	TABLE ANGLE (Degree)	RAW VALUE (dBuV)	CORRECTION FACTOR (dB/m)
1	5150.00	67.15 PK	74.00	-6.85	1.90 V	0	59.35	7.80
2	5150.00	52.86 AV	54.00	-1.14	1.90 V	0	45.06	7.80
3	*5180.00	122.39 PK			1.90 V	0	114.46	7.93
4	*5180.00	110.17 AV			1.90 V	0	102.24	7.93
5	#10360.00	58.36 PK	74.00	-15.64	1.84 V	356	39.89	18.47
6	#10360.00	44.11 AV	54.00	-9.89	1.84 V	356	25.64	18.47

REMARKS:

1. Emission Level(dBuV/m) = Raw Value(dBuV) + Correction Factor(dB/m)
2. Correction Factor(dB/m) = Antenna Factor(dB/m) + Cable Factor(dB) – Pre-Amplifier Factor(dB)
3. The other emission levels were very low against the limit.
4. Margin value = Emission Level – Limit value
5. " * ": Fundamental frequency.
6. " # ": The radiated frequency is out of the restricted band.

CHANNEL	TX Channel 40	DETECTOR FUNCTION	Peak (PK)
FREQUENCY RANGE	1GHz ~ 40GHz		Average (AV)

ANTENNA POLARITY & TEST DISTANCE: HORIZONTAL AT 3 M

NO.	FREQ. (MHz)	EMISSION LEVEL (dBuV/m)	LIMIT (dBuV/m)	MARGIN (dB)	ANTENNA HEIGHT (m)	TABLE ANGLE (Degree)	RAW VALUE (dBuV)	CORRECTION FACTOR (dB/m)
1	*5200.00	109.54 PK			1.00 H	36	101.52	8.02
2	*5200.00	96.71 AV			1.00 H	36	88.69	8.02
3	#10400.00	57.10 PK	74.00	-16.90	2.15 H	84	38.46	18.64
4	#10400.00	43.39 AV	54.00	-10.61	2.15 H	84	24.75	18.64

ANTENNA POLARITY & TEST DISTANCE: VERTICAL AT 3 M

NO.	FREQ. (MHz)	EMISSION LEVEL (dBuV/m)	LIMIT (dBuV/m)	MARGIN (dB)	ANTENNA HEIGHT (m)	TABLE ANGLE (Degree)	RAW VALUE (dBuV)	CORRECTION FACTOR (dB/m)
1	*5200.00	122.22 PK			1.78 V	13	114.20	8.02
2	*5200.00	110.34 AV			1.78 V	13	102.32	8.02
3	#10400.00	58.28 PK	74.00	-15.72	1.83 V	215	39.64	18.64
4	#10400.00	44.25 AV	54.00	-9.75	1.83 V	215	25.61	18.64

REMARKS:

1. Emission Level(dBuV/m) = Raw Value(dBuV) + Correction Factor(dB/m)
2. Correction Factor(dB/m) = Antenna Factor(dB/m) + Cable Factor(dB) – Pre-Amplifier Factor(dB)
3. The other emission levels were very low against the limit.
4. Margin value = Emission Level – Limit value
5. " * ": Fundamental frequency.
6. " # ": The radiated frequency is out of the restricted band.

CHANNEL	TX Channel 48	DETECTOR FUNCTION	Peak (PK)
FREQUENCY RANGE	1GHz ~ 40GHz		Average (AV)

ANTENNA POLARITY & TEST DISTANCE: HORIZONTAL AT 3 M

NO.	FREQ. (MHz)	EMISSION LEVEL (dBuV/m)	LIMIT (dBuV/m)	MARGIN (dB)	ANTENNA HEIGHT (m)	TABLE ANGLE (Degree)	RAW VALUE (dBuV)	CORRECTION FACTOR (dB/m)
1	*5240.00	109.61 PK			1.04 H	25	101.46	8.15
2	*5240.00	96.94 AV			1.04 H	25	88.79	8.15
3	5350.00	46.84 PK	74.00	-27.16	1.04 H	25	38.26	8.58
4	5350.00	33.61 AV	54.00	-20.39	1.04 H	25	25.03	8.58

ANTENNA POLARITY & TEST DISTANCE: VERTICAL AT 3 M

NO.	FREQ. (MHz)	EMISSION LEVEL (dBuV/m)	LIMIT (dBuV/m)	MARGIN (dB)	ANTENNA HEIGHT (m)	TABLE ANGLE (Degree)	RAW VALUE (dBuV)	CORRECTION FACTOR (dB/m)
1	*5240.00	123.03 PK			1.86 V	14	114.88	8.15
2	*5240.00	110.83 AV			1.86 V	14	102.68	8.15
3	5350.00	59.27 PK	74.00	-14.73	1.86 V	14	50.69	8.58
4	5350.00	45.78 AV	54.00	-8.22	1.86 V	14	37.20	8.58
5	#10480.00	58.82 PK	74.00	-15.18	2.17 V	78	39.86	18.96
6	#10480.00	44.64 AV	54.00	-9.36	2.17 V	78	25.68	18.96

REMARKS:

1. Emission Level(dBuV/m) = Raw Value(dBuV) + Correction Factor(dB/m)
2. Correction Factor(dB/m) = Antenna Factor(dB/m) + Cable Factor(dB) – Pre-Amplifier Factor(dB)
3. The other emission levels were very low against the limit.
4. Margin value = Emission Level – Limit value
5. " * ": Fundamental frequency.
6. " # ": The radiated frequency is out of the restricted band.

CHANNEL	TX Channel 149	DETECTOR FUNCTION	Peak (PK)
FREQUENCY RANGE	1GHz ~ 40GHz		Average (AV)

ANTENNA POLARITY & TEST DISTANCE: HORIZONTAL AT 3 M

NO.	FREQ. (MHz)	EMISSION LEVEL (dBuV/m)	LIMIT (dBuV/m)	MARGIN (dB)	ANTENNA HEIGHT (m)	TABLE ANGLE (Degree)	RAW VALUE (dBuV)	CORRECTION FACTOR (dB/m)
1	#5606.09	63.16 PK	68.20	-5.04	1.06 H	41	53.82	9.34
2	*5745.00	103.07 PK			1.06 H	41	93.68	9.39
3	*5745.00	91.88 AV			1.06 H	41	82.49	9.39
4	#5959.96	64.81 PK	68.20	-3.39	1.06 H	41	54.93	9.88
5	11490.00	59.06 PK	74.00	-14.94	1.85 H	225	38.97	20.09
6	11490.00	45.01 AV	54.00	-8.99	1.85 H	225	24.92	20.09

ANTENNA POLARITY & TEST DISTANCE: VERTICAL AT 3 M

NO.	FREQ. (MHz)	EMISSION LEVEL (dBuV/m)	LIMIT (dBuV/m)	MARGIN (dB)	ANTENNA HEIGHT (m)	TABLE ANGLE (Degree)	RAW VALUE (dBuV)	CORRECTION FACTOR (dB/m)
1	#5634.53	63.38 PK	68.20	-4.82	1.89 V	14	54.02	9.36
2	*5745.00	119.28 PK			1.89 V	14	109.89	9.39
3	*5745.00	108.15 AV			1.89 V	14	98.76	9.39
4	#5971.92	63.93 PK	68.20	-4.27	1.89 V	14	54.00	9.93
5	11490.00	60.05 PK	74.00	-13.95	2.18 V	318	39.96	20.09
6	11490.00	45.45 AV	54.00	-8.55	2.18 V	318	25.36	20.09

REMARKS:

1. Emission Level(dBuV/m) = Raw Value(dBuV) + Correction Factor(dB/m)
2. Correction Factor(dB/m) = Antenna Factor(dB/m) + Cable Factor(dB) – Pre-Amplifier Factor(dB)
3. The other emission levels were very low against the limit.
4. Margin value = Emission Level – Limit value
5. " * ": Fundamental frequency.
6. " # ": The radiated frequency is out of the restricted band.

CHANNEL	TX Channel 157	DETECTOR FUNCTION	Peak (PK)
FREQUENCY RANGE	1GHz ~ 40GHz		Average (AV)

ANTENNA POLARITY & TEST DISTANCE: HORIZONTAL AT 3 M

NO.	FREQ. (MHz)	EMISSION LEVEL (dBuV/m)	LIMIT (dBuV/m)	MARGIN (dB)	ANTENNA HEIGHT (m)	TABLE ANGLE (Degree)	RAW VALUE (dBuV)	CORRECTION FACTOR (dB/m)
1	#5597.31	63.25 PK	68.20	-4.95	1.04 H	19	53.90	9.35
2	*5785.00	104.87 PK			1.04 H	19	95.46	9.41
3	*5785.00	92.97 AV			1.04 H	19	83.56	9.41
4	#6005.49	63.68 PK	68.20	-4.52	1.04 H	19	53.62	10.06
5	11570.00	58.72 PK	74.00	-15.28	2.71 H	37	38.43	20.29
6	11570.00	44.56 AV	54.00	-9.44	2.71 H	37	24.27	20.29

ANTENNA POLARITY & TEST DISTANCE: VERTICAL AT 3 M

NO.	FREQ. (MHz)	EMISSION LEVEL (dBuV/m)	LIMIT (dBuV/m)	MARGIN (dB)	ANTENNA HEIGHT (m)	TABLE ANGLE (Degree)	RAW VALUE (dBuV)	CORRECTION FACTOR (dB/m)
1	#5595.04	62.97 PK	68.20	-5.23	2.03 V	15	53.63	9.34
2	*5785.00	118.97 PK			2.03 V	15	109.56	9.41
3	*5785.00	107.07 AV			2.03 V	15	97.66	9.41
4	#6004.02	63.85 PK	68.20	-4.35	2.03 V	15	53.80	10.05
5	11570.00	60.14 PK	74.00	-13.86	1.48 V	184	39.85	20.29
6	11570.00	46.06 AV	54.00	-7.94	1.48 V	184	25.77	20.29

REMARKS:

- Emission Level(dBuV/m) = Raw Value(dBuV) + Correction Factor(dB/m)
- Correction Factor(dB/m) = Antenna Factor(dB/m) + Cable Factor(dB) – Pre-Amplifier Factor(dB)
- The other emission levels were very low against the limit.
- Margin value = Emission Level – Limit value
- " * ": Fundamental frequency.
- " # ": The radiated frequency is out of the restricted band.

CHANNEL	TX Channel 165	DETECTOR FUNCTION	Peak (PK)
FREQUENCY RANGE	1GHz ~ 40GHz		Average (AV)

ANTENNA POLARITY & TEST DISTANCE: HORIZONTAL AT 3 M

NO.	FREQ. (MHz)	EMISSION LEVEL (dBuV/m)	LIMIT (dBuV/m)	MARGIN (dB)	ANTENNA HEIGHT (m)	TABLE ANGLE (Degree)	RAW VALUE (dBuV)	CORRECTION FACTOR (dB/m)
1	#5609.20	63.45 PK	68.20	-4.75	1.06 H	26	54.11	9.34
2	*5825.00	103.01 PK			1.06 H	26	93.54	9.47
3	*5825.00	92.01 AV			1.06 H	26	82.54	9.47
4	#5980.55	64.41 PK	68.20	-3.79	1.06 H	26	54.46	9.95
5	11650.00	58.96 PK	74.00	-15.04	1.99 H	274	38.64	20.32
6	11650.00	44.68 AV	54.00	-9.32	1.99 H	274	24.36	20.32

ANTENNA POLARITY & TEST DISTANCE: VERTICAL AT 3 M

NO.	FREQ. (MHz)	EMISSION LEVEL (dBuV/m)	LIMIT (dBuV/m)	MARGIN (dB)	ANTENNA HEIGHT (m)	TABLE ANGLE (Degree)	RAW VALUE (dBuV)	CORRECTION FACTOR (dB/m)
1	#5603.03	64.55 PK	68.20	-3.65	2.07 V	13	55.21	9.34
2	*5825.00	118.12 PK			2.07 V	13	108.65	9.47
3	*5825.00	106.09 AV			2.07 V	13	96.62	9.47
4	#6022.98	63.84 PK	68.20	-4.36	2.07 V	13	53.65	10.19
5	11650.00	60.16 PK	74.00	-13.84	2.36 V	291	39.84	20.32
6	11650.00	45.94 AV	54.00	-8.06	2.36 V	291	25.62	20.32

REMARKS:

1. Emission Level(dBuV/m) = Raw Value(dBuV) + Correction Factor(dB/m)
2. Correction Factor(dB/m) = Antenna Factor(dB/m) + Cable Factor(dB) – Pre-Amplifier Factor(dB)
3. The other emission levels were very low against the limit.
4. Margin value = Emission Level – Limit value
5. " * ": Fundamental frequency.
6. " # ": The radiated frequency is out of the restricted band.

802.11n (40MHz)

CHANNEL	TX Channel 38	DETECTOR FUNCTION	Peak (PK)
FREQUENCY RANGE	1GHz ~ 40GHz		Average (AV)

ANTENNA POLARITY & TEST DISTANCE: HORIZONTAL AT 3 M

NO.	FREQ. (MHz)	EMISSION LEVEL (dBuV/m)	LIMIT (dBuV/m)	MARGIN (dB)	ANTENNA HEIGHT (m)	TABLE ANGLE (Degree)	RAW VALUE (dBuV)	CORRECTION FACTOR (dB/m)
1	5150.00	62.00 PK	74.00	-12.00	1.00 H	21	54.20	7.80
2	5150.00	46.89 AV	54.00	-7.11	1.00 H	21	39.09	7.80
3	*5190.00	102.12 PK			1.00 H	21	94.15	7.97
4	*5190.00	90.11 AV			1.00 H	21	82.14	7.97
5	#10380.00	57.34 PK	74.00	-16.66	1.96 H	196	38.78	18.56
6	#10380.00	43.19 AV	54.00	-10.81	1.96 H	196	24.63	18.56

ANTENNA POLARITY & TEST DISTANCE: VERTICAL AT 3 M

NO.	FREQ. (MHz)	EMISSION LEVEL (dBuV/m)	LIMIT (dBuV/m)	MARGIN (dB)	ANTENNA HEIGHT (m)	TABLE ANGLE (Degree)	RAW VALUE (dBuV)	CORRECTION FACTOR (dB/m)
1	5150.00	69.17 PK	74.00	-4.83	1.88 V	7	61.37	7.80
2	5150.00	52.94 AV	54.00	-1.06	1.88 V	7	45.14	7.80
3	*5190.00	120.43 PK			1.88 V	7	112.46	7.97
4	*5190.00	107.04 AV			1.88 V	7	99.07	7.97
5	#10380.00	58.18 PK	74.00	-15.82	1.52 V	284	39.62	18.56
6	#10380.00	43.69 AV	54.00	-10.31	1.52 V	284	25.13	18.56

REMARKS:

1. Emission Level(dBuV/m) = Raw Value(dBuV) + Correction Factor(dB/m)
2. Correction Factor(dB/m) = Antenna Factor(dB/m) + Cable Factor(dB) – Pre-Amplifier Factor(dB)
3. The other emission levels were very low against the limit.
4. Margin value = Emission Level – Limit value
5. " * ": Fundamental frequency.
6. " # ": The radiated frequency is out of the restricted band.

CHANNEL	TX Channel 46	DETECTOR FUNCTION	Peak (PK)
FREQUENCY RANGE	1GHz ~ 40GHz		Average (AV)

ANTENNA POLARITY & TEST DISTANCE: HORIZONTAL AT 3 M

NO.	FREQ. (MHz)	EMISSION LEVEL (dBuV/m)	LIMIT (dBuV/m)	MARGIN (dB)	ANTENNA HEIGHT (m)	TABLE ANGLE (Degree)	RAW VALUE (dBuV)	CORRECTION FACTOR (dB/m)
1	*5230.00	106.77 PK			1.00 H	25	98.65	8.12
2	*5230.00	89.58 AV			1.00 H	25	81.46	8.12
3	5350.00	60.74 PK	74.00	-13.26	1.00 H	25	52.16	8.58
4	5350.00	47.21 AV	54.00	-6.79	1.00 H	25	38.63	8.58
5	#10460.00	57.36 PK	74.00	-16.64	1.74 H	41	38.49	18.87
6	#10460.00	43.07 AV	54.00	-10.93	1.74 H	41	24.20	18.87

ANTENNA POLARITY & TEST DISTANCE: VERTICAL AT 3 M

NO.	FREQ. (MHz)	EMISSION LEVEL (dBuV/m)	LIMIT (dBuV/m)	MARGIN (dB)	ANTENNA HEIGHT (m)	TABLE ANGLE (Degree)	RAW VALUE (dBuV)	CORRECTION FACTOR (dB/m)
1	*5230.00	119.66 PK			1.97 V	0	111.54	8.12
2	*5230.00	107.42 AV			1.97 V	0	99.30	8.12
3	5350.00	63.16 PK	74.00	-10.84	1.97 V	359	54.58	8.58
4	5350.00	48.51 AV	54.00	-5.49	1.97 V	359	39.93	8.58
5	#10460.00	58.77 PK	74.00	-15.23	1.28 V	341	39.90	18.87
6	#10460.00	44.02 AV	54.00	-9.98	1.28 V	341	25.15	18.87

REMARKS:

1. Emission Level(dBuV/m) = Raw Value(dBuV) + Correction Factor(dB/m)
2. Correction Factor(dB/m) = Antenna Factor(dB/m) + Cable Factor(dB) – Pre-Amplifier Factor(dB)
3. The other emission levels were very low against the limit.
4. Margin value = Emission Level – Limit value
5. " * ": Fundamental frequency.
6. " # ": The radiated frequency is out of the restricted band.

CHANNEL	TX Channel 151	DETECTOR FUNCTION	Peak (PK)
FREQUENCY RANGE	1GHz ~ 40GHz		Average (AV)

ANTENNA POLARITY & TEST DISTANCE: HORIZONTAL AT 3 M

NO.	FREQ. (MHz)	EMISSION LEVEL (dBuV/m)	LIMIT (dBuV/m)	MARGIN (dB)	ANTENNA HEIGHT (m)	TABLE ANGLE (Degree)	RAW VALUE (dBuV)	CORRECTION FACTOR (dB/m)
1	#5630.93	63.50 PK	68.20	-4.70	1.08 H	19	54.15	9.35
2	*5755.00	105.66 PK			1.08 H	19	96.26	9.40
3	*5755.00	95.86 AV			1.08 H	19	86.46	9.40
4	#5928.14	63.31 PK	68.20	-4.89	1.08 H	19	53.55	9.76
5	11510.00	58.60 PK	74.00	-15.40	2.36 H	201	38.49	20.11
6	11510.00	44.50 AV	54.00	-9.50	2.36 H	201	24.39	20.11

ANTENNA POLARITY & TEST DISTANCE: VERTICAL AT 3 M

NO.	FREQ. (MHz)	EMISSION LEVEL (dBuV/m)	LIMIT (dBuV/m)	MARGIN (dB)	ANTENNA HEIGHT (m)	TABLE ANGLE (Degree)	RAW VALUE (dBuV)	CORRECTION FACTOR (dB/m)
1	#5640.89	65.88 PK	68.20	-2.32	2.02 V	4	56.52	9.36
2	*5755.00	116.29 PK			2.02 V	4	106.89	9.40
3	*5755.00	106.18 AV			2.02 V	4	96.78	9.40
4	#5925.53	63.41 PK	68.20	-4.79	2.02 V	4	53.65	9.76

REMARKS:

1. Emission Level(dBuV/m) = Raw Value(dBuV) + Correction Factor(dB/m)
2. Correction Factor(dB/m) = Antenna Factor(dB/m) + Cable Factor(dB) – Pre-Amplifier Factor(dB)
3. The other emission levels were very low against the limit.
4. Margin value = Emission Level – Limit value
5. " * ": Fundamental frequency.
6. " # ": The radiated frequency is out of the restricted band.

CHANNEL	TX Channel 159	DETECTOR FUNCTION	Peak (PK)
FREQUENCY RANGE	1GHz ~ 40GHz		Average (AV)

ANTENNA POLARITY & TEST DISTANCE: HORIZONTAL AT 3 M

NO.	FREQ. (MHz)	EMISSION LEVEL (dBuV/m)	LIMIT (dBuV/m)	MARGIN (dB)	ANTENNA HEIGHT (m)	TABLE ANGLE (Degree)	RAW VALUE (dBuV)	CORRECTION FACTOR (dB/m)
1	#5626.08	62.69 PK	68.20	-5.51	1.07 H	12	53.34	9.35
2	*5795.00	104.83 PK			1.07 H	12	95.41	9.42
3	*5795.00	93.79 AV			1.07 H	12	84.37	9.42
4	#5993.96	62.56 PK	68.20	-5.64	1.07 H	12	52.55	10.01
5	11590.00	59.08 PK	74.00	-14.92	1.48 H	330	38.74	20.34
6	11590.00	44.54 AV	54.00	-9.46	1.48 H	330	24.20	20.34

ANTENNA POLARITY & TEST DISTANCE: VERTICAL AT 3 M

NO.	FREQ. (MHz)	EMISSION LEVEL (dBuV/m)	LIMIT (dBuV/m)	MARGIN (dB)	ANTENNA HEIGHT (m)	TABLE ANGLE (Degree)	RAW VALUE (dBuV)	CORRECTION FACTOR (dB/m)
1	#5646.53	64.12 PK	68.20	-4.08	2.08 V	4	54.76	9.36
2	*5795.00	116.31 PK			2.08 V	4	106.89	9.42
3	*5795.00	105.74 AV			2.08 V	4	96.32	9.42
4	#6017.45	63.93 PK	68.20	-4.27	2.08 V	4	53.78	10.15
5	11590.00	59.92 PK	74.00	-14.08	2.28 V	347	39.58	20.34
6	11590.00	45.52 AV	54.00	-8.48	2.28 V	347	25.18	20.34

REMARKS:

1. Emission Level(dBuV/m) = Raw Value(dBuV) + Correction Factor(dB/m)
2. Correction Factor(dB/m) = Antenna Factor(dB/m) + Cable Factor(dB) – Pre-Amplifier Factor(dB)
3. The other emission levels were very low against the limit.
4. Margin value = Emission Level – Limit value
5. " * ": Fundamental frequency.
6. " # ": The radiated frequency is out of the restricted band.

802.11ac (80MHz)

CHANNEL	TX Channel 42	DETECTOR FUNCTION	Peak (PK)
FREQUENCY RANGE	1GHz ~ 40GHz		Average (AV)

ANTENNA POLARITY & TEST DISTANCE: HORIZONTAL AT 3 M

NO.	FREQ. (MHz)	EMISSION LEVEL (dBuV/m)	LIMIT (dBuV/m)	MARGIN (dB)	ANTENNA HEIGHT (m)	TABLE ANGLE (Degree)	RAW VALUE (dBuV)	CORRECTION FACTOR (dB/m)
1	5150.00	59.53 PK	74.00	-14.47	1.00 H	5	51.73	7.80
2	5150.00	46.15 AV	54.00	-7.85	1.00 H	5	38.35	7.80
3	*5210.00	96.34 PK			1.00 H	5	88.29	8.05
4	*5210.00	85.84 AV			1.00 H	5	77.79	8.05
5	5350.00	59.27 PK	74.00	-14.73	1.00 H	5	50.69	8.58
6	5350.00	45.39 AV	54.00	-8.61	1.00 H	5	36.81	8.58
7	#10420.00	57.13 PK	74.00	-16.87	1.88 H	234	38.41	18.72
8	#10420.00	42.95 AV	54.00	-11.05	1.88 H	234	24.23	18.72

ANTENNA POLARITY & TEST DISTANCE: VERTICAL AT 3 M

NO.	FREQ. (MHz)	EMISSION LEVEL (dBuV/m)	LIMIT (dBuV/m)	MARGIN (dB)	ANTENNA HEIGHT (m)	TABLE ANGLE (Degree)	RAW VALUE (dBuV)	CORRECTION FACTOR (dB/m)
1	5150.00	67.26 PK	74.00	-6.74	1.78 V	0	59.46	7.80
2	5150.00	52.92 AV	54.00	-1.08	1.78 V	0	45.12	7.80
3	*5210.00	111.66 PK			1.78 V	0	103.61	8.05
4	*5210.00	100.22 AV			1.78 V	0	92.17	8.05
5	5350.00	60.63 PK	74.00	-13.37	1.78 V	0	52.05	8.58
6	5350.00	46.82 AV	54.00	-7.18	1.78 V	0	38.24	8.58
7	#10420.00	58.42 PK	74.00	-15.58	1.67 V	288	39.70	18.72
8	#10420.00	44.53 AV	54.00	-9.47	1.67 V	288	25.81	18.72

REMARKS:

1. Emission Level(dBuV/m) = Raw Value(dBuV) + Correction Factor(dB/m)
2. Correction Factor(dB/m) = Antenna Factor(dB/m) + Cable Factor(dB) – Pre-Amplifier Factor(dB)
3. The other emission levels were very low against the limit.
4. Margin value = Emission Level – Limit value
5. " * ": Fundamental frequency.
6. " # ": The radiated frequency is out of the restricted band.

CHANNEL	TX Channel 155	DETECTOR FUNCTION	Peak (PK)
FREQUENCY RANGE	1GHz ~ 40GHz		Average (AV)

ANTENNA POLARITY & TEST DISTANCE: HORIZONTAL AT 3 M

NO.	FREQ. (MHz)	EMISSION LEVEL (dBuV/m)	LIMIT (dBuV/m)	MARGIN (dB)	ANTENNA HEIGHT (m)	TABLE ANGLE (Degree)	RAW VALUE (dBuV)	CORRECTION FACTOR (dB/m)
1	#5634.27	63.31 PK	68.20	-4.89	1.10 H	28	53.95	9.36
2	*5775.00	98.39 PK			1.10 H	28	88.98	9.41
3	*5775.00	89.05 AV			1.10 H	28	79.64	9.41
4	#6014.17	63.25 PK	68.20	-4.95	1.10 H	28	53.12	10.13
5	11550.00	58.69 PK	74.00	-15.31	1.42 H	208	38.47	20.22
6	11550.00	44.41 AV	54.00	-9.59	1.42 H	208	24.19	20.22

ANTENNA POLARITY & TEST DISTANCE: VERTICAL AT 3 M

NO.	FREQ. (MHz)	EMISSION LEVEL (dBuV/m)	LIMIT (dBuV/m)	MARGIN (dB)	ANTENNA HEIGHT (m)	TABLE ANGLE (Degree)	RAW VALUE (dBuV)	CORRECTION FACTOR (dB/m)
1	#5639.42	66.76 PK	68.20	-1.44	2.08 V	4	57.40	9.36
2	*5775.00	108.10 PK			2.08 V	4	98.69	9.41
3	*5775.00	98.15 AV			2.08 V	4	88.74	9.41
4	#5931.34	65.09 PK	68.20	-3.11	2.08 V	4	55.31	9.78
5	11550.00	60.03 PK	74.00	-13.97	1.77 V	124	39.81	20.22
6	11550.00	46.10 AV	54.00	-7.90	1.77 V	124	25.88	20.22

REMARKS:

1. Emission Level(dBuV/m) = Raw Value(dBuV) + Correction Factor(dB/m)
2. Correction Factor(dB/m) = Antenna Factor(dB/m) + Cable Factor(dB) – Pre-Amplifier Factor(dB)
3. The other emission levels were very low against the limit.
4. Margin value = Emission Level – Limit value
5. " * ": Fundamental frequency.
6. " # ": The radiated frequency is out of the restricted band.

Beamforming_NSS1 Mode (Mode A)

802.11ac (20MHz)

CHANNEL	TX Channel 36	DETECTOR FUNCTION	Peak (PK)
FREQUENCY RANGE	1GHz ~ 40GHz		Average (AV)

ANTENNA POLARITY & TEST DISTANCE: HORIZONTAL AT 3 M

NO.	FREQ. (MHz)	EMISSION LEVEL (dBuV/m)	LIMIT (dBuV/m)	MARGIN (dB)	ANTENNA HEIGHT (m)	TABLE ANGLE (Degree)	RAW VALUE (dBuV)	CORRECTION FACTOR (dB/m)
1	5150.00	59.17 PK	74.00	-14.83	1.69 H	182	53.23	5.94
2	5150.00	46.75 AV	54.00	-7.25	1.69 H	182	40.81	5.94
3	*5180.00	107.06 PK			1.69 H	182	101.03	6.03
4	*5180.00	94.92 AV			1.69 H	182	88.89	6.03
5	#10360.00	55.43 PK	74.00	-18.57	1.11 H	261	39.33	16.10
6	#10360.00	41.22 AV	54.00	-12.78	1.11 H	261	25.12	16.10

ANTENNA POLARITY & TEST DISTANCE: VERTICAL AT 3 M

NO.	FREQ. (MHz)	EMISSION LEVEL (dBuV/m)	LIMIT (dBuV/m)	MARGIN (dB)	ANTENNA HEIGHT (m)	TABLE ANGLE (Degree)	RAW VALUE (dBuV)	CORRECTION FACTOR (dB/m)
1	5150.00	63.80 PK	74.00	-10.20	2.66 V	44	57.86	5.94
2	5150.00	47.05 AV	54.00	-6.95	2.66 V	44	41.11	5.94
3	*5180.00	118.67 PK			2.66 V	44	112.64	6.03
4	*5180.00	105.51 AV			2.66 V	44	99.48	6.03
5	#10360.00	56.35 PK	74.00	-17.65	1.95 V	234	40.25	16.10
6	#10360.00	42.44 AV	54.00	-11.56	1.95 V	234	26.34	16.10

REMARKS:

1. Emission Level(dBuV/m) = Raw Value(dBuV) + Correction Factor(dB/m)
2. Correction Factor(dB/m) = Antenna Factor(dB/m) + Cable Factor(dB) – Pre-Amplifier Factor(dB)
3. The other emission levels were very low against the limit.
4. Margin value = Emission Level – Limit value
5. " * ": Fundamental frequency.
6. " # ": The radiated frequency is out of the restricted band.

CHANNEL	TX Channel 40	DETECTOR FUNCTION	Peak (PK)
FREQUENCY RANGE	1GHz ~ 40GHz		Average (AV)

ANTENNA POLARITY & TEST DISTANCE: HORIZONTAL AT 3 M

NO.	FREQ. (MHz)	EMISSION LEVEL (dBuV/m)	LIMIT (dBuV/m)	MARGIN (dB)	ANTENNA HEIGHT (m)	TABLE ANGLE (Degree)	RAW VALUE (dBuV)	CORRECTION FACTOR (dB/m)
1	*5200.00	107.52 PK			1.52 H	175	101.41	6.11
2	*5200.00	94.14 AV			1.52 H	175	88.03	6.11
3	#10400.00	55.48 PK	74.00	-18.52	1.99 H	182	39.22	16.26
4	#10400.00	41.39 AV	54.00	-12.61	1.99 H	182	25.13	16.26

ANTENNA POLARITY & TEST DISTANCE: VERTICAL AT 3 M

NO.	FREQ. (MHz)	EMISSION LEVEL (dBuV/m)	LIMIT (dBuV/m)	MARGIN (dB)	ANTENNA HEIGHT (m)	TABLE ANGLE (Degree)	RAW VALUE (dBuV)	CORRECTION FACTOR (dB/m)
1	*5200.00	119.07 PK			2.43 V	48	112.96	6.11
2	*5200.00	105.38 AV			2.43 V	48	99.27	6.11
3	#10400.00	56.81 PK	74.00	-17.19	1.52 V	241	40.55	16.26
4	#10400.00	42.65 AV	54.00	-11.35	1.52 V	241	26.39	16.26

REMARKS:

1. Emission Level(dBuV/m) = Raw Value(dBuV) + Correction Factor(dB/m)
2. Correction Factor(dB/m) = Antenna Factor(dB/m) + Cable Factor(dB) – Pre-Amplifier Factor(dB)
3. The other emission levels were very low against the limit.
4. Margin value = Emission Level – Limit value
5. " * ": Fundamental frequency.
6. " # ": The radiated frequency is out of the restricted band.

CHANNEL	TX Channel 48	DETECTOR FUNCTION	Peak (PK)
FREQUENCY RANGE	1GHz ~ 40GHz		Average (AV)

ANTENNA POLARITY & TEST DISTANCE: HORIZONTAL AT 3 M

NO.	FREQ. (MHz)	EMISSION LEVEL (dBuV/m)	LIMIT (dBuV/m)	MARGIN (dB)	ANTENNA HEIGHT (m)	TABLE ANGLE (Degree)	RAW VALUE (dBuV)	CORRECTION FACTOR (dB/m)
1	*5240.00	108.30 PK			1.55 H	179	102.03	6.27
2	*5240.00	95.39 AV			1.55 H	179	89.12	6.27
3	5350.00	58.63 PK	74.00	-15.37	1.55 H	179	51.88	6.75
4	5350.00	44.98 AV	54.00	-9.02	1.55 H	179	38.23	6.75
5	#10480.00	56.35 PK	74.00	-17.65	1.57 H	201	39.88	16.47
6	#10480.00	41.70 AV	54.00	-12.30	1.57 H	201	25.23	16.47

ANTENNA POLARITY & TEST DISTANCE: VERTICAL AT 3 M

NO.	FREQ. (MHz)	EMISSION LEVEL (dBuV/m)	LIMIT (dBuV/m)	MARGIN (dB)	ANTENNA HEIGHT (m)	TABLE ANGLE (Degree)	RAW VALUE (dBuV)	CORRECTION FACTOR (dB/m)
1	*5240.00	119.29 PK			2.51 V	50	113.02	6.27
2	*5240.00	106.06 AV			2.51 V	50	99.79	6.27
3	5350.00	59.04 PK	74.00	-14.96	2.51 V	50	52.29	6.75
4	5350.00	45.46 AV	54.00	-8.54	2.51 V	50	38.71	6.75
5	#10480.00	57.01 PK	74.00	-16.99	1.18 V	236	40.54	16.47
6	#10480.00	43.01 AV	54.00	-10.99	1.18 V	236	26.54	16.47

REMARKS:

1. Emission Level(dBuV/m) = Raw Value(dBuV) + Correction Factor(dB/m)
2. Correction Factor(dB/m) = Antenna Factor(dB/m) + Cable Factor(dB) – Pre-Amplifier Factor(dB)
3. The other emission levels were very low against the limit.
4. Margin value = Emission Level – Limit value
5. " * ": Fundamental frequency.
6. " # ": The radiated frequency is out of the restricted band.

CHANNEL	TX Channel 149	DETECTOR FUNCTION	Peak (PK)
FREQUENCY RANGE	1GHz ~ 40GHz		Average (AV)

ANTENNA POLARITY & TEST DISTANCE: HORIZONTAL AT 3 M

NO.	FREQ. (MHz)	EMISSION LEVEL (dBuV/m)	LIMIT (dBuV/m)	MARGIN (dB)	ANTENNA HEIGHT (m)	TABLE ANGLE (Degree)	RAW VALUE (dBuV)	CORRECTION FACTOR (dB/m)
1	#5609.52	61.51 PK	68.20	-6.69	1.37 H	178	54.14	7.37
2	*5745.00	105.02 PK			1.37 H	178	97.63	7.39
3	*5745.00	90.28 AV			1.37 H	178	82.89	7.39
4	#5960.97	62.93 PK	68.20	-5.27	1.37 H	178	54.96	7.97
5	11490.00	56.48 PK	74.00	-17.52	1.69 H	205	39.28	17.20
6	11490.00	42.39 AV	54.00	-11.61	1.69 H	205	25.19	17.20

ANTENNA POLARITY & TEST DISTANCE: VERTICAL AT 3 M

NO.	FREQ. (MHz)	EMISSION LEVEL (dBuV/m)	LIMIT (dBuV/m)	MARGIN (dB)	ANTENNA HEIGHT (m)	TABLE ANGLE (Degree)	RAW VALUE (dBuV)	CORRECTION FACTOR (dB/m)
1	#5606.60	62.70 PK	68.20	-5.50	2.65 V	280	55.33	7.37
2	*5745.00	115.27 PK			2.65 V	280	107.88	7.39
3	*5745.00	100.60 AV			2.65 V	280	93.21	7.39
4	#6010.35	62.32 PK	68.20	-5.88	2.65 V	280	54.12	8.20
5	11490.00	57.48 PK	74.00	-16.52	2.13 V	152	40.28	17.20
6	11490.00	44.04 AV	54.00	-9.96	2.13 V	152	26.84	17.20

REMARKS:

1. Emission Level(dBuV/m) = Raw Value(dBuV) + Correction Factor(dB/m)
2. Correction Factor(dB/m) = Antenna Factor(dB/m) + Cable Factor(dB) – Pre-Amplifier Factor(dB)
3. The other emission levels were very low against the limit.
4. Margin value = Emission Level – Limit value
5. " * ": Fundamental frequency.
6. " # ": The radiated frequency is out of the restricted band.

CHANNEL	TX Channel 157	DETECTOR FUNCTION	Peak (PK)
FREQUENCY RANGE	1GHz ~ 40GHz		Average (AV)

ANTENNA POLARITY & TEST DISTANCE: HORIZONTAL AT 3 M

NO.	FREQ. (MHz)	EMISSION LEVEL (dBuV/m)	LIMIT (dBuV/m)	MARGIN (dB)	ANTENNA HEIGHT (m)	TABLE ANGLE (Degree)	RAW VALUE (dBuV)	CORRECTION FACTOR (dB/m)
1	#5624.41	61.75 PK	68.20	-6.45	1.42 H	169	54.38	7.37
2	*5785.00	104.71 PK			1.42 H	169	97.28	7.43
3	*5785.00	90.22 AV			1.42 H	169	82.79	7.43
4	#6019.25	63.76 PK	68.20	-4.44	1.42 H	169	55.51	8.25
5	11570.00	56.45 PK	74.00	-17.55	1.58 H	241	39.19	17.26
6	11570.00	43.07 AV	54.00	-10.93	1.58 H	241	25.81	17.26

ANTENNA POLARITY & TEST DISTANCE: VERTICAL AT 3 M

NO.	FREQ. (MHz)	EMISSION LEVEL (dBuV/m)	LIMIT (dBuV/m)	MARGIN (dB)	ANTENNA HEIGHT (m)	TABLE ANGLE (Degree)	RAW VALUE (dBuV)	CORRECTION FACTOR (dB/m)
1	#5643.35	62.85 PK	68.20	-5.35	2.71 V	261	55.49	7.36
2	*5785.00	115.39 PK			2.71 V	261	107.96	7.43
3	*5785.00	100.40 AV			2.71 V	261	92.97	7.43
4	#5938.98	62.74 PK	68.20	-5.46	2.71 V	261	54.87	7.87
5	11570.00	57.77 PK	74.00	-16.23	1.23 V	341	40.51	17.26
6	11570.00	44.13 AV	54.00	-9.87	1.23 V	341	26.87	17.26

REMARKS:

1. Emission Level(dBuV/m) = Raw Value(dBuV) + Correction Factor(dB/m)
2. Correction Factor(dB/m) = Antenna Factor(dB/m) + Cable Factor(dB) – Pre-Amplifier Factor(dB)
3. The other emission levels were very low against the limit.
4. Margin value = Emission Level – Limit value
5. " * ": Fundamental frequency.
6. " # ": The radiated frequency is out of the restricted band.

CHANNEL	TX Channel 165	DETECTOR FUNCTION	Peak (PK)
FREQUENCY RANGE	1GHz ~ 40GHz		Average (AV)

ANTENNA POLARITY & TEST DISTANCE: HORIZONTAL AT 3 M

NO.	FREQ. (MHz)	EMISSION LEVEL (dBuV/m)	LIMIT (dBuV/m)	MARGIN (dB)	ANTENNA HEIGHT (m)	TABLE ANGLE (Degree)	RAW VALUE (dBuV)	CORRECTION FACTOR (dB/m)
1	#5633.73	62.56 PK	68.20	-5.64	1.66 H	191	55.19	7.37
2	*5825.00	104.54 PK			1.66 H	191	97.03	7.51
3	*5825.00	89.97 AV			1.66 H	191	82.46	7.51
4	#5950.02	62.41 PK	68.20	-5.79	1.66 H	191	54.49	7.92
5	11650.00	56.58 PK	74.00	-17.42	1.55 H	189	39.35	17.23
6	11650.00	42.87 AV	54.00	-11.13	1.55 H	189	25.64	17.23

ANTENNA POLARITY & TEST DISTANCE: VERTICAL AT 3 M

NO.	FREQ. (MHz)	EMISSION LEVEL (dBuV/m)	LIMIT (dBuV/m)	MARGIN (dB)	ANTENNA HEIGHT (m)	TABLE ANGLE (Degree)	RAW VALUE (dBuV)	CORRECTION FACTOR (dB/m)
1	#5624.18	63.45 PK	68.20	-4.75	2.78 V	259	56.08	7.37
2	*5825.00	114.54 PK			2.78 V	259	107.03	7.51
3	*5825.00	99.23 AV			2.78 V	259	91.72	7.51
4	#5967.06	62.87 PK	68.20	-5.33	2.78 V	259	54.88	7.99
5	11650.00	58.07 PK	74.00	-15.93	2.30 V	204	40.84	17.23
6	11650.00	43.90 AV	54.00	-10.10	2.30 V	204	26.67	17.23

REMARKS:

1. Emission Level(dBuV/m) = Raw Value(dBuV) + Correction Factor(dB/m)
2. Correction Factor(dB/m) = Antenna Factor(dB/m) + Cable Factor(dB) – Pre-Amplifier Factor(dB)
3. The other emission levels were very low against the limit.
4. Margin value = Emission Level – Limit value
5. " * ": Fundamental frequency.
6. " # ": The radiated frequency is out of the restricted band.

802.11ac (40MHz)

CHANNEL	TX Channel 38	DETECTOR FUNCTION	Peak (PK)
FREQUENCY RANGE	1GHz ~ 40GHz		Average (AV)

ANTENNA POLARITY & TEST DISTANCE: HORIZONTAL AT 3 M

NO.	FREQ. (MHz)	EMISSION LEVEL (dBuV/m)	LIMIT (dBuV/m)	MARGIN (dB)	ANTENNA HEIGHT (m)	TABLE ANGLE (Degree)	RAW VALUE (dBuV)	CORRECTION FACTOR (dB/m)
1	5150.00	62.30 PK	74.00	-11.70	1.66 H	191	56.36	5.94
2	5150.00	46.07 AV	54.00	-7.93	1.66 H	191	40.13	5.94
3	*5190.00	108.50 PK			1.66 H	191	102.43	6.07
4	*5190.00	97.70 AV			1.66 H	191	91.63	6.07
5	#10380.00	55.55 PK	74.00	-18.45	2.11 H	254	39.36	16.19
6	#10380.00	41.73 AV	54.00	-12.27	2.11 H	254	25.54	16.19

ANTENNA POLARITY & TEST DISTANCE: VERTICAL AT 3 M

NO.	FREQ. (MHz)	EMISSION LEVEL (dBuV/m)	LIMIT (dBuV/m)	MARGIN (dB)	ANTENNA HEIGHT (m)	TABLE ANGLE (Degree)	RAW VALUE (dBuV)	CORRECTION FACTOR (dB/m)
1	5150.00	67.57 PK	74.00	-6.43	2.50 V	42	61.63	5.94
2	5150.00	46.78 AV	54.00	-7.22	2.50 V	42	40.84	5.94
3	*5190.00	118.28 PK			2.50 V	42	112.21	6.07
4	*5190.00	107.16 AV			2.50 V	42	101.09	6.07
5	#10380.00	56.44 PK	74.00	-17.56	1.62 V	273	40.25	16.19
6	#10380.00	42.50 AV	54.00	-11.50	1.62 V	273	26.31	16.19

REMARKS:

1. Emission Level(dBuV/m) = Raw Value(dBuV) + Correction Factor(dB/m)
2. Correction Factor(dB/m) = Antenna Factor(dB/m) + Cable Factor(dB) – Pre-Amplifier Factor(dB)
3. The other emission levels were very low against the limit.
4. Margin value = Emission Level – Limit value
5. " * ": Fundamental frequency.
6. " # ": The radiated frequency is out of the restricted band.

CHANNEL	TX Channel 46	DETECTOR FUNCTION	Peak (PK)
FREQUENCY RANGE	1GHz ~ 40GHz		Average (AV)

ANTENNA POLARITY & TEST DISTANCE: HORIZONTAL AT 3 M

NO.	FREQ. (MHz)	EMISSION LEVEL (dBuV/m)	LIMIT (dBuV/m)	MARGIN (dB)	ANTENNA HEIGHT (m)	TABLE ANGLE (Degree)	RAW VALUE (dBuV)	CORRECTION FACTOR (dB/m)
1	*5230.00	108.09 PK			1.47 H	180	101.86	6.23
2	*5230.00	96.59 AV			1.47 H	180	90.36	6.23
3	5350.00	58.21 PK	74.00	-15.79	1.47 H	180	51.46	6.75
4	5350.00	45.38 AV	54.00	-8.62	1.47 H	180	38.63	6.75
5	#10460.00	55.65 PK	74.00	-18.35	2.15 H	46	39.24	16.41
6	#10460.00	42.22 AV	54.00	-11.78	2.15 H	46	25.81	16.41

ANTENNA POLARITY & TEST DISTANCE: VERTICAL AT 3 M

NO.	FREQ. (MHz)	EMISSION LEVEL (dBuV/m)	LIMIT (dBuV/m)	MARGIN (dB)	ANTENNA HEIGHT (m)	TABLE ANGLE (Degree)	RAW VALUE (dBuV)	CORRECTION FACTOR (dB/m)
1	*5230.00	118.25 PK			2.16 V	49	112.02	6.23
2	*5230.00	106.46 AV			2.16 V	49	100.23	6.23
3	5350.00	58.88 PK	74.00	-15.12	2.16 V	49	52.13	6.75
4	5350.00	45.77 AV	54.00	-8.23	2.16 V	49	39.02	6.75
5	#10460.00	56.98 PK	74.00	-17.02	1.85 V	202	40.57	16.41
6	#10460.00	42.57 AV	54.00	-11.43	1.85 V	202	26.16	16.41

REMARKS:

1. Emission Level(dBuV/m) = Raw Value(dBuV) + Correction Factor(dB/m)
2. Correction Factor(dB/m) = Antenna Factor(dB/m) + Cable Factor(dB) – Pre-Amplifier Factor(dB)
3. The other emission levels were very low against the limit.
4. Margin value = Emission Level – Limit value
5. " * " : Fundamental frequency.
6. " # " : The radiated frequency is out of the restricted band.

CHANNEL	TX Channel 151	DETECTOR FUNCTION	Peak (PK)
FREQUENCY RANGE	1GHz ~ 40GHz		Average (AV)

ANTENNA POLARITY & TEST DISTANCE: HORIZONTAL AT 3 M

NO.	FREQ. (MHz)	EMISSION LEVEL (dBuV/m)	LIMIT (dBuV/m)	MARGIN (dB)	ANTENNA HEIGHT (m)	TABLE ANGLE (Degree)	RAW VALUE (dBuV)	CORRECTION FACTOR (dB/m)
1	#5611.16	62.57 PK	68.20	-5.63	1.42 H	185	55.20	7.37
2	*5755.00	103.11 PK			1.42 H	185	95.71	7.40
3	*5755.00	92.35 AV			1.42 H	185	84.95	7.40
4	#5942.50	61.57 PK	68.20	-6.63	1.42 H	185	53.69	7.88
5	11510.00	56.35 PK	74.00	-17.65	1.63 H	220	39.15	17.20
6	11510.00	42.28 AV	54.00	-11.72	1.63 H	220	25.08	17.20

ANTENNA POLARITY & TEST DISTANCE: VERTICAL AT 3 M

NO.	FREQ. (MHz)	EMISSION LEVEL (dBuV/m)	LIMIT (dBuV/m)	MARGIN (dB)	ANTENNA HEIGHT (m)	TABLE ANGLE (Degree)	RAW VALUE (dBuV)	CORRECTION FACTOR (dB/m)
1	#5620.76	63.08 PK	68.20	-5.12	2.69 V	270	55.71	7.37
2	*5755.00	113.04 PK			2.69 V	270	105.64	7.40
3	*5755.00	102.53 AV			2.69 V	270	95.13	7.40
4	#5975.65	63.09 PK	68.20	-5.11	2.69 V	270	55.07	8.02
5	11510.00	57.65 PK	74.00	-16.35	1.88 V	280	40.45	17.20
6	11510.00	43.86 AV	54.00	-10.14	1.88 V	280	26.66	17.20

REMARKS:

1. Emission Level(dBuV/m) = Raw Value(dBuV) + Correction Factor(dB/m)
2. Correction Factor(dB/m) = Antenna Factor(dB/m) + Cable Factor(dB) – Pre-Amplifier Factor(dB)
3. The other emission levels were very low against the limit.
4. Margin value = Emission Level – Limit value
5. " * ": Fundamental frequency.
6. " # ": The radiated frequency is out of the restricted band.

CHANNEL	TX Channel 159	DETECTOR FUNCTION	Peak (PK)
FREQUENCY RANGE	1GHz ~ 40GHz		Average (AV)

ANTENNA POLARITY & TEST DISTANCE: HORIZONTAL AT 3 M

NO.	FREQ. (MHz)	EMISSION LEVEL (dBuV/m)	LIMIT (dBuV/m)	MARGIN (dB)	ANTENNA HEIGHT (m)	TABLE ANGLE (Degree)	RAW VALUE (dBuV)	CORRECTION FACTOR (dB/m)
1	#5614.28	61.47 PK	68.20	-6.73	1.66 H	158	54.10	7.37
2	*5795.00	103.01 PK			1.66 H	158	95.56	7.45
3	*5795.00	92.40 AV			1.66 H	158	84.95	7.45
4	#5974.85	62.05 PK	68.20	-6.15	1.66 H	158	54.03	8.02
5	11590.00	56.90 PK	74.00	-17.10	1.93 H	174	39.63	17.27
6	11590.00	42.35 AV	54.00	-11.65	1.93 H	174	25.08	17.27

ANTENNA POLARITY & TEST DISTANCE: VERTICAL AT 3 M

NO.	FREQ. (MHz)	EMISSION LEVEL (dBuV/m)	LIMIT (dBuV/m)	MARGIN (dB)	ANTENNA HEIGHT (m)	TABLE ANGLE (Degree)	RAW VALUE (dBuV)	CORRECTION FACTOR (dB/m)
1	#5645.15	63.29 PK	68.20	-4.91	1.99 V	269	55.93	7.36
2	*5795.00	113.27 PK			1.99 V	269	105.82	7.45
3	*5795.00	102.58 AV			1.99 V	269	95.13	7.45
4	#6001.21	62.88 PK	68.20	-5.32	1.99 V	269	54.75	8.13
5	11590.00	58.11 PK	74.00	-15.89	2.18 V	258	40.84	17.27
6	11590.00	44.12 AV	54.00	-9.88	2.18 V	258	26.85	17.27

REMARKS:

1. Emission Level(dBuV/m) = Raw Value(dBuV) + Correction Factor(dB/m)
2. Correction Factor(dB/m) = Antenna Factor(dB/m) + Cable Factor(dB) – Pre-Amplifier Factor(dB)
3. The other emission levels were very low against the limit.
4. Margin value = Emission Level – Limit value
5. " * ": Fundamental frequency.
6. " # ": The radiated frequency is out of the restricted band.

802.11ac (80MHz)

CHANNEL	TX Channel 42	DETECTOR FUNCTION	Peak (PK)
FREQUENCY RANGE	1GHz ~ 40GHz		Average (AV)

ANTENNA POLARITY & TEST DISTANCE: HORIZONTAL AT 3 M

NO.	FREQ. (MHz)	EMISSION LEVEL (dBuV/m)	LIMIT (dBuV/m)	MARGIN (dB)	ANTENNA HEIGHT (m)	TABLE ANGLE (Degree)	RAW VALUE (dBuV)	CORRECTION FACTOR (dB/m)
1	5150.00	66.20 PK	74.00	-7.80	1.62 H	192	60.26	5.94
2	5150.00	45.30 AV	54.00	-8.70	1.62 H	192	39.36	5.94
3	*5210.00	106.18 PK			1.62 H	192	100.03	6.15
4	*5210.00	96.51 AV			1.62 H	192	90.36	6.15
5	5350.00	57.99 PK	74.00	-16.01	1.62 H	192	51.24	6.75
6	5350.00	44.75 AV	54.00	-9.25	1.62 H	192	38.00	6.75
7	#10420.00	55.96 PK	74.00	-18.04	1.91 H	144	39.65	16.31
8	#10420.00	41.44 AV	54.00	-12.56	1.91 H	144	25.13	16.31

ANTENNA POLARITY & TEST DISTANCE: VERTICAL AT 3 M

NO.	FREQ. (MHz)	EMISSION LEVEL (dBuV/m)	LIMIT (dBuV/m)	MARGIN (dB)	ANTENNA HEIGHT (m)	TABLE ANGLE (Degree)	RAW VALUE (dBuV)	CORRECTION FACTOR (dB/m)
1	5150.00	70.31 PK	74.00	-3.69	2.43 V	51	64.37	5.94
2	5150.00	46.84 AV	54.00	-7.16	2.43 V	51	40.90	5.94
3	*5210.00	116.38 PK			2.43 V	51	110.23	6.15
4	*5210.00	107.37 AV			2.43 V	51	101.22	6.15
5	5350.00	60.13 PK	74.00	-13.87	2.43 V	51	53.38	6.75
6	5350.00	45.14 AV	54.00	-8.86	2.43 V	51	38.39	6.75
7	#10420.00	57.16 PK	74.00	-16.84	1.85 V	236	40.85	16.31
8	#10420.00	42.60 AV	54.00	-11.40	1.85 V	236	26.29	16.31

REMARKS:

1. Emission Level(dBuV/m) = Raw Value(dBuV) + Correction Factor(dB/m)
2. Correction Factor(dB/m) = Antenna Factor(dB/m) + Cable Factor(dB) – Pre-Amplifier Factor(dB)
3. The other emission levels were very low against the limit.
4. Margin value = Emission Level – Limit value
5. " * ": Fundamental frequency.
6. " # ": The radiated frequency is out of the restricted band.

CHANNEL	TX Channel 155	DETECTOR FUNCTION	Peak (PK)
FREQUENCY RANGE	1GHz ~ 40GHz		Average (AV)

ANTENNA POLARITY & TEST DISTANCE: HORIZONTAL AT 3 M

NO.	FREQ. (MHz)	EMISSION LEVEL (dBuV/m)	LIMIT (dBuV/m)	MARGIN (dB)	ANTENNA HEIGHT (m)	TABLE ANGLE (Degree)	RAW VALUE (dBuV)	CORRECTION FACTOR (dB/m)
1	#5611.94	63.76 PK	68.20	-4.44	1.52 H	192	56.40	7.36
2	*5775.00	104.67 PK			1.52 H	192	97.25	7.42
3	*5775.00	85.90 AV			1.52 H	192	78.48	7.42
4	#5981.87	63.50 PK	68.20	-4.70	1.52 H	192	55.44	8.06
5	11550.00	56.60 PK	74.00	-17.40	1.84 H	201	39.36	17.24
6	11550.00	42.88 AV	54.00	-11.12	1.84 H	201	25.64	17.24

ANTENNA POLARITY & TEST DISTANCE: VERTICAL AT 3 M

NO.	FREQ. (MHz)	EMISSION LEVEL (dBuV/m)	LIMIT (dBuV/m)	MARGIN (dB)	ANTENNA HEIGHT (m)	TABLE ANGLE (Degree)	RAW VALUE (dBuV)	CORRECTION FACTOR (dB/m)
1	#5630.20	64.01 PK	68.20	-4.19	2.64 V	272	56.65	7.36
2	*5775.00	114.98 PK			2.64 V	272	107.56	7.42
3	*5775.00	96.04 AV			2.64 V	272	88.62	7.42
4	#5945.24	63.06 PK	68.20	-5.14	2.64 V	272	55.16	7.90
5	11550.00	57.91 PK	74.00	-16.09	1.69 V	24	40.67	17.24
6	11550.00	44.08 AV	54.00	-9.92	1.69 V	24	26.84	17.24

REMARKS:

1. Emission Level(dBuV/m) = Raw Value(dBuV) + Correction Factor(dB/m)
2. Correction Factor(dB/m) = Antenna Factor(dB/m) + Cable Factor(dB) – Pre-Amplifier Factor(dB)
3. The other emission levels were very low against the limit.
4. Margin value = Emission Level – Limit value
5. " * ": Fundamental frequency.
6. " # ": The radiated frequency is out of the restricted band.

Beamforming_NSS1 Mode (Mode B)

802.11ac (20MHz)

CHANNEL	TX Channel 36	DETECTOR FUNCTION	Peak (PK)
FREQUENCY RANGE	1GHz ~ 40GHz		Average (AV)

ANTENNA POLARITY & TEST DISTANCE: HORIZONTAL AT 3 M

NO.	FREQ. (MHz)	EMISSION LEVEL (dBuV/m)	LIMIT (dBuV/m)	MARGIN (dB)	ANTENNA HEIGHT (m)	TABLE ANGLE (Degree)	RAW VALUE (dBuV)	CORRECTION FACTOR (dB/m)
1	5150.00	58.12 PK	74.00	-15.88	1.70 H	189	52.18	5.94
2	5150.00	43.93 AV	54.00	-10.07	1.70 H	189	37.99	5.94
3	*5180.00	105.26 PK			1.70 H	189	99.23	6.03
4	*5180.00	92.86 AV			1.70 H	189	86.83	6.03
5	#10360.00	54.76 PK	74.00	-19.24	1.96 H	308	38.66	16.10
6	#10360.00	40.62 AV	54.00	-13.38	1.96 H	308	24.52	16.10

ANTENNA POLARITY & TEST DISTANCE: VERTICAL AT 3 M

NO.	FREQ. (MHz)	EMISSION LEVEL (dBuV/m)	LIMIT (dBuV/m)	MARGIN (dB)	ANTENNA HEIGHT (m)	TABLE ANGLE (Degree)	RAW VALUE (dBuV)	CORRECTION FACTOR (dB/m)
1	5150.00	64.59 PK	74.00	-9.41	2.06 V	167	58.65	5.94
2	5150.00	48.02 AV	54.00	-5.98	2.06 V	167	42.08	5.94
3	*5180.00	121.83 PK			2.06 V	167	115.80	6.03
4	*5180.00	108.68 AV			2.06 V	167	102.65	6.03
5	#10360.00	55.46 PK	74.00	-18.54	1.44 V	221	39.36	16.10
6	#10360.00	41.30 AV	54.00	-12.70	1.44 V	221	25.20	16.10

REMARKS:

1. Emission Level(dBuV/m) = Raw Value(dBuV) + Correction Factor(dB/m)
2. Correction Factor(dB/m) = Antenna Factor(dB/m) + Cable Factor(dB) – Pre-Amplifier Factor(dB)
3. The other emission levels were very low against the limit.
4. Margin value = Emission Level – Limit value
5. " * ": Fundamental frequency.
6. " # ": The radiated frequency is out of the restricted band.

CHANNEL	TX Channel 40	DETECTOR FUNCTION	Peak (PK)
FREQUENCY RANGE	1GHz ~ 40GHz		Average (AV)

ANTENNA POLARITY & TEST DISTANCE: HORIZONTAL AT 3 M

NO.	FREQ. (MHz)	EMISSION LEVEL (dBuV/m)	LIMIT (dBuV/m)	MARGIN (dB)	ANTENNA HEIGHT (m)	TABLE ANGLE (Degree)	RAW VALUE (dBuV)	CORRECTION FACTOR (dB/m)
1	*5200.00	105.89 PK			1.64 H	193	99.78	6.11
2	*5200.00	93.04 AV			1.64 H	193	86.93	6.11
3	#10400.00	55.05 PK	74.00	-18.95	2.20 H	178	38.79	16.26
4	#10400.00	40.89 AV	54.00	-13.11	2.20 H	178	24.63	16.26

ANTENNA POLARITY & TEST DISTANCE: VERTICAL AT 3 M

NO.	FREQ. (MHz)	EMISSION LEVEL (dBuV/m)	LIMIT (dBuV/m)	MARGIN (dB)	ANTENNA HEIGHT (m)	TABLE ANGLE (Degree)	RAW VALUE (dBuV)	CORRECTION FACTOR (dB/m)
1	*5200.00	121.55 PK			2.04 V	172	115.44	6.11
2	*5200.00	107.56 AV			2.04 V	172	101.45	6.11
3	#10400.00	56.15 PK	74.00	-17.85	1.58 V	241	39.89	16.26
4	#10400.00	41.90 AV	54.00	-12.10	1.58 V	241	25.64	16.26

REMARKS:

1. Emission Level(dBuV/m) = Raw Value(dBuV) + Correction Factor(dB/m)
2. Correction Factor(dB/m) = Antenna Factor(dB/m) + Cable Factor(dB) – Pre-Amplifier Factor(dB)
3. The other emission levels were very low against the limit.
4. Margin value = Emission Level – Limit value
5. " * ": Fundamental frequency.
6. " # ": The radiated frequency is out of the restricted band.

CHANNEL	TX Channel 48	DETECTOR FUNCTION	Peak (PK)
FREQUENCY RANGE	1GHz ~ 40GHz		Average (AV)

ANTENNA POLARITY & TEST DISTANCE: HORIZONTAL AT 3 M

NO.	FREQ. (MHz)	EMISSION LEVEL (dBuV/m)	LIMIT (dBuV/m)	MARGIN (dB)	ANTENNA HEIGHT (m)	TABLE ANGLE (Degree)	RAW VALUE (dBuV)	CORRECTION FACTOR (dB/m)
1	*5240.00	105.80 PK			1.58 H	174	99.53	6.27
2	*5240.00	63.23 AV			1.58 H	174	56.96	6.27
3	5350.00	58.59 PK	74.00	-15.41	1.58 H	174	51.84	6.75
4	5350.00	45.44 AV	54.00	-8.56	1.58 H	174	38.69	6.75
5	#10480.00	55.11 PK	74.00	-18.89	2.28 H	241	38.64	16.47
6	#10480.00	41.09 AV	54.00	-12.91	2.28 H	241	24.62	16.47

ANTENNA POLARITY & TEST DISTANCE: VERTICAL AT 3 M

NO.	FREQ. (MHz)	EMISSION LEVEL (dBuV/m)	LIMIT (dBuV/m)	MARGIN (dB)	ANTENNA HEIGHT (m)	TABLE ANGLE (Degree)	RAW VALUE (dBuV)	CORRECTION FACTOR (dB/m)
1	*5240.00	121.75 PK			2.03 V	245	115.48	6.27
2	*5240.00	108.82 AV			2.03 V	245	102.55	6.27
3	5350.00	58.88 PK	74.00	-15.12	2.03 V	245	52.13	6.75
4	5350.00	46.44 AV	54.00	-7.56	2.03 V	245	39.69	6.75
5	#10480.00	56.34 PK	74.00	-17.66	1.69 V	102	39.87	16.47
6	#10480.00	42.28 AV	54.00	-11.72	1.69 V	102	25.81	16.47

REMARKS:

1. Emission Level(dBuV/m) = Raw Value(dBuV) + Correction Factor(dB/m)
2. Correction Factor(dB/m) = Antenna Factor(dB/m) + Cable Factor(dB) – Pre-Amplifier Factor(dB)
3. The other emission levels were very low against the limit.
4. Margin value = Emission Level – Limit value
5. " * ": Fundamental frequency.
6. " # ": The radiated frequency is out of the restricted band.

CHANNEL	TX Channel 149	DETECTOR FUNCTION	Peak (PK)
FREQUENCY RANGE	1GHz ~ 40GHz		Average (AV)

ANTENNA POLARITY & TEST DISTANCE: HORIZONTAL AT 3 M

NO.	FREQ. (MHz)	EMISSION LEVEL (dBuV/m)	LIMIT (dBuV/m)	MARGIN (dB)	ANTENNA HEIGHT (m)	TABLE ANGLE (Degree)	RAW VALUE (dBuV)	CORRECTION FACTOR (dB/m)
1	#5616.75	62.28 PK	68.20	-5.92	1.51 H	216	54.92	7.36
2	*5745.00	98.90 PK			1.51 H	216	91.51	7.39
3	*5745.00	81.84 AV			1.51 H	216	74.45	7.39
4	#5936.15	61.62 PK	68.20	-6.58	1.51 H	216	53.76	7.86
5	11490.00	56.84 PK	74.00	-17.16	2.08 H	152	39.64	17.20
6	11490.00	42.44 AV	54.00	-11.56	2.08 H	152	25.24	17.20

ANTENNA POLARITY & TEST DISTANCE: VERTICAL AT 3 M

NO.	FREQ. (MHz)	EMISSION LEVEL (dBuV/m)	LIMIT (dBuV/m)	MARGIN (dB)	ANTENNA HEIGHT (m)	TABLE ANGLE (Degree)	RAW VALUE (dBuV)	CORRECTION FACTOR (dB/m)
1	#5597.33	61.80 PK	68.20	-6.40	1.99 V	5	54.42	7.38
2	*5745.00	117.26 PK			1.99 V	5	109.87	7.39
3	*5745.00	100.69 AV			1.99 V	5	93.30	7.39
4	#5925.27	62.30 PK	68.20	-5.90	1.99 V	5	54.48	7.82
5	11490.00	57.72 PK	74.00	-16.28	1.00 V	238	40.52	17.20
6	11490.00	43.58 AV	54.00	-10.42	1.00 V	238	26.38	17.20

REMARKS:

1. Emission Level(dBuV/m) = Raw Value(dBuV) + Correction Factor(dB/m)
2. Correction Factor(dB/m) = Antenna Factor(dB/m) + Cable Factor(dB) – Pre-Amplifier Factor(dB)
3. The other emission levels were very low against the limit.
4. Margin value = Emission Level – Limit value
5. " * ": Fundamental frequency.
6. " # ": The radiated frequency is out of the restricted band.

CHANNEL	TX Channel 157	DETECTOR FUNCTION	Peak (PK)
FREQUENCY RANGE	1GHz ~ 40GHz		Average (AV)

ANTENNA POLARITY & TEST DISTANCE: HORIZONTAL AT 3 M

NO.	FREQ. (MHz)	EMISSION LEVEL (dBuV/m)	LIMIT (dBuV/m)	MARGIN (dB)	ANTENNA HEIGHT (m)	TABLE ANGLE (Degree)	RAW VALUE (dBuV)	CORRECTION FACTOR (dB/m)
1	#5614.07	60.88 PK	68.20	-7.32	1.49 H	220	53.51	7.37
2	*5785.00	98.76 PK			1.49 H	220	91.33	7.43
3	*5785.00	81.81 AV			1.49 H	220	74.38	7.43
4	#5934.88	60.49 PK	68.20	-7.71	1.49 H	220	52.64	7.85
5	11570.00	56.91 PK	74.00	-17.09	2.14 H	236	39.65	17.26
6	11570.00	43.10 AV	54.00	-10.90	2.14 H	236	25.84	17.26

ANTENNA POLARITY & TEST DISTANCE: VERTICAL AT 3 M

NO.	FREQ. (MHz)	EMISSION LEVEL (dBuV/m)	LIMIT (dBuV/m)	MARGIN (dB)	ANTENNA HEIGHT (m)	TABLE ANGLE (Degree)	RAW VALUE (dBuV)	CORRECTION FACTOR (dB/m)
1	#5616.84	62.08 PK	68.20	-6.12	1.98 V	116	54.72	7.36
2	*5785.00	116.58 PK			1.98 V	116	109.15	7.43
3	*5785.00	100.42 AV			1.98 V	116	92.99	7.43
4	#5972.19	62.42 PK	68.20	-5.78	1.98 V	116	54.40	8.02
5	11570.00	57.52 PK	74.00	-16.48	1.25 V	101	40.26	17.26
6	11570.00	44.08 AV	54.00	-9.92	1.25 V	101	26.82	17.26

REMARKS:

1. Emission Level(dBuV/m) = Raw Value(dBuV) + Correction Factor(dB/m)
2. Correction Factor(dB/m) = Antenna Factor(dB/m) + Cable Factor(dB) – Pre-Amplifier Factor(dB)
3. The other emission levels were very low against the limit.
4. Margin value = Emission Level – Limit value
5. " * ": Fundamental frequency.
6. " # ": The radiated frequency is out of the restricted band.

CHANNEL	TX Channel 165	DETECTOR FUNCTION	Peak (PK)
FREQUENCY RANGE	1GHz ~ 40GHz		Average (AV)

ANTENNA POLARITY & TEST DISTANCE: HORIZONTAL AT 3 M

NO.	FREQ. (MHz)	EMISSION LEVEL (dBuV/m)	LIMIT (dBuV/m)	MARGIN (dB)	ANTENNA HEIGHT (m)	TABLE ANGLE (Degree)	RAW VALUE (dBuV)	CORRECTION FACTOR (dB/m)
1	#5616.04	61.83 PK	68.20	-6.37	1.47 H	203	54.47	7.36
2	*5825.00	97.94 PK			1.47 H	203	90.43	7.51
3	*5825.00	81.40 AV			1.47 H	203	73.89	7.51
4	#5943.77	62.24 PK	68.20	-5.96	1.47 H	203	54.34	7.90
5	11650.00	56.86 PK	74.00	-17.14	1.88 H	251	39.63	17.23
6	11650.00	42.26 AV	54.00	-11.74	1.88 H	251	25.03	17.23

ANTENNA POLARITY & TEST DISTANCE: VERTICAL AT 3 M

NO.	FREQ. (MHz)	EMISSION LEVEL (dBuV/m)	LIMIT (dBuV/m)	MARGIN (dB)	ANTENNA HEIGHT (m)	TABLE ANGLE (Degree)	RAW VALUE (dBuV)	CORRECTION FACTOR (dB/m)
1	#5579.14	62.17 PK	68.20	-6.03	1.91 V	8	54.81	7.36
2	*5825.00	115.76 PK			1.91 V	8	108.25	7.51
3	*5825.00	99.54 AV			1.91 V	8	92.03	7.51
4	#5988.51	63.19 PK	68.20	-5.01	1.91 V	8	55.11	8.08
5	11650.00	58.04 PK	74.00	-15.96	1.17 V	304	40.81	17.23
6	11650.00	43.45 AV	54.00	-10.55	1.17 V	304	26.22	17.23

REMARKS:

1. Emission Level(dBuV/m) = Raw Value(dBuV) + Correction Factor(dB/m)
2. Correction Factor(dB/m) = Antenna Factor(dB/m) + Cable Factor(dB) – Pre-Amplifier Factor(dB)
3. The other emission levels were very low against the limit.
4. Margin value = Emission Level – Limit value
5. " * ": Fundamental frequency.
6. " # ": The radiated frequency is out of the restricted band.

802.11ac (40MHz)

CHANNEL	TX Channel 38	DETECTOR FUNCTION	Peak (PK)
FREQUENCY RANGE	1GHz ~ 40GHz		Average (AV)

ANTENNA POLARITY & TEST DISTANCE: HORIZONTAL AT 3 M

NO.	FREQ. (MHz)	EMISSION LEVEL (dBuV/m)	LIMIT (dBuV/m)	MARGIN (dB)	ANTENNA HEIGHT (m)	TABLE ANGLE (Degree)	RAW VALUE (dBuV)	CORRECTION FACTOR (dB/m)
1	5150.00	69.30 PK	74.00	-4.70	1.91 H	142	63.36	5.94
2	5150.00	45.30 AV	54.00	-8.70	1.91 H	142	39.36	5.94
3	*5190.00	107.10 PK			1.91 H	142	101.03	6.07
4	*5190.00	96.74 AV			1.91 H	142	90.67	6.07
5	#10380.00	55.51 PK	74.00	-18.49	2.36 H	186	39.32	16.19
6	#10380.00	40.35 AV	54.00	-13.65	2.36 H	186	24.16	16.19

ANTENNA POLARITY & TEST DISTANCE: VERTICAL AT 3 M

NO.	FREQ. (MHz)	EMISSION LEVEL (dBuV/m)	LIMIT (dBuV/m)	MARGIN (dB)	ANTENNA HEIGHT (m)	TABLE ANGLE (Degree)	RAW VALUE (dBuV)	CORRECTION FACTOR (dB/m)
1	5150.00	72.98 PK	74.00	-1.02	2.06 V	301	67.04	5.94
2	5150.00	48.19 AV	54.00	-5.81	2.06 V	301	42.25	5.94
3	*5190.00	118.99 PK			2.06 V	301	112.92	6.07
4	*5190.00	107.10 AV			2.06 V	301	101.03	6.07
5	#10380.00	56.55 PK	74.00	-17.45	1.64 V	225	40.36	16.19
6	#10380.00	41.55 AV	54.00	-12.45	1.64 V	225	25.36	16.19

REMARKS:

1. Emission Level(dBuV/m) = Raw Value(dBuV) + Correction Factor(dB/m)
2. Correction Factor(dB/m) = Antenna Factor(dB/m) + Cable Factor(dB) – Pre-Amplifier Factor(dB)
3. The other emission levels were very low against the limit.
4. Margin value = Emission Level – Limit value
5. " * ": Fundamental frequency.
6. " # ": The radiated frequency is out of the restricted band.

CHANNEL	TX Channel 46	DETECTOR FUNCTION	Peak (PK)
FREQUENCY RANGE	1GHz ~ 40GHz		Average (AV)

ANTENNA POLARITY & TEST DISTANCE: HORIZONTAL AT 3 M

NO.	FREQ. (MHz)	EMISSION LEVEL (dBuV/m)	LIMIT (dBuV/m)	MARGIN (dB)	ANTENNA HEIGHT (m)	TABLE ANGLE (Degree)	RAW VALUE (dBuV)	CORRECTION FACTOR (dB/m)
1	*5230.00	107.93 PK			1.89 H	144	101.70	6.23
2	*5230.00	97.11 AV			1.89 H	144	90.88	6.23
3	5350.00	58.62 PK	74.00	-15.38	1.89 H	144	51.87	6.75
4	5350.00	45.38 AV	54.00	-8.62	1.89 H	144	38.63	6.75
5	#10460.00	55.77 PK	74.00	-18.23	2.20 H	169	39.36	16.41
6	#10460.00	40.93 AV	54.00	-13.07	2.20 H	169	24.52	16.41

ANTENNA POLARITY & TEST DISTANCE: VERTICAL AT 3 M

NO.	FREQ. (MHz)	EMISSION LEVEL (dBuV/m)	LIMIT (dBuV/m)	MARGIN (dB)	ANTENNA HEIGHT (m)	TABLE ANGLE (Degree)	RAW VALUE (dBuV)	CORRECTION FACTOR (dB/m)
1	*5230.00	118.76 PK			2.06 V	234	112.53	6.23
2	*5230.00	108.38 AV			2.06 V	234	102.15	6.23
3	5350.00	59.03 PK	74.00	-14.97	2.06 V	234	52.28	6.75
4	5350.00	45.74 AV	54.00	-8.26	2.06 V	234	38.99	6.75
5	#10460.00	57.07 PK	74.00	-16.93	1.58 V	336	40.66	16.41
6	#10460.00	41.77 AV	54.00	-12.23	1.58 V	336	25.36	16.41

REMARKS:

1. Emission Level(dBuV/m) = Raw Value(dBuV) + Correction Factor(dB/m)
2. Correction Factor(dB/m) = Antenna Factor(dB/m) + Cable Factor(dB) – Pre-Amplifier Factor(dB)
3. The other emission levels were very low against the limit.
4. Margin value = Emission Level – Limit value
5. " # ": The radiated frequency is out of the restricted band.

CHANNEL	TX Channel 151	DETECTOR FUNCTION	Peak (PK)
FREQUENCY RANGE	1GHz ~ 40GHz		Average (AV)

ANTENNA POLARITY & TEST DISTANCE: HORIZONTAL AT 3 M

NO.	FREQ. (MHz)	EMISSION LEVEL (dBuV/m)	LIMIT (dBuV/m)	MARGIN (dB)	ANTENNA HEIGHT (m)	TABLE ANGLE (Degree)	RAW VALUE (dBuV)	CORRECTION FACTOR (dB/m)
1	#5615.95	61.53 PK	68.20	-6.67	1.34 H	185	54.17	7.36
2	*5755.00	105.28 PK			1.34 H	185	97.88	7.40
3	*5755.00	91.04 AV			1.34 H	185	83.64	7.40
4	#5950.73	60.99 PK	68.20	-7.21	1.34 H	185	53.06	7.93
5	11510.00	56.46 PK	74.00	-17.54	1.96 H	205	39.26	17.20
6	11510.00	42.43 AV	54.00	-11.57	1.96 H	205	25.23	17.20

ANTENNA POLARITY & TEST DISTANCE: VERTICAL AT 3 M

NO.	FREQ. (MHz)	EMISSION LEVEL (dBuV/m)	LIMIT (dBuV/m)	MARGIN (dB)	ANTENNA HEIGHT (m)	TABLE ANGLE (Degree)	RAW VALUE (dBuV)	CORRECTION FACTOR (dB/m)
1	#5637.82	62.87 PK	68.20	-5.33	2.32 V	6	55.51	7.36
2	*5755.00	114.43 PK			2.32 V	6	107.03	7.40
3	*5755.00	100.53 AV			2.32 V	6	93.13	7.40
4	#5956.07	62.47 PK	68.20	-5.73	2.32 V	6	54.53	7.94
5	11510.00	57.35 PK	74.00	-16.65	1.29 V	258	40.15	17.20
6	11510.00	43.45 AV	54.00	-10.55	1.29 V	258	26.25	17.20

REMARKS:

1. Emission Level(dBuV/m) = Raw Value(dBuV) + Correction Factor(dB/m)
2. Correction Factor(dB/m) = Antenna Factor(dB/m) + Cable Factor(dB) – Pre-Amplifier Factor(dB)
3. The other emission levels were very low against the limit.
4. Margin value = Emission Level – Limit value
5. " * ": Fundamental frequency.
6. " # ": The radiated frequency is out of the restricted band.

CHANNEL	TX Channel 159	DETECTOR FUNCTION	Peak (PK)
FREQUENCY RANGE	1GHz ~ 40GHz		Average (AV)

ANTENNA POLARITY & TEST DISTANCE: HORIZONTAL AT 3 M

NO.	FREQ. (MHz)	EMISSION LEVEL (dBuV/m)	LIMIT (dBuV/m)	MARGIN (dB)	ANTENNA HEIGHT (m)	TABLE ANGLE (Degree)	RAW VALUE (dBuV)	CORRECTION FACTOR (dB/m)
1	#5645.28	61.75 PK	68.20	-6.45	1.41 H	177	54.39	7.36
2	*5795.00	104.49 PK			1.41 H	177	97.04	7.45
3	*5795.00	90.97 AV			1.41 H	177	83.52	7.45
4	#5956.56	61.54 PK	68.20	-6.66	1.41 H	177	53.59	7.95
5	11590.00	56.79 PK	74.00	-17.21	1.88 H	190	39.52	17.27
6	11590.00	43.12 AV	54.00	-10.88	1.88 H	190	25.85	17.27

ANTENNA POLARITY & TEST DISTANCE: VERTICAL AT 3 M

NO.	FREQ. (MHz)	EMISSION LEVEL (dBuV/m)	LIMIT (dBuV/m)	MARGIN (dB)	ANTENNA HEIGHT (m)	TABLE ANGLE (Degree)	RAW VALUE (dBuV)	CORRECTION FACTOR (dB/m)
1	#5611.11	62.09 PK	68.20	-6.11	1.98 V	1	54.72	7.37
2	*5795.00	114.56 PK			1.98 V	1	107.11	7.45
3	*5795.00	100.81 AV			1.98 V	1	93.36	7.45
4	#5940.65	62.36 PK	68.20	-5.84	1.98 V	1	54.48	7.88
5	11590.00	58.12 PK	74.00	-15.88	1.24 V	195	40.85	17.27
6	11590.00	44.11 AV	54.00	-9.89	1.24 V	195	26.84	17.27

REMARKS:

1. Emission Level(dBuV/m) = Raw Value(dBuV) + Correction Factor(dB/m)
2. Correction Factor(dB/m) = Antenna Factor(dB/m) + Cable Factor(dB) – Pre-Amplifier Factor(dB)
3. The other emission levels were very low against the limit.
4. Margin value = Emission Level – Limit value
5. " * ": Fundamental frequency.
6. " # ": The radiated frequency is out of the restricted band.

802.11ac (80MHz)

CHANNEL	TX Channel 42	DETECTOR FUNCTION	Peak (PK)
FREQUENCY RANGE	1GHz ~ 40GHz		Average (AV)

ANTENNA POLARITY & TEST DISTANCE: HORIZONTAL AT 3 M

NO.	FREQ. (MHz)	EMISSION LEVEL (dBuV/m)	LIMIT (dBuV/m)	MARGIN (dB)	ANTENNA HEIGHT (m)	TABLE ANGLE (Degree)	RAW VALUE (dBuV)	CORRECTION FACTOR (dB/m)
1	5150.00	67.18 PK	74.00	-6.82	1.24 H	81	61.24	5.94
2	5150.00	44.57 AV	54.00	-9.43	1.24 H	81	38.63	5.94
3	*5210.00	104.04 PK			1.24 H	81	97.89	6.15
4	*5210.00	91.97 AV			1.24 H	81	85.82	6.15
5	5350.00	57.99 PK	74.00	-16.01	1.24 H	81	51.24	6.75
6	5350.00	44.78 AV	54.00	-9.22	1.24 H	81	38.03	6.75
7	#10420.00	55.52 PK	74.00	-18.48	1.96 H	325	39.21	16.31
8	#10420.00	40.47 AV	54.00	-13.53	1.96 H	325	24.16	16.31

ANTENNA POLARITY & TEST DISTANCE: VERTICAL AT 3 M

NO.	FREQ. (MHz)	EMISSION LEVEL (dBuV/m)	LIMIT (dBuV/m)	MARGIN (dB)	ANTENNA HEIGHT (m)	TABLE ANGLE (Degree)	RAW VALUE (dBuV)	CORRECTION FACTOR (dB/m)
1	5150.00	72.79 PK	74.00	-1.21	1.96 V	240	66.85	5.94
2	5150.00	47.10 AV	54.00	-6.90	1.96 V	240	41.16	5.94
3	*5210.00	113.83 PK			1.96 V	240	107.68	6.15
4	*5210.00	102.13 AV			1.96 V	240	95.98	6.15
5	5350.00	58.51 PK	74.00	-15.49	1.96 V	240	51.76	6.75
6	5350.00	45.24 AV	54.00	-8.76	1.96 V	240	38.49	6.75
7	#10420.00	56.57 PK	74.00	-17.43	1.88 V	142	40.26	16.31
8	#10420.00	42.12 AV	54.00	-11.88	1.88 V	142	25.81	16.31

REMARKS:

1. Emission Level(dBuV/m) = Raw Value(dBuV) + Correction Factor(dB/m)
2. Correction Factor(dB/m) = Antenna Factor(dB/m) + Cable Factor(dB) – Pre-Amplifier Factor(dB)
3. The other emission levels were very low against the limit.
4. Margin value = Emission Level – Limit value
5. " * ": Fundamental frequency.
6. " # ": The radiated frequency is out of the restricted band.

CHANNEL	TX Channel 155	DETECTOR FUNCTION	Peak (PK)
FREQUENCY RANGE	1GHz ~ 40GHz		Average (AV)

ANTENNA POLARITY & TEST DISTANCE: HORIZONTAL AT 3 M

NO.	FREQ. (MHz)	EMISSION LEVEL (dBuV/m)	LIMIT (dBuV/m)	MARGIN (dB)	ANTENNA HEIGHT (m)	TABLE ANGLE (Degree)	RAW VALUE (dBuV)	CORRECTION FACTOR (dB/m)
1	#5631.98	61.63 PK	68.20	-6.57	1.29 H	188	54.27	7.36
2	*5775.00	101.55 PK			1.29 H	188	94.13	7.42
3	*5775.00	88.90 AV			1.29 H	188	81.48	7.42
4	#5948.32	61.75 PK	68.20	-6.45	1.29 H	188	53.84	7.91
5	11550.00	56.87 PK	74.00	-17.13	1.69 H	341	39.63	17.24
6	11550.00	42.26 AV	54.00	-11.74	1.69 H	341	25.02	17.24

ANTENNA POLARITY & TEST DISTANCE: VERTICAL AT 3 M

NO.	FREQ. (MHz)	EMISSION LEVEL (dBuV/m)	LIMIT (dBuV/m)	MARGIN (dB)	ANTENNA HEIGHT (m)	TABLE ANGLE (Degree)	RAW VALUE (dBuV)	CORRECTION FACTOR (dB/m)
1	#5631.74	63.30 PK	68.20	-4.90	2.03 V	2	55.94	7.36
2	*5775.00	117.45 PK			2.03 V	2	110.03	7.42
3	*5775.00	107.46 AV			2.03 V	2	100.04	7.42
4	#5944.36	63.52 PK	68.20	-4.68	2.03 V	2	55.62	7.90
5	11550.00	58.13 PK	74.00	-15.87	1.45 V	223	40.89	17.24
6	11550.00	44.09 AV	54.00	-9.91	1.45 V	223	26.85	17.24

REMARKS:

1. Emission Level(dBuV/m) = Raw Value(dBuV) + Correction Factor(dB/m)
2. Correction Factor(dB/m) = Antenna Factor(dB/m) + Cable Factor(dB) – Pre-Amplifier Factor(dB)
3. The other emission levels were very low against the limit.
4. Margin value = Emission Level – Limit value
5. " * ": Fundamental frequency.
6. " # ": The radiated frequency is out of the restricted band.

BELOW 1GHz WORST-CASE DATA:
CDD Mode (Mode A)
802.11a

CHANNEL	TX Channel 48	DETECTOR FUNCTION	Quasi-Peak (QP)
FREQUENCY RANGE	9kHz ~ 1GHz		

ANTENNA POLARITY & TEST DISTANCE: HORIZONTAL AT 3 M

NO.	FREQ. (MHz)	EMISSION LEVEL (dBuV/m)	LIMIT (dBuV/m)	MARGIN (dB)	ANTENNA HEIGHT (m)	TABLE ANGLE (Degree)	RAW VALUE (dBuV)	CORRECTION FACTOR (dB/m)
1	52.16	20.19 QP	40.00	-19.81	2.34 H	360	29.16	-8.97
2	151.49	19.02 QP	43.50	-24.48	1.52 H	360	28.13	-9.11
3	233.55	27.28 QP	46.00	-18.72	1.81 H	189	38.14	-10.86
4	289.67	23.31 QP	46.00	-22.69	1.66 H	257	30.94	-7.63
5	391.76	32.01 QP	46.00	-13.99	2.35 H	205	37.52	-5.51
6	503.55	28.39 QP	46.00	-17.61	1.17 H	197	31.29	-2.90

ANTENNA POLARITY & TEST DISTANCE: VERTICAL AT 3 M

NO.	FREQ. (MHz)	EMISSION LEVEL (dBuV/m)	LIMIT (dBuV/m)	MARGIN (dB)	ANTENNA HEIGHT (m)	TABLE ANGLE (Degree)	RAW VALUE (dBuV)	CORRECTION FACTOR (dB/m)
1	36.55	31.48 QP	40.00	-8.52	1.16 V	207	41.88	-10.40
2	51.97	30.59 QP	40.00	-9.41	1.63 V	145	39.55	-8.96
3	101.54	21.46 QP	43.50	-22.04	1.57 V	290	35.18	-13.72
4	244.95	26.53 QP	46.00	-19.47	1.84 V	189	36.18	-9.65
5	391.28	30.65 QP	46.00	-15.35	1.57 V	194	36.18	-5.53
6	516.46	28.44 QP	46.00	-17.56	1.66 V	272	31.11	-2.67

REMARKS:

1. Emission Level(dBuV/m) = Raw Value(dBuV) + Correction Factor(dB/m)
2. Correction Factor(dB/m) = Antenna Factor(dB/m) + Cable Factor(dB) – Pre-Amplifier Factor(dB)
3. The other emission levels were very low against the limit.
4. Margin value = Emission Level – Limit value

CDD Mode (Mode B)
802.11a

CHANNEL	TX Channel 48	DETECTOR FUNCTION	Quasi-Peak (QP)
FREQUENCY RANGE	9kHz ~ 1GHz		

ANTENNA POLARITY & TEST DISTANCE: HORIZONTAL AT 3 M

NO.	FREQ. (MHz)	EMISSION LEVEL (dBuV/m)	LIMIT (dBuV/m)	MARGIN (dB)	ANTENNA HEIGHT (m)	TABLE ANGLE (Degree)	RAW VALUE (dBuV)	CORRECTION FACTOR (dB/m)
1	52.60	18.84 QP	40.00	-21.16	2.28 H	133	27.85	-9.01
2	114.54	18.41 QP	43.50	-25.09	1.94 H	122	30.66	-12.25
3	150.72	18.39 QP	43.50	-25.11	2.04 H	141	27.50	-9.11
4	225.02	17.48 QP	46.00	-28.52	1.85 H	29	28.81	-11.33
5	274.49	30.68 QP	46.00	-15.32	2.64 H	277	38.68	-8.00
6	409.56	34.32 QP	46.00	-11.68	1.00 H	37	39.52	-5.20

ANTENNA POLARITY & TEST DISTANCE: VERTICAL AT 3 M

NO.	FREQ. (MHz)	EMISSION LEVEL (dBuV/m)	LIMIT (dBuV/m)	MARGIN (dB)	ANTENNA HEIGHT (m)	TABLE ANGLE (Degree)	RAW VALUE (dBuV)	CORRECTION FACTOR (dB/m)
1	39.94	30.77 QP	40.00	-9.23	2.16 V	157	40.69	-9.92
2	52.31	28.00 QP	40.00	-12.00	1.23 V	152	36.98	-8.98
3	105.22	22.69 QP	43.50	-20.81	1.18 V	56	35.87	-13.18
4	150.91	20.18 QP	43.50	-23.32	1.45 V	105	29.29	-9.11
5	275.07	28.51 QP	46.00	-17.49	1.58 V	140	36.50	-7.99
6	408.79	34.64 QP	46.00	-11.36	1.44 V	179	39.85	-5.21

REMARKS:

1. Emission Level(dBuV/m) = Raw Value(dBuV) + Correction Factor(dB/m)
2. Correction Factor(dB/m) = Antenna Factor(dB/m) + Cable Factor(dB) – Pre-Amplifier Factor(dB)
3. The other emission levels were very low against the limit.
4. Margin value = Emission Level – Limit value

4.2 Conducted Emission Measurement

4.2.1 Limits of Conducted Emission Measurement

Frequency (MHz)	Conducted Limit (dBuV)	
	Quasi-peak	Average
0.15 - 0.5	66 - 56	56 - 46
0.50 - 5.0	56	46
5.0 - 30.0	60	50

Note: 1. The lower limit shall apply at the transition frequencies.

2. The limit decreases in line with the logarithm of the frequency in the range of 0.15 to 0.50MHz.

4.2.2 Test Instruments

Description & Manufacturer	Model No.	Serial No.	Cal. Date	Cal. Due
ROHDE & SCHWARZ TEST RECEIVER	ESCS 30	100276	Apr. 10, 2017	Apr. 09, 2018
ROHDE & SCHWARZ Artificial Mains Network (for EUT)	ENV216	101197	May 22, 2017	May 21, 2018
LISN With Adapter (for EUT)	AD10	C10Ada-002	May 22, 2017	May 21, 2018
ROHDE & SCHWARZ Artificial Mains Network (for peripherals)	ESH3-Z5	100218	Nov. 23, 2016	Nov. 22, 2017
SCHWARZBECK Artificial Mains Network (For EUT)	NNLK8129	8129229	May 09, 2017	May 08, 2018
Software	Cond_V7.3.7.4	NA	NA	NA
RF cable (JYEBAO) With 10dB PAD	5D-FB	Cable-C10.01	Feb. 14, 2017	Feb. 13, 2018
SUHNER Terminator (For ROHDE & SCHWARZ LISN)	65BNC-5001	E1-011484	May 18, 2017	May 17, 2018
ROHDE & SCHWARZ Artificial Mains Network (For TV EUT)	ESH3-Z5	100220	Nov. 08, 2016	Nov. 07, 2017
LISN With Adapter (for TV EUT)	100220	N/A	Nov. 08, 2016	Nov. 07, 2017

Notes: 1. The calibration interval of the above test instruments is 12 months and the calibrations are traceable to NML/ROC and NIST/USA.

2. The test was performed in Shielded Room No. 10.

3. The VCCI Site Registration No. C-1852.

4.2.3 Test Procedure

- The EUT was placed 0.4 meters from the conducting wall of the shielded room with EUT being connected to the power mains through a line impedance stabilization network (LISN). Other support units were connected to the power mains through another LISN. The two LISNs provide 50 ohm/ 50uH of coupling impedance for the measuring instrument.
- Both lines of the power mains connected to the EUT were checked for maximum conducted interference.
- The frequency range from 150kHz to 30MHz was searched. Emission levels under (Limit - 20dB) was not recorded.

NOTE: All modes of operation were investigated and the worst-case emissions are reported.

4.2.4 Deviation from Test Standard

No deviation.

4.2.5 Test Setup

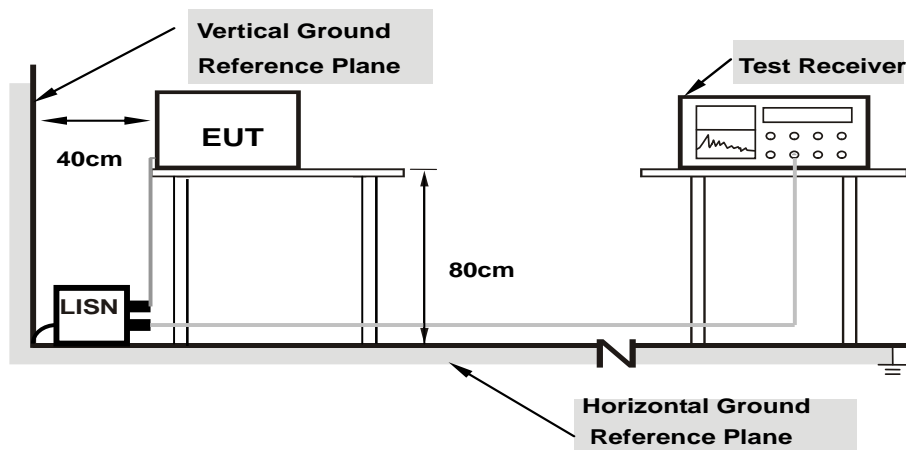

Note: 1.Support units were connected to second LISN.

For the actual test configuration, please refer to the attached file (Test Setup Photo).

4.2.6 EUT Operating Condition

- Connected the EUT with AC adaptor or PoE placed on testing table.
- The EUT perform R/W function with USB flash from AE notebooks via LAN cables.
- Set the EUT under transmission condition continuously at specific channel frequency.

4.2.7 Test Results

CDD Mode (Mode A)

Phase	Line (L)	Detector Function	Quasi-Peak (QP) / Average (AV)
-------	----------	-------------------	--------------------------------

No	Freq. [MHz]	Corr.	Reading Value		Emission Level		Limit		Margin	
		Factor (dB)	[dB (uV)]		[dB (uV)]		[dB (uV)]		(dB)	
	Q.P.	AV.	Q.P.	AV.	Q.P.	AV.	Q.P.	AV.	Q.P.	AV.
1	0.15000	9.65	33.32	24.03	42.97	33.68	66.00	56.00	-23.03	-22.32
2	0.35703	9.66	36.96	36.83	46.62	46.49	58.80	48.80	-12.18	-2.31
3	0.63828	9.68	19.92	18.22	29.60	27.90	56.00	46.00	-26.40	-18.10
4	4.09766	9.84	20.05	13.08	29.89	22.92	56.00	46.00	-26.11	-23.08
5	9.97656	9.93	26.26	21.70	36.19	31.63	60.00	50.00	-23.81	-18.37
6	21.87500	10.02	28.12	26.55	38.14	36.57	60.00	50.00	-21.86	-13.43

REMARKS:

1. Q.P. and AV. are abbreviations of quasi-peak and average individually.
2. The emission levels of other frequencies were very low against the limit.
3. Margin value = Emission level - Limit value
4. Correction factor = Insertion loss + Cable loss
5. Emission Level = Correction Factor + Reading Value.

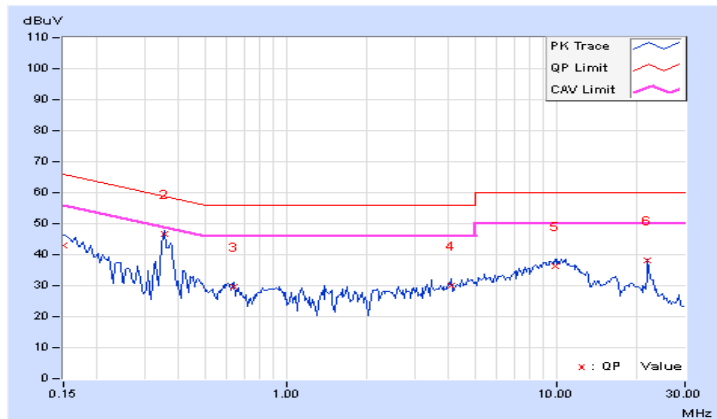

Phase	Neutral (N)	Detector Function	Quasi-Peak (QP) / Average (AV)
-------	-------------	-------------------	--------------------------------

No	Freq. [MHz]	Corr.	Reading Value		Emission Level		Limit		Margin	
		Factor	[dB (uV)]		[dB (uV)]		[dB (uV)]		(dB)	
		(dB)	Q.P.	AV.	Q.P.	AV.	Q.P.	AV.	Q.P.	AV.
1	0.15391	9.67	37.26	24.53	46.93	34.20	65.79	55.79	-18.86	-21.59
2	0.35313	9.68	38.20	36.66	47.88	46.34	58.89	48.89	-11.01	-2.55
3	0.63828	9.69	20.62	19.02	30.31	28.71	56.00	46.00	-25.69	-17.29
4	2.62891	9.78	17.93	11.07	27.71	20.85	56.00	46.00	-28.29	-25.15
5	10.91016	9.96	25.99	21.34	35.95	31.30	60.00	50.00	-24.05	-18.70
6	21.87500	10.08	29.12	28.49	39.20	38.57	60.00	50.00	-20.80	-11.43

REMARKS:

1. Q.P. and AV. are abbreviations of quasi-peak and average individually.
2. The emission levels of other frequencies were very low against the limit.
3. Margin value = Emission level - Limit value
4. Correction factor = Insertion loss + Cable loss
5. Emission Level = Correction Factor + Reading Value.

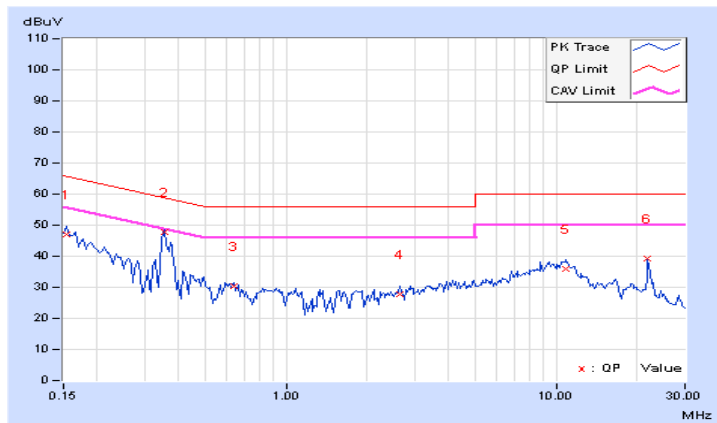

CDD Mode (Mode B)

Phase	Line (L)	Detector Function	Quasi-Peak (QP) / Average (AV)
-------	----------	-------------------	--------------------------------

No	Freq. [MHz]	Corr.	Reading Value		Emission Level		Limit		Margin	
		Factor (dB)	[dB (uV)]		[dB (uV)]		[dB (uV)]		(dB)	
		Q.P.	AV.	Q.P.	AV.	Q.P.	AV.	Q.P.	AV.	
1	0.15781	9.65	37.44	25.48	47.09	35.13	65.58	55.58	-18.49	-20.45
2	0.35703	9.66	37.95	36.34	47.61	46.00	58.80	48.80	-11.19	-2.80
3	0.64609	9.68	20.56	18.85	30.24	28.53	56.00	46.00	-25.76	-17.47
4	0.98594	9.70	18.64	12.07	28.34	21.77	56.00	46.00	-27.66	-24.23
5	3.61328	9.82	19.84	12.56	29.66	22.38	56.00	46.00	-26.34	-23.62
6	10.50000	9.93	26.21	21.65	36.14	31.58	60.00	50.00	-23.86	-18.42

REMARKS:

1. Q.P. and AV. are abbreviations of quasi-peak and average individually.
2. The emission levels of other frequencies were very low against the limit.
3. Margin value = Emission level - Limit value
4. Correction factor = Insertion loss + Cable loss
5. Emission Level = Correction Factor + Reading Value.

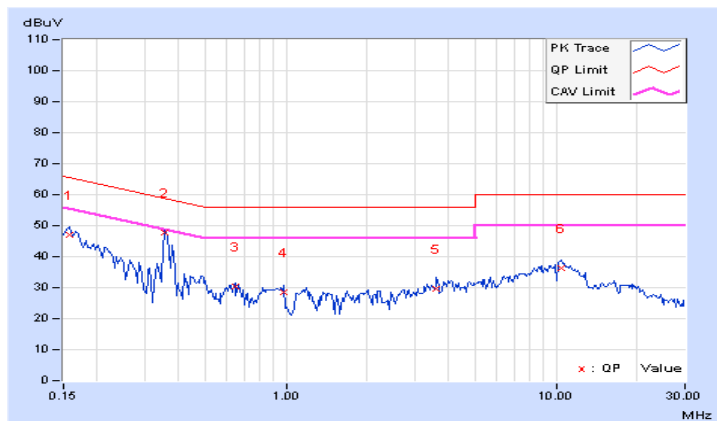

Phase	Neutral (N)	Detector Function	Quasi-Peak (QP) / Average (AV)
-------	-------------	-------------------	--------------------------------

No	Freq. [MHz]	Corr.	Reading Value		Emission Level		Limit		Margin	
		Factor	[dB (uV)]		[dB (uV)]		[dB (uV)]		(dB)	
		(dB)	Q.P.	AV.	Q.P.	AV.	Q.P.	AV.	Q.P.	AV.
1	0.15391	9.67	36.27	25.04	45.94	34.71	65.79	55.79	-19.85	-21.08
2	0.36094	9.68	36.46	33.29	46.14	42.97	58.71	48.71	-12.57	-5.74
3	0.95859	9.71	18.07	13.59	27.78	23.30	56.00	46.00	-28.22	-22.70
4	1.40625	9.73	18.54	14.17	28.27	23.90	56.00	46.00	-27.73	-22.10
5	4.14844	9.86	19.70	12.96	29.56	22.82	56.00	46.00	-26.44	-23.18
6	10.00391	9.95	26.20	21.56	36.15	31.51	60.00	50.00	-23.85	-18.49

REMARKS:

1. Q.P. and AV. are abbreviations of quasi-peak and average individually.
2. The emission levels of other frequencies were very low against the limit.
3. Margin value = Emission level - Limit value
4. Correction factor = Insertion loss + Cable loss
5. Emission Level = Correction Factor + Reading Value.

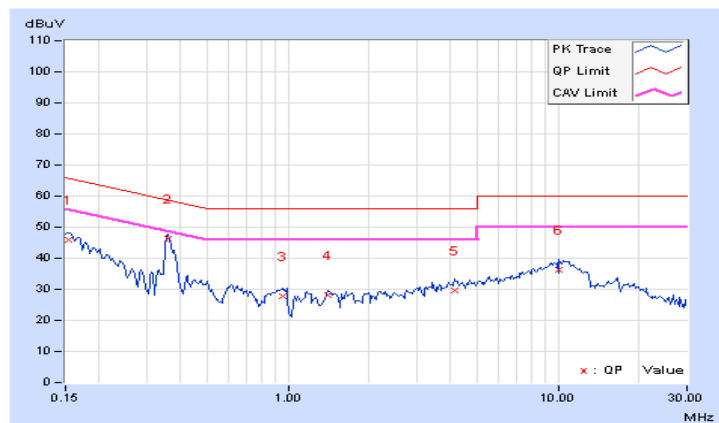

CDD Mode (Mode C)

Phase	Line (L)	Detector Function	Quasi-Peak (QP) / Average (AV)
-------	----------	-------------------	--------------------------------

No	Freq. [MHz]	Corr.	Reading Value		Emission Level		Limit		Margin	
		Factor (dB)	[dB (uV)]		[dB (uV)]		[dB (uV)]		(dB)	
			Q.P.	AV.	Q.P.	AV.	Q.P.	AV.	Q.P.	AV.
1	0.15000	9.65	29.03	15.95	38.68	25.60	66.00	56.00	-27.32	-30.40
2	0.41563	9.66	26.60	18.71	36.26	28.37	57.54	47.54	-21.28	-19.17
3	0.72031	9.68	14.55	6.73	24.23	16.41	56.00	46.00	-31.77	-29.59
4	1.66406	9.73	9.33	1.32	19.06	11.05	56.00	46.00	-36.94	-34.95
5	3.47266	9.81	7.63	1.53	17.44	11.34	56.00	46.00	-38.56	-34.66
6	13.31250	9.95	8.70	0.83	18.65	10.78	60.00	50.00	-41.35	-39.22

REMARKS:

1. Q.P. and AV. are abbreviations of quasi-peak and average individually.
2. The emission levels of other frequencies were very low against the limit.
3. Margin value = Emission level - Limit value
4. Correction factor = Insertion loss + Cable loss
5. Emission Level = Correction Factor + Reading Value.

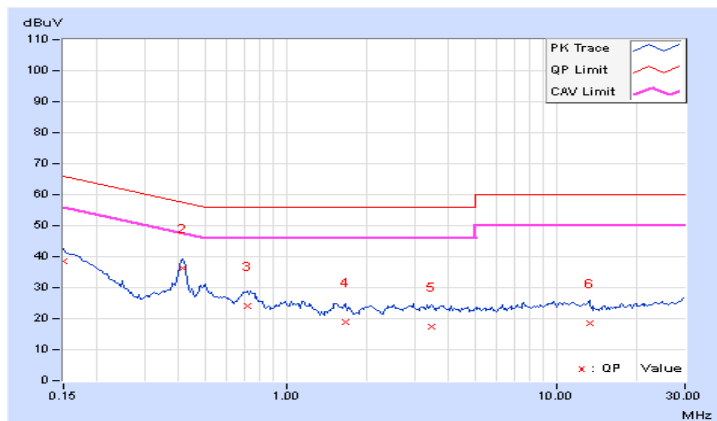

Phase	Neutral (N)	Detector Function	Quasi-Peak (QP) / Average (AV)
-------	-------------	-------------------	--------------------------------

No	Freq. [MHz]	Corr.	Reading Value		Emission Level		Limit		Margin	
		Factor	[dB (uV)]		[dB (uV)]		[dB (uV)]		(dB)	
		(dB)	Q.P.	AV.	Q.P.	AV.	Q.P.	AV.	Q.P.	AV.
1	0.15391	9.67	25.72	12.33	35.39	22.00	65.79	55.79	-30.40	-33.79
2	0.41172	9.68	25.76	17.90	35.44	27.58	57.61	47.61	-22.17	-20.03
3	0.50156	9.69	14.69	6.35	24.38	16.04	56.00	46.00	-31.62	-29.96
4	1.07813	9.71	10.28	2.74	19.99	12.45	56.00	46.00	-36.01	-33.55
5	4.62500	9.87	5.52	1.99	15.39	11.86	56.00	46.00	-40.61	-34.14
6	13.27734	9.99	10.42	2.35	20.41	12.34	60.00	50.00	-39.59	-37.66

REMARKS:

1. Q.P. and AV. are abbreviations of quasi-peak and average individually.
2. The emission levels of other frequencies were very low against the limit.
3. Margin value = Emission level - Limit value
4. Correction factor = Insertion loss + Cable loss
5. Emission Level = Correction Factor + Reading Value.

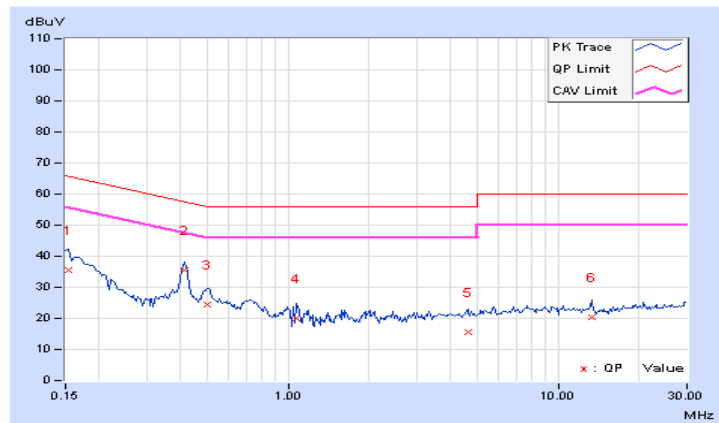

CDD Mode (Mode D)

Phase	Line (L)	Detector Function	Quasi-Peak (QP) / Average (AV)
-------	----------	-------------------	--------------------------------

No	Freq. [MHz]	Corr.	Reading Value		Emission Level		Limit		Margin	
		Factor (dB)	[dB (uV)]		[dB (uV)]		[dB (uV)]		(dB)	
			Q.P.	AV.	Q.P.	AV.	Q.P.	AV.	Q.P.	AV.
1	0.15000	9.65	27.97	14.66	37.62	24.31	66.00	56.00	-28.38	-31.69
2	0.41563	9.66	26.12	18.47	35.78	28.13	57.54	47.54	-21.76	-19.41
3	0.49375	9.67	15.87	6.64	25.54	16.31	56.10	46.10	-30.56	-29.79
4	0.73984	9.68	12.51	4.80	22.19	14.48	56.00	46.00	-33.81	-31.52
5	2.43750	9.76	5.10	2.93	14.86	12.69	56.00	46.00	-41.14	-33.31
6	13.28516	9.95	9.48	1.50	19.43	11.45	60.00	50.00	-40.57	-38.55

REMARKS:

1. Q.P. and AV. are abbreviations of quasi-peak and average individually.
2. The emission levels of other frequencies were very low against the limit.
3. Margin value = Emission level - Limit value
4. Correction factor = Insertion loss + Cable loss
5. Emission Level = Correction Factor + Reading Value.

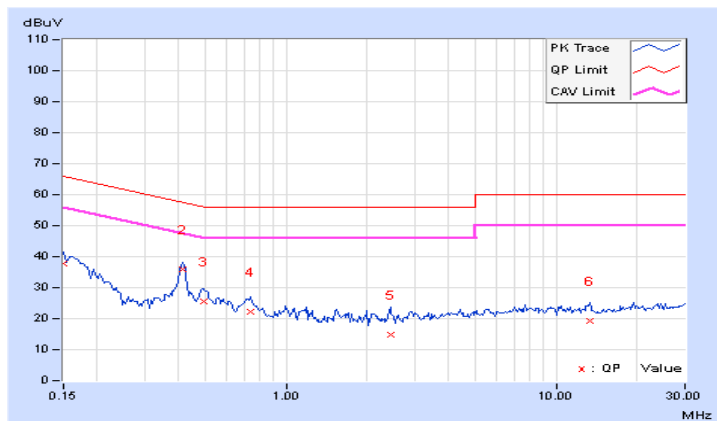

Phase	Neutral (N)	Detector Function	Quasi-Peak (QP) / Average (AV)
-------	-------------	-------------------	--------------------------------

No	Freq. [MHz]	Corr.	Reading Value		Emission Level		Limit		Margin	
		Factor	[dB (uV)]		[dB (uV)]		[dB (uV)]		(dB)	
		(dB)	Q.P.	AV.	Q.P.	AV.	Q.P.	AV.	Q.P.	AV.
1	0.15000	9.68	29.03	16.25	38.71	25.93	66.00	56.00	-27.29	-30.07
2	0.41563	9.68	26.85	19.10	36.53	28.78	57.54	47.54	-21.01	-18.76
3	0.50156	9.69	15.52	7.29	25.21	16.98	56.00	46.00	-30.79	-29.02
4	0.74375	9.70	14.35	6.28	24.05	15.98	56.00	46.00	-31.95	-30.02
5	1.66016	9.74	9.86	1.42	19.60	11.16	56.00	46.00	-36.40	-34.84
6	7.75781	9.92	3.96	3.72	13.88	13.64	60.00	50.00	-46.12	-36.36

REMARKS:

1. Q.P. and AV. are abbreviations of quasi-peak and average individually.
2. The emission levels of other frequencies were very low against the limit.
3. Margin value = Emission level - Limit value
4. Correction factor = Insertion loss + Cable loss
5. Emission Level = Correction Factor + Reading Value.

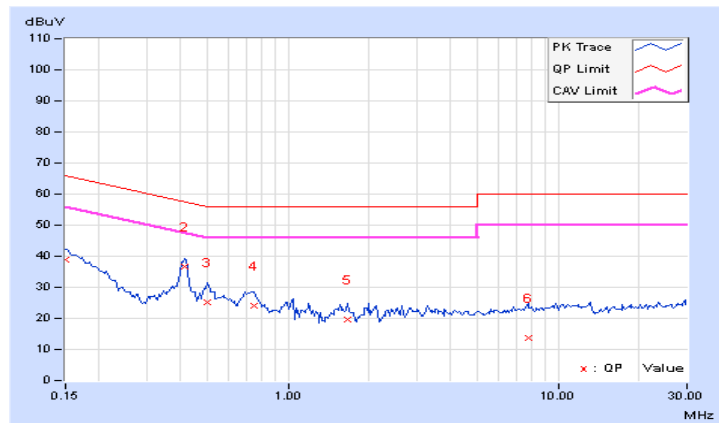

4.3 Transmit Power Measurement

4.3.1 Limits of Transmit Power Measurement

Operation Band	EUT Category		Limit
U-NII-1		Outdoor Access Point	1 Watt (30 dBm) (Max. e.i.r.p \leq 125mW(21 dBm) at any elevation angle above 30 degrees as measured from the horizon)
		Fixed point-to-point Access Point	1 Watt (30 dBm)
	√	Indoor Access Point	1 Watt (30 dBm)
		Mobile and Portable client device	250mW (24 dBm)
U-NII-2A	---		250mW (24 dBm) or 11 dBm+10 log B*
U-NII-2C	---		250mW (24 dBm) or 11 dBm+10 log B*
U-NII-3	√		1 Watt (30 dBm)

*B is the 26 dB emission bandwidth in megahertz

Per KDB 662911 Method of conducted output power measurement on IEEE 802.11 devices,

Array Gain = 0 dB (i.e., no array gain) for $N_{ANT} \leq 4$;

Array Gain = 0 dB (i.e., no array gain) for channel widths ≥ 40 MHz for any N_{ANT} ;

Array Gain = $5 \log(N_{ANT}/N_{SS})$ dB or 3 dB, whichever is less for 20-MHz channel widths with $N_{ANT} \geq 5$.

For power measurements on all other devices: Array Gain = $10 \log(N_{ANT}/N_{SS})$ dB.

4.3.2 Test Setup

FOR POWER OUTPUT MEASUREMENT

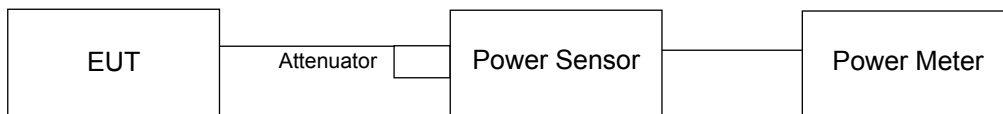

FOR 26dB OCCUPIED BANDWIDTH

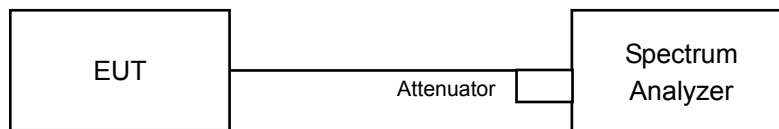

4.3.3 Test Instruments

Refer to section 4.1.2 to get information of above instrument.

4.3.4 Test Procedure

For Average Power Measurement

For 802.11a, 802.11ac (20MHz), 802.11ac (40MHz)

Method PM is used to perform output power measurement, trigger and gating function of wide band power meter is enabled to measure max output power of TX on burst. Duty factor is not added to measured value.

For 802.11ac (80MHz)

- 1) Set span to encompass the entire 26 dB EBW (or, alternatively, the entire 99% occupied bandwidth) of the signal.
- 2) Set sweep trigger to "free run".
- 3) Set RBW = 1 MHz.
- 4) Set VBW \geq 3 MHz
- 5) Number of points in sweep \geq 2 Span / RBW.
- 6) Sweep time \leq (number of points in sweep) * T
- 7) Using emission bandwidth to determine the frequency span for integration the channel bandwidth.
- 8) Detector = RMS.
- 9) Trace mode = max hold.
- 10) Allow max hold to run for at least 60 seconds, or longer as needed to allow the trace to stabilize.

For 26dB Occupied Bandwidth

- 1) Set RBW = approximately 1% of the emission bandwidth.
- 2) Set the VBW > RBW.
- 3) Detector = Peak.
- 4) Trace mode = max hold.
- 5) Measure the maximum width of the emission that is 26 dB down from the peak of the emission. Compare this with the RBW setting of the analyzer. Readjust RBW and repeat measurement as needed until the RBW/EBW ratio is approximately 1%.

4.3.5 Deviation from Test Standard

No deviation.

4.3.6 EUT Operating Condition

The software provided by client to enable the EUT under transmission condition continuously at lowest, middle and highest channel frequencies individually.

4.3.7 Test Result

CDD Mode (Mode A)

Power Output:

802.11a

Chan.	Chan. Freq. (MHz)	Maximum Conducted Power (dBm)				Total Power (mW)	Total Power (dBm)	Power Limit (dBm)	Pass/Fail
		Chain 0	Chain 1	Chain 2	Chain 3				
36	5180	11.78	11.67	11.42	11.56	57.945	17.63	30.00	Pass
40	5200	11.81	11.70	11.42	11.60	58.284	17.66	30.00	Pass
48	5240	11.77	11.65	11.45	11.58	58.005	17.63	30.00	Pass
149	5745	23.81	23.76	23.64	23.72	944.831	29.75	30.00	Pass
157	5785	23.86	23.78	23.68	23.74	951.939	29.79	30.00	Pass
165	5825	23.84	23.75	23.67	23.70	946.472	29.76	30.00	Pass

802.11n (20MHz)

Chan.	Chan. Freq. (MHz)	Maximum Conducted Power (dBm)				Total Power (mW)	Total Power (dBm)	Power Limit (dBm)	Pass/Fail
		Chain 0	Chain 1	Chain 2	Chain 3				
36	5180	12.02	11.93	11.82	11.89	62.176	17.94	30.00	Pass
40	5200	12.07	11.94	11.76	11.88	62.151	17.93	30.00	Pass
48	5240	12.13	11.99	11.74	11.88	62.488	17.96	30.00	Pass
149	5745	23.84	23.75	23.60	23.72	943.832	29.75	30.00	Pass
157	5785	23.85	23.71	23.64	23.69	942.714	29.74	30.00	Pass
165	5825	23.87	23.77	23.62	23.74	948.749	29.77	30.00	Pass

802.11n (40MHz)

Chan.	Chan. Freq. (MHz)	Maximum Conducted Power (dBm)				Total Power (mW)	Total Power (dBm)	Power Limit (dBm)	Pass/Fail
		Chain 0	Chain 1	Chain 2	Chain 3				
38	5190	12.25	12.13	12.00	12.04	64.964	18.13	30.00	Pass
46	5230	12.26	12.17	12.04	12.11	65.560	18.17	30.00	Pass
151	5755	23.83	23.72	23.62	23.70	941.618	29.74	30.00	Pass
159	5795	23.87	23.75	23.59	23.72	944.983	29.75	30.00	Pass

802.11ac (80MHz)

Chan.	Chan. Freq. (MHz)	Maximum Conducted Power (dBm)				Total Power (mW)	Total Power (dBm)	Power Limit (dBm)	Pass/Fail
		Chain 0	Chain 1	Chain 2	Chain 3				
42	5210	12.32	12.18	12.05	12.09	65.794	18.18	30.00	Pass
155	5775	21.98	21.90	21.81	21.86	617.81	27.91	30.00	Pass

26dB Bandwidth:
802.11a

Channel	Channel Frequency (MHz)	26dBc Bandwidth (MHz)				Pass/Fail
		Chain 0	Chain 1	Chain 2	Chain 3	
36	5180	20.11	20.13	20.11	20.32	Pass
40	5200	19.87	20.04	20.02	19.96	Pass
48	5240	20.09	19.92	20.11	20.17	Pass

802.11n (20MHz)

Channel	Channel Frequency (MHz)	26dBc Bandwidth (MHz)				Pass/Fail
		Chain 0	Chain 1	Chain 2	Chain 3	
36	5180	20.71	20.55	20.71	20.50	Pass
40	5200	20.82	20.93	20.89	20.92	Pass
48	5240	20.78	20.63	21.13	20.76	Pass

802.11n (40MHz)

Channel	Channel Frequency (MHz)	26dBc Bandwidth (MHz)				Pass/Fail
		Chain 0	Chain 1	Chain 2	Chain 3	
38	5190	39.99	40.06	40.25	40.13	Pass
46	5230	39.91	40.00	40.02	40.02	Pass

802.11ac (80MHz)

Channel	Channel Frequency (MHz)	26dBc Bandwidth (MHz)				Pass/Fail
		Chain 0	Chain 1	Chain 2	Chain 3	
42	5210	83.52	83.99	84.34	83.70	Pass

Spectrum Plot of Worst Value

802.11a / Chain 3: CH36

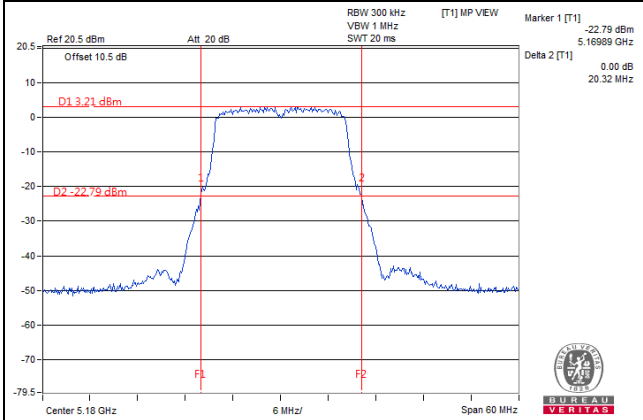

802.11n (20MHz) / Chain 1: CH40

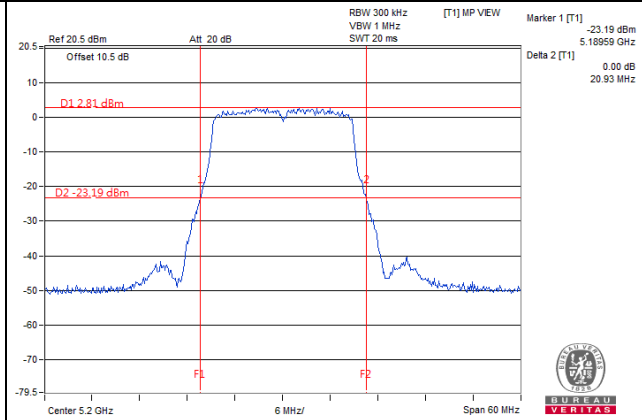

802.11n (40MHz) / Chain 2: CH38

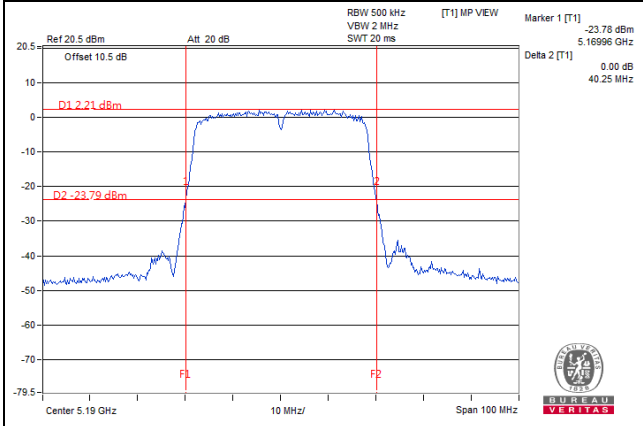

802.11ac (80MHz) / Chain 2: CH42

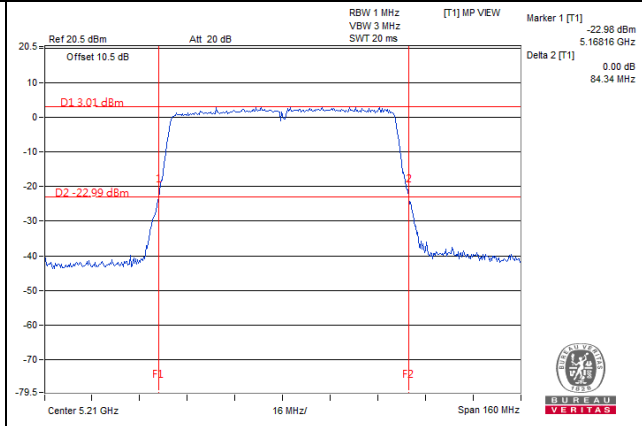

CDD Mode (Mode B)
Power Output:
802.11a

Chan.	Chan. Freq. (MHz)	Maximum Conducted Power (dBm)				Total Power (mW)	Total Power (dBm)	Power Limit (dBm)	Pass/Fail
		Chain 0	Chain 1	Chain 2	Chain 3				
36	5180	10.09	10.01	9.95	9.96	40.026	16.02	30.00	Pass
40	5200	10.12	10.07	9.92	10.01	40.282	16.05	30.00	Pass
48	5240	10.14	10.05	9.98	9.99	40.375	16.06	30.00	Pass
149	5745	23.81	23.76	23.64	23.72	944.831	29.75	30.00	Pass
157	5785	23.86	23.78	23.68	23.74	951.939	29.79	30.00	Pass
165	5825	23.84	23.75	23.67	23.70	946.472	29.76	30.00	Pass

802.11n (20MHz)

Chan.	Chan. Freq. (MHz)	Maximum Conducted Power (dBm)				Total Power (mW)	Total Power (dBm)	Power Limit (dBm)	Pass/Fail
		Chain 0	Chain 1	Chain 2	Chain 3				
36	5180	10.45	10.37	10.25	10.26	43.191	16.35	30.00	Pass
40	5200	10.42	10.39	10.22	10.31	43.215	16.36	30.00	Pass
48	5240	10.38	10.32	10.27	10.32	43.085	16.34	30.00	Pass
149	5745	23.84	23.75	23.60	23.72	943.832	29.75	30.00	Pass
157	5785	23.85	23.71	23.64	23.69	942.714	29.74	30.00	Pass
165	5825	23.87	23.77	23.62	23.74	948.749	29.77	30.00	Pass

802.11n (40MHz)

Chan.	Chan. Freq. (MHz)	Maximum Conducted Power (dBm)				Total Power (mW)	Total Power (dBm)	Power Limit (dBm)	Pass/Fail
		Chain 0	Chain 1	Chain 2	Chain 3				
38	5190	10.63	10.52	10.39	10.47	44.916	16.52	30.00	Pass
46	5230	10.65	10.60	10.42	10.49	45.305	16.56	30.00	Pass
151	5755	23.83	23.72	23.62	23.70	941.618	29.74	30.00	Pass
159	5795	23.87	23.75	23.59	23.72	944.983	29.75	30.00	Pass

802.11ac (80MHz)

Chan.	Chan. Freq. (MHz)	Maximum Conducted Power (dBm)				Total Power (mW)	Total Power (dBm)	Power Limit (dBm)	Pass/Fail
		Chain 0	Chain 1	Chain 2	Chain 3				
42	5210	10.68	10.61	10.48	10.55	45.722	16.60	30.00	Pass
155	5775	20.54	20.44	20.25	20.37	438.72	26.42	30.00	Pass

26dB Bandwidth:

802.11a

Channel	Channel Frequency (MHz)	26dBc Bandwidth (MHz)				Pass/Fail
		Chain 0	Chain 1	Chain 2	Chain 3	
36	5180	19.97	20.04	20.11	20.05	Pass
40	5200	20.02	19.99	19.94	20.04	Pass
48	5240	20.10	20.27	20.13	20.06	Pass

802.11n (20MHz)

Channel	Channel Frequency (MHz)	26dBc Bandwidth (MHz)				Pass/Fail
		Chain 0	Chain 1	Chain 2	Chain 3	
36	5180	20.71	20.91	20.89	20.75	Pass
40	5200	20.75	20.87	20.86	20.71	Pass
48	5240	21.10	20.74	20.91	20.66	Pass

802.11n (40MHz)

Channel	Channel Frequency (MHz)	26dBc Bandwidth (MHz)				Pass/Fail
		Chain 0	Chain 1	Chain 2	Chain 3	
38	5190	40.02	40.05	40.37	39.76	Pass
46	5230	39.91	40.32	40.15	40.12	Pass

802.11ac (80MHz)

Channel	Channel Frequency (MHz)	26dBc Bandwidth (MHz)				Pass/Fail
		Chain 0	Chain 1	Chain 2	Chain 3	
42	5210	83.97	83.93	84.26	84.09	Pass

Spectrum Plot of Worst Value

802.11a / Chain 1: CH48

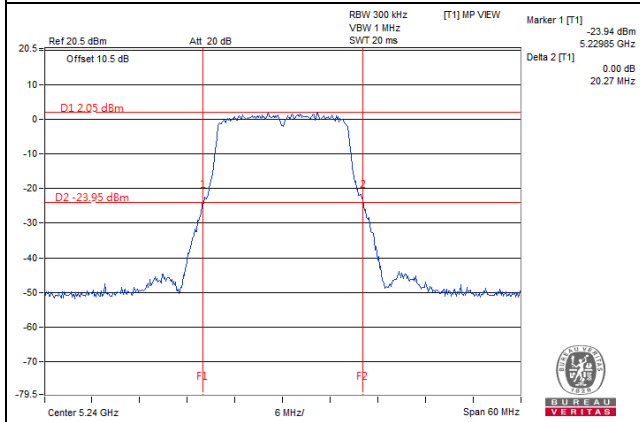

802.11n (20MHz) / Chain 0: CH48

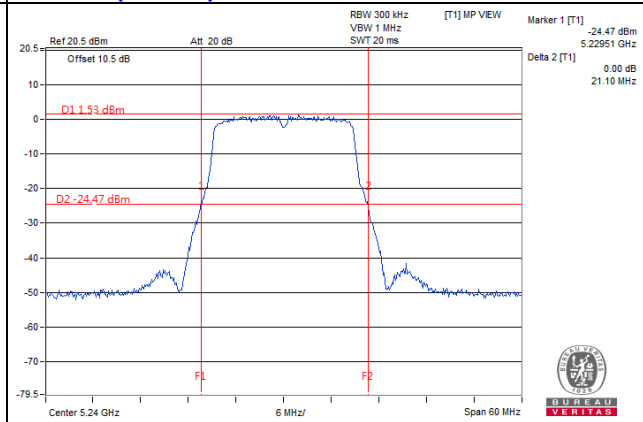

802.11n (40MHz) / Chain 2:CH38

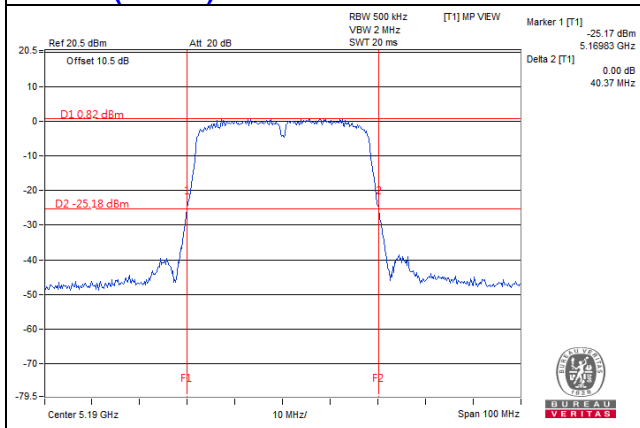

802.11ac (80MHz) / Chain 2:CH42

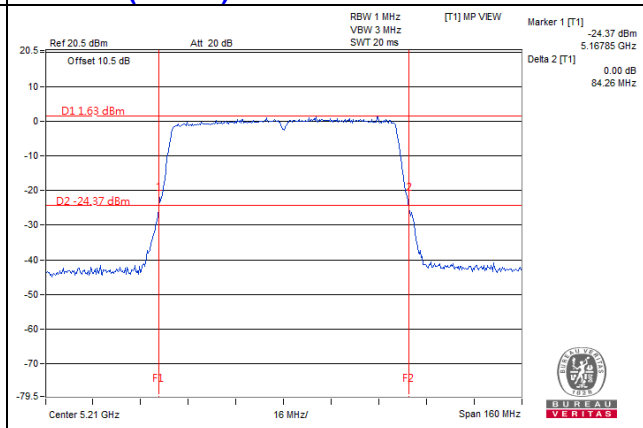

Beamforming_NSS1 Mode (Mode A)

Power Output:

802.11ac (20MHz)

Chan.	Chan. Freq. (MHz)	Maximum Conducted Power (dBm)				Total Power (mW)	Total Power (dBm)	Power Limit (dBm)	Pass/Fail
		Chain 0	Chain 1	Chain 2	Chain 3				
36	5180	7.02	6.89	6.81	6.87	19.583	12.92	25.63	Pass
40	5200	7.09	6.89	6.78	6.88	19.643	12.93	25.63	Pass
48	5240	7.15	6.91	6.74	6.91	19.727	12.95	25.63	Pass
149	5745	19.32	19.27	19.11	19.20	334.681	25.25	25.63	Pass
157	5785	19.35	19.22	19.15	19.18	334.677	25.25	25.63	Pass
165	5825	19.38	19.25	19.12	19.23	336.247	25.27	25.63	Pass

NOTE: Directional gain = $10 \log[(10^{G1/20} + 10^{G2/20} + \dots + 10^{GN/20})^2 / 4] = 10.37\text{dBi} > 6\text{dBi}$, so the Conducted Power limit shall be reduced to $30 - (10.37 - 6) = 25.63\text{dBm}$

802.11ac (40MHz)

Chan.	Chan. Freq. (MHz)	Maximum Conducted Power (dBm)				Total Power (mW)	Total Power (dBm)	Power Limit (dBm)	Pass/Fail
		Chain 0	Chain 1	Chain 2	Chain 3				
38	5190	7.22	7.11	7.06	7.03	20.541	13.13	25.63	Pass
46	5230	7.28	7.17	7.04	7.12	20.768	13.17	25.63	Pass
151	5755	19.32	19.23	19.14	19.21	334.663	25.25	25.63	Pass
159	5795	19.36	19.24	19.10	19.22	335.087	25.25	25.63	Pass

NOTE: Directional gain = $10 \log[(10^{G1/20} + 10^{G2/20} + \dots + 10^{GN/20})^2 / 4] = 10.37\text{dBi} > 6\text{dBi}$, so the Conducted Power limit shall be reduced to $30 - (10.37 - 6) = 25.63\text{dBm}$

802.11ac (80MHz)

Chan.	Chan. Freq. (MHz)	Maximum Conducted Power (dBm)				Total Power (mW)	Total Power (dBm)	Power Limit (dBm)	Pass/Fail
		Chain 0	Chain 1	Chain 2	Chain 3				
42	5210	7.28	7.15	7.08	7.09	20.756	13.17	25.63	Pass
155	5775	19.42	19.40	19.34	19.32	346.002	25.39	25.63	Pass

NOTE: Directional gain = $10 \log[(10^{G1/20} + 10^{G2/20} + \dots + 10^{GN/20})^2 / 4] = 10.37\text{dBi} > 6\text{dBi}$, so the Conducted Power limit shall be reduced to $30 - (10.37 - 6) = 25.63\text{dBm}$

Beamforming_NSS1 Mode (Mode B)

Power Output:

802.11ac (20MHz)

Chan.	Chan. Freq. (MHz)	Maximum Conducted Power (dBm)				Total Power (mW)	Total Power (dBm)	Power Limit (dBm)	Pass/Fail
		Chain 0	Chain 1	Chain 2	Chain 3				
36	5180	5.45	5.32	5.25	5.31	13.658	11.35	23.98	Pass
40	5200	5.40	5.40	5.24	5.31	13.672	11.36	23.98	Pass
48	5240	5.37	5.32	5.28	5.32	13.624	11.34	23.98	Pass
149	5745	17.85	17.76	17.62	17.71	237.488	23.76	23.98	Pass
157	5785	17.77	17.74	17.64	17.72	236.502	23.74	23.98	Pass
165	5825	17.88	17.77	17.63	17.74	238.589	23.78	23.98	Pass

NOTE: Directional gain = $10 \log[(10^{G1/20} + 10^{G2/20} + \dots + 10^{GN/20})^2 / 4] = 12.02\text{dBi} > 6\text{dBi}$, so the Conducted Power limit shall be reduced to $30 - (12.02 - 6) = 23.98\text{dBm}$

802.11ac (40MHz)

Chan.	Chan. Freq. (MHz)	Maximum Conducted Power (dBm)				Total Power (mW)	Total Power (dBm)	Power Limit (dBm)	Pass/Fail
		Chain 0	Chain 1	Chain 2	Chain 3				
38	5190	5.62	5.51	5.39	5.46	14.179	11.52	23.98	Pass
46	5230	5.65	5.58	5.42	5.51	14.326	11.56	23.98	Pass
151	5755	17.85	17.71	17.65	17.70	237.068	23.75	23.98	Pass
159	5795	17.87	17.75	17.61	17.72	237.634	23.76	23.98	Pass

NOTE: Directional gain = $10 \log[(10^{G1/20} + 10^{G2/20} + \dots + 10^{GN/20})^2 / 4] = 12.02\text{dBi} > 6\text{dBi}$, so the Conducted Power limit shall be reduced to $30 - (12.02 - 6) = 23.98\text{dBm}$

802.11ac (80MHz)

Chan.	Chan. Freq. (MHz)	Maximum Conducted Power (dBm)				Total Power (mW)	Total Power (dBm)	Power Limit (dBm)	Pass/Fail
		Chain 0	Chain 1	Chain 2	Chain 3				
42	5210	5.67	5.62	5.48	5.55	14.459	11.60	23.98	Pass
155	5775	17.88	17.91	17.62	17.62	238.798	23.78	23.98	Pass

NOTE: Directional gain = $10 \log[(10^{G1/20} + 10^{G2/20} + \dots + 10^{GN/20})^2 / 4] = 12.02\text{dBi} > 6\text{dBi}$, so the Conducted Power limit shall be reduced to $30 - (12.02 - 6) = 23.98\text{dBm}$

4.4 Occupied Bandwidth Measurement

4.4.1 Test Setup

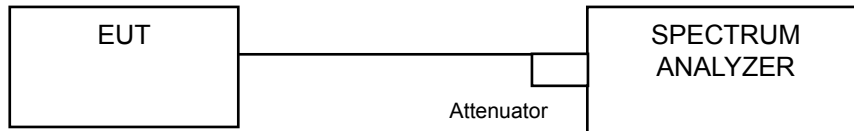

4.4.2 Test Instruments

Refer to section 4.1.2 to get information of above instrument.

4.4.3 Test Procedure

The transmitter output was connected to the spectrum analyzer through an attenuator. The bandwidth of the fundamental frequency was measured by spectrum analyzer with resolution bandwidth in the range of 1% to 5% of the anticipated emission bandwidth, and a video bandwidth at least 3x the resolution bandwidth and set the detector to SAMPLE. The width of a frequency band such that, below the lower and above the upper frequency limits, the mean powers emitted are each equal to a specified percentage 0.5 %of the total mean power of a given emission.

4.4.4 Test Results

CDD Mode (Mode A)

802.11a

Channel	Channel Frequency (MHz)	Occupied Bandwidth (Mhz)				Pass / Fail
		Chain 0	Chain 1	Chain 2	Chain 3	
36	5180	16.56	16.44	16.56	16.44	Pass
40	5200	16.44	16.44	16.44	16.56	Pass
48	5240	16.44	16.56	16.44	16.44	Pass
149	5745	16.52	16.60	16.60	16.60	Pass
157	5785	16.60	16.60	16.60	16.60	Pass
165	5825	16.60	16.60	16.60	16.60	Pass

802.11n (20MHz)

Channel	Channel Frequency (MHz)	Occupied Bandwidth (Mhz)				Pass / Fail
		Chain 0	Chain 1	Chain 2	Chain 3	
36	5180	17.76	17.76	17.64	17.64	Pass
40	5200	17.64	17.64	17.64	17.64	Pass
48	5240	17.64	17.64	17.64	17.64	Pass
149	5745	17.73	17.70	17.70	17.70	Pass
157	5785	17.80	17.80	17.70	17.80	Pass
165	5825	17.80	17.70	17.70	17.70	Pass

802.11n (40MHz)

Channel	Channel Frequency (MHz)	Occupied Bandwidth (Mhz)				Pass / Fail
		Chain 0	Chain 1	Chain 2	Chain 3	
38	5190	36.00	36.00	36.00	36.00	Pass
46	5230	36.00	36.00	36.00	36.00	Pass
151	5755	36.23	36.16	36.16	36.16	Pass
159	5795	36.16	36.16	36.33	36.33	Pass

802.11ac (80MHz)

Channel	Channel Frequency (MHz)	Occupied Bandwidth (Mhz)				Pass / Fail
		Chain 0	Chain 1	Chain 2	Chain 3	
42	5210	75.84	75.84	75.84	75.84	Pass
155	5775	76.08	76.16	76.16	76.16	Pass

Spectrum Plot of Worst Value

802.11a / Chain 0: CH157

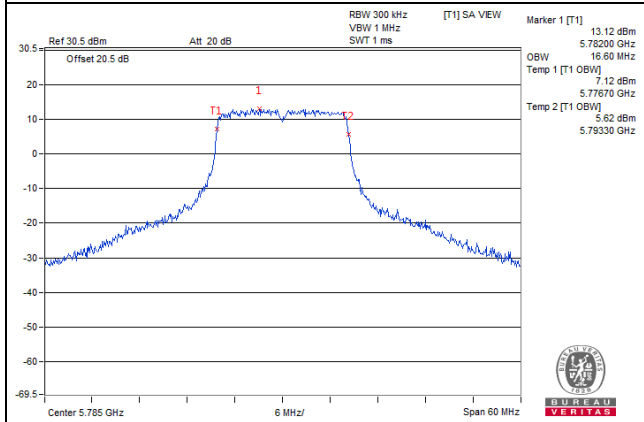

802.11n (20MHz) / Chain 0: CH157

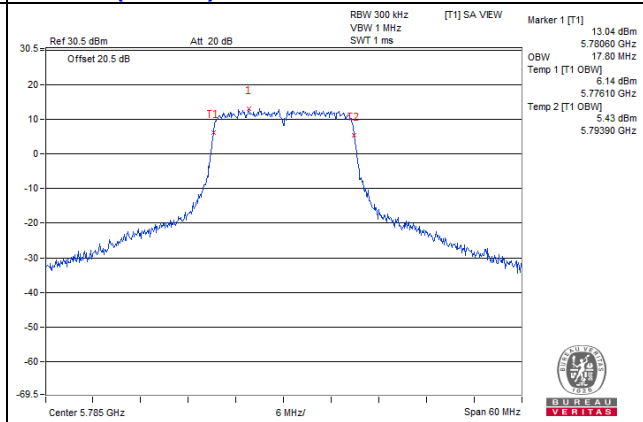

802.11n (40MHz) / Chain 2: CH159

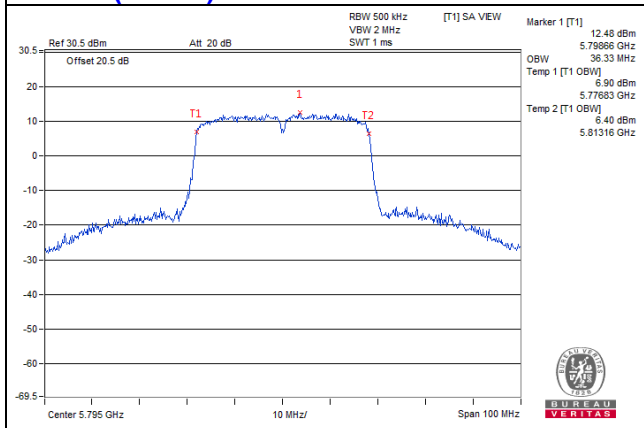

802.11ac (80MHz) / Chain 1: CH155

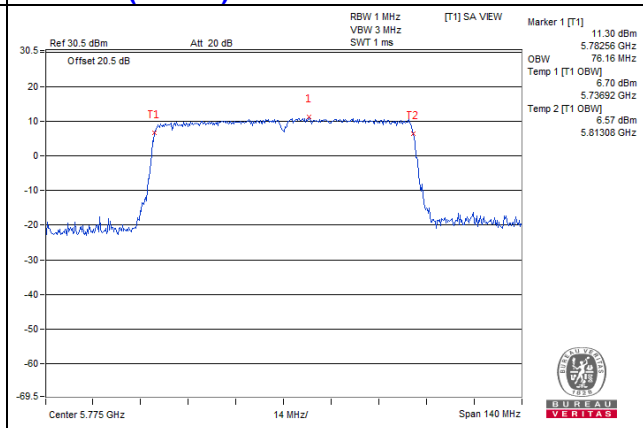

CDD Mode (Mode B)

802.11a

Channel	Channel Frequency (MHz)	Occupied Bandwidth (Mhz)				Pass / Fail
		Chain 0	Chain 1	Chain 2	Chain 3	
36	5180	16.56	16.44	16.56	16.44	Pass
40	5200	16.44	16.56	16.44	16.56	Pass
48	5240	16.56	16.56	16.56	16.56	Pass
149	5745	16.52	16.60	16.60	16.60	Pass
157	5785	16.60	16.60	16.60	16.60	Pass
165	5825	16.60	16.60	16.60	16.60	Pass

802.11n (20MHz)

Channel	Channel Frequency (MHz)	Occupied Bandwidth (Mhz)				Pass / Fail
		Chain 0	Chain 1	Chain 2	Chain 3	
36	5180	17.64	17.64	17.64	17.64	Pass
40	5200	17.64	17.64	17.64	17.76	Pass
48	5240	17.76	17.64	17.64	17.64	Pass
149	5745	17.73	17.70	17.70	17.70	Pass
157	5785	17.80	17.80	17.70	17.80	Pass
165	5825	17.80	17.70	17.70	17.70	Pass

802.11n (40MHz)

Channel	Channel Frequency (MHz)	Occupied Bandwidth (Mhz)				Pass / Fail
		Chain 0	Chain 1	Chain 2	Chain 3	
38	5190	36.00	36.00	36.00	36.00	Pass
46	5230	36.00	36.00	36.00	36.00	Pass
151	5755	36.23	36.16	36.16	36.16	Pass
159	5795	36.16	36.16	36.33	36.33	Pass

802.11ac (80MHz)

Channel	Channel Frequency (MHz)	Occupied Bandwidth (Mhz)				Pass / Fail
		Chain 0	Chain 1	Chain 2	Chain 3	
42	5210	75.84	75.84	75.84	75.84	Pass
155	5775	75.88	76.16	75.88	76.16	Pass

Spectrum Plot of Worst Value

802.11a / Chain 0: CH157

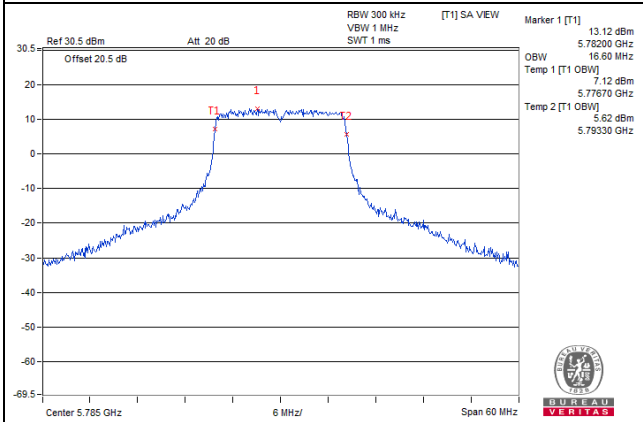

802.11n (20MHz) / Chain 0: CH157

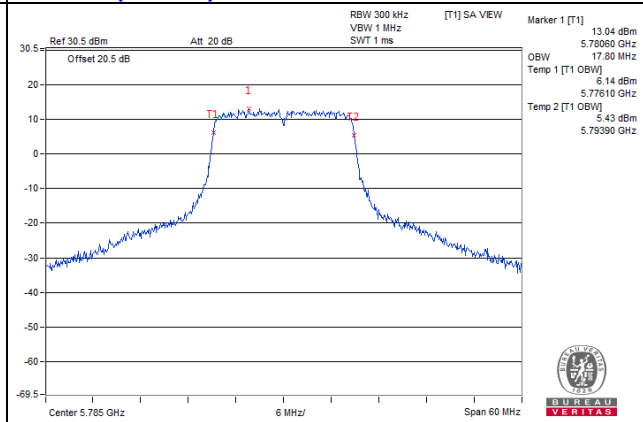

802.11n (40MHz) / Chain 2: CH159

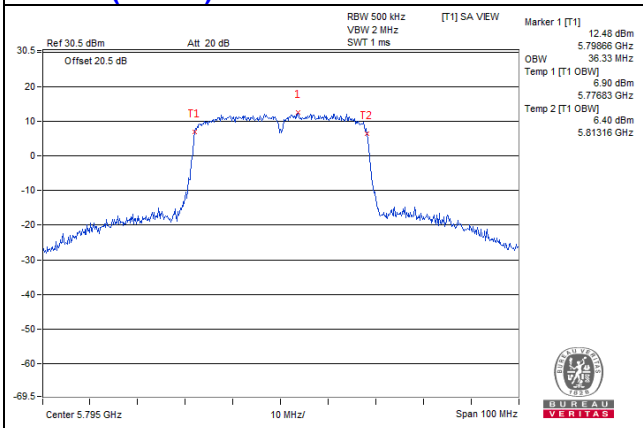

802.11ac (80MHz) / Chain 1: CH155

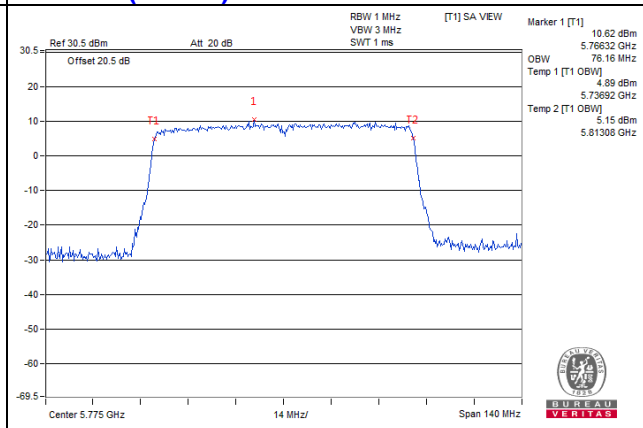

4.5 Peak Power Spectral Density Measurement

4.5.1 Limits of Peak Power Spectral Density Measurement

Operation Band	EUT Category		Limit
U-NII-1		Outdoor Access Point	17dBm/ MHz
		Fixed point-to-point Access Point	
	√	Indoor Access Point	
		Mobile and Portable client device	11dBm/ MHz
U-NII-2A	---		11dBm/ MHz
U-NII-2C	---		11dBm/ MHz
U-NII-3	√		30dBm/ 500kHz

4.5.2 Test Setup

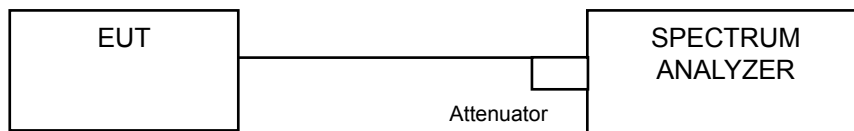

4.5.3 Test Instruments

Refer to section 4.1.2 to get information of above instrument.

4.5.4 Test Procedure

For U-NII-1 band:

Using method SA-1

1. Set span to encompass the entire emission bandwidth (EBW) of the signal.
2. Set RBW = 1 MHz, Set VBW ≥ 3 MHz, Detector = RMS
3. Sweep time = auto, trigger set to “free run”.
4. Trace average at least 100 traces in power averaging mode.
5. Record the max value

※For U-NII-3:

- 1) Set span to encompass the entire emission bandwidth (EBW) of the signal.
- 2) Set RBW = 500 kHz, Set VBW ≥ 3 RBW, Detector = RMS
- 3) Sweep time = auto, trigger set to “free run”.
- 4) Trace average at least 100 traces in power averaging mode.
- 5) Record the max value and add 10 log (1/duty cycle)

4.5.5 Deviation from Test Standard

No deviation.

4.5.6 EUT Operating Condition

Same as Item 4.3.6.

4.5.7 Test Results

CDD Mode (Mode A) For U-NII-1 band 802.11a

Chan.	Chan. Freq. (MHz)	PSD (dBm)				Duty Factor	Total PSD WITH Duty Factor (dBm)	MAX. Limit (dBm)	Pass / Fail
		Chain 0	Chain 1	Chain 2	Chain 3				
36	5180	-1.73	-1.66	-1.69	-1.71	0.21	4.54	12.63	Pass
40	5200	-1.61	-1.63	-1.65	-1.70	0.21	4.59	12.63	Pass
48	5240	-1.63	-1.62	-1.59	-1.65	0.21	4.61	12.63	Pass

NOTE:

- Method 1 of power density measurement of KDB 662911 is using for calculating total power density. Total power density is summing entire spectra across corresponding frequency bins on the various outputs by computer.
- Directional gain = $10 \log[(10^{G1/20} + 10^{G2/20} + \dots + 10^{GN/20})^2 / 4] = 10.37\text{dBi} > 6\text{dBi}$, so the PSD limit shall be reduced to $17 - (10.37 - 6) = 12.63\text{dBm}$
- Refer to section 3.3 for duty cycle spectrum plot.

802.11n (20MHz)

Chan.	Chan. Freq. (MHz)	PSD (dBm)				Duty Factor	Total PSD WITH Duty Factor (dBm)	MAX. Limit (dBm)	Pass / Fail
		Chain 0	Chain 1	Chain 2	Chain 3				
36	5180	-2.28	-2.27	-2.29	-2.29	0.14	3.87	12.63	Pass
40	5200	-2.24	-2.17	-2.22	-2.18	0.14	3.95	12.63	Pass
48	5240	-2.20	-2.08	-2.21	-2.13	0.14	4.00	12.63	Pass

NOTE:

- Method 1 of power density measurement of KDB 662911 is using for calculating total power density. Total power density is summing entire spectra across corresponding frequency bins on the various outputs by computer.
- Directional gain = $10 \log[(10^{G1/20} + 10^{G2/20} + \dots + 10^{GN/20})^2 / 4] = 10.37\text{dBi} > 6\text{dBi}$, so the PSD limit shall be reduced to $17 - (10.37 - 6) = 12.63\text{dBm}$
- Refer to section 3.3 for duty cycle spectrum plot.

802.11n (40MHz)

Chan.	Chan. Freq. (MHz)	PSD (dBm)				Duty Factor	Total PSD WITH Duty Factor (dBm)	MAX. Limit (dBm)	Pass / Fail
		Chain 0	Chain 1	Chain 2	Chain 3				
38	5190	-4.97	-5.06	-5.05	-5.07	0.24	1.22	12.63	Pass
46	5230	-4.91	-4.81	-4.90	-4.81	0.24	1.40	12.63	Pass

NOTE:

- Method 1 of power density measurement of KDB 662911 is using for calculating total power density. Total power density is summing entire spectra across corresponding frequency bins on the various outputs by computer.
- Directional gain = $10 \log[(10^{G1/20} + 10^{G2/20} + \dots + 10^{GN/20})^2 / 4] = 10.37\text{dBi} > 6\text{dBi}$, so the PSD limit shall be reduced to $17 - (10.37 - 6) = 12.63\text{dBm}$
- Refer to section 3.3 for duty cycle spectrum plot.

802.11ac (80MHz)

Chan.	Chan. Freq. (MHz)	PSD (dBm)				Duty Factor	Total PSD WITH Duty Factor (dBm)	MAX. Limit (dBm)	Pass / Fail
		Chain 0	Chain 1	Chain 2	Chain 3				
42	5210	-7.94	-7.96	-7.84	-7.85	0.41	-1.47	12.63	Pass

NOTE:

- Method 1 of power density measurement of KDB 662911 is using for calculating total power density. Total power density is summing entire spectra across corresponding frequency bins on the various outputs by computer.
- Directional gain = $10 \log[(10^{G1/20} + 10^{G2/20} + \dots + 10^{GN/20})^2 / 4] = 10.37\text{dBi} > 6\text{dBi}$, so the PSD limit shall be reduced to $17 - (10.37 - 6) = 12.63\text{dBm}$
- Refer to section 3.3 for duty cycle spectrum plot.

Spectrum Plot of Worst Value

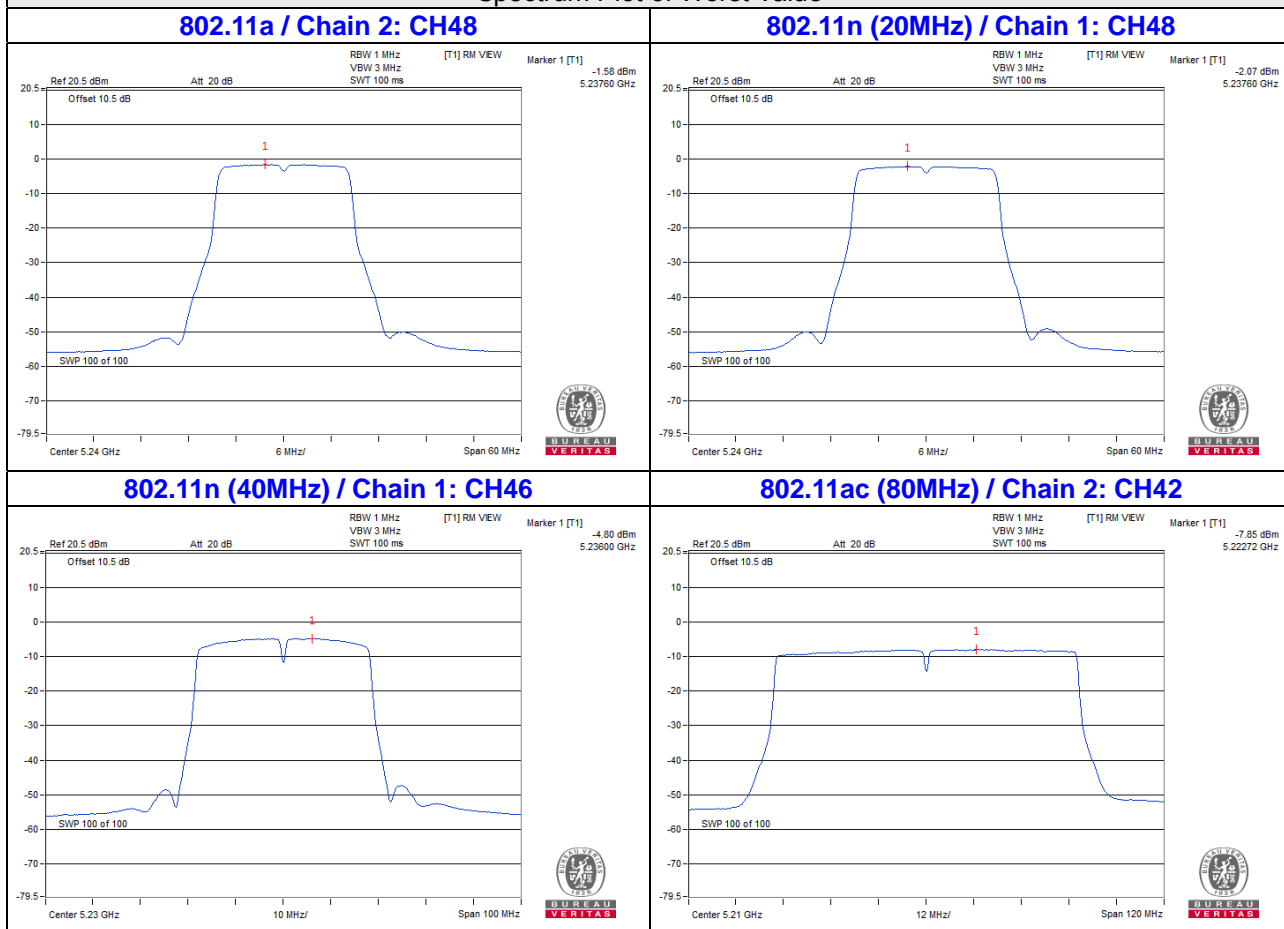

CDD Mode (Mode B)
For U-NII-1 band
802.11a

Chan.	Chan. Freq. (MHz)	PSD (dBm)				Duty Factor	Total PSD WITH Duty Factor (dBm)	MAX. Limit (dBm)	Pass / Fail
		Chain 0	Chain 1	Chain 2	Chain 3				
36	5180	-3.10	-3.14	-3.09	-2.99	0.21	3.15	10.98	Pass
40	5200	-2.93	-2.92	-2.99	-3.02	0.21	3.27	10.98	Pass
48	5240	-3.09	-3.03	-3.13	-3.13	0.21	3.14	10.98	Pass

NOTE:

- Method 1 of power density measurement of KDB 662911 is using for calculating total power density. Total power density is summing entire spectra across corresponding frequency bins on the various outputs by computer.
- Directional gain = $10 \log[(10^{G1/20} + 10^{G2/20} + \dots + 10^{GN/20})^2 / 4] = 12.02\text{dBi} > 6\text{dBi}$, so the PSD limit shall be reduced to $17 - (12.02 - 6) = 10.98\text{dBm}$
- Refer to section 3.3 for duty cycle spectrum plot.

802.11n (20MHz)

Chan.	Chan. Freq. (MHz)	PSD (dBm)				Duty Factor	Total PSD WITH Duty Factor (dBm)	MAX. Limit (dBm)	Pass / Fail
		Chain 0	Chain 1	Chain 2	Chain 3				
36	5180	-3.72	-3.64	-3.57	-3.65	0.14	2.51	10.98	Pass
40	5200	-3.61	-3.59	-3.59	-3.54	0.14	2.57	10.98	Pass
48	5240	-3.71	-3.62	-3.69	-3.60	0.14	2.50	10.98	Pass

NOTE:

- Method 1 of power density measurement of KDB 662911 is using for calculating total power density. Total power density is summing entire spectra across corresponding frequency bins on the various outputs by computer.
- Directional gain = $10 \log[(10^{G1/20} + 10^{G2/20} + \dots + 10^{GN/20})^2 / 4] = 12.02\text{dBi} > 6\text{dBi}$, so the PSD limit shall be reduced to $17 - (12.02 - 6) = 10.98\text{dBm}$
- Refer to section 3.3 for duty cycle spectrum plot.

802.11n (40MHz)

Chan.	Chan. Freq. (MHz)	PSD (dBm)				Duty Factor	Total PSD WITH Duty Factor (dBm)	MAX. Limit (dBm)	Pass / Fail
		Chain 0	Chain 1	Chain 2	Chain 3				
38	5190	-6.47	-6.44	-6.41	-6.41	0.24	-0.18	10.98	Pass
46	5230	-6.21	-6.21	-6.21	-6.29	0.24	0.03	10.98	Pass

NOTE:

- Method 1 of power density measurement of KDB 662911 is using for calculating total power density. Total power density is summing entire spectra across corresponding frequency bins on the various outputs by computer.
- Directional gain = $10 \log[(10^{G1/20} + 10^{G2/20} + \dots + 10^{GN/20})^2 / 4] = 12.02\text{dBi} > 6\text{dBi}$, so the PSD limit shall be reduced to $17 - (12.02 - 6) = 10.98\text{dBm}$
- Refer to section 3.3 for duty cycle spectrum plot.

802.11ac (80MHz)

Chan.	Chan. Freq. (MHz)	PSD (dBm)				Duty Factor	Total PSD WITH Duty Factor (dBm)	MAX. Limit (dBm)	Pass / Fail
		Chain 0	Chain 1	Chain 2	Chain 3				
42	5210	-9.76	-9.74	-9.79	-9.73	0.41	-3.32	10.98	Pass

NOTE:

- Method 1 of power density measurement of KDB 662911 is using for calculating total power density. Total power density is summing entire spectra across corresponding frequency bins on the various outputs by computer.
- Directional gain = $10 \log[(10^{G1/20} + 10^{G2/20} + \dots + 10^{GN/20})^2 / 4] = 12.02\text{dBi} > 6\text{dBi}$, so the PSD limit shall be reduced to $17 - (12.02 - 6) = 10.98\text{dBm}$
- Refer to section 3.3 for duty cycle spectrum plot.

Spectrum Plot of Worst Value

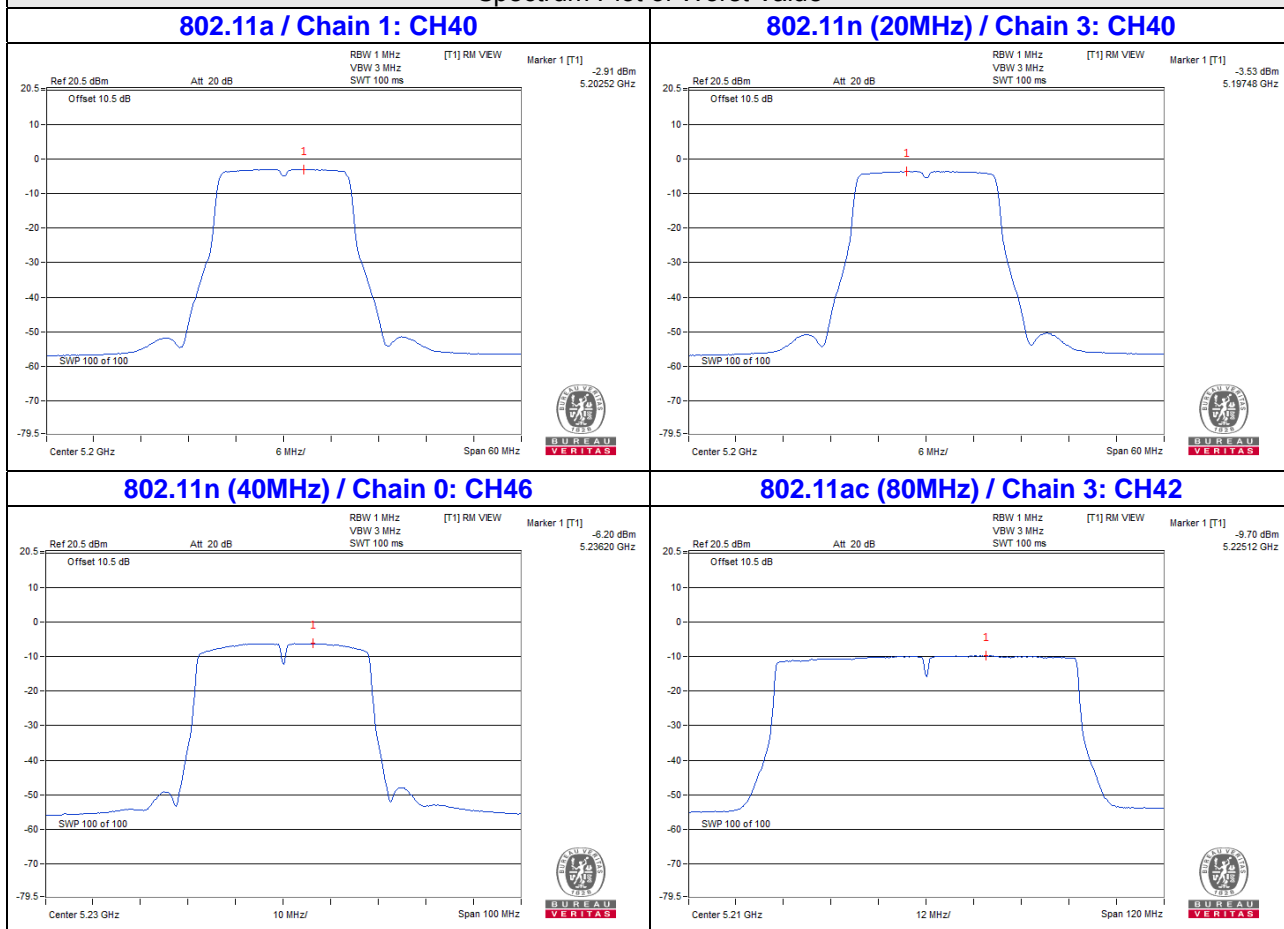

CDD Mode (Mode A)

For U-NII-3:
802.11a

TX chain	Channel	Freq. (MHz)	PSD (dBm/500kHz)	10 log (N=4) dB	Duty Factor	Total PSD (dBm/500kHz)	Limit (dBm/500kHz)	Pass /Fail
0	149	5745	16.77	6.02	0.21	23.00	25.63	Pass
	157	5785	16.70	6.02	0.21	22.93	25.63	Pass
	165	5825	16.65	6.02	0.21	22.88	25.63	Pass
1	149	5745	16.63	6.02	0.21	22.86	25.63	Pass
	157	5785	16.72	6.02	0.21	22.95	25.63	Pass
	165	5825	16.52	6.02	0.21	22.75	25.63	Pass
2	149	5745	16.46	6.02	0.21	22.69	25.63	Pass
	157	5785	16.70	6.02	0.21	22.93	25.63	Pass
	165	5825	16.50	6.02	0.21	22.73	25.63	Pass
3	149	5745	16.72	6.02	0.21	22.95	25.63	Pass
	157	5785	16.70	6.02	0.21	22.93	25.63	Pass
	165	5825	16.63	6.02	0.21	22.86	25.63	Pass

NOTE:

- Directional gain = $10 \log[(10^{G1/20} + 10^{G2/20} + \dots + 10^{GN/20})^2 / 4] = 10.37\text{dBi} > 6\text{dBi}$, so the PSD limit shall be reduced to $30 - (10.37 - 6) = 25.63\text{dBm}$
- Refer to section 3.3 for duty cycle spectrum plot.

802.11n (20MHz)

TX chain	Channel	Freq. (MHz)	PSD (dBm/500kHz)	10 log (N=4) dB	Duty Factor	Total PSD (dBm/500kHz)	Limit (dBm/500kHz)	Pass /Fail
0	149	5745	16.60	6.02	0.14	22.76	25.63	Pass
	157	5785	16.53	6.02	0.14	22.69	25.63	Pass
	165	5825	16.42	6.02	0.14	22.58	25.63	Pass
1	149	5745	16.63	6.02	0.14	22.79	25.63	Pass
	157	5785	16.55	6.02	0.14	22.71	25.63	Pass
	165	5825	16.56	6.02	0.14	22.72	25.63	Pass
2	149	5745	16.25	6.02	0.14	22.41	25.63	Pass
	157	5785	16.68	6.02	0.14	22.84	25.63	Pass
	165	5825	16.27	6.02	0.14	22.43	25.63	Pass
3	149	5745	16.62	6.02	0.14	22.78	25.63	Pass
	157	5785	16.61	6.02	0.14	22.77	25.63	Pass
	165	5825	16.42	6.02	0.14	22.58	25.63	Pass

NOTE:

- Directional gain = $10 \log[(10^{G1/20} + 10^{G2/20} + \dots + 10^{GN/20})^2 / 4] = 10.37\text{dBi} > 6\text{dBi}$, so the PSD limit shall be reduced to $30 - (10.37 - 6) = 25.63\text{dBm}$
- Refer to section 3.3 for duty cycle spectrum plot.

802.11n (40MHz)

TX chain	Channel	Freq. (MHz)	PSD (dBm/500kHz)	10 log (N=4) dB	Duty Factor	Total PSD (dBm/500kHz)	Limit (dBm/500kHz)	Pass /Fail
0	151	5755	12.97	6.02	0.24	19.23	25.63	Pass
	159	5795	12.83	6.02	0.24	19.09	25.63	Pass
1	151	5755	12.95	6.02	0.24	19.21	25.63	Pass
	159	5795	12.97	6.02	0.24	19.23	25.63	Pass
2	151	5755	12.96	6.02	0.24	19.22	25.63	Pass
	159	5795	12.96	6.02	0.24	19.22	25.63	Pass
3	151	5755	12.92	6.02	0.24	19.18	25.63	Pass
	159	5795	12.92	6.02	0.24	19.18	25.63	Pass

NOTE:

1. Directional gain = $10 \log[(10^{G1/20} + 10^{G2/20} + \dots + 10^{GN/20})^2 / 4] = 10.37\text{dBi} > 6\text{dBi}$, so the PSD limit shall be reduced to $30 - (10.37 - 6) = 25.63\text{dBm}$
2. Refer to section 3.3 for duty cycle spectrum plot.

802.11ac (80MHz)

TX chain	Channel	Freq. (MHz)	PSD (dBm/500kHz)	10 log (N=4) dB	Duty Factor	Total PSD (dBm/500kHz)	Limit (dBm/500kHz)	Pass /Fail
0	155	5775	8.50	6.02	0.41	14.93	25.63	Pass
1	155	5775	8.24	6.02	0.41	14.67	25.63	Pass
2	155	5775	8.74	6.02	0.41	15.17	25.63	Pass
3	155	5775	8.68	6.02	0.41	15.11	25.63	Pass

NOTE:

1. Directional gain = $10 \log[(10^{G1/20} + 10^{G2/20} + \dots + 10^{GN/20})^2 / 4] = 10.37\text{dBi} > 6\text{dBi}$, so the PSD limit shall be reduced to $30 - (10.37 - 6) = 25.63\text{dBm}$
2. Refer to section 3.3 for duty cycle spectrum plot.

Spectrum Plot of Worst Value

802.11a / Chain 0: CH149

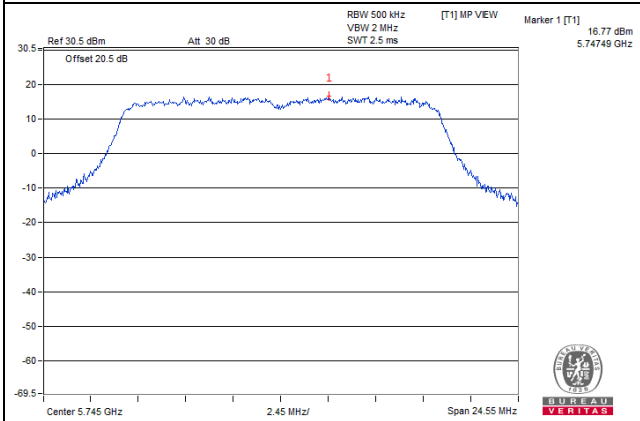

802.11n (20MHz) / Chain 2: CH157

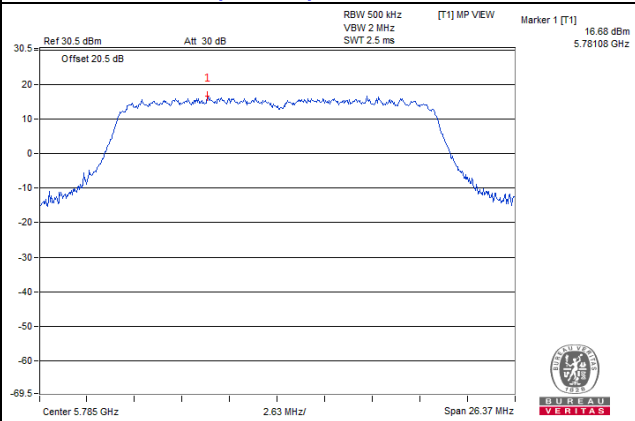

802.11n (40MHz) / Chain 0: CH151

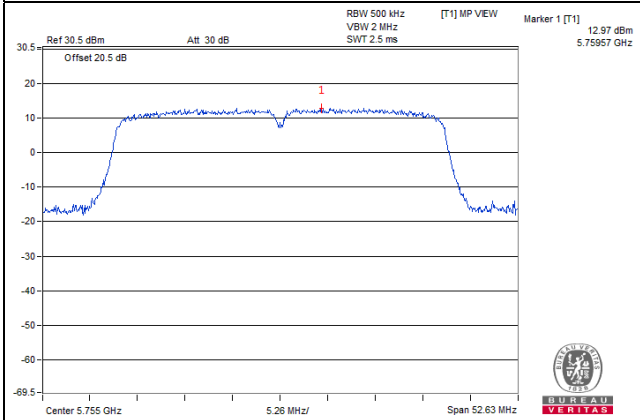

802.11ac (80MHz) / Chain 2: CH155

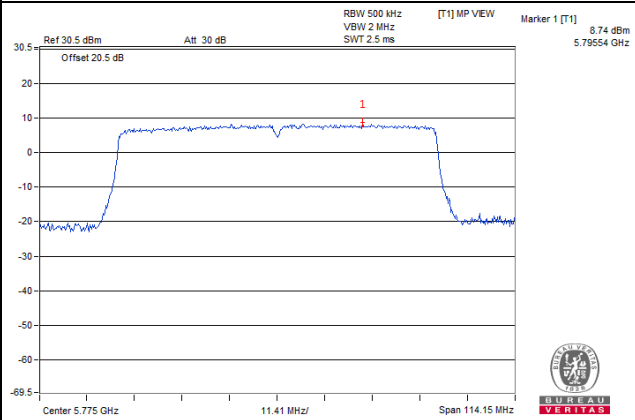

CDD Mode (Mode B)

For U-NII-3:
802.11a

TX chain	Channel	Freq. (MHz)	PSD (dBm/500kHz)	10 log (N=4) dB	Duty Factor	Total PSD (dBm/500kHz)	Limit (dBm/500kHz)	Pass /Fail
0	149	5745	16.77	6.02	0.21	23.00	23.98	Pass
	157	5785	16.60	6.02	0.21	22.83	23.98	Pass
	165	5825	16.65	6.02	0.21	22.88	23.98	Pass
1	149	5745	16.63	6.02	0.21	22.86	23.98	Pass
	157	5785	16.72	6.02	0.21	22.95	23.98	Pass
	165	5825	16.52	6.02	0.21	22.75	23.98	Pass
2	149	5745	16.46	6.02	0.21	22.69	23.98	Pass
	157	5785	16.70	6.02	0.21	22.93	23.98	Pass
	165	5825	16.50	6.02	0.21	22.73	23.98	Pass
3	149	5745	16.72	6.02	0.21	22.95	23.98	Pass
	157	5785	16.70	6.02	0.21	22.93	23.98	Pass
	165	5825	16.63	6.02	0.21	22.86	23.98	Pass

NOTE:

1. Directional gain = $10 \log[(10^{G1/20} + 10^{G2/20} + \dots + 10^{GN/20})^2 / 4]$ = 12.02dBi >6dBi, so the PSD limit shall be reduced to $30-(12.02-6) = 23.98\text{dBm}$
2. Refer to section 3.3 for duty cycle spectrum plot.

802.11n (20MHz)

TX chain	Channel	Freq. (MHz)	PSD (dBm/500kHz)	10 log (N=4) dB	Duty Factor	Total PSD (dBm/500kHz)	Limit (dBm/500kHz)	Pass /Fail
0	149	5745	16.60	6.02	0.14	22.76	23.98	Pass
	157	5785	16.53	6.02	0.14	22.69	23.98	Pass
	165	5825	16.42	6.02	0.14	22.58	23.98	Pass
1	149	5745	16.63	6.02	0.14	22.79	23.98	Pass
	157	5785	16.55	6.02	0.14	22.71	23.98	Pass
	165	5825	16.56	6.02	0.14	22.72	23.98	Pass
2	149	5745	16.25	6.02	0.14	22.41	23.98	Pass
	157	5785	16.68	6.02	0.14	22.84	23.98	Pass
	165	5825	16.27	6.02	0.14	22.43	23.98	Pass
3	149	5745	16.62	6.02	0.14	22.78	23.98	Pass
	157	5785	16.61	6.02	0.14	22.77	23.98	Pass
	165	5825	16.42	6.02	0.14	22.58	23.98	Pass

NOTE:

1. Directional gain = $10 \log[(10^{G1/20} + 10^{G2/20} + \dots + 10^{GN/20})^2 / 4]$ = 12.02dBi >6dBi, so the PSD limit shall be reduced to $30-(12.02-6) = 23.98\text{dBm}$
2. Refer to section 3.3 for duty cycle spectrum plot.

802.11n (40MHz)

TX chain	Channel	Freq. (MHz)	PSD (dBm/500kHz)	10 log (N=4) dB	Duty Factor	Total PSD (dBm/500kHz)	Limit (dBm/500kHz)	Pass /Fail
0	151	5755	12.97	6.02	0.24	19.23	23.98	Pass
	159	5795	12.83	6.02	0.24	19.09	23.98	Pass
1	151	5755	12.95	6.02	0.24	19.21	23.98	Pass
	159	5795	12.97	6.02	0.24	19.23	23.98	Pass
2	151	5755	12.96	6.02	0.24	19.22	23.98	Pass
	159	5795	12.96	6.02	0.24	19.22	23.98	Pass
3	151	5755	12.92	6.02	0.24	19.18	23.98	Pass
	159	5795	12.92	6.02	0.24	19.18	23.98	Pass

NOTE:

1. Directional gain = $10 \log[(10^{G1/20} + 10^{G2/20} + \dots + 10^{GN/20})^2 / 4] = 12.02\text{dBi} > 6\text{dBi}$, so the PSD limit shall be reduced to $30 - (12.02 - 6) = 23.98\text{dBm}$
2. Refer to section 3.3 for duty cycle spectrum plot.

802.11ac (80MHz)

TX chain	Channel	Freq. (MHz)	PSD (dBm/500kHz)	10 log (N=4) dB	Duty Factor	Total PSD (dBm/500kHz)	Limit (dBm/500kHz)	Pass /Fail
0	155	5775	7.21	6.02	0.41	13.64	23.98	Pass
1	155	5775	7.10	6.02	0.41	13.53	23.98	Pass
2	155	5775	7.40	6.02	0.41	13.83	23.98	Pass
3	155	5775	7.25	6.02	0.41	13.68	23.98	Pass

NOTE:

1. Directional gain = $10 \log[(10^{G1/20} + 10^{G2/20} + \dots + 10^{GN/20})^2 / 4] = 12.02\text{dBi} > 6\text{dBi}$, so the PSD limit shall be reduced to $30 - (12.02 - 6) = 23.98\text{dBm}$
2. Refer to section 3.3 for duty cycle spectrum plot.

Spectrum Plot of Worst Value

802.11a / Chain 0: CH149

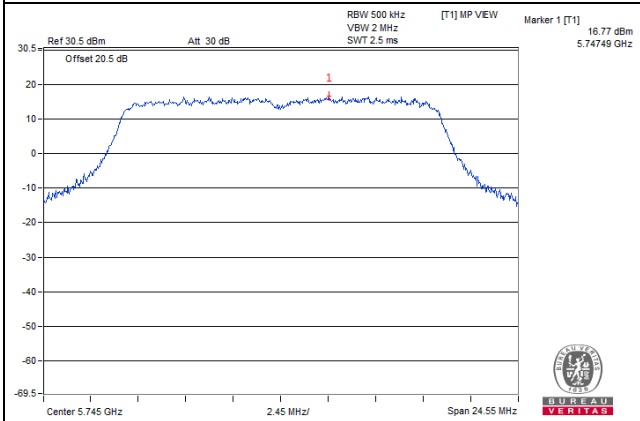

802.11n (20MHz) / Chain 2: CH157

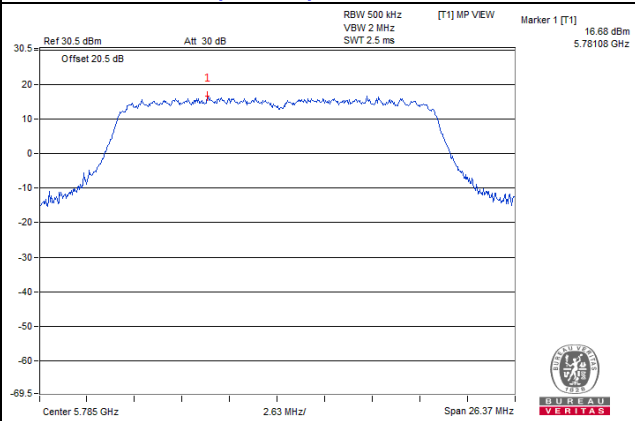

802.11n (40MHz) / Chain 0: CH151

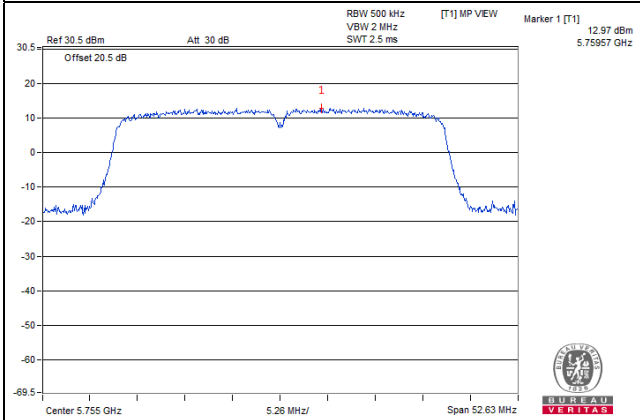

802.11ac (80MHz) / Chain 2: CH155

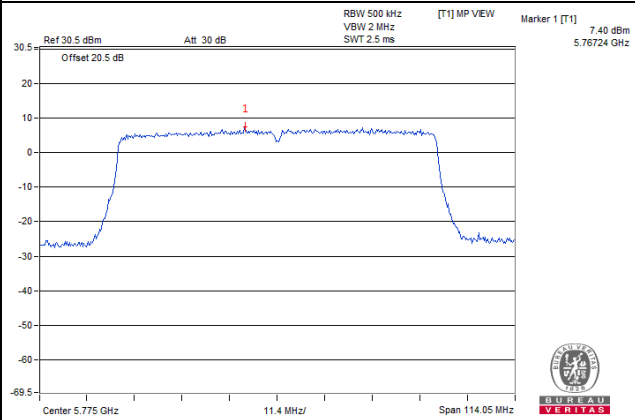

4.6 Frequency Stability Measurement

4.6.1 Limits of Frequency Stability Measurement

The frequency of the carrier signal shall be maintained within band of operation

4.6.2 Test Setup

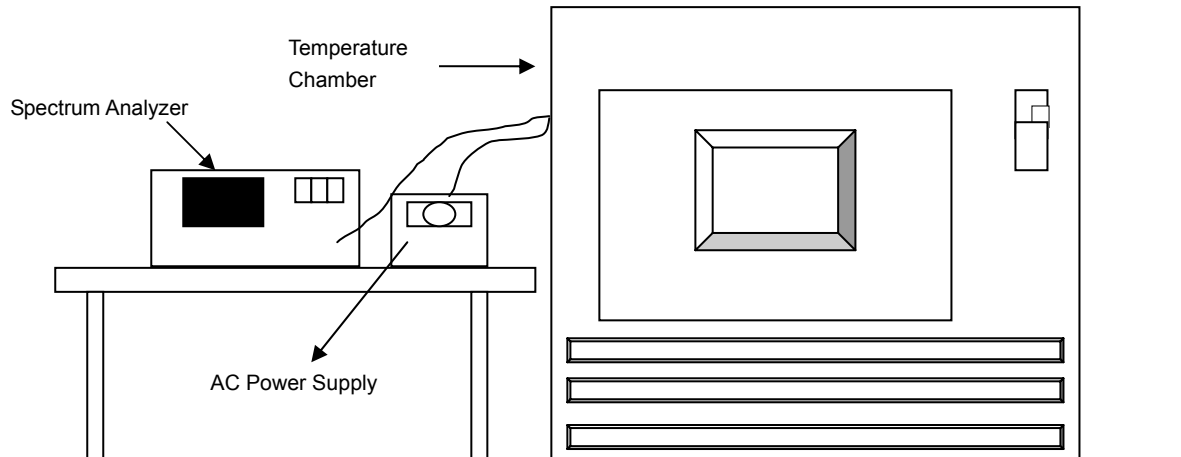

4.6.3 Test Instruments

Refer to section 4.1.2 to get information of above instrument.

4.6.4 Test Procedure

- The EUT was placed inside the environmental test chamber and powered by nominal AC voltage.
- Turn the EUT on and couple its output to a spectrum analyzer.
- Turn the EUT off and set the chamber to the highest temperature specified.
- Allow sufficient time (approximately 30 min) for the temperature of the chamber to stabilize, turn the EUT on and measure the operating frequency after 2, 5, and 10 Minutes.
- Repeat step 2 and 3 with the temperature chamber set to the lowest temperature.
- The test chamber was allowed to stabilize at +20 degree C for a minimum of 30 Minutes. The supply voltage was then adjusted on the EUT from 85% to 115% and the frequency record.

4.6.5 Deviation from Test Standard

No deviation.

4.6.6 EUT Operating Condition

Set the EUT transmit at un-modulation mode to test frequency stability.

4.6.7 Test Results

Frequency Stability Versus Temp.									
Operating Frequency: 5180 MHz									
TEMP. (°C)	Power Supply (Vac)	0 Minute		2 Minute		5 Minute		10 Minute	
		Measured Frequency (MHz)	Pass/Fail	Measured Frequency (MHz)	Pass/Fail	Measured Frequency (MHz)	Pass/Fail	Measured Frequency (MHz)	Pass/Fail
50	120	5180.043564	Pass	5180.043532	Pass	5180.043877	Pass	5180.04395	Pass
40	120	5180.043481	Pass	5180.043097	Pass	5180.043422	Pass	5180.043086	Pass
30	120	5180.043035	Pass	5180.043088	Pass	5180.043108	Pass	5180.043277	Pass
20	120	5180.04313	Pass	5180.043437	Pass	5180.043422	Pass	5180.043294	Pass
10	120	5180.042681	Pass	5180.042755	Pass	5180.042620	Pass	5180.042642	Pass
0	120	5180.043208	Pass	5180.04277	Pass	5180.043225	Pass	5180.042832	Pass
-10	120	5180.04329	Pass	5180.043271	Pass	5180.043236	Pass	5180.043515	Pass
-20	120	5180.043087	Pass	5180.043001	Pass	5180.043238	Pass	5180.043339	Pass

Frequency Stability Versus Voltage									
Operating Frequency: 5180 MHz									
TEMP. (°C)	Power Supply (Vac)	0 Minute		2 Minute		5 Minute		10 Minute	
		Measured Frequency (MHz)	Pass/Fail	Measured Frequency (MHz)	Pass/Fail	Measured Frequency (MHz)	Pass/Fail	Measured Frequency (MHz)	Pass/Fail
20	138	5180.043538	Pass	5180.043473	Pass	5180.043426	Pass	5180.043252	Pass
	120	5180.04313	Pass	5180.043437	Pass	5180.043422	Pass	5180.043294	Pass
	102	5180.042106	Pass	5180.042089	Pass	5180.041827	Pass	5180.042102	Pass

4.7 6dB Bandwidth Measurement

4.7.1 Limits of 6dB Bandwidth Measurement

The minimum of 6dB Bandwidth Measurement is 0.5MHz.

4.7.2 Test Setup

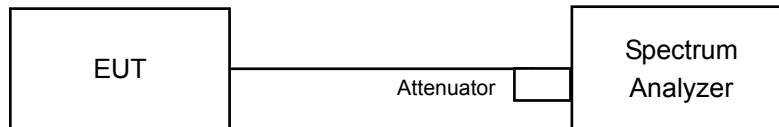

4.7.3 Test Instruments

Refer to section 4.1.2 to get information of above instrument.

4.7.4 Test Procedure

MEASUREMENT PROCEDURE REF

- a. Set resolution bandwidth (RBW) = 100kHz
- b. Set the video bandwidth (VBW) $\geq 3 \times$ RBW, Detector = Peak.
- c. Trace mode = max hold.
- d. Sweep = auto couple.
- e. Measure the maximum width of the emission that is constrained by the frequencies associated with the two amplitude points (upper and lower) that are attenuated by 6 dB relative to the maximum level measured in the fundamental emission

4.7.5 Deviation from Test Standard

No deviation.

4.7.6 EUT Operating Condition

The software provided by client to enable the EUT under transmission condition continuously at lowest, middle and highest channel frequencies individually.

4.7.7 Test Results

CDD Mode (Mode A)
802.11a

Channel	Frequency (MHz)	6dB Bandwidth (MHz)				Minimum Limit (MHz)	Pass / Fail
		Chain 0	Chain 1	Chain 2	Chain 3		
149	5745	16.37	16.37	16.36	16.36	0.5	Pass
157	5785	16.36	16.36	16.38	16.37	0.5	Pass
165	5825	16.36	16.37	16.36	16.37	0.5	Pass

802.11n (20MHz)

Channel	Frequency (MHz)	6dB Bandwidth (MHz)				Minimum Limit (MHz)	Pass / Fail
		Chain 0	Chain 1	Chain 2	Chain 3		
149	5745	17.31	17.59	17.57	17.59	0.5	Pass
157	5785	17.59	17.57	17.58	17.60	0.5	Pass
165	5825	17.60	17.60	17.59	17.28	0.5	Pass

802.11n (40MHz)

Channel	Frequency (MHz)	6dB Bandwidth (MHz)				Minimum Limit (MHz)	Pass / Fail
		Chain 0	Chain 1	Chain 2	Chain 3		
151	5755	35.08	35.24	35.20	35.24	0.5	Pass
159	5795	35.22	35.17	35.19	35.25	0.5	Pass

802.11ac (80MHz)

Channel	Frequency (MHz)	6dB Bandwidth (MHz)				Minimum Limit (MHz)	Pass / Fail
		Chain 0	Chain 1	Chain 2	Chain 3		
155	5775	76.11	76.05	76.10	76.20	0.5	Pass

Spectrum Plot of Worst Value

802.11a / Chain 2: CH157

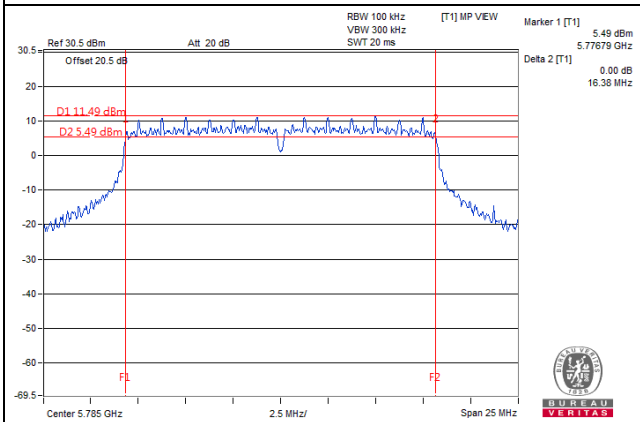

802.11n (20MHz) / Chain 0: CH165

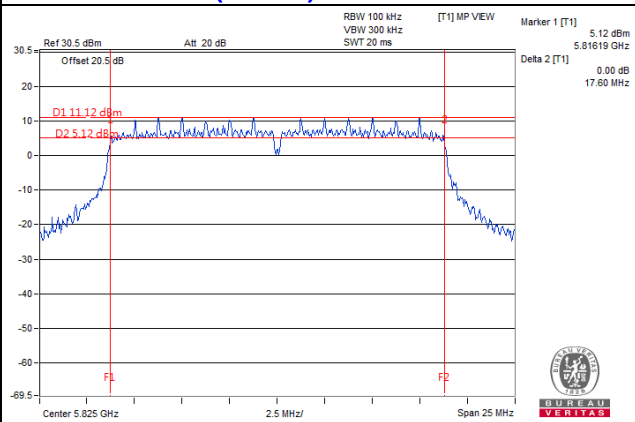

802.11n (40MHz) / Chain 3: CH159

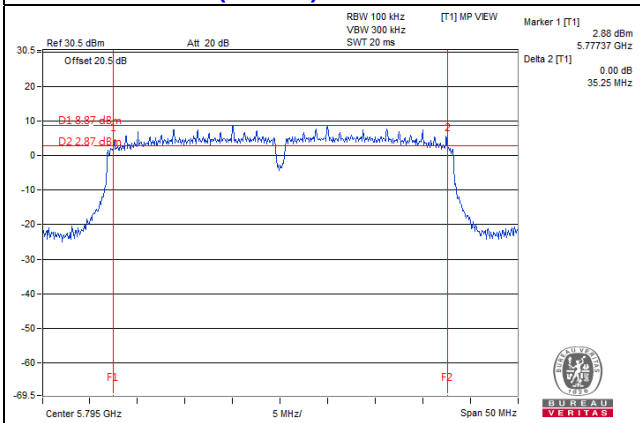

802.11ac (80MHz) / Chain 3: CH155

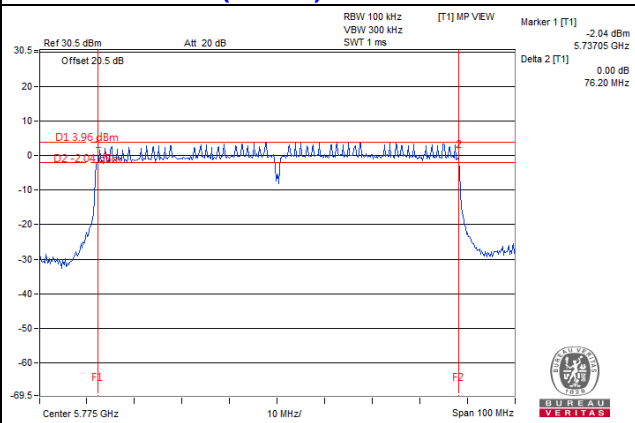

CDD Mode (Mode B)
802.11a

Channel	Frequency (MHz)	6dB Bandwidth (MHz)				Minimum Limit (MHz)	Pass / Fail
		Chain 0	Chain 1	Chain 2	Chain 3		
149	5745	16.37	16.37	16.36	16.36	0.5	Pass
157	5785	16.36	16.36	16.38	16.37	0.5	Pass
165	5825	16.36	16.37	16.36	16.37	0.5	Pass

802.11n (20MHz)

Channel	Frequency (MHz)	6dB Bandwidth (MHz)				Minimum Limit (MHz)	Pass / Fail
		Chain 0	Chain 1	Chain 2	Chain 3		
149	5745	17.31	17.59	17.57	17.59	0.5	Pass
157	5785	17.59	17.57	17.58	17.60	0.5	Pass
165	5825	17.60	17.60	17.59	17.28	0.5	Pass

802.11n (40MHz)

Channel	Frequency (MHz)	6dB Bandwidth (MHz)				Minimum Limit (MHz)	Pass / Fail
		Chain 0	Chain 1	Chain 2	Chain 3		
151	5755	35.08	35.24	35.20	35.24	0.5	Pass
159	5795	35.22	35.17	35.19	35.25	0.5	Pass

802.11ac (80MHz)

Channel	Frequency (MHz)	6dB Bandwidth (MHz)				Minimum Limit (MHz)	Pass / Fail
		Chain 0	Chain 1	Chain 2	Chain 3		
155	5775	75.95	76.14	76.03	76.17	0.5	Pass

Spectrum Plot of Worst Value

802.11a / Chain 2: CH157

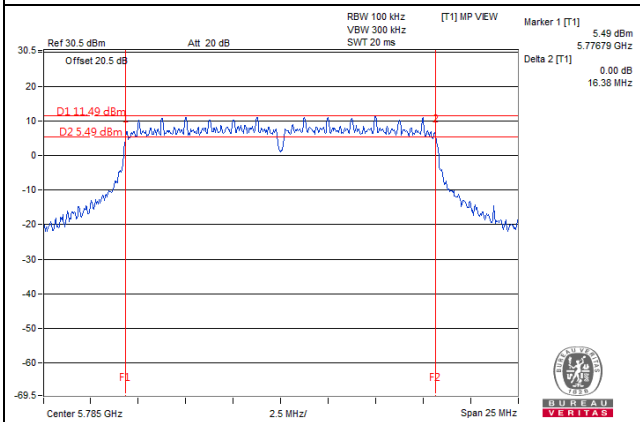

802.11n (20MHz) / Chain 0: CH165

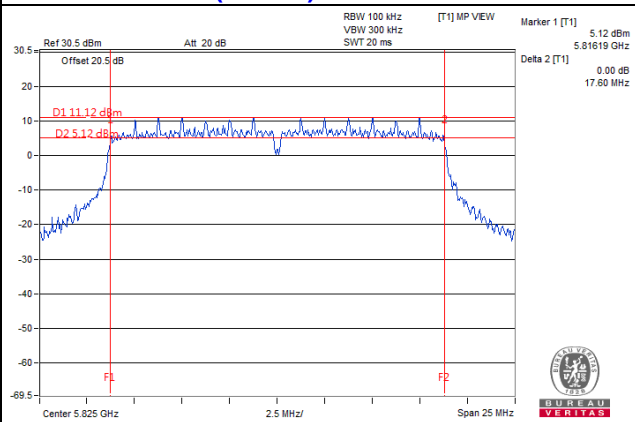

802.11n (40MHz) / Chain 3: CH159

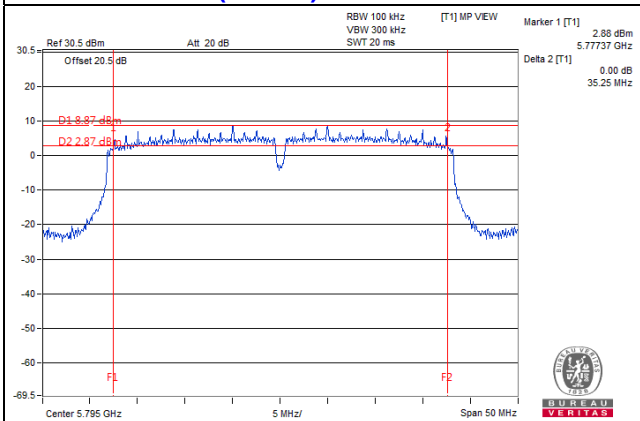

802.11ac (80MHz) / Chain 3: CH155

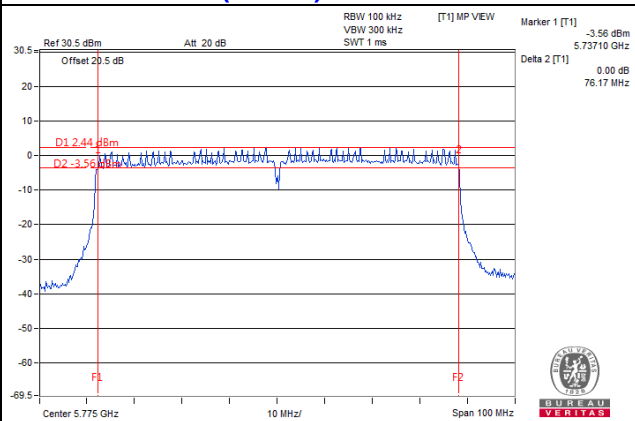

5 Pictures of Test Arrangements

Please refer to the attached file (Test Setup Photo).

Annex A- Radiated Out of Band Emission (OOBE) Measurement (For U-NII-3 band)

CDD Mode (Mode A)

802.11a

CH149

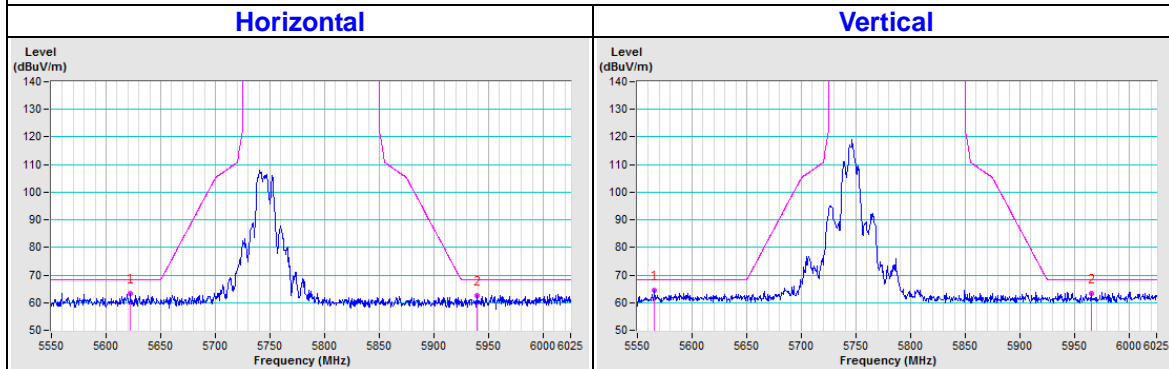

CH157

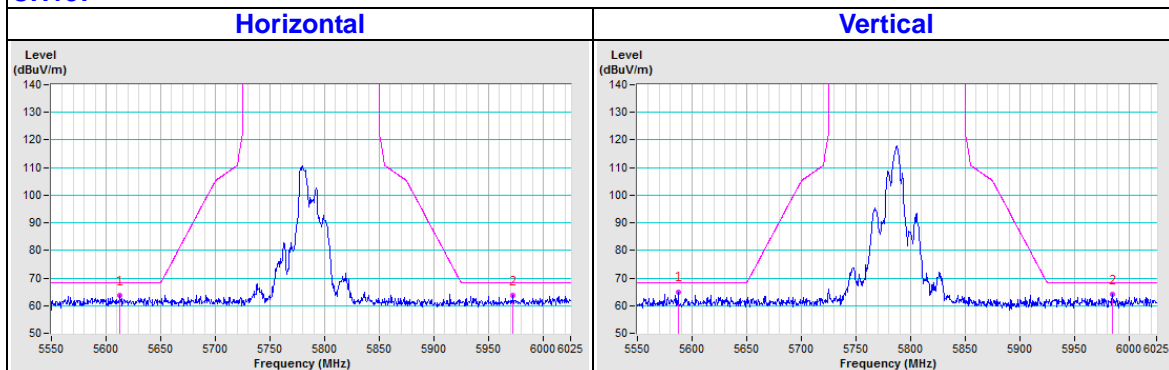

CH165

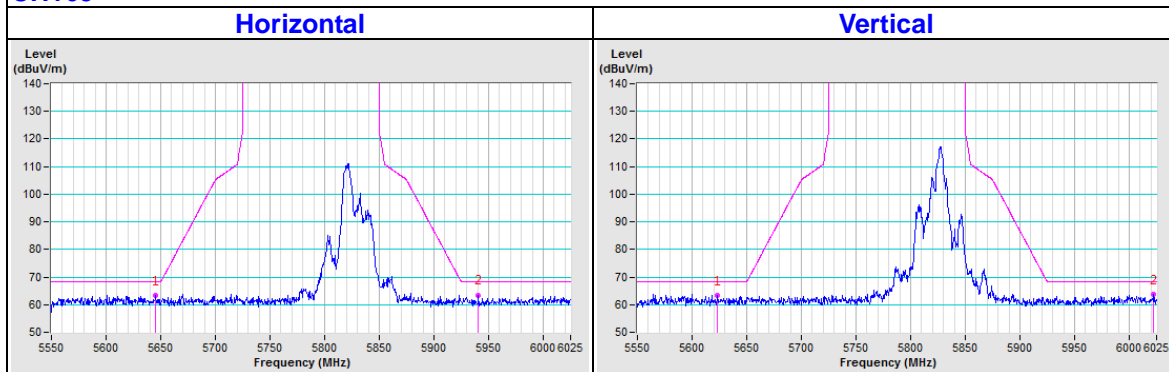

802.11n (20MHz)

CH149

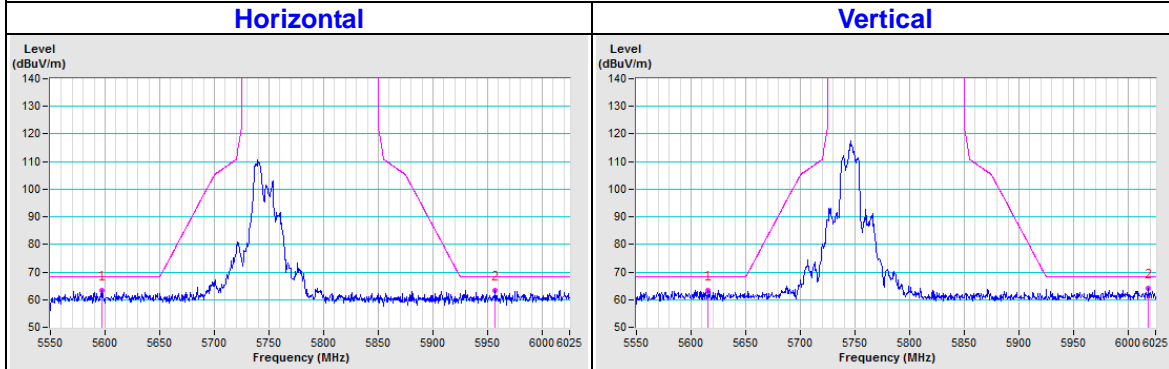

CH157

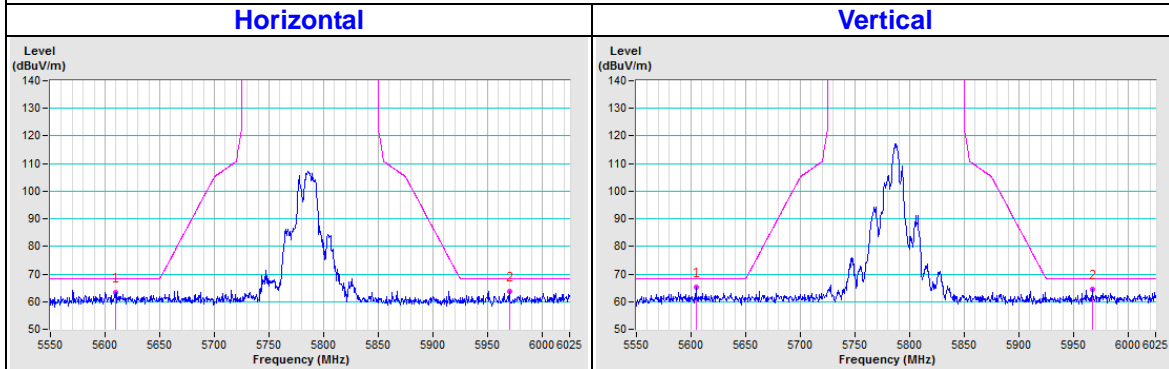

CH165

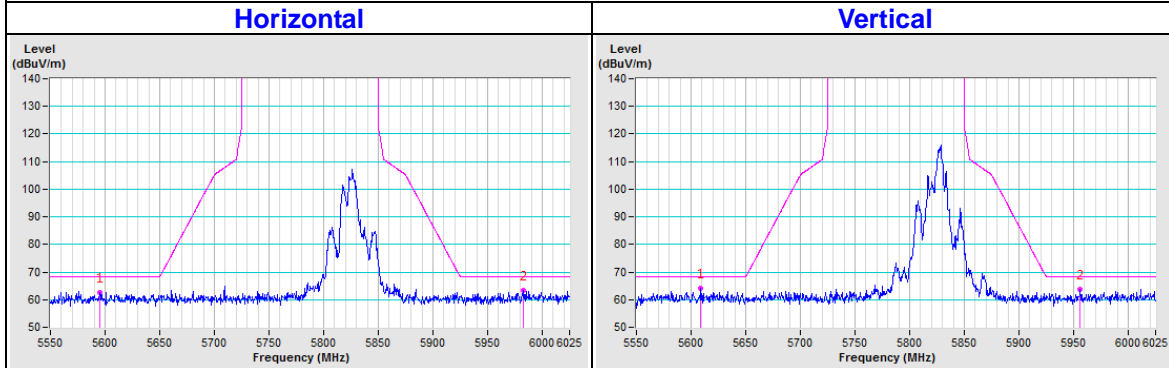

802.11n (40MHz)

CH151

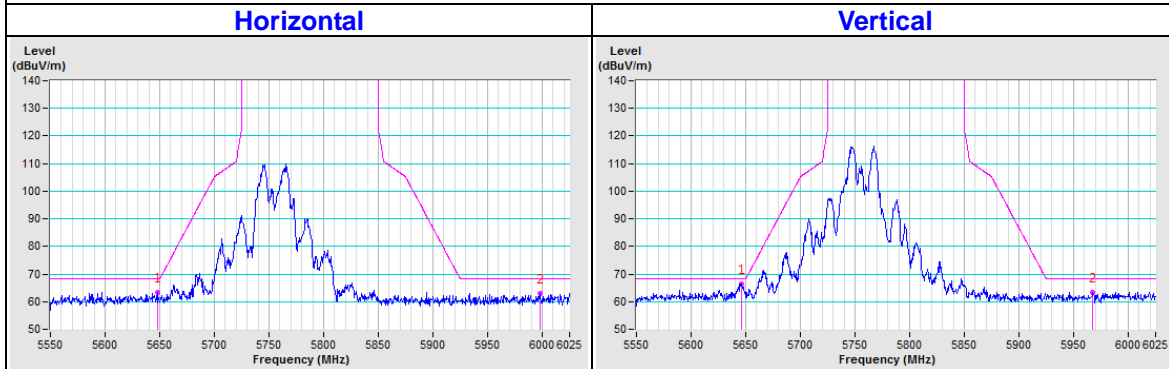

CH159

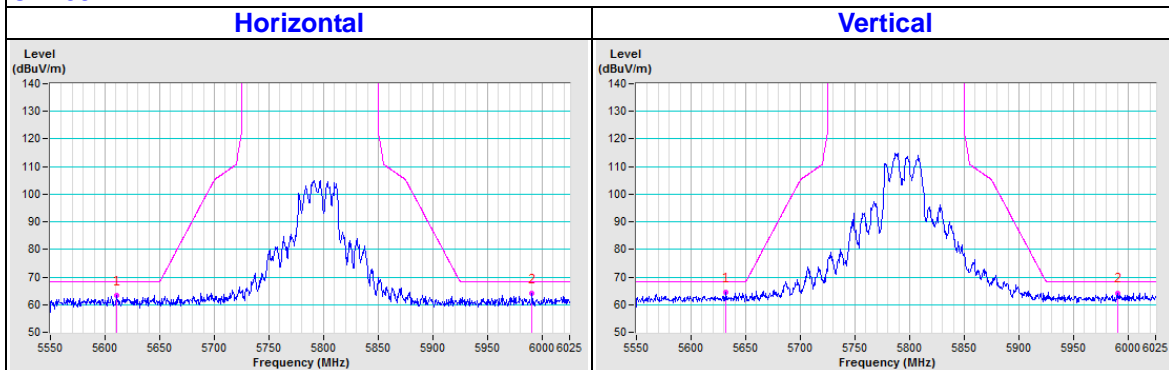

802.11ac (80MHz)

CH155

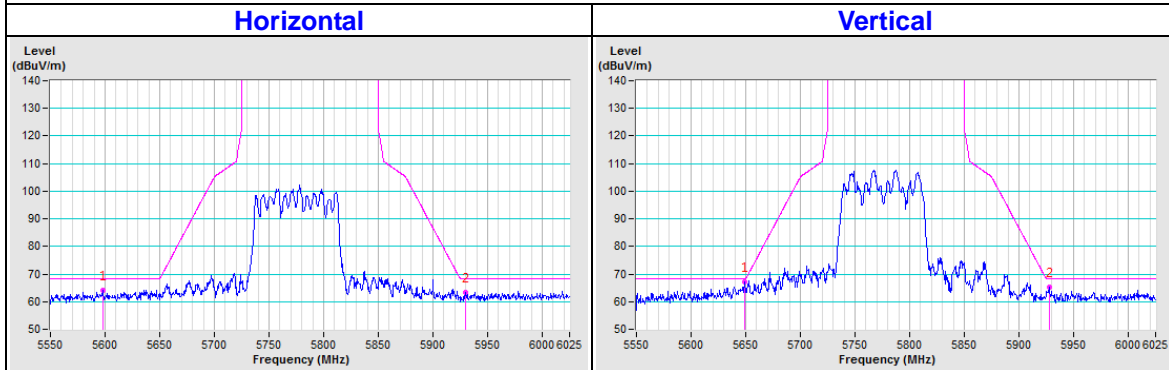

CDD Mode (Mode B)

802.11a

CH149

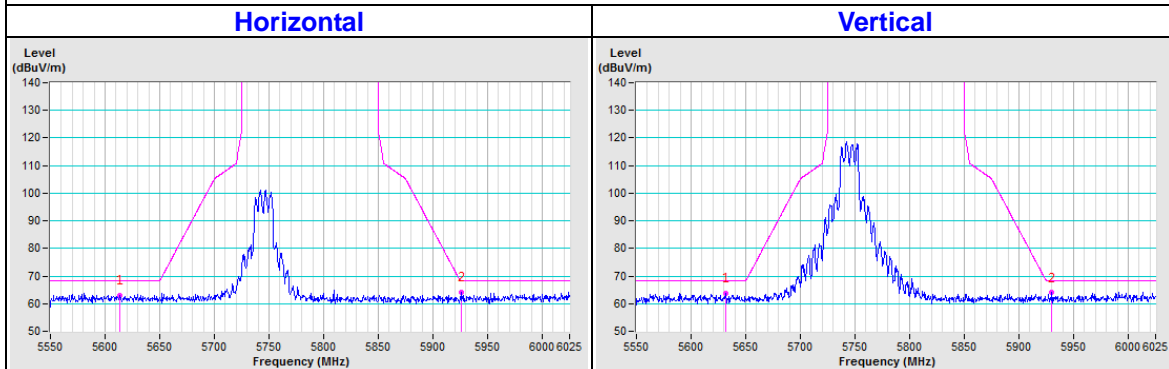

CH157

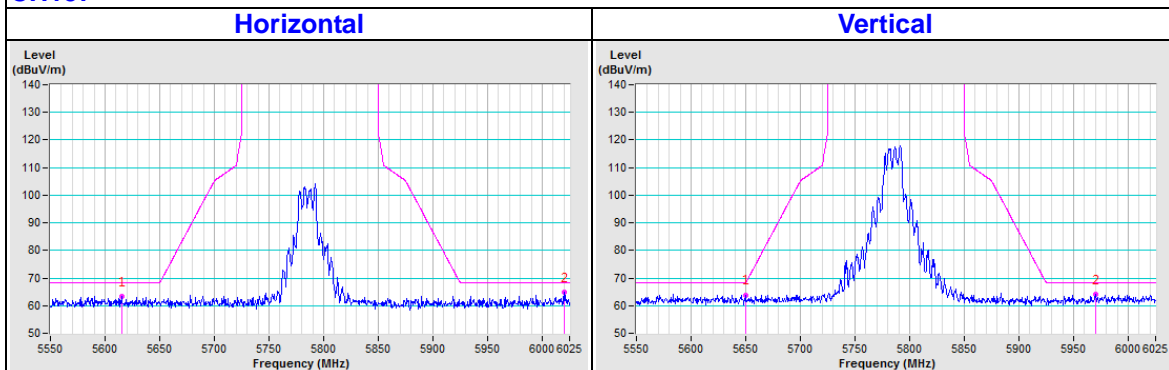

CH165

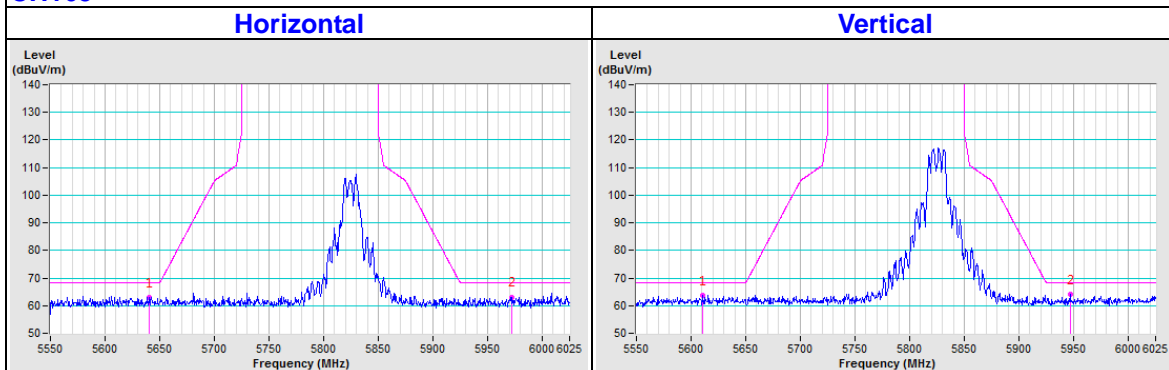

802.11n (20MHz)

CH149

Horizontal

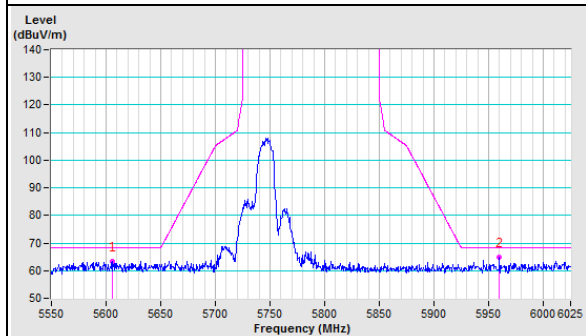

Vertical

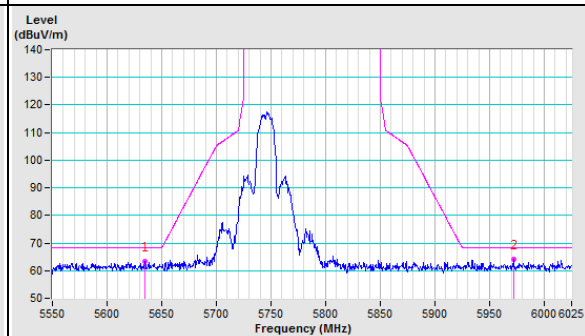

CH157

Horizontal

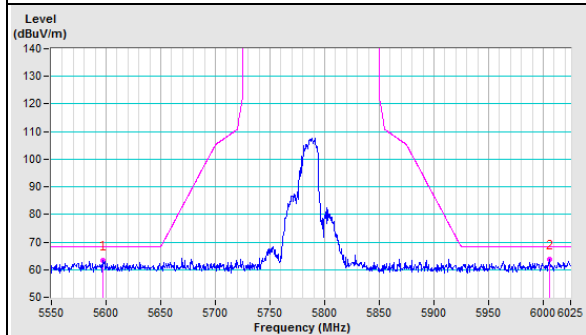

Vertical

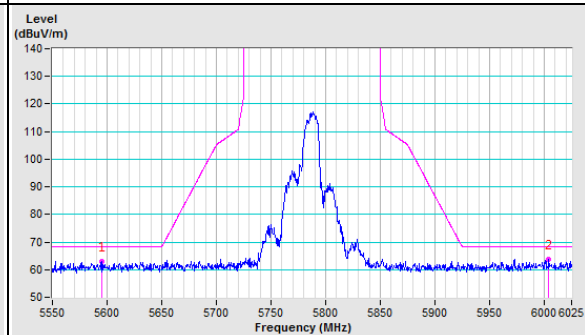

CH165

Horizontal

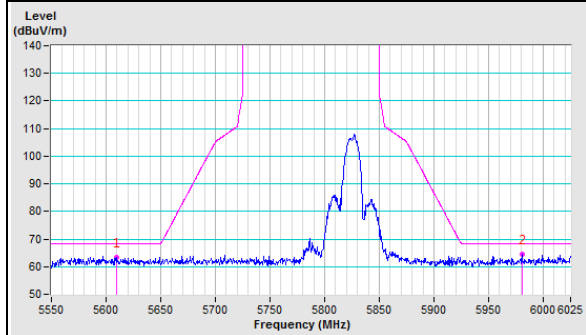

Vertical

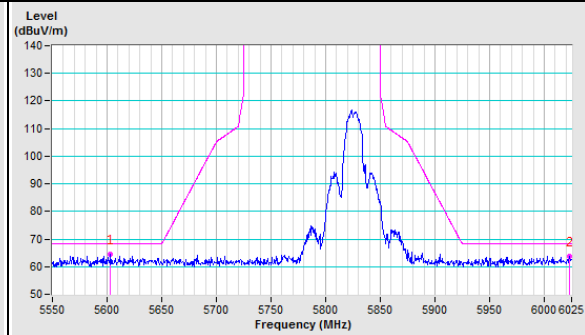

802.11n (40MHz)

CH151

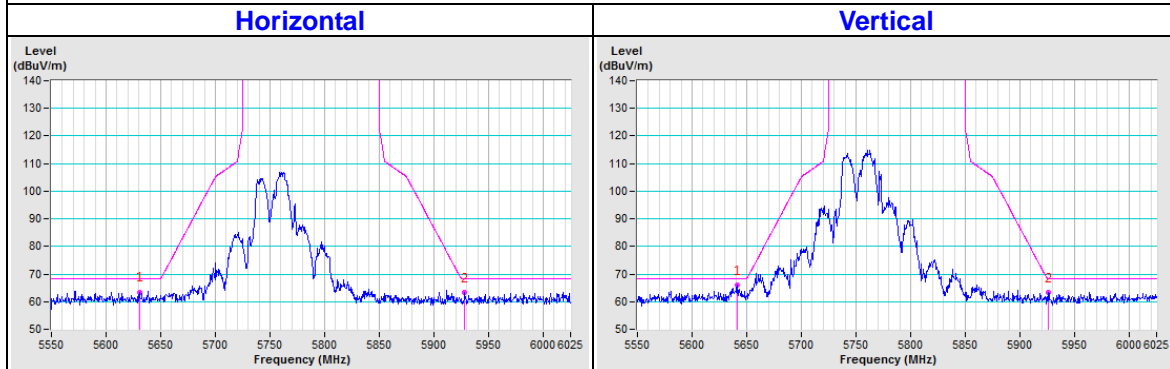

CH159

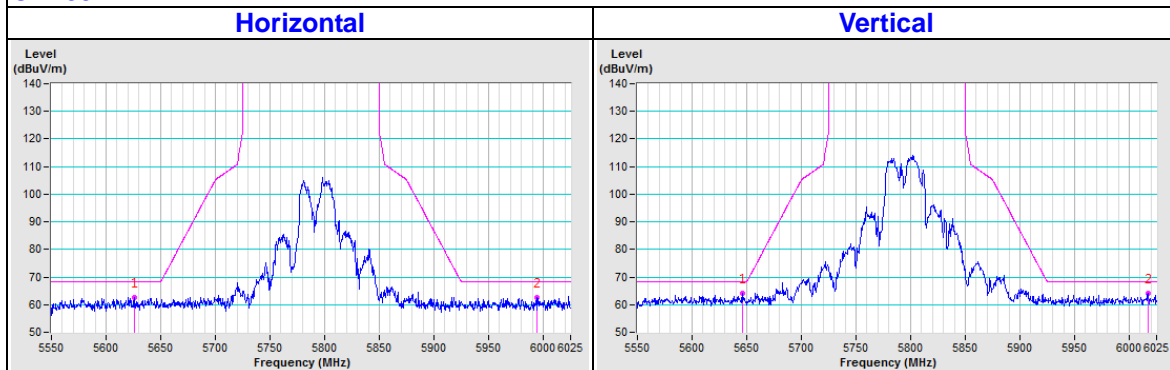

802.11ac (80MHz)

CH155

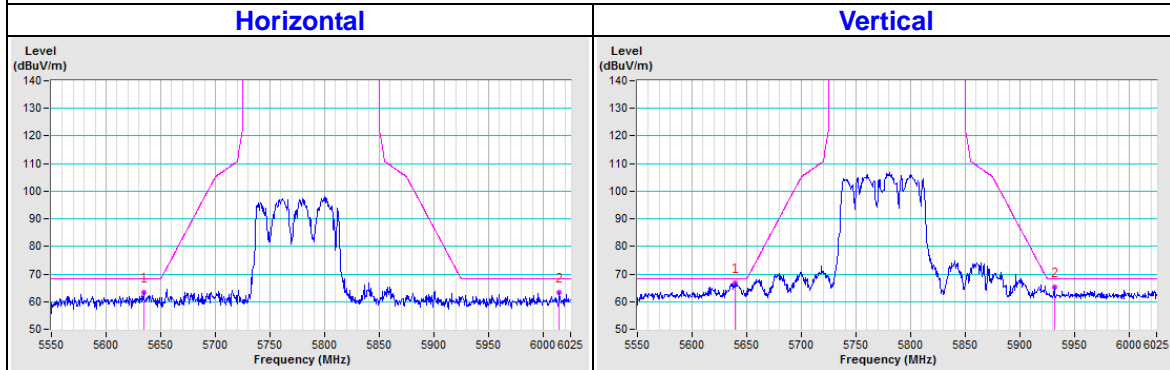

Beamforming_NSS1 Mode (Mode A)

802.11ac (20MHz)

CH149

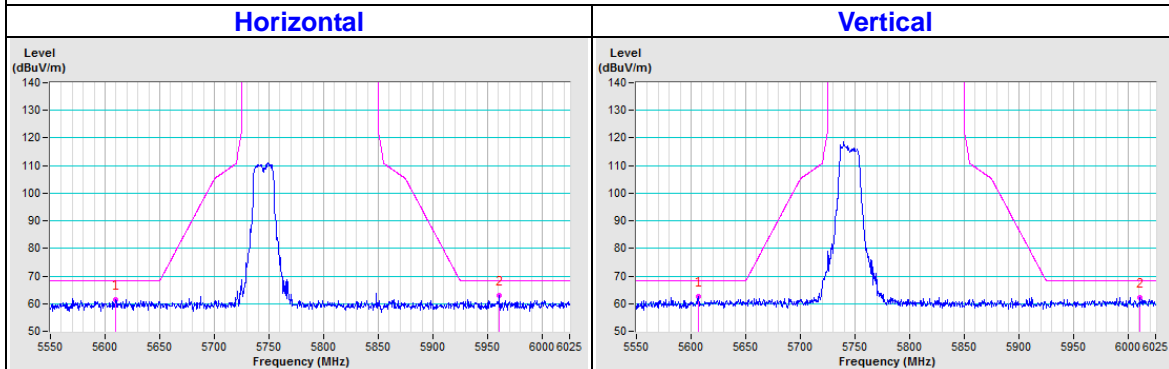

CH157

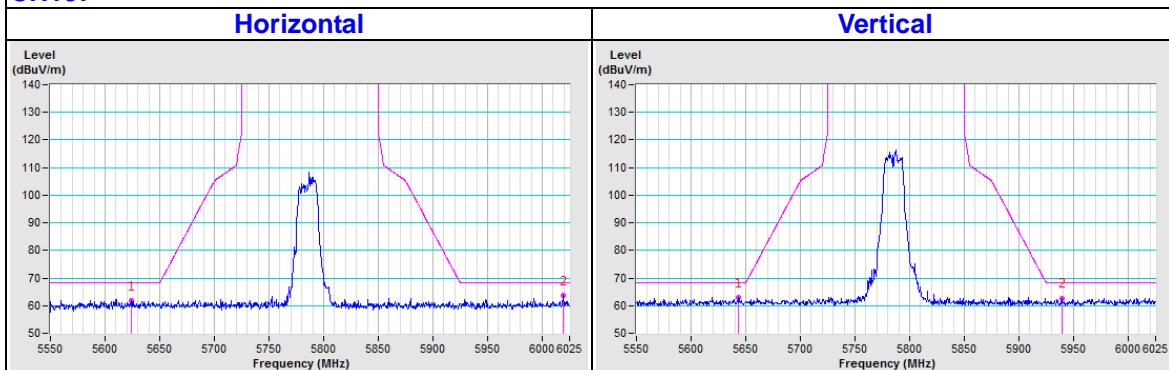

CH165

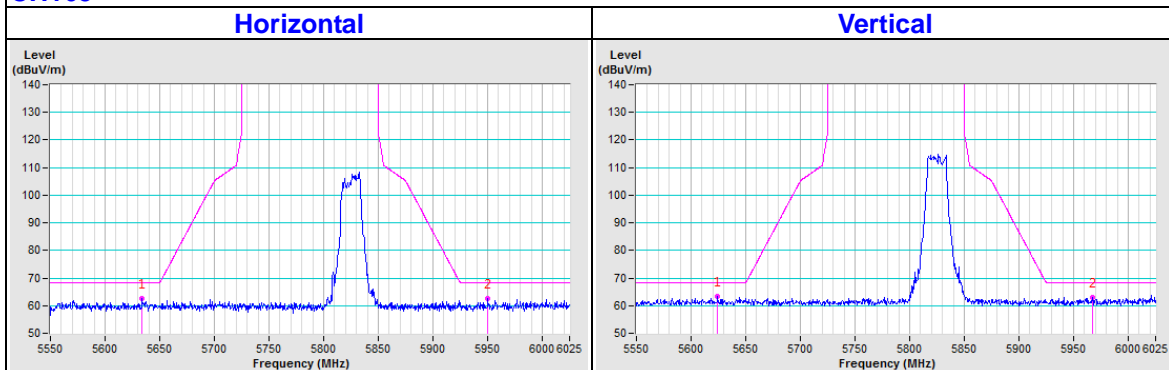

802.11ac (40MHz)

CH151

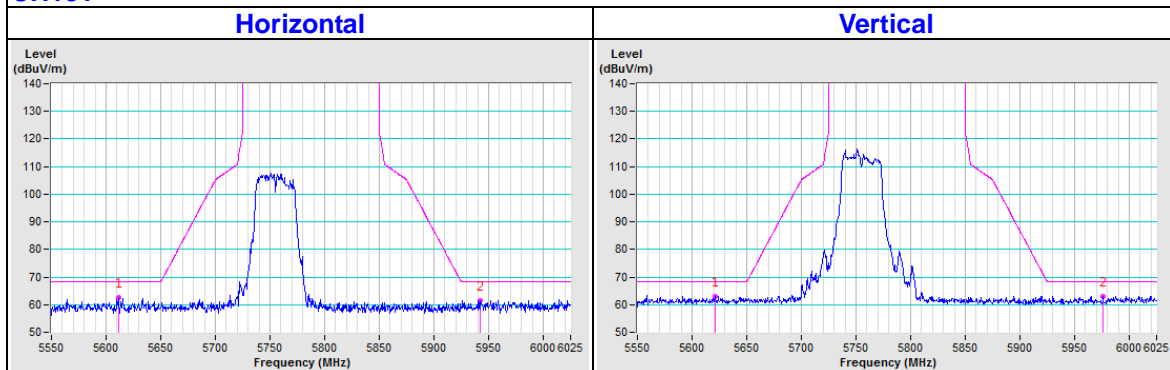

CH159

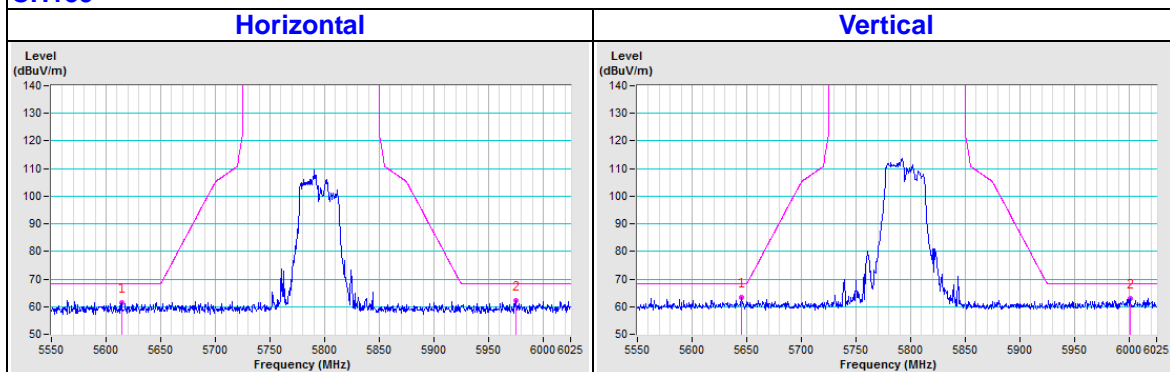

802.11ac (80MHz)

CH155

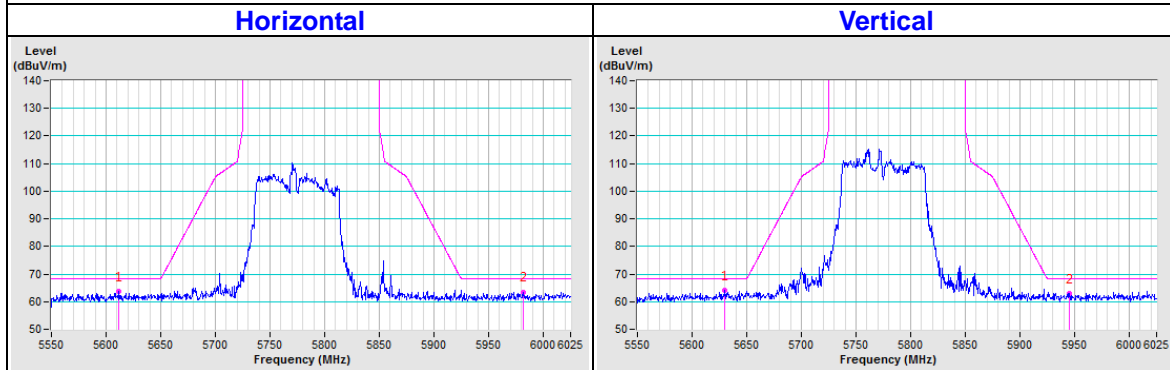

Beamforming_NSS1 Mode (Mode B)

802.11ac (20MHz)

CH149

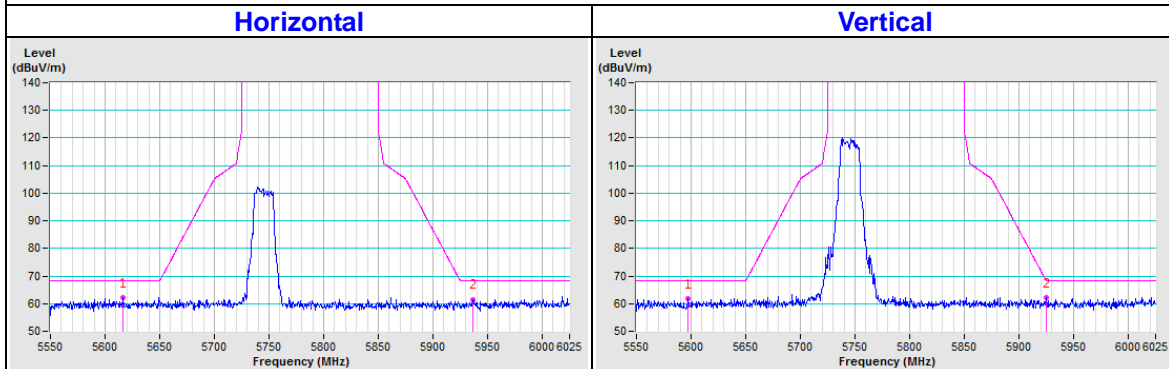

CH157

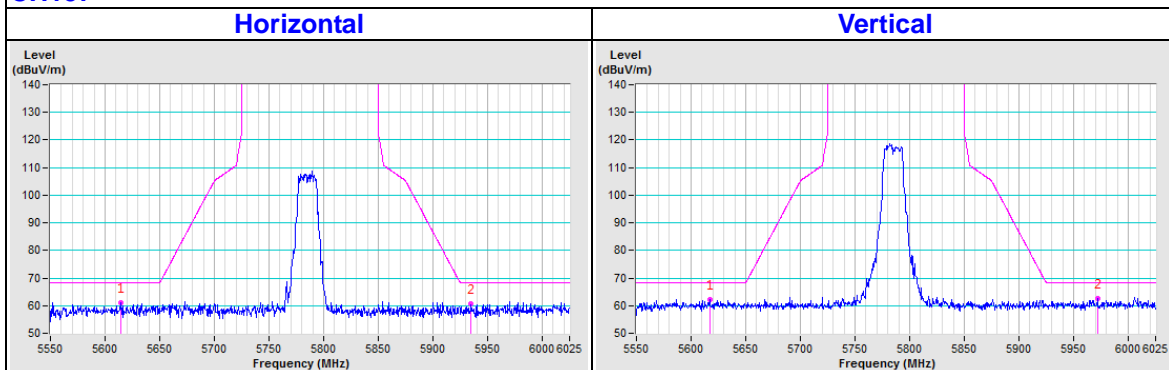

CH165

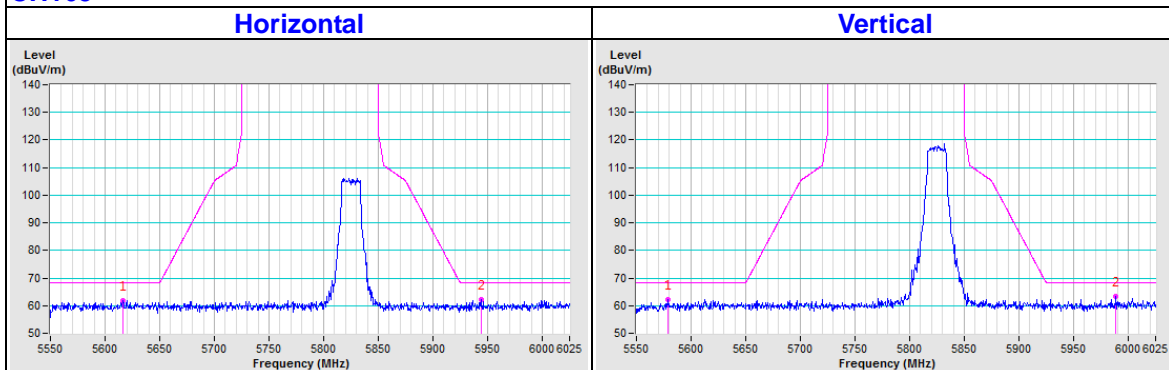

802.11ac (40MHz)

CH151

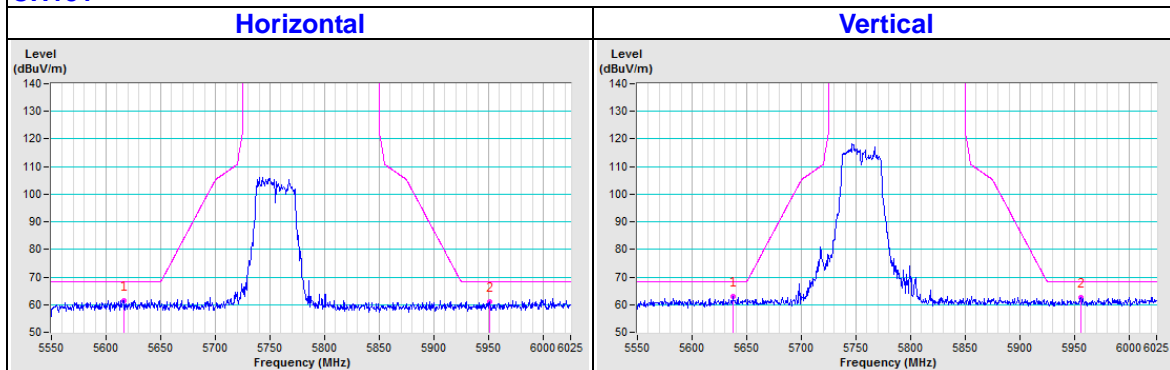

CH159

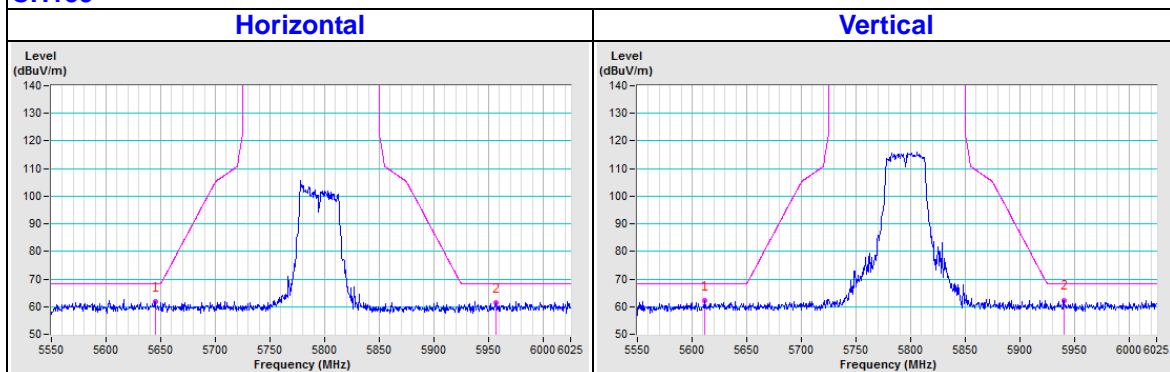

802.11ac (80MHz)

CH155

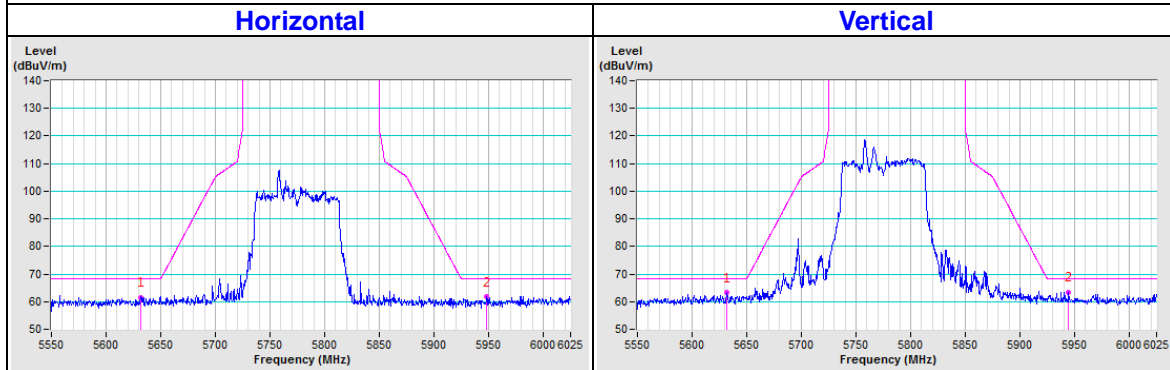

Appendix – Information on the Testing Laboratories

We, Bureau Veritas Consumer Products Services (H.K.) Ltd., Taoyuan Branch, were founded in 1988 to provide our best service in EMC, Radio, Telecom and Safety consultation. Our laboratories are accredited and approved according to ISO/IEC 17025.

If you have any comments, please feel free to contact us at the following:

Linko EMC/RF Lab

Tel: 886-2-26052180

Fax: 886-2-26051924

Hsin Chu EMC/RF/Telecom Lab

Tel: 886-3-6668565

Fax: 886-3-6668323

Hwa Ya EMC/RF/Safety Lab

Tel: 886-3-3183232

Fax: 886-3-3270892

Email: service.adt@tw.bureauveritas.com

Web Site: www.bureauveritas-adt.com

The address and road map of all our labs can be found in our web site also.

--- END ---