

## FCC Test Report

**Report No.:** RF180425D01-1

**FCC ID:** 2ALJ3AP211H

**Test Model:** AP211H

**Received Date:** Apr. 25, 2018

**Test Date:** May 9 ~ Jun. 27, 2018

**Issued Date:** Jul. 5, 2018

**Applicant:** HAN Networks Co., Ltd.

**Address:** 5/F, Building 37, No.8 Dongbeiwang West Road, HaiDian District, Beijing, China

**Issued By:** Bureau Veritas Consumer Products Services (H.K.) Ltd., Taoyuan Branch

**Lab Address:** No. 47-2, 14th Ling, Chia Pau Vil., Lin Kou Dist., New Taipei City, Taiwan (R.O.C.)

**FCC Registration /  
Designation Number:** 198487 / TW2021



This report is for your exclusive use. Any copying or replication of this report to or for any other person or entity, or use of our name or trademark, is permitted only with our prior written permission. This report sets forth our findings solely with respect to the test samples identified herein. The results set forth in this report are not indicative or representative of the quality or characteristics of the lot from which a test sample was taken or any similar or identical product unless specifically and expressly noted. Our report includes all of the tests requested by you and the results thereof based upon the information that you provided to us. You have 60 days from date of issuance of this report to notify us of any material error or omission caused by our negligence, provided, however, that such notice shall be in writing and shall specifically address the issue you wish to raise. A failure to raise such issue within the prescribed time shall constitute your unqualified acceptance of the completeness of this report, the tests conducted and the correctness of the report contents. Unless specific mention, the uncertainty of measurement has been explicitly taken into account to declare the compliance or non-compliance to the specification. The report must not be used by the client to claim product certification, approval, or endorsement by TAF or any government agencies.

## Table of Contents

<b>Release Control Record .....</b>	<b>4</b>
<b>1 Certificate of Conformity .....</b>	<b>5</b>
<b>2 Summary of Test Results.....</b>	<b>6</b>
2.1 Measurement Uncertainty.....	6
2.2 Modification Record.....	6
<b>3 General Information .....</b>	<b>7</b>
3.1 General Description of EUT .....	7
3.2 Description of Test Modes .....	9
3.2.1 Test Mode Applicability and Tested Channel Detail .....	10
3.3 Duty Cycle of Test Signal.....	13
3.4 Description of Support Units .....	14
3.4.1 Configuration of System under Test .....	14
3.5 General Description of Applied Standard .....	15
<b>4 Test Types and Results .....</b>	<b>16</b>
4.1 Radiated Emission and Bandedge Measurement .....	16
4.1.1 Limits of Radiated Emission and Bandedge Measurement .....	16
4.1.2 Test Instruments.....	17
4.1.3 Test Procedure.....	18
4.1.4 Deviation from Test Standard .....	18
4.1.5 Test Setup.....	19
4.1.6 EUT Operating Condition .....	20
4.1.7 Test Results .....	21
4.2 Conducted Emission Measurement.....	52
4.2.1 Limits of Conducted Emission Measurement .....	52
4.2.2 Test Instruments.....	52
4.2.3 Test Procedure.....	53
4.2.4 Deviation from Test Standard .....	53
4.2.5 Test Setup.....	53
4.2.6 EUT Operating Condition .....	53
4.2.7 Test Results .....	54
4.3 Transmit Power Measurement.....	58
4.3.1 Limits of Transmit Power Measurement .....	58
4.3.2 Test Setup.....	58
4.3.3 Test Instruments.....	59
4.3.4 Test Procedure.....	59
4.3.5 Deviation from Test Standard .....	60
4.3.6 EUT Operating Condition .....	60
4.3.7 Test Result .....	61
4.4 Occupied Bandwidth Measurement.....	65
4.4.1 Test Setup.....	65
4.4.2 Test Instruments.....	65
4.4.3 Test Procedure.....	65
4.4.4 Test Results .....	66
4.5 Peak Power Spectral Density Measurement.....	68
4.5.1 Limits of Peak Power Spectral Density Measurement .....	68
4.5.2 Test Setup.....	68
4.5.3 Test Instruments.....	68
4.5.4 Test Procedure.....	69
4.5.5 Deviation from Test Standard .....	69
4.5.6 EUT Operating Condition .....	69
4.5.7 Test Results .....	70
4.6 Frequency Stability Measurement.....	74

4.6.1	Limits of Frequency Stability Measurement.....	74
4.6.2	Test Setup.....	74
4.6.3	Test Instruments.....	74
4.6.4	Test Procedure.....	74
4.6.5	Deviation from Test Standard.....	74
4.6.6	EUT Operating Condition.....	74
4.6.7	Test Results.....	75
4.7	6dB Bandwidth Measurement.....	76
4.7.1	Limits of 6dB Bandwidth Measurement.....	76
4.7.2	Test Setup.....	76
4.7.3	Test Instruments.....	76
4.7.4	Test Procedure.....	76
4.7.5	Deviation from Test Standard.....	76
4.7.6	EUT Operating Condition.....	76
4.7.7	Test Results.....	77
<b>5</b>	<b>Pictures of Test Arrangements.....</b>	<b>79</b>
	<b>Annex A- Radiated Out of Band Emission (OOBE) Measurement (For U-NII-3 band) .....</b>	<b>80</b>
	<b>Appendix – Information on the Testing Laboratories .....</b>	<b>83</b>



### Release Control Record

Issue No.	Description	Date Issued
RF180425D01-1	Original release.	Jul. 5, 2018

## 1 Certificate of Conformity

**Product:** HAN Access Point

**Brand:** HAN

**Test Model:** AP211H

**Sample Status:** Engineering sample

**Applicant:** HAN Networks Co., Ltd.

**Test Date:** May 9 ~ Jun. 27, 2018

**Standard:** 47 CFR FCC Part 15, Subpart E (Section 15.407)  
ANSI C63.10: 2013

The above equipment has been tested by **Bureau Veritas Consumer Products Services (H.K.) Ltd., Taoyuan Branch**, and found compliance with the requirement of the above standards. The test record, data evaluation & Equipment Under Test (EUT) configurations represented herein are true and accurate accounts of the measurements of the sample's RF characteristics under the conditions specified in this report.

**Prepared by :** Annie Chang, **Date:** Jul. 5, 2018  
Annie Chang / Senior Specialist

**Approved by :** Rex Lai, **Date:** Jul. 5, 2018  
Rex Lai / Associate Technical Manager

## 2 Summary of Test Results

47 CFR FCC Part 15, Subpart E (Section 15.407)			
FCC Clause	Test Item	Result	Remarks
15.407(b)(6)	AC Power Conducted Emissions	Pass	Meet the requirement of limit. Minimum passing margin is -3.92dB at 15.07422MHz.
15.407(b)(1/2/3/4(i/ii)/6)	Radiated Emissions & Band Edge Measurement*	Pass	Meet the requirement of limit. Minimum passing margin is -1.02dB at 5150.00MHz.
15.407(a)(1/2/3)	Max Average Transmit Power	Pass	Meet the requirement of limit.
---	Occupied Bandwidth Measurement	-	Reference only.
15.407(a)(1/2/3)	Peak Power Spectral Density	Pass	Meet the requirement of limit.
15.407(e)	6dB bandwidth	Pass	Meet the requirement of limit. (U-NII-3 Band only)
15.407(g)	Frequency Stability	Pass	Meet the requirement of limit.
15.203	Antenna Requirement	Pass	No antenna connector is used.

\*For U-NII-3 band compliance with rule part 15.407(b)(4)(i), the OOB test plots were recorded in Annex A.

### 2.1 Measurement Uncertainty

Where relevant, the following measurement uncertainty levels have been estimated for tests performed on the EUT as specified in CISPR 16-4-2:

Measurement	Frequency	Expanded Uncertainty (k=2) (±)
Conducted Emissions at mains ports	150kHz ~ 30MHz	2.79 dB
Radiated Emissions up to 1 GHz	9kHz ~ 30MHz	2.38 dB
	30MHz ~ 1000MHz	5.54 dB
Radiated Emissions above 1 GHz	1GHz ~ 6GHz	4.77 dB
	6GHz ~ 18GHz	5.48 dB

### 2.2 Modification Record

There were no modifications required for compliance.

### 3 General Information

#### 3.1 General Description of EUT

Product	HAN Access Point
Brand	HAN
Test Model	AP211H
Status of EUT	Engineering sample
Power Supply Rating	48Vdc from Adapter or 55Vdc from PoE
Modulation Type	64QAM, 16QAM, QPSK, BPSK for OFDM 256QAM for OFDM in 11ac mode only.
Modulation Technology	OFDM
Transfer Rate	802.11a: 54/48/36/24/18/12/9/6Mbps 802.11n: up to 300Mbps 802.11ac: up to 866.6Mbps
Operating Frequency	5180 ~ 5240MHz, 5745 ~ 5825MHz
Number of Channel	<b>5180 ~ 5240MHz</b> 4 for 802.11a, 802.11n (20MHz), 802.11ac (20MHz) 2 for 802.11n (40MHz), 802.11ac (40MHz) 1 for 802.11ac (80MHz) <b>5745 ~ 5825MHz</b> 5 for 802.11a, 802.11n (20MHz) 802.11ac (20MHz) 2 for 802.11n (40MHz) 802.11ac (40MHz) 1 for 802.11ac (80MHz)
Output Power	<b>5180 ~ 5240MHz:</b> 389.583mW <b>5745 ~ 5825MHz:</b> 418.218mW
Antenna Type	Printed antenna with 6.3dBi gain
Antenna Connector	N/A
Accessory Device	N/A
Data Cable Supplied	N/A

Note:

- The EUT provides 2 completed transmitters and 2 receivers.

Modulation Mode	TX Function
802.11a	2TX
802.11n (20MHz)	2TX
802.11n (40MHz)	2TX
802.11ac (20MHz)	2TX
802.11ac (40MHz)	2TX
802.11ac (80MHz)	2TX

Note: The modulation and bandwidth are similar for 802.11n mode for 20MHz (40MHz) and 802.11ac mode for 20MHz (40MHz), therefore investigated worst case to representative mode in test report. (Final test mode refer section 3.2.1)

2. The EUT uses following adapter or PoE Adapter (Support unit only):

Item	Brand	Model No.	Rating
Adapter	DELTA	ADP-30HR B	AC I/P: 100-240V, 50-60Hz, 1A DC O/P: 48V, 0.66A Non-shielded DC (1.5m) with one ferrite core
PoE Adapter	Microsemi	PD-9001GR/AT/AC	AC I/P: 100-240V, 50/60Hz, 0.67A DC O/P: 55V, 0.6A

3. For Radiated test, the EUT was pre-tested with the following modes:

- ✧ Operating Mode, Powered from Adapter
- ✧ Operating Mode, Powered from PoE

The worst emission level was found when the EUT tested under **Operating Mode, Powered from Adapter**, therefore, only its test data was recorded in this report.

4. The above EUT information is declared by manufacturer and for more detailed features description, please refers to the manufacturer's specifications or user's manual.



### 3.2 Description of Test Modes

#### FOR 5180 ~ 5240MHz

4 channels are provided for 802.11a, 802.11n (20MHz), 802.11ac (20MHz):

Channel	Frequency	Channel	Frequency
36	5180 MHz	44	5220 MHz
40	5200 MHz	48	5240 MHz

2 channels are provided for 802.11n (40MHz), 802.11ac (40MHz):

Channel	Frequency	Channel	Frequency
38	5190 MHz	46	5230 MHz

1 channel is provided for 802.11ac (80MHz):

Channel	Frequency
42	5210MHz

#### FOR 5745 ~ 5825MHz:

5 channels are provided for 802.11a, 802.11n (20MHz), 802.11ac (20MHz):

Channel	Frequency	Channel	Frequency
149	5745MHz	161	5805MHz
153	5765MHz	165	5825MHz
157	5785MHz		

2 channels are provided for 802.11n (40MHz), 802.11ac (40MHz):

Channel	Frequency	Channel	Frequency
151	5755MHz	159	5795MHz

1 channel is provided for 802.11ac (80MHz):

Channel	Frequency
155	5775MHz

### 3.2.1 Test Mode Applicability and Tested Channel Detail

EUT Configure Mode	Applicable To				Description
	RE $\geq$ 1G	RE<1G	PLC	APCM	
A	√	√	√	√	Powered from Adapter
B	-	-	√	-	Powered from PoE

Where **RE $\geq$ 1G**: Radiated Emission above 1GHz      **RE<1G**: Radiated Emission below 1GHz  
**PLC**: Power Line Conducted Emission      **APCM**: Antenna Port Conducted Measurement

**NOTE:**

1. The EUT had been pre-tested on the positioned of each 3 axis. The worst case was found when positioned on **Y-plane**.
2. "-" means no effect.

#### Radiated Emission Test (Above 1GHz):

- Pre-Scan has been conducted to determine the worst-case mode from all possible combinations between available modulations, data rates and antenna ports (if EUT with antenna diversity architecture).
- Following channel(s) was (were) selected for the final test as listed below.

CDD Mode							
EUT Configure Mode	Mode	FREQ. Band (MHz)	Available Channel	Tested Channel	Modulation Technology	Modulation Type	Data Rate (Mbps)
A	802.11a	5180-5240	36 to 48	36, 40, 48	OFDM	BPSK	6
A	802.11ac (20MHz)		36 to 48	36, 40, 48	OFDM	BPSK	6.5
A	802.11ac (40MHz)		38 to 46	38, 46	OFDM	BPSK	13.5
A	802.11ac (80MHz)		42	42	OFDM	BPSK	29.3
A	802.11a	5745-5825	149 to 165	149, 157, 165	OFDM	BPSK	6
A	802.11ac (20MHz)		149 to 165	149, 157, 165	OFDM	BPSK	6.5
A	802.11ac (40MHz)		151 to 159	151, 159	OFDM	BPSK	13.5
A	802.11ac (80MHz)		155	155	OFDM	BPSK	29.3
Beamforming_NSS1 Mode							
EUT Configure Mode	Mode	FREQ. Band (MHz)	Available Channel	Tested Channel	Modulation Technology	Modulation Type	Data Rate (Mbps)
A	802.11ac (20MHz)	5180-5240	36 to 48	36, 40, 48	OFDM	BPSK	6.5
A	802.11ac (40MHz)		38 to 46	38, 46	OFDM	BPSK	13.5
A	802.11ac (80MHz)		42	42	OFDM	BPSK	29.3
A	802.11ac (20MHz)	5745-5825	149 to 165	149, 157, 165	OFDM	BPSK	6.5
A	802.11ac (40MHz)		151 to 159	151, 159	OFDM	BPSK	13.5
A	802.11ac (80MHz)		155	155	OFDM	BPSK	29.3

**Radiated Emission Test (Below 1GHz):**

- Pre-Scan has been conducted to determine the worst-case mode from all possible combinations between available modulations, data rates and antenna ports (if EUT with antenna diversity architecture).
- Following channel(s) was (were) selected for the final test as listed below.

CDD Mode							
EUT Configure Mode	Mode	FREQ. Band (MHz)	Available Channel	Tested Channel	Modulation Technology	Modulation Type	Data Rate (Mbps)
A	802.11a	5180-5240	36 to 48	40	OFDM	BPSK	6
A	802.11a	5745-5825	149 to 165		OFDM	BPSK	6

**Power Line Conducted Emission Test:**

- Pre-Scan has been conducted to determine the worst-case mode from all possible combinations between available modulations, data rates and antenna ports (if EUT with antenna diversity architecture).
- Following channel(s) was (were) selected for the final test as listed below.

CDD Mode							
EUT Configure Mode	Mode	FREQ. Band (MHz)	Available Channel	Tested Channel	Modulation Technology	Modulation Type	Data Rate (Mbps)
A & B	802.11a	5180-5240	36 to 48	40	OFDM	BPSK	6
A & B	802.11a	5745-5825	149 to 165		OFDM	BPSK	6

**Antenna Port Conducted Measurement:**

- This item includes all test value of each mode, but only includes spectrum plot of worst value of each mode.
- Pre-Scan has been conducted to determine the worst-case mode from all possible combinations between available modulations, data rates and antenna ports (if EUT with antenna diversity architecture).
- Following channel(s) was (were) selected for the final test as listed below.
- The EUT was tested with CDD Mode & Beamforming\_NSS1 Mode for Maximum Peak Output Power test. The worst case was found when the EUT was tested with CDD Mode. Therefore, other test items were tested with CDD Mode only.

CDD Mode							
EUT Configure Mode	Mode	FREQ. Band (MHz)	Available Channel	Tested Channel	Modulation Technology	Modulation Type	Data Rate (Mbps)
A	802.11a	5180-5240	36 to 48	36, 40, 48	OFDM	BPSK	6
A	802.11ac (20MHz)		36 to 48	36, 40, 48	OFDM	BPSK	6.5
A	802.11ac (40MHz)		38 to 46	38, 46	OFDM	BPSK	13.5
A	802.11ac (80MHz)		42	42	OFDM	BPSK	29.3
A	802.11a	5745-5825	149 to 165	149, 157, 165	OFDM	BPSK	6
A	802.11ac (20MHz)		149 to 165	149, 157, 165	OFDM	BPSK	6.5
A	802.11ac (40MHz)		151 to 159	151, 159	OFDM	BPSK	13.5
A	802.11ac (80MHz)		155	155	OFDM	BPSK	29.3

Beamforming_NSS1 Mode (Output Power Only)							
EUT Configure Mode	Mode	FREQ. Band (MHz)	Available Channel	Tested Channel	Modulation Technology	Modulation Type	Data Rate (Mbps)
A	802.11ac (20MHz)	5180-5240	36 to 48	36, 40, 48	OFDM	BPSK	6.5
A	802.11ac (40MHz)		38 to 46	38, 46	OFDM	BPSK	13.5
A	802.11ac (80MHz)		42	42	OFDM	BPSK	29.3
A	802.11ac (20MHz)	5745-5825	149 to 165	149, 157, 165	OFDM	BPSK	6.5
A	802.11ac (40MHz)		151 to 159	151, 159	OFDM	BPSK	13.5
A	802.11ac (80MHz)		155	155	OFDM	BPSK	29.3

**Test Condition:**

Applicable To	EUT Configure Mode	Environmental Conditions	Input Power	Tested By
RE $\geq$ 1G	A	22deg. C, 76%RH	120Vac, 60Hz	James Wei
RE<1G	A	23deg. C, 74%RH	120Vac, 60Hz	James Wei
PLC	A	25deg. C, 78%RH	120Vac, 60Hz	Starlitaly Wu
	B	25deg. C, 75%RH	120Vac, 60Hz	Starlitaly Wu
APCM	A	25deg. C, 76%RH	120Vac, 60Hz	Saxon Lee

### 3.3 Duty Cycle of Test Signal

If duty cycle of test signal is  $\geq 98\%$ , duty factor is not required.

If duty cycle of test signal is  $< 98\%$ , duty factor shall be considered.

**802.11a:** Duty cycle =  $2.019/2.088 = 0.967$ , Duty factor =  $10 * \log(1/0.967) = 0.15$

**802.11ac (20MHz):** Duty cycle =  $4.949/5.017 = 0.986$

**802.11ac (40MHz):** Duty cycle =  $2.37/2.47 = 0.960$ , Duty factor =  $10 * \log(1/0.960) = 0.18$

**802.11ac (80MHz):** Duty cycle =  $1.089/1.200 = 0.908$ , Duty factor =  $10 * \log(1/0.908) = 0.42$

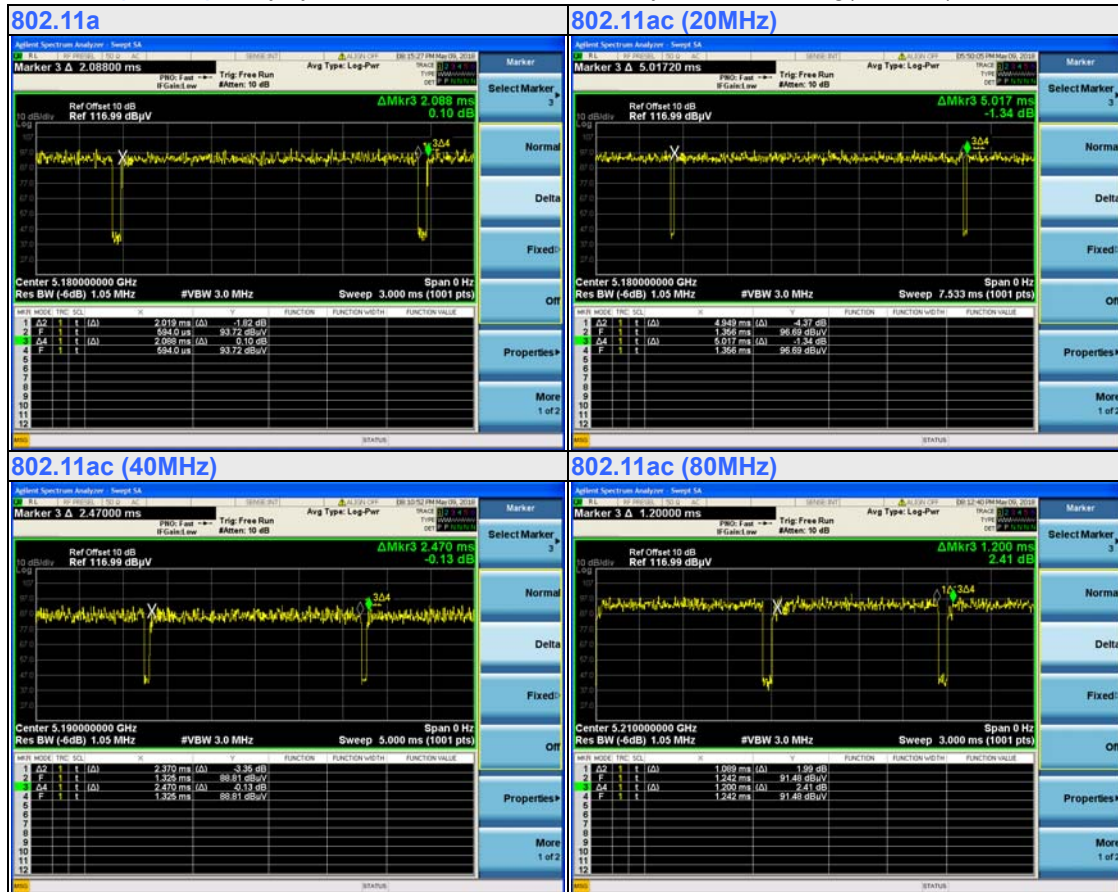

### 3.4 Description of Support Units

The EUT has been tested as an independent unit together with other necessary accessories or support units. The following support units or accessories were used to form a representative test configuration during the tests.

ID	Product	Brand	Model No.	Serial No.	FCC ID	Remarks
A.	Adapter	DELTA	ADP-30HR B	N/A	N/A	Supplied by client
B.	Notebook PC	DELL	PP27L	8SNZ12S	FCC DoC Approved	Provided by Lab
C.	PoE Adapter	Microsemi	PD-9001GR/AT/AC	N/A	N/A	Supplied by client

Note:

1. All power cords of the above support units are non-shielded (1.8m).
2. Item B acted as communication partners to transfer data.

ID	Descriptions	Qty.	Length (m)	Shielding (Yes/No)	Cores (Qty.)	Remarks
1.	DC cable	1	1.5	N	0	Supplied by client
2.	LAN cable	1	10	N	0	Provided by Lab
3.	AC Cable	1	1.8	N	0	Provided by Lab
4.	LAN cable	1	1.5	N	0	Provided by Lab
5.	AC Cable	1	1.8	N	0	Provided by Lab

Note: The core(s) is(are) originally attached to the cable(s).

#### 3.4.1 Configuration of System under Test

For Mode A:

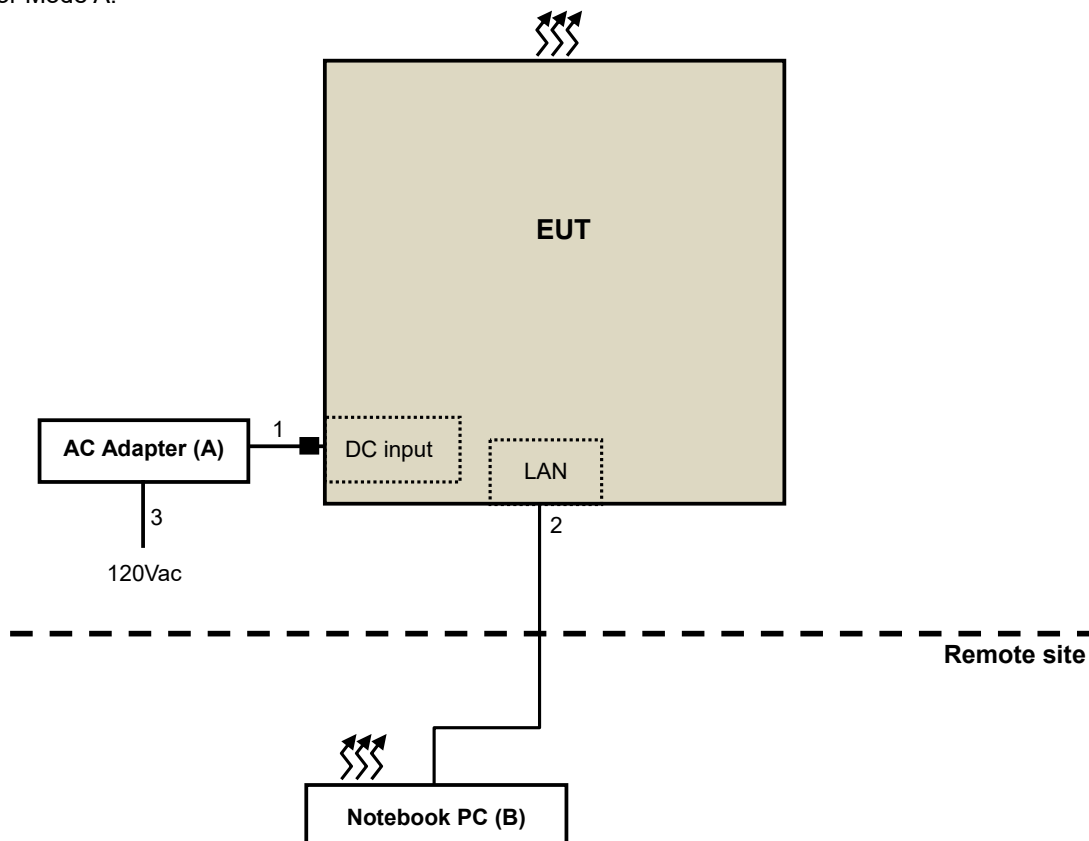

For Mode B:

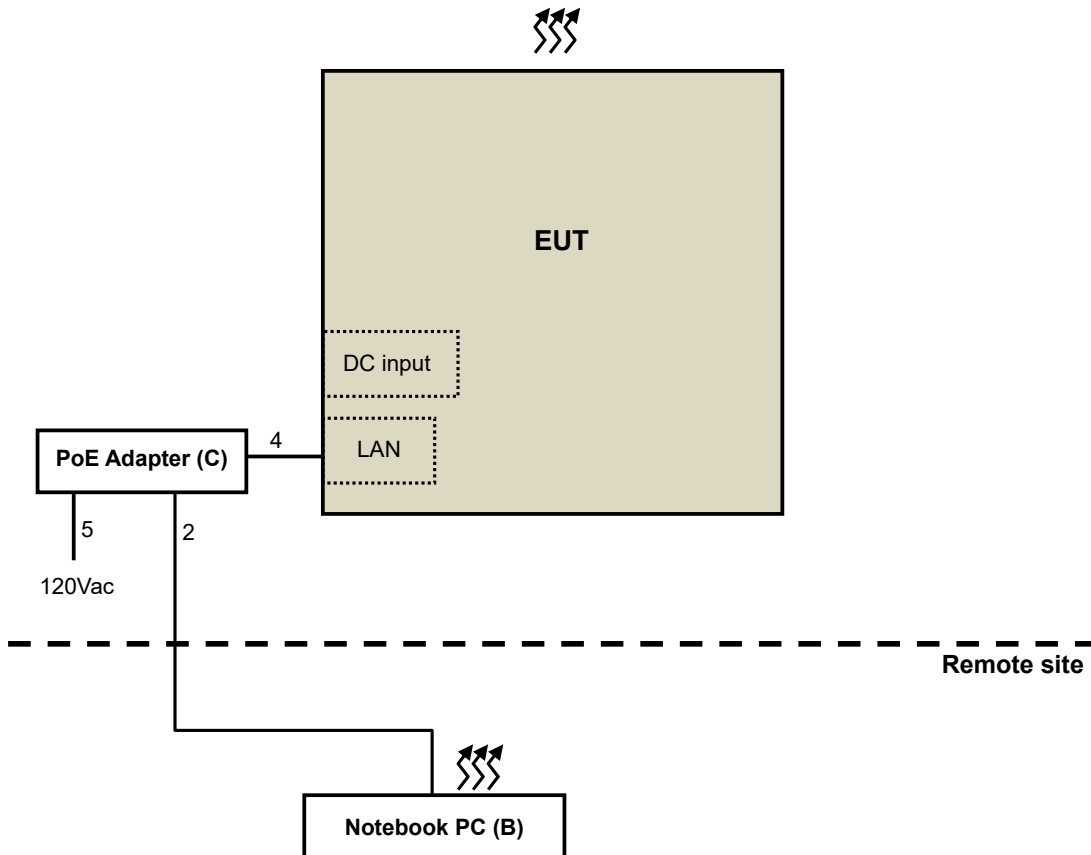

### 3.5 General Description of Applied Standard

The EUT is a RF Product. According to the specifications of the manufacturer, it must comply with the requirements of the following standards:

- FCC Part 15, Subpart E (15.407)**
- KDB 789033 D02 General UNII Test Procedure New Rules v02r01**
- KDB 662911 D01 Multiple Transmitter Output v02r01**
- ANSI C63.10-2013**

All test items have been performed and recorded as per the above standards.

## 4 Test Types and Results

### 4.1 Radiated Emission and Bandedge Measurement

#### 4.1.1 Limits of Radiated Emission and Bandedge Measurement

Radiated emissions which fall in the restricted bands must comply with the radiated emission limits specified as below table.

Frequencies (MHz)	Field Strength (microvolts/meter)	Measurement Distance (meters)
0.009 ~ 0.490	2400/F(kHz)	300
0.490 ~ 1.705	24000/F(kHz)	30
1.705 ~ 30.0	30	30
30 ~ 88	100	3
88 ~ 216	150	3
216 ~ 960	200	3
Above 960	500	3

#### NOTE:

- The lower limit shall apply at the transition frequencies.
- Emission level (dBuV/m) = 20 log Emission level (uV/m).
- For frequencies above 1000MHz, the field strength limits are based on average detector, however, the peak field strength of any emission shall not exceed the maximum permitted average limits, specified above by more than 20dB under any condition of modulation.

Limits of unwanted emission out of the restricted bands

Applicable To		Limit	
789033 D02 General UNII Test Procedure New Rules v02r01		Field Strength at 3m	
		PK:74 (dBµV/m)	AV:54 (dBµV/m)
Frequency Band	Applicable To	EIRP Limit	Equivalent Field Strength at 3m
5150~5250 MHz	15.407(b)(1)	PK:-27 (dBm/MHz)	PK:68.2(dBµV/m)
5250~5350 MHz	15.407(b)(2)		
5470~5725 MHz	15.407(b)(3)		
5725~5850 MHz	<input checked="" type="checkbox"/> 15.407(b)(4)(i)	PK:-27 (dBm/MHz) <sup>*1</sup> PK:10 (dBm/MHz) <sup>*2</sup> PK:15.6 (dBm/MHz) <sup>*3</sup> PK:27 (dBm/MHz) <sup>*4</sup>	PK: 68.2(dBµV/m) <sup>*1</sup> PK:105.2 (dBµV/m) <sup>*2</sup> PK: 110.8(dBµV/m) <sup>*3</sup> PK:122.2 (dBµV/m) <sup>*4</sup>
	<input type="checkbox"/> 15.407(b)(4)(ii)	Emission limits in section 15.247(d)	
*1 beyond 75 MHz or more above of the band edge.		*2 below the band edge increasing linearly to 10 dBm/MHz at 25 MHz above.	
*3 below the band edge increasing linearly to a level of 15.6 dBm/MHz at 5 MHz above.		*4 from 5 MHz above or below the band edge increasing linearly to a level of 27 dBm/MHz at the band edge.	

#### Note:

The following formula is used to convert the equipment isotropic radiated power (eirp) to field strength:

$$E = \frac{1000000\sqrt{30P}}{3} \mu\text{V/m, where P is the eirp (Watts).}$$



#### 4.1.2 Test Instruments

DESCRIPTION & MANUFACTURER	MODEL NO.	SERIAL NO.	CALIBRATED DATE	CALIBRATED UNTIL
HP Preamplifier	8447D	2432A03504	Feb. 21, 2018	Feb. 20, 2019
HP Preamplifier	8449B	3008A01201	Feb. 22, 2018	Feb. 21, 2019
MITEQ Preamplifier	AMF-6F-260400-33-8P	892164	Feb. 21, 2018	Feb. 20, 2019
Agilent TEST RECEIVER	N9038A	MY51210129	Feb. 6, 2018	Feb. 5, 2019
Schwarzbeck Antenna	VULB 9168	139	Nov. 29, 2017	Nov. 28, 2018
Schwarzbeck Antenna	VHBA 9123	480	May 19, 2017	May 18, 2019
Schwarzbeck Horn Antenna	BBHA-9170	212	Dec. 1, 2017	Nov. 30, 2018
Schwarzbeck Horn Antenna	BBHA 9120-D1	D130	Dec. 1, 2017	Nov. 30, 2018
ADT. Turn Table	TT100	0306	NA	NA
ADT. Tower	AT100	0306	NA	NA
Software	Radiated_V7.6.15.9.5	NA	NA	NA
SUHNER RF cable With 4dB PAD	SF104	CABLE-CH6	Aug. 14, 2017	Aug. 13, 2018
SUHNER RF cable With 3dB PAD	SF102	Cable-CH8-3.6m	Aug. 14, 2017	Aug. 13, 2018
KEYSIGHT Spectrum Analyzer	N9030A	MY54490260	Jul. 26, 2017	Jul. 25, 2018
Loop Antenna EMCI	LPA600	270	Aug. 11, 2017	Aug. 10, 2019
EMCO Horn Antenna	3115	00028257	Nov. 30, 2017	Nov. 29, 2018
Highpass filter Wainwright Instruments	WHK 3.1/18G-10SS	SN 8	NA	NA
ROHDE & SCHWARZ Spectrum Analyzer	FSV40	101042	Sep. 29, 2017	Sep. 28, 2018
Anritsu Power Sensor	MA2411B	0738404	Apr. 26, 2018	Apr. 25, 2019
Anritsu Power Meter	ML2495A	0842014	Apr. 26, 2018	Apr. 25, 2019

- NOTE:**
1. The calibration interval of the above test instruments is 12/24 months. And the calibrations are traceable to NML/ROC and NIST/USA.
  2. The horn antenna and HP preamplifier (model: 8449B) are used only for the measurement of emission frequency above 1GHz if tested.
  3. The test was performed in Chamber No. 6.
  4. The Industry Canada Reference No. IC 7450E-6.
  5. Tested Date: May 9 ~ Jun. 1, 2018

#### 4.1.3 Test Procedure

##### **For Radiated emission below 30MHz**

- a. The EUT was placed on the top of a rotating table 0.8 meters above the ground at a 3 meter chamber room. The table was rotated 360 degrees to determine the position of the highest radiation.
- b. The EUT was set 3 meters away from the interference-receiving antenna, which was mounted on the top of a variable-height antenna tower.
- c. Parallel, perpendicular, and ground-parallel orientations of the antenna are set to make the measurement.
- d. For each suspected emission, the EUT was arranged to its worst case and the rotatable table was turned from 0 degrees to 360 degrees to find the maximum reading.
- e. The test-receiver system was set to Quasi-Peak Detect Function and Specified Bandwidth with Maximum Hold Mode.

##### **NOTE:**

1. The resolution bandwidth and video bandwidth of test receiver/spectrum analyzer is 9kHz at frequency below 30MHz.

##### **For Radiated emission above 30MHz**

- a. The EUT was placed on the top of a rotating table 0.8 meters (for 30MHz ~ 1GHz) / 1.5 meters (for above 1GHz) above the ground at 3 meter chamber room for test. The table was rotated 360 degrees to determine the position of the highest radiation.
- b. The EUT was set 3 meters away from the interference-receiving antenna, which was mounted on the top of a variable-height antenna tower.
- c. The height of antenna is varied from one meter to four meters above the ground to determine the maximum value of the field strength. Both horizontal and vertical polarizations of the antenna are set to make the measurement.
- d. For each suspected emission, the EUT was arranged to its worst case and then the antenna was tuned to heights from 1 meter to 4 meters and the rotatable table was turned from 0 degrees to 360 degrees to find the maximum reading.
- e. The test-receiver system was set to quasi-peak detect function and specified bandwidth with maximum hold mode when the test frequency is below 1 GHz.
- f. The test-receiver system was set to peak and average detects function and specified bandwidth with maximum hold mode when the test frequency is above 1 GHz. If the peak reading value also meets average limit, measurement with the average detector is unnecessary.

##### **Note:**

1. The resolution bandwidth and video bandwidth of test receiver/spectrum analyzer is 120kHz for Quasi-peak detection (QP) at frequency below 1GHz.
2. The resolution bandwidth of test receiver/spectrum analyzer is 1 MHz and the video bandwidth is 3 MHz for Peak detection (PK) at frequency above 1GHz.
3. The resolution bandwidth of test receiver/spectrum analyzer is 1MHz and the video bandwidth is  $\geq 1/T$  (Duty cycle < 98%) or 10Hz (Duty cycle  $\geq 98\%$ ) for Average detection (AV) at frequency above 1GHz.
4. All modes of operation were investigated and the worst-case emissions are reported.

#### 4.1.4 Deviation from Test Standard

No deviation.

#### 4.1.5 Test Setup

##### For Radiated emission below 30MHz

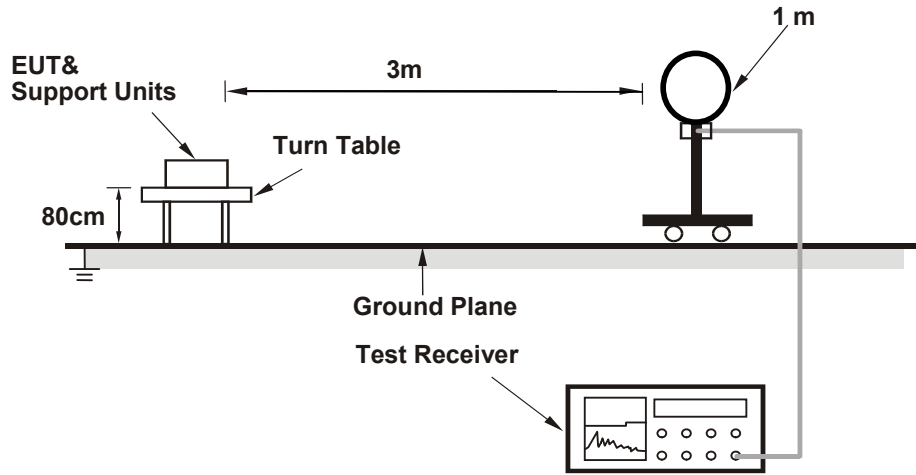

##### For Radiated emission 30MHz to 1GHz

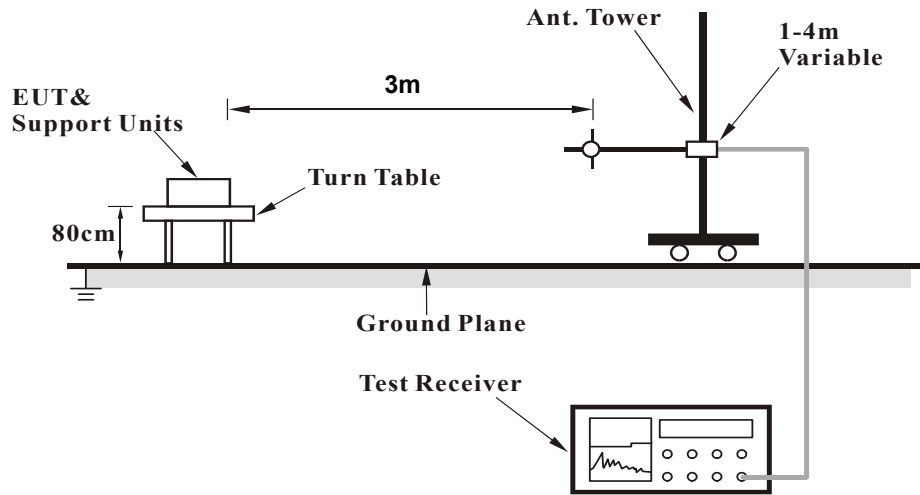

### For Radiated emission above 1GHz

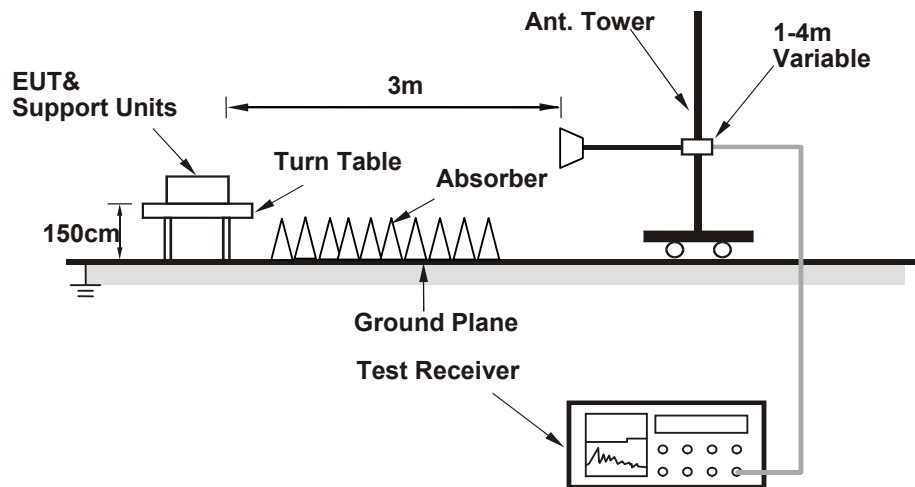

For the actual test configuration, please refer to the attached file (Test Setup Photo).

#### 4.1.6 EUT Operating Condition

- a. Connected the EUT with AC adapter placed on testing table.
- b. Set the EUT under transmission condition continuously at specific channel frequency.

4.1.7 Test Results

Above 1GHz Data:

CDD Mode

802.11a

<b>CHANNEL</b>	TX Channel 36	<b>DETECTOR FUNCTION</b>	Peak (PK)
<b>FREQUENCY RANGE</b>	1GHz ~ 40GHz		Average (AV)

ANTENNA POLARITY & TEST DISTANCE: HORIZONTAL AT 3 M								
NO.	FREQ. (MHz)	EMISSION LEVEL (dBuV/m)	LIMIT (dBuV/m)	MARGIN (dB)	ANTENNA HEIGHT (m)	TABLE ANGLE (Degree)	RAW VALUE (dBuV)	CORRECTION FACTOR (dB/m)
1	5150.00	66.23 PK	74.00	-7.77	2.40 H	80	62.57	3.66
2	5150.00	52.92 AV	54.00	-1.08	2.40 H	80	49.26	3.66
3	*5180.00	113.74 PK			2.40 H	80	110.36	3.38
4	*5180.00	102.99 AV			2.40 H	80	99.61	3.38
5	#10360.00	58.39 PK	74.00	-15.61	1.17 H	312	43.70	14.69
6	#10360.00	43.54 AV	54.00	-10.46	1.17 H	312	28.85	14.69

ANTENNA POLARITY & TEST DISTANCE: VERTICAL AT 3 M								
NO.	FREQ. (MHz)	EMISSION LEVEL (dBuV/m)	LIMIT (dBuV/m)	MARGIN (dB)	ANTENNA HEIGHT (m)	TABLE ANGLE (Degree)	RAW VALUE (dBuV)	CORRECTION FACTOR (dB/m)
1	5150.00	65.68 PK	74.00	-8.32	1.00 V	112	62.02	3.66
2	5150.00	51.56 AV	54.00	-2.44	1.00 V	112	47.90	3.66
3	*5180.00	112.68 PK			1.00 V	112	109.30	3.38
4	*5180.00	101.49 AV			1.00 V	112	98.11	3.38
5	#10360.00	56.51 PK	74.00	-17.49	1.59 V	209	41.82	14.69
6	#10360.00	42.40 AV	54.00	-11.60	1.59 V	209	27.71	14.69

REMARKS:

1. Emission Level(dBuV/m) = Raw Value(dBuV) + Correction Factor(dB/m)
2. Correction Factor(dB/m) = Antenna Factor(dB/m) + Cable Factor(dB) – Pre-Amplifier Factor(dB)
3. The other emission levels were very low against the limit.
4. Margin value = Emission Level – Limit value
5. " \* " : Fundamental frequency.
6. " # " : The radiated frequency is out of the restricted band.

<b>CHANNEL</b>	TX Channel 40	<b>DETECTOR FUNCTION</b>	Peak (PK)
<b>FREQUENCY RANGE</b>	1GHz ~ 40GHz		Average (AV)

**ANTENNA POLARITY & TEST DISTANCE: HORIZONTAL AT 3 M**

NO.	FREQ. (MHz)	EMISSION LEVEL (dBuV/m)	LIMIT (dBuV/m)	MARGIN (dB)	ANTENNA HEIGHT (m)	TABLE ANGLE (Degree)	RAW VALUE (dBuV)	CORRECTION FACTOR (dB/m)
1	5150.00	67.01 PK	74.00	-6.99	2.75 H	83	63.35	3.66
2	5150.00	52.88 AV	54.00	-1.12	2.75 H	83	49.22	3.66
3	*5200.00	116.25 PK			2.75 H	83	113.06	3.19
4	*5200.00	105.02 AV			2.75 H	83	101.83	3.19
5	#10400.00	58.92 PK	74.00	-15.08	1.48 H	315	43.98	14.94
6	#10400.00	44.06 AV	54.00	-9.94	1.48 H	315	29.12	14.94

**ANTENNA POLARITY & TEST DISTANCE: VERTICAL AT 3 M**

NO.	FREQ. (MHz)	EMISSION LEVEL (dBuV/m)	LIMIT (dBuV/m)	MARGIN (dB)	ANTENNA HEIGHT (m)	TABLE ANGLE (Degree)	RAW VALUE (dBuV)	CORRECTION FACTOR (dB/m)
1	5150.00	66.47 PK	74.00	-7.53	1.15 V	115	62.81	3.66
2	5150.00	51.21 AV	54.00	-2.79	1.15 V	115	47.55	3.66
3	*5200.00	114.32 PK			1.15 V	115	111.13	3.19
4	*5200.00	103.56 AV			1.15 V	115	100.37	3.19
5	#10400.00	57.12 PK	74.00	-16.88	1.85 V	251	42.18	14.94
6	#10400.00	42.97 AV	54.00	-11.03	1.85 V	251	28.03	14.94

**REMARKS:**

1. Emission Level(dBuV/m) = Raw Value(dBuV) + Correction Factor(dB/m)
2. Correction Factor(dB/m) = Antenna Factor(dB/m) + Cable Factor(dB) – Pre-Amplifier Factor(dB)
3. The other emission levels were very low against the limit.
4. Margin value = Emission Level – Limit value
5. " \* " : Fundamental frequency.
6. " # " : The radiated frequency is out of the restricted band.

<b>CHANNEL</b>	TX Channel 48	<b>DETECTOR FUNCTION</b>	Peak (PK)
<b>FREQUENCY RANGE</b>	1GHz ~ 40GHz		Average (AV)

ANTENNA POLARITY & TEST DISTANCE: HORIZONTAL AT 3 M								
NO.	FREQ. (MHz)	EMISSION LEVEL (dBuV/m)	LIMIT (dBuV/m)	MARGIN (dB)	ANTENNA HEIGHT (m)	TABLE ANGLE (Degree)	RAW VALUE (dBuV)	CORRECTION FACTOR (dB/m)
1	*5240.00	115.64 PK			1.93 H	81	112.64	3.00
2	*5240.00	103.40 AV			1.93 H	81	100.40	3.00
3	5350.00	54.33 PK	74.00	-19.67	1.93 H	81	51.41	2.92
4	5350.00	42.81 AV	54.00	-11.19	1.93 H	81	39.89	2.92
5	#10480.00	59.32 PK	74.00	-14.68	1.22 H	289	43.81	15.51
6	#10480.00	44.42 AV	54.00	-9.58	1.22 H	289	28.91	15.51

ANTENNA POLARITY & TEST DISTANCE: VERTICAL AT 3 M								
NO.	FREQ. (MHz)	EMISSION LEVEL (dBuV/m)	LIMIT (dBuV/m)	MARGIN (dB)	ANTENNA HEIGHT (m)	TABLE ANGLE (Degree)	RAW VALUE (dBuV)	CORRECTION FACTOR (dB/m)
1	*5240.00	114.08 PK			1.08 V	128	111.08	3.00
2	*5240.00	102.22 AV			1.08 V	128	99.22	3.00
3	5350.00	54.02 PK	74.00	-19.98	1.08 V	128	51.10	2.92
4	5350.00	40.47 AV	54.00	-13.53	1.08 V	128	37.55	2.92
5	#10480.00	57.42 PK	74.00	-16.58	1.66 V	200	41.91	15.51
6	#10480.00	43.31 AV	54.00	-10.69	1.66 V	200	27.80	15.51

**REMARKS:**

1. Emission Level(dBuV/m) = Raw Value(dBuV) + Correction Factor(dB/m)
2. Correction Factor(dB/m) = Antenna Factor(dB/m) + Cable Factor(dB) – Pre-Amplifier Factor(dB)
3. The other emission levels were very low against the limit.
4. Margin value = Emission Level – Limit value
5. " \* " : Fundamental frequency.
6. " # " : The radiated frequency is out of the restricted band.

<b>CHANNEL</b>	TX Channel 149	<b>DETECTOR FUNCTION</b>	Peak (PK)
<b>FREQUENCY RANGE</b>	1GHz ~ 40GHz		Average (AV)

**ANTENNA POLARITY & TEST DISTANCE: HORIZONTAL AT 3 M**

NO.	FREQ. (MHz)	EMISSION LEVEL (dBuV/m)	LIMIT (dBuV/m)	MARGIN (dB)	ANTENNA HEIGHT (m)	TABLE ANGLE (Degree)	RAW VALUE (dBuV)	CORRECTION FACTOR (dB/m)
1	#5643.31	54.86 PK	68.20	-13.34	1.66 H	87	51.07	3.79
2	*5745.00	116.96 PK			1.66 H	87	112.51	4.45
3	*5745.00	105.11 AV			1.66 H	87	100.66	4.45
4	#5930.20	54.11 PK	68.20	-14.09	1.66 H	87	48.92	5.19
5	11490.00	58.78 PK	74.00	-15.22	1.82 H	312	42.28	16.50
6	11490.00	44.01 AV	54.00	-9.99	1.82 H	312	27.51	16.50

**ANTENNA POLARITY & TEST DISTANCE: VERTICAL AT 3 M**

NO.	FREQ. (MHz)	EMISSION LEVEL (dBuV/m)	LIMIT (dBuV/m)	MARGIN (dB)	ANTENNA HEIGHT (m)	TABLE ANGLE (Degree)	RAW VALUE (dBuV)	CORRECTION FACTOR (dB/m)
1	#5624.59	54.32 PK	68.20	-13.88	1.41 V	80	50.60	3.72
2	*5745.00	115.53 PK			1.41 V	80	111.08	4.45
3	*5745.00	103.49 AV			1.41 V	80	99.04	4.45
4	#5981.29	53.60 PK	68.20	-14.60	1.41 V	80	48.21	5.39
5	11490.00	57.52 PK	74.00	-16.48	1.51 V	300	41.02	16.50
6	11490.00	42.69 AV	54.00	-11.31	1.51 V	300	26.19	16.50

**REMARKS:**

1. Emission Level(dBuV/m) = Raw Value(dBuV) + Correction Factor(dB/m)
2. Correction Factor(dB/m) = Antenna Factor(dB/m) + Cable Factor(dB) – Pre-Amplifier Factor(dB)
3. The other emission levels were very low against the limit.
4. Margin value = Emission Level – Limit value
5. " \* ": Fundamental frequency.
6. " # ": The radiated frequency is out of the restricted band.



<b>CHANNEL</b>	TX Channel 157	<b>DETECTOR FUNCTION</b>	Peak (PK)
<b>FREQUENCY RANGE</b>	1GHz ~ 40GHz		Average (AV)

**ANTENNA POLARITY & TEST DISTANCE: HORIZONTAL AT 3 M**

NO.	FREQ. (MHz)	EMISSION LEVEL (dBuV/m)	LIMIT (dBuV/m)	MARGIN (dB)	ANTENNA HEIGHT (m)	TABLE ANGLE (Degree)	RAW VALUE (dBuV)	CORRECTION FACTOR (dB/m)
1	#5647.74	53.66 PK	68.20	-14.54	2.45 H	86	49.86	3.80
2	*5785.00	118.52 PK			2.45 H	86	113.77	4.75
3	*5785.00	107.02 AV			2.45 H	86	102.27	4.75
4	#5962.02	53.64 PK	68.20	-14.56	2.45 H	86	48.35	5.29
5	11570.00	59.02 PK	74.00	-14.98	1.89 H	321	42.41	16.61
6	11570.00	44.21 AV	54.00	-9.79	1.89 H	321	27.60	16.61

**ANTENNA POLARITY & TEST DISTANCE: VERTICAL AT 3 M**

NO.	FREQ. (MHz)	EMISSION LEVEL (dBuV/m)	LIMIT (dBuV/m)	MARGIN (dB)	ANTENNA HEIGHT (m)	TABLE ANGLE (Degree)	RAW VALUE (dBuV)	CORRECTION FACTOR (dB/m)
1	#5626.64	53.78 PK	68.20	-14.42	1.50 V	82	50.05	3.73
2	*5785.00	116.88 PK			1.50 V	82	112.13	4.75
3	*5785.00	104.94 AV			1.50 V	82	100.19	4.75
4	#5980.56	54.98 PK	68.20	-13.22	1.50 V	82	49.59	5.39
5	11570.00	57.73 PK	74.00	-16.27	1.42 V	246	41.12	16.61
6	11570.00	42.88 AV	54.00	-11.12	1.42 V	246	26.27	16.61

**REMARKS:**

1. Emission Level(dBuV/m) = Raw Value(dBuV) + Correction Factor(dB/m)
2. Correction Factor(dB/m) = Antenna Factor(dB/m) + Cable Factor(dB) – Pre-Amplifier Factor(dB)
3. The other emission levels were very low against the limit.
4. Margin value = Emission Level – Limit value
5. " \* " : Fundamental frequency.
6. " # " : The radiated frequency is out of the restricted band.

<b>CHANNEL</b>	TX Channel 165	<b>DETECTOR FUNCTION</b>	Peak (PK)
<b>FREQUENCY RANGE</b>	1GHz ~ 40GHz		Average (AV)

ANTENNA POLARITY & TEST DISTANCE: HORIZONTAL AT 3 M								
NO.	FREQ. (MHz)	EMISSION LEVEL (dBuV/m)	LIMIT (dBuV/m)	MARGIN (dB)	ANTENNA HEIGHT (m)	TABLE ANGLE (Degree)	RAW VALUE (dBuV)	CORRECTION FACTOR (dB/m)
1	#5644.74	53.53 PK	68.20	-14.67	2.64 H	78	49.74	3.79
2	*5825.00	117.27 PK			2.64 H	78	112.30	4.97
3	*5825.00	105.55 AV			2.64 H	78	100.58	4.97
4	#5925.10	56.28 PK	68.20	-11.92	2.64 H	78	51.11	5.17
5	11650.00	58.62 PK	74.00	-15.38	1.91 H	301	42.26	16.36
6	11650.00	43.84 AV	54.00	-10.16	1.91 H	301	27.48	16.36

ANTENNA POLARITY & TEST DISTANCE: VERTICAL AT 3 M								
NO.	FREQ. (MHz)	EMISSION LEVEL (dBuV/m)	LIMIT (dBuV/m)	MARGIN (dB)	ANTENNA HEIGHT (m)	TABLE ANGLE (Degree)	RAW VALUE (dBuV)	CORRECTION FACTOR (dB/m)
1	#5645.39	53.52 PK	68.20	-14.68	1.58 V	88	49.73	3.79
2	*5825.00	115.94 PK			1.58 V	88	110.97	4.97
3	*5825.00	103.91 AV			1.58 V	88	98.94	4.97
4	#5929.83	52.65 PK	68.20	-15.55	1.58 V	88	47.46	5.19
5	11650.00	57.25 PK	74.00	-16.75	1.64 V	284	40.89	16.36
6	11650.00	42.50 AV	54.00	-11.50	1.64 V	284	26.14	16.36

**REMARKS:**

1. Emission Level(dBuV/m) = Raw Value(dBuV) + Correction Factor(dB/m)
2. Correction Factor(dB/m) = Antenna Factor(dB/m) + Cable Factor(dB) – Pre-Amplifier Factor(dB)
3. The other emission levels were very low against the limit.
4. Margin value = Emission Level – Limit value
5. " \* " : Fundamental frequency.
6. " # " : The radiated frequency is out of the restricted band.

802.11ac (20MHz)

<b>CHANNEL</b>	TX Channel 36	<b>DETECTOR FUNCTION</b>	Peak (PK)
<b>FREQUENCY RANGE</b>	1GHz ~ 40GHz		Average (AV)

**ANTENNA POLARITY & TEST DISTANCE: HORIZONTAL AT 3 M**

NO.	FREQ. (MHz)	EMISSION LEVEL (dBuV/m)	LIMIT (dBuV/m)	MARGIN (dB)	ANTENNA HEIGHT (m)	TABLE ANGLE (Degree)	RAW VALUE (dBuV)	CORRECTION FACTOR (dB/m)
1	5150.00	65.54 PK	74.00	-8.46	2.51 H	82	61.88	3.66
2	5150.00	52.83 AV	54.00	-1.17	2.51 H	82	49.17	3.66
3	*5180.00	114.18 PK			2.51 H	82	110.80	3.38
4	*5180.00	101.91 AV			2.51 H	82	98.53	3.38
5	#10360.00	58.98 PK	74.00	-15.02	1.11 H	317	44.29	14.69
6	#10360.00	43.25 AV	54.00	-10.75	1.11 H	317	28.56	14.69

**ANTENNA POLARITY & TEST DISTANCE: VERTICAL AT 3 M**

NO.	FREQ. (MHz)	EMISSION LEVEL (dBuV/m)	LIMIT (dBuV/m)	MARGIN (dB)	ANTENNA HEIGHT (m)	TABLE ANGLE (Degree)	RAW VALUE (dBuV)	CORRECTION FACTOR (dB/m)
1	5150.00	63.78 PK	74.00	-10.22	1.00 V	112	60.12	3.66
2	5150.00	51.13 AV	54.00	-2.87	1.00 V	112	47.47	3.66
3	*5180.00	112.79 PK			1.00 V	112	109.41	3.38
4	*5180.00	100.38 AV			1.00 V	112	97.00	3.38
5	#10360.00	56.76 PK	74.00	-17.24	2.69 V	103	42.07	14.69
6	#10360.00	40.90 AV	54.00	-13.10	2.69 V	103	26.21	14.69

**REMARKS:**

1. Emission Level(dBuV/m) = Raw Value(dBuV) + Correction Factor(dB/m)
2. Correction Factor(dB/m) = Antenna Factor(dB/m) + Cable Factor(dB) – Pre-Amplifier Factor(dB)
3. The other emission levels were very low against the limit.
4. Margin value = Emission Level – Limit value
5. " \* ": Fundamental frequency.
6. " # ": The radiated frequency is out of the restricted band.

<b>CHANNEL</b>	TX Channel 40	<b>DETECTOR FUNCTION</b>	Peak (PK)
<b>FREQUENCY RANGE</b>	1GHz ~ 40GHz		Average (AV)

ANTENNA POLARITY & TEST DISTANCE: HORIZONTAL AT 3 M								
NO.	FREQ. (MHz)	EMISSION LEVEL (dBuV/m)	LIMIT (dBuV/m)	MARGIN (dB)	ANTENNA HEIGHT (m)	TABLE ANGLE (Degree)	RAW VALUE (dBuV)	CORRECTION FACTOR (dB/m)
1	5150.00	67.42 PK	74.00	-6.58	2.52 H	78	63.76	3.66
2	5150.00	52.88 AV	54.00	-1.12	2.52 H	78	49.22	3.66
3	*5200.00	116.06 PK			2.52 H	78	112.87	3.19
4	*5200.00	103.24 AV			2.52 H	78	100.05	3.19
5	#10400.00	60.75 PK	74.00	-13.25	1.22 H	305	45.81	14.94
6	#10400.00	44.31 AV	54.00	-9.69	1.22 H	305	29.37	14.94

ANTENNA POLARITY & TEST DISTANCE: VERTICAL AT 3 M								
NO.	FREQ. (MHz)	EMISSION LEVEL (dBuV/m)	LIMIT (dBuV/m)	MARGIN (dB)	ANTENNA HEIGHT (m)	TABLE ANGLE (Degree)	RAW VALUE (dBuV)	CORRECTION FACTOR (dB/m)
1	5150.00	64.48 PK	74.00	-9.52	1.11 V	108	60.82	3.66
2	5150.00	51.44 AV	54.00	-2.56	1.11 V	108	47.78	3.66
3	*5200.00	113.98 PK			1.11 V	108	110.79	3.19
4	*5200.00	101.70 AV			1.11 V	108	98.51	3.19
5	#10400.00	57.38 PK	74.00	-16.62	2.64 V	97	42.44	14.94
6	#10400.00	41.43 AV	54.00	-12.57	2.64 V	97	26.49	14.94

**REMARKS:**

1. Emission Level(dBuV/m) = Raw Value(dBuV) + Correction Factor(dB/m)
2. Correction Factor(dB/m) = Antenna Factor(dB/m) + Cable Factor(dB) – Pre-Amplifier Factor(dB)
3. The other emission levels were very low against the limit.
4. Margin value = Emission Level – Limit value
5. " \* " : Fundamental frequency.
6. " # " : The radiated frequency is out of the restricted band.

<b>CHANNEL</b>	TX Channel 48	<b>DETECTOR FUNCTION</b>	Peak (PK)
<b>FREQUENCY RANGE</b>	1GHz ~ 40GHz		Average (AV)

**ANTENNA POLARITY & TEST DISTANCE: HORIZONTAL AT 3 M**

NO.	FREQ. (MHz)	EMISSION LEVEL (dBuV/m)	LIMIT (dBuV/m)	MARGIN (dB)	ANTENNA HEIGHT (m)	TABLE ANGLE (Degree)	RAW VALUE (dBuV)	CORRECTION FACTOR (dB/m)
1	*5240.00	115.43 PK			2.09 H	81	112.43	3.00
2	*5240.00	102.95 AV			2.09 H	81	99.95	3.00
3	5350.00	54.29 PK	74.00	-19.71	2.09 H	81	51.37	2.92
4	5350.00	40.28 AV	54.00	-13.72	2.09 H	81	37.36	2.92
5	#10480.00	59.59 PK	74.00	-14.41	1.16 H	306	44.08	15.51
6	#10480.00	44.00 AV	54.00	-10.00	1.16 H	306	28.49	15.51

**ANTENNA POLARITY & TEST DISTANCE: VERTICAL AT 3 M**

NO.	FREQ. (MHz)	EMISSION LEVEL (dBuV/m)	LIMIT (dBuV/m)	MARGIN (dB)	ANTENNA HEIGHT (m)	TABLE ANGLE (Degree)	RAW VALUE (dBuV)	CORRECTION FACTOR (dB/m)
1	*5240.00	114.13 PK			1.03 V	108	111.13	3.00
2	*5240.00	101.92 AV			1.03 V	108	98.92	3.00
3	5350.00	53.02 PK	74.00	-20.98	1.03 V	108	50.10	2.92
4	5350.00	39.21 AV	54.00	-14.79	1.03 V	108	36.29	2.92
5	#10480.00	57.43 PK	74.00	-16.57	2.74 V	111	41.92	15.51
6	#10480.00	41.58 AV	54.00	-12.42	2.74 V	111	26.07	15.51

**REMARKS:**

1. Emission Level(dBuV/m) = Raw Value(dBuV) + Correction Factor(dB/m)
2. Correction Factor(dB/m) = Antenna Factor(dB/m) + Cable Factor(dB) – Pre-Amplifier Factor(dB)
3. The other emission levels were very low against the limit.
4. Margin value = Emission Level – Limit value
5. " \* " : Fundamental frequency.
6. " # " : The radiated frequency is out of the restricted band.

<b>CHANNEL</b>	TX Channel 149	<b>DETECTOR FUNCTION</b>	Peak (PK)
<b>FREQUENCY RANGE</b>	1GHz ~ 40GHz		Average (AV)

**ANTENNA POLARITY & TEST DISTANCE: HORIZONTAL AT 3 M**

NO.	FREQ. (MHz)	EMISSION LEVEL (dBuV/m)	LIMIT (dBuV/m)	MARGIN (dB)	ANTENNA HEIGHT (m)	TABLE ANGLE (Degree)	RAW VALUE (dBuV)	CORRECTION FACTOR (dB/m)
1	#5648.79	54.56 PK	68.20	-13.64	1.70 H	73	50.76	3.80
2	*5745.00	116.19 PK			1.70 H	73	111.74	4.45
3	*5745.00	103.43 AV			1.70 H	73	98.98	4.45
4	#5975.77	54.06 PK	68.20	-14.14	1.70 H	73	48.70	5.36
5	11490.00	57.13 PK	74.00	-16.87	1.18 H	203	40.63	16.50
6	11490.00	43.72 AV	54.00	-10.28	1.18 H	203	27.22	16.50

**ANTENNA POLARITY & TEST DISTANCE: VERTICAL AT 3 M**

NO.	FREQ. (MHz)	EMISSION LEVEL (dBuV/m)	LIMIT (dBuV/m)	MARGIN (dB)	ANTENNA HEIGHT (m)	TABLE ANGLE (Degree)	RAW VALUE (dBuV)	CORRECTION FACTOR (dB/m)
1	#5637.76	53.25 PK	68.20	-14.95	1.66 V	89	49.48	3.77
2	*5745.00	114.27 PK			1.66 V	89	109.82	4.45
3	*5745.00	101.46 AV			1.66 V	89	97.01	4.45
4	#5935.64	52.46 PK	68.20	-15.74	1.66 V	89	47.26	5.20
5	11490.00	56.05 PK	74.00	-17.95	1.64 V	341	39.55	16.50
6	11490.00	42.60 AV	54.00	-11.40	1.64 V	341	26.10	16.50

**REMARKS:**

1. Emission Level(dBuV/m) = Raw Value(dBuV) + Correction Factor(dB/m)
2. Correction Factor(dB/m) = Antenna Factor(dB/m) + Cable Factor(dB) – Pre-Amplifier Factor(dB)
3. The other emission levels were very low against the limit.
4. Margin value = Emission Level – Limit value
5. " \* " : Fundamental frequency.
6. " # " : The radiated frequency is out of the restricted band.

<b>CHANNEL</b>	TX Channel 157	<b>DETECTOR FUNCTION</b>	Peak (PK)
<b>FREQUENCY RANGE</b>	1GHz ~ 40GHz		Average (AV)

**ANTENNA POLARITY & TEST DISTANCE: HORIZONTAL AT 3 M**

NO.	FREQ. (MHz)	EMISSION LEVEL (dBuV/m)	LIMIT (dBuV/m)	MARGIN (dB)	ANTENNA HEIGHT (m)	TABLE ANGLE (Degree)	RAW VALUE (dBuV)	CORRECTION FACTOR (dB/m)
1	#5633.09	53.27 PK	68.20	-14.93	1.69 H	73	49.52	3.75
2	*5785.00	116.65 PK			1.69 H	73	111.90	4.75
3	*5785.00	103.78 AV			1.69 H	73	99.03	4.75
4	#5936.01	54.29 PK	68.20	-13.91	1.69 H	73	49.09	5.20
5	11570.00	57.29 PK	74.00	-16.71	1.35 H	201	40.68	16.61
6	11570.00	43.86 AV	54.00	-10.14	1.35 H	201	27.25	16.61

**ANTENNA POLARITY & TEST DISTANCE: VERTICAL AT 3 M**

NO.	FREQ. (MHz)	EMISSION LEVEL (dBuV/m)	LIMIT (dBuV/m)	MARGIN (dB)	ANTENNA HEIGHT (m)	TABLE ANGLE (Degree)	RAW VALUE (dBuV)	CORRECTION FACTOR (dB/m)
1	#5620.43	55.47 PK	68.20	-12.73	1.59 V	99	51.77	3.70
2	*5785.00	114.71 PK			1.59 V	99	109.96	4.75
3	*5785.00	101.82 AV			1.59 V	99	97.07	4.75
4	#5953.83	53.56 PK	68.20	-14.64	1.59 V	99	48.31	5.25
5	11570.00	56.23 PK	74.00	-17.77	1.69 V	328	39.62	16.61
6	11570.00	42.79 AV	54.00	-11.21	1.69 V	328	26.18	16.61

**REMARKS:**

1. Emission Level(dBuV/m) = Raw Value(dBuV) + Correction Factor(dB/m)
2. Correction Factor(dB/m) = Antenna Factor(dB/m) + Cable Factor(dB) – Pre-Amplifier Factor(dB)
3. The other emission levels were very low against the limit.
4. Margin value = Emission Level – Limit value
5. " \* " : Fundamental frequency.
6. " # " : The radiated frequency is out of the restricted band.

<b>CHANNEL</b>	TX Channel 165	<b>DETECTOR FUNCTION</b>	Peak (PK)
<b>FREQUENCY RANGE</b>	1GHz ~ 40GHz		Average (AV)

**ANTENNA POLARITY & TEST DISTANCE: HORIZONTAL AT 3 M**

NO.	FREQ. (MHz)	EMISSION LEVEL (dBuV/m)	LIMIT (dBuV/m)	MARGIN (dB)	ANTENNA HEIGHT (m)	TABLE ANGLE (Degree)	RAW VALUE (dBuV)	CORRECTION FACTOR (dB/m)
1	#5641.50	54.33 PK	68.20	-13.87	2.07 H	89	50.55	3.78
2	*5825.00	116.03 PK			2.07 H	89	111.06	4.97
3	*5825.00	103.07 AV			2.07 H	89	98.10	4.97
4	#5930.70	54.87 PK	68.20	-13.33	2.07 H	89	49.68	5.19
5	11650.00	56.79 PK	74.00	-17.21	1.32 H	185	40.43	16.36
6	11650.00	43.47 AV	54.00	-10.53	1.32 H	185	27.11	16.36

**ANTENNA POLARITY & TEST DISTANCE: VERTICAL AT 3 M**

NO.	FREQ. (MHz)	EMISSION LEVEL (dBuV/m)	LIMIT (dBuV/m)	MARGIN (dB)	ANTENNA HEIGHT (m)	TABLE ANGLE (Degree)	RAW VALUE (dBuV)	CORRECTION FACTOR (dB/m)
1	#5646.22	53.97 PK	68.20	-14.23	2.02 V	92	50.18	3.79
2	*5825.00	114.24 PK			2.02 V	92	109.27	4.97
3	*5825.00	101.63 AV			2.02 V	92	96.66	4.97
4	#5928.95	55.29 PK	68.20	-12.91	2.02 V	92	50.10	5.19
5	11650.00	55.74 PK	74.00	-18.26	1.95 V	326	39.38	16.36
6	11650.00	42.35 AV	54.00	-11.65	1.95 V	326	25.99	16.36

**REMARKS:**

1. Emission Level(dBuV/m) = Raw Value(dBuV) + Correction Factor(dB/m)
2. Correction Factor(dB/m) = Antenna Factor(dB/m) + Cable Factor(dB) – Pre-Amplifier Factor(dB)
3. The other emission levels were very low against the limit.
4. Margin value = Emission Level – Limit value
5. " \* " : Fundamental frequency.
6. " # " : The radiated frequency is out of the restricted band.



802.11ac (40MHz)

<b>CHANNEL</b>	TX Channel 38	<b>DETECTOR FUNCTION</b>	Peak (PK)
<b>FREQUENCY RANGE</b>	1GHz ~ 40GHz		Average (AV)

**ANTENNA POLARITY & TEST DISTANCE: HORIZONTAL AT 3 M**

NO.	FREQ. (MHz)	EMISSION LEVEL (dBuV/m)	LIMIT (dBuV/m)	MARGIN (dB)	ANTENNA HEIGHT (m)	TABLE ANGLE (Degree)	RAW VALUE (dBuV)	CORRECTION FACTOR (dB/m)
1	5150.00	66.27 PK	74.00	-7.73	2.26 H	80	62.61	3.66
2	<b>5150.00</b>	<b>52.98 AV</b>	<b>54.00</b>	<b>-1.02</b>	<b>2.26 H</b>	<b>80</b>	<b>49.32</b>	<b>3.66</b>
3	*5190.00	108.05 PK			2.26 H	80	104.76	3.29
4	*5190.00	96.98 AV			2.26 H	80	93.69	3.29
5	#10380.00	57.64 PK	74.00	-16.36	1.88 H	261	42.83	14.81
6	#10380.00	44.25 AV	54.00	-9.75	1.88 H	261	29.44	14.81

**ANTENNA POLARITY & TEST DISTANCE: VERTICAL AT 3 M**

NO.	FREQ. (MHz)	EMISSION LEVEL (dBuV/m)	LIMIT (dBuV/m)	MARGIN (dB)	ANTENNA HEIGHT (m)	TABLE ANGLE (Degree)	RAW VALUE (dBuV)	CORRECTION FACTOR (dB/m)
1	5150.00	66.76 PK	74.00	-7.24	1.25 V	103	63.10	3.66
2	5150.00	51.22 AV	54.00	-2.78	1.25 V	103	47.56	3.66
3	*5190.00	105.20 PK			1.25 V	103	101.91	3.29
4	*5190.00	94.02 AV			1.25 V	103	90.73	3.29
5	#10380.00	55.10 PK	74.00	-18.90	1.15 V	182	40.29	14.81
6	#10380.00	43.64 AV	54.00	-10.36	1.15 V	182	28.83	14.81

**REMARKS:**

1. Emission Level(dBuV/m) = Raw Value(dBuV) + Correction Factor(dB/m)
2. Correction Factor(dB/m) = Antenna Factor(dB/m) + Cable Factor(dB) – Pre-Amplifier Factor(dB)
3. The other emission levels were very low against the limit.
4. Margin value = Emission Level – Limit value
5. " \* " : Fundamental frequency.
6. " # " : The radiated frequency is out of the restricted band.

<b>CHANNEL</b>	TX Channel 46	<b>DETECTOR FUNCTION</b>	Peak (PK)
<b>FREQUENCY RANGE</b>	1GHz ~ 40GHz		Average (AV)

**ANTENNA POLARITY & TEST DISTANCE: HORIZONTAL AT 3 M**

NO.	FREQ. (MHz)	EMISSION LEVEL (dBuV/m)	LIMIT (dBuV/m)	MARGIN (dB)	ANTENNA HEIGHT (m)	TABLE ANGLE (Degree)	RAW VALUE (dBuV)	CORRECTION FACTOR (dB/m)
1	*5230.00	113.49 PK			1.80 H	77	110.45	3.04
2	*5230.00	101.69 AV			1.80 H	77	98.65	3.04
3	5350.00	59.45 PK	74.00	-14.55	1.80 H	77	56.53	2.92
4	5350.00	44.10 AV	54.00	-9.90	1.80 H	77	41.18	2.92
5	#10460.00	58.56 PK	74.00	-15.44	1.92 H	258	43.18	15.38
6	#10460.00	44.95 AV	54.00	-9.05	1.92 H	258	29.57	15.38

**ANTENNA POLARITY & TEST DISTANCE: VERTICAL AT 3 M**

NO.	FREQ. (MHz)	EMISSION LEVEL (dBuV/m)	LIMIT (dBuV/m)	MARGIN (dB)	ANTENNA HEIGHT (m)	TABLE ANGLE (Degree)	RAW VALUE (dBuV)	CORRECTION FACTOR (dB/m)
1	*5230.00	110.65 PK			1.37 V	119	107.61	3.04
2	*5230.00	99.26 AV			1.37 V	119	96.22	3.04
3	5350.00	58.73 PK	74.00	-15.27	1.37 V	119	55.81	2.92
4	5350.00	45.61 AV	54.00	-8.39	1.37 V	119	42.69	2.92
5	#10460.00	55.92 PK	74.00	-18.08	1.24 V	195	40.54	15.38
6	#10460.00	44.39 AV	54.00	-9.61	1.24 V	195	29.01	15.38

**REMARKS:**

1. Emission Level(dBuV/m) = Raw Value(dBuV) + Correction Factor(dB/m)
2. Correction Factor(dB/m) = Antenna Factor(dB/m) + Cable Factor(dB) – Pre-Amplifier Factor(dB)
3. The other emission levels were very low against the limit.
4. Margin value = Emission Level – Limit value
5. " \* ": Fundamental frequency.
6. " # ": The radiated frequency is out of the restricted band.

<b>CHANNEL</b>	TX Channel 151	<b>DETECTOR FUNCTION</b>	Peak (PK)
<b>FREQUENCY RANGE</b>	1GHz ~ 40GHz		Average (AV)

**ANTENNA POLARITY & TEST DISTANCE: HORIZONTAL AT 3 M**

NO.	FREQ. (MHz)	EMISSION LEVEL (dBuV/m)	LIMIT (dBuV/m)	MARGIN (dB)	ANTENNA HEIGHT (m)	TABLE ANGLE (Degree)	RAW VALUE (dBuV)	CORRECTION FACTOR (dB/m)
1	#5645.28	62.75 PK	68.20	-5.45	2.32 H	92	58.96	3.79
2	*5755.00	113.92 PK			2.32 H	92	109.40	4.52
3	*5755.00	102.43 AV			2.32 H	92	97.91	4.52
4	#5927.87	56.96 PK	68.20	-11.24	2.32 H	92	51.79	5.17
5	11510.00	56.97 PK	74.00	-17.03	1.82 H	204	40.43	16.54
6	11510.00	43.72 AV	54.00	-10.28	1.82 H	204	27.18	16.54

**ANTENNA POLARITY & TEST DISTANCE: VERTICAL AT 3 M**

NO.	FREQ. (MHz)	EMISSION LEVEL (dBuV/m)	LIMIT (dBuV/m)	MARGIN (dB)	ANTENNA HEIGHT (m)	TABLE ANGLE (Degree)	RAW VALUE (dBuV)	CORRECTION FACTOR (dB/m)
1	#5644.60	60.92 PK	68.20	-7.28	1.11 V	109	57.13	3.79
2	*5755.00	110.01 PK			1.11 V	109	105.49	4.52
3	*5755.00	98.43 AV			1.11 V	109	93.91	4.52
4	#5926.97	55.22 PK	68.20	-12.98	1.11 V	109	50.05	5.17
5	11510.00	55.76 PK	74.00	-18.24	1.03 V	293	39.22	16.54
6	11510.00	42.35 AV	54.00	-11.65	1.03 V	293	25.81	16.54

**REMARKS:**

1. Emission Level(dBuV/m) = Raw Value(dBuV) + Correction Factor(dB/m)
2. Correction Factor(dB/m) = Antenna Factor(dB/m) + Cable Factor(dB) – Pre-Amplifier Factor(dB)
3. The other emission levels were very low against the limit.
4. Margin value = Emission Level – Limit value
5. " \* " : Fundamental frequency.
6. " # " : The radiated frequency is out of the restricted band.

<b>CHANNEL</b>	TX Channel 159	<b>DETECTOR FUNCTION</b>	Peak (PK)
<b>FREQUENCY RANGE</b>	1GHz ~ 40GHz		Average (AV)

**ANTENNA POLARITY & TEST DISTANCE: HORIZONTAL AT 3 M**

NO.	FREQ. (MHz)	EMISSION LEVEL (dBuV/m)	LIMIT (dBuV/m)	MARGIN (dB)	ANTENNA HEIGHT (m)	TABLE ANGLE (Degree)	RAW VALUE (dBuV)	CORRECTION FACTOR (dB/m)
1	#5643.78	55.39 PK	68.20	-12.81	1.00 H	146	51.60	3.79
2	*5795.00	110.91 PK			1.00 H	146	106.09	4.82
3	*5795.00	100.13 AV			1.00 H	146	95.31	4.82
4	#5934.86	56.85 PK	68.20	-11.35	1.00 H	146	51.65	5.20
5	11590.00	56.90 PK	74.00	-17.10	1.61 H	242	40.28	16.62
6	11590.00	43.68 AV	54.00	-10.32	1.61 H	242	27.06	16.62

**ANTENNA POLARITY & TEST DISTANCE: VERTICAL AT 3 M**

NO.	FREQ. (MHz)	EMISSION LEVEL (dBuV/m)	LIMIT (dBuV/m)	MARGIN (dB)	ANTENNA HEIGHT (m)	TABLE ANGLE (Degree)	RAW VALUE (dBuV)	CORRECTION FACTOR (dB/m)
1	#5585.59	53.43 PK	68.20	-14.77	1.39 V	110	49.86	3.57
2	*5795.00	107.00 PK			1.39 V	110	102.18	4.82
3	*5795.00	94.60 AV			1.39 V	110	89.78	4.82
4	#5934.73	54.66 PK	68.20	-13.54	1.39 V	110	49.46	5.20
5	11590.00	55.55 PK	74.00	-18.45	1.00 V	249	38.93	16.62
6	11590.00	42.25 AV	54.00	-11.75	1.00 V	249	25.63	16.62

**REMARKS:**

1. Emission Level(dBuV/m) = Raw Value(dBuV) + Correction Factor(dB/m)
2. Correction Factor(dB/m) = Antenna Factor(dB/m) + Cable Factor(dB) – Pre-Amplifier Factor(dB)
3. The other emission levels were very low against the limit.
4. Margin value = Emission Level – Limit value
5. " \* ": Fundamental frequency.
6. " # ": The radiated frequency is out of the restricted band.

802.11ac (80MHz)

<b>CHANNEL</b>	TX Channel 42	<b>DETECTOR FUNCTION</b>	Peak (PK)
<b>FREQUENCY RANGE</b>	1GHz ~ 40GHz		Average (AV)

**ANTENNA POLARITY & TEST DISTANCE: HORIZONTAL AT 3 M**

NO.	FREQ. (MHz)	EMISSION LEVEL (dBuV/m)	LIMIT (dBuV/m)	MARGIN (dB)	ANTENNA HEIGHT (m)	TABLE ANGLE (Degree)	RAW VALUE (dBuV)	CORRECTION FACTOR (dB/m)
1	5150.00	67.03 PK	74.00	-6.97	2.13 H	80	63.37	3.66
2	5150.00	52.93 AV	54.00	-1.07	2.13 H	80	49.27	3.66
3	*5210.00	102.29 PK			2.13 H	80	99.15	3.14
4	*5210.00	91.97 AV			2.13 H	80	88.83	3.14
5	5350.00	54.80 PK	74.00	-19.20	2.13 H	80	51.88	2.92
6	5350.00	41.52 AV	54.00	-12.48	2.13 H	80	38.60	2.92
7	#10420.00	53.41 PK	74.00	-20.59	1.72 H	289	38.32	15.09
8	#10420.00	40.92 AV	54.00	-13.08	1.72 H	289	25.83	15.09

**ANTENNA POLARITY & TEST DISTANCE: VERTICAL AT 3 M**

NO.	FREQ. (MHz)	EMISSION LEVEL (dBuV/m)	LIMIT (dBuV/m)	MARGIN (dB)	ANTENNA HEIGHT (m)	TABLE ANGLE (Degree)	RAW VALUE (dBuV)	CORRECTION FACTOR (dB/m)
1	5150.00	67.37 PK	74.00	-6.63	1.00 V	106	63.71	3.66
2	5150.00	52.48 AV	54.00	-1.52	1.00 V	106	48.82	3.66
3	*5210.00	101.20 PK			1.00 V	106	98.06	3.14
4	*5210.00	89.99 AV			1.00 V	106	86.85	3.14
5	5350.00	54.47 PK	74.00	-19.53	1.00 V	106	51.55	2.92
6	5350.00	41.14 AV	54.00	-12.86	1.00 V	106	38.22	2.92
7	#10420.00	52.71 PK	74.00	-21.29	1.02 V	103	37.62	15.09
8	#10420.00	40.36 AV	54.00	-13.64	1.02 V	103	25.27	15.09

**REMARKS:**

1. Emission Level(dBuV/m) = Raw Value(dBuV) + Correction Factor(dB/m)
2. Correction Factor(dB/m) = Antenna Factor(dB/m) + Cable Factor(dB) – Pre-Amplifier Factor(dB)
3. The other emission levels were very low against the limit.
4. Margin value = Emission Level – Limit value
5. " \* ": Fundamental frequency.
6. " # ": The radiated frequency is out of the restricted band.

<b>CHANNEL</b>	TX Channel 155	<b>DETECTOR FUNCTION</b>	Peak (PK)
<b>FREQUENCY RANGE</b>	1GHz ~ 40GHz		Average (AV)

**ANTENNA POLARITY & TEST DISTANCE: HORIZONTAL AT 3 M**

NO.	FREQ. (MHz)	EMISSION LEVEL (dBuV/m)	LIMIT (dBuV/m)	MARGIN (dB)	ANTENNA HEIGHT (m)	TABLE ANGLE (Degree)	RAW VALUE (dBuV)	CORRECTION FACTOR (dB/m)
1	#5656.84	72.20 PK	73.26	-1.06	1.05 H	145	68.35	3.85
2	*5775.00	105.98 PK			1.05 H	145	101.30	4.68
3	*5775.00	95.18 AV			1.05 H	145	90.50	4.68
4	#5932.94	65.20 PK	68.20	-3.00	1.05 H	145	60.02	5.18
5	11550.00	55.92 PK	74.00	-18.08	1.15 H	178	39.34	16.58
6	11550.00	41.95 AV	54.00	-12.05	1.15 H	178	25.37	16.58

**ANTENNA POLARITY & TEST DISTANCE: VERTICAL AT 3 M**

NO.	FREQ. (MHz)	EMISSION LEVEL (dBuV/m)	LIMIT (dBuV/m)	MARGIN (dB)	ANTENNA HEIGHT (m)	TABLE ANGLE (Degree)	RAW VALUE (dBuV)	CORRECTION FACTOR (dB/m)
1	#5649.61	65.95 PK	68.20	-2.25	1.01 V	106	62.15	3.80
2	*5775.00	104.82 PK			1.01 V	106	100.14	4.68
3	*5775.00	94.24 AV			1.01 V	106	89.56	4.68
4	#5924.26	60.58 PK	68.75	-8.17	1.01 V	106	55.40	5.18
5	11550.00	55.02 PK	74.00	-18.98	2.23 V	346	38.44	16.58
6	11550.00	41.45 AV	54.00	-12.55	2.23 V	346	24.87	16.58

**REMARKS:**

1. Emission Level(dBuV/m) = Raw Value(dBuV) + Correction Factor(dB/m)
2. Correction Factor(dB/m) = Antenna Factor(dB/m) + Cable Factor(dB) – Pre-Amplifier Factor(dB)
3. The other emission levels were very low against the limit.
4. Margin value = Emission Level – Limit value
5. " \* " : Fundamental frequency.
6. " # " : The radiated frequency is out of the restricted band.

**Beamforming\_NSS1 Mode**

**802.11ac (20MHz)**

<b>CHANNEL</b>	TX Channel 36	<b>DETECTOR FUNCTION</b>	Peak (PK)
<b>FREQUENCY RANGE</b>	1GHz ~ 40GHz		Average (AV)

**ANTENNA POLARITY & TEST DISTANCE: HORIZONTAL AT 3 M**

NO.	FREQ. (MHz)	EMISSION LEVEL (dBuV/m)	LIMIT (dBuV/m)	MARGIN (dB)	ANTENNA HEIGHT (m)	TABLE ANGLE (Degree)	RAW VALUE (dBuV)	CORRECTION FACTOR (dB/m)
1	5150.00	64.42 PK	74.00	-9.58	2.45 H	77	60.76	3.66
2	5150.00	52.76 AV	54.00	-1.24	2.45 H	77	49.10	3.66
3	*5180.00	112.19 PK			2.45 H	77	108.81	3.38
4	*5180.00	100.70 AV			2.45 H	77	97.32	3.38
5	#10360.00	57.31 PK	74.00	-16.69	1.77 H	205	42.62	14.69
6	#10360.00	42.28 AV	54.00	-11.72	1.77 H	205	27.59	14.69

**ANTENNA POLARITY & TEST DISTANCE: VERTICAL AT 3 M**

NO.	FREQ. (MHz)	EMISSION LEVEL (dBuV/m)	LIMIT (dBuV/m)	MARGIN (dB)	ANTENNA HEIGHT (m)	TABLE ANGLE (Degree)	RAW VALUE (dBuV)	CORRECTION FACTOR (dB/m)
1	5150.00	61.02 PK	74.00	-12.98	1.00 V	107	57.36	3.66
2	5150.00	47.77 AV	54.00	-6.23	1.00 V	107	44.11	3.66
3	*5180.00	109.41 PK			1.00 V	107	106.03	3.38
4	*5180.00	98.25 AV			1.00 V	107	94.87	3.38
5	#10360.00	55.27 PK	74.00	-18.73	1.62 V	103	40.58	14.69
6	#10360.00	40.86 AV	54.00	-13.14	1.62 V	103	26.17	14.69

**REMARKS:**

1. Emission Level(dBuV/m) = Raw Value(dBuV) + Correction Factor(dB/m)
2. Correction Factor(dB/m) = Antenna Factor(dB/m) + Cable Factor(dB) – Pre-Amplifier Factor(dB)
3. The other emission levels were very low against the limit.
4. Margin value = Emission Level – Limit value
5. " \* " : Fundamental frequency.
6. " # " : The radiated frequency is out of the restricted band.

<b>CHANNEL</b>	TX Channel 40	<b>DETECTOR FUNCTION</b>	Peak (PK)
<b>FREQUENCY RANGE</b>	1GHz ~ 40GHz		Average (AV)

**ANTENNA POLARITY & TEST DISTANCE: HORIZONTAL AT 3 M**

NO.	FREQ. (MHz)	EMISSION LEVEL (dBuV/m)	LIMIT (dBuV/m)	MARGIN (dB)	ANTENNA HEIGHT (m)	TABLE ANGLE (Degree)	RAW VALUE (dBuV)	CORRECTION FACTOR (dB/m)
1	*5200.00	112.18 PK			1.67 H	89	108.99	3.19
2	*5200.00	100.78 AV			1.67 H	89	97.59	3.19
3	#10400.00	57.60 PK	74.00	-16.40	1.03 H	281	42.66	14.94
4	#10400.00	42.55 AV	54.00	-11.45	1.03 H	281	27.61	14.94

**ANTENNA POLARITY & TEST DISTANCE: VERTICAL AT 3 M**

NO.	FREQ. (MHz)	EMISSION LEVEL (dBuV/m)	LIMIT (dBuV/m)	MARGIN (dB)	ANTENNA HEIGHT (m)	TABLE ANGLE (Degree)	RAW VALUE (dBuV)	CORRECTION FACTOR (dB/m)
1	*5200.00	109.60 PK			1.05 V	119	106.41	3.19
2	*5200.00	98.11 AV			1.05 V	119	94.92	3.19
3	#10400.00	55.61 PK	74.00	-18.39	1.88 V	204	40.67	14.94
4	#10400.00	41.27 AV	54.00	-12.73	1.88 V	204	26.33	14.94

**REMARKS:**

1. Emission Level(dBuV/m) = Raw Value(dBuV) + Correction Factor(dB/m)
2. Correction Factor(dB/m) = Antenna Factor(dB/m) + Cable Factor(dB) – Pre-Amplifier Factor(dB)
3. The other emission levels were very low against the limit.
4. Margin value = Emission Level – Limit value
5. " \* " : Fundamental frequency.
6. " # " : The radiated frequency is out of the restricted band.



<b>CHANNEL</b>	TX Channel 48	<b>DETECTOR FUNCTION</b>	Peak (PK)
<b>FREQUENCY RANGE</b>	1GHz ~ 40GHz		Average (AV)

**ANTENNA POLARITY & TEST DISTANCE: HORIZONTAL AT 3 M**

NO.	FREQ. (MHz)	EMISSION LEVEL (dBuV/m)	LIMIT (dBuV/m)	MARGIN (dB)	ANTENNA HEIGHT (m)	TABLE ANGLE (Degree)	RAW VALUE (dBuV)	CORRECTION FACTOR (dB/m)
1	*5240.00	109.67 PK			2.07 H	61	106.67	3.00
2	*5240.00	98.51 AV			2.07 H	61	95.51	3.00
3	5350.00	58.53 PK	74.00	-15.47	2.07 H	61	55.61	2.92
4	5350.00	41.54 AV	54.00	-12.46	2.07 H	61	38.62	2.92
5	#10480.00	57.73 PK	74.00	-16.27	1.52 H	182	42.22	15.51
6	#10480.00	42.88 AV	54.00	-11.12	1.52 H	182	27.37	15.51

**ANTENNA POLARITY & TEST DISTANCE: VERTICAL AT 3 M**

NO.	FREQ. (MHz)	EMISSION LEVEL (dBuV/m)	LIMIT (dBuV/m)	MARGIN (dB)	ANTENNA HEIGHT (m)	TABLE ANGLE (Degree)	RAW VALUE (dBuV)	CORRECTION FACTOR (dB/m)
1	*5240.00	107.55 PK			1.00 V	122	104.55	3.00
2	*5240.00	95.81 AV			1.00 V	122	92.81	3.00
3	5350.00	56.74 PK	74.00	-17.26	1.00 V	122	53.82	2.92
4	5350.00	38.69 AV	54.00	-15.31	1.00 V	122	35.77	2.92
5	#10480.00	55.59 PK	74.00	-18.41	1.62 V	302	40.08	15.51
6	#10480.00	41.52 AV	54.00	-12.48	1.62 V	302	26.01	15.51

**REMARKS:**

1. Emission Level(dBuV/m) = Raw Value(dBuV) + Correction Factor(dB/m)
2. Correction Factor(dB/m) = Antenna Factor(dB/m) + Cable Factor(dB) – Pre-Amplifier Factor(dB)
3. The other emission levels were very low against the limit.
4. Margin value = Emission Level – Limit value
5. " \* " : Fundamental frequency.
6. " # " : The radiated frequency is out of the restricted band.

<b>CHANNEL</b>	TX Channel 149	<b>DETECTOR FUNCTION</b>	Peak (PK)
<b>FREQUENCY RANGE</b>	1GHz ~ 40GHz		Average (AV)

**ANTENNA POLARITY & TEST DISTANCE: HORIZONTAL AT 3 M**

NO.	FREQ. (MHz)	EMISSION LEVEL (dBuV/m)	LIMIT (dBuV/m)	MARGIN (dB)	ANTENNA HEIGHT (m)	TABLE ANGLE (Degree)	RAW VALUE (dBuV)	CORRECTION FACTOR (dB/m)
1	#5592.22	61.11 PK	68.20	-7.09	2.92 H	83	57.51	3.60
2	*5745.00	110.85 PK			2.92 H	83	106.40	4.45
3	*5745.00	99.62 AV			2.92 H	83	95.17	4.45
4	#5940.70	54.88 PK	68.20	-13.32	2.92 H	83	49.67	5.21
5	11490.00	58.67 PK	74.00	-15.33	1.82 H	209	42.17	16.50
6	11490.00	42.93 AV	54.00	-11.07	1.82 H	209	26.43	16.50

**ANTENNA POLARITY & TEST DISTANCE: VERTICAL AT 3 M**

NO.	FREQ. (MHz)	EMISSION LEVEL (dBuV/m)	LIMIT (dBuV/m)	MARGIN (dB)	ANTENNA HEIGHT (m)	TABLE ANGLE (Degree)	RAW VALUE (dBuV)	CORRECTION FACTOR (dB/m)
1	#5641.88	53.89 PK	68.20	-14.31	1.54 V	96	50.11	3.78
2	*5745.00	107.70 PK			1.54 V	96	103.25	4.45
3	*5745.00	97.09 AV			1.54 V	96	92.64	4.45
4	#5957.57	54.11 PK	68.20	-14.09	1.54 V	96	48.85	5.26
5	11490.00	56.72 PK	74.00	-17.28	1.03 V	84	40.22	16.50
6	11490.00	41.63 AV	54.00	-12.37	1.03 V	84	25.13	16.50

**REMARKS:**

1. Emission Level(dBuV/m) = Raw Value(dBuV) + Correction Factor(dB/m)
2. Correction Factor(dB/m) = Antenna Factor(dB/m) + Cable Factor(dB) – Pre-Amplifier Factor(dB)
3. The other emission levels were very low against the limit.
4. Margin value = Emission Level – Limit value
5. " \* " : Fundamental frequency.
6. " # " : The radiated frequency is out of the restricted band.

<b>CHANNEL</b>	TX Channel 157	<b>DETECTOR FUNCTION</b>	Peak (PK)
<b>FREQUENCY RANGE</b>	1GHz ~ 40GHz		Average (AV)

ANTENNA POLARITY & TEST DISTANCE: HORIZONTAL AT 3 M								
NO.	FREQ. (MHz)	EMISSION LEVEL (dBuV/m)	LIMIT (dBuV/m)	MARGIN (dB)	ANTENNA HEIGHT (m)	TABLE ANGLE (Degree)	RAW VALUE (dBuV)	CORRECTION FACTOR (dB/m)
1	#5627.99	58.02 PK	68.20	-10.18	3.81 H	103	54.29	3.73
2	*5785.00	111.94 PK			3.81 H	103	107.19	4.75
3	*5785.00	101.15 AV			3.81 H	103	96.40	4.75
4	#5984.81	53.27 PK	68.20	-14.93	3.81 H	103	47.85	5.42
5	11570.00	58.93 PK	74.00	-15.07	1.88 H	217	42.32	16.61
6	11570.00	43.18 AV	54.00	-10.82	1.88 H	217	26.57	16.61

ANTENNA POLARITY & TEST DISTANCE: VERTICAL AT 3 M								
NO.	FREQ. (MHz)	EMISSION LEVEL (dBuV/m)	LIMIT (dBuV/m)	MARGIN (dB)	ANTENNA HEIGHT (m)	TABLE ANGLE (Degree)	RAW VALUE (dBuV)	CORRECTION FACTOR (dB/m)
1	#5639.36	53.77 PK	68.20	-14.43	1.65 V	100	50.00	3.77
2	*5785.00	109.28 PK			1.65 V	100	104.53	4.75
3	*5785.00	98.47 AV			1.65 V	100	93.72	4.75
4	#5999.04	55.21 PK	68.20	-12.99	1.65 V	100	49.72	5.49
5	11570.00	57.08 PK	74.00	-16.92	1.12 V	72	40.47	16.61
6	11570.00	42.00 AV	54.00	-12.00	1.12 V	72	25.39	16.61

**REMARKS:**

1. Emission Level(dBuV/m) = Raw Value(dBuV) + Correction Factor(dB/m)
2. Correction Factor(dB/m) = Antenna Factor(dB/m) + Cable Factor(dB) – Pre-Amplifier Factor(dB)
3. The other emission levels were very low against the limit.
4. Margin value = Emission Level – Limit value
5. " \* " : Fundamental frequency.
6. " # " : The radiated frequency is out of the restricted band.

<b>CHANNEL</b>	TX Channel 165	<b>DETECTOR FUNCTION</b>	Peak (PK)
<b>FREQUENCY RANGE</b>	1GHz ~ 40GHz		Average (AV)

**ANTENNA POLARITY & TEST DISTANCE: HORIZONTAL AT 3 M**

NO.	FREQ. (MHz)	EMISSION LEVEL (dBuV/m)	LIMIT (dBuV/m)	MARGIN (dB)	ANTENNA HEIGHT (m)	TABLE ANGLE (Degree)	RAW VALUE (dBuV)	CORRECTION FACTOR (dB/m)
1	#5626.97	54.85 PK	68.20	-13.35	3.88 H	89	51.12	3.73
2	*5825.00	111.64 PK			3.88 H	89	106.67	4.97
3	*5825.00	99.85 AV			3.88 H	89	94.88	4.97
4	#5962.26	54.30 PK	68.20	-13.90	3.88 H	89	49.01	5.29
5	11650.00	58.59 PK	74.00	-15.41	1.97 H	248	42.23	16.36
6	11650.00	42.84 AV	54.00	-11.16	1.97 H	248	26.48	16.36

**ANTENNA POLARITY & TEST DISTANCE: VERTICAL AT 3 M**

NO.	FREQ. (MHz)	EMISSION LEVEL (dBuV/m)	LIMIT (dBuV/m)	MARGIN (dB)	ANTENNA HEIGHT (m)	TABLE ANGLE (Degree)	RAW VALUE (dBuV)	CORRECTION FACTOR (dB/m)
1	#5627.03	54.24 PK	68.20	-13.96	1.67 V	72	50.51	3.73
2	*5825.00	108.38 PK			1.66 V	143	103.41	4.97
3	*5825.00	97.85 AV			1.66 V	143	92.88	4.97
4	#5974.19	54.95 PK	68.20	-13.25	1.67 V	72	49.60	5.35
5	11650.00	56.67 PK	74.00	-17.33	1.00 V	27	40.31	16.36
6	11650.00	41.54 AV	54.00	-12.46	1.00 V	27	25.18	16.36

**REMARKS:**

1. Emission Level(dBuV/m) = Raw Value(dBuV) + Correction Factor(dB/m)
2. Correction Factor(dB/m) = Antenna Factor(dB/m) + Cable Factor(dB) – Pre-Amplifier Factor(dB)
3. The other emission levels were very low against the limit.
4. Margin value = Emission Level – Limit value
5. " \* " : Fundamental frequency.
6. " # " : The radiated frequency is out of the restricted band.

802.11ac (40MHz)

<b>CHANNEL</b>	TX Channel 38	<b>DETECTOR FUNCTION</b>	Peak (PK)
<b>FREQUENCY RANGE</b>	1GHz ~ 40GHz		Average (AV)

ANTENNA POLARITY & TEST DISTANCE: HORIZONTAL AT 3 M								
NO.	FREQ. (MHz)	EMISSION LEVEL (dBuV/m)	LIMIT (dBuV/m)	MARGIN (dB)	ANTENNA HEIGHT (m)	TABLE ANGLE (Degree)	RAW VALUE (dBuV)	CORRECTION FACTOR (dB/m)
1	5150.00	69.11 PK	74.00	-4.89	1.58 H	60	65.45	3.66
2	5150.00	52.82 AV	54.00	-1.18	1.58 H	60	49.16	3.66
3	*5190.00	108.40 PK			1.58 H	60	105.11	3.29
4	*5190.00	98.11 AV			1.58 H	60	94.82	3.29
5	#10380.00	57.64 PK	74.00	-16.36	1.74 H	242	42.83	14.81
6	#10380.00	41.15 AV	54.00	-12.85	1.74 H	242	26.34	14.81

ANTENNA POLARITY & TEST DISTANCE: VERTICAL AT 3 M								
NO.	FREQ. (MHz)	EMISSION LEVEL (dBuV/m)	LIMIT (dBuV/m)	MARGIN (dB)	ANTENNA HEIGHT (m)	TABLE ANGLE (Degree)	RAW VALUE (dBuV)	CORRECTION FACTOR (dB/m)
1	5150.00	68.89 PK	74.00	-5.11	1.00 V	116	65.23	3.66
2	5150.00	51.95 AV	54.00	-2.05	1.00 V	116	48.29	3.66
3	*5190.00	107.80 PK			1.00 V	116	104.51	3.29
4	*5190.00	97.47 AV			1.00 V	116	94.18	3.29
5	#10380.00	55.50 PK	74.00	-18.50	1.12 V	141	40.69	14.81
6	#10380.00	40.22 AV	54.00	-13.78	1.12 V	141	25.41	14.81

**REMARKS:**

1. Emission Level(dBuV/m) = Raw Value(dBuV) + Correction Factor(dB/m)
2. Correction Factor(dB/m) = Antenna Factor(dB/m) + Cable Factor(dB) – Pre-Amplifier Factor(dB)
3. The other emission levels were very low against the limit.
4. Margin value = Emission Level – Limit value
5. " \* ": Fundamental frequency.
6. " # ": The radiated frequency is out of the restricted band.

<b>CHANNEL</b>	TX Channel 46	<b>DETECTOR FUNCTION</b>	Peak (PK)
<b>FREQUENCY RANGE</b>	1GHz ~ 40GHz		Average (AV)

ANTENNA POLARITY & TEST DISTANCE: HORIZONTAL AT 3 M								
NO.	FREQ. (MHz)	EMISSION LEVEL (dBuV/m)	LIMIT (dBuV/m)	MARGIN (dB)	ANTENNA HEIGHT (m)	TABLE ANGLE (Degree)	RAW VALUE (dBuV)	CORRECTION FACTOR (dB/m)
1	*5230.00	111.17 PK			1.68 H	71	108.13	3.04
2	*5230.00	101.23 AV			1.68 H	71	98.19	3.04
3	5350.00	58.39 PK	74.00	-15.61	1.68 H	71	55.47	2.92
4	5350.00	41.71 AV	54.00	-12.29	1.68 H	71	38.79	2.92
5	#10460.00	58.35 PK	74.00	-15.65	1.77 H	281	42.97	15.38
6	#10460.00	41.89 AV	54.00	-12.11	1.77 H	281	26.51	15.38

ANTENNA POLARITY & TEST DISTANCE: VERTICAL AT 3 M								
NO.	FREQ. (MHz)	EMISSION LEVEL (dBuV/m)	LIMIT (dBuV/m)	MARGIN (dB)	ANTENNA HEIGHT (m)	TABLE ANGLE (Degree)	RAW VALUE (dBuV)	CORRECTION FACTOR (dB/m)
1	*5230.00	110.33 PK			1.02 V	122	107.29	3.04
2	*5230.00	100.63 AV			1.02 V	122	97.59	3.04
3	5350.00	56.19 PK	74.00	-17.81	1.02 V	122	53.27	2.92
4	5350.00	40.38 AV	54.00	-13.62	1.02 V	122	37.46	2.92
5	#10460.00	56.26 PK	74.00	-17.74	1.19 V	203	40.88	15.38
6	#10460.00	41.10 AV	54.00	-12.90	1.19 V	203	25.72	15.38

**REMARKS:**

1. Emission Level(dBuV/m) = Raw Value(dBuV) + Correction Factor(dB/m)
2. Correction Factor(dB/m) = Antenna Factor(dB/m) + Cable Factor(dB) – Pre-Amplifier Factor(dB)
3. The other emission levels were very low against the limit.
4. Margin value = Emission Level – Limit value
5. " \* " : Fundamental frequency.
6. " # " : The radiated frequency is out of the restricted band.

<b>CHANNEL</b>	TX Channel 151	<b>DETECTOR FUNCTION</b>	Peak (PK)
<b>FREQUENCY RANGE</b>	1GHz ~ 40GHz		Average (AV)

**ANTENNA POLARITY & TEST DISTANCE: HORIZONTAL AT 3 M**

NO.	FREQ. (MHz)	EMISSION LEVEL (dBuV/m)	LIMIT (dBuV/m)	MARGIN (dB)	ANTENNA HEIGHT (m)	TABLE ANGLE (Degree)	RAW VALUE (dBuV)	CORRECTION FACTOR (dB/m)
1	#5640.18	53.70 PK	68.20	-14.50	1.46 H	61	49.92	3.78
2	*5755.00	110.39 PK			1.46 H	61	105.87	4.52
3	*5755.00	99.55 AV			1.46 H	61	95.03	4.52
4	#5979.39	53.81 PK	68.20	-14.39	1.46 H	61	48.43	5.38
5	11510.00	59.09 PK	74.00	-14.91	1.77 H	251	42.55	16.54
6	11510.00	42.92 AV	54.00	-11.08	1.77 H	251	26.38	16.54

**ANTENNA POLARITY & TEST DISTANCE: VERTICAL AT 3 M**

NO.	FREQ. (MHz)	EMISSION LEVEL (dBuV/m)	LIMIT (dBuV/m)	MARGIN (dB)	ANTENNA HEIGHT (m)	TABLE ANGLE (Degree)	RAW VALUE (dBuV)	CORRECTION FACTOR (dB/m)
1	#5652.46	53.92 PK	70.02	-16.10	1.22 V	96	50.10	3.82
2	*5755.00	108.76 PK			1.22 V	96	104.24	4.52
3	*5755.00	98.24 AV			1.22 V	96	93.72	4.52
4	#5934.76	54.09 PK	68.20	-14.11	1.22 V	96	48.89	5.20
5	#115100.00	40.31 PK	74.00	-33.69	1.00 V	76	40.31	0.00
6	#115100.00	25.23 AV	54.00	-28.77	1.00 V	76	25.23	0.00

**REMARKS:**

1. Emission Level(dBuV/m) = Raw Value(dBuV) + Correction Factor(dB/m)
2. Correction Factor(dB/m) = Antenna Factor(dB/m) + Cable Factor(dB) – Pre-Amplifier Factor(dB)
3. The other emission levels were very low against the limit.
4. Margin value = Emission Level – Limit value
5. " \* " : Fundamental frequency.
6. " # " : The radiated frequency is out of the restricted band.

<b>CHANNEL</b>	TX Channel 159	<b>DETECTOR FUNCTION</b>	Peak (PK)
<b>FREQUENCY RANGE</b>	1GHz ~ 40GHz		Average (AV)

**ANTENNA POLARITY & TEST DISTANCE: HORIZONTAL AT 3 M**

NO.	FREQ. (MHz)	EMISSION LEVEL (dBuV/m)	LIMIT (dBuV/m)	MARGIN (dB)	ANTENNA HEIGHT (m)	TABLE ANGLE (Degree)	RAW VALUE (dBuV)	CORRECTION FACTOR (dB/m)
1	#5637.33	59.59 PK	68.20	-8.61	1.60 H	86	55.82	3.77
2	*5795.00	111.76 PK			1.60 H	86	106.94	4.82
3	*5795.00	101.54 AV			1.60 H	86	96.72	4.82
4	#5944.96	53.04 PK	68.20	-15.16	1.60 H	86	47.83	5.21
5	11590.00	59.23 PK	74.00	-14.77	1.82 H	237	42.61	16.62
6	11590.00	43.03 AV	54.00	-10.97	1.82 H	237	26.41	16.62

**ANTENNA POLARITY & TEST DISTANCE: VERTICAL AT 3 M**

NO.	FREQ. (MHz)	EMISSION LEVEL (dBuV/m)	LIMIT (dBuV/m)	MARGIN (dB)	ANTENNA HEIGHT (m)	TABLE ANGLE (Degree)	RAW VALUE (dBuV)	CORRECTION FACTOR (dB/m)
1	#5633.52	53.15 PK	68.20	-15.05	1.74 V	63	49.40	3.75
2	*5795.00	110.54 PK			1.74 V	63	105.72	4.82
3	*5795.00	100.37 AV			1.74 V	63	95.55	4.82
4	#5932.43	52.33 PK	68.20	-15.87	1.74 V	63	47.15	5.18
5	11590.00	57.10 PK	74.00	-16.90	1.02 V	119	40.48	16.62
6	11590.00	42.01 AV	54.00	-11.99	1.02 V	119	25.39	16.62

**REMARKS:**

1. Emission Level(dBuV/m) = Raw Value(dBuV) + Correction Factor(dB/m)
2. Correction Factor(dB/m) = Antenna Factor(dB/m) + Cable Factor(dB) – Pre-Amplifier Factor(dB)
3. The other emission levels were very low against the limit.
4. Margin value = Emission Level – Limit value
5. " \* " : Fundamental frequency.
6. " # " : The radiated frequency is out of the restricted band.



802.11ac (80MHz)

<b>CHANNEL</b>	TX Channel 42	<b>DETECTOR FUNCTION</b>	Peak (PK)
<b>FREQUENCY RANGE</b>	1GHz ~ 40GHz		Average (AV)

**ANTENNA POLARITY & TEST DISTANCE: HORIZONTAL AT 3 M**

NO.	FREQ. (MHz)	EMISSION LEVEL (dBuV/m)	LIMIT (dBuV/m)	MARGIN (dB)	ANTENNA HEIGHT (m)	TABLE ANGLE (Degree)	RAW VALUE (dBuV)	CORRECTION FACTOR (dB/m)
1	5150.00	67.48 PK	74.00	-6.52	1.83 H	69	63.82	3.66
2	5150.00	52.89 AV	54.00	-1.11	1.83 H	69	49.23	3.66
3	*5210.00	102.99 PK			1.83 H	69	99.85	3.14
4	*5210.00	92.77 AV			1.83 H	69	89.63	3.14
5	5350.00	53.82 PK	74.00	-20.18	1.83 H	69	50.90	2.92
6	5350.00	42.67 AV	54.00	-11.33	1.83 H	69	39.75	2.92
7	#10420.00	56.91 PK	74.00	-17.09	1.82 H	162	41.82	15.09
8	#10420.00	41.52 AV	54.00	-12.48	1.82 H	162	26.43	15.09

**ANTENNA POLARITY & TEST DISTANCE: VERTICAL AT 3 M**

NO.	FREQ. (MHz)	EMISSION LEVEL (dBuV/m)	LIMIT (dBuV/m)	MARGIN (dB)	ANTENNA HEIGHT (m)	TABLE ANGLE (Degree)	RAW VALUE (dBuV)	CORRECTION FACTOR (dB/m)
1	5150.00	64.80 PK	74.00	-9.20	1.02 V	109	61.14	3.66
2	5150.00	52.18 AV	54.00	-1.82	1.02 V	109	48.52	3.66
3	*5210.00	101.59 PK			1.02 V	109	98.45	3.14
4	*5210.00	91.82 AV			1.02 V	109	88.68	3.14
5	5350.00	53.39 PK	74.00	-20.61	1.02 V	109	50.47	2.92
6	5350.00	42.45 AV	54.00	-11.55	1.02 V	109	39.53	2.92
7	#10420.00	55.01 PK	74.00	-18.99	1.00 V	42	39.92	15.09
8	#10420.00	39.92 AV	54.00	-14.08	1.00 V	42	24.83	15.09

**REMARKS:**

1. Emission Level(dBuV/m) = Raw Value(dBuV) + Correction Factor(dB/m)
2. Correction Factor(dB/m) = Antenna Factor(dB/m) + Cable Factor(dB) – Pre-Amplifier Factor(dB)
3. The other emission levels were very low against the limit.
4. Margin value = Emission Level – Limit value
5. " \* ": Fundamental frequency.
6. " # ": The radiated frequency is out of the restricted band.

<b>CHANNEL</b>	TX Channel 155	<b>DETECTOR FUNCTION</b>	Peak (PK)
<b>FREQUENCY RANGE</b>	1GHz ~ 40GHz		Average (AV)

ANTENNA POLARITY & TEST DISTANCE: HORIZONTAL AT 3 M								
NO.	FREQ. (MHz)	EMISSION LEVEL (dBuV/m)	LIMIT (dBuV/m)	MARGIN (dB)	ANTENNA HEIGHT (m)	TABLE ANGLE (Degree)	RAW VALUE (dBuV)	CORRECTION FACTOR (dB/m)
1	#5632.35	58.36 PK	68.20	-9.84	3.46 H	81	54.62	3.74
2	*5775.00	108.14 PK			3.46 H	81	103.46	4.68
3	*5775.00	97.87 AV			3.46 H	81	93.19	4.68
4	#5935.15	53.69 PK	68.20	-14.51	3.46 H	81	48.49	5.20
5	11550.00	58.26 PK	74.00	-15.74	1.82 H	154	41.68	16.58
6	11550.00	42.89 AV	54.00	-11.11	1.82 H	154	26.31	16.58

ANTENNA POLARITY & TEST DISTANCE: VERTICAL AT 3 M								
NO.	FREQ. (MHz)	EMISSION LEVEL (dBuV/m)	LIMIT (dBuV/m)	MARGIN (dB)	ANTENNA HEIGHT (m)	TABLE ANGLE (Degree)	RAW VALUE (dBuV)	CORRECTION FACTOR (dB/m)
1	#5626.27	56.98 PK	68.20	-11.22	1.00 V	115	53.25	3.73
2	*5775.00	105.16 PK			1.00 V	115	100.48	4.68
3	*5775.00	95.05 AV			1.00 V	115	90.37	4.68
4	#5937.04	56.48 PK	68.20	-11.72	1.00 V	115	51.28	5.20
5	11550.00	56.69 PK	74.00	-17.31	1.33 V	71	40.11	16.58
6	11550.00	41.60 AV	54.00	-12.40	1.33 V	71	25.02	16.58

**REMARKS:**

1. Emission Level(dBuV/m) = Raw Value(dBuV) + Correction Factor(dB/m)
2. Correction Factor(dB/m) = Antenna Factor(dB/m) + Cable Factor(dB) – Pre-Amplifier Factor(dB)
3. The other emission levels were very low against the limit.
4. Margin value = Emission Level – Limit value
5. " \* " : Fundamental frequency.
6. " # " : The radiated frequency is out of the restricted band.

**Below 1GHz Data:**

**CDD Mode**

<b>CHANNEL</b>	TX Channel 40	<b>DETECTOR FUNCTION</b>	Quasi-Peak (QP)
<b>FREQUENCY RANGE</b>	9kHz ~ 1GHz		

**ANTENNA POLARITY & TEST DISTANCE: HORIZONTAL AT 3 M**

NO.	FREQ. (MHz)	EMISSION LEVEL (dBuV/m)	LIMIT (dBuV/m)	MARGIN (dB)	ANTENNA HEIGHT (m)	TABLE ANGLE (Degree)	RAW VALUE (dBuV)	CORRECTION FACTOR (dB/m)
1	42.90	23.10 QP	40.00	-16.90	1.07 H	95	30.59	-7.49
2	107.36	17.17 QP	43.50	-26.33	2.65 H	52	28.00	-10.83
3	534.74	30.81 QP	46.00	-15.19	2.98 H	82	31.27	-0.46
4	650.02	32.33 QP	46.00	-13.67	1.66 H	160	30.28	2.05
5	775.01	35.10 QP	46.00	-10.90	1.46 H	260	30.43	4.67
6	859.79	33.83 QP	46.00	-12.17	2.05 H	151	28.47	5.36

**ANTENNA POLARITY & TEST DISTANCE: VERTICAL AT 3 M**

NO.	FREQ. (MHz)	EMISSION LEVEL (dBuV/m)	LIMIT (dBuV/m)	MARGIN (dB)	ANTENNA HEIGHT (m)	TABLE ANGLE (Degree)	RAW VALUE (dBuV)	CORRECTION FACTOR (dB/m)
1	43.00	35.34 QP	40.00	-4.66	2.28 V	164	42.83	-7.49
2	53.62	29.85 QP	40.00	-10.15	1.05 V	17	37.08	-7.23
3	92.76	24.99 QP	43.50	-18.51	1.15 V	254	37.51	-12.52
4	522.47	28.66 QP	46.00	-17.34	2.68 V	155	29.17	-0.51
5	815.41	33.71 QP	46.00	-12.29	1.48 V	245	28.74	4.97
6	930.11	35.58 QP	46.00	-10.42	1.03 V	133	28.88	6.70

**REMARKS:**

1. Emission Level(dBuV/m) = Raw Value(dBuV) + Correction Factor(dB/m)
2. Correction Factor(dB/m) = Antenna Factor(dB/m) + Cable Factor(dB) – Pre-Amplifier Factor(dB)
3. The other emission levels were very low against the limit.
4. Margin value = Emission Level – Limit value

## 4.2 Conducted Emission Measurement

### 4.2.1 Limits of Conducted Emission Measurement

Frequency (MHz)	Conducted Limit (dBuV)	
	Quasi-peak	Average
0.15 - 0.5	66 - 56	56 - 46
0.50 - 5.0	56	46
5.0 - 30.0	60	50

Note: 1. The lower limit shall apply at the transition frequencies.

2. The limit decreases in line with the logarithm of the frequency in the range of 0.15 to 0.50MHz.

### 4.2.2 Test Instruments

Description & Manufacturer	Model No.	Serial No.	Cal. Date	Cal. Due
ROHDE & SCHWARZ TEST RECEIVER	ESR3	102413	Feb. 8, 2018	Feb. 7, 2019
ROHDE & SCHWARZ Artificial Mains Network (for EUT)	ESH2-Z5	100104	Dec. 6, 2017	Dec. 5, 2018
LISN With Adapter (for EUT)	AD10	C09Ada-001	Dec. 6, 2017	Dec. 5, 2018
ROHDE & SCHWARZ Artificial Mains Network (for peripherals)	ESH3-Z5	847265/023	Nov. 03, 2017	Nov. 02, 2018
SCHWARZBECK Artificial Mains Network (For EUT)	NNLK8129	8129229	May 3, 2018	May 2, 2019
Software	Cond_V7.3.7.4	NA	NA	NA
RF cable (JYEBAO) With 10dB PAD	5D-FB	Cable-C09.01	Feb. 21, 2018	Feb. 20, 2019
SUHNER Terminator (For ROHDE & SCHWARZ LISN)	65BNC-5001	E1-010789	May 8, 2018	May 7, 2019

Notes: 1. The calibration interval of the above test instruments is 12 months and the calibrations are traceable to NML/ROC and NIST/USA.

2. The test was performed in Shielded Room No. 9.

3. Tested Date: Jun. 1 ~ 27, 2018

#### 4.2.3 Test Procedure

- a. The EUT was placed 0.4 meters from the conducting wall of the shielded room with EUT being connected to the power mains through a line impedance stabilization network (LISN). Other support units were connected to the power mains through another LISN. The two LISNs provide 50 ohm/ 50uH of coupling impedance for the measuring instrument.
- b. Both lines of the power mains connected to the EUT were checked for maximum conducted interference.
- c. The frequency range from 150kHz to 30MHz was searched. Emission levels under (Limit - 20dB) was not recorded.

**NOTE:** All modes of operation were investigated and the worst-case emissions are reported.

#### 4.2.4 Deviation from Test Standard

No deviation.

#### 4.2.5 Test Setup

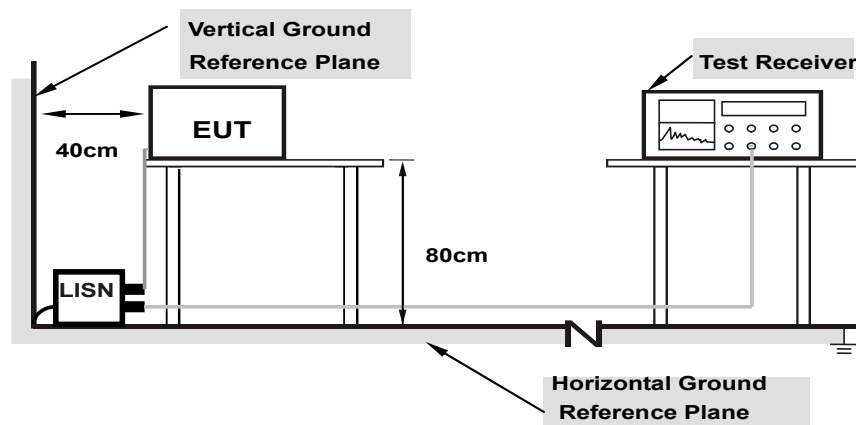

**Note: 1.Support units were connected to second LISN.**

For the actual test configuration, please refer to the attached file (Test Setup Photo).

#### 4.2.6 EUT Operating Condition

Mode A:

- a. Connected the EUT with AC adapter placed on testing table.
- b. Set the EUT under transmission condition continuously at specific channel frequency.

Mode B:

- a. Connected the EUT with PoE adapter placed on testing table.
- b. Set the EUT under transmission condition continuously at specific channel frequency.

#### 4.2.7 Test Results

##### CDD Mode

Phase	Line (L)	Detector Function	Quasi-Peak (QP) / Average (AV)
Test Mode	Mode A		

No	Freq. [MHz]	Corr. Factor (dB)	Reading Value		Emission Level		Limit		Margin	
			[dB (uV)]		[dB (uV)]		[dB (uV)]		(dB)	
			Q.P.	AV.	Q.P.	AV.	Q.P.	AV.	Q.P.	AV.
1	0.18125	10.12	28.62	17.75	38.74	27.87	64.43	54.43	-25.69	-26.56
2	0.37266	10.15	36.67	30.63	46.82	40.78	58.44	48.44	-11.62	-7.66
3	1.09766	10.26	24.90	16.87	35.16	27.13	56.00	46.00	-20.84	-18.87
4	3.46875	10.43	22.62	14.21	33.05	24.64	56.00	46.00	-22.95	-21.36
5	12.40234	10.77	28.70	25.57	39.47	36.34	60.00	50.00	-20.53	-13.66
<b>6</b>	<b>15.07422</b>	<b>10.89</b>	<b>35.68</b>	<b>35.19</b>	<b>46.57</b>	<b>46.08</b>	<b>60.00</b>	<b>50.00</b>	<b>-13.43</b>	<b>-3.92</b>

##### REMARKS:

1. Q.P. and AV. are abbreviations of quasi-peak and average individually.
2. The emission levels of other frequencies were very low against the limit.
3. Margin value = Emission level - Limit value
4. Correction factor = Insertion loss + Cable loss
5. Emission Level = Correction Factor + Reading Value.

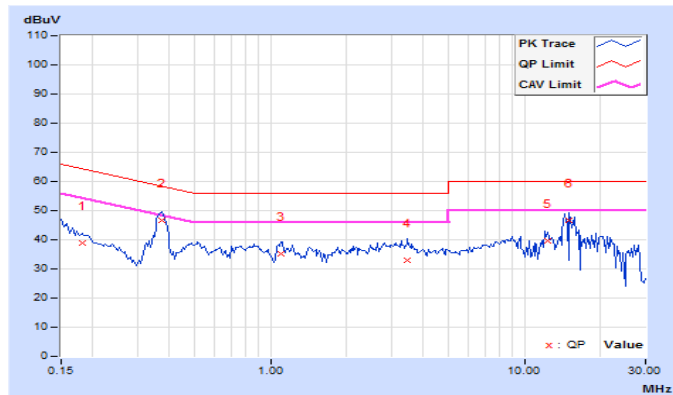

Phase	Neutral (N)	Detector Function	Quasi-Peak (QP) / Average (AV)
Test Mode	Mode A		

No	Freq. [MHz]	Corr. Factor (dB)	Reading Value		Emission Level		Limit		Margin	
			[dB (uV)]		[dB (uV)]		[dB (uV)]		(dB)	
			Q.P.	AV.	Q.P.	AV.	Q.P.	AV.	Q.P.	AV.
1	0.15391	10.12	33.02	20.42	43.14	30.54	65.79	55.79	-22.65	-25.25
2	0.36875	10.16	38.43	33.05	48.59	43.21	58.53	48.53	-9.94	-5.32
3	1.06641	10.27	25.60	14.62	35.87	24.89	56.00	46.00	-20.13	-21.11
4	3.53125	10.45	23.20	14.20	33.65	24.65	56.00	46.00	-22.35	-21.35
5	12.40234	10.71	27.87	25.48	38.58	36.19	60.00	50.00	-21.42	-13.81
6	15.07422	10.77	35.40	34.95	46.17	45.72	60.00	50.00	-13.83	-4.28

**REMARKS:**

1. Q.P. and AV. are abbreviations of quasi-peak and average individually.
2. The emission levels of other frequencies were very low against the limit.
3. Margin value = Emission level - Limit value
4. Correction factor = Insertion loss + Cable loss
5. Emission Level = Correction Factor + Reading Value.

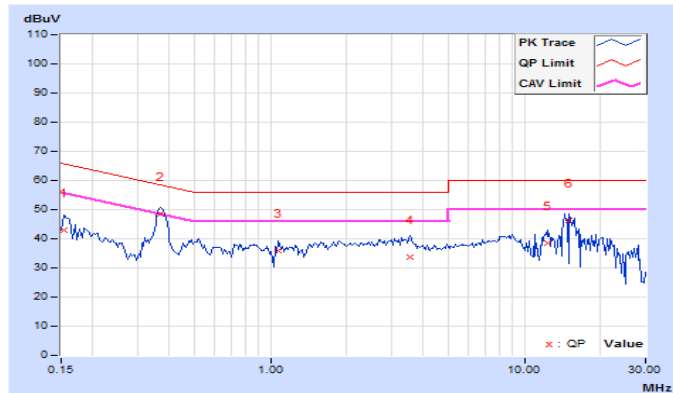

Phase	Line (L)	Detector Function	Quasi-Peak (QP) / Average (AV)
Test Mode	Mode B		

No	Freq. [MHz]	Corr. Factor (dB)	Reading Value		Emission Level		Limit		Margin	
			[dB (uV)]		[dB (uV)]		[dB (uV)]		(dB)	
			Q.P.	AV.	Q.P.	AV.	Q.P.	AV.	Q.P.	AV.
1	0.16564	10.11	37.13	28.33	47.24	38.44	65.18	55.18	-17.94	-16.74
2	0.42761	10.15	30.34	23.27	40.49	33.42	57.30	47.30	-16.81	-13.88
3	0.80107	10.22	17.15	11.18	27.37	21.40	56.00	46.00	-28.63	-24.60
4	2.74043	10.38	12.07	6.90	22.45	17.28	56.00	46.00	-33.55	-28.72
5	21.88338	11.13	30.19	27.81	41.32	38.94	60.00	50.00	-18.68	-11.06
6	29.66037	11.13	21.24	14.98	32.37	26.11	60.00	50.00	-27.63	-23.89

**REMARKS:**

1. Q.P. and AV. are abbreviations of quasi-peak and average individually.
2. The emission levels of other frequencies were very low against the limit.
3. Margin value = Emission level - Limit value
4. Correction factor = Insertion loss + Cable loss
5. Emission Level = Correction Factor + Reading Value.

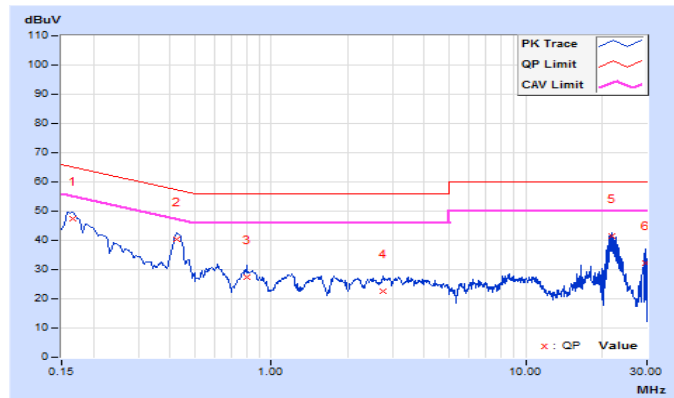



Phase	Neutral (N)	Detector Function	Quasi-Peak (QP) / Average (AV)
Test Mode	Mode B		

No	Freq. [MHz]	Corr.	Reading Value		Emission Level		Limit		Margin	
		Factor	[dB (uV)]		[dB (uV)]		[dB (uV)]		(dB)	
		(dB)	Q.P.	AV.	Q.P.	AV.	Q.P.	AV.	Q.P.	AV.
1	0.16173	10.12	37.22	26.46	47.34	36.58	65.37	55.37	-18.03	-18.79
2	0.42761	10.17	28.78	21.89	38.95	32.06	57.30	47.30	-18.35	-15.24
3	0.58602	10.19	17.50	12.19	27.69	22.38	56.00	46.00	-28.31	-23.62
4	1.19598	10.28	12.62	7.16	22.90	17.44	56.00	46.00	-33.10	-28.56
5	4.19886	10.50	7.41	2.89	17.91	13.39	56.00	46.00	-38.09	-32.61
6	21.64096	10.85	29.65	26.62	40.50	37.47	60.00	50.00	-19.50	-12.53

**REMARKS:**

1. Q.P. and AV. are abbreviations of quasi-peak and average individually.
2. The emission levels of other frequencies were very low against the limit.
3. Margin value = Emission level - Limit value
4. Correction factor = Insertion loss + Cable loss
5. Emission Level = Correction Factor + Reading Value.

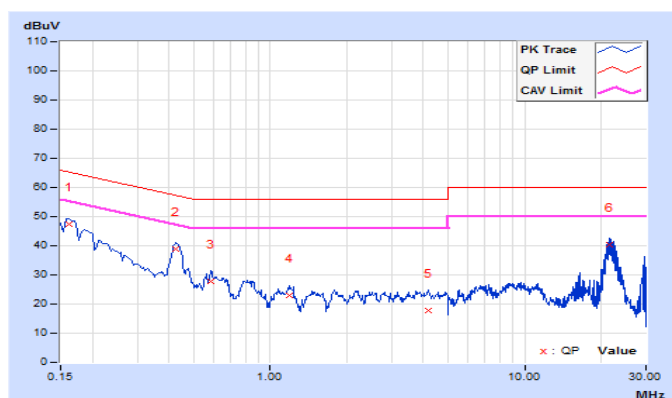

### 4.3 Transmit Power Measurement

#### 4.3.1 Limits of Transmit Power Measurement

Operation Band	EUT Category		Limit
U-NII-1		Outdoor Access Point	1 Watt (30 dBm) (Max. e.i.r.p $\leq$ 125mW(21 dBm) at any elevation angle above 30 degrees as measured from the horizon)
		Fixed point-to-point Access Point	1 Watt (30 dBm)
	√	Indoor Access Point	1 Watt (30 dBm)
		Client device	250mW (24 dBm)
U-NII-2A	---		250mW (24 dBm) or 11 dBm+10 log B*
U-NII-2C	---		250mW (24 dBm) or 11 dBm+10 log B*
U-NII-3	√		1 Watt (30 dBm)

\*B is the 26 dB emission bandwidth in megahertz

Per KDB 662911 Method of conducted output power measurement on IEEE 802.11 devices,

Array Gain = 0 dB (i.e., no array gain) for  $N_{ANT} \leq 4$ ;

Array Gain = 0 dB (i.e., no array gain) for channel widths  $\geq 40$  MHz for any  $N_{ANT}$ ;

Array Gain =  $5 \log(N_{ANT}/N_{SS})$  dB or 3 dB, whichever is less for 20-MHz channel widths with  $N_{ANT} \geq 5$ .

For power measurements on all other devices: Array Gain =  $10 \log(N_{ANT}/N_{SS})$  dB.

#### 4.3.2 Test Setup

##### For Power Output Measurement

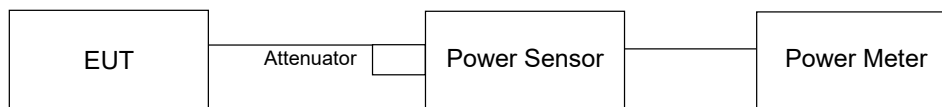

##### For 26dB Occupied Bandwidth

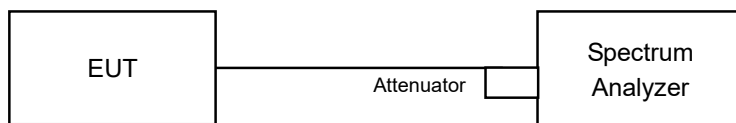

#### 4.3.3 Test Instruments

DESCRIPTION & MANUFACTURER	MODEL NO.	SERIAL NO.	CALIBRATED DATE	CALIBRATED UNTIL
ROHDE & SCHWARZ Spectrum Analyzer	FSV40	101042	Sep. 29, 2017	Sep. 28, 2018
Anritsu Power Sensor	MA2411B	0738404	Apr. 26, 2018	Apr. 25, 2019
Anritsu Power Meter	ML2495A	0842014	Apr. 26, 2018	Apr. 25, 2019
Temperature & Humidity Chamber	MHU-225AU	920409	May 25, 2018	May 24, 2019
DIGITAL POWER METER IDRC	CP-240	240515	Sep. 8, 2017	Sep. 7, 2018
AC Power Source ExTech	CFW-105	E000603	NA	NA

- NOTE:**
1. The calibration interval of the above test instruments is 12/24 months. And the calibrations are traceable to NML/ROC and NIST/USA.
  2. The test was performed in Chamber No. 6.
  3. The Industry Canada Reference No. IC 7450E-6.
  4. Tested Date: Jun. 27, 2018

#### 4.3.4 Test Procedure

##### For Average Power Measurement

##### For 802.11a, 802.11ac (20MHz), 802.11ac (40MHz)

Method PM is used to perform output power measurement, trigger and gating function of wide band power meter is enabled to measure max output power of TX on burst and set the detector to AVERAGE. Duty factor is not added to measured value.

##### For 802.11ac (80MHz)

- 1) Set span to encompass the entire 26 dB EBW (or, alternatively, the entire 99% occupied bandwidth) of the signal.
- 2) Set sweep trigger to "free run".
- 3) Set RBW = 1 MHz
- 4) Set VBW  $\geq$  3 MHz
- 5) Number of points in sweep  $\geq$  2 Span / RBW.
- 6) Sweep time  $\leq$  (number of points in sweep) \* T
- 7) Using emission bandwidth to determine the frequency span for integration the channel bandwidth.
- 8) Detector = RMS.
- 9) Trace mode = max hold.
- 10) Allow max hold to run for at least 60 seconds, or longer as needed to allow the trace to stabilize.

##### For 26dB Occupied Bandwidth

- 1) Set RBW = approximately 1% of the emission bandwidth.
- 2) Set the VBW > RBW.
- 3) Detector = Peak.
- 4) Trace mode = max hold.
- 5) Measure the maximum width of the emission that is 26 dB down from the peak of the emission. Compare this with the RBW setting of the analyzer. Readjust RBW and repeat measurement as needed until the RBW/EBW ratio is approximately 1%.

#### 4.3.5 Deviation from Test Standard

No deviation.

#### 4.3.6 EUT Operating Condition

The software provided by client to enable the EUT under transmission condition continuously at lowest, middle and highest channel frequencies individually.

#### 4.3.7 Test Result

Mode A

CDD Mode

Power Output:

802.11a

Chan.	Chan. Freq. (MHz)	Maximum Conducted Power (dBm)		Total Power (mW)	Total Power (dBm)	Power Limit (dBm)	Pass/Fail
		Chain 0	Chain 1				
36	5180	19.00	19.28	164.156	22.15	29.70	Pass
40	5200	21.95	22.41	330.856	25.20	29.70	Pass
48	5240	22.58	22.95	378.376	25.78	29.70	Pass
149	5745	23.05	23.23	412.215	26.15	29.70	Pass
157	5785	23.04	23.19	409.821	26.13	29.70	Pass
165	5825	23.01	23.15	406.524	26.09	29.70	Pass

**Note:** Antenna gain = 6.3dBi > 6dBi , so the limit shall be reduced to  $30-(6.3-6) = 29.70$ dBm.

802.11ac (20MHz)

Chan.	Chan. Freq. (MHz)	Maximum Conducted Power (dBm)		Total Power (mW)	Total Power (dBm)	Power Limit (dBm)	Pass/Fail
		Chain 0	Chain 1				
36	5180	19.27	19.67	177.211	22.48	29.70	Pass
40	5200	21.20	21.54	274.387	24.38	29.70	Pass
48	5240	20.72	21.15	248.349	23.95	29.70	Pass
149	5745	23.05	23.07	404.605	26.07	29.70	Pass
157	5785	22.98	23.22	408.503	26.11	29.70	Pass
165	5825	23.08	23.11	407.880	26.11	29.70	Pass

**Note:** Antenna gain = 6.3dBi > 6dBi , so the limit shall be reduced to  $30-(6.3-6) = 29.70$ dBm.

802.11ac (40MHz)

Chan.	Chan. Freq. (MHz)	Maximum Conducted Power (dBm)		Total Power (mW)	Total Power (dBm)	Power Limit (dBm)	Pass/Fail
		Chain 0	Chain 1				
38	5190	15.65	16.14	77.843	18.91	29.70	Pass
46	5230	22.58	23.19	<b>389.583</b>	25.91	29.70	Pass
151	5755	23.02	23.38	<b>418.218</b>	26.21	29.70	Pass
159	5795	22.94	23.06	399.091	26.01	29.70	Pass

**Note:** Antenna gain = 6.3dBi > 6dBi , so the limit shall be reduced to  $30-(6.3-6) = 29.70$ dBm.

802.11ac (80MHz)

Chan.	Chan. Freq. (MHz)	Maximum Conducted Power (dBm)		Total Power (mW)	Total Power (dBm)	Power Limit (dBm)	Pass/Fail
		Chain 0	Chain 1				
42	5210	14.79	15.26	63.704	18.04	29.70	Pass
155	5775	20.01	20.25	206.156	23.14	29.70	Pass

**Note:** Antenna gain = 6.3dBi > 6dBi , so the limit shall be reduced to  $30-(6.3-6) = 29.70$ dBm.

**26dB Bandwidth:**

**802.11a**

Channel	Channel Frequency (MHz)	26dBc Bandwidth (MHz)	
		Chain 0	Chain 1
36	5180	23.07	22.30
40	5200	32.67	34.61
48	5240	37.99	37.99

**802.11ac (20MHz)**

Channel	Channel Frequency (MHz)	26dBc Bandwidth (MHz)	
		Chain 0	Chain 1
36	5180	28.73	28.52
40	5200	39.56	39.19
48	5240	36.16	36.23

**802.11ac (40MHz)**

Channel	Channel Frequency (MHz)	26dBc Bandwidth (MHz)	
		Chain 0	Chain 1
38	5190	40.40	40.16
46	5230	77.93	80.61

**802.11ac (80MHz)**

Channel	Channel Frequency (MHz)	26dBc Bandwidth (MHz)	
		Chain 0	Chain 1
42	5210	82.75	82.43

### Spectrum Plot of Worst Value

**802.11a\_Chain 0 / CH48**

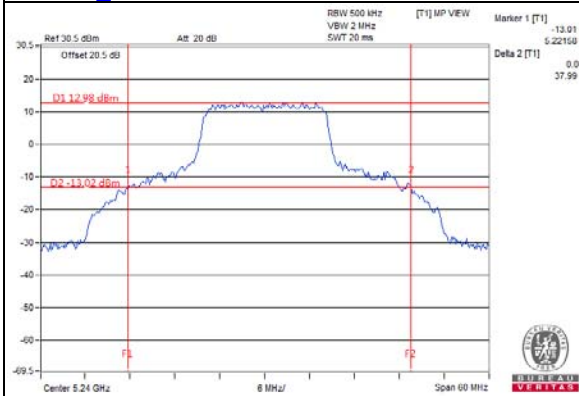

**802.11ac (20MHz)\_Chain 0 / CH40**

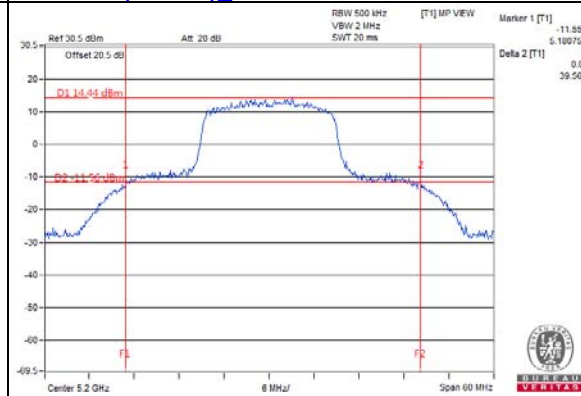

**802.11ac (40MHz)\_Chain 1 / CH46**

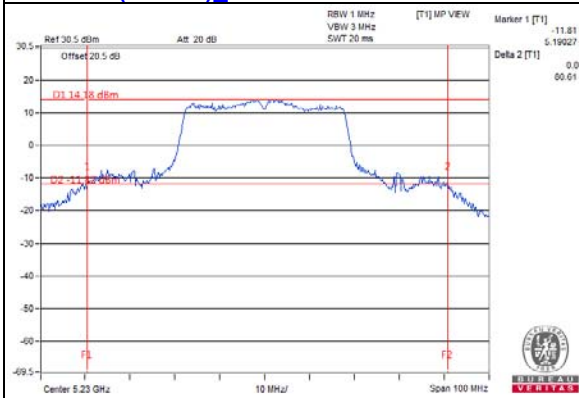

**802.11ac (80MHz)\_Chain 0 / CH42**

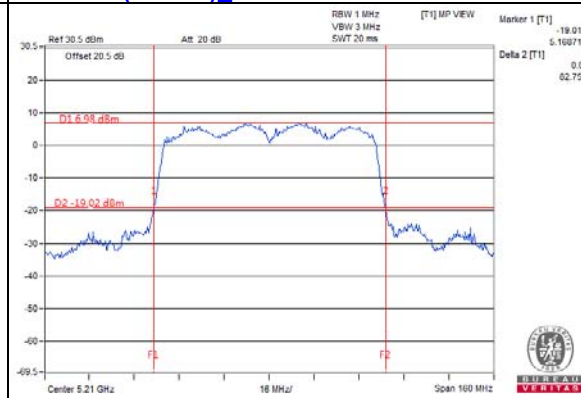

### Beamforming\_NSS1 Mode

#### Power Output:

#### 802.11ac (20MHz)

Chan.	Chan. Freq. (MHz)	Maximum Conducted Power (dBm)		Total Power (mW)	Total Power (dBm)	Power Limit (dBm)	Pass/Fail
		Chain 0	Chain 1				
36	5180	19.27	19.67	177.211	22.48	26.69	Pass
40	5200	19.29	19.78	179.978	22.55	26.69	Pass
48	5240	19.32	19.93	183.908	22.65	26.69	Pass
149	5745	19.68	19.73	186.869	22.72	26.69	Pass
157	5785	19.72	19.85	190.361	22.80	26.69	Pass
165	5825	19.78	19.92	193.235	22.86	26.69	Pass

**Note:** Directional gain =  $6.3\text{dBi} + 10\log(2) = 9.31\text{dBi} > 6\text{dBi}$  , so the limit shall be reduced to  $30-(9.31-6) = 26.69\text{dBm}$ .

#### 802.11ac (40MHz)

Chan.	Chan. Freq. (MHz)	Maximum Conducted Power (dBm)		Total Power (mW)	Total Power (dBm)	Power Limit (dBm)	Pass/Fail
		Chain 0	Chain 1				
38	5190	15.65	16.14	77.843	18.91	26.69	Pass
46	5230	20.19	20.61	219.552	23.42	26.69	Pass
151	5755	20.29	20.62	222.250	23.47	26.69	Pass
159	5795	20.31	20.68	224.349	23.51	26.69	Pass

**Note:** Directional gain =  $6.3\text{dBi} + 10\log(2) = 9.31\text{dBi} > 6\text{dBi}$  , so the limit shall be reduced to  $30-(9.31-6) = 26.69\text{dBm}$ .

#### 802.11ac (80MHz)

Chan.	Chan. Freq. (MHz)	Maximum Conducted Power (dBm)		Total Power (mW)	Total Power (dBm)	Power Limit (dBm)	Pass/Fail
		Chain 0	Chain 1				
42	5210	14.79	15.26	63.704	18.04	26.69	Pass
155	5775	20.01	20.25	206.156	23.14	26.69	Pass

**Note:** Directional gain =  $6.3\text{dBi} + 10\log(2) = 9.31\text{dBi} > 6\text{dBi}$  , so the limit shall be reduced to  $30-(9.31-6) = 26.69\text{dBm}$ .



## 4.4 Occupied Bandwidth Measurement

### 4.4.1 Test Setup

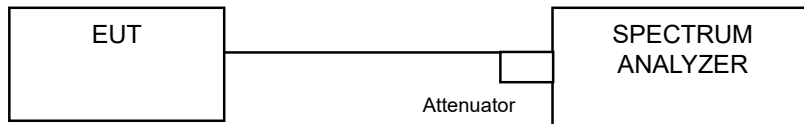

### 4.4.2 Test Instruments

Refer to section 4.3.3 to get information of above instrument.

### 4.4.3 Test Procedure

The transmitter output was connected to the spectrum analyzer through an attenuator. The bandwidth of the fundamental frequency was measured by spectrum analyzer with resolution bandwidth in the range of 1% to 5% of the anticipated emission bandwidth, and a video bandwidth at least 3x the resolution bandwidth and set the detector to SAMPLE. The width of a frequency band such that, below the lower and above the upper frequency limits, the mean powers emitted are each equal to a specified percentage 0.5 % of the total mean power of a given emission.

4.4.4 Test Results

Mode A  
CDD Mode  
802.11a

Channel	Channel Frequency (MHz)	Occupied Bandwidth (MHz)	
		Chain 0	Chain 1
36	5180	16.78	16.68
40	5200	17.52	17.52
48	5240	19.39	19.68
149	5745	29.57	29.40
157	5785	32.60	31.00
165	5825	29.00	27.00

802.11ac (20MHz)

Channel	Channel Frequency (MHz)	Occupied Bandwidth (MHz)	
		Chain 0	Chain 1
36	5180	18.48	18.36
40	5200	18.48	18.48
48	5240	19.04	19.08
149	5745	28.78	28.90
157	5785	32.60	32.90
165	5825	28.10	28.30

802.11ac (40MHz)

Channel	Channel Frequency (MHz)	Occupied Bandwidth (MHz)	
		Chain 0	Chain 1
38	5190	36.40	36.20
46	5230	37.80	38.00
151	5755	41.59	42.00
159	5795	46.17	46.00

802.11ac (80MHz)

Channel	Channel Frequency (MHz)	Occupied Bandwidth (MHz)	
		Chain 0	Chain 1
42	5210	75.36	75.36
155	5775	77.31	77.56

### Spectrum Plot of Worst Value

**802.11a Chain0 / CH157**

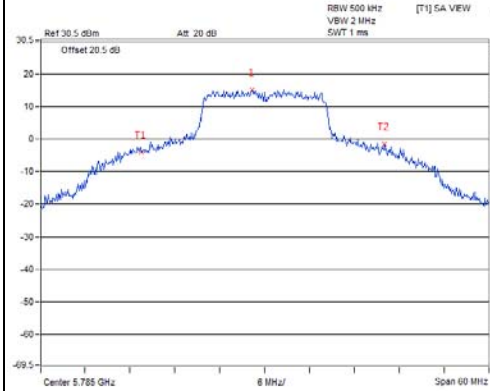

**802.11ac (20MHz) Chain1 / CH157**

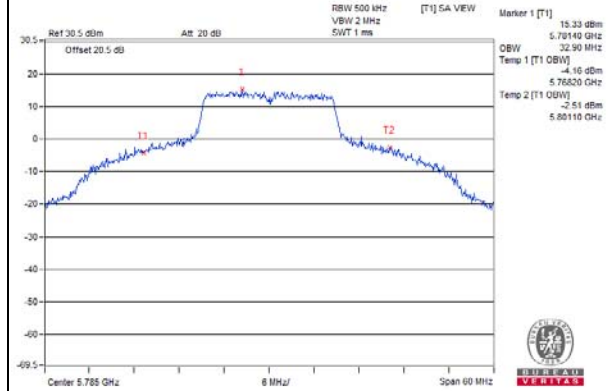

**802.11ac(40MHz) Chain0 / CH159**

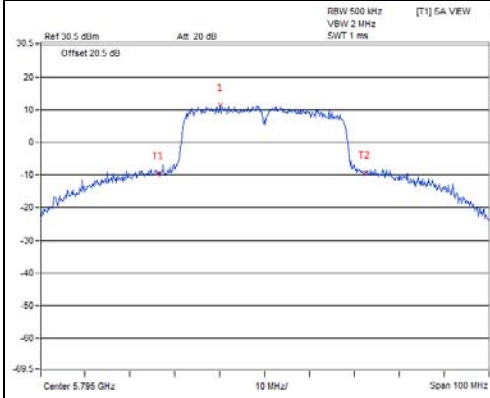

**802.11ac (80MHz) Chain1 / CH155**

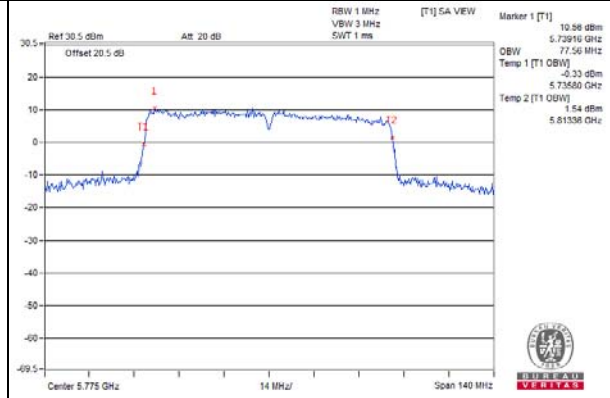

#### 4.5 Peak Power Spectral Density Measurement

##### 4.5.1 Limits of Peak Power Spectral Density Measurement

Operation Band	EUT Category		Limit
U-NII-1		Outdoor Access Point	17dBm/ MHz
		Fixed point-to-point Access Point	
	√	Indoor Access Point	
		Client device	11dBm/ MHz
U-NII-2A	---		11dBm/ MHz
U-NII-2C	---		11dBm/ MHz
U-NII-3	√		30dBm/ 500kHz

##### 4.5.2 Test Setup

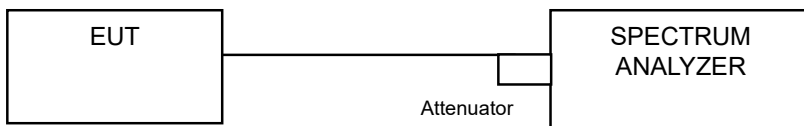

##### 4.5.3 Test Instruments

Refer to section 4.3.3 to get information of above instrument.

#### 4.5.4 Test Procedure

##### **For U-NII-1 band:**

Using method SA-1, Duty cycle >98%:

- 1) Set span to encompass the entire emission bandwidth (EBW) of the signal.
- 2) Set RBW = 30 kHz, Set VBW  $\geq$  1 MHz, Detector = RMS
- 3) Set Channel power measure = 1MHz
- 4) Sweep time = auto, trigger set to "free run".
- 5) Trace average at least 100 traces in power averaging mode.
- 6) Record the max value

Using method SA-2, Duty cycle <98%:

- 1) Set span to encompass the entire emission bandwidth (EBW) of the signal.
- 2) Set RBW = 30 kHz, Set VBW  $\geq$  1 MHz, Detector = RMS
- 3) Set Channel power measure = 1MHz
- 4) Sweep time = auto, trigger set to "free run".
- 5) Trace average at least 100 traces in power averaging mode.
- 6) Record the max value and add  $10 \log (1/\text{duty cycle})$

##### **For U-NII-3 band:**

Using method SA-1, Duty cycle >98%:

- 1) Set span to encompass the entire emission bandwidth (EBW) of the signal.
- 2) Set RBW = 1 MHz, Set VBW  $\geq$  3 MHz, Detector = RMS
- 3) Sweep time = auto, trigger set to "free run".
- 4) Trace average at least 100 traces in power averaging mode.
- 5) Record the max value

Using method SA-2, Duty cycle <98%:

- 1) Set span to encompass the entire emission bandwidth (EBW) of the signal.
- 2) Set RBW = 1 MHz, Set VBW  $\geq$  3 MHz, Detector = RMS
- 3) Sweep time = auto, trigger set to "free run".
- 4) Trace average at least 100 traces in power averaging mode.
- 5) Record the max value and add  $10 \log (1/\text{duty cycle})$

#### 4.5.5 Deviation from Test Standard

No deviation.

#### 4.5.6 EUT Operating Condition

Same as Item 4.3.6.

#### 4.5.7 Test Results

##### Mode A

##### CDD Mode

##### 802.11a

Chan.	Chan. Freq. (MHz)	PSD (dBm)		Duty Factor	Total PSD With Duty Factor (dBm)	MAX. Limit (dBm)	Pass / Fail
		Chain 0	Chain 1				
36	5180	4.09	4.08	0.15	7.24	13.69	Pass
40	5200	5.38	5.41	0.15	8.55	13.69	Pass
48	5240	6.02	6.08	0.15	9.21	13.69	Pass

- Note:**
1. Method a) of power density measurement of KDB 662911 is using for calculating total power density. Total power density is summing entire spectra across corresponding frequency bins on the various outputs by computer.
  2. Directional gain =  $6.3\text{dBi} + 10\log(2) = 9.31\text{dBi} > 6\text{dBi}$  , so the power density limit shall be reduced to  $17-(9.31-6) = 13.69\text{dBm}$ .
  3. Refer to section 3.3 for duty cycle spectrum plot.

##### 802.11ac (20MHz)

Chan.	Chan. Freq. (MHz)	PSD (dBm)		Total PSD (dBm)	MAX. Limit (dBm)	Pass / Fail
		Chain 0	Chain 1			
36	5180	5.25	5.26	8.27	13.69	Pass
40	5200	6.63	6.66	9.66	13.69	Pass
48	5240	5.77	5.72	8.76	13.69	Pass

- Note:**
1. Method a) of power density measurement of KDB 662911 is using for calculating total power density. Total power density is summing entire spectra across corresponding frequency bins on the various outputs by computer.
  2. Directional gain =  $6.3\text{dBi} + 10\log(2) = 9.31\text{dBi} > 6\text{dBi}$  , so the power density limit shall be reduced to  $17-(9.31-6) = 13.69\text{dBm}$ .
  3. Refer to section 3.3 for duty cycle spectrum plot.

##### 802.11ac (40MHz)

Chan.	Chan. Freq. (MHz)	PSD (dBm)		Duty Factor	Total PSD With Duty Factor (dBm)	MAX. Limit (dBm)	Pass / Fail
		Chain 0	Chain 1				
38	5190	0.61	0.50	0.18	3.75	13.69	Pass
46	5230	3.97	3.99	0.18	7.17	13.69	Pass

- Note:**
1. Method a) of power density measurement of KDB 662911 is using for calculating total power density. Total power density is summing entire spectra across corresponding frequency bins on the various outputs by computer.
  2. Directional gain =  $6.3\text{dBi} + 10\log(2) = 9.31\text{dBi} > 6\text{dBi}$  , so the power density limit shall be reduced to  $17-(9.31-6) = 13.69\text{dBm}$ .
  3. Refer to section 3.3 for duty cycle spectrum plot.

### 802.11ac (80MHz)

Chan.	Chan. Freq. (MHz)	PSD (dBm)		Duty Factor	Total PSD With Duty Factor (dBm)	MAX. Limit (dBm)	Pass / Fail
		Chain 0	Chain 1				
42	5210	-3.71	-3.79	0.42	-0.32	13.69	Pass

- Note:**
- Method a) of power density measurement of KDB 662911 is using for calculating total power density. Total power density is summing entire spectra across corresponding frequency bins on the various outputs by computer.
  - Directional gain =  $6.3\text{dBi} + 10\log(2) = 9.31\text{dBi} > 6\text{dBi}$  , so the power density limit shall be reduced to  $17-(9.31-6) = 13.69\text{dBm}$ .
  - Refer to section 3.3 for duty cycle spectrum plot.

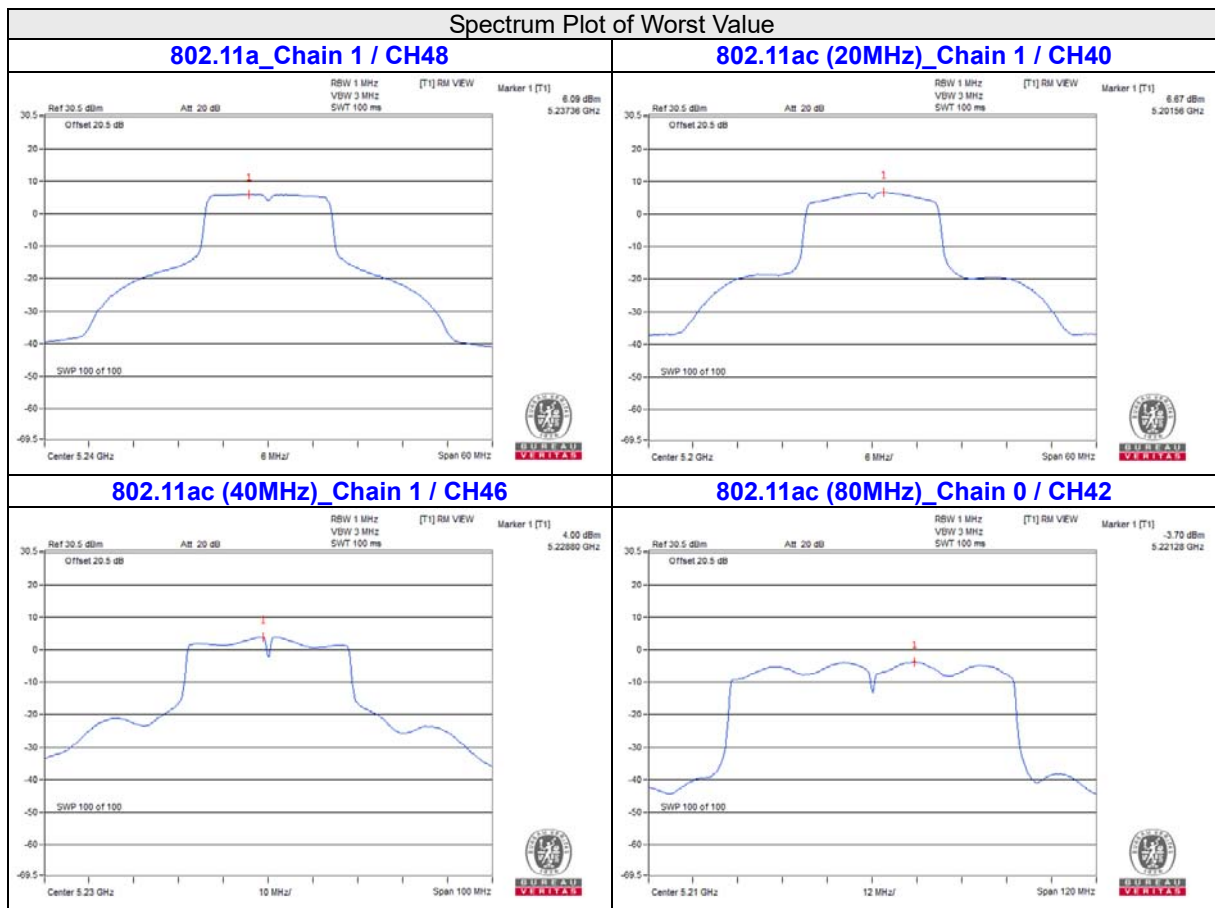

**For U-NII-3:**

TX chain	Channel	Freq. (MHz)	PSD (dBm/500kHz)	10 log (N=2) dB	Duty Factor	Total PSD (dBm/500kHz)	Limit (dBm/500kHz)	Pass /Fail
0	149	5745	-0.62	-0.62	3.01	2.54	26.69	Pass
	157	5785	-0.37	-0.37	3.01	2.79	26.69	Pass
	165	5825	-0.77	-0.77	3.01	2.39	26.69	Pass
1	149	5745	-0.73	-0.73	3.01	2.43	26.69	Pass
	157	5785	-0.20	-0.20	3.01	2.96	26.69	Pass
	165	5825	-0.76	-0.76	3.01	2.40	26.69	Pass

- Note:**
- Method a) of power density measurement of KDB 662911 is using for calculating total power density. Total power density is summing entire spectra across corresponding frequency bins on the various outputs by computer.
  - Directional gain =  $6.3\text{dBi} + 10\log(2) = 9.31\text{dBi} > 6\text{dBi}$  , so the power density limit shall be reduced to  $30-(9.31-6) = 26.69\text{dBm}$ .
  - Refer to section 3.3 for duty cycle spectrum plot.

**802.11ac (20MHz)**

TX chain	Channel	Freq. (MHz)	PSD (dBm/500kHz)	10 log (N=2) dB	Total PSD (dBm/500kHz)	Limit (dBm/500kHz)	Pass /Fail
0	149	5745	-0.69	3.01	2.32	26.69	Pass
	157	5785	-0.36	3.01	2.65	26.69	Pass
	165	5825	-0.94	3.01	2.07	26.69	Pass
1	149	5745	-0.83	3.01	2.18	26.69	Pass
	157	5785	-0.35	3.01	2.66	26.69	Pass
	165	5825	-1.05	3.01	1.96	26.69	Pass

- Note:**
- Method a) of power density measurement of KDB 662911 is using for calculating total power density. Total power density is summing entire spectra across corresponding frequency bins on the various outputs by computer.
  - Directional gain =  $6.3\text{dBi} + 10\log(2) = 9.31\text{dBi} > 6\text{dBi}$  , so the power density limit shall be reduced to  $30-(9.31-6) = 26.69\text{dBm}$ .

**802.11ac (40MHz)**

TX chain	Channel	Freq. (MHz)	PSD (dBm/500kHz)	10 log (N=2) dB	Duty Factor	Total PSD (dBm/500kHz)	Limit (dBm/500kHz)	Pass /Fail
0	151	5755	-4.45	3.01	0.18	-1.26	26.69	Pass
	159	5795	-4.34	3.01	0.18	-1.15	26.69	Pass
1	151	5755	-4.52	3.01	0.18	-1.33	26.69	Pass
	159	5795	-4.41	3.01	0.18	-1.22	26.69	Pass

- Note:**
- Method a) of power density measurement of KDB 662911 is using for calculating total power density. Total power density is summing entire spectra across corresponding frequency bins on the various outputs by computer.
  - Directional gain =  $6.3\text{dBi} + 10\log(2) = 9.31\text{dBi} > 6\text{dBi}$  , so the power density limit shall be reduced to  $30-(9.31-6) = 26.69\text{dBm}$ .
  - Refer to section 3.3 for duty cycle spectrum plot.



### 802.11ac (80MHz)

TX chain	Channel	Freq. (MHz)	PSD (dBm/500kHz)	10 log (N=2) dB	Duty Factor	Total PSD (dBm/500kHz)	Limit (dBm/500kHz)	Pass /Fail
0	155	5775	-8.87	3.01	0.42	-5.44	26.69	Pass
1	155	5775	-8.89	3.01	0.42	-5.46	26.69	Pass

- Note:**
- Method a) of power density measurement of KDB 662911 is using for calculating total power density. Total power density is summing entire spectra across corresponding frequency bins on the various outputs by computer.
  - Directional gain = 6.3dBi + 10log(2) = 9.31dBi > 6dBi , so the power density limit shall be reduced to 30-(9.31-6) = 26.69dBm.
  - Refer to section 3.3 for duty cycle spectrum plot.

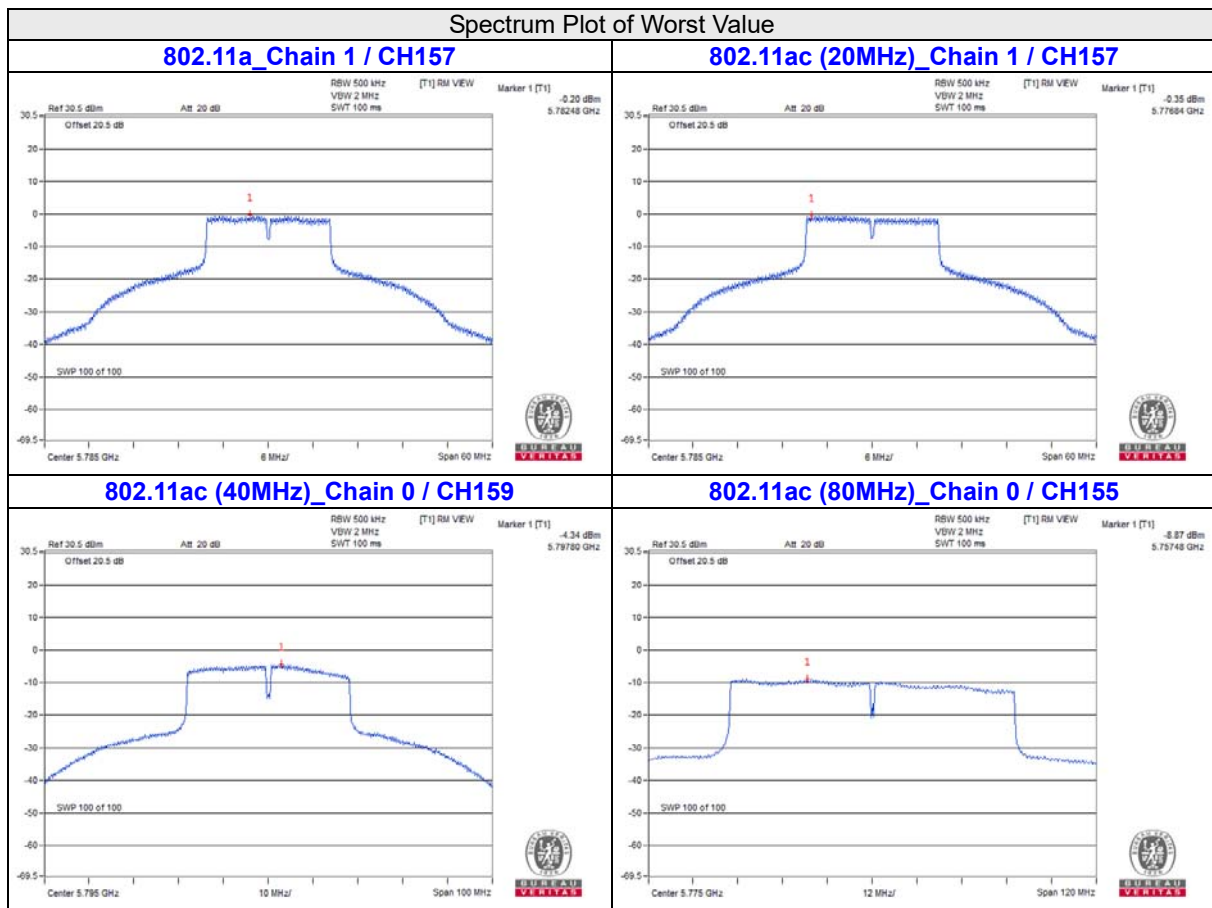

## 4.6 Frequency Stability Measurement

### 4.6.1 Limits of Frequency Stability Measurement

The frequency of the carrier signal shall be maintained within band of operation

### 4.6.2 Test Setup

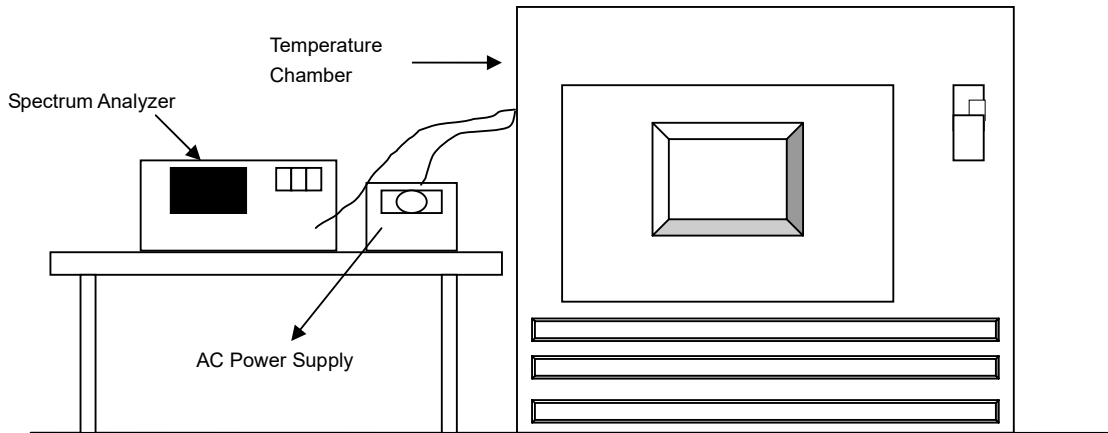

### 4.6.3 Test Instruments

Refer to section 4.3.3 to get information of above instrument.

### 4.6.4 Test Procedure

- The EUT was placed inside the environmental test chamber and powered by nominal AC voltage.
- Turn the EUT on and couple its output to a spectrum analyzer.
- Turn the EUT off and set the chamber to the highest temperature specified.
- Allow sufficient time (approximately 30 min) for the temperature of the chamber to stabilize, turn the EUT on and measure the operating frequency after 2, 5, and 10 Minutes.
- Repeat step 2 and 3 with the temperature chamber set to the lowest temperature.
- The test chamber was allowed to stabilize at +20 degree C for a minimum of 30 Minutes. The supply voltage was then adjusted on the EUT from 85% to 115% and the frequency record.

### 4.6.5 Deviation from Test Standard

No deviation.

### 4.6.6 EUT Operating Condition

Set the EUT transmit at un-modulation mode to test frequency stability.

4.6.7 Test Results

Frequency Stability Versus Temp.									
Operating Frequency: 5180 MHz									
TEMP. (°C)	Power Supply (Vac)	0 Minute		2 Minute		5 Minute		10 Minute	
		Measured Frequency (MHz)	Pass/Fail	Measured Frequency (MHz)	Pass/Fail	Measured Frequency (MHz)	Pass/Fail	Measured Frequency (MHz)	Pass/Fail
40	120	5180.0159	PASS	5180.0144	PASS	5180.0175	PASS	5180.0185	PASS
30	120	5180.0131	PASS	5180.0116	PASS	5180.0129	PASS	5180.0155	PASS
20	120	5179.9924	PASS	5179.9922	PASS	5179.9908	PASS	5179.9940	PASS
10	120	5180.0001	PASS	5179.9971	PASS	5179.9998	PASS	5179.9999	PASS
0	120	5179.983	PASS	5179.9788	PASS	5179.9809	PASS	5179.9816	PASS

Frequency Stability Versus Voltage									
Operating Frequency: 5180 MHz									
TEMP. (°C)	Power Supply (Vac)	0 Minute		2 Minute		5 Minute		10 Minute	
		Measured Frequency (MHz)	Pass/Fail	Measured Frequency (MHz)	Pass/Fail	Measured Frequency (MHz)	Pass/Fail	Measured Frequency (MHz)	Pass/Fail
20	138	5179.9926	PASS	5179.9913	PASS	5179.9905	PASS	5179.9936	PASS
	120	5179.9924	PASS	5179.9922	PASS	5179.9908	PASS	5179.9940	PASS
	102	5179.9934	PASS	5179.9917	PASS	5179.9905	PASS	5179.9941	PASS

## 4.7 6dB Bandwidth Measurement

### 4.7.1 Limits of 6dB Bandwidth Measurement

The minimum of 6dB Bandwidth Measurement is 0.5MHz.

### 4.7.2 Test Setup

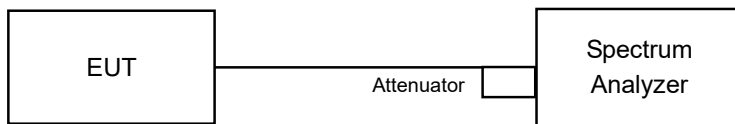

### 4.7.3 Test Instruments

Refer to section 4.3.3 to get information of above instrument.

### 4.7.4 Test Procedure

#### MEASUREMENT PROCEDURE REF

- a. Set resolution bandwidth (RBW) = 100kHz
- b. Set the video bandwidth (VBW)  $\geq 3 \times$  RBW, Detector = Peak.
- c. Trace mode = max hold.
- d. Sweep = auto couple.
- e. Measure the maximum width of the emission that is constrained by the frequencies associated with the two amplitude points (upper and lower) that are attenuated by 6 dB relative to the maximum level measured in the fundamental emission

### 4.7.5 Deviation from Test Standard

No deviation.

### 4.7.6 EUT Operating Condition

The software provided by client to enable the EUT under transmission condition continuously at lowest, middle and highest channel frequencies individually.

4.7.7 Test Results

**802.11a**

Channel	Frequency (MHz)	6dB Bandwidth (MHz)		Minimum Limit (MHz)	Pass / Fail
		Chain 0	Chain 1		
149	5745	16.38	16.39	0.5	PASS
157	5785	16.40	16.39	0.5	PASS
165	5825	16.37	16.36	0.5	PASS

**802.11ac (20MHz)**

Channel	Frequency (MHz)	6dB Bandwidth (MHz)		Minimum Limit (MHz)	Pass / Fail
		Chain 0	Chain 1		
149	5745	17.59	17.60	0.5	PASS
157	5785	17.65	17.63	0.5	PASS
165	5825	17.59	17.58	0.5	PASS

**802.11ac (40MHz)**

Channel	Frequency (MHz)	6dB Bandwidth (MHz)		Minimum Limit (MHz)	Pass / Fail
		Chain 0	Chain 1		
151	5755	33.90	34.19	0.5	PASS
159	5795	35.12	35.10	0.5	PASS

**802.11ac (80MHz)**

Channel	Frequency (MHz)	6dB Bandwidth (MHz)		Minimum Limit (MHz)	Pass / Fail
		Chain 0	Chain 1		
155	5775	75.81	75.93	0.5	PASS

Spectrum Plot of Worst Value

802.11a\_Chain 0 / CH157

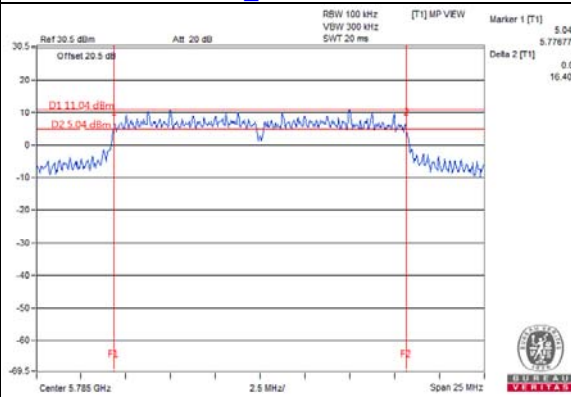

802.11ac (20MHz)\_Chain 0 / CH157

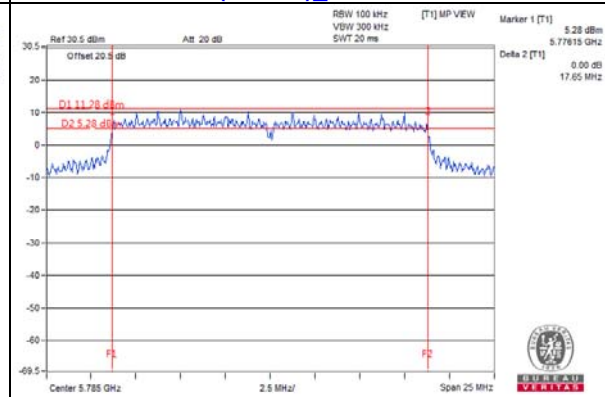

802.11ac (40MHz)\_Chain 0 / CH159

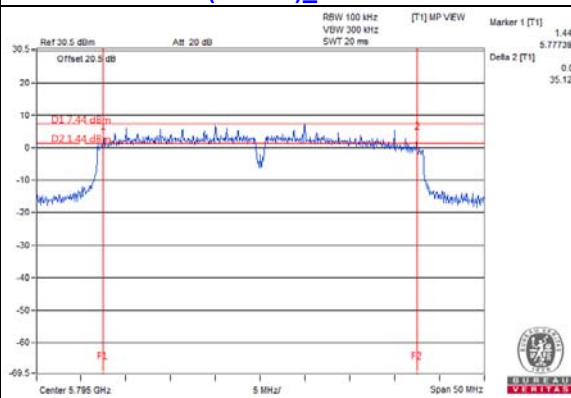

802.11ac (80MHz)\_Chain 1 / CH155

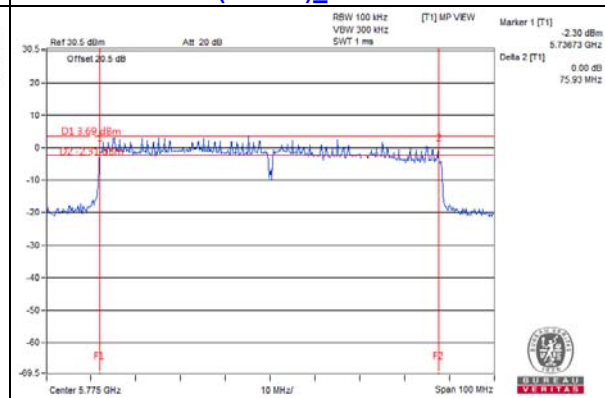

## 5 Pictures of Test Arrangements

Please refer to the attached file (Test Setup Photo).

**Annex A- Radiated Out of Band Emission (OOBE) Measurement (For U-NII-3 band)**

**802.11a**

**CH149**

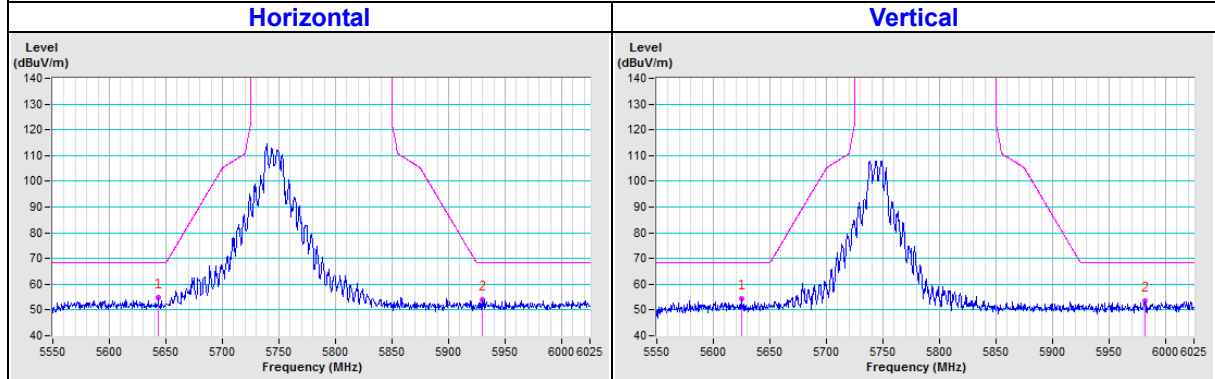

**CH157**

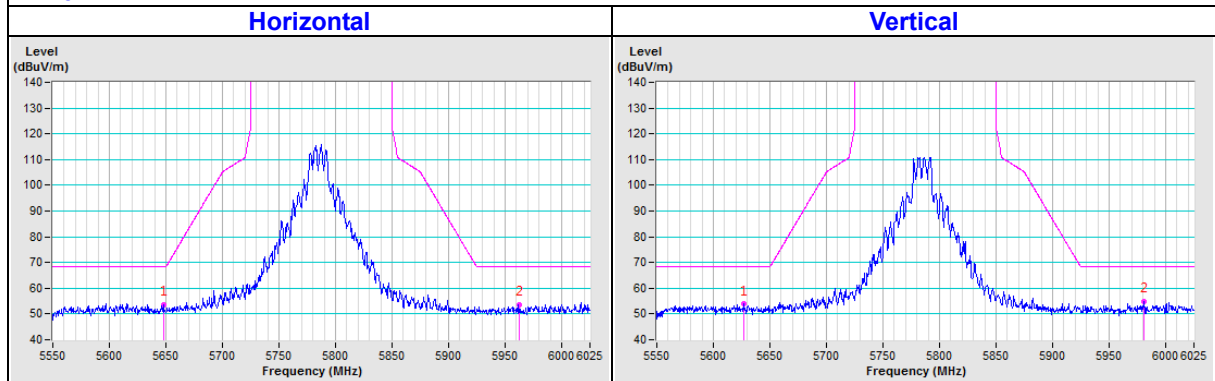

**CH165**

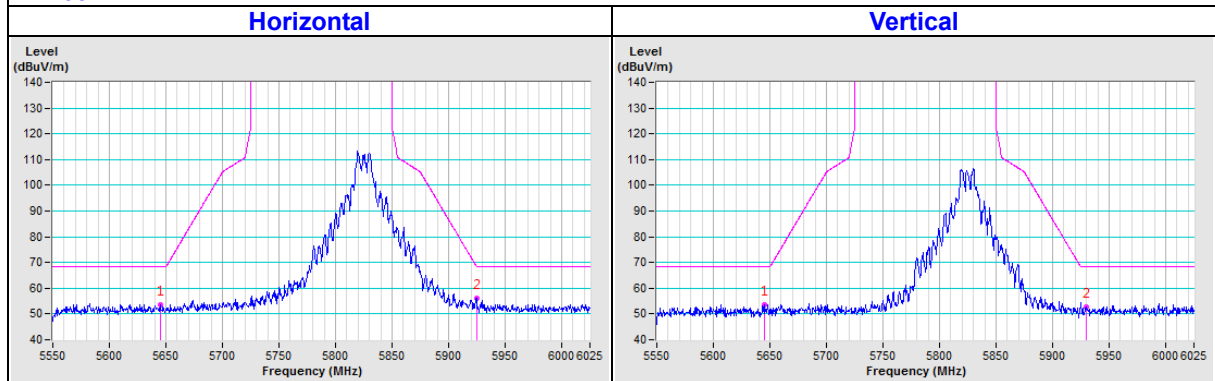



**802.11ac (20MHz)**

**CH149**

**Horizontal**

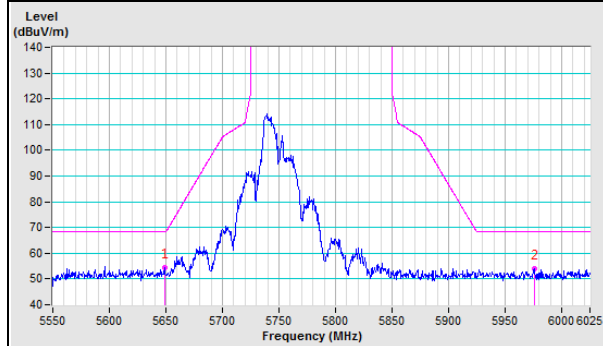

**Vertical**

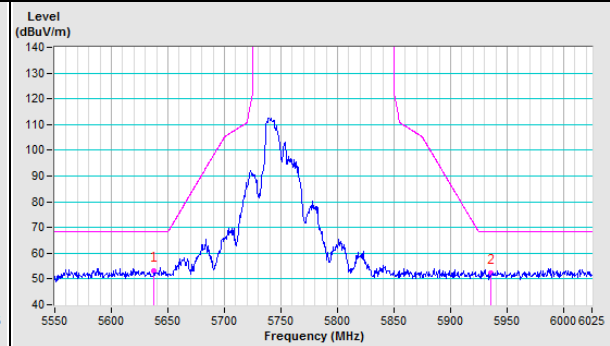

**CH157**

**Horizontal**

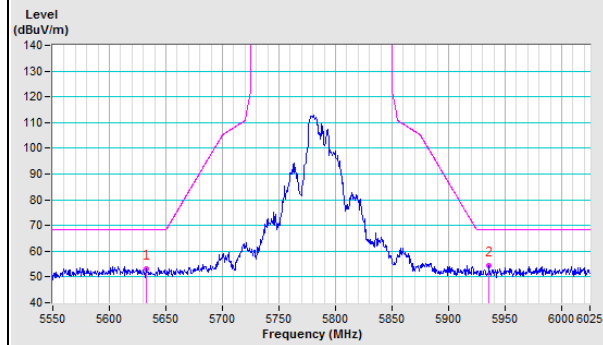

**Vertical**

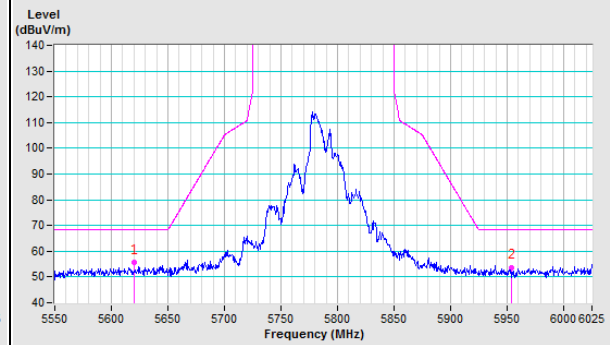

**CH165**

**Horizontal**

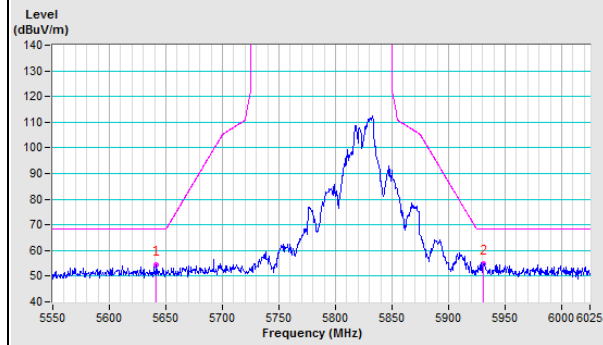

**Vertical**

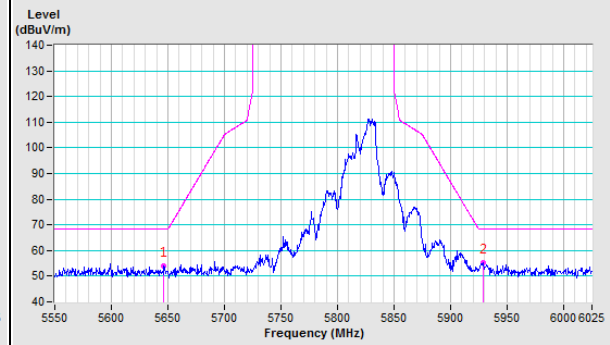

**802.11ac (40MHz)**

**CH151**

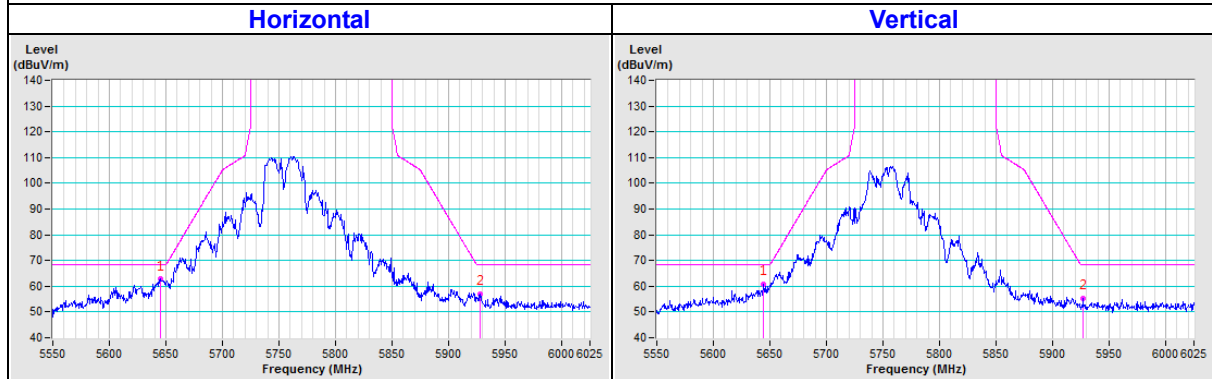

**CH159**

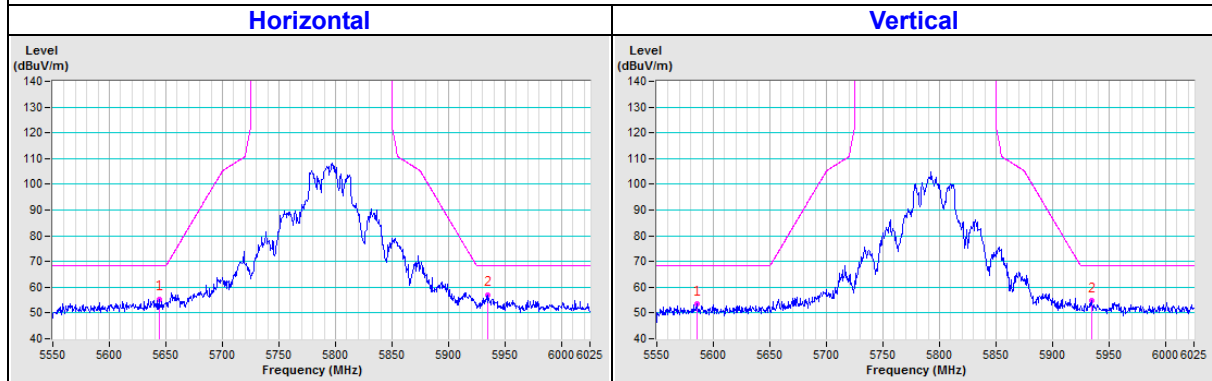

**802.11ac (80MHz)**

**CH155**

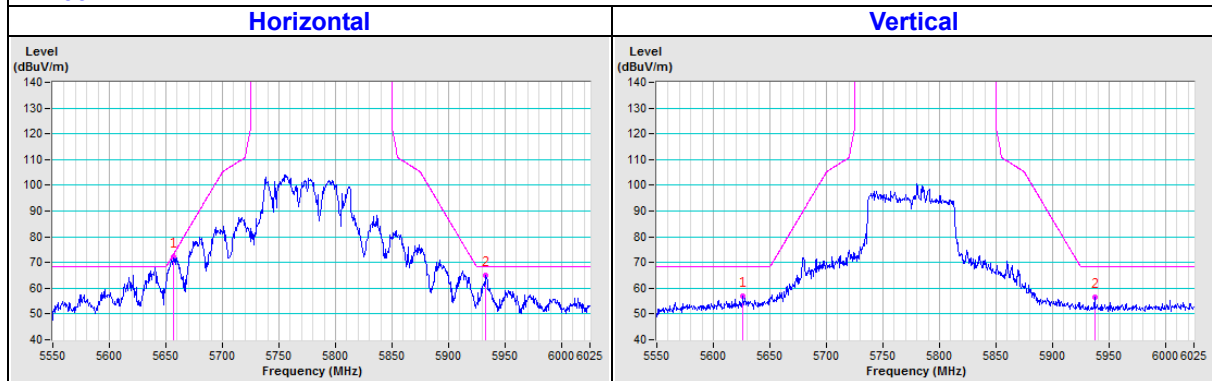

## Appendix – Information on the Testing Laboratories

We, Bureau Veritas Consumer Products Services (H.K.) Ltd., Taoyuan Branch, were founded in 1988 to provide our best service in EMC, Radio, Telecom and Safety consultation. Our laboratories are FCC recognized accredited test firms and accredited according to ISO/IEC 17025.

If you have any comments, please feel free to contact us at the following:

### Linkou EMC/RF Lab

Tel: 886-2-26052180

Fax: 886-2-26051924

### Hsin Chu EMC/RF/Telecom Lab

Tel: 886-3-6668565

Fax: 886-3-6668323

### Hwa Ya EMC/RF/Safety Lab

Tel: 886-3-3183232

Fax: 886-3-3270892

**Email:** [service.adt@tw.bureauveritas.com](mailto:service.adt@tw.bureauveritas.com)

**Web Site:** [www.bureauveritas-adt.com](http://www.bureauveritas-adt.com)

The address and road map of all our labs can be found in our web site also.

--- END ---