

FCC Test Report

Report No.: FC180425D01

FCC ID: 2ALJ3AP211H

Test Model: AP211H

Received Date: Apr. 25, 2018

Test Date: Apr. 25 ~ May 29, 2018

Issued Date: Jul. 5, 2018

Applicant: HAN Networks Co., Ltd.

Address: 5/F, Building 37, No.8 Dongbeiwang West Road, HaiDian District, Beijing, China

Issued By: Bureau Veritas Consumer Products Services (H.K.) Ltd., Taoyuan Branch

Lab Address: No. 47-2, 14th Ling, Chia Pau Vil., Lin Kou Dist., New Taipei City, Taiwan (R.O.C.)

**FCC Registration /
Designation Number:** 418586 / TW1078



This report is for your exclusive use. Any copying or replication of this report to or for any other person or entity, or use of our name or trademark, is permitted only with our prior written permission. This report sets forth our findings solely with respect to the test samples identified herein. The results set forth in this report are not indicative or representative of the quality or characteristics of the lot from which a test sample was taken or any similar or identical product unless specifically and expressly noted. Our report includes all of the tests requested by you and the results thereof based upon the information that you provided to us. You have 60 days from date of issuance of this report to notify us of any material error or omission caused by our negligence, provided, however, that such notice shall be in writing and shall specifically address the issue you wish to raise. A failure to raise such issue within the prescribed time shall constitute your unqualified acceptance of the completeness of this report, the tests conducted and the correctness of the report contents. Unless specifically mentioned, the uncertainty of measurement has been explicitly taken into account to declare the compliance or non-compliance to the specification. The report must not be used by the client to claim product certification, approval, or endorsement by A2LA or any agency of the U.S. government. The report must not be used by the client to claim product certification, approval, or endorsement by TAF or any government agencies.

Table of Contents

Release Control Record	3
1 Certificate of Conformity	4
2 Summary of Test Results	5
2.1 Measurement Uncertainty	5
2.2 Modification Record	5
3 General Information	6
3.1 Features of EUT	6
3.2 General Description of EUT	6
3.3 Operating Modes of EUT and Determination of Worst Case Operating Mode	7
3.4 Test Program Used and Operation Descriptions	7
3.5 Primary Clock Frequencies of Internal Source	7
4 Configuration and Connections with EUT	8
4.1 Connection Diagram of EUT and Peripheral Devices	8
4.2 Configuration of Peripheral Devices and Cable Connections	10
5 Conducted Emissions at Mains Ports	11
5.1 Limits	11
5.2 Test Instruments	11
5.3 Test Arrangement	12
5.4 Test Results	13
6 Radiated Emissions up to 1 GHz	17
6.1 Limits	17
6.2 Test Instruments	17
6.3 Test Arrangement	18
6.4 Test Results	19
7 Radiated Emissions above 1 GHz	23
7.1 Limits	23
7.2 Test Instruments	24
7.3 Test Arrangement	25
7.4 Test Results	26
8 Pictures of Test Arrangements	34
Appendix – Information on the Testing Laboratories	35



Release Control Record

Issue No.	Description	Date Issued
FC180425D01	Original release.	Jul. 5, 2018

1 Certificate of Conformity

Product: HAN Access Point

Brand: HAN

Test Model: AP211H

Sample Status: Engineering sample

Applicant: HAN Networks Co., Ltd.

Test Date: Apr. 25 ~ May 29, 2018

Standards: 47 CFR FCC Part 15, Subpart B, Class B
ICES-003:2016 Issue 6, Class B
ANSI C63.4:2014

The above equipment has been tested by **Bureau Veritas Consumer Products Services (H.K.) Ltd., Taoyuan Branch**, and found compliance with the requirement of the above standards. The test record, data evaluation & Equipment Under Test (EUT) configurations represented herein are true and accurate accounts of the measurements of the sample's EMC characteristics under the conditions specified in this report.

Prepared by : Annie Chang, **Date:** Jul. 5, 2018
Annie Chang / Senior Specialist

Approved by : Jim Hsiang, **Date:** Jul. 5, 2018
Jim Hsiang / Associate Technical Manager

2 Summary of Test Results

47 CFR FCC Part 15, Subpart B / ICES-003:2016 Issue 6, Class B

ANSI C63.4:2014

FCC Clause	ICES-003 Clause	Test Item	Result/Remarks	Verdict
15.107	6.1	AC Power Line Conducted Emissions	Minimum passing Class B margin is -3.06 dB at 0.39609 MHz	Pass
15.109	6.2.1	Radiated Emissions up to 1 GHz	Minimum passing Class B margin is -2.38 dB at 125.00 MHz	Pass
	6.2.2	Radiated Emissions above 1 GHz	Minimum passing Class B margin is -11.76 dB at 23570.55 MHz	Pass

Note: There is no deviation to the applied test methods and requirements covered by the scope of this report.

2.1 Measurement Uncertainty

Where relevant, the following measurement uncertainty levels have been estimated for tests performed on the EUT as specified in CISPR 16-4-2:

The listed uncertainties are the worst case uncertainty for the entire range of measurement. Please note that the uncertainty values are provided for informational purposes only and are not used in determining the PASS/FAIL results.

Measurement	Frequency	Expanded Uncertainty (k=2) (±)
Conducted Emissions at mains ports	150kHz ~ 30MHz	2.79 dB
Radiated Emissions up to 1 GHz	30MHz ~ 1GHz	3.97 dB
Radiated Emissions above 1 GHz	1GHz ~ 6GHz	5.11 dB
	6GHz ~ 18GHz	4.50 dB

2.2 Modification Record

There were no modifications required for compliance.

3 General Information

3.1 Features of EUT

The tests reported herein were performed according to the method specified by HAN Networks Co., Ltd., for detailed feature description, please refer to the manufacturer's specifications or user's manual.

3.2 General Description of EUT

Product	HAN Access Point
Brand	HAN
Test Model	AP211H
Sample Status	Engineering sample
Operating Software	N/A
Power Supply Rating	48Vdc from Adapter or 55Vdc from PoE
Accessory Device	N/A
Data Cable Supplied	N/A

Note:

1. The EUT is a HAN Access Point.

2. The EUT uses following adapter or PoE Adapter (Support unit only):

Item	Brand	Model No.	Rating
Adapter	DELTA	ADP-30HR B	AC I/P: 100-240V, 50-60Hz, 1A DC O/P: 48V, 0.66A Non-shielded DC (1.5m) with one ferrite core
PoE Adapter	Microsemi	PD-9001GR/AT/AC	AC I/P: 100-240V, 50/60Hz, 0.67A DC O/P: 55V, 0.6A

3.3 Operating Modes of EUT and Determination of Worst Case Operating Mode

1. The EUT has been pre-tested under following test modes, and **pre-tested Mode 1 & 4** were the worse cases.

Pre-tested Mode	Test Condition
1	WiFi 2.4G+5G Link, LAN2+WAN+PT*2 (1Gbps), LAN3 (PoE, 1Gbps), USB R/W, Adapter
2	WiFi 2.4G+5G Link, LAN2+WAN+PT*2 (100Mbps), LAN3 (PoE, 100Mbps), USB R/W, Adapter
3	WiFi 2.4G+5G Link, LAN2+WAN+PT*2 (10Mbps), LAN3 (PoE, 10Mbps), USB R/W, Adapter
4	WiFi 2.4G+5G Link, LAN2+WAN+PT*2 (1Gbps), LAN3 (PoE, 1Gbps), USB R/W, PoE

2. According to the test result and client's requirement, the EUT was tested as the following modes:

Mode	Test Condition	Input Power
Conducted emission test		
1	WiFi 2.4G+5G Link, LAN2+WAN+PT*2 (1Gbps), LAN3 (PoE, 1Gbps), USB R/W, Adapter	120Vac, 60Hz
2	WiFi 2.4G+5G Link, LAN2+WAN+PT*2 (1Gbps), LAN3 (PoE, 1Gbps), USB R/W, PoE	
Radiated emission test		
1	WiFi 2.4G+5G Link, LAN2+WAN+PT*2 (1Gbps), LAN3 (PoE, 1Gbps), USB R/W, Adapter	120Vac, 60Hz
2	WiFi 2.4G+5G Link, LAN2+WAN+PT*2 (1Gbps), LAN3 (PoE, 1Gbps), USB R/W, PoE	55Vdc

3.4 Test Program Used and Operation Descriptions

- a. Connected the EUT with AC adapter / PoE Adapter placed on testing table.
- b. Turned on the power of all equipment.
- c. Prepared five notebooks, one PC and one AP to act as communication partners and placed them outside of testing area.
- d. The EUT perform R/W function with external USB flash from notebooks via LAN cables.
- e. EUT sent and received messages to/from AP (kept in a remote area) via wireless transmission.
- f. The communication partner sent data to EUT by command "Ping" via LAN.
- g. Steps d-g were repeated.

3.5 Primary Clock Frequencies of Internal Source

The highest frequency generated or used within the EUT or on which the EUT operates or tunes is 6GHz, provided by HAN Networks Co., Ltd., for detailed internal source, please refer to the manufacturer's specifications.

4 Configuration and Connections with EUT

4.1 Connection Diagram of EUT and Peripheral Devices

Mode 1:

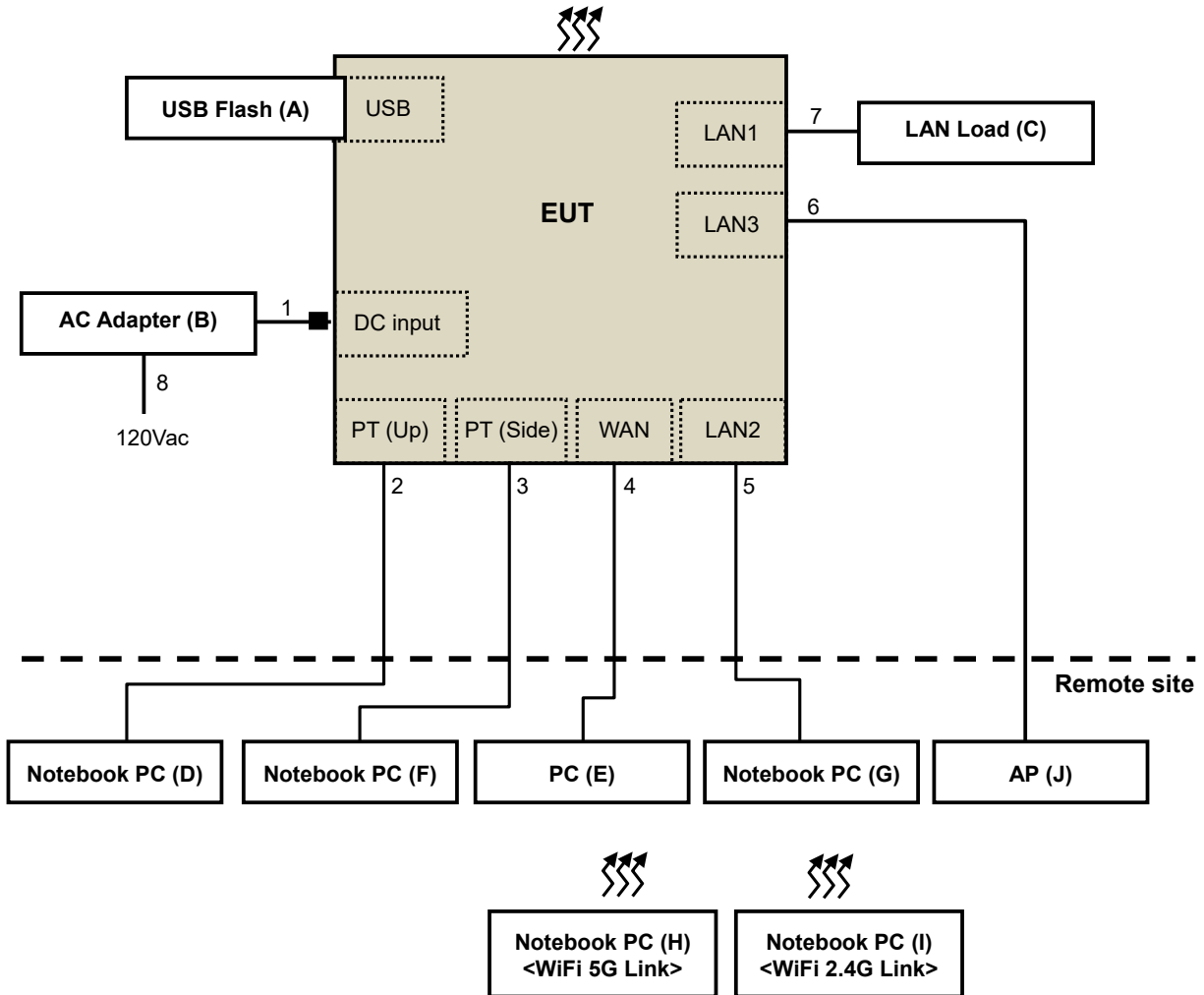

Mode 2:

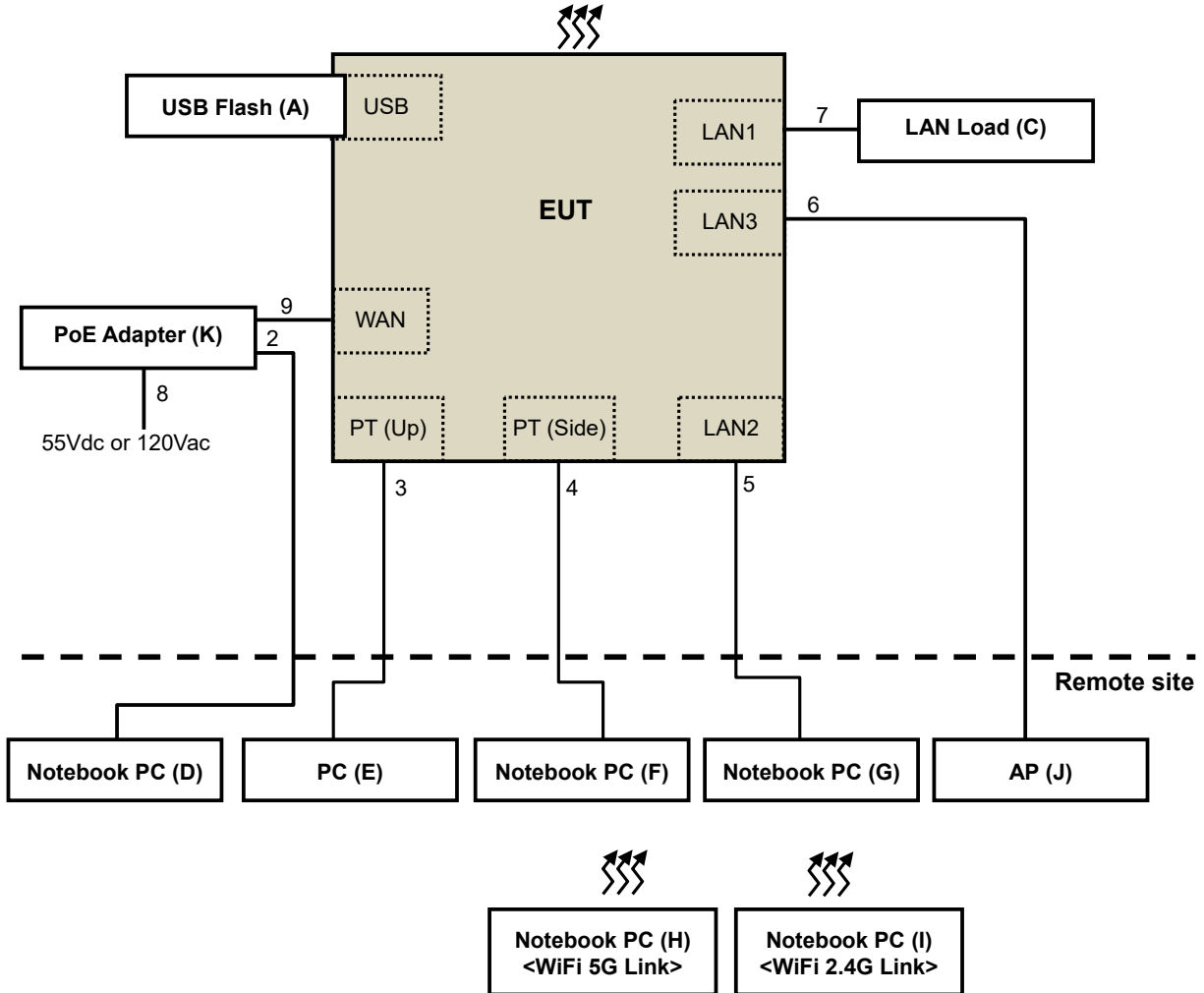

4.2 Configuration of Peripheral Devices and Cable Connections

ID	Product	Brand	Model No.	Serial No.	FCC ID	Remarks
A.	USB Flash	Trnscead	N/A	N/A	N/A	Provided by Lab
B.	AC Adapter	DELTA	ADP-30HR B	N/A	N/A	Supplied by client
C.	Load	N/A	N/A	N/A	N/A	Provided by Lab
D.	Notebook PC	DELL	PP27L	9SNZ12S	FCC DoC Approved	Provided by Lab
E.	PERSONAL COMPUTER	DELL	XPS 8500	JPFJYBX	FCC DoC Approved	Provided by Lab
F.	Notebook PC	DELL	XPS 8500	JPFJYBX	FCC DoC Approved	Provided by Lab
G.	Notebook PC	DELL	P41G	GT4W952	FCC DoC Approved	Provided by Lab
H.	Notebook PC	SONY	SVS151A12P	275548477001024	FCC DoC Approved	Provided by Lab
I.	Notebook PC	DELL	P41G	HT4W952	FCC DoC Approved	Provided by Lab
J.	AP	HAN	AP211H	N/A	N/A	Provided by Lab
K.	PoE Adapter	Microsemi	PD-9001GR/AT/AC	N/A	N/A	Supplied by client

Note:

1. All power cords of the above support units are non-shielded (1.8m).
2. Items D~J acted as communication partners to transfer data.

ID	Descriptions	Qty.	Length (m)	Shielding (Yes/No)	Cores (Qty.)	Remarks
1.	DC cable	1	1.5	N	1	Supplied by client
2.	LAN cable (Cat.5e)	1	10	N	0	Provided by Lab
3.	LAN cable (Cat.5e)	1	10	N	0	Provided by Lab
4.	LAN cable (Cat.5e)	1	10	N	0	Provided by Lab
5.	LAN cable (Cat.5e)	1	10	N	0	Provided by Lab
6.	LAN cable (Cat.5e)	1	10	N	0	Provided by Lab
7.	LAN cable (Cat.5e)	1	1.5	N	0	Provided by Lab
8.	AC cable	1	1.8	N	0	Provided by Lab
9.	LAN cable (Cat.5e)	1	1.5	N	0	Provided by Lab

Note: The core(s) is(are) originally attached to the cable(s)

5 Conducted Emissions at Mains Ports

5.1 Limits

Frequency (MHz)	Class A (dBuV)		Class B (dBuV)	
	Quasi-peak	Average	Quasi-peak	Average
0.15 - 0.5	79	66	66 - 56	56 - 46
0.50 - 5.0	73	60	56	46
5.0 - 30.0	73	60	60	50

- Notes: 1. The lower limit shall apply at the transition frequencies.
 2. The limit decreases linearly with the logarithm of the frequency in the range of 0.15 to 0.50 MHz.

5.2 Test Instruments

Description & Manufacturer	Model No.	Serial No.	Cal. Date	Cal. Due
ROHDE & SCHWARZ TEST RECEIVER	ESR3	102413	Feb. 8, 2018	Feb. 7, 2019
ROHDE & SCHWARZ Artificial Mains Network (for EUT)	ESH2-Z5	100104	Dec. 6, 2017	Dec. 5, 2018
LISN With Adapter (for EUT)	AD10	C09Ada-001	Dec. 6, 2017	Dec. 5, 2018
ROHDE & SCHWARZ Artificial Mains Network (for peripherals)	ESH3-Z5	847265/023	Nov. 3, 2017	Nov. 2, 2018
Software	Cond_V7.3.7.4	NA	NA	NA
RF cable (JYBAO) With 10dB PAD	5D-FB	Cable-C09.01	Feb. 21, 2018	Feb. 20, 2019

- Notes: 1. The calibration interval of the above test instruments is 12 months and the calibrations are traceable to NML/ROC and NIST/USA.
 2. The test was performed in Shielded Room No. 9.
 3. The VCCI Site Registration No. C-1312.
 4. Tested Date: Apr. 27 ~ May 29, 2018

5.3 Test Arrangement

- The EUT was placed 0.4 meters from the conducting wall of the shielded room with EUT being connected to the power mains through a line impedance stabilization network (LISN). Other support units were connected to the power mains through another LISN. The two LISNs provide 50 Ohm/ 50uH of coupling impedance for the measuring instrument.
- Both lines of the power mains connected to the EUT were checked for maximum conducted interference.
- The test results of conducted emissions at mains ports are recorded of six worst margins for quasi-peak (mandatory) [and average (if necessary)] values against the limits at frequencies of interest unless the margin is 20 dB or greater.

Note: The resolution bandwidth and video bandwidth of test receiver is 9kHz for quasi-peak detection (QP) and average detection (AV) at frequency 0.15MHz-30MHz.

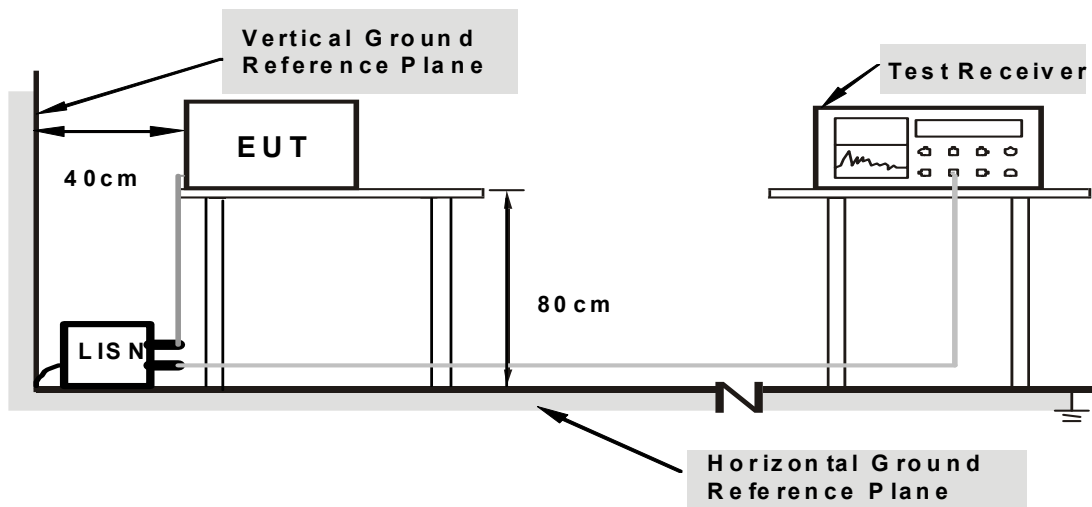

Note: Support units were connected to second LISN.

For the actual test configuration, please refer to the related item – Photographs of the Test Configuration.

5.4 Test Results

Frequency Range	150kHz ~ 30MHz	Detector Function & Resolution Bandwidth	Quasi-Peak (QP) / Average (AV), 9kHz
Input Power	120Vac, 60Hz	Environmental Conditions	26°C, 72%RH
Tested by	ED. Lin		
Test Mode	Mode 1		

Phase Of Power : Line (L)										
No	Frequency (MHz)	Correction Factor (dB)	Reading Value (dBuV)		Emission Level (dBuV)		Limit (dBuV)		Margin (dB)	
			Q.P.	AV.	Q.P.	AV.	Q.P.	AV.	Q.P.	AV.
1	0.15391	10.11	34.79	26.35	44.90	36.46	65.79	55.79	-20.89	-19.33
2	0.34922	10.14	37.17	29.92	47.31	40.06	58.98	48.98	-11.67	-8.92
3	0.38828	10.15	39.98	33.65	50.13	43.80	58.10	48.10	-7.97	-4.30
4	0.64609	10.19	32.76	27.49	42.95	37.68	56.00	46.00	-13.05	-8.32
5	0.93906	10.24	30.29	22.30	40.53	32.54	56.00	46.00	-15.47	-13.46
6	3.19922	10.41	29.61	21.85	40.02	32.26	56.00	46.00	-15.98	-13.74
7	9.16406	10.64	30.42	24.27	41.06	34.91	60.00	50.00	-18.94	-15.09

Remarks:

1. Q.P. and AV. are abbreviations of quasi-peak and average individually.
2. The emission levels of other frequencies were very low against the limit.
3. Margin value = Emission level – Limit value
4. Correction factor = Insertion loss + Cable loss
5. Emission Level = Correction Factor + Reading Value

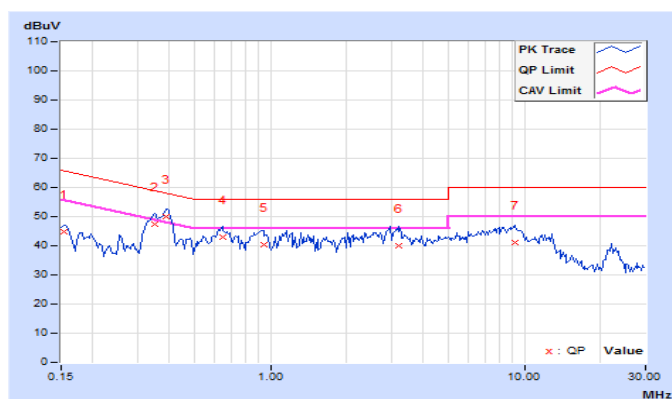

Frequency Range	150kHz ~ 30MHz	Detector Function & Resolution Bandwidth	Quasi-Peak (QP) / Average (AV), 9kHz
Input Power	120Vac, 60Hz	Environmental Conditions	26°C, 72%RH
Tested by	ED. Lin		
Test Mode	Mode 1		

Phase Of Power : Neutral (N)										
No	Frequency (MHz)	Correction Factor (dB)	Reading Value (dBuV)		Emission Level (dBuV)		Limit (dBuV)		Margin (dB)	
			Q.P.	AV.	Q.P.	AV.	Q.P.	AV.	Q.P.	AV.
1	0.34922	10.15	37.94	29.58	48.09	39.73	58.98	48.98	-10.89	-9.25
2	0.39609	10.16	40.02	34.71	50.18	44.87	57.93	47.93	-7.75	-3.06
3	0.63047	10.20	30.62	18.50	40.82	28.70	56.00	46.00	-15.18	-17.30
4	0.93516	10.26	29.42	22.49	39.68	32.75	56.00	46.00	-16.32	-13.25
5	2.85938	10.40	27.83	19.17	38.23	29.57	56.00	46.00	-17.77	-16.43
6	3.26953	10.43	29.10	20.00	39.53	30.43	56.00	46.00	-16.47	-15.57
7	9.17578	10.63	29.65	24.11	40.28	34.74	60.00	50.00	-19.72	-15.26

Remarks:

1. Q.P. and AV. are abbreviations of quasi-peak and average individually.
2. The emission levels of other frequencies were very low against the limit.
3. Margin value = Emission level – Limit value
4. Correction factor = Insertion loss + Cable loss
5. Emission Level = Correction Factor + Reading Value

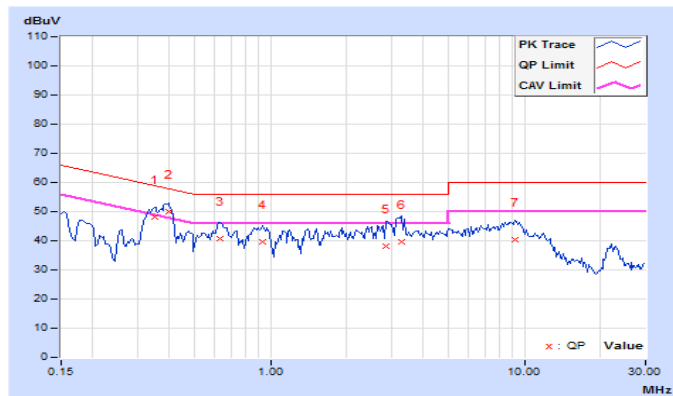

Frequency Range	150kHz ~ 30MHz	Detector Function & Resolution Bandwidth	Quasi-Peak (QP) / Average (AV), 9kHz
Input Power	120Vac, 60Hz	Environmental Conditions	25°C, 70%RH
Tested by	Ane Wang		
Test Mode	Mode 2		

Phase Of Power : Line (L)										
No	Frequency (MHz)	Correction Factor (dB)	Reading Value (dBuV)		Emission Level (dBuV)		Limit (dBuV)		Margin (dB)	
			Q.P.	AV.	Q.P.	AV.	Q.P.	AV.	Q.P.	AV.
1	0.16172	10.11	37.48	28.60	47.59	38.71	65.38	55.38	-17.79	-16.67
2	0.39933	10.15	32.95	26.98	43.10	37.13	57.87	47.87	-14.77	-10.74
3	0.44688	10.16	30.28	24.94	40.44	35.10	56.93	46.93	-16.49	-11.83
4	0.65391	10.19	22.75	15.84	32.94	26.03	56.00	46.00	-23.06	-19.97
5	3.62109	10.44	15.86	9.33	26.30	19.77	56.00	46.00	-29.70	-26.23
6	11.16406	10.72	16.46	11.10	27.18	21.82	60.00	50.00	-32.82	-28.18
7	23.65041	11.12	28.25	24.11	39.37	35.23	60.00	50.00	-20.63	-14.77

Remarks:

1. Q.P. and AV. are abbreviations of quasi-peak and average individually.
2. The emission levels of other frequencies were very low against the limit.
3. Margin value = Emission level – Limit value
4. Correction factor = Insertion loss + Cable loss
5. Emission Level = Correction Factor + Reading Value

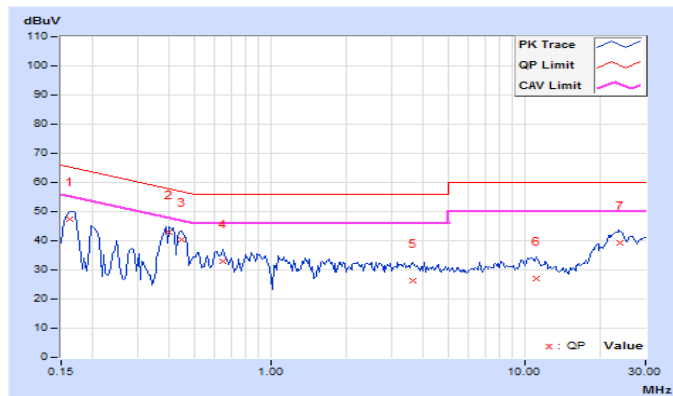

Frequency Range	150kHz ~ 30MHz	Detector Function & Resolution Bandwidth	Quasi-Peak (QP) / Average (AV), 9kHz
Input Power	120Vac, 60Hz	Environmental Conditions	25°C, 70%RH
Tested by	Ane Wang		
Test Mode	Mode 2		

Phase Of Power : Neutral (N)										
No	Frequency (MHz)	Correction Factor (dB)	Reading Value (dBuV)		Emission Level (dBuV)		Limit (dBuV)		Margin (dB)	
			Q.P.	AV.	Q.P.	AV.	Q.P.	AV.	Q.P.	AV.
1	0.16417	10.13	37.25	26.98	47.38	37.11	65.25	55.25	-17.87	-18.14
2	0.40391	10.16	31.77	27.36	41.93	37.52	57.77	47.77	-15.84	-10.25
3	0.44679	10.17	29.13	24.12	39.30	34.29	56.93	46.93	-17.63	-12.64
4	0.65781	10.21	21.42	13.38	31.63	23.59	56.00	46.00	-24.37	-22.41
5	3.41797	10.44	12.29	5.10	22.73	15.54	56.00	46.00	-33.27	-30.46
6	10.67188	10.67	15.92	10.50	26.59	21.17	60.00	50.00	-33.41	-28.83
7	22.83984	10.80	22.18	16.93	32.98	27.73	60.00	50.00	-27.02	-22.27
8	29.98828	10.52	23.28	18.23	33.80	28.75	60.00	50.00	-26.20	-21.25

Remarks:

1. Q.P. and AV. are abbreviations of quasi-peak and average individually.
2. The emission levels of other frequencies were very low against the limit.
3. Margin value = Emission level – Limit value
4. Correction factor = Insertion loss + Cable loss
5. Emission Level = Correction Factor + Reading Value

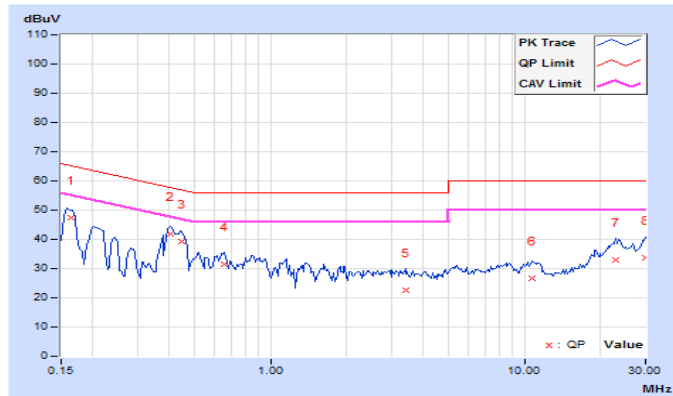

6 Radiated Emissions up to 1 GHz

6.1 Limits

Emissions radiated outside of the specified bands, shall be according to the general radiated limits as following:

Radiated Emissions Limits at 10 meters (dB μ V/m)				
Frequencies (MHz)	FCC 15B / ICES-003, Class A	FCC 15B / ICES-003, Class B	CISPR 22, Class A	CISPR 22, Class B
30-88	39	29.5	40	30
88-216	43.5	33.1		
216-230	46.4	35.6		
230-960				
960-1000	49.5	43.5	47	37

Radiated Emissions Limits at 3 meters (dB μ V/m)				
Frequencies (MHz)	FCC 15B / ICES-003, Class A	FCC 15B / ICES-003, Class B	CISPR 22, Class A	CISPR 22, Class B
30-88	49.5	40	50.5	40.5
88-216	54	43.5		
216-230	56.9	46		
230-960				
960-1000	60	54	57.5	47.5

- Notes:
1. The lower limit shall apply at the transition frequencies.
 2. Emission level (dB μ V/m) = 20 log Emission level (uV/m).
 3. QP detector shall be applied if not specified.

6.2 Test Instruments

Description & Manufacturer	Model No.	Serial No.	Cal. Date	Cal. Due
ROHDE & SCHWARZ TEST RECEIVER	ESCS 30	100027	Dec. 4, 2017	Dec. 3, 2018
Schwarzbeck Bilog Antenna	VULB9168	9168-303	Nov. 29, 2017	Nov. 28, 2018
Agilent Preamplifier	8447D	2944A08119	Feb. 21, 2018	Feb. 20, 2019
ADT. Turn Table	TT100	0205	NA	NA
ADT. Tower	AT100	0205	NA	NA
Software	Radiated_V7.6.15.9.5	NA	NA	NA
ADT RF Switches BOX	EMH-011	1001	Oct. 26, 2017	Oct. 25, 2018
Pacific RF cable With 5dB PAD	8D	CABLE-ST2-01	Oct. 26, 2017	Oct. 25, 2018

- Notes:
1. The calibration interval of the above test instruments is 12 months and the calibrations are traceable to NML/ROC and NIST/USA.
 2. The test was performed in Open Site No. 2.
 3. The VCCI Site Registration No. R-237.
 4. Tested Date: Apr. 26, 2018

6.3 Test Arrangement

- The EUT was placed on the top of a rotating table 0.8 meters above the ground at an accredited test facility. The table was rotated 360 degrees to determine the position of the highest radiation.
- The EUT was set 10 meters away from the interference-receiving antenna, which was mounted on the top of a variable-height antenna tower.
- The antenna is a broadband antenna, and its height is varied from one meter to four meters above the ground to determine the maximum value of the field strength. Both horizontal and vertical polarizations of the antenna are set to make the measurement.
- For each suspected emission, the EUT was arranged to its worst case and then the antenna was tuned to heights from 1 meter to 4 meters and the rotatable table was turned from 0 degrees to 360 degrees to find the maximum reading.
- The test-receiver system was set to quasi-peak detect function and specified bandwidth with maximum hold mode when the test frequency is below 1 GHz.

Note: The resolution bandwidth and video bandwidth of test receiver/spectrum analyzer is 120kHz for quasi-peak detection (QP) at frequency below 1GHz.

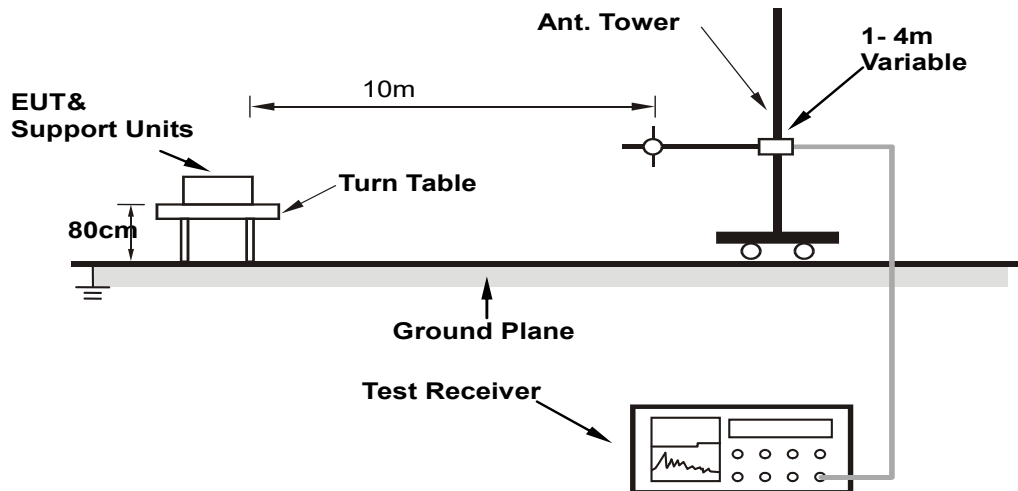

For the actual test configuration, please refer to the related item – Photographs of the Test Configuration.

6.4 Test Results

Frequency Range	30MHz ~ 1GHz	Detector Function & Resolution Bandwidth	Quasi-Peak (QP), 120kHz
Input Power	120Vac, 60Hz	Environmental Conditions	26°C, 75%RH
Tested by	Hermes Lin		
Test Mode	Mode 1		

Antenna Polarity & Test Distance : Horizontal at 10 m								
No	Frequency (MHz)	Emission Level (dBuV/m)	Limit (dBuV/m)	Margin (dB)	Antenna Height (m)	Table Angle (Degree)	Raw Value (dBuV)	Correction Factor (dB/m)
1	65.76	23.23 QP	30.00	-6.77	4.00 H	247	33.33	-10.10
2	116.75	22.51 QP	30.00	-7.49	4.00 H	1	33.99	-11.48
3	125.00	22.33 QP	30.00	-7.67	4.00 H	24	32.96	-10.63
4	171.84	23.11 QP	30.00	-6.89	4.00 H	22	32.49	-9.38
5	240.06	27.67 QP	37.00	-9.33	4.00 H	223	38.19	-10.52
6	250.56	26.08 QP	37.00	-10.92	4.00 H	97	36.44	-10.36
7	500.01	29.19 QP	37.00	-7.81	1.58 H	270	32.84	-3.65
8	625.11	32.49 QP	37.00	-4.51	1.19 H	349	33.40	-0.91
9	750.16	31.64 QP	37.00	-5.36	1.06 H	236	31.08	0.56
10	875.00	29.62 QP	37.00	-7.38	1.53 H	296	27.32	2.30

Remarks:

1. Emission Level(dBuV/m) = Raw Value(dBuV) + Correction Factor(dB/m)
2. Correction Factor(dB/m) = Antenna Factor (dB/m) + Cable Factor (dB) – Pre-Amplifier Factor (dB)
3. The other emission levels were very low against the limit.
4. Margin value = Emission level – Limit value

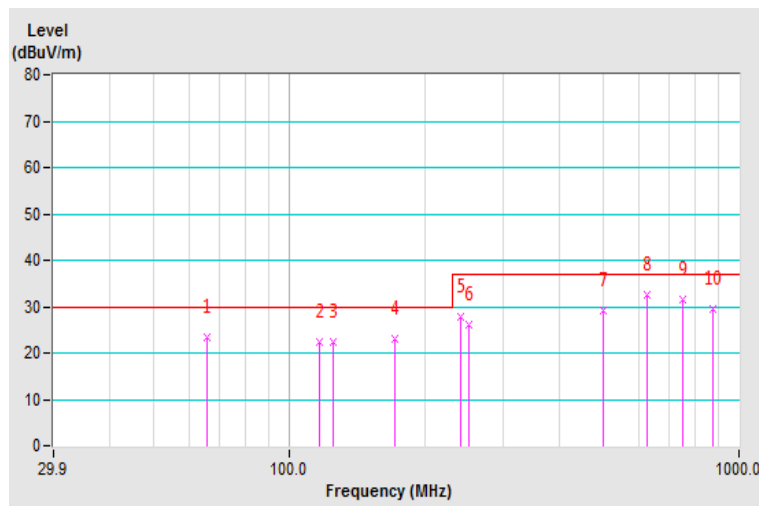

Frequency Range	30MHz ~ 1GHz	Detector Function & Resolution Bandwidth	Quasi-Peak (QP), 120kHz
Input Power	120Vac, 60Hz	Environmental Conditions	26°C, 75%RH
Tested by	Hermes Lin		
Test Mode	Mode 1		

Antenna Polarity & Test Distance : Vertical at 10 m								
No	Frequency (MHz)	Emission Level (dBuV/m)	Limit (dBuV/m)	Margin (dB)	Antenna Height (m)	Table Angle (Degree)	Raw Value (dBuV)	Correction Factor (dB/m)
1	48.70	26.87 QP	30.00	-3.13	1.00 V	22	35.69	-8.82
2	125.00	27.62 QP	30.00	-2.38	1.00 V	95	38.25	-10.63
3	157.28	24.72 QP	30.00	-5.28	1.00 V	85	33.41	-8.69
4	175.28	23.06 QP	30.00	-6.94	1.00 V	337	32.81	-9.75
5	229.20	21.81 QP	30.00	-8.19	1.00 V	90	33.64	-11.83
6	240.00	28.15 QP	37.00	-8.85	1.00 V	125	38.67	-10.52
7	250.12	26.80 QP	37.00	-10.20	1.00 V	333	37.17	-10.37
8	500.01	28.60 QP	37.00	-8.40	1.57 V	164	32.25	-3.65
9	625.11	30.85 QP	37.00	-6.15	2.53 V	207	31.76	-0.91
10	750.16	29.73 QP	37.00	-7.27	2.64 V	325	29.17	0.56
11	875.00	30.36 QP	37.00	-6.64	3.02 V	303	28.06	2.30

Remarks:

1. Emission Level(dBuV/m) = Raw Value(dBuV) + Correction Factor(dB/m)
2. Correction Factor(dB/m) = Antenna Factor (dB/m) + Cable Factor (dB) – Pre-Amplifier Factor (dB)
3. The other emission levels were very low against the limit.
4. Margin value = Emission level – Limit value

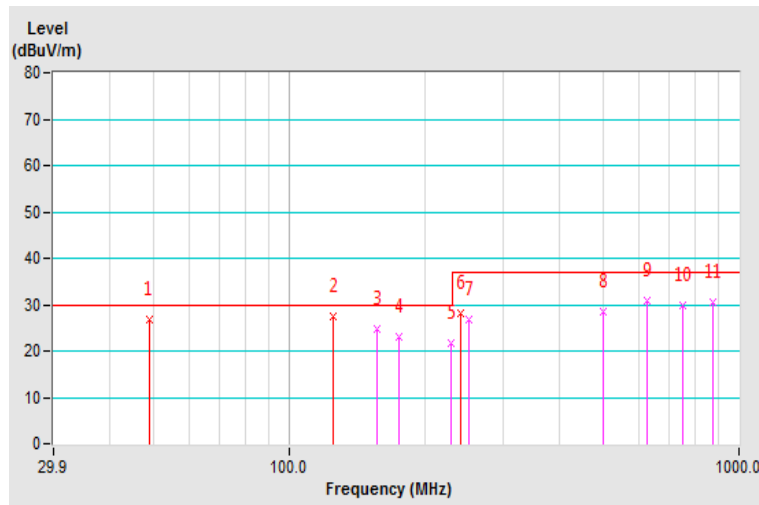

Frequency Range	30MHz ~ 1GHz	Detector Function & Resolution Bandwidth	Quasi-Peak (QP), 120kHz
Input Power	55Vdc	Environmental Conditions	26°C, 75%RH
Tested by	Vhenson Huang		
Test Mode	Mode 2		

Antenna Polarity & Test Distance : Horizontal at 10 m								
No	Frequency (MHz)	Emission Level (dBuV/m)	Limit (dBuV/m)	Margin (dB)	Antenna Height (m)	Table Angle (Degree)	Raw Value (dBuV)	Correction Factor (dB/m)
1	53.19	22.52 QP	30.00	-7.48	4.00 H	263	31.35	-8.83
2	74.25	24.59 QP	30.00	-5.41	4.00 H	342	36.53	-11.94
3	125.01	21.67 QP	30.00	-8.33	4.00 H	127	32.30	-10.63
4	154.99	24.30 QP	30.00	-5.70	4.00 H	86	33.02	-8.72
5	221.35	22.90 QP	30.00	-7.10	4.00 H	46	34.93	-12.03
6	250.03	29.69 QP	37.00	-7.31	3.64 H	152	40.06	-10.37
7	500.01	29.33 QP	37.00	-7.67	1.59 H	268	32.98	-3.65
8	625.52	31.39 QP	37.00	-5.61	2.19 H	2	32.29	-0.90
9	750.01	32.62 QP	37.00	-4.38	1.33 H	280	32.07	0.55
10	875.01	32.51 QP	37.00	-4.49	1.00 H	223	30.22	2.29
11	999.99	31.97 QP	37.00	-5.03	1.00 H	217	27.84	4.13

Remarks:

1. Emission Level(dBuV/m) = Raw Value(dBuV) + Correction Factor(dB/m)
2. Correction Factor(dB/m) = Antenna Factor (dB/m) + Cable Factor (dB) - Pre-Amplifier Factor (dB)
3. The other emission levels were very low against the limit.
4. Margin value = Emission level - Limit value

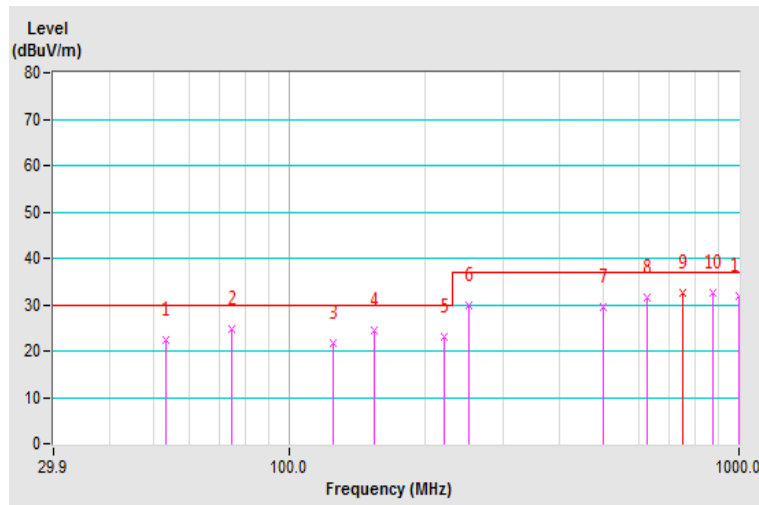

Frequency Range	30MHz ~ 1GHz	Detector Function & Resolution Bandwidth	Quasi-Peak (QP), 120kHz
Input Power	55Vdc	Environmental Conditions	26°C, 75%RH
Tested by	Vhenson Huang		
Test Mode	Mode 2		

Antenna Polarity & Test Distance : Vertical at 10 m								
No	Frequency (MHz)	Emission Level (dBuV/m)	Limit (dBuV/m)	Margin (dB)	Antenna Height (m)	Table Angle (Degree)	Raw Value (dBuV)	Correction Factor (dB/m)
1	49.58	26.23 QP	30.00	-3.77	1.52 V	37	35.05	-8.82
2	78.22	26.30 QP	30.00	-3.70	1.08 V	246	39.38	-13.08
3	109.48	22.71 QP	30.00	-7.29	1.00 V	329	34.92	-12.21
4	125.00	26.49 QP	30.00	-3.51	1.00 V	138	37.12	-10.63
5	136.57	23.42 QP	30.00	-6.58	1.00 V	278	32.94	-9.52
6	174.68	24.63 QP	30.00	-5.37	1.00 V	17	34.32	-9.69
7	203.57	24.64 QP	30.00	-5.36	1.00 V	149	36.88	-12.24
8	250.05	30.29 QP	37.00	-6.71	1.00 V	252	40.66	-10.37
9	375.04	28.53 QP	37.00	-8.47	1.00 V	359	35.16	-6.63
10	500.01	30.80 QP	37.00	-6.20	3.58 V	215	34.45	-3.65
11	625.52	31.13 QP	37.00	-5.87	2.69 V	140	32.03	-0.90
12	750.01	31.95 QP	37.00	-5.05	2.44 V	108	31.40	0.55
13	875.02	31.98 QP	37.00	-5.02	2.41 V	308	29.69	2.29
14	999.99	31.67 QP	37.00	-5.33	2.20 V	105	27.54	4.13

Remarks:

1. Emission Level(dBuV/m) = Raw Value(dBuV) + Correction Factor(dB/m)
2. Correction Factor(dB/m) = Antenna Factor (dB/m) + Cable Factor (dB) – Pre-Amplifier Factor (dB)
3. The other emission levels were very low against the limit.
4. Margin value = Emission level – Limit value

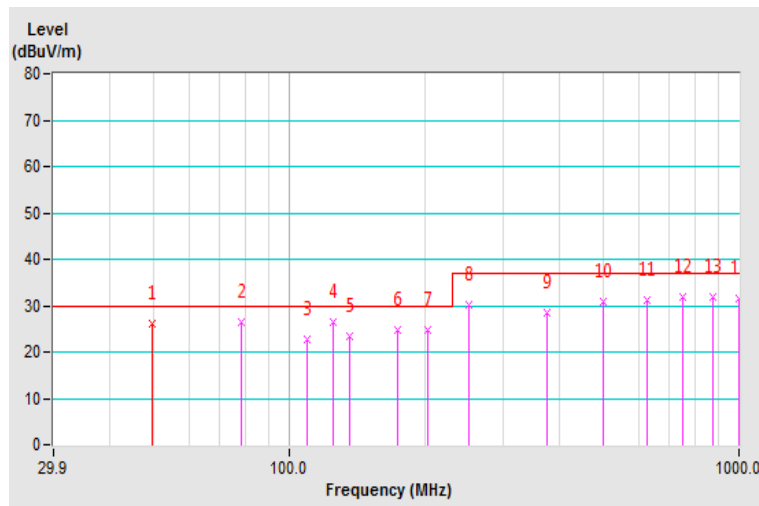

7 Radiated Emissions above 1 GHz

7.1 Limits

Emissions radiated outside of the specified bands, shall be according to the general radiated limits as following:

Radiated Emissions Limits at 10 meters (dB μ V/m)				
Frequencies (MHz)	FCC 15B / ICES-003, Class A	FCC 15B / ICES-003, Class B	CISPR 22, Class A	CISPR 22, Class B
1000-3000	Avg: 49.5	Avg: 43.5	Not defined	Not defined
Above 3000	Peak: 69.5	Peak: 63.5	Not defined	Not defined

Radiated Emissions Limits at 3 meters (dB μ V/m)				
Frequencies (MHz)	FCC 15B / ICES-003, Class A	FCC 15B / ICES-003, Class B	CISPR 22, Class A	CISPR 22, Class B
1000-3000	Avg: 60	Avg: 54	Avg: 56 Peak: 76	Avg: 50 Peak: 70
Above 3000	Peak: 80	Peak: 74	Avg: 60 Peak: 80	Avg: 54 Peak: 74

Radiated Emissions Limits at 1.5 meters (dB μ V/m)				
Frequencies (MHz)	FCC 15B / ICES-003, Class A	FCC 15B / ICES-003, Class B	CISPR 22, Class A	CISPR 22, Class B
Above 18000	Avg: 66 Peak: 86	Avg: 60 Peak: 80	Avg: 66 Peak: 86	Avg: 60 Peak: 80

Radiated Emissions Limits at 1 meters (dB μ V/m)				
Frequencies (MHz)	FCC 15B / ICES-003, Class A	FCC 15B / ICES-003, Class B	CISPR 22, Class A	CISPR 22, Class B
Above 18000	Avg: 69.5 Peak: 89.5	Avg: 63.5 Peak: 83.5	Avg: 69.5 Peak: 89.5	Avg: 63.5 Peak: 83.5

- Notes:
1. The lower limit shall apply at the transition frequencies.
 2. Emission level (dB μ V/m) = 20 log Emission level (μ V/m).
 3. As shown in 15.35(b), for frequencies above 1000MHz, the field strength limits are based on average detector, however, the peak field strength of any emission shall not exceed the maximum permitted average limits, specified above by more than 20dB under any condition of modulation.

Frequency Range (For unintentional radiators)

Highest frequency generated or used in the device or on which the device operates or tunes (MHz)	Upper frequency of measurement range (MHz)
Below 1.705	30
1.705-108	1000
108-500	2000
500-1000	5000
Above 1000	5th harmonic of the highest frequency or 40GHz, whichever is lower

7.2 Test Instruments

Description & Manufacturer	Model No.	Serial No.	Cal. Date	Cal. Due
Agilent Spectrum	E4446A	MY51100009	Jun. 1, 2017	May 31, 2018
Agilent Test Receiver	N9038A	MY50010135	Jun. 29, 2017	Jun. 28, 2018
Agilent Preamplifier	8449B	3008A02367	Feb. 22, 2018	Feb. 21, 2019
MITEQ Preamplifier	AMF-6F-260400-33-8P	892164	Feb. 21, 2018	Feb. 20, 2019
EMCI Preamplifier	EMC184045B	980235	Feb. 22, 2018	Feb. 21, 2019
Schwarzbeck Horn Antenna	BBHA-9170	212	Dec. 1, 2017	Nov. 30, 2018
EMCO Horn Antenna	3115	9312-4192	Dec. 1, 2017	Nov. 30, 2018
Max Full. Turn Table & Tower	MF7802	MF780208103	NA	NA
Software	Radiated_V8.7.08	NA	NA	NA
SUHNER RF cable With 4dB PAD	SF106-18	Cable-CH7-01	Aug. 14, 2017	Aug. 13, 2018
SUHNER RF cable With 3/4dB PAD	SF102	Cable-CH7-3.6m	Aug. 14, 2017	Aug. 13, 2018
MICRO-TRONICS Notch filter	BRC50703-01	010	May 31, 2017	May 30, 2018
MICRO-TRONICS Band Pass Filter	BRM17690	005	May 31, 2017	May 30, 2018

- Notes: 1. The calibration interval of the above test instruments is 12 months and the calibrations are traceable to NML/ROC and NIST/USA.
2. The test was performed in Chamber No. 7.
3. The Industry Canada Reference No. IC 7450E-7.
4. The VCCI Site Registration No. G-39
5. Tested Date: Apr. 26, 2018

7.3 Test Arrangement

- The EUT was placed on the horizontal metal ground plane at an accredited test facility, orientated for normal use, but separated from metallic contact with the reference metal ground plane by insulation.
- The EUT was set 3 meters / 1.5 meter / 1 meter away from the interference-receiving antenna, which was mounted on the top of a variable-height antenna tower.
- The height of antenna can be varied from one meter to four meters, the height of adjustment depends on the EUT height and the antenna 3dB beamwidth both, to detect the maximum value of the field strength. Both horizontal and vertical polarizations of the antenna are set to make the measurement.
- For each suspected emission, the EUT was arranged to its worst case and then the antenna was tuned to heights and the rotatable table was turned from 0 degrees to 360 degrees to find the maximum reading.
- The spectrum analyzer system was set to peak and average detect function and specified bandwidth with maximum hold mode when the test frequency is above 1 GHz.

Note:

- The resolution bandwidth of test receiver/spectrum analyzer is 1MHz and video bandwidth is 3MHz for Peak detection (PK) at frequency above 1GHz. The resolution bandwidth of test receiver/spectrum analyzer is 1 MHz for Average detection (AV) at frequency above 1GHz.
- For measurement of frequency 1 GHz ~ 18 GHz, the EUT was set 3 meters away from the receiver antenna
- For measurement of frequency 18 GHz ~ 40 GHz, the EUT was set 1.5 meter / 1 meter away from the receiver antenna

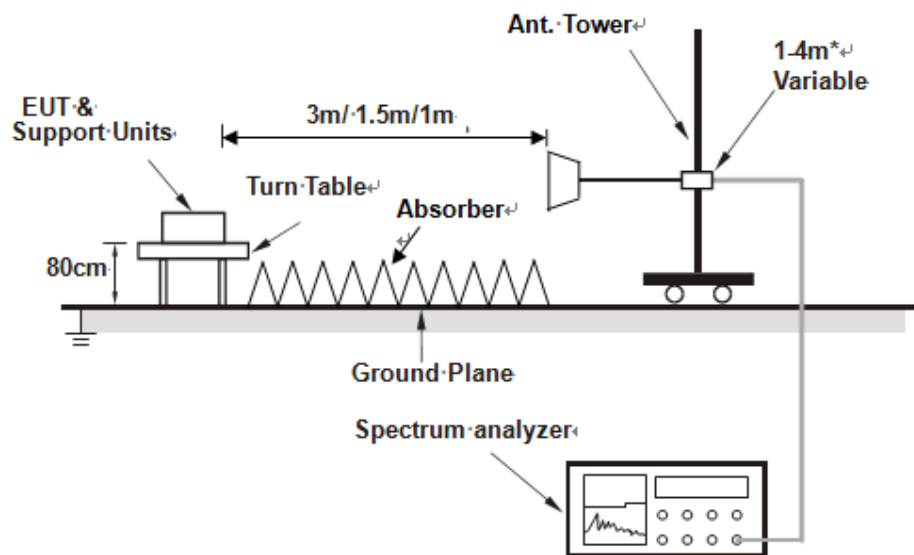

* :depends on the EUT height and the antenna 3dB beamwidth both.

For the actual test configuration, please refer to the related item – Photographs of the Test Configuration.

7.4 Test Results

Frequency Range	1GHz ~ 18GHz	Detector Function & Resolution Bandwidth	Peak (PK) / Average (AV), 1MHz
Input Power	120Vac, 60Hz	Environmental Conditions	23°C, 70%RH
Tested by	Ane Wang		
Test Mode	Mode 1		

Antenna Polarity & Test Distance : Horizontal at 3 m								
No	Frequency (MHz)	Emission Level (dBuV/m)	Limit (dBuV/m)	Margin (dB)	Antenna Height (m)	Table Angle (Degree)	Raw Value (dBuV)	Correction Factor (dB/m)
1	2458.87	46.30 PK	74.00	-27.70	2.18 H	168	47.86	-1.56
2	2458.87	32.59 AV	54.00	-21.41	2.18 H	168	34.15	-1.56
3	5243.35	51.88 PK	74.00	-22.12	1.18 H	320	46.31	5.57
4	5243.35	37.91 AV	54.00	-16.09	1.18 H	320	32.34	5.57
5	6126.10	53.04 PK	74.00	-20.96	2.00 H	360	47.47	5.57
6	6126.10	38.20 AV	54.00	-15.80	2.00 H	360	32.63	5.57

Remarks:

1. Emission Level(dBuV/m) = Raw Value(dBuV) + Correction Factor(dB/m)
2. Correction Factor(dB/m) = Antenna Factor (dB/m) + Cable Factor (dB) – Pre-Amplifier Factor (dB)
3. The other emission levels were very low against the limit.
4. Margin value = Emission level – Limit value

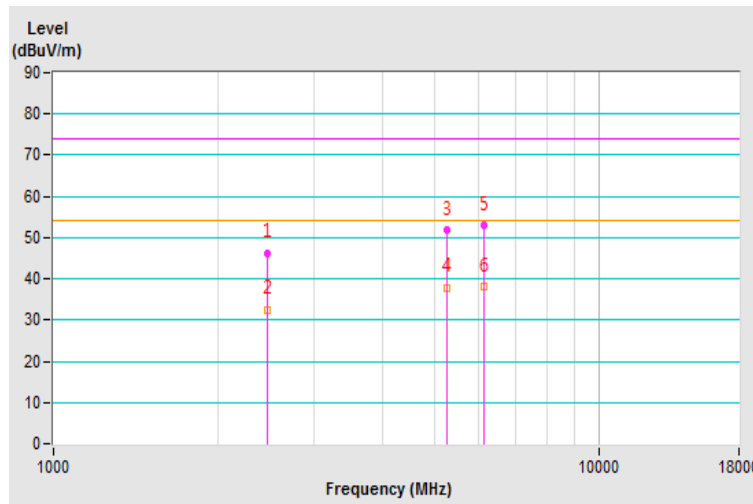

Frequency Range	1GHz ~ 18GHz	Detector Function & Resolution Bandwidth	Peak (PK) / Average (AV), 1MHz
Input Power	120Vac, 60Hz	Environmental Conditions	23°C, 70%RH
Tested by	Ane Wang		
Test Mode	Mode 1		

Antenna Polarity & Test Distance : Vertical at 3 m								
No	Frequency (MHz)	Emission Level (dBuV/m)	Limit (dBuV/m)	Margin (dB)	Antenna Height (m)	Table Angle (Degree)	Raw Value (dBuV)	Correction Factor (dB/m)
1	2458.21	46.65 PK	74.00	-27.35	1.33 V	339	48.22	-1.57
2	2458.21	32.56 AV	54.00	-21.44	1.33 V	339	34.13	-1.57
3	3219.66	47.81 PK	74.00	-26.19	2.00 V	360	46.33	1.48
4	3219.66	34.55 AV	54.00	-19.45	2.00 V	360	33.07	1.48
5	5294.58	52.04 PK	74.00	-21.96	1.09 V	157	46.61	5.43
6	5294.58	37.96 AV	54.00	-16.04	1.09 V	157	32.53	5.43

Remarks:

1. Emission Level(dBuV/m) = Raw Value(dBuV) + Correction Factor(dB/m)
2. Correction Factor(dB/m) = Antenna Factor (dB/m) + Cable Factor (dB) – Pre-Amplifier Factor (dB)
3. The other emission levels were very low against the limit.
4. Margin value = Emission level – Limit value

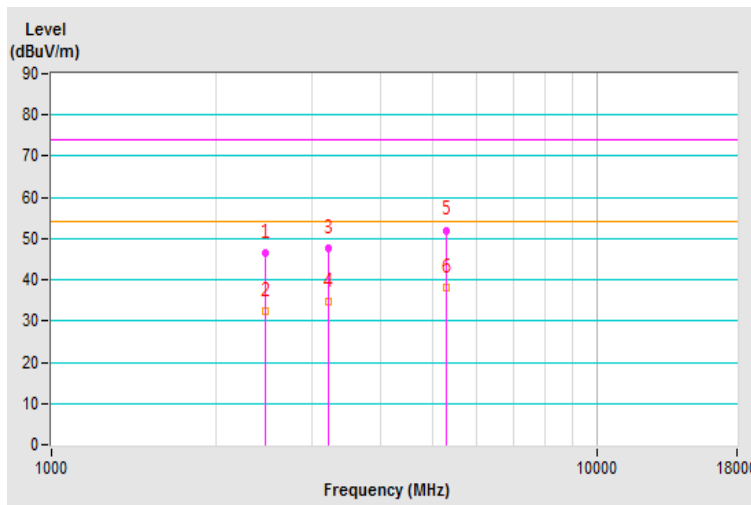

Frequency Range	18GHz ~ 30GHz	Detector Function & Resolution Bandwidth	Peak (PK) / Average (AV), 1MHz
Input Power	120Vac, 60Hz	Environmental Conditions	23°C, 70%RH
Tested by	Ane Wang		
Test Mode	Mode 1		

Antenna Polarity & Test Distance : Horizontal at 1.5 m								
No	Frequency (MHz)	Emission Level (dBuV/m)	Limit (dBuV/m)	Margin (dB)	Antenna Height (m)	Table Angle (Degree)	Raw Value (dBuV)	Correction Factor (dB/m)
1	23351.38	61.98 PK	80.00	-18.02	1.52 H	44	63.35	-1.37
2	23351.38	47.59 AV	60.00	-12.41	1.52 H	44	48.96	-1.37

Remarks:

1. Emission Level(dBuV/m) = Raw Value(dBuV) + Correction Factor(dB/m)
2. Correction Factor(dB/m) = Antenna Factor (dB/m) + Cable Factor (dB) – Pre-Amplifier Factor (dB)
3. The other emission levels were very low against the limit.
4. Margin value = Emission level – Limit value

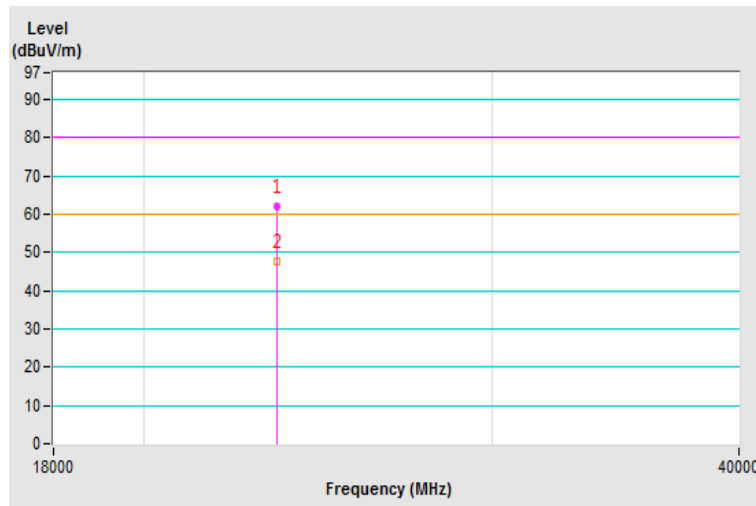

Frequency Range	18GHz ~ 30GHz	Detector Function & Resolution Bandwidth	Peak (PK) / Average (AV), 1MHz
Input Power	120Vac, 60Hz	Environmental Conditions	23°C, 70%RH
Tested by	Ane Wang		
Test Mode	Mode 1		

Antenna Polarity & Test Distance : Vertical at 1.5 m								
No	Frequency (MHz)	Emission Level (dBuV/m)	Limit (dBuV/m)	Margin (dB)	Antenna Height (m)	Table Angle (Degree)	Raw Value (dBuV)	Correction Factor (dB/m)
1	22654.27	61.80 PK	80.00	-18.20	2.70 V	147	63.62	-1.82
2	22654.27	47.95 AV	60.00	-12.05	2.70 V	147	49.77	-1.82

Remarks:

1. Emission Level(dBuV/m) = Raw Value(dBuV) + Correction Factor(dB/m)
2. Correction Factor(dB/m) = Antenna Factor (dB/m) + Cable Factor (dB) – Pre-Amplifier Factor (dB)
3. The other emission levels were very low against the limit.
4. Margin value = Emission level – Limit value

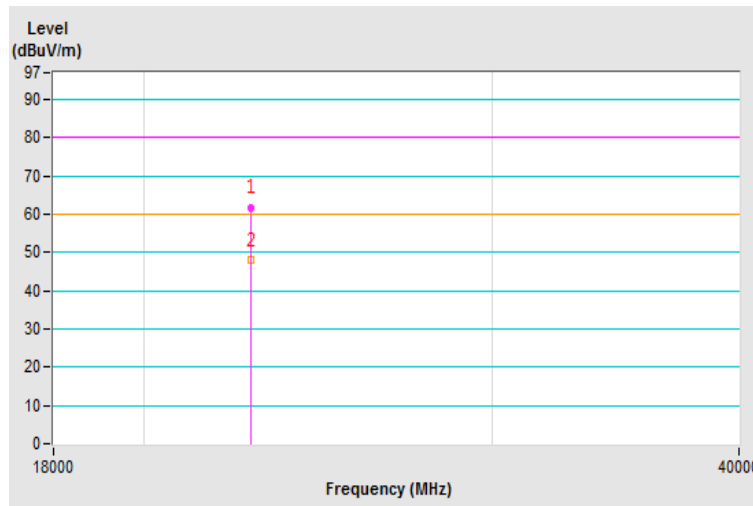

Frequency Range	1GHz ~ 18GHz	Detector Function & Resolution Bandwidth	Peak (PK) / Average (AV), 1MHz
Input Power	120Vac, 60Hz	Environmental Conditions	23°C, 70%RH
Tested by	Ane Wang		
Test Mode	Mode 2		

Antenna Polarity & Test Distance : Horizontal at 3 m								
No	Frequency (MHz)	Emission Level (dBuV/m)	Limit (dBuV/m)	Margin (dB)	Antenna Height (m)	Table Angle (Degree)	Raw Value (dBuV)	Correction Factor (dB/m)
1	2458.87	46.30 PK	74.00	-27.70	2.18 H	168	47.92	-1.62
2	2458.87	32.59 AV	54.00	-21.41	2.18 H	168	34.21	-1.62
3	5243.35	51.88 PK	74.00	-22.12	1.18 H	320	45.40	6.48
4	5243.35	37.91 AV	54.00	-16.09	1.18 H	320	31.43	6.48
5	6126.10	53.04 PK	74.00	-20.96	2.00 H	360	45.99	7.05
6	6126.10	38.20 AV	54.00	-15.80	2.00 H	360	31.15	7.05

Remarks:

1. Emission Level(dBuV/m) = Raw Value(dBuV) + Correction Factor(dB/m)
2. Correction Factor(dB/m) = Antenna Factor (dB/m) + Cable Factor (dB) – Pre-Amplifier Factor (dB)
3. The other emission levels were very low against the limit.
4. Margin value = Emission level – Limit value

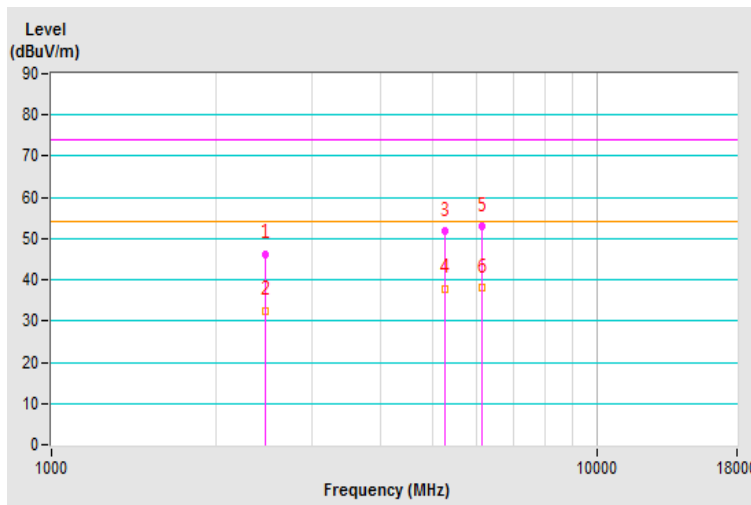

Frequency Range	1GHz ~ 18GHz	Detector Function & Resolution Bandwidth	Peak (PK) / Average (AV), 1MHz
Input Power	120Vac, 60Hz	Environmental Conditions	23°C, 70%RH
Tested by	Ane Wang		
Test Mode	Mode 2		

Antenna Polarity & Test Distance : Vertical at 3 m								
No	Frequency (MHz)	Emission Level (dBuV/m)	Limit (dBuV/m)	Margin (dB)	Antenna Height (m)	Table Angle (Degree)	Raw Value (dBuV)	Correction Factor (dB/m)
1	2459.71	45.65 PK	74.00	-28.35	2.00 V	53	47.21	-1.56
2	2459.71	32.65 AV	54.00	-21.35	2.00 V	53	34.21	-1.56
3	5263.14	52.45 PK	74.00	-21.55	2.63 V	175	46.92	5.53
4	5263.14	38.39 AV	54.00	-15.61	2.63 V	175	32.86	5.53
5	7902.64	55.77 PK	74.00	-18.23	2.61 V	147	47.38	8.39
6	7902.64	41.99 AV	54.00	-12.01	2.61 V	147	33.60	8.39

Remarks:

1. Emission Level(dBuV/m) = Raw Value(dBuV) + Correction Factor(dB/m)
2. Correction Factor(dB/m) = Antenna Factor (dB/m) + Cable Factor (dB) – Pre-Amplifier Factor (dB)
3. The other emission levels were very low against the limit.
4. Margin value = Emission level – Limit value

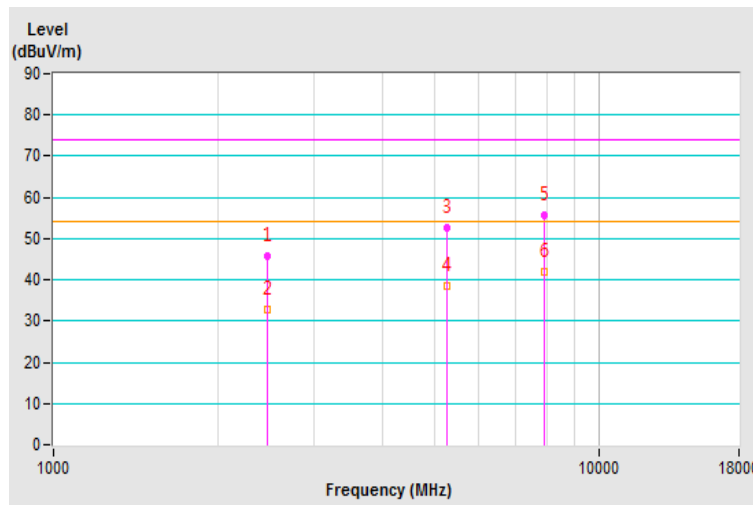

Frequency Range	18GHz ~ 30GHz	Detector Function & Resolution Bandwidth	Peak (PK) / Average (AV), 1MHz
Input Power	120Vac, 60Hz	Environmental Conditions	23°C, 70%RH
Tested by	Ane Wang		
Test Mode	Mode 2		

Antenna Polarity & Test Distance : Horizontal at 1.5 m								
No	Frequency (MHz)	Emission Level (dBuV/m)	Limit (dBuV/m)	Margin (dB)	Antenna Height (m)	Table Angle (Degree)	Raw Value (dBuV)	Correction Factor (dB/m)
1	23570.55	62.49 PK	80.00	-17.51	1.47 H	183	64.03	-1.54
2	23570.55	48.24 AV	60.00	-11.76	1.47 H	183	49.78	-1.54

Remarks:

1. Emission Level(dBuV/m) = Raw Value(dBuV) + Correction Factor(dB/m)
2. Correction Factor(dB/m) = Antenna Factor (dB/m) + Cable Factor (dB) – Pre-Amplifier Factor (dB)
3. The other emission levels were very low against the limit.
4. Margin value = Emission level – Limit value

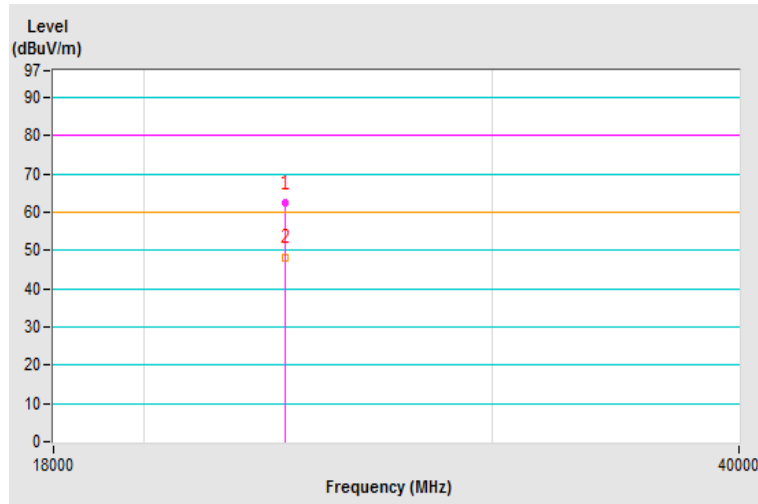

Frequency Range	18GHz ~ 30GHz	Detector Function & Resolution Bandwidth	Peak (PK) / Average (AV), 1MHz
Input Power	120Vac, 60Hz	Environmental Conditions	23°C, 70%RH
Tested by	Ane Wang		
Test Mode	Mode 2		

Antenna Polarity & Test Distance : Vertical at 1.5 m								
No	Frequency (MHz)	Emission Level (dBuV/m)	Limit (dBuV/m)	Margin (dB)	Antenna Height (m)	Table Angle (Degree)	Raw Value (dBuV)	Correction Factor (dB/m)
1	22644.97	62.34 PK	80.00	-17.66	1.82 V	275	64.16	-1.82
2	22644.97	47.92 AV	60.00	-12.08	1.82 V	275	49.74	-1.82

Remarks:

1. Emission Level(dBuV/m) = Raw Value(dBuV) + Correction Factor(dB/m)
2. Correction Factor(dB/m) = Antenna Factor (dB/m) + Cable Factor (dB) – Pre-Amplifier Factor (dB)
3. The other emission levels were very low against the limit.
4. Margin value = Emission level – Limit value

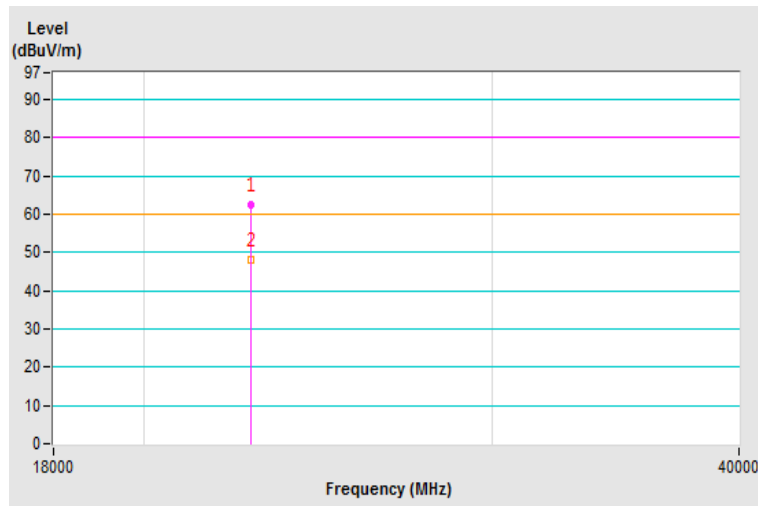

8 Pictures of Test Arrangements

Please refer to the attached file (Test Setup Photo).

Appendix – Information on the Testing Laboratories

We, Bureau Veritas Consumer Products Services (H.K.) Ltd., Taoyuan Branch, were founded in 1988 to provide our best service in EMC, Radio, Telecom and Safety consultation. Our laboratories are accredited and approved according to ISO/IEC 17025.

If you have any comments, please feel free to contact us at the following:

Linko EMC/RF Lab

Tel: 886-2-26052180

Fax: 886-2-26051924

Hsin Chu EMC/RF Lab

Tel: 886-3-6668565

Fax: 886-3-6668323

Hwa Ya EMC/RF/Safety/Telecom Lab

Tel: 886-3-3183232

Fax: 886-3-3270892

Email: service.adt@tw.bureauveritas.com

Web Site: www.bureauveritas-adt.com

The address and road map of all our labs can be found in our web site also.

--- END ---