



FCC TEST REPORT

FCC ID: 2ALIPM07030

On Behalf of

Max-Future Electronics Co.,Limited

LED DESK LAMP BT SPEAKER

Model No.: M07030, LT-458, SP901

Prepared for : Max-Future Electronics Co.,Limited
Address : 5/F, Building B, No. 537, Gushu 1st Road Xi'xiang Street, Bao'an
District, Shenzhen City, Guangdong, China

Prepared By : Shenzhen Alpha Product Testing Co., Ltd.
Address : Building i, No.2, Lixin Road, Fuyong Street, Bao'an District, 518103,
Shenzhen, Guangdong, China

Report Number : T1881058 01
Date of Receipt : July 10, 2018
Date of Test : July 10, 2018- July 18, 2018
Date of Report : July 18, 2018
Version Number : REV0

TABLE OF CONTENTS

Description	Page
1. Summary of Standards And Results.....	6
1.1. Description of Standards and Results	6
2. General Information.....	7
2.1. Description of Device (EUT).....	7
2.2. Accessories of Device (EUT)	8
2.3. Tested Supporting System Details	8
2.4. Block Diagram of connection between EUT and simulators.....	8
2.5. Test Mode Description.....	8
2.6. Test Conditions	8
2.7. Test Facility.....	9
2.8. Measurement Uncertainty.....	9
2.9. Test Equipment List	10
3. Maximum Peak Output power	11
3.1. Limit.....	11
3.2. Test Procedure.....	11
3.3. Test Setup.....	11
3.4. Test Result.....	11
4. Bandwidth.....	12
4.1. Limit.....	12
4.2. Test Procedure.....	12
4.3. Test Result.....	12
5. Carrier Frequency Separation	15
5.1. Limit.....	15
5.2. Test Procedure.....	15
5.3. Test Result.....	15
6. Number Of Hopping Channel	17
6.1. Limit.....	17
6.2. Test Procedure.....	17
6.3. Test Result.....	17
7. Dwell Time	19
7.1. Test limit	19
7.2. Test Procedure.....	19
7.3. Test Result.....	19
8. Radiated emissions	23
8.1. Limit.....	23
8.2. Block Diagram of Test setup.....	24
8.3. Test Procedure.....	25
8.4. Test Result.....	25
9. Band Edge Compliance	31

9.1. Block Diagram of Test Setup.....	31
9.2. Limit.....	31
9.3. Test Procedure.....	31
9.4. Test Result.....	31
10. Power Line Conducted Emissions.....	36
10.1. Block Diagram of Test Setup.....	36
10.2. Limit.....	36
10.3. Test Procedure.....	36
10.4. Test Result.....	36
11. Antenna Requirements.....	39
11.1. Limit.....	39
11.2. Result.....	39
12. Test setup photo	40
12.1. Photos of Radiated emission.....	40
12.2. Photos of Conducted Emission test	41
13. Photos of EUT	42

TEST REPORT DECLARATION

Applicant : Max-Future Electronics Co.,Limited
Address : 5/F, Building B, No. 537, Gushu 1st Road Xi'xiang Street, Bao'an District,
Shenzhen City, Guangdong, China
Manufacturer : Max-Future Electronics Co.,Limited
Address : 5/F, Building B, No. 537, Gushu 1st Road Xi'xiang Street, Bao'an District,
Shenzhen City, Guangdong, China
EUT Description : LED DESK LAMP BT SPEAKER
(A) Model No. : M07030, LT-458, SP901
(B) Trademark : N/A

Measurement Standard Used:

**FCC Rules and Regulations Part 15 Subpart C Section 15.247: 2017,
ANSI C63.10:2013**

The device described above is tested by Shenzhen Alpha Product Testing Co., Ltd. to determine the maximum emission levels emanating from the device. The maximum emission levels are compared to the FCC Part 15 Subpart C limits both conducted and radiated emissions. The test results are contained in this test report and Shenzhen Alpha Product Testing Co., Ltd. is assumed of full responsibility for the accuracy and completeness of these tests.

After the test, our opinion is that EUT compliance with the requirement of the above standards.

This report applies to above tested sample only. This report shall not be reproduced in parts without written approval of Shenzhen Alpha Product Testing Co., Ltd.

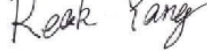
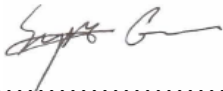
Tested by (name + signature).....: Reak Yang
Project Engineer 
Approved by (name + signature).....: Simple Guan
Project Manager 
Date of issue.....: July 18, 2018

Revision History

Revision	Issue Date	Revisions	Revised By
00	July 18, 2018	Initial released Issue	Simple Guan

1. SUMMARY OF STANDARDS AND RESULTS

1.1. Description of Standards and Results

The EUT have been tested according to the applicable standards as referenced below:

Test Item	Standards Paragraph	Result
Maximum Peak Output Power	FCC Part 15: 15.247(b)(1) ANSI C63.10 :2013	P
Bandwidth	FCC Part 15: 15.215 ANSI C63.10 :2013	P
Carrier Frequency Separation	FCC Part 15: 15.247(a)(1) ANSI C63.10 :2013	P
Number Of Hopping Channel	FCC Part 15: 15.247(a)(1)(iii) ANSI C63.10 :2013	P
Dwell Time	FCC Part 15: 15.247(a)(1)(iii) ANSI C63.10 :2013	P
Radiated Emission	FCC Part 15: 15.209 FCC Part 15: 15.247(d) ANSI C63.10 :2013	P
Band Edge Compliance	FCC Part 15: 15.247(d) ANSI C63.10 :2013	P
Power Line Conducted Emissions	FCC Part 15: 15.207 ANSI C63.10 :2013	P
Antenna requirement	FCC Part 15: 15.203	P
Note:	1. P is an abbreviation for Pass. 2. F is an abbreviation for Fail. 3. N/A is an abbreviation for Not Applicable.	

2. GENERAL INFORMATION

2.1. Description of Device (EUT)

Description	:	LED DESK LAMP BT SPEAKER
Model Number	:	M07030, LT-458, SP901
Diff	:	There is no difference between all the models, except the model number, this report performs the model M07030.
Trademark	:	N/A
Test Voltage	:	DC 3.7V by battery Input: DC 5V/500mA
Radio Technology	:	Bluetooth 5.0
Operation frequency	:	2402-2480MHz
Channel No.	:	79 Channels
Modulation type	:	GFSK, $\pi/4$ DQPSK, 8- DPSK
Antenna Type	:	PCB Antenna, Maximum Gain is 1.9dBi
Software version	:	V1.0
Hardware version	:	V3.0

2.2. Accessories of Device (EUT)

Accessory 1 : N/A

2.3. Tested Supporting System Details

No.	Description	Manufacturer	Model	Serial Number	Certification or DOC
1.	Power Supply	ABT	S005AYU0500050	N/A	N/A
2.	USB cable (shielded)	/	/	N/A	N/A

2.4. Block Diagram of connection between EUT and simulators

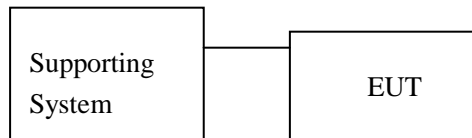

2.5. Test Mode Description

Tested mode, channel, and data rate information		
Mode	Channel	Frequency (MHz)
GFSK	Low :CH1	2402
	Middle: CH40	2441
	High: CH79	2480
π /4 DQPSK	Low :CH1	2402
	Middle: CH40	2441
	High: CH79	2480
8- DPSK	Low :CH1	2402
	Middle: CH40	2441
	High: CH79	2480

2.6. Test Conditions

Items	Required	Actual
Temperature range:	15-35°C	27°C
Humidity range:	25-75%	56%
Pressure range:	86-106kPa	980kPa

2.7. Test Facility

Shenzhen Alpha Product Testing Co., Ltd
 Building i, No.2, Lixin Road, Fuyong Street, Bao'an District, 518103,
 Shenzhen, Guangdong, China

June 21, 2018 File on Federal Communication Commission
 Registration Number: 293961

July 25, 2017 Certificated by IC
 Registration Number: 12135A

2.8. Measurement Uncertainty

(95% confidence levels, k=2)

Item	Uncertainty
Uncertainty for Power point Conducted Emissions Test	2.74dB
Uncertainty for Radiation Emission test in 3m chamber (below 30MHz)	2.13 dB(Polarize: V)
	2.57dB(Polarize: H)
Uncertainty for Radiation Emission test in 3m chamber (30MHz to 1GHz)	3.77dB(Polarize: V)
	3.80dB(Polarize: H)
Uncertainty for Radiation Emission test in 3m chamber (1GHz to 25GHz)	4.16dB(Polarize: H)
	4.13dB(Polarize: V)
Uncertainty for radio frequency	5.4×10^{-8}
Uncertainty for conducted RF Power	0.37dB
Uncertainty for temperature	0.2°C
Uncertainty for humidity	1%
Uncertainty for DC and low frequency voltages	0.06%

2.9. Test Equipment List

Equipment	Manufacture	Model No.	Serial No.	Last cal.	Cal Interval
3m Semi-Anechoic	ETS-LINDGREN	N/A	SEL0017	2017.09.22	1 Year
Spectrum analyzer	Agilent	E4407B	MY46185649	2017.09.22	1 Year
Receiver	R&S	ESCI	1166.5950K03-1011	2017.09.22	1 Year
Receiver	R&S	ESCI	101202	2017.09.22	1 Year
Bilog Antenna	Schwarzbeck	VULB 9168	VULB9168-438	2016.09.30	2 Year
Horn Antenna	EMCO	3115	640201028-06	2016.09.30	2 Year
Active Loop Antenna	Beijing Daze	ZN30900A	SEL0097	2016.09.30	2 Year
Cable	Resenberger	N/A	No.1	2017.09.22	1 Year
Cable	SCHWARZBECK	N/A	No.2	2017.09.22	1 Year
Cable	SCHWARZBECK	N/A	No.3	2017.09.22	1 Year
Pre-amplifier	Schwarzbeck	BBV9743	9743-019	2017.09.22	1 Year
Pre-amplifier	R&S	AFS33-1800265 0-30-8P-44	SEL0080	2017.09.22	1 Year
Temperature controller	Terchy	MHQ	120	2017.09.22	1 Year
L.I.S.N.#1	Schwarzbeck	NSLK8126	8126466	2017.09.22	1 Year
L.I.S.N.#2	ROHDE&SCHWARZ	ENV216	101043	2017.09.22	1 Year
20db Attenuator	ICPROBING	IATS1	82347	2017.09.22	1 Year
18-40 Horn Antenna	18-40G antenna	Sas-574	571	2018-3-15	3 Year
Power Meter	Anritsu	ML2487A	6K00001491	2017.09.22	1 Year

3. MAXIMUM PEAK OUTPUT POWER

3.1.Limit

Please refer section 15.247.

For frequency hopping systems operating in the 2400-2483.5 MHz band employing at least 75 non-overlapping hopping channels, and all frequency hopping systems in the 5725-5850 MHz band: 1 watt. For all other frequency hopping systems in the 2400-2483.5 MHz band: 0.125 watts, the e.i.r.p shall not exceed 4W

3.2.Test Procedure

The transmitter output is connected to the RF Power Meter. The RF Power Meter is set to the peak power detection.

3.3.Test Setup

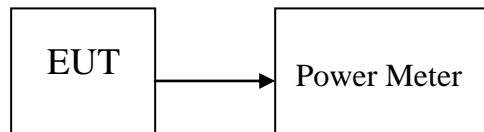

3.4.Test Result

Mode	Freq (MHz)	PK Output Power (dBm)	PK Output Power (mW)	Limit (dBm)	Result
GFSK	2402	1.921	1.556	30	Pass
	2441	1.639	1.458	30	Pass
	2480	1.776	1.505	30	Pass
$\pi/4$ DQPSK,	2402	1.251	1.334	21	Pass
	2441	1.369	1.371	21	Pass
	2480	1.477	1.405	21	Pass
8- DPSK	2402	1.903	1.550	21	Pass
	2441	1.263	1.338	21	Pass
	2480	1.009	1.262	21	Pass
Conclusion: PASS					

4. BANDWIDTH

4.1.Limit

Intentional radiators operating under the alternative provisions to the general emission limits, as contained in §§ 15.217 through 15.257 and in Subpart E of this part, must be designed to ensure that the 20 dB bandwidth of the emission, or whatever bandwidth may otherwise be specified in the specific rule section under which the equipment operates, is contained within the frequency band designated in the rule section under which the equipment is operated.

4.2.Test Procedure

The RF output of EUT was connected to the spectrum analyzer by RF cable and attenuator. The bandwidth of the fundamental frequency was measured by spectrum analyzer with 30kHz RBW and 100kHz VBW. The 20dB bandwidth is defined as the total spectrum the power of which is higher than peak power minus 20dB.

4.3.Test Result

Mode	Freq (MHz)	20dB Bandwidth (KHz)	Conclusion
GFSK	2402	920.6	PASS
	2441	931.0	PASS
	2480	917.1	PASS
π /4 DQPSK	2402	1280.0	PASS
	2441	1280.0	PASS
	2480	1299.0	PASS
8- DPSK	2402	1266.0	PASS
	2441	1263.0	PASS
	2480	1268.0	PASS

Original Test data For 20dB bandwidth

GFSK mode	π /4 DQPSK
-----------	------------

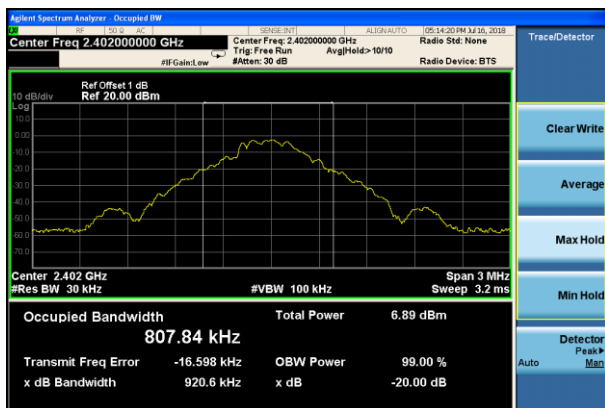

Lowest channel

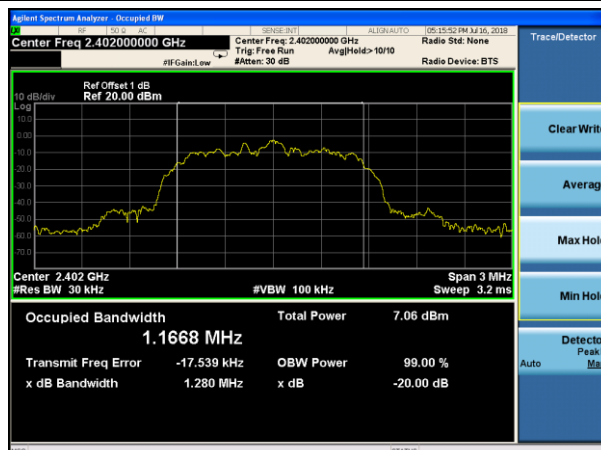

Lowest channel



Middle channel

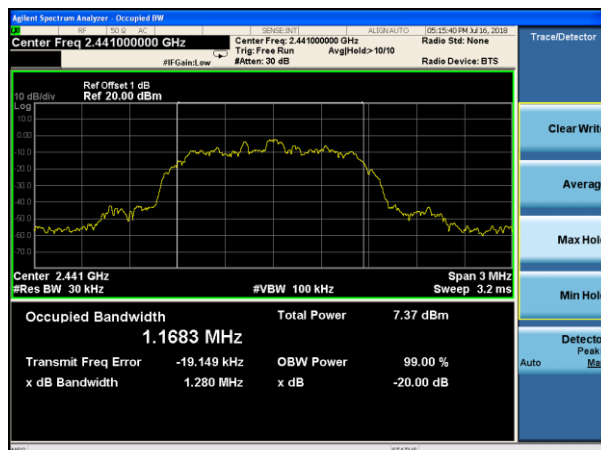

Middle channel

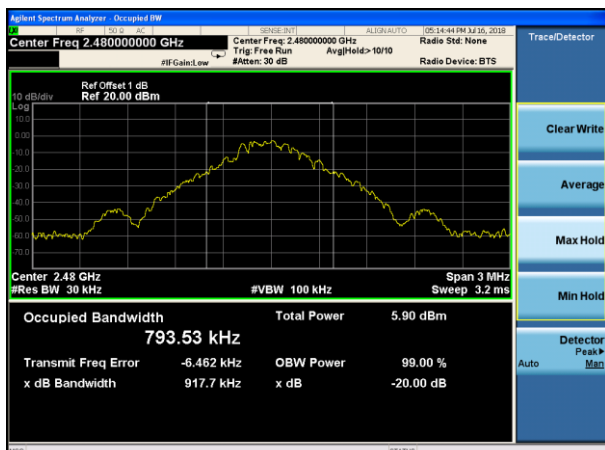

Highest channel

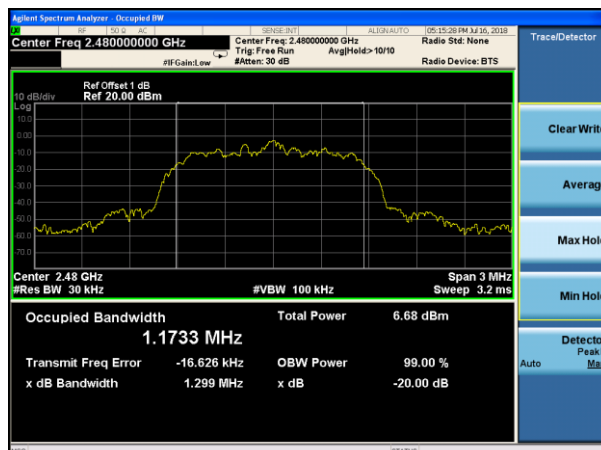

Highest channel

8- DPSK

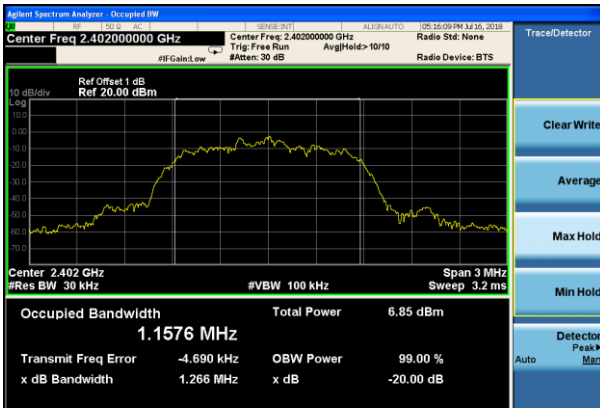

Lowest channel



Middle channel



Highest channel

:

5. CARRIER FREQUENCY SEPARATION

5.1.Limit

Frequency hopping systems shall have hopping channel carrier frequencies separated by a minimum of 25 kHz or the 20 dB bandwidth of the hopping channel, whichever is greater. Alternatively, frequency hopping systems operating in the 2400-2483.5 MHz band may have hopping channel carrier frequencies that are separated by 25 kHz or two-thirds of the 20 dB bandwidth of the hopping channel, whichever is greater, provided the systems operate with an output power no greater than 125 mW

5.2.Test Procedure

The RF output of EUT was connected to the spectrum analyzer by RF cable and attenuator. The carrier frequency was measured by spectrum analyzer with 100kHz RBW and 300kHz VBW.

5.3.Test Result

Mode/Channel	Channel separation (MHz)	20dB Bandwidth (KHz)	Limit (KHz)	Conclusion
GFSK	1.004	931.0	620.67	PASS
$\pi/4$ DQPSK	0.998	1299.0	866.00	PASS
8- DPSK	1.000	1268.0	845.33	PASS

Original test data for channel separation



GFSK

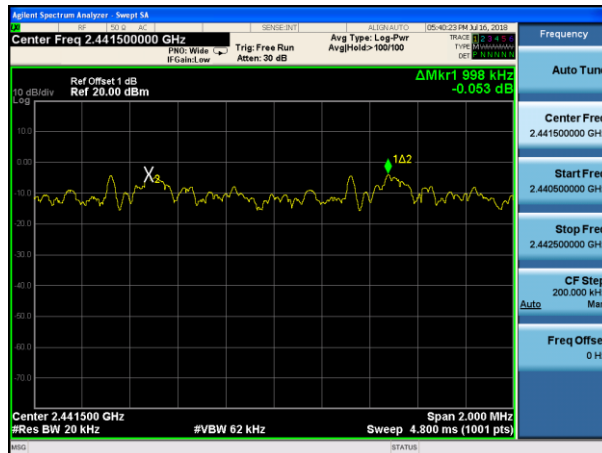

$\pi/4$ DQPSK

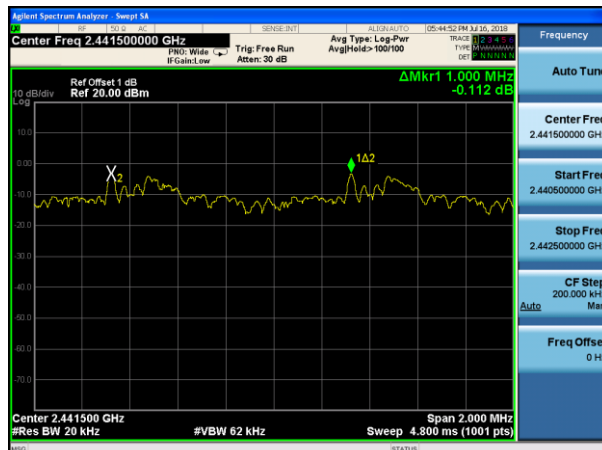

8- DPSK

6. NUMBER OF HOPPING CHANNEL

6.1.Limit

Frequency hopping systems in the 2400-2483.5 MHz band shall use at least 15 channels

6.2.Test Procedure

The RF output of EUT was connected to the spectrum analyzer by RF cable and attenuator. The number of hopping channel was measured by spectrum analyzer with 100kHz RBW and 300KHz VBW.

6.3.Test Result

Mode	Number of hopping channel	Limit	Conclusion
GFSK	79	>15	PASS
π /4 DQPSK	79	>15	PASS
8- DPSK	79	>15	PASS

Original test data for hopping channel number

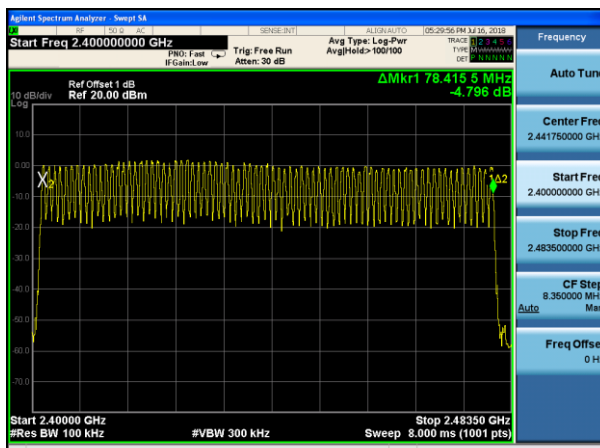

GFSK

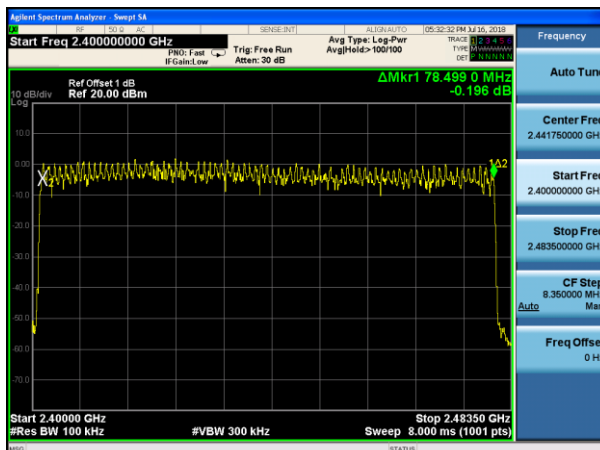

$\pi/4$ DQPSK

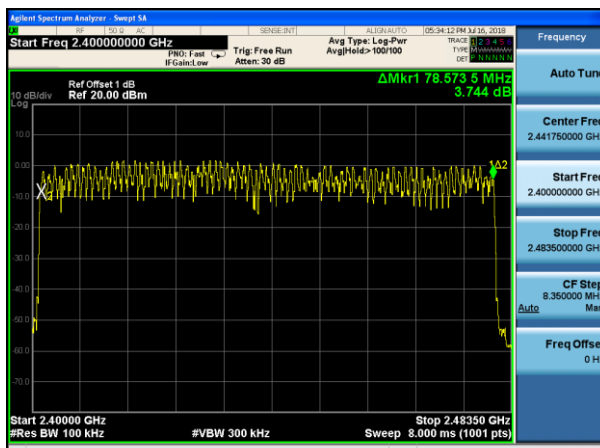

8- DPSK

7. DWELL TIME

7.1. Test limit

Please refer section 15.247

According to §15.247(a)(1)(iii), Frequency hopping systems operating in the 2400MHz-2483.5 MHz. The average time of occupancy on any frequency shall not be greater than 0.4 s within period of 0.4 seconds multiplied by the number of hopping channels employed.

7.2. Test Procedure

7.2.1. Place the EUT on the table and set it in transmitting mode.

7.2.2. Remove the antenna from the EUT and then connect a low loss RF cable from the antenna port to the spectrum analyzer.

7.2.3. Set center frequency of spectrum analyzer = operating frequency.

7.2.4. Set the spectrum analyzer as RBW, VBW=1MHz, Span = 0Hz, Sweep = auto.

7.2.5. Repeat above procedures until all frequency measured were complete.

7.3. Test Result

PASS.

Detailed information please see the following page.

Mode	Data Packet	Frequency (MHz)	Pulse Duration (ms)	Dwell Time (ms)	Limit (ms)	Conclusion
GFSK	DH1	2441	0.374	119.680	400	PASS
	DH3	2441	1.642	262.720		PASS
	DH5	2441	2.880	307.200		PASS
π /4 DQPSK	DH1	2441	0.394	126.080	400	PASS
	DH3	2441	1.632	261.120		PASS
	DH5	2441	2.890	308.267		PASS
8- DPSK	DH1	2441	0.394	126.080	400	PASS
	DH3	2441	1.637	261.920		PASS
	DH5	2441	2.870	306.133		PASS

Note: 1 A period time = $0.4 \text{ (s)} * 79 = 31.6 \text{ (s)}$

2 DH1 time slot = $\text{Pulse Duration} * (1600 / (2 * 79)) * \text{A period time} / 1000$

DH3 time slot = $\text{Pulse Duration} * (1600 / (4 * 79)) * \text{A period time} / 1000$

DH5 time slot = $\text{Pulse Duration} * (1600 / (6 * 79)) * \text{A period time} / 1000$

Dwell time

GFSK

$\pi/4$ -DQPSK

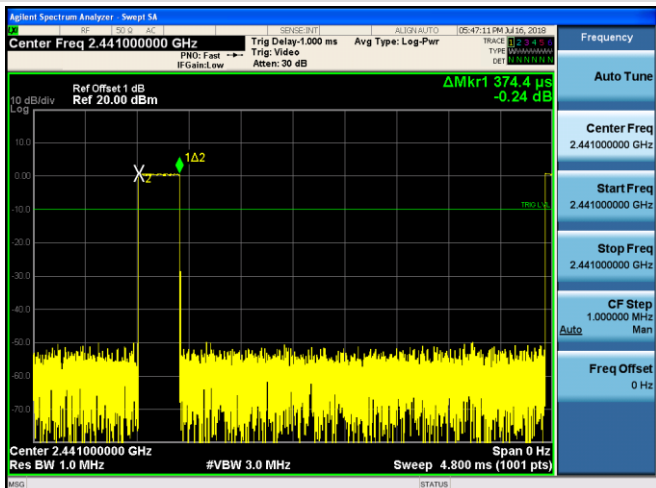

Channel 39 / 2441 MHz - DH1

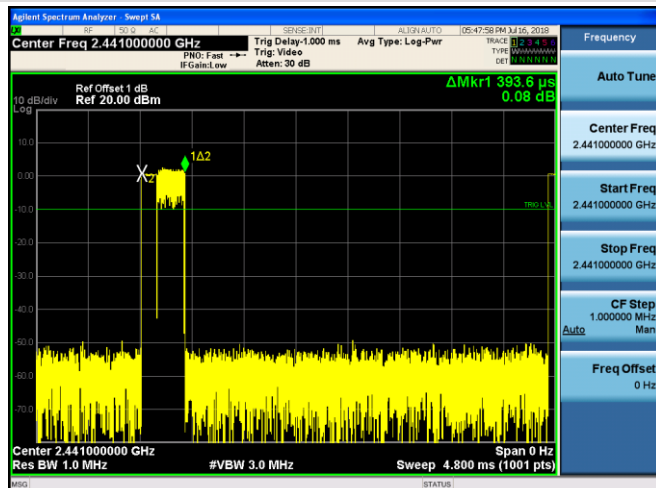

Channel 39 / 2441 MHz - 2DH1

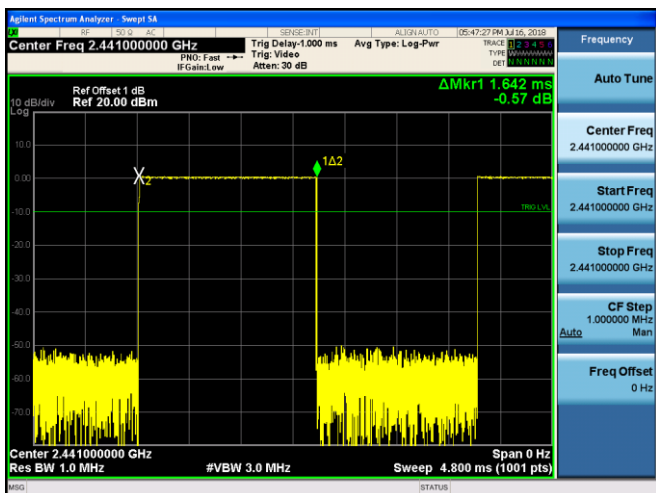

Channel 39 / 2441 MHz - DH3

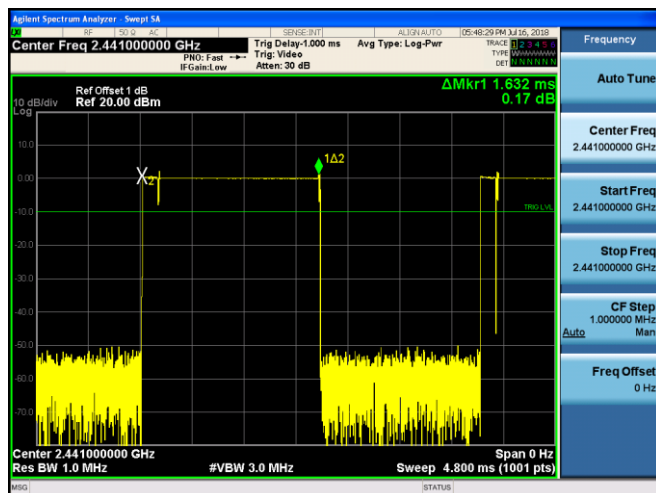

Channel 39 / 2441 MHz - 2DH3

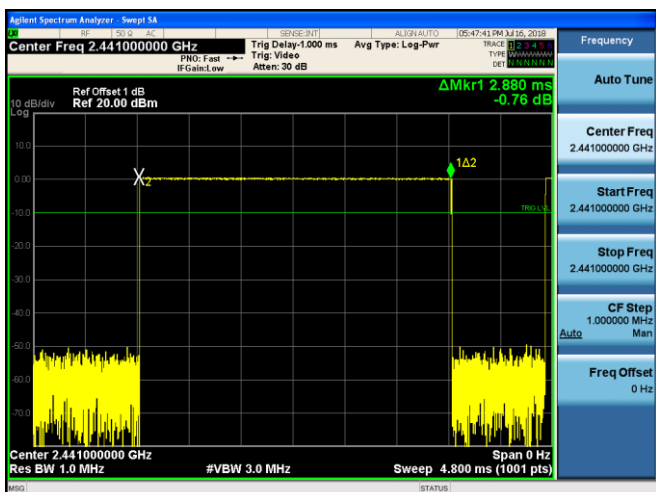

Channel 39 / 2441 MHz - DH5

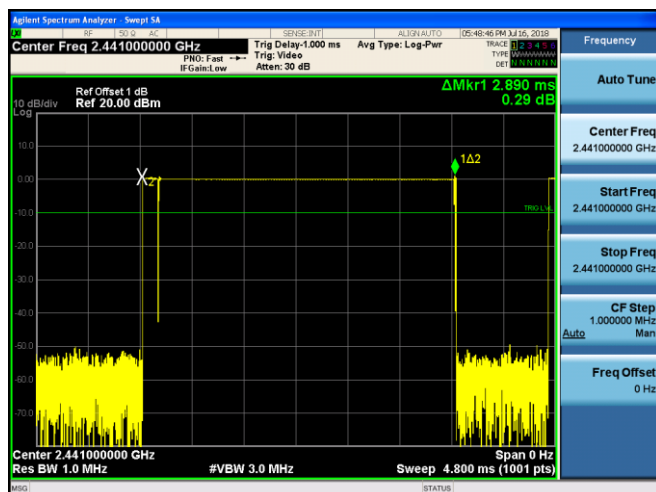

Channel 39 / 2441 MHz - 2DH5

Dwell time

8DPSK

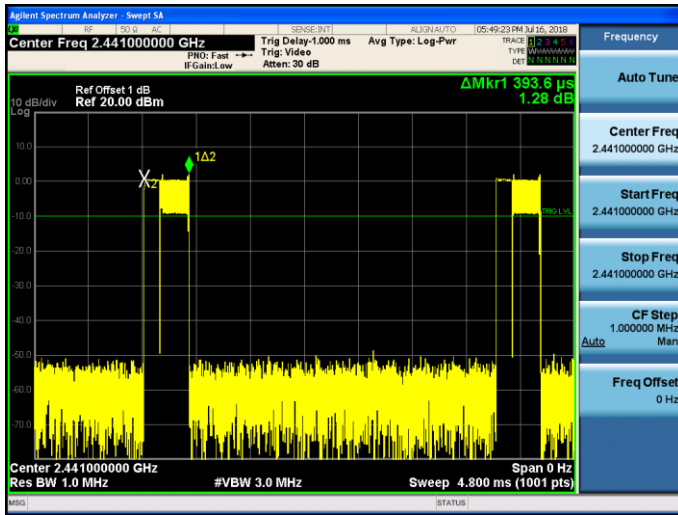

Channel 39 / 2441 MHz - 3DH1

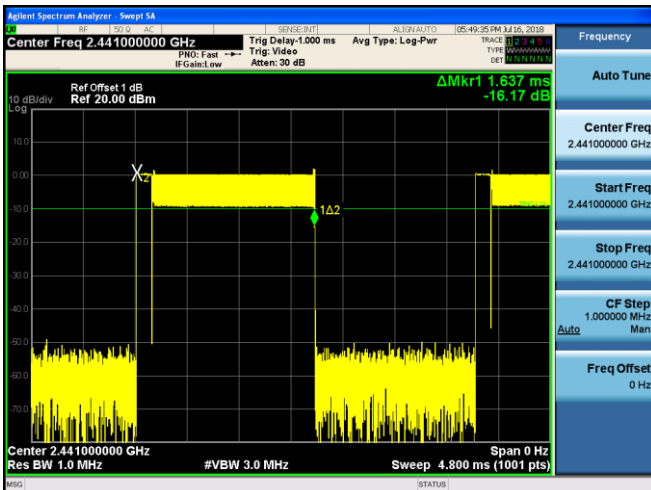

2 Channel 39 / 2441 MHz - 3DH3

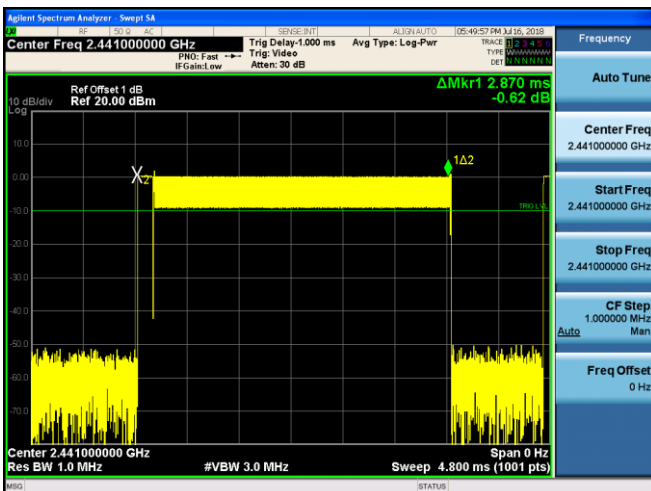

Channel 39 / 2441 MHz - 3DH5

8. RADIATED EMISSIONS

8.1.Limit

All the emissions appearing within 15.205 restricted frequency bands shall not exceed the limits shown in 15.209, all the other emissions shall be at least 20dB below the fundamental emissions, or comply with 15.209 limits.

15.205 Restricted frequency band

MHz	MHz	MHz	GHz
0.090 - 0.110	16.42 - 16.423	399.9 - 410	4.5 - 5.15
¹ 0.495 - 0.505	16.69475 - 16.69525	608 - 614	5.35 - 5.46
2.1735 - 2.1905	16.80425 - 16.80475	960 - 1240	7.25 - 7.75
4.125 - 4.128	25.5 - 25.67	1300 - 1427	8.025 - 8.5
4.17725 - 4.17775	37.5 - 38.25	1435 - 1626.5	9.0 - 9.2
4.20725 - 4.20775	73 - 74.6	1645.5 - 1646.5	9.3 - 9.5
6.215 - 6.218	74.8 - 75.2	1660 - 1710	10.6 - 12.7
6.26775 - 6.26825	108 - 121.94	1718.8 - 1722.2	13.25 - 13.4
6.31175 - 6.31225	123 - 138	2200 - 2300	14.47 - 14.5
8.291 - 8.294	149.9 - 150.05	2310 - 2390	15.35 - 16.2
8.362 - 8.366	156.52475 - 156.52525	2483.5 - 2500	17.7 - 21.4
8.37625 - 8.38675	156.7 - 156.9	2690 - 2900	22.01 - 23.12
8.41425 - 8.41475	162.0125 - 167.17	3260 - 3267	23.6 - 24.0
12.29 - 12.293	167.72 - 173.2	3332 - 3339	31.2 - 31.8
12.51975 - 12.52025	240 - 285	3345.8 - 3358	36.43 - 36.5
12.57675 - 12.57725	322 - 335.4	3600 - 4400	(²)

15.209 Limit

FREQUENCY MHz	DISTANCE Meters	FIELD STRENGTHS LIMIT	
		$\mu\text{V}/\text{m}$	$\text{dB}(\mu\text{V})/\text{m}$
0.009-0.490	300	2400/F(KHz)	/
0.490-1.705	30	24000/F(KHz)	/
1.705-30	30	30	29.5
30 ~ 88	3	100	40.0
88 ~ 216	3	150	43.5
216 ~ 960	3	200	46.0
960 ~ 1000	3	500	54.0
Above 1000	3	74.0 dB(μV)/m (Peak) 54.0 dB(μV)/m (Average)	

8.2. Block Diagram of Test setup

8.2.1 In 3m Anechoic Chamber Test Setup Diagram for below 30MHz

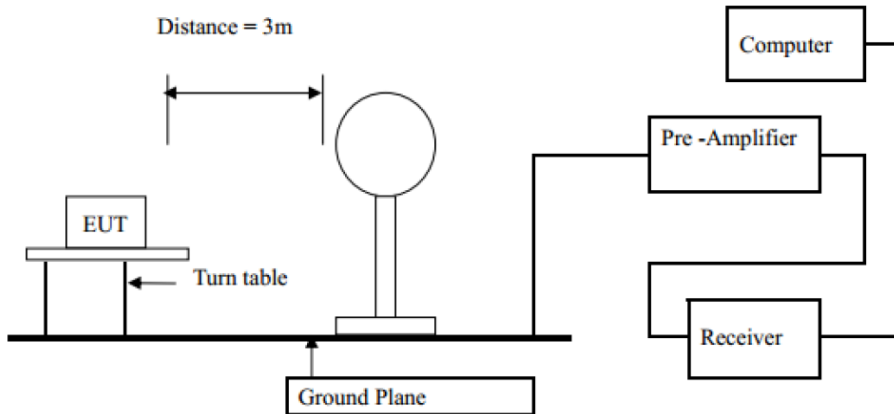

8.2.1 In 3m Anechoic Chamber Test Setup Diagram for below 1GHz

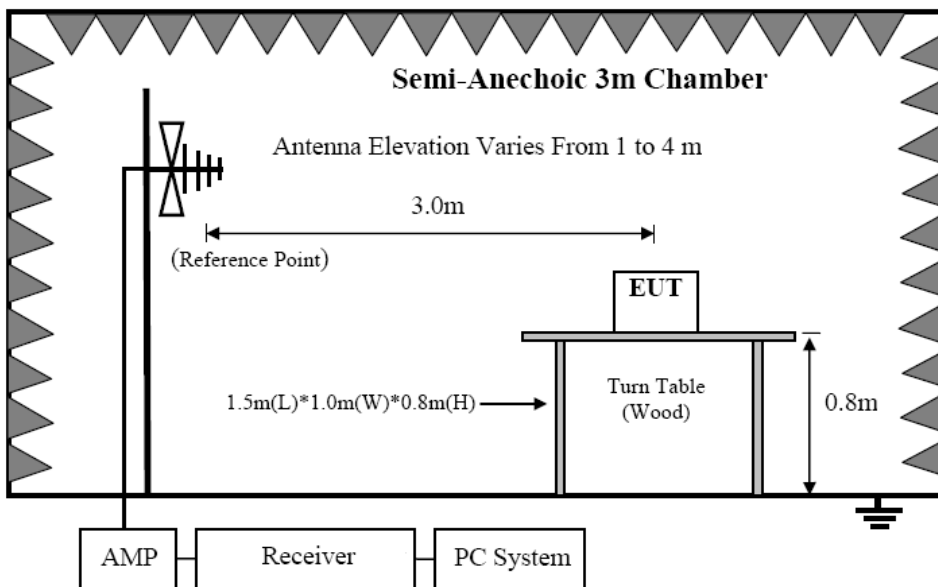

8.2.2 In 3m Anechoic Chamber Test Setup Diagram for frequency above 1GHz

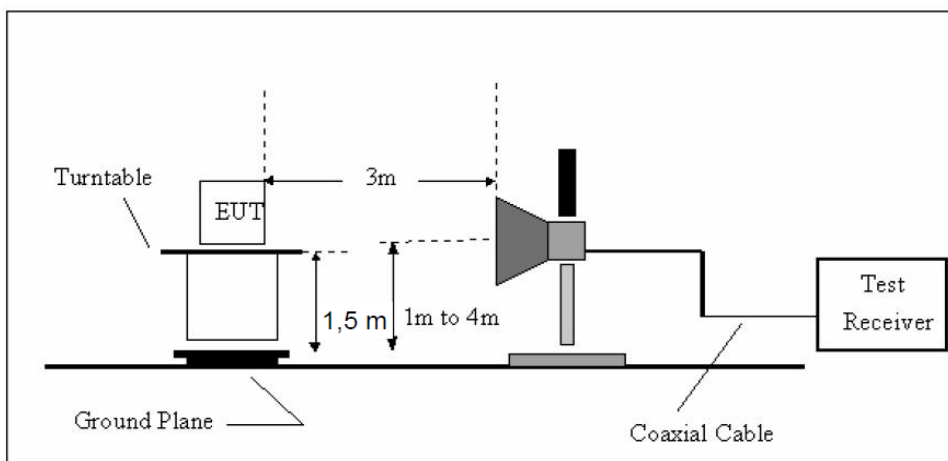

Note: For harmonic emissions test a appropriate high pass filter was inserted in the input port of AMP.

8.3. Test Procedure

- (1) EUT was placed on a non-metallic table, 80 cm above the ground plane inside a semi-anechoic chamber.
- (2) Setup EUT and simulator as shown in section 1.4 and 6.1
- (3) Test antenna was located 3m from the EUT on an adjustable mast. Below pre-scan procedure was first performed in order to find prominent radiated emissions.
 - (a) Change work frequency or channel of device if practicable.
 - (b) Change modulation type of device if practicable.
 - (c) Rotated EUT though three orthogonal axes to determine the attitude of EUT arrangement produces highest emissions
- (4) Spectrum frequency from 9KHz to 25GHz (tenth harmonic of fundamental frequency) was investigated
- (5) For final emissions measurements at each frequency of interest, the EUT were rotated and the antenna height was varied between 1m and 4m in order to maximize the emission. Measurements in both horizontal and vertical polarities were made and the data was recorded. In order to find the maximum emission, the relative positions of equipments and all of the interface cables were changed according to ANSI C63.10 :2013on Radiated Emission test.
- (6) For emissions above 1GHz, both Peak and Average level were measured with Spectrum Analyzer, and the RBW is set at 1MHz, VBW is set at 3MHz for Peak measure; RBW is set at 1MHz, VBW is set at 10Hz for Average measure.

8.4. Test Result

We have scanned the 10th harmonic from 9KHz to the EUT's highest frequency..
Detailed information please see the following page.

From 9KHz to 30MHz: Conclusion: PASS

Note: The amplitude of spurious emissions which are attenuated by more than 20dB below the permissible value has no need to be reported.

From 30MHz to 1000MHz: Conclusion: PASS

Vertical:

Radiated Emission Measurement

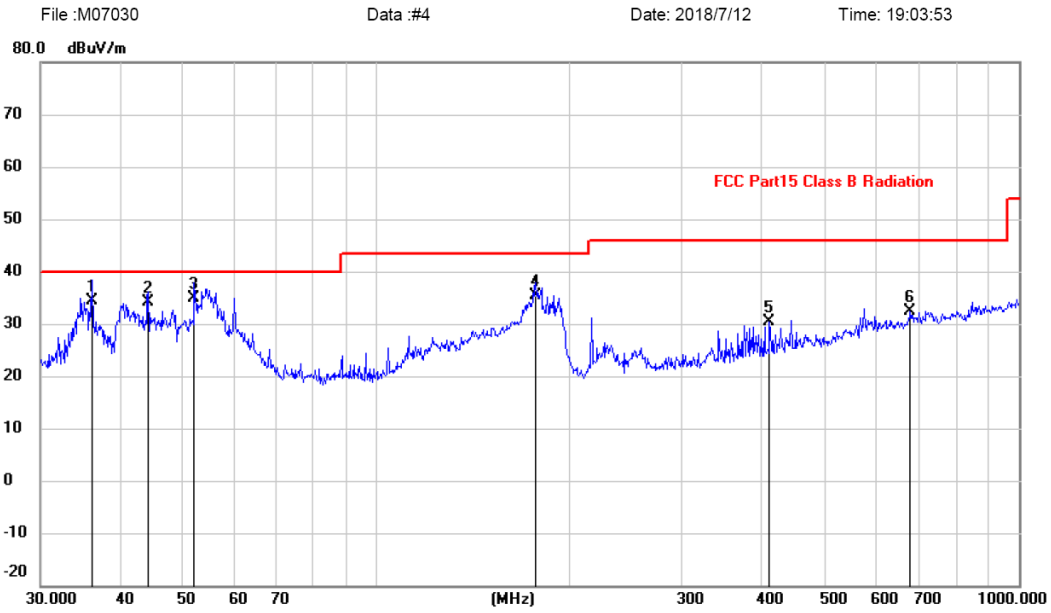

No.	Mk.	Freq.	Reading Level	Correct Factor	Measurement	Limit	Margin	Antenna Height	Table Degree	
		MHz	dBuV	dB	dBuV/m	dBuV/m	dB	cm	degree	Comment
1		36.0007	20.85	13.50	34.35	40.00	-5.65			QP
2		44.1200	20.36	13.85	34.21	40.00	-5.79			QP
3	*	52.0251	21.21	13.62	34.83	40.00	-5.17			QP
4		176.8875	22.80	12.66	35.46	43.50	-8.04			QP
5		410.3824	14.41	15.93	30.34	46.00	-15.66			peak
6		677.5797	11.52	20.97	32.49	46.00	-13.51			peak

Note: 1. *:Maximum data; x:Over limit; !:over margin.

2.Measurement=Reading Level+Correct Factor; Correct Factor=Antenna Factor+Cable Loss.

Horizontal:

Radiated Emission Measurement

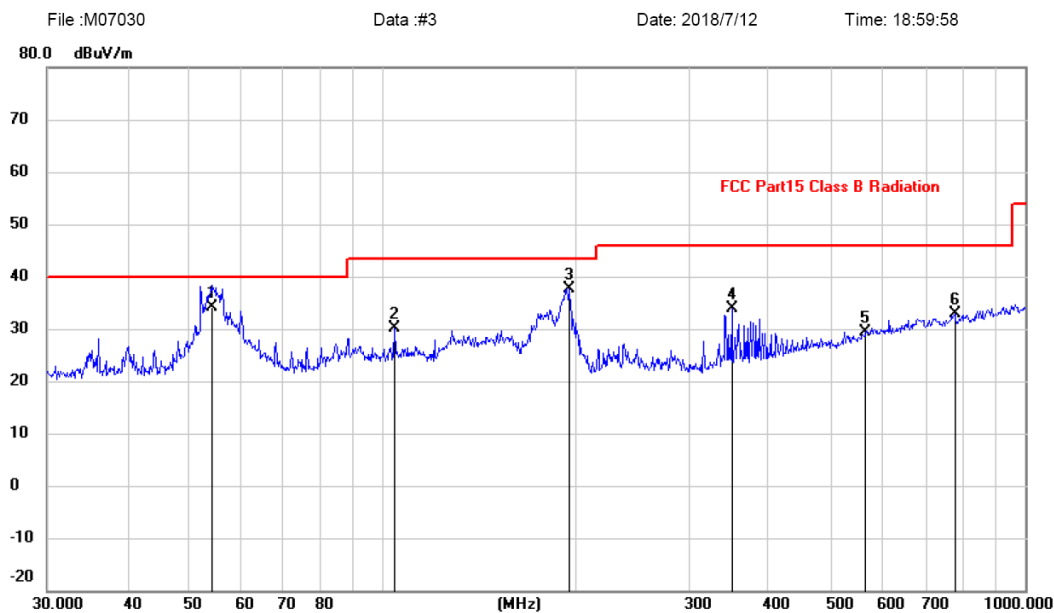

No.	Mk.	Freq.	Reading Level	Correct Factor	Measurement	Limit	Margin	Antenna Height	Table Degree
		MHz	dBuV	dB	dBuV/m	dBuV/m	dB	cm	degree
1		54.2608	20.76	13.38	34.14	40.00	-5.86	QP	
2		104.1701	19.24	10.99	30.23	43.50	-13.27	peak	
3	*	195.8216	27.12	10.58	37.70	43.50	-5.80	peak	
4		350.4766	19.37	14.41	33.78	46.00	-12.22	peak	
5		566.6221	10.38	18.95	29.33	46.00	-16.67	peak	
6		776.8777	11.15	21.78	32.93	46.00	-13.07	peak	

Note:1. *:Maximum data; x:Over limit; !:over margin.

2.Measurement=Reading Level+Correct Factor; Correct Factor=Antenna Factor+Cable Loss.

Remark: All modes have been tested, and only worst data of GFSK mode, Channel 2480MHz (AC 120V/60Hz) was listed in this report.

From 1G-25GHz

Test Mode: GFSK TX Low									
Freq (MHz)	Read Level (dBuV/m)	Polar (H/V)	Antenna Factor (dB/m)	Cable loss(dB)	Amp Factor (dB)	Result (dBuV/m)	Limit (dBuV/m)	Margin (dB)	Remark
4804	43.24	V	33.95	10.18	34.26	53.11	74	20.89	PK
4804	32.75	V	33.95	10.18	34.26	42.62	54	11.38	AV
7206	/		/						
9608	/		/						
4824	43.76	H	33.95	10.18	34.26	53.63	74	20.37	PK
4824	31.91	H	33.95	10.18	34.26	41.78	54	12.22	AV
7206									
9608									
Test Mode: GFSK TX Mid									
4882	41.93	H	33.93	10.2	34.29	51.77	74	22.23	PK
4882	33.31	H	33.93	10.2	34.29	43.15	54	10.85	AV
7323	/								
9764	/								
4882	41.93	H	33.93	10.2	34.29	51.77	74	22.23	PK
4882	33.31	H	33.93	10.2	34.29	43.15	54	10.85	AV
7323									
9764									
Test Mode: GFSK TX High									
4960	41.92	V	33.98	10.22	34.25	51.87	74	22.13	PK
4960	32.20	V	33.98	10.22	34.25	42.15	54	11.85	AV
7440	/								
9920	/								
4960	42.82	H	33.98	10.22	34.25	52.77	74	21.23	PK
4960	31.49	H	33.98	10.22	34.25	41.44	54	12.56	AV
7440	/								
9920	/								
Note:									
1, Result = Read level + Antenna factor + cable loss-Amp factor									
2, All the other emissions not reported were too low to read and deemed to comply with FCC limit.									

From 1G-25GHz

Test Mode: $\pi/4$ DQPSK TX Low									
Freq (MHz)	Read Level (dBuV/m)	Polar (H/V)	Antenna Factor (dB/m)	Cable loss(dB)	Amp Factor (dB)	Result (dBuV/m)	Limit (dBuV/m)	Margin (dB)	Remark
4804	43.17	V	33.95	10.18	34.26	53.04	74	20.96	PK
4804	32.48	V	33.95	10.18	34.26	42.35	54	11.65	AV
7206	/		/						
9608	/		/						
4824	43.40	H	33.95	10.18	34.26	53.27	74	20.73	PK
4824	32.89	H	33.95	10.18	34.26	42.76	54	11.24	AV
7206									
9608									
Test Mode: $\pi/4$ DQPSK TX Mid									
4882	43.82	V	33.93	10.2	34.29	53.66	74	20.34	PK
4882	31.65	V	33.93	10.2	34.29	41.49	54	12.51	AV
7323	/								
9764	/								
4882	44.56	H	33.93	10.2	34.29	54.40	74	19.60	PK
4882	33.29	H	33.93	10.2	34.29	43.13	54	10.87	AV
7323									
9764									
Test Mode: $\pi/4$ DQPSK TX High									
4960	42.99	V	33.98	10.22	34.25	52.94	74	21.06	PK
4960	32.55	V	33.98	10.22	34.25	42.50	54	11.50	AV
7440	/								
9920	/								
4960	43.08	H	33.98	10.22	34.25	53.03	74	20.97	PK
4960	31.48	H	33.98	10.22	34.25	41.43	54	12.57	AV
7440	/								
9920	/								
Note:									
1, Result = Read level + Antenna factor + cable loss-Amp factor									
2, All the other emissions not reported were too low to read and deemed to comply with FCC limit.									

From 1G-25GHz

Test Mode: 8- DQPSK TX Low									
Freq (MHz)	Read Level (dBuV/m)	Polar (H/V)	Antenna Factor (dB/m)	Cable loss(dB)	Amp Factor (dB)	Result (dBuV/m)	Limit (dBuV/m)	Margin (dB)	Remark
4804	41.97	V	33.95	10.18	34.26	51.84	74	22.16	PK
4804	32.16	V	33.95	10.18	34.26	42.03	54	11.97	AV
7206	/		/						
9608	/		/						
4824	41.07	H	33.95	10.18	34.26	50.94	74	23.06	PK
4824	32.62	H	33.95	10.18	34.26	42.49	54	11.51	AV
7206									
9608									
Test Mode: 8- DQPSK TX Mid									
4882	41.15	V	33.93	10.2	34.29	50.99	74	23.01	PK
4882	32.54	V	33.93	10.2	34.29	42.38	54	11.62	AV
7323	/								
9764	/								
4882	42.77	H	33.93	10.2	34.29	52.61	74	21.39	PK
4882	33.27	H	33.93	10.2	34.29	43.11	54	10.89	AV
7323									
9764									
Test Mode: 8- DQPSK TX High									
4960	42.62	V	33.98	10.22	34.25	52.57	74	21.43	PK
4960	32.77	V	33.98	10.22	34.25	42.72	54	11.28	AV
7440	/								
9920	/								
4960	42.78	H	33.98	10.22	34.25	52.73	74	21.27	PK
4960	31.97	H	33.98	10.22	34.25	41.92	54	12.08	AV
7440	/								
9920	/								
Note:									
1, Result = Read level + Antenna factor + cable loss-Amp factor									
2, All the other emissions not reported were too low to read and deemed to comply with FCC limit.									

9. BAND EDGE COMPLIANCE

9.1. Block Diagram of Test Setup

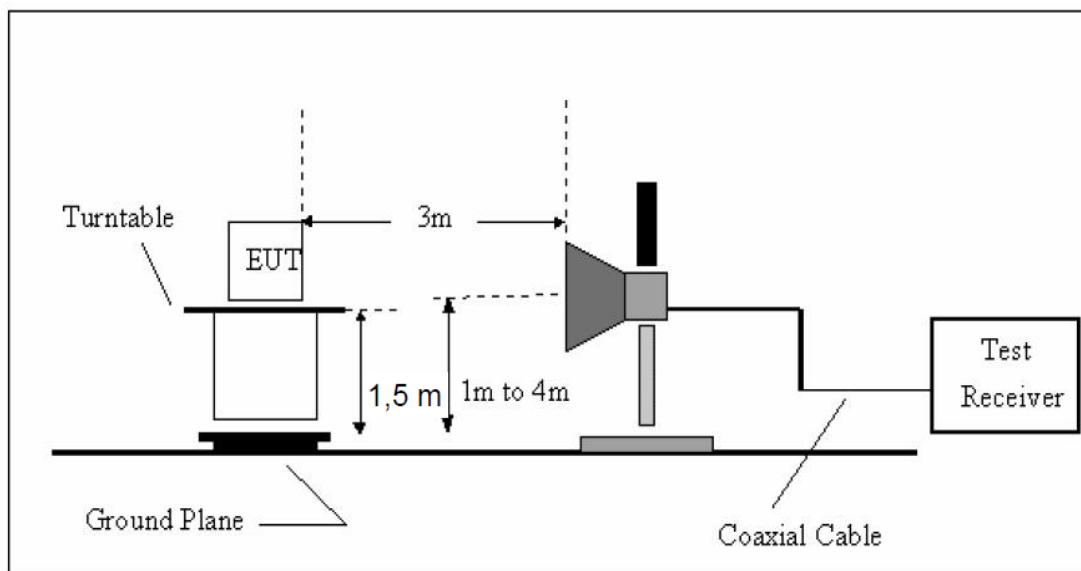

9.2. Limit

All the lower and upper band-edges emissions appearing within restricted frequency bands shall not exceed the limits shown in 15.209, all the other emissions outside operation shall be at least 20dB below the fundamental emissions, or comply with 15.209 limits.

9.3. Test Procedure

All restriction band and non- restriction band have been tested , only worse case is reported.

9.4. Test Result

PASS. (See below detailed test data)

Radiated Method:

Test mode: GFSK Tx Low									
Freq (MHz)	Read Level (dBuV/m)	Polar (H/V)	Antenna Factor (dB/m)	Cable loss (dB)	Amp Factor (dB)	Result (dBuV/m)	Limit (dBuV/m)	Margin (dB)	Remark
2390	45.00	V	27.62	3.92	34.97	41.57	74	32.43	PK
2390	--	V	--	--	--	--	54	--	AV
2390	41.00	H	27.62	3.92	34.97	37.57	74	36.43	PK
2390	--	H	--	--	--	--	54	--	AV
Test mode: GFSK Tx High									
2483.5	43.39	V	27.89	4	34.97	40.31	74	33.69	PK
2483.5	--	V	--	--	--	--	54	--	AV
2483.5	42.32	H	27.89	4	34.97	39.24	74	34.76	PK
2483.5	--	H	--	--	--	--	54	--	AV
Test mode: $\pi/4$ DQPSK Tx Low									
Freq (MHz)	Read Level (dBuV/m)	Polar (H/V)	Antenna Factor (dB/m)	Cable loss (dB)	Amp Factor (dB)	Result (dBuV/m)	Limit (dBuV/m)	Margin (dB)	Remark
2390	45.01	V	27.62	3.92	34.97	41.58	74	32.42	PK
2390	--	V	--	--	--	--	54	--	AV
2390	40.10	H	27.62	3.92	34.97	36.67	74	37.33	PK
2390	--	H	--	--	--	--	54	--	AV
Test mode: $\pi/4$ DQPSK Tx High									
2483.5	42.95	V	27.89	4	34.97	39.87	74	34.13	PK
2483.5	--	V	--	--	--	--	54	--	AV
2483.5	40.49	H	27.89	4	34.97	37.41	74	36.59	PK
2483.5	--	H	--	--	--	--	54	--	AV
Test mode: 8- DPSK Tx Low									
Freq (MHz)	Read Level (dBuV/m)	Polar (H/V)	Antenna Factor (dB/m)	Cable loss (dB)	Amp Factor (dB)	Result (dBuV/m)	Limit (dBuV/m)	Margin (dB)	Remark
2390	43.39	V	27.62	3.92	34.97	39.96	74	34.04	PK
2390	--	V	--	--	--	--	54	--	AV
2390	40.83	H	27.62	3.92	34.97	37.40	74	36.60	PK
2390	--	H	--	--	--	--	54	--	AV
Test mode: 8- DPSK Tx High									
2483.5	42.10	V	27.89	4	34.97	39.02	74	34.98	PK
2483.5	--	V	--	--	--	--	54	--	AV
2483.5	41.18	H	27.89	4	34.97	38.10	74	35.90	PK
2483.5	--	H	--	--	--	--	54	--	AV

Note:

- 1, Result = Read level + Antenna factor + cable loss - Amp factor
- 2, All the other emissions not reported were too low to read and deemed to comply with FCC limit.

Conducted Method

GFSK Mode:

Test channel:	Lowest channel
---------------	----------------

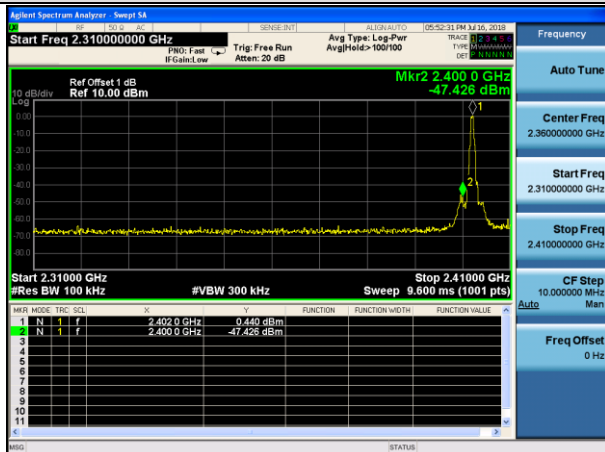

No-hopping mode

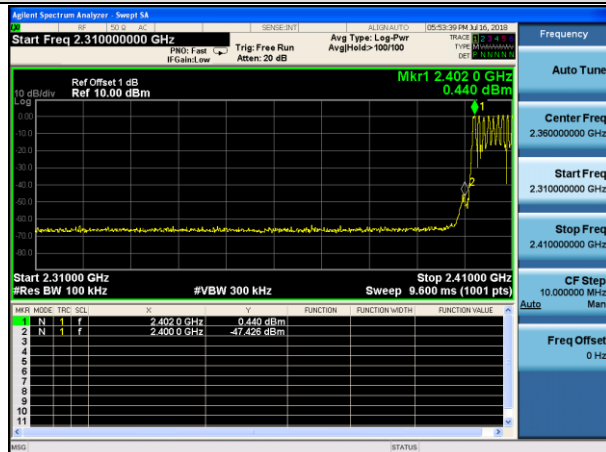

Hopping mode

Test channel:	Highest channel
---------------	-----------------

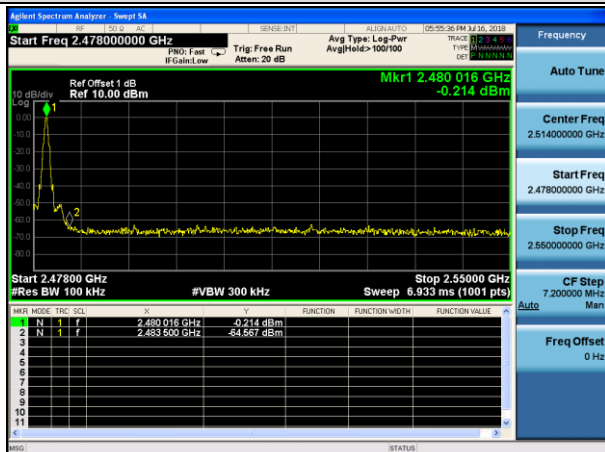

No-hopping mode

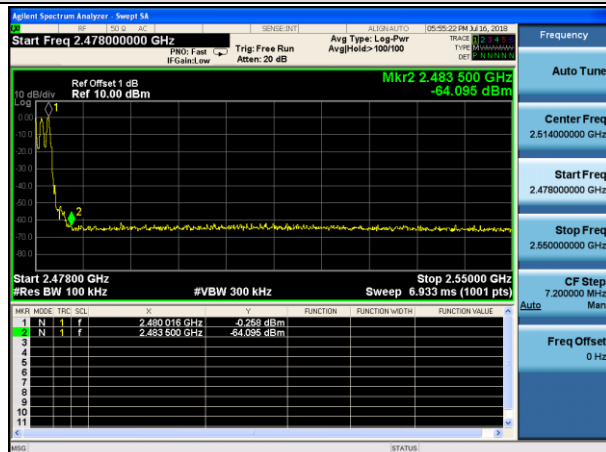

Hopping mode

Pi/4QPSK Mode:

Test channel:

Lowest channel

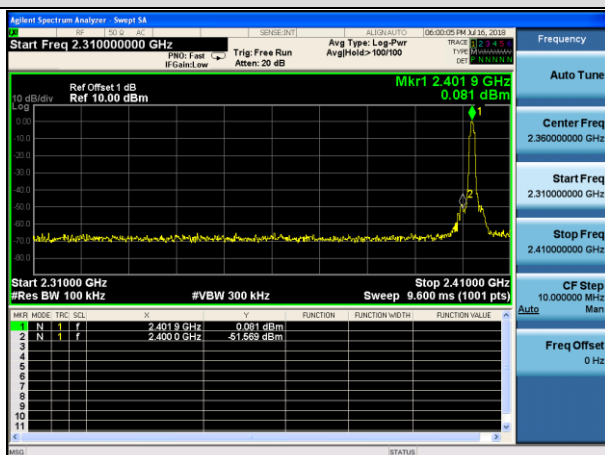

No-hopping mode

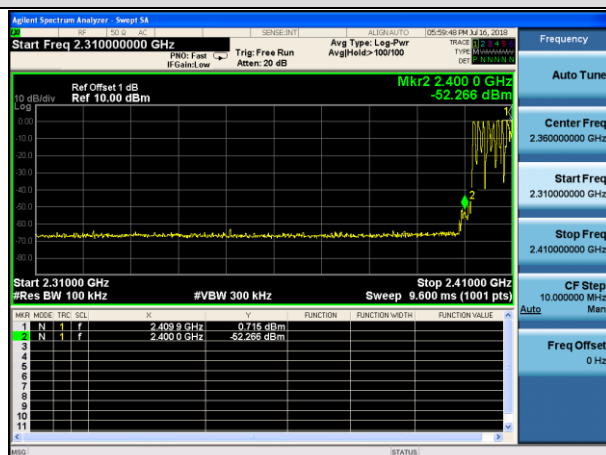

Hopping mode

Test channel:

Highest channel

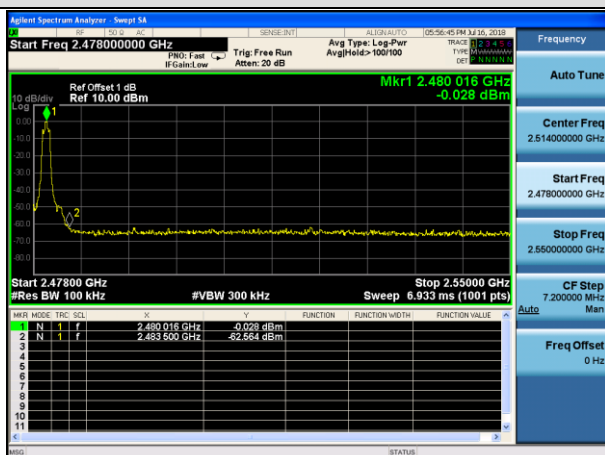

No-hopping mode

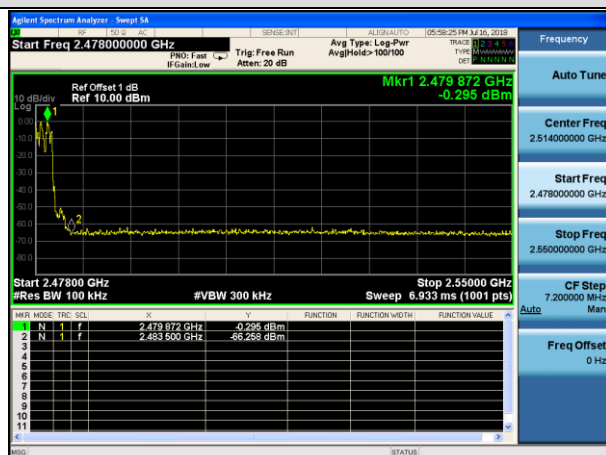

Hopping mode

8DPSK Mode:

Test channel:

Lowest channel

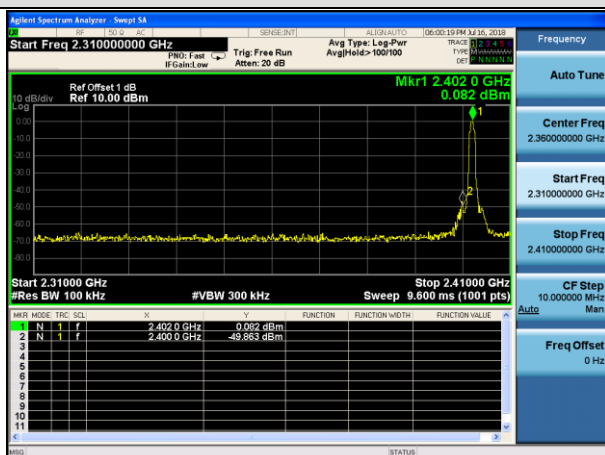

No-hopping mode

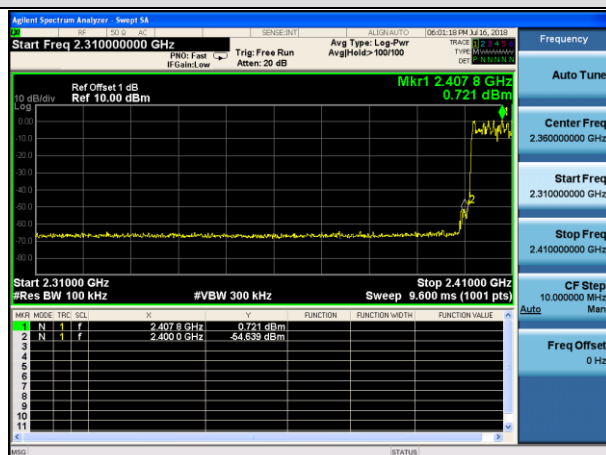

Hopping mode

Test channel:

Highest channel

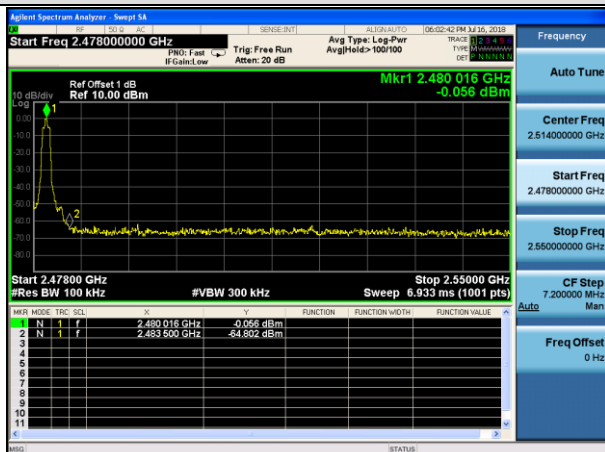

No-hopping mode

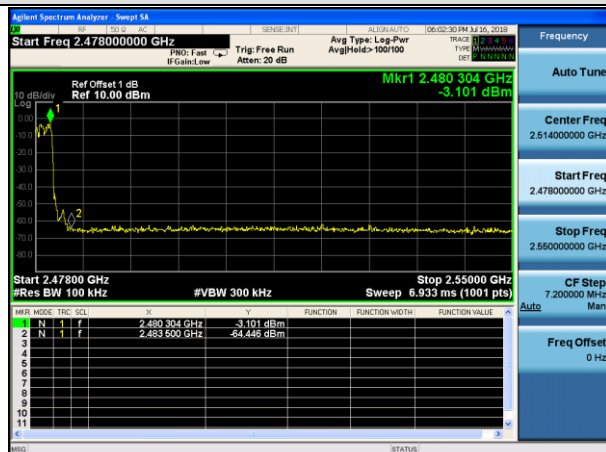

Hopping mode

10. POWER LINE CONDUCTED EMISSIONS

10.1. Block Diagram of Test Setup

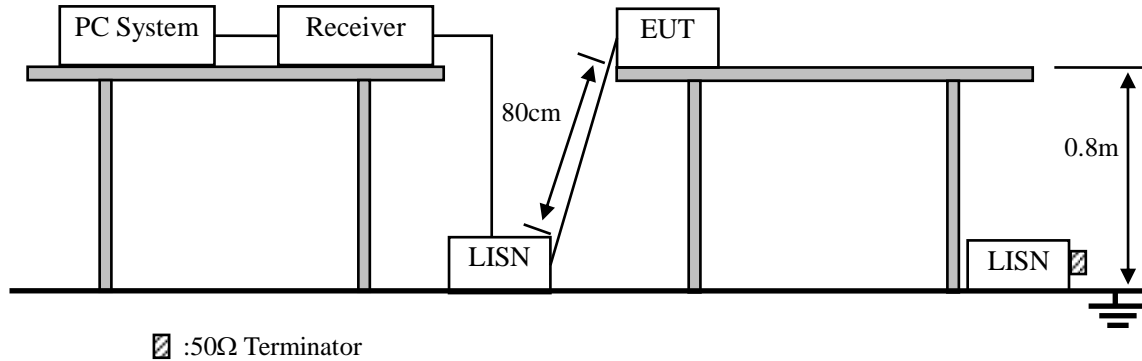

10.2. Limit

Frequency	Maximum RF Line Voltage	
	Quasi-Peak Level dB(μ V)	Average Level dB(μ V)
150kHz ~ 500kHz	66 ~ 56*	56 ~ 46*
500kHz ~ 5MHz	56	46
5MHz ~ 30MHz	60	50

Notes: 1. * Decreasing linearly with logarithm of frequency.

2. The lower limit shall apply at the transition frequencies.

10.3. Test Procedure

- (1) The EUT was placed on a non-metallic table, 80cm above the ground plane.
- (2) Setup the EUT and simulator as shown in 10.1
- (3) The EUT Power connected to the power mains through a power adapter and a line impedance stabilization network (L.I.S.N1). The other peripheral devices power cord connected to the power mains through a line impedance stabilization network (L.I.S.N2), this provided a 50-ohm coupling impedance for the EUT (Please refer to the block diagram of the test setup and photographs). Both sides of power line were checked for maximum conducted interference. In order to find the maximum emission, the relative positions of equipments and all of the interface cables were changed according to ANSI C63.10 :2013on conducted Emission test.
- (4) The bandwidth of test receiver is set at 10KHz.
- (5) The frequency range from 150 KHz to 30MHz is checked.

10.4. Test Result

PASS. (See below detailed test data)

Note: If peak Result comply with AV limit, QP and AV Result is deemed to comply with AV limit

Line:

Conducted Emission Measurement

File :07

Data :#2

Date: 2018-7-13

Time: 11:50:28

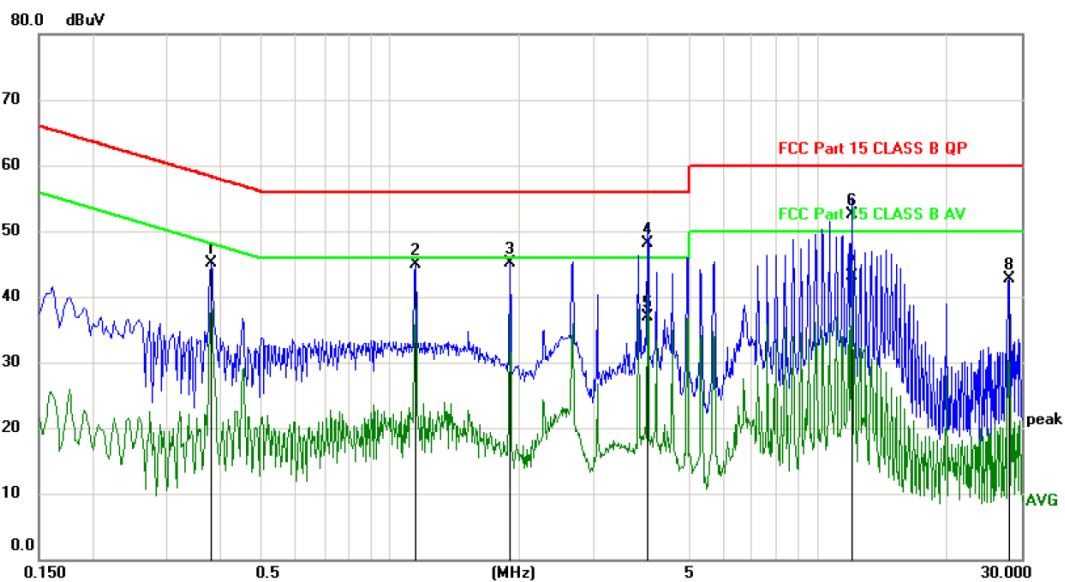

No.	Mk.	Freq. MHz	Reading Level dBuV	Correct Factor dB	Measure- ment dBuV	Limit dBuV	Margin dB	Detector	Comment
1		0.3810	35.35	9.70	45.05	58.26	-13.21	peak	
2		1.1430	35.17	9.78	44.95	56.00	-11.05	peak	
3		1.9050	35.25	9.87	45.12	56.00	-10.88	peak	
4		4.0050	38.00	10.08	48.08	56.00	-7.92	QP	
5		4.0050	26.82	10.08	36.90	46.00	-9.10	AVG	
6		12.0060	42.17	10.38	52.55	60.00	-7.45	QP	
7	*	12.0060	32.78	10.38	43.16	50.00	-6.84	AVG	
8		28.0050	31.77	10.90	42.67	60.00	-17.33	peak	

*:Maximum data x:Over limit !:over margin

Note: Measurement=Reading Level+Correc Factor. Factor=(LISN or ISN or PLC or Current Probe)Factor+Cable

Neutral:

Conducted Emission Measurement

File :07 Data :#1 Date: 2018-7-13 Time: 11:46:46

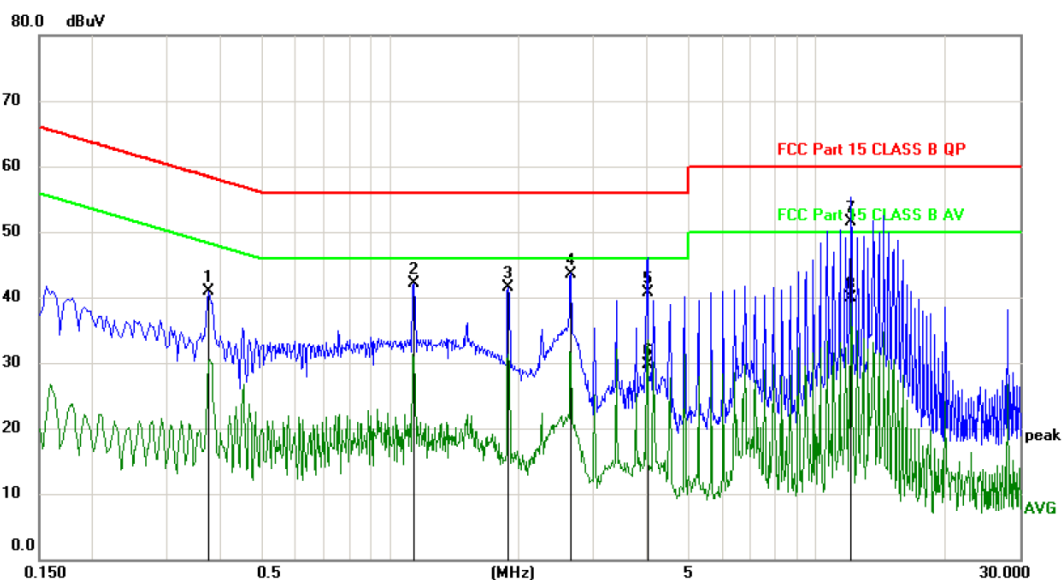

No. Mk.	Freq. MHz	Reading Level dBuV	Correct Factor dB	Measurement dBuV	Limit dBuV	Margin dB	Detector	Comment
1	0.3750	31.28	9.70	40.98	58.39	-17.41	peak	
2	1.1400	32.34	9.78	42.12	56.00	-13.88	peak	
3	1.8960	31.66	9.87	41.53	56.00	-14.47	peak	
4	2.6550	33.64	9.96	43.60	56.00	-12.40	peak	
5	4.0080	30.72	10.08	40.80	56.00	-15.20	QP	
6	4.0080	19.59	10.08	29.67	46.00	-16.33	AVG	
7 *	12.0180	41.04	10.38	51.42	60.00	-8.58	QP	
8	12.0180	29.55	10.38	39.93	50.00	-10.07	AVG	

*:Maximum data x:Over limit !:over margin

Note: Measurement=Reading Level+Correc Factor. Factor=(LISN or ISN or PLC or Current Probe)Factor+Cable

Remark: All modes have been tested, and only worst data of GFSK mode, Channel 2480MHz (AC 120V/60Hz) was listed in this report.

11. ANTENNA REQUIREMENTS

11.1. Limit

For intentional device, according to FCC 47 CFR Section 15.203, an intentional radiator shall be designed to ensure that no antenna other than that furnished by the responsible party shall be used with the device. And according to FCC 47 CFR Section 15.247 (b), if transmitting antennas of directional gain greater than 6dBi are used, the power shall be reduced by the amount in dB that the directional gain of the antenna exceeds 6dBi.

11.2. Result

The EUT antenna is PCB Antenna. It complies with the standard requirement.

12. TEST SETUP PHOTO

12.1. Photos of Radiated emission

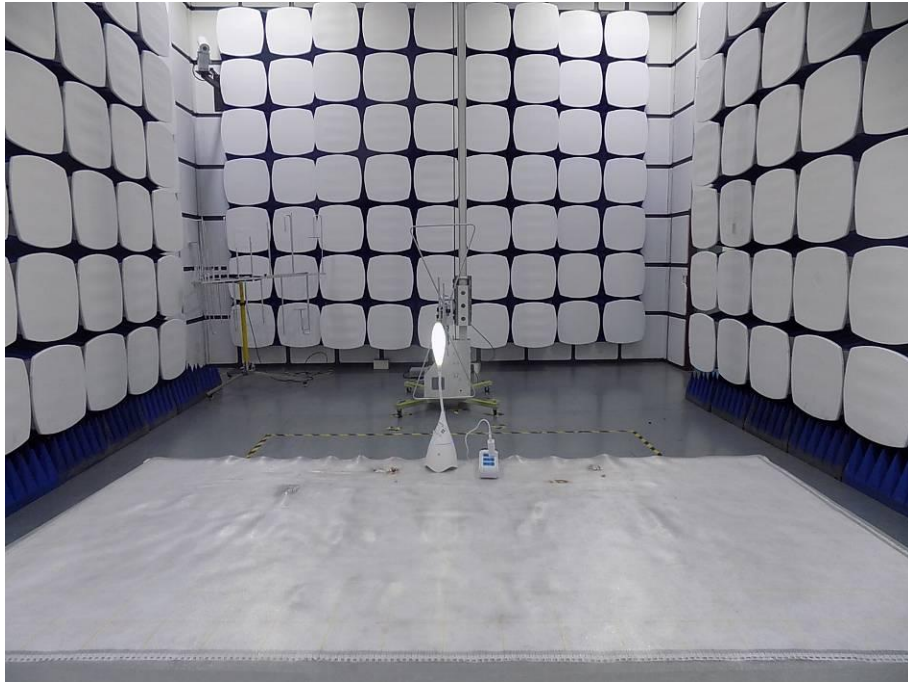

12.2.Photos of Conducted Emission test

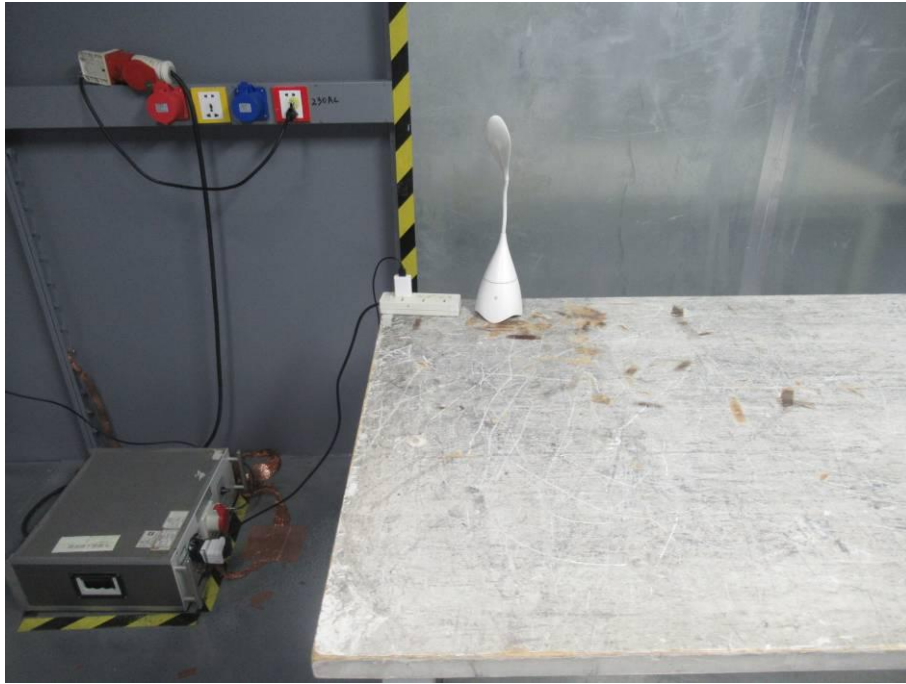

13. PHOTOS OF EUT



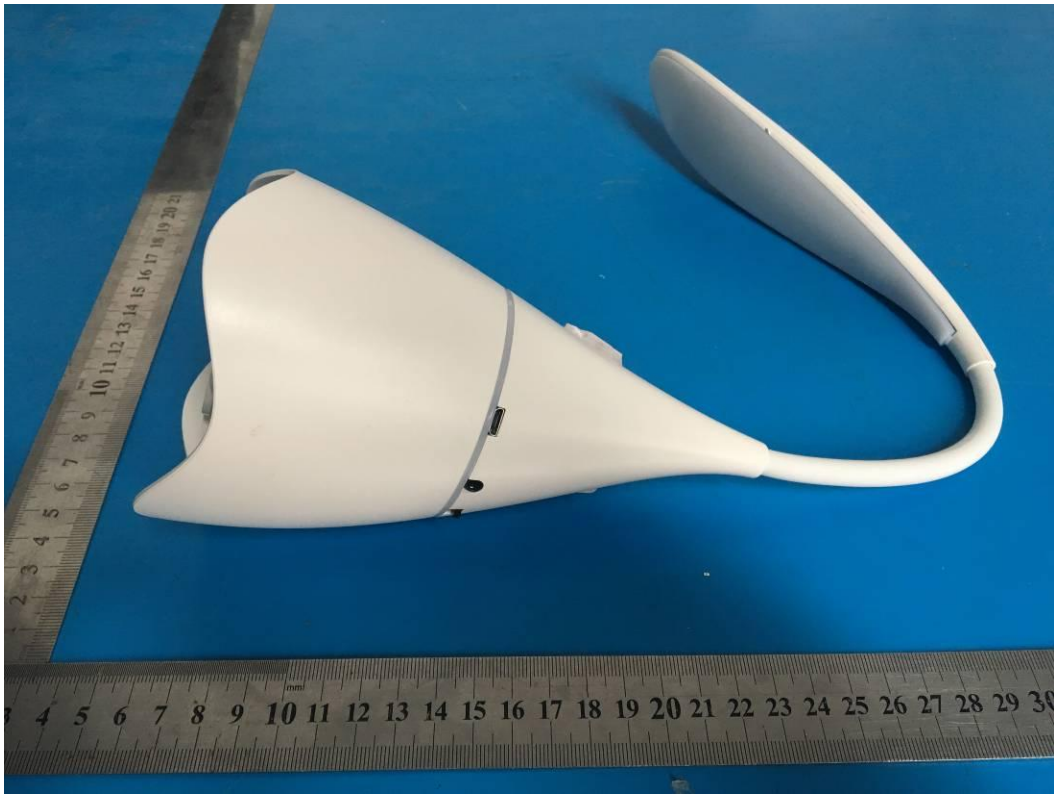



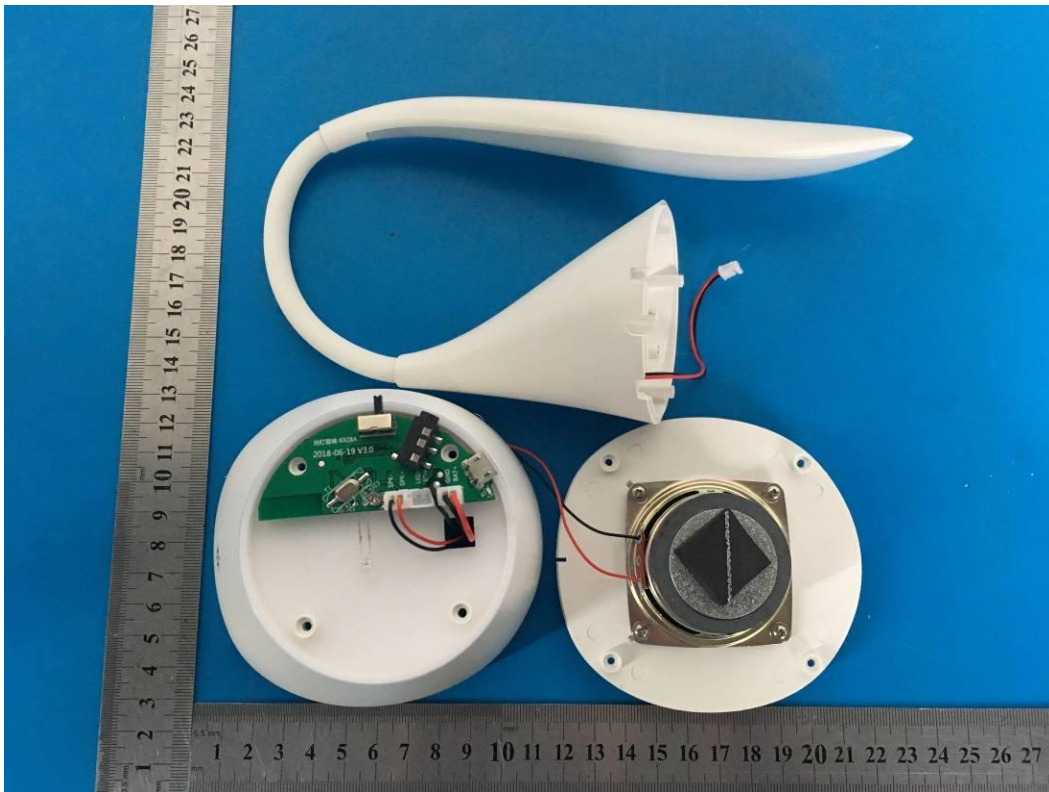
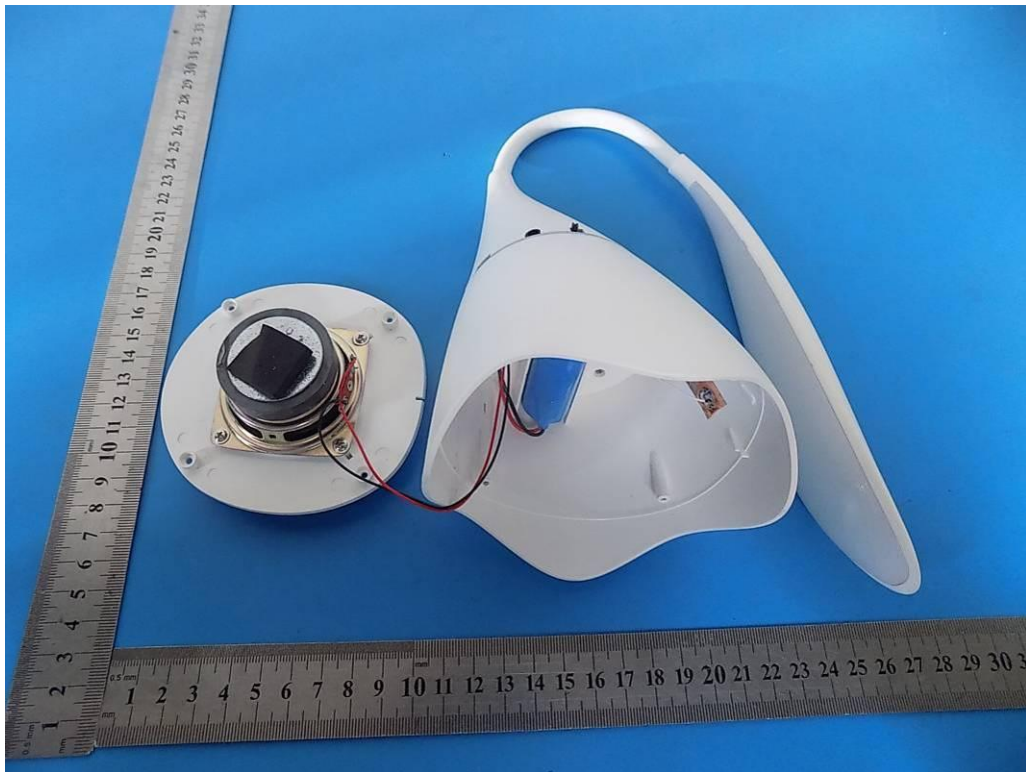

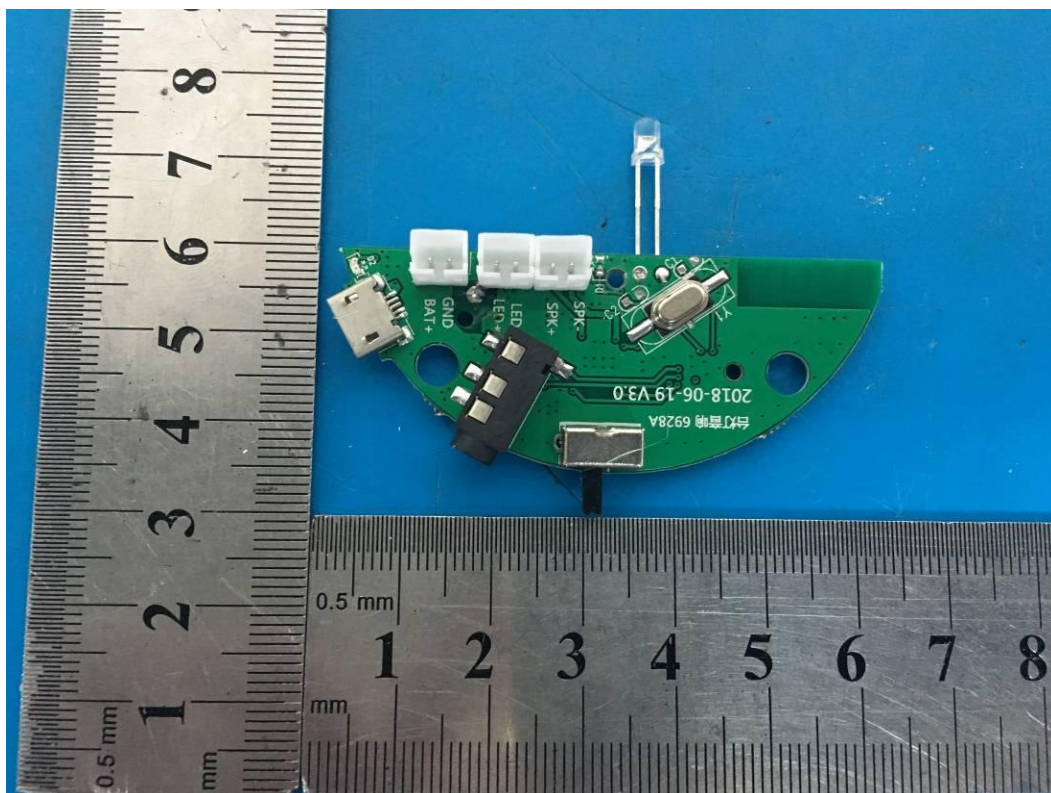
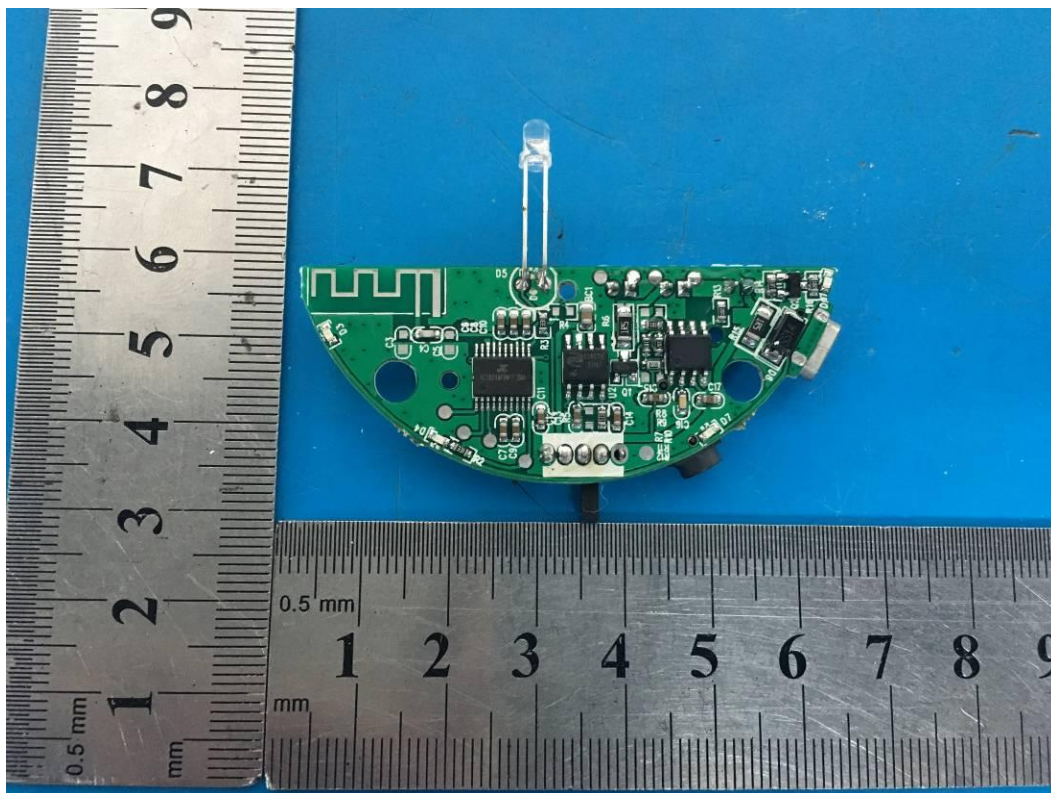

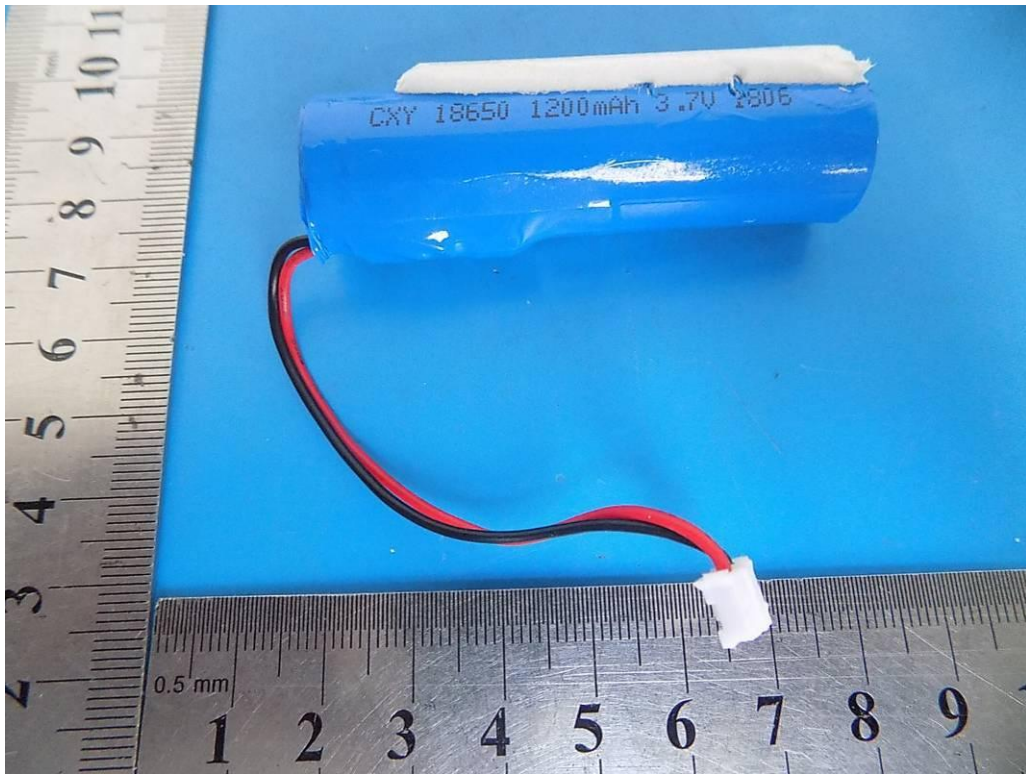

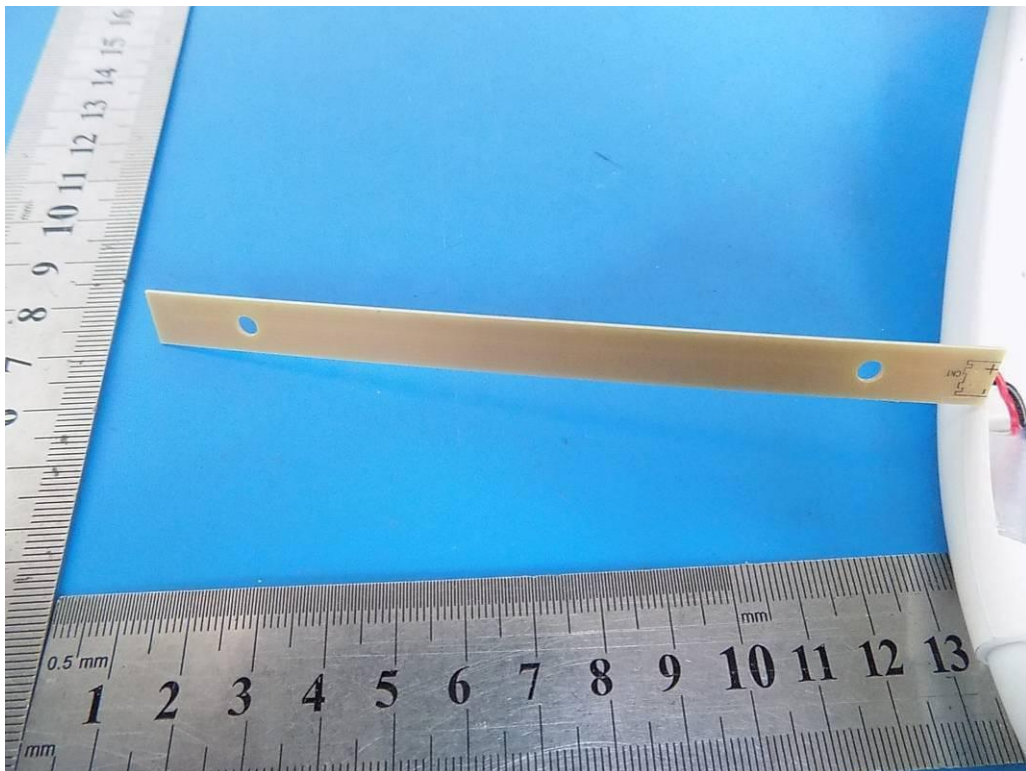
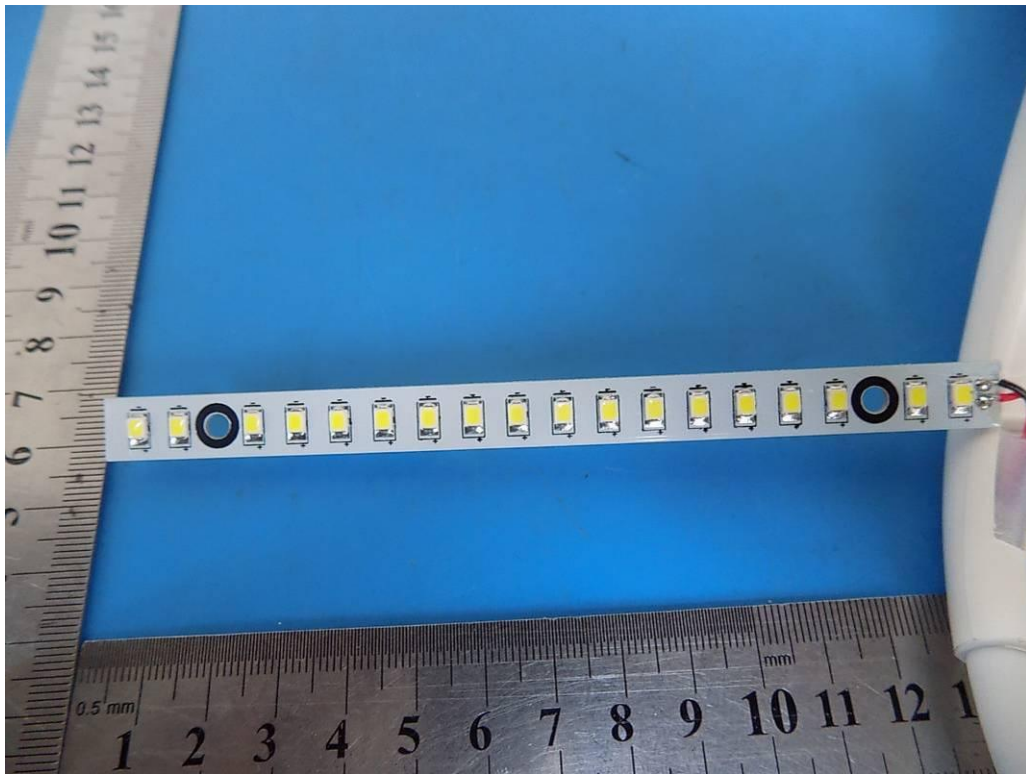

-----THE END OF REPORT-----