

FCC Test Report

Report No.: RF170109E09-1

FCC ID: 2ALIE-VRG531X

Test Model: VRG5-31412SFP

Received Date: Jan. 09, 2017

Test Date: Jan. 25 to Feb. 16, 2017

Issued Date: June 29, 2017

Applicant: Connection Technology System Inc

Address: 18F-6, No.79, Sec.1, Xintai 5th Rd., Xizhi Dist., New Taipei City 221, Taiwan (R.O.C.)

Issued By: Bureau Veritas Consumer Products Services (H.K.) Ltd., Taoyuan Branch
Hsin Chu Laboratory

Lab Address: E-2, No.1, Li Hsin 1st Road, Hsinchu Science Park, Hsinchu City 300,
Taiwan R.O.C.

Test Location (1): E-2, No.1, Li Hsin 1st Road, Hsinchu Science Park, Hsinchu City 300,
Taiwan R.O.C.

Test Location (2): No. 49, Ln. 206, Wende Rd., Shangshan Tsuen, Chiung Lin Hsiang, Hsin
Chu Hsien 307, Taiwan R.O.C.



This report is for your exclusive use. Any copying or replication of this report to or for any other person or entity, or use of our name or trademark, is permitted only with our prior written permission. This report sets forth our findings solely with respect to the test samples identified herein. The results set forth in this report are not indicative or representative of the quality or characteristics of the lot from which a test sample was taken or any similar or identical product unless specifically and expressly noted. Our report includes all of the tests requested by you and the results thereof based upon the information that you provided to us. You have 60 days from date of issuance of this report to notify us of any material error or omission caused by our negligence, provided, however, that such notice shall be in writing and shall specifically address the issue you wish to raise. A failure to raise such issue within the prescribed time shall constitute your unqualified acceptance of the completeness of this report, the tests conducted and the correctness of the report contents. Unless specific mention, the uncertainty of measurement has been explicitly taken into account to declare the compliance or non-compliance to the specification. The report must not be used by the client to claim product certification, approval, or endorsement by TAF or any government agencies.

Table of Contents

Release Control Record	4
1 Certificate of Conformity	5
2 Summary of Test Results	6
2.1 Measurement Uncertainty	6
2.2 Modification Record	6
3 General Information	7
3.1 General Description of EUT	7
3.2 Description of Test Modes	9
3.2.1 Test Mode Applicability and Tested Channel Detail	10
3.3 Duty Cycle of Test Signal	12
3.4 Description of Support Units	13
3.4.1 Configuration of System under Test	14
3.5 General Description of Applied Standard	15
4 Test Types and Results	16
4.1 Radiated Emission and Bandedge Measurement	16
4.1.1 Limits of Radiated Emission and Bandedge Measurement	16
4.1.2 Test Instruments	17
4.1.3 Test Procedure	19
4.1.4 Deviation from Test Standard	19
4.1.5 Test Setup	20
4.1.6 EUT Operating Condition	21
4.1.7 Test Results	22
4.2 Conducted Emission Measurement	41
4.2.1 Limits of Conducted Emission Measurement	41
4.2.2 Test Instruments	41
4.2.3 Test Procedure	42
4.2.4 Deviation from Test Standard	42
4.2.5 Test Setup	42
4.2.6 EUT Operating Condition	42
4.2.7 Test Results	43
4.3 Transmit Power Measurement	45
4.3.1 Limits of Transmit Power Measurement	45
4.3.2 Test Setup	45
4.3.3 Test Instruments	45
4.3.4 Test Procedure	45
4.3.5 Deviation from Test Standard	45
4.3.6 EUT Operating Condition	45
4.3.7 Test Result	46
4.4 Occupied Bandwidth Measurement	47
4.4.1 Test Setup	47
4.4.2 Test Instruments	47
4.4.3 Test Procedure	47
4.4.4 Test Results	48
4.5 Peak Power Spectral Density Measurement	52
4.5.1 Limits of Peak Power Spectral Density Measurement	52
4.5.2 Test Setup	52
4.5.3 Test Instruments	52
4.5.4 Test Procedure	53
4.5.5 Deviation from Test Standard	53
4.5.6 EUT Operating Condition	53
4.5.7 Test Results	54
4.6 Frequency Stability Measurement	60
4.6.1 Limits of Frequency Stability Measurement	60

4.6.2	Test Setup.....	60
4.6.3	Test Instruments	60
4.6.4	Test Procedure	60
4.6.5	Deviation from Test Standard	60
4.6.6	EUT Operating Condition	60
4.6.7	Test Results	61
4.7	6dB Bandwidth Measurement	62
4.7.1	Limits of 6dB Bandwidth Measurement.....	62
4.7.2	Test Setup.....	62
4.7.3	Test Instruments	62
4.7.4	Test Procedure	62
4.7.5	Deviation from Test Standard	62
4.7.6	EUT Operating Condition	62
4.7.7	Test Results	63
5	Pictures of Test Arrangements.....	65
	Annex A- Radiated Out of Band Emission (OOBE) Measurement (For U-NII-3 band)	66
	Appendix – Information on the Testing Laboratories	69

Release Control Record

Issue No.	Description	Date Issued
RF170109E09-1	Original release.	June 29, 2017

1 Certificate of Conformity

Product: Wireless Home Gateway

Brand: CTS

Test Model: VRG5-31412SFP

Sample Status: ENGINEERING SAMPLE

Applicant: Connection Technology System Inc

Test Date: Jan. 25 to Feb. 16, 2017

Standard: 47 CFR FCC Part 15, Subpart E (Section 15.407)
ANSI C63.10: 2013

The above equipment has been tested by **Bureau Veritas Consumer Products Services (H.K.) Ltd., Taoyuan Branch**, and found compliance with the requirement of the above standards. The test record, data evaluation & Equipment Under Test (EUT) configurations represented herein are true and accurate accounts of the measurements of the sample's EMC characteristics under the conditions specified in this report.

Prepared by :  _____, **Date:** _____ June 29, 2017
Wendy Wu / Specialist

Approved by :  _____, **Date:** _____ June 29, 2017
May Chen / Manager

2 Summary of Test Results

47 CFR FCC Part 15, Subpart E (Section 15.407)			
FCC Clause	Test Item	Result	Remarks
15.407(b)(6)	AC Power Conducted Emissions	Pass	Meet the requirement of limit. Minimum passing margin is -7.66dB at 0.34531MHz.
15.407(b) (1/2/3/4(i/ii)/6)	Radiated Emissions & Band Edge Measurement*	Pass	Meet the requirement of limit. Minimum passing margin is -3.5dB at 11650.00MHz.
15.407(a)(1/2/3)	Max Average Transmit Power	Pass	Meet the requirement of limit.
---	Occupied Bandwidth Measurement	-	Reference only.
15.407(a)(1/2/3)	Peak Power Spectral Density	Pass	Meet the requirement of limit.
15.407(e)	6dB bandwidth	Pass	Meet the requirement of limit. (U-NII-3 Band only)
15.407(g)	Frequency Stability	Pass	Meet the requirement of limit.
15.203	Antenna Requirement	Pass	Antenna connector is i-pex(MHF) not a standard connector.

*For U-NII-3 band compliance with rule part 15.407(b)(4)(i), the OOB test plots were recorded in Annex A.

2.1 Measurement Uncertainty

Where relevant, the following measurement uncertainty levels have been estimated for tests performed on the EUT as specified in CISPR 16-4-2:

Measurement	Frequency	Expanded Uncertainty (k=2) (±)
Conducted Emissions at mains ports	150kHz ~ 30MHz	1.83 dB
Radiated Emissions up to 1 GHz	30MHz ~ 1GHz	5.36 dB
Radiated Emissions above 1 GHz	1GHz ~ 6GHz	3.47 dB
	6GHz ~ 18GHz	3.75 dB
	18GHz ~ 40GHz	3.30 dB

2.2 Modification Record

There were no modifications required for compliance.

3 General Information

3.1 General Description of EUT

Product	Wireless Home Gateway
Brand	CTS
Test Model	VRG5-31412SFP
Status of EUT	ENGINEERING SAMPLE
Power Supply Rating	DC 12V from power adapter
Modulation Type	CCK, DQPSK, DBPSK for DSSS 64QAM, 16QAM, QPSK, BPSK for OFDM 256QAM for OFDM in 11ac mode only
Modulation Technology	DSSS, OFDM
Transfer Rate	802.11b: up to 11Mbps 802.11a/g: up to 54Mbps 802.11n: up to 300Mbps 802.11ac: up to 866.7Mbps
Operating Frequency	2.4GHz: 2.412 ~ 2.462GHz 5GHz: 5.18 ~ 5.24GHz, 5.745 ~ 5.825GHz
Number of Channel	2.4GHz: 802.11b, 802.11g, 802.11n (HT20): 11 802.11n (HT40): 7 5GHz: 802.11a, 802.11n (HT20), 802.11ac (VHT20): 9 802.11n (HT40), 802.11ac (VHT40): 4 802.11ac (VHT80): 2
Output Power	2.4GHz: 502.463mW 5.18 ~ 5.24GHz: 55.918mW 5.745 ~ 5.825GHz: 59.365mW
Antenna Type	Refer to Note
Antenna Connector	Refer to Note
Accessory Device	Adapter x 1
Data Cable Supplied	NA

Note:

1. Simultaneously transmission condition.

Condition	Technology	
1	WLAN 2.4GHz	WLAN 5GHz

2. The EUT must be supplied with a power adapter as following table:

Brand	Model No.	Spec.
UMEC	UP0251M-12PA	Input: 100-240Vac, 0.6A, 50/60Hz Output: 12V, 2.1A DC output cable(unshielded, 1.8m)

3. The antennas provided to the EUT, please refer to the following table:

Antenna No.	Brand	Antenna Net. Gain(dBi)	Frequency range (GHz)	Antenna Type	Connecter Type	Cable Length (mm)
1	Master Wave	5.14	2.4~2.4835	Dipole	i-pex(MHF)	190
		5.56	5.15~5.85			
2	Master Wave	5.14	2.4~2.4835	Dipole	i-pex(MHF)	190
		5.56	5.15~5.85			

4. The EUT incorporates a MIMO function.

2.4GHz Band			
MODULATION MODE	DATA RATE (MCS)	TX & RX CONFIGURATION	
802.11b	1 ~ 11Mbps	2TX	2RX
802.11g	6 ~ 54Mbps	2TX	2RX
802.11n (HT20)	MCS 0~7	2TX	2RX
	MCS 8~15	2TX	2RX
802.11n (HT40)	MCS 0~7	2TX	2RX
	MCS 8~15	2TX	2RX
5GHz Band			
MODULATION MODE	DATA RATE (MCS)	TX & RX CONFIGURATION	
802.11a	6 ~ 54Mbps	2TX	2RX
802.11n (HT20)	MCS 0~7	2TX	2RX
	MCS 8~15	2TX	2RX
802.11n (HT40)	MCS 0~7	2TX	2RX
	MCS 8~15	2TX	2RX
802.11ac (VHT20)	MCS0~8 Nss=1	2TX	2RX
	MCS0~8 Nss=2	2TX	2RX
802.11ac (VHT40)	MCS0~9 Nss=1	2TX	2RX
	MCS0~9 Nss=2	2TX	2RX
802.11ac (VHT80)	MCS0~9 Nss=1	2TX	2RX
	MCS0~9 Nss=2	2TX	2RX

Note:

- The modulation and bandwidth are similar for 802.11n mode for 20MHz (40MHz) and 802.11ac mode for 20MHz (40MHz), therefore investigated worst case to representative mode in test report. (Final test mode refer section 3.2.1)

5. The above EUT information is declared by manufacturer and for more detailed features description, please refer to the manufacturer's specifications or user's manual.

3.2 Description of Test Modes

FOR 5180 ~ 5240MHz

4 channels are provided for 802.11a, 802.11n (HT20), 802.11ac (VHT20):

Channel	Frequency	Channel	Frequency
36	5180MHz	44	5220MHz
40	5200MHz	48	5240MHz

2 channels are provided for 802.11n (HT40), 802.11ac (VHT40):

Channel	Frequency	Channel	Frequency
38	5190MHz	46	5230MHz

1 channel is provided for 802.11ac (VHT80):

Channel	Frequency
42	5210MHz

FOR 5745 ~ 5825MHz:

5 channels are provided for 802.11a, 802.11n (HT20), 802.11ac (VHT20):

Channel	Frequency	Channel	Frequency
149	5745MHz	161	5805MHz
153	5765MHz	165	5825MHz
157	5785MHz		

2 channels are provided for 802.11n (HT40), 802.11ac (VHT40):

Channel	Frequency	Channel	Frequency
151	5755MHz	159	5795MHz

1 channel is provided for 802.11ac (VHT80):

Channel	Frequency
155	5775MHz

3.2.1 Test Mode Applicability and Tested Channel Detail

EUT Configure Mode	Applicable To				Description
	RE≥1G	RE<1G	PLC	APCM	
-	√	√	√	√	-

Where **RE≥1G**: Radiated Emission above 1GHz **RE<1G**: Radiated Emission below 1GHz
PLC: Power Line Conducted Emission **APCM**: Antenna Port Conducted Measurement

NOTE:

1. The EUT had been pre-tested on the positioned of each 2axis. The worst case was found when positioned on **X-plane**.

Radiated Emission Test (Above 1GHz):

- Pre-Scan has been conducted to determine the worst-case mode from all possible combinations between available modulations, data rates and antenna ports (if EUT with antenna diversity architecture).
- Following channel(s) was (were) selected for the final test as listed below.

Mode	FREQ. Band (MHz)	Available Channel	Tested Channel	Modulation Technology	Modulation Type	Data Rate (Mbps)
802.11a	5180-5240	36 to 48	36, 40, 48	OFDM	BPSK	6
802.11ac (VHT20)		36 to 48	36, 40, 48	OFDM	BPSK	6.5
802.11ac (VHT40)		38 to 46	38, 46	OFDM	BPSK	13.5
802.11ac (VHT80)		42	42	OFDM	BPSK	29.3
802.11a	5745-5825	149 to 165	149, 157, 165	OFDM	BPSK	6
802.11ac (VHT20)		149 to 165	149, 157, 165	OFDM	BPSK	6.5
802.11ac (VHT40)		151 to 159	151, 159	OFDM	BPSK	13.5
802.11ac (VHT80)		155	155	OFDM	BPSK	29.3

Radiated Emission Test (Below 1GHz):

- Pre-Scan has been conducted to determine the worst-case mode from all possible combinations between available modulations, data rates and antenna ports (if EUT with antenna diversity architecture).
- Following channel(s) was (were) selected for the final test as listed below.

Mode	FREQ. Band (MHz)	Available Channel	Tested Channel	Modulation Technology	Modulation Type	Data Rate (Mbps)
802.11a	5745-5825	149 to 165	165	OFDM	BPSK	6

Power Line Conducted Emission Test:

- Pre-Scan has been conducted to determine the worst-case mode from all possible combinations between available modulations, data rates and antenna ports (if EUT with antenna diversity architecture).
- Following channel(s) was (were) selected for the final test as listed below.

Mode	FREQ. Band (MHz)	Available Channel	Tested Channel	Modulation Technology	Modulation Type	Data Rate (Mbps)
802.11a	5745-5825	149 to 165	165	OFDM	BPSK	6

Antenna Port Conducted Measurement:

- This item includes all test value of each mode, but only includes spectrum plot of worst value of each mode.
- Pre-Scan has been conducted to determine the worst-case mode from all possible combinations between available modulations, data rates and antenna ports (if EUT with antenna diversity architecture).
- Following channel(s) was (were) selected for the final test as listed below.

Mode	FREQ. Band (MHz)	Available Channel	Tested Channel	Modulation Technology	Modulation Type	Data Rate (Mbps)
802.11a	5180-5240	36 to 48	36, 40, 48	OFDM	BPSK	6
802.11ac (VHT20)		36 to 48	36, 40, 48	OFDM	BPSK	6.5
802.11ac (VHT40)		38 to 46	38, 46	OFDM	BPSK	13.5
802.11ac (VHT80)		42	42	OFDM	BPSK	29.3
802.11a	5745-5825	149 to 165	149, 157, 165	OFDM	BPSK	6
802.11ac (VHT20)		149 to 165	149, 157, 165	OFDM	BPSK	6.5
802.11ac (VHT40)		151 to 159	151, 159	OFDM	BPSK	13.5
802.11ac (VHT80)		155	155	OFDM	BPSK	29.3

Test Condition:

Applicable To	Environmental Conditions	Input Power	Tested By
RE≥1G	22deg. C, 63%RH	120Vac, 60Hz	Terry Huang
RE<1G	25deg. C, 64%RH	120Vac, 60Hz	Jyunchun Lin
PLC	24deg. C, 65%RH	120Vac, 60Hz	Jyunchun Lin
APCM	25deg. C, 60%RH	120Vac, 60Hz	Robert Cheng

3.3 Duty Cycle of Test Signal

If duty cycle of test signal is < 98%, duty factor shall be considered.

802.11a: Duty cycle = 1.395 ms/1.45 ms = 0.962, Duty factor = $10 * \log(1/0.962) = 0.17$

802.11ac (VHT20): Duty cycle = 1.306 ms/1.406 ms = 0.929, Duty factor = $10 * \log(1/0.929) = 0.32$

802.11ac (VHT40): Duty cycle = 0.646 ms/0.843 ms = 0.766, Duty factor = $10 * \log(1/0.766) = 1.16$

802.11ac (VHT80): Duty cycle = 0.323 ms/0.451 ms = 0.716, Duty factor = $10 * \log(1/0.716) = 1.45$

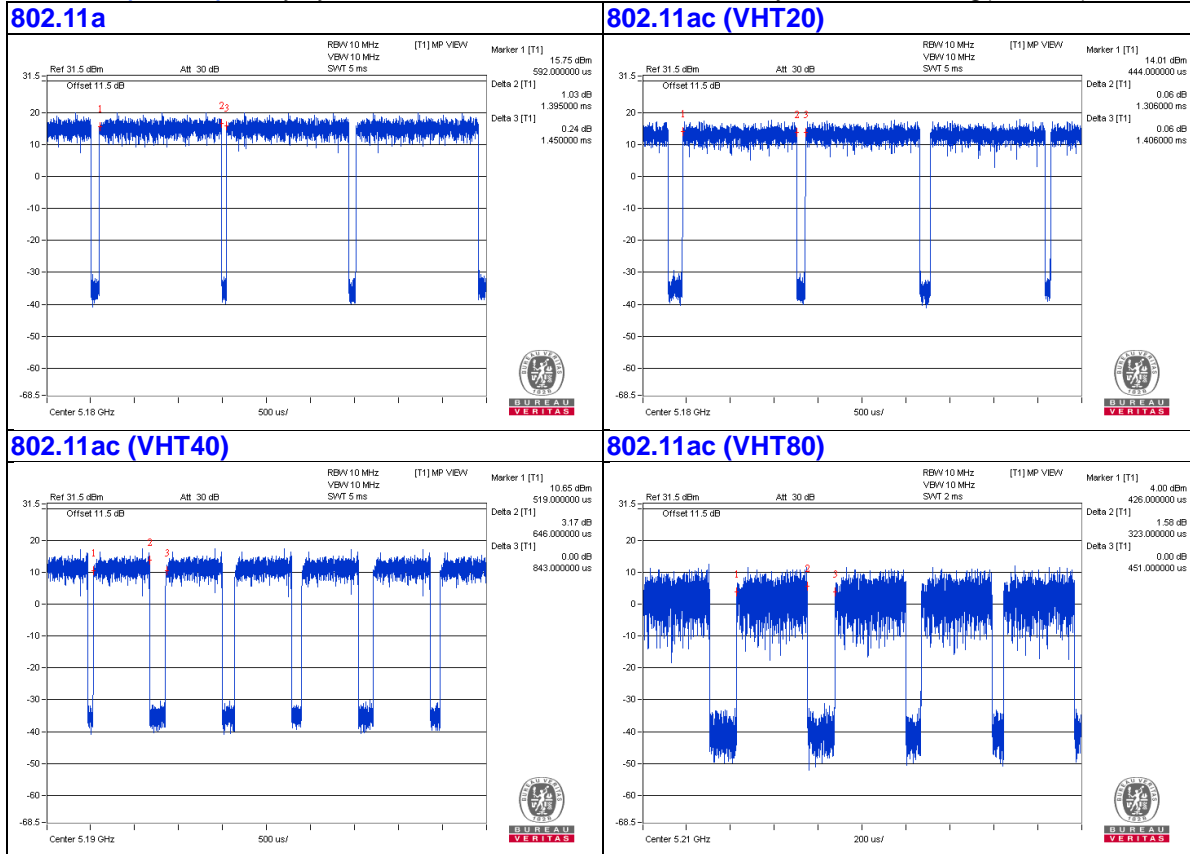

3.4 Description of Support Units

The EUT has been tested as an independent unit together with other necessary accessories or support units. The following support units or accessories were used to form a representative test configuration during the tests.

ID	Product	Brand	Model No.	Serial No.	FCC ID	Remarks
A.	Laptop	DELL	E5430	HYV4VY1	FCC DoC	Provided by Lab
B.	Laptop	DELL	E5430	HYV4VY1	FCC DoC	Provided by Lab
C.	Laptop	DELL	E5440	6FC7F12	FCC DoC	Provided by Lab
D.	iPod	Apple	MD778TA/A	CC4JG680F4T1	NA	Provided by Lab
E.	iPod	Apple	MD778TA/A	CC4JL03FF4T1	NA	Provided by Lab
F.	Fiber to RJ45	NA	NA	NA	NA	Supplied by client

Note:

1. All power cords of the above support units are non-shielded (1.8m).
2. Items E-F acted as communication partners to transfer data.

ID	Descriptions	Qty.	Length (m)	Shielding (Yes/No)	Cores (Qty.)	Remarks
1.	DC Cable	1	1.8	No	0	Supplied by client
2.	Fiber Cable	1	0.3	No	0	Supplied by client
3.	RJ-45 Cable	1	10	No	0	Provided by Lab
4.	RJ-45 Cable	1	10	No	0	Provided by Lab
5.	RJ-45 Cable	1	10	No	0	Provided by Lab
6.	USB Cable	1	0.1	Yes	0	Provided by Lab
7.	USB Cable	1	0.1	Yes	0	Provided by Lab
8.	RJ-11 Cable	1	10	No	0	Provided by Lab

Note: The core(s) is(are) originally attached to the cable(s).

3.4.1 Configuration of System under Test

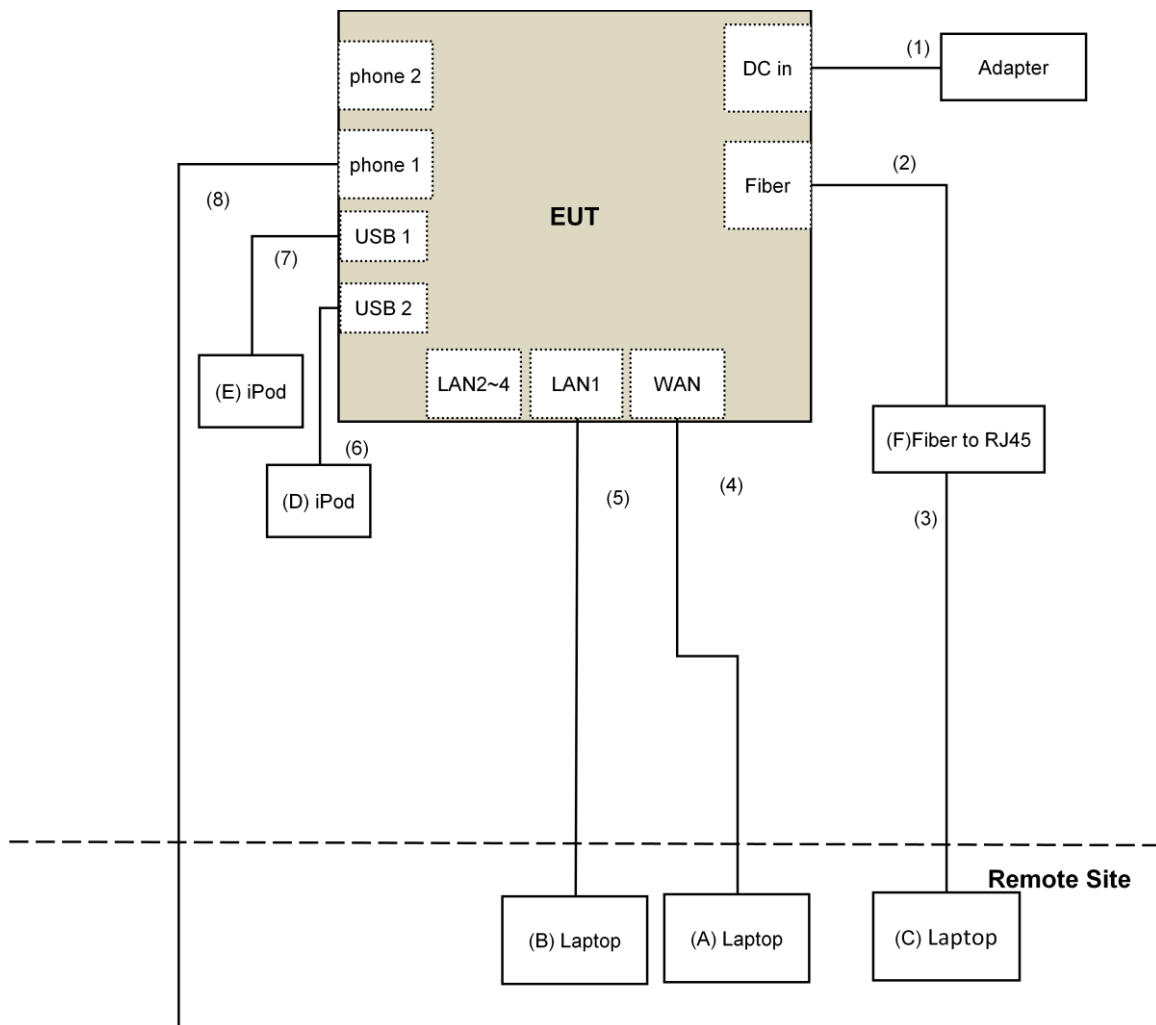

3.5 General Description of Applied Standard

The EUT is a RF Product. According to the specifications of the manufacturer, it must comply with the requirements of the following standards:

FCC Part 15, Subpart E (15.407)
KDB 789033 D02 General UNII Test Procedure New Rules v01r04
KDB 662911 D01 Multiple Transmitter Output v02r01
ANSI C63.10-2013

All test items have been performed and recorded as per the above standards.

NOTE: The EUT has been verified to comply with the requirements of FCC Part 15, Subpart B, Class B (DoC). The test report has been issued separately.

4 Test Types and Results

4.1 Radiated Emission and Bandedge Measurement

4.1.1 Limits of Radiated Emission and Bandedge Measurement

Radiated emissions which fall in the restricted bands must comply with the radiated emission limits specified as below table.

Frequencies (MHz)	Field Strength (microvolts/meter)	Measurement Distance (meters)
0.009 ~ 0.490	2400/F(kHz)	300
0.490 ~ 1.705	24000/F(kHz)	30
1.705 ~ 30.0	30	30
30 ~ 88	100	3
88 ~ 216	150	3
216 ~ 960	200	3
Above 960	500	3

NOTE:

1. The lower limit shall apply at the transition frequencies.
2. Emission level (dBuV/m) = 20 log Emission level (uV/m).
3. For frequencies above 1000MHz, the field strength limits are based on average detector, however, the peak field strength of any emission shall not exceed the maximum permitted average limits, specified above by more than 20dB under any condition of modulation.

Limits of unwanted emission out of the restricted bands

Applicable To		Limit	
789033 D02 General UNII Test Procedure New Rules v01r04		Field Strength at 3m	
		PK:74 (dBuV/m)	AV:54 (dBuV/m)
Frequency Band	Applicable To	EIRP Limit	Equivalent Field Strength at 3m
5150~5250 MHz	15.407(b)(1)	PK:-27 (dBm/MHz)	PK:68.2(dBuV/m)
5250~5350 MHz	15.407(b)(2)		
5470~5725 MHz	15.407(b)(3)		
5725~5850 MHz	<input checked="" type="checkbox"/> 15.407(b)(4)(i)	PK:-27 (dBm/MHz) ^{*1} PK:10 (dBm/MHz) ^{*2} PK:15.6 (dBm/MHz) ^{*3} PK:27 (dBm/MHz) ^{*4}	PK: 68.2(dBuV/m) ^{*1} PK:105.2 (dBuV/m) ^{*2} PK: 110.8(dBuV/m) ^{*3} PK:122.2 (dBuV/m) ^{*4}
	<input type="checkbox"/> 15.407(b)(4)(ii)	Emission limits in section 15.247(d)	
^{*1} beyond 75 MHz or more above of the band edge.		^{*2} below the band edge increasing linearly to 10 dBm/MHz at 25 MHz above.	
^{*3} below the band edge increasing linearly to a level of 15.6 dBm/MHz at 5 MHz above.		^{*4} from 5 MHz above or below the band edge increasing linearly to a level of 27 dBm/MHz at the band edge.	

Note:

The following formula is used to convert the equipment isotropic radiated power (eirp) to field strength:

$$E = \frac{1000000\sqrt{30P}}{3} \mu\text{V/m, where P is the eirp (Watts).}$$

4.1.2 Test Instruments

DESCRIPTION & MANUFACTURER	MODEL NO.	SERIAL NO.	CALIBRATED DATE	CALIBRATED UNTIL
Test Receiver Keysight	N9038A	MY54450088	July 20, 2016	July 19, 2017
Pre-Amplifier ^(*) EMCI	EMC001340	980142	Jan. 20, 2016	Jan. 19, 2018
Loop Antenna ^(*) Electro-Metrics	EM-6879	264	Dec. 16, 2016	Dec. 15, 2018
RF Cable	NA	LOOPCAB-001 LOOPCAB-002	Jan. 17, 2017	Jan. 16, 2018
Pre-Amplifier Mini-Circuits	ZFL-1000VH2B	AMP-ZFL-01	Nov. 10, 2016	Nov. 09, 2017
Trilog Broadband Antenna SCHWARZBECK	VULB 9168	9168-406	Dec. 13, 2016	Dec. 12, 2017
RF Cable	8D	966-4-1 966-4-2 966-4-3	Apr. 02, 2016	Apr. 01, 2017
Fixed attenuator Mini-Circuits	UNAT-5+	PAD-3m-4-01	Oct. 05, 2016	Oct. 04, 2017
Horn_Antenna SCHWARZBECK	BBHA 9120D	9120D-783	Dec. 27, 2016	Dec. 26, 2017
Pre-Amplifier EMCI	EMC12630SE	980385	Feb. 02, 2017	Feb. 01, 2018
RF Cable	EMC104-SM-SM-2000 EMC104-SM-SM-5000 EMC104-SM-SM-5000	160923 150318 150323	Feb. 02, 2017 Mar. 30, 2016 Mar. 30, 2016	Feb. 01, 2018 Mar. 29, 2017 Mar. 29, 2017
Pre-Amplifier EMCI	EMC184045SE	980387	Feb. 02, 2017	Feb. 01, 2018
Horn_Antenna SCHWARZBECK	BBHA 9170	BBHA9170608	Dec. 15, 2016	Dec. 14, 2017
RF Cable	SUCOFLEX 102	36432/2 36433/2	Jan. 15, 2017	Jan. 14, 2018
Software	ADT_Radiated_V8.7.08	NA	NA	NA
Antenna Tower & Turn Table Max-Full	MF-7802	MF780208410	NA	NA
Boresight Antenna Fixture	FBA-01	FBA-SIP02	NA	NA
Spectrum Analyzer R&S	FSv40	100964	June 28, 2016	June 27, 2017
Power meter Anritsu	ML2495A	1014008	May 5, 2016	May 4, 2017
Power sensor Anritsu	MA2411B	0917122	May 5, 2016	May 4, 2017
AC Power Source Extech Electronics	6205	1440452	NA	NA
Temperature & Humidity Chamber Giant Force	GTH-150-40-SP-AR	MAA0812-008	Jan. 11, 2017	Jan. 10, 2018
Digital Multimeter FLUKE	87III	73680266	Nov. 10, 2016	Nov. 09, 2017

Note:

1. The calibration interval of the above test instruments is 12 months and the calibrations are traceable to NML/ROC and NIST/USA.
2. *The calibration interval of the above test instruments is 24 months and the calibrations are traceable to NML/ROC and NIST/USA.
3. The test was performed in 966 Chamber No. 4.
4. The FCC Site Registration No. is 292998
5. The CANADA Site Registration No. is 20331-2
- 6 Loop antenna was used for all emissions below 30 MHz.
7. Tested Date: Feb. 07 to 16, 2017

4.1.3 Test Procedure

For Radiated emission below 30MHz

- a. The EUT was placed on the top of a rotating table 0.8 meters above the ground at a 3 meter chamber room. The table was rotated 360 degrees to determine the position of the highest radiation.
- b. The EUT was set 3 meters away from the interference-receiving antenna, which was mounted on the top of a variable-height antenna tower.
- c. Both X and Y axes of the antenna are set to make the measurement.
- d. For each suspected emission, the EUT was arranged to its worst case and the rotatable table was turned from 0 degrees to 360 degrees to find the maximum reading.
- e. The test-receiver system was set to Quasi-Peak Detect Function and Specified Bandwidth with Maximum Hold Mode.

NOTE:

1. The resolution bandwidth and video bandwidth of test receiver/spectrum analyzer is 9kHz at frequency below 30MHz.

For Radiated emission above 30MHz

- a. The EUT was placed on the top of a rotating table 0.8 meters (for 30MHz ~ 1GHz) / 1.5 meters (for above 1GHz) above the ground at 3 meter chamber room for test. The table was rotated 360 degrees to determine the position of the highest radiation.
- b. The EUT was set 3 meters away from the interference-receiving antenna, which was mounted on the top of a variable-height antenna tower.
- c. The height of antenna is varied from one meter to four meters above the ground to determine the maximum value of the field strength. Both horizontal and vertical polarizations of the antenna are set to make the measurement.
- d. For each suspected emission, the EUT was arranged to its worst case and then the antenna was tuned to heights from 1 meter to 4 meters and the rotatable table was turned from 0 degrees to 360 degrees to find the maximum reading.
- e. The test-receiver system was set to quasi-peak detect function and specified bandwidth with maximum hold mode when the test frequency is below 1 GHz.
- f. The test-receiver system was set to peak and average detect function and specified bandwidth with maximum hold mode when the test frequency is above 1 GHz. If the peak reading value also meets average limit, measurement with the average detector is unnecessary.

Note:

1. The resolution bandwidth and video bandwidth of test receiver/spectrum analyzer is 120kHz for Quasi-peak detection (QP) at frequency below 1GHz.
2. The resolution bandwidth of test receiver/spectrum analyzer is 1 MHz and the video bandwidth is 3 MHz for Peak detection (PK) at frequency above 1GHz.
3. The resolution bandwidth of test receiver/spectrum analyzer is 1MHz and the video bandwidth is $\geq 1/T$ (Duty cycle < 98%) or 10Hz (Duty cycle $\geq 98\%$) for Average detection (AV) at frequency above 1GHz.
4. All modes of operation were investigated and the worst-case emissions are reported.

4.1.4 Deviation from Test Standard

No deviation.

4.1.5 Test Setup

For Radiated emission below 30MHz

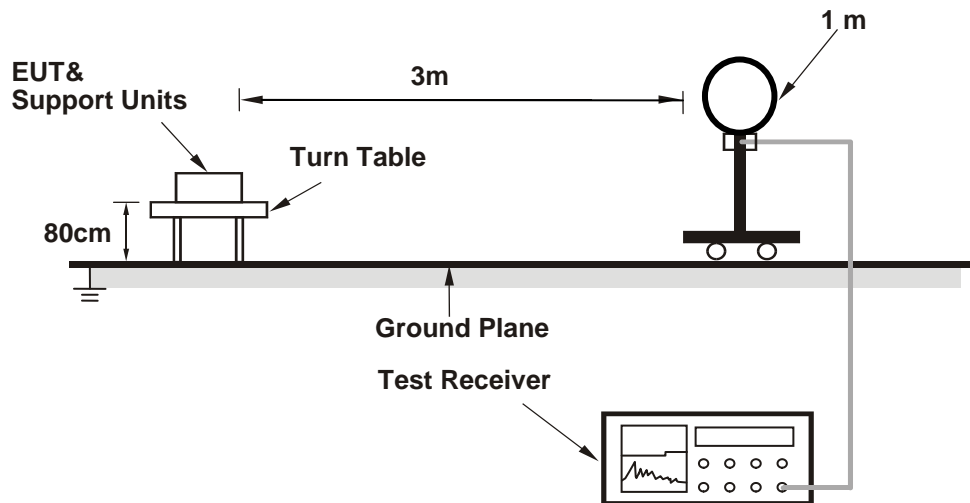

For Radiated emission 30MHz to 1GHz

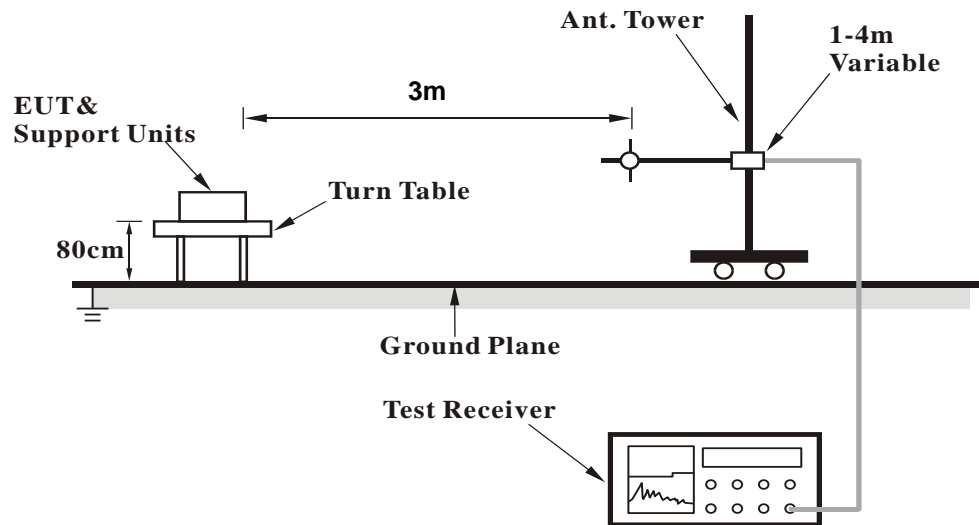

For Radiated emission above 1GHz

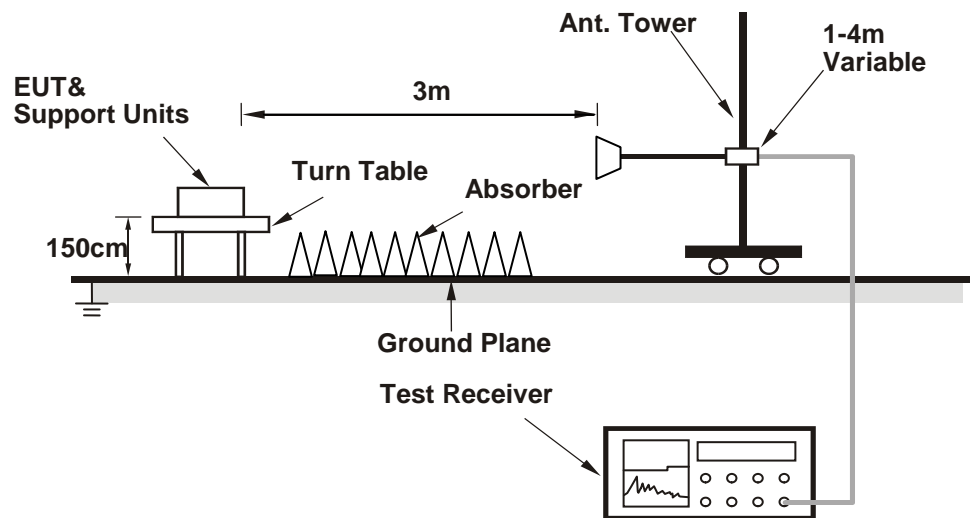

For the actual test configuration, please refer to the attached file (Test Setup Photo).

4.1.6 EUT Operating Condition

- a. Connected the EUT with the Laptop which is placed on remote site.
- b. Controlling software (MP_TEST [RTL819x Ver3.0-2014/09/30]) has been activated to set the EUT on specific status.

4.1.7 Test Results

Above 1GHz Data:

802.11a

CHANNEL	TX Channel 36	DETECTOR FUNCTION	Peak (PK)
FREQUENCY RANGE	1GHz ~ 40GHz		Average (AV)

ANTENNA POLARITY & TEST DISTANCE: HORIZONTAL AT 3 M

NO.	FREQ. (MHz)	EMISSION LEVEL (dBuV/m)	LIMIT (dBuV/m)	MARGIN (dB)	ANTENNA HEIGHT (m)	TABLE ANGLE (Degree)	RAW VALUE (dBuV)	CORRECTION FACTOR (dB/m)
1	5150.00	49.5 PK	74.0	-24.5	2.20 H	158	46.6	2.9
2	5150.00	39.1 AV	54.0	-14.9	2.20 H	158	36.2	2.9
3	*5180.00	103.1 PK			2.20 H	158	100.1	3.0
4	*5180.00	91.2 AV			2.20 H	158	88.2	3.0
5	#10360.00	50.4 PK	74.0	-23.6	3.97 H	105	38.3	12.1
6	#10360.00	39.6 AV	54.0	-14.4	3.97 H	105	27.5	12.1
7	15540.00	50.5 PK	74.0	-23.5	1.65 H	200	38.6	11.9
8	15540.00	38.5 AV	54.0	-15.5	1.65 H	200	26.6	11.9

ANTENNA POLARITY & TEST DISTANCE: VERTICAL AT 3 M

NO.	FREQ. (MHz)	EMISSION LEVEL (dBuV/m)	LIMIT (dBuV/m)	MARGIN (dB)	ANTENNA HEIGHT (m)	TABLE ANGLE (Degree)	RAW VALUE (dBuV)	CORRECTION FACTOR (dB/m)
1	5150.00	50.1 PK	74.0	-23.9	3.81 V	84	47.2	2.9
2	5150.00	39.6 AV	54.0	-14.4	3.81 V	84	36.7	2.9
3	*5180.00	106.0 PK			3.81 V	84	103.0	3.0
4	*5180.00	95.9 AV			3.81 V	84	92.9	3.0
5	#10360.00	55.7 PK	74.0	-18.3	3.43 V	359	43.6	12.1
6	#10360.00	46.0 AV	54.0	-8.0	3.43 V	359	33.9	12.1
7	15540.00	51.1 PK	74.0	-22.9	2.19 V	316	39.2	11.9
8	15540.00	41.6 AV	54.0	-12.4	2.19 V	316	29.7	11.9

REMARKS:

1. Emission Level(dBuV/m) = Raw Value(dBuV) + Correction Factor(dB/m)
2. Correction Factor(dB/m) = Antenna Factor(dB/m) + Cable Factor(dB) – Pre-Amplifier Factor(dB)
3. The other emission levels were very low against the limit.
4. Margin value = Emission Level – Limit value
5. " * ": Fundamental frequency.
6. " # ": The radiated frequency is out of the restricted band.

CHANNEL	TX Channel 40	DETECTOR FUNCTION	Peak (PK)
FREQUENCY RANGE	1GHz ~ 40GHz		Average (AV)

ANTENNA POLARITY & TEST DISTANCE: HORIZONTAL AT 3 M

NO.	FREQ. (MHz)	EMISSION LEVEL (dBuV/m)	LIMIT (dBuV/m)	MARGIN (dB)	ANTENNA HEIGHT (m)	TABLE ANGLE (Degree)	RAW VALUE (dBuV)	CORRECTION FACTOR (dB/m)
1	*5200.00	102.8 PK			2.24 H	161	99.8	3.0
2	*5200.00	91.0 AV			2.24 H	161	88.0	3.0
3	#10400.00	51.0 PK	74.0	-23.0	4.00 H	100	39.0	12.0
4	#10400.00	39.9 AV	54.0	-14.1	4.00 H	100	27.9	12.0
5	15600.00	49.9 PK	74.0	-24.1	1.65 H	198	37.8	12.1
6	15600.00	38.2 AV	54.0	-15.8	1.65 H	198	26.1	12.1

ANTENNA POLARITY & TEST DISTANCE: VERTICAL AT 3 M

NO.	FREQ. (MHz)	EMISSION LEVEL (dBuV/m)	LIMIT (dBuV/m)	MARGIN (dB)	ANTENNA HEIGHT (m)	TABLE ANGLE (Degree)	RAW VALUE (dBuV)	CORRECTION FACTOR (dB/m)
1	*5200.00	106.1 PK			3.99 V	272	103.1	3.0
2	*5200.00	96.1 AV			3.99 V	272	93.1	3.0
3	#10400.00	54.9 PK	74.0	-19.1	3.35 V	360	42.9	12.0
4	#10400.00	45.1 AV	54.0	-8.9	3.35 V	360	33.1	12.0
5	15600.00	51.0 PK	74.0	-23.0	2.13 V	319	38.9	12.1
6	15600.00	41.5 AV	54.0	-12.5	2.13 V	319	29.4	12.1

REMARKS:

1. Emission Level(dBuV/m) = Raw Value(dBuV) + Correction Factor(dB/m)
2. Correction Factor(dB/m) = Antenna Factor(dB/m) + Cable Factor(dB) – Pre-Amplifier Factor(dB)
3. The other emission levels were very low against the limit.
4. Margin value = Emission Level – Limit value
5. " * ": Fundamental frequency.
6. " # ": The radiated frequency is out of the restricted band.

CHANNEL	TX Channel 48	DETECTOR FUNCTION	Peak (PK)
FREQUENCY RANGE	1GHz ~ 40GHz		Average (AV)

ANTENNA POLARITY & TEST DISTANCE: HORIZONTAL AT 3 M

NO.	FREQ. (MHz)	EMISSION LEVEL (dBuV/m)	LIMIT (dBuV/m)	MARGIN (dB)	ANTENNA HEIGHT (m)	TABLE ANGLE (Degree)	RAW VALUE (dBuV)	CORRECTION FACTOR (dB/m)
1	*5240.00	102.4 PK			2.22 H	156	99.2	3.2
2	*5240.00	90.5 AV			2.22 H	156	87.3	3.2
3	5350.00	51.4 PK	74.0	-22.6	2.22 H	156	48.0	3.4
4	5350.00	44.6 AV	54.0	-9.4	2.22 H	156	41.2	3.4
5	#10480.00	51.2 PK	74.0	-22.8	3.99 H	110	39.0	12.2
6	#10480.00	40.2 AV	54.0	-13.8	3.99 H	110	28.0	12.2
7	15720.00	50.3 PK	74.0	-23.7	1.64 H	205	37.4	12.9
8	15720.00	38.7 AV	54.0	-15.3	1.64 H	205	25.8	12.9

ANTENNA POLARITY & TEST DISTANCE: VERTICAL AT 3 M

NO.	FREQ. (MHz)	EMISSION LEVEL (dBuV/m)	LIMIT (dBuV/m)	MARGIN (dB)	ANTENNA HEIGHT (m)	TABLE ANGLE (Degree)	RAW VALUE (dBuV)	CORRECTION FACTOR (dB/m)
1	*5240.00	105.8 PK			3.99 V	299	102.6	3.2
2	*5240.00	96.2 AV			3.99 V	299	93.0	3.2
3	5350.00	52.2 PK	74.0	-21.8	3.99 V	299	48.8	3.4
4	5350.00	44.9 AV	54.0	-9.1	3.99 V	299	41.5	3.4
5	#10480.00	55.2 PK	74.0	-18.8	3.39 V	358	43.0	12.2
6	#10480.00	45.5 AV	54.0	-8.5	3.39 V	358	33.3	12.2
7	15720.00	50.8 PK	74.0	-23.2	2.14 V	314	37.9	12.9
8	15720.00	41.2 AV	54.0	-12.8	2.14 V	314	28.3	12.9

REMARKS:

1. Emission Level(dBuV/m) = Raw Value(dBuV) + Correction Factor(dB/m)
2. Correction Factor(dB/m) = Antenna Factor(dB/m) + Cable Factor(dB) – Pre-Amplifier Factor(dB)
3. The other emission levels were very low against the limit.
4. Margin value = Emission Level – Limit value
5. " * ": Fundamental frequency.
6. " # ": The radiated frequency is out of the restricted band.

CHANNEL	TX Channel 149	DETECTOR FUNCTION	Peak (PK)
FREQUENCY RANGE	1GHz ~ 40GHz		Average (AV)

ANTENNA POLARITY & TEST DISTANCE: HORIZONTAL AT 3 M

NO.	FREQ. (MHz)	EMISSION LEVEL (dBuV/m)	LIMIT (dBuV/m)	MARGIN (dB)	ANTENNA HEIGHT (m)	TABLE ANGLE (Degree)	RAW VALUE (dBuV)	CORRECTION FACTOR (dB/m)
1	#5580.57	55.1 PK	68.2	-13.1	2.93 H	203	51.6	3.5
2	*5745.00	98.8 PK			2.93 H	203	94.8	4.0
3	*5745.00	89.8 AV			2.93 H	203	85.8	4.0
4	#5984.41	55.3 PK	68.2	-12.9	2.93 H	203	51.3	4.0
5	11490.00	49.0 PK	74.0	-25.0	1.52 H	40	36.2	12.8
6	11490.00	39.4 AV	54.0	-14.6	1.52 H	40	26.6	12.8
7	#17235.00	51.6 PK	74.0	-22.4	1.50 H	203	34.2	17.4
8	#17235.00	39.5 AV	54.0	-14.5	1.50 H	203	22.1	17.4

ANTENNA POLARITY & TEST DISTANCE: VERTICAL AT 3 M

NO.	FREQ. (MHz)	EMISSION LEVEL (dBuV/m)	LIMIT (dBuV/m)	MARGIN (dB)	ANTENNA HEIGHT (m)	TABLE ANGLE (Degree)	RAW VALUE (dBuV)	CORRECTION FACTOR (dB/m)
1	#5621.74	55.5 PK	68.2	-12.7	1.21 V	360	51.9	3.6
2	*5745.00	106.3 PK			1.21 V	360	102.3	4.0
3	*5745.00	97.3 AV			1.21 V	360	93.3	4.0
4	#5955.77	55.2 PK	68.2	-13.0	1.21 V	360	51.2	4.0
5	11490.00	59.1 PK	74.0	-14.9	3.57 V	231	46.3	12.8
6	11490.00	49.5 AV	54.0	-4.5	3.57 V	231	36.7	12.8
7	#17235.00	55.6 PK	74.0	-18.4	2.13 V	198	38.2	17.4
8	#17235.00	47.8 AV	54.0	-6.2	2.13 V	198	30.4	17.4

REMARKS:

1. Emission Level(dBuV/m) = Raw Value(dBuV) + Correction Factor(dB/m)
2. Correction Factor(dB/m) = Antenna Factor(dB/m) + Cable Factor(dB) – Pre-Amplifier Factor(dB)
3. The other emission levels were very low against the limit.
4. Margin value = Emission Level – Limit value
5. " * ": Fundamental frequency.
6. " # ": The radiated frequency is out of the restricted band.

CHANNEL	TX Channel 157	DETECTOR FUNCTION	Peak (PK)
FREQUENCY RANGE	1GHz ~ 40GHz		Average (AV)

ANTENNA POLARITY & TEST DISTANCE: HORIZONTAL AT 3 M

NO.	FREQ. (MHz)	EMISSION LEVEL (dBuV/m)	LIMIT (dBuV/m)	MARGIN (dB)	ANTENNA HEIGHT (m)	TABLE ANGLE (Degree)	RAW VALUE (dBuV)	CORRECTION FACTOR (dB/m)
1	#5606.73	54.7 PK	68.2	-13.5	2.87 H	224	51.1	3.6
2	*5785.00	98.6 PK			2.87 H	224	94.6	4.0
3	*5785.00	89.8 AV			2.87 H	224	85.8	4.0
4	#5967.37	55.2 PK	68.2	-13.0	2.87 H	224	51.2	4.0
5	11570.00	48.6 PK	74.0	-25.4	1.52 H	31	36.0	12.6
6	11570.00	39.2 AV	54.0	-14.8	1.52 H	31	26.6	12.6
7	#17355.00	51.9 PK	74.0	-22.1	1.53 H	201	33.8	18.1
8	#17355.00	39.6 AV	54.0	-14.4	1.53 H	201	21.5	18.1

ANTENNA POLARITY & TEST DISTANCE: VERTICAL AT 3 M

NO.	FREQ. (MHz)	EMISSION LEVEL (dBuV/m)	LIMIT (dBuV/m)	MARGIN (dB)	ANTENNA HEIGHT (m)	TABLE ANGLE (Degree)	RAW VALUE (dBuV)	CORRECTION FACTOR (dB/m)
1	#5621.57	54.8 PK	68.2	-13.4	1.28 V	40	51.2	3.6
2	*5785.00	106.4 PK			1.28 V	40	102.4	4.0
3	*5785.00	97.1 AV			1.28 V	40	93.1	4.0
4	#5944.38	55.8 PK	68.2	-12.4	1.28 V	40	51.8	4.0
5	11570.00	59.1 PK	74.0	-14.9	3.61 V	230	46.5	12.6
6	11570.00	49.5 AV	54.0	-4.5	3.61 V	230	36.9	12.6
7	#17355.00	55.5 PK	74.0	-18.5	2.15 V	185	37.4	18.1
8	#17355.00	47.5 AV	54.0	-6.5	2.15 V	185	29.4	18.1

REMARKS:

1. Emission Level(dBuV/m) = Raw Value(dBuV) + Correction Factor(dB/m)
2. Correction Factor(dB/m) = Antenna Factor(dB/m) + Cable Factor(dB) – Pre-Amplifier Factor(dB)
3. The other emission levels were very low against the limit.
4. Margin value = Emission Level – Limit value
5. " * ": Fundamental frequency.
6. " # ": The radiated frequency is out of the restricted band.

CHANNEL	TX Channel 165	DETECTOR FUNCTION	Peak (PK)
FREQUENCY RANGE	1GHz ~ 40GHz		Average (AV)

ANTENNA POLARITY & TEST DISTANCE: HORIZONTAL AT 3 M

NO.	FREQ. (MHz)	EMISSION LEVEL (dBuV/m)	LIMIT (dBuV/m)	MARGIN (dB)	ANTENNA HEIGHT (m)	TABLE ANGLE (Degree)	RAW VALUE (dBuV)	CORRECTION FACTOR (dB/m)
1	#5591.46	55.0 PK	68.2	-13.2	2.90 H	218	51.5	3.5
2	*5825.00	98.9 PK			2.90 H	218	94.8	4.1
3	*5825.00	89.8 AV			2.90 H	218	85.7	4.1
4	#6005.16	56.4 PK	68.2	-11.8	2.90 H	218	52.3	4.1
5	11650.00	49.7 PK	74.0	-24.3	1.50 H	43	36.9	12.8
6	11650.00	39.6 AV	54.0	-14.4	1.50 H	43	26.8	12.8
7	#17475.00	52.2 PK	74.0	-21.8	1.55 H	214	33.4	18.8
8	#17475.00	40.1 AV	54.0	-13.9	1.55 H	214	21.3	18.8

ANTENNA POLARITY & TEST DISTANCE: VERTICAL AT 3 M

NO.	FREQ. (MHz)	EMISSION LEVEL (dBuV/m)	LIMIT (dBuV/m)	MARGIN (dB)	ANTENNA HEIGHT (m)	TABLE ANGLE (Degree)	RAW VALUE (dBuV)	CORRECTION FACTOR (dB/m)
1	#5586.22	55.1 PK	68.2	-13.1	1.41 V	40	51.6	3.5
2	*5825.00	106.6 PK			1.41 V	40	102.5	4.1
3	*5825.00	96.5 AV			1.41 V	40	92.4	4.1
4	#5928.23	56.5 PK	68.2	-11.7	1.41 V	40	52.5	4.0
5	11650.00	60.0 PK	74.0	-14.0	3.58 V	238	47.2	12.8
6	11650.00	50.5 AV	54.0	-3.5	3.58 V	238	37.7	12.8
7	#17475.00	56.8 PK	74.0	-17.2	2.14 V	176	38.0	18.8
8	#17475.00	48.1 AV	54.0	-5.9	2.14 V	176	29.3	18.8

REMARKS:

1. Emission Level(dBuV/m) = Raw Value(dBuV) + Correction Factor(dB/m)
2. Correction Factor(dB/m) = Antenna Factor(dB/m) + Cable Factor(dB) – Pre-Amplifier Factor(dB)
3. The other emission levels were very low against the limit.
4. Margin value = Emission Level – Limit value
5. " * ": Fundamental frequency.
6. " # ": The radiated frequency is out of the restricted band.

802.11ac (VHT20)

CHANNEL	TX Channel 36	DETECTOR FUNCTION	Peak (PK)
FREQUENCY RANGE	1GHz ~ 40GHz		Average (AV)

ANTENNA POLARITY & TEST DISTANCE: HORIZONTAL AT 3 M								
NO.	FREQ. (MHz)	EMISSION LEVEL (dBuV/m)	LIMIT (dBuV/m)	MARGIN (dB)	ANTENNA HEIGHT (m)	TABLE ANGLE (Degree)	RAW VALUE (dBuV)	CORRECTION FACTOR (dB/m)
1	5150.00	49.1 PK	74.0	-24.9	2.92 H	217	46.2	2.9
2	5150.00	39.8 AV	54.0	-14.2	2.92 H	217	36.9	2.9
3	*5180.00	100.5 PK			2.92 H	217	97.5	3.0
4	*5180.00	91.3 AV			2.92 H	217	88.3	3.0
5	#10360.00	50.8 PK	74.0	-23.2	3.94 H	98	38.7	12.1
6	#10360.00	39.7 AV	54.0	-14.3	3.94 H	98	27.6	12.1
7	15540.00	50.6 PK	74.0	-23.4	1.68 H	207	38.7	11.9
8	15540.00	38.7 AV	54.0	-15.3	1.68 H	207	26.8	11.9

ANTENNA POLARITY & TEST DISTANCE: VERTICAL AT 3 M								
NO.	FREQ. (MHz)	EMISSION LEVEL (dBuV/m)	LIMIT (dBuV/m)	MARGIN (dB)	ANTENNA HEIGHT (m)	TABLE ANGLE (Degree)	RAW VALUE (dBuV)	CORRECTION FACTOR (dB/m)
1	5150.00	49.6 PK	74.0	-24.4	3.79 V	271	46.7	2.9
2	5150.00	40.3 AV	54.0	-13.7	3.79 V	271	37.4	2.9
3	*5180.00	103.3 PK			3.79 V	271	100.3	3.0
4	*5180.00	95.9 AV			3.79 V	271	92.9	3.0
5	#10360.00	54.5 PK	74.0	-19.5	3.39 V	360	42.4	12.1
6	#10360.00	44.9 AV	54.0	-9.1	3.39 V	360	32.8	12.1
7	15540.00	50.4 PK	74.0	-23.6	2.15 V	332	38.5	11.9
8	15540.00	41.0 AV	54.0	-13.0	2.15 V	332	29.1	11.9

REMARKS:

- Emission Level(dBuV/m) = Raw Value(dBuV) + Correction Factor(dB/m)
- Correction Factor(dB/m) = Antenna Factor(dB/m) + Cable Factor(dB) – Pre-Amplifier Factor(dB)
- The other emission levels were very low against the limit.
- Margin value = Emission Level – Limit value
- " * ": Fundamental frequency.
- " # ": The radiated frequency is out of the restricted band.

CHANNEL	TX Channel 40	DETECTOR FUNCTION	Peak (PK)
FREQUENCY RANGE	1GHz ~ 40GHz		Average (AV)

ANTENNA POLARITY & TEST DISTANCE: HORIZONTAL AT 3 M

NO.	FREQ. (MHz)	EMISSION LEVEL (dBuV/m)	LIMIT (dBuV/m)	MARGIN (dB)	ANTENNA HEIGHT (m)	TABLE ANGLE (Degree)	RAW VALUE (dBuV)	CORRECTION FACTOR (dB/m)
1	*5200.00	101.2 PK			2.96 H	229	98.2	3.0
2	*5200.00	90.8 AV			2.96 H	229	87.8	3.0
3	#10400.00	49.8 PK	74.0	-24.2	4.00 H	113	37.8	12.0
4	#10400.00	39.1 AV	54.0	-14.9	4.00 H	113	27.1	12.0
5	15600.00	50.7 PK	74.0	-23.3	1.70 H	211	38.6	12.1
6	15600.00	38.5 AV	54.0	-15.5	1.70 H	211	26.4	12.1

ANTENNA POLARITY & TEST DISTANCE: VERTICAL AT 3 M

NO.	FREQ. (MHz)	EMISSION LEVEL (dBuV/m)	LIMIT (dBuV/m)	MARGIN (dB)	ANTENNA HEIGHT (m)	TABLE ANGLE (Degree)	RAW VALUE (dBuV)	CORRECTION FACTOR (dB/m)
1	*5200.00	104.0 PK			3.98 V	154	101.0	3.0
2	*5200.00	95.5 AV			3.98 V	154	92.5	3.0
3	#10400.00	54.2 PK	74.0	-19.8	3.35 V	358	42.2	12.0
4	#10400.00	44.3 AV	54.0	-9.7	3.35 V	358	32.3	12.0
5	15600.00	51.0 PK	74.0	-23.0	2.19 V	325	38.9	12.1
6	15600.00	39.8 AV	54.0	-14.2	2.19 V	325	27.7	12.1

REMARKS:

1. Emission Level(dBuV/m) = Raw Value(dBuV) + Correction Factor(dB/m)
2. Correction Factor(dB/m) = Antenna Factor(dB/m) + Cable Factor(dB) – Pre-Amplifier Factor(dB)
3. The other emission levels were very low against the limit.
4. Margin value = Emission Level – Limit value
5. " * ": Fundamental frequency.
6. " # ": The radiated frequency is out of the restricted band.

CHANNEL	TX Channel 48	DETECTOR FUNCTION	Peak (PK)
FREQUENCY RANGE	1GHz ~ 40GHz		Average (AV)

ANTENNA POLARITY & TEST DISTANCE: HORIZONTAL AT 3 M

NO.	FREQ. (MHz)	EMISSION LEVEL (dBuV/m)	LIMIT (dBuV/m)	MARGIN (dB)	ANTENNA HEIGHT (m)	TABLE ANGLE (Degree)	RAW VALUE (dBuV)	CORRECTION FACTOR (dB/m)
1	*5240.00	102.4 PK			2.92 H	211	99.2	3.2
2	*5240.00	91.4 AV			2.92 H	211	88.2	3.2
3	5399.00	52.7 PK	74.0	-21.3	2.92 H	211	49.3	3.4
4	5399.00	47.1 AV	54.0	-6.9	2.92 H	211	43.7	3.4
5	#10480.00	50.7 PK	74.0	-23.3	3.95 H	120	38.5	12.2
6	#10480.00	40.1 AV	54.0	-13.9	3.95 H	120	27.9	12.2
7	15720.00	50.3 PK	74.0	-23.7	1.60 H	192	37.4	12.9
8	15720.00	38.5 AV	54.0	-15.5	1.60 H	192	25.6	12.9

ANTENNA POLARITY & TEST DISTANCE: VERTICAL AT 3 M

NO.	FREQ. (MHz)	EMISSION LEVEL (dBuV/m)	LIMIT (dBuV/m)	MARGIN (dB)	ANTENNA HEIGHT (m)	TABLE ANGLE (Degree)	RAW VALUE (dBuV)	CORRECTION FACTOR (dB/m)
1	*5240.00	105.5 PK			4.00 V	179	102.3	3.2
2	*5240.00	96.1 AV			4.00 V	179	92.9	3.2
3	5399.00	53.9 PK	74.0	-20.1	4.00 V	301	50.5	3.4
4	5399.00	47.6 AV	54.0	-6.4	4.00 V	301	44.2	3.4
5	#10480.00	54.6 PK	74.0	-19.4	3.33 V	360	42.4	12.2
6	#10480.00	44.7 AV	54.0	-9.3	3.33 V	360	32.5	12.2
7	15720.00	51.4 PK	74.0	-22.6	2.22 V	310	38.5	12.9
8	15720.00	40.3 AV	54.0	-13.7	2.22 V	310	27.4	12.9

REMARKS:

1. Emission Level(dBuV/m) = Raw Value(dBuV) + Correction Factor(dB/m)
2. Correction Factor(dB/m) = Antenna Factor(dB/m) + Cable Factor(dB) – Pre-Amplifier Factor(dB)
3. The other emission levels were very low against the limit.
4. Margin value = Emission Level – Limit value
5. " * ": Fundamental frequency.
6. " # ": The radiated frequency is out of the restricted band.

CHANNEL	TX Channel 149	DETECTOR FUNCTION	Peak (PK)
FREQUENCY RANGE	1GHz ~ 40GHz		Average (AV)

ANTENNA POLARITY & TEST DISTANCE: HORIZONTAL AT 3 M

NO.	FREQ. (MHz)	EMISSION LEVEL (dBuV/m)	LIMIT (dBuV/m)	MARGIN (dB)	ANTENNA HEIGHT (m)	TABLE ANGLE (Degree)	RAW VALUE (dBuV)	CORRECTION FACTOR (dB/m)
1	#5611.94	54.5 PK	68.2	-13.7	1.44 H	43	50.9	3.6
2	*5745.00	94.0 PK			1.44 H	43	90.0	4.0
3	*5745.00	84.0 AV			1.44 H	43	80.0	4.0
4	#5984.11	55.9 PK	68.2	-12.3	1.44 H	43	51.9	4.0
5	11490.00	50.9 PK	74.0	-23.1	3.92 H	98	38.1	12.8
6	11490.00	40.1 AV	54.0	-13.9	3.92 H	98	27.3	12.8
7	#17235.00	50.1 PK	74.0	-23.9	1.71 H	198	32.7	17.4
8	#17235.00	38.3 AV	54.0	-15.7	1.71 H	198	20.9	17.4

ANTENNA POLARITY & TEST DISTANCE: VERTICAL AT 3 M

NO.	FREQ. (MHz)	EMISSION LEVEL (dBuV/m)	LIMIT (dBuV/m)	MARGIN (dB)	ANTENNA HEIGHT (m)	TABLE ANGLE (Degree)	RAW VALUE (dBuV)	CORRECTION FACTOR (dB/m)
1	#5629.05	56.3 PK	68.2	-11.9	1.34 V	357	52.7	3.6
2	*5745.00	104.7 PK			1.34 V	357	100.7	4.0
3	*5745.00	95.7 AV			1.34 V	357	91.7	4.0
4	#5978.31	54.7 PK	68.2	-13.5	1.34 V	357	50.7	4.0
5	11490.00	54.5 PK	74.0	-19.5	3.40 V	360	41.7	12.8
6	11490.00	44.4 AV	54.0	-9.6	3.40 V	360	31.6	12.8
7	#17235.00	51.0 PK	74.0	-23.0	2.15 V	324	33.6	17.4
8	#17235.00	40.0 AV	54.0	-14.0	2.15 V	324	22.6	17.4

REMARKS:

1. Emission Level(dBuV/m) = Raw Value(dBuV) + Correction Factor(dB/m)
2. Correction Factor(dB/m) = Antenna Factor(dB/m) + Cable Factor(dB) – Pre-Amplifier Factor(dB)
3. The other emission levels were very low against the limit.
4. Margin value = Emission Level – Limit value
5. " * ": Fundamental frequency.
6. " # ": The radiated frequency is out of the restricted band.

CHANNEL	TX Channel 157	DETECTOR FUNCTION	Peak (PK)
FREQUENCY RANGE	1GHz ~ 40GHz		Average (AV)

ANTENNA POLARITY & TEST DISTANCE: HORIZONTAL AT 3 M

NO.	FREQ. (MHz)	EMISSION LEVEL (dBuV/m)	LIMIT (dBuV/m)	MARGIN (dB)	ANTENNA HEIGHT (m)	TABLE ANGLE (Degree)	RAW VALUE (dBuV)	CORRECTION FACTOR (dB/m)
1	#5609.26	55.4 PK	68.2	-12.8	1.48 H	43	51.8	3.6
2	*5785.00	94.3 PK			1.48 H	43	90.3	4.0
3	*5785.00	84.5 AV			1.48 H	43	80.5	4.0
4	#6006.44	55.3 PK	68.2	-12.9	1.48 H	43	51.2	4.1
5	11570.00	50.5 PK	74.0	-23.5	3.98 H	96	37.9	12.6
6	11570.00	40.0 AV	54.0	-14.0	3.98 H	96	27.4	12.6
7	#17355.00	50.6 PK	74.0	-23.4	1.69 H	204	32.5	18.1
8	#17355.00	38.7 AV	54.0	-15.3	1.69 H	204	20.6	18.1

ANTENNA POLARITY & TEST DISTANCE: VERTICAL AT 3 M

NO.	FREQ. (MHz)	EMISSION LEVEL (dBuV/m)	LIMIT (dBuV/m)	MARGIN (dB)	ANTENNA HEIGHT (m)	TABLE ANGLE (Degree)	RAW VALUE (dBuV)	CORRECTION FACTOR (dB/m)
1	#5623.84	55.8 PK	68.2	-12.4	1.33 V	356	52.2	3.6
2	*5785.00	105.4 PK			1.33 V	356	101.4	4.0
3	*5785.00	95.4 AV			1.33 V	356	91.4	4.0
4	#5945.37	55.9 PK	68.2	-12.3	1.33 V	356	51.9	4.0
5	11570.00	53.6 PK	74.0	-20.4	3.39 V	357	41.0	12.6
6	11570.00	43.8 AV	54.0	-10.2	3.39 V	357	31.2	12.6
7	#17355.00	50.8 PK	74.0	-23.2	2.20 V	313	32.7	18.1
8	#17355.00	39.6 AV	54.0	-14.4	2.20 V	313	21.5	18.1

REMARKS:

1. Emission Level(dBuV/m) = Raw Value(dBuV) + Correction Factor(dB/m)
2. Correction Factor(dB/m) = Antenna Factor(dB/m) + Cable Factor(dB) – Pre-Amplifier Factor(dB)
3. The other emission levels were very low against the limit.
4. Margin value = Emission Level – Limit value
5. " * ": Fundamental frequency.
6. " # ": The radiated frequency is out of the restricted band.

CHANNEL	TX Channel 165	DETECTOR FUNCTION	Peak (PK)
FREQUENCY RANGE	1GHz ~ 40GHz		Average (AV)

ANTENNA POLARITY & TEST DISTANCE: HORIZONTAL AT 3 M

NO.	FREQ. (MHz)	EMISSION LEVEL (dBuV/m)	LIMIT (dBuV/m)	MARGIN (dB)	ANTENNA HEIGHT (m)	TABLE ANGLE (Degree)	RAW VALUE (dBuV)	CORRECTION FACTOR (dB/m)
1	#5598.41	54.0 PK	68.2	-14.2	1.50 H	29	50.4	3.6
2	*5825.00	94.2 PK			1.50 H	29	90.1	4.1
3	*5825.00	84.5 AV			1.50 H	29	80.4	4.1
4	#5974.70	55.3 PK	68.2	-12.9	1.50 H	29	51.3	4.0
5	11650.00	49.6 PK	74.0	-24.4	4.00 H	113	36.8	12.8
6	11650.00	39.1 AV	54.0	-14.9	4.00 H	113	26.3	12.8
7	#17475.00	50.9 PK	74.0	-23.1	1.66 H	195	32.1	18.8
8	#17475.00	38.8 AV	54.0	-15.2	1.66 H	195	20.0	18.8

ANTENNA POLARITY & TEST DISTANCE: VERTICAL AT 3 M

NO.	FREQ. (MHz)	EMISSION LEVEL (dBuV/m)	LIMIT (dBuV/m)	MARGIN (dB)	ANTENNA HEIGHT (m)	TABLE ANGLE (Degree)	RAW VALUE (dBuV)	CORRECTION FACTOR (dB/m)
1	#5594.27	54.6 PK	68.2	-13.6	1.50 V	38	51.1	3.5
2	*5825.00	105.5 PK			1.50 V	38	101.4	4.1
3	*5825.00	95.4 AV			1.50 V	38	91.3	4.1
4	#5985.99	54.6 PK	68.2	-13.6	1.50 V	38	50.6	4.0
5	11650.00	54.4 PK	74.0	-19.6	3.32 V	360	41.6	12.8
6	11650.00	44.3 AV	54.0	-9.7	3.32 V	360	31.5	12.8
7	#17475.00	50.7 PK	74.0	-23.3	2.25 V	311	31.9	18.8
8	#17475.00	39.7 AV	54.0	-14.3	2.25 V	311	20.9	18.8

REMARKS:

1. Emission Level(dBuV/m) = Raw Value(dBuV) + Correction Factor(dB/m)
2. Correction Factor(dB/m) = Antenna Factor(dB/m) + Cable Factor(dB) – Pre-Amplifier Factor(dB)
3. The other emission levels were very low against the limit.
4. Margin value = Emission Level – Limit value
5. " * ": Fundamental frequency.
6. " # ": The radiated frequency is out of the restricted band.

802.11ac (VHT40)

CHANNEL	TX Channel 38	DETECTOR FUNCTION	Peak (PK)
FREQUENCY RANGE	1GHz ~ 40GHz		Average (AV)

ANTENNA POLARITY & TEST DISTANCE: HORIZONTAL AT 3 M

NO.	FREQ. (MHz)	EMISSION LEVEL (dBuV/m)	LIMIT (dBuV/m)	MARGIN (dB)	ANTENNA HEIGHT (m)	TABLE ANGLE (Degree)	RAW VALUE (dBuV)	CORRECTION FACTOR (dB/m)
1	5150.00	54.5 PK	74.0	-19.5	3.56 H	360	51.6	2.9
2	5150.00	42.6 AV	54.0	-11.4	3.56 H	360	39.7	2.9
3	*5190.00	99.8 PK			3.56 H	360	96.8	3.0
4	*5190.00	88.4 AV			3.56 H	360	85.4	3.0
5	5350.00	50.7 PK	74.0	-23.3	3.56 H	360	47.3	3.4
6	5350.00	45.2 AV	54.0	-8.8	3.56 H	360	41.8	3.4
7	#10380.00	46.5 PK	74.0	-27.5	3.71 H	108	34.4	12.1
8	#10380.00	36.2 AV	54.0	-17.8	3.71 H	108	24.1	12.1
9	15570.00	45.3 PK	74.0	-28.7	1.66 H	191	33.2	12.1
10	15570.00	35.2 AV	54.0	-18.8	1.66 H	191	23.1	12.1

ANTENNA POLARITY & TEST DISTANCE: VERTICAL AT 3 M

NO.	FREQ. (MHz)	EMISSION LEVEL (dBuV/m)	LIMIT (dBuV/m)	MARGIN (dB)	ANTENNA HEIGHT (m)	TABLE ANGLE (Degree)	RAW VALUE (dBuV)	CORRECTION FACTOR (dB/m)
1	5150.00	55.3 PK	74.0	-18.7	3.92 V	224	52.4	2.9
2	5150.00	43.1 AV	54.0	-10.9	3.92 V	224	40.2	2.9
3	*5190.00	103.0 PK			3.92 V	224	100.0	3.0
4	*5190.00	93.6 AV			3.92 V	224	90.6	3.0
5	5350.00	51.9 PK	74.0	-22.1	3.92 V	224	48.5	3.4
6	5350.00	45.8 AV	54.0	-8.2	3.92 V	224	42.4	3.4
7	#10380.00	51.3 PK	74.0	-22.7	3.37 V	360	39.2	12.1
8	#10380.00	41.0 AV	54.0	-13.0	3.37 V	360	28.9	12.1
9	15570.00	48.5 PK	74.0	-25.5	2.18 V	323	36.4	12.1
10	15570.00	37.5 AV	54.0	-16.5	2.18 V	323	25.4	12.1

REMARKS:

- Emission Level(dBuV/m) = Raw Value(dBuV) + Correction Factor(dB/m)
- Correction Factor(dB/m) = Antenna Factor(dB/m) + Cable Factor(dB) – Pre-Amplifier Factor(dB)
- The other emission levels were very low against the limit.
- Margin value = Emission Level – Limit value
- " * ": Fundamental frequency.
- " # ": The radiated frequency is out of the restricted band.

CHANNEL	TX Channel 46	DETECTOR FUNCTION	Peak (PK)
FREQUENCY RANGE	1GHz ~ 40GHz		Average (AV)

ANTENNA POLARITY & TEST DISTANCE: HORIZONTAL AT 3 M

NO.	FREQ. (MHz)	EMISSION LEVEL (dBuV/m)	LIMIT (dBuV/m)	MARGIN (dB)	ANTENNA HEIGHT (m)	TABLE ANGLE (Degree)	RAW VALUE (dBuV)	CORRECTION FACTOR (dB/m)
1	*5230.00	99.3 PK			3.53 H	360	96.2	3.1
2	*5230.00	88.0 AV			3.53 H	360	84.9	3.1
3	5390.00	53.9 PK	74.0	-20.1	3.53 H	360	50.5	3.4
4	5390.00	46.8 AV	54.0	-7.2	3.53 H	360	43.4	3.4
5	#10460.00	46.0 PK	74.0	-28.0	3.70 H	99	33.8	12.2
6	#10460.00	35.9 AV	54.0	-18.1	3.70 H	99	23.7	12.2
7	15690.00	45.4 PK	74.0	-28.6	1.71 H	199	32.5	12.9
8	15690.00	35.1 AV	54.0	-18.9	1.71 H	199	22.2	12.9

ANTENNA POLARITY & TEST DISTANCE: VERTICAL AT 3 M

NO.	FREQ. (MHz)	EMISSION LEVEL (dBuV/m)	LIMIT (dBuV/m)	MARGIN (dB)	ANTENNA HEIGHT (m)	TABLE ANGLE (Degree)	RAW VALUE (dBuV)	CORRECTION FACTOR (dB/m)
1	*5230.00	102.6 PK			3.99 V	197	99.5	3.1
2	*5230.00	93.2 AV			3.99 V	197	90.1	3.1
3	5390.00	54.4 PK	74.0	-19.6	3.99 V	222	51.0	3.4
4	5390.00	47.4 AV	54.0	-6.6	3.99 V	222	44.0	3.4
5	#10460.00	51.1 PK	74.0	-22.9	3.34 V	359	38.9	12.2
6	#10460.00	40.6 AV	54.0	-13.4	3.34 V	359	28.4	12.2
7	15690.00	48.2 PK	74.0	-25.8	2.18 V	310	35.3	12.9
8	15690.00	37.2 AV	54.0	-16.8	2.18 V	310	24.3	12.9

REMARKS:

1. Emission Level(dBuV/m) = Raw Value(dBuV) + Correction Factor(dB/m)
2. Correction Factor(dB/m) = Antenna Factor(dB/m) + Cable Factor(dB) – Pre-Amplifier Factor(dB)
3. The other emission levels were very low against the limit.
4. Margin value = Emission Level – Limit value
5. " * ": Fundamental frequency.
6. " # ": The radiated frequency is out of the restricted band.

CHANNEL	TX Channel 151	DETECTOR FUNCTION	Peak (PK)
FREQUENCY RANGE	1GHz ~ 40GHz		Average (AV)

ANTENNA POLARITY & TEST DISTANCE: HORIZONTAL AT 3 M

NO.	FREQ. (MHz)	EMISSION LEVEL (dBuV/m)	LIMIT (dBuV/m)	MARGIN (dB)	ANTENNA HEIGHT (m)	TABLE ANGLE (Degree)	RAW VALUE (dBuV)	CORRECTION FACTOR (dB/m)
1	#5642.22	55.0 PK	68.2	-13.2	2.69 H	339	51.3	3.7
2	*5755.00	96.2 PK			2.69 H	339	92.2	4.0
3	*5755.00	85.8 AV			2.69 H	339	81.8	4.0
4	#5976.92	55.4 PK	68.2	-12.8	2.69 H	339	51.4	4.0
5	11510.00	46.8 PK	74.0	-27.2	3.75 H	100	34.0	12.8
6	11510.00	36.5 AV	54.0	-17.5	3.75 H	100	23.7	12.8
7	#17265.00	45.4 PK	74.0	-28.6	1.67 H	202	27.8	17.6
8	#17265.00	35.6 AV	54.0	-18.4	1.67 H	202	18.0	17.6

ANTENNA POLARITY & TEST DISTANCE: VERTICAL AT 3 M

NO.	FREQ. (MHz)	EMISSION LEVEL (dBuV/m)	LIMIT (dBuV/m)	MARGIN (dB)	ANTENNA HEIGHT (m)	TABLE ANGLE (Degree)	RAW VALUE (dBuV)	CORRECTION FACTOR (dB/m)
1	#5642.32	55.5 PK	68.2	-12.7	1.25 V	40	51.8	3.7
2	*5755.00	101.5 PK			1.25 V	40	97.5	4.0
3	*5755.00	93.4 AV			1.25 V	40	89.4	4.0
4	#5941.01	54.9 PK	68.2	-13.3	1.25 V	40	50.9	4.0
5	11510.00	50.9 PK	74.0	-23.1	3.40 V	358	38.1	12.8
6	11510.00	40.6 AV	54.0	-13.4	3.40 V	358	27.8	12.8
7	#17265.00	48.0 PK	74.0	-26.0	2.20 V	325	30.4	17.6
8	#17265.00	36.9 AV	54.0	-17.1	2.20 V	325	19.3	17.6

REMARKS:

1. Emission Level(dBuV/m) = Raw Value(dBuV) + Correction Factor(dB/m)
2. Correction Factor(dB/m) = Antenna Factor(dB/m) + Cable Factor(dB) – Pre-Amplifier Factor(dB)
3. The other emission levels were very low against the limit.
4. Margin value = Emission Level – Limit value
5. " * ": Fundamental frequency.
6. " # ": The radiated frequency is out of the restricted band.

CHANNEL	TX Channel 159	DETECTOR FUNCTION	Peak (PK)
FREQUENCY RANGE	1GHz ~ 40GHz		Average (AV)

ANTENNA POLARITY & TEST DISTANCE: HORIZONTAL AT 3 M

NO.	FREQ. (MHz)	EMISSION LEVEL (dBuV/m)	LIMIT (dBuV/m)	MARGIN (dB)	ANTENNA HEIGHT (m)	TABLE ANGLE (Degree)	RAW VALUE (dBuV)	CORRECTION FACTOR (dB/m)
1	#5619.60	54.3 PK	68.2	-13.9	2.67 H	349	50.7	3.6
2	*5795.00	96.1 PK			2.67 H	349	92.0	4.1
3	*5795.00	85.7 AV			2.67 H	349	81.6	4.1
4	#5960.32	55.6 PK	68.2	-12.6	2.67 H	349	51.6	4.0
5	11590.00	46.2 PK	74.0	-27.8	3.73 H	95	33.6	12.6
6	11590.00	35.8 AV	54.0	-18.2	3.73 H	95	23.2	12.6
7	#17385.00	44.9 PK	74.0	-29.1	1.72 H	203	26.5	18.4
8	#17385.00	35.0 AV	54.0	-19.0	1.72 H	203	16.6	18.4

ANTENNA POLARITY & TEST DISTANCE: VERTICAL AT 3 M

NO.	FREQ. (MHz)	EMISSION LEVEL (dBuV/m)	LIMIT (dBuV/m)	MARGIN (dB)	ANTENNA HEIGHT (m)	TABLE ANGLE (Degree)	RAW VALUE (dBuV)	CORRECTION FACTOR (dB/m)
1	#5568.30	54.7 PK	68.2	-13.5	1.50 V	40	51.2	3.5
2	*5795.00	102.1 PK			1.50 V	40	98.0	4.1
3	*5795.00	92.8 AV			1.50 V	40	88.7	4.1
4	#5968.76	55.5 PK	68.2	-12.7	1.50 V	40	51.5	4.0
5	11590.00	51.3 PK	74.0	-22.7	3.31 V	358	38.7	12.6
6	11590.00	40.5 AV	54.0	-13.5	3.31 V	358	27.9	12.6
7	#17385.00	48.3 PK	74.0	-25.7	2.16 V	298	29.9	18.4
8	#17385.00	37.2 AV	54.0	-16.8	2.16 V	298	18.8	18.4

REMARKS:

1. Emission Level(dBuV/m) = Raw Value(dBuV) + Correction Factor(dB/m)
2. Correction Factor(dB/m) = Antenna Factor(dB/m) + Cable Factor(dB) – Pre-Amplifier Factor(dB)
3. The other emission levels were very low against the limit.
4. Margin value = Emission Level – Limit value
5. " * ": Fundamental frequency.
6. " # ": The radiated frequency is out of the restricted band.

802.11ac (VHT80)

CHANNEL	TX Channel 42	DETECTOR FUNCTION	Peak (PK)
FREQUENCY RANGE	1GHz ~ 40GHz		Average (AV)

ANTENNA POLARITY & TEST DISTANCE: HORIZONTAL AT 3 M								
NO.	FREQ. (MHz)	EMISSION LEVEL (dBuV/m)	LIMIT (dBuV/m)	MARGIN (dB)	ANTENNA HEIGHT (m)	TABLE ANGLE (Degree)	RAW VALUE (dBuV)	CORRECTION FACTOR (dB/m)
1	5150.00	51.5 PK	74.0	-22.5	2.88 H	360	48.6	2.9
2	5150.00	42.1 AV	54.0	-11.9	2.88 H	360	39.2	2.9
3	*5210.00	97.2 PK			2.88 H	360	94.2	3.0
4	*5210.00	85.1 AV			2.88 H	360	82.1	3.0
5	5350.00	52.3 PK	74.0	-21.7	2.88 H	360	48.9	3.4
6	5350.00	45.9 AV	54.0	-8.1	2.88 H	360	42.5	3.4
7	#10420.00	45.8 PK	74.0	-28.2	3.76 H	116	33.8	12.0
8	#10420.00	35.2 AV	54.0	-18.8	3.76 H	116	23.2	12.0
9	15630.00	44.8 PK	74.0	-29.2	1.60 H	190	32.4	12.4
10	15630.00	34.6 AV	54.0	-19.4	1.60 H	190	22.2	12.4

ANTENNA POLARITY & TEST DISTANCE: VERTICAL AT 3 M								
NO.	FREQ. (MHz)	EMISSION LEVEL (dBuV/m)	LIMIT (dBuV/m)	MARGIN (dB)	ANTENNA HEIGHT (m)	TABLE ANGLE (Degree)	RAW VALUE (dBuV)	CORRECTION FACTOR (dB/m)
1	5150.00	52.2 PK	74.0	-21.8	3.63 V	235	49.3	2.9
2	5150.00	43.0 AV	54.0	-11.0	3.63 V	235	40.1	2.9
3	*5210.00	100.1 PK			3.63 V	235	97.1	3.0
4	*5210.00	90.3 AV			3.63 V	235	87.3	3.0
5	5350.00	52.7 PK	74.0	-21.3	3.63 V	223	49.3	3.4
6	5350.00	46.6 AV	54.0	-7.4	3.63 V	223	43.2	3.4
7	#10420.00	49.4 PK	74.0	-24.6	3.36 V	360	37.4	12.0
8	#10420.00	38.5 AV	54.0	-15.5	3.36 V	360	26.5	12.0
9	15630.00	47.2 PK	74.0	-26.8	2.15 V	312	34.8	12.4
10	15630.00	35.9 AV	54.0	-18.1	2.15 V	312	23.5	12.4

REMARKS:

1. Emission Level(dBuV/m) = Raw Value(dBuV) + Correction Factor(dB/m)
2. Correction Factor(dB/m) = Antenna Factor(dB/m) + Cable Factor(dB) – Pre-Amplifier Factor(dB)
3. The other emission levels were very low against the limit.
4. Margin value = Emission Level – Limit value
5. " * ": Fundamental frequency.
6. " # ": The radiated frequency is out of the restricted band.

CHANNEL	TX Channel 155	DETECTOR FUNCTION	Peak (PK)
FREQUENCY RANGE	1GHz ~ 40GHz		Average (AV)

ANTENNA POLARITY & TEST DISTANCE: HORIZONTAL AT 3 M

NO.	FREQ. (MHz)	EMISSION LEVEL (dBuV/m)	LIMIT (dBuV/m)	MARGIN (dB)	ANTENNA HEIGHT (m)	TABLE ANGLE (Degree)	RAW VALUE (dBuV)	CORRECTION FACTOR (dB/m)
1	#5586.35	54.2 PK	68.2	-14.0	2.84 H	356	50.7	3.5
2	*5775.00	92.0 PK			2.84 H	356	88.0	4.0
3	*5775.00	83.2 AV			2.84 H	356	79.2	4.0
4	#5943.79	55.3 PK	68.2	-12.9	2.84 H	360	51.3	4.0
5	11550.00	45.5 PK	74.0	-28.5	3.77 H	113	32.8	12.7
6	11550.00	35.2 AV	54.0	-18.8	3.77 H	113	22.5	12.7
7	#17325.00	44.6 PK	74.0	-29.4	1.60 H	201	26.8	17.8
8	#17325.00	34.5 AV	54.0	-19.5	1.60 H	201	16.7	17.8

ANTENNA POLARITY & TEST DISTANCE: VERTICAL AT 3 M

NO.	FREQ. (MHz)	EMISSION LEVEL (dBuV/m)	LIMIT (dBuV/m)	MARGIN (dB)	ANTENNA HEIGHT (m)	TABLE ANGLE (Degree)	RAW VALUE (dBuV)	CORRECTION FACTOR (dB/m)
1	#5621.95	55.0 PK	68.2	-13.2	1.51 V	360	51.4	3.6
2	*5775.00	98.4 PK			1.51 V	360	94.4	4.0
3	*5775.00	89.6 AV			1.51 V	360	85.6	4.0
4	#5974.99	55.2 PK	68.2	-13.0	1.51 V	360	51.2	4.0
5	11550.00	48.7 PK	74.0	-25.3	3.41 V	360	36.0	12.7
6	11550.00	38.0 AV	54.0	-16.0	3.41 V	360	25.3	12.7
7	#17325.00	47.2 PK	74.0	-26.8	2.11 V	302	29.4	17.8
8	#17325.00	36.2 AV	54.0	-17.8	2.11 V	302	18.4	17.8

REMARKS:

1. Emission Level(dBuV/m) = Raw Value(dBuV) + Correction Factor(dB/m)
2. Correction Factor(dB/m) = Antenna Factor(dB/m) + Cable Factor(dB) – Pre-Amplifier Factor(dB)
3. The other emission levels were very low against the limit.
4. Margin value = Emission Level – Limit value
5. " * ": Fundamental frequency.
6. " # ": The radiated frequency is out of the restricted band.

Below 1GHz Data:

802.11a

CHANNEL	TX Channel 165	DETECTOR FUNCTION	Quasi-Peak (QP)
FREQUENCY RANGE	9kHz ~ 1GHz		

ANTENNA POLARITY & TEST DISTANCE: HORIZONTAL AT 3 M

NO.	FREQ. (MHz)	EMISSION LEVEL (dBuV/m)	LIMIT (dBuV/m)	MARGIN (dB)	ANTENNA HEIGHT (m)	TABLE ANGLE (Degree)	RAW VALUE (dBuV)	CORRECTION FACTOR (dB/m)
1	34.15	34.0 QP	40.0	-6.0	3.00 H	189	42.9	-8.9
2	147.49	31.6 QP	43.5	-11.9	2.50 H	75	39.9	-8.3
3	386.69	32.9 QP	46.0	-13.1	1.00 H	360	38.7	-5.8
4	561.56	38.3 QP	46.0	-7.7	1.50 H	0	40.0	-1.7
5	750.01	34.7 QP	46.0	-11.3	1.00 H	349	32.7	2.0
6	875.02	38.5 QP	46.0	-7.5	1.00 H	354	35.0	3.5

ANTENNA POLARITY & TEST DISTANCE: VERTICAL AT 3 M

NO.	FREQ. (MHz)	EMISSION LEVEL (dBuV/m)	LIMIT (dBuV/m)	MARGIN (dB)	ANTENNA HEIGHT (m)	TABLE ANGLE (Degree)	RAW VALUE (dBuV)	CORRECTION FACTOR (dB/m)
1	142.88	30.5 QP	43.5	-13.0	1.00 V	28	38.8	-8.3
2	386.62	33.7 QP	46.0	-12.3	1.50 V	15	39.5	-5.8
3	500.01	34.7 QP	46.0	-11.3	1.00 V	356	37.5	-2.8
4	579.99	39.5 QP	46.0	-6.5	1.00 V	181	40.6	-1.1
5	750.01	35.6 QP	46.0	-10.4	1.50 V	235	33.6	2.0
6	875.02	39.5 QP	46.0	-6.5	1.50 V	57	36.0	3.5

REMARKS:

1. Emission Level(dBuV/m) = Raw Value(dBuV) + Correction Factor(dB/m)
2. Correction Factor(dB/m) = Antenna Factor(dB/m) + Cable Factor(dB) – Pre-Amplifier Factor(dB)
3. The other emission levels were very low against the limit.
4. Margin value = Emission Level – Limit value

4.2 Conducted Emission Measurement

4.2.1 Limits of Conducted Emission Measurement

Frequency (MHz)	Conducted Limit (dBuV)	
	Quasi-peak	Average
0.15 - 0.5	66 - 56	56 - 46
0.50 - 5.0	56	46
5.0 - 30.0	60	50

Note: 1. The lower limit shall apply at the transition frequencies.

2. The limit decreases in line with the logarithm of the frequency in the range of 0.15 to 0.50MHz.

4.2.2 Test Instruments

DESCRIPTION & MANUFACTURER	MODEL NO.	SERIAL NO.	CALIBRATED DATE	CALIBRATED UNTIL
Test Receiver R&S	ESCS 30	847124/029	Oct. 24, 2016	Oct. 23, 2017
Line-Impedance Stabilization Network (for EUT) R&S	ESH3-Z5	848773/004	Oct. 26, 2016	Oct. 25, 2017
Line-Impedance Stabilization Network (for Peripheral) R&S	ENV216	100072	June 13, 2016	June 12, 2017
50 ohms Terminator	N/A	EMC-02	Sep. 29, 2016	Sep. 28, 2017
RF Cable	5D-FB	COCCAB-001	Sep. 30, 2016	Sep. 29, 2017
10 dB PAD Mini-Circuits	HAT-10+	CONATT-004	June 20, 2016	June 19, 2017
Software BVADT	BVADT_Cond_ V7.3.7.4	NA	NA	NA

Note:

1. The calibration interval of the above test instruments are 12 months and the calibrations are traceable to NML/ROC and NIST/USA.
2. The test was performed in Shielded Room No. 1.
3. Tested Date: Jan. 25, 2017

4.2.3 Test Procedure

- The EUT was placed 0.4 meters from the conducting wall of the shielded room with EUT being connected to the power mains through a line impedance stabilization network (LISN). Other support units were connected to the power mains through another LISN. The two LISNs provide 50 ohm/ 50uH of coupling impedance for the measuring instrument.
- Both lines of the power mains connected to the EUT were checked for maximum conducted interference.
- The frequency range from 150kHz to 30MHz was searched. Emission levels under (Limit - 20dB) was not recorded.

NOTE: All modes of operation were investigated and the worst-case emissions are reported.

4.2.4 Deviation from Test Standard

No deviation.

4.2.5 Test Setup

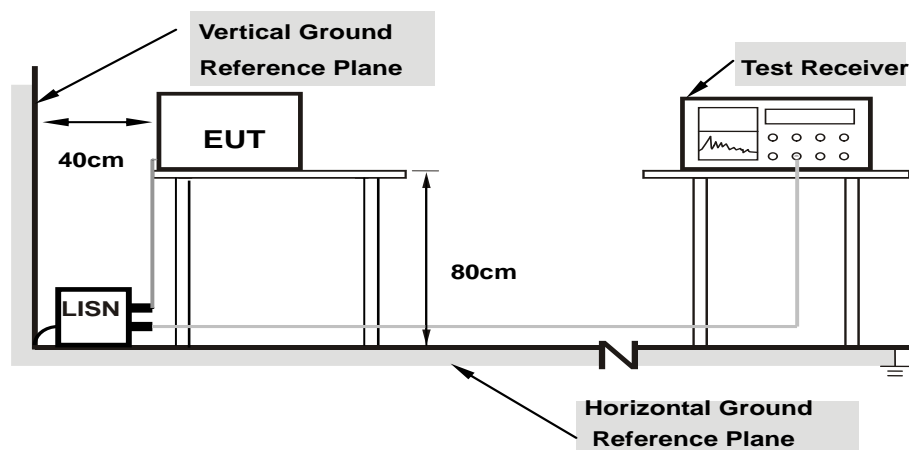

Note: 1.Support units were connected to second LISN.

For the actual test configuration, please refer to the attached file (Test Setup Photo).

4.2.6 EUT Operating Condition

Same as 4.1.6.

4.2.7 Test Results

Phase	Line (L)	Detector Function	Quasi-Peak (QP) / Average (AV)
-------	----------	-------------------	--------------------------------

No	Freq. [MHz]	Corr.	Reading Value		Emission Level		Limit		Margin	
		Factor (dB)	[dB (uV)]		[dB (uV)]		[dB (uV)]		(dB)	
			Q.P.	AV.	Q.P.	AV.	Q.P.	AV.	Q.P.	AV.
1	0.15000	10.19	39.83	25.19	50.02	35.38	66.00	56.00	-15.98	-20.62
2	0.19687	10.19	35.54	22.63	45.73	32.82	63.74	53.74	-18.01	-20.92
3	0.34531	10.21	33.38	31.20	43.59	41.41	59.07	49.07	-15.48	-7.66
4	0.82578	10.25	18.77	9.98	29.02	20.23	56.00	46.00	-26.98	-25.77
5	2.97656	10.24	30.85	16.68	41.09	26.92	56.00	46.00	-14.91	-19.08
6	19.65625	11.36	27.07	19.71	38.43	31.07	60.00	50.00	-21.57	-18.93

REMARKS:

1. Q.P. and AV. are abbreviations of quasi-peak and average individually.
2. The emission levels of other frequencies were very low against the limit.
3. Margin value = Emission level - Limit value
4. Correction factor = Insertion loss + Cable loss
5. Emission Level = Correction Factor + Reading Value.

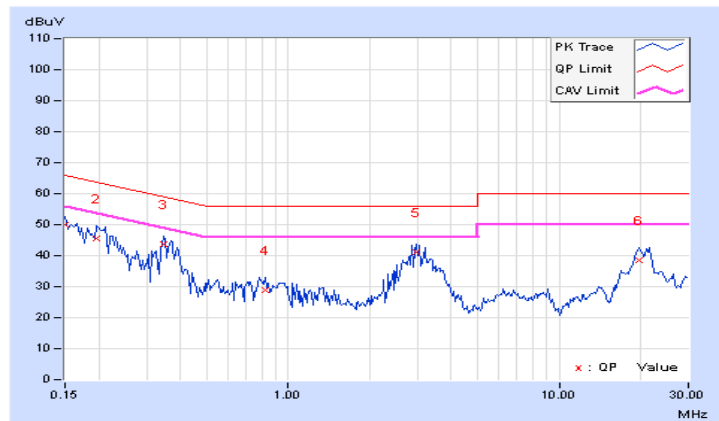

Phase	Neutral (N)	Detector Function	Quasi-Peak (QP) / Average (AV)
-------	-------------	-------------------	--------------------------------

No	Freq. [MHz]	Corr.	Reading Value		Emission Level		Limit		Margin	
		Factor	[dB (uV)]		[dB (uV)]		[dB (uV)]		(dB)	
	(dB)	Q.P.	AV.	Q.P.	AV.	Q.P.	AV.	Q.P.	AV.	
1	0.15391	10.18	37.58	23.41	47.76	33.59	65.79	55.79	-18.03	-22.20
2	0.21250	10.16	28.46	17.07	38.62	27.23	63.11	53.11	-24.49	-25.88
3	0.36875	10.20	31.82	28.56	42.02	38.76	58.53	48.53	-16.51	-9.77
4	1.58594	10.26	19.93	11.85	30.19	22.11	56.00	46.00	-25.81	-23.89
5	2.82031	10.23	26.46	13.50	36.69	23.73	56.00	46.00	-19.31	-22.27
6	19.54297	11.08	27.29	20.36	38.37	31.44	60.00	50.00	-21.63	-18.56

REMARKS:

1. Q.P. and AV. are abbreviations of quasi-peak and average individually.
2. The emission levels of other frequencies were very low against the limit.
3. Margin value = Emission level - Limit value
4. Correction factor = Insertion loss + Cable loss
5. Emission Level = Correction Factor + Reading Value.

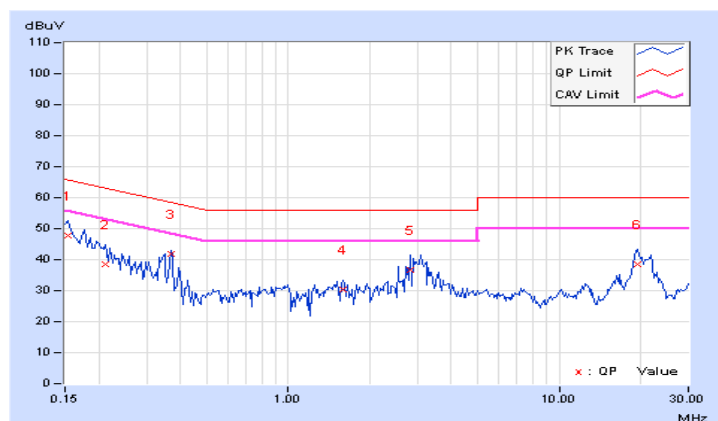

4.3 Transmit Power Measurement

4.3.1 Limits of Transmit Power Measurement

Operation Band	EUT Category		Limit
U-NII-1		Outdoor Access Point	1 Watt (30 dBm) (Max. e.i.r.p \leq 125mW(21 dBm) at any elevation angle above 30 degrees as measured from the horizon)
		Fixed point-to-point Access Point	1 Watt (30 dBm)
	√	Indoor Access Point	1 Watt (30 dBm)
		Mobile and Portable client device	250mW (24 dBm)
U-NII-2A			250mW (24 dBm) or 11 dBm+10 log B*
U-NII-2C			250mW (24 dBm) or 11 dBm+10 log B*
U-NII-3	√		1 Watt (30 dBm)

*B is the 26 dB emission bandwidth in megahertz

Per KDB 662911 Method of conducted output power measurement on IEEE 802.11 devices,

Array Gain = 0 dB (i.e., no array gain) for $N_{ANT} \leq 4$;

Array Gain = 0 dB (i.e., no array gain) for channel widths ≥ 40 MHz for any N_{ANT} ;

Array Gain = $5 \log(N_{ANT}/N_{SS})$ dB or 3 dB, whichever is less for 20-MHz channel widths with $N_{ANT} \geq 5$.

For power measurements on all other devices: Array Gain = $10 \log(N_{ANT}/N_{SS})$ dB.

4.3.2 Test Setup

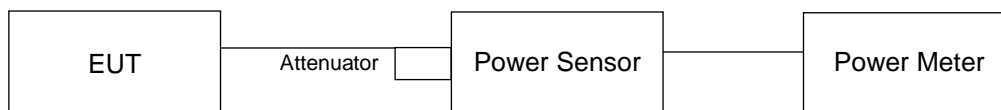

4.3.3 Test Instruments

Refer to section 4.1.2 to get information of above instrument.

4.3.4 Test Procedure

Method PM is used to perform output power measurement, trigger and gating function of wide band power meter is enabled to measure max output power of TX on burst. Duty factor is not added to measured value.

4.3.5 Deviation from Test Standard

No deviation.

4.3.6 EUT Operating Condition

The software provided by client to enable the EUT under transmission condition continuously at lowest, middle and highest channel frequencies individually.

4.3.7 Test Result

802.11a

Chan.	Chan. Freq. (MHz)	Maximum Conducted Power (dBm)		Total Power (mW)	Total Power (dBm)	Limit (dBm)	Pass / Fail
		Chain 0	Chain 1				
36	5180	14.36	14.28	54.082	17.33	30.00	Pass
40	5200	14.52	14.27	55.044	17.41	30.00	Pass
48	5240	14.51	14.42	55.918	17.48	30.00	Pass
149	5745	14.41	14.37	54.959	17.40	30.00	Pass
157	5785	14.10	14.17	51.826	17.15	30.00	Pass
165	5825	14.73	14.72	59.365	17.74	30.00	Pass

802.11ac (VHT20)

Chan.	Chan. Freq. (MHz)	Maximum Conducted Power (dBm)		Total Power (mW)	Total Power (dBm)	Limit (dBm)	Pass / Fail
		Chain 0	Chain 1				
36	5180	13.49	13.20	43.229	16.36	30.00	Pass
40	5200	13.47	13.31	43.662	16.40	30.00	Pass
48	5240	13.80	13.51	46.427	16.67	30.00	Pass
149	5745	13.31	13.20	42.322	16.27	30.00	Pass
157	5785	13.29	13.40	43.208	16.36	30.00	Pass
165	5825	13.64	13.45	45.252	16.56	30.00	Pass

802.11ac (VHT40)

Chan.	Chan. Freq. (MHz)	Maximum Conducted Power (dBm)		Total Power (mW)	Total Power (dBm)	Limit (dBm)	Pass / Fail
		Chain 0	Chain 1				
38	5190	13.36	13.72	45.227	16.55	30.00	Pass
46	5230	13.42	13.39	43.806	16.42	30.00	Pass
151	5755	13.37	13.48	44.011	16.44	30.00	Pass
159	5795	13.49	13.24	43.422	16.38	30.00	Pass

802.11ac (VHT80)

Chan.	Chan. Freq. (MHz)	Maximum Conducted Power (dBm)		Total Power (mW)	Total Power (dBm)	Limit (dBm)	Pass / Fail
		Chain 0	Chain 1				
42	5210	12.72	12.42	36.165	15.58	30.00	Pass
155	5775	12.48	12.51	35.525	15.51	30.00	Pass

4.4 Occupied Bandwidth Measurement

4.4.1 Test Setup

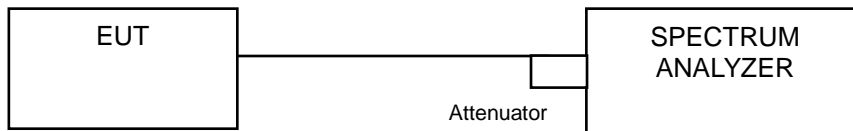

4.4.2 Test Instruments

Refer to section 4.1.2 to get information of above instrument.

4.4.3 Test Procedure

The transmitter output was connected to the spectrum analyzer through an attenuator. The bandwidth of the fundamental frequency was measured by spectrum analyzer with resolution bandwidth in the range of 1% to 5% of the anticipated emission bandwidth, and a video bandwidth at least 3x the resolution bandwidth and set the detector to SAMPLE. The width of a frequency band such that, below the lower and above the upper frequency limits, the mean powers emitted are each equal to a specified percentage 0.5 %of the total mean power of a given emission.

4.4.4 Test Results

802.11a

Channel	Channel Frequency (MHz)	Occupied Bandwidth (MHz)	
		CHAIN 0	CHAIN 1
36	5180	16.80	16.92
40	5200	16.92	17.04
48	5240	16.80	16.92
149	5745	17.88	27.36
157	5785	18.48	24.00
165	5825	21.96	27.24

802.11ac (VHT20)

Channel	Channel Frequency (MHz)	Occupied Bandwidth (MHz)	
		CHAIN 0	CHAIN 1
36	5180	17.88	17.88
40	5200	17.88	17.76
48	5240	17.88	17.88
149	5745	18.12	20.16
157	5785	18.00	23.52
165	5825	19.92	28.92

802.11ac (VHT40)

Channel	Channel Frequency (MHz)	Occupied Bandwidth (MHz)	
		CHAIN 0	CHAIN 1
38	5190	36.96	36.72
46	5230	36.72	36.96
151	5755	38.40	38.40
159	5795	44.16	44.16

802.11ac (VHT80)

Channel	Channel Frequency (MHz)	Occupied Bandwidth (MHz)	
		CHAIN 0	CHAIN 1
42	5210	75.36	76.32
155	5775	75.84	76.80

Spectrum Plot of Worst Value

802.11a_Chain1 / CH149

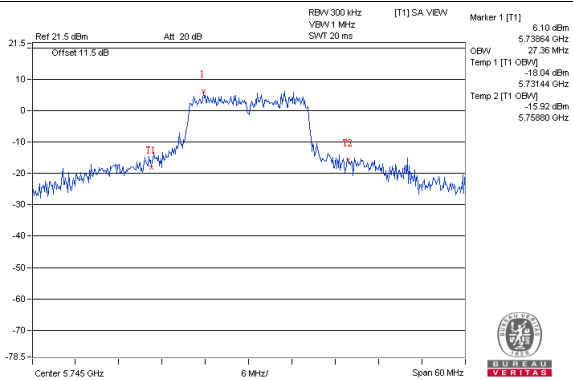

802.11ac (VHT20)_Chain1 / CH165

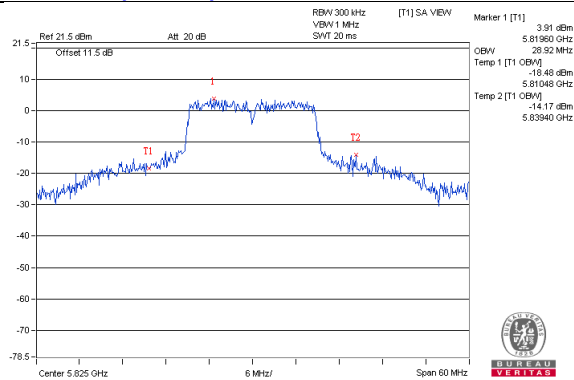

802.11ac (VHT40)_Chain0 / CH159

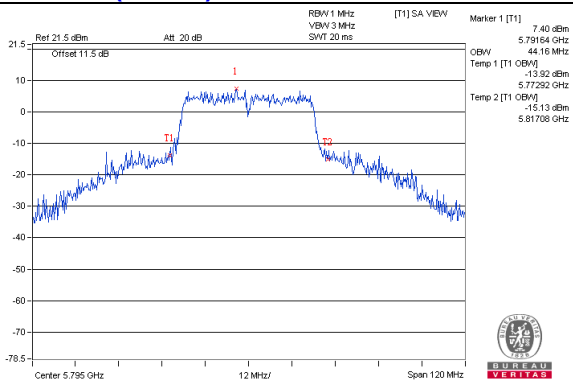

802.11ac (VHT80)_Chain1 / CH155

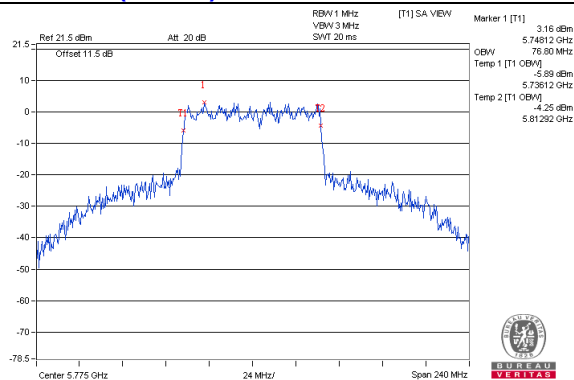

Spectrum Plot for near by DFS band (DFS is required, if 99% OCP straddle into U-NII-2A band)

802.11a_Chain0 / CH48

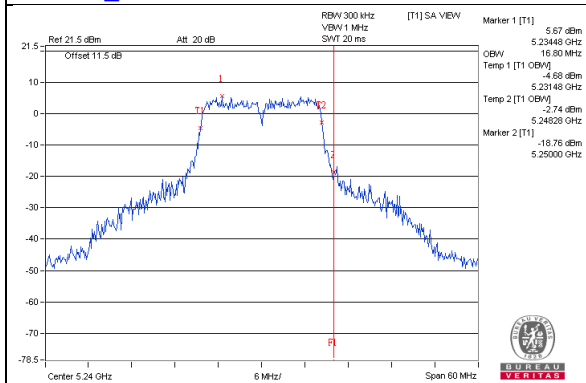

802.11a_Chain1 / CH48

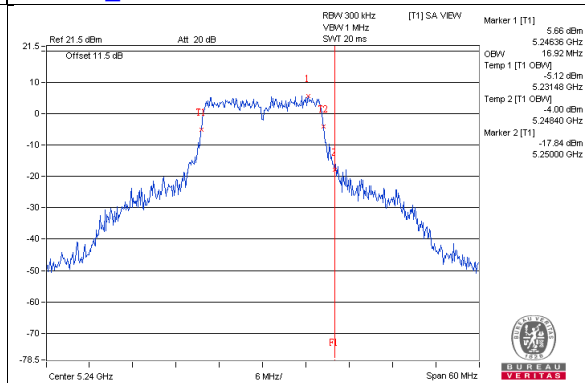

802.11ac(VHT20)_Chain0 / CH48

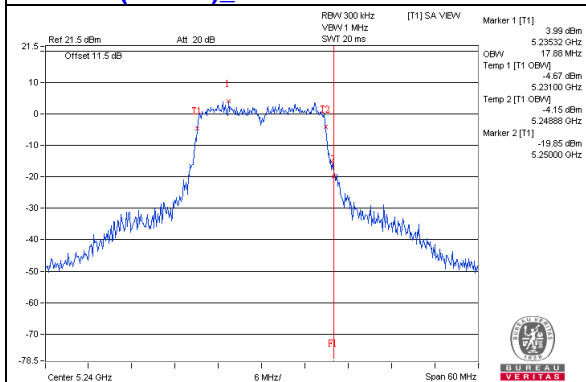

802.11ac(VHT20)_Chain1 / CH48

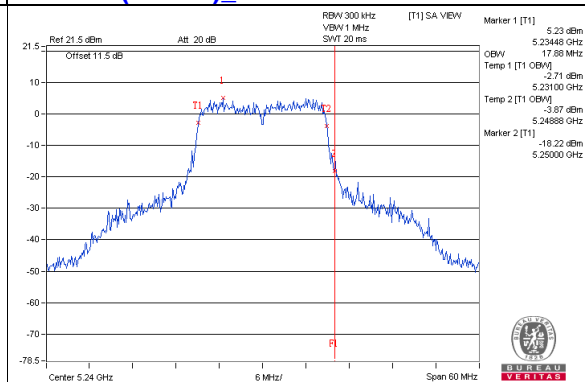

802.11ac(VHT40)_Chain0 / CH46

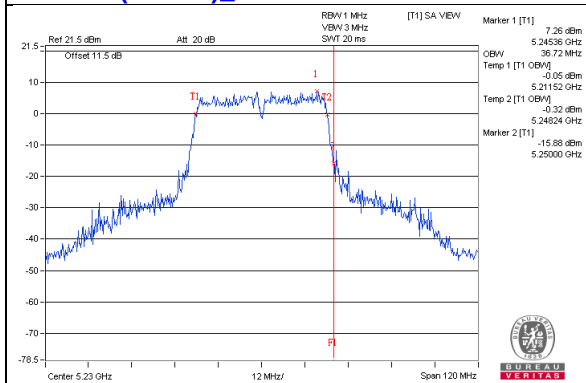

802.11ac(VHT40)_Chain1 / CH46

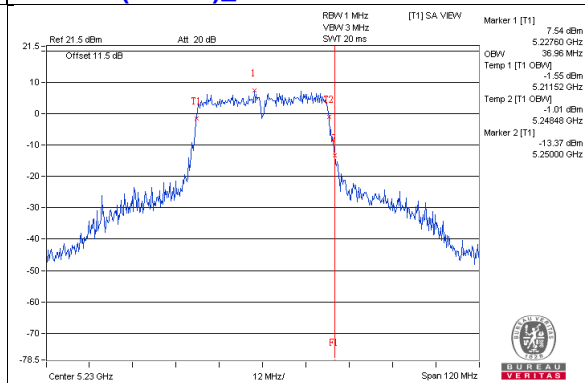

802.11ac(VHT80)_Chain0 / CH42

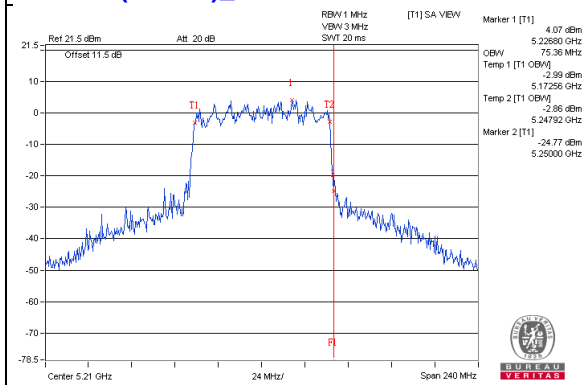

802.11ac(VHT80)_Chain1 / CH42

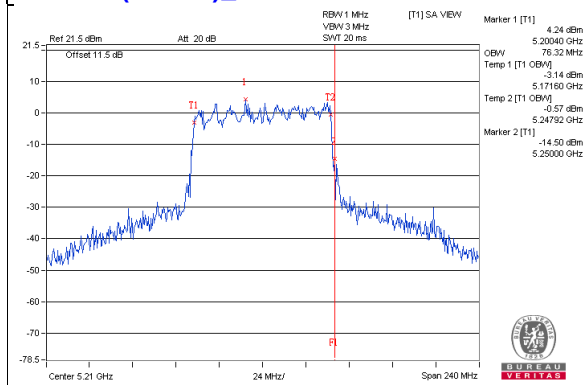

Spectrum Plot for near by DFS band (DFS is required, if 99% OCP straddle into U-NII-2C band)

802.11a_Chain0 / CH149

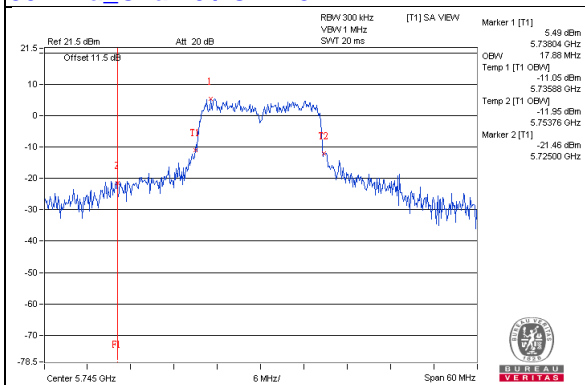

802.11a_Chain1 / CH149

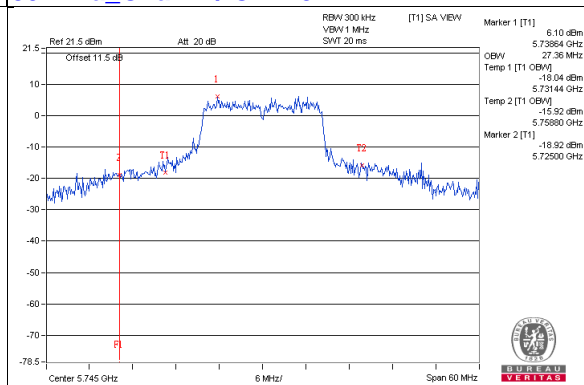

802.11ac(VHT20)_Chain0 / CH149

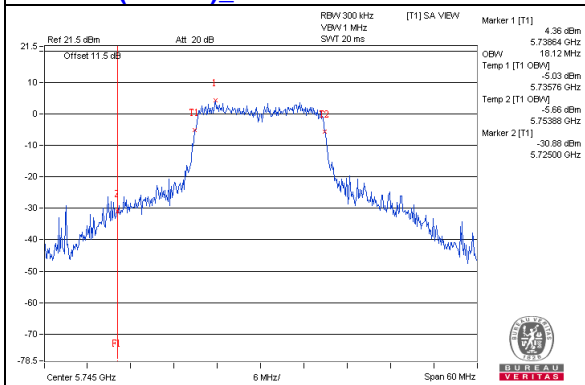

802.11ac(VHT20)_Chain1 / CH149

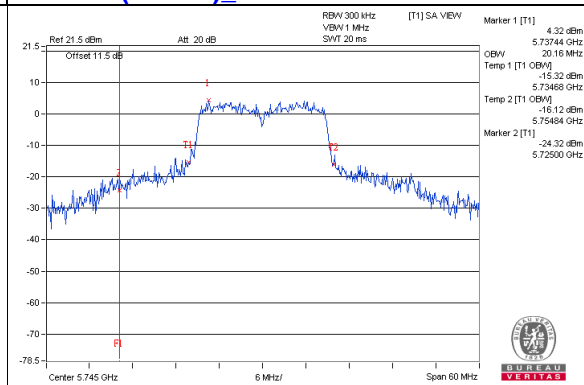

802.11ac(VHT40)_Chain0 / CH151

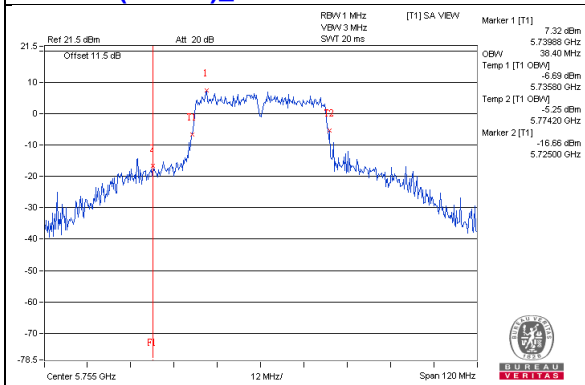

802.11ac(VHT40)_Chain1 / CH151

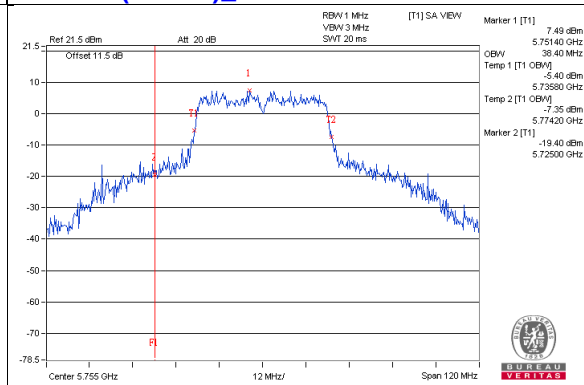

802.11ac(VHT80)_Chain0 / CH155

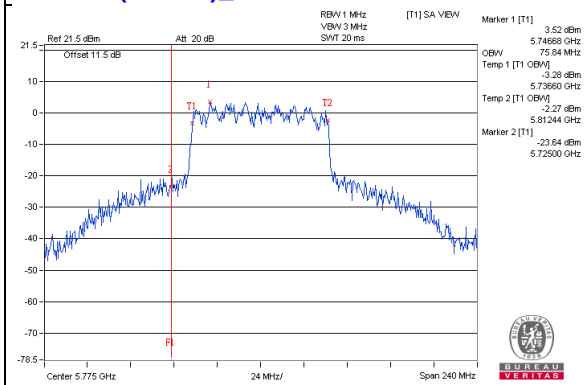

802.11ac(VHT80)_Chain1 / CH155

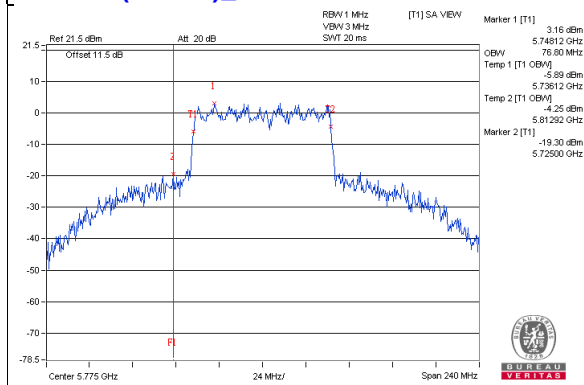

4.5 Peak Power Spectral Density Measurement

4.5.1 Limits of Peak Power Spectral Density Measurement

Operation Band	EUT Category		Limit
U-NII-1		Outdoor Access Point	17dBm/ MHz
		Fixed point-to-point Access Point	
	√	Indoor Access Point	
		Mobile and Portable client device	11dBm/ MHz
U-NII-2A			11dBm/ MHz
U-NII-2C			11dBm/ MHz
U-NII-3	√		30dBm/ 500kHz

4.5.2 Test Setup

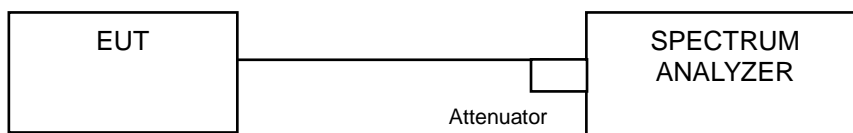

4.5.3 Test Instruments

Refer to section 4.1.2 to get information of above instrument.

4.5.4 Test Procedure

For U-NII-1:

Using method SA-2

1. Set span to encompass the entire emission bandwidth (EBW) of the signal.
2. Set RBW = 1 MHz, Set VBW \geq 3 MHz, Detector = RMS
3. Sweep time = auto, trigger set to "free run".
4. Trace average at least 100 traces in power averaging mode.
5. Record the max value and add 10 log (1/duty cycle)

For U-NII-3:

1. Set span to encompass the entire emission bandwidth (EBW) of the signal.
2. Set RBW = 300 kHz, Set VBW \geq 1 MHz, Detector = RMS
3. Use the peak marker function to determine the maximum power level in any 300 kHz band segment within the fundamental EBW.
4. Scale the observed power level to an equivalent value in 500 kHz by adjusting (reducing) the measured power by a bandwidth correction factor (BWCF) where $BWCF = 10\log(500 \text{ kHz}/300\text{kHz})$
5. Sweep time = auto, trigger set to "free run".
6. Trace average at least 100 traces in power averaging mode.
7. Record the max value and add 10 log (1/duty cycle)

4.5.5 Deviation from Test Standard

No deviation.

4.5.6 EUT Operating Condition

Same as Item 4.3.6.

4.5.7 Test Results

For U-NII-1:

802.11a

Chan.	Chan. Freq. (MHz)	PSD W/O Duty Factor (dBm/MHz)		Duty Factor (dB)	Total PSD With Duty Factor (dBm/MHz)	MAX. Limit (dBm/MHz)	Pass / Fail
		Chain 0	Chain 1				
36	5180	0.16	0.03	0.17	3.27	14.43	Pass
40	5200	-0.50	0.46	0.17	3.18	14.43	Pass
48	5240	0.91	1.18	0.17	4.23	14.43	Pass

- Note:**
- Method a) of power density measurement of KDB 662911 is using for calculating total power density. Total power density is summing entire spectra across corresponding frequency bins on the various outputs by computer.
 - Directional gain = $5.56\text{dBi} + 10\log(2) = 8.57\text{dBi} > 6\text{dBi}$, so the power density limit shall be reduced to $17-(8.57-6) = 14.43\text{dBm}$.
 - Refer to section 3.3 for duty cycle spectrum plot.

802.11ac (VHT20)

Chan.	Chan. Freq. (MHz)	PSD W/O Duty Factor (dBm/MHz)		Duty Factor (dB)	Total PSD With Duty Factor (dBm/MHz)	MAX. Limit (dBm/MHz)	Pass / Fail
		Chain 0	Chain 1				
36	5180	-2.98	-1.17	0.32	1.35	14.43	Pass
40	5200	-1.44	-1.56	0.32	1.83	14.43	Pass
48	5240	-1.57	-0.74	0.32	2.20	14.43	Pass

- Note:**
- Method a) of power density measurement of KDB 662911 is using for calculating total power density. Total power density is summing entire spectra across corresponding frequency bins on the various outputs by computer.
 - Directional gain = $5.56\text{dBi} + 10\log(2) = 8.57\text{dBi} > 6\text{dBi}$, so the power density limit shall be reduced to $17-(8.57-6) = 14.43\text{dBm}$.
 - Refer to section 3.3 for duty cycle spectrum plot.

802.11ac (VHT40)

Chan.	Chan. Freq. (MHz)	PSD W/O Duty Factor (dBm/MHz)		Duty Factor (dB)	Total PSD With Duty Factor (dBm/MHz)	MAX. Limit (dBm/MHz)	Pass / Fail
		Chain 0	Chain 1				
38	5190	-9.00	-2.59	1.16	-0.54	14.43	Pass
46	5230	-4.38	-5.30	1.16	-0.65	14.43	Pass

- Note:**
- Method a) of power density measurement of KDB 662911 is using for calculating total power density. Total power density is summing entire spectra across corresponding frequency bins on the various outputs by computer.
 - Directional gain = $5.56\text{dBi} + 10\log(2) = 8.57\text{dBi} > 6\text{dBi}$, so the power density limit shall be reduced to $17-(8.57-6) = 14.43\text{dBm}$.
 - Refer to section 3.3 for duty cycle spectrum plot.

802.11ac (VHT80)

Chan.	Chan. Freq. (MHz)	PSD W/O Duty Factor (dBm/MHz)		Duty Factor (dB)	Total PSD With Duty Factor (dBm/MHz)	MAX. Limit (dBm/MHz)	Pass / Fail
		Chain 0	Chain 1				
42	5210	-10.30	-8.14	1.45	-4.63	14.43	Pass

- Note:**
- Method a) of power density measurement of KDB 662911 is using for calculating total power density. Total power density is summing entire spectra across corresponding frequency bins on the various outputs by computer.
 - Directional gain = $5.56\text{dBi} + 10\log(2) = 8.57\text{dBi} > 6\text{dBi}$, so the power density limit shall be reduced to $17-(8.57-6) = 14.43\text{dBm}$.
 - Refer to section 3.3 for duty cycle spectrum plot.

Spectrum Plot of Worst Value

802.11a_Chain 1 / CH48

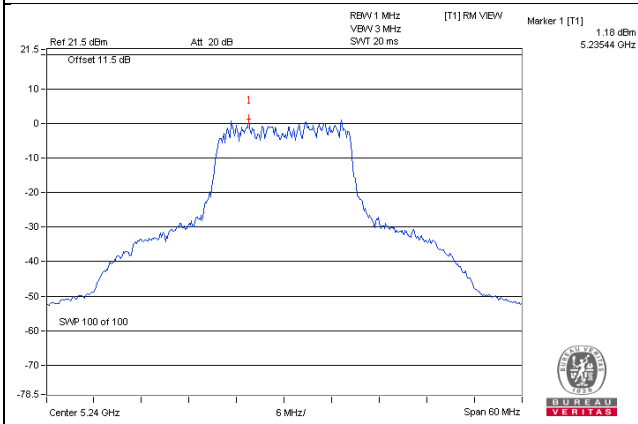

802.11ac (VHT20)_Chain 1 / CH48

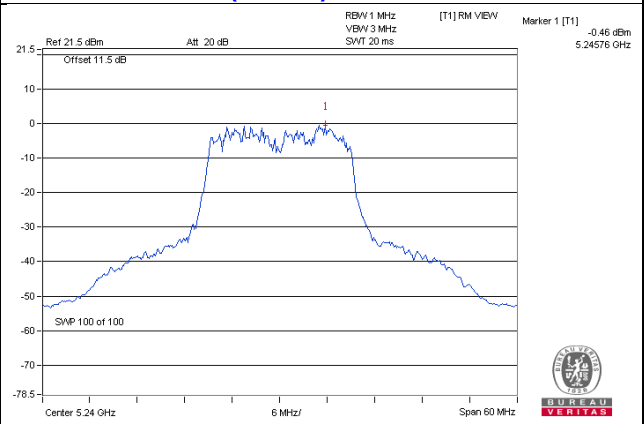

802.11ac (VHT40)_Chain 1 / CH38

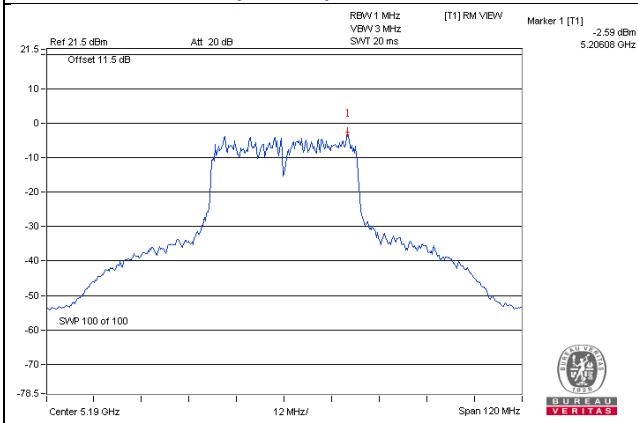

802.11ac (VHT80)_Chain 1 / CH42

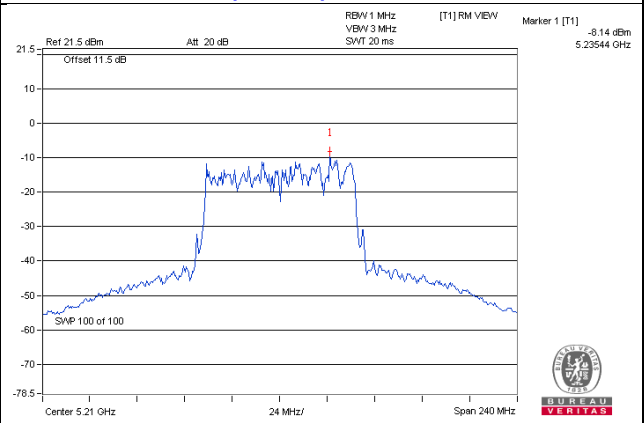

For U-NII-3:
802.11a

TX chain	Chan.	Chan. Freq. (MHz)	PSD W/O Duty Factor		10 log (N=2) dB	Duty Factor (dB)	Total PSD With Duty Factor (dBm/500kHz)	Limit (dBm/500kHz)	Pass /Fail
			(dBm/300kHz)	(dBm/500kHz)					
0	149	5745	-8.09	-5.87	3.01	0.17	-2.69	27.43	Pass
	157	5785	-8.41	-6.19	3.01	0.17	-3.01	27.43	Pass
	165	5825	-9.17	-6.95	3.01	0.17	-3.77	27.43	Pass
1	149	5745	-6.97	-4.75	3.01	0.17	-1.57	27.43	Pass
	157	5785	-7.65	-5.43	3.01	0.17	-2.25	27.43	Pass
	165	5825	-8.28	-6.06	3.01	0.17	-2.88	27.43	Pass

Note: 1. Directional gain = $5.56\text{dBi} + 10\log(2) = 8.57\text{dBi}$ $i > 6\text{dBi}$, so the power density limit shall be reduced to $30-(8.57-6) = 27.43\text{dBm}$.

2. Refer to section 3.3 for duty cycle spectrum plot.

802.11ac (VHT20)

TX chain	Chan.	Chan. Freq. (MHz)	PSD W/O Duty Factor		10 log (N=2) dB	Duty Factor (dB)	Total PSD With Duty Factor (dBm/500kHz)	Limit (dBm/500kHz)	Pass /Fail
			(dBm/300kHz)	(dBm/500kHz)					
0	149	5745	-9.27	-7.05	3.01	0.32	-3.72	27.43	Pass
	157	5785	-10.53	-8.31	3.01	0.32	-4.98	27.43	Pass
	165	5825	-9.18	-6.96	3.01	0.32	-3.63	27.43	Pass
1	149	5745	-8.58	-6.36	3.01	0.32	-3.03	27.43	Pass
	157	5785	-9.21	-6.99	3.01	0.32	-3.66	27.43	Pass
	165	5825	-9.25	-7.03	3.01	0.32	-3.70	27.43	Pass

Note: 1. Directional gain = $5.56\text{dBi} + 10\log(2) = 8.57\text{dBi}$ $i > 6\text{dBi}$, so the power density limit shall be reduced to $30-(8.57-6) = 27.43\text{dBm}$.

2. Refer to section 3.3 for duty cycle spectrum plot.

802.11ac (VHT40)

TX chain	Chan.	Chan. Freq. (MHz)	PSD W/O Duty Factor		10 log (N=2) dB	Duty Factor (dB)	Total PSD With Duty Factor (dBm/500kHz)	Limit (dBm/500kHz)	Pass /Fail
			(dBm/300kHz)	(dBm/500kHz)					
0	151	5755	-12.87	-10.65	3.01	1.16	-6.48	27.43	Pass
	159	5795	-13.29	-11.07	3.01	1.16	-6.90	27.43	Pass
1	151	5755	-12.78	-10.56	3.01	1.16	-6.39	27.43	Pass
	159	5795	-12.80	-10.58	3.01	1.16	-6.41	27.43	Pass

Note: 1. Directional gain = $5.56\text{dBi} + 10\log(2) = 8.57\text{dBi}$ $i > 6\text{dBi}$, so the power density limit shall be reduced to $30-(8.57-6) = 27.43\text{dBm}$.

2. Refer to section 3.3 for duty cycle spectrum plot.

802.11ac (VHT80)

TX chain	Chan.	Chan. Freq. (MHz)	PSD W/O Duty Factor		10 log (N=2) dB	Duty Factor (dB)	Total PSD With Duty Factor (dBm/500kHz)	Limit (dBm/500kHz)	Pass /Fail
			(dBm/300kHz)	(dBm/500kHz)					
0	155	5775	-16.57	-14.35	3.01	1.45	-9.89	27.43	Pass
1	155	5775	-15.85	-13.63	3.01	1.45	-9.17	27.43	Pass

Note: 1. Directional gain = $5.56\text{dBi} + 10\log(2) = 8.57\text{dBi}$ $i > 6\text{dBi}$, so the power density limit shall be reduced to $30-(8.57-6) = 27.43\text{dBm}$.

2. Refer to section 3.3 for duty cycle spectrum plot.

Spectrum Plot of Worst Value

802.11a – Chain 1: CH 149

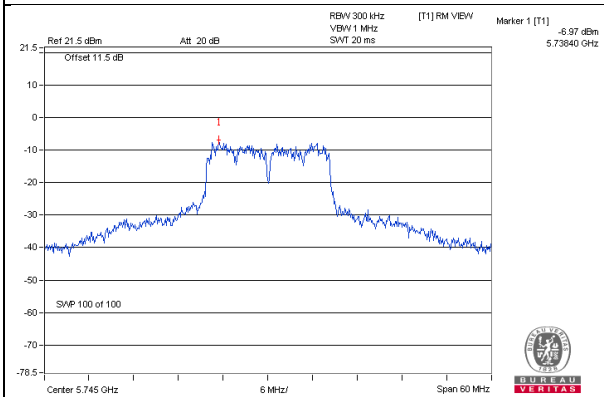

802.11ac (VHT20) – Chain 1: CH 149

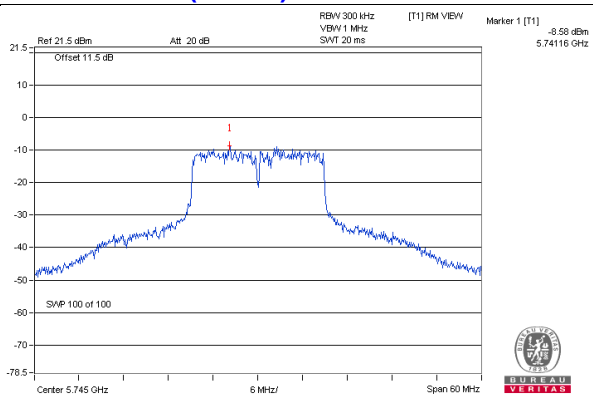

802.11ac (VHT40) – Chain 1: CH 151

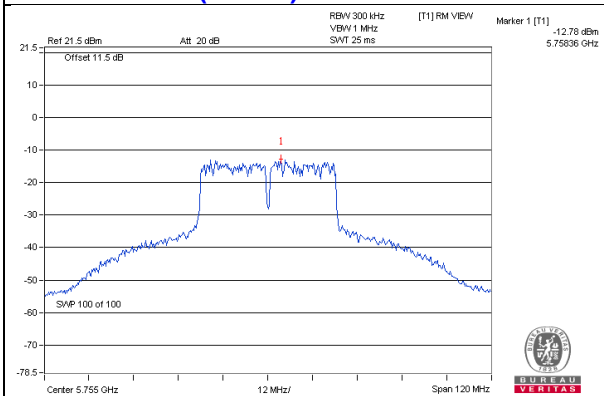

802.11ac (VHT80) – Chain 1: CH 155

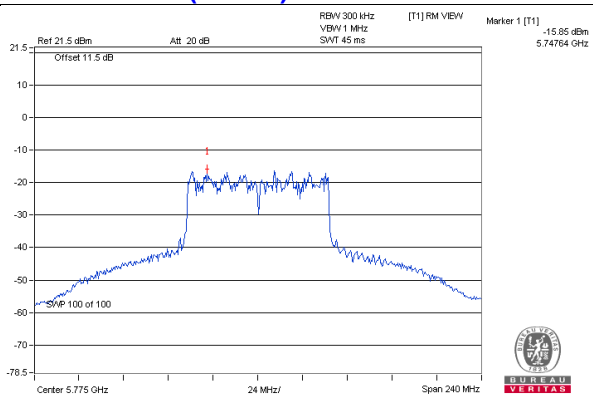

4.6 Frequency Stability Measurement

4.6.1 Limits of Frequency Stability Measurement

The frequency of the carrier signal shall be maintained within band of operation

4.6.2 Test Setup

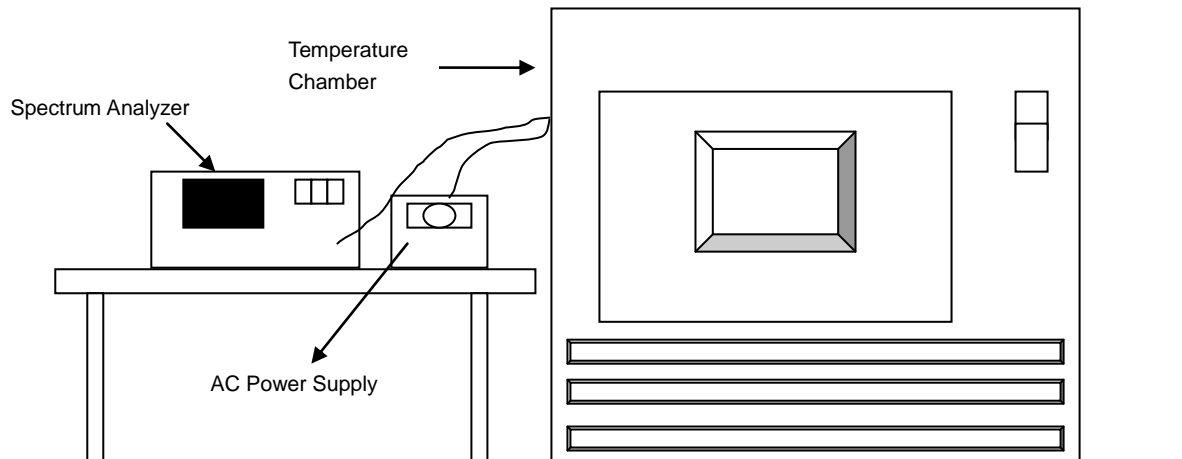

4.6.3 Test Instruments

Refer to section 4.1.2 to get information of above instrument.

4.6.4 Test Procedure

- The EUT was placed inside the environmental test chamber and powered by nominal AC voltage.
- Turn the EUT on and couple its output to a spectrum analyzer.
- Turn the EUT off and set the chamber to the highest temperature specified.
- Allow sufficient time (approximately 30 min) for the temperature of the chamber to stabilize, turn the EUT on and measure the operating frequency after 2, 5, and 10 Minutes.
- Repeat step 2 and 3 with the temperature chamber set to the lowest temperature.
- The test chamber was allowed to stabilize at +20 degree C for a minimum of 30 Minutes. The supply voltage was then adjusted on the EUT from 85% to 115% and the frequency record.

4.6.5 Deviation from Test Standard

No deviation.

4.6.6 EUT Operating Condition

Set the EUT transmit at un-modulation mode to test frequency stability.

4.6.7 Test Results

Frequency Stability Versus Temp.									
Operating Frequency: 5180 MHz									
TEMP. (°C)	Power Supply (Vac)	0 Minute		2 Minute		5 Minute		10 Minute	
		Measured Frequency (MHz)	Pass/Fail	Measured Frequency (MHz)	Pass/Fail	Measured Frequency (MHz)	Pass/Fail	Measured Frequency (MHz)	Pass/Fail
50	120	5180.0031	PASS	5180.0026	PASS	5180.0044	PASS	5180.0072	PASS
40	120	5179.9972	PASS	5179.9957	PASS	5179.9988	PASS	5179.9985	PASS
30	120	5180.0191	PASS	5180.0168	PASS	5180.0184	PASS	5180.0152	PASS
20	120	5180.006	PASS	5180.0061	PASS	5180.0078	PASS	5180.0041	PASS
10	120	5179.9803	PASS	5179.9793	PASS	5179.9802	PASS	5179.9824	PASS
0	120	5180.0165	PASS	5180.0161	PASS	5180.013	PASS	5180.0148	PASS
-10	120	5179.9746	PASS	5179.9751	PASS	5179.9757	PASS	5179.9742	PASS
-20	120	5179.9995	PASS	5179.9956	PASS	5179.9972	PASS	5179.999	PASS
-30	120	5180.0038	PASS	5180.0046	PASS	5180.005	PASS	5180.0039	PASS

Frequency Stability Versus Voltage									
Operating Frequency: 5180 MHz									
TEMP. (°C)	Power Supply (Vac)	0 Minute		2 Minute		5 Minute		10 Minute	
		Measured Frequency (MHz)	Pass/Fail	Measured Frequency (MHz)	Pass/Fail	Measured Frequency (MHz)	Pass/Fail	Measured Frequency (MHz)	Pass/Fail
20	138	5180.0068	PASS	5180.0052	PASS	5180.007	PASS	5180.0049	PASS
	120	5180.006	PASS	5180.0061	PASS	5180.0078	PASS	5180.0041	PASS
	102	5180.0065	PASS	5180.0051	PASS	5180.0073	PASS	5180.0042	PASS

4.7 6dB Bandwidth Measurement

4.7.1 Limits of 6dB Bandwidth Measurement

The minimum of 6dB Bandwidth Measurement is 0.5MHz.

4.7.2 Test Setup

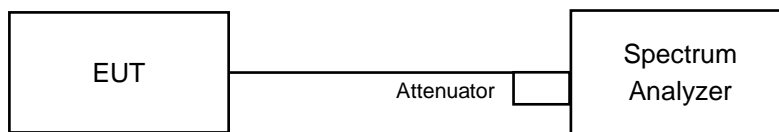

4.7.3 Test Instruments

Refer to section 4.1.2 to get information of above instrument.

4.7.4 Test Procedure

MEASUREMENT PROCEDURE REF

- Set resolution bandwidth (RBW) = 100kHz
- Set the video bandwidth (VBW) $\geq 3 \times$ RBW, Detector = Peak.
- Trace mode = max hold.
- Sweep = auto couple.
- Measure the maximum width of the emission that is constrained by the frequencies associated with the two amplitude points (upper and lower) that are attenuated by 6 dB relative to the maximum level measured in the fundamental emission

4.7.5 Deviation from Test Standard

No deviation.

4.7.6 EUT Operating Condition

The software provided by client to enable the EUT under transmission condition continuously at lowest, middle and highest channel frequencies individually.

4.7.7 Test Results

802.11a

Channel	Frequency (MHz)	6dB Bandwidth (MHz)		Minimum Limit (MHz)	Pass / Fail
		Chain 0	Chain 1		
149	5745	16.34	16.12	0.5	PASS
157	5785	16.30	16.11	0.5	PASS
165	5825	16.32	16.12	0.5	PASS

802.11ac (VHT20)

Channel	Frequency (MHz)	6dB Bandwidth (MHz)		Minimum Limit (MHz)	Pass / Fail
		Chain 0	Chain 1		
149	5745	17.35	16.70	0.5	PASS
157	5785	16.74	17.07	0.5	PASS
165	5825	17.11	17.01	0.5	PASS

802.11ac (VHT40)

Channel	Frequency (MHz)	6dB Bandwidth (MHz)		Minimum Limit (MHz)	Pass / Fail
		Chain 0	Chain 1		
151	5755	35.67	35.72	0.5	PASS
159	5795	35.86	35.56	0.5	PASS

802.11ac (VHT80)

Channel	Frequency (MHz)	6dB Bandwidth (MHz)		Minimum Limit (MHz)	Pass / Fail
		Chain 0	Chain 1		
155	5775	75.32	75.52	0.5	PASS

Spectrum Plot of Worst Value

802.11a_Chain 1 / CH157

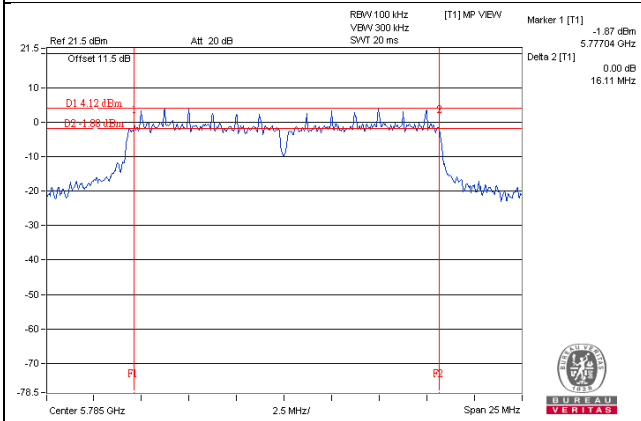

802.11ac (VHT20)_Chain 1 / CH149

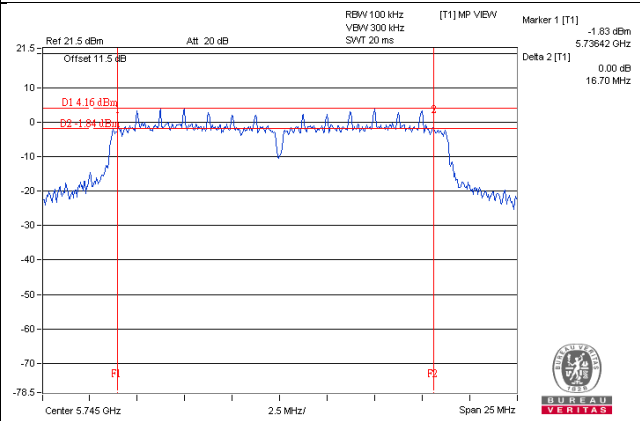

802.11ac (VHT40)_Chain 1 / CH159

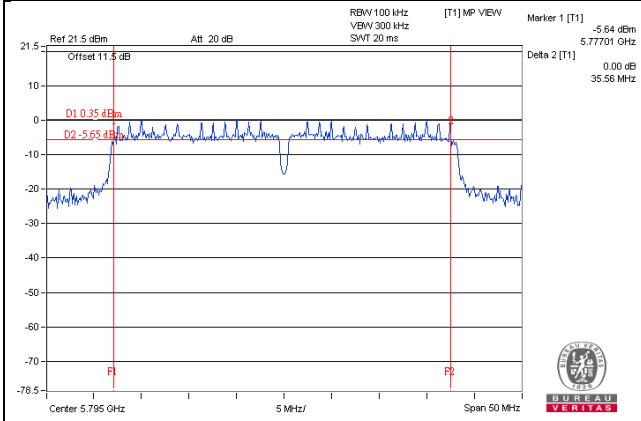

802.11ac (VHT80)_Chain 0 / CH155

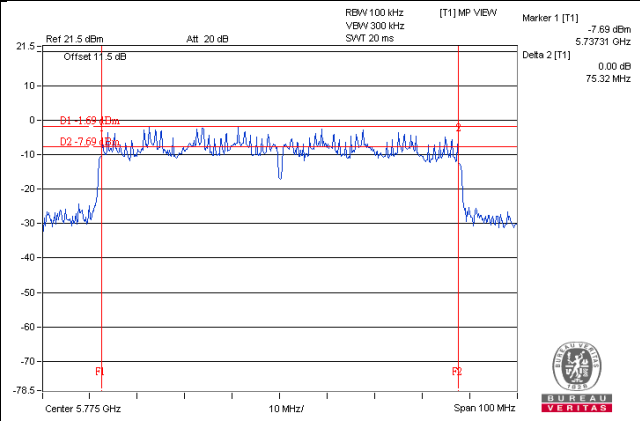

5 Pictures of Test Arrangements

Please refer to the attached file (Test Setup Photo).

Annex A- Radiated Out of Band Emission (OOBE) Measurement (For U-NII-3 band)

802.11a

CH 149 5745 MHz

Horizontal

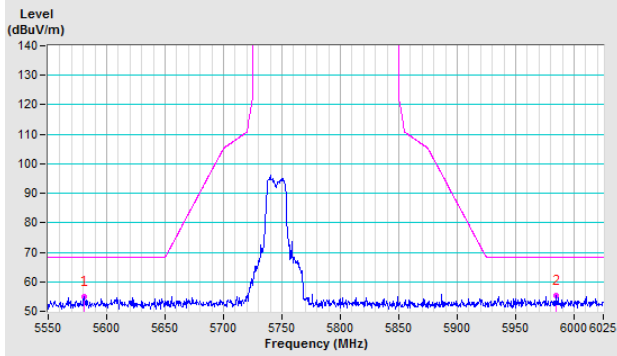

Vertical

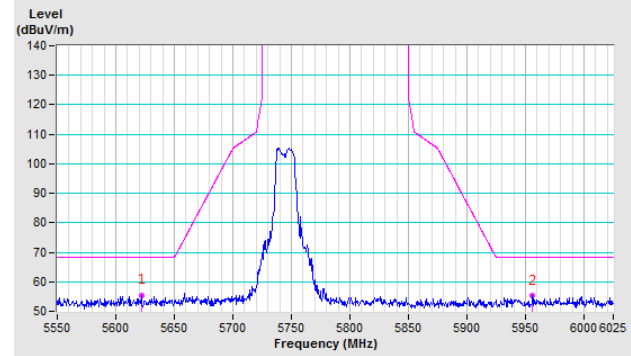

CH 157 5785 MHz

Horizontal

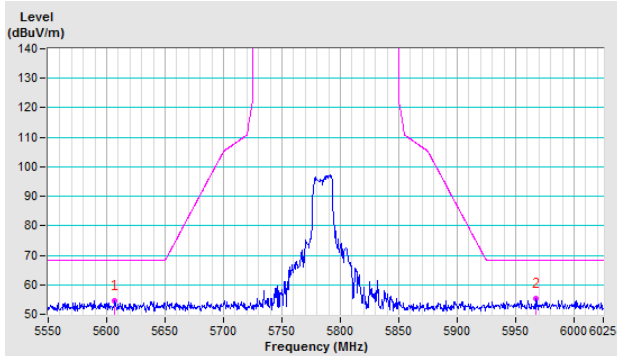

Vertical

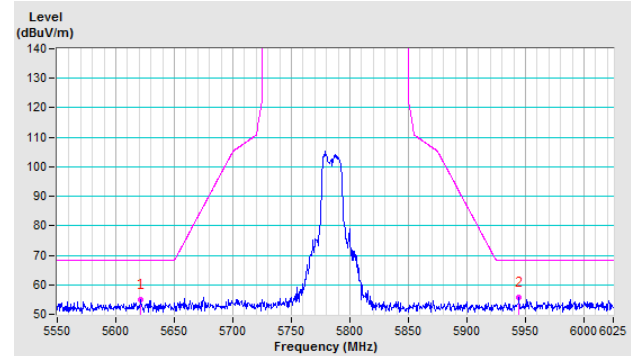

CH 165 5825 MHz

Horizontal

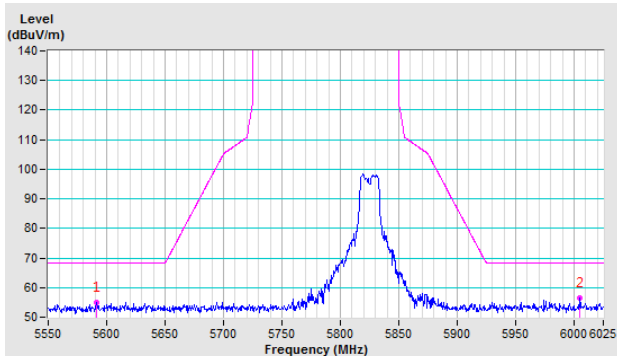

Vertical

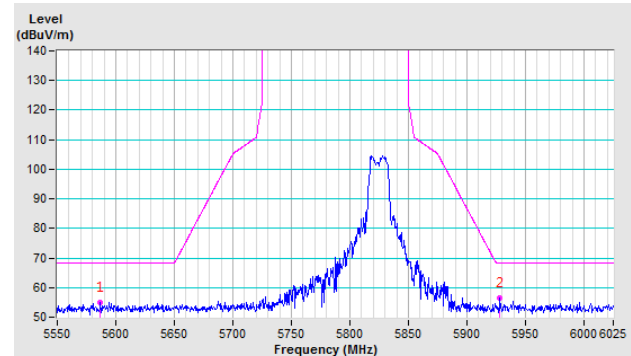

802.11ac (VHT20)

CH 149 5745 MHz

Horizontal

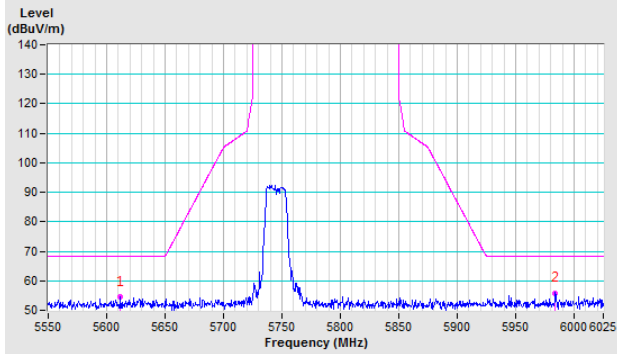

Vertical

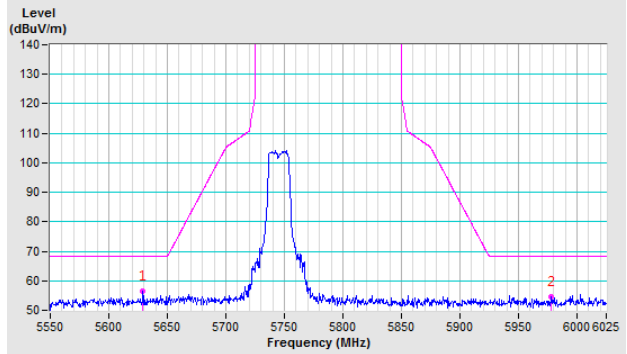

CH 157 5785 MHz

Horizontal

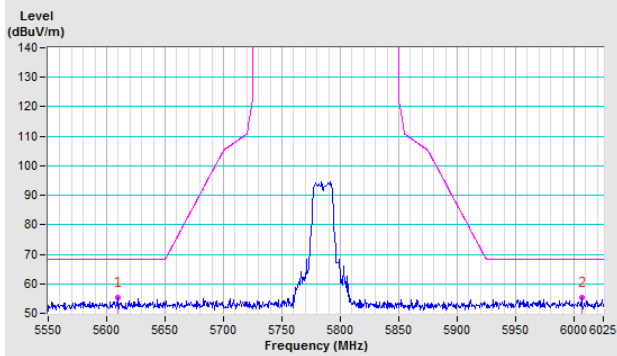

Vertical

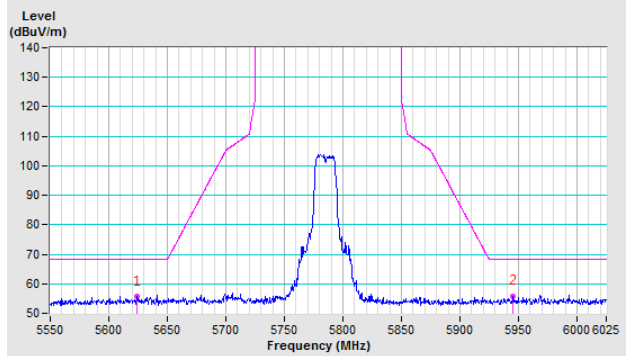

CH 165 5825 MHz

Horizontal

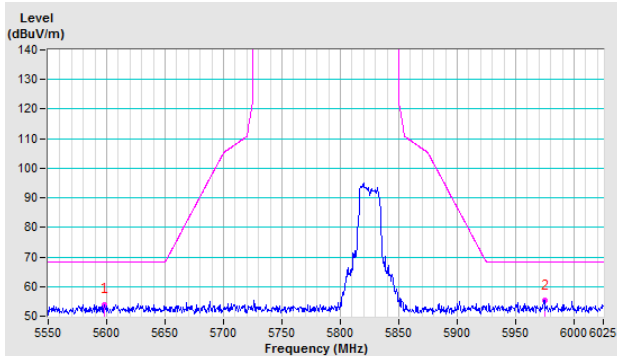

Vertical

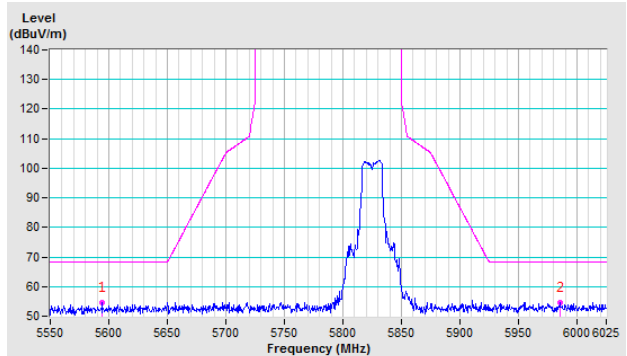

802.11ac (VHT40)

CH 151 5755 MHz

Horizontal

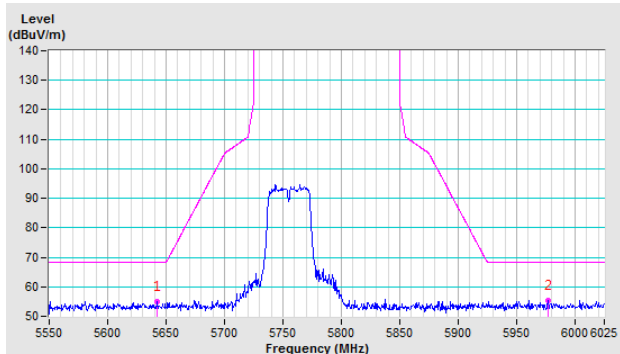

Vertical

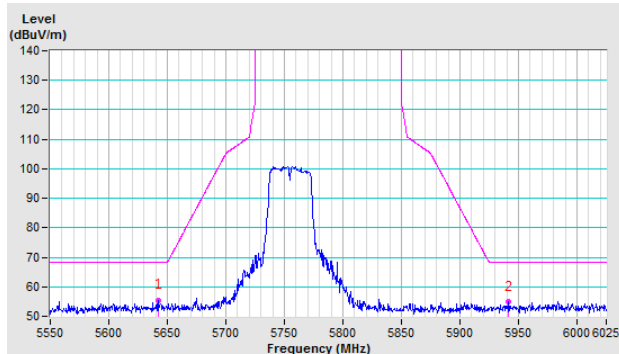

CH 159 5795 MHz

Horizontal

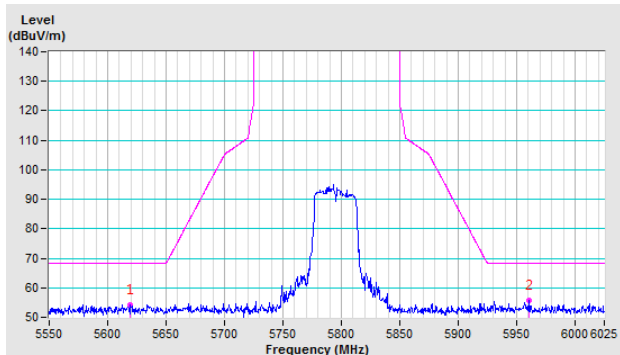

Vertical

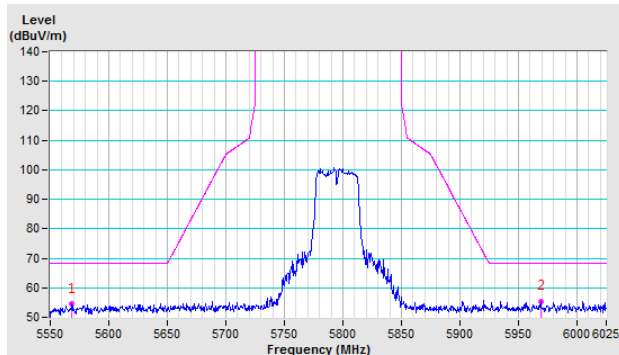

802.11ac (VHT80)

CH 155 5775 MHz

Horizontal

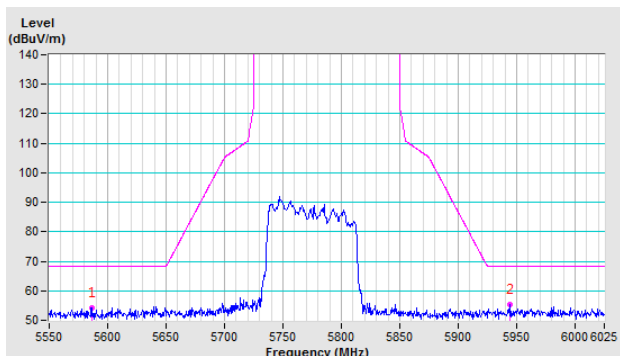

Vertical

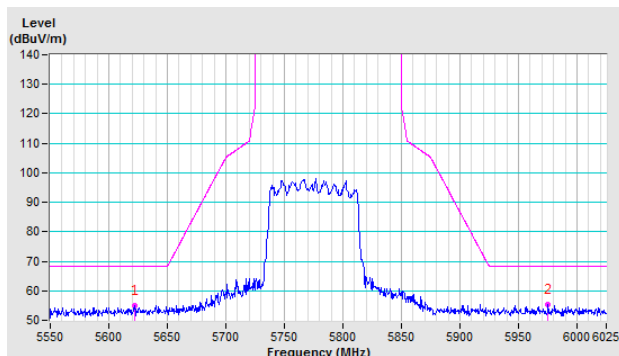

Appendix – Information on the Testing Laboratories

We, Bureau Veritas Consumer Products Services (H.K.) Ltd., Taoyuan Branch, were founded in 1988 to provide our best service in EMC, Radio, Telecom and Safety consultation. Our laboratories are accredited and approved according to ISO/IEC 17025.

If you have any comments, please feel free to contact us at the following:

Linko EMC/RF Lab

Tel: 886-2-26052180

Fax: 886-2-26051924

Hsin Chu EMC/RF/Telecom Lab

Tel: 886-3-6668565

Fax: 886-3-6668323

Hwa Ya EMC/RF/Safety Lab

Tel: 886-3-3183232

Fax: 886-3-3270892

Email: service.adt@tw.bureauveritas.com

Web Site: www.bureauveritas-adt.com

The address and road map of all our labs can be found in our web site also.

--- END ---