



FCC&IC Test Report

FCC ID: 2ALHZHP87B

Product Name:	Bluetooth Headphone with active noise cancellation
Trademark:	N/A
Model Name :	IAHP87B
Prepared For :	KO-STAR DEVELOPMENT CO.,LTD
Address :	No.3, Yicun Industrial Area, Xikeng, Henggang Town, Longgang Distict, Shenzhen, China
Prepared By :	Shenzhen BCTC Technology Co., Ltd.
Address :	No.101,Yousong Road,Longhua New District, Shenzhen,China
Test Date:	Apr. 20, 2017 – May 12, 2017
Date of Report :	May 12, 2017
Report No.:	BCTC-LH170401503E



TEST RESULT CERTIFICATION

Applicant's name..... : KO-STAR DEVELOPMENT CO.,LTD

Address..... : No.3, Yicun Industrial Area, Xikeng, Henggang Town, Longgang Distict, Shenzhen, China

Manufacture's Name..... : SHENZHEN BASSWORLD TECHNOLOGY CO., LTD

Address..... : No.3, Yicun Industrial Area, Xikeng, Henggang Town, Longgang Distict, Shenzhen, China

Product description

Product name.....: Bluetooth Headphone with active noise cancellation

Trademark.....: N/A

Model and/or type reference : IAHP87B

Standards..... : FCC Part15.247
ANSI C63.10-2013
RSS-247 Issue 2, February 2017
RSS-Gen Issue 4, November 2014

This device described above has been tested by BCTC, and the test results show that the equipment under test (EUT) is in compliance with the FCC requirements. And it is applicable only to the tested sample identified in the report.

This report shall not be reproduced except in full, without the written approval of BCTC, this document may be altered or revised by BCTC, personal only, and shall be noted in the revision of the document.

Prepared by(Engineer): Snow Zeng

Snow Zeng

Reviewer(Supervisor): Jade Yang

Jade Yang

Approved(Manager): Carson Zhang

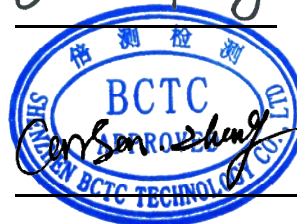

**Table of Contents**

	Page
1 . SUMMARY OF TEST RESULTS	5
1.1 TEST FACILITY	5
1.2 MEASUREMENT UNCERTAINTY	6
2 . GENERAL INFORMATION	7
2.1 GENERAL DESCRIPTION OF EUT	7
2.2 DESCRIPTION OF TEST MODES	8
2.3 BLOCK DIGRAM SHOWING THE CONFIGURATION OF SYSTEM TESTED	9
2.4 DESCRIPTION OF SUPPORT UNITS(CONDUCTED MODE)	9
2.5 EQUIPMENTS LIST FOR ALL TEST ITEMS	10
3 . EMC EMISSION TEST	11
3.1 CONDUCTED EMISSION MEASUREMENT	11
3.1.1 POWER LINE CONDUCTED EMISSION LIMITS	11
3.1.2 TEST PROCEDURE	11
3.1.3 DEVIATION FROM TEST STANDARD	11
3.1.4 TEST SETUP	12
3.1.5 EUT OPERATING CONDITIONS	12
3.1.6 TEST RESULTS	12
3.2 RADIATED EMISSION MEASUREMENT	15
3.2.1 RADIATED EMISSION LIMITS	15
3.2.2 TEST PROCEDURE	16
3.2.3 DEVIATION FROM TEST STANDARD	16
3.2.4 TEST SETUP	16
3.2.5 EUT OPERATING CONDITIONS	17
3.2.6 TEST RESULTS (BETWEEN 9KHZ – 30 MHZ)	18
3.2.7 TEST RESULTS (BETWEEN 30MHZ – 1GHZ)	19
3.2.8 TEST RESULTS (1GHZ~25GHZ)	21
3.3 RADIATED BAND EMISSION MEASUREMENT	25
3.3.1 TEST REQUIREMENT:	25
3.3.2 TEST PROCEDURE	25
3.3.3 DEVIATION FROM TEST STANDARD	26
3.3.4 TEST SETUP	26
3.3.5 EUT OPERATING CONDITIONS	26
4 . BANDWIDTH TEST	32
4.1 APPLIED PROCEDURES / LIMIT	32
4.1.1 TEST PROCEDURE	32
4.1.2 DEVIATION FROM STANDARD	32
4.1.3 TEST SETUP	32
4.1.4 EUT OPERATION CONDITIONS	32
4.1.5 TEST RESULTS	33
5 . NUMBER OF HOPPING CHANNEL	37
5.1 APPLIED PROCEDURES / LIMIT	37
5.1.1 TEST PROCEDURE	37
5.1.2 DEVIATION FROM STANDARD	37
5.1.3 TEST SETUP	37



Table of Contents		Page
5.1.4 EUT OPERATION CONDITIONS		37
5.1.5 TEST RESULTS		37
6 . AVERAGE TIME OF OCCUPANCY		39
6.1 APPLIED PROCEDURES / LIMIT		39
6.1.1 TEST PROCEDURE		39
6.1.2 DEVIATION FROM STANDARD		39
6.1.3 TEST SETUP		39
6.1.4 EUT OPERATION CONDITIONS		39
6.1.5 TEST RESULTS		40
7 . HOPPING CHANNEL SEPARATION MEASUREMENT		42
7.1 APPLIED PROCEDURES / LIMIT		42
7.1.1 TEST PROCEDURE		42
7.1.2 DEVIATION FROM STANDARD		42
7.1.3 TEST SETUP		42
7.1.4 EUT OPERATION CONDITIONS		42
7.1.5 TEST RESULTS		43
8 . HOPPING CHANNEL SEPARATION MEASUREMENT		45
8.1 APPLIED PROCEDURES / LIMIT		45
8.1.1 TEST PROCEDURE		45
8.1.2 DEVIATION FROM STANDARD		45
8.1.3 TEST SETUP		45
8.1.4 EUT OPERATION CONDITIONS		45
8.1.5 TEST RESULTS		46
9 . ANTENNA REQUIREMENT		47
9.1 STANDARD REQUIREMENT		47
9.2 EUT ANTENNA		47
10 . TEST SEUUP PHOTO		48
11 . EUT PHOTO		50



1. SUMMARY OF TEST RESULTS

Test procedures according to the technical standards:

FCC Part15 (15.247) , Subpart C RSS-247			
Standard Section	Test Item	Judgment	Remark
RSS-Gen 8.8 15.207 RSS-247	Conducted Emission	PASS	
15.247(a)(1) RSS-247 5.1(d)	Hopping Channel Separation	PASS	
15.247(b)(1) RSS-247 5.1(b)	Peak Output Power	PASS	
15.247(c) RSS-247 5.5 RSS-Gen 8.9	Radiated Spurious Emission	PASS	
15.247(a)(iii) RSS-247 5.1(d)	Number of Hopping Frequency	PASS	
15.247(a)(iii) RSS-247 5.1(d)	Dwell Time	PASS	
15.247(a)(1) RSS-247 5.1(a)	Bandwidth	PASS	
15.205 RSS-247	Band Edge Emission	PASS	
15.203 RSS-247	Antenna Requirement	PASS	

NOTE:

(1) "N/A" denotes test is not applicable in this Test Report

1.1 TEST FACILITY

Shenzhen BCTC Technology Co., Ltd.

Add. : No.101, Yousong Road, Longhua New District, Shenzhen, China

FCC Registered No.: 187086



1.2 MEASUREMENT UNCERTAINTY

The reported uncertainty of measurement $y \pm U$, where expanded uncertainty U is based on a standard uncertainty multiplied by a coverage factor of $k=2$, providing a level of confidence of approximately **95 %**.

No.	Item	Uncertainty
1	Conducted Emission Test	$\pm 1.38\text{dB}$
2	RF power,conducted	$\pm 0.16\text{dB}$
3	Spurious emissions,conducted	$\pm 0.21\text{dB}$
4	All emissions,radiated(<1G)	$\pm 4.68\text{dB}$
5	All emissions,radiated(>1G)	$\pm 4.89\text{dB}$
6	Temperature	$\pm 0.5^{\circ}\text{C}$
7	Humidity	$\pm 2\%$



2. GENERAL INFORMATION

2.1 GENERAL DESCRIPTION OF EUT

Equipment	Bluetooth Headphone with active noise cancellation	
Trade Name	N/A	
Model Name	IAHP87B	
Model Difference	N/A	
Product Description	The EUT is a Bluetooth Speaker	
	Operation Frequency:	2402~2480 MHz
	Modulation Type:	GFSK, PI/4 DPSK, 8DPSK
	Bit Rate of Transmitter	1/2/3Mbps
	Number Of Channel	79 CH
	Antenna type:	PCB antenna
	Antenna Gain (dBi)	0dBi
	Based on the application, features, or specification exhibited in User's Manual, the EUT is considered as an ITE/Computing Device. More details of EUT technical specification, please refer to the User's Manual.	
Channel List	Please refer to the Note 2.	
Power	DC 3.7V DC 5V from USB port	
Adapter	--	
hardware version	--	
Software version	--	
Serial number	--	
Connecting I/O Port(s)	Please refer to the User's Manual	

Note:

1. For a more detailed features description, please refer to the manufacturer's specifications or the User's Manual.



2.

Channel List					
Channel	Frequency (MHz)	Channel	Frequency (MHz)	Channel	Frequency (MHz)
00	2402	27	2429	54	2456
01	2403	28	2430	55	2457
02	2404	29	2431	56	2458
~	~	~	~	~	~
08	2410	35	2437	62	2464
09	2411	36	2438	63	2465
10	2412	37	2439	64	2466
11	2413	38	2441	65	2467
12	2414	39	2441	66	2468
13	2415	40	2442	67	2469
~	~	~	~	~	~
14	2416	41	2443	68	2470
22	2424	49	2451	76	2478
23	2425	50	2452	77	2479
24	2426	51	2453	78	2480
25	2427	52	2454		
26	2428	53	2455		

2.2 DESCRIPTION OF TEST MODES

To investigate the maximum EMI emission characteristics generates from EUT, the test system was pre-scanning tested base on the consideration of following EUT operation mode or test configuration mode which possible have effect on EMI emission level. Each of these EUT operation mode(s) or test configuration mode(s) mentioned above was evaluated respectively.

Pretest Mode	Description	
Mode 1	CH00	GFSK,PI/4 DPSK,8DPSK
Mode 2	CH39	
Mode 3	CH78	
Mode 4	Link Mode	
For Conducted & Radiated Emission		
Final Test Mode	Description	
Mode 1	CH00	GFSK,PI/4 DPSK,8DPSK
Mode 2	CH39	
Mode 3	CH78	
Mode 4	Link Mode	

Note:

(1) The measurements are performed at the highest, middle, lowest available channels.

2.3 BLOCK DIGRAM SHOWING THE CONFIGURATION OF SYSTEM TESTED

Radiated & Conducted Spurious Emission Test

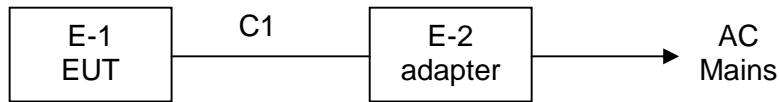

2.4 DESCRIPTION OF SUPPORT UNITS(CONDUCTED MODE)

The EUT has been tested as an independent unit together with other necessary accessories or support units. The following support units or accessories were used to form a representative test configuration during the tests.

Item	Equipment	Mfr/Brand	Model/Type No.	Series No.	Note
E-1	Bluetooth Headphone with active noise cancellation	N/A	IAHP87B	N/A	EUT
E-2	Adapter(provide by test lab)	N/A	BCTC-050050	N/A	Input: AC 100-240V 50/60Hz Output: DC 5V/0.5A

Item	Shielded Type	Ferrite Core	Length	Note
C1	No	No	0.8m	USB Line

Note:

- (1) For detachable type I/O cable should be specified the length in cm in 『Length』 column.



2.5 EQUIPMENTS LIST FOR ALL TEST ITEMS

Radiation test, Band-edge test and 6db bandwidth test equipment

Item	Equipment	Manufacturer	Type No.	Serial No.	Last calibration	Calibrated until
1	Spectrum Analyzer (9kHz-26.5GHz)	Agilent	E4407B	MY45108040	2016.08.27	2017.08.26
2	Test Receiver (9kHz-7GHz)	R&S	ESPI	101318	2016.08.27	2017.08.26
3	Bilog Antenna (30MHz-1GHz)	R&S	VULB 9168	VULB91 68-438	2016.08.27	2017.08.26
4	Horn Antenna (1GHz-18GHz)	SCHWARZBECK	BBHA9120D	1201	2016.09.03	2017.09.03
5	Horn Antenna (14GHz-40GHz)	SCHWARZBECK	BBHA 9170	9170-181	2016.09.03	2017.09.03
6	Amplifier (9KHz-6GHz)	SCHWARZBECK	BBV9744	9744-0037	2016.08.27	2017.08.26
7	Amplifier (1GHz-18GHz)	SCHWARZBECK	BBV9718	9718-309	2016.08.27	2017.08.26
8	Amplifier (18GHz-40GHz)	SCHWARZBECK	BBV 9721	9721-205	2016.08.27	2017.08.26
9	Loop Antenna (9KHz-30MHz)	SCHWARZBECK	FMZB1519B	00014	2016.09.03	2017.09.03
10	RF cables1 (9kHz-1GHz)	R&S	R203	R20X	2016.08.27	2017.08.26
11	RF cables2 (1GHz-40GHz)	R&S	R204	R21X	2016.08.27	2017.08.26
12	Antenna connector	Florida RF Labs	N/A	RF 01#	2016.08.27	2017.08.26
13	Power Metter	ANRITSU	ML2487A	6K00001568	2016.08.27	2017.08.26
14	Power Sensor (AV)	ANRITSU	ML2491A	030989	2016.08.27	2017.08.26
15	Signal Analyzer 9kHz-26.5GHz	Agilent	N9010A	MY48030494	2016.08.27	2017.08.26
16	Test Receiver 20kHz-40GHz	R&S	ESU 40	100376	2016.08.27	2017.08.26
17	D.C. Power Supply	LongWei	PS-305D	010964729	2016.08.27	2017.08.26

Conduction Test equipment

Item	Equipment	Manufacturer	Type No.	Serial No.	Last calibration	Calibrated until
1	Test Receiver	R&S	ESCI	1166.5950K03-1 01165-ha	2016.08.27	2017.08.26
2	LISN	SCHWARZBECK	NSLK8127	8127739	2016.08.27	2017.08.26
3	LISN	R&S	NSLK8126	8126487	2016.08.27	2017.08.26
4	RF cables	R&S	R204	R20X	2016.08.27	2017.08.26
5	Attenuator	R&S	ESH3-Z2	143206	2016.08.27	2017.08.26



3. EMC EMISSION TEST

3.1 CONDUCTED EMISSION MEASUREMENT

3.1.1 POWER LINE CONDUCTED EMISSION Limits (Frequency Range 150KHz-30MHz)

FREQUENCY (MHz)	Limit (dBuV)		Standard
	Quasi-peak	Average	
0.15 -0.5	66 - 56 *	56 - 46 *	FCC
0.50 -5.0	56.00	46.00	FCC
5.0 -30.0	60.00	50.00	FCC

Note:

- (1) The tighter limit applies at the band edges.
- (2) The limit of " * " marked band means the limitation decreases linearly with the logarithm of the frequency in the range.

The following table is the setting of the receiver

Receiver Parameters	Setting
Attenuation	10 dB
Start Frequency	0.15 MHz
Stop Frequency	30 MHz
IF Bandwidth	9 kHz

3.1.2 TEST PROCEDURE

- a. The EUT was placed 0.8 meters from the horizontal ground plane with EUT being connected to the power mains through a line impedance stabilization network (LISN). All other support equipments powered from additional LISN(s). The LISN provide 50 Ohm/ 50uH of coupling impedance for the measuring instrument.
- b. Interconnecting cables that hang closer than 40 cm to the ground plane shall be folded back and forth in the center forming a bundle 30 to 40 cm long.
- c. I/O cables that are not connected to a peripheral shall be bundled in the center. The end of the cable may be terminated, if required, using the correct terminating impedance. The overall length shall not exceed 1 m.
- d. LISN at least 80 cm from nearest part of EUT chassis.
- e. For the actual test configuration, please refer to the related Item –EUT Test Photos.

3.1.3 DEVIATION FROM TEST STANDARD

No deviation

3.1.4 TEST SETUP

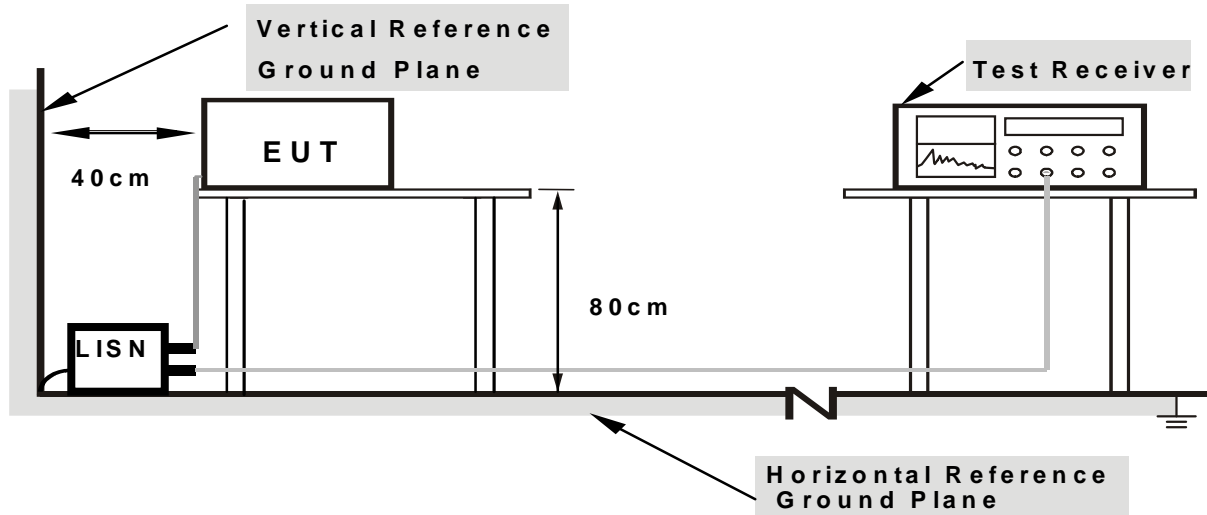

Note: 1.Support units were connected to second LISN.

2.Both of LISNs (AMN) are 80 cm from EUT and at least 80 from other units and other metal planes

3.1.5 EUT OPERATING CONDITIONS

The EUT was configured for testing in a typical fashion (as a customer would normally use it). The EUT has been programmed to continuously transmit during test. This operating condition was tested and used to collect the included data.

3.1.6 TEST RESULTS



Temperature :	25 °C	Relative Humidity :	54%
Pressure :	1010hPa	Phase :	L
Test Voltage :	AC 120V/60Hz	Test Mode :	Mode 4

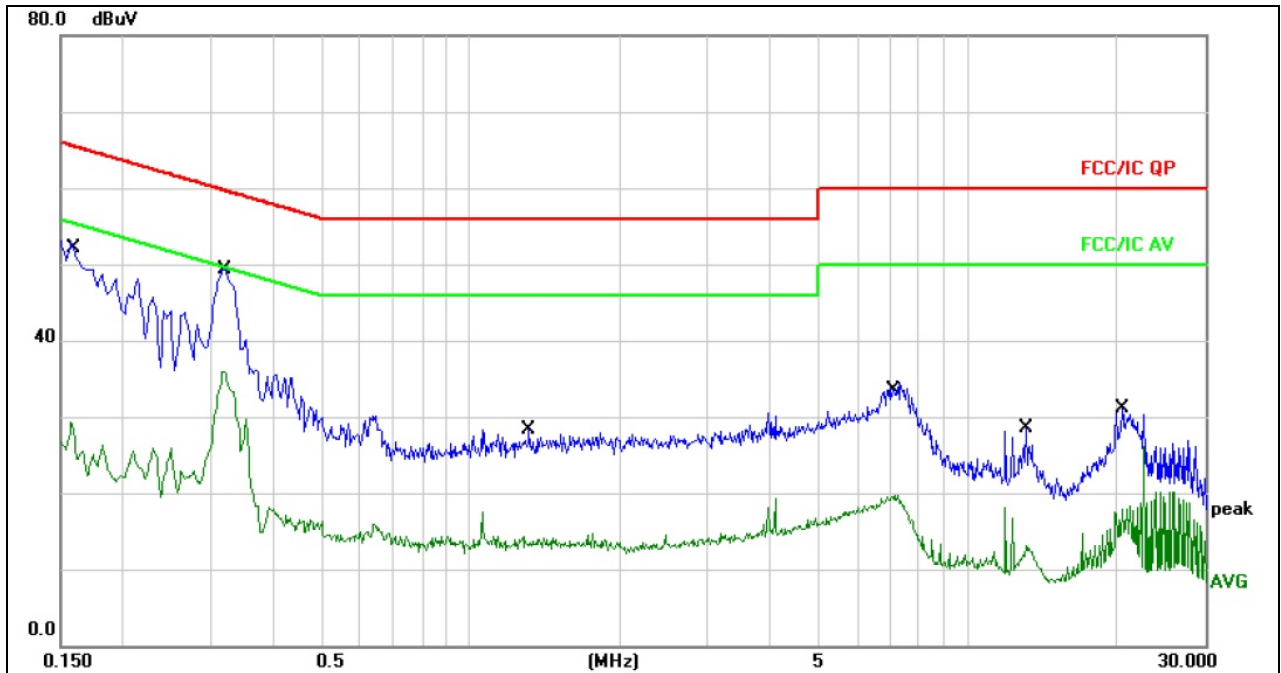

Remark:

1. All readings are Quasi-Peak and Average values.
2. Factor = Insertion Loss + Cable Loss.

No. Mk.	Freq. MHz	Reading Level dBuV	Correct Factor dB	Measure- ment dBuV	Limit dBuV	Over dB	Detector	Comment
1	0.1607	39.75	10.05	49.80	65.42	-15.62	QP	
2	0.1607	15.99	10.05	26.04	55.42	-29.38	AVG	
3 *	0.3180	39.17	10.10	49.27	59.76	-10.49	QP	
4	0.3180	25.75	10.10	35.85	49.76	-13.91	AVG	
5	1.3099	18.18	10.17	28.35	56.00	-27.65	QP	
6	1.3099	3.66	10.17	13.83	46.00	-32.17	AVG	
7	7.1100	24.40	10.10	34.50	60.00	-25.50	QP	
8	7.1100	9.60	10.10	19.70	50.00	-30.30	AVG	
9	13.0900	18.40	10.14	28.54	60.00	-31.46	QP	
10	13.0900	2.96	10.14	13.10	50.00	-36.90	AVG	
11	20.4780	20.85	10.17	31.02	60.00	-28.98	QP	
12	20.4780	7.73	10.17	17.90	50.00	-32.10	AVG	



Temperature :	25 °C	Relative Humidity :	54%
Pressure :	1010hPa	Phase :	N
Test Voltage :	AC 120V/60Hz	Test Mode :	Mode 4

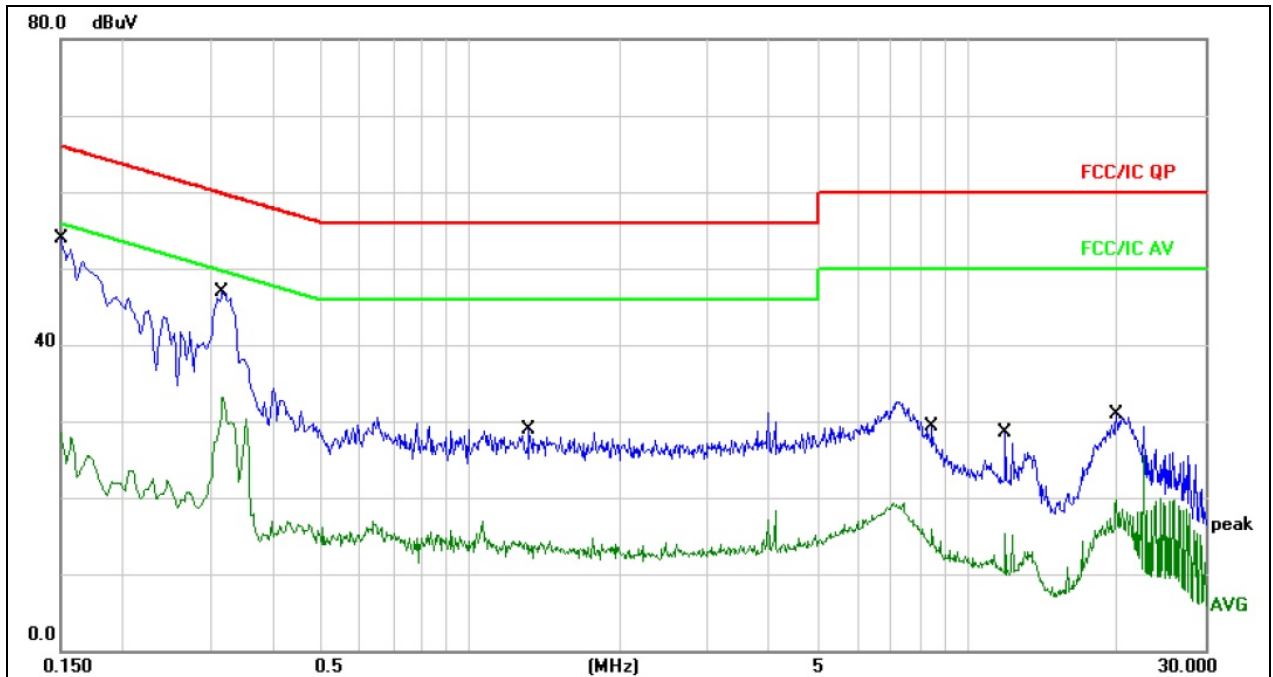

Remark:

1. All readings are Quasi-Peak and Average values.
2. Factor = Insertion Loss + Cable Loss.

No.	Mk.	Freq. MHz	Reading Level dBuV	Correct Factor dB	Measure- ment dBuV	Limit dBuV	Over dB	Detector	Comment
1	*	0.1500	43.82	10.05	53.87	65.99	-12.12	QP	
2		0.1500	15.98	10.05	26.03	55.99	-29.96	AVG	
3		0.3180	36.86	10.10	46.96	59.76	-12.80	QP	
4		0.3180	23.08	10.10	33.18	49.76	-16.58	AVG	
5		1.3099	18.79	10.17	28.96	56.00	-27.04	QP	
6		1.3099	3.62	10.17	13.79	46.00	-32.21	AVG	
7		8.4700	19.10	10.11	29.21	60.00	-30.79	QP	
8		8.4700	3.95	10.11	14.06	50.00	-35.94	AVG	
9		11.9100	18.34	10.13	28.47	60.00	-31.53	QP	
10		11.9100	-0.20	10.13	9.93	50.00	-40.07	AVG	
11		19.8500	20.73	10.17	30.90	60.00	-29.10	QP	
12		19.8500	9.57	10.17	19.74	50.00	-30.26	AVG	



3.2 RADIATED EMISSION MEASUREMENT

3.2.1 RADIATED EMISSION LIMITS (Frequency Range 9kHz-1000MHz)

In case the emission fall within the restricted band specified on 15.205(a), then the 15.209(a) and RSS-Gen limit in the table below has to be followed.

Frequencies (MHz)	Field Strength (micorvolts/meter)	Measurement Distance (meters)
0.009~0.490	2400/F(KHz)	300
0.490~1.705	24000/F(KHz)	30
1.705~30.0	30	30
30~88	100	3
88~216	150	3
216~960	200	3
Above 960	500	3

LIMITS OF RADIATED EMISSION MEASUREMENT (Above 1000MHz)

FREQUENCY (MHz)	Limit (dBuV/m) (at 3M)	
	PEAK	AVERAGE
Above 1000	74	54

Notes:

- (1) The limit for radiated test was performed according to FCC PART 15C.
- (2) The tighter limit applies at the band edges.
- (3) Emission level (dBuV/m)=20log Emission level (uV/m).

Spectrum Parameter	Setting
Attenuation	Auto
Start Frequency	1000 MHz
Stop Frequency	25GHz
RB / VB (emission in restricted band)	1 MHz / 1 MHz for Peak, 1 MHz / 10Hz for Average

Receiver Parameter	Setting
Attenuation	Auto
Start ~ Stop Frequency	9kHz~150kHz / RB 200Hz for QP
Start ~ Stop Frequency	150kHz~30MHz / RB 9kHz for QP
Start ~ Stop Frequency	30MHz~1000MHz / RB 120kHz for QP

3.2.2 TEST PROCEDURE

Below 1GHz test procedure as below:

- a. The EUT was placed on the top of a rotating table 0.8 meters above the ground at a 3 meter semi-anechoic chamber. The table was rotated 360 degrees to determine the position of the highest radiation.
- b. The EUT was set 3 meters away from the interference-receiving antenna, which was mounted on the top of a variable-height antenna tower.
- c. The antenna height is varied from one meter to four meters above the ground to determine the maximum value of the field strength. Both horizontal and vertical polarizations of the antenna are set to make the measurement.
- d. For each suspected emission, the EUT was arranged to its worst case and then the antenna was tuned to heights from 1 meter to 4 meters (for the test frequency of below 30MHz, the antenna was tuned to heights 1 meter) and the rotatable table was turned from 0 degrees to 360 degrees to find the maximum reading.
- e. The test-receiver system was set to Peak Detect Function and Specified Bandwidth with Maximum Hold Mode.
- f. If the emission level of the EUT in peak mode was 10dB lower than the limit specified, then testing could be stopped and the peak values of the EUT would be reported. Otherwise the emissions that did not have 10dB margin would be re-tested one by one using peak, quasi-peak or average method as specified and then reported in a data sheet.

Above 1GHz test procedure as below:

- g. Different between above is the test site, change from Semi- Anechoic Chamber to fully Anechoic Chamber and change form table 0.8 metre to 1.5 metre(Above 18GHz the distance is 1 meter and table is 1.5 metre).
- h. Test the EUT in the lowest channel ,the middle channel ,the Highest channel

Note:

Both horizontal and vertical antenna polarities were tested and performed pretest to three orthogonal axis. The worst case emissions were reported

3.2.3 DEVIATION FROM TEST STANDARD

No deviation

3.2.4 TEST SETUP

(A) Radiated Emission Test-Up Frequency Below 30MHz

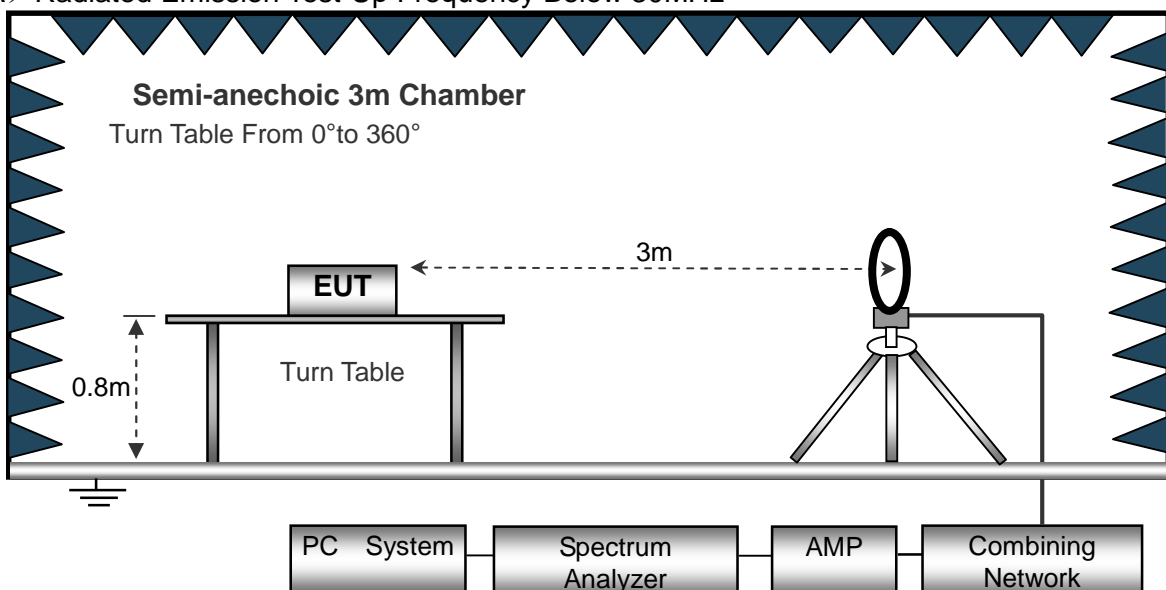

(B) Radiated Emission Test-Up Frequency 30MHz~1GHz

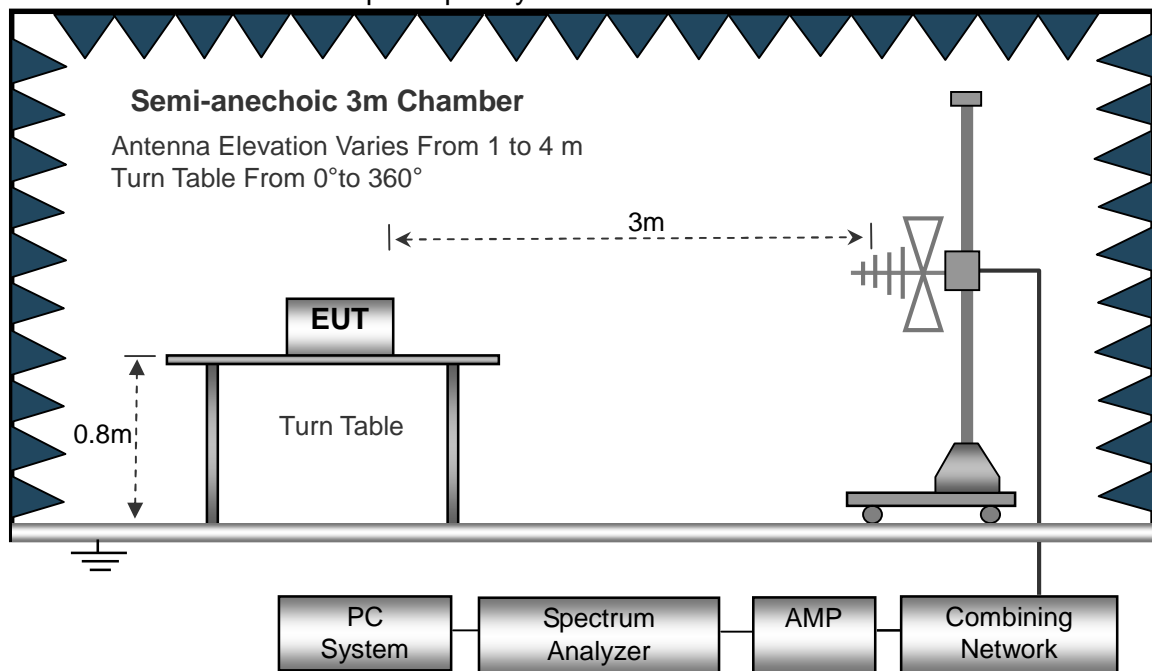

(C) Radiated Emission Test-Up Frequency Above 1GHz

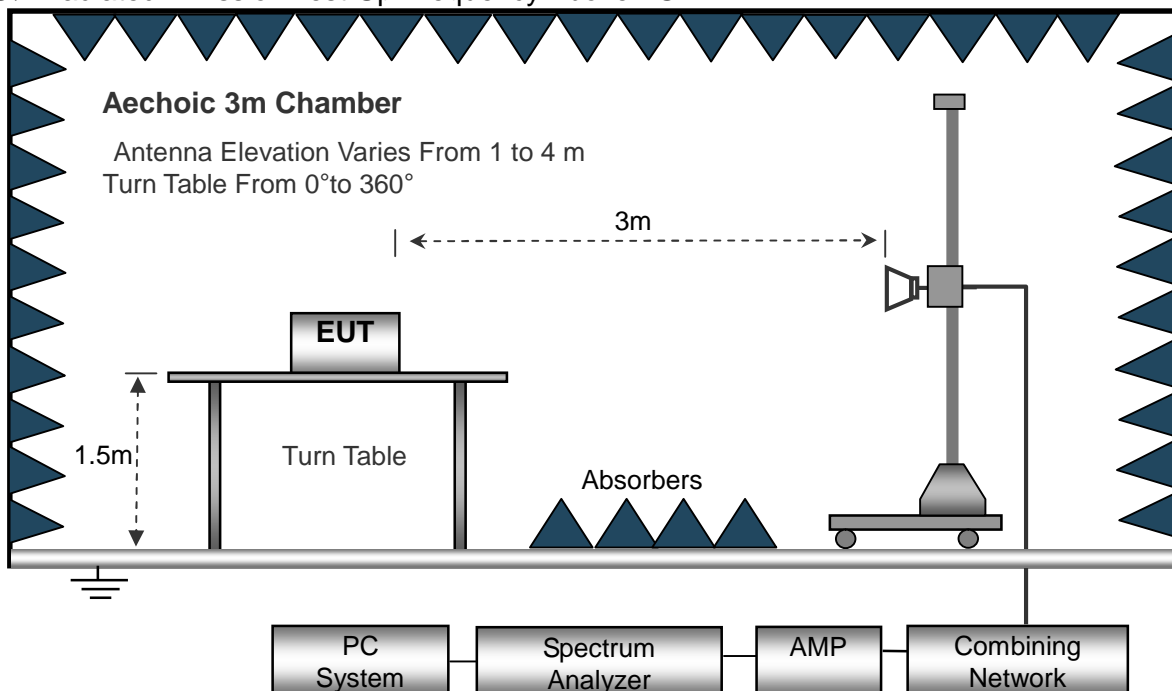

3.2.5 EUT OPERATING CONDITIONS

The EUT tested system was configured as the statements of 2.3 Unless otherwise a special operating condition is specified in the follows during the testing.

**3.2.6 TEST RESULTS (BETWEEN 9KHZ – 30 MHZ)**

Temperature:	20°C	Relative Humidity:	48%
Pressure:	1010 hPa	Test Voltage :	DC 3.7V
Test Mode :	Mode 4	Polarization :	--

Freq. (MHz)	Reading (dBuV/m)	Limit (dBuV/m)	Margin (dB)	State P/F
--	--	--	--	PASS
--	--	--	--	PASS

NOTE:

The amplitude of spurious emissions which are attenuated by more than 20dB below the permissible value has no need to be reported.

Distance extrapolation factor = $40 \log(\text{specific distance}/\text{test distance})$ (dB);

Limit line = specific limits(dBuv) + distance extrapolation factor.



3.2.7 TEST RESULTS (BETWEEN 30MHZ – 1GHZ)

Temperature :	26°C	Relative Humidity :	54%
Pressure :	1010 hPa	Polarization :	Horizontal
Test Voltage :	DC 3.7V		
Test Mode :	Mode 4		

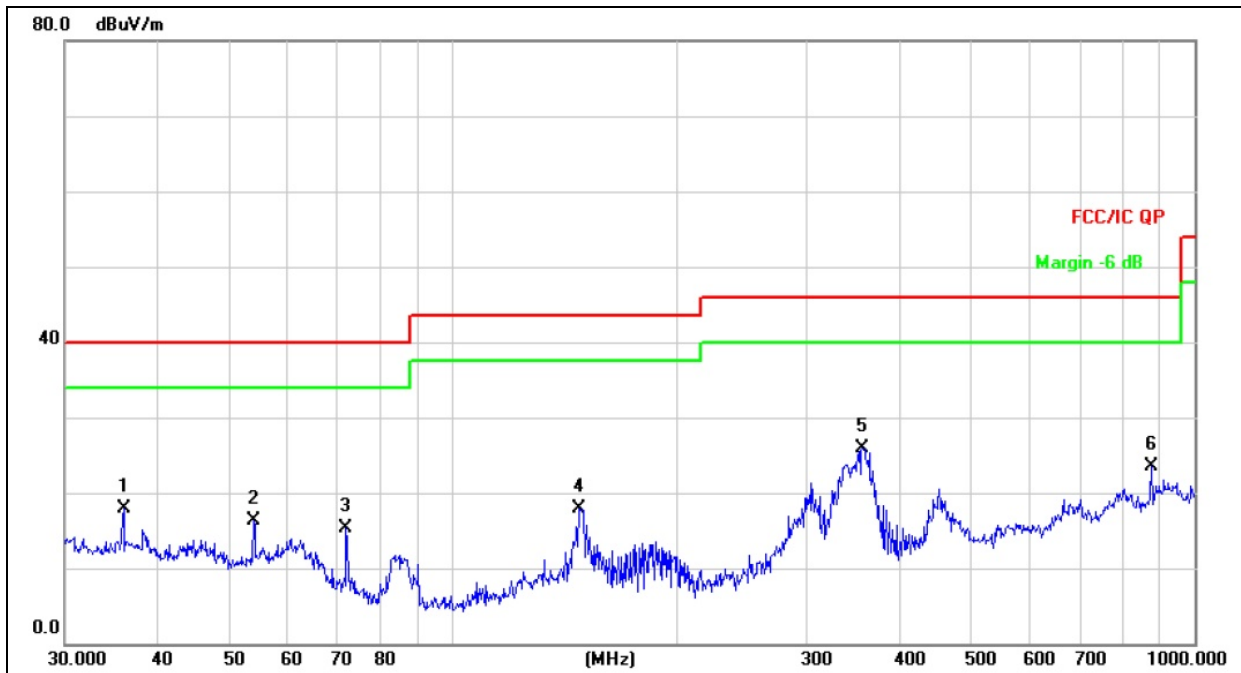

Remark:
Factor = Antenna Factor + Cable Loss – Pre-amplifier.

No.	Mk.	Freq. MHz	Reading Level dBuV	Correct Factor dB/m	Measure- ment dBuV/m	Limit dBuV/m	Over dB	Detector
1		36.0007	26.40	-8.59	17.81	40.00	-22.19	QP
2		53.8818	27.14	-10.93	16.21	40.00	-23.79	QP
3		71.8320	30.42	-15.19	15.23	40.00	-24.77	QP
4		147.9214	30.89	-12.96	17.93	43.50	-25.57	QP
5	*	356.6758	37.11	-11.27	25.84	46.00	-20.16	QP
6		875.2470	25.19	-1.75	23.44	46.00	-22.56	QP



Temperature :	26°C	Relative Humidity :	54%
Pressure :	1010 hPa	Polarization :	Vertical
Test Voltage :	DC 3.7V		
Test Mode :	Mode 4		

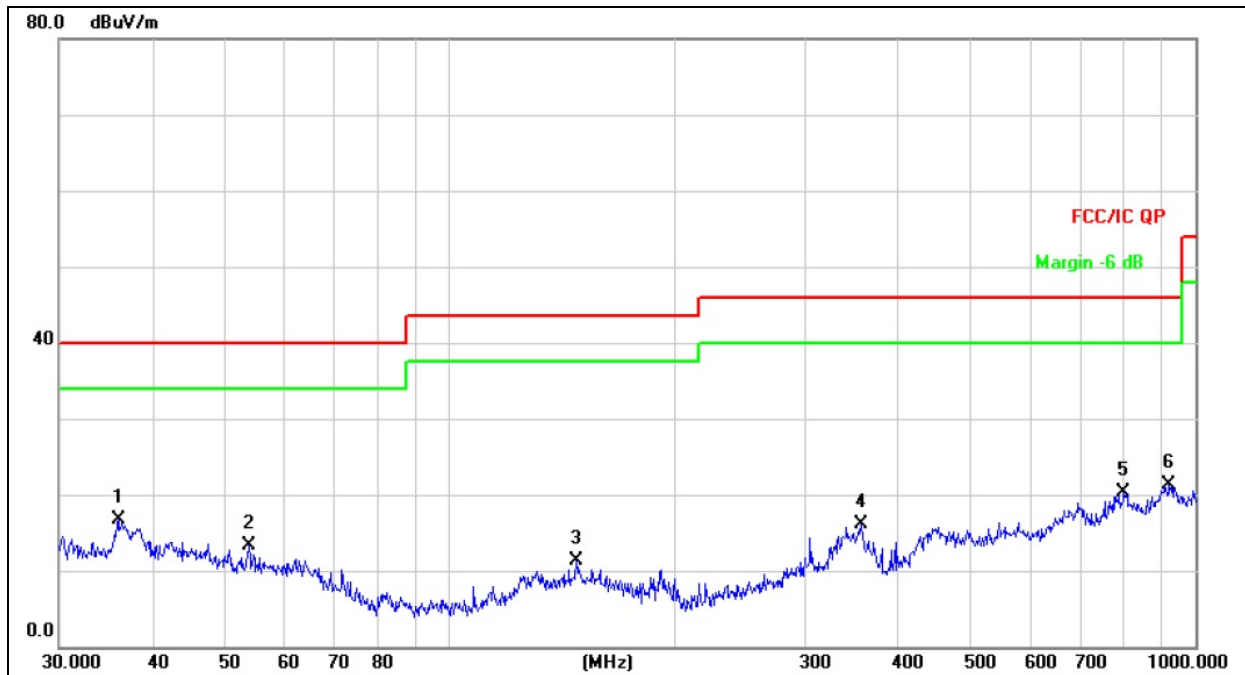

Remark:
Factor = Antenna Factor + Cable Loss – Pre-amplifier.

No.	Mk.	Freq.	Reading Level	Correct Factor	Measurement	Limit	Over	
		MHz	dBuV	dB/m	dBuV/m	dBuV/m	dB	Detector
1	*	36.0007	25.27	-8.59	16.68	40.00	-23.32	QP
2		53.8818	24.18	-10.93	13.25	40.00	-26.75	QP
3		147.9214	24.18	-12.96	11.22	43.50	-32.28	QP
4		356.6758	27.34	-11.27	16.07	46.00	-29.93	QP
5		801.7863	22.88	-2.49	20.39	46.00	-25.61	QP
6		922.5157	22.30	-1.05	21.25	46.00	-24.75	QP



3.2.8 TEST RESULTS (1GHZ~25GHZ)

GFSK

Polar (H/V)	Frequency	Meter Reading	Pre-amplifier	Cable Loss	Antenna Factor	Emission Level	Limits	Margin	Detector Type
	(MHz)	(dBuV)	(dB)	(dB)	(dB/m)	(dBuV/m)	(dBuV/m)	(dB)	
operation frequency:2402									
V	4804.00	62.31	38.06	7.78	23.25	55.28	74.00	-18.72	PK
V	4804.00	46.96	38.06	7.78	23.25	39.93	54.00	-14.07	AV
V	7206.00	60.73	38.45	8.13	23.71	54.12	74.00	-19.88	PK
V	7206.00	44.67	38.45	8.13	23.71	38.06	54.00	-15.94	AV
V	16132.00	54.80	38.75	10.36	26.57	52.98	74.00	-21.02	PK
H	4804.00	62.51	38.06	7.78	23.25	55.48	74.00	-18.52	PK
H	4804.00	46.80	38.06	7.78	23.25	39.77	54.00	-14.23	AV
H	7206.00	60.95	38.45	8.13	23.71	54.34	74.00	-19.66	PK
H	7206.00	44.53	38.45	8.13	23.71	37.92	54.00	-16.08	AV
H	16132.00	54.95	38.75	10.36	26.57	53.13	74.00	-20.87	PK
operation frequency:2441									
V	4882.00	62.58	38.11	7.82	23.61	55.90	74.00	-18.10	PK
V	4882.00	46.46	38.11	7.82	23.61	39.78	54.00	-14.22	AV
V	7323.00	60.58	38.51	8.28	23.96	54.31	74.00	-19.69	PK
V	7323.00	44.32	38.51	8.28	23.93	38.02	54.00	-15.98	AV
V	16132.00	54.84	38.75	10.36	26.57	53.02	74.00	-20.98	PK
H	4882.00	62.77	38.11	7.82	23.61	56.09	74.00	-17.91	PK
H	4882.00	46.77	38.11	7.82	23.61	40.09	54.00	-13.91	AV
H	7323.00	60.67	38.51	8.28	23.96	54.40	74.00	-19.60	PK
H	7323.00	44.43	38.51	8.28	23.93	38.13	54.00	-15.87	AV
H	16132.00	54.99	38.75	10.36	26.57	53.17	74.00	-20.83	PK
operation frequency:2480									
V	4960.00	63.35	38.26	7.96	23.83	56.88	74.00	-17.12	PK
V	4960.00	47.09	38.26	7.96	23.83	40.62	54.00	-13.38	AV
V	7440.00	60.36	38.72	8.31	24.03	53.98	74.00	-20.02	PK
V	7440.00	44.20	38.72	8.31	24.03	37.82	54.00	-16.18	AV
V	16132.00	54.83	38.75	10.36	26.57	53.01	74.00	-20.99	PK
H	2480.00	63.54	38.26	7.96	23.83	57.07	74.00	-16.93	PK
H	2480.00	47.00	38.26	7.96	23.83	40.53	54.00	-13.47	AV
H	4960.00	62.01	38.72	8.31	24.03	55.63	74.00	-18.37	PK
H	4960.00	44.90	38.72	8.31	24.03	38.52	54.00	-15.48	AV
H	16132.00	54.88	38.75	10.36	26.57	53.06	74.00	-20.94	PK

Remark:

1. Emission Level = Meter Reading + Antenna Factor + Cable Loss – Pre-amplifier, Margin= Emission Level - Limit
2. If peak below the average limit, the average emission was no test.
3. The amplitude of spurious emissions which are attenuated by more than 20dB below the permissible value has no need to be reported.



PI/4 DPSK

Polar (H/V)	Frequency	Meter Reading	Pre-amplifier	Cable Loss	Antenna Factor	Emission Level	Limits	Margin	Detector Type
	(MHz)	(dBuV)	(dB)	(dB)	(dB/m)	(dBuV/m)	(dBuV/m)	(dB)	
operation frequency:2402									
V	4804.00	62.98	38.06	7.78	23.25	55.95	74.00	-18.05	PK
V	4804.00	46.54	38.06	7.78	23.25	39.51	54.00	-14.49	AV
V	7206.00	60.52	38.45	8.13	23.71	53.91	74.00	-20.09	PK
V	7206.00	44.29	38.45	8.13	23.71	37.68	54.00	-16.32	AV
V	16132.00	54.75	38.75	10.36	26.57	52.93	74.00	-21.07	PK
H	4804.00	62.89	38.06	7.78	23.25	55.86	74.00	-18.14	PK
H	4804.00	46.69	38.06	7.78	23.25	39.66	54.00	-14.34	AV
H	7206.00	60.58	38.45	8.13	23.71	53.97	74.00	-20.03	PK
H	7206.00	44.61	38.45	8.13	23.71	38.00	54.00	-16.00	AV
H	16132.00	54.86	38.75	10.36	26.57	53.04	74.00	-20.96	PK
operation frequency:2441									
V	4882.00	62.07	38.11	7.82	23.61	55.39	74.00	-18.61	PK
V	4882.00	46.18	38.11	7.82	23.61	39.50	54.00	-14.50	AV
V	7323.00	60.06	38.51	8.28	23.96	53.79	74.00	-20.21	PK
V	7323.00	43.77	38.51	8.28	23.93	37.47	54.00	-16.53	AV
V	16132.00	54.95	38.75	10.36	26.57	53.13	74.00	-20.87	PK
H	4882.00	62.74	38.11	7.82	23.61	56.06	74.00	-17.94	PK
H	4882.00	46.34	38.11	7.82	23.61	39.66	54.00	-14.34	AV
H	7323.00	60.28	38.51	8.28	23.96	54.01	74.00	-19.99	PK
H	7323.00	44.31	38.51	8.28	23.93	38.01	54.00	-15.99	AV
H	16132.00	54.56	38.75	10.36	26.57	52.74	74.00	-21.26	PK
operation frequency:2480									
V	4960.00	62.59	38.26	7.96	23.83	56.12	74.00	-17.88	PK
V	4960.00	46.42	38.26	7.96	23.83	39.95	54.00	-14.05	AV
V	7440.00	60.41	38.72	8.31	24.03	54.03	74.00	-19.97	PK
V	7440.00	44.71	38.72	8.31	24.03	38.33	54.00	-15.67	AV
V	16132.00	54.58	38.75	10.36	26.57	52.76	74.00	-21.24	PK
H	2480.00	63.32	38.26	7.96	23.83	56.85	74.00	-17.15	PK
H	2480.00	47.02	38.26	7.96	23.83	40.55	54.00	-13.45	AV
H	4960.00	60.57	38.72	8.31	24.03	54.19	74.00	-19.81	PK
H	4960.00	44.51	38.72	8.31	24.03	38.13	54.00	-15.87	AV
H	16132.00	54.88	38.75	10.36	26.57	53.06	74.00	-20.94	PK

Remark:

1. Emission Level = Meter Reading + Antenna Factor + Cable Loss – Pre-amplifier, Margin= Emission Level - Limit
2. If peak below the average limit, the average emission was no test.
3. The amplitude of spurious emissions which are attenuated by more than 20dB below the permissible value has no need to be reported.



8DPSK

Polar (H/V)	Frequency	Meter Reading	Pre-amplifier	Cable Loss	Antenna Factor	Emission Level	Limits	Margin	Detector Type
	(MHz)	(dBuV)	(dB)	(dB)	(dB/m)	(dBuV/m)	(dBuV/m)	(dB)	
operation frequency:2402									
V	4804.00	62.75	38.06	7.78	23.25	55.72	74.00	-18.28	PK
V	4804.00	46.72	38.06	7.78	23.25	39.69	54.00	-14.31	AV
V	7206.00	60.40	38.45	8.13	23.71	53.79	74.00	-20.21	PK
V	7206.00	44.25	38.45	8.13	23.71	37.64	54.00	-16.36	AV
V	16132.00	54.42	38.75	10.36	26.57	52.60	74.00	-21.40	PK
H	4804.00	62.87	38.06	7.78	23.25	55.84	74.00	-18.16	PK
H	4804.00	46.44	38.06	7.78	23.25	39.41	54.00	-14.59	AV
H	7206.00	60.77	38.45	8.13	23.71	54.16	74.00	-19.84	PK
H	7206.00	44.25	38.45	8.13	23.71	37.64	54.00	-16.36	AV
H	16132.00	54.56	38.75	10.36	26.57	52.74	74.00	-21.26	PK
operation frequency:2441									
V	4882.00	62.81	38.11	7.82	23.61	56.13	74.00	-17.87	PK
V	4882.00	46.70	38.11	7.82	23.61	40.02	54.00	-13.98	AV
V	7323.00	60.81	38.51	8.28	23.96	54.54	74.00	-19.46	PK
V	7323.00	44.31	38.51	8.28	23.93	38.01	54.00	-15.99	AV
V	16132.00	54.65	38.75	10.36	26.57	52.83	74.00	-21.17	PK
H	4882.00	62.68	38.11	7.82	23.61	56.00	74.00	-18.00	PK
H	4882.00	46.44	38.11	7.82	23.61	39.76	54.00	-14.24	AV
H	7323.00	60.25	38.51	8.28	23.96	53.98	74.00	-20.02	PK
H	7323.00	44.32	38.51	8.28	23.93	38.02	54.00	-15.98	AV
H	16132.00	54.78	38.75	10.36	26.57	52.96	74.00	-21.04	PK
operation frequency:2480									
V	4960.00	62.25	38.26	7.96	23.83	55.78	74.00	-18.22	PK
V	4960.00	46.12	38.26	7.96	23.83	39.65	54.00	-14.35	AV
V	7440.00	60.06	38.72	8.31	24.03	53.68	74.00	-20.32	PK
V	7440.00	44.32	38.72	8.31	24.03	37.94	54.00	-16.06	AV
V	16132.00	54.69	38.75	10.36	26.57	52.87	74.00	-21.13	PK
H	2480.00	62.51	38.26	7.96	23.83	56.04	74.00	-17.96	PK
H	2480.00	46.07	38.26	7.96	23.83	39.60	54.00	-14.40	AV
H	4960.00	60.50	38.72	8.31	24.03	54.12	74.00	-19.88	PK
H	4960.00	43.93	38.72	8.31	24.03	37.55	54.00	-16.45	AV
H	16132.00	54.14	38.75	10.36	26.57	52.32	74.00	-21.68	PK

Remark:

1. Emission Level = Meter Reading + Antenna Factor + Cable Loss – Pre-amplifier, Margin= Emission Level - Limit
2. If peak below the average limit, the average emission was no test.
3. The amplitude of spurious emissions which are attenuated by more than 20dB below the permissible value has no need to be reported.



During the test, pre-scan the GFSK, Pi/4QPSK, 8DPSK modulation, and found the GFSK modulation which is worse case.

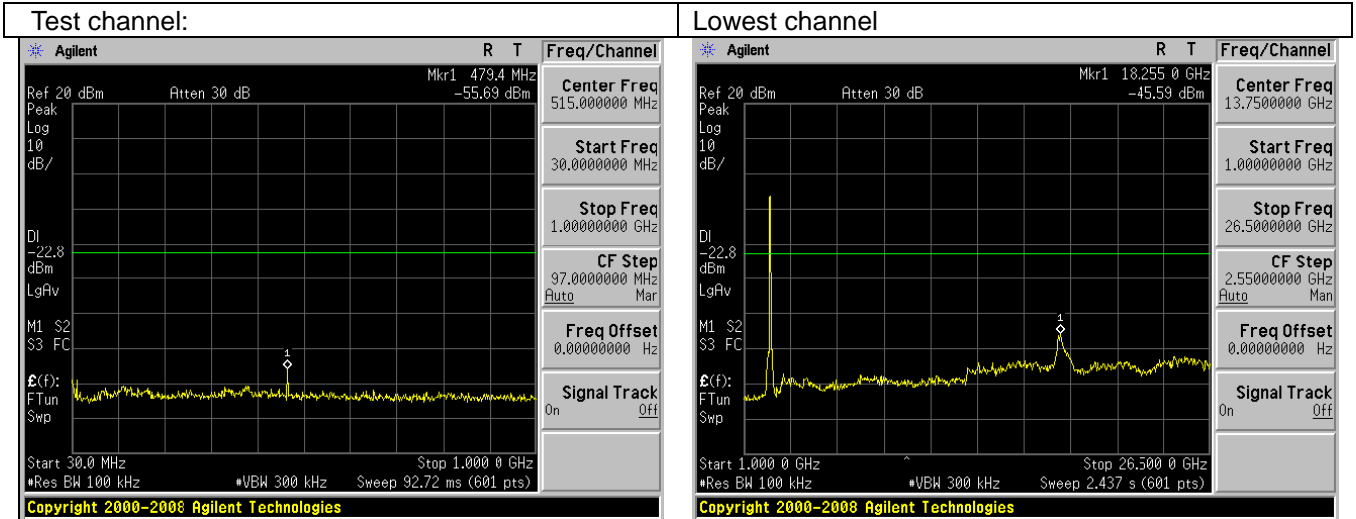

30MHz~10GHz

10GHz~25GHz

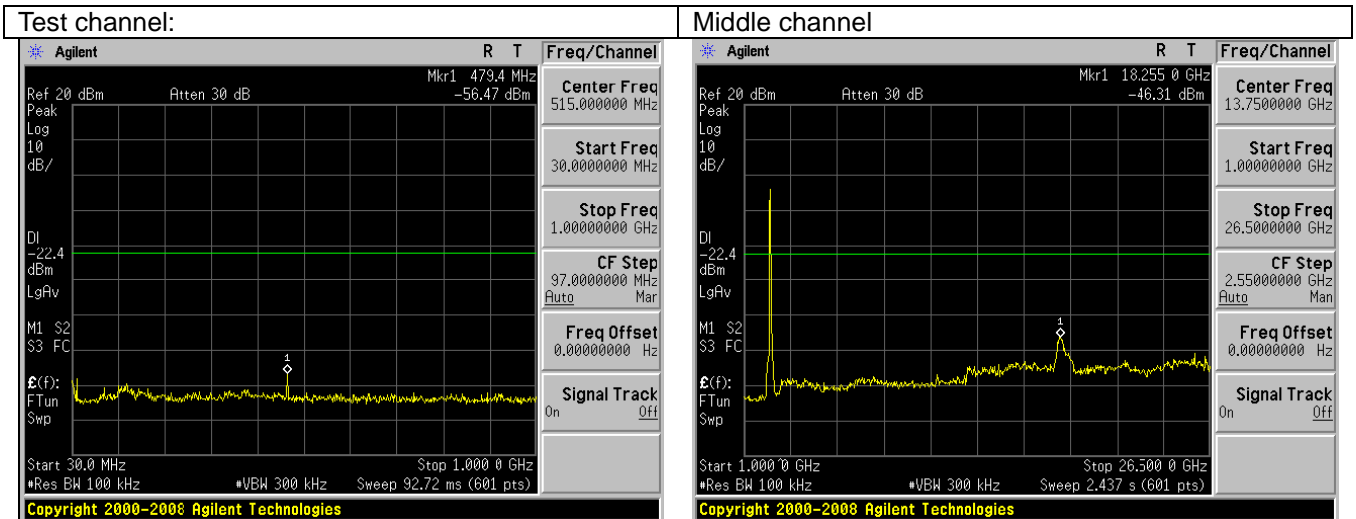

30MHz~10GHz

10GHz~25GHz

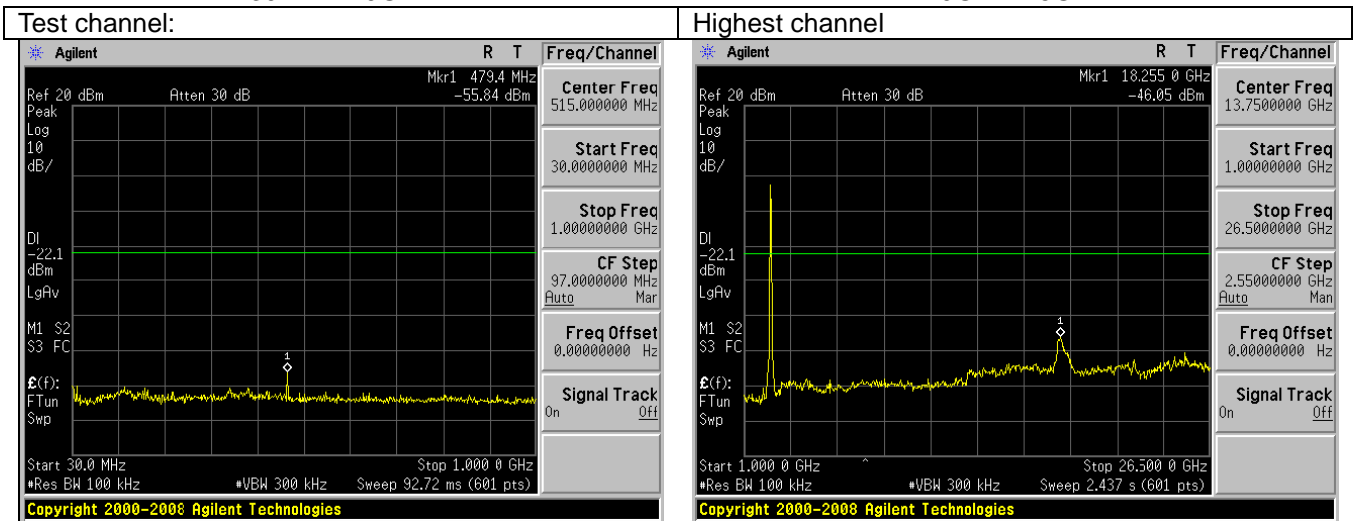

30MHz~10GHz

10GHz~25GHz



3.3 RADIATED BAND EMISSION MEASUREMENT

3.3.1 TEST REQUIREMENT:

FCC Part15 C Section 15.209 and 15.205, RSS-247

LIMITS OF RADIATED EMISSION MEASUREMENT (Above 1000MHz)

FREQUENCY (MHz)	Limit (dBuV/m) (at 3M)	
	PEAK	AVERAGE
Above 1000	74	54

Notes:

- (1) The limit for radiated test was performed according to FCC PART 15C.
- (2) The tighter limit applies at the band edges.
- (3) Emission level (dBuV/m)=20log Emission level (uV/m).

Spectrum Parameter	Setting
Attenuation	Auto
Start Frequency	2300MHz
Stop Frequency	2520
RB / VB (emission in restricted band)	1 MHz / 1 MHz for Peak, 1 MHz / 10Hz for Average

3.3.2 TEST PROCEDURE

Above 1GHz test procedure as below:

- a. 1. The EUT was placed on the top of a rotating table 1.5 meters above the ground at a 3 meter camber. The table was rotated 360 degrees to determine the position of the highest radiation.
- b. The EUT was set 3 meters away from the interference-receiving antenna, which was mounted on the top of a variable-height antenna tower.
- c. The antenna height is varied from one meter to four meters above the ground to determine the maximum value of the field strength. Both horizontal and vertical polarizations of the antenna are set to make the measurement.
- d. For each suspected emission, the EUT was arranged to its worst case and then the antenna was tuned to heights from 1 meter to 4 meters and the rota table was turned from 0 degrees to 360 degrees to find the maximum reading.
- e. The test-receiver system was set to Peak Detect Function and Specified Bandwidth with Maximum Hold Mode.
- f. If the emission level of the EUT in peak mode was 10dB lower than the limit specified, then testing could be stopped and the peak values of the EUT would be reported. Otherwise the emissions that did not have 10dB margin would be re-tested one by one using peak, quasi-peak or average method as specified and then reported in a data sheet.
- g. Test the EUT in the lowest channel,the Highest channel

Note:

Both horizontal and vertical antenna polarities were tested and performed pretest to three orthogonal axis. The worst case emissions were reported

3.3.3 DEVIATION FROM TEST STANDARD

No deviation

3.3.4 TEST SETUP

Radiated Emission Test-Up Frequency Above 1GHz

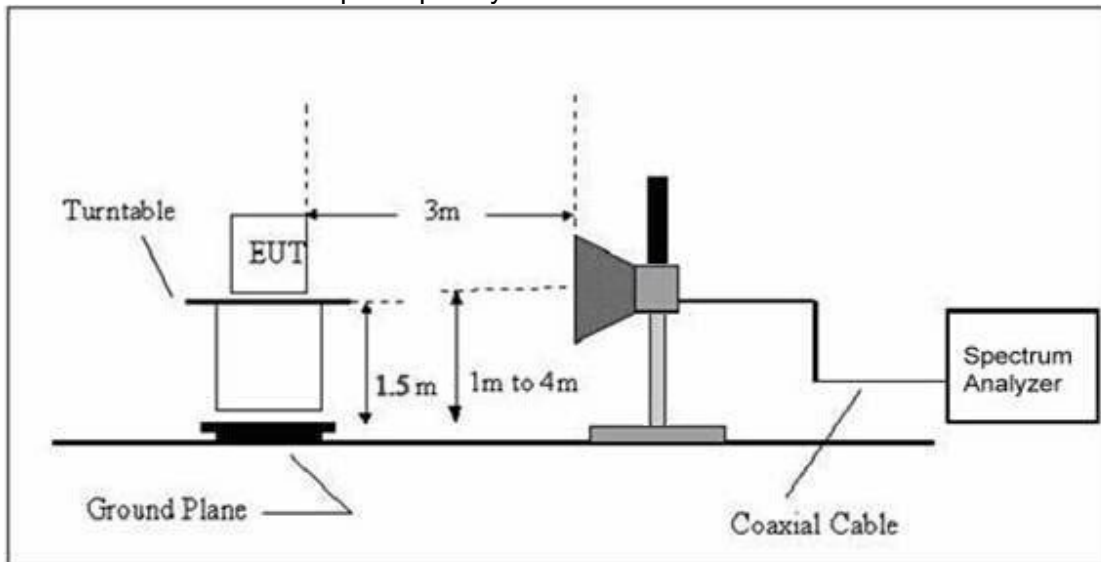

3.3.5 EUT OPERATING CONDITIONS

The EUT tested system was configured as the statements of 2.3 Unless otherwise a special operating condition is specified in the follows during the testing.



3.3.6 TEST RESULT

GFSK

Polar (H/V)	Frequency	Meter Reading	Pre-amplifier	Cable Loss	Antenna Factor	Emission level	Limits	Margin	Detector Type
	(MHz)	(dBuV)	(dB)	(dB)	(dB/m)	(dBuV/m)	(dBuV/m)	(dB)	
operation frequency:2402									
V	2390.00	66.33	38.06	7.42	20.15	55.84	74.00	-18.16	PK
V	2390.00	55.08	38.06	7.42	20.15	44.59	54.00	-9.41	AV
V	2400.00	66.53	38.06	7.42	20.15	56.04	74.00	-17.96	PK
V	2400.00	54.67	38.06	7.42	20.15	44.18	54.00	-9.82	AV
H	2390.00	66.61	38.06	7.42	20.15	56.12	74.00	-17.88	PK
H	2390.00	55.11	38.06	7.42	20.15	44.62	54.00	-9.38	AV
H	2400.00	66.48	38.06	7.42	20.15	55.99	74.00	-18.01	PK
H	2400.00	55.05	38.06	7.42	20.15	44.56	54.00	-9.44	AV

Polar (H/V)	Frequency	Meter Reading	Pre-amplifier	Cable Loss	Antenna Factor	Emission Level	Limits	Margin	Detector Type
	(MHz)	(dBuV)	(dB)	(dB)	(dB/m)	(dBuV/m)	(dBuV/m)	(dB)	
operation frequency:2480									
V	2483.50	66.53	38.17	7.42	20.51	56.29	74.00	-17.71	PK
V	2483.50	55.32	38.17	7.42	20.51	45.08	54.00	-8.92	AV
V	2500.00	66.47	38.20	7.45	20.54	56.26	74.00	-17.74	PK
V	2500.00	54.78	38.20	7.45	20.54	44.57	54.00	-9.43	AV
H	2483.50	66.65	38.17	7.42	20.51	56.41	74.00	-17.59	PK
H	2483.50	55.36	38.17	7.42	20.51	45.12	54.00	-8.88	AV
H	2500.00	66.28	38.20	7.45	20.54	56.07	74.00	-17.93	PK
H	2500.00	55.62	38.20	7.45	20.54	45.41	54.00	-8.59	AV

Remark:

1. Emission Level = Meter Reading + Factor, Margin= Emission Level - Limit
2. If peak below the average limit, the average emission was no test.
3. The amplitude of spurious emissions which are attenuated by more than 20dB below the permissible value has no need to be reported.



PI/4 DPSK

Polar (H/V)	Frequency	Meter Reading	Pre-amplifier	Cable Loss	Antenna Factor	Emission evel	Limits	Margin	Detector Type
	(MHz)	(dBuV)	(dB)	(dB)	(dB/m)	(dBuV/m)	(dBuV/m)	(dB)	
operation frequency:2402									
V	2390.00	66.48	38.06	7.42	20.15	55.99	74.00	-18.01	PK
V	2390.00	55.21	38.06	7.42	20.15	44.72	54.00	-9.28	AV
V	2400.00	66.69	38.06	7.42	20.15	56.20	74.00	-17.80	PK
V	2400.00	54.80	38.06	7.42	20.15	44.31	54.00	-9.69	AV
H	2390.00	66.77	38.06	7.42	20.15	56.28	74.00	-17.72	PK
H	2390.00	55.24	38.06	7.42	20.15	44.75	54.00	-9.25	AV
H	2400.00	66.64	38.06	7.42	20.15	56.15	74.00	-17.85	PK
H	2400.00	55.18	38.06	7.42	20.15	44.69	54.00	-9.31	AV

Polar (H/V)	Frequency	Meter Reading	Pre-amplifier	Cable Loss	Antenna Factor	Emission Level	Limits	Margin	Detector Type
	(MHz)	(dBuV)	(dB)	(dB)	(dB/m)	(dBuV/m)	(dBuV/m)	(dB)	
operation frequency:2480									
V	2483.50	66.69	38.17	7.42	20.51	56.45	74.00	-17.55	PK
V	2483.50	55.47	38.17	7.42	20.51	45.23	54.00	-8.77	AV
V	2500.00	66.63	38.20	7.45	20.54	56.42	74.00	-17.58	PK
V	2500.00	54.91	38.20	7.45	20.54	44.70	54.00	-9.30	AV
H	2483.50	66.81	38.17	7.42	20.51	56.57	74.00	-17.43	PK
H	2483.50	55.51	38.17	7.42	20.51	45.27	54.00	-8.73	AV
H	2500.00	66.43	38.20	7.45	20.54	56.22	74.00	-17.78	PK
H	2500.00	55.76	38.20	7.45	20.54	45.55	54.00	-8.45	AV

Remark:

1. Emission Level = Meter Reading + Factor, Margin= Emission Level - Limit
2. If peak below the average limit, the average emission was no test.
3. The amplitude of spurious emissions which are attenuated by more than 20dB below the permissible value has no need to be reported.



8DPSK

Polar (H/V)	Frequency	Meter Reading	Pre-amplifier	Cable Loss	Antenna Factor	Emission Level	Limits	Margin	Detector Type
	(MHz)	(dBuV)	(dB)	(dB)	(dB/m)	(dBuV/m)	(dBuV/m)	(dB)	
operation frequency:2402									
V	2390.00	66.66	38.06	7.42	20.15	56.17	74.00	-17.83	PK
V	2390.00	55.38	38.06	7.42	20.15	44.89	54.00	-9.11	AV
V	2400.00	66.88	38.06	7.42	20.15	56.39	74.00	-17.61	PK
V	2400.00	54.95	38.06	7.42	20.15	44.46	54.00	-9.54	AV
H	2390.00	66.95	38.06	7.42	20.15	56.46	74.00	-17.54	PK
H	2390.00	55.41	38.06	7.42	20.15	44.92	54.00	-9.08	AV
H	2400.00	66.82	38.06	7.42	20.15	56.33	74.00	-17.67	PK
H	2400.00	55.34	38.06	7.42	20.15	44.85	54.00	-9.15	AV

Polar (H/V)	Frequency	Meter Reading	Pre-amplifier	Cable Loss	Antenna Factor	Emission Level	Limits	Margin	Detector Type
	(MHz)	(dBuV)	(dB)	(dB)	(dB/m)	(dBuV/m)	(dBuV/m)	(dB)	
operation frequency:2480									
V	2483.50	66.88	38.17	7.42	20.51	56.64	74.00	-17.36	PK
V	2483.50	55.62	38.17	7.42	20.51	45.38	54.00	-8.62	AV
V	2500.00	66.81	38.20	7.45	20.54	56.60	74.00	-17.40	PK
V	2500.00	55.05	38.20	7.45	20.54	44.84	54.00	-9.16	AV
H	2483.50	66.99	38.17	7.42	20.51	56.75	74.00	-17.25	PK
H	2483.50	55.66	38.17	7.42	20.51	45.42	54.00	-8.58	AV
H	2500.00	66.61	38.20	7.45	20.54	56.40	74.00	-17.60	PK
H	2500.00	55.91	38.20	7.45	20.54	45.70	54.00	-8.30	AV

Remark:

1. Emission Level = Meter Reading + Factor, Margin= Emission Level - Limit
2. If peak below the average limit, the average emission was no test.
3. The amplitude of spurious emissions which are attenuated by more than 20dB below the permissible value has no need to be reported.



For Conducted
Unhopping
GFSK

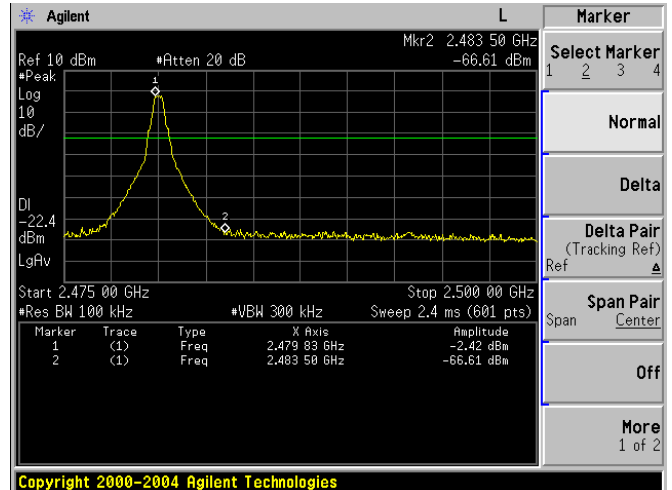
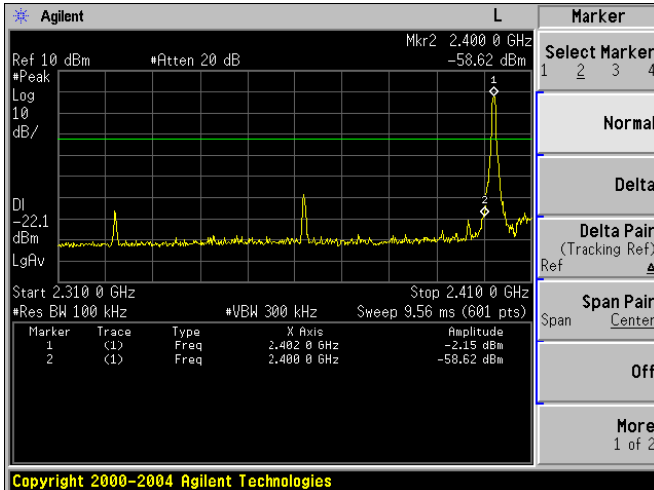

PI/4 DPSK

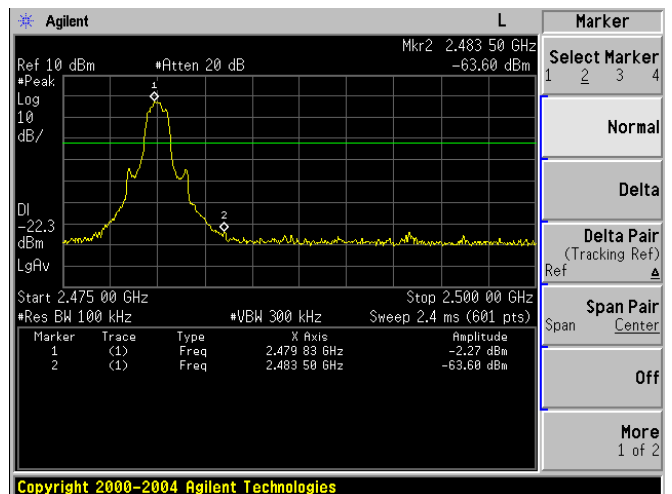
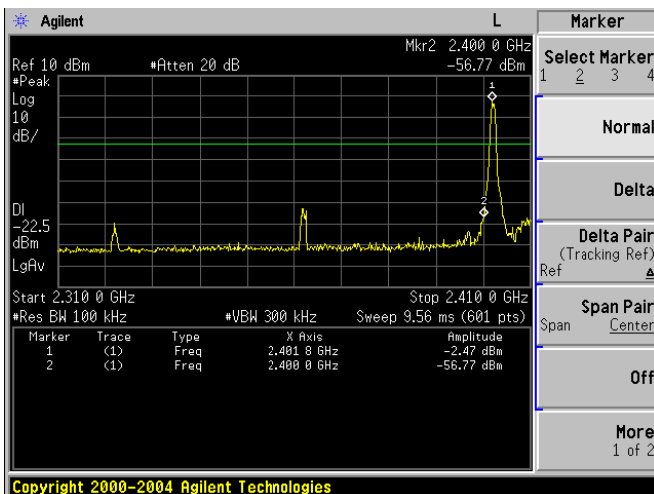

8DPSK

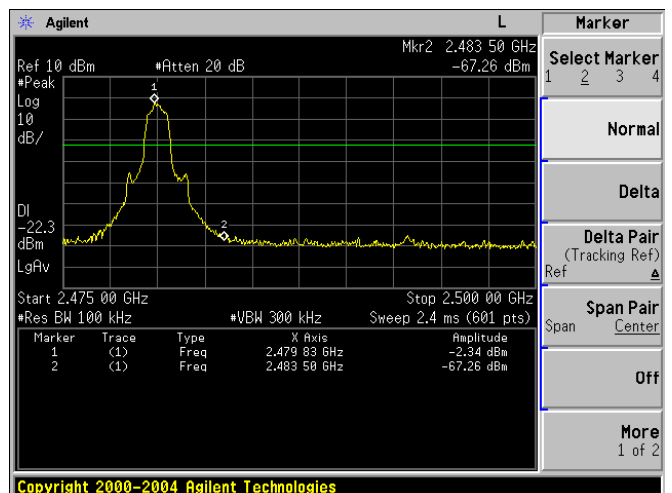
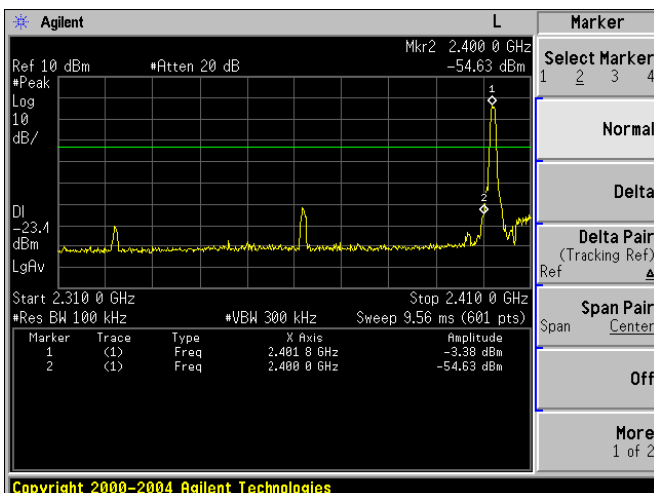



Hopping Mode

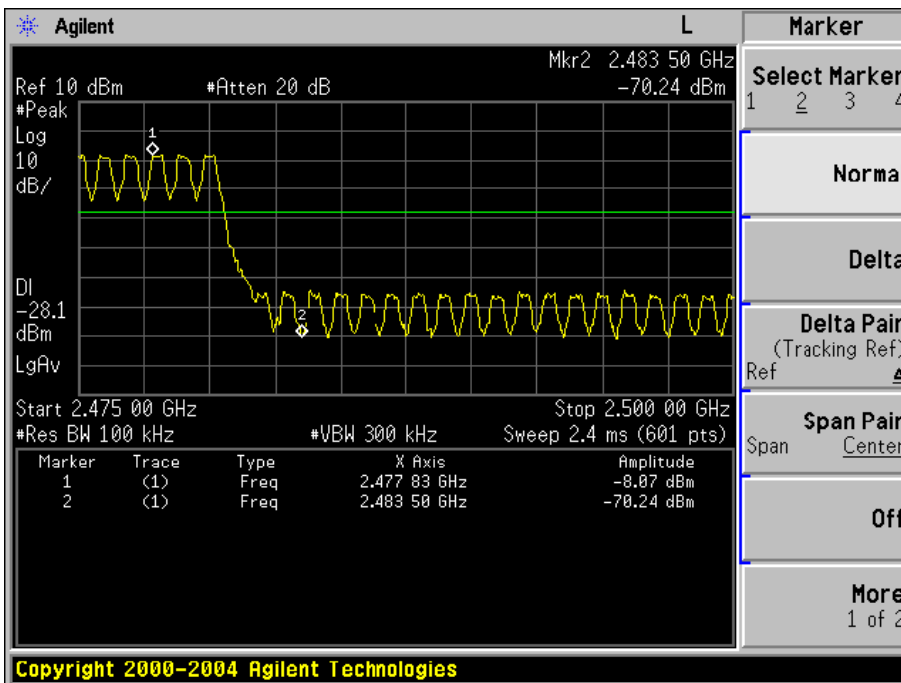
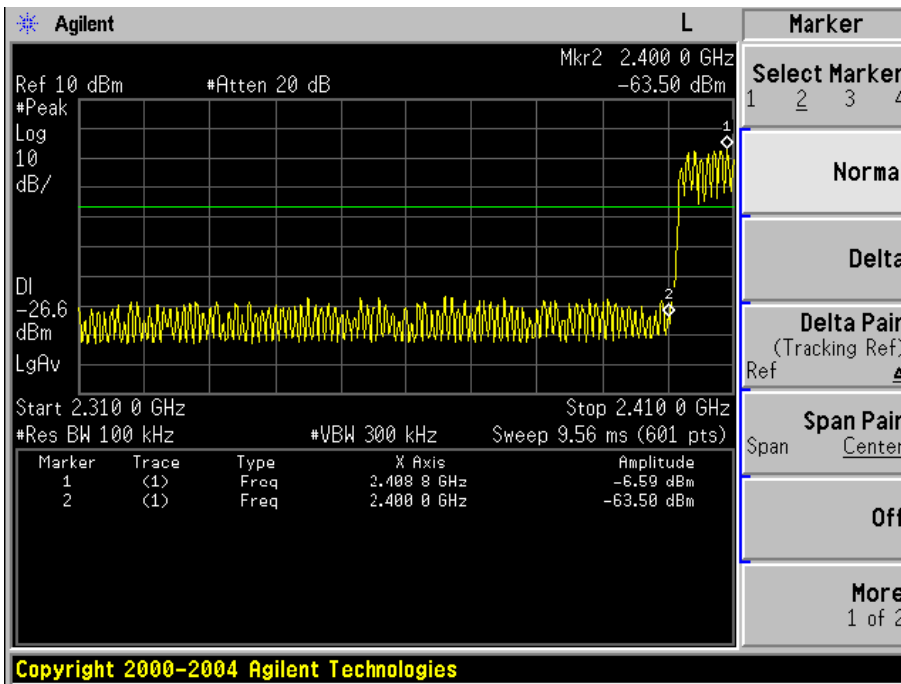



4. BANDWIDTH TEST

4.1 APPLIED PROCEDURES / LIMIT

FCC Part15 (15.247) , Subpart C	
Section	Test Item
15.247(a)(2) RSS-247	Bandwidth

4.1.1 TEST PROCEDURE

1. Set RBW = 30 kHz.
2. Set the video bandwidth (VBW) \geq RBW.
3. Detector = Peak.
4. Trace mode = max hold.
5. Sweep = auto couple.
6. Allow the trace to stabilize.
7. Measure the maximum width of the emission that is constrained by the frequencies associated with the two outermost amplitude points (upper and lower frequencies) that are attenuated by 20 dB relative to the maximum level measured in the fundamental emission.

4.1.2 DEVIATION FROM STANDARD

No deviation.

4.1.3 TEST SETUP

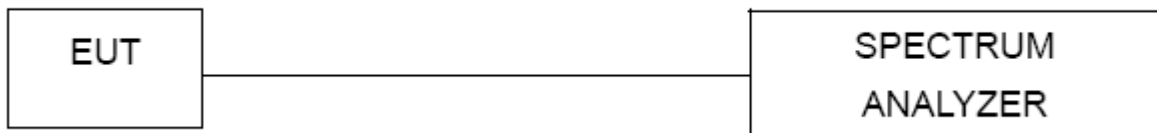

4.1.4 EUT OPERATION CONDITIONS

The EUT tested system was configured as the statements of 2.3 Unless otherwise a special operating condition is specified in the follows during the testing.



4.1.5 TEST RESULTS

Temperature :	25°C	Relative Humidity :	60%
Pressure :	1012 hPa	Test Voltage :	DC 3.7V
Test Mode :	TX Mode /CH00, CH39, CH78		

	Frequency (MHz)	20dB Bandwidth	99% Bandwidth	Result
GFSK	2402	0.866	0.411	Pass
	2441	0.852	0.423	Pass
	2480	0.863	0.408	Pass
PI/4 DPSK	2402	1.221	0.870	Pass
	2441	1.219	0.880	Pass
	2480	1.223	0.872	Pass
8DPSK	2402	1.211	0.827	Pass
	2441	1.208	0.829	Pass
	2480	1.204	0.826	Pass



GFSK

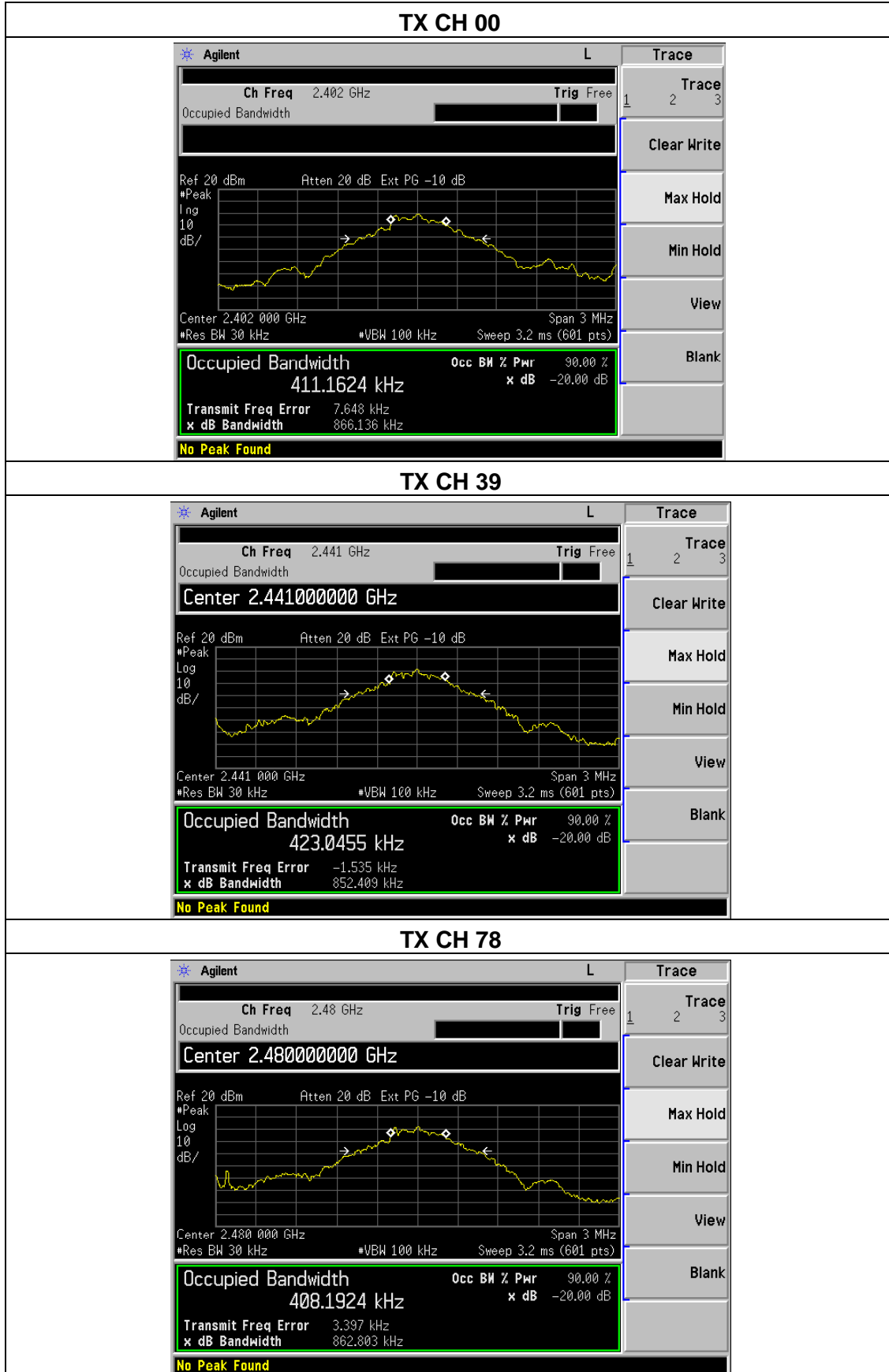



PI/4 DPSK

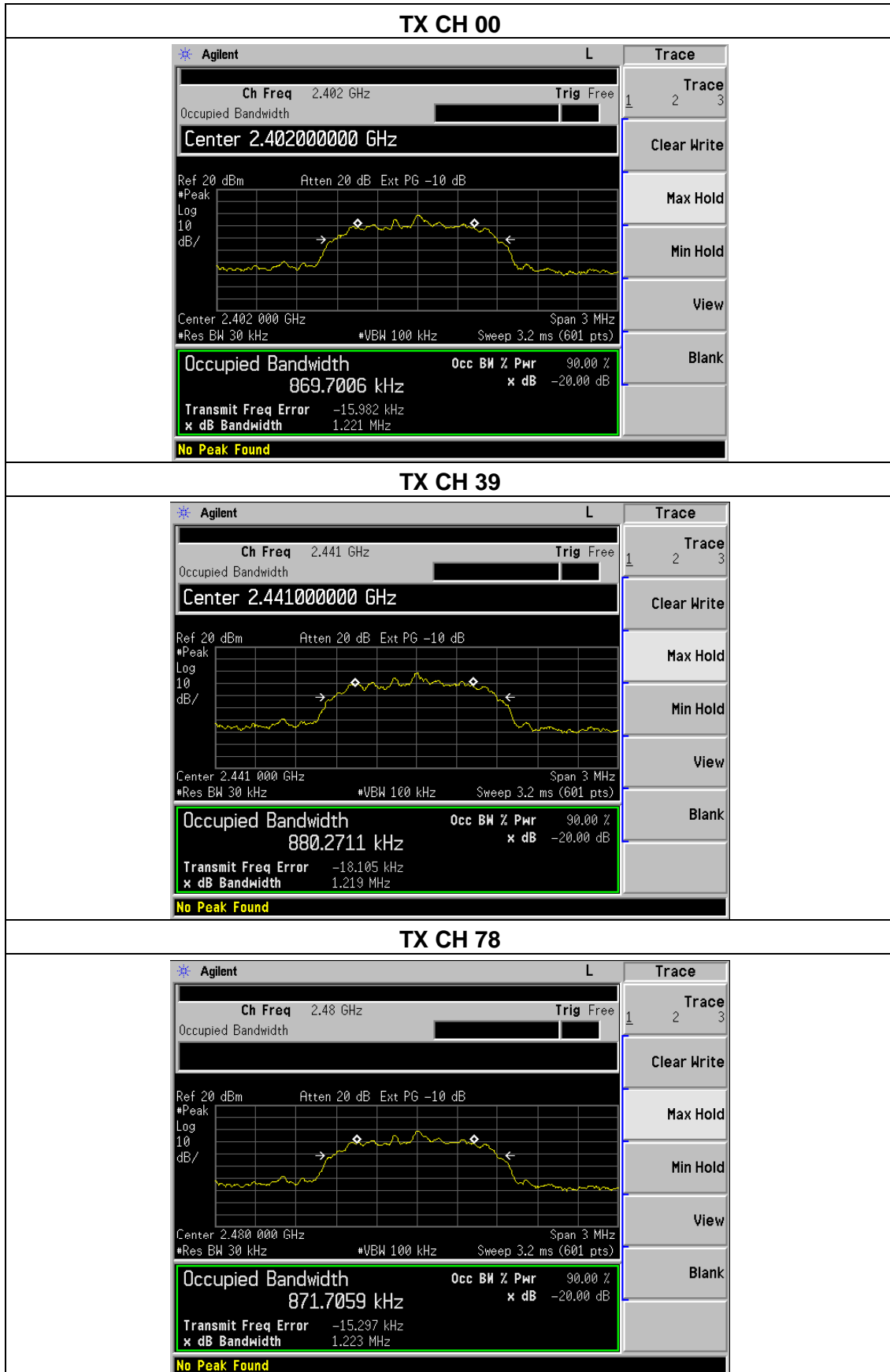



8DPSK

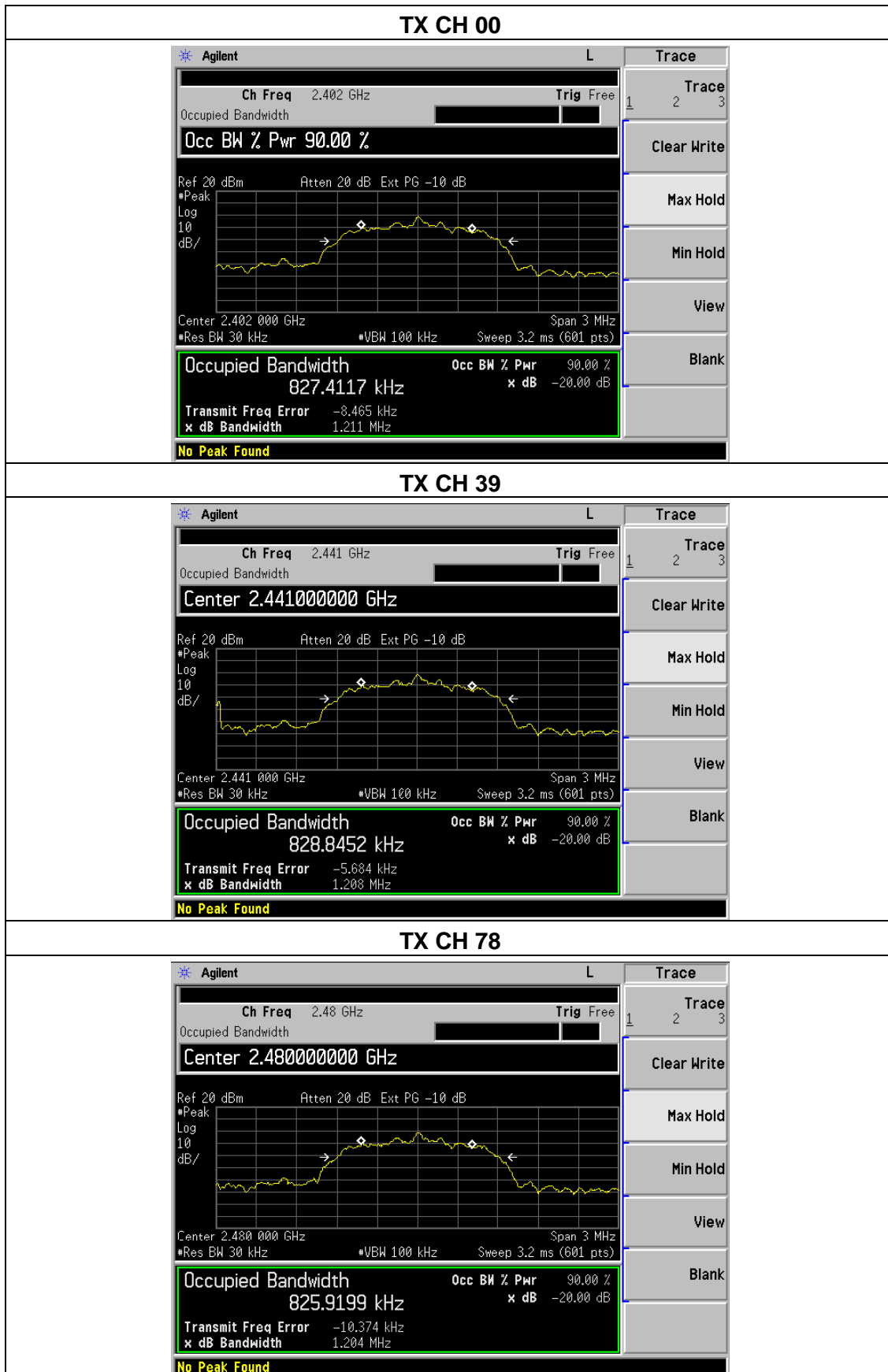

5. NUMBER OF HOPPING CHANNEL

5.1 APPLIED PROCEDURES / LIMIT

FCC Part15 (15.247) , Subpart C				
Section	Test Item	Limit	Frequency Range (MHz)	Result
15.247 (a)(1)(iii) RSS-247	Number of Hopping Channel	≥15	2400-2483.5	PASS

Spectrum Parameters	Setting
Attenuation	Auto
Span Frequency	= the frequency band of operation
RB	RBW ≥ 1% of the span
VB	VBW ≥ RBW
Detector	Peak
Trace	Max Hold
Sweep Time	Auto

5.1.1 TEST PROCEDURE

- a. The EUT was directly connected to the spectrum analyzer and antenna output port as show in the block diagram below,
- b. Spectrum Setting : RBW= 100KHz, VBW=100KHz, Sweep time = Auto.

5.1.2 DEVIATION FROM STANDARD

No deviation.

5.1.3 TEST SETUP



5.1.4 EUT OPERATION CONDITIONS

The EUT tested system was configured as the statements of 2.4 Unless otherwise a special operating condition is specified in the follows during the testing.

5.1.5 TEST RESULTS



Temperature :	25 °C	Relative Humidity :	60%
Pressure :	1015 hPa	Test Voltage :	DC 3.7V
Test Mode :	Hopping Mode		

Number of Hopping Channel	79
---------------------------	----

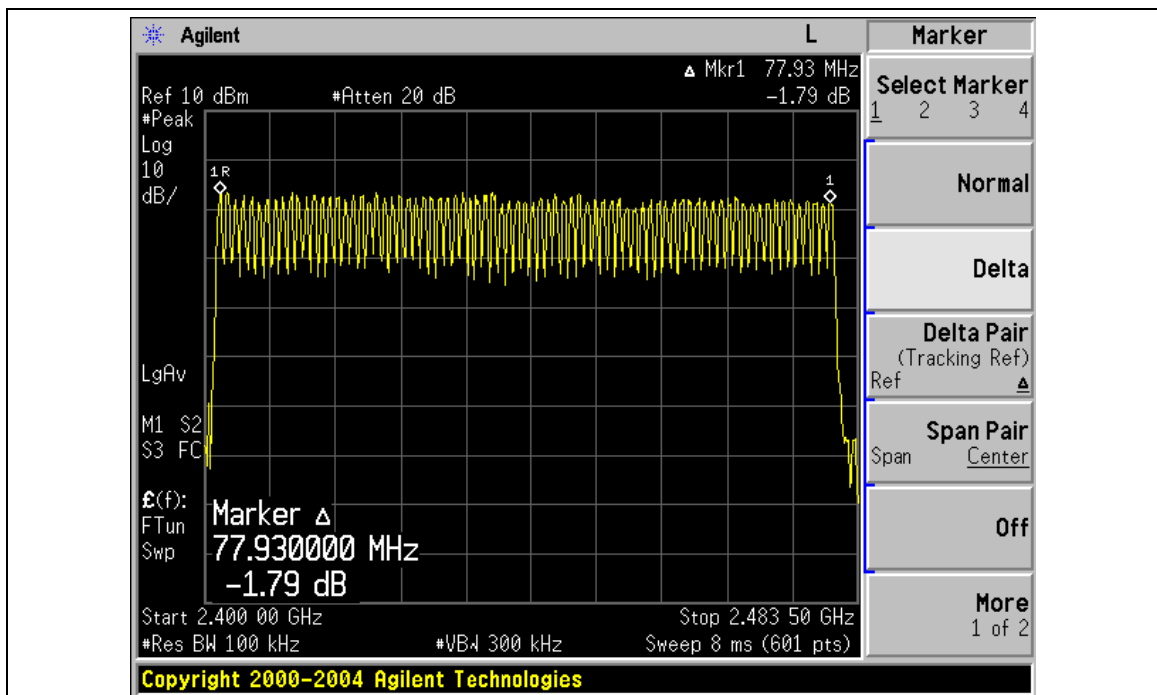



6. AVERAGE TIME OF OCCUPANCY

6.1 APPLIED PROCEDURES / LIMIT

FCC Part15 (15.247) , Subpart C				
Section	Test Item	Limit	Frequency Range (MHz)	Result
15.247 (a)(1)(iii) Rss-247	Average Time of Occupancy	0.4sec	2400-2483.5	PASS

6.1.1 TEST PROCEDURE

- a. The transmitter output (antenna port) was connected to the spectrum analyzer
- b. Set RBW of spectrum analyzer to 1MHz and VBW to 1MHz.
- c. Use a video trigger with the trigger level set to enable triggering only on full pulses.
- d. Sweep Time is more than once pulse time.
- e. Set the center frequency on any frequency would be measure and set the frequency span to zero span.
- f. Measure the maximum time duration of one single pulse.
- g. Set the EUT for DH5, DH3 and DH1 packet transmitting.
- h. Measure the maximum time duration of one single pulse.
- i. A Period Time = (channel number)*0.4
 DH1 Time Slot: Reading * (1600/2)*31.6/(channel number)
 DH3 Time Slot: Reading * (1600/4)*31.6/(channel number)
 DH5 Time Slot: Reading * (1600/6)*31.6/(channel number)

6.1.2 DEVIATION FROM STANDARD

No deviation.

6.1.3 TEST SETUP



6.1.4 EUT OPERATION CONDITIONS

The EUT tested system was configured as the statements of 2.4 Unless otherwise a special operating condition is specified in the follows during the testing.

**6.1.5 TEST RESULTS**

EUT :	Smart Band	Model Name :	A2
Temperature :	25 °C	Relative Humidity :	60%
Pressure :	1012 hPa	Test Voltage :	DC 3.7V
Test Mode :	CH39-DH5, 2DH5, 3DH5		

Frequency	Packet	Dwell time(ms)	Limit(ms)	Result
2402MHz	DH1/2-DH1/3-DH1	123.84	400	Pass
2441MHz	DH3/2-DH3/3-DH3	261.28	400	Pass
2480MHz	DH5/2-DH5/3-DH5	308.59	400	Pass

The test period: $T = 0.4 \text{ Second/Channel} \times 79 \text{ Channel} = 31.6 \text{ s}$

Test channel: 2402MHz/2441MHz/2480MHz as blow

DH1/2-DH1/3-DH1 time slot= $0.387(\text{ms}) \times (1600 / (2 \times 79)) \times 31.6 = 123.84\text{ms}$

DH3/2-DH3/3-DH3 time slot= $1.633(\text{ms}) \times (1600 / (4 \times 79)) \times 31.6 = 261.28\text{ms}$

DH5/2-DH5/3-DH5 time slot= $2.893(\text{ms}) \times (1600 / (6 \times 79)) \times 31.6 = 308.59\text{ms}$



Test channel: 2402MHz/2441MHz/2480MHz

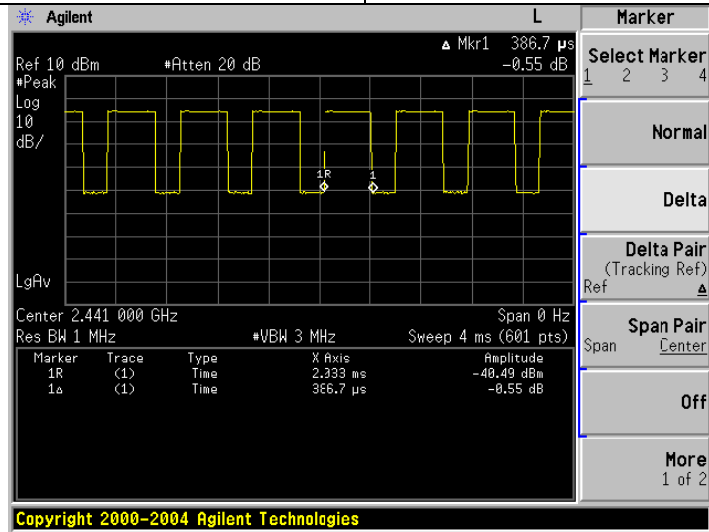

DH1/2-DH1/3-DH1

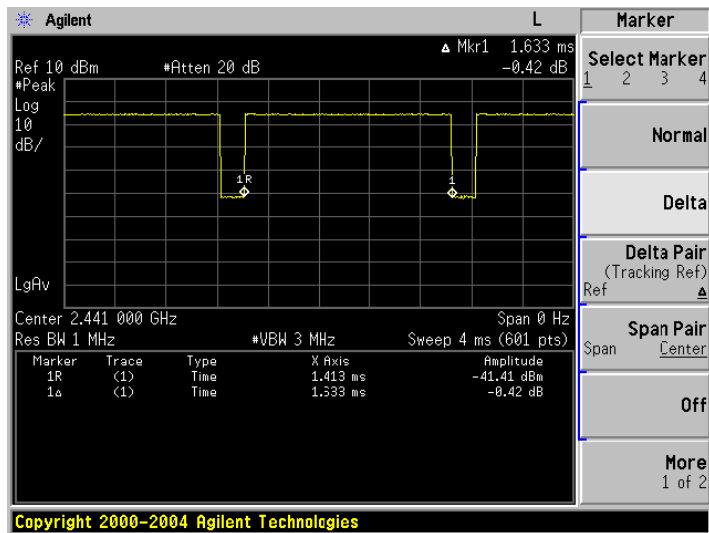

DH3/2-DH3/3-DH3

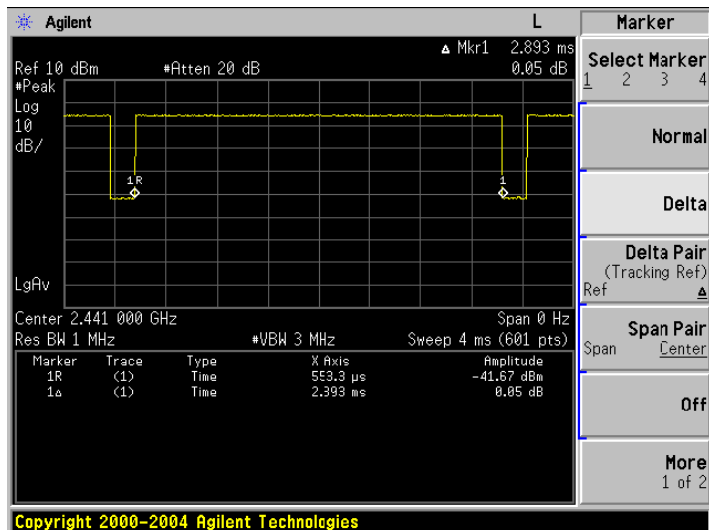

DH5/2-DH5/3-DH5

7. HOPPING CHANNEL SEPARATION MEASUREMENT

7.1 APPLIED PROCEDURES / LIMIT

Frequency hopping systems operating in the 2400-2483.5 MHz band may have hopping channel carrier frequencies that are separated by 25 kHz or two-thirds of the 20 dB bandwidth of the hopping channel, whichever is greater.

Spectrum Parameter	Setting
Attenuation	Auto
Span Frequency	> Measurement Bandwidth or Channel Separation
RB	100 kHz (Channel Separation)
VB	300 kHz (Channel Separation)
Detector	Peak
Trace	Max Hold
Sweep Time	Auto

7.1.1 TEST PROCEDURE

- a. The transmitter output (antenna port) was connected to the spectrum analyser in peak hold mode.
- b. The resolution bandwidth of 100 kHz and the video bandwidth of 300 kHz were utilised for channel separation measurement.

7.1.2 DEVIATION FROM STANDARD

No deviation.

7.1.3 TEST SETUP

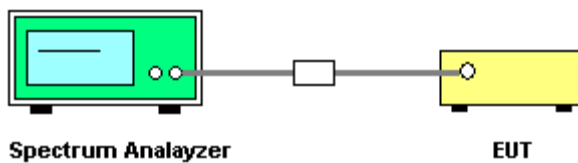

7.1.4 EUT OPERATION CONDITIONS

The EUT was programmed to be in continuously transmitting mode.



7.1.5 TEST RESULTS

Temperature :	25 °C	Relative Humidity :	60%
Pressure :	1012 hPa	Test Voltage :	DC 3.7V
Test Mode :	GFSK, PI/4 DPSK, 8DPSK		

Test Mode	Ch. Separation (MHz)	Limit (MHz)	Result
GFSK	1.00	0.934	Complies
PI/4 DPSK	1.00	0.748	Complies
8DPSK	1.00	0.779	Complies

GFSK

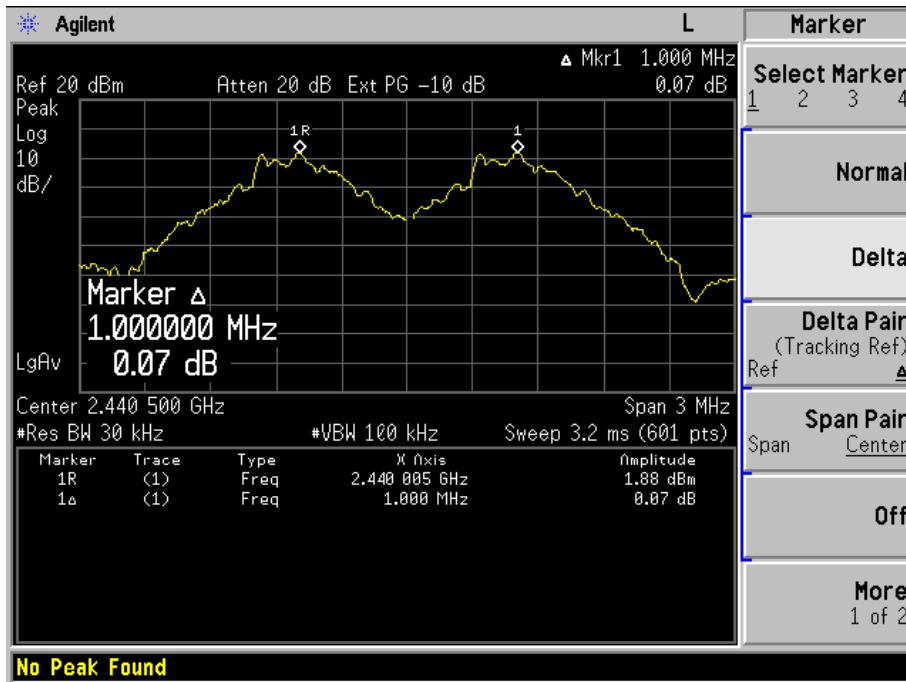



PI/4 DPSK

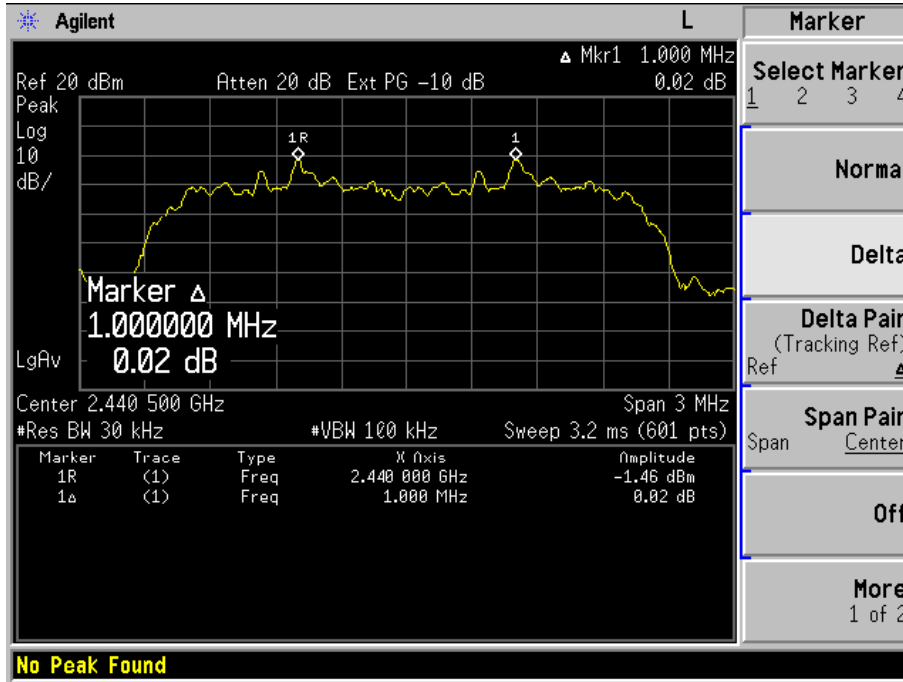

8DPSK

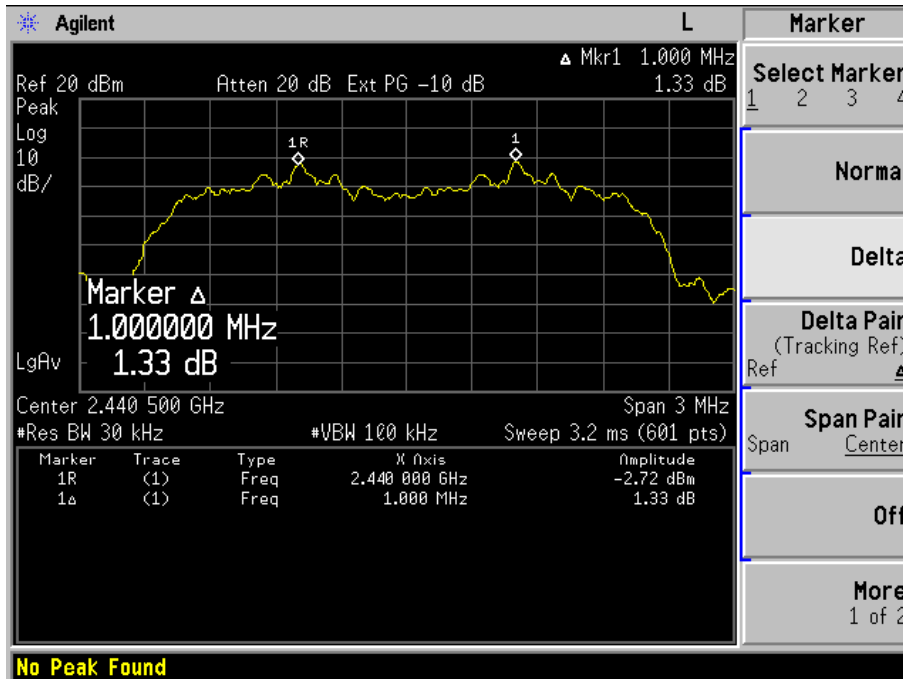

8. HOPPING CHANNEL SEPARATION MEASUREMENT

8.1 APPLIED PROCEDURES / LIMIT

FCC Part15 (15.247) , Subpart C				
Section	Test Item	Limit	Frequency Range (MHz)	Result
15.247 (b)(i) RSS-247	Peak Output Power	30Bm or 20.96dBm	2400-2483.5	PASS

8.1.1 TEST PROCEDURE

- a. The EUT was directly connected to the power meter and antenna output port as show in the block diagram below,
- b. Spectrum Setting : RBW > the 20 dB bandwidth of the emission being measured
 Span = approximately 5 times the 20 dB bandwidth, centered on a hopping channel
 VBW ≥ RBW
 Sweep = auto
 Detector function = peak
 Trace = max hold

8.1.2 DEVIATION FROM STANDARD

No deviation.

8.1.3 TEST SETUP



8.1.4 EUT OPERATION CONDITIONS

The EUT tested system was configured as the statements of 2.4 Unless otherwise a special operating condition is specified in the follows during the testing.



8.1.5 TEST RESULTS

Temperature :	25 °C	Relative Humidity :	60%
Pressure :	1012 hPa	Test Voltage :	DC 3.7V
Test Mode :	CH00/ CH39 /CH78 (1M/2M/3Mbps Mode)		

1Mbps			
Test Channel	Frequency (MHz)	Peak Output Power (dBm)	LIMIT (dBm)
CH00	2402	0.35	30.00
CH39	2441	0.32	30.00
CH78	2480	0.33	30.00
2Mbps			
CH00	2402	0.26	20.96
CH39	2441	0.24	20.96
CH78	2480	0.25	20.96
3Mbps			
CH00	2402	0.18	20.96
CH39	2441	0.17	20.96
CH78	2480	0.16	20.96



9. ANTENNA REQUIREMENT

9.1 STANDARD REQUIREMENT

15.203 requirement: For intentional device, according to 15.203: an intentional radiator shall be designed to ensure that no antenna other than that furnished by the responsible party shall be used with the device.

9.2 EUT ANTENNA

The EUT antenna is pcb antenna,. It comply with the standard requirement.

10. TEST SEUUP PHOTO

Radiated Measurement Photos

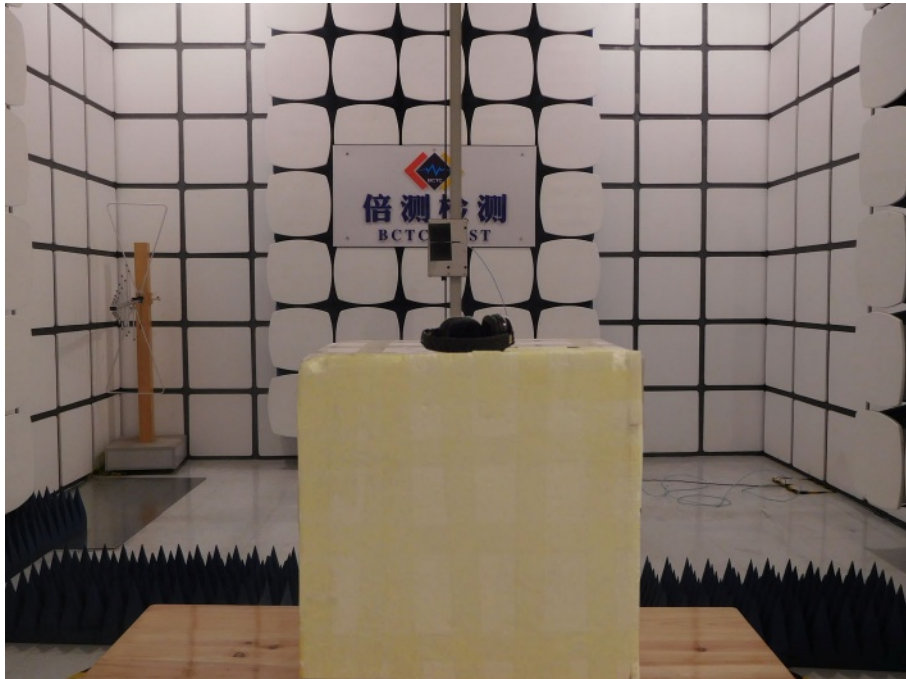

Conducted Measurement Photos



11. EUT PHOTO



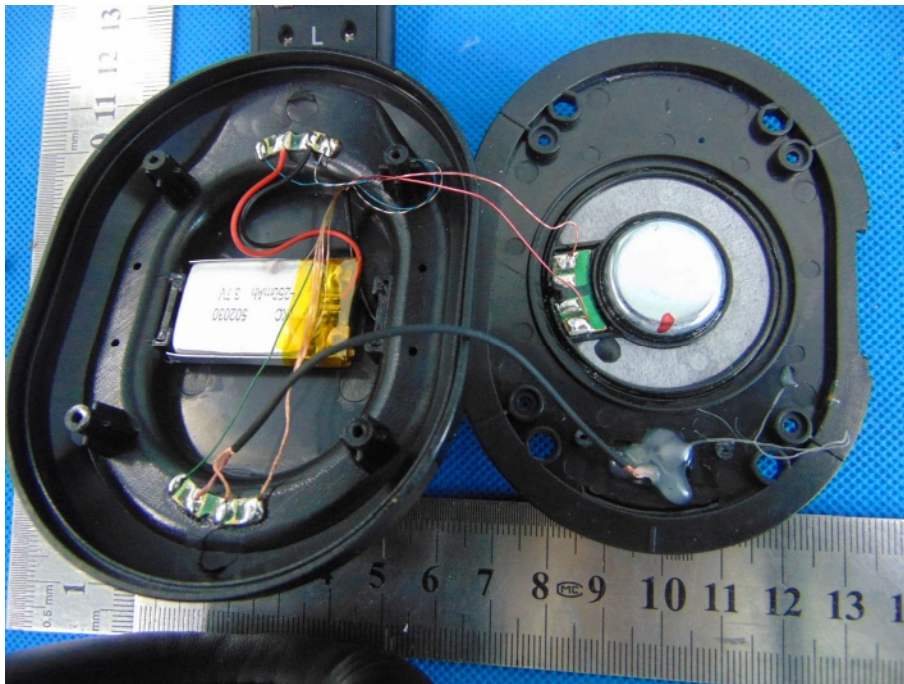

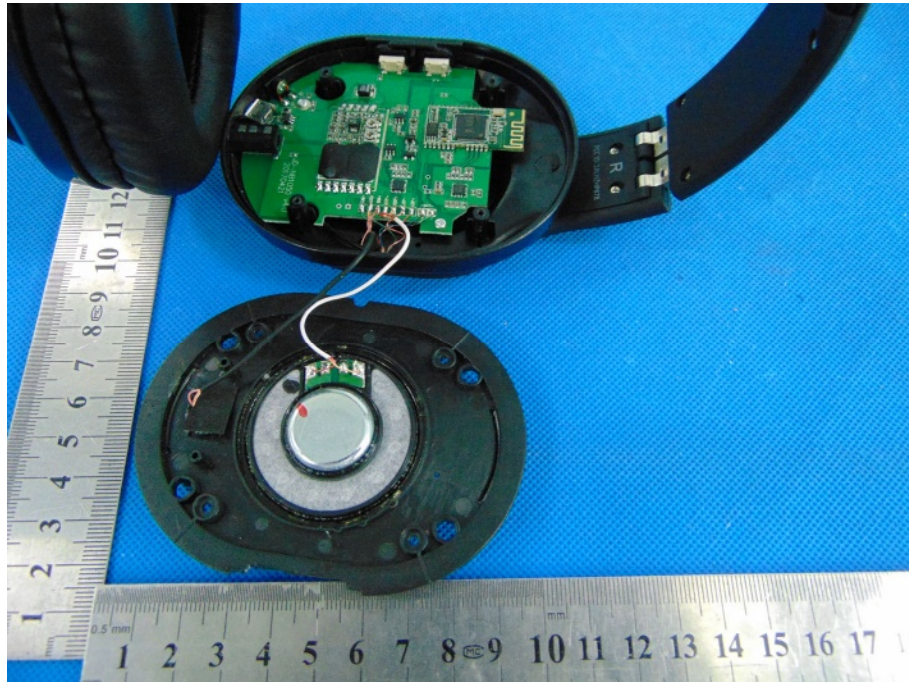

***** END OF REPORT *****