

Brand/Model : 2ALHR012_Antenna 2402MHz,2440MHz,2480MHz

Antenna Type : Flat Antenna

Location : SATIMO StarLab

Date : 2023/11/09~2023/11/10

Temperature: 25.1

Humidity(%) : 65

Impedance(Ω) : 50	VSWR : ≤ 2.4
----------------------------	-------------------

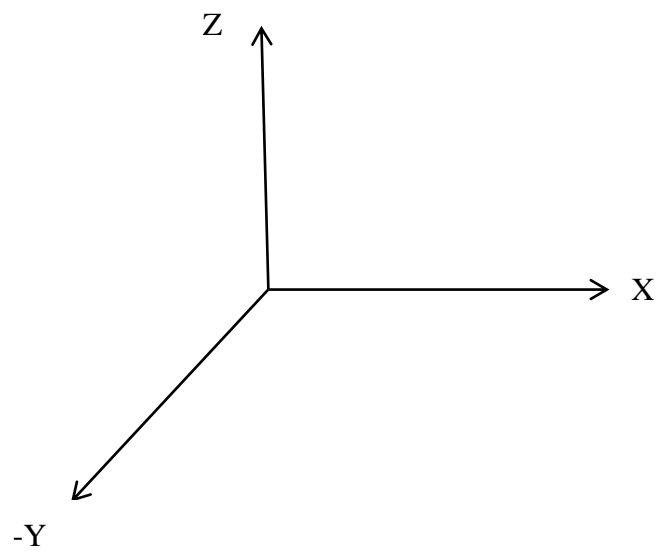
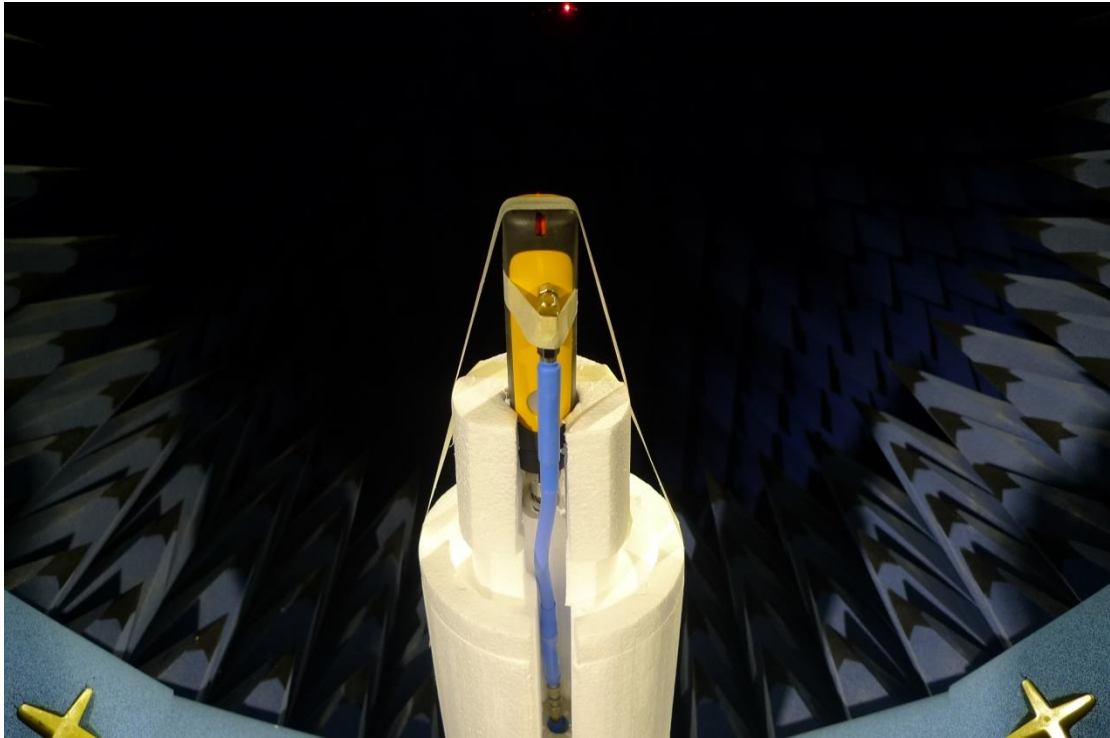

Frequency(MHz) : 2402	Field Type : 3D	No : 2ALHR010_Antenna
Maximum Gain(dBi) : -0.38	Maximum Direction(degree) : Phi: 0, Theta: -120	
Minimum Gain(dBi): -14.6	Minimum Direction(degree) : Phi: 0.47,Theta : 13	
Average Gain(dBi) : -7.68	Efficiency(%) : 26.6	

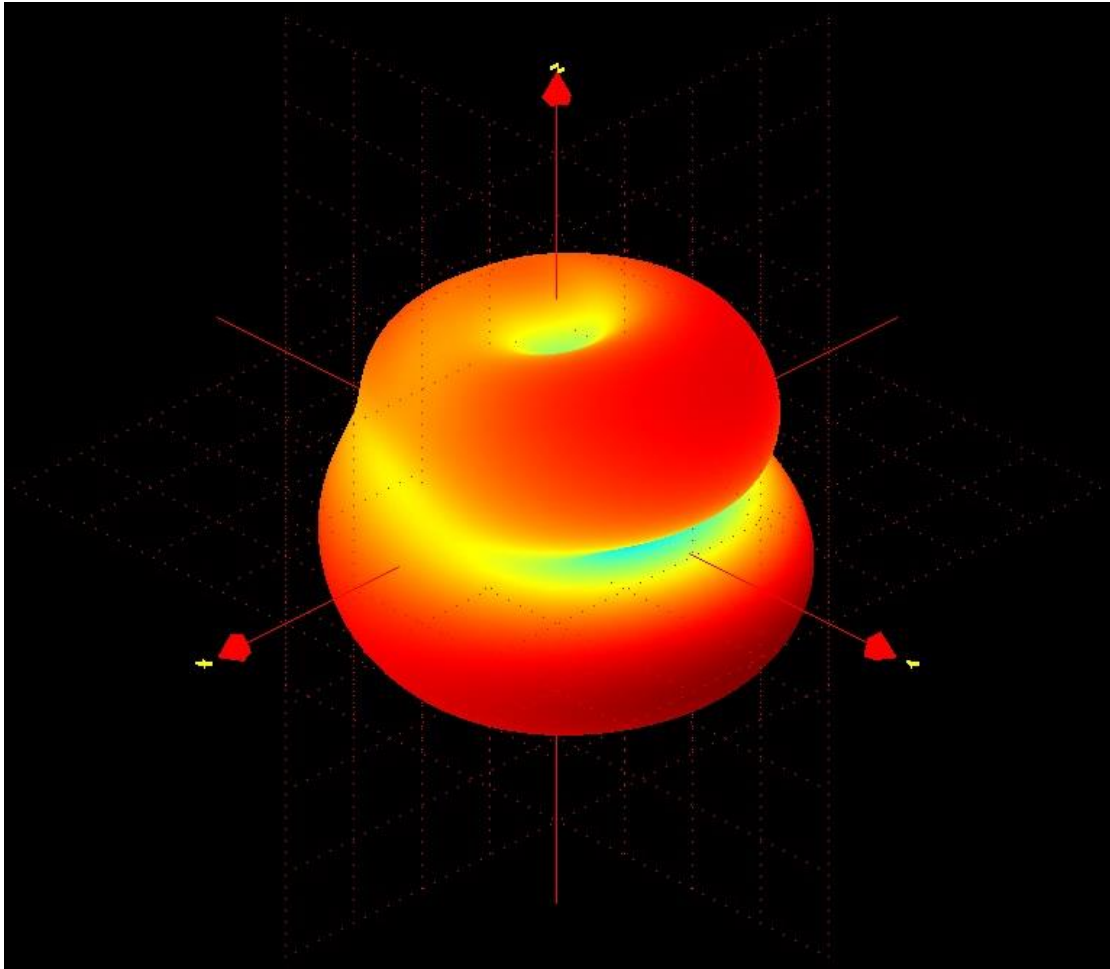

(3D)

Frequency(MHz) : 2402	Field Type : 2D(XZ)
Maximum Gain(dBi) : -2.4	Maximum Direction(degree) : -120
Minimum Gain(dBi) : -13.4	Minimum Direction(degree) : 179

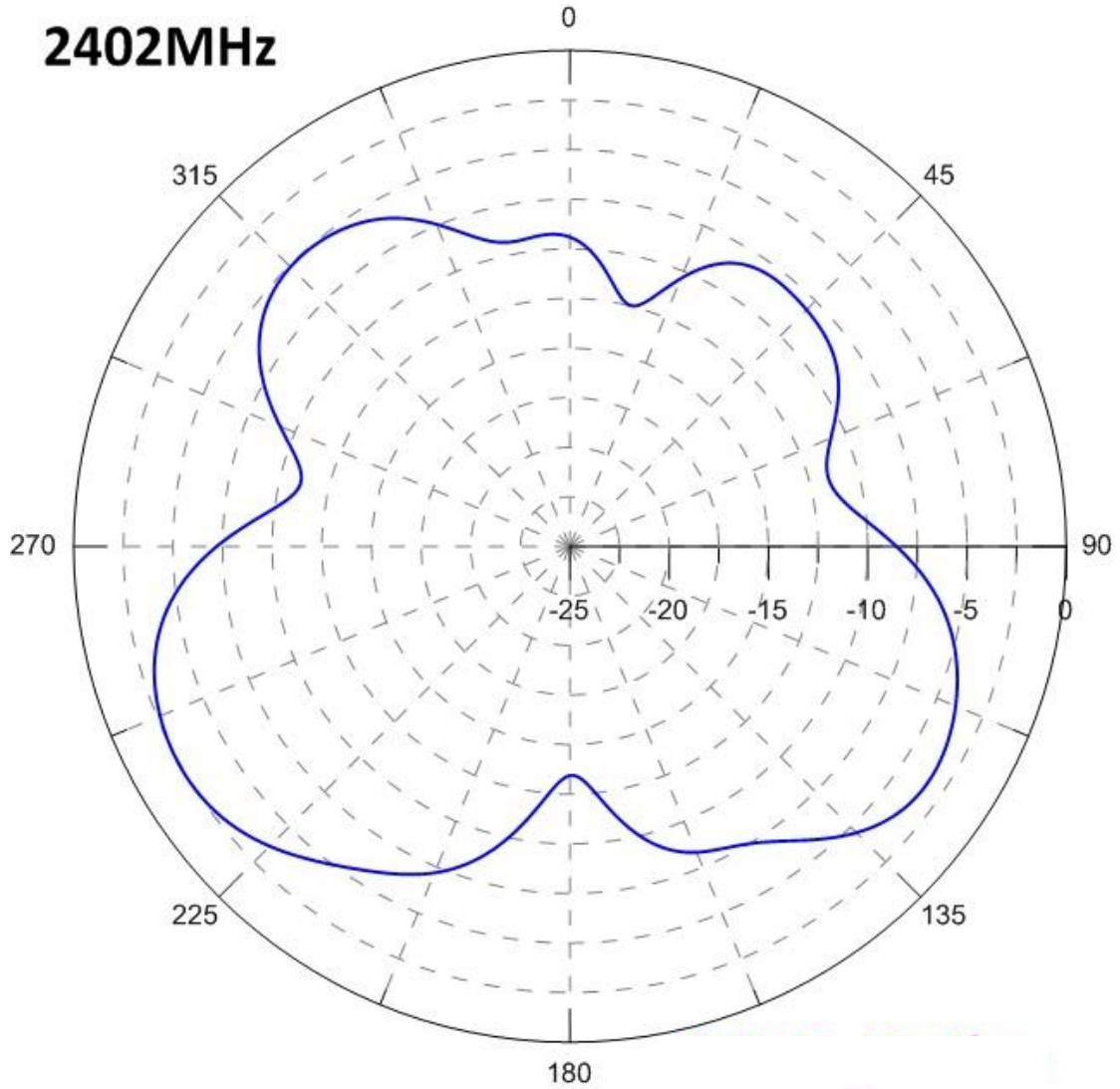

Frequency(MHz) : 2402	Field Type Type : 2D(YZ)
Maximum Gain(dBi) : -0.38	Maximum Direction(degree) : 81
Minimum Gain(dBi) : -31.5	Minimum Direction(degree) : 116

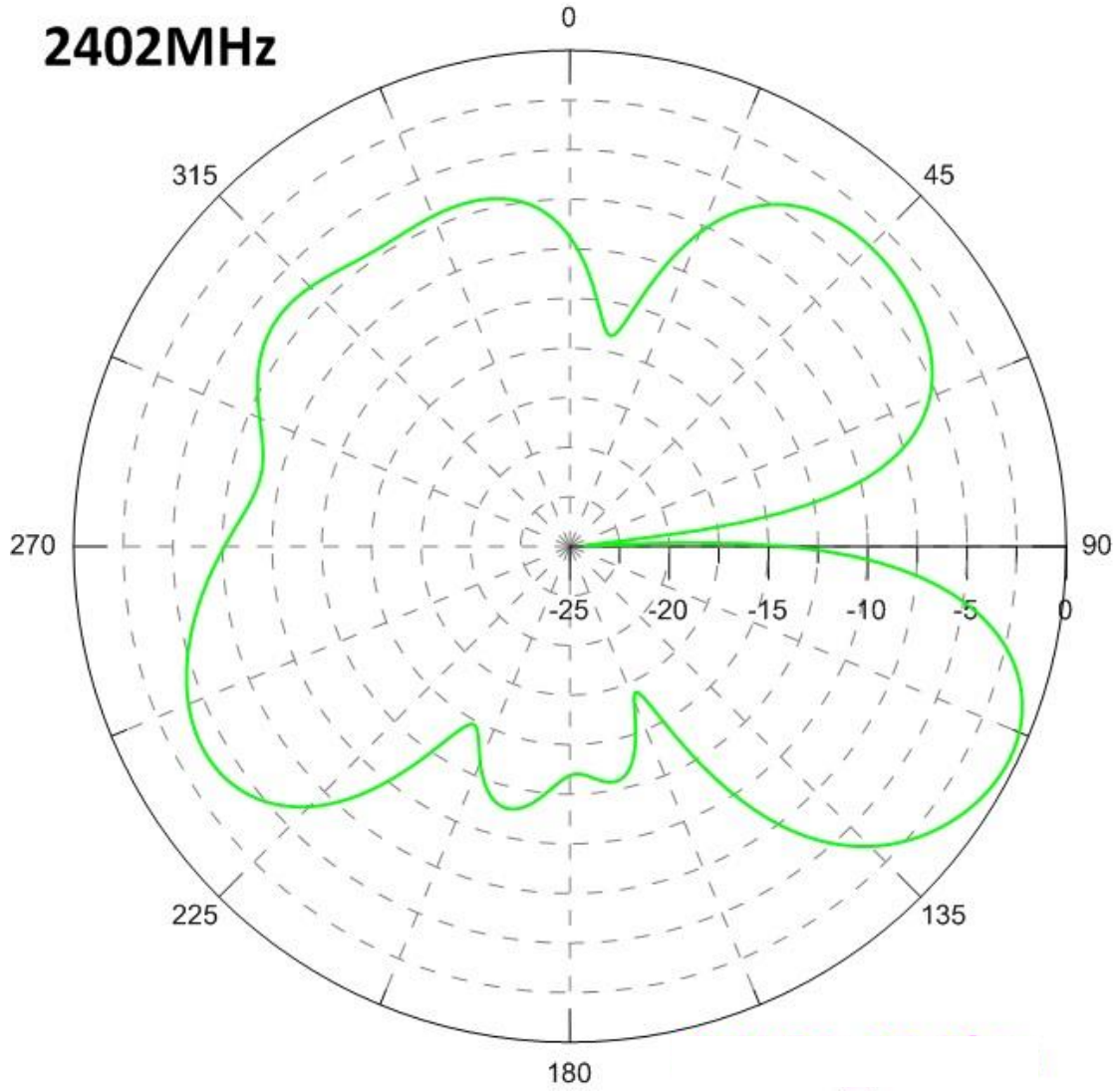

Frequency(MHz) : 2402	Field Type Type : 2D(XY)
Maximum Gain(dBi) : -6.4	Maximum Direction(degree) : 209
Minimum Gain(dBi) : -14.1	Minimum Direction(degree) : 84

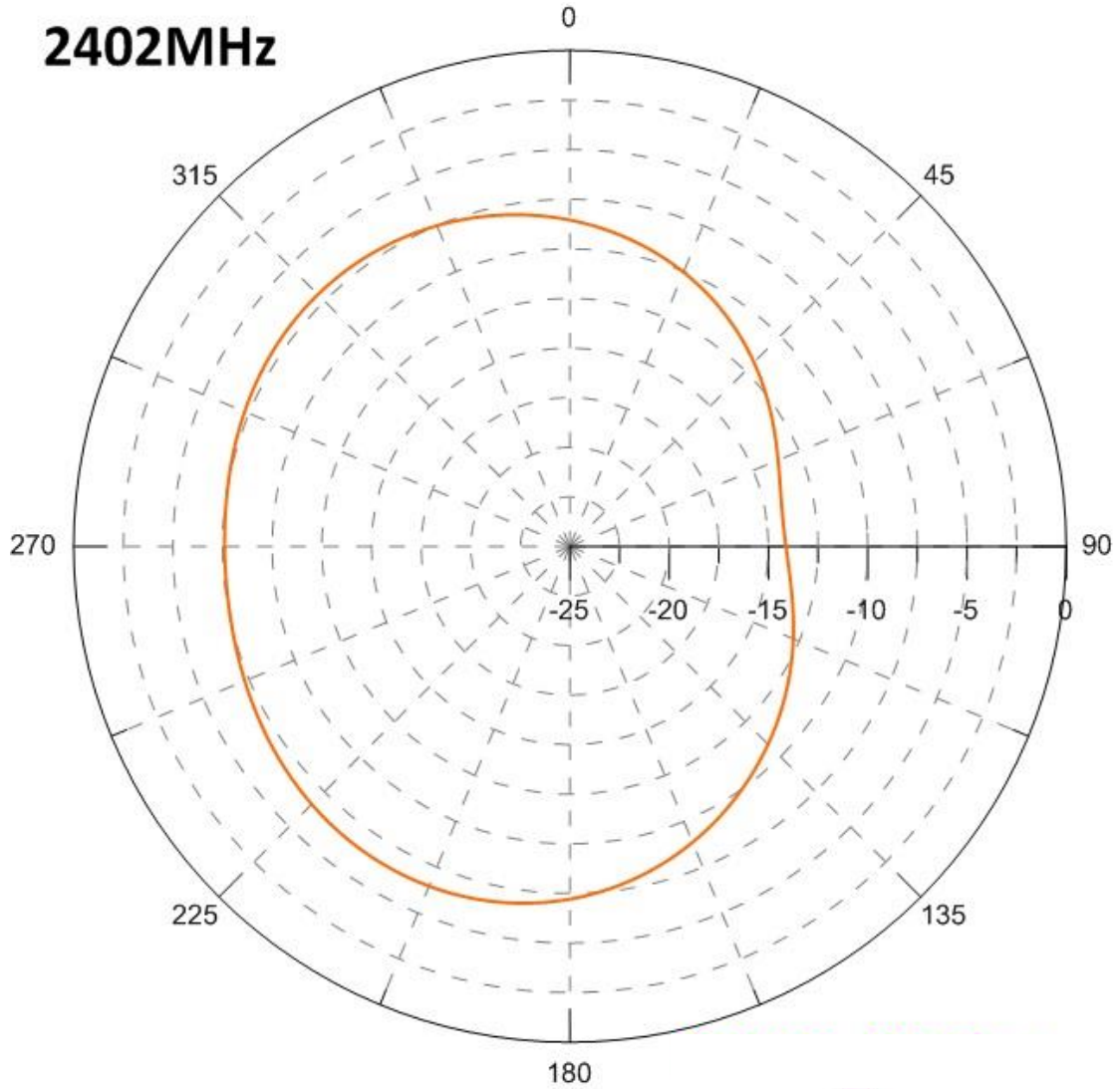

Frequency(MHz) : 2440	Field Type : 3D	No : 2ALHR010_Antenna
Maximum Gain(dBi) : -1.13	Maximum Direction(degree) : Phi:1.7,Theta:-1.1	
Minimum Gain(dBi) : -21.4	Minimum Direction(degree) : Phi: 1.1,Theta:-26.4	
Average Gain(dBi) : -8.27	Efficiency(%) : 23	

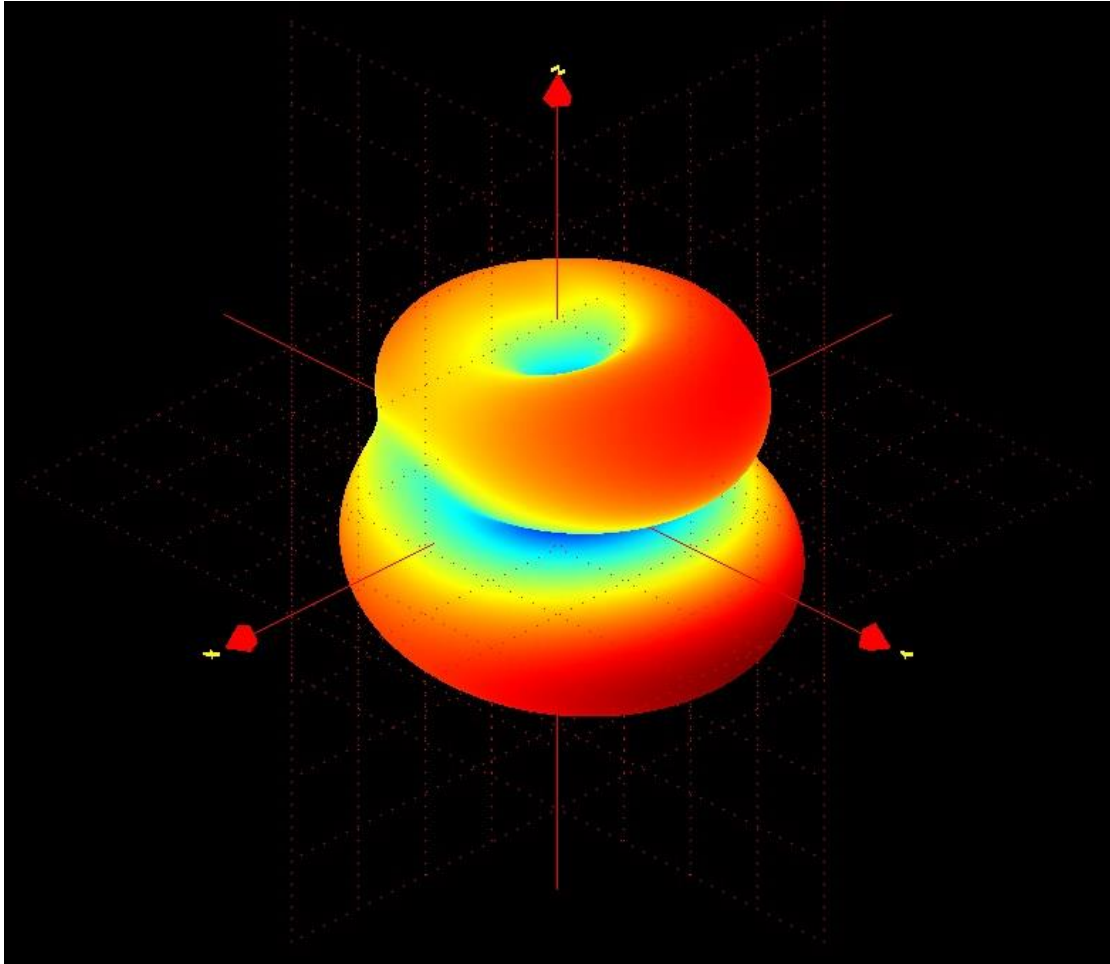

(3D)

Frequency(MHz) : 2440	Field Type : 2D(XZ)
Maximum Gain(dBi) : -2.93	Maximum Direction(degree) : -119
Minimum Gain(dBi) : -14.7	Minimum Direction(degree) : -179

2440MHz

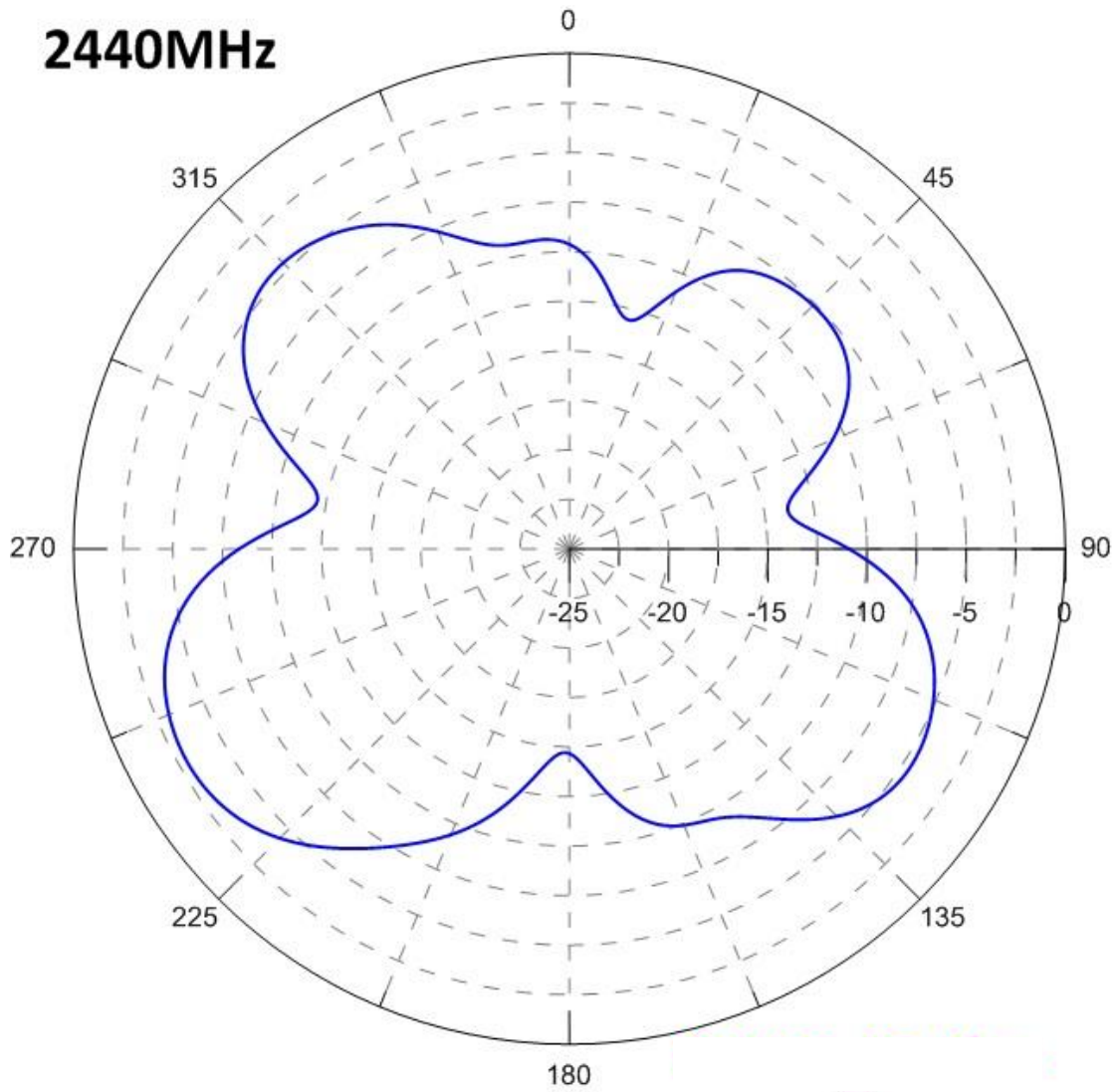

Frequency(MHz) : 2440	Field Type : 2D(YZ)
Maximum Gain(dBi) : -1.2	Maximum Direction(degree) : 117
Minimum Gain(dBi) : -20.4	Minimum Direction(degree) : 87

2440MHz

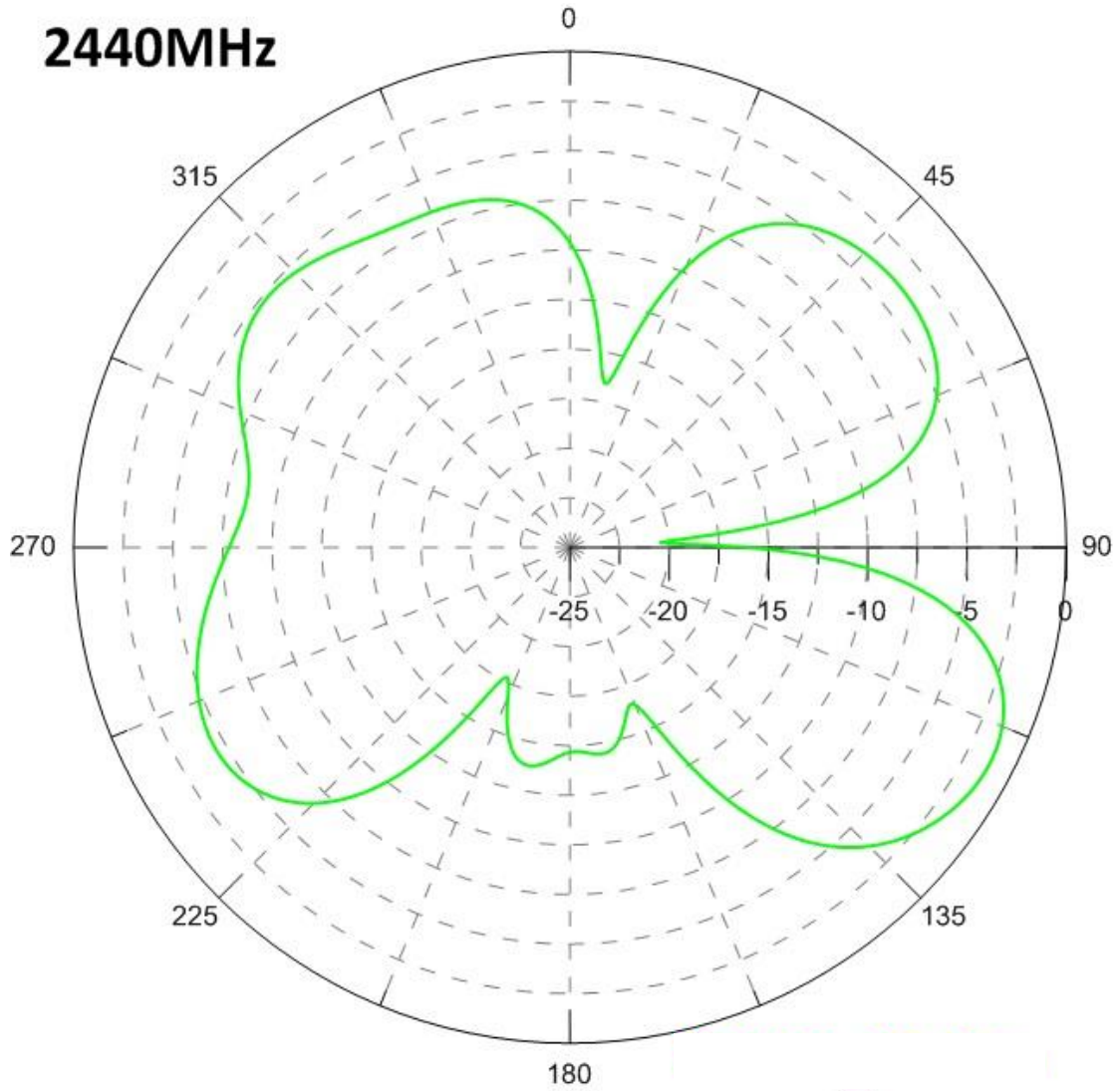

Frequency(MHz) : 2440	Field Type : 2D(XY)
Maximum Gain(dBi) : -7.1	Maximum Direction(degree) : 217
Minimum Gain(dBi) : -16.5	Minimum Direction(degree) : 69

2440MHz

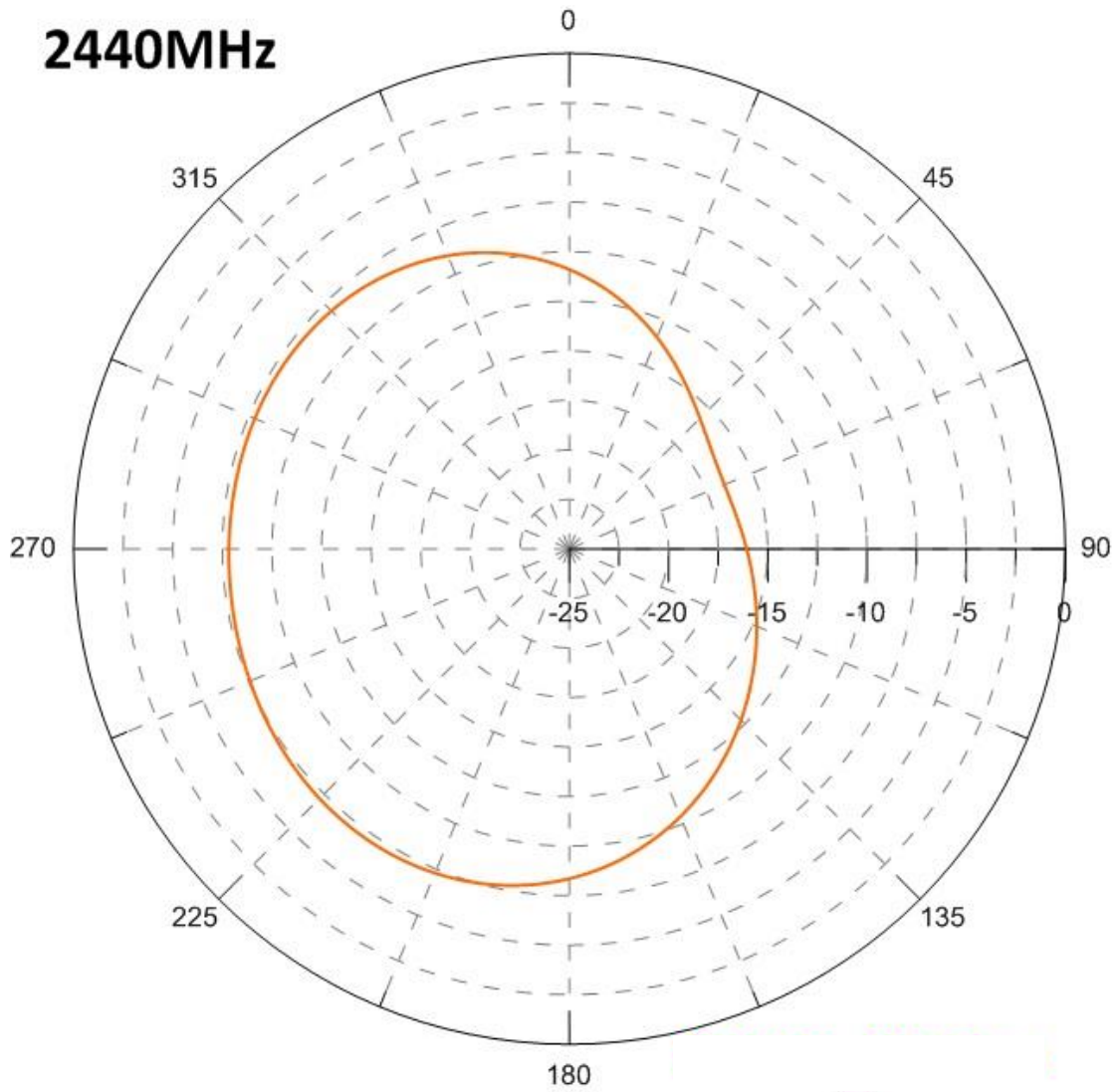

Frequency(MHz) : 2480	Field Type : 3D	No : 2ALHR010_Antenna
Maximum Gain(dBi) : -1.78	Maximum Direction(degree) : Phi: 1.76 , Theta:-28.1	
Minimum Gain(dBi) : -23.7	Minimum Direction(degree) : Phi: 0.89, Theta:-29.7	
Average Gain(dBi) :	Efficiency(%) :	

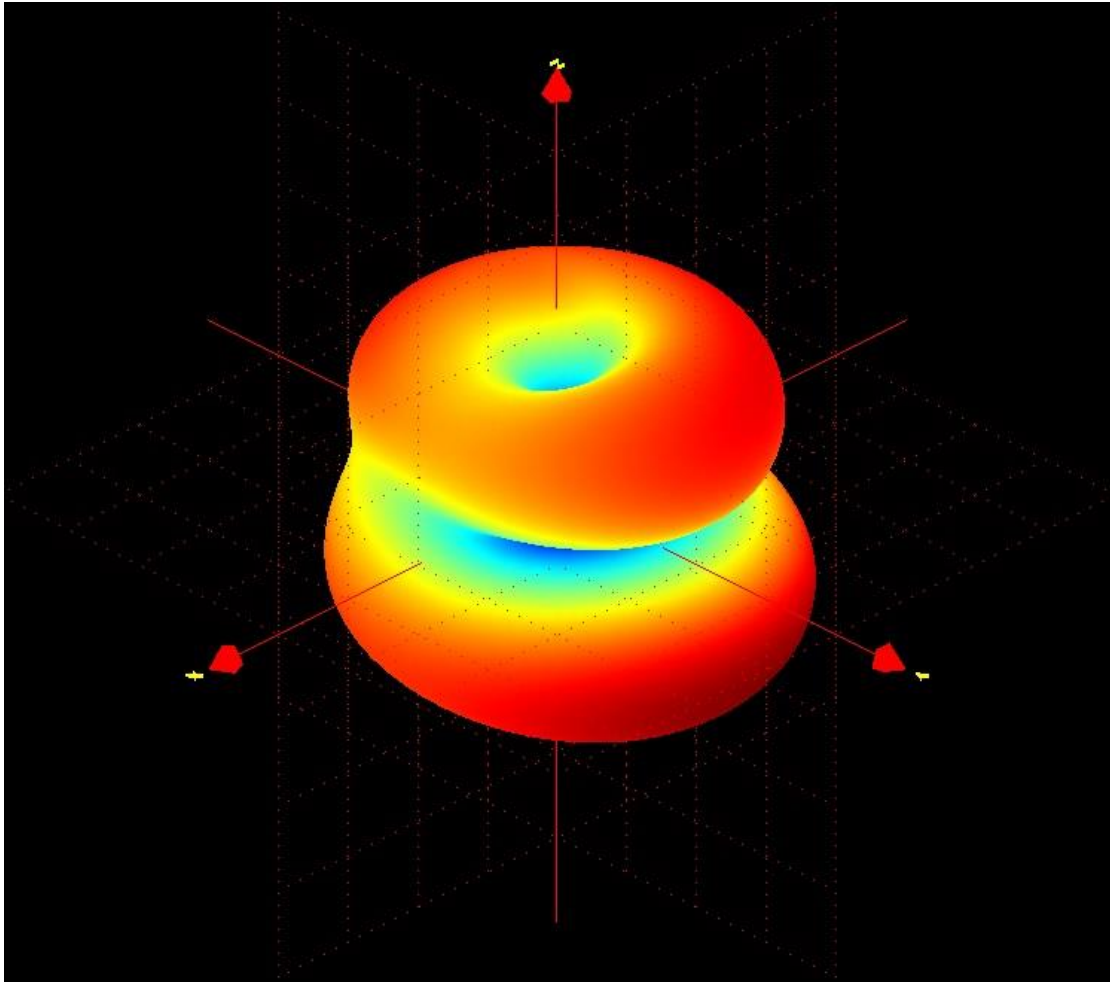

(3D)

Frequency(MHz) : 2480	Field Type : 2D(XZ)
Maximum Gain(dBi) : -3.5	Maximum Direction(degree) : -117
Minimum Gain(dBi) : -15.4	Minimum Direction(degree) : 180

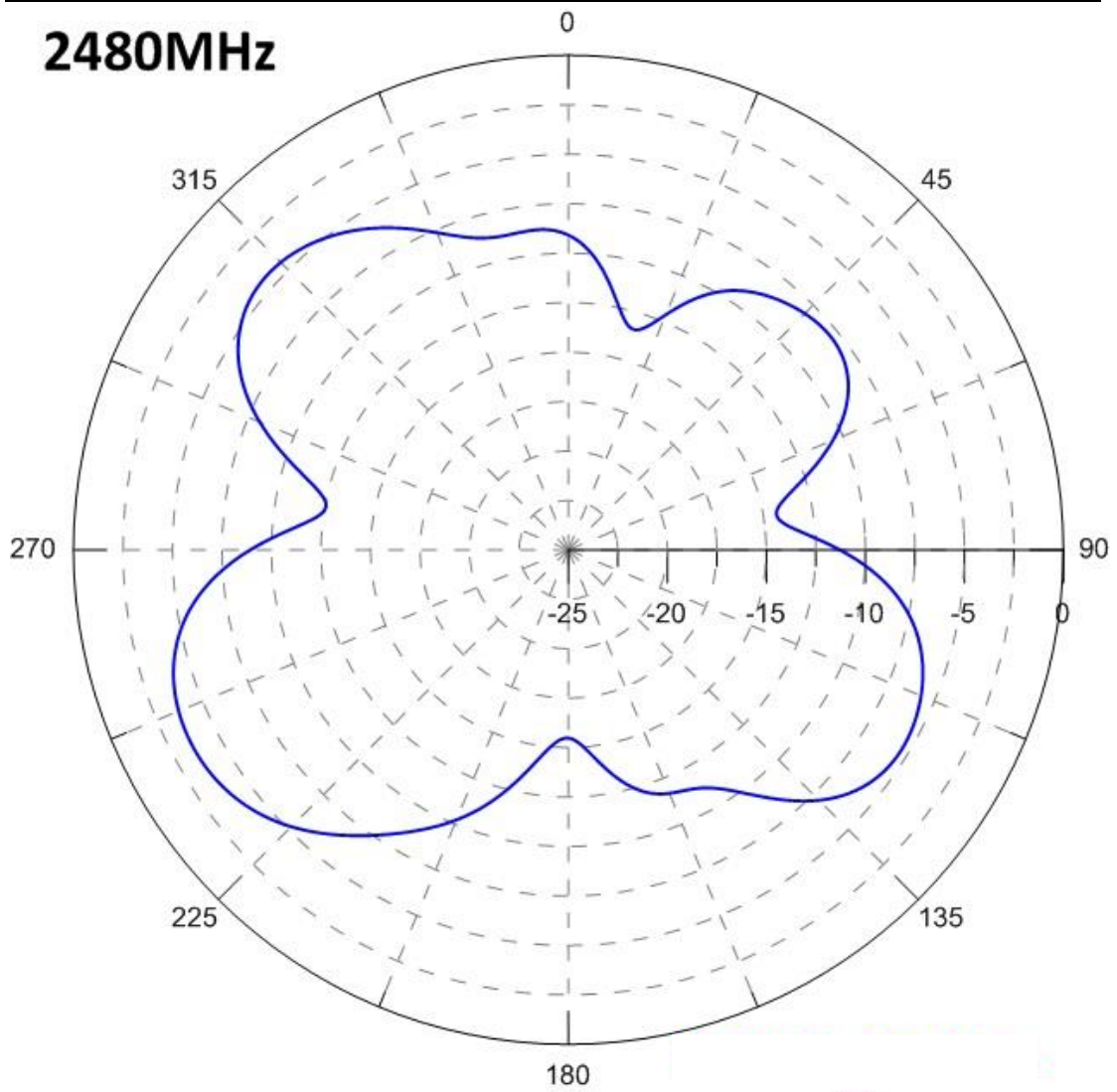

Frequency(MHz) : 2480	Field Type : 2D(YZ)
Maximum Gain(dBi) : -1.8	Maximum Direction(degree) : 118
Minimum Gain(dBi) : -18.5	Minimum Direction(degree) : 87

2480MHz

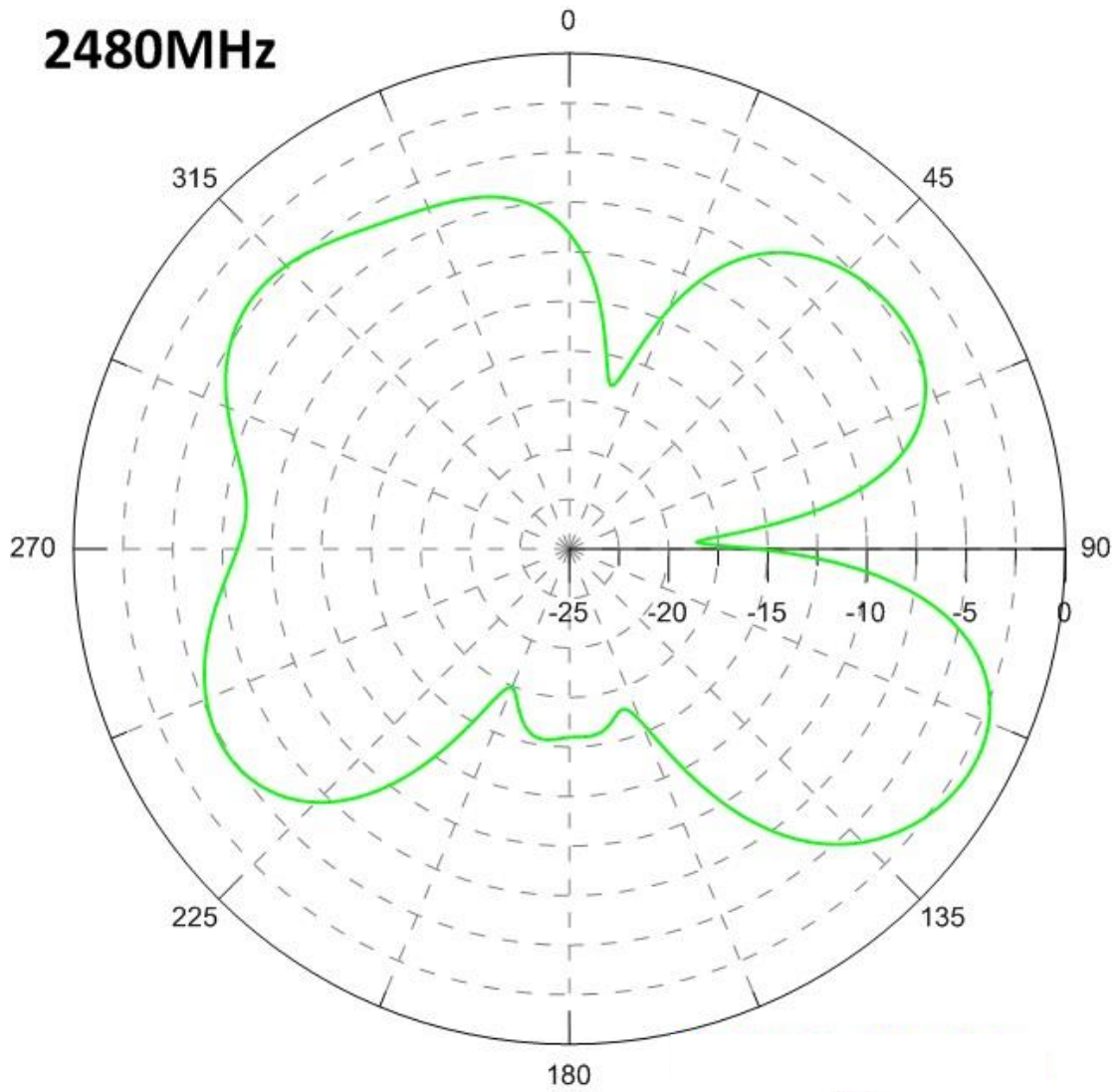

Frequency(MHz) : 2480	Field Type : 2D(XY)
Maximum Gain(dBi) : -7.6	Maximum Direction(degree) : 218
Minimum Gain(dBi) : -16.4	Minimum Direction(degree) : 60

2480MHz

