



RF Test Report

Applicant : Linctronix Ltd.
Product Type : Bluetooth IoT Gateway
Trade Name : LINCTRONIX
Model Number : LBS-3026
Test Specification : FCC 47 CFR PART 15 SUBPART E
ANSI C63.10:2013
Receive Date : Feb. 03, 2016
Test Period : Apr. 14 ~ Apr. 28, 2016
Issue Date : Sep. 20, 2017

Issue by

A Test Lab Techno Corp.
No. 140-1, Changan Street, Bade District,
Taoyuan City 33465, Taiwan (R.O.C)
Tel : +86-3-2710188 / Fax : +86-3-2710190



Taiwan Accreditation Foundation accreditation number: 1330
Test Firm MRA designation number: TW0010

Note: This report shall not be reproduced except in full, without the written approval of A Test Lab Techno Corp. This document may be altered or revised by A Test Lab Techno Corp. personnel only, and shall be noted in the revision section of the document. The client should not use it to claim product endorsement by TAF, or any government agencies. The test results in the report only apply to the tested sample.



Revision History

Rev.	Issue Date	Revisions	Revised By
00	Sep. 20, 2017	Initial Issue	Nina Lin

Verification of Compliance

Issued Date: Sep. 20, 2017

Applicant : Linctronix Ltd.
Product Type : Bluetooth IoT Gateway
Trade Name : LINCTRONIX
Model Number : LBS-3026
FCC ID : 2ALHC-LBS3026
EUT Rated Voltage : DC 5V, 1A
Test Voltage : 120 Vac / 60 Hz
Applicable Standard : FCC 47 CFR PART 15 SUBPART E
ANSI C63.10:2013
Test Result : Complied

Performing Lab. : A Test Lab Techno Corp.
No. 140-1, Changan Street, Bade District,
Taoyuan City 33465, Taiwan (R.O.C)
Tel : +86-3-2710188 / Fax : +86-3-2710190



Taiwan Accreditation Foundation accreditation number: 1330

<http://www.atl-lab.com.tw/e-index.htm>

A Test Lab Techno Corp. tested the above equipment in accordance with the requirements set forth in the above standards. All indications of Pass/Fail in this report are opinions expressed by A Test Lab Techno Corp. based on interpretations and/or observations of test results. Measurement Uncertainties were not taken into account and are published for informational purposes only. The test results show that the equipment tested is capable of demonstrating compliance with the requirements as documented in this report.

Approved By : Fly Lu Reviewed By : Eric Ou Yang
(Manager) (Fly Lu) (Testing Engineer) (Eric Ou Yang)



TABLE OF CONTENTS

1	General Information	5
1.1.	Summary of Test Result.....	5
1.2.	Measurement Uncertainty	5
2	EUT Description	6
3	Test Methodology.....	8
3.1.	Mode of Operation	8
3.2.	EUT Exercise Software.....	13
3.3.	Configuration of Test System Details	14
3.4.	Test Site Environment.....	14
4	Test Results.....	15
4.1.	AC Power Conducted Emission Measurement	15
4.2.	Test Procedure	16
4.3.	Transmitter Radiated Emissions Measurement.....	19
4.4.	Maximum Conducted Output Power Measurement.....	121
4.5.	26dB RF Bandwidth Measurement	127
4.6.	6dB RF Bandwidth Measurement	139
4.7.	Peak Power Spectral Density Measurement	144
4.8.	Frequency Stability Measurement.....	161
4.9.	Antenna Requirement.....	164



1 General Information

1.1. Summary of Test Result

Standard	Item	Result	Remark
FCC			
15.407(b)(6) 15.207	AC Power Conducted Emission	PASS	---
15.407(b) 15.205 / 15.209	Transmitter Radiated Emissions	PASS	---
15.407(a)	Maximum Conducted Output Power	PASS	---
15.407(a)	26dB RF Bandwidth	Reference	---
15.407(e)	6dB RF Bandwidth	PASS	----
15.407(a)	Peak Power Spectral Density	PASS	---
15.407(g)	Frequency Stability	PASS	---
15.407(a) 15.203	Antenna Requirement	PASS	---

The test results of this report relate only to the tested sample(s) identified in this report. Manufacturer or whom it may concern should recognize the pass or fail of the test result.

1.2. Measurement Uncertainty

Test Item	Frequency Range	Uncertainty (dB)
Conducted Emission	9kHz ~ 150KHz	2.7
	150kHz ~ 30MHz	2.7
Radiated Emission	9kHz ~ 30MHz	1.7
	30MHz ~ 1000MHz	5.7
	1000MHz ~ 18000MHz	5.5
	18000MHz ~ 26500MHz	4.8
	26500MHz ~ 40000MHz	4.8
Conducted Output Power		+0.27 dB / -0.28 dB
RF Bandwidth		4.96%
Power Spectral Density		+0.71 dB / -0.77 dB
Frequency Stability		+ 2.212 x 10 ⁻⁷ % / - 2.170 x 10 ⁻⁷ %
Duty Cycle		1.06%
Time Occupancy		1.40%



2 EUT Description

Applicant	Linctronix Ltd. 9F-1, No.66, Chongqing Rd., Banqiao Dist.,New Taipei City 22063, Taiwan			
Manufacturer	Linctronix Ltd. 9F-1, No.66, Chongqing Rd., Banqiao Dist.,New Taipei City 22063, Taiwan			
Product Type	Bluetooth IoT Gateway			
Trade Name	LINCTRONIX			
Model Number	LBS-3026			
FCC ID	2ALHC-LBS3026			
Operate Frequency	Frequency Band		Frequency Range (MHz)	Number of Channels
	IEEE 802.11a	U-NII Band I	5180 – 5240	4
		U-NII Band II-A	5260 – 5320	4
		U-NII Band II-C	5500 – 5700	11
		U-NII Band III	5745 – 5825	5
	IEEE 802.11n 5GHz 20 MHz	U-NII Band I	5180 – 5240	4
		U-NII Band II-A	5260 – 5320	4
		U-NII Band II-C	5500 – 5700	11
		U-NII Band III	5745 – 5825	5
	IEEE 802.11n 5GHz 40 MHz	U-NII Band I	5190 – 5230	2
		U-NII Band II-A	5270 – 5310	2
		U-NII Band II-C	5510 – 5670	5
U-NII Band III		5755 – 5795	2	
Modulation Type	OFDM			
Equipment Type	Client without radar detection			
Antenna information	Type		Max. Gain (dBi)	
	FPC Antenna		2.5	
Antenna Delivery	Reference section 3.1			
Frequency stability specification	± 20 ppm			
Operate Temp. Range	-10 ~ +55 °C			



Frequency Band		RF Output Power (W)
IEEE 802.11a	U-NII Band I	0.017
	U-NII Band II-A	0.015
	U-NII Band II-C	0.013
	U-NII Band III	0.012
IEEE 802.11n 5GHz 20 MHz	U-NII Band I	0.017
	U-NII Band II-A	0.015
	U-NII Band II-C	0.014
	U-NII Band III	0.012
IEEE 802.11n 5GHz 40 MHz	U-NII Band I	0.017
	U-NII Band II-A	0.016
	U-NII Band II-C	0.013
	U-NII Band III	0.012

3 Test Methodology

3.1. Mode of Operation

Decision of Test ATL has verified the construction and function in typical operation. All the test modes were carried out with the EUT in normal operation, which was shown in this test report and defined as:

Test Mode
Mode 1: Transmit mode
Mode 2: IEEE 802.11a Continuous TX mode
Mode 3: IEEE 802.11n 5GHz 20MHz Continuous TX mode
Mode 4: IEEE 802.11n 5GHz 40MHz Continuous TX mode

Software used to control the EUT for staying in continuous transmitting mode was programmed.

After verification, all tests were carried out with the worst case test modes as shown below except radiated spurious emission below 1GHz and power line conducted emissions below 30MHz, which worst case was in normal link mode only.

Equipment Type	
Outdoor access point	---
Indoor access point	---
Fixed point-to-point access points	---
Client devices	V

Test Mode	Antenna Delivery	Data Rate	Band	Test Channel
Mode 2	1TX	6	U-NII Band I	36, 40, 48
			U-NII Band II-A	52, 56, 64
			U-NII Band II-C	100, 112, 140
			U-NII Band III	149, 157, 165
Mode 3	1TX	6.5	U-NII Band I	36, 40, 48
			U-NII Band II-A	52, 56, 64
			U-NII Band II-C	100, 112, 140
			U-NII Band III	149, 157, 165
Mode 4	1TX	13.5	U-NII Band I	38, 46
			U-NII Band II-A	54, 62
			U-NII Band II-C	102, 110, 134
			U-NII Band III	151, 159



Duty cycle

Test Mode	Frequency (MHz)	on time (ms)	on+off time (ms)	Duty cycle	Duty Factor (dB)	1/T Minimum VBW (kHz)
Mode 2	5180.0	2.090	2.360	0.886	0.528	0.478
Mode 3	5180.0	1.940	2.220	0.874	0.586	0.515
Mode 4	5190.0	0.960	1.240	0.774	1.112	1.042

Duty Cycle Graphs

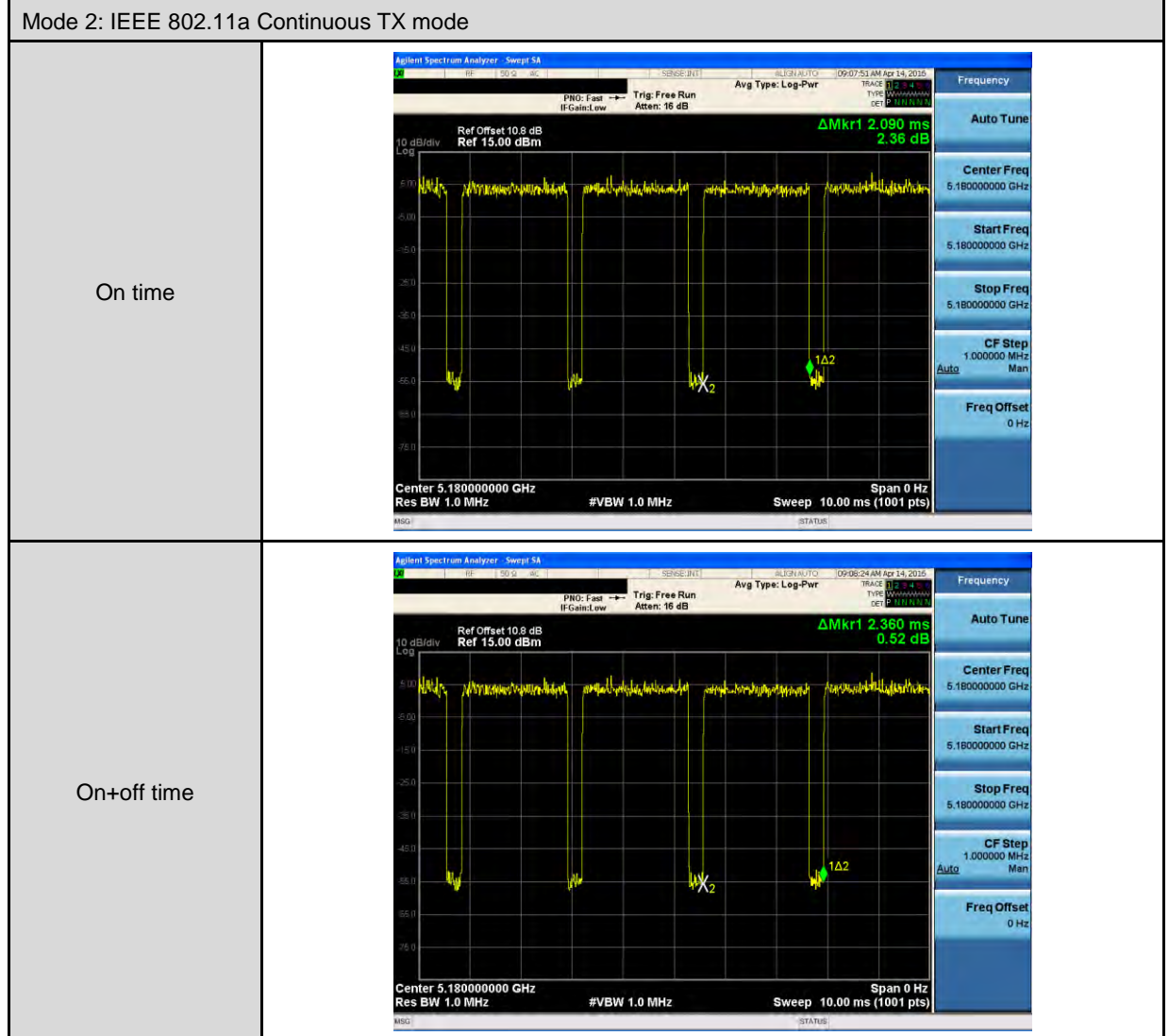

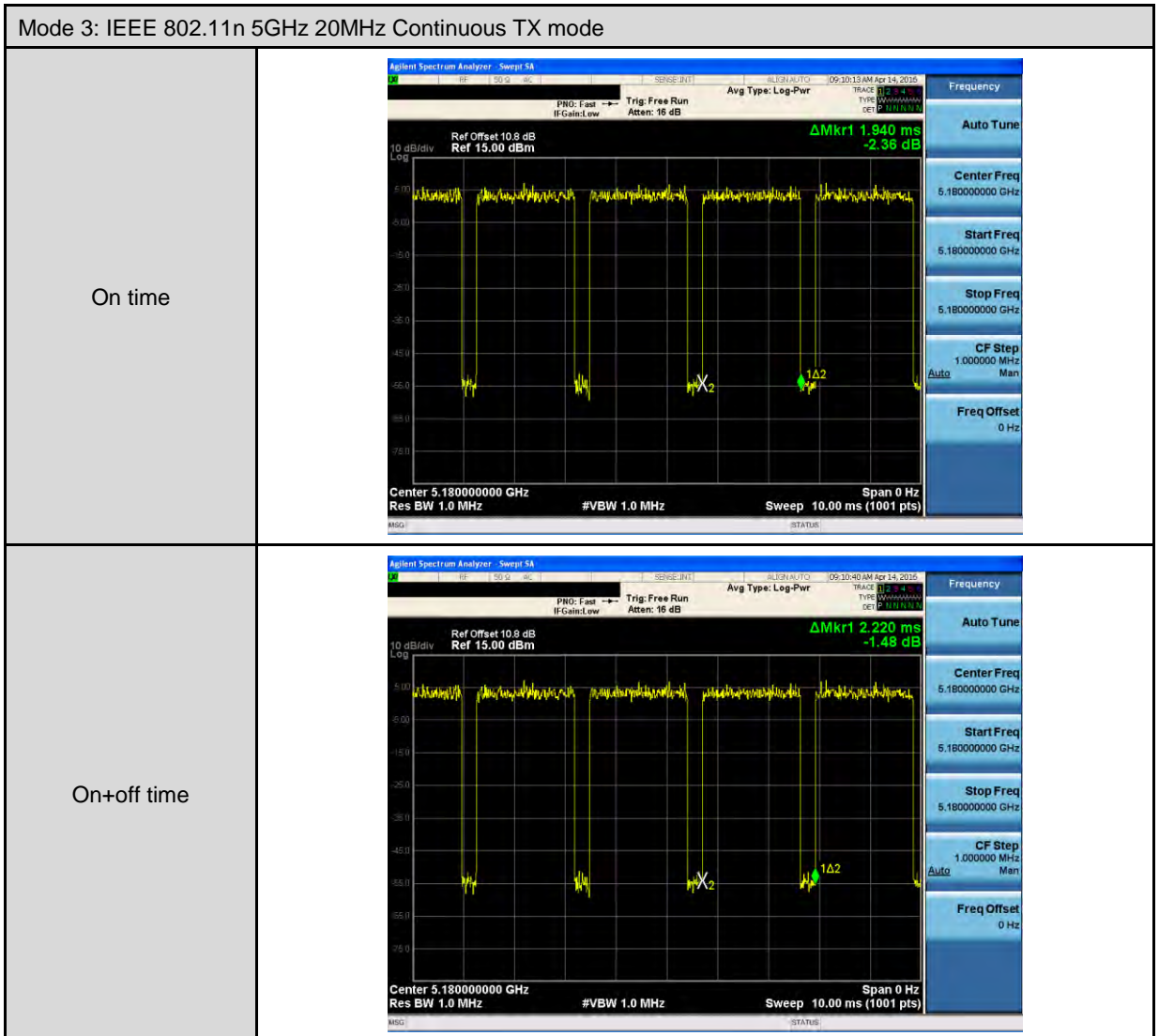

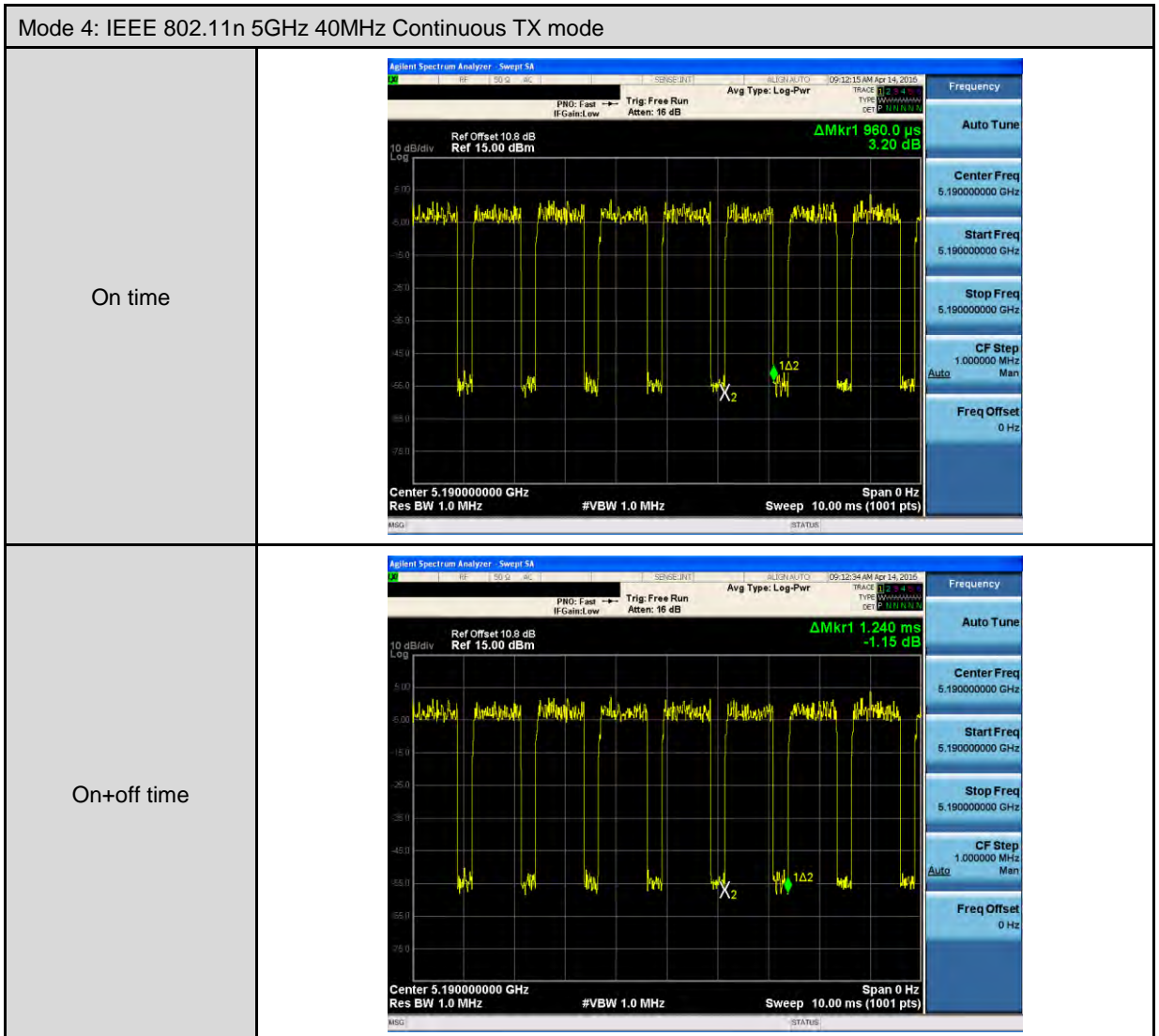



3.2. EUT Exercise Software

The EUT is operated in the engineering mode to fix the TX frequency for the purposes of measurement. According to its specifications, the EUT must comply with the requirements of Section 15.407 under the FCC Rules Part 15 Subpart E.

1.	Setup the EUT shown on 3.3.
2.	Turn on the power of all equipment.
3.	EUT run test program.

Measurement Software	
1	EZ-EMC Ver. ATL-03A1-1
2	EZ-EMC Ver ATL-ITC-3A1-1

3.3. Configuration of Test System Details

Conducted Emission

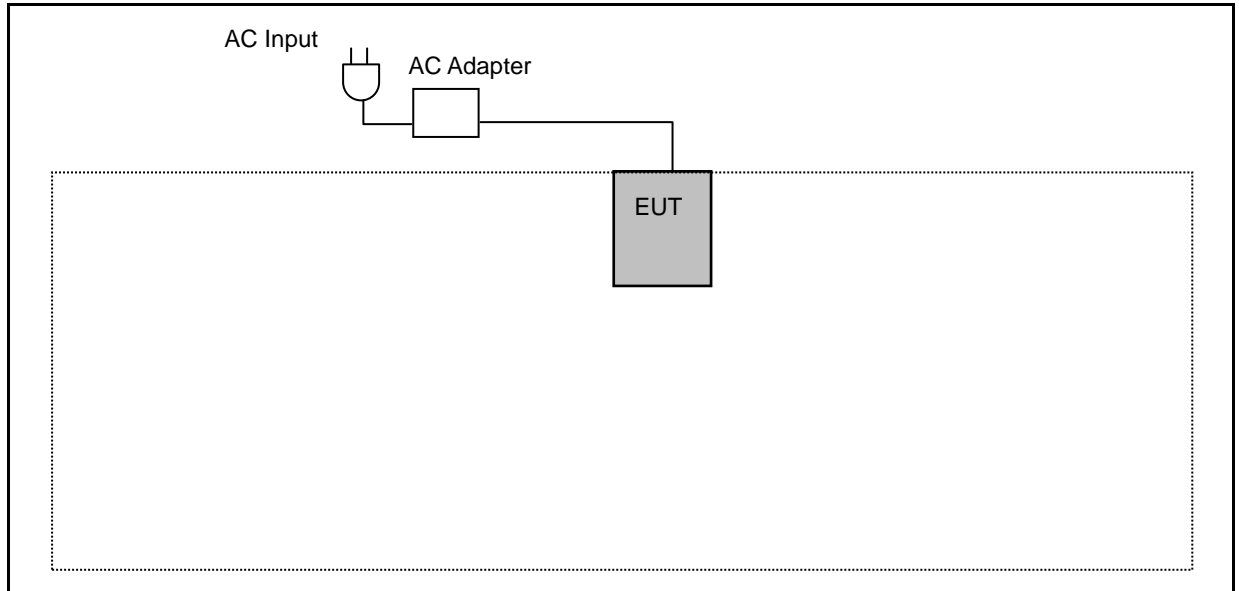

Radiated Emission

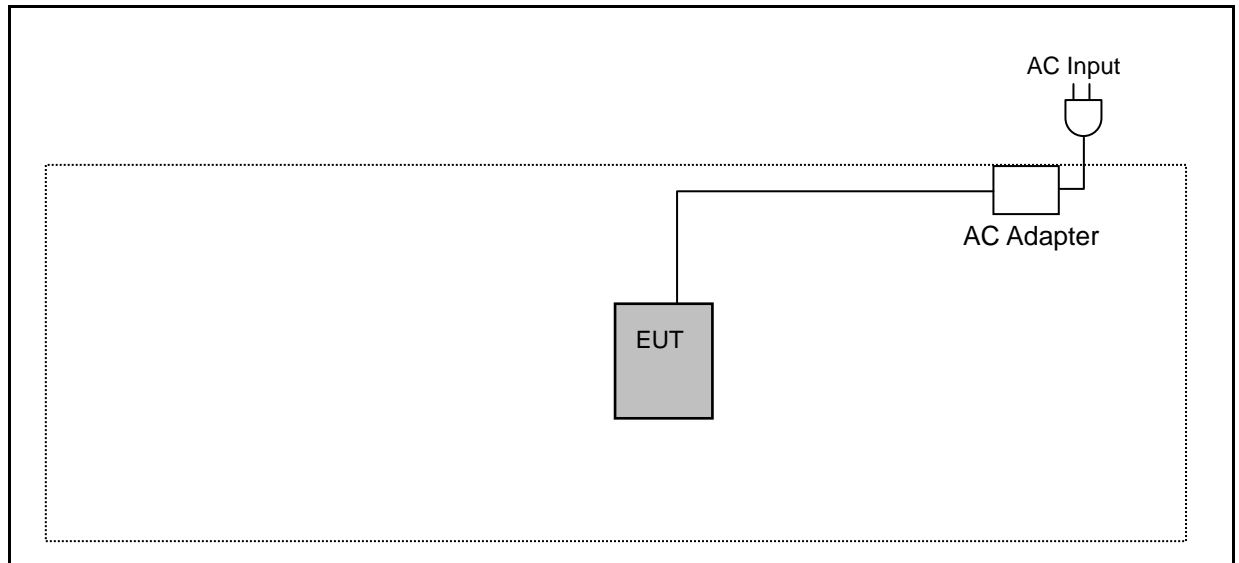

3.4. Test Site Environment

Items	Required (IEC 60068-1)	Actual
Temperature (°C)	15-35	26
Humidity (%RH)	25-75	60
Barometric pressure (mbar)	860-1060	950

4 Test Results

4.1. AC Power Conducted Emission Measurement

■ Limit

Frequency (MHz)	Quasi-peak	Average
0.15 - 0.5	66 to 56	56 to 46
0.50 - 5.0	56	46
5.0 - 30.0	60	50

■ Test Instruments

Describe	Manufacturer	Model Number	Serial Number	Cal. Date	Remark
Test Receiver	R&S	ESCI	100367	06/25/2015	1 year
LISN	R&S	ENV216	101040	03/15/2016	1 year
LISN	R&S	ENV216	101041	03/07/2016	1 year
RF Cable	Woken	00100D1380194M	TE-02-02	06/26/2015	1 year
Test Site	ATL	TE02	TE02	N.C.R.	-----

Note: N.C.R. = No Calibration Request.

■ Test Setup

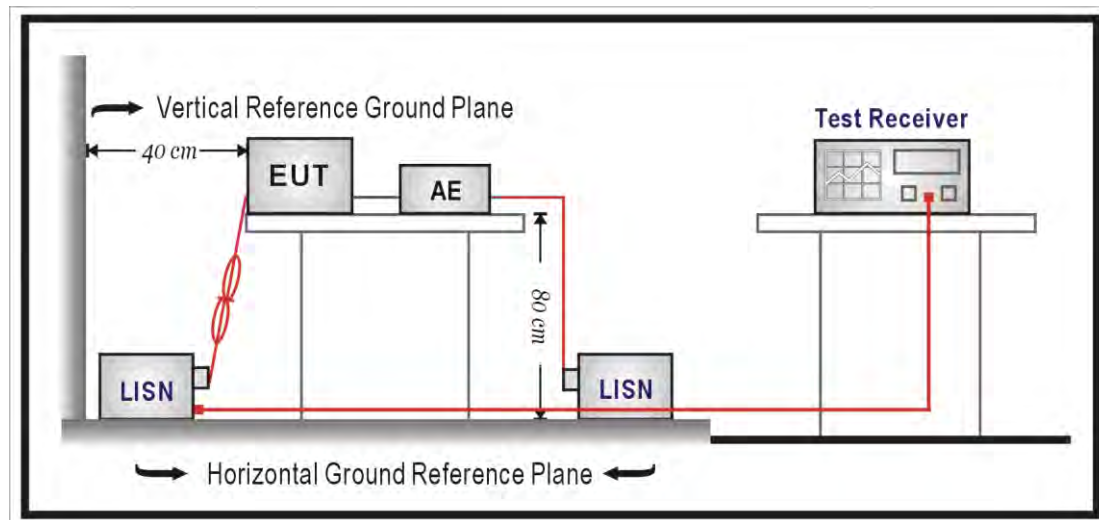

4.2. Test Procedure

The EUT and simulators are connected to the main power through a line impedance stabilization network (L.I.S.N.). This provides a $50\Omega//50\mu\text{H}$ coupling impedance for the measuring equipment. The peripheral devices are also connected to the main power through a LISN that provides a $50\Omega//50\mu\text{H}$ coupling impedance with 50ohm termination.

Tabletop device shall be placed on a non-conducting platform, of nominal size 1 m by 1.5 m, raised 80 cm above the reference ground plane. The wall of screened room shall be located 40cm to the rear of the EUT. Other surfaces of tabletop or floor standing EUT shall be at least 80cm from any other ground conducting surface including one or more LISNs. For floor-standing device shall be placed under the EUT with a 12mm insulating material.

Conducted emissions were investigated over the frequency range from 0.15 MHz to 30 MHz using a resolution bandwidth of 9 kHz. The equipment under test (EUT) shall be meet the limits in section 4.1, as applicable, including the average limit and the quasi-peak limit when using respectively, an average detector and quasi-peak detector measured in accordance with the methods described of related standard. When all of peak value were complied with quasi-peak and average limit from 150kHz to 30MHz then quasi-peak and average measurement was unnecessary.

The AMN shall be placed 0,8 m from the boundary of the unit under test and bonded to a ground reference plane for AMNs mounted on top of the ground reference plane. This distance is between the closest points of the AMN and the EUT. All other units of the EUT and associated equipment shall be at least 0,8 m from the AMN. If the mains power cable is longer than 1m then the cable shall be folded back and forth at the centre of the lead to form a bundle no longer than 0.4m. All of interconnecting cables that hang closer than 40cm to the ground plane shall be folded back and forth in the center forming a bundle 30 cm to 40 cm long. All of EUT and AE shall be separate place more than 0.1m. All 50Ω ports of the LISN shall be resistively terminated into 50Ω loads when not connected to the measuring instrument.

If the reading of the measuring receiver shows fluctuations close to the limit, the reading shall be observed for at least 15 s at each measurement frequency; the higher reading shall be recorded with the exception of any brief isolated high reading which shall be ignored.



■ Test Result

Standard:	FCC Part 15.407	Line:	L1
Test item:	Conducted Emission	Power:	AC 120V/60Hz
Test Mode:	Mode 1	Temp.(°C)/Hum.(%RH):	26(°C)/60%RH
		Date:	04/28/2016
Description:			

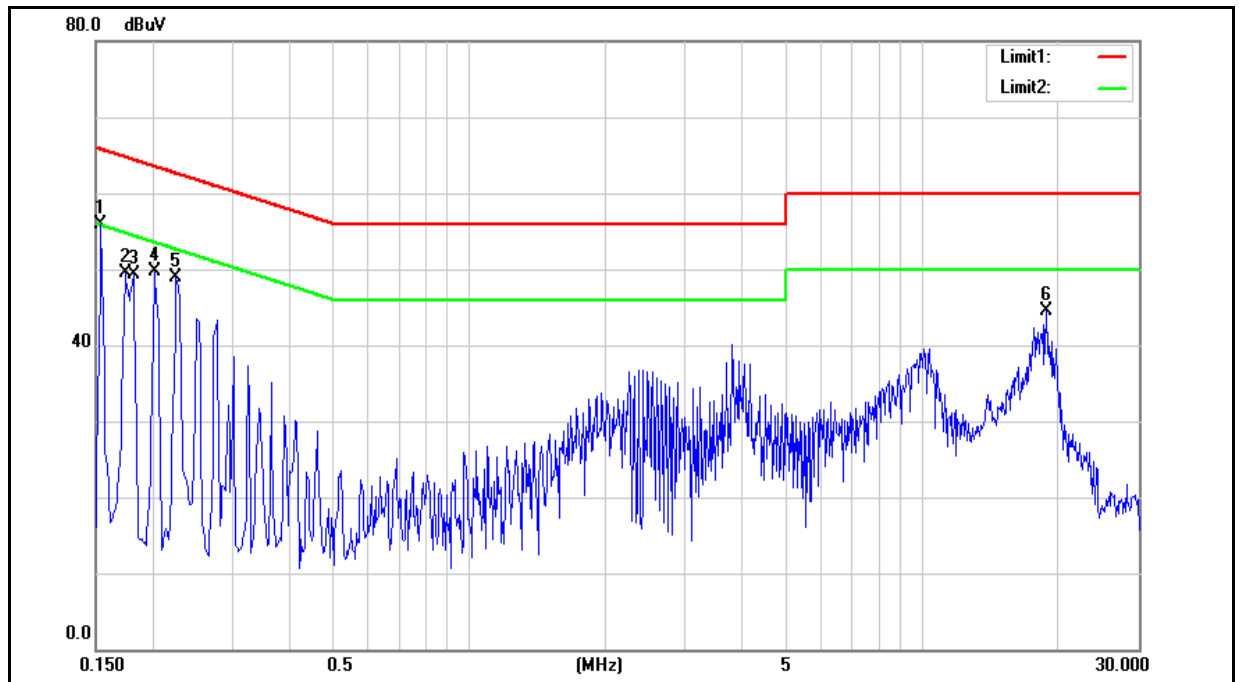

No.	Frequency (MHz)	QP reading (dBuV)	AVG reading (dBuV)	Correction factor (dB)	QP result (dBuV)	AVG result (dBuV)	QP limit (dBuV)	AVG limit (dBuV)	QP margin (dB)	AVG margin (dB)	Remark
1	0.1540	40.33	12.09	9.60	49.93	21.69	65.78	55.78	-15.85	-34.09	Pass
2	0.1740	39.93	26.96	9.60	49.53	36.56	64.77	54.77	-15.24	-18.21	Pass
3	0.1820	36.22	11.99	9.59	45.81	21.58	64.39	54.39	-18.58	-32.81	Pass
4	0.2020	33.97	6.71	9.59	43.56	16.30	63.53	53.53	-19.97	-37.23	Pass
5	0.2260	32.03	14.98	9.59	41.62	24.57	62.60	52.60	-20.98	-28.03	Pass
6	18.7780	29.54	17.72	9.95	39.49	27.67	60.00	50.00	-20.51	-22.33	Pass

Note: 1. Result = Correction factor + Reading

2. Correction factor = Antenna Factor + Cable loss – Pre-Amplifier gain.



Standard:	FCC Part 15.407	Line:	N
Test item:	Conducted Emission	Power:	AC 120V/60Hz
Test Mode:	Mode 1	Temp.(°C)/Hum.(%RH):	26(°C)/60%RH
		Date:	04/28/2016
Description:			

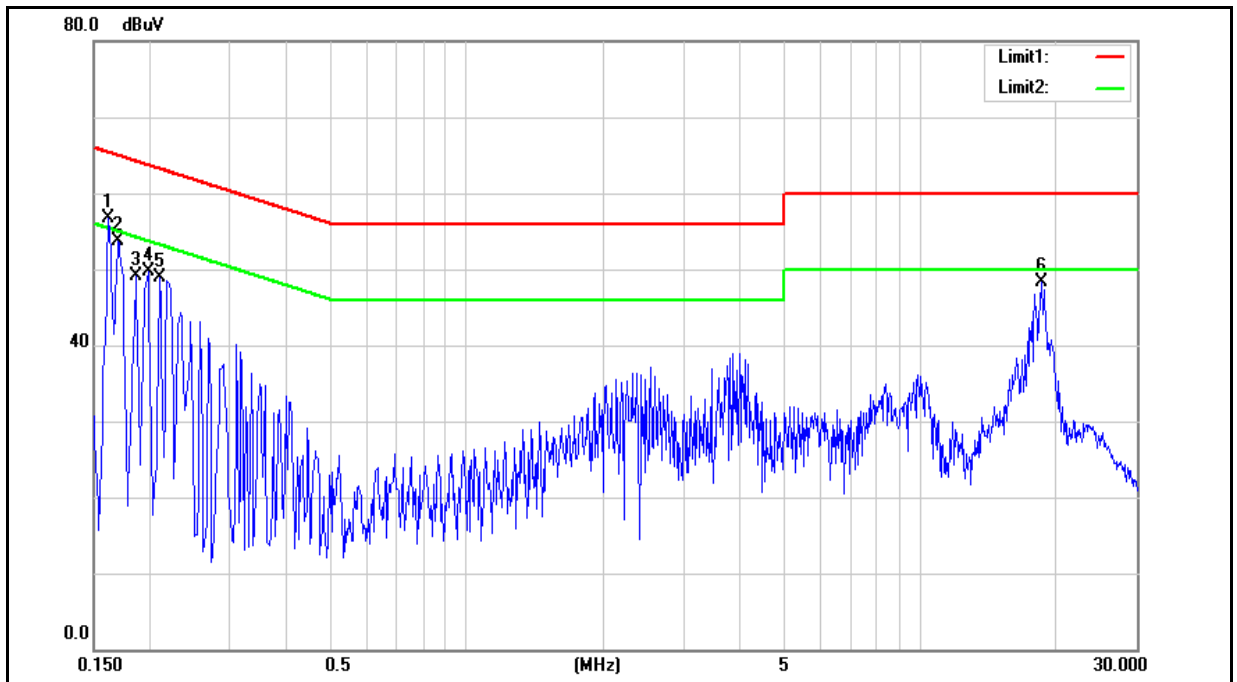

No.	Frequency (MHz)	QP reading (dBuV)	AVG reading (dBuV)	Correction factor (dB)	QP result (dBuV)	AVG result (dBuV)	QP limit (dBuV)	AVG limit (dBuV)	QP margin (dB)	AVG margin (dB)	Remark
1	0.1620	39.16	11.47	9.59	48.75	21.06	65.36	55.36	-16.61	-34.30	Pass
2	0.1700	39.39	24.23	9.59	48.98	33.82	64.96	54.96	-15.98	-21.14	Pass
3	0.1860	35.95	8.56	9.58	45.53	18.14	64.21	54.21	-18.68	-36.07	Pass
4	0.1980	34.00	6.65	9.58	43.58	16.23	63.69	53.69	-20.11	-37.46	Pass
5	0.2100	32.84	5.76	9.58	42.42	15.34	63.21	53.21	-20.79	-37.87	Pass
6	18.5660	30.96	16.46	10.08	41.04	26.54	60.00	50.00	-18.96	-23.46	Pass

Note: 1. Result = Correction factor + Reading
 2. Correction factor = Antenna Factor + Cable loss – Pre-Amplifier gain.

4.3. Transmitter Radiated Emissions Measurement

■ Limit

(1) Undesirable emission limits. Except as shown in paragraph (b)(7) of this section, the maximum emissions outside of the frequency bands of operation shall be attenuated in accordance with the following limits:

(a) For transmitters operating in the 5.15-5.25 GHz band: All emissions outside of the 5.15-5.35 GHz band shall not exceed an e.i.r.p. of -27 dBm/MHz.

(b) For transmitters operating in the 5.25-5.35 GHz band: All emissions outside of the 5.15-5.35 GHz band shall not exceed an e.i.r.p. of -27 dBm/MHz.

(c) For transmitters operating in the 5.47-5.725 GHz band: All emissions outside of the 5.47-5.725 GHz band shall not exceed an e.i.r.p. of -27 dBm/MHz.

(d) For transmitters operating in the 5.725-5.85 GHz band:

(i) All emissions shall be limited to a level of -27 dBm/MHz at 75 MHz or more above or below the band edge increasing linearly to 10 dBm/MHz at 25 MHz above or below the band edge, and from 25 MHz above or below the band edge increasing linearly to a level of 15.6 dBm/MHz at 5 MHz above or below the band edge, and from 5 MHz above or below the band edge increasing linearly to a level of 27 dBm/MHz at the band edge.

(2) Limits of Radiated Emission Measurement

Emissions radiated outside of the specified bands, shall be according to the general radiated limits in 15.209 as following:

Frequency Range (MHz)	Field Strength (microvolts/meter)	Measurement Distance (meters)
0.009 ~ 0.490	2400/F(kHz)	300
0.490 ~ 1.705	24000/F(kHz)	30
1.705 ~ 30.0	30	30
30 ~ 88	10	3
88 ~ 216	150	3
216 ~ 960	200	3
Above 960	500	3

- Note:
1. The lower limit shall apply at the transition frequencies.
 2. Emission level (dBuV/m) = 20 log Emission level (uV/m).
 3. As shown in 15.35(b), for frequencies above 1000MHz, the field strength limits are based on average detector, however, the peak field strength of any emission shall not exceed the maximum permitted average limits, specified above by more than 20dB under any condition of modulation.

■ Test Instruments

3 Meter Chamber					
Equipment	Manufacturer	Model Number	Serial Number	Cal. Date	Remark
RF Pre-selector	Agilent	N9039A	MY46520256	01/08/2016	1 year
Spectrum Analyzer	Agilent	E4446A	MY46180578	01/08/2016	1 year
Pre Amplifier	Agilent	8449B	3008A02237	10/07/2015	1 year
Pre Amplifier	Agilent	8447D	2944A11119	01/11/2016	1 year
Broadband Antenna	Schwarzbeck	VULB9168	416	09/25/2015	1 year
Horn Antenna (1~18GHz)	SCHWARZBECK MESS-ELEKTRONIK	BBHA9120D	9120D-550	06/12/2015	1 year
Horn Antenna (18~40GHz)	ETS	3116	86467	09/01/2015	1 year
Loop Antenna	COM-POWER CORPORATION	AL-130	121014	02/01/2016	1 year
Microwave Cable	EMCI	EMC102-KM-KM-14000	151001	02/23/2016	1 year
Microwave Cable	EMCI	EMC-104-SM-SM-14000	140202	02/23/2016	1 year
Microwave Cable	EMCI	EMC104-SM-SM-600	140301	02/23/2016	1 year
Test Site	ATL	TE01	888001	08/27/2015	1 year

Note: N.C.R. = No Calibration Request.

■ Setup

9kHz ~ 30MHz

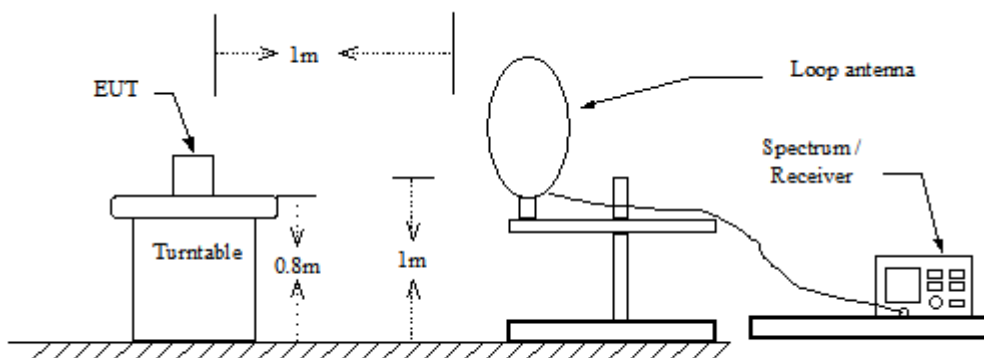

30MHz ~ 1GHz

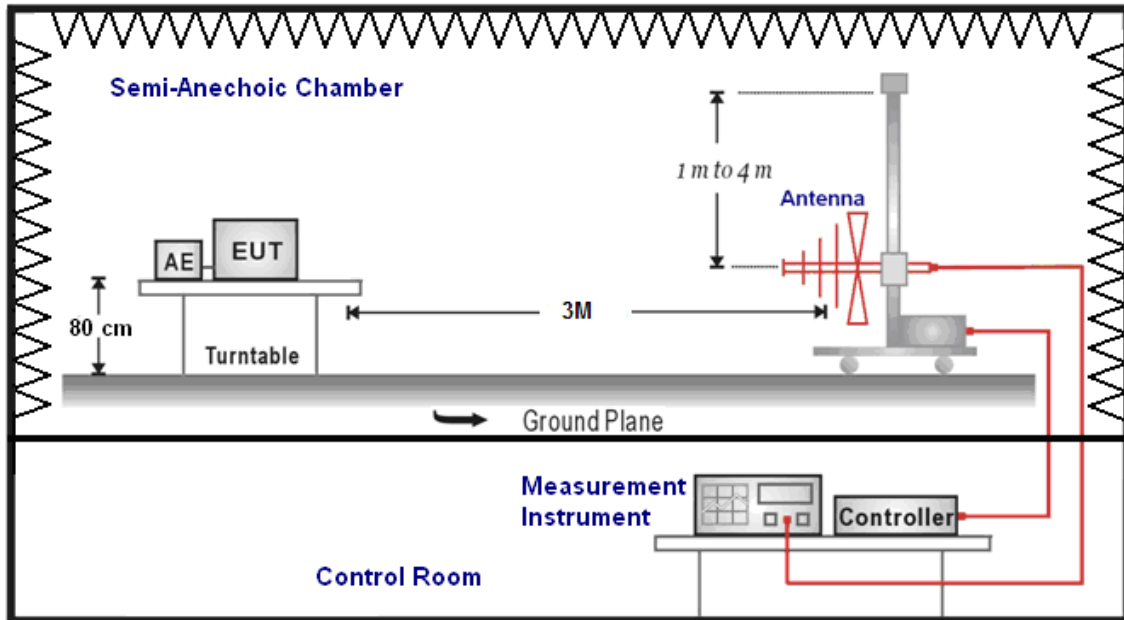

Above 1GHz

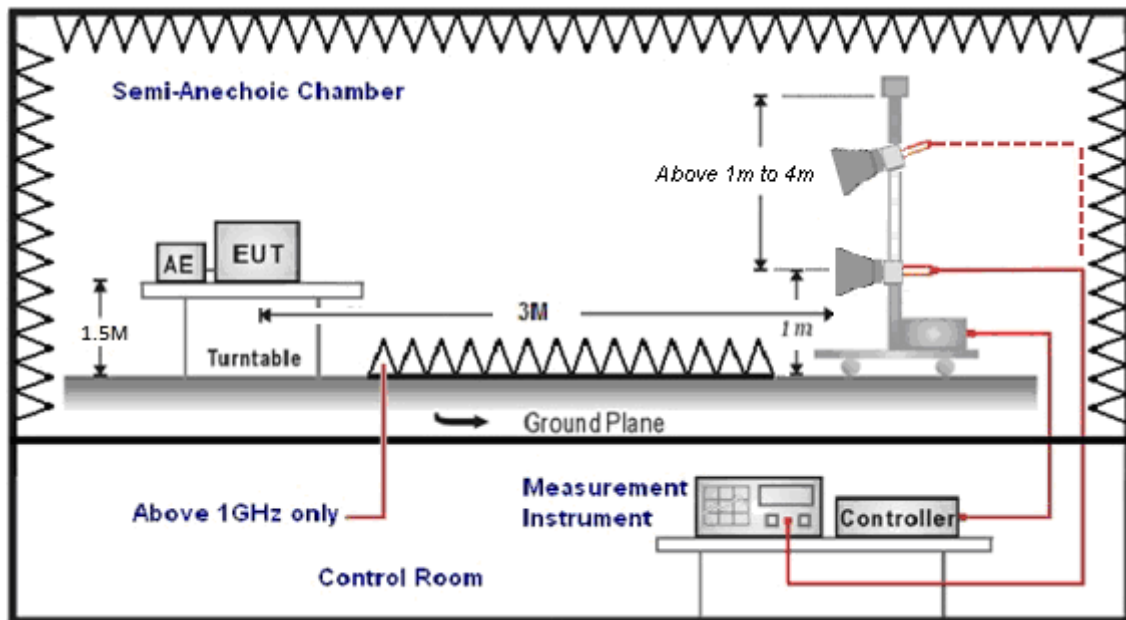

■ Test Procedure

Final radiation measurements were made on a three-meter, Semi Anechoic Chamber. The EUT system was placed on a nonconductive turntable which is 0.8 or 1.5 meters height (below 1GHz use 0.8m turntable / above 1GHz use 1.5m turntable), top surface 1.0 x 1.5 meter. The spectrum was examined from 250 MHz to 2.5 GHz in order to cover the whole spectrum below 10th harmonic which could generate from the EUT. During the test, EUT was set to transmit continuously & Measurements spectrum range from 9 kHz to 40 GHz is investigated.

For measurements below 1 GHz the resolution bandwidth is set to 100 kHz for peak detection measurements or 120 kHz for quasi-peak detection measurements. Peak detection is used unless otherwise noted as quasi-peak.

For restricted measurements above 1 GHz the resolution bandwidth is set to 1 MHz, and then the video bandwidth is set to 3 MHz for peak measurements and 10 Hz for average measurements when Duty cycle > 0.98 / 1/T for average measurements when Duty cycle < 0.98.

For out of band measurements above 1 GHz the resolution bandwidth is set to 1 MHz, and then the video bandwidth is set to 3 MHz for peak measurements.

A nonconductive material surrounded the EUT to supporting the EUT for standing on three orthogonal planes. At each condition, the EUT was rotated 360 degrees, and the antenna was raised and lowered from one to four meters to find the maximum emission levels. Measurements were taken using both horizontal and vertical antenna polarization.

SCHWARZBECK MESS-ELEKTRONIK Trilog-Broadband Antenna at 3 Meter and the ETS-Lindgren Double-Ridged Waveguide Horn antenna Schwarzbeck Mess-Elektronik Broadband Horn Antenna was used in frequencies 1 – 40 GHz at a distance of 3 meter. The antenna at an angle toward the source of the emission. All test results were extrapolated to equivalent signal at 3 meters utilizing an inverse linear distance extrapolation Factor (20dB/decade).

For testing above 1GHz, the emission level of the EUT in peak mode was 20dB lower than average limit (that means the emission level in peak mode also complies with the limit in average mode), then testing will be stopped and peak values of EUT will be reported, otherwise, the emissions will be measured in average mode again and reported.

Appropriate preamplifiers were used for improving sensitivity and precautions were taken to avoid overloading or desensitizing the spectrum analyzer. No post – detector video filters were used in the test.

The spectrum analyzer's 6 dB bandwidth was set to 1 MHz, and the analyzer was operated in the peak detection mode, for frequencies both below and up 1 GHz. The average levels were obtained by subtracting the duty cycle correction factor from the peak readings.

The following procedures were used to convert the emission levels measured in decibels referenced to 1 microvolt (dBuV) into field intensity in micro volts per meter (uV/m).

The actual field intensity in decibels referenced to 1 microvolt in to field intensity in micro volts per meter (dBuV/m).



The actual field intensity in referenced to 1 microvolt per meter (dBuV/m) is determined by algebraically adding the measured reading in dBuV, the antenna factor (dB), and cable loss (dB) and Subtracting the gain of preamplifier (dB) is auto calculate in spectrum analyzer.

$$(1) \text{ Amplitude (dBuV/m) = FI (dBuV) +AF (dBuV) +CL (dBuV)-Gain (dB)}$$

FI= Reading of the field intensity.

AF= Antenna factor.

CL= Cable loss.

P.S Amplitude is auto calculate in spectrum analyzer.

$$(2) \text{ Actual Amplitude (dBuV/m) = Amplitude (dBuV)-Dis(dB)}$$

The FCC specified emission limits were calculated according the EUT operating frequency and by following linear interpolation equations:

(a) For fundamental frequency : Transmitter Output < +30dBm

(b) For spurious frequency : Spurious emission limits = fundamental emission limit /10

Measuring Instruments and setting

The following table is the setting of spectrum analyzer and receiver.

Spectrum Parameter	Setting
Attenuation	Auto
Start Frequency	1000MHz
Stop Frequency	40GHz
RBW/VBW(Emission in restricted band)	1MHz / 3MHz for Peak 1MHz / (1/T) for Average
RBW/VBW(Emission in non-restricted band)	1MHz / 3MHz for Peak



■ Test Result

Below 1GHz

Standard:		FCC Part 15.407		Test Distance:		3m	
Test item:		Harmonic		Power:		AC 120V/60Hz	
Test Mode:		Mode 1		Temp.(°C)/Hum.(%RH):		26(°C)/60%RH	
				Date:		04/26/2016	
Frequency (MHz)	Reading (dBuV)	Correct Factor (dB/m)	Result (dBuV/m)	Limit (dBuV/m)	Margin (dB)	Remark	Ant.Polar. H / V
168.0000	40.83	-5.40	35.43	43.50	-8.07	QP	H
264.0000	38.26	-4.79	33.47	46.00	-12.53	QP	H
333.0000	35.97	-2.91	33.06	46.00	-12.94	QP	H
599.5000	28.16	2.91	31.07	46.00	-14.93	QP	H
678.5000	26.35	4.33	30.68	46.00	-15.32	QP	H
875.5000	25.93	8.08	34.01	46.00	-11.99	QP	H
168.0000	38.52	-5.40	33.12	43.50	-10.38	QP	V
200.0000	37.44	-7.82	29.62	43.50	-13.88	QP	V
332.0000	34.04	-2.93	31.11	46.00	-14.89	QP	V
399.5000	34.48	-1.71	32.77	46.00	-13.23	QP	V
600.0000	39.28	2.92	42.20	46.00	-3.80	QP	V
873.0000	29.07	8.03	37.10	46.00	-8.90	QP	V

Note:1.Result (dBuV/m) = Correct Factor (dB/m) + Reading(dBuV).

2.Correction factor (dB/m) = Antenna Factor (dB/m) + Cable loss (dB) – Pre-Amplifier gain (dB).

3. When the peak results are less than average limit, so not need to evaluate the average.



Above 1GHz

Standard:	FCC Part 15.407	Test Distance:	3m
Test item:	Harmonic	Power:	AC 120V/60Hz
Frequency:	5180MHz	Temp.(°C)/Hum.(%RH):	26(°C)/60%RH
Mode:	Mode 2	Date:	04/25/2016
Ant.Polar.:	Horizontal		

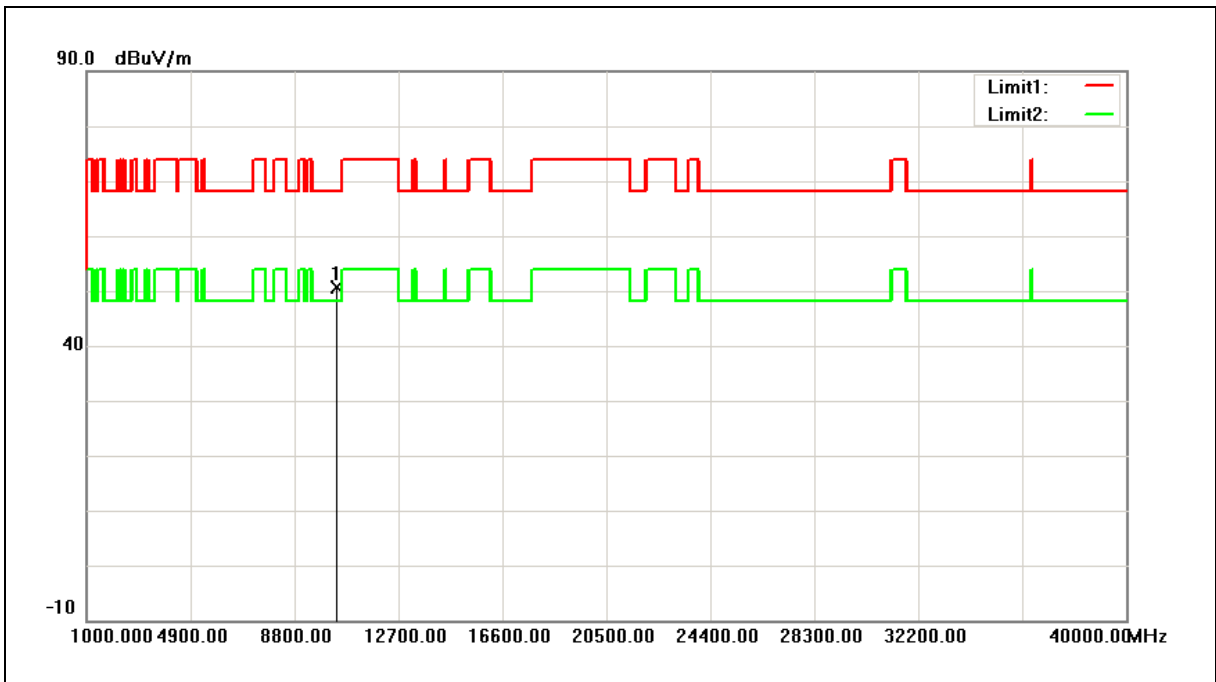

No.	Frequency (MHz)	Reading (dBuV)	Correct Factor (dB/m)	Result (dBuV/m)	Limit (dBuV/m)	Margin (dB)	Remark
1	10360.000	45.45	5.21	50.66	68.20	-17.54	peak

Note:1.Result (dBuV/m) = Correct Factor (dB/m) + Reading(dBuV).

2.Correction factor (dB/m) = Antenna Factor (dB/m) + Cable loss (dB) – Pre-Amplifier gain (dB).

3. When the peak results are less than average limit, so not need to evaluate the average.



Standard:	FCC Part 15.407	Test Distance:	3m
Test item:	Harmonic	Power:	AC 120V/60Hz
Frequency:	5180MHz	Temp.(°C)/Hum.(%RH):	26(°C)/60%RH
Mode:	Mode 2	Date:	04/25/2016
Ant.Polar.:	Vertical		

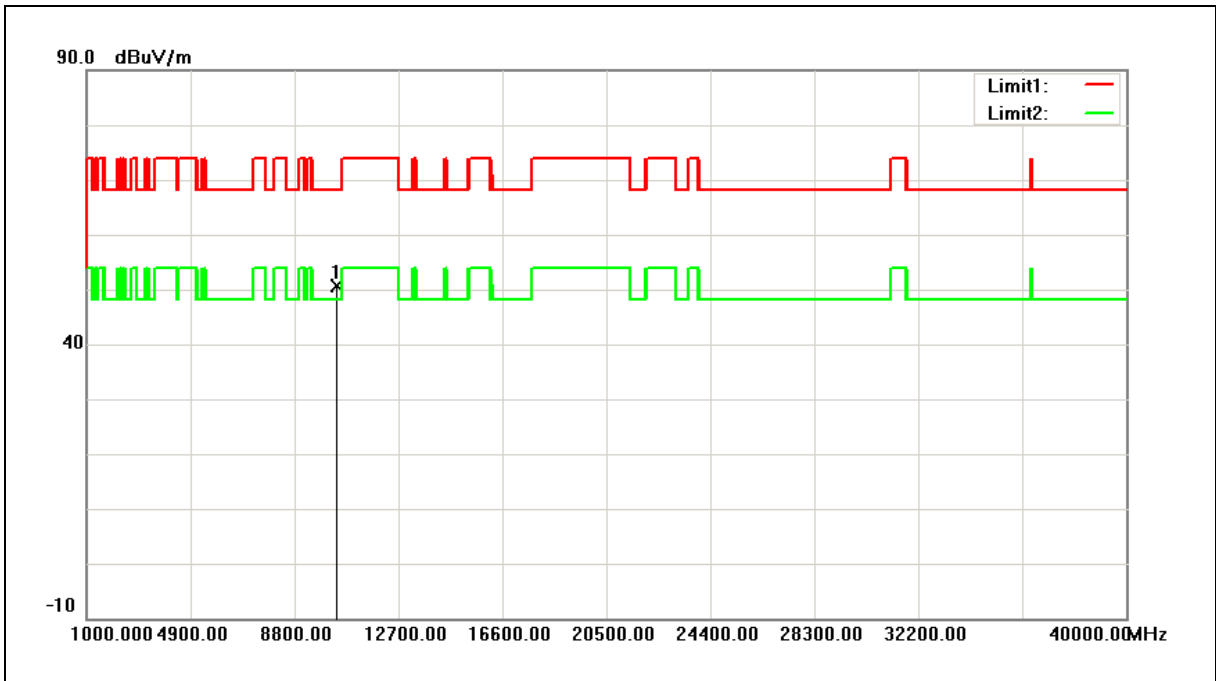

No.	Frequency (MHz)	Reading (dBuV)	Correct Factor (dB/m)	Result (dBuV/m)	Limit (dBuV/m)	Margin (dB)	Remark
1	10360.000	45.52	5.21	50.73	68.20	-17.47	peak

- Note:1.Result (dBuV/m) = Correct Factor (dB/m) + Reading(dBuV).
 2.Correction factor (dB/m) = Antenna Factor (dB/m) + Cable loss (dB) – Pre-Amplifier gain (dB).
 3. When the peak results are less than average limit, so not need to evaluate the average.



Standard:	FCC Part 15.407	Test Distance:	3m
Test item:	Harmonic	Power:	AC 120V/60Hz
Frequency:	5200MHz	Temp.(°C)/Hum. (%RH):	26(°C)/60%RH
Mode:	Mode 2	Date:	04/25/2016
Ant.Polar.:	Horizontal		

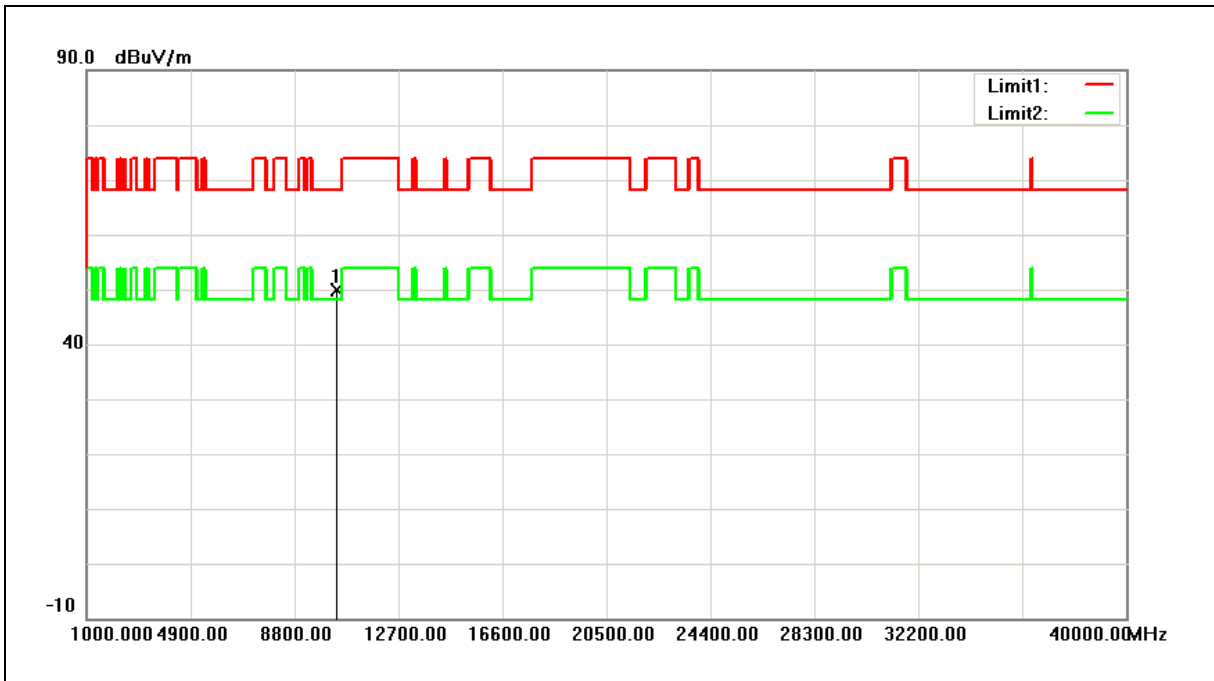

No.	Frequency (MHz)	Reading (dBuV)	Correct Factor (dB/m)	Result (dBuV/m)	Limit (dBuV/m)	Margin (dB)	Remark
1	10400.000	44.55	5.33	49.88	68.20	-18.32	peak

- Note:1.Result (dBuV/m) = Correct Factor (dB/m) + Reading(dBuV).
- 2.Correction factor (dB/m) = Antenna Factor (dB/m) + Cable loss (dB) – Pre-Amplifier gain (dB).
3. When the peak results are less than average limit, so not need to evaluate the average.



Standard:	FCC Part 15.407	Test Distance:	3m
Test item:	Harmonic	Power:	AC 120V/60Hz
Frequency:	5200MHz	Temp.(°C)/Hum.(%RH):	26(°C)/60%RH
Mode:	Mode 2	Date:	04/25/2016
Ant.Polar.:	Vertical		

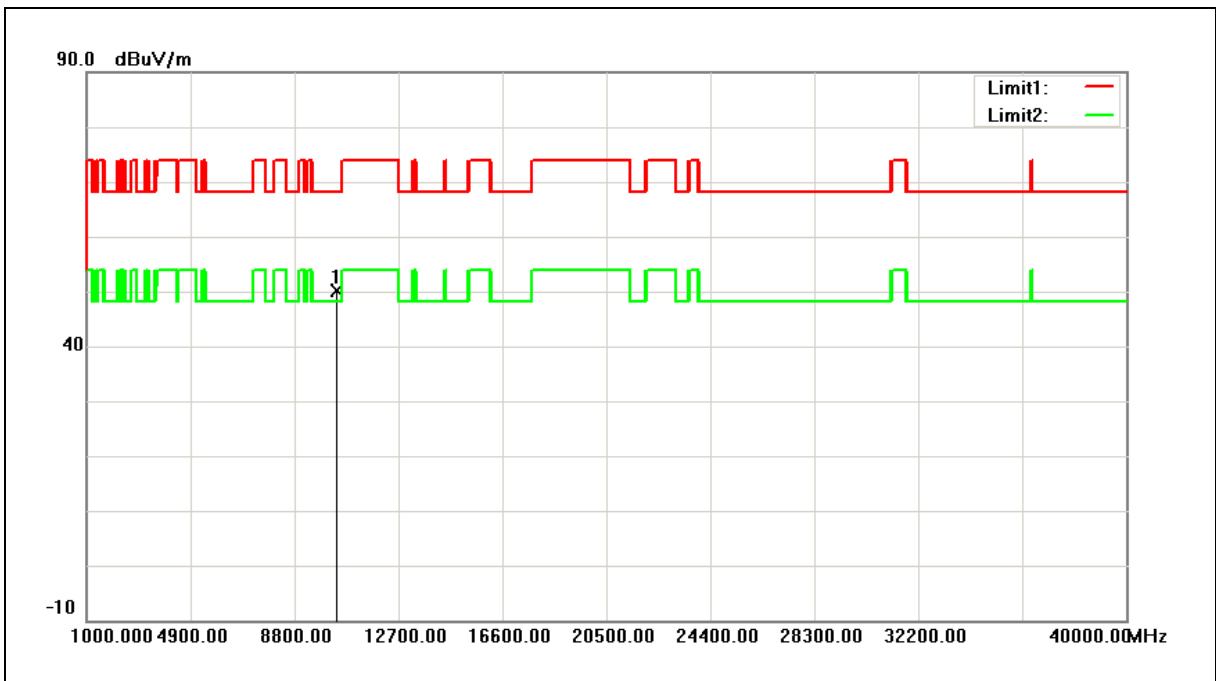

No.	Frequency (MHz)	Reading (dBuV)	Correct Factor (dB/m)	Result (dBuV/m)	Limit (dBuV/m)	Margin (dB)	Remark
1	10400.000	44.79	5.33	50.12	68.20	-18.08	peak

- Note:1.Result (dBuV/m) = Correct Factor (dB/m) + Reading(dBuV).
 2.Correction factor (dB/m) = Antenna Factor (dB/m) + Cable loss (dB) – Pre-Amplifier gain (dB).
 3. When the peak results are less than average limit, so not need to evaluate the average.



Standard:	FCC Part 15.407	Test Distance:	3m
Test item:	Harmonic	Power:	AC 120V/60Hz
Frequency:	5240MHz	Temp.(°C)/Hum.(%RH):	26(°C)/60%RH
Mode:	Mode 2	Date:	04/25/2016
Ant.Polar.:	Horizontal		

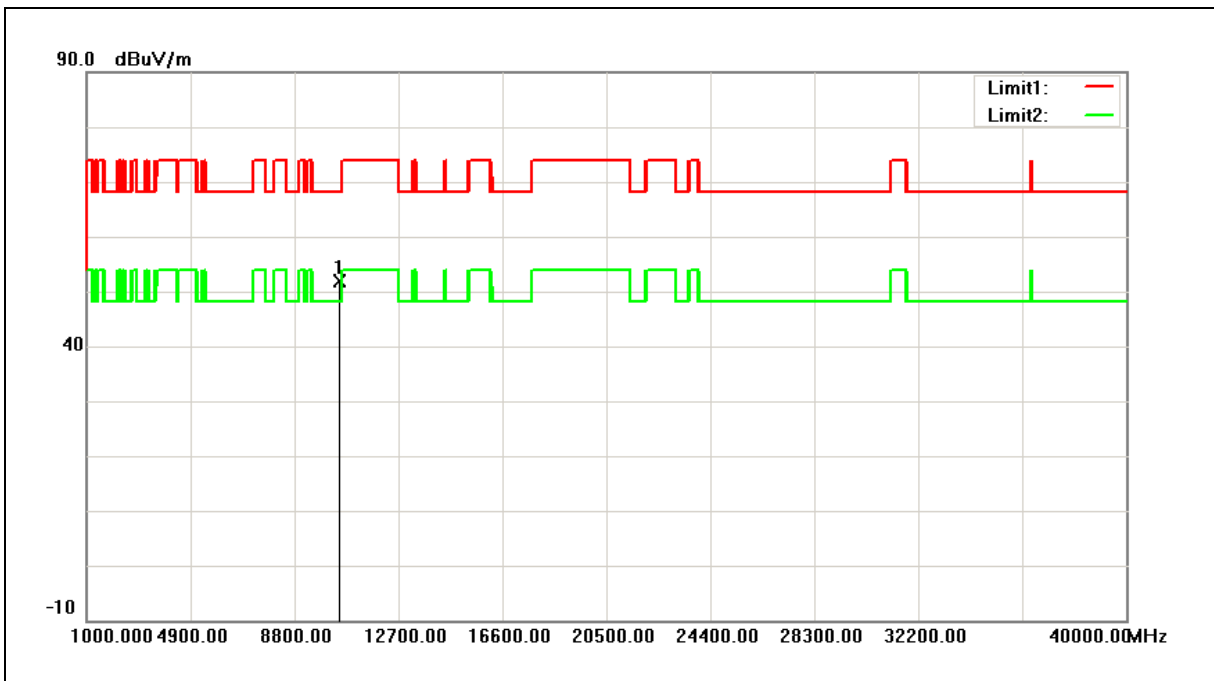

No.	Frequency (MHz)	Reading (dBuV)	Correct Factor (dB/m)	Result (dBuV/m)	Limit (dBuV/m)	Margin (dB)	Remark
1	10480.000	46.39	5.55	51.94	68.20	-16.26	peak

- Note:1.Result (dBuV/m) = Correct Factor (dB/m) + Reading(dBuV).
 2.Correction factor (dB/m) = Antenna Factor (dB/m) + Cable loss (dB) – Pre-Amplifier gain (dB).
 3. When the peak results are less than average limit, so not need to evaluate the average.



Standard:	FCC Part 15.407	Test Distance:	3m
Test item:	Harmonic	Power:	AC 120V/60Hz
Frequency:	5240MHz	Temp.(°C)/Hum. (%RH):	26(°C)/60%RH
Mode:	Mode 2	Date:	04/25/2016
Ant.Polar.:	Vertical		

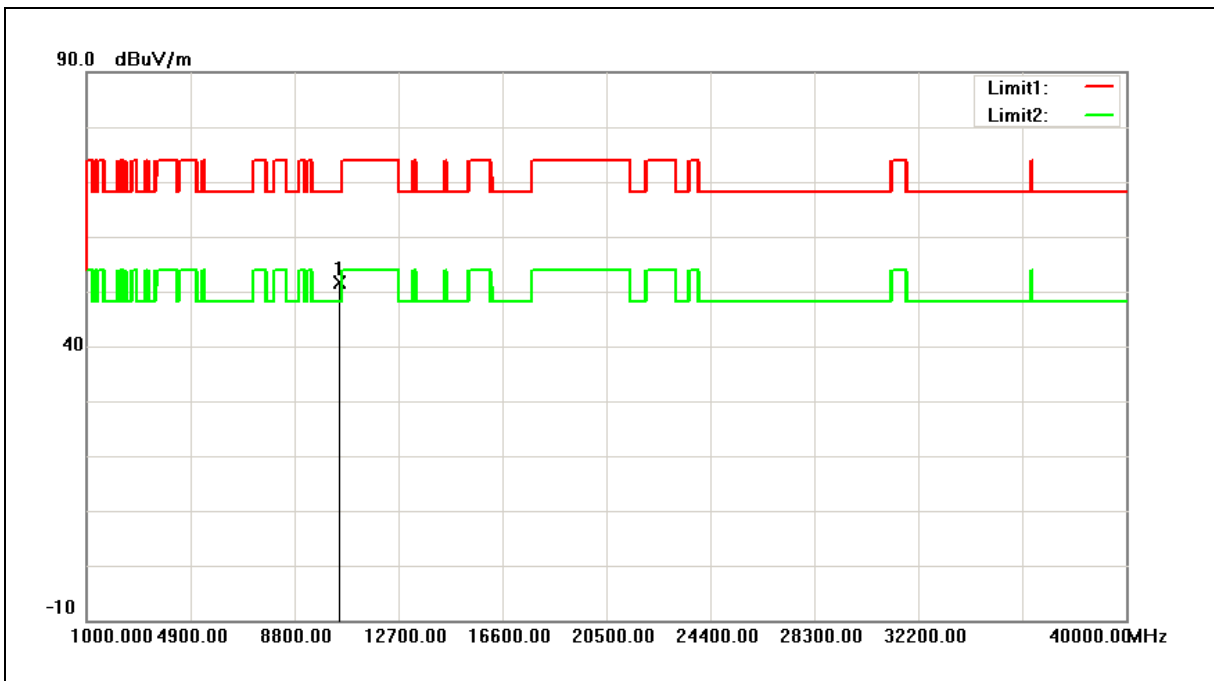

No.	Frequency (MHz)	Reading (dBuV)	Correct Factor (dB/m)	Result (dBuV/m)	Limit (dBuV/m)	Margin (dB)	Remark
1	10480.000	46.16	5.55	51.71	68.20	-16.49	peak

- Note:1.Result (dBuV/m) = Correct Factor (dB/m) + Reading(dBuV).
 2.Correction factor (dB/m) = Antenna Factor (dB/m) + Cable loss (dB) – Pre-Amplifier gain (dB).
 3. When the peak results are less than average limit, so not need to evaluate the average.



Standard:	FCC Part 15.407	Test Distance:	3m
Test item:	Harmonic	Power:	AC 120V/60Hz
Frequency:	5260MHz	Temp.(°C)/Hum.(%RH):	26(°C)/60%RH
Mode:	Mode 2	Date:	04/25/2016
Ant.Polar.:	Horizontal		

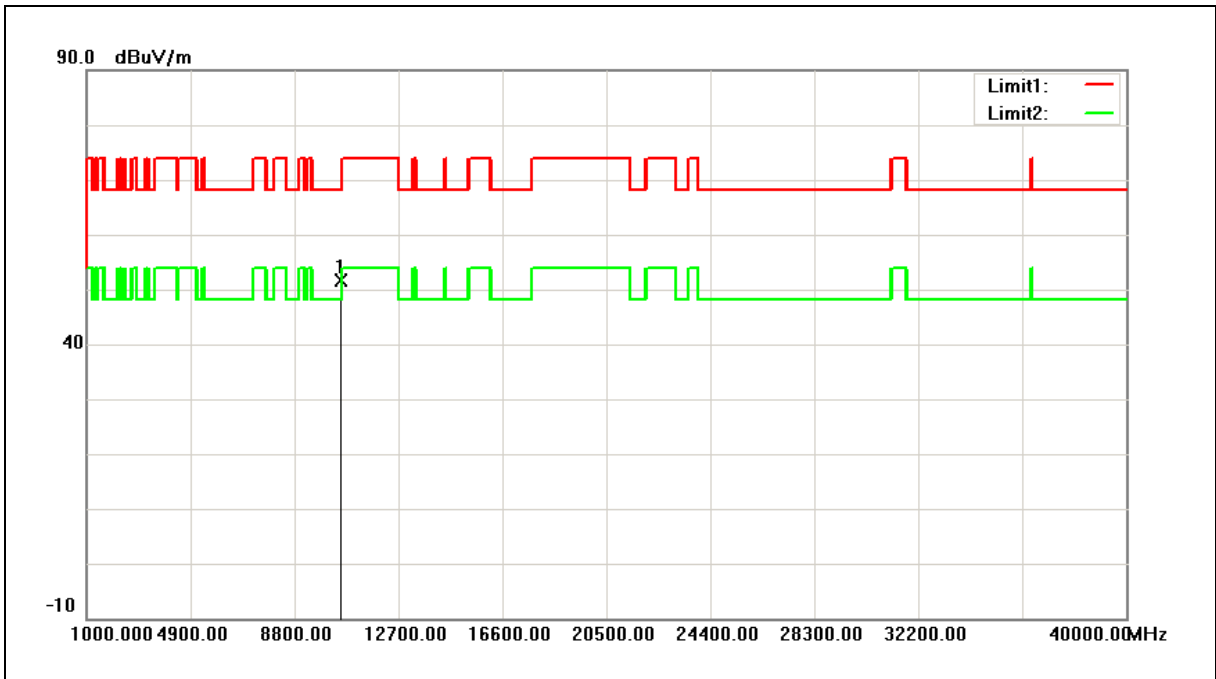

No.	Frequency (MHz)	Reading (dBuV)	Correct Factor (dB/m)	Result (dBuV/m)	Limit (dBuV/m)	Margin (dB)	Remark
1	10520.000	46.00	5.64	51.64	68.20	-16.56	peak

- Note:1.Result (dBuV/m) = Correct Factor (dB/m) + Reading(dBuV).
 2.Correction factor (dB/m) = Antenna Factor (dB/m) + Cable loss (dB) – Pre-Amplifier gain (dB).
 3. When the peak results are less than average limit, so not need to evaluate the average.



Standard:	FCC Part 15.407	Test Distance:	3m
Test item:	Harmonic	Power:	AC 120V/60Hz
Frequency:	5260MHz	Temp.(°C)/Hum.(%RH):	26(°C)/60%RH
Mode:	Mode 2	Date:	04/25/2016
Ant.Polar.:	Vertical		

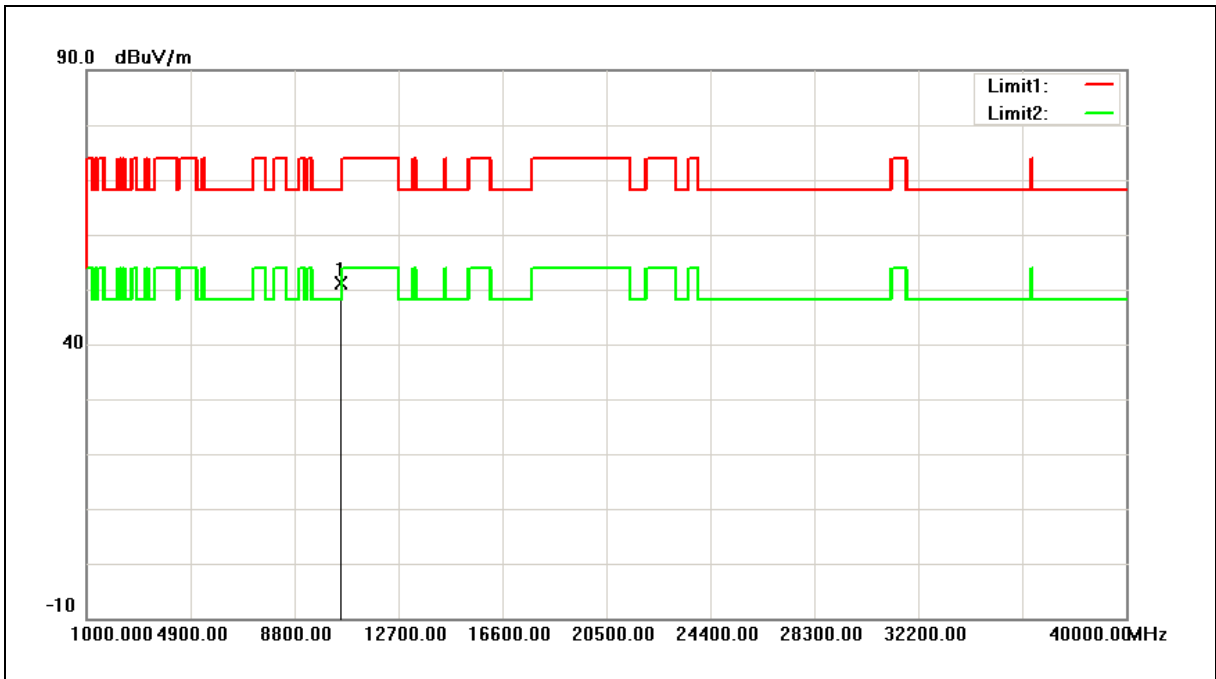

No.	Frequency (MHz)	Reading (dBuV)	Correct Factor (dB/m)	Result (dBuV/m)	Limit (dBuV/m)	Margin (dB)	Remark
1	10520.000	45.54	5.64	51.18	68.20	-17.02	peak

- Note:1.Result (dBuV/m) = Correct Factor (dB/m) + Reading(dBuV).
 2.Correction factor (dB/m) = Antenna Factor (dB/m) + Cable loss (dB) – Pre-Amplifier gain (dB).
 3. When the peak results are less than average limit, so not need to evaluate the average.



Standard:	FCC Part 15.407	Test Distance:	3m
Test item:	Harmonic	Power:	AC 120V/60Hz
Frequency:	5280MHz	Temp.(°C)/Hum.(%RH):	26(°C)/60%RH
Mode:	Mode 2	Date:	04/25/2016
Ant.Polar.:	Horizontal		

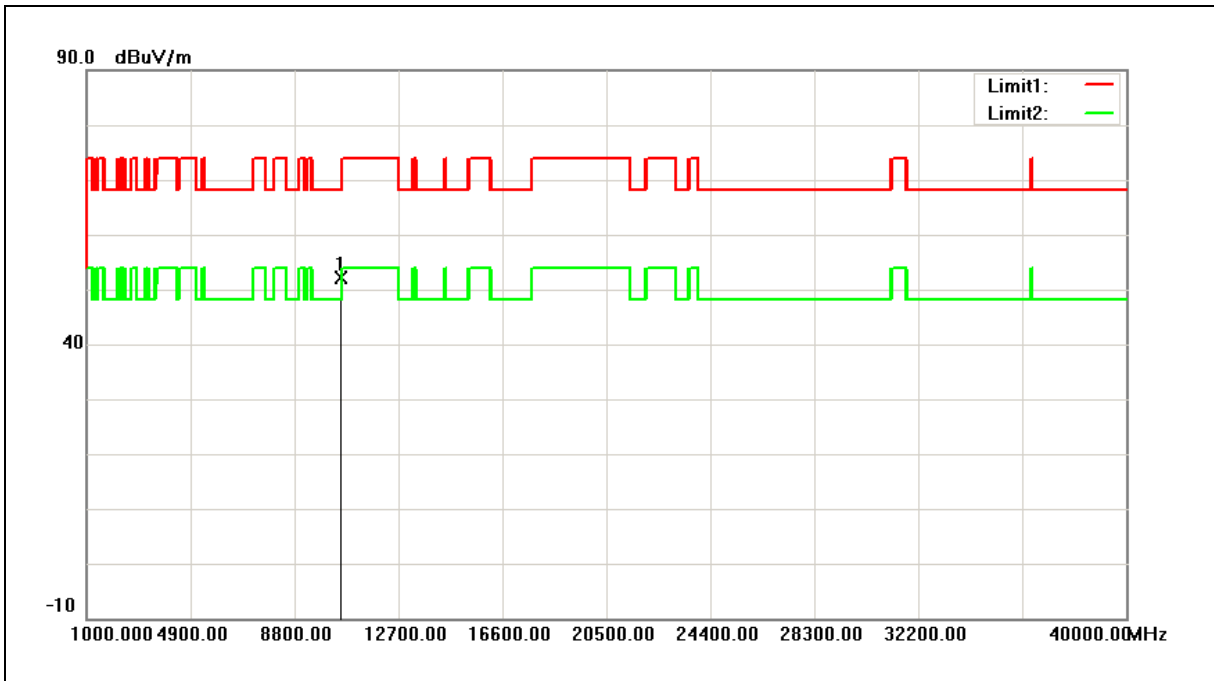

No.	Frequency (MHz)	Reading (dBuV)	Correct Factor (dB/m)	Result (dBuV/m)	Limit (dBuV/m)	Margin (dB)	Remark
1	10560.000	46.57	5.68	52.25	68.20	-15.95	peak

- Note:1.Result (dBuV/m) = Correct Factor (dB/m) + Reading(dBuV).
- 2.Correction factor (dB/m) = Antenna Factor (dB/m) + Cable loss (dB) – Pre-Amplifier gain (dB).
3. When the peak results are less than average limit, so not need to evaluate the average.



Standard:	FCC Part 15.407	Test Distance:	3m
Test item:	Harmonic	Power:	AC 120V/60Hz
Frequency:	5280MHz	Temp.(°C)/Hum. (%RH):	26(°C)/60%RH
Mode:	Mode 2	Date:	04/25/2016
Ant.Polar.:	Vertical		

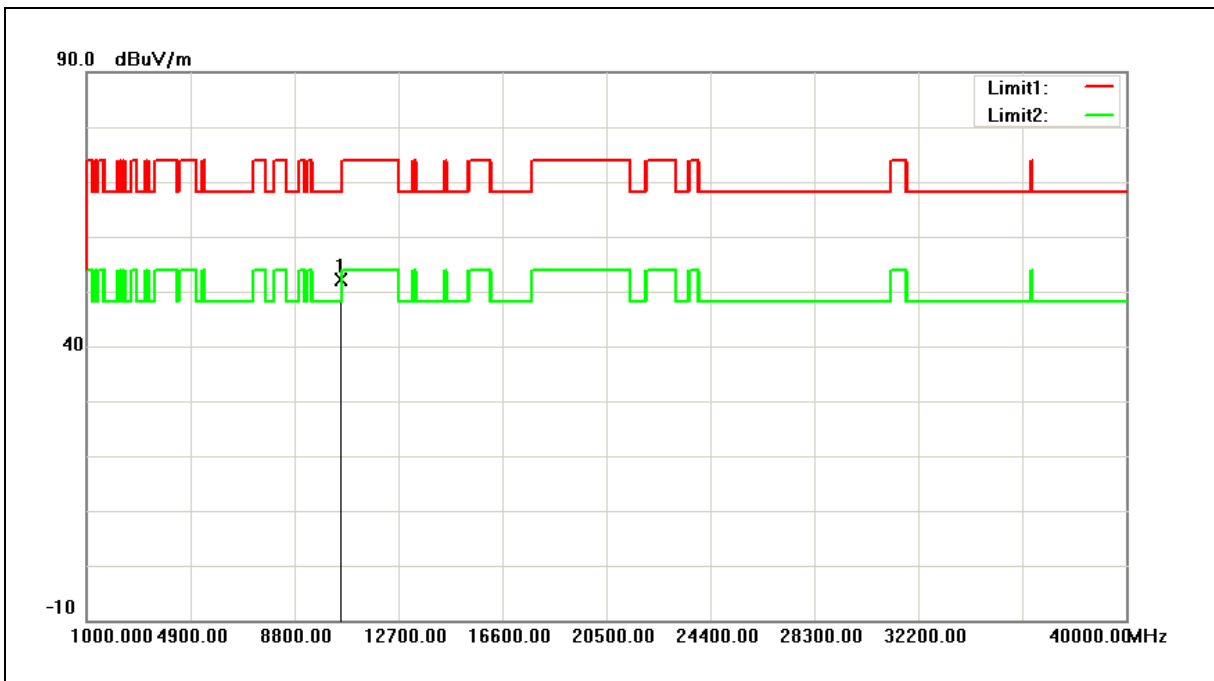

No.	Frequency (MHz)	Reading (dBuV)	Correct Factor (dB/m)	Result (dBuV/m)	Limit (dBuV/m)	Margin (dB)	Remark
1	10560.000	46.38	5.68	52.06	68.20	-16.14	peak

- Note:1.Result (dBuV/m) = Correct Factor (dB/m) + Reading(dBuV).
 2.Correction factor (dB/m) = Antenna Factor (dB/m) + Cable loss (dB) – Pre-Amplifier gain (dB).
 3. When the peak results are less than average limit, so not need to evaluate the average.



Standard:	FCC Part 15.407	Test Distance:	3m
Test item:	Harmonic	Power:	AC 120V/60Hz
Frequency:	5320MHz	Temp.(°C)/Hum. (%RH):	26(°C)/60%RH
Mode:	Mode 2	Date:	04/25/2016
Ant.Polar.:	Horizontal		

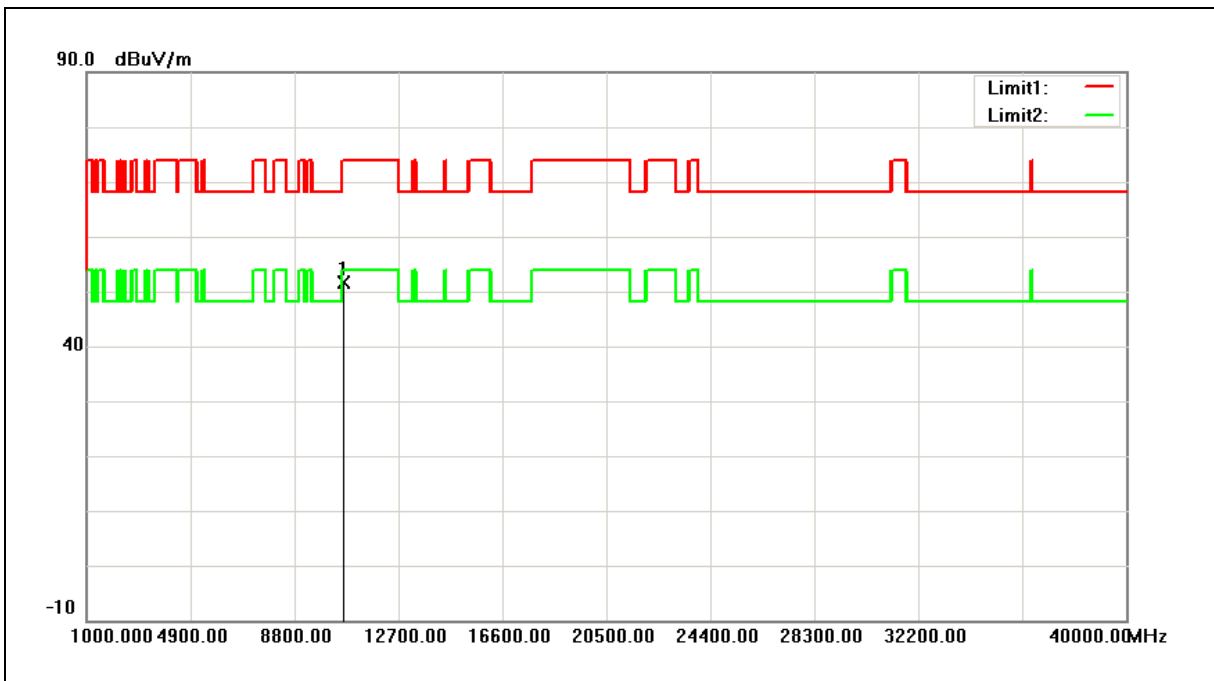

No.	Frequency (MHz)	Reading (dBuV)	Correct Factor (dB/m)	Result (dBuV/m)	Limit (dBuV/m)	Margin (dB)	Remark
1	10640.000	45.95	5.78	51.73	74.00	-22.27	peak

- Note:1.Result (dBuV/m) = Correct Factor (dB/m) + Reading(dBuV).
 2.Correction factor (dB/m) = Antenna Factor (dB/m) + Cable loss (dB) – Pre-Amplifier gain (dB).
 3. When the peak results are less than average limit, so not need to evaluate the average.



Standard:	FCC Part 15.407	Test Distance:	3m
Test item:	Harmonic	Power:	AC 120V/60Hz
Frequency:	5320MHz	Temp.(°C)/Hum.(%RH):	26(°C)/60%RH
Mode:	Mode 2	Date:	04/25/2016
Ant.Polar.:	Vertical		

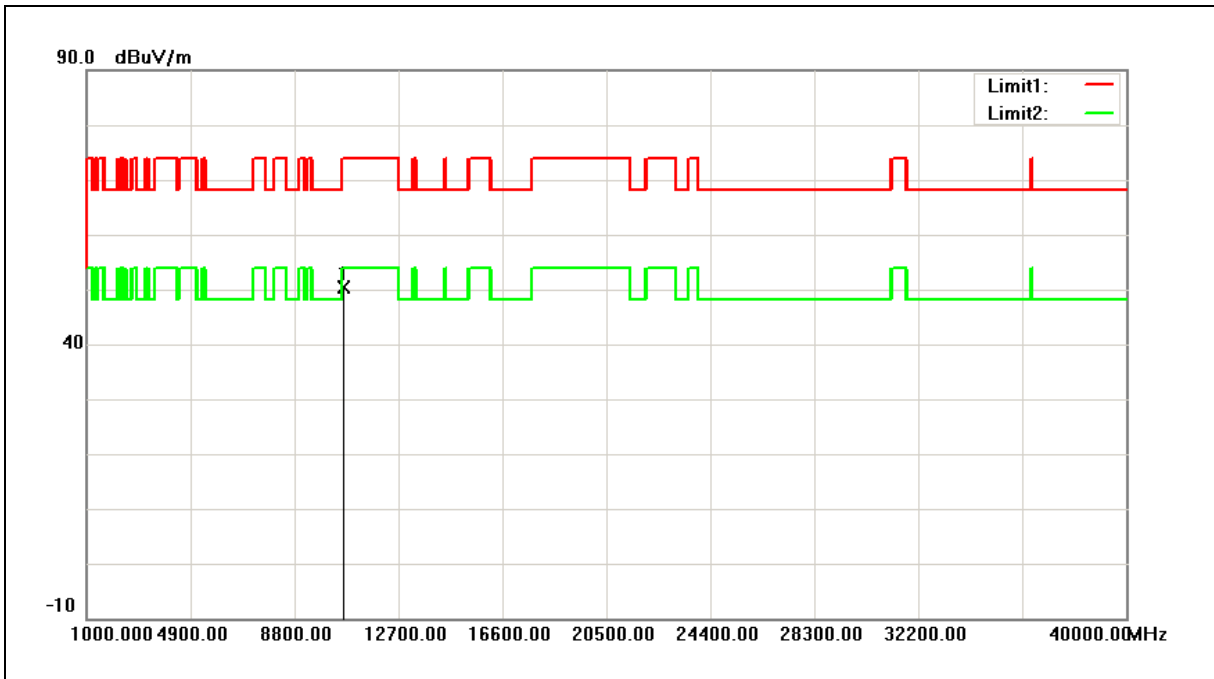

No.	Frequency (MHz)	Reading (dBuV)	Correct Factor (dB/m)	Result (dBuV/m)	Limit (dBuV/m)	Margin (dB)	Remark
1	10640.000	44.71	5.78	50.49	74.00	-23.51	peak

- Note:1.Result (dBuV/m) = Correct Factor (dB/m) + Reading(dBuV).
- 2.Correction factor (dB/m) = Antenna Factor (dB/m) + Cable loss (dB) – Pre-Amplifier gain (dB).
3. When the peak results are less than average limit, so not need to evaluate the average.



Standard:	FCC Part 15.407	Test Distance:	3m
Test item:	Harmonic	Power:	AC 120V/60Hz
Frequency:	5500MHz	Temp.(°C)/Hum.(%RH):	26(°C)/60%RH
Mode:	Mode 2	Date:	04/25/2016
Ant.Polar.:	Horizontal		

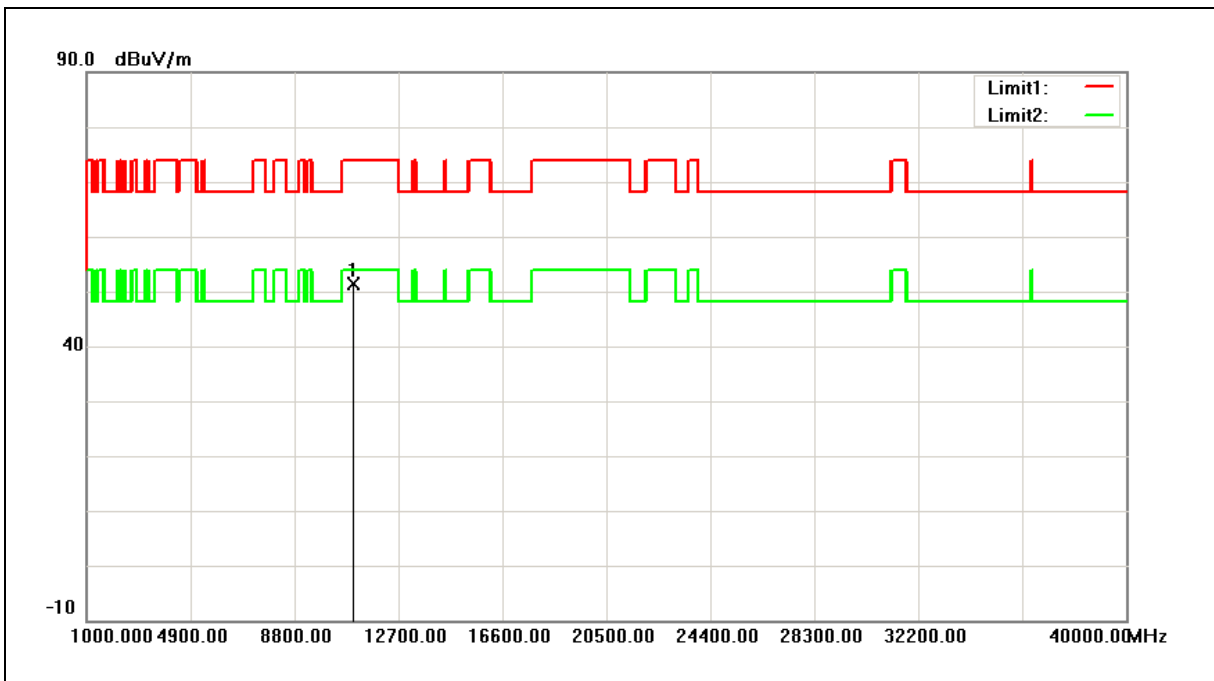

No.	Frequency (MHz)	Reading (dBuV)	Correct Factor (dB/m)	Result (dBuV/m)	Limit (dBuV/m)	Margin (dB)	Remark
1	11000.000	45.13	6.18	51.31	74.00	-22.69	peak

- Note:1.Result (dBuV/m) = Correct Factor (dB/m) + Reading(dBuV).
 2.Correction factor (dB/m) = Antenna Factor (dB/m) + Cable loss (dB) – Pre-Amplifier gain (dB).
 3. When the peak results are less than average limit, so not need to evaluate the average.



Standard:	FCC Part 15.407	Test Distance:	3m
Test item:	Harmonic	Power:	AC 120V/60Hz
Frequency:	5500MHz	Temp.(°C)/Hum.(%RH):	26(°C)/60%RH
Mode:	Mode 2	Date:	04/25/2016
Ant.Polar.:	Vertical		

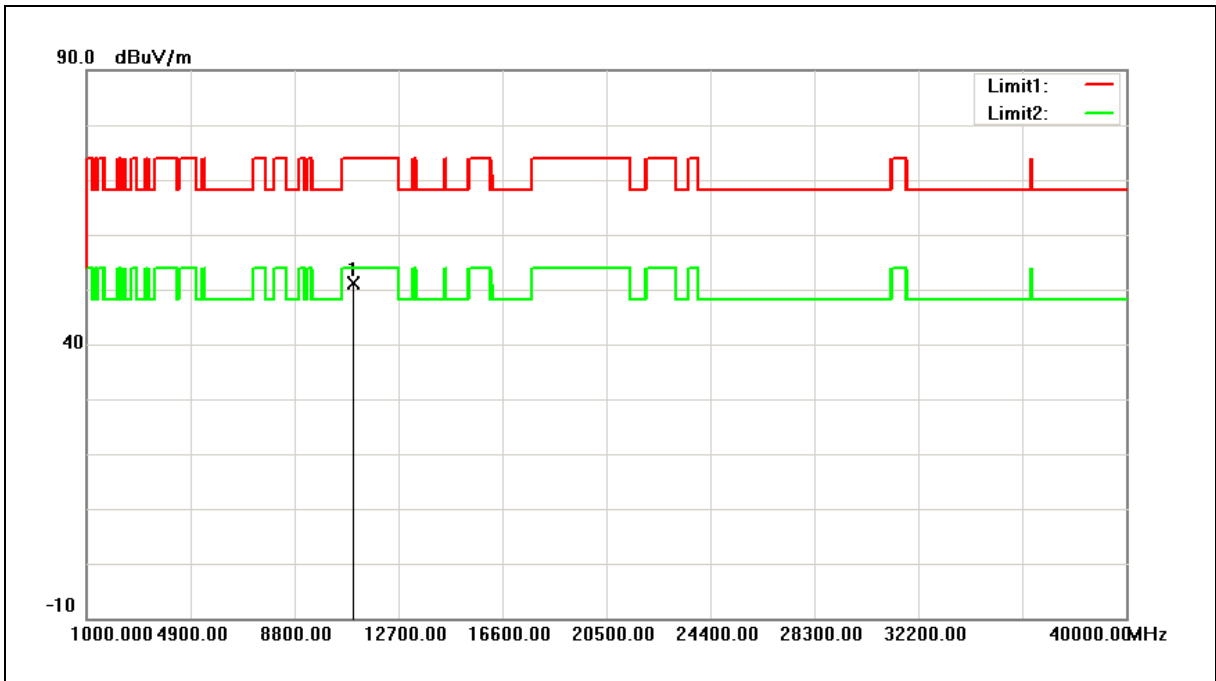

No.	Frequency (MHz)	Reading (dBuV)	Correct Factor (dB/m)	Result (dBuV/m)	Limit (dBuV/m)	Margin (dB)	Remark
1	11000.000	44.96	6.18	51.14	74.00	-22.86	peak

- Note:1.Result (dBuV/m) = Correct Factor (dB/m) + Reading(dBuV).
 2.Correction factor (dB/m) = Antenna Factor (dB/m) + Cable loss (dB) – Pre-Amplifier gain (dB).
 3. When the peak results are less than average limit, so not need to evaluate the average.



Standard:	FCC Part 15.407	Test Distance:	3m
Test item:	Harmonic	Power:	AC 120V/60Hz
Frequency:	5560MHz	Temp.(°C)/Hum. (%RH):	26(°C)/60%RH
Mode:	Mode 2	Date:	04/25/2016
Ant.Polar.:	Horizontal		

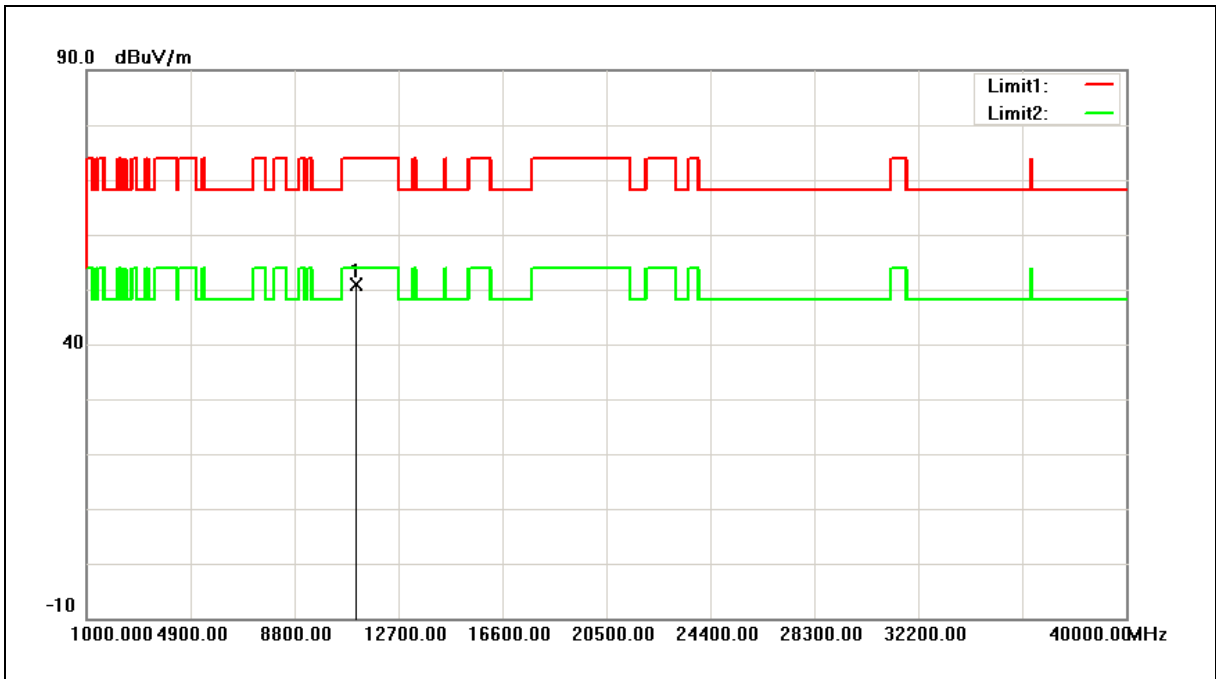

No.	Frequency (MHz)	Reading (dBuV)	Correct Factor (dB/m)	Result (dBuV/m)	Limit (dBuV/m)	Margin (dB)	Remark
1	11120.000	44.74	6.24	50.98	74.00	-23.02	peak

- Note:1.Result (dBuV/m) = Correct Factor (dB/m) + Reading(dBuV).
- 2.Correction factor (dB/m) = Antenna Factor (dB/m) + Cable loss (dB) – Pre-Amplifier gain (dB).
3. When the peak results are less than average limit, so not need to evaluate the average.



Standard:	FCC Part 15.407	Test Distance:	3m
Test item:	Harmonic	Power:	AC 120V/60Hz
Frequency:	5560MHz	Temp.(°C)/Hum.(%RH):	26(°C)/60%RH
Mode:	Mode 2	Date:	04/25/2016
Ant.Polar.:	Vertical		

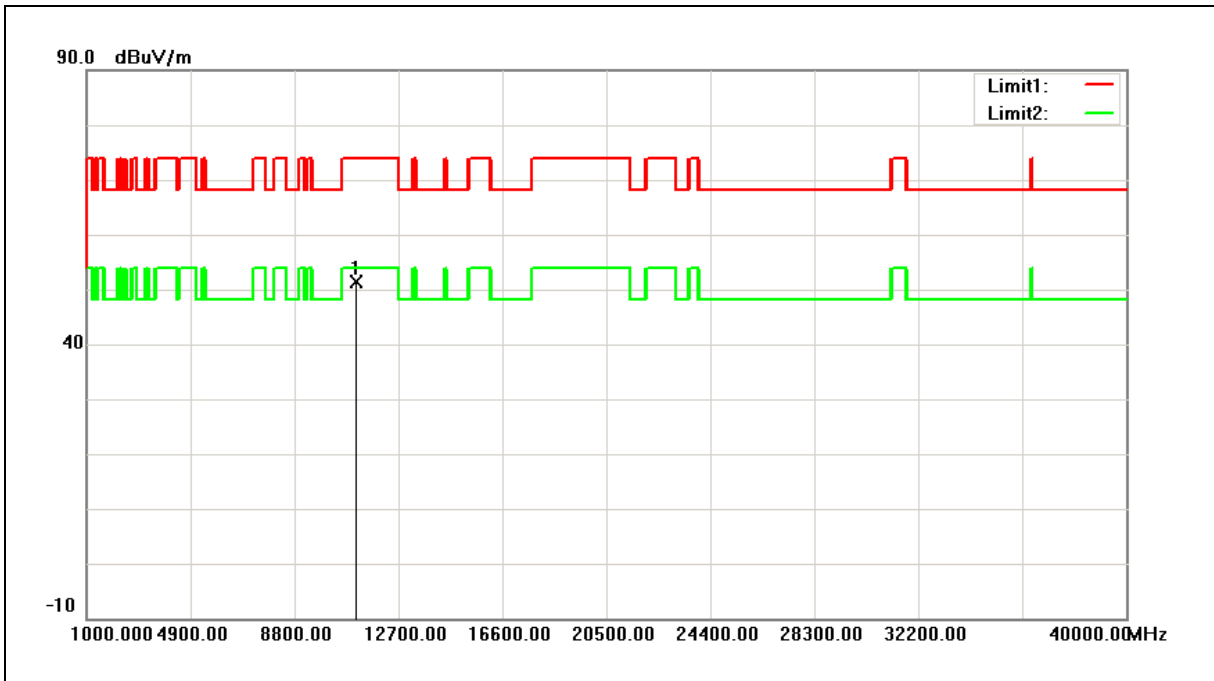

No.	Frequency (MHz)	Reading (dBuV)	Correct Factor (dB/m)	Result (dBuV/m)	Limit (dBuV/m)	Margin (dB)	Remark
1	11120.000	45.23	6.24	51.47	74.00	-22.53	peak

- Note:1.Result (dBuV/m) = Correct Factor (dB/m) + Reading(dBuV).
 2.Correction factor (dB/m) = Antenna Factor (dB/m) + Cable loss (dB) – Pre-Amplifier gain (dB).
 3. When the peak results are less than average limit, so not need to evaluate the average.



Standard:	FCC Part 15.407	Test Distance:	3m
Test item:	Harmonic	Power:	AC 120V/60Hz
Frequency:	5700MHz	Temp.(°C)/Hum. (%RH):	26(°C)/60%RH
Mode:	Mode 2	Date:	04/25/2016
Ant.Polar.:	Horizontal		

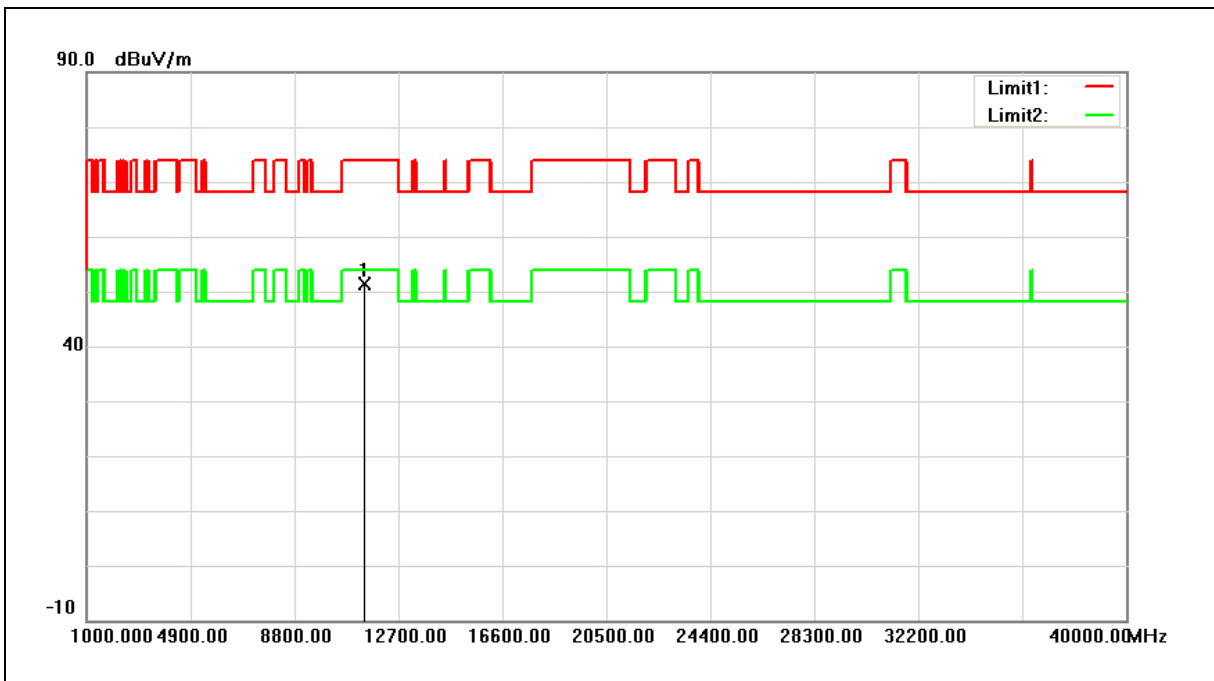

No.	Frequency (MHz)	Reading (dBuV)	Correct Factor (dB/m)	Result (dBuV/m)	Limit (dBuV/m)	Margin (dB)	Remark
1	11400.000	44.97	6.39	51.36	74.00	-22.64	peak

- Note:1.Result (dBuV/m) = Correct Factor (dB/m) + Reading(dBuV).
 2.Correction factor (dB/m) = Antenna Factor (dB/m) + Cable loss (dB) – Pre-Amplifier gain (dB).
 3. When the peak results are less than average limit, so not need to evaluate the average.



Standard:	FCC Part 15.407	Test Distance:	3m
Test item:	Harmonic	Power:	AC 120V/60Hz
Frequency:	5700MHz	Temp.(°C)/Hum. (%RH):	26(°C)/60%RH
Mode:	Mode 2	Date:	04/25/2016
Ant.Polar.:	Vertical		

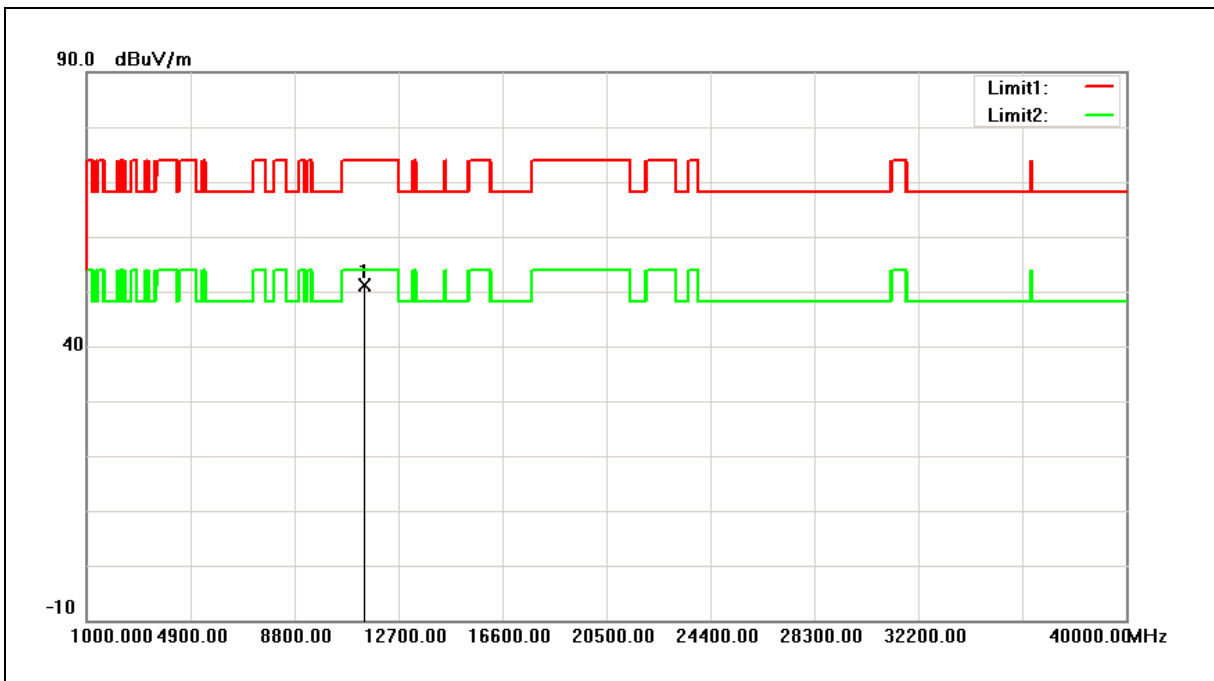

No.	Frequency (MHz)	Reading (dBuV)	Correct Factor (dB/m)	Result (dBuV/m)	Limit (dBuV/m)	Margin (dB)	Remark
1	11400.000	44.70	6.39	51.09	74.00	-22.91	peak

- Note:1.Result (dBuV/m) = Correct Factor (dB/m) + Reading(dBuV).
- 2.Correction factor (dB/m) = Antenna Factor (dB/m) + Cable loss (dB) – Pre-Amplifier gain (dB).
3. When the peak results are less than average limit, so not need to evaluate the average.



Standard:	FCC Part 15.407	Test Distance:	3m
Test item:	Harmonic	Power:	AC 120V/60Hz
Frequency:	5745MHz	Temp.(°C)/Hum.(%RH):	26(°C)/60%RH
Mode:	Mode 2	Date:	04/25/2016
Ant.Polar.:	Horizontal		

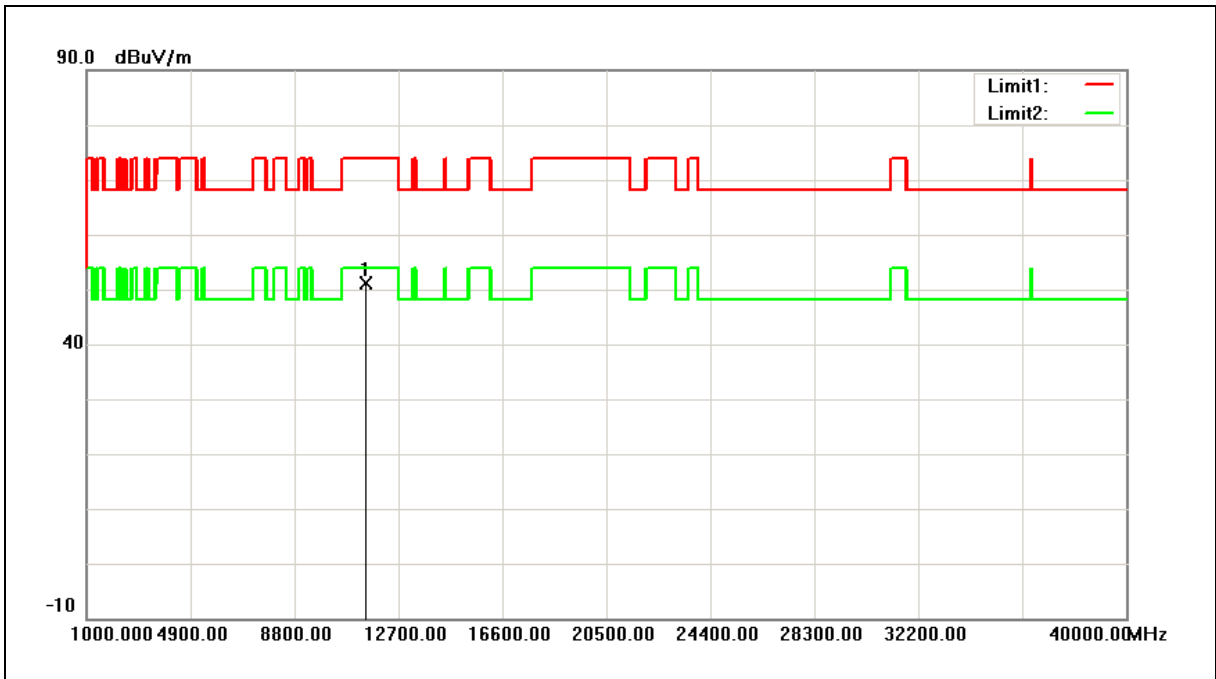

No.	Frequency (MHz)	Reading (dBuV)	Correct Factor (dB/m)	Result (dBuV/m)	Limit (dBuV/m)	Margin (dB)	Remark
1	11490.000	44.79	6.44	51.23	74.00	-22.77	peak

- Note:1.Result (dBuV/m) = Correct Factor (dB/m) + Reading(dBuV).
- 2.Correction factor (dB/m) = Antenna Factor (dB/m) + Cable loss (dB) – Pre-Amplifier gain (dB).
3. When the peak results are less than average limit, so not need to evaluate the average.



Standard:	FCC Part 15.407	Test Distance:	3m
Test item:	Harmonic	Power:	AC 120V/60Hz
Frequency:	5745MHz	Temp.(°C)/Hum.(%RH):	26(°C)/60%RH
Mode:	Mode 2	Date:	04/25/2016
Ant.Polar.:	Vertical		

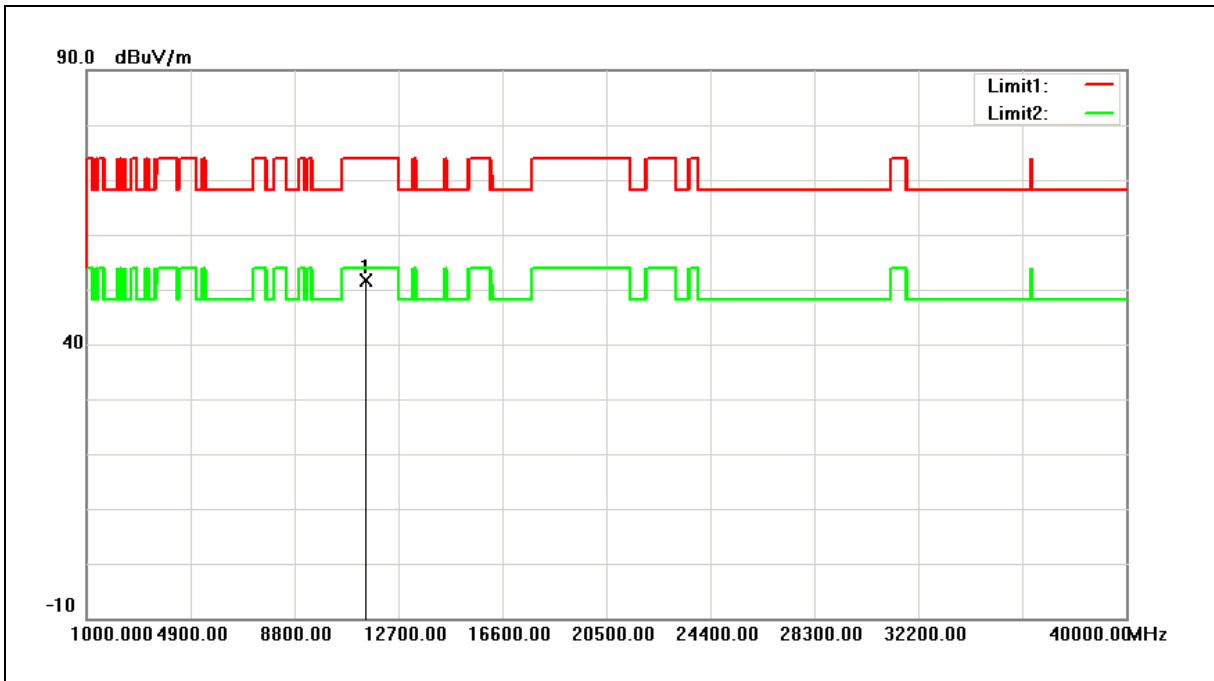

No.	Frequency (MHz)	Reading (dBuV)	Correct Factor (dB/m)	Result (dBuV/m)	Limit (dBuV/m)	Margin (dB)	Remark
1	11490.000	45.23	6.44	51.67	74.00	-22.33	peak

- Note:1.Result (dBuV/m) = Correct Factor (dB/m) + Reading(dBuV).
- 2.Correction factor (dB/m) = Antenna Factor (dB/m) + Cable loss (dB) – Pre-Amplifier gain (dB).
3. When the peak results are less than average limit, so not need to evaluate the average.



Standard:	FCC Part 15.407	Test Distance:	3m
Test item:	Harmonic	Power:	AC 120V/60Hz
Frequency:	5785MHz	Temp.(°C)/Hum.(%RH):	26(°C)/60%RH
Mode:	Mode 2	Date:	04/25/2016
Ant.Polar.:	Horizontal		

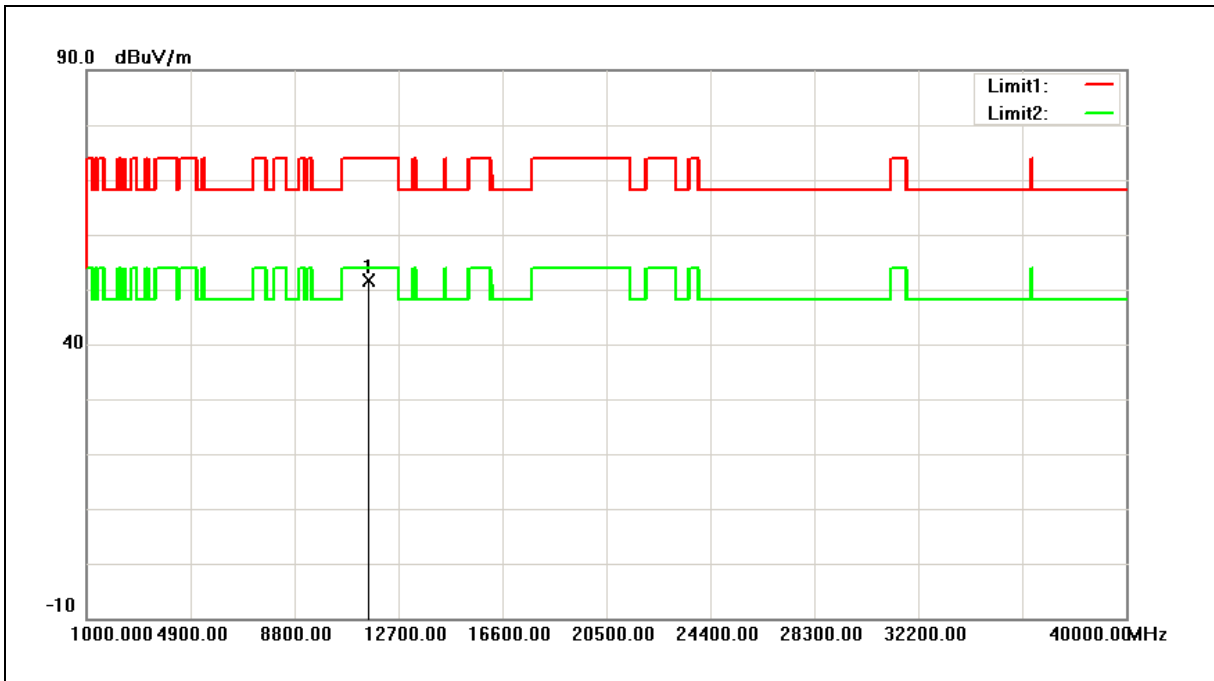

No.	Frequency (MHz)	Reading (dBuV)	Correct Factor (dB/m)	Result (dBuV/m)	Limit (dBuV/m)	Margin (dB)	Remark
1	11570.000	45.11	6.63	51.74	74.00	-22.26	peak

- Note:1.Result (dBuV/m) = Correct Factor (dB/m) + Reading(dBuV).
 2.Correction factor (dB/m) = Antenna Factor (dB/m) + Cable loss (dB) – Pre-Amplifier gain (dB).
 3. When the peak results are less than average limit, so not need to evaluate the average.



Standard:	FCC Part 15.407	Test Distance:	3m
Test item:	Harmonic	Power:	AC 120V/60Hz
Frequency:	5785MHz	Temp.(°C)/Hum.(%RH):	26(°C)/60%RH
Mode:	Mode 2	Date:	04/25/2016
Ant.Polar.:	Vertical		

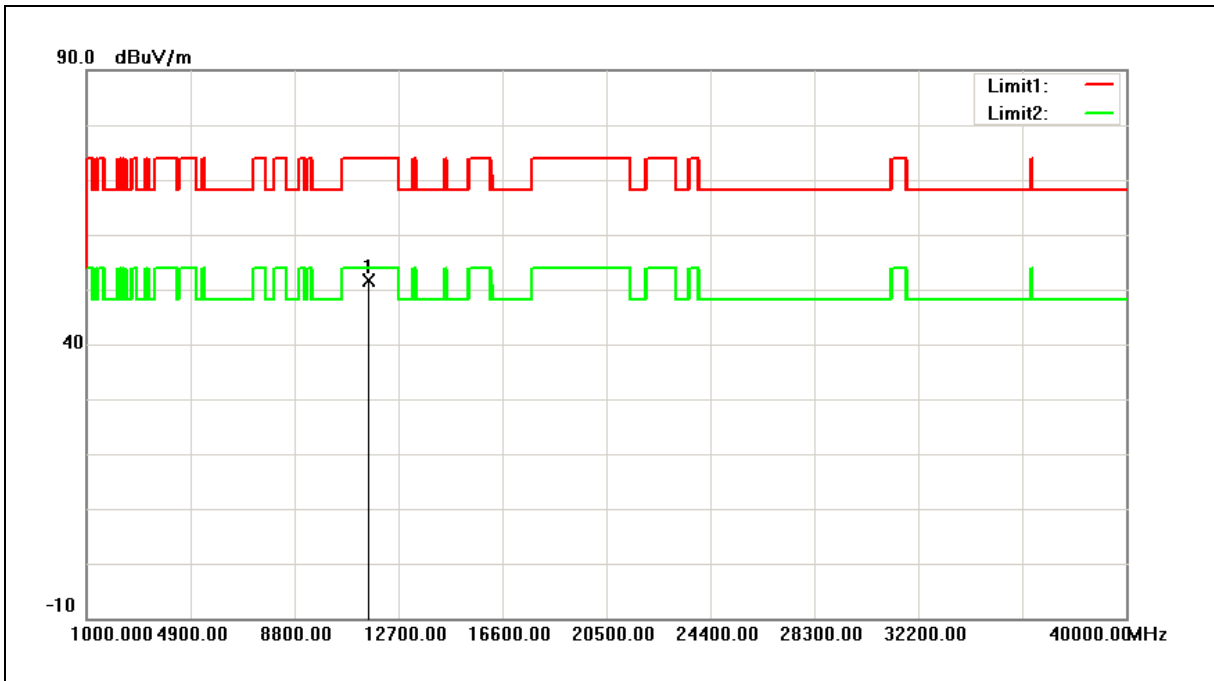

No.	Frequency (MHz)	Reading (dBuV)	Correct Factor (dB/m)	Result (dBuV/m)	Limit (dBuV/m)	Margin (dB)	Remark
1	11570.000	45.03	6.63	51.66	74.00	-22.34	peak

- Note:1.Result (dBuV/m) = Correct Factor (dB/m) + Reading(dBuV).
 2.Correction factor (dB/m) = Antenna Factor (dB/m) + Cable loss (dB) – Pre-Amplifier gain (dB).
 3. When the peak results are less than average limit, so not need to evaluate the average.



Standard:	FCC Part 15.407	Test Distance:	3m
Test item:	Harmonic	Power:	AC 120V/60Hz
Frequency:	5825MHz	Temp.(°C)/Hum.(%RH):	26(°C)/60%RH
Mode:	Mode 2	Date:	04/25/2016
Ant.Polar.:	Horizontal		

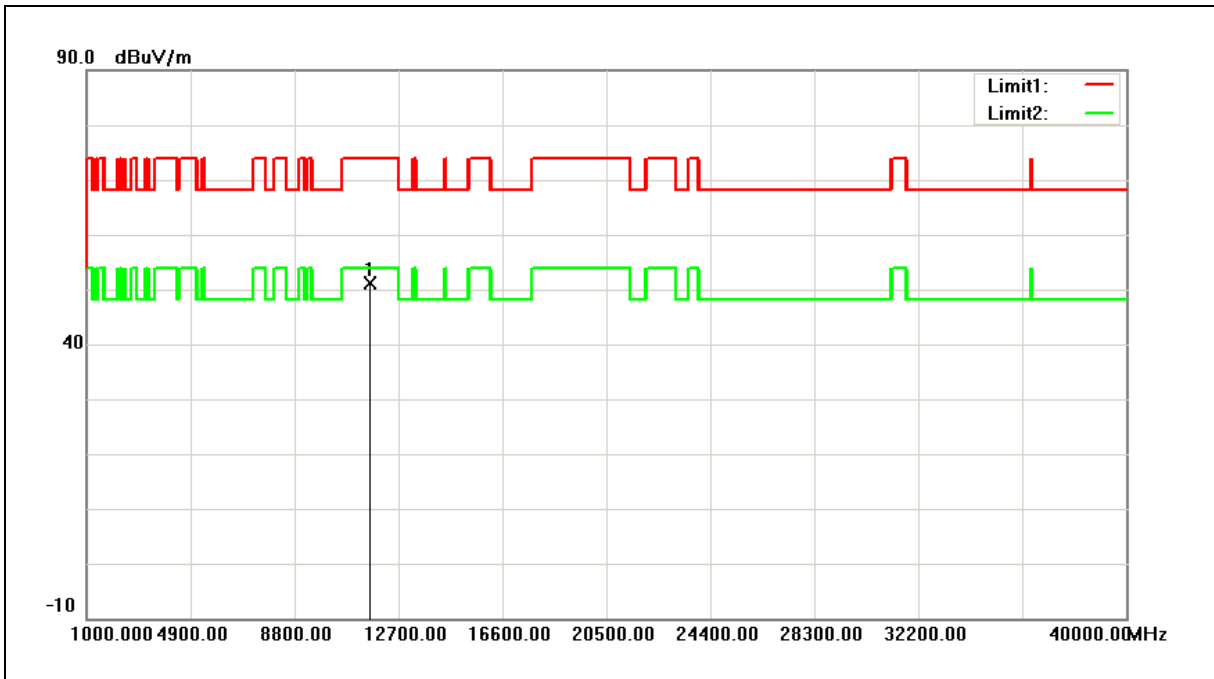

No.	Frequency (MHz)	Reading (dBuV)	Correct Factor (dB/m)	Result (dBuV/m)	Limit (dBuV/m)	Margin (dB)	Remark
1	11650.000	44.33	6.85	51.18	74.00	-22.82	peak

Note:1.Result (dBuV/m) = Correct Factor (dB/m) + Reading(dBuV).

2.Correction factor (dB/m) = Antenna Factor (dB/m) + Cable loss (dB) – Pre-Amplifier gain (dB).

3. When the peak results are less than average limit, so not need to evaluate the average.



Standard:	FCC Part 15.407	Test Distance:	3m
Test item:	Harmonic	Power:	AC 120V/60Hz
Frequency:	5825MHz	Temp.(°C)/Hum.(%RH):	26(°C)/60%RH
Mode:	Mode 2	Date:	04/25/2016
Ant.Polar.:	Vertical		

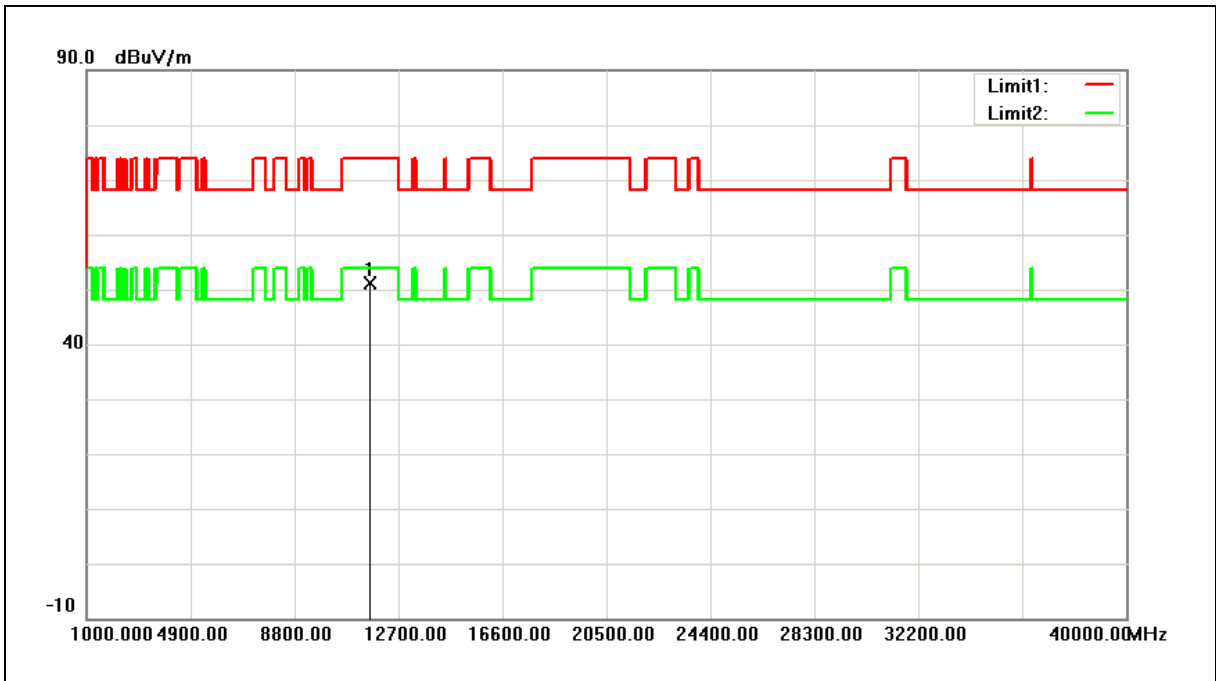

No.	Frequency (MHz)	Reading (dBuV)	Correct Factor (dB/m)	Result (dBuV/m)	Limit (dBuV/m)	Margin (dB)	Remark
1	11650.000	44.24	6.85	51.09	74.00	-22.91	peak

- Note:1.Result (dBuV/m) = Correct Factor (dB/m) + Reading(dBuV).
 2.Correction factor (dB/m) = Antenna Factor (dB/m) + Cable loss (dB) – Pre-Amplifier gain (dB).
 3. When the peak results are less than average limit, so not need to evaluate the average.



Standard:	FCC Part 15.407	Test Distance:	3m
Test item:	Harmonic	Power:	AC 120V/60Hz
Frequency:	5180MHz	Temp.(°C)/Hum.(%RH):	26(°C)/60%RH
Mode:	Mode 3	Date:	04/25/2016
Ant.Polar.:	Horizontal		

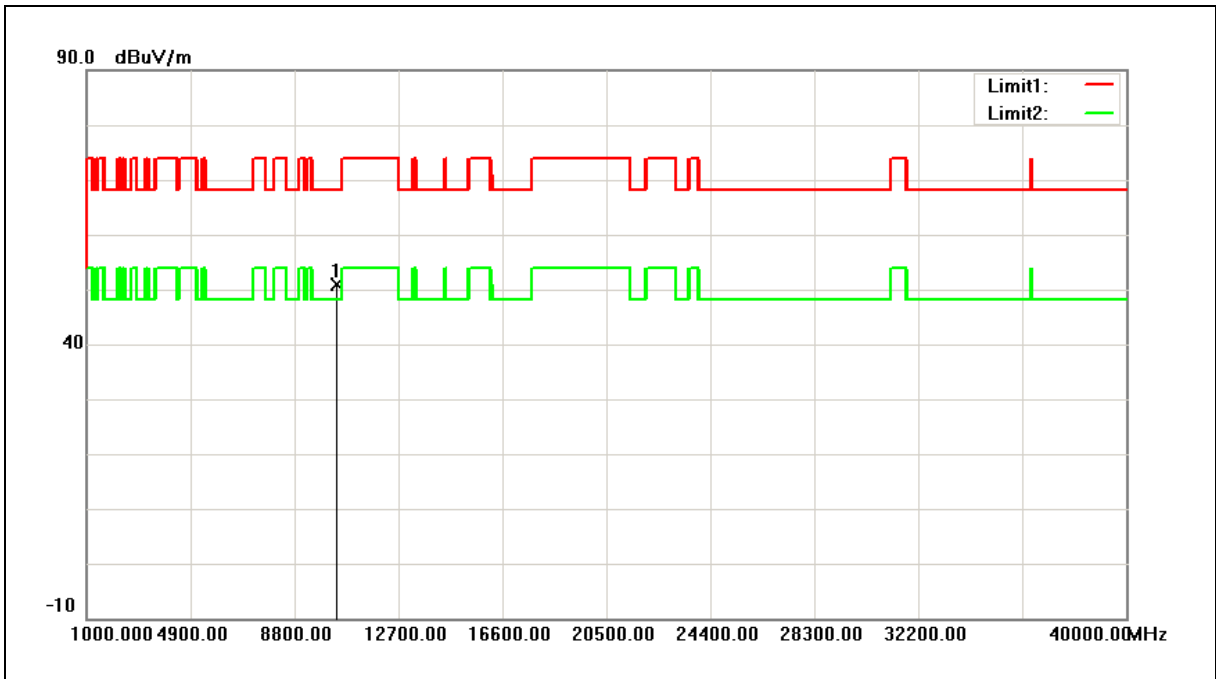

No.	Frequency (MHz)	Reading (dBuV)	Correct Factor (dB/m)	Result (dBuV/m)	Limit (dBuV/m)	Margin (dB)	Remark
1	10360.000	45.58	5.21	50.79	68.20	-17.41	peak

- Note:1.Result (dBuV/m) = Correct Factor (dB/m) + Reading(dBuV).
 2.Correction factor (dB/m) = Antenna Factor (dB/m) + Cable loss (dB) – Pre-Amplifier gain (dB).
 3. When the peak results are less than average limit, so not need to evaluate the average.



Standard:	FCC Part 15.407	Test Distance:	3m
Test item:	Harmonic	Power:	AC 120V/60Hz
Frequency:	5180MHz	Temp.(°C)/Hum.(%RH):	26(°C)/60%RH
Mode:	Mode 3	Date:	04/25/2016
Ant.Polar.:	Vertical		

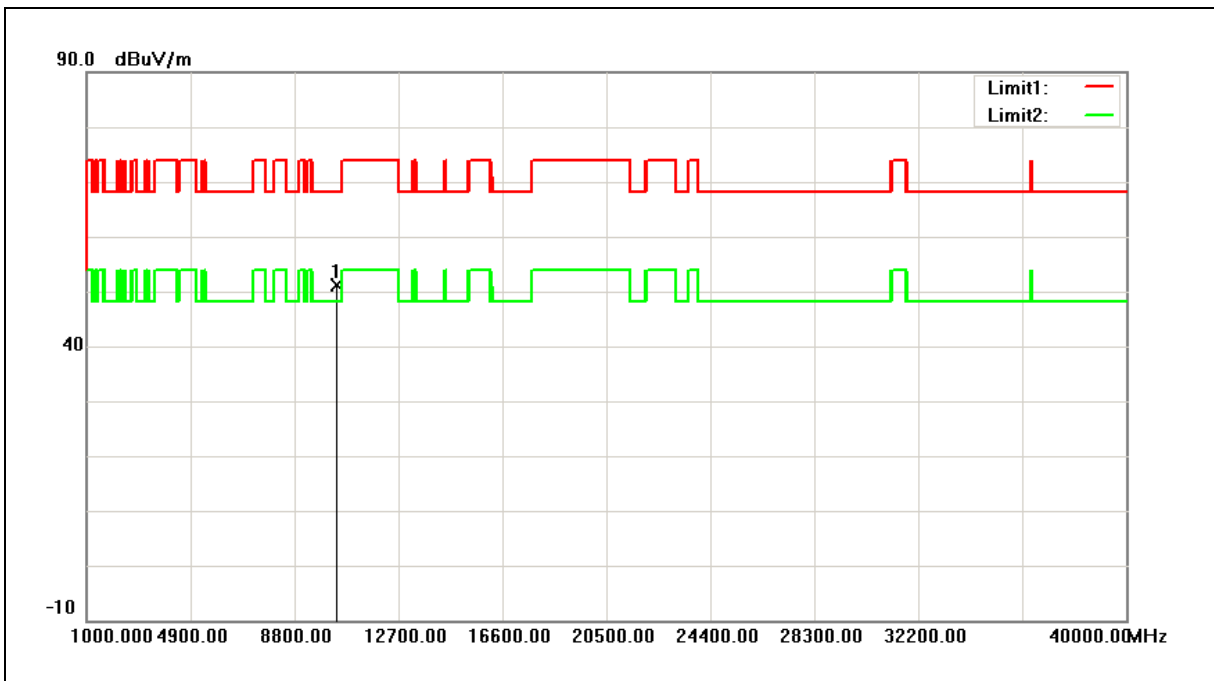

No.	Frequency (MHz)	Reading (dBuV)	Correct Factor (dB/m)	Result (dBuV/m)	Limit (dBuV/m)	Margin (dB)	Remark
1	10360.000	45.95	5.21	51.16	68.20	-17.04	peak

- Note:1.Result (dBuV/m) = Correct Factor (dB/m) + Reading(dBuV).
- 2.Correction factor (dB/m) = Antenna Factor (dB/m) + Cable loss (dB) – Pre-Amplifier gain (dB).
3. When the peak results are less than average limit, so not need to evaluate the average.



Standard:	FCC Part 15.407	Test Distance:	3m
Test item:	Harmonic	Power:	AC 120V/60Hz
Frequency:	5200MHz	Temp.(°C)/Hum.(%RH):	26(°C)/60%RH
Mode:	Mode 3	Date:	04/25/2016
Ant.Polar.:	Horizontal		

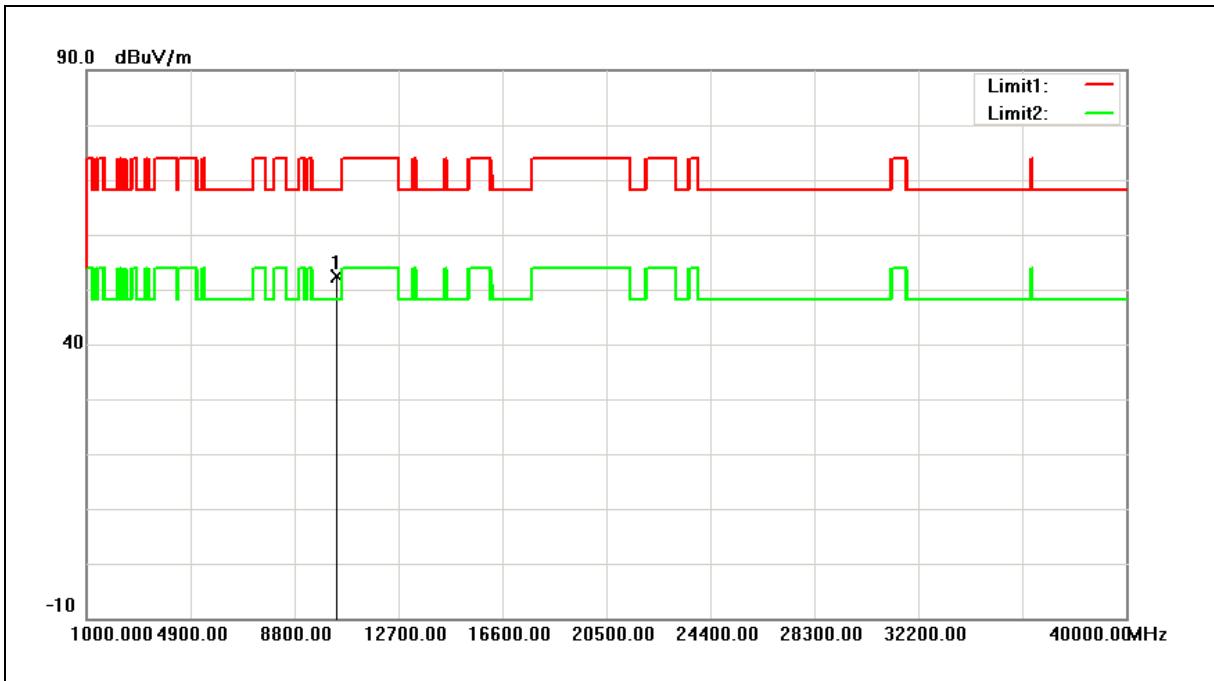

No.	Frequency (MHz)	Reading (dBuV)	Correct Factor (dB/m)	Result (dBuV/m)	Limit (dBuV/m)	Margin (dB)	Remark
1	10400.000	46.98	5.33	52.31	68.20	-15.89	peak

- Note:1.Result (dBuV/m) = Correct Factor (dB/m) + Reading(dBuV).
 2.Correction factor (dB/m) = Antenna Factor (dB/m) + Cable loss (dB) – Pre-Amplifier gain (dB).
 3. When the peak results are less than average limit, so not need to evaluate the average.



Standard:	FCC Part 15.407	Test Distance:	3m
Test item:	Harmonic	Power:	AC 120V/60Hz
Frequency:	5200MHz	Temp.(°C)/Hum.(%RH):	26(°C)/60%RH
Mode:	Mode 3	Date:	04/25/2016
Ant.Polar.:	Vertical		

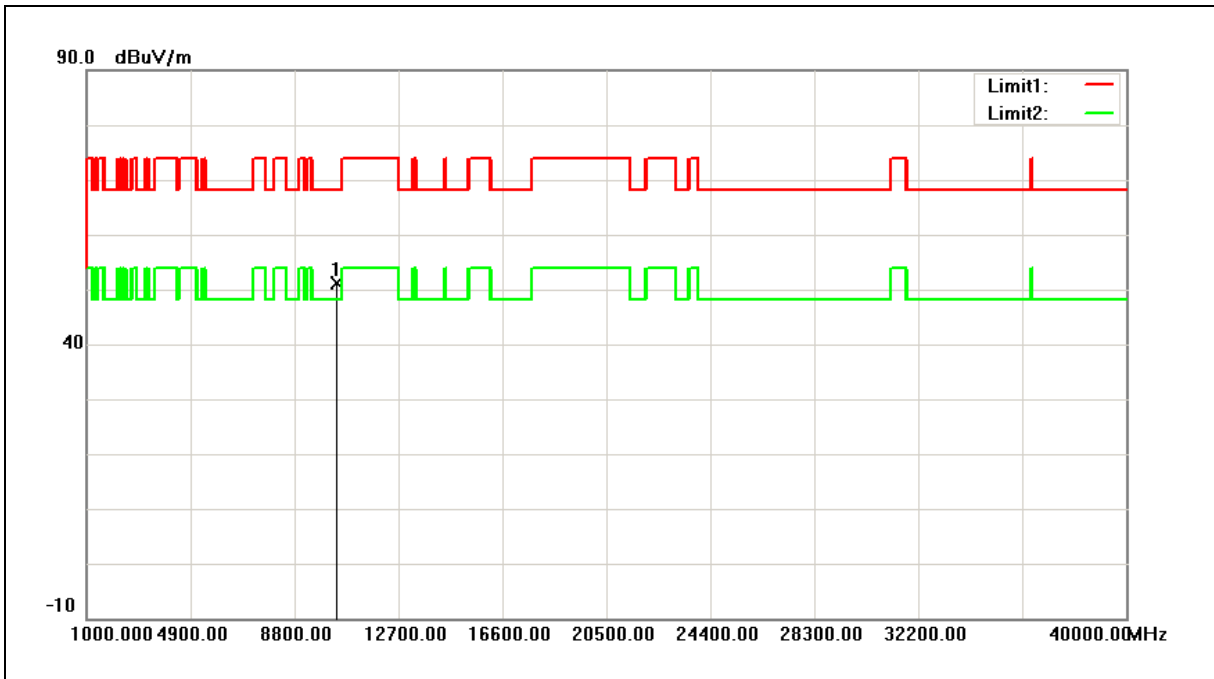

No.	Frequency (MHz)	Reading (dBuV)	Correct Factor (dB/m)	Result (dBuV/m)	Limit (dBuV/m)	Margin (dB)	Remark
1	10400.000	45.75	5.33	51.08	68.20	-17.12	peak

- Note:1.Result (dBuV/m) = Correct Factor (dB/m) + Reading(dBuV).
 2.Correction factor (dB/m) = Antenna Factor (dB/m) + Cable loss (dB) – Pre-Amplifier gain (dB).
 3. When the peak results are less than average limit, so not need to evaluate the average.



Standard:	FCC Part 15.407	Test Distance:	3m
Test item:	Harmonic	Power:	AC 120V/60Hz
Frequency:	5240MHz	Temp.(°C)/Hum.(%RH):	26(°C)/60%RH
Mode:	Mode 3	Date:	04/25/2016
Ant.Polar.:	Horizontal		

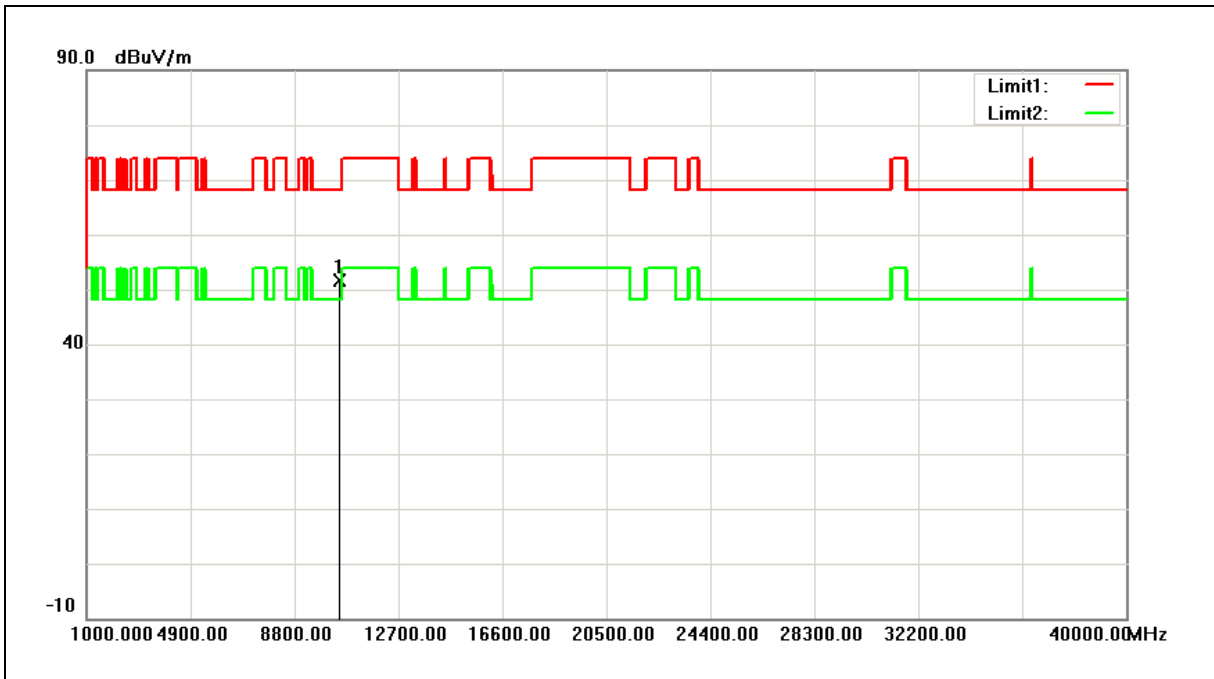

No.	Frequency (MHz)	Reading (dBuV)	Correct Factor (dB/m)	Result (dBuV/m)	Limit (dBuV/m)	Margin (dB)	Remark
1	10480.000	46.01	5.55	51.56	68.20	-16.64	peak

- Note:1.Result (dBuV/m) = Correct Factor (dB/m) + Reading(dBuV).
- 2.Correction factor (dB/m) = Antenna Factor (dB/m) + Cable loss (dB) – Pre-Amplifier gain (dB).
3. When the peak results are less than average limit, so not need to evaluate the average.



Standard:	FCC Part 15.407	Test Distance:	3m
Test item:	Harmonic	Power:	AC 120V/60Hz
Frequency:	5240MHz	Temp.(°C)/Hum.(%RH):	26(°C)/60%RH
Mode:	Mode 3	Date:	04/25/2016
Ant.Polar.:	Vertical		

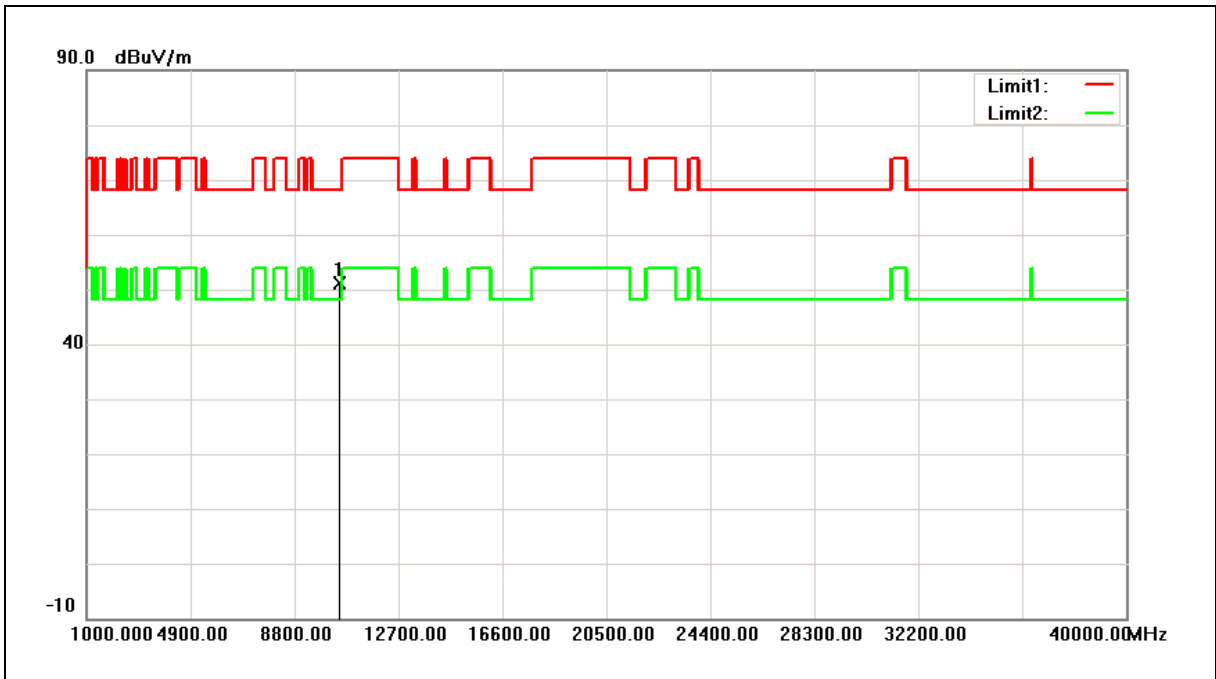

No.	Frequency (MHz)	Reading (dBuV)	Correct Factor (dB/m)	Result (dBuV/m)	Limit (dBuV/m)	Margin (dB)	Remark
1	10480.000	45.69	5.55	51.24	68.20	-16.96	peak

- Note:1.Result (dBuV/m) = Correct Factor (dB/m) + Reading(dBuV).
 2.Correction factor (dB/m) = Antenna Factor (dB/m) + Cable loss (dB) – Pre-Amplifier gain (dB).
 3. When the peak results are less than average limit, so not need to evaluate the average.



Standard:	FCC Part 15.407	Test Distance:	3m
Test item:	Harmonic	Power:	AC 120V/60Hz
Frequency:	5260MHz	Temp.(°C)/Hum.(%RH):	26(°C)/60%RH
Mode:	Mode 3	Date:	04/25/2016
Ant.Polar.:	Horizontal		

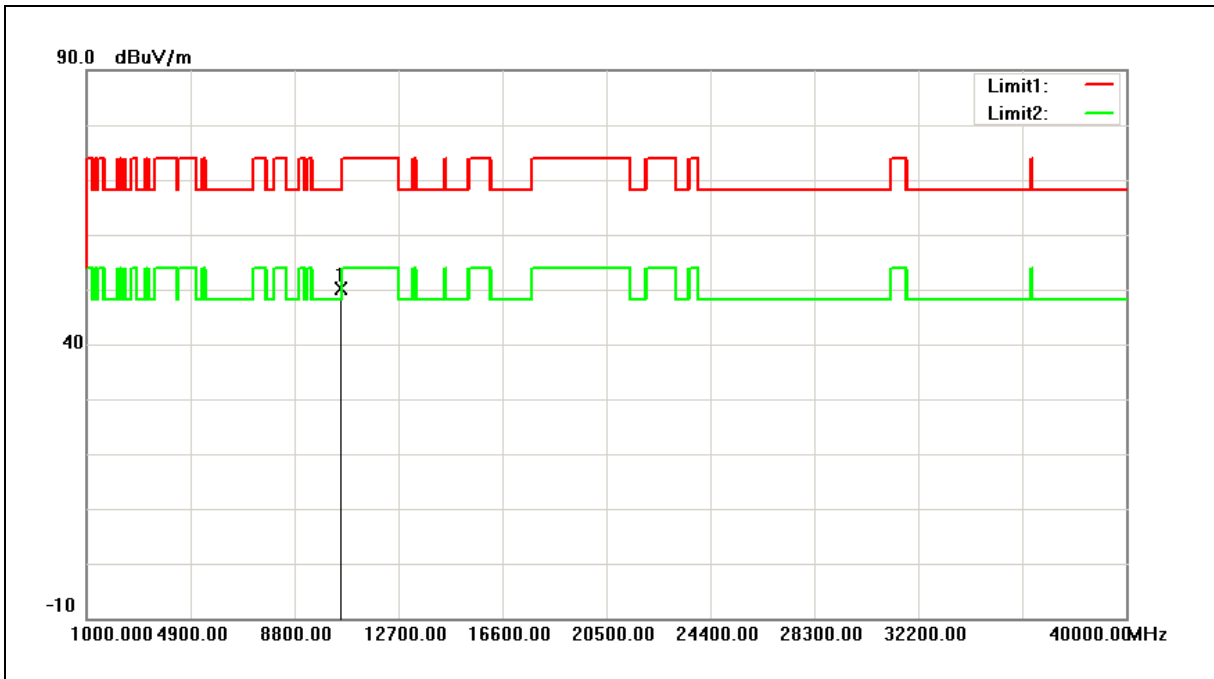

No.	Frequency (MHz)	Reading (dBuV)	Correct Factor (dB/m)	Result (dBuV/m)	Limit (dBuV/m)	Margin (dB)	Remark
1	10520.000	44.44	5.64	50.08	68.20	-18.12	peak

- Note:1.Result (dBuV/m) = Correct Factor (dB/m) + Reading(dBuV).
- 2.Correction factor (dB/m) = Antenna Factor (dB/m) + Cable loss (dB) – Pre-Amplifier gain (dB).
3. When the peak results are less than average limit, so not need to evaluate the average.



Standard:	FCC Part 15.407	Test Distance:	3m
Test item:	Harmonic	Power:	AC 120V/60Hz
Frequency:	5260MHz	Temp.(°C)/Hum.(%RH):	26(°C)/60%RH
Mode:	Mode 3	Date:	04/25/2016
Ant.Polar.:	Vertical		

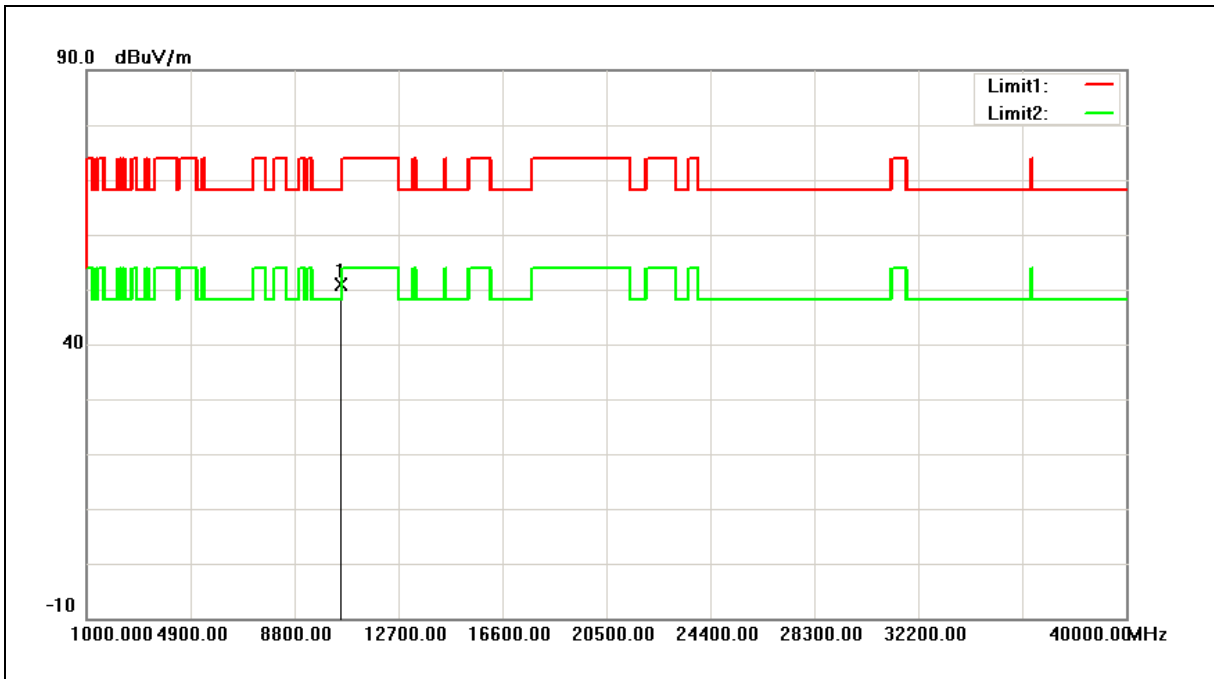

No.	Frequency (MHz)	Reading (dBuV)	Correct Factor (dB/m)	Result (dBuV/m)	Limit (dBuV/m)	Margin (dB)	Remark
1	10520.000	45.13	5.64	50.77	68.20	-17.43	peak

- Note:1.Result (dBuV/m) = Correct Factor (dB/m) + Reading(dBuV).
- 2.Correction factor (dB/m) = Antenna Factor (dB/m) + Cable loss (dB) – Pre-Amplifier gain (dB).
3. When the peak results are less than average limit, so not need to evaluate the average.



Standard:	FCC Part 15.407	Test Distance:	3m
Test item:	Harmonic	Power:	AC 120V/60Hz
Frequency:	5280MHz	Temp.(°C)/Hum. (%RH):	26(°C)/60%RH
Mode:	Mode 3	Date:	04/25/2016
Ant.Polar.:	Horizontal		

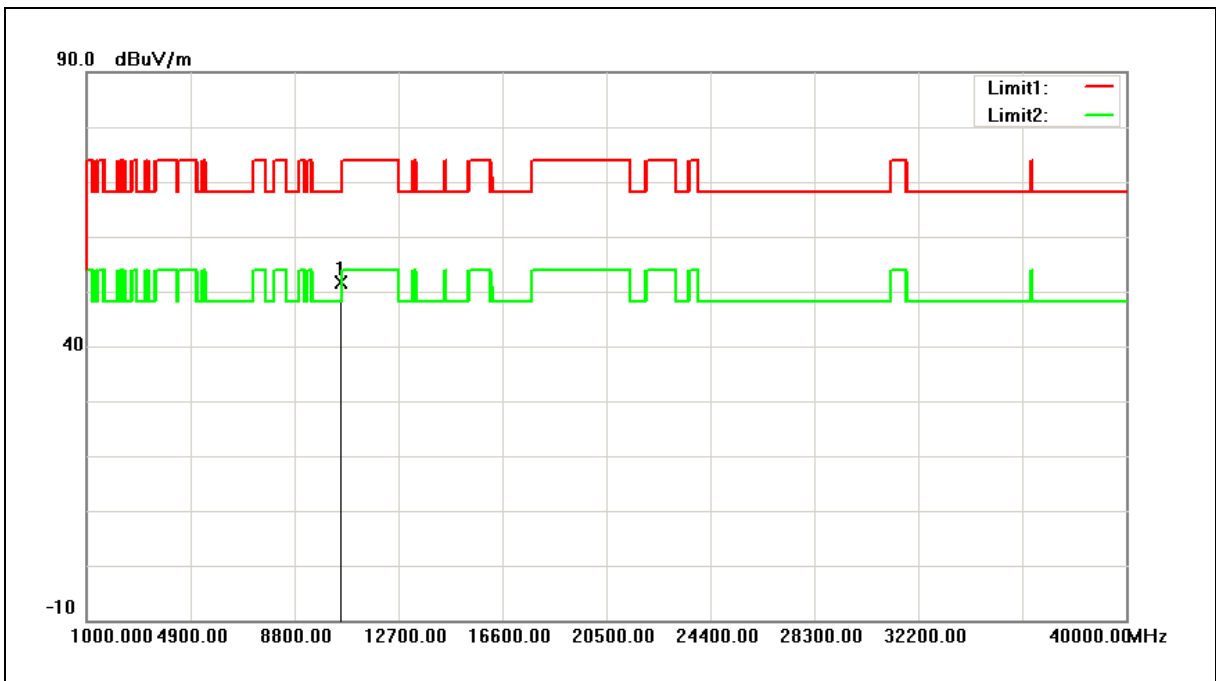

No.	Frequency (MHz)	Reading (dBuV)	Correct Factor (dB/m)	Result (dBuV/m)	Limit (dBuV/m)	Margin (dB)	Remark
1	10560.000	45.97	5.68	51.65	68.20	-16.55	peak

- Note:1.Result (dBuV/m) = Correct Factor (dB/m) + Reading(dBuV).
 2.Correction factor (dB/m) = Antenna Factor (dB/m) + Cable loss (dB) – Pre-Amplifier gain (dB).
 3. When the peak results are less than average limit, so not need to evaluate the average.



Standard:	FCC Part 15.407	Test Distance:	3m
Test item:	Harmonic	Power:	AC 120V/60Hz
Frequency:	5280MHz	Temp.(°C)/Hum.(%RH):	26(°C)/60%RH
Mode:	Mode 3	Date:	04/25/2016
Ant.Polar.:	Vertical		

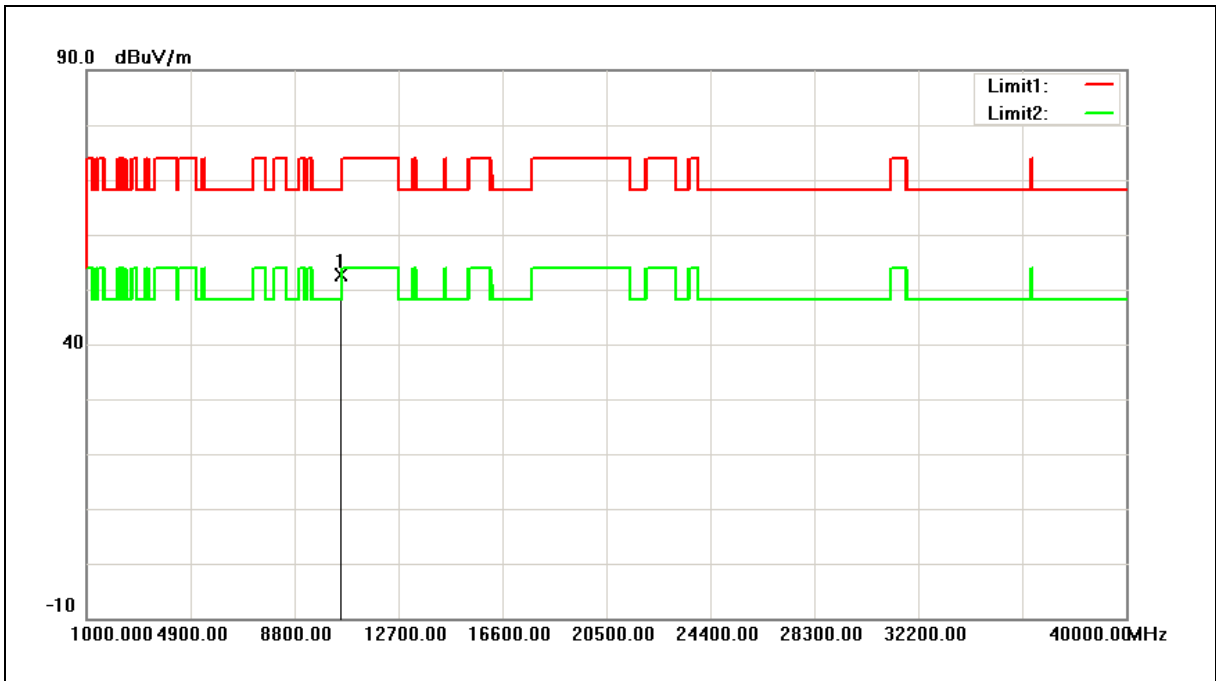

No.	Frequency (MHz)	Reading (dBuV)	Correct Factor (dB/m)	Result (dBuV/m)	Limit (dBuV/m)	Margin (dB)	Remark
1	10560.000	47.05	5.68	52.73	68.20	-15.47	peak

- Note:1.Result (dBuV/m) = Correct Factor (dB/m) + Reading(dBuV).
- 2.Correction factor (dB/m) = Antenna Factor (dB/m) + Cable loss (dB) – Pre-Amplifier gain (dB).
3. When the peak results are less than average limit, so not need to evaluate the average.



Standard:	FCC Part 15.407	Test Distance:	3m
Test item:	Harmonic	Power:	AC 120V/60Hz
Frequency:	5320MHz	Temp.(°C)/Hum.(%RH):	26(°C)/60%RH
Mode:	Mode 3	Date:	04/25/2016
Ant.Polar.:	Horizontal		

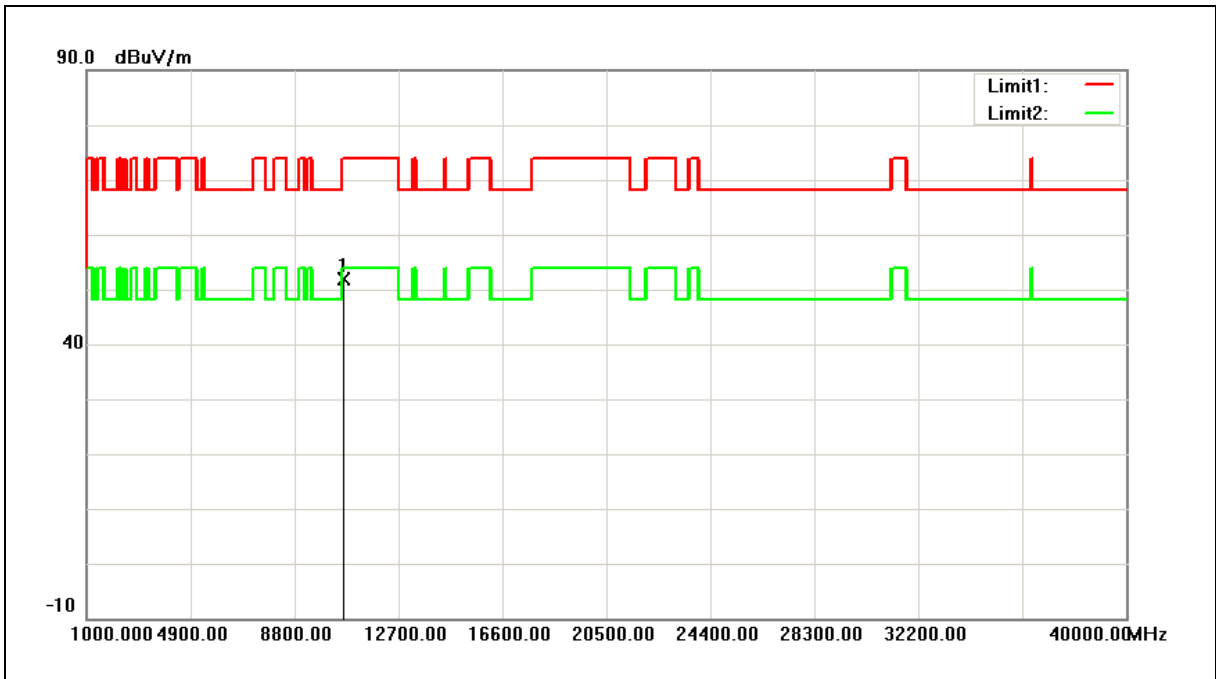

No.	Frequency (MHz)	Reading (dBuV)	Correct Factor (dB/m)	Result (dBuV/m)	Limit (dBuV/m)	Margin (dB)	Remark
1	10640.000	46.04	5.78	51.82	74.00	-22.18	peak

- Note:1.Result (dBuV/m) = Correct Factor (dB/m) + Reading(dBuV).
 2.Correction factor (dB/m) = Antenna Factor (dB/m) + Cable loss (dB) – Pre-Amplifier gain (dB).
 3. When the peak results are less than average limit, so not need to evaluate the average.



Standard:	FCC Part 15.407	Test Distance:	3m
Test item:	Harmonic	Power:	AC 120V/60Hz
Frequency:	5320MHz	Temp.(°C)/Hum.(%RH):	26(°C)/60%RH
Mode:	Mode 3	Date:	04/25/2016
Ant.Polar.:	Vertical		

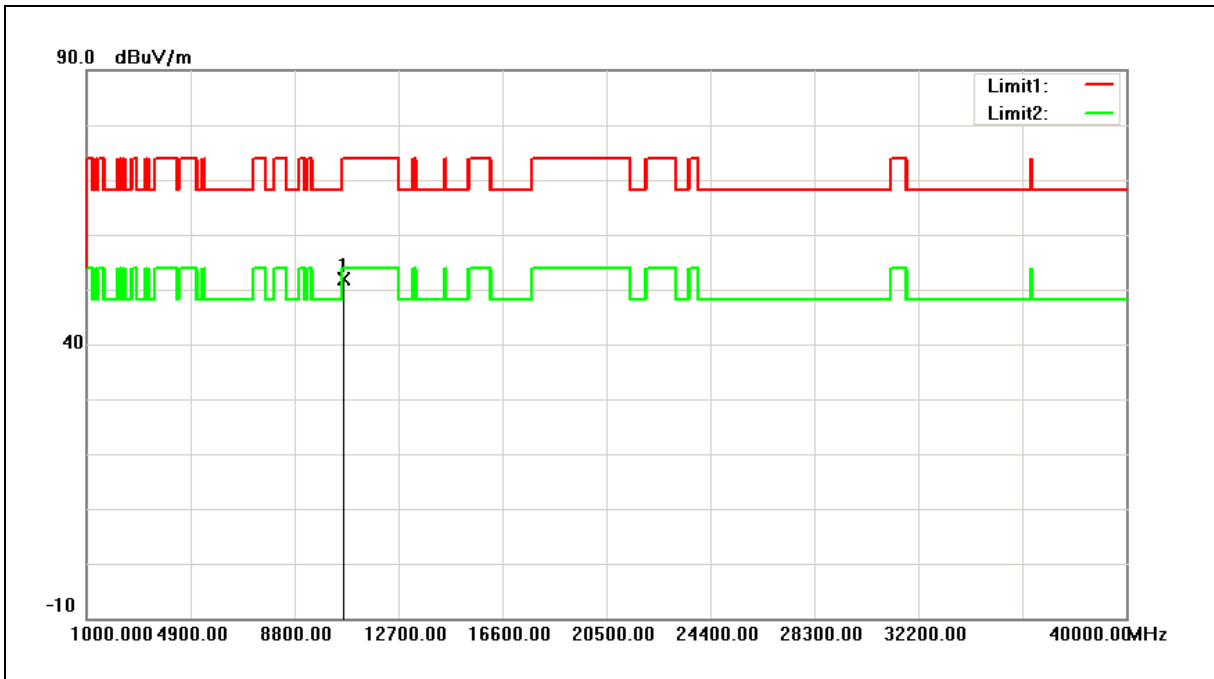

No.	Frequency (MHz)	Reading (dBuV)	Correct Factor (dB/m)	Result (dBuV/m)	Limit (dBuV/m)	Margin (dB)	Remark
1	10640.000	46.13	5.78	51.91	74.00	-22.09	peak

- Note:1.Result (dBuV/m) = Correct Factor (dB/m) + Reading(dBuV).
 2.Correction factor (dB/m) = Antenna Factor (dB/m) + Cable loss (dB) – Pre-Amplifier gain (dB).
 3. When the peak results are less than average limit, so not need to evaluate the average.



Standard:	FCC Part 15.407	Test Distance:	3m
Test item:	Harmonic	Power:	AC 120V/60Hz
Frequency:	5500MHz	Temp.(°C)/Hum. (%RH):	26(°C)/60%RH
Mode:	Mode 3	Date:	04/25/2016
Ant.Polar.:	Horizontal		

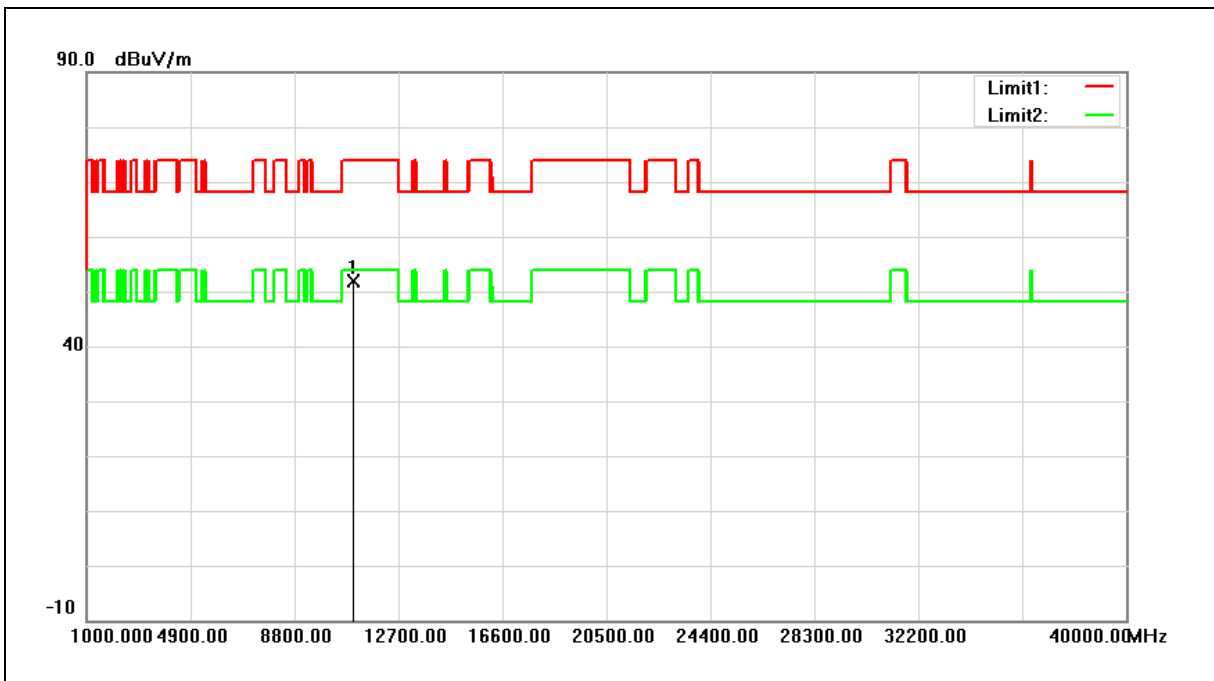

No.	Frequency (MHz)	Reading (dBuV)	Correct Factor (dB/m)	Result (dBuV/m)	Limit (dBuV/m)	Margin (dB)	Remark
1	11000.000	45.70	6.18	51.88	74.00	-22.12	peak

- Note:1.Result (dBuV/m) = Correct Factor (dB/m) + Reading(dBuV).
 2.Correction factor (dB/m) = Antenna Factor (dB/m) + Cable loss (dB) – Pre-Amplifier gain (dB).
 3. When the peak results are less than average limit, so not need to evaluate the average.



Standard:	FCC Part 15.407	Test Distance:	3m
Test item:	Harmonic	Power:	AC 120V/60Hz
Frequency:	5500MHz	Temp.(°C)/Hum.(%RH):	26(°C)/60%RH
Mode:	Mode 3	Date:	04/25/2016
Ant.Polar.:	Vertical		

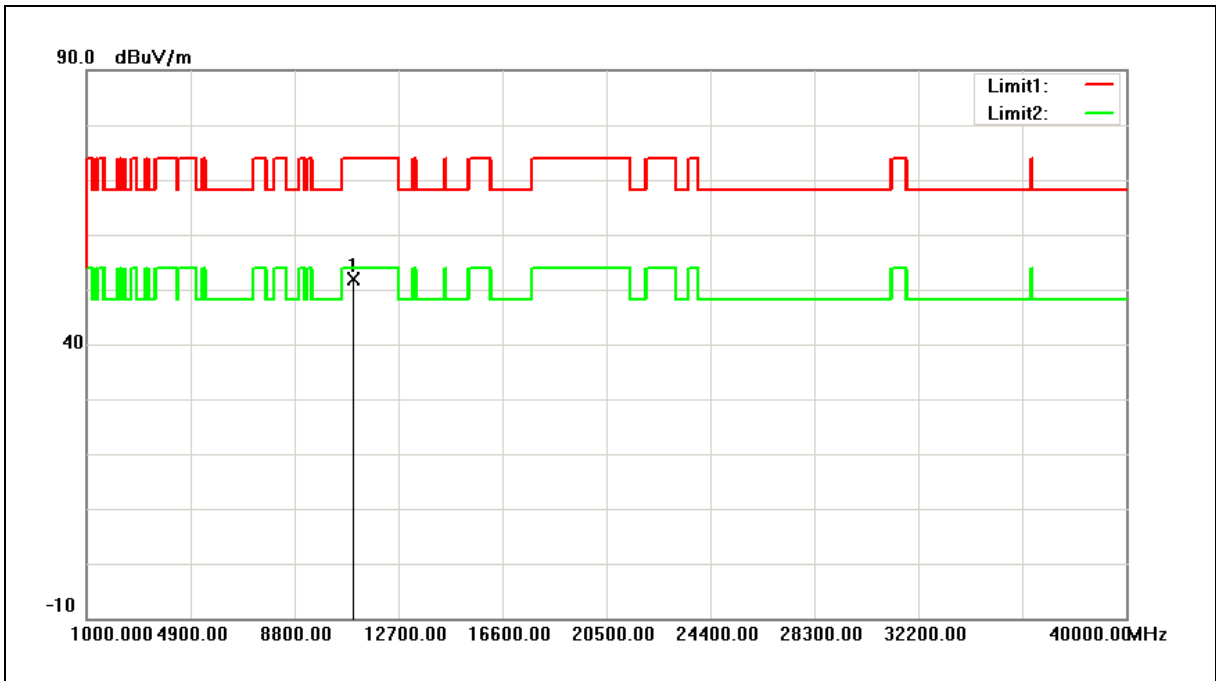

No.	Frequency (MHz)	Reading (dBuV)	Correct Factor (dB/m)	Result (dBuV/m)	Limit (dBuV/m)	Margin (dB)	Remark
1	11000.000	45.71	6.18	51.89	74.00	-22.11	peak

- Note:1.Result (dBuV/m) = Correct Factor (dB/m) + Reading(dBuV).
 2.Correction factor (dB/m) = Antenna Factor (dB/m) + Cable loss (dB) – Pre-Amplifier gain (dB).
 3. When the peak results are less than average limit, so not need to evaluate the average.



Standard:	FCC Part 15.407	Test Distance:	3m
Test item:	Harmonic	Power:	AC 120V/60Hz
Frequency:	5560MHz	Temp.(°C)/Hum. (%RH):	26(°C)/60%RH
Mode:	Mode 3	Date:	04/25/2016
Ant.Polar.:	Horizontal		

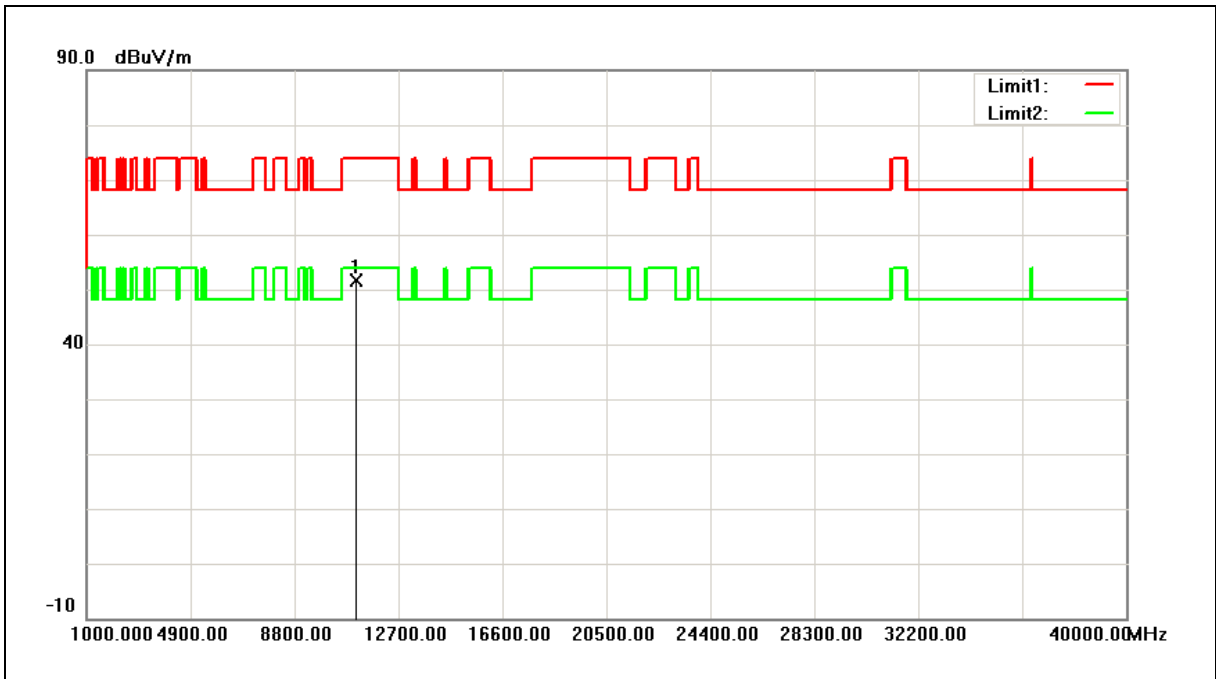

No.	Frequency (MHz)	Reading (dBuV)	Correct Factor (dB/m)	Result (dBuV/m)	Limit (dBuV/m)	Margin (dB)	Remark
1	11120.000	45.32	6.24	51.56	74.00	-22.44	peak

- Note:1.Result (dBuV/m) = Correct Factor (dB/m) + Reading(dBuV).
- 2.Correction factor (dB/m) = Antenna Factor (dB/m) + Cable loss (dB) – Pre-Amplifier gain (dB).
3. When the peak results are less than average limit, so not need to evaluate the average.



Standard:	FCC Part 15.407	Test Distance:	3m
Test item:	Harmonic	Power:	AC 120V/60Hz
Frequency:	5560MHz	Temp.(°C)/Hum.(%RH):	26(°C)/60%RH
Mode:	Mode 3	Date:	04/25/2016
Ant.Polar.:	Vertical		

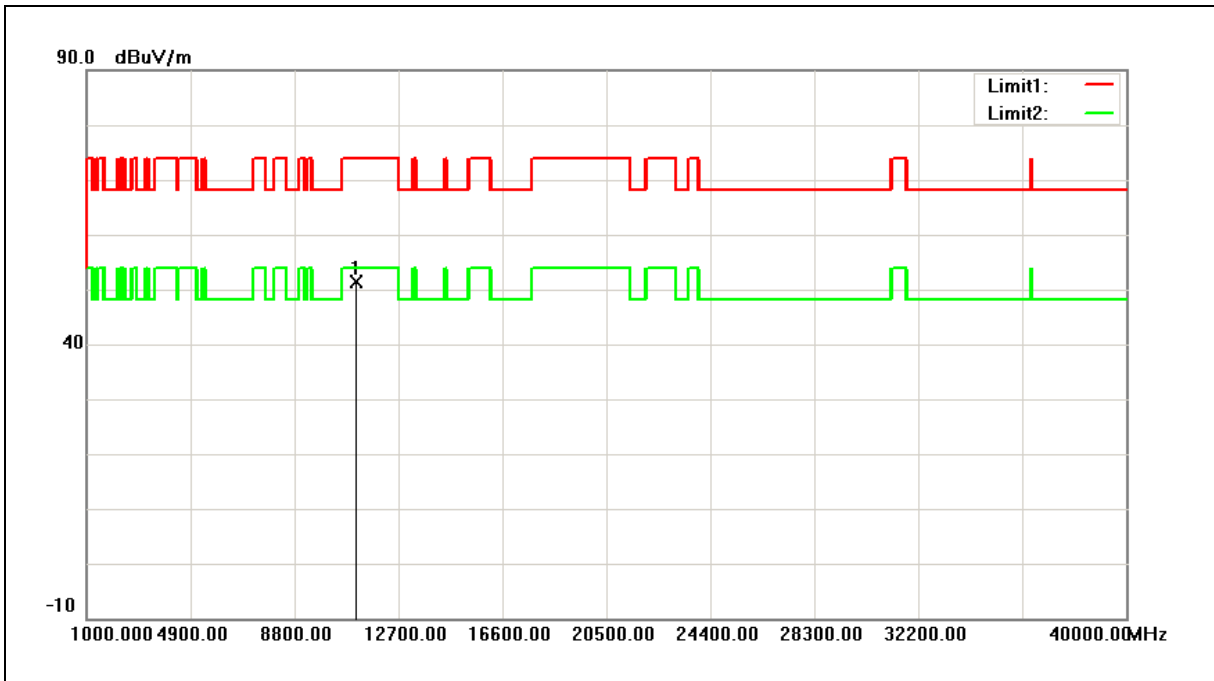

No.	Frequency (MHz)	Reading (dBuV)	Correct Factor (dB/m)	Result (dBuV/m)	Limit (dBuV/m)	Margin (dB)	Remark
1	11120.000	45.25	6.24	51.49	74.00	-22.51	peak

- Note:1.Result (dBuV/m) = Correct Factor (dB/m) + Reading(dBuV).
 2.Correction factor (dB/m) = Antenna Factor (dB/m) + Cable loss (dB) – Pre-Amplifier gain (dB).
 3. When the peak results are less than average limit, so not need to evaluate the average.



Standard:	FCC Part 15.407	Test Distance:	3m
Test item:	Harmonic	Power:	AC 120V/60Hz
Frequency:	5700MHz	Temp.(°C)/Hum.(%RH):	26(°C)/60%RH
Mode:	Mode 3	Date:	04/25/2016
Ant.Polar.:	Horizontal		

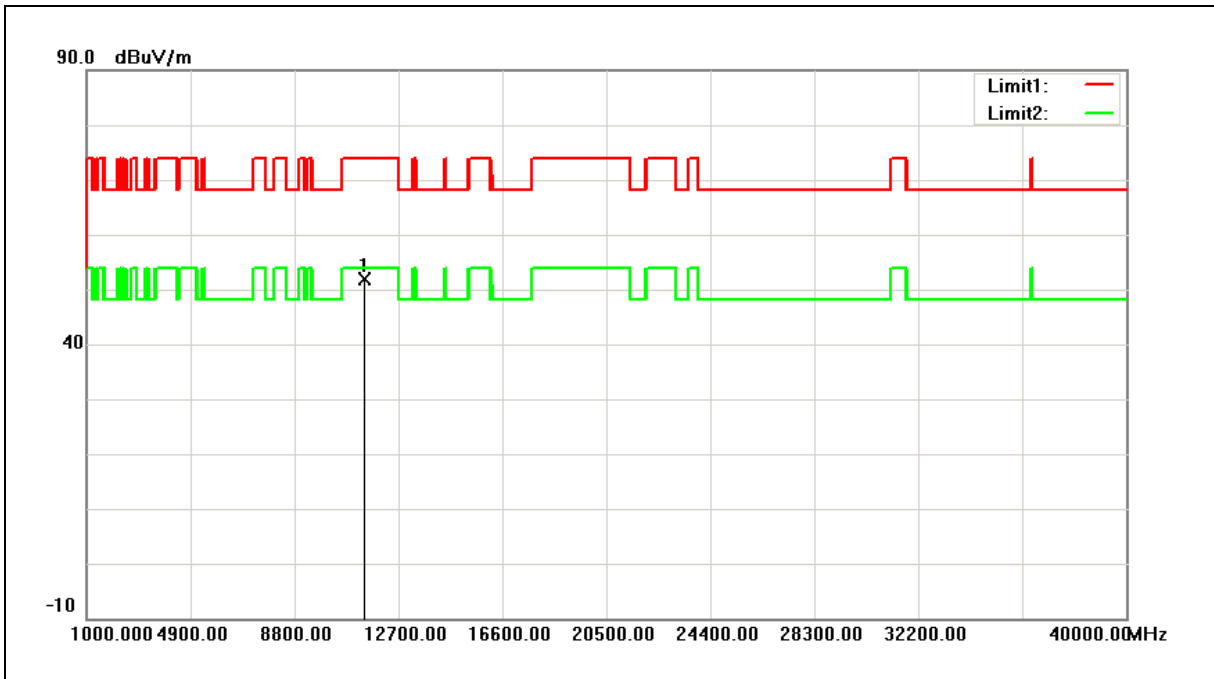

No.	Frequency (MHz)	Reading (dBuV)	Correct Factor (dB/m)	Result (dBuV/m)	Limit (dBuV/m)	Margin (dB)	Remark
1	11400.000	45.37	6.39	51.76	74.00	-22.24	peak

- Note:1.Result (dBuV/m) = Correct Factor (dB/m) + Reading(dBuV).
 2.Correction factor (dB/m) = Antenna Factor (dB/m) + Cable loss (dB) – Pre-Amplifier gain (dB).
 3. When the peak results are less than average limit, so not need to evaluate the average.



Standard:	FCC Part 15.407	Test Distance:	3m
Test item:	Harmonic	Power:	AC 120V/60Hz
Frequency:	5700MHz	Temp.(°C)/Hum.(%RH):	26(°C)/60%RH
Mode:	Mode 3	Date:	04/25/2016
Ant.Polar.:	Vertical		

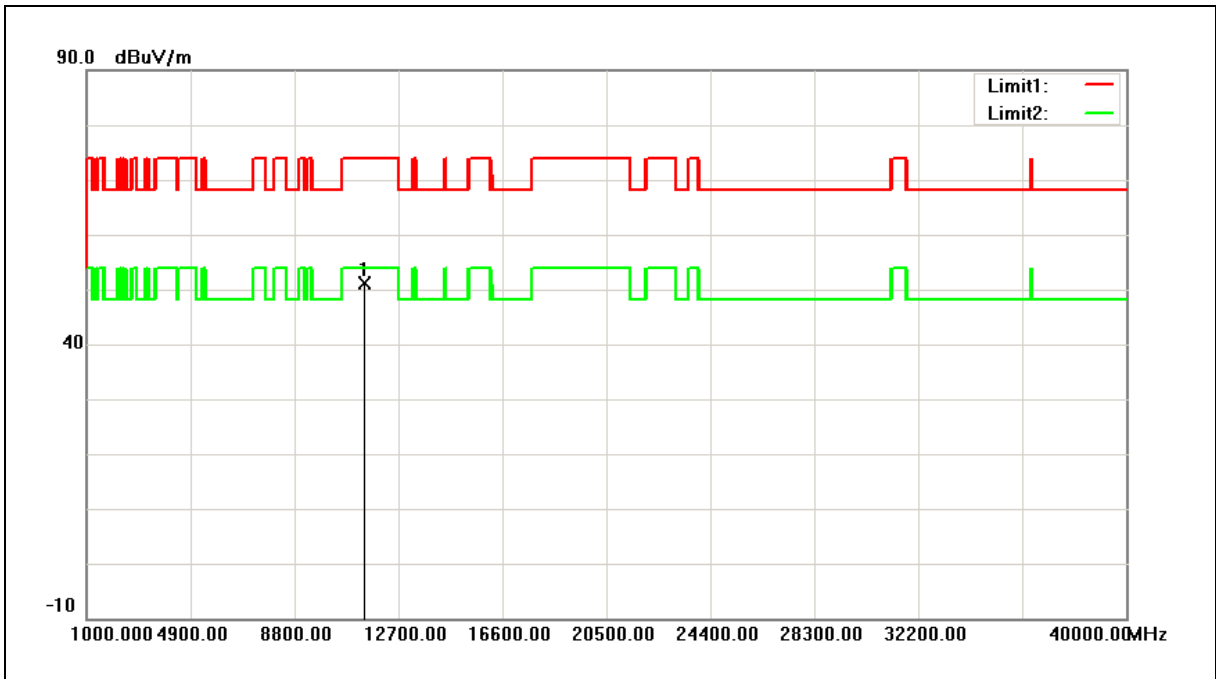

No.	Frequency (MHz)	Reading (dBuV)	Correct Factor (dB/m)	Result (dBuV/m)	Limit (dBuV/m)	Margin (dB)	Remark
1	11400.000	44.84	6.39	51.23	74.00	-22.77	peak

- Note:1.Result (dBuV/m) = Correct Factor (dB/m) + Reading(dBuV).
 2.Correction factor (dB/m) = Antenna Factor (dB/m) + Cable loss (dB) – Pre-Amplifier gain (dB).
 3. When the peak results are less than average limit, so not need to evaluate the average.



Standard:	FCC Part 15.407	Test Distance:	3m
Test item:	Harmonic	Power:	AC 120V/60Hz
Frequency:	5745MHz	Temp.(°C)/Hum.(%RH):	26(°C)/60%RH
Mode:	Mode 3	Date:	04/25/2016
Ant.Polar.:	Horizontal		

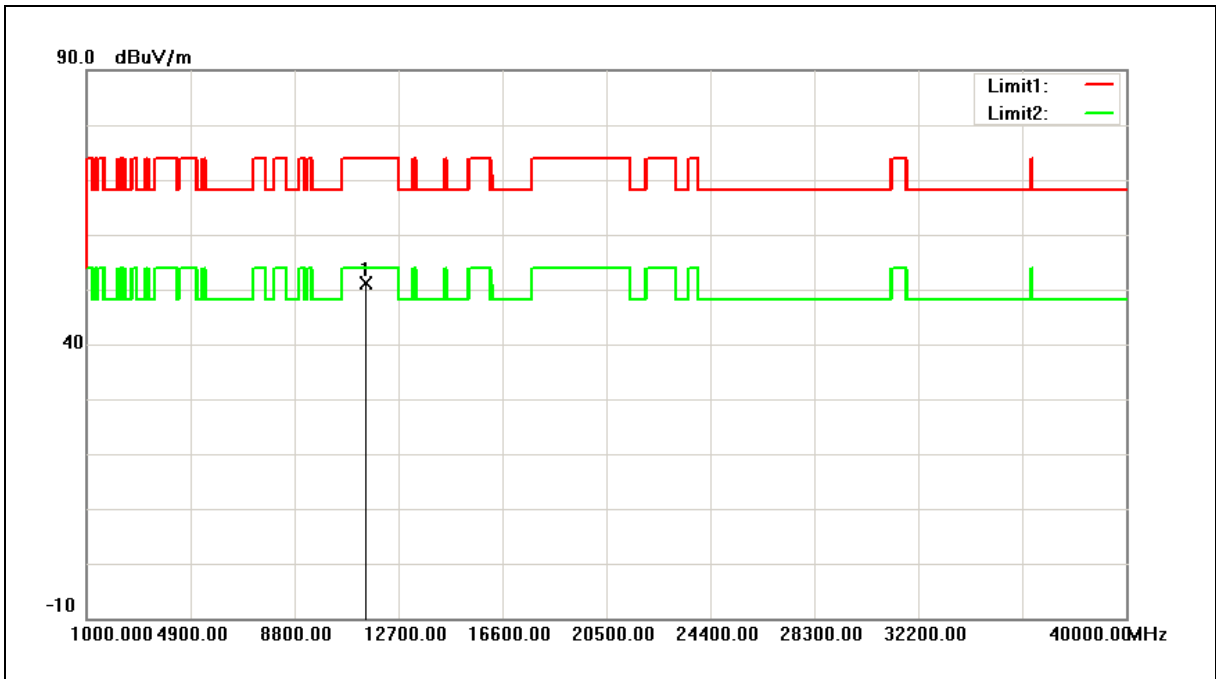

No.	Frequency (MHz)	Reading (dBuV)	Correct Factor (dB/m)	Result (dBuV/m)	Limit (dBuV/m)	Margin (dB)	Remark
1	11490.000	44.72	6.44	51.16	74.00	-22.84	peak

- Note:1.Result (dBuV/m) = Correct Factor (dB/m) + Reading(dBuV).
 2.Correction factor (dB/m) = Antenna Factor (dB/m) + Cable loss (dB) – Pre-Amplifier gain (dB).
 3. When the peak results are less than average limit, so not need to evaluate the average.



Standard:	FCC Part 15.407	Test Distance:	3m
Test item:	Harmonic	Power:	AC 120V/60Hz
Frequency:	5745MHz	Temp.(°C)/Hum.(%RH):	26(°C)/60%RH
Mode:	Mode 3	Date:	04/25/2016
Ant.Polar.:	Vertical		

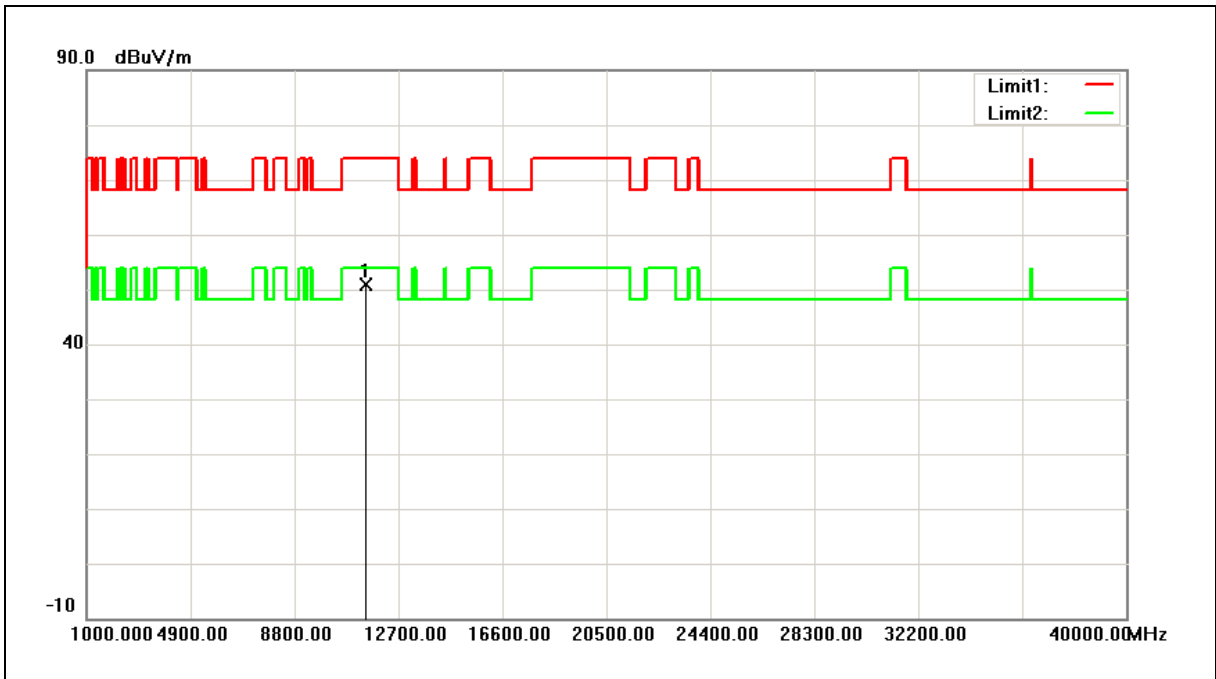

No.	Frequency (MHz)	Reading (dBuV)	Correct Factor (dB/m)	Result (dBuV/m)	Limit (dBuV/m)	Margin (dB)	Remark
1	11490.000	44.41	6.44	50.85	74.00	-23.15	peak

- Note:1.Result (dBuV/m) = Correct Factor (dB/m) + Reading(dBuV).
 2.Correction factor (dB/m) = Antenna Factor (dB/m) + Cable loss (dB) – Pre-Amplifier gain (dB).
 3. When the peak results are less than average limit, so not need to evaluate the average.



Standard:	FCC Part 15.407	Test Distance:	3m
Test item:	Harmonic	Power:	AC 120V/60Hz
Frequency:	5785MHz	Temp.(°C)/Hum.(%RH):	26(°C)/60%RH
Mode:	Mode 3	Date:	04/26/2016
Ant.Polar.:	Horizontal		

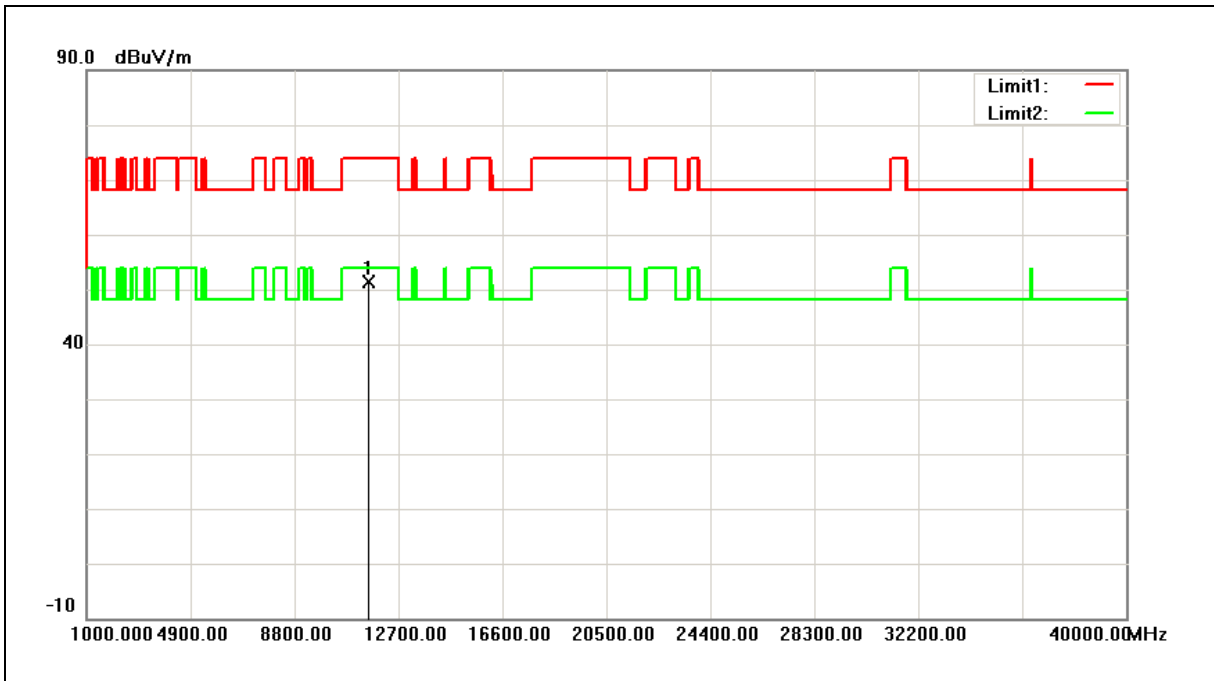

No.	Frequency (MHz)	Reading (dBuV)	Correct Factor (dB/m)	Result (dBuV/m)	Limit (dBuV/m)	Margin (dB)	Remark
1	11570.000	44.70	6.63	51.33	74.00	-22.67	peak

- Note:1.Result (dBuV/m) = Correct Factor (dB/m) + Reading(dBuV).
 2.Correction factor (dB/m) = Antenna Factor (dB/m) + Cable loss (dB) – Pre-Amplifier gain (dB).
 3. When the peak results are less than average limit, so not need to evaluate the average.



Standard:	FCC Part 15.407	Test Distance:	3m
Test item:	Harmonic	Power:	AC 120V/60Hz
Frequency:	5785MHz	Temp.(°C)/Hum. (%RH):	26(°C)/60%RH
Mode:	Mode 3	Date:	04/26/2016
Ant.Polar.:	Vertical		

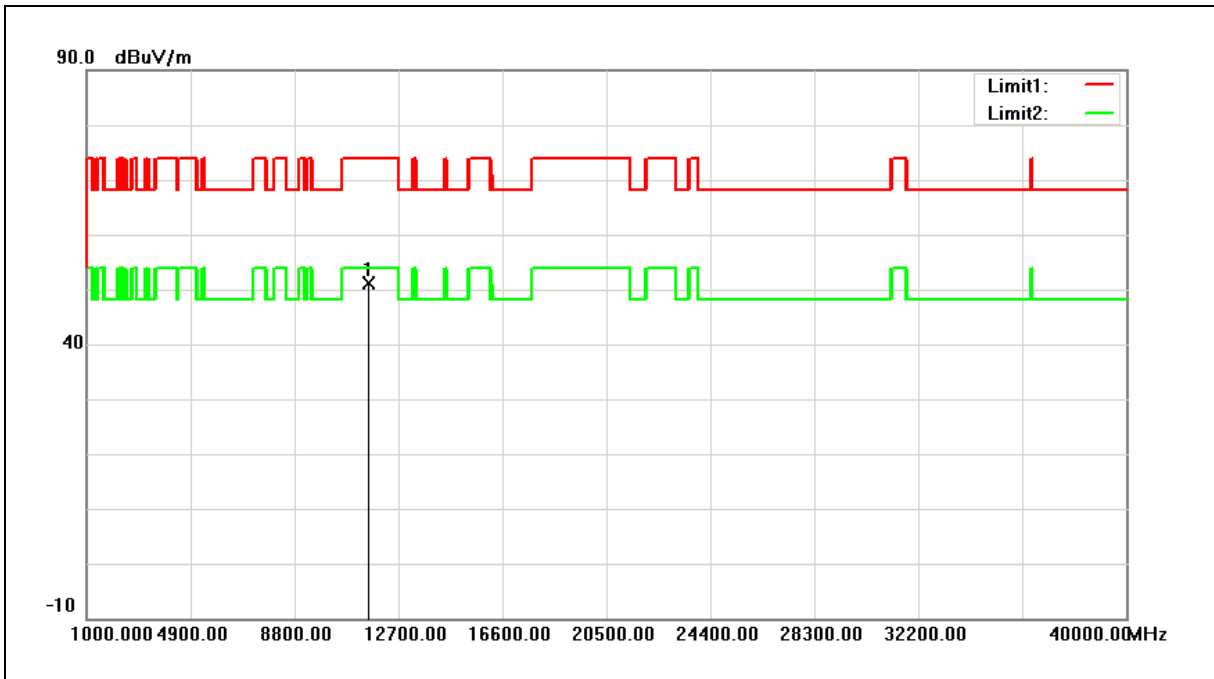

No.	Frequency (MHz)	Reading (dBuV)	Correct Factor (dB/m)	Result (dBuV/m)	Limit (dBuV/m)	Margin (dB)	Remark
1	11570.000	44.62	6.63	51.25	74.00	-22.75	peak

- Note:1.Result (dBuV/m) = Correct Factor (dB/m) + Reading(dBuV).
 2.Correction factor (dB/m) = Antenna Factor (dB/m) + Cable loss (dB) – Pre-Amplifier gain (dB).
 3. When the peak results are less than average limit, so not need to evaluate the average.



Standard:	FCC Part 15.407	Test Distance:	3m
Test item:	Harmonic	Power:	AC 120V/60Hz
Frequency:	5825MHz	Temp.(°C)/Hum.(%RH):	26(°C)/60%RH
Mode:	Mode 3	Date:	04/26/2016
Ant.Polar.:	Horizontal		

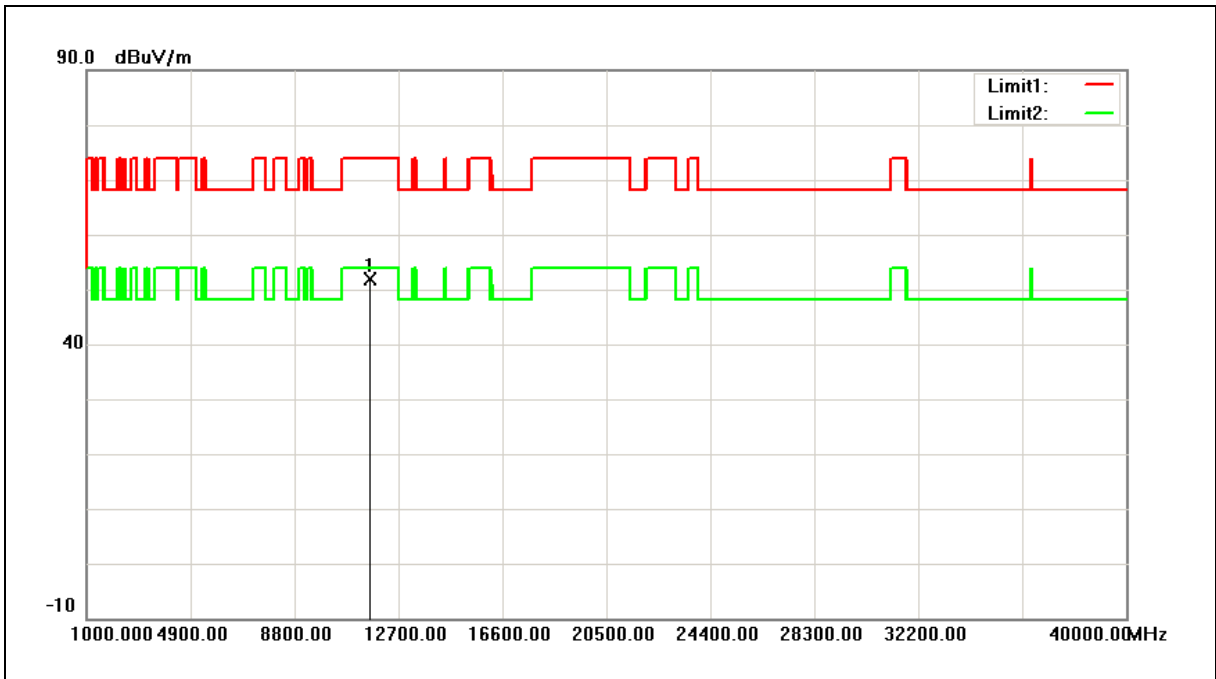

No.	Frequency (MHz)	Reading (dBuV)	Correct Factor (dB/m)	Result (dBuV/m)	Limit (dBuV/m)	Margin (dB)	Remark
1	11650.000	45.06	6.85	51.91	74.00	-22.09	peak

- Note:1.Result (dBuV/m) = Correct Factor (dB/m) + Reading(dBuV).
 2.Correction factor (dB/m) = Antenna Factor (dB/m) + Cable loss (dB) – Pre-Amplifier gain (dB).
 3. When the peak results are less than average limit, so not need to evaluate the average.



Standard:	FCC Part 15.407	Test Distance:	3m
Test item:	Harmonic	Power:	AC 120V/60Hz
Frequency:	5825MHz	Temp.(°C)/Hum.(%RH):	26(°C)/60%RH
Mode:	Mode 3	Date:	04/26/2016
Ant.Polar.:	Vertical		

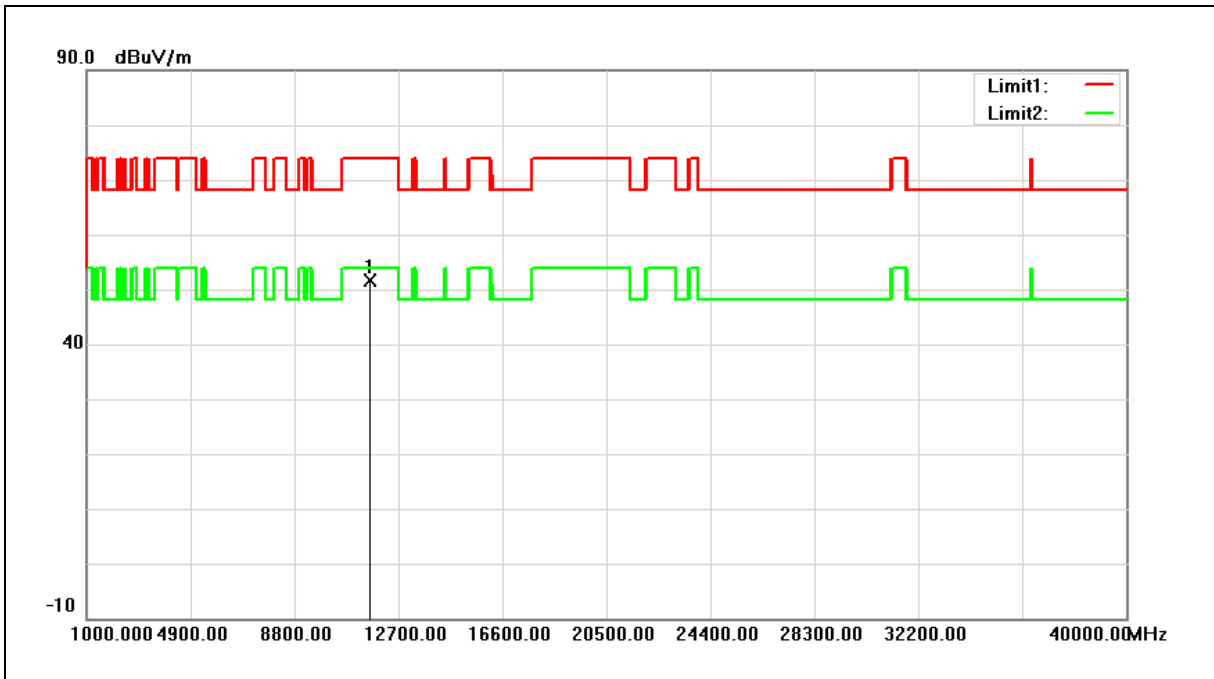

No.	Frequency (MHz)	Reading (dBuV)	Correct Factor (dB/m)	Result (dBuV/m)	Limit (dBuV/m)	Margin (dB)	Remark
1	11650.000	44.77	6.85	51.62	74.00	-22.38	peak

- Note:1.Result (dBuV/m) = Correct Factor (dB/m) + Reading(dBuV).
 2.Correction factor (dB/m) = Antenna Factor (dB/m) + Cable loss (dB) – Pre-Amplifier gain (dB).
 3. When the peak results are less than average limit, so not need to evaluate the average.



Standard:	FCC Part 15.407	Test Distance:	3m
Test item:	Harmonic	Power:	AC 120V/60Hz
Frequency:	5190MHz	Temp.(°C)/Hum. (%RH):	26(°C)/60%RH
Mode:	Mode 4	Date:	04/26/2016
Ant.Polar.:	Horizontal		

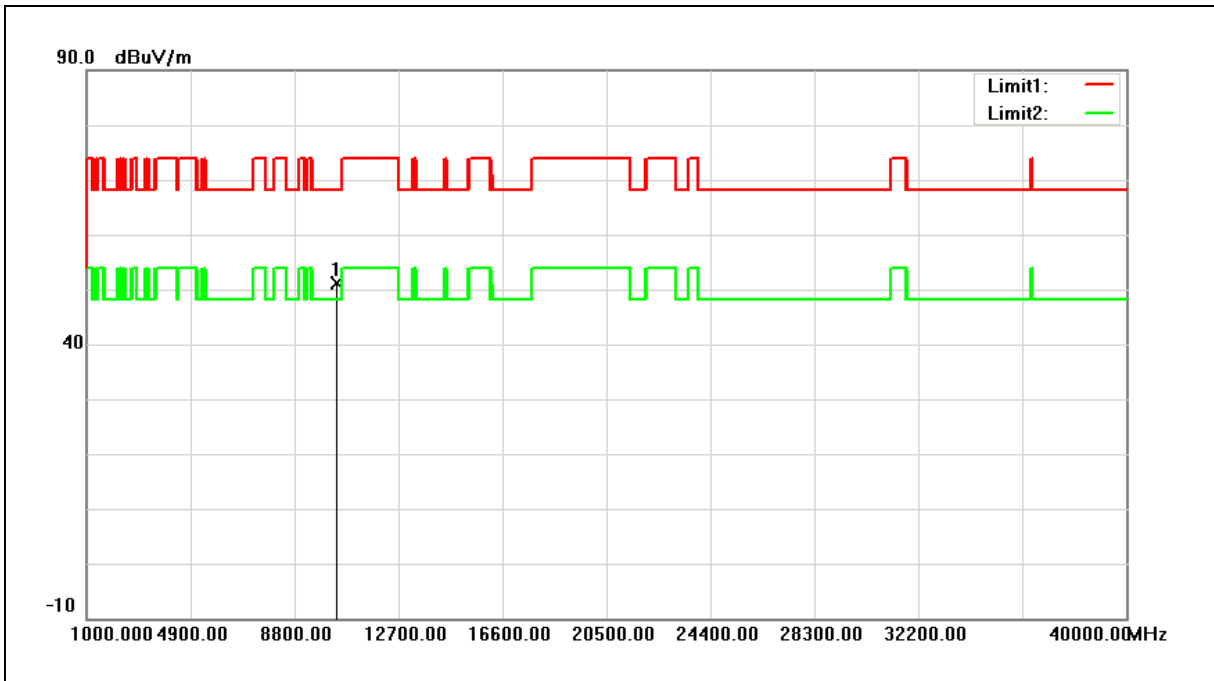

No.	Frequency (MHz)	Reading (dBuV)	Correct Factor (dB/m)	Result (dBuV/m)	Limit (dBuV/m)	Margin (dB)	Remark
1	10380.000	45.84	5.27	51.11	68.20	-17.09	peak

- Note:1.Result (dBuV/m) = Correct Factor (dB/m) + Reading(dBuV).
 2.Correction factor (dB/m) = Antenna Factor (dB/m) + Cable loss (dB) – Pre-Amplifier gain (dB).
 3. When the peak results are less than average limit, so not need to evaluate the average.



Standard:	FCC Part 15.407	Test Distance:	3m
Test item:	Harmonic	Power:	AC 120V/60Hz
Frequency:	5190MHz	Temp.(°C)/Hum.(%RH):	26(°C)/60%RH
Mode:	Mode 4	Date:	04/26/2016
Ant.Polar.:	Vertical		

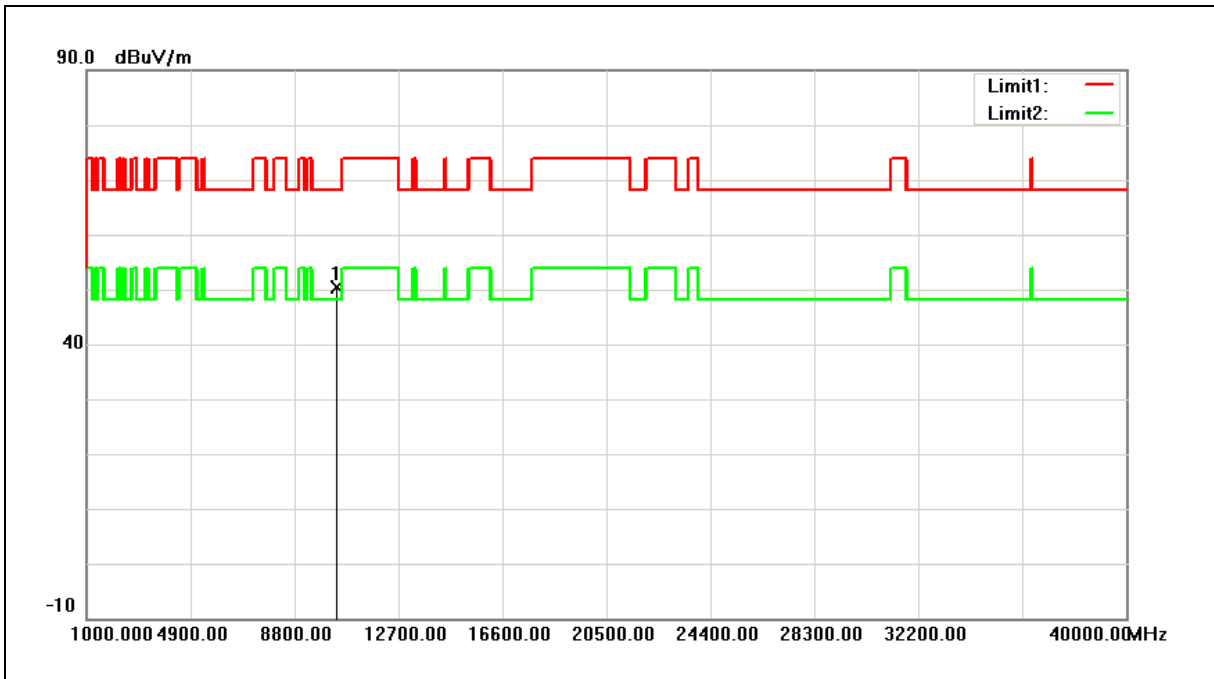

No.	Frequency (MHz)	Reading (dBuV)	Correct Factor (dB/m)	Result (dBuV/m)	Limit (dBuV/m)	Margin (dB)	Remark
1	10380.000	45.02	5.27	50.29	68.20	-17.91	peak

- Note:1.Result (dBuV/m) = Correct Factor (dB/m) + Reading(dBuV).
 2.Correction factor (dB/m) = Antenna Factor (dB/m) + Cable loss (dB) – Pre-Amplifier gain (dB).
 3. When the peak results are less than average limit, so not need to evaluate the average.



Standard:	FCC Part 15.407	Test Distance:	3m
Test item:	Harmonic	Power:	AC 120V/60Hz
Frequency:	5230MHz	Temp.(°C)/Hum.(%RH):	26(°C)/60%RH
Mode:	Mode 4	Date:	04/26/2016
Ant.Polar.:	Horizontal		

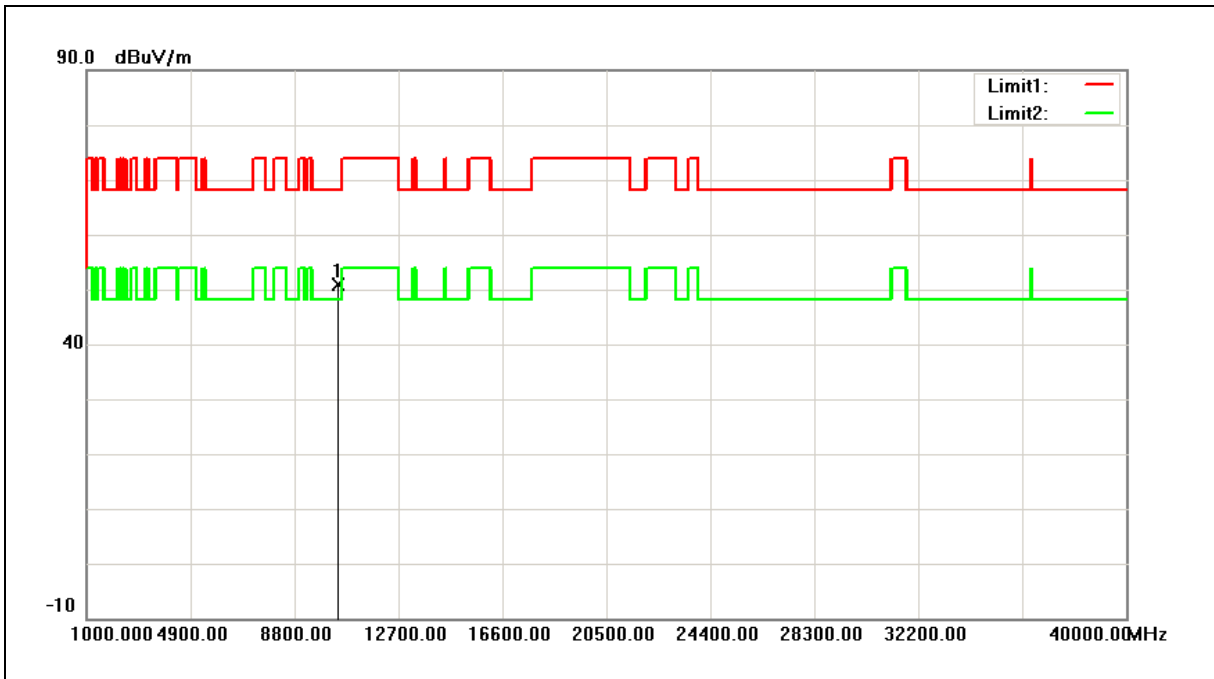

No.	Frequency (MHz)	Reading (dBuV)	Correct Factor (dB/m)	Result (dBuV/m)	Limit (dBuV/m)	Margin (dB)	Remark
1	10460.000	45.47	5.50	50.97	68.20	-17.23	peak

- Note:1.Result (dBuV/m) = Correct Factor (dB/m) + Reading(dBuV).
 2.Correction factor (dB/m) = Antenna Factor (dB/m) + Cable loss (dB) – Pre-Amplifier gain (dB).
 3. When the peak results are less than average limit, so not need to evaluate the average.



Standard:	FCC Part 15.407	Test Distance:	3m
Test item:	Harmonic	Power:	AC 120V/60Hz
Frequency:	5230MHz	Temp.(°C)/Hum.(%RH):	26(°C)/60%RH
Mode:	Mode 4	Date:	04/26/2016
Ant.Polar.:	Vertical		

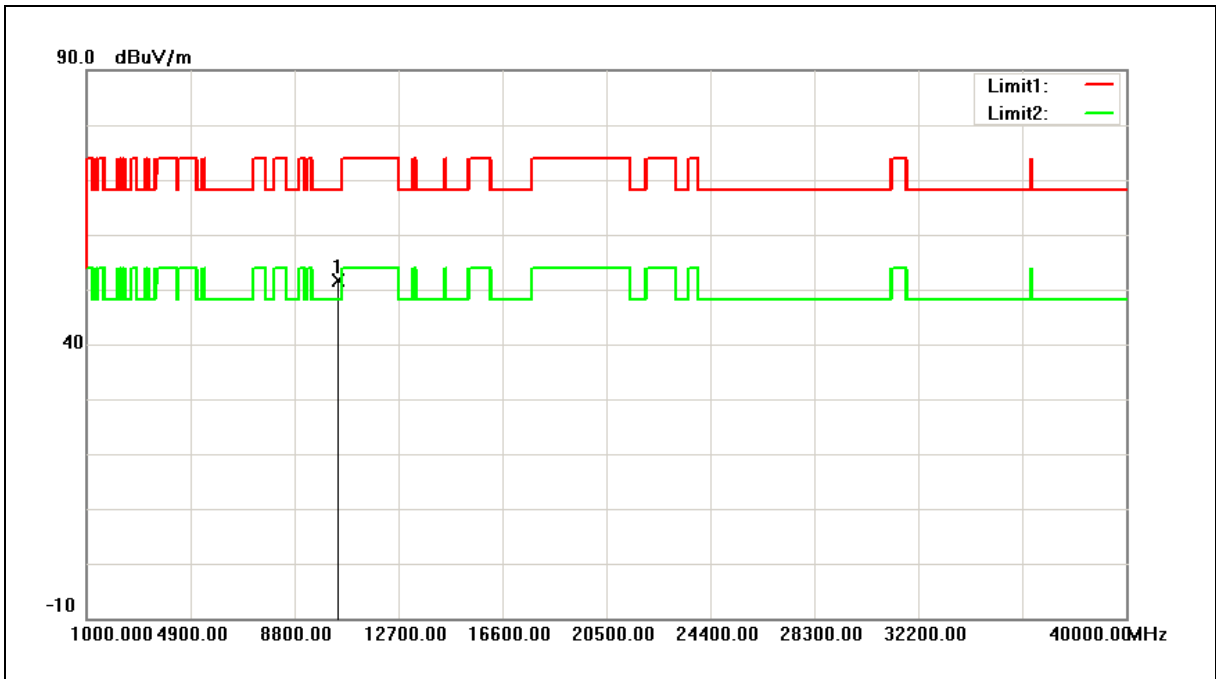

No.	Frequency (MHz)	Reading (dBuV)	Correct Factor (dB/m)	Result (dBuV/m)	Limit (dBuV/m)	Margin (dB)	Remark
1	10460.000	46.06	5.50	51.56	68.20	-16.64	peak

- Note:1.Result (dBuV/m) = Correct Factor (dB/m) + Reading(dBuV).
- 2.Correction factor (dB/m) = Antenna Factor (dB/m) + Cable loss (dB) – Pre-Amplifier gain (dB).
3. When the peak results are less than average limit, so not need to evaluate the average.



Standard:	FCC Part 15.407	Test Distance:	3m
Test item:	Harmonic	Power:	AC 120V/60Hz
Frequency:	5270MHz	Temp.(°C)/Hum.(%RH):	26(°C)/60%RH
Mode:	Mode 4	Date:	04/26/2016
Ant.Polar.:	Horizontal		

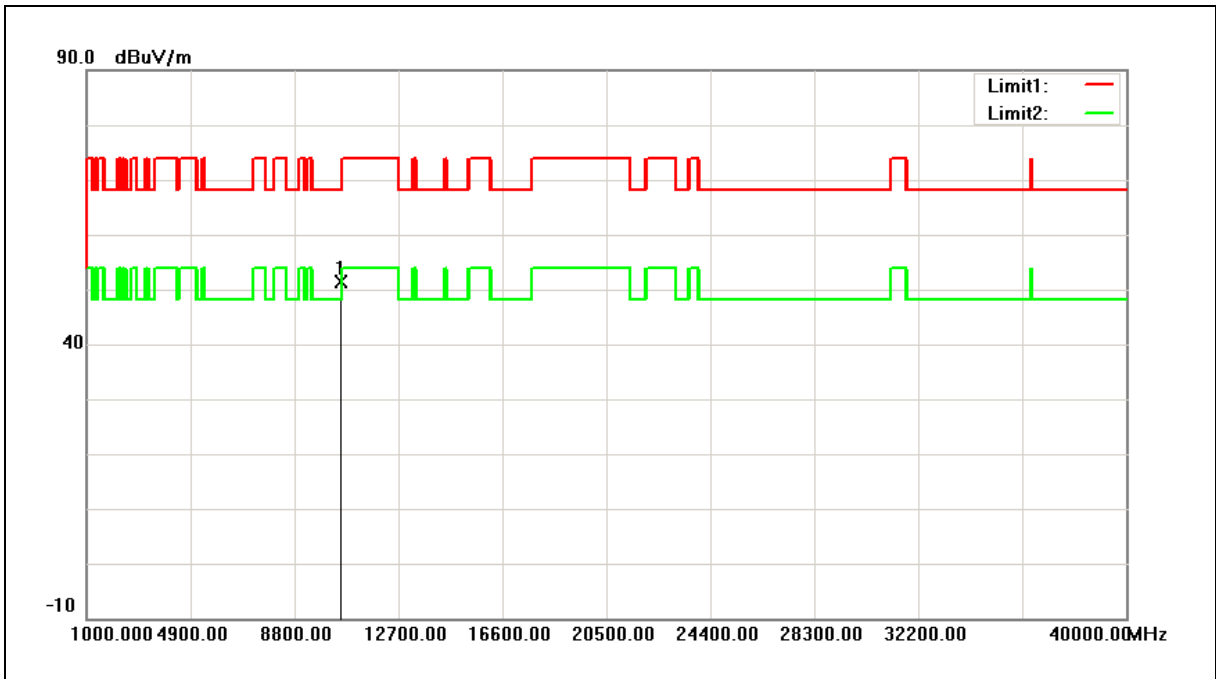

No.	Frequency (MHz)	Reading (dBuV)	Correct Factor (dB/m)	Result (dBuV/m)	Limit (dBuV/m)	Margin (dB)	Remark
1	10540.000	45.76	5.66	51.42	68.20	-16.78	peak

- Note:1.Result (dBuV/m) = Correct Factor (dB/m) + Reading(dBuV).
 2.Correction factor (dB/m) = Antenna Factor (dB/m) + Cable loss (dB) – Pre-Amplifier gain (dB).
 3. When the peak results are less than average limit, so not need to evaluate the average.



Standard:	FCC Part 15.407	Test Distance:	3m
Test item:	Harmonic	Power:	AC 120V/60Hz
Frequency:	5270MHz	Temp.(°C)/Hum.(%RH):	26(°C)/60%RH
Mode:	Mode 4	Date:	04/26/2016
Ant.Polar.:	Vertical		

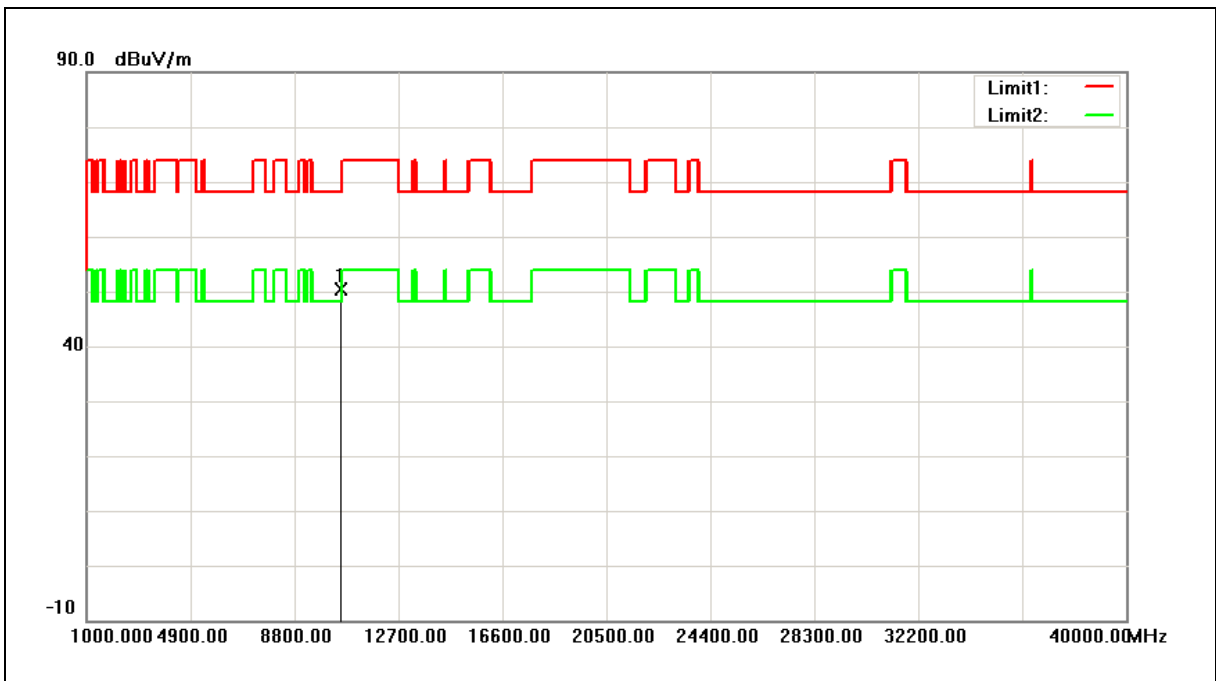

No.	Frequency (MHz)	Reading (dBuV)	Correct Factor (dB/m)	Result (dBuV/m)	Limit (dBuV/m)	Margin (dB)	Remark
1	10540.000	44.70	5.66	50.36	68.20	-17.84	peak

- Note:1.Result (dBuV/m) = Correct Factor (dB/m) + Reading(dBuV).
- 2.Correction factor (dB/m) = Antenna Factor (dB/m) + Cable loss (dB) – Pre-Amplifier gain (dB).
3. When the peak results are less than average limit, so not need to evaluate the average.



Standard:	FCC Part 15.407	Test Distance:	3m
Test item:	Harmonic	Power:	AC 120V/60Hz
Frequency:	5310MHz	Temp.(°C)/Hum. (%RH):	26(°C)/60%RH
Mode:	Mode 4	Date:	04/26/2016
Ant.Polar.:	Horizontal		

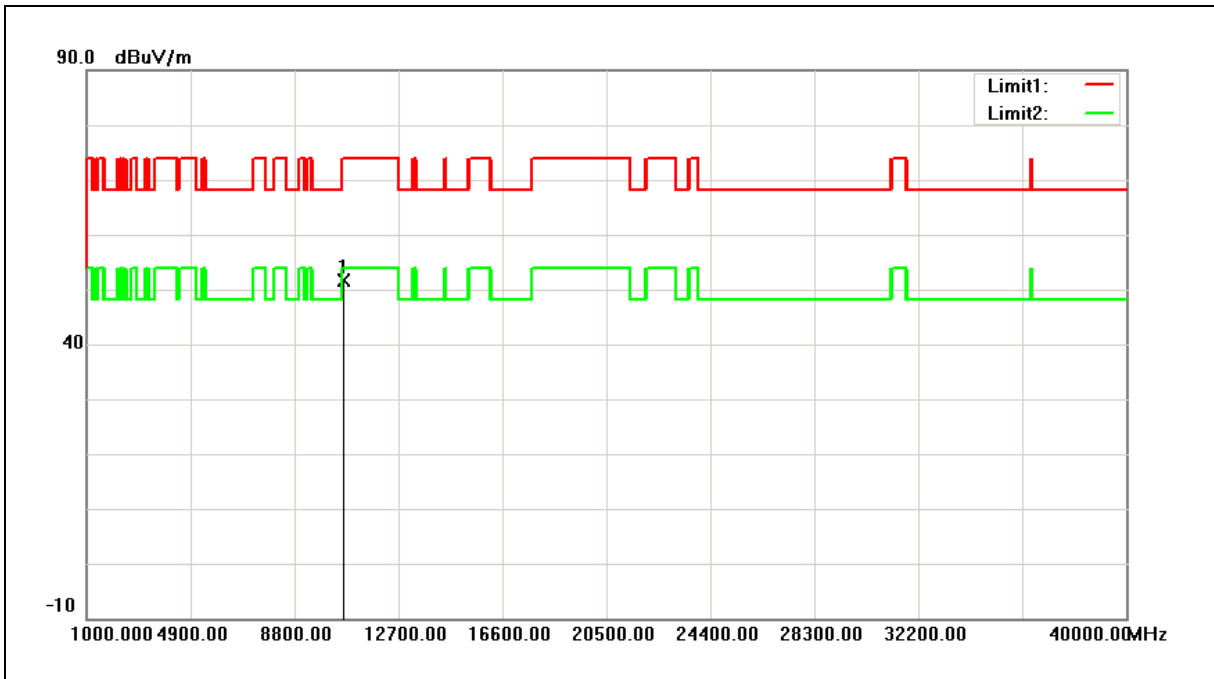

No.	Frequency (MHz)	Reading (dBuV)	Correct Factor (dB/m)	Result (dBuV/m)	Limit (dBuV/m)	Margin (dB)	Remark
1	10620.000	45.77	5.75	51.52	74.00	-22.48	peak

- Note:1.Result (dBuV/m) = Correct Factor (dB/m) + Reading(dBuV).
 2.Correction factor (dB/m) = Antenna Factor (dB/m) + Cable loss (dB) – Pre-Amplifier gain (dB).
 3. When the peak results are less than average limit, so not need to evaluate the average.



Standard:	FCC Part 15.407	Test Distance:	3m
Test item:	Harmonic	Power:	AC 120V/60Hz
Frequency:	5310MHz	Temp.(°C)/Hum.(%RH):	26(°C)/60%RH
Mode:	Mode 4	Date:	04/26/2016
Ant.Polar.:	Vertical		

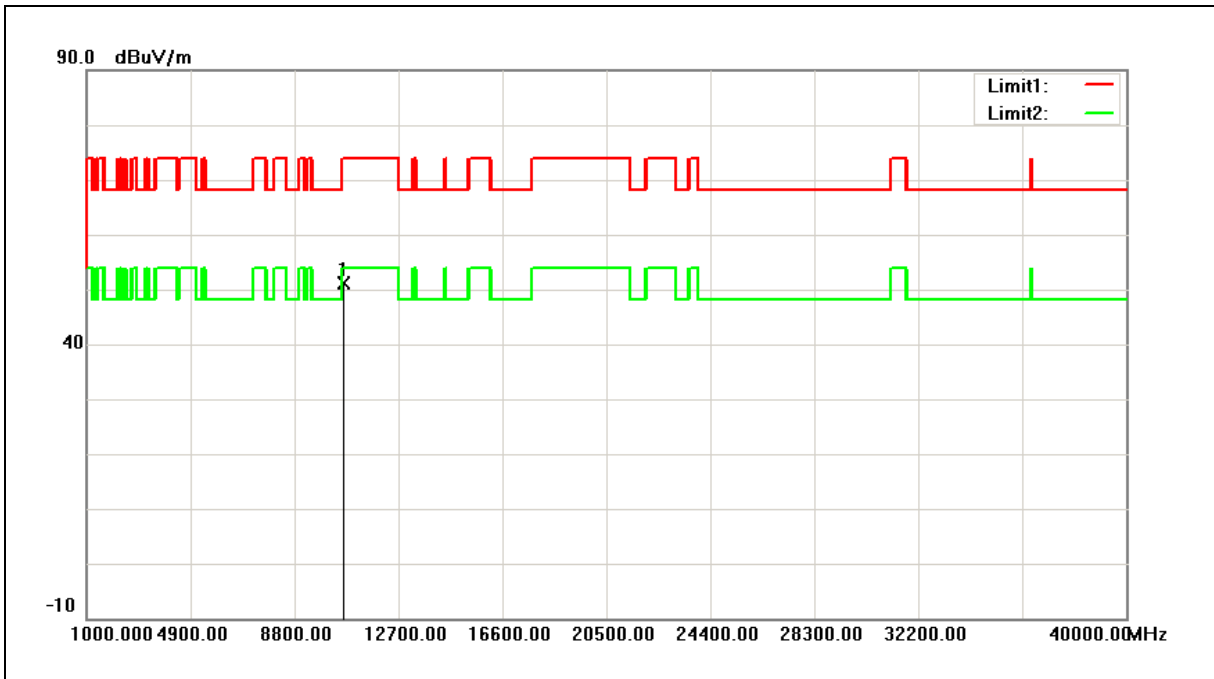

No.	Frequency (MHz)	Reading (dBuV)	Correct Factor (dB/m)	Result (dBuV/m)	Limit (dBuV/m)	Margin (dB)	Remark
1	10620.000	45.32	5.75	51.07	74.00	-22.93	peak

- Note:1.Result (dBuV/m) = Correct Factor (dB/m) + Reading(dBuV).
 2.Correction factor (dB/m) = Antenna Factor (dB/m) + Cable loss (dB) – Pre-Amplifier gain (dB).
 3. When the peak results are less than average limit, so not need to evaluate the average.



Standard:	FCC Part 15.407	Test Distance:	3m
Test item:	Harmonic	Power:	AC 120V/60Hz
Frequency:	5510MHz	Temp.(°C)/Hum.(%RH):	26(°C)/60%RH
Mode:	Mode 4	Date:	04/26/2016
Ant.Polar.:	Horizontal		

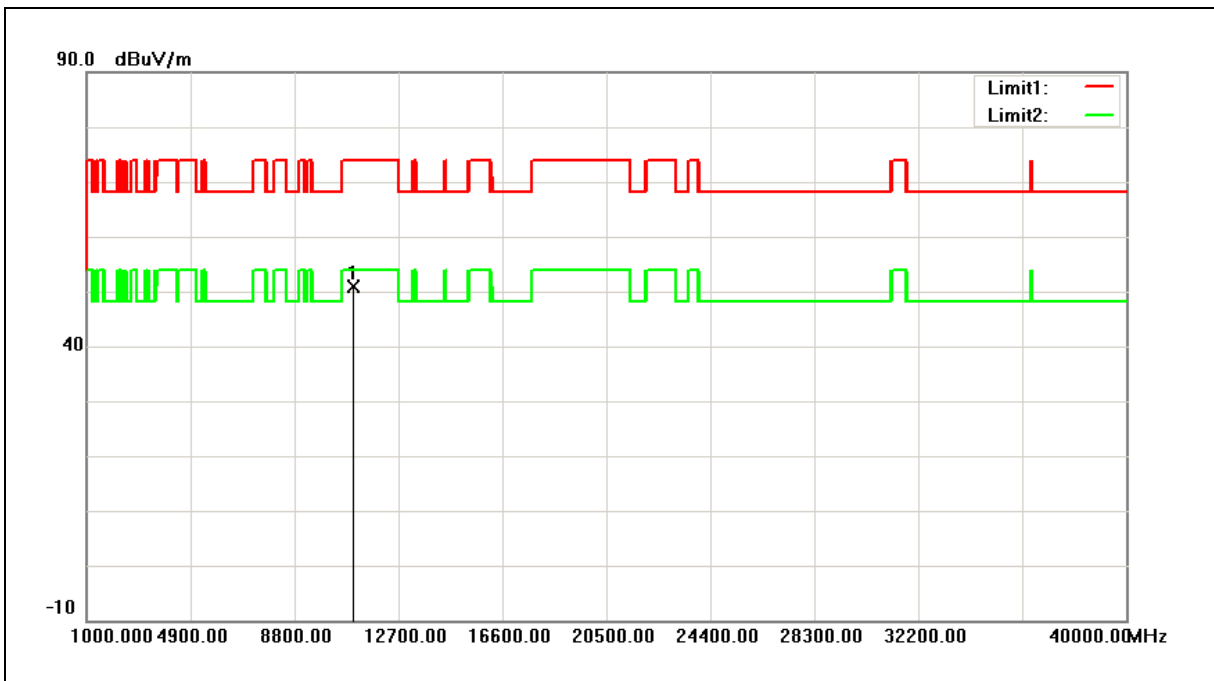

No.	Frequency (MHz)	Reading (dBuV)	Correct Factor (dB/m)	Result (dBuV/m)	Limit (dBuV/m)	Margin (dB)	Remark
1	11020.000	44.78	6.19	50.97	74.00	-23.03	peak

Note:1.Result (dBuV/m) = Correct Factor (dB/m) + Reading(dBuV).

2.Correction factor (dB/m) = Antenna Factor (dB/m) + Cable loss (dB) – Pre-Amplifier gain (dB).

3. When the peak results are less than average limit, so not need to evaluate the average.



Standard:	FCC Part 15.407	Test Distance:	3m
Test item:	Harmonic	Power:	AC 120V/60Hz
Frequency:	5510MHz	Temp.(°C)/Hum.(%RH):	26(°C)/60%RH
Mode:	Mode 4	Date:	04/26/2016
Ant.Polar.:	Vertical		

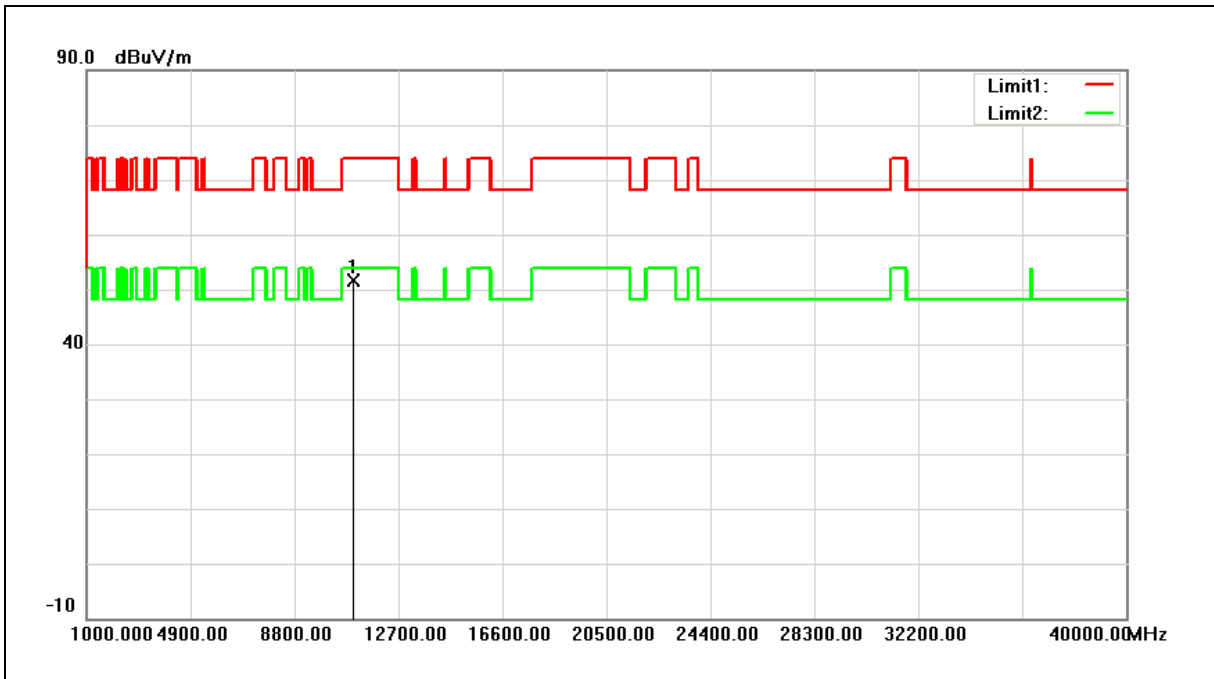

No.	Frequency (MHz)	Reading (dBuV)	Correct Factor (dB/m)	Result (dBuV/m)	Limit (dBuV/m)	Margin (dB)	Remark
1	11020.000	45.32	6.19	51.51	74.00	-22.49	peak

- Note:1.Result (dBuV/m) = Correct Factor (dB/m) + Reading(dBuV).
 2.Correction factor (dB/m) = Antenna Factor (dB/m) + Cable loss (dB) – Pre-Amplifier gain (dB).
 3. When the peak results are less than average limit, so not need to evaluate the average.



Standard:	FCC Part 15.407	Test Distance:	3m
Test item:	Harmonic	Power:	AC 120V/60Hz
Frequency:	5550MHz	Temp.(°C)/Hum. (%RH):	26(°C)/60%RH
Mode:	Mode 4	Date:	04/26/2016
Ant.Polar.:	Horizontal		

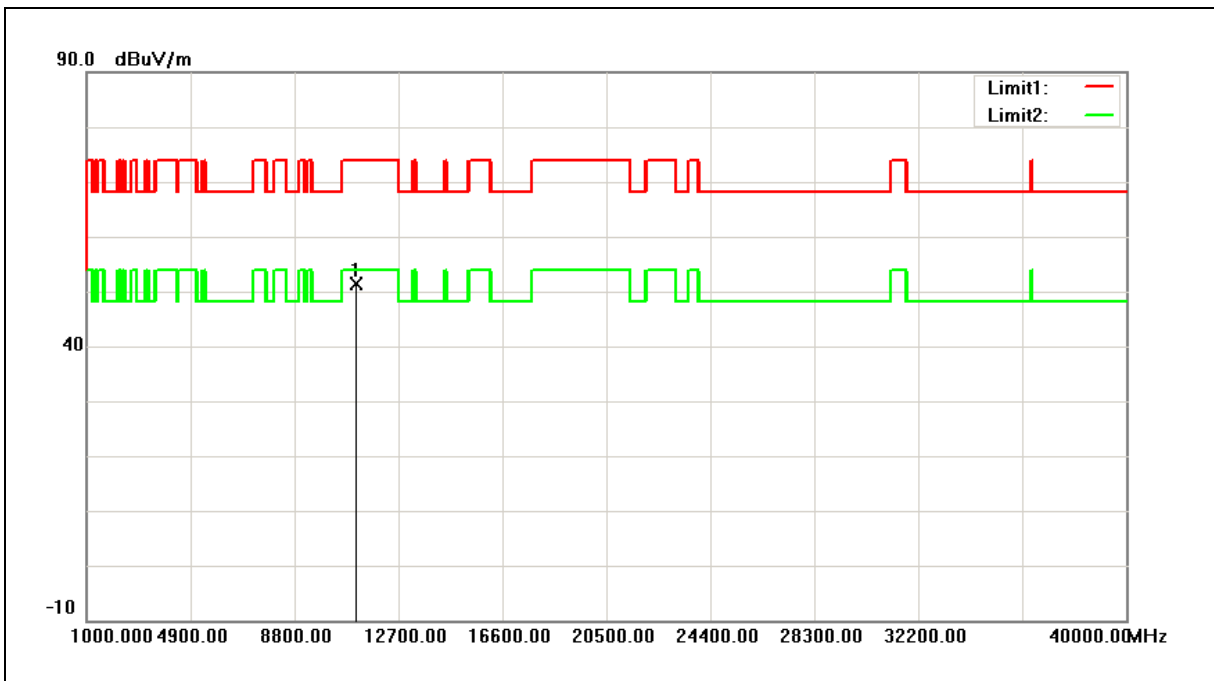

No.	Frequency (MHz)	Reading (dBuV)	Correct Factor (dB/m)	Result (dBuV/m)	Limit (dBuV/m)	Margin (dB)	Remark
1	11100.000	45.12	6.23	51.35	74.00	-22.65	peak

- Note:1.Result (dBuV/m) = Correct Factor (dB/m) + Reading(dBuV).
 2.Correction factor (dB/m) = Antenna Factor (dB/m) + Cable loss (dB) – Pre-Amplifier gain (dB).
 3. When the peak results are less than average limit, so not need to evaluate the average.



Standard:	FCC Part 15.407	Test Distance:	3m
Test item:	Harmonic	Power:	AC 120V/60Hz
Frequency:	5550MHz	Temp.(°C)/Hum.(%RH):	26(°C)/60%RH
Mode:	Mode 4	Date:	04/26/2016
Ant.Polar.:	Vertical		

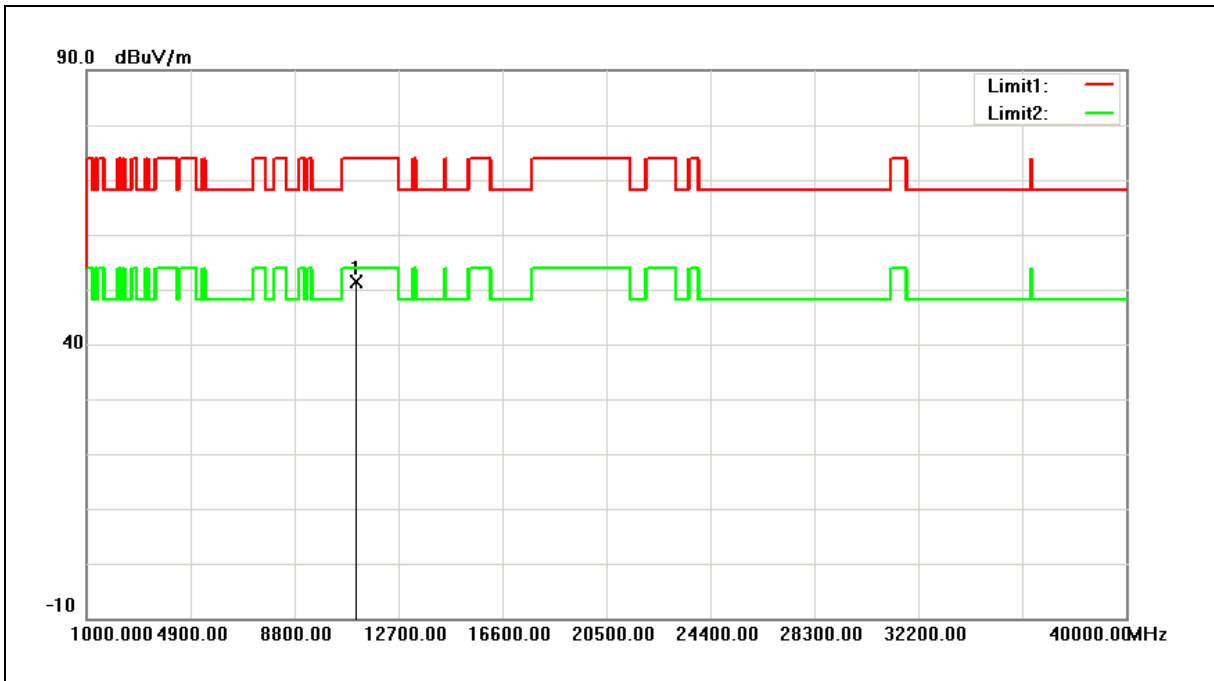

No.	Frequency (MHz)	Reading (dBuV)	Correct Factor (dB/m)	Result (dBuV/m)	Limit (dBuV/m)	Margin (dB)	Remark
1	11100.000	45.20	6.23	51.43	74.00	-22.57	peak

- Note:1.Result (dBuV/m) = Correct Factor (dB/m) + Reading(dBuV).
 2.Correction factor (dB/m) = Antenna Factor (dB/m) + Cable loss (dB) – Pre-Amplifier gain (dB).
 3. When the peak results are less than average limit, so not need to evaluate the average.



Standard:	FCC Part 15.407	Test Distance:	3m
Test item:	Harmonic	Power:	AC 120V/60Hz
Frequency:	5670MHz	Temp.(°C)/Hum. (%RH):	26(°C)/60%RH
Mode:	Mode 4	Date:	04/26/2016
Ant.Polar.:	Horizontal		

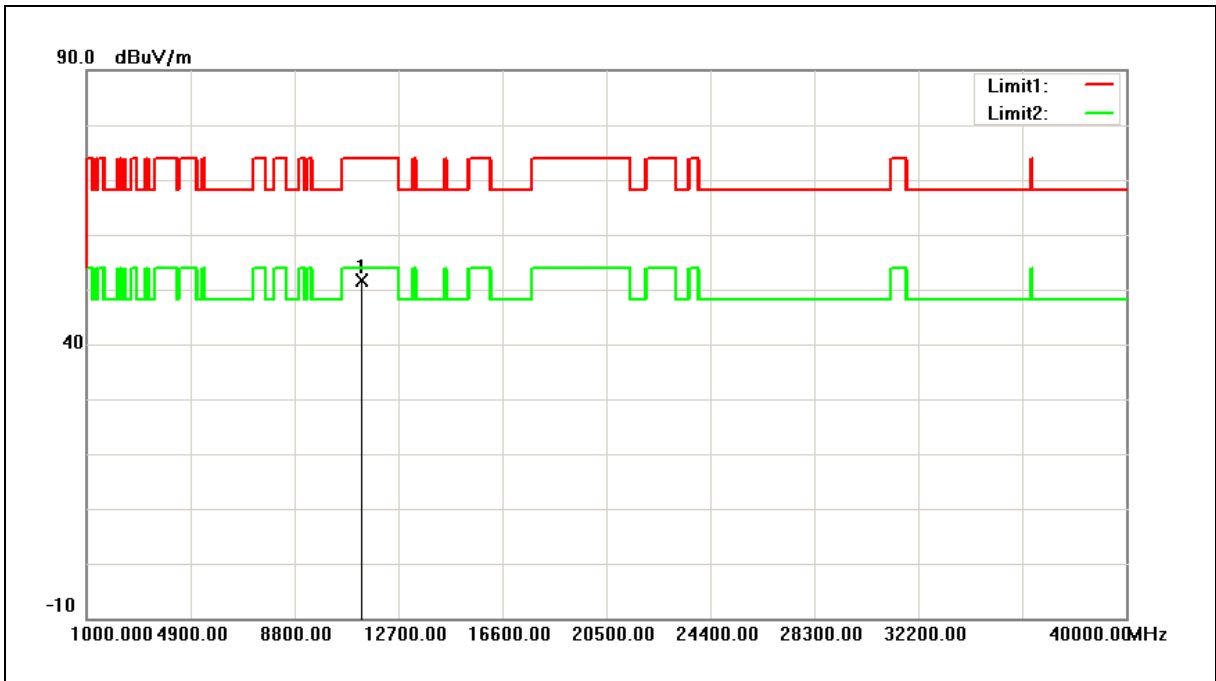

No.	Frequency (MHz)	Reading (dBuV)	Correct Factor (dB/m)	Result (dBuV/m)	Limit (dBuV/m)	Margin (dB)	Remark
1	11340.000	45.38	6.36	51.74	74.00	-22.26	peak

- Note:1.Result (dBuV/m) = Correct Factor (dB/m) + Reading(dBuV).
 2.Correction factor (dB/m) = Antenna Factor (dB/m) + Cable loss (dB) – Pre-Amplifier gain (dB).
 3. When the peak results are less than average limit, so not need to evaluate the average.



Standard:	FCC Part 15.407	Test Distance:	3m
Test item:	Harmonic	Power:	AC 120V/60Hz
Frequency:	5670MHz	Temp.(°C)/Hum. (%RH):	26(°C)/60%RH
Mode:	Mode 4	Date:	04/26/2016
Ant.Polar.:	Vertical		

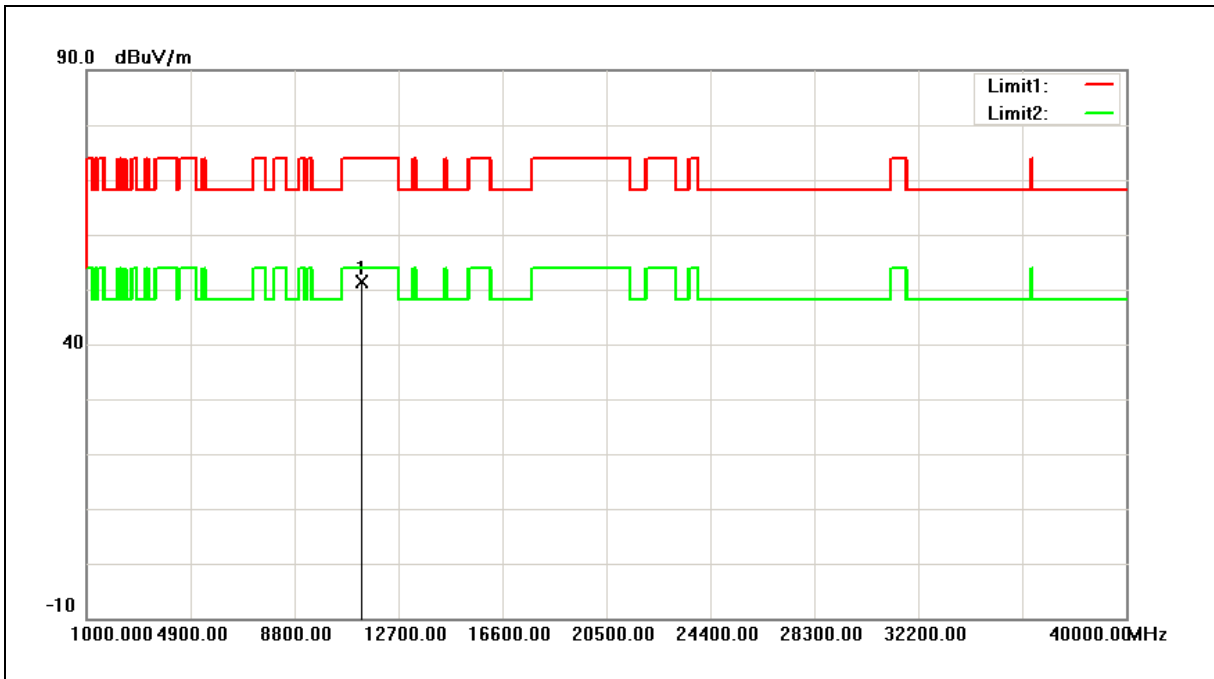

No.	Frequency (MHz)	Reading (dBuV)	Correct Factor (dB/m)	Result (dBuV/m)	Limit (dBuV/m)	Margin (dB)	Remark
1	11340.000	44.93	6.36	51.29	74.00	-22.71	peak

- Note:1.Result (dBuV/m) = Correct Factor (dB/m) + Reading(dBuV).
 2.Correction factor (dB/m) = Antenna Factor (dB/m) + Cable loss (dB) – Pre-Amplifier gain (dB).
 3. When the peak results are less than average limit, so not need to evaluate the average.



Standard:	FCC Part 15.407	Test Distance:	3m
Test item:	Harmonic	Power:	AC 120V/60Hz
Frequency:	5755MHz	Temp.(°C)/Hum.(%RH):	26(°C)/60%RH
Mode:	Mode 4	Date:	04/26/2016
Ant.Polar.:	Horizontal		

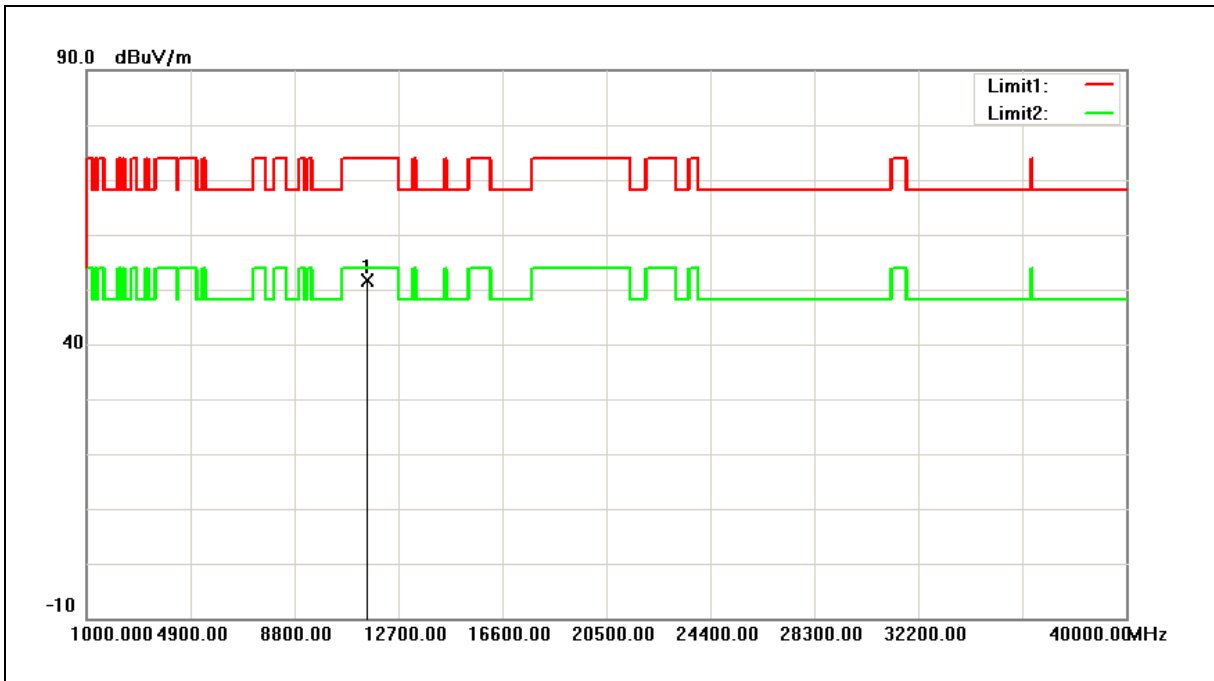

No.	Frequency (MHz)	Reading (dBuV)	Correct Factor (dB/m)	Result (dBuV/m)	Limit (dBuV/m)	Margin (dB)	Remark
1	11510.000	45.11	6.47	51.58	74.00	-22.42	peak

- Note:1.Result (dBuV/m) = Correct Factor (dB/m) + Reading(dBuV).
 2.Correction factor (dB/m) = Antenna Factor (dB/m) + Cable loss (dB) – Pre-Amplifier gain (dB).
 3. When the peak results are less than average limit, so not need to evaluate the average.



Standard:	FCC Part 15.407	Test Distance:	3m
Test item:	Harmonic	Power:	AC 120V/60Hz
Frequency:	5755MHz	Temp.(°C)/Hum. (%RH):	26(°C)/60%RH
Mode:	Mode 4	Date:	04/26/2016
Ant.Polar.:	Vertical		

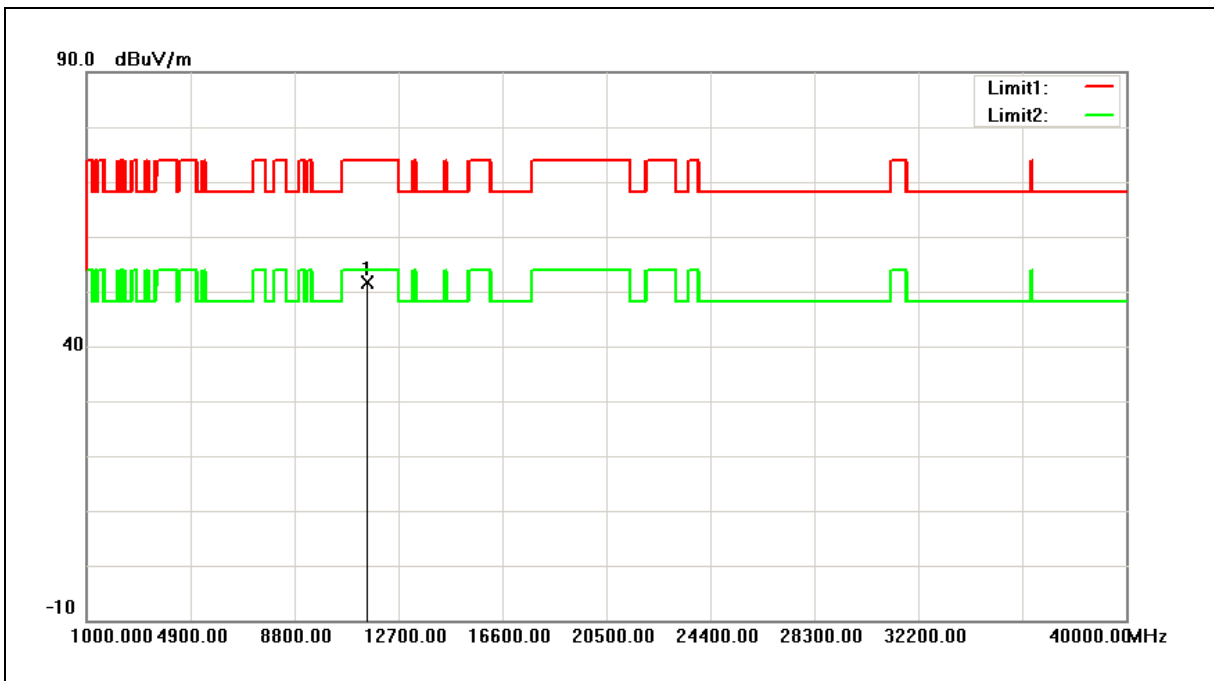

No.	Frequency (MHz)	Reading (dBuV)	Correct Factor (dB/m)	Result (dBuV/m)	Limit (dBuV/m)	Margin (dB)	Remark
1	11510.000	45.17	6.47	51.64	74.00	-22.36	peak

- Note:1.Result (dBuV/m) = Correct Factor (dB/m) + Reading(dBuV).
 2.Correction factor (dB/m) = Antenna Factor (dB/m) + Cable loss (dB) – Pre-Amplifier gain (dB).
 3. When the peak results are less than average limit, so not need to evaluate the average.



Standard:	FCC Part 15.407	Test Distance:	3m
Test item:	Harmonic	Power:	AC 120V/60Hz
Frequency:	5795MHz	Temp.(°C)/Hum.(%RH):	26(°C)/60%RH
Mode:	Mode 4	Date:	04/26/2016
Ant.Polar.:	Horizontal		

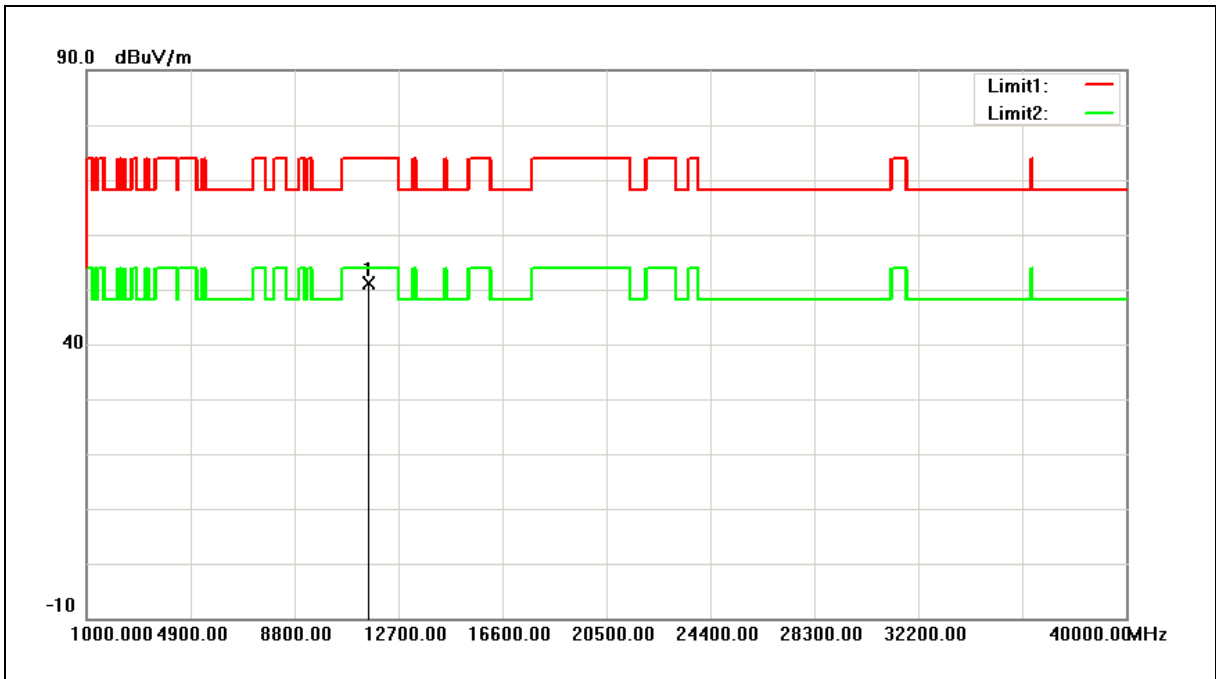

No.	Frequency (MHz)	Reading (dBuV)	Correct Factor (dB/m)	Result (dBuV/m)	Limit (dBuV/m)	Margin (dB)	Remark
1	11590.000	44.33	6.69	51.02	74.00	-22.98	peak

- Note:1.Result (dBuV/m) = Correct Factor (dB/m) + Reading(dBuV).
 2.Correction factor (dB/m) = Antenna Factor (dB/m) + Cable loss (dB) – Pre-Amplifier gain (dB).
 3. When the peak results are less than average limit, so not need to evaluate the average.



Standard:	FCC Part 15.407	Test Distance:	3m
Test item:	Harmonic	Power:	AC 120V/60Hz
Frequency:	5795MHz	Temp.(°C)/Hum. (%RH):	26(°C)/60%RH
Mode:	Mode 4	Date:	04/26/2016
Ant.Polar.:	Vertical		

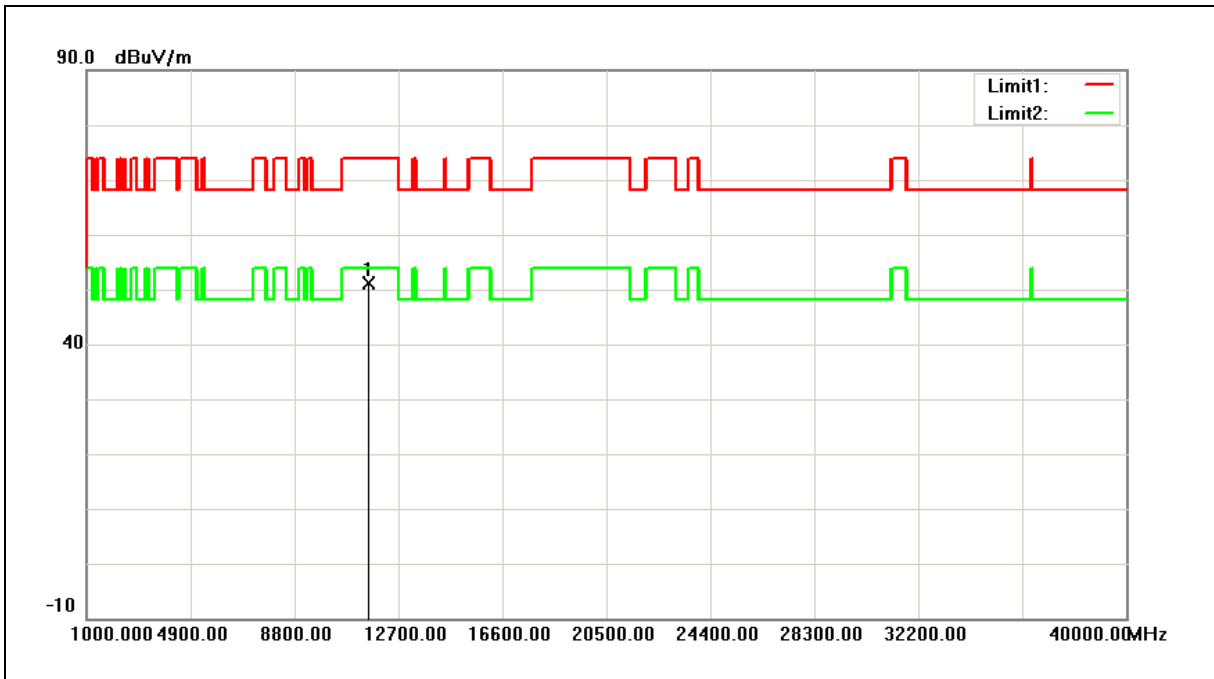

No.	Frequency (MHz)	Reading (dBuV)	Correct Factor (dB/m)	Result (dBuV/m)	Limit (dBuV/m)	Margin (dB)	Remark
1	11590.000	44.48	6.69	51.17	74.00	-22.83	peak

- Note:1.Result (dBuV/m) = Correct Factor (dB/m) + Reading(dBuV).
 2.Correction factor (dB/m) = Antenna Factor (dB/m) + Cable loss (dB) – Pre-Amplifier gain (dB).
 3. When the peak results are less than average limit, so not need to evaluate the average.



Band Edge

Standard:	FCC Part 15.407	Test Distance:	3m
Test item:	Band edge	Power:	AC 120V/60Hz
Frequency:	5180MHz	Temp.(°C)/Hum. (%RH):	26(°C)/60%RH
Mode:	Mode 2	Date:	04/24/2016
Ant.Polar.:	Horizontal		

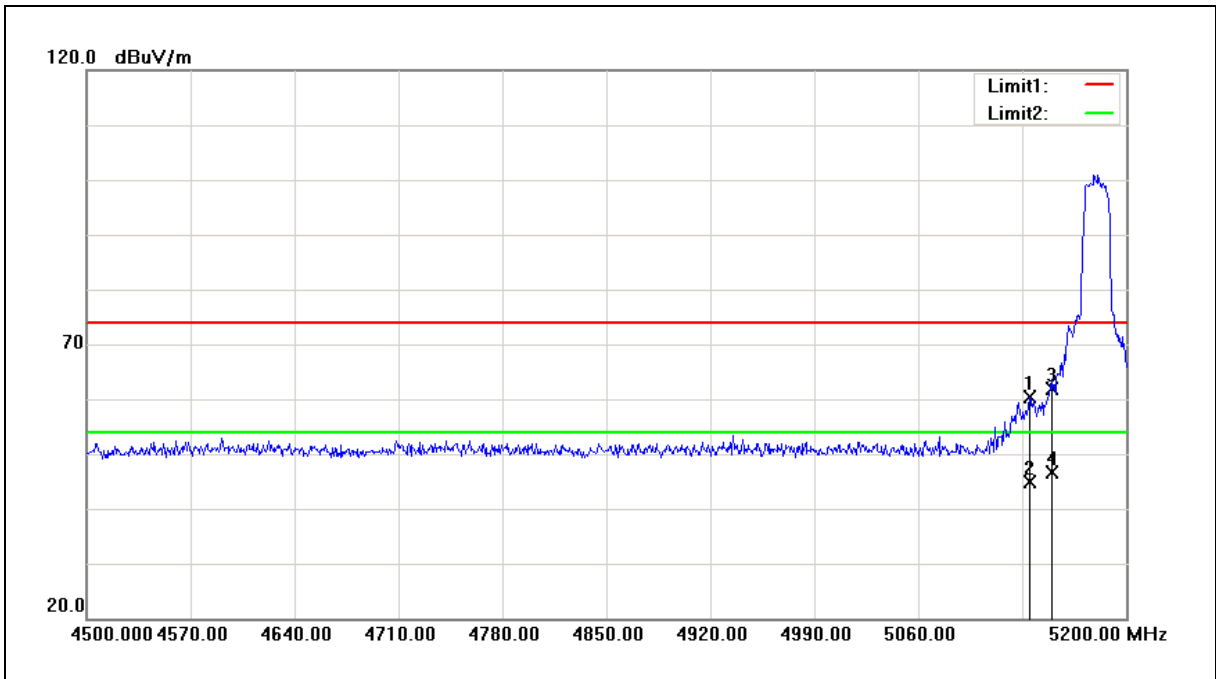

No.	Frequency (MHz)	Reading (dBuV)	Correct Factor (dB/m)	Result (dBuV/m)	Limit (dBuV/m)	Margin (dB)	Remark
1	5134.900	52.18	8.27	60.45	74.00	-13.55	peak
2	5134.900	36.71	8.27	44.98	54.00	-9.02	AVG
3	5150.000	53.68	8.29	61.97	74.00	-12.03	peak
4	5150.000	38.28	8.29	46.57	54.00	-7.43	AVG

Note:1.Result (dBuV/m) = Correct Factor (dB/m) + Reading(dBuV).

2.Correction factor (dB/m) = Antenna Factor (dB/m) + Cable loss (dB) – Pre-Amplifier gain (dB).

3. When the peak results are less than average limit, so not need to evaluate the average.



Standard:	FCC Part 15.407	Test Distance:	3m
Test item:	Band edge	Power:	AC 120V/60Hz
Frequency:	5180MHz	Temp.(°C)/Hum.(%RH):	26(°C)/60%RH
Mode:	Mode 2	Date:	04/24/2016
Ant.Polar.:	Vertical		

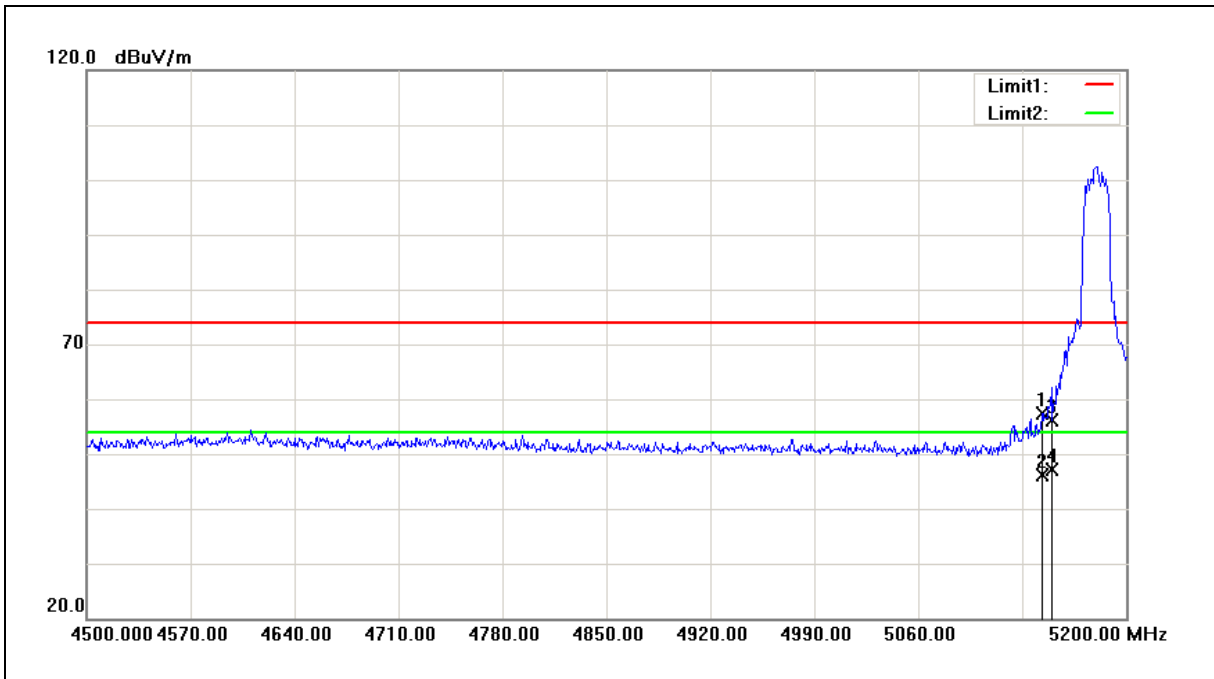

No.	Frequency (MHz)	Reading (dBuV)	Correct Factor (dB/m)	Result (dBuV/m)	Limit (dBuV/m)	Margin (dB)	Remark
1	5143.300	49.20	8.28	57.48	74.00	-16.52	peak
2	5143.300	37.90	8.28	46.18	54.00	-7.82	AVG
3	5150.000	47.80	8.29	56.09	74.00	-17.91	peak
4	5150.000	38.93	8.29	47.22	54.00	-6.78	AVG

Note:1.Result (dBuV/m) = Correct Factor (dB/m) + Reading(dBuV).

2.Correction factor (dB/m) = Antenna Factor (dB/m) + Cable loss (dB) – Pre-Amplifier gain (dB).

3. When the peak results are less than average limit, so not need to evaluate the average.



Standard:	FCC Part 15.407	Test Distance:	3m
Test item:	Band edge	Power:	AC 120V/60Hz
Frequency:	5320MHz	Temp.(°C)/Hum.(%RH):	26(°C)/60%RH
Mode:	Mode 2	Date:	04/24/2016
Ant.Polar.:	Horizontal		

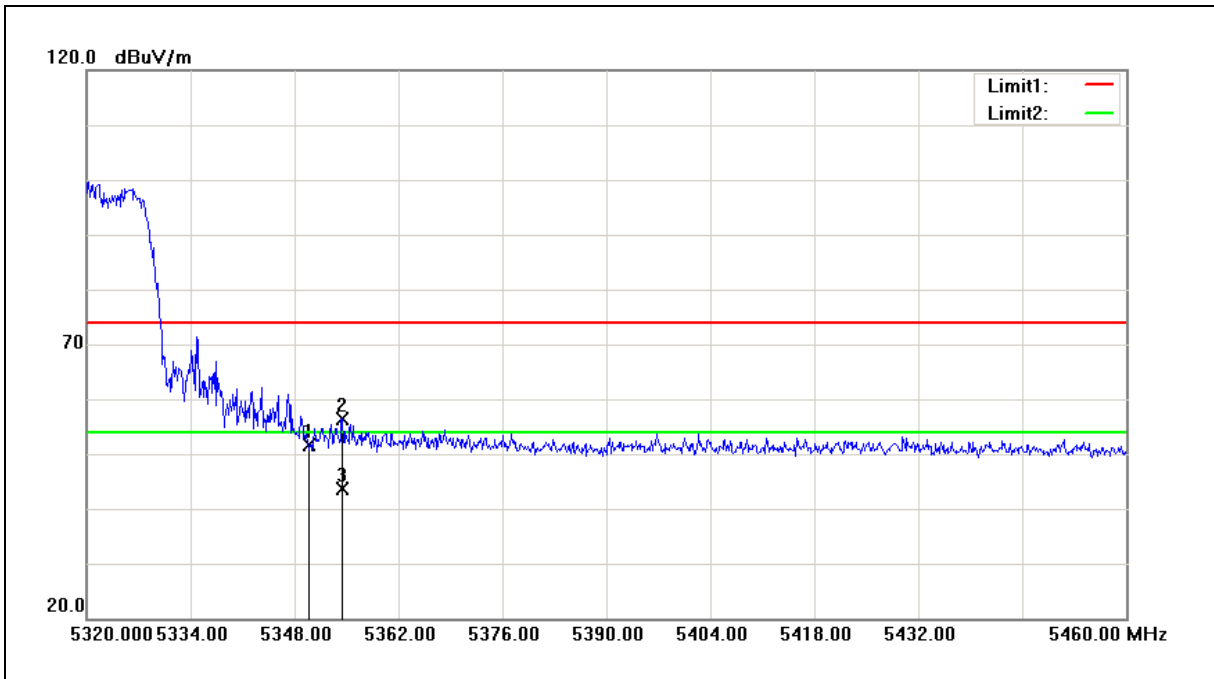

No.	Frequency (MHz)	Reading (dBuV)	Correct Factor (dB/m)	Result (dBuV/m)	Limit (dBuV/m)	Margin (dB)	Remark
1	5350.000	43.10	8.50	51.60	74.00	-22.40	peak
2	5354.440	47.85	8.51	56.36	74.00	-17.64	peak
3	5354.440	35.03	8.51	43.54	54.00	-10.46	AVG

- Note:1.Result (dBuV/m) = Correct Factor (dB/m) + Reading(dBuV).
- 2.Correction factor (dB/m) = Antenna Factor (dB/m) + Cable loss (dB) – Pre-Amplifier gain (dB).
3. When the peak results are less than average limit, so not need to evaluate the average.



Standard:	FCC Part 15.407	Test Distance:	3m
Test item:	Band edge	Power:	AC 120V/60Hz
Frequency:	5320MHz	Temp.(°C)/Hum.(%RH):	26(°C)/60%RH
Mode:	Mode 2	Date:	04/24/2016
Ant.Polar.:	Vertical		

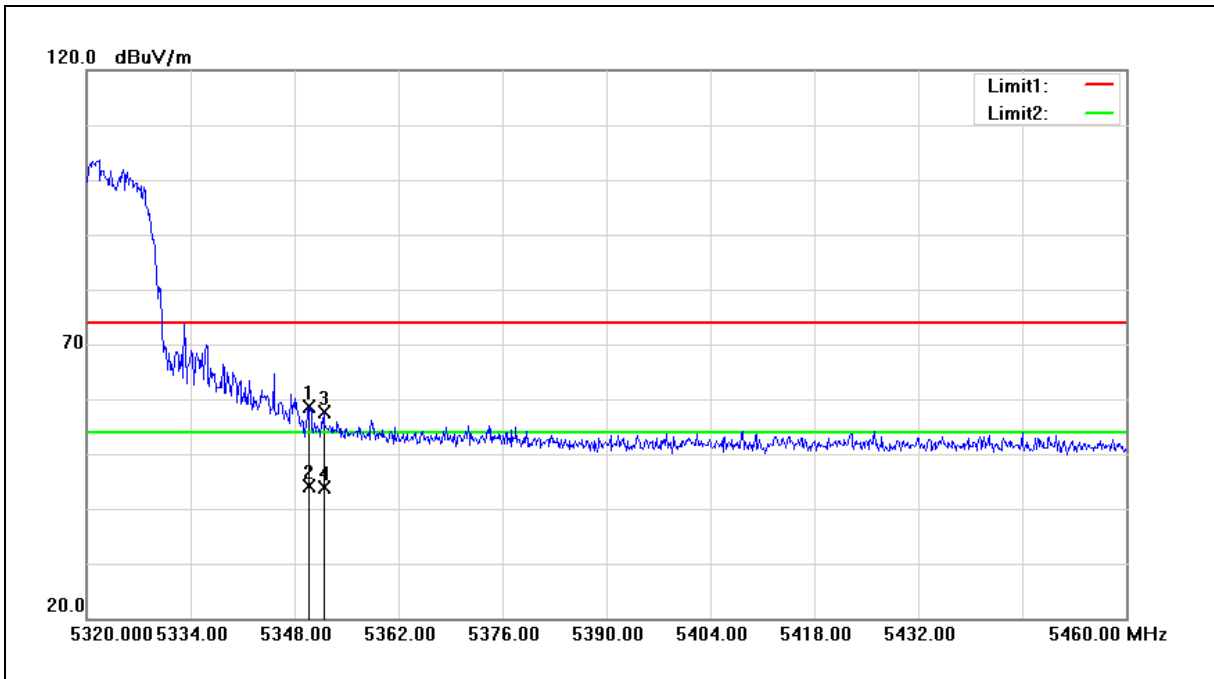

No.	Frequency (MHz)	Reading (dBuV)	Correct Factor (dB/m)	Result (dBuV/m)	Limit (dBuV/m)	Margin (dB)	Remark
1	5350.000	50.07	8.50	58.57	74.00	-15.43	peak
2	5350.000	35.73	8.50	44.23	54.00	-9.77	AVG
3	5351.920	49.15	8.50	57.65	74.00	-16.35	peak
4	5351.920	35.31	8.50	43.81	54.00	-10.19	AVG

Note:1.Result (dBuV/m) = Correct Factor (dB/m) + Reading(dBuV).

2.Correction factor (dB/m) = Antenna Factor (dB/m) + Cable loss (dB) – Pre-Amplifier gain (dB).

3. When the peak results are less than average limit, so not need to evaluate the average.



Standard:	FCC Part 15.407	Test Distance:	3m
Test item:	Band edge	Power:	AC 120V/60Hz
Frequency:	5500MHz	Temp.(°C)/Hum.(%RH):	26(°C)/60%RH
Mode:	Mode 2	Date:	04/24/2016
Ant.Polar.:	Horizontal		

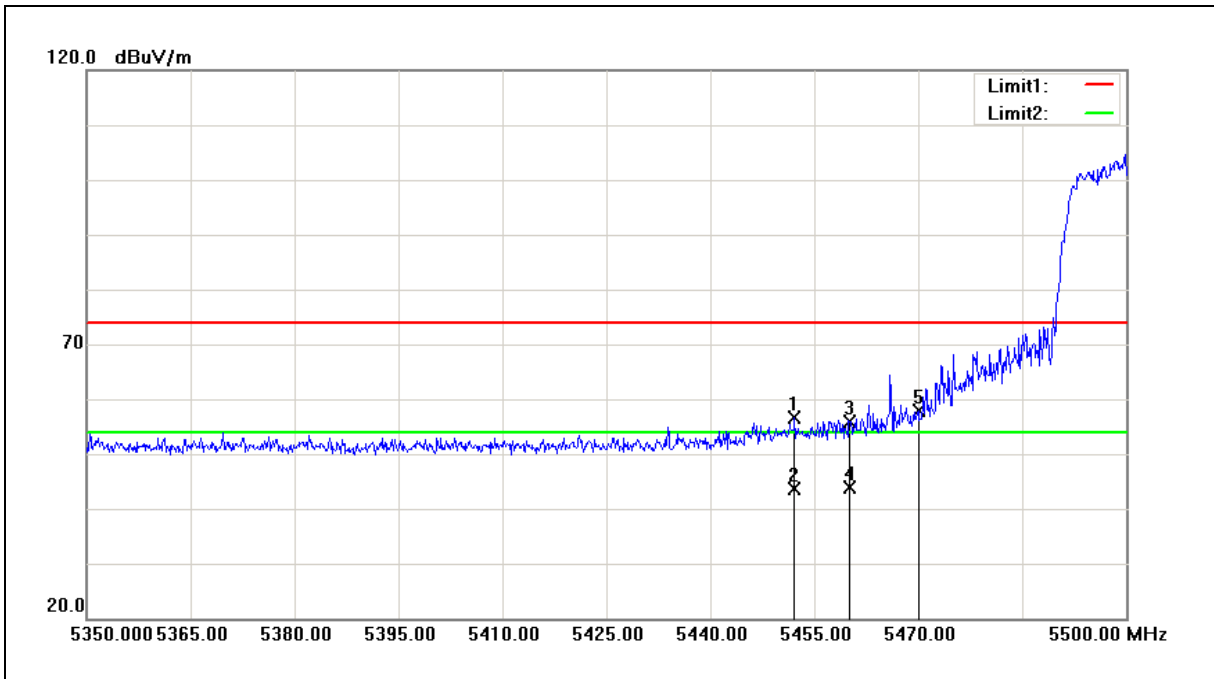

No.	Frequency (MHz)	Reading (dBuV)	Correct Factor (dB/m)	Result (dBuV/m)	Limit (dBuV/m)	Margin (dB)	Remark
1	5452.150	48.02	8.61	56.63	74.00	-17.37	peak
2	5452.150	35.00	8.61	43.61	54.00	-10.39	AVG
3	5460.000	47.18	8.62	55.80	74.00	-18.20	peak
4	5460.000	35.21	8.62	43.83	54.00	-10.17	AVG
5	5470.000	49.13	8.63	57.76	78.20	-20.44	peak

Note:1.Result (dBuV/m) = Correct Factor (dB/m) + Reading(dBuV).

2.Correction factor (dB/m) = Antenna Factor (dB/m) + Cable loss (dB) – Pre-Amplifier gain (dB).

3. When the peak results are less than average limit, so not need to evaluate the average.



Standard:	FCC Part 15.407	Test Distance:	3m
Test item:	Band edge	Power:	AC 120V/60Hz
Frequency:	5500MHz	Temp.(°C)/Hum.(%RH):	26(°C)/60%RH
Mode:	Mode 2	Date:	04/24/2016
Ant.Polar.:	Vertical		

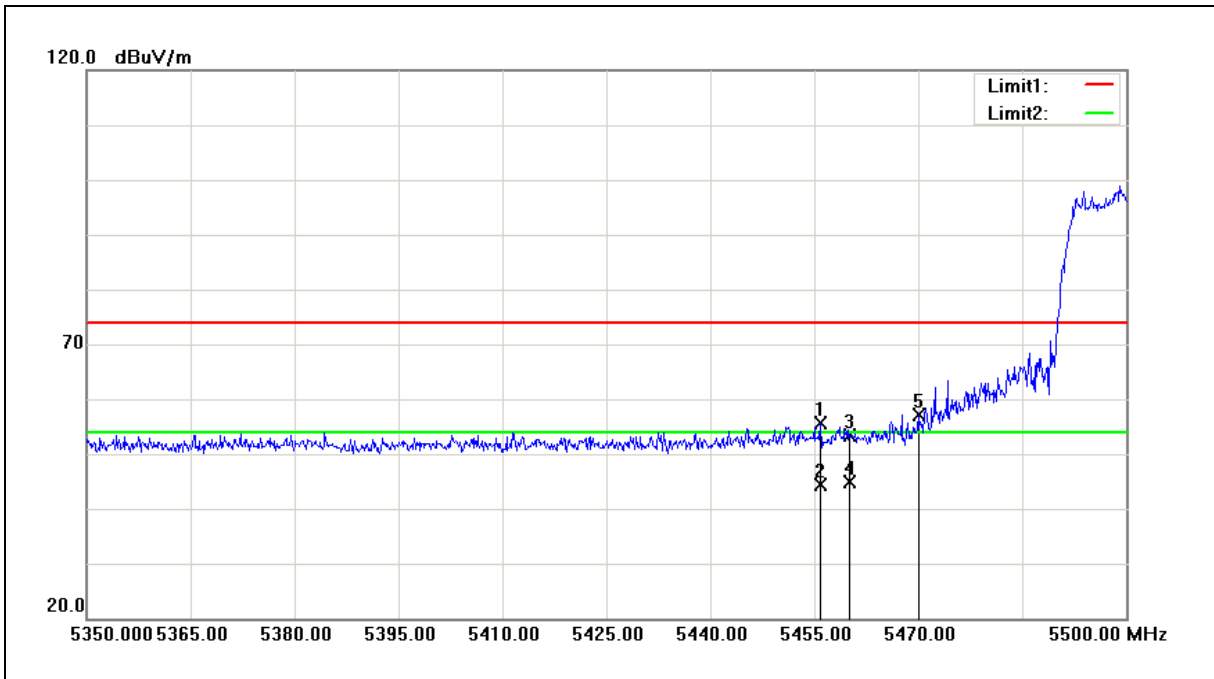

No.	Frequency (MHz)	Reading (dBuV)	Correct Factor (dB/m)	Result (dBuV/m)	Limit (dBuV/m)	Margin (dB)	Remark
1	5455.900	47.01	8.61	55.62	74.00	-18.38	peak
2	5455.900	35.73	8.61	44.34	54.00	-9.66	AVG
3	5460.000	44.74	8.62	53.36	74.00	-20.64	peak
4	5460.000	36.34	8.62	44.96	54.00	-9.04	AVG
5	5470.000	48.59	8.63	57.22	78.20	-20.98	peak

Note:1.Result (dBuV/m) = Correct Factor (dB/m) + Reading(dBuV).

2.Correction factor (dB/m) = Antenna Factor (dB/m) + Cable loss (dB) – Pre-Amplifier gain (dB).

3. When the peak results are less than average limit, so not need to evaluate the average.



Standard:	FCC Part 15.407	Test Distance:	3m
Test item:	Band edge	Power:	AC 120V/60Hz
Frequency:	5745MHz	Temp.(°C)/Hum.(%RH):	26(°C)/60%RH
Mode:	Mode 2	Date:	04/24/2016
Ant.Polar.:	Horizontal		

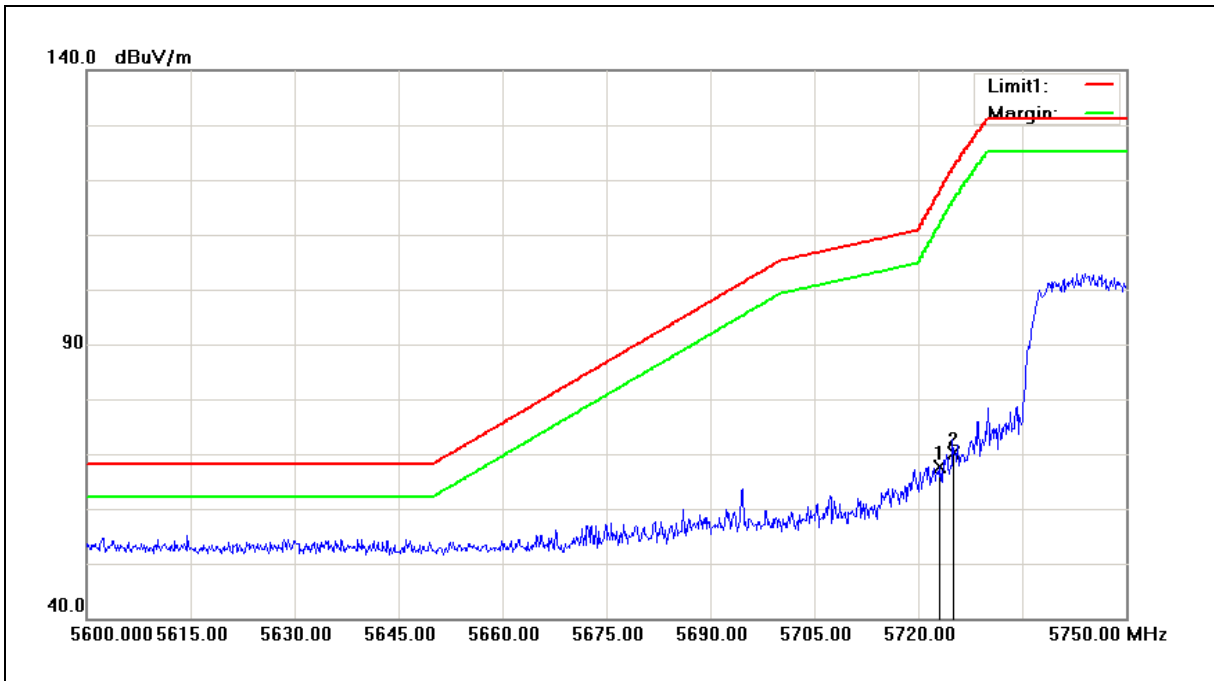

No.	Frequency (MHz)	Reading (dBuV)	Correct Factor (dB/m)	Result (dBuV/m)	Limit (dBuV/m)	Margin (dB)	Remark
1	5723.150	58.57	9.18	67.75	117.98	-50.23	peak
2	5725.000	60.91	9.19	70.10	122.20	-52.10	peak

Note:1.Result (dBuV/m) = Correct Factor (dB/m) + Reading(dBuV).

2.Correction factor (dB/m) = Antenna Factor (dB/m) + Cable loss (dB) – Pre-Amplifier gain (dB).

3. When the peak results are less than average limit, so not need to evaluate the average.



Standard:	FCC Part 15.407	Test Distance:	3m
Test item:	Band edge	Power:	AC 120V/60Hz
Frequency:	5745MHz	Temp.(°C)/Hum.(%RH):	26(°C)/60%RH
Mode:	Mode 2	Date:	04/24/2016
Ant.Polar.:	Vertical		

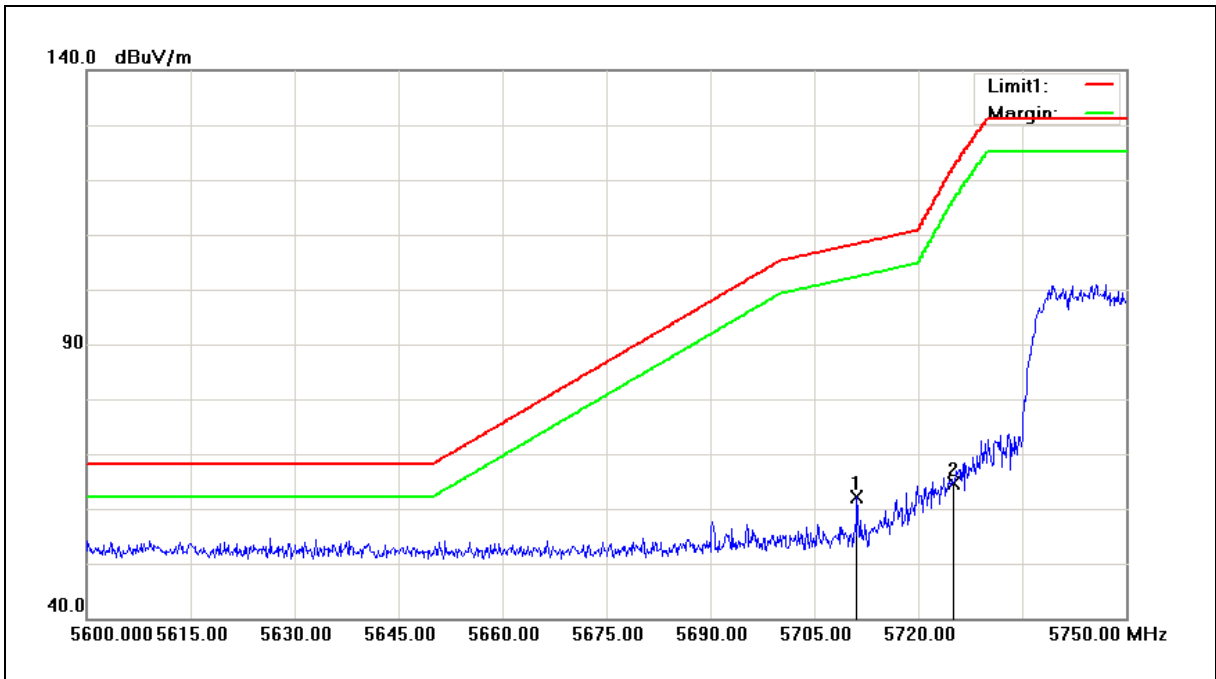

No.	Frequency (MHz)	Reading (dBuV)	Correct Factor (dB/m)	Result (dBuV/m)	Limit (dBuV/m)	Margin (dB)	Remark
1	5711.150	52.95	9.16	62.11	108.32	-46.21	peak
2	5725.000	55.54	9.19	64.73	122.20	-57.47	peak

- Note:1.Result (dBuV/m) = Correct Factor (dB/m) + Reading(dBuV).
- 2.Correction factor (dB/m) = Antenna Factor (dB/m) + Cable loss (dB) – Pre-Amplifier gain (dB).
3. When the peak results are less than average limit, so not need to evaluate the average.



Standard:	FCC Part 15.407	Test Distance:	3m
Test item:	Band edge	Power:	AC 120V/60Hz
Frequency:	5825MHz	Temp.(°C)/Hum.(%RH):	26(°C)/60%RH
Mode:	Mode 2	Date:	04/24/2016
Ant.Polar.:	Horizontal		

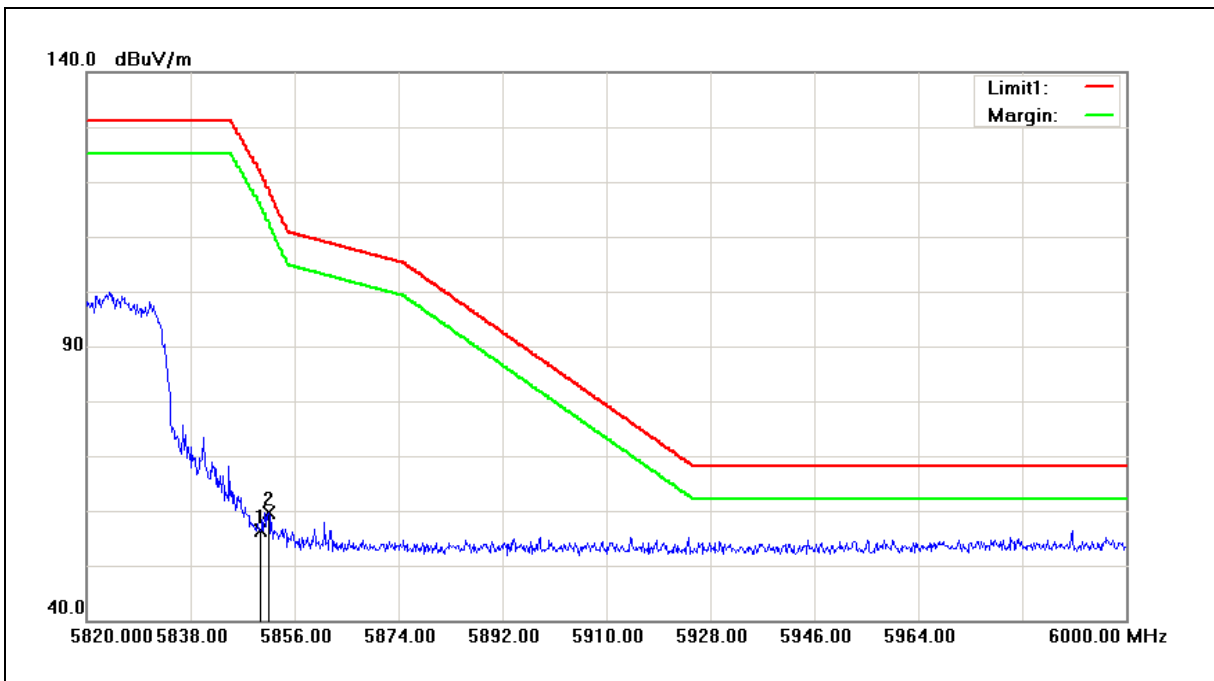

No.	Frequency (MHz)	Reading (dBuV)	Correct Factor (dB/m)	Result (dBuV/m)	Limit (dBuV/m)	Margin (dB)	Remark
1	5850.000	46.84	9.46	56.30	122.20	-65.90	peak
2	5851.500	50.23	9.47	59.70	118.78	-59.08	peak

- Note:1.Result (dBuV/m) = Correct Factor (dB/m) + Reading(dBuV).
 2.Correction factor (dB/m) = Antenna Factor (dB/m) + Cable loss (dB) – Pre-Amplifier gain (dB).
 3. When the peak results are less than average limit, so not need to evaluate the average.



Standard:	FCC Part 15.407	Test Distance:	3m
Test item:	Band edge	Power:	AC 120V/60Hz
Frequency:	5825MHz	Temp.(°C)/Hum.(%RH):	26(°C)/60%RH
Mode:	Mode 2	Date:	04/24/2016
Ant.Polar.:	Vertical		

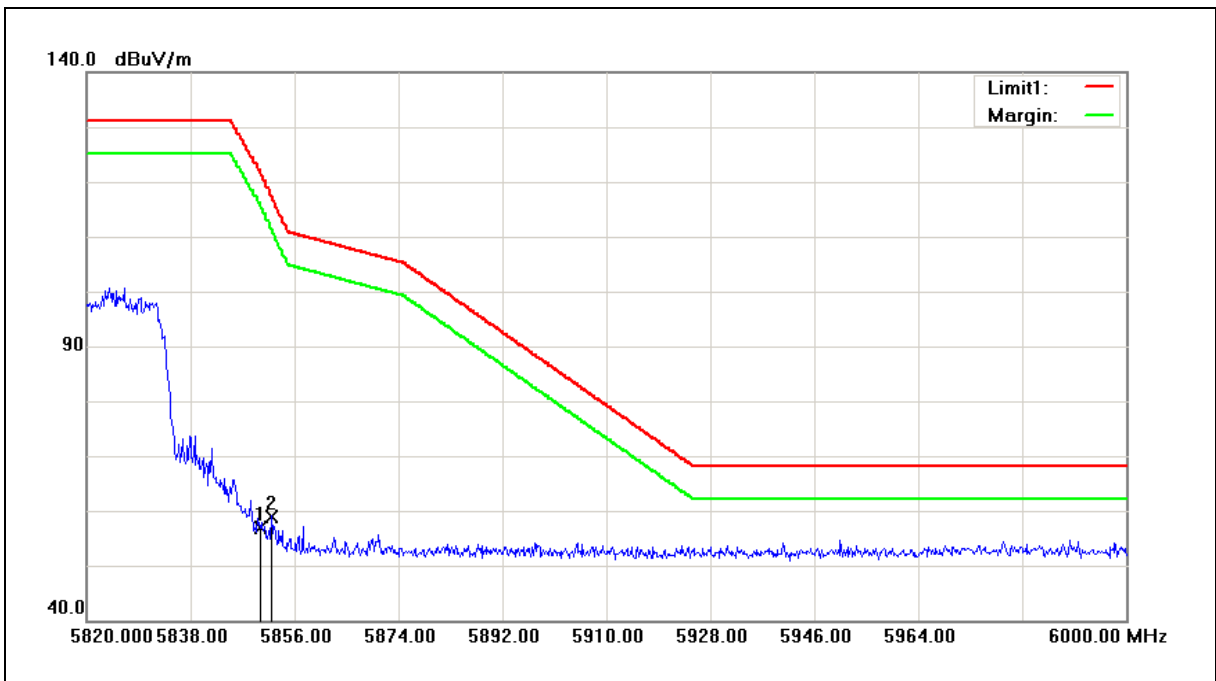

No.	Frequency (MHz)	Reading (dBuV)	Correct Factor (dB/m)	Result (dBuV/m)	Limit (dBuV/m)	Margin (dB)	Remark
1	5850.000	47.49	9.46	56.95	122.20	-65.25	peak
2	5852.040	49.53	9.47	59.00	117.55	-58.55	peak

Note:1.Result (dBuV/m) = Correct Factor (dB/m) + Reading(dBuV).

2.Correction factor (dB/m) = Antenna Factor (dB/m) + Cable loss (dB) – Pre-Amplifier gain (dB).

3. When the peak results are less than average limit, so not need to evaluate the average.



Standard:	FCC Part 15.407	Test Distance:	3m
Test item:	Band edge	Power:	AC 120V/60Hz
Frequency:	5180MHz	Temp.(°C)/Hum. (%RH):	26(°C)/60%RH
Mode:	Mode 3	Date:	04/24/2016
Ant.Polar.:	Horizontal		

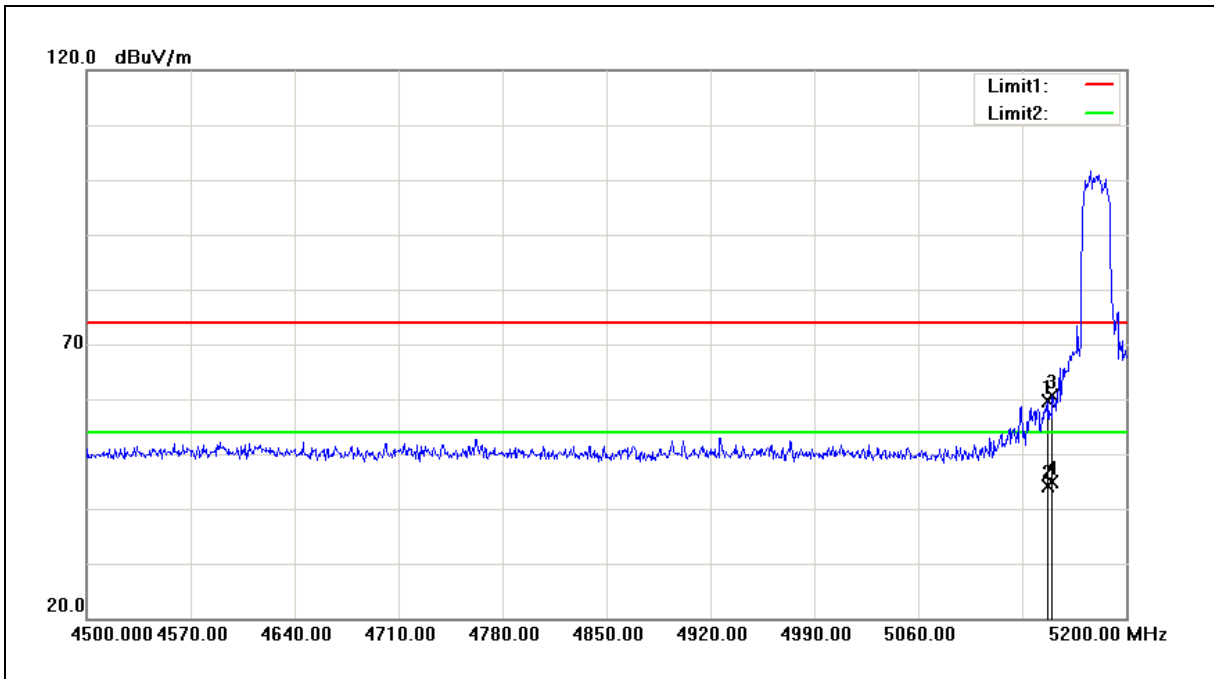

No.	Frequency (MHz)	Reading (dBuV)	Correct Factor (dB/m)	Result (dBuV/m)	Limit (dBuV/m)	Margin (dB)	Remark
1	5147.500	51.47	8.28	59.75	74.00	-14.25	peak
2	5147.500	35.73	8.28	44.01	54.00	-9.99	AVG
3	5150.000	52.28	8.29	60.57	74.00	-13.43	peak
4	5150.000	36.64	8.29	44.93	54.00	-9.07	AVG

Note:1.Result (dBuV/m) = Correct Factor (dB/m) + Reading(dBuV).

2.Correction factor (dB/m) = Antenna Factor (dB/m) + Cable loss (dB) – Pre-Amplifier gain (dB).

3. When the peak results are less than average limit, so not need to evaluate the average.



Standard:	FCC Part 15.407	Test Distance:	3m
Test item:	Band edge	Power:	AC 120V/60Hz
Frequency:	5180MHz	Temp.(°C)/Hum.(%RH):	26(°C)/60%RH
Mode:	Mode 3	Date:	04/24/2016
Ant.Polar.:	Vertical		

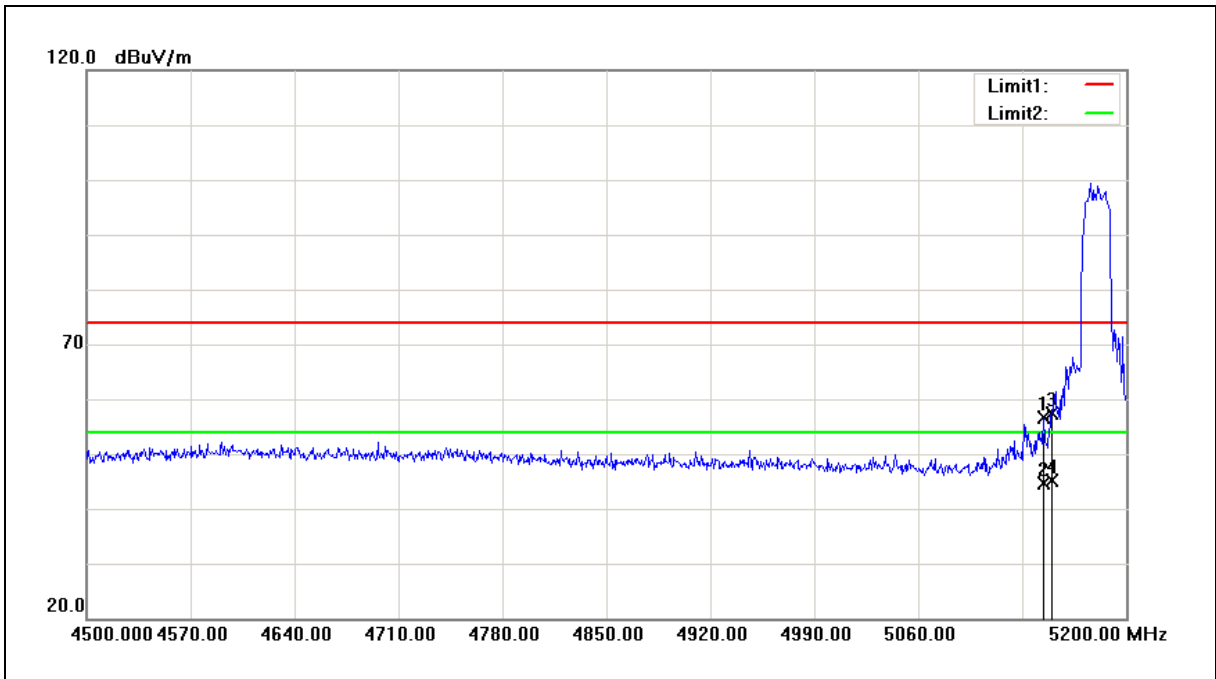

No.	Frequency (MHz)	Reading (dBuV)	Correct Factor (dB/m)	Result (dBuV/m)	Limit (dBuV/m)	Margin (dB)	Remark
1	5144.000	48.39	8.28	56.67	74.00	-17.33	peak
2	5144.000	36.41	8.28	44.69	54.00	-9.31	AVG
3	5150.000	49.10	8.29	57.39	74.00	-16.61	peak
4	5150.000	36.83	8.29	45.12	54.00	-8.88	AVG

Note:1.Result (dBuV/m) = Correct Factor (dB/m) + Reading(dBuV).

2.Correction factor (dB/m) = Antenna Factor (dB/m) + Cable loss (dB) – Pre-Amplifier gain (dB).

3. When the peak results are less than average limit, so not need to evaluate the average.



Standard:	FCC Part 15.407	Test Distance:	3m
Test item:	Band edge	Power:	AC 120V/60Hz
Frequency:	5320MHz	Temp.(°C)/Hum. (%RH):	26(°C)/60%RH
Mode:	Mode 3	Date:	04/24/2016
Ant.Polar.:	Horizontal		

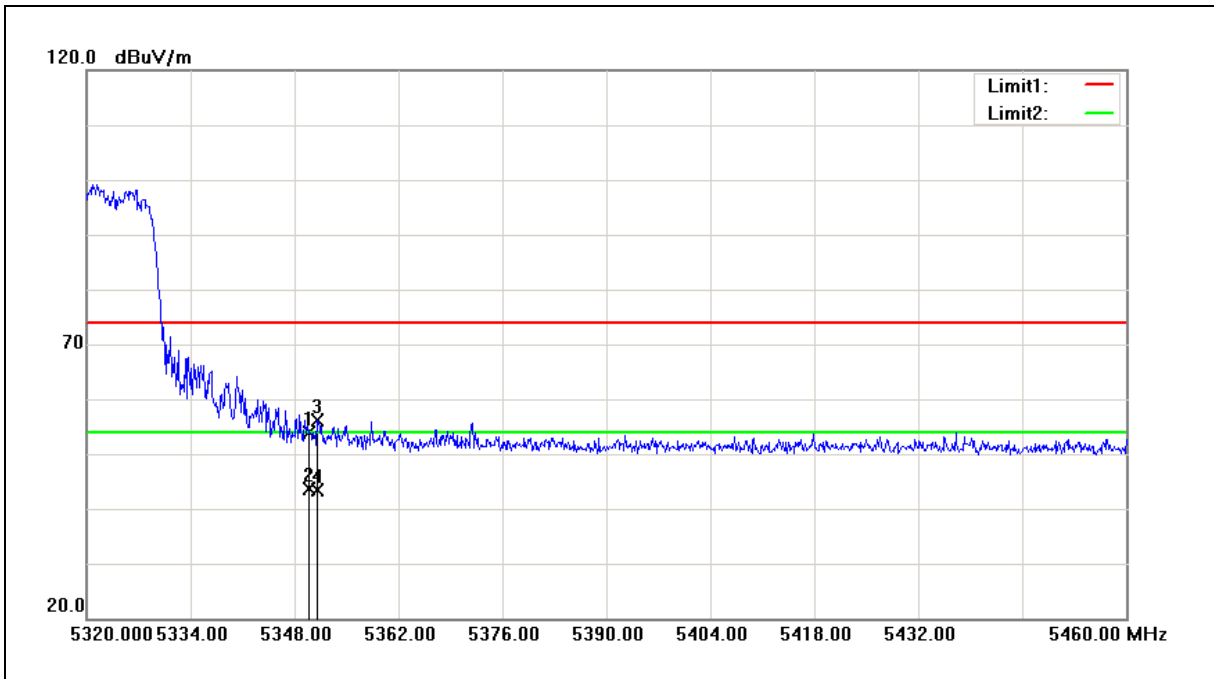

No.	Frequency (MHz)	Reading (dBuV)	Correct Factor (dB/m)	Result (dBuV/m)	Limit (dBuV/m)	Margin (dB)	Remark
1	5350.000	45.44	8.50	53.94	74.00	-20.06	peak
2	5350.000	35.05	8.50	43.55	54.00	-10.45	AVG
3	5351.080	47.66	8.50	56.16	74.00	-17.84	peak
4	5351.080	34.88	8.50	43.38	54.00	-10.62	AVG

Note:1.Result (dBuV/m) = Correct Factor (dB/m) + Reading(dBuV).

2.Correction factor (dB/m) = Antenna Factor (dB/m) + Cable loss (dB) – Pre-Amplifier gain (dB).

3. When the peak results are less than average limit, so not need to evaluate the average.



Standard:	FCC Part 15.407	Test Distance:	3m
Test item:	Band edge	Power:	AC 120V/60Hz
Frequency:	5320MHz	Temp.(°C)/Hum.(%RH):	26(°C)/60%RH
Mode:	Mode 3	Date:	04/24/2016
Ant.Polar.:	Vertical		

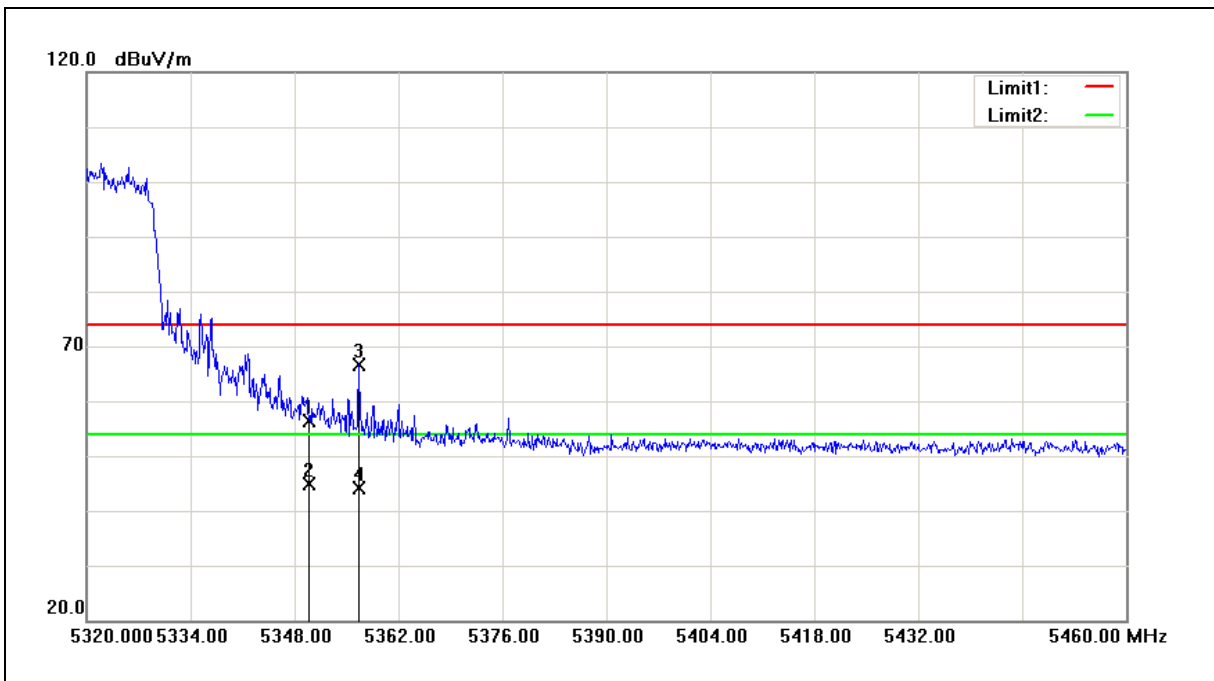

No.	Frequency (MHz)	Reading (dBuV)	Correct Factor (dB/m)	Result (dBuV/m)	Limit (dBuV/m)	Margin (dB)	Remark
1	5350.000	47.97	8.50	56.47	74.00	-17.53	peak
2	5350.000	36.45	8.50	44.95	54.00	-9.05	AVG
3	5356.680	58.08	8.51	66.59	74.00	-7.41	peak
4	5356.680	35.73	8.51	44.24	54.00	-9.76	AVG

Note:1.Result (dBuV/m) = Correct Factor (dB/m) + Reading(dBuV).

2.Correction factor (dB/m) = Antenna Factor (dB/m) + Cable loss (dB) – Pre-Amplifier gain (dB).

3. When the peak results are less than average limit, so not need to evaluate the average.



Standard:	FCC Part 15.407	Test Distance:	3m
Test item:	Band edge	Power:	AC 120V/60Hz
Frequency:	5500MHz	Temp.(°C)/Hum.(%RH):	26(°C)/60%RH
Mode:	Mode 3	Date:	04/24/2016
Ant.Polar.:	Horizontal		

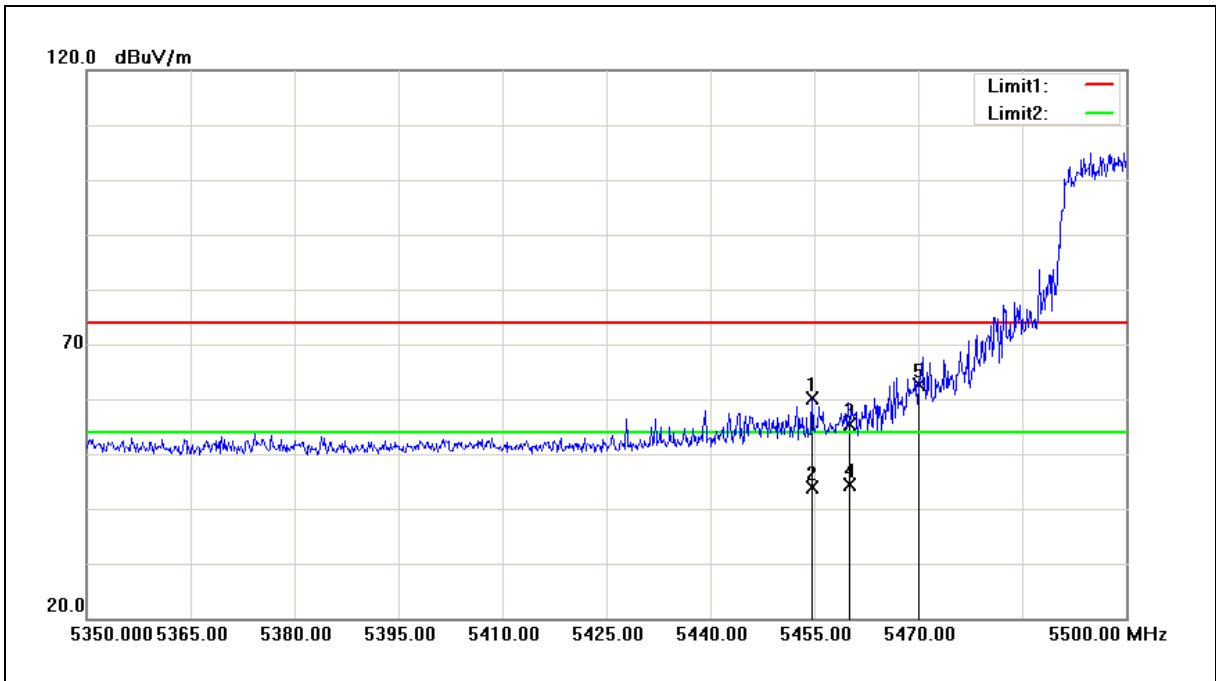

No.	Frequency (MHz)	Reading (dBuV)	Correct Factor (dB/m)	Result (dBuV/m)	Limit (dBuV/m)	Margin (dB)	Remark
1	5454.700	51.59	8.61	60.20	74.00	-13.80	peak
2	5454.700	35.16	8.61	43.77	54.00	-10.23	AVG
3	5460.000	46.86	8.62	55.48	74.00	-18.52	peak
4	5460.000	35.76	8.62	44.38	54.00	-9.62	AVG
5	5470.000	54.12	8.63	62.75	78.20	-15.45	peak

Note:1.Result (dBuV/m) = Correct Factor (dB/m) + Reading(dBuV).

2.Correction factor (dB/m) = Antenna Factor (dB/m) + Cable loss (dB) – Pre-Amplifier gain (dB).

3. When the peak results are less than average limit, so not need to evaluate the average.



Standard:	FCC Part 15.407	Test Distance:	3m
Test item:	Band edge	Power:	AC 120V/60Hz
Frequency:	5500MHz	Temp.(°C)/Hum.(%RH):	26(°C)/60%RH
Mode:	Mode 3	Date:	04/24/2016
Ant.Polar.:	Vertical		

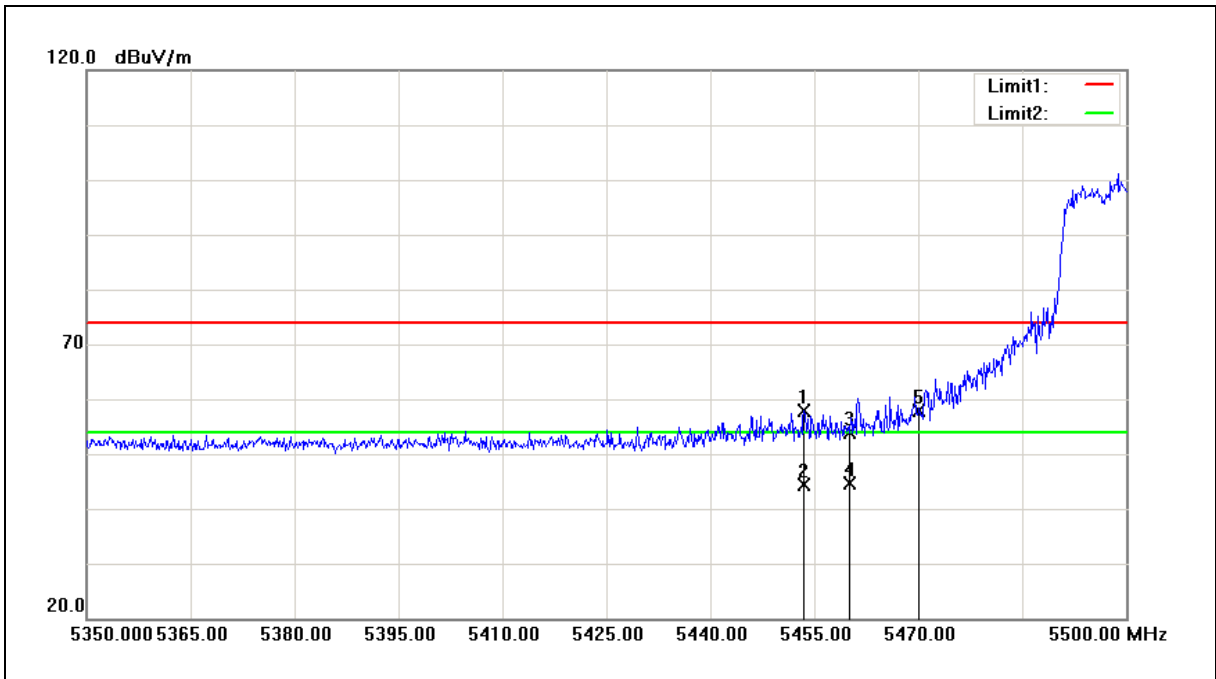

No.	Frequency (MHz)	Reading (dBuV)	Correct Factor (dB/m)	Result (dBuV/m)	Limit (dBuV/m)	Margin (dB)	Remark
1	5453.500	49.35	8.61	57.96	74.00	-16.04	peak
2	5453.500	35.80	8.61	44.41	54.00	-9.59	AVG
3	5460.000	45.20	8.62	53.82	74.00	-20.18	peak
4	5460.000	36.12	8.62	44.74	54.00	-9.26	AVG
5	5470.000	49.13	8.63	57.76	78.20	-20.44	peak

Note:1.Result (dBuV/m) = Correct Factor (dB/m) + Reading(dBuV).

2.Correction factor (dB/m) = Antenna Factor (dB/m) + Cable loss (dB) – Pre-Amplifier gain (dB).

3. When the peak results are less than average limit, so not need to evaluate the average.



Standard:	FCC Part 15.407	Test Distance:	3m
Test item:	Band edge	Power:	AC 120V/60Hz
Frequency:	5745MHz	Temp.(°C)/Hum.(%RH):	26(°C)/60%RH
Mode:	Mode 3	Date:	04/24/2016
Ant.Polar.:	Horizontal		

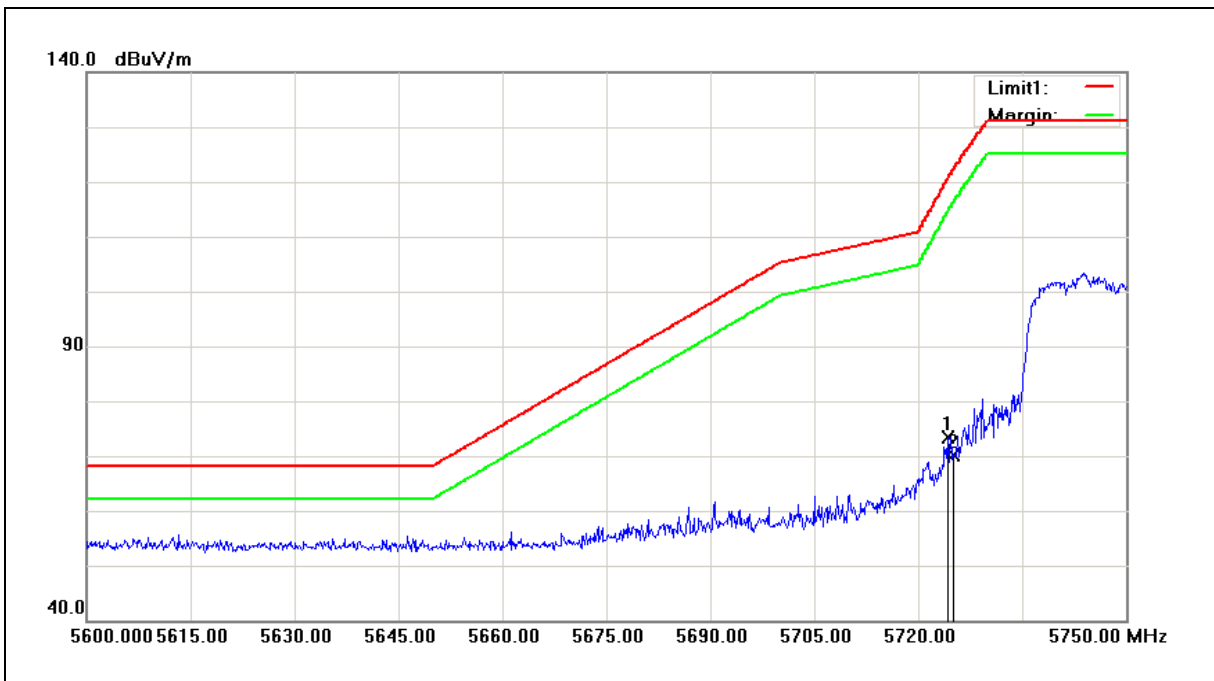

No.	Frequency (MHz)	Reading (dBuV)	Correct Factor (dB/m)	Result (dBuV/m)	Limit (dBuV/m)	Margin (dB)	Remark
1	5724.200	64.11	9.18	73.29	120.38	-47.09	peak
2	5725.000	60.88	9.19	70.07	122.20	-52.13	peak

Note:1.Result (dBuV/m) = Correct Factor (dB/m) + Reading(dBuV).

2.Correction factor (dB/m) = Antenna Factor (dB/m) + Cable loss (dB) – Pre-Amplifier gain (dB).

3. When the peak results are less than average limit, so not need to evaluate the average.



Standard:	FCC Part 15.407	Test Distance:	3m
Test item:	Band edge	Power:	AC 120V/60Hz
Frequency:	5745MHz	Temp.(°C)/Hum.(%RH):	26(°C)/60%RH
Mode:	Mode 3	Date:	04/24/2016
Ant.Polar.:	Vertical		

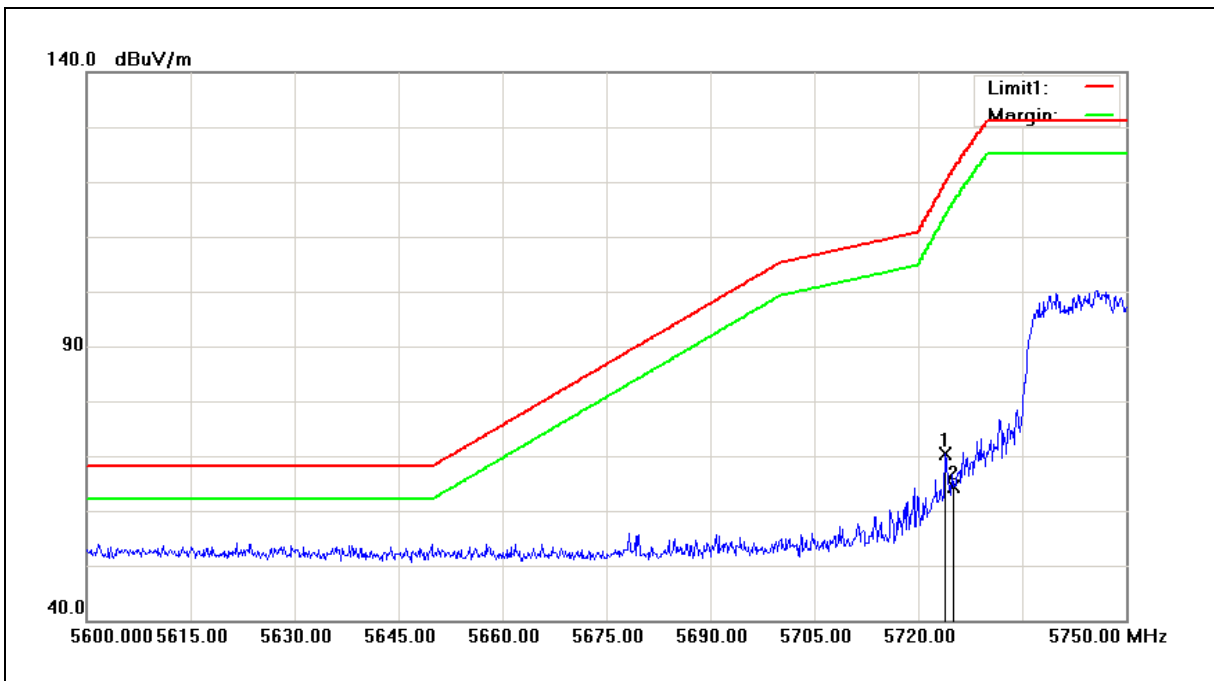

No.	Frequency (MHz)	Reading (dBuV)	Correct Factor (dB/m)	Result (dBuV/m)	Limit (dBuV/m)	Margin (dB)	Remark
1	5723.900	61.11	9.18	70.29	119.69	-49.40	peak
2	5725.000	55.27	9.19	64.46	122.20	-57.74	peak

Note:1.Result (dBuV/m) = Correct Factor (dB/m) + Reading(dBuV).

2.Correction factor (dB/m) = Antenna Factor (dB/m) + Cable loss (dB) – Pre-Amplifier gain (dB).

3. When the peak results are less than average limit, so not need to evaluate the average.



Standard:	FCC Part 15.407	Test Distance:	3m
Test item:	Band edge	Power:	AC 120V/60Hz
Frequency:	5825MHz	Temp.(°C)/Hum. (%RH):	26(°C)/60%RH
Mode:	Mode 3	Date:	04/24/2016
Ant.Polar.:	Horizontal		

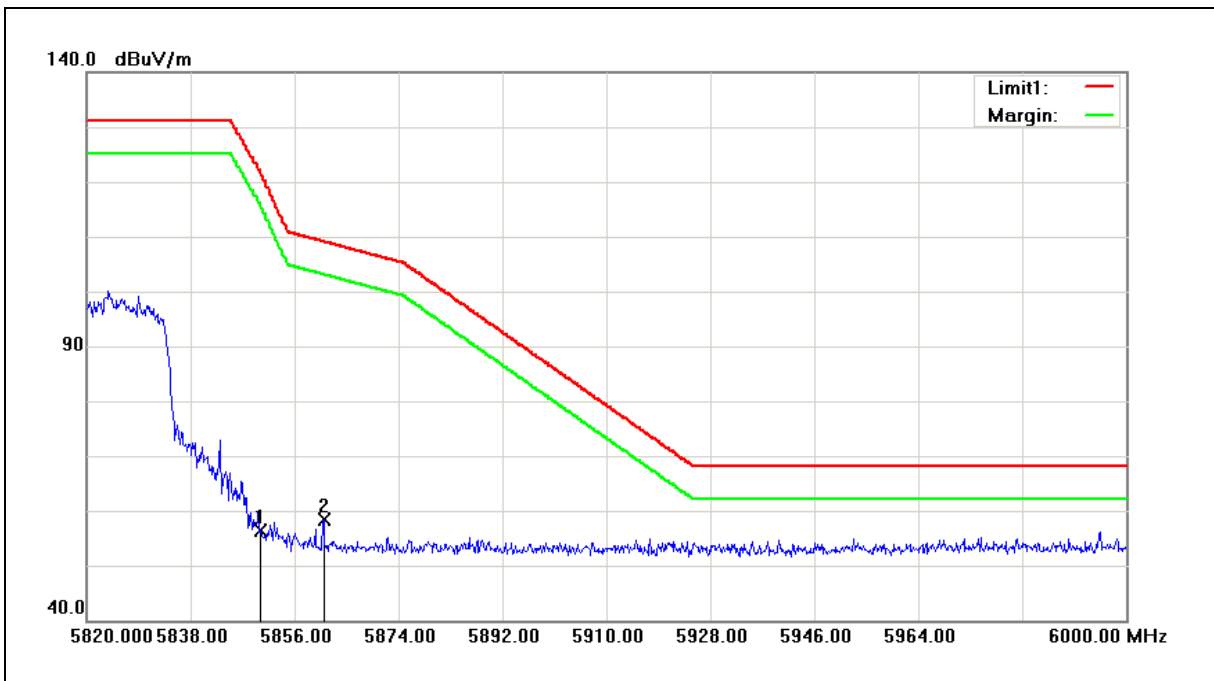

No.	Frequency (MHz)	Reading (dBuV)	Correct Factor (dB/m)	Result (dBuV/m)	Limit (dBuV/m)	Margin (dB)	Remark
1	5850.000	47.01	9.46	56.47	122.20	-65.73	peak
2	5861.040	48.97	9.49	58.46	109.11	-50.65	peak

- Note:1.Result (dBuV/m) = Correct Factor (dB/m) + Reading(dBuV).
- 2.Correction factor (dB/m) = Antenna Factor (dB/m) + Cable loss (dB) – Pre-Amplifier gain (dB).
3. When the peak results are less than average limit, so not need to evaluate the average.



Standard:	FCC Part 15.407	Test Distance:	3m
Test item:	Band edge	Power:	AC 120V/60Hz
Frequency:	5825MHz	Temp.(°C)/Hum.(%RH):	26(°C)/60%RH
Mode:	Mode 3	Date:	04/24/2016
Ant.Polar.:	Vertical		

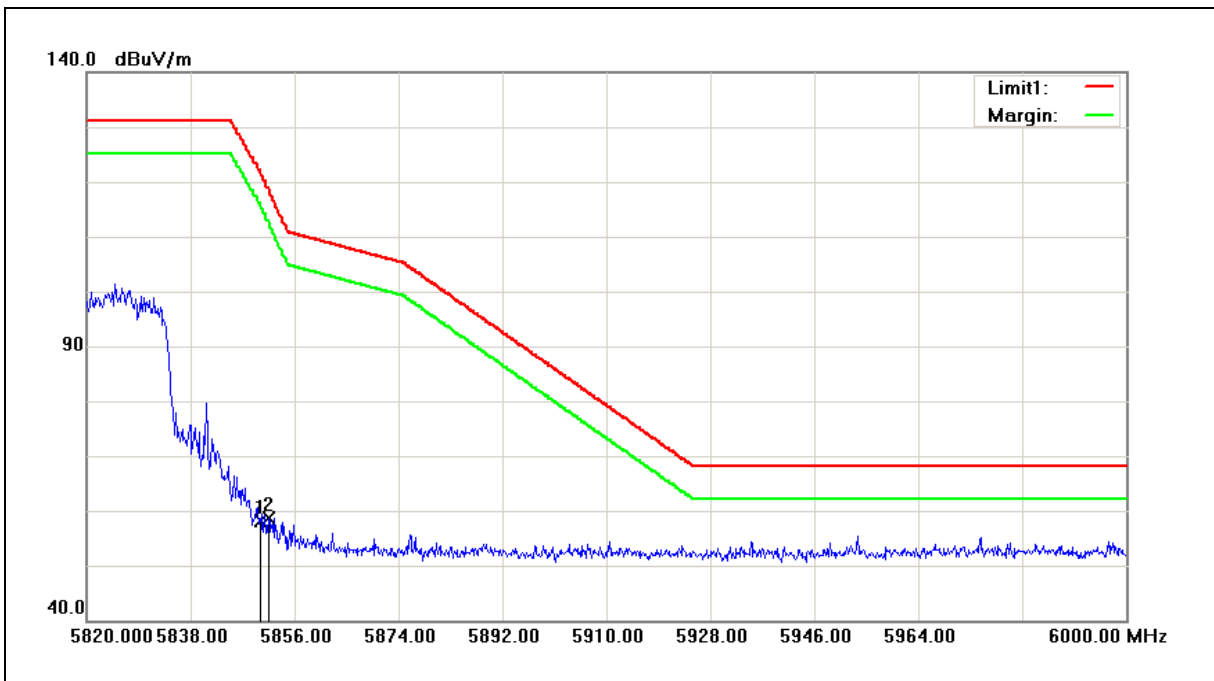

No.	Frequency (MHz)	Reading (dBuV)	Correct Factor (dB/m)	Result (dBuV/m)	Limit (dBuV/m)	Margin (dB)	Remark
1	5850.000	48.72	9.46	58.18	122.20	-64.02	peak
2	5851.500	49.19	9.47	58.66	118.78	-60.12	peak

Note:1.Result (dBuV/m) = Correct Factor (dB/m) + Reading(dBuV).

2.Correction factor (dB/m) = Antenna Factor (dB/m) + Cable loss (dB) – Pre-Amplifier gain (dB).

3. When the peak results are less than average limit, so not need to evaluate the average.



Standard:	FCC Part 15.407	Test Distance:	3m
Test item:	Band edge	Power:	AC 120V/60Hz
Frequency:	5190MHz	Temp.(°C)/Hum.(%RH):	26(°C)/60%RH
Mode:	Mode 4	Date:	04/24/2016
Ant.Polar.:	Horizontal		

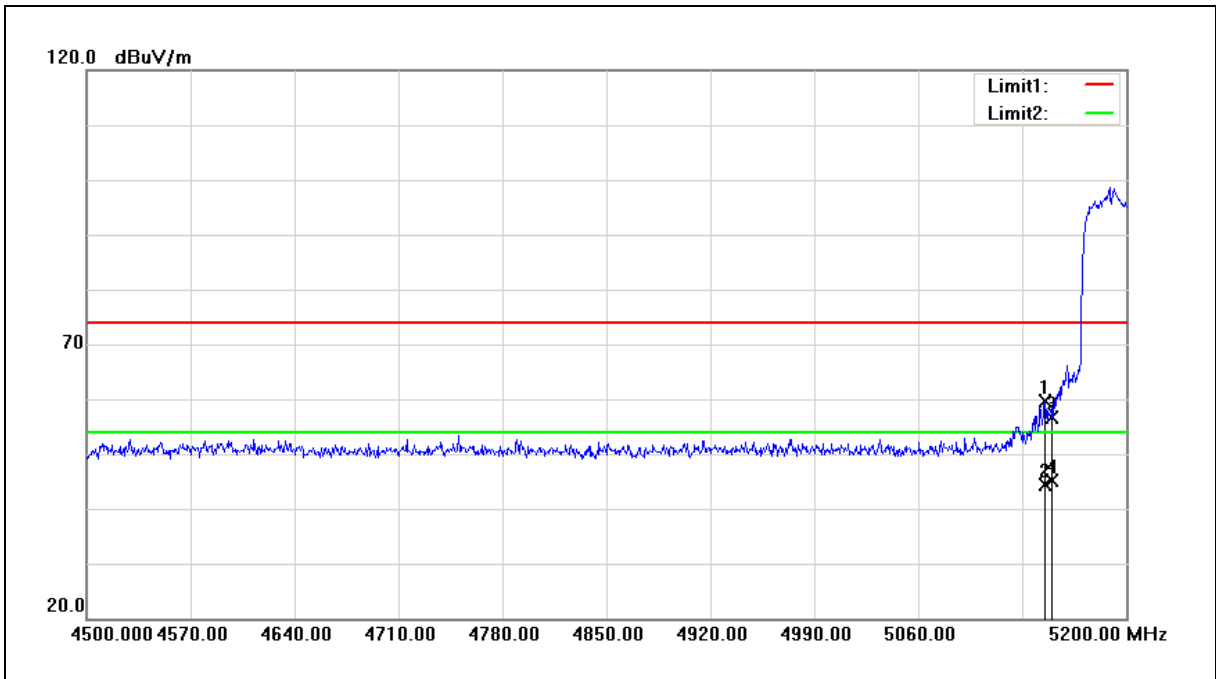

No.	Frequency (MHz)	Reading (dBuV)	Correct Factor (dB/m)	Result (dBuV/m)	Limit (dBuV/m)	Margin (dB)	Remark
1	5145.400	51.37	8.28	59.65	74.00	-14.35	peak
2	5145.400	35.98	8.28	44.26	54.00	-9.74	AVG
3	5150.000	48.30	8.29	56.59	74.00	-17.41	peak
4	5150.000	36.90	8.29	45.19	54.00	-8.81	AVG

Note:1.Result (dBuV/m) = Correct Factor (dB/m) + Reading(dBuV).

2.Correction factor (dB/m) = Antenna Factor (dB/m) + Cable loss (dB) – Pre-Amplifier gain (dB).

3. When the peak results are less than average limit, so not need to evaluate the average.



Standard:	FCC Part 15.407	Test Distance:	3m
Test item:	Band edge	Power:	AC 120V/60Hz
Frequency:	5190MHz	Temp.(°C)/Hum.(%RH):	26(°C)/60%RH
Mode:	Mode 4	Date:	04/24/2016
Ant.Polar.:	Vertical		

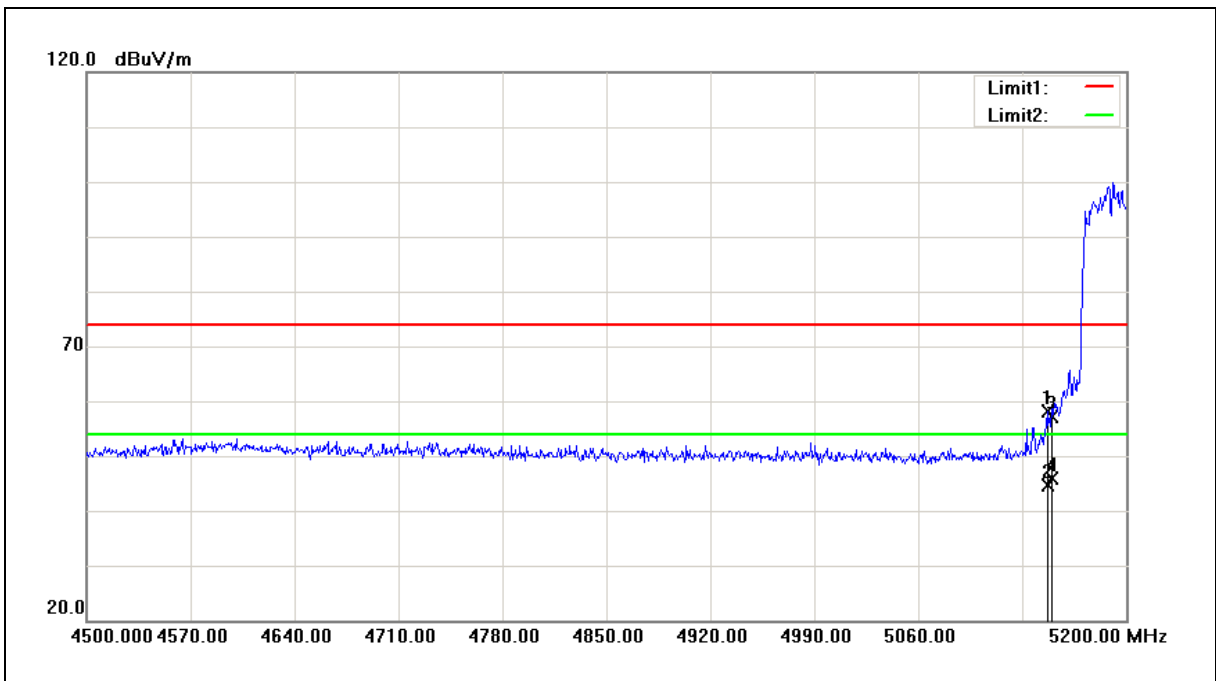

No.	Frequency (MHz)	Reading (dBuV)	Correct Factor (dB/m)	Result (dBuV/m)	Limit (dBuV/m)	Margin (dB)	Remark
1	5146.800	49.78	8.28	58.06	74.00	-15.94	peak
2	5146.800	36.44	8.28	44.72	54.00	-9.28	AVG
3	5150.000	48.86	8.29	57.15	74.00	-16.85	peak
4	5150.000	37.69	8.29	45.98	54.00	-8.02	AVG

Note:1.Result (dBuV/m) = Correct Factor (dB/m) + Reading(dBuV).

2.Correction factor (dB/m) = Antenna Factor (dB/m) + Cable loss (dB) – Pre-Amplifier gain (dB).

3. When the peak results are less than average limit, so not need to evaluate the average.



Standard:	FCC Part 15.407	Test Distance:	3m
Test item:	Band edge	Power:	AC 120V/60Hz
Frequency:	5310MHz	Temp.(°C)/Hum.(%RH):	26(°C)/60%RH
Mode:	Mode 4	Date:	04/24/2016
Ant.Polar.:	Horizontal		

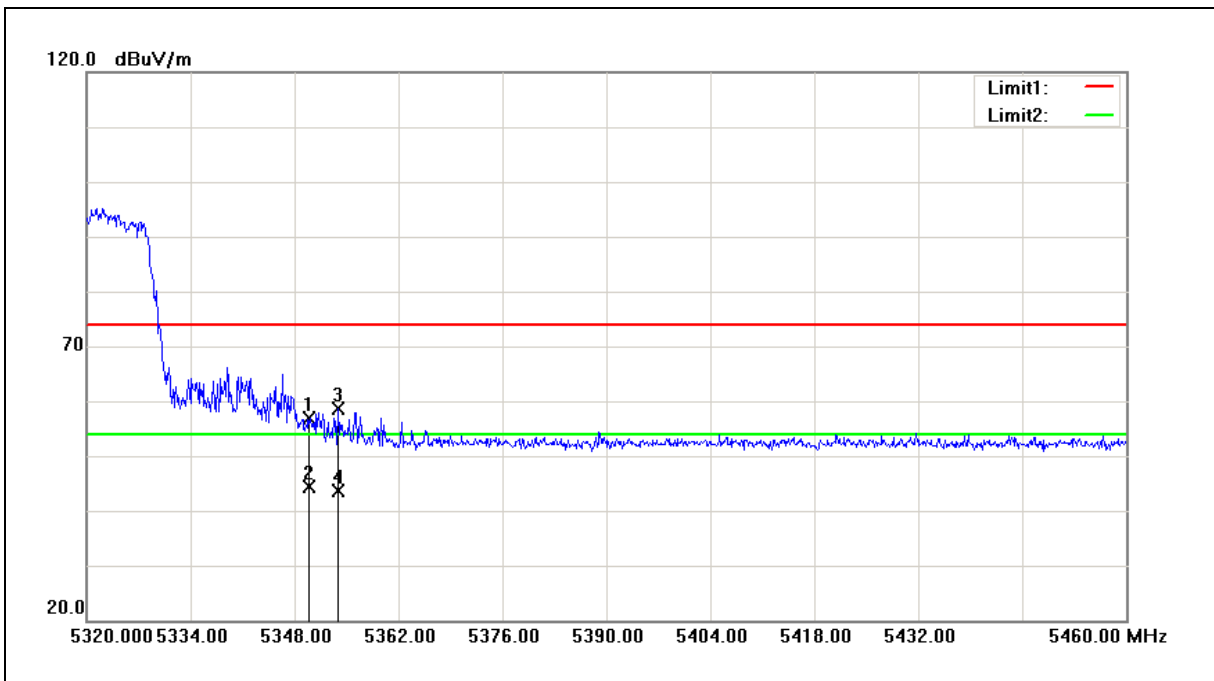

No.	Frequency (MHz)	Reading (dBuV)	Correct Factor (dB/m)	Result (dBuV/m)	Limit (dBuV/m)	Margin (dB)	Remark
1	5350.000	48.34	8.50	56.84	74.00	-17.16	peak
2	5350.000	35.86	8.50	44.36	54.00	-9.64	AVG
3	5353.880	50.15	8.51	58.66	74.00	-15.34	peak
4	5353.880	35.06	8.51	43.57	54.00	-10.43	AVG

Note:1.Result (dBuV/m) = Correct Factor (dB/m) + Reading(dBuV).

2.Correction factor (dB/m) = Antenna Factor (dB/m) + Cable loss (dB) – Pre-Amplifier gain (dB).

3. When the peak results are less than average limit, so not need to evaluate the average.



Standard:	FCC Part 15.407	Test Distance:	3m
Test item:	Band edge	Power:	AC 120V/60Hz
Frequency:	5310MHz	Temp.(°C)/Hum.(%RH):	26(°C)/60%RH
Mode:	Mode 4	Date:	04/24/2016
Ant.Polar.:	Vertical		

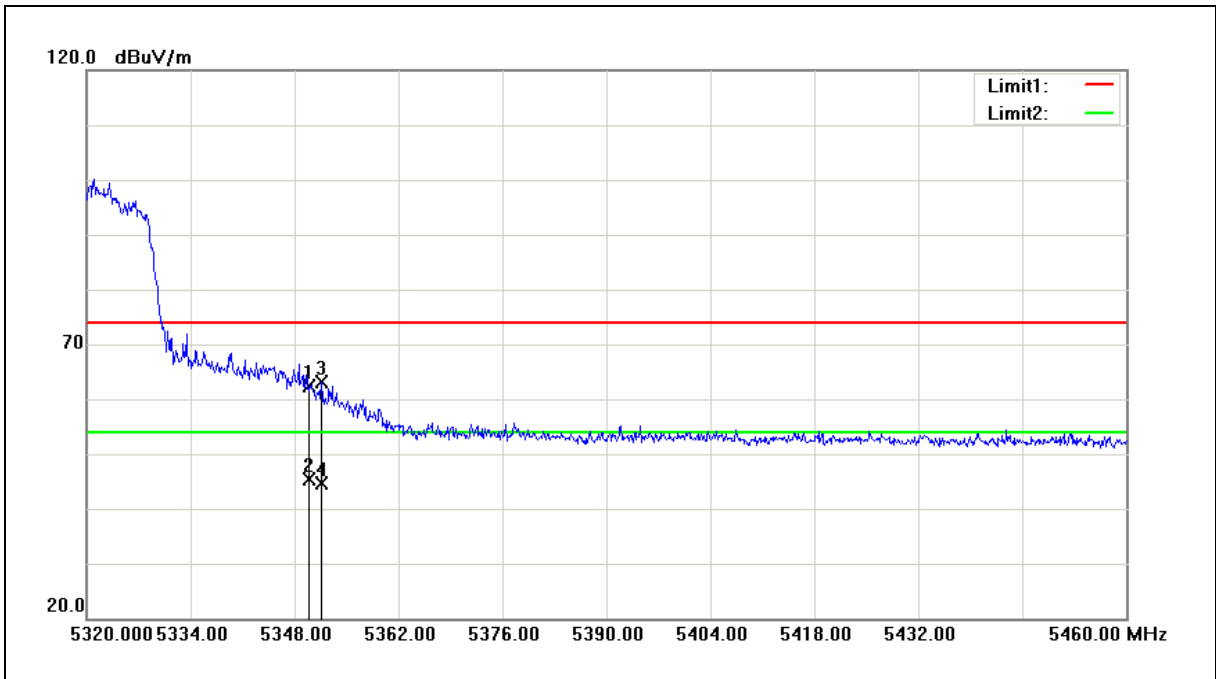

No.	Frequency (MHz)	Reading (dBuV)	Correct Factor (dB/m)	Result (dBuV/m)	Limit (dBuV/m)	Margin (dB)	Remark
1	5350.000	53.88	8.50	62.38	74.00	-11.62	peak
2	5350.000	36.87	8.50	45.37	54.00	-8.63	AVG
3	5351.640	54.53	8.50	63.03	74.00	-10.97	peak
4	5351.640	36.19	8.50	44.69	54.00	-9.31	AVG

Note:1.Result (dBuV/m) = Correct Factor (dB/m) + Reading(dBuV).

2.Correction factor (dB/m) = Antenna Factor (dB/m) + Cable loss (dB) – Pre-Amplifier gain (dB).

3. When the peak results are less than average limit, so not need to evaluate the average.



Standard:	FCC Part 15.407	Test Distance:	3m
Test item:	Band edge	Power:	AC 120V/60Hz
Frequency:	5510MHz	Temp.(°C)/Hum.(%RH):	26(°C)/60%RH
Mode:	Mode 4	Date:	04/24/2016
Ant.Polar.:	Horizontal		

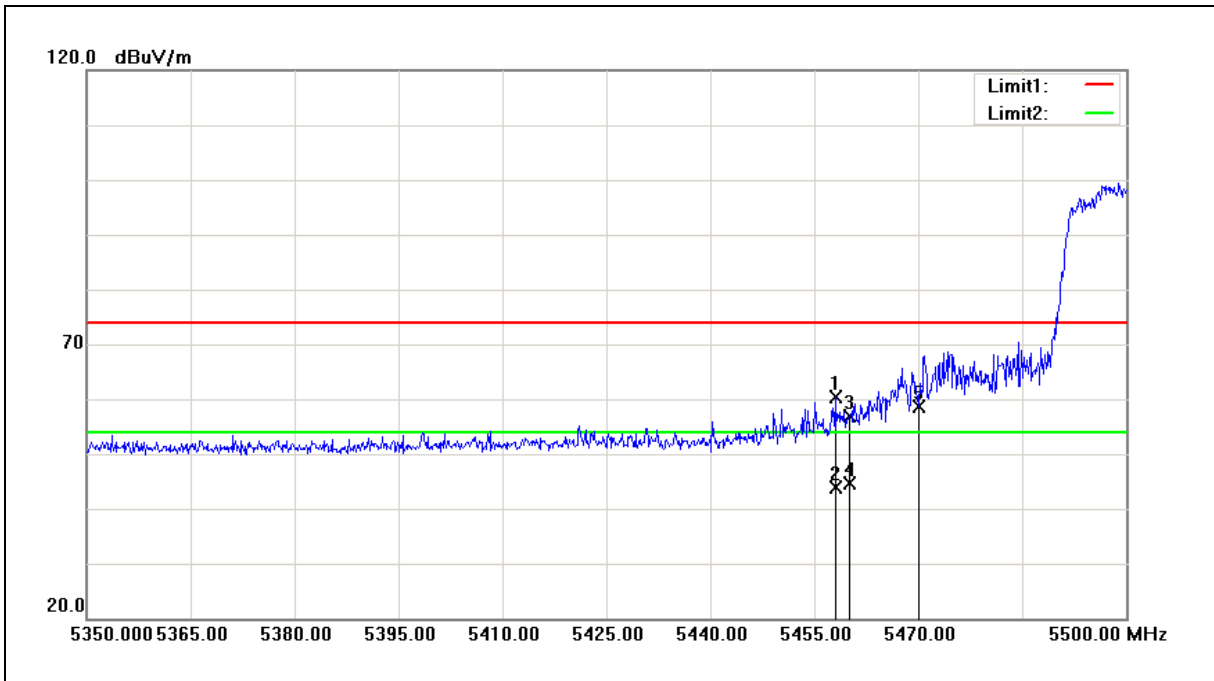

No.	Frequency (MHz)	Reading (dBuV)	Correct Factor (dB/m)	Result (dBuV/m)	Limit (dBuV/m)	Margin (dB)	Remark
1	5458.000	51.87	8.61	60.48	74.00	-13.52	peak
2	5458.000	35.18	8.61	43.79	54.00	-10.21	AVG
3	5460.000	48.26	8.62	56.88	74.00	-17.12	peak
4	5460.000	36.04	8.62	44.66	54.00	-9.34	AVG
5	5470.000	50.11	8.63	58.74	78.20	-19.46	peak

Note:1.Result (dBuV/m) = Correct Factor (dB/m) + Reading(dBuV).

2.Correction factor (dB/m) = Antenna Factor (dB/m) + Cable loss (dB) – Pre-Amplifier gain (dB).

3. When the peak results are less than average limit, so not need to evaluate the average.



Standard:	FCC Part 15.407	Test Distance:	3m
Test item:	Band edge	Power:	AC 120V/60Hz
Frequency:	5510MHz	Temp.(°C)/Hum.(%RH):	26(°C)/60%RH
Mode:	Mode 4	Date:	04/24/2016
Ant.Polar.:	Vertical		

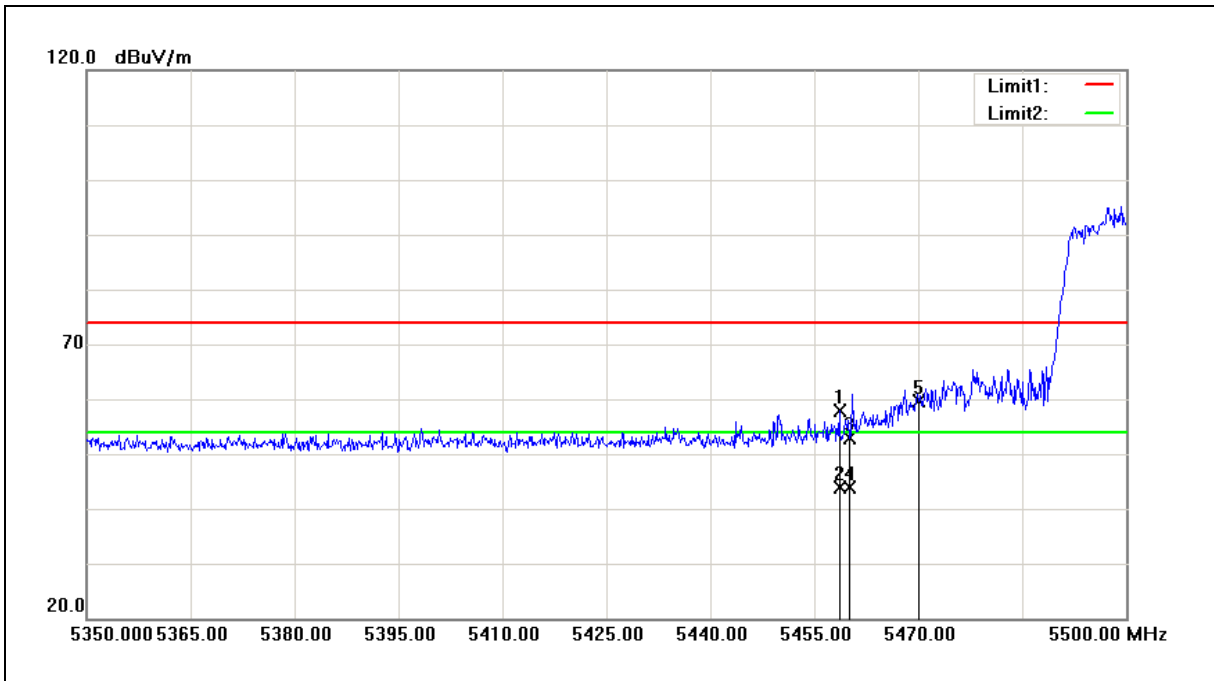

No.	Frequency (MHz)	Reading (dBuV)	Correct Factor (dB/m)	Result (dBuV/m)	Limit (dBuV/m)	Margin (dB)	Remark
1	5458.600	49.28	8.62	57.90	74.00	-16.10	peak
2	5458.600	35.14	8.62	43.76	54.00	-10.24	AVG
3	5460.000	44.14	8.62	52.76	74.00	-21.24	peak
4	5460.000	35.32	8.62	43.94	54.00	-10.06	AVG
5	5470.000	50.93	8.63	59.56	78.20	-18.64	peak

Note:1.Result (dBuV/m) = Correct Factor (dB/m) + Reading(dBuV).

2.Correction factor (dB/m) = Antenna Factor (dB/m) + Cable loss (dB) – Pre-Amplifier gain (dB).

3. When the peak results are less than average limit, so not need to evaluate the average.



Standard:	FCC Part 15.407	Test Distance:	3m
Test item:	Band edge	Power:	AC 120V/60Hz
Frequency:	5755MHz	Temp.(°C)/Hum.(%RH):	26(°C)/60%RH
Mode:	Mode 4	Date:	04/24/2016
Ant.Polar.:	Horizontal		

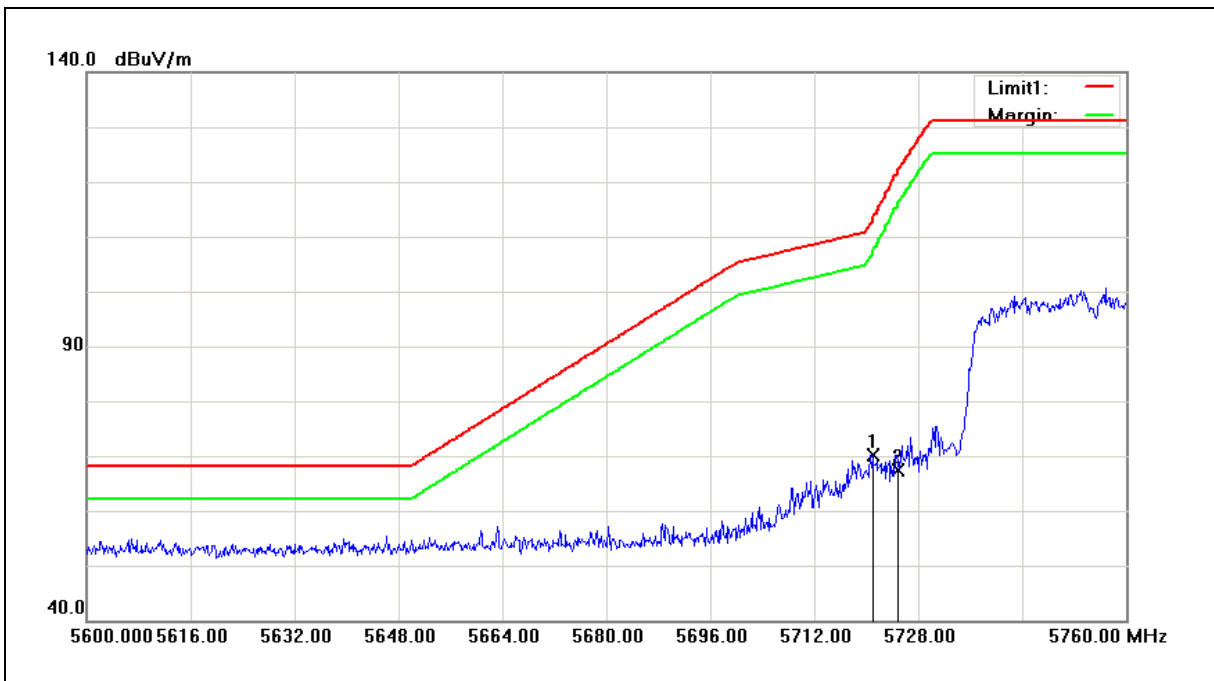

No.	Frequency (MHz)	Reading (dBuV)	Correct Factor (dB/m)	Result (dBuV/m)	Limit (dBuV/m)	Margin (dB)	Remark
1	5720.960	61.00	9.18	70.18	112.99	-42.81	peak
2	5725.000	58.11	9.19	67.30	122.20	-54.90	peak

Note:1.Result (dBuV/m) = Correct Factor (dB/m) + Reading(dBuV).

2.Correction factor (dB/m) = Antenna Factor (dB/m) + Cable loss (dB) – Pre-Amplifier gain (dB).

3. When the peak results are less than average limit, so not need to evaluate the average.



Standard:	FCC Part 15.407	Test Distance:	3m
Test item:	Band edge	Power:	AC 120V/60Hz
Frequency:	5755MHz	Temp.(°C)/Hum.(%RH):	26(°C)/60%RH
Mode:	Mode 4	Date:	04/24/2016
Ant.Polar.:	Vertical		

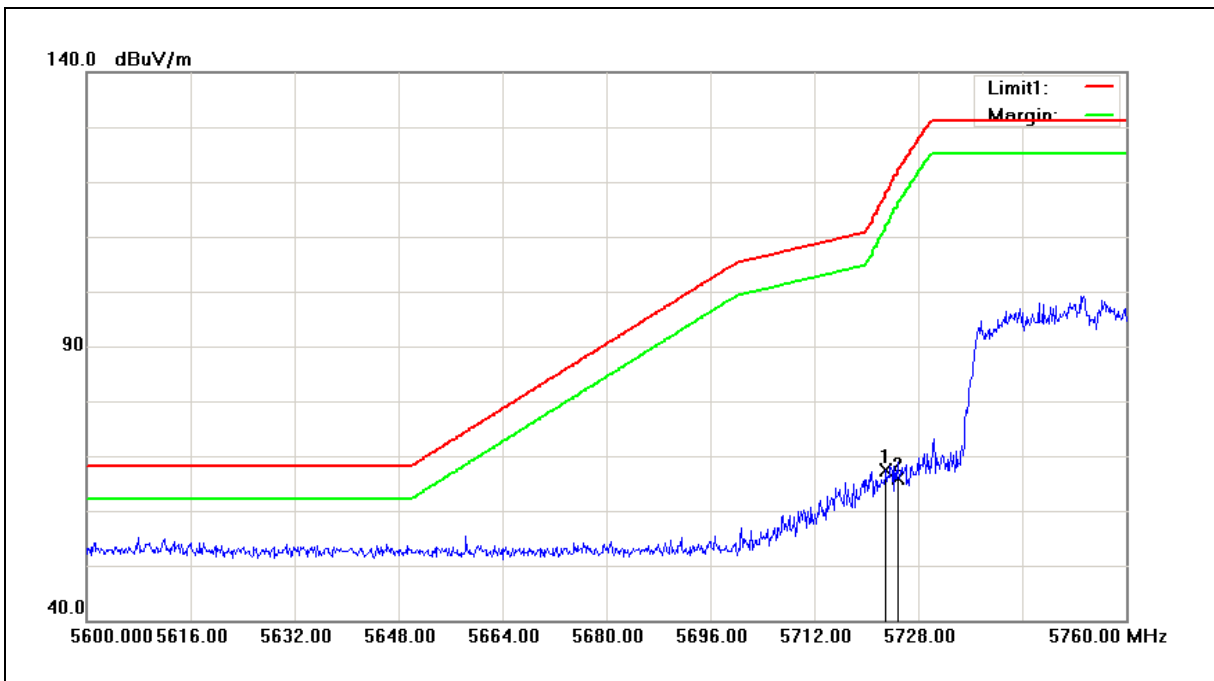

No.	Frequency (MHz)	Reading (dBuV)	Correct Factor (dB/m)	Result (dBuV/m)	Limit (dBuV/m)	Margin (dB)	Remark
1	5723.040	58.12	9.18	67.30	117.73	-50.43	peak
2	5725.000	56.70	9.19	65.89	122.20	-56.31	peak

- Note:1.Result (dBuV/m) = Correct Factor (dB/m) + Reading(dBuV).
 2.Correction factor (dB/m) = Antenna Factor (dB/m) + Cable loss (dB) – Pre-Amplifier gain (dB).
 3. When the peak results are less than average limit, so not need to evaluate the average.



Standard:	FCC Part 15.407	Test Distance:	3m
Test item:	Band edge	Power:	AC 120V/60Hz
Frequency:	5795MHz	Temp.(°C)/Hum.(%RH):	26(°C)/60%RH
Mode:	Mode 4	Date:	04/24/2016
Ant.Polar.:	Horizontal		

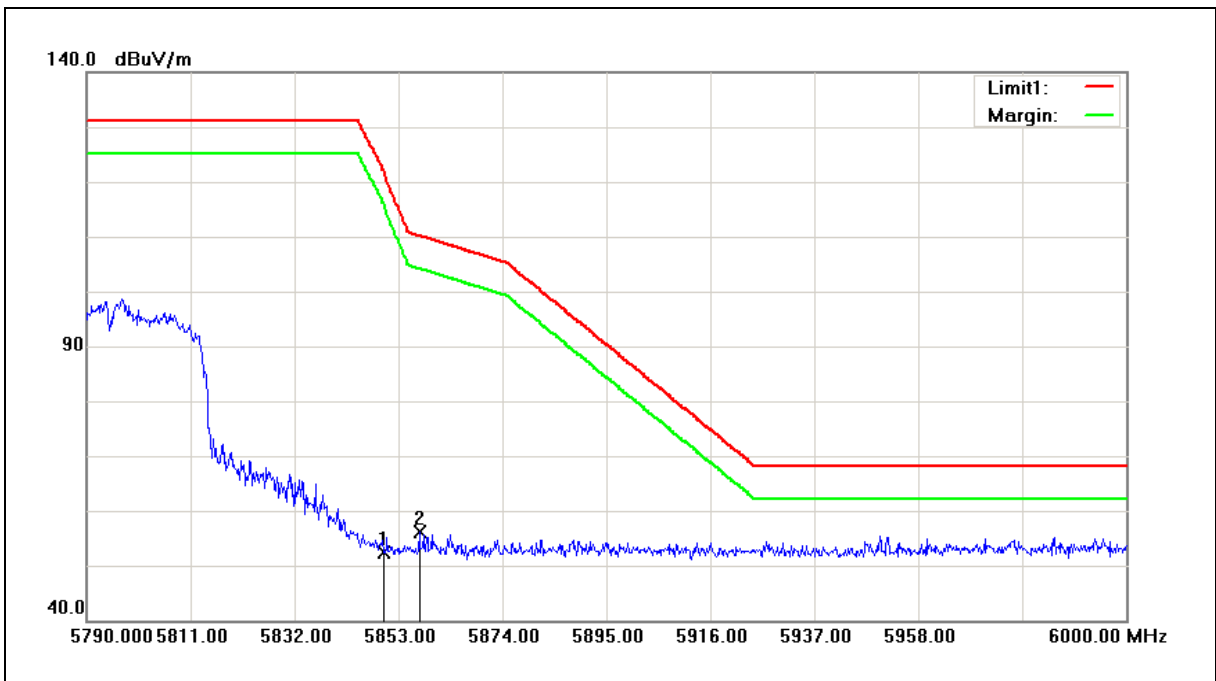

No.	Frequency (MHz)	Reading (dBuV)	Correct Factor (dB/m)	Result (dBuV/m)	Limit (dBuV/m)	Margin (dB)	Remark
1	5850.000	43.01	9.46	52.47	122.20	-69.73	peak
2	5857.200	46.68	9.48	56.16	110.18	-54.02	peak

Note:1.Result (dBuV/m) = Correct Factor (dB/m) + Reading(dBuV).

2.Correction factor (dB/m) = Antenna Factor (dB/m) + Cable loss (dB) – Pre-Amplifier gain (dB).

3. When the peak results are less than average limit, so not need to evaluate the average.



Standard:	FCC Part 15.407	Test Distance:	3m
Test item:	Band edge	Power:	AC 120V/60Hz
Frequency:	5795MHz	Temp.(°C)/Hum. (%RH):	26(°C)/60%RH
Mode:	Mode 4	Date:	04/24/2016
Ant.Polar.:	Vertical		

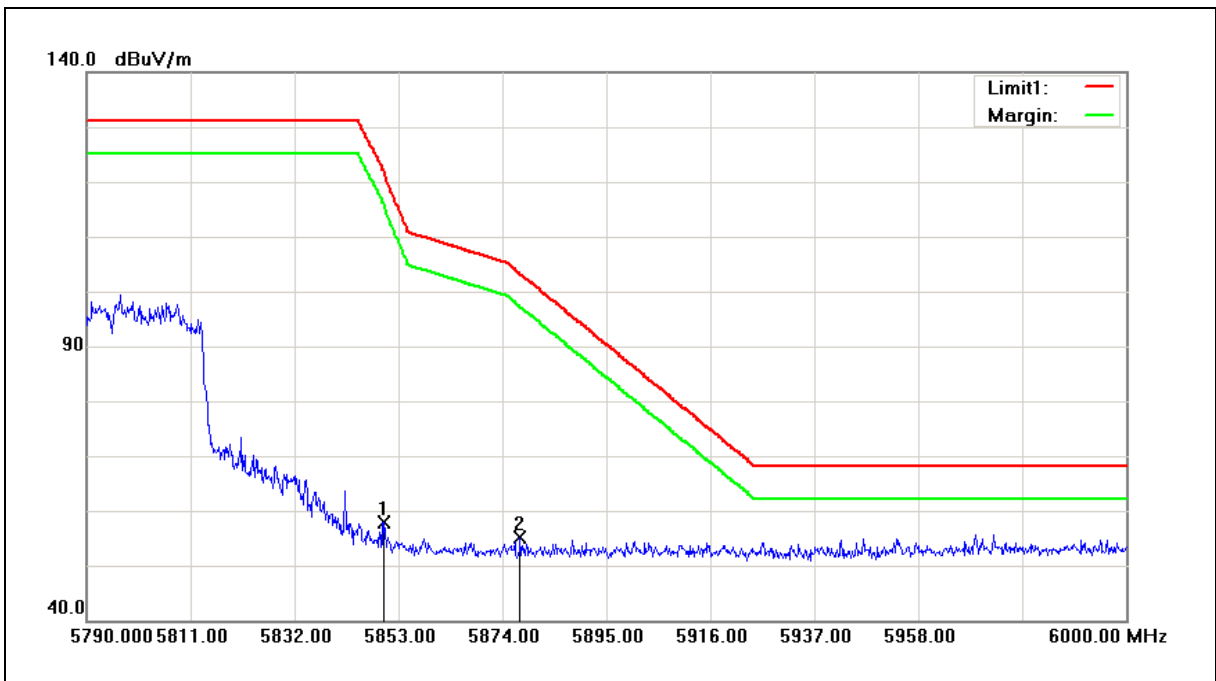

No.	Frequency (MHz)	Reading (dBuV)	Correct Factor (dB/m)	Result (dBuV/m)	Limit (dBuV/m)	Margin (dB)	Remark
1	5850.000	48.38	9.46	57.84	122.20	-64.36	peak
2	5877.570	45.55	9.53	55.08	103.30	-48.22	peak

- Note:1.Result (dBuV/m) = Correct Factor (dB/m) + Reading(dBuV).
- 2.Correction factor (dB/m) = Antenna Factor (dB/m) + Cable loss (dB) – Pre-Amplifier gain (dB).
3. When the peak results are less than average limit, so not need to evaluate the average.

4.4. Maximum Conducted Output Power Measurement

■ Limit

Frequency Range (MHz)	FCC Maximum Conducted Output Power Limit
	Client
5.150 ~ 5.250 GHz	The lesser of 250mW (24dBm)
5.250 ~ 5.350 GHz	The lesser of 250mW (24dBm) or 11dBm + 10log (B)
5.470 ~ 5.725 GHz	The lesser of 250mW (24dBm) or 11dBm + 10log (B)
5.725 ~ 5.850 GHz	The lesser of 1W (30dBm)

According FCC KDB 662911 D01 v02r01 – for power measurements on IEEE802.11 devices,

■ Test Setup

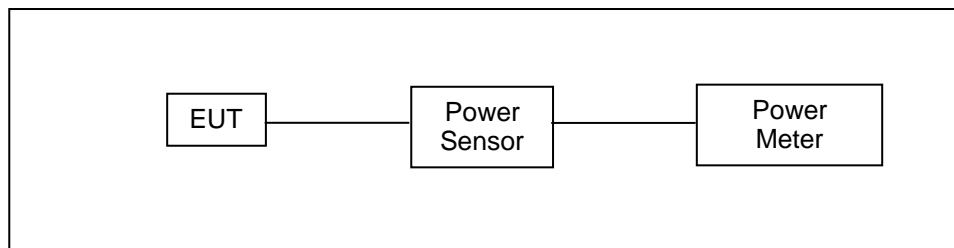

■ Test Instruments

Equipment	Manufacturer	Model Number	Serial Number	Cal. Date	Remark
Power Sensor	Anritsu	MA2411B	1126022	08/24/2015	1 year
Power Meter	Anritsu	ML2495A	1135009	08/24/2015	1 year
Microwave Cable	EMCI	EMC104-SM-SM-1 500	140303	02/23/2016	1 year
Test Site	ATL	TE05	TE05	N.C.R.	-----

Note: N.C.R. = No Calibration Request.

■ Test Procedure

The test is performed in accordance with KDB789033: D02 General UNII Test Procedures New Rules v01r04, Guidelines for Compliance Testing of Unlicensed National Information Infrastructure (U-NII) Devices

Section (E) Maximum Conducted Output Power

3. Measurement using a Power Meter (PM)

b) Method PM-G (Measurement using a gated RF average power meter)



■ Test Result

Test Item		Maximum Conducted Output Power		
Test Mode		Mode 2: IEEE 802.11a Continuous TX mode		
Frequency (MHz)	Data Rate	ANT-0		FCC Limit (dBm)
		Max. Output Power		
		(dBm)	(W)	
5180	6M	12.23	0.017	≤ 24
5200		12.12	0.016	≤ 24
5220		12.02	0.016	≤ 24
5240		11.99	0.016	≤ 24
5260		11.86	0.015	≤ 23.79
5280		11.72	0.015	≤ 23.79
5300		11.59	0.014	≤ 23.79
5320		11.52	0.014	≤ 23.79
5500		11.14	0.013	≤ 23.79
5520		11.10	0.013	≤ 23.79
5540		11.11	0.013	≤ 23.79
5560		11.06	0.013	≤ 23.79
5580		11.13	0.013	≤ 23.79
5600		11.05	0.013	≤ 23.79
5620		11.02	0.013	≤ 23.79
5640		11.01	0.013	≤ 23.79
5660		10.97	0.013	≤ 23.79
5680		10.91	0.012	≤ 23.79
5700		10.85	0.012	≤ 23.79
5745		10.69	0.012	≤ 30
5765	10.57	0.011	≤ 30	
5785	10.33	0.011	≤ 30	
5805	10.12	0.010	≤ 30	
5825	9.82	0.010	≤ 30	

Note: The relevant measured result has the offset with cable loss already.



Test Item		Maximum Conducted Output Power		
Test Mode		Mode 2: IEEE 802.11a Continuous TX mode		
Frequency (MHz)	Data Rate	ANT-0		FCC Limit (dBm)
		Max. Output Power		
		(dBm)	(W)	
5180	54M	12.11	0.016	≤ 24
5200		12.05	0.016	≤ 24
5220		11.92	0.016	≤ 24
5240		11.89	0.015	≤ 24
5260		11.73	0.015	≤ 23.79
5280		11.65	0.015	≤ 23.79
5300		11.49	0.014	≤ 23.79
5320		11.42	0.014	≤ 23.79
5500		11.07	0.013	≤ 23.79
5520		11.01	0.013	≤ 23.79
5540		10.98	0.013	≤ 23.79
5560		10.93	0.012	≤ 23.79
5580		10.97	0.013	≤ 23.79
5600		10.95	0.012	≤ 23.79
5620		10.88	0.012	≤ 23.79
5640		10.90	0.012	≤ 23.79
5660		10.83	0.012	≤ 23.79
5680		10.78	0.012	≤ 23.79
5700		10.75	0.012	≤ 23.79
5745		10.61	0.012	≤ 30
5765		10.49	0.011	≤ 30
5785		10.25	0.011	≤ 30
5805		10.02	0.010	≤ 30
5825		9.75	0.009	≤ 30

Note: The relevant measured result has the offset with cable loss already.



Test Item		Maximum Conducted Output Power		
Test Mode		Mode 3: IEEE 802.11n 5GHz 20MHz Continuous TX mode		
Frequency (MHz)	Data Rate	ANT-0		FCC Limit (dBm)
		Max. Output Power		
		(dBm)	(W)	
5180	6.5M	12.20	0.017	≤ 24
5200		11.97	0.016	≤ 24
5220		11.75	0.015	≤ 24
5240		11.74	0.015	≤ 24
5260		11.82	0.015	≤ 23.78
5280		11.64	0.015	≤ 23.78
5300		11.42	0.014	≤ 23.78
5320		11.31	0.014	≤ 23.78
5500		11.38	0.014	≤ 24
5520		11.45	0.014	≤ 24
5540		10.95	0.012	≤ 24
5560		11.06	0.013	≤ 24
5580		11.07	0.013	≤ 24
5600		11.03	0.013	≤ 24
5620		10.96	0.012	≤ 24
5640		11.05	0.013	≤ 24
5660		11.09	0.013	≤ 24
5680		10.78	0.012	≤ 24
5700		10.87	0.012	≤ 24
5745		10.78	0.012	≤ 30
5765		10.75	0.012	≤ 30
5785		10.68	0.012	≤ 30
5805		10.51	0.011	≤ 30
5825		10.14	0.010	≤ 30

Note: The relevant measured result has the offset with cable loss already.



Test Item		Maximum Conducted Output Power		
Test Mode		Mode 3: IEEE 802.11n 5GHz 20MHz Continuous TX mode		
Frequency (MHz)	Data Rate	ANT-0		FCC Limit (dBm)
		Max. Output Power		
		(dBm)	(W)	
5180	65M	12.11	0.016	≤ 24
5200		11.92	0.016	≤ 24
5220		11.68	0.015	≤ 24
5240		11.64	0.015	≤ 24
5260		11.67	0.015	≤ 23.78
5280		11.58	0.014	≤ 23.78
5300		11.38	0.014	≤ 23.78
5320		11.27	0.013	≤ 23.78
5500		11.32	0.014	≤ 24
5520		11.39	0.014	≤ 24
5540		10.89	0.012	≤ 24
5560		10.95	0.012	≤ 24
5580		10.94	0.012	≤ 24
5600		10.92	0.012	≤ 24
5620		10.89	0.012	≤ 24
5640		10.98	0.013	≤ 24
5660		11.01	0.013	≤ 24
5680		10.71	0.012	≤ 24
5700		10.79	0.012	≤ 24
5745		10.71	0.012	≤ 30
5765		10.64	0.012	≤ 30
5785		10.57	0.011	≤ 30
5805		10.46	0.011	≤ 30
5825		10.09	0.010	≤ 30

Note: The relevant measured result has the offset with cable loss already.



Test Item		Maximum Conducted Output Power			
Test Mode		Mode 4: IEEE 802.11n 5GHz 40MHz Continuous TX mode			
Frequency (MHz)	Data Rate	ANT-0		FCC Limit (dBm)	
		Max. Output Power			
		(dBm)	(W)		
5190	13.5M	12.31	0.017	≤ 24	
5230		12.11	0.016	≤ 24	
5270		11.97	0.016	≤ 24	
5310		11.62	0.015	≤ 24	
5510		11.21	0.013	≤ 24	
5550		11.18	0.013	≤ 24	
5590		11.17	0.013	≤ 24	
5630		11.07	0.013	≤ 24	
5670		11.04	0.013	≤ 24	
5755		10.79	0.012	≤ 30	
5795		10.33	0.011	≤ 30	
5190		135M	12.09	0.016	≤ 24
5230			11.85	0.015	≤ 24
5270	11.77		0.015	≤ 24	
5310	11.42		0.014	≤ 24	
5510	11.01		0.013	≤ 24	
5550	10.95		0.012	≤ 24	
5590	10.91		0.012	≤ 24	
5630	10.81		0.012	≤ 24	
5670	10.76		0.012	≤ 24	
5755	10.57		0.011	≤ 30	
5795	10.13	0.010	≤ 30		

Note: The relevant measured result has the offset with cable loss already.

4.5. 26dB RF Bandwidth Measurement

■ **Limit**

N/A

■ **Test Setup**

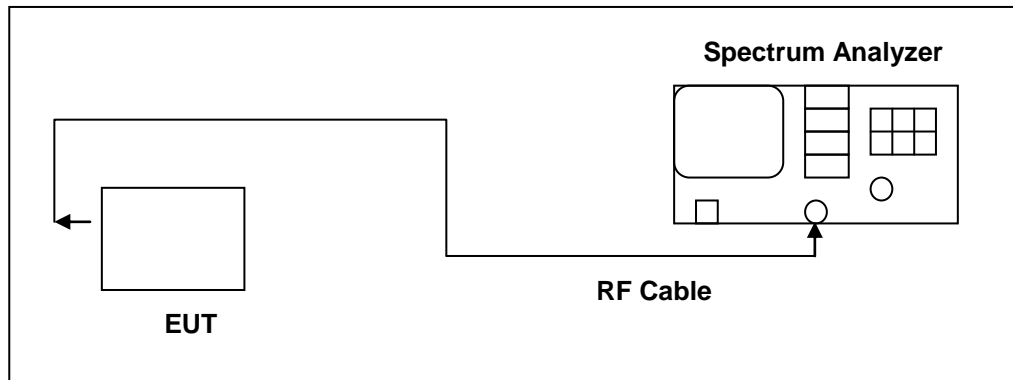

■ **Test Instruments**

Equipment	Manufacturer	Model Number	Serial Number	Cal. Date	Remark
Spectrum Analyzer	Agilent	E4445A	MY45300744	12/15/2015	1 year
Microwave Cable	EMCI	EMC104-SM-SM-1 500	140303	02/23/2016	1 year
Test Site	ATL	TE05	TE05	N.C.R.	-----

Note: N.C.R. = No Calibration Request.

■ **Test Procedure**

The test is performed in accordance with KDB789033: D02 General UNII Test Procedures New Rules v01r04, Guidelines for Compliance Testing of Unlicensed National Information Infrastructure (U-NII) Devices - Part 15, Subpart E.

Spectrum Parameter	Setting
Attenuation	Auto
Span Frequency	>26dB Bandwidth
RBW	Approximately 1% of the emission bandwidth
VBW	VBW > RBW
Detector	Peak
Trace	Max Hold
Sweep Time	Auto



■ Test Result

Test Item	26dB RF Bandwidth Measurement
Test Mode	Mode 2: IEEE 802.11a Continuous TX mode
Frequency (MHz)	ANT-0
	26dB Bandwidth (MHz)
5180	19.320
5200	18.970
5240	19.040
5260	19.030
5280	19.040
5320	19.070
5500	19.910
5560	18.990
5700	20.290

Test Item	26dB RF Bandwidth Measurement
Test Mode	Mode 3: IEEE 802.11n 5GHz 20MHz Continuous TX mode
Frequency (MHz)	ANT-0
	26dB Bandwidth (MHz)
5180	20.750
5200	20.240
5240	20.650
5260	19.950
5280	21.410
5320	18.980
5500	23.640
5560	23.840
5700	24.940



Test Item	26dB RF Bandwidth Measurement
Test Mode	Mode 4: IEEE 802.11n 5GHz 40MHz Continuous TX mode
Frequency (MHz)	ANT-0
	26dB Bandwidth (MHz)
5190	40.560
5230	40.210
5270	40.240
5310	40.240
5510	42.800
5550	40.300
5670	40.540



■ Test Graphs

Mode 2: IEEE 802.11a Continuous TX mode_ ANT-0																			
5180 MHz	<p>Agilent Spectrum Analyzer: Occupied BW</p> <p>Center Freq: 5.18000000 GHz Trig: Free Run #Atten: 16 dB</p> <p>Ref 10.00 dBm</p> <p>Center 5.18 GHz #Res BW 300 kHz #VBW 1 MHz Span 25 MHz Sweep 1 ms</p> <table border="1"> <tr> <td>Occupied Bandwidth</td> <td>Total Power</td> <td>17.2 dBm</td> </tr> <tr> <td>16.501 MHz</td> <td></td> <td></td> </tr> <tr> <td>Transmit Freq Error</td> <td>OBW Power</td> <td>99.00 %</td> </tr> <tr> <td>-8.036 kHz</td> <td></td> <td></td> </tr> <tr> <td>x dB Bandwidth</td> <td>x dB</td> <td>-26.00 dB</td> </tr> <tr> <td>19.32 MHz</td> <td></td> <td></td> </tr> </table>	Occupied Bandwidth	Total Power	17.2 dBm	16.501 MHz			Transmit Freq Error	OBW Power	99.00 %	-8.036 kHz			x dB Bandwidth	x dB	-26.00 dB	19.32 MHz		
Occupied Bandwidth	Total Power	17.2 dBm																	
16.501 MHz																			
Transmit Freq Error	OBW Power	99.00 %																	
-8.036 kHz																			
x dB Bandwidth	x dB	-26.00 dB																	
19.32 MHz																			
5200 MHz	<p>Agilent Spectrum Analyzer: Occupied BW</p> <p>Center Freq: 5.20000000 GHz Trig: Free Run #Atten: 16 dB</p> <p>Ref 10.00 dBm</p> <p>Center 5.2 GHz #Res BW 300 kHz #VBW 1 MHz Span 25 MHz Sweep 1 ms</p> <table border="1"> <tr> <td>Occupied Bandwidth</td> <td>Total Power</td> <td>17.0 dBm</td> </tr> <tr> <td>16.488 MHz</td> <td></td> <td></td> </tr> <tr> <td>Transmit Freq Error</td> <td>OBW Power</td> <td>99.00 %</td> </tr> <tr> <td>-27.114 kHz</td> <td></td> <td></td> </tr> <tr> <td>x dB Bandwidth</td> <td>x dB</td> <td>-26.00 dB</td> </tr> <tr> <td>18.97 MHz</td> <td></td> <td></td> </tr> </table>	Occupied Bandwidth	Total Power	17.0 dBm	16.488 MHz			Transmit Freq Error	OBW Power	99.00 %	-27.114 kHz			x dB Bandwidth	x dB	-26.00 dB	18.97 MHz		
Occupied Bandwidth	Total Power	17.0 dBm																	
16.488 MHz																			
Transmit Freq Error	OBW Power	99.00 %																	
-27.114 kHz																			
x dB Bandwidth	x dB	-26.00 dB																	
18.97 MHz																			
5240 MHz	<p>Agilent Spectrum Analyzer: Occupied BW</p> <p>Center Freq: 5.24000000 GHz Trig: Free Run #Atten: 16 dB</p> <p>Ref 10.00 dBm</p> <p>Center 5.24 GHz #Res BW 300 kHz #VBW 1 MHz Span 25 MHz Sweep 1 ms</p> <table border="1"> <tr> <td>Occupied Bandwidth</td> <td>Total Power</td> <td>16.8 dBm</td> </tr> <tr> <td>16.510 MHz</td> <td></td> <td></td> </tr> <tr> <td>Transmit Freq Error</td> <td>OBW Power</td> <td>99.00 %</td> </tr> <tr> <td>-21.704 kHz</td> <td></td> <td></td> </tr> <tr> <td>x dB Bandwidth</td> <td>x dB</td> <td>-26.00 dB</td> </tr> <tr> <td>19.04 MHz</td> <td></td> <td></td> </tr> </table>	Occupied Bandwidth	Total Power	16.8 dBm	16.510 MHz			Transmit Freq Error	OBW Power	99.00 %	-21.704 kHz			x dB Bandwidth	x dB	-26.00 dB	19.04 MHz		
Occupied Bandwidth	Total Power	16.8 dBm																	
16.510 MHz																			
Transmit Freq Error	OBW Power	99.00 %																	
-21.704 kHz																			
x dB Bandwidth	x dB	-26.00 dB																	
19.04 MHz																			



Mode 2: IEEE 802.11a Continuous TX mode_ ANT-0																			
5260 MHz	<p>Agilent Spectrum Analyzer: Occupied BW</p> <p>Center Freq: 5.260000000 GHz Trig: Free Run #Atten: 16 dB</p> <p>Radio Std: None Radio Device: BTS</p> <p>10 dB/div Ref 10.00 dBm</p> <p>Center 5.26 GHz #Res BW 300 kHz #VBW 1 MHz Span 25 MHz Sweep 1 ms</p> <table border="1"> <tr> <td>Occupied Bandwidth</td> <td>Total Power</td> <td>17.1 dBm</td> </tr> <tr> <td>16.512 MHz</td> <td></td> <td></td> </tr> <tr> <td>Transmit Freq Error</td> <td>OBW Power</td> <td>99.00 %</td> </tr> <tr> <td>-25.062 kHz</td> <td></td> <td></td> </tr> <tr> <td>x dB Bandwidth</td> <td>x dB</td> <td>-26.00 dB</td> </tr> <tr> <td>19.03 MHz</td> <td></td> <td></td> </tr> </table> <p>MSG: STATUS</p>	Occupied Bandwidth	Total Power	17.1 dBm	16.512 MHz			Transmit Freq Error	OBW Power	99.00 %	-25.062 kHz			x dB Bandwidth	x dB	-26.00 dB	19.03 MHz		
Occupied Bandwidth	Total Power	17.1 dBm																	
16.512 MHz																			
Transmit Freq Error	OBW Power	99.00 %																	
-25.062 kHz																			
x dB Bandwidth	x dB	-26.00 dB																	
19.03 MHz																			
5280 MHz	<p>Agilent Spectrum Analyzer: Occupied BW</p> <p>Center Freq: 5.280000000 GHz Trig: Free Run #Atten: 16 dB</p> <p>Radio Std: None Radio Device: BTS</p> <p>10 dB/div Ref 10.00 dBm</p> <p>Center 5.28 GHz #Res BW 300 kHz #VBW 1 MHz Span 25 MHz Sweep 1 ms</p> <table border="1"> <tr> <td>Occupied Bandwidth</td> <td>Total Power</td> <td>16.5 dBm</td> </tr> <tr> <td>16.501 MHz</td> <td></td> <td></td> </tr> <tr> <td>Transmit Freq Error</td> <td>OBW Power</td> <td>99.00 %</td> </tr> <tr> <td>-14.619 kHz</td> <td></td> <td></td> </tr> <tr> <td>x dB Bandwidth</td> <td>x dB</td> <td>-26.00 dB</td> </tr> <tr> <td>19.04 MHz</td> <td></td> <td></td> </tr> </table> <p>MSG: STATUS</p>	Occupied Bandwidth	Total Power	16.5 dBm	16.501 MHz			Transmit Freq Error	OBW Power	99.00 %	-14.619 kHz			x dB Bandwidth	x dB	-26.00 dB	19.04 MHz		
Occupied Bandwidth	Total Power	16.5 dBm																	
16.501 MHz																			
Transmit Freq Error	OBW Power	99.00 %																	
-14.619 kHz																			
x dB Bandwidth	x dB	-26.00 dB																	
19.04 MHz																			
5320 MHz	<p>Agilent Spectrum Analyzer: Occupied BW</p> <p>Center Freq: 5.320000000 GHz Trig: Free Run #Atten: 16 dB</p> <p>Radio Std: None Radio Device: BTS</p> <p>10 dB/div Ref 10.00 dBm</p> <p>Center 5.32 GHz #Res BW 300 kHz #VBW 1 MHz Span 25 MHz Sweep 1 ms</p> <table border="1"> <tr> <td>Occupied Bandwidth</td> <td>Total Power</td> <td>16.3 dBm</td> </tr> <tr> <td>16.511 MHz</td> <td></td> <td></td> </tr> <tr> <td>Transmit Freq Error</td> <td>OBW Power</td> <td>99.00 %</td> </tr> <tr> <td>-43.355 kHz</td> <td></td> <td></td> </tr> <tr> <td>x dB Bandwidth</td> <td>x dB</td> <td>-26.00 dB</td> </tr> <tr> <td>19.07 MHz</td> <td></td> <td></td> </tr> </table> <p>MSG: STATUS</p>	Occupied Bandwidth	Total Power	16.3 dBm	16.511 MHz			Transmit Freq Error	OBW Power	99.00 %	-43.355 kHz			x dB Bandwidth	x dB	-26.00 dB	19.07 MHz		
Occupied Bandwidth	Total Power	16.3 dBm																	
16.511 MHz																			
Transmit Freq Error	OBW Power	99.00 %																	
-43.355 kHz																			
x dB Bandwidth	x dB	-26.00 dB																	
19.07 MHz																			



Mode 2: IEEE 802.11a Continuous TX mode_ ANT-0	
5500 MHz	<p>Agilent Spectrum Analyzer: Occupied BW</p> <p>Center Freq: 5.50000000 GHz Trig: Free Run #Atten: 16 dB</p> <p>Radio Std: None Radio Device: BTS</p> <p>Frequency: 5.50000000 GHz</p> <p>Center Freq: 5.50000000 GHz</p> <p>CF Step: 2.500000 MHz</p> <p>Freq Offset: 0 Hz</p> <p>Center 5.5 GHz #Res BW 300 kHz #VBW 1 MHz Span 25 MHz Sweep 1 ms</p> <p>Occupied Bandwidth: 16.464 MHz Total Power: 15.4 dBm</p> <p>Transmit Freq Error: -50.177 kHz OBW Power: 99.00 %</p> <p>x dB Bandwidth: 19.91 MHz x dB: -26.00 dB</p> <p>Ref 10.00 dBm</p> <p>MSG: Alignment Completed</p>
5560 MHz	<p>Agilent Spectrum Analyzer: Occupied BW</p> <p>Center Freq: 5.56000000 GHz Trig: Free Run #Atten: 16 dB</p> <p>Radio Std: None Radio Device: BTS</p> <p>Frequency: 5.56000000 GHz</p> <p>Center Freq: 5.56000000 GHz</p> <p>CF Step: 2.500000 MHz</p> <p>Freq Offset: 0 Hz</p> <p>Center 5.56 GHz #Res BW 300 kHz #VBW 1 MHz Span 25 MHz Sweep 1 ms</p> <p>Occupied Bandwidth: 16.538 MHz Total Power: 16.5 dBm</p> <p>Transmit Freq Error: -19.322 kHz OBW Power: 99.00 %</p> <p>x dB Bandwidth: 18.99 MHz x dB: -26.00 dB</p> <p>Ref 10.00 dBm</p> <p>MSG:</p>
5700 MHz	<p>Agilent Spectrum Analyzer: Occupied BW</p> <p>Center Freq: 5.70000000 GHz Trig: Free Run #Atten: 16 dB</p> <p>Radio Std: None Radio Device: BTS</p> <p>Frequency: 5.70000000 GHz</p> <p>Center Freq: 5.70000000 GHz</p> <p>CF Step: 2.500000 MHz</p> <p>Freq Offset: 0 Hz</p> <p>Center 5.7 GHz #Res BW 300 kHz #VBW 1 MHz Span 25 MHz Sweep 1 ms</p> <p>Occupied Bandwidth: 16.519 MHz Total Power: 15.9 dBm</p> <p>Transmit Freq Error: -30.812 kHz OBW Power: 99.00 %</p> <p>x dB Bandwidth: 20.29 MHz x dB: -26.00 dB</p> <p>Ref 10.00 dBm</p> <p>MSG:</p>



Mode 3: IEEE 802.11n 5GHz 20MHz Continuous TX mode_ ANT-0	
5180 MHz	<p>Agilent Spectrum Analyzer - Occupied BW</p> <p>Center Freq: 5.180000000 GHz Trig: Free Run #Atten: 16 dB</p> <p>Radio Std: None Radio Device: BTS</p> <p>Frequency: 5.180000000 GHz</p> <p>Center Freq: 5.180000000 GHz</p> <p>CF Step: 2.500000 MHz</p> <p>Freq Offset: 0 Hz</p> <p>Center 5.18 GHz #Res BW 300 kHz #VBW 1 MHz Span 25 MHz Sweep 1 ms</p> <p>Occupied Bandwidth: 17.557 MHz Total Power: 18.9 dBm</p> <p>Transmit Freq Error: -12.777 kHz OBW Power: 99.00 %</p> <p>x dB Bandwidth: 20.75 MHz x dB: -26.00 dB</p>
5200 MHz	<p>Agilent Spectrum Analyzer - Occupied BW</p> <p>Center Freq: 5.200000000 GHz Trig: Free Run #Atten: 16 dB</p> <p>Radio Std: None Radio Device: BTS</p> <p>Frequency: 5.200000000 GHz</p> <p>Center Freq: 5.200000000 GHz</p> <p>CF Step: 2.500000 MHz</p> <p>Freq Offset: 0 Hz</p> <p>Center 5.2 GHz #Res BW 300 kHz #VBW 1 MHz Span 25 MHz Sweep 1 ms</p> <p>Occupied Bandwidth: 17.539 MHz Total Power: 18.2 dBm</p> <p>Transmit Freq Error: -19.342 kHz OBW Power: 99.00 %</p> <p>x dB Bandwidth: 20.24 MHz x dB: -26.00 dB</p>
5240 MHz	<p>Agilent Spectrum Analyzer - Occupied BW</p> <p>Center Freq: 5.240000000 GHz Trig: Free Run #Atten: 16 dB</p> <p>Radio Std: None Radio Device: BTS</p> <p>Frequency: 5.240000000 GHz</p> <p>Center Freq: 5.240000000 GHz</p> <p>CF Step: 2.500000 MHz</p> <p>Freq Offset: 0 Hz</p> <p>Center 5.24 GHz #Res BW 300 kHz #VBW 1 MHz Span 25 MHz Sweep 1 ms</p> <p>Occupied Bandwidth: 17.539 MHz Total Power: 17.9 dBm</p> <p>Transmit Freq Error: -34.919 kHz OBW Power: 99.00 %</p> <p>x dB Bandwidth: 20.65 MHz x dB: -26.00 dB</p>



Mode 3: IEEE 802.11n 5GHz 20MHz Continuous TX mode_ ANT-0	
5260 MHz	<p>Agilent Spectrum Analyzer - Occupied BW</p> <p>Center Freq: 5.260000000 GHz Trig: Free Run #Atten: 16 dB</p> <p>Ref 10.00 dBm</p> <p>Center 5.26 GHz #Res BW 300 kHz #VBW 1 MHz Span 25 MHz Sweep 1 ms</p> <p>Occupied Bandwidth 17.529 MHz Total Power 17.0 dBm Transmit Freq Error -9.567 kHz OBW Power 99.00 % x dB Bandwidth 19.95 MHz x dB -26.00 dB</p> <p>Frequency: 5.260000000 GHz CF Step: 2.500000 MHz Freq Offset: 0 Hz</p>
5280 MHz	<p>Agilent Spectrum Analyzer - Occupied BW</p> <p>Center Freq: 5.280000000 GHz Trig: Free Run #Atten: 16 dB</p> <p>Ref 10.00 dBm</p> <p>Center 5.28 GHz #Res BW 300 kHz #VBW 1 MHz Span 25 MHz Sweep 1 ms</p> <p>Occupied Bandwidth 17.561 MHz Total Power 17.5 dBm Transmit Freq Error -26.853 kHz OBW Power 99.00 % x dB Bandwidth 21.41 MHz x dB -26.00 dB</p> <p>Frequency: 5.280000000 GHz CF Step: 2.500000 MHz Freq Offset: 0 Hz</p>
5320 MHz	<p>Agilent Spectrum Analyzer - Occupied BW</p> <p>Center Freq: 5.320000000 GHz Trig: Free Run #Atten: 16 dB</p> <p>Ref 10.00 dBm</p> <p>Center 5.32 GHz #Res BW 300 kHz #VBW 1 MHz Span 25 MHz Sweep 1 ms</p> <p>Occupied Bandwidth 17.506 MHz Total Power 16.5 dBm Transmit Freq Error -6.763 kHz OBW Power 99.00 % x dB Bandwidth 18.98 MHz x dB -26.00 dB</p> <p>Frequency: 5.320000000 GHz CF Step: 2.500000 MHz Freq Offset: 0 Hz</p>



Mode 3: IEEE 802.11n 5GHz 20MHz Continuous TX mode_ ANT-0	
5500 MHz	<p>Agilent Spectrum Analyzer - Occupied BW</p> <p>Center Freq: 5.500000000 GHz Trig: Free Run #Atten: 16 dB</p> <p>Ref 10.00 dBm</p> <p>Center 5.5 GHz #Res BW 300 kHz #VBW 1 MHz Span 25 MHz Sweep 1 ms</p> <p>Occupied Bandwidth 17.594 MHz Total Power 17.5 dBm Transmit Freq Error -37.410 kHz OBW Power 99.00 % x dB Bandwidth 23.64 MHz x dB -26.00 dB</p> <p>Frequency: 5.500000000 GHz CF Step: 2.500000 MHz Freq Offset: 0 Hz</p>
5560 MHz	<p>Agilent Spectrum Analyzer - Occupied BW</p> <p>Center Freq: 5.560000000 GHz Trig: Free Run #Atten: 16 dB</p> <p>Ref 10.00 dBm</p> <p>Center 5.56 GHz #Res BW 300 kHz #VBW 1 MHz Span 25 MHz Sweep 1 ms</p> <p>Occupied Bandwidth 17.618 MHz Total Power 17.2 dBm Transmit Freq Error -44.317 kHz OBW Power 99.00 % x dB Bandwidth 23.84 MHz x dB -26.00 dB</p> <p>Frequency: 5.560000000 GHz CF Step: 2.500000 MHz Freq Offset: 0 Hz</p>
5700 MHz	<p>Agilent Spectrum Analyzer - Occupied BW</p> <p>Center Freq: 5.700000000 GHz Trig: Free Run #Atten: 16 dB</p> <p>Ref 10.00 dBm</p> <p>Center 5.7 GHz #Res BW 300 kHz #VBW 1 MHz Span 25 MHz Sweep 1 ms</p> <p>Occupied Bandwidth 17.626 MHz Total Power 16.5 dBm Transmit Freq Error -6.108 kHz OBW Power 99.00 % x dB Bandwidth 24.94 MHz x dB -26.00 dB</p> <p>Frequency: 5.700000000 GHz CF Step: 2.500000 MHz Freq Offset: 0 Hz</p>

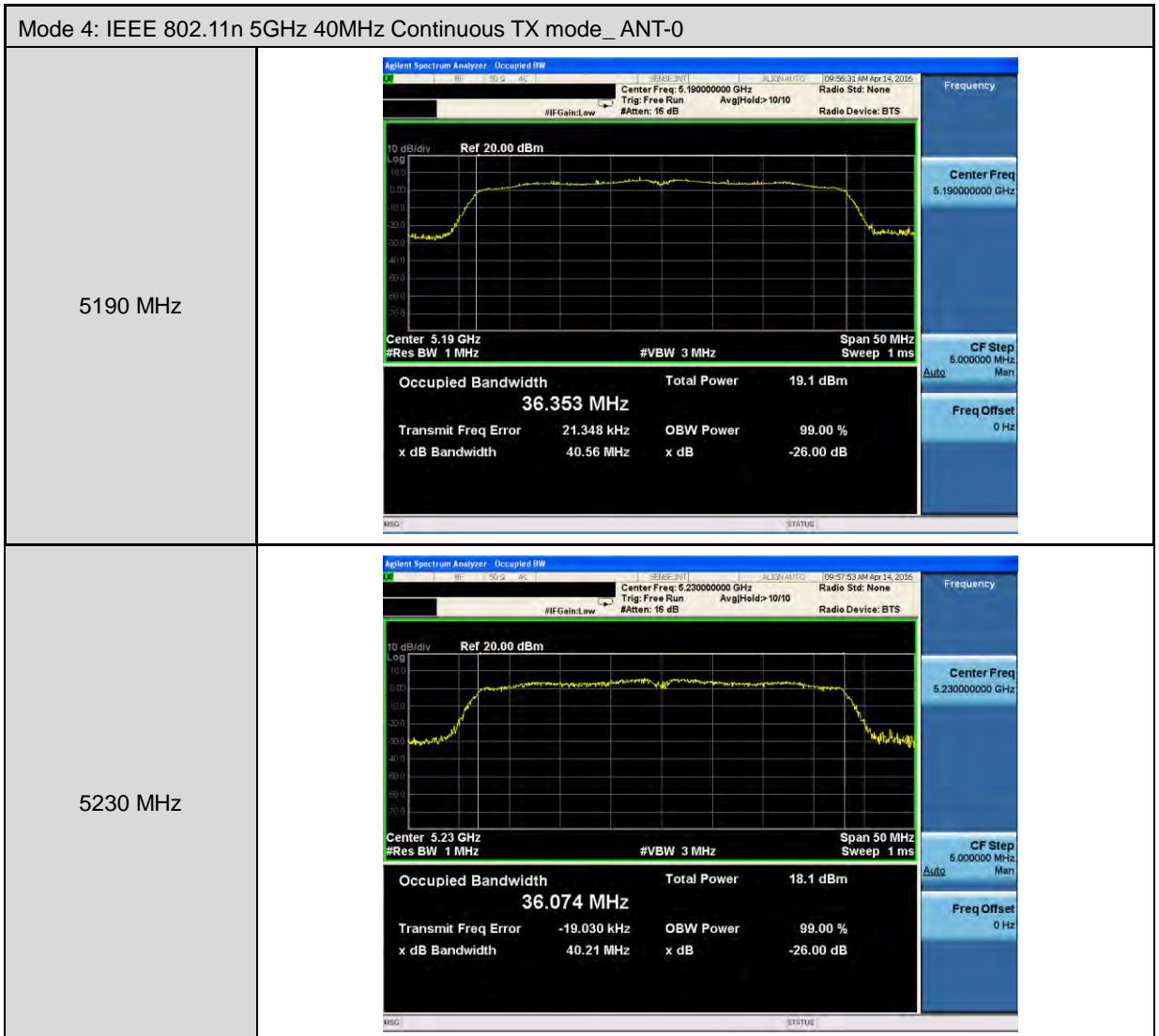

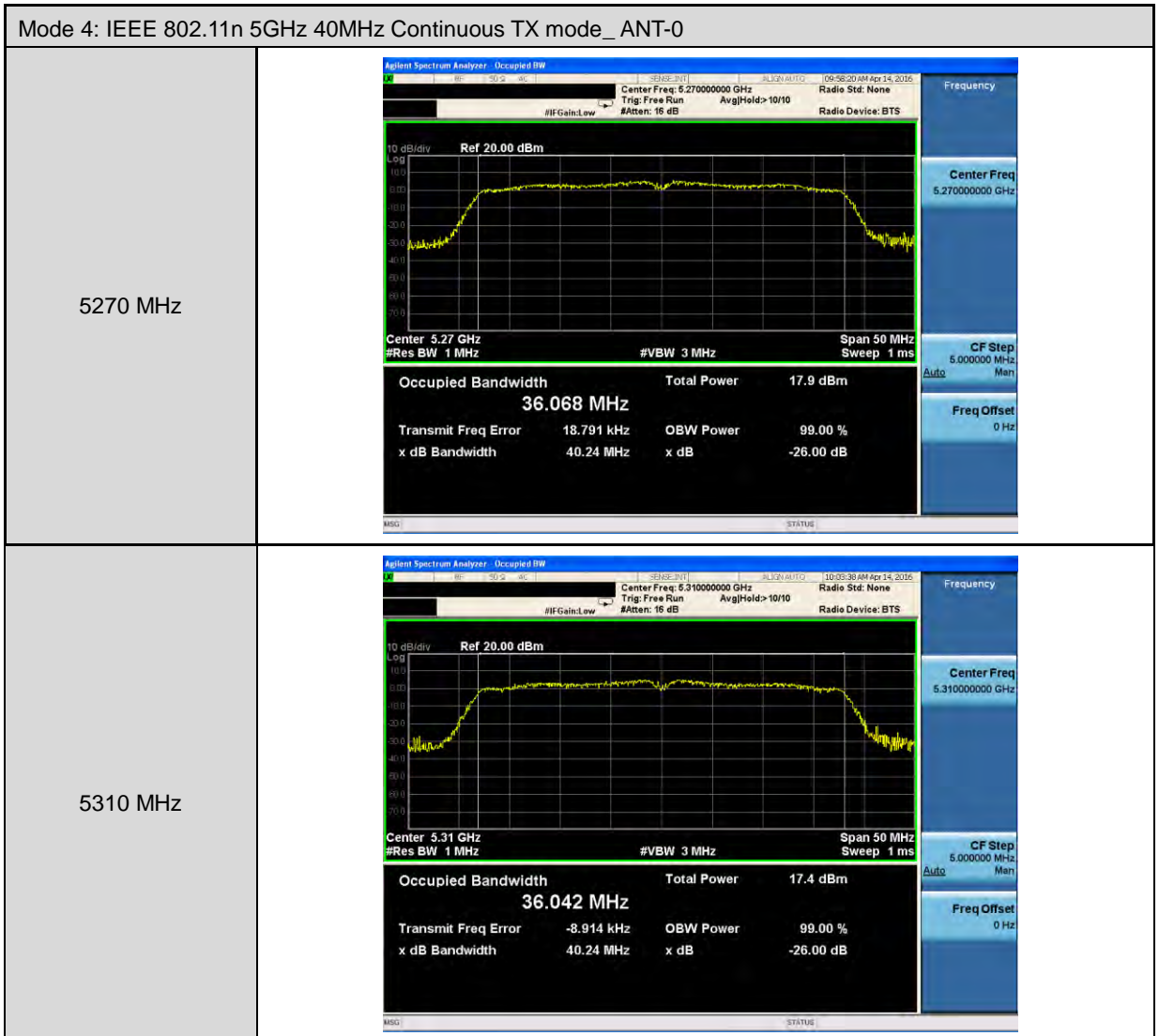



Mode 4: IEEE 802.11n 5GHz 40MHz Continuous TX mode_ ANT-0	
5510 MHz	<p>Agilent Spectrum Analyzer - Occupied BW</p> <p>Center Freq: 5.510000000 GHz Trig: Free Run #Atten: 16 dB</p> <p>Radio Std: None Radio Device: BTS</p> <p>Frequency: 5.51000000 GHz</p> <p>Center Freq: 5.51000000 GHz</p> <p>CF Step: 5.000000 MHz</p> <p>Freq Offset: 0 Hz</p> <p>Center 5.51 GHz #Res BW 1 MHz #VBW 3 MHz Span 50 MHz Sweep 1 ms</p> <p>Occupied Bandwidth: 36.200 MHz Total Power: 17.3 dBm Transmit Freq Error: -110.57 kHz OBW Power: 99.00 % x dB Bandwidth: 42.80 MHz x dB: -26.00 dB</p> <p>Ref 20.00 dBm</p> <p>MSG: STATUS</p>
5550 MHz	<p>Agilent Spectrum Analyzer - Occupied BW</p> <p>Center Freq: 5.550000000 GHz Trig: Free Run #Atten: 16 dB</p> <p>Radio Std: None Radio Device: BTS</p> <p>Frequency: 5.55000000 GHz</p> <p>Center Freq: 5.55000000 GHz</p> <p>CF Step: 5.000000 MHz</p> <p>Freq Offset: 0 Hz</p> <p>Center 5.55 GHz #Res BW 1 MHz #VBW 3 MHz Span 50 MHz Sweep 1 ms</p> <p>Occupied Bandwidth: 36.166 MHz Total Power: 17.3 dBm Transmit Freq Error: -33.278 kHz OBW Power: 99.00 % x dB Bandwidth: 40.30 MHz x dB: -26.00 dB</p> <p>Ref 20.00 dBm</p> <p>MSG: STATUS</p>
5670 MHz	<p>Agilent Spectrum Analyzer - Occupied BW</p> <p>Center Freq: 5.670000000 GHz Trig: Free Run #Atten: 16 dB</p> <p>Radio Std: None Radio Device: BTS</p> <p>Frequency: 5.67000000 GHz</p> <p>Center Freq: 5.67000000 GHz</p> <p>CF Step: 5.000000 MHz</p> <p>Freq Offset: 0 Hz</p> <p>Center 5.67 GHz #Res BW 1 MHz #VBW 3 MHz Span 50 MHz Sweep 1 ms</p> <p>Occupied Bandwidth: 36.179 MHz Total Power: 17.0 dBm Transmit Freq Error: 3.126 kHz OBW Power: 99.00 % x dB Bandwidth: 40.54 MHz x dB: -26.00 dB</p> <p>Ref 20.00 dBm</p> <p>MSG: STATUS</p>

4.6. 6dB RF Bandwidth Measurement

■ **Limit**

6dB RF Bandwidth

Systems using digital modulation techniques may operate in the 5725~5850MHz bands. The minimum 6 dB band-width shall be at least 500 kHz.

■ **Test Setup**

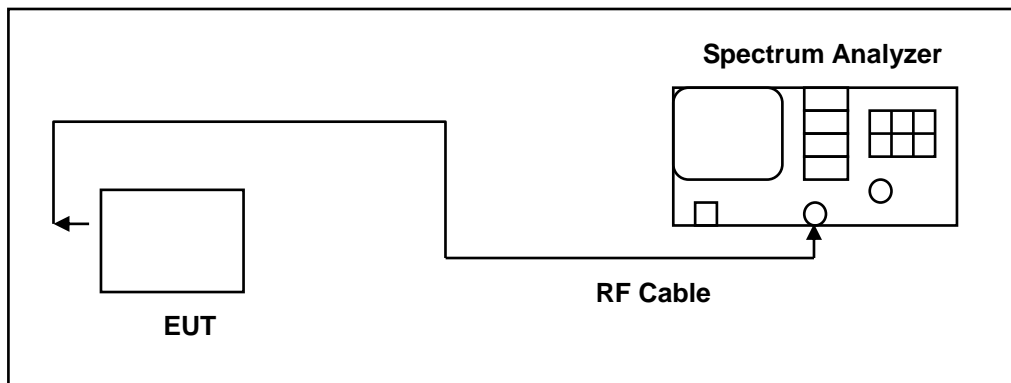

■ **Test Instruments**

Equipment	Manufacturer	Model Number	Serial Number	Cal. Date	Cal. Period
Spectrum Analyzer	Agilent	E4445A	MY45300744	12/15/2015	1 year
Test Site	ATL	TE05	TE05	N.C.R.	-----

Note: N.C.R. = No Calibration Request.

■ **Test Procedure**

6dB RF Bandwidth

The EUT tested to UNII test procedure of KDB789033 D02 for compliance to FCC 47CFR 15.407 requirements. The antenna port of the EUT was connected to the input of a spectrum analyzer. Analyzer RES BW was set to 100 kHz. For each RF output channel investigated, the spectrum analyzer center frequency was set to the channel carrier. A peak output reading was taken, a DISPLAY line was drawn 6 dB lower than peak level. The 6 dB bandwidth was determined from where the channel output spectrum intersected the display line. The test was performed at 3 channels.



■ Test Result

Test Item	6dB RF Bandwidth	
Test Mode	Mode 2: IEEE 802.11a Continuous TX mode	
Frequency (MHz)	6dB Bandwidth (kHz)	Limit (kHz)
	ANT-0	
5745	15460	> 500
5785	15030	> 500
5825	15150	> 500

Test Item	6dB RF Bandwidth	
Test Mode	Mode 3: IEEE 802.11n 5GHz 20MHz Continuous TX mode	
Frequency (MHz)	6dB Bandwidth (kHz)	Limit (kHz)
	ANT-0	
5745	15040	> 500
5785	16540	> 500
5825	17290	> 500

Test Item	6dB RF Bandwidth	
Test Mode	Mode 4: IEEE 802.11n 5GHz 40MHz Continuous TX mode	
Frequency (MHz)	6dB Bandwidth (kHz)	Limit (kHz)
	ANT-0	
5755	35140	> 500
5795	35150	> 500



■ Test Graphs

Mode 2: IEEE 802.11a Continuous TX mode_ANT-0																			
5745 MHz	<p>Agilent Spectrum Analyzer - Occupied BW</p> <p>Center Freq: 5.745000000 GHz Trig: Free Run #IF Gain: Low #Att: 16 dB</p> <p>Ref 10.00 dBm</p> <p>Center 5.745 GHz #Res BW 100 kHz #VBW 300 kHz Span 30 MHz Sweep 2.933 ms</p> <table border="1"> <tr> <td>Occupied Bandwidth</td> <td>Total Power</td> <td>16.3 dBm</td> </tr> <tr> <td>16.368 MHz</td> <td></td> <td></td> </tr> <tr> <td>Transmit Freq Error</td> <td>OBW Power</td> <td>99.00 %</td> </tr> <tr> <td>-31.302 kHz</td> <td>x dB</td> <td>-6.00 dB</td> </tr> <tr> <td>x dB Bandwidth</td> <td></td> <td></td> </tr> <tr> <td>15.46 MHz</td> <td></td> <td></td> </tr> </table>	Occupied Bandwidth	Total Power	16.3 dBm	16.368 MHz			Transmit Freq Error	OBW Power	99.00 %	-31.302 kHz	x dB	-6.00 dB	x dB Bandwidth			15.46 MHz		
Occupied Bandwidth	Total Power	16.3 dBm																	
16.368 MHz																			
Transmit Freq Error	OBW Power	99.00 %																	
-31.302 kHz	x dB	-6.00 dB																	
x dB Bandwidth																			
15.46 MHz																			
5785 MHz	<p>Agilent Spectrum Analyzer - Occupied BW</p> <p>Center Freq: 5.785000000 GHz Trig: Free Run #IF Gain: Low #Att: 16 dB</p> <p>Ref 10.00 dBm</p> <p>Center 5.785 GHz #Res BW 100 kHz #VBW 300 kHz Span 30 MHz Sweep 2.933 ms</p> <table border="1"> <tr> <td>Occupied Bandwidth</td> <td>Total Power</td> <td>15.4 dBm</td> </tr> <tr> <td>16.353 MHz</td> <td></td> <td></td> </tr> <tr> <td>Transmit Freq Error</td> <td>OBW Power</td> <td>99.00 %</td> </tr> <tr> <td>-27.845 kHz</td> <td>x dB</td> <td>-6.00 dB</td> </tr> <tr> <td>x dB Bandwidth</td> <td></td> <td></td> </tr> <tr> <td>15.03 MHz</td> <td></td> <td></td> </tr> </table>	Occupied Bandwidth	Total Power	15.4 dBm	16.353 MHz			Transmit Freq Error	OBW Power	99.00 %	-27.845 kHz	x dB	-6.00 dB	x dB Bandwidth			15.03 MHz		
Occupied Bandwidth	Total Power	15.4 dBm																	
16.353 MHz																			
Transmit Freq Error	OBW Power	99.00 %																	
-27.845 kHz	x dB	-6.00 dB																	
x dB Bandwidth																			
15.03 MHz																			
5825 MHz	<p>Agilent Spectrum Analyzer - Occupied BW</p> <p>Center Freq: 5.825000000 GHz Trig: Free Run #IF Gain: Low #Att: 16 dB</p> <p>Ref 10.00 dBm</p> <p>Center 5.825 GHz #Res BW 100 kHz #VBW 300 kHz Span 30 MHz Sweep 2.933 ms</p> <table border="1"> <tr> <td>Occupied Bandwidth</td> <td>Total Power</td> <td>14.2 dBm</td> </tr> <tr> <td>16.357 MHz</td> <td></td> <td></td> </tr> <tr> <td>Transmit Freq Error</td> <td>OBW Power</td> <td>99.00 %</td> </tr> <tr> <td>-36.294 kHz</td> <td>x dB</td> <td>-6.00 dB</td> </tr> <tr> <td>x dB Bandwidth</td> <td></td> <td></td> </tr> <tr> <td>15.15 MHz</td> <td></td> <td></td> </tr> </table>	Occupied Bandwidth	Total Power	14.2 dBm	16.357 MHz			Transmit Freq Error	OBW Power	99.00 %	-36.294 kHz	x dB	-6.00 dB	x dB Bandwidth			15.15 MHz		
Occupied Bandwidth	Total Power	14.2 dBm																	
16.357 MHz																			
Transmit Freq Error	OBW Power	99.00 %																	
-36.294 kHz	x dB	-6.00 dB																	
x dB Bandwidth																			
15.15 MHz																			



Mode 3: IEEE 802.11n 5GHz 20MHz Continuous TX mode_ANT-0	
5745 MHz	<p>Agilent Spectrum Analyzer - Occupied BW</p> <p>Center Freq: 5.74500000 GHz Trig: Free Run #IFGain: Low #Att: 16 dB</p> <p>Ref 10.00 dBm</p> <p>Center 5.745 GHz #Res BW 100 kHz</p> <p>Span 30 MHz Sweep 2.933 ms</p> <p>Occupied Bandwidth 17.584 MHz</p> <p>Total Power 15.1 dBm</p> <p>Transmit Freq Error -25.403 kHz</p> <p>x dB Bandwidth 15.04 MHz</p> <p>OBW Power 99.00 %</p> <p>x dB -6.00 dB</p> <p>Frequency: 5.74500000 GHz</p> <p>CF Step: 3.000000 MHz</p> <p>Freq Offset: 0 Hz</p>
5785 MHz	<p>Agilent Spectrum Analyzer - Occupied BW</p> <p>Center Freq: 5.78500000 GHz Trig: Free Run #IFGain: Low #Att: 16 dB</p> <p>Ref 10.00 dBm</p> <p>Center 5.785 GHz #Res BW 100 kHz</p> <p>Span 30 MHz Sweep 2.933 ms</p> <p>Occupied Bandwidth 17.552 MHz</p> <p>Total Power 15.5 dBm</p> <p>Transmit Freq Error -36.883 kHz</p> <p>x dB Bandwidth 16.54 MHz</p> <p>OBW Power 99.00 %</p> <p>x dB -6.00 dB</p> <p>Frequency: 5.78500000 GHz</p> <p>CF Step: 3.000000 MHz</p> <p>Freq Offset: 0 Hz</p>
5825 MHz	<p>Agilent Spectrum Analyzer - Occupied BW</p> <p>Center Freq: 5.82500000 GHz Trig: Free Run #IFGain: Low #Att: 16 dB</p> <p>Ref 10.00 dBm</p> <p>Center 5.825 GHz #Res BW 100 kHz</p> <p>Span 30 MHz Sweep 2.933 ms</p> <p>Occupied Bandwidth 17.571 MHz</p> <p>Total Power 14.8 dBm</p> <p>Transmit Freq Error -33.198 kHz</p> <p>x dB Bandwidth 17.29 MHz</p> <p>OBW Power 99.00 %</p> <p>x dB -6.00 dB</p> <p>Frequency: 5.82500000 GHz</p> <p>CF Step: 3.000000 MHz</p> <p>Freq Offset: 0 Hz</p>



Mode 4: IEEE 802.11n 5GHz 40MHz Continuous TX mode_ANT-0																			
5755 MHz	<p>Agilent Spectrum Analyzer - Occupied BW</p> <p>Center Freq: 5.755000000 GHz Trig: Free Run #IF Gain: Low #Att: 16 dB</p> <p>Radio Std: None Radio Device: BTS</p> <p>Frequency: 5.75500000 GHz</p> <p>Center Freq: 5.75500000 GHz</p> <p>CF Step: 5.000000 MHz</p> <p>Freq Offset: 0 Hz</p> <p>Center 5.755 GHz #Res BW 100 kHz #VBW 300 kHz Span 50 MHz Sweep 4.8 ms</p> <table border="1"> <tr> <td>Occupied Bandwidth</td> <td>Total Power</td> <td>16.3 dBm</td> </tr> <tr> <td>35.927 MHz</td> <td></td> <td></td> </tr> <tr> <td>Transmit Freq Error</td> <td>OBW Power</td> <td>99.00 %</td> </tr> <tr> <td>-47.243 kHz</td> <td>x dB</td> <td>-6.00 dB</td> </tr> <tr> <td>x dB Bandwidth</td> <td></td> <td></td> </tr> <tr> <td>35.14 MHz</td> <td></td> <td></td> </tr> </table>	Occupied Bandwidth	Total Power	16.3 dBm	35.927 MHz			Transmit Freq Error	OBW Power	99.00 %	-47.243 kHz	x dB	-6.00 dB	x dB Bandwidth			35.14 MHz		
Occupied Bandwidth	Total Power	16.3 dBm																	
35.927 MHz																			
Transmit Freq Error	OBW Power	99.00 %																	
-47.243 kHz	x dB	-6.00 dB																	
x dB Bandwidth																			
35.14 MHz																			
5795 MHz	<p>Agilent Spectrum Analyzer - Occupied BW</p> <p>Center Freq: 5.795000000 GHz Trig: Free Run #IF Gain: Low #Att: 16 dB</p> <p>Radio Std: None Radio Device: BTS</p> <p>Frequency: 5.79500000 GHz</p> <p>Center Freq: 5.79500000 GHz</p> <p>CF Step: 5.000000 MHz</p> <p>Freq Offset: 0 Hz</p> <p>Center 5.795 GHz #Res BW 100 kHz #VBW 300 kHz Span 50 MHz Sweep 4.8 ms</p> <table border="1"> <tr> <td>Occupied Bandwidth</td> <td>Total Power</td> <td>16.0 dBm</td> </tr> <tr> <td>35.900 MHz</td> <td></td> <td></td> </tr> <tr> <td>Transmit Freq Error</td> <td>OBW Power</td> <td>99.00 %</td> </tr> <tr> <td>-53.868 kHz</td> <td>x dB</td> <td>-6.00 dB</td> </tr> <tr> <td>x dB Bandwidth</td> <td></td> <td></td> </tr> <tr> <td>35.15 MHz</td> <td></td> <td></td> </tr> </table>	Occupied Bandwidth	Total Power	16.0 dBm	35.900 MHz			Transmit Freq Error	OBW Power	99.00 %	-53.868 kHz	x dB	-6.00 dB	x dB Bandwidth			35.15 MHz		
Occupied Bandwidth	Total Power	16.0 dBm																	
35.900 MHz																			
Transmit Freq Error	OBW Power	99.00 %																	
-53.868 kHz	x dB	-6.00 dB																	
x dB Bandwidth																			
35.15 MHz																			

4.7. Peak Power Spectral Density Measurement

■ Limit

Conducted power spectral density

Frequency Range (MHz)	FCC Limit
	Client
5.150 ~ 5.250 GHz	11 dBm/MHz
5.250 ~ 5.350 GHz	11 dBm/MHz
5.470 ~ 5.725 GHz	11 dBm/MHz
5.725 ~ 5.850 GHz	30 dBm/500KHz

According FCC KDB 662911 D01 v02r01 – for power spectral density measurements on IEEE802.11 devices,

■ Test Setup

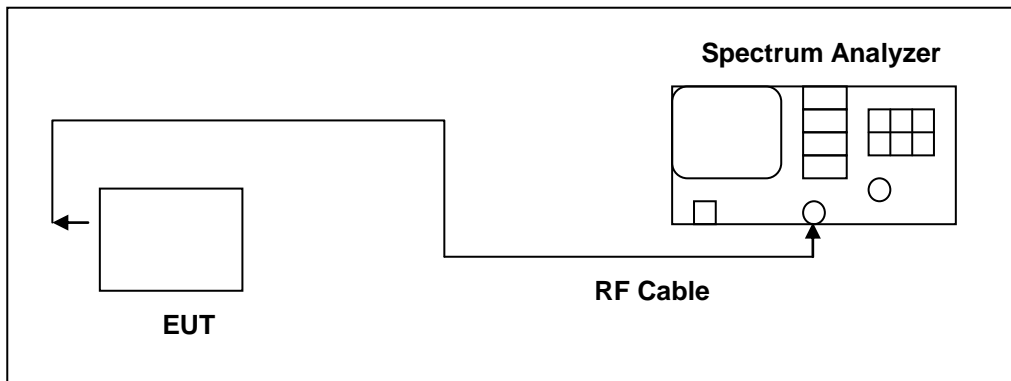

■ Test Instruments

Equipment	Manufacturer	Model Number	Serial Number	Cal. Date	Remark
Spectrum Analyzer	Agilent	E4445A	MY45300744	12/15/2015	1 year
Test Site	ATL	TE05	TE05	N.C.R.	-----

Note: N.C.R. = No Calibration Request.

**■ Test Procedure**

The test is performed in accordance with KDB789033: D02 General UNII Test Procedures New Rules v01r04, Guidelines for Compliance Testing of Unlicensed National Information Infrastructure (U-NII) Devices - Part 15, Subpart E.

Spectrum Parameter	Setting
Attenuation	Auto
Span Frequency	Encompass the entire emissions bandwidth (EBW) of the signal
RBW	1 MHz (5725 ~ 5850MHz use 100 kHz)
VBW	3 MHz (5725 ~ 5850MHz use 300 kHz)
Detector	RMS
Trace	AVERAGE
Sweep Time	Auto
Trace Average	100 times
Note: If measurement bandwidth of Maximum PSD is specified in 500 kHz, add $10\log(500\text{kHz}/100\text{kHz})$ to the measured result.	



■ Test Result

Test Item	Conducted power spectral density			
Test Mode	Mode 2: IEEE 802.11a link mode			
Frequency (MHz)	ANT-0			
	Measurement (dBm/MHz)	Duty Factor (dB)	Calculated (dBm/MHz)	Limit (dBm/MHz)
5180	0.419	0.528	0.947	< 11
5200	0.147	0.528	0.675	
5240	0.128	0.528	0.656	
5260	-0.303	0.528	0.225	
5280	-0.553	0.528	-0.025	
5320	-0.252	0.528	0.276	
5500	-0.884	0.528	-0.356	
5560	-0.440	0.528	0.088	
5700	-0.538	0.528	-0.010	

Note: Method SA-2, Power density = measured result + 10log(1/duty cycle) + Conversion ratio = measured result + duty factor.

Test Item	Conducted power spectral density			
Test Mode	Mode 2: IEEE 802.11a link mode			
Frequency (MHz)	ANT-0			
	Measurement (dBm/100KHz)	Duty Factor (dB)	Calculated (dBm/500KHz)	Limit (dBm/500KHz)
5745	-10.15	0.528	-2.63	< 30
5785	-10.25	0.528	-2.73	
5825	-10.64	0.528	-3.12	

Note: Method SA-2, Power density = measured result + 10log(1/duty cycle) + Conversion ratio = measured result + duty factor.

Conversion ratio = 10*Log(500k/100k)



Test Item	Conducted power spectral density			
Test Mode	Mode 3: IEEE 802.11n 5GHz 20MHz Continuous TX mode			
Frequency (MHz)	ANT-0			
	Measurement (dBm/MHz)	Duty Factor (dB)	Calculated (dBm/MHz)	Limit (dBm/MHz)
5180	0.332	0.586	0.918	< 11
5200	-0.096	0.586	0.490	
5240	-0.183	0.586	0.403	
5260	-0.232	0.586	0.354	
5280	-0.419	0.586	0.167	
5320	-0.882	0.586	-0.296	
5500	-0.793	0.586	-0.207	
5560	-0.828	0.586	-0.242	
5700	-1.067	0.586	-0.481	

Test Item	Conducted power spectral density			
Test Mode	Mode 3: IEEE 802.11n 5GHz 20MHz Continuous TX mode			
Frequency (MHz)	ANT-0			
	Measurement (dBm/100KHz)	Duty Factor (dB)	Calculated (dBm/500KHz)	Limit (dBm/500KHz)
5745	-10.29	0.586	-2.71	< 30
5785	-10.62	0.586	-3.04	
5825	-11.16	0.586	-3.58	

Note: Method SA-2, Power density = measured result + 10log(1/duty cycle) + Conversion ratio = measured result + duty factor.

Conversion ratio = 10*Log(500k/100k)



Test Item	Conducted power spectral density			
Test Mode	Mode 4: IEEE 802.11n 5GHz 40MHz Continuous TX mode			
Frequency (MHz)	ANT-0			
	Measurement (dBm/MHz)	Duty Factor (dB)	Calculated (dBm/MHz)	Limit (dBm/MHz)
5190	-2.367	1.112	-1.255	< 11
5230	-2.903	1.112	-1.791	
5270	-3.217	1.112	-2.105	
5310	-3.584	1.112	-2.472	
5510	-3.751	1.112	-2.639	
5550	-3.634	1.112	-2.522	
5670	-3.834	1.112	-2.722	

Note: Method SA-2, Power density = measured result + 10log(1/duty cycle) + Conversion ratio = measured result + duty factor.

Test Item	Conducted power spectral density			
Test Mode	Mode 4: IEEE 802.11n 5GHz 40MHz Continuous TX mode			
Frequency (MHz)	ANT-0			
	Measurement (dBm/100KHz)	Duty Factor (dB)	Calculated (dBm/500KHz)	Limit (dBm/500KHz)
5755	-12.84	1.112	-4.74	< 30
5795	-13.62	1.112	-5.51	

Note: Method SA-2, Power density = measured result + 10log(1/duty cycle) + Conversion ratio = measured result + duty factor.

Conversion ratio = 10*Log(500k/100k)



■ Test Graphs

Mode 2: IEEE 802.11a Continuous TX mode_ ANT-0	
5180 MHz	<p>Agilent Spectrum Analyzer: Swept SA PNO: Fast IF Gain: Low Trig: Free Run Avg Type: RMS Avg Hold: 100/100 Ref Offset 11.4 dB Ref 15.00 dBm Mkr1 5.180 84 GHz 0.419 dBm Center 5.18000 GHz #Res BW 1.0 MHz #VBW 3.0 MHz Sweep 1.000 ms (1001 pts) Span 40.00 MHz</p>
5200 MHz	<p>Agilent Spectrum Analyzer: Swept SA PNO: Fast IF Gain: Low Trig: Free Run Avg Type: RMS Avg Hold: 100/100 Ref Offset 11.4 dB Ref 15.00 dBm Mkr1 5.201 00 GHz 0.147 dBm Center 5.20000 GHz #Res BW 1.0 MHz #VBW 3.0 MHz Sweep 1.000 ms (1001 pts) Span 40.00 MHz</p>
5240 MHz	<p>Agilent Spectrum Analyzer: Swept SA PNO: Fast IF Gain: Low Trig: Free Run Avg Type: RMS Avg Hold: 100/100 Ref Offset 11.4 dB Ref 15.00 dBm Mkr1 5.240 80 GHz 0.128 dBm Center 5.24000 GHz #Res BW 1.0 MHz #VBW 3.0 MHz Sweep 1.000 ms (1001 pts) Span 40.00 MHz</p>





Mode 2: IEEE 802.11a Continuous TX mode_ ANT-0	
5260 MHz	<p>Agilent Spectrum Analyzer: Swept SA Frequency: 5.260000000 GHz Center Freq: 5.260000000 GHz Start Freq: 5.240000000 GHz Stop Freq: 5.280000000 GHz CF Step: 4.000000 MHz Freq Offset: 0 Hz Mkr1 5.261 00 GHz -0.303 dBm Ref Offset 11.4 dB Ref 15.00 dBm Center 5.26000 GHz #Res BW 1.0 MHz #VBW 3.0 MHz* Span 40.00 MHz Sweep 1.000 ms (1001 pts)</p>
5280 MHz	<p>Agilent Spectrum Analyzer: Swept SA Frequency: 5.280000000 GHz Center Freq: 5.280000000 GHz Start Freq: 5.260000000 GHz Stop Freq: 5.300000000 GHz CF Step: 4.000000 MHz Freq Offset: 0 Hz Mkr1 5.279 04 GHz -0.553 dBm Ref Offset 11.4 dB Ref 15.00 dBm Center 5.28000 GHz #Res BW 1.0 MHz #VBW 3.0 MHz* Span 40.00 MHz Sweep 1.000 ms (1001 pts)</p>
5320 MHz	<p>Agilent Spectrum Analyzer: Swept SA Frequency: 5.320000000 GHz Center Freq: 5.320000000 GHz Start Freq: 5.300000000 GHz Stop Freq: 5.340000000 GHz CF Step: 4.000000 MHz Freq Offset: 0 Hz Mkr1 5.319 00 GHz -0.252 dBm Ref Offset 11.4 dB Ref 15.00 dBm Center 5.32000 GHz #Res BW 1.0 MHz #VBW 3.0 MHz* Span 40.00 MHz Sweep 1.000 ms (1001 pts)</p>



Mode 2: IEEE 802.11a Continuous TX mode_ ANT-0	
5500 MHz	
5560 MHz	
5700 MHz	

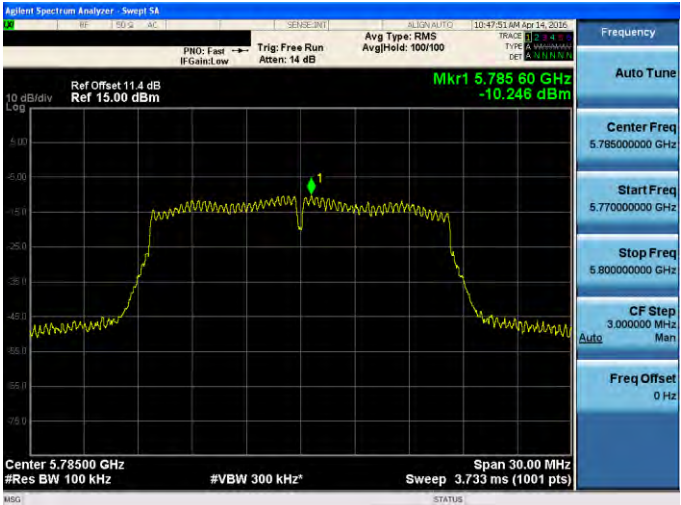

Mode 2: IEEE 802.11a Continuous TX mode_ ANT-0	
5745 MHz	 <p>Agilent Spectrum Analyzer, Swept SA PNO: Fast IF Gain: Low Trig: Free Run Avg Type: RMS Avg Hold: 100/100 Ref Offset 11.4 dB Ref 15.00 dBm Mkr1 5.745 80 GHz -10.150 dBm Center 5.74500 GHz #Res BW 100 kHz #VBW 300 kHz Sweep 3.733 ms (1001 pts) Span 30.00 MHz</p>
5785 MHz	 <p>Agilent Spectrum Analyzer, Swept SA PNO: Fast IF Gain: Low Trig: Free Run Avg Type: RMS Avg Hold: 100/100 Ref Offset 11.4 dB Ref 15.00 dBm Mkr1 5.785 80 GHz -10.246 dBm Center 5.78500 GHz #Res BW 100 kHz #VBW 300 kHz Sweep 3.733 ms (1001 pts) Span 30.00 MHz</p>
5825 MHz	 <p>Agilent Spectrum Analyzer, Swept SA PNO: Fast IF Gain: Low Trig: Free Run Avg Type: RMS Avg Hold: 100/100 Ref Offset 11.4 dB Ref 15.00 dBm Mkr1 5.825 80 GHz -10.636 dBm Center 5.82500 GHz #Res BW 100 kHz #VBW 300 kHz Sweep 3.733 ms (1001 pts) Span 30.00 MHz</p>





Mode 3: IEEE 802.11n 5GHz 20MHz Continuous TX mode_ ANT-0	
5180 MHz	<p>Agilent Spectrum Analyzer: Sweep 5A PNO: Fast IF Gain: Low Trig: Free Run Avg Type: RMS Avg Hold: 100/100 Ref Offset 11.4 dB Ref 15.00 dBm Mkr1 5.180 72 GHz 0.332 dBm Center 5.18000 GHz #Res BW 1.0 MHz #VBW 3.0 MHz Span 40.00 MHz Sweep 1.000 ms (1001 pts)</p>
5200 MHz	<p>Agilent Spectrum Analyzer: Sweep 5A PNO: Fast IF Gain: Low Trig: Free Run Avg Type: RMS Avg Hold: 100/100 Ref Offset 11.4 dB Ref 15.00 dBm Mkr1 5.198 72 GHz -0.096 dBm Center 5.20000 GHz #Res BW 1.0 MHz #VBW 3.0 MHz Span 40.00 MHz Sweep 1.000 ms (1001 pts)</p>
5240 MHz	<p>Agilent Spectrum Analyzer: Sweep 5A PNO: Fast IF Gain: Low Trig: Free Run Avg Type: RMS Avg Hold: 100/100 Ref Offset 11.4 dB Ref 15.00 dBm Mkr1 5.238 88 GHz -0.193 dBm Center 5.24000 GHz #Res BW 1.0 MHz #VBW 3.0 MHz Span 40.00 MHz Sweep 1.000 ms (1001 pts)</p>





Mode 3: IEEE 802.11n 5GHz 20MHz Continuous TX mode_ ANT-0	
5260 MHz	<p>Agilent Spectrum Analyzer: Swept SA 10:26:40 AM Apr 14, 2016 PNO: Fast IF Gain: Low Trig: Free Run Avg Type: RMS Avg Hold: 100/100 Ref Offset 11.4 dB Ref 15.00 dBm Mkr1 5.260 80 GHz -0.232 dBm Center 5.26000 GHz #Res BW 1.0 MHz #VBW 3.0 MHz Span 40.00 MHz Sweep 1.000 ms (1001 pts)</p>
5280 MHz	<p>Agilent Spectrum Analyzer: Swept SA 10:27:07 AM Apr 14, 2016 PNO: Fast IF Gain: Low Trig: Free Run Avg Type: RMS Avg Hold: 100/100 Ref Offset 11.4 dB Ref 15.00 dBm Mkr1 5.279 04 GHz -0.419 dBm Center 5.28000 GHz #Res BW 1.0 MHz #VBW 3.0 MHz Span 40.00 MHz Sweep 1.000 ms (1001 pts)</p>
5320 MHz	<p>Agilent Spectrum Analyzer: Swept SA 10:27:31 AM Apr 14, 2016 PNO: Fast IF Gain: Low Trig: Free Run Avg Type: RMS Avg Hold: 100/100 Ref Offset 11.4 dB Ref 15.00 dBm Mkr1 5.319 12 GHz -0.882 dBm Center 5.32000 GHz #Res BW 1.0 MHz #VBW 3.0 MHz Span 40.00 MHz Sweep 1.000 ms (1001 pts)</p>



Mode 3: IEEE 802.11n 5GHz 20MHz Continuous TX mode_ ANT-0	
<p>5500 MHz</p>	
<p>5560 MHz</p>	
<p>5700 MHz</p>	

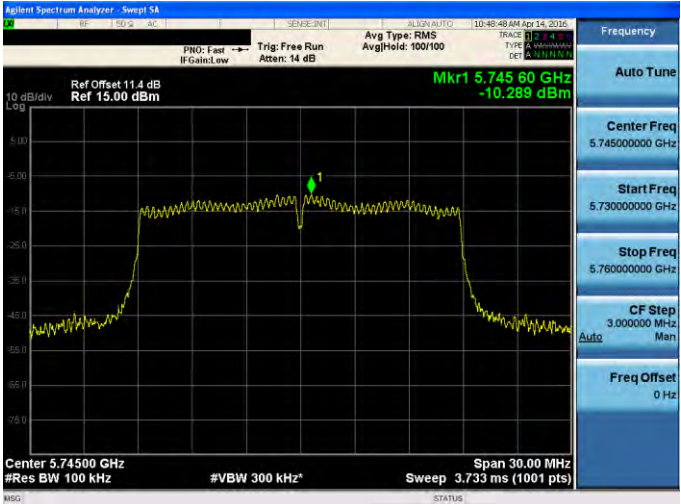
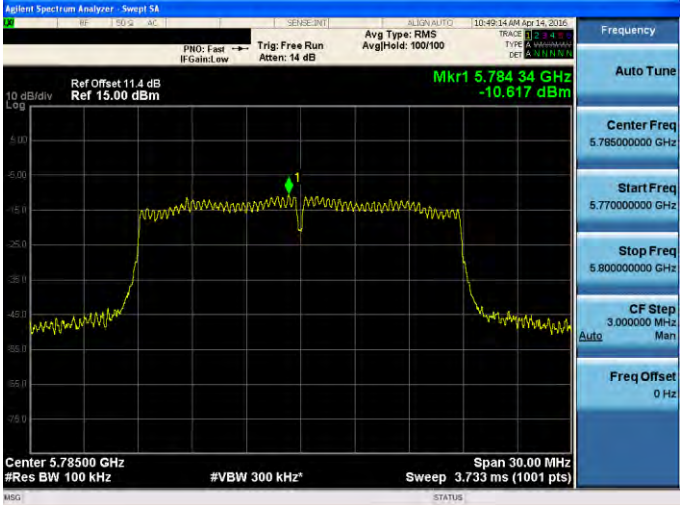

Mode 3: IEEE 802.11n 5GHz 20MHz Continuous TX mode_ ANT-0	
5745 MHz	 <p>Agilent Spectrum Analyzer: Swept SA PNO: Fast IF Gain: Low Trig: Free Run Avg Type: RMS Avg Hold: 100/100 Ref Offset 11.4 dB Ref 15.00 dBm Mkr1 5.745 80 GHz -10.289 dBm Center 5.74500 GHz #Res BW 100 kHz #VBW 300 kHz Span 30.00 MHz Sweep 3.733 ms (1001 pts)</p>
5785 MHz	 <p>Agilent Spectrum Analyzer: Swept SA PNO: Fast IF Gain: Low Trig: Free Run Avg Type: RMS Avg Hold: 100/100 Ref Offset 11.4 dB Ref 15.00 dBm Mkr1 5.784 34 GHz -10.617 dBm Center 5.78500 GHz #Res BW 100 kHz #VBW 300 kHz Span 30.00 MHz Sweep 3.733 ms (1001 pts)</p>
5825 MHz	 <p>Agilent Spectrum Analyzer: Swept SA PNO: Fast IF Gain: Low Trig: Free Run Avg Type: RMS Avg Hold: 100/100 Ref Offset 11.4 dB Ref 15.00 dBm Mkr1 5.825 80 GHz -11.156 dBm Center 5.82500 GHz #Res BW 100 kHz #VBW 300 kHz Span 30.00 MHz Sweep 3.733 ms (1001 pts)</p>

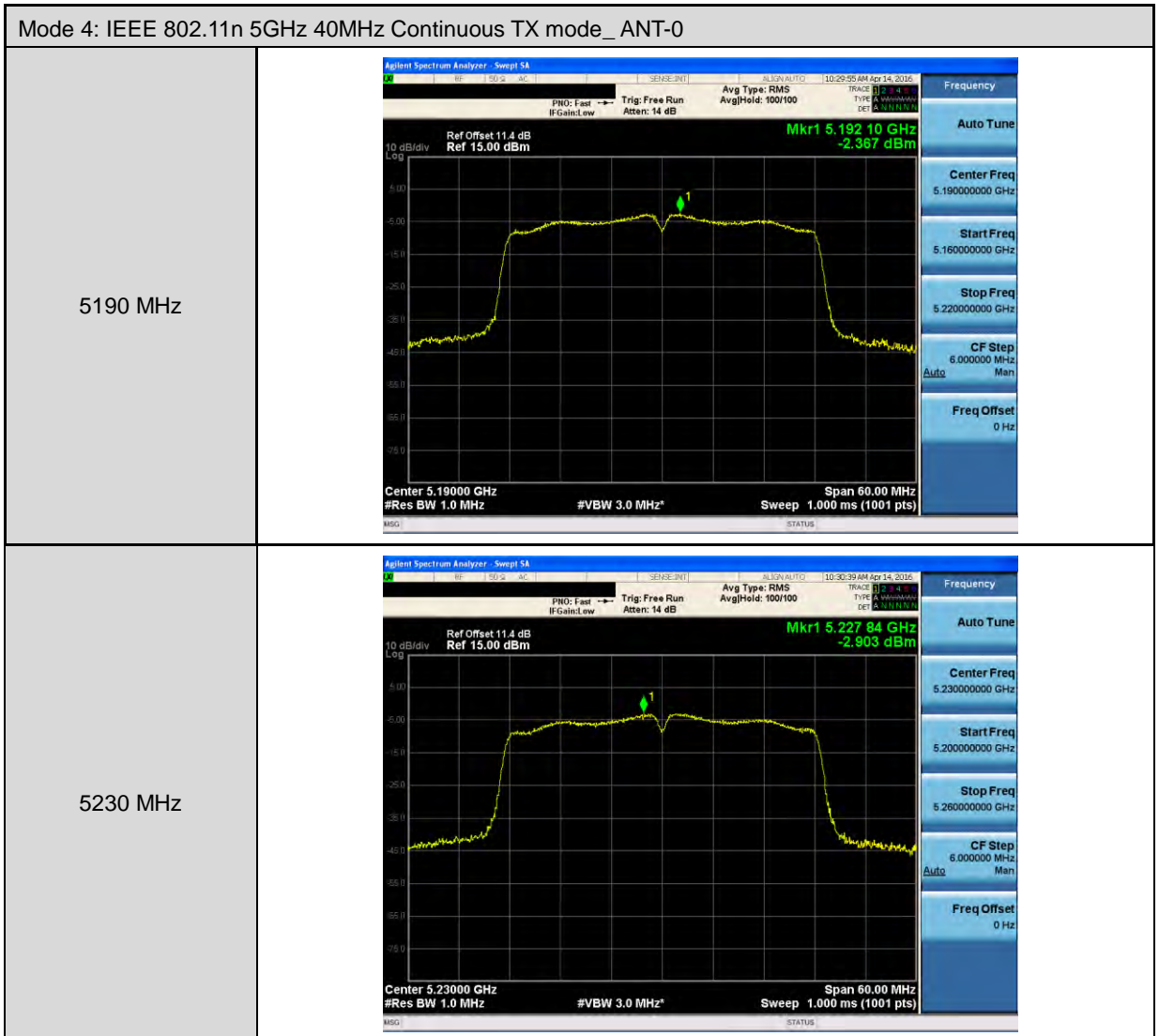

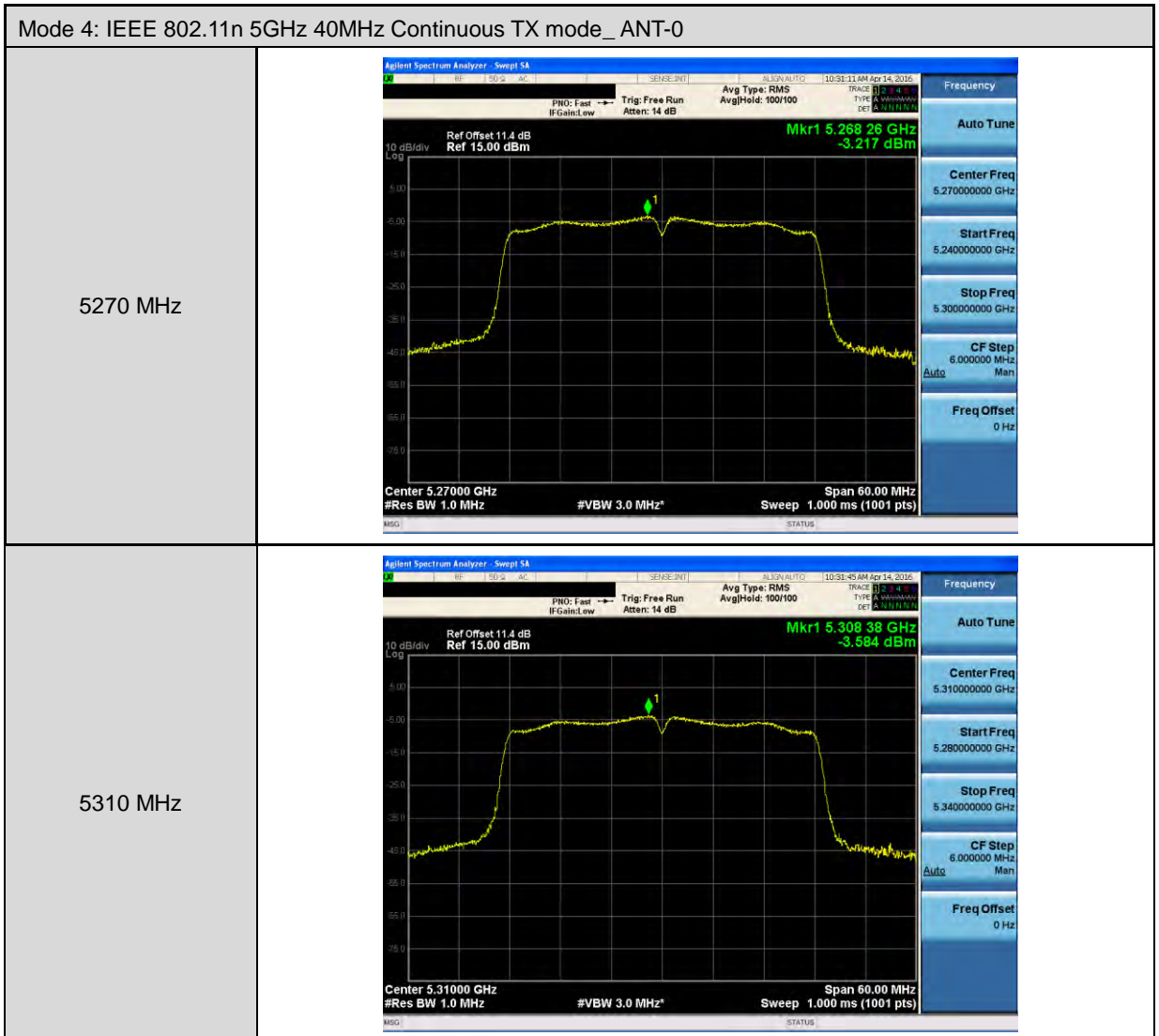



Mode 4: IEEE 802.11n 5GHz 40MHz Continuous TX mode_ ANT-0	
5510 MHz	<p>Agilent Spectrum Analyzer: Swept SA PNO: Fast IF Gain: Low Trig: Free Run Avg Type: RMS Avg Hold: 100/100 Ref Offset 11.4 dB Ref 15.00 dBm Mkr1 5.50838 GHz -3.751 dBm Center 5.51000 GHz #Res BW 1.0 MHz #VBW 3.0 MHz Sweep 1.000 ms (1001 pts) Span 60.00 MHz</p>
5550 MHz	<p>Agilent Spectrum Analyzer: Swept SA PNO: Fast IF Gain: Low Trig: Free Run Avg Type: RMS Avg Hold: 100/100 Ref Offset 11.4 dB Ref 15.00 dBm Mkr1 5.54888 GHz -3.634 dBm Center 5.55000 GHz #Res BW 1.0 MHz #VBW 3.0 MHz Sweep 1.000 ms (1001 pts) Span 60.00 MHz</p>
5670 MHz	<p>Agilent Spectrum Analyzer: Swept SA PNO: Fast IF Gain: Low Trig: Free Run Avg Type: RMS Avg Hold: 100/100 Ref Offset 11.4 dB Ref 15.00 dBm Mkr1 5.67144 GHz -3.834 dBm Center 5.67000 GHz #Res BW 1.0 MHz #VBW 3.0 MHz Sweep 1.000 ms (1001 pts) Span 60.00 MHz</p>

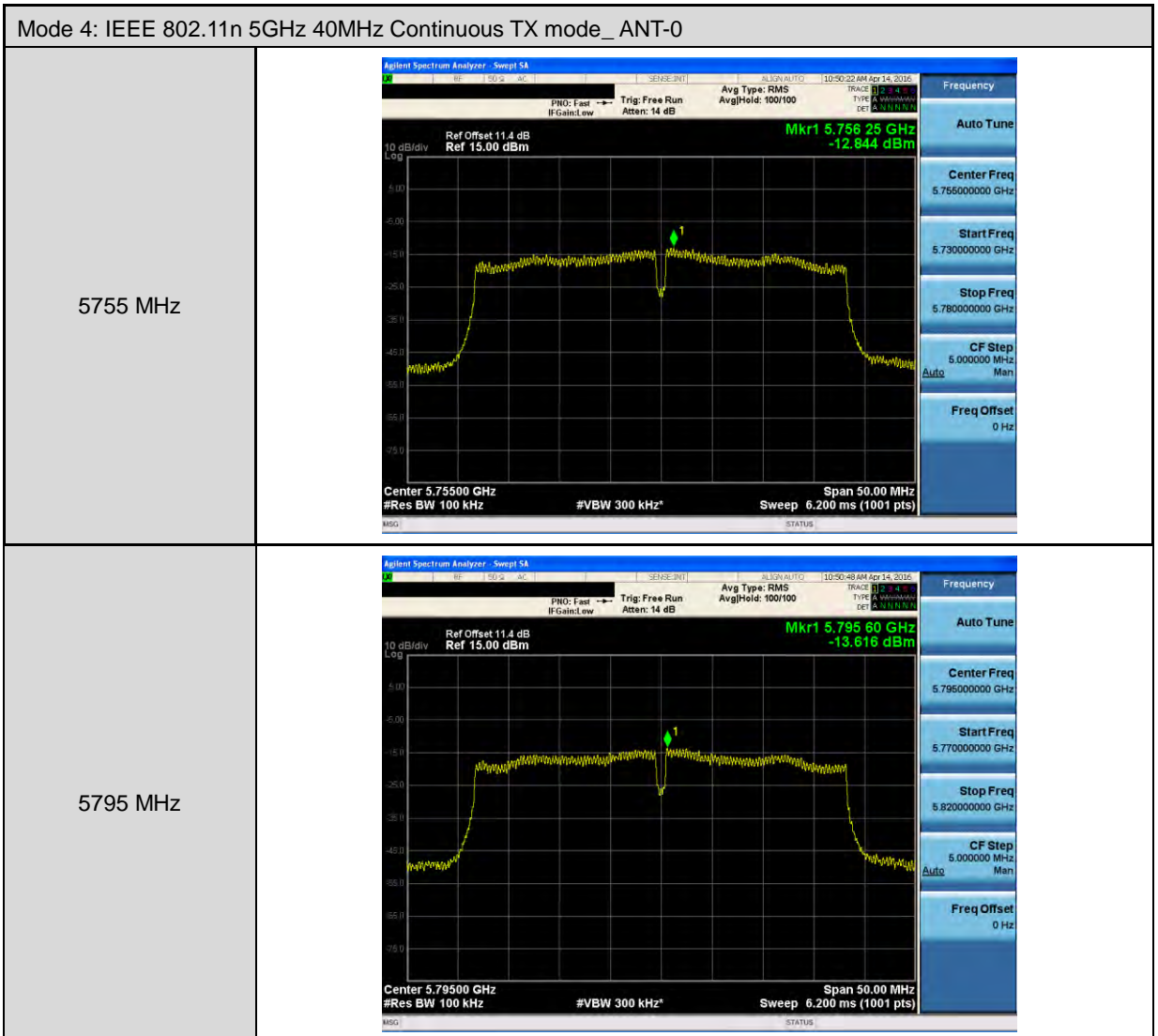

4.8. Frequency Stability Measurement

■ Limit

Manufacturers of U-NII devices are responsible for ensuring frequency stability such that an emission is maintained within the band of operation under all conditions of normal operation as specified in the users manual.

■ Test Setup

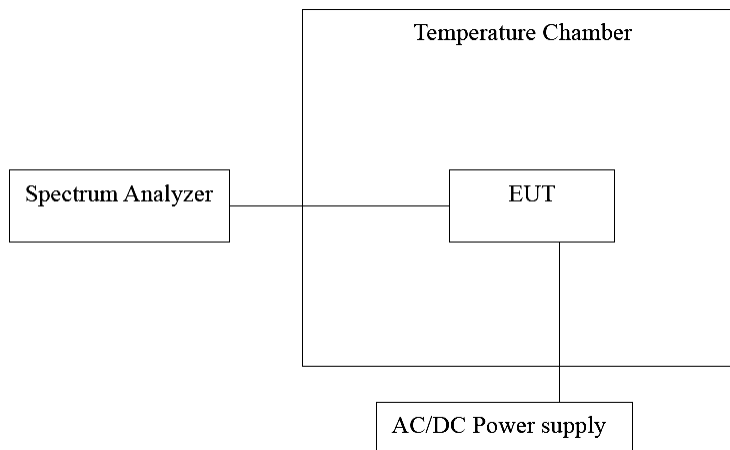

■ Test Instruments

Equipment	Manufacturer	Model Number	Serial Number	Cal. Date	Remark
Spectrum Analyzer	Agilent	E4408B	MY45107753	07/27/2015	1 year
Temperature & Humidity Chamber	TAICHY	MHU-225LA	980729	04/27/2015	1 year
Test Site	ATL	TE05	TE05	N.C.R.	-----

Note: N.C.R. = No Calibration Request.

■ Test Procedure

1. The EUT was placed inside the environmental test chamber and powered by nominal AC/DC voltage.
2. Turn the EUT on and couple its output to a spectrum analyzer.
3. Turn the EUT off and set the chamber to the highest temperature specified.
4. Allow sufficient time (approximately 30 min) for the temperature of the chamber to stabilize.
5. Repeat step 2 and 3 with the temperature chamber set to the lowest temperature.
6. The test chamber was allowed to stabilize at +20 degree C for a minimum of 30 minutes. The supply voltage was then adjusted on the EUT from 85% to 115% and the frequency record.



■ Test Result

Temperature Variations

Test Item	Frequency Stability					
Frequency	Temp. (°C)	Voltage (Vac)	Measured Freq. (MHz)	Delta Freq. (Hz)	Tolerance (ppm)	Result (Pass/Fail)
5200 MHz	-10	120	5199.9586	-41400	-7.962	Pass
	0		5199.9702	-29800	-5.731	Pass
	10		5199.9782	-21800	-4.192	Pass
	20		5199.9814	-18600	-3.577	Pass
	30		5200.0038	3800	0.731	Pass
	40		5200.0132	13200	2.538	Pass
	50		5200.021	21000	4.038	Pass
5280 MHz	-10	120	5279.9504	-49600	-9.394	Pass
	0		5279.9567	-43300	-8.201	Pass
	10		5279.9691	-30900	-5.852	Pass
	20		5279.9757	-24300	-4.602	Pass
	30		5279.9956	-4400	-0.833	Pass
	40		5280.0065	6500	1.231	Pass
	50		5280.0135	13500	2.557	Pass
5560 MHz	-10	120	5559.9454	-54600	-9.820	Pass
	0		5559.9537	-46300	-8.327	Pass
	10		5559.9656	-34400	-6.187	Pass
	20		5559.973	-27000	-4.856	Pass
	30		5559.9945	-5500	-0.989	Pass
	40		5560.011	11000	1.978	Pass
	50		5560.0138	13800	2.482	Pass
5785 MHz	-10	120	5784.9439	-56100	-9.697	Pass
	0		5784.956	-44000	-7.606	Pass
	10		5784.9667	-33300	-5.756	Pass
	20		5784.9706	-29400	-5.082	Pass
	30		5784.9842	-15800	-2.731	Pass
	40		5785.0053	5300	0.916	Pass
	50		5785.0159	15900	2.748	Pass

Note: The manufacturer's frequency stability specification is better than 20ppm.

**Voltage Variations**

Test Item	Frequency Stability					
Frequency	Temp. (°C)	Voltage (Vac)	Measured Freq. (MHz)	Delta Freq. (Hz)	Tolerance (ppm)	Result (Pass/Fail)
5200 MHz	20	138	5199.9767	-23300	-4.481	Pass
		120	5199.9909	-9100	-1.750	Pass
		102	5200.0024	2400	0.462	Pass
5280 MHz	20	138	5279.9674	-32600	-6.174	Pass
		120	5279.984	-16000	-3.030	Pass
		102	5279.9976	-2400	-0.455	Pass
5560 MHz	20	138	5559.9697	-30300	-5.450	Pass
		120	5559.9734	-26600	-4.784	Pass
		102	5559.9927	-7300	-1.313	Pass
5785 MHz	20	138	5784.962	-38000	-6.569	Pass
		120	5784.9802	-19800	-3.423	Pass
		102	5784.99	-10000	-1.729	Pass

Note: The manufacturer's frequency stability specification is better than 20ppm.



4.9. Antenna Requirement

■ Limit

For intentional device, according to 15.203, an intentional radiator shall be designed to ensure that no antenna other than that furnished by the responsible party shall be used with the device.

And According to 15.407 (a), if transmitting antennas of directional gain greater than 6 dBi are used, the power shall be reduced by the amount in dB that the directional gain of the antenna exceeds 6dBi.

■ Antenna Connector Construction

See section 2 – antenna information.