

FCC RADIO TEST REPORT

FCC ID: 2ALH2-PFAQ100

Product : PIQS Virtual Touch Projector

Trade Mark : PIQS

Model Name : Q1

Serial Model : Q1S, Q+, Q1+, Q Plus, Q1 Plus, Q Pro,
Q1 Pro

Report No. : SER180630307005E

Prepared for

PIQS Technology(Shenzhen) Limited
West, 6F Buiding 1, No.35 CuiJing Road, Pingshan New District,
Shenzhen City, Guangdong Province, P.R.China

Prepared by

Shenzhen NTEK Testing Technology Co., Ltd.
1/F, Building E, Fenda Science Park, Sanwei Community,
Xixiang Street Bao'an District, Shenzhen 518126 P.R. China
Tel.: +86-755-6115 6588
Fax.: +86-755-6115 6599
Website:<http://www.ntek.org.cn>

TEST RESULT CERTIFICATION

Applicant's name : PIQS Technology(Shenzhen) Limited
Address : West, 6F Buiding 1, No.35 CuiJing Road, Pingshan New District,
Shenzhen City, Guangdong Province, P.R.China

Manufacturer's Name : Butterfly technology(Shenzhen) Limited
Address : East, 6F Buiding 1, No.35 CuiJing Road, Pingshan New
District, Shenzhen City, Guangdong Province, P.R.China

Product description

Product name : PIQS Virtual Touch Projector

Model and/or type reference : Q1

Serial Model : Q1S, Q+, Q1+, Q Plus, Q1 Plus, Q Pro, Q1 Pro

Standards : FCC Part15.407

Test procedure ANSI C63.10-2013 and KDB 789033 D02 General UNII Test
Procedures New Rules v01r01
FCC KDB 662911 D01 Multiple Transmitter Output v02r01
FCC KDB 662911 D02 MIMO With Cross Polarized Antenna V01

This device described above has been tested by NTEK, and the test results show that the equipment under test (EUT) is in compliance with the FCC requirements/ the Industry Canada requirements.. And it is applicable only to the tested sample identified in the report.

This report shall not be reproduced except in full, without the written approval of NTEK, this document may be altered or revised by NTEK, personnel only, and shall be noted in the revision of the document.

Date of Test

Date (s) of performance of tests 02 Jul. 2018 ~ 13 Aug. 2018

Date of Issue..... 13 Aug. 2018

Test Result..... **Pass**

Testing Engineer : Allen Liu
(Allen Liu)

Technical Manager : Jason Chen
(Jason Chen)

Authorized Signatory : Sam Chen
(Sam Chen)

Table of Contents

	Page
1 . SUMMARY OF TEST RESULTS	6
1.1 FACILITIES AND ACCREDITATIONS	7
1.2 MEASUREMENT UNCERTAINTY	7
2 . GENERAL INFORMATION	8
2.1 GENERAL DESCRIPTION OF EUT	8
2.2 DESCRIPTION OF TEST MODES	12
2.3 BLOCK DIGRAM SHOWING THE CONFIGURATION OF SYSTEM TESTED	13
2.4 DESCRIPTION OF SUPPORT UNITS(CONDUCTED MODE)	14
2.5 EQUIPMENTS LIST FOR ALL TEST ITEMS	15
3 . EMC EMISSION TEST	17
3.1 CONDUCTED EMISSION MEASUREMENT	17
3.1.1 POWER LINE CONDUCTED EMISSION LIMITS	17
3.1.2 TEST PROCEDURE	18
3.1.3 DEVIATION FROM TEST STANDARD	18
3.1.4 TEST SETUP	18
3.1.5 EUT OPERATING CONDITIONS	18
3.2 RADIATED EMISSION MEASUREMENT	23
3.2.1 APPLICABLE STANDARD	23
3.2.2 CONFORMANCE LIMIT	23
3.2.3 MEASURING INSTRUMENTS	23
3.2.4 TEST CONFIGURATION	24
3.2.5 TEST PROCEDURE	25
3.2.6 TEST RESULTS (9KHZ – 30 MHZ)	26
3.2.7 TEST RESULTS (30MHZ – 1GHZ)	27
3.2.8 TEST RESULTS (1GHZ-26GHZ)	31
3.2.9 TEST RESULTS (26GHZ-40GHZ)	33
4 . POWER SPECTRAL DENSITY TEST	37
4.1 APPLIED PROCEDURES / LIMIT	37
4.2 TEST PROCEDURE	38
4.3 DEVIATION FROM STANDARD	38
4.4 TEST SETUP	38
4.5 EUT OPERATION CONDITIONS	38
4.6 TEST RESULTS	39
5 . 26DB & 99% EMISSION BANDWIDTH	47
5.1 APPLIED PROCEDURES / LIMIT	47
5.2 TEST PROCEDURE	47
5.3 EUT OPERATION CONDITIONS	48

Table of Contents

	Page
5.4 TEST RESULTS	49
6 . MINIMUM 6 DB BANDWIDTH	57
6.1 APPLIED PROCEDURES / LIMIT	57
6.2 TEST PROCEDURE	57
6.3 DEVIATION FROM STANDARD	57
6.4 TEST SETUP	57
6.5 EUT OPERATION CONDITIONS	57
6.6 TEST RESULTS	58
7 . MAXIMUM CONDUCTED OUTPUT POWER	66
7.1 PPLIED PROCEDURES / LIMIT	66
7.2 TEST PROCEDURE	66
7.3 DEVIATION FROM STANDARD	68
7.4 TEST SETUP	68
7.5 EUT OPERATION CONDITIONS	68
7.6 TEST RESULTS	69
8 . OUT OF BAND EMISSIONS	71
8.1 APPLICABLE STANDARD	71
8.2 TEST PROCEDURE	71
8.3 DEVIATION FROM STANDARD	71
8.4 TEST SETUP	71
8.5 EUT OPERATION CONDITIONS	71
8.6 TEST RESULTS	72
9.SPURIOUS RF CONDUCTED EMISSIONS	79
9.1CONFORMANCE LIMIT	79
9.2MEASURING INSTRUMENTS	79
9.3TEST SETUP	79
9.4TEST PROCEDURE	79
9.5TEST RESULTS	79
10. FREQUENCY STABILITY MEASUREMENT	94
10.1 LIMIT	94
10.2 TEST PROCEDURES	94
10.3 TEST SETUP LAYOUT	94
10.4 EUT OPERATION DURING TEST	94
10.5 TEST RESULTS	95
11. ANTENNA REQUIREMENT	101
11.1 STANDARD REQUIREMENT	101
11.2 EUT ANTENNA	101



Revision History

Report No.	Version	Description	Issued Date
SER180630307005E	Rev.01	Initial issue of report	Aug. 13, 2018

1. SUMMARY OF TEST RESULTS

Test procedures according to the technical standards:

FCC Part15 (15.407) , Subpart E			
Standard Section	Test Item	Judgment	Remark
15.207	AC Power Line Conducted Emissions	PASS	
15.209(a), 15.407 (b)(1) 15.407 (b)(4) 15.407 (b)(6)	Spurious Radiated Emissions	PASS	(Outsourcing)
15.407 (a)(1) 15.407 (a)(3) 15.1049	26 dB and 99% Emission Bandwidth	PASS	
15.407(e)	Minimum 6 dB bandwidth	PASS	
15.407 (a)(1) 15.407 (a)(3)	Maximum Conducted Output Power	PASS	
2.1051, 15.407(b)(1) 15.407(b)(4)	Band Edge	PASS	
15.407 (a)(1) 15.407 (a)(3)	Power Spectral Density	PASS	
2.1051, 15.407(b)	Spurious Emissions at Antenna Terminals	PASS	
15.203	Antenna Requirement	PASS	

NOTE:

(1) "N/A" denotes test is not applicable in this Test Report

Outsourcing: The 26G-40G Spurious Radiated Emissions in this test were outsourced to the Shenzhen Academy of Metrology & Quality Inspection(The A2LA Certificate Registration Number is 3292.01)

1.1 FACILITIES AND ACCREDITATIONS

FACILITIES

All measurement facilities used to collect the measurement data are located at 1/F, Building E, Fenda Science Park, Sanwei Community, Xixiang Street, Bao'an District, Shenzhen 518126 P.R. China.

The sites are constructed in conformance with the requirements of ANSI C63.7, ANSI C63.10 and CISPR Publication 22.

LABORATORY ACCREDITATIONS AND LISTINGS

Site Description

CNAS-Lab. : The Laboratory has been assessed and proved to be in compliance with CNAS-CL01:2006 (identical to ISO/IEC 17025:2005)
The Certificate Registration Number is L5516.

IC-Registration The Certificate Registration Number is 9270A-1.

FCC- Accredited Test Firm Registration Number: 463705.
Designation Number: CN1184

A2LA-Lab. The Certificate Registration Number is 4298.01
This laboratory is accredited in accordance with the recognized International Standard ISO/IEC 17025:2005 General requirements for the competence of testing and calibration laboratories.
This accreditation demonstrates technical competence for a defined scope and the operation of a laboratory quality management system (refer to joint ISO-ILAC-IAF Communiqué dated 8 January 2009).

Name of Firm : Shenzhen NTEK Testing Technology Co., Ltd.

Site Location : 1/F, Building E, Fenda Science Park, Sanwei Community, Xixiang Street, Bao'an District, Shenzhen 518126 P.R. China.

1.2 MEASUREMENT UNCERTAINTY

The reported uncertainty of measurement $y \pm U$, where expanded uncertainty U is based on a standard uncertainty multiplied by a coverage factor of $k=2$, providing a level of confidence of approximately 95 %.

No.	Item	Uncertainty
1	Conducted Emission Test	$\pm 2.80\text{dB}$
2	RF power, conducted	$\pm 0.16\text{dB}$
3	Spurious emissions, conducted	$\pm 0.21\text{dB}$
4	All emissions, radiated(30MHz~1GHz)	$\pm 2.64\text{dB}$
5	All emissions, radiated(1GHz~6GHz)	$\pm 2.40\text{dB}$
6	All emissions, radiated(> 6GHz)	$\pm 2.52\text{dB}$
7	Temperature	$\pm 0.5^\circ\text{C}$
8	Humidity	$\pm 2\%$

2. GENERAL INFORMATION

2.1 GENERAL DESCRIPTION OF EUT

Equipment	PIQS Virtual Touch Projector		
Trade Mark	PIQS		
Model Name	Q1		
Serial Model	Q1S, Q+, Q1+, Q Plus, Q1 Plus, Q Pro, Q1 Pro		
Model Difference	All the model are the same circuit and RF module, except the colour.		
FCC ID	2ALH2-PFAQ100		
Product Description	IEEE 802.11 WLAN Mode Supported	<input checked="" type="checkbox"/> 802.11a(20MHz channel bandwidth) <input checked="" type="checkbox"/> 802.11n/ac(20MHz channel bandwidth) <input checked="" type="checkbox"/> 802.11n/ac(40MHz channel bandwidth) <input checked="" type="checkbox"/> 802.11ac(80MHz channel bandwidth)	
	Data Rate	802.11 a: 6,9,12,18,24,36,48,54Mbps; 802.11n(HT20):MCS0-MCS15; 802.11n(HT40):MCS0-MCS15; 802.11ac: NSS1,MCS0-MCS9,NSS2,MCS0-MCS9;	
	Modulation	OFDM with BPSK/QPSK/16QAM/64QAM/256QAM for 802.11a/n/ac;	
	Operating Frequency Range	<input checked="" type="checkbox"/> 5180-5240MHz for 802.11a/n(HT20)/ac20; 5190-5230MHz for 802.11n(HT40)/ac40; 5210MHz for 802.11 ac80; <input checked="" type="checkbox"/> 5745-5825 MHz for 802.11a/n(HT20)/ac20; 5755-5795 MHz for 802.11a/n(HT40)/ac40; 5775MHz for 802.11 ac80;	
	Number of Channels	<input checked="" type="checkbox"/> 4 channels for 802.11a/n20/ac20 in the 5180-5240MHz band ; 2 channels for 802.11 n40/ac40 in the 5190-5230MHz band 1 channels for 802.11 ac80 in the 5210MHz band ; <input checked="" type="checkbox"/> 5 channels for 802.11a/n20/ac20 in the 5745-5825MHz band ; 2 channels for 802.11 n40/ac40 in the 5755-5795MHz band 1 channels for 802.11 ac80 in the 5775MHz band ;	
	Antenna Type	Antenna A/B: FPCB Antenna	
	Smart system	<input checked="" type="checkbox"/> SISO for 802.11a <input checked="" type="checkbox"/> MIMO for 802.11n/ac	
	Antenna Gain	See Table for Filed Antenna	
		Based on the application, features, or specification exhibited in User's Manual, More details of EUT technical specification, please refer to the User's Manual.	
	Ratings	DC 19V from Adapter	
Adapter	Model: ADP-120ZB BB Input: AC 100~240V, 50-60Hz, 2.0A Output: DC 19V, 6.32A		
Battery	N/A		
Connecting I/O Port(s)	Please refer to the User's Manual		

Note:

1. For a more detailed features description, please refer to the manufacturer's specifications or the User's Manual.
2. Frequency and Channel list for 802.11a/n(20MHz) band I (5180-5240MHz):

802.11a/n/ac(20MHz) Carrier Frequency Channel							
Channel	Frequency (MHz)	Channel	Frequency (MHz)	Channel	Frequency (MHz)	Channel	Frequency (MHz)
36	5180	44	5220	-	-	-	-
40	5200	48	5240	-	-	-	-

Frequency and Channel list for 802.11n(40MHz) band I (5190-5230MHz):

802.11n /ac(40MHz) Carrier Frequency Channel							
Channel	Frequency (MHz)	Channel	Frequency (MHz)	Channel	Frequency (MHz)	Channel	Frequency (MHz)
38	5190	-	-	-	-	-	-
46	5230	-	-	-	-	-	-

802.11ac (80MHz) Carrier Frequency Channel	
Channel	Frequency (MHz)
42	5210

Frequency and Channel list for 802.11a/n(20 MHz) band IV (5745-5825MHz):

802.11a/n/ac(20 MHz) Carrier Frequency Channel							
Channel	Frequency (MHz)	Channel	Frequency (MHz)	Channel	Frequency (MHz)	Channel	Frequency (MHz)
149	5745	153	5765	157	5785	161	5805
165	5825	-	-	-	-	-	-

Frequency and Channel list for 802.11n(40MHz) band IV (5755-5795MHz):

802.11n/ac 40MHz Carrier Frequency Channel					
Channel	Frequency (MHz)	Channel	Frequency (MHz)	Channel	Frequency (MHz)
151	5755	159	5795	-	-

802.11ac 80MHz Carrier Frequency Channel	
Channel	Frequency (MHz)
155	5775

The EUT has two types of antenna.

Antenna	Brand	Model Name (P/N)	Antenna Type	Connector	Antenna Gain(dBi)	
					5.2G	5.8G
A(main)	N/A	N/A	FPCB	I-PEX	2	2
B(aux)	N/A	N/A	FPCB	I-PEX	2	2

Note: The EUT has two types of antenna.

Only the highest antenna gain for each type has been recorded in this test report, please refer to antenna list for more antenna information.

5G Band:

For IEEE 802.11a mode (1TX, 2RX):

The EUT can support both 1TX and 2RX functions.

For 1TX

Only Chain 1 can be used as transmitting antenna.

Chain 1 and Chain 2 could receive simultaneously.

For IEEE 802.11n mode (1TX/2TX, 2RX):

The EUT can support both 1TX and 2TX functions.

For 1TX

Only Chain 1 can be used as transmitting antenna.

Chain 1 and Chain 2 could receive simultaneously.

For 2TX

Chain 1 and Chain 2 could both transmit/receive simultaneously.

Only 2TX function was selected to test and record in the report, the 1TX test results were covered by 2TX Test results.

For IEEE 802.11ac mode (1TX/2TX, 2RX):

The EUT can support both 1TX and 2TX functions.

For 1TX

Only Chain 1 can be used as transmitting antenna.

Chain 1 and Chain 2 could receive simultaneously.

For 2TX

Both Chain 1 and Chain 2 can be used as transmitting/receiving antenna.

Chain 1 and Chain 2 could both transmit/receive simultaneously.

Only 2TX function was selected to test and record in the report, the 1TX test results were covered by 2TX Test results.

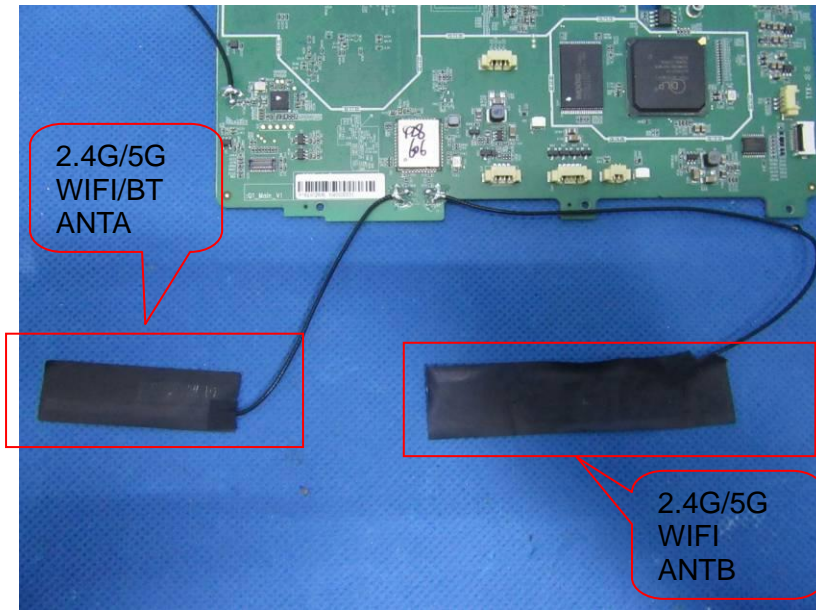

For 802.11n/ac mode: ANT A& B can transmit simultaneously.

And the data is recorded for radiated emission, and band edge.

For MIMO mode, Directional gain= $[10\log(G_A + G_B)]$ dbi =5.01dbi in 5.2GHz

Directional gain= $[10\log(G_A + G_B)]$ dbi =5.01dbi in 5.8GHz

802.11n/ac 5GHz has MIMO mode.

Note: GA means antenna gain for ANT A in Num.
 GB means antenna gain for ANT B in Num.

2.2 DESCRIPTION OF TEST MODES

To investigate the maximum EMI emission characteristics generates from EUT, the test system was pre-scanning tested base on the consideration of following EUT operation mode or test configuration mode which possible have effect on EMI emission level. Each of these EUT operation mode(s) or test configuration mode(s) mentioned above was evaluated respectively.

Pretest Mode	Description
Mode 1	Normal Link Mode
Mode 2	802.11a/n/ac 20 CH36/ CH40/ CH 48 802.11a /n/ac 20 CH149/ CH157/ CH 165
Mode 3	802.11n/ac40 CH38/ CH 46 802.11n/ac40 CH 151 / CH 159
Mode 4	802.11ac80 CH 42/CH 155

For Radiated Emission	
Final Test Mode	Description
Mode 1	Normal Link Mode
Mode 2	802.11a/n/ac 20 CH36/ CH40/ CH 48 802.11a /n/ac 20 CH149/ CH157/ CH 165
Mode 3	802.11n/ac40 CH38/ CH 46 802.11n/ac40 CH 151 / CH 159
Mode 4	802.11 ac80 CH 42/CH 155

Note:

- (1) The measurements are performed at the highest, middle, lowest available channels.
- (2) The measurements are performed at all Bit Rate of Transmitter, the worst data was reported

2.3 BLOCK DIGRAM SHOWING THE CONFIGURATION OF SYSTEM TESTED

For AC Conducted Emission Mode

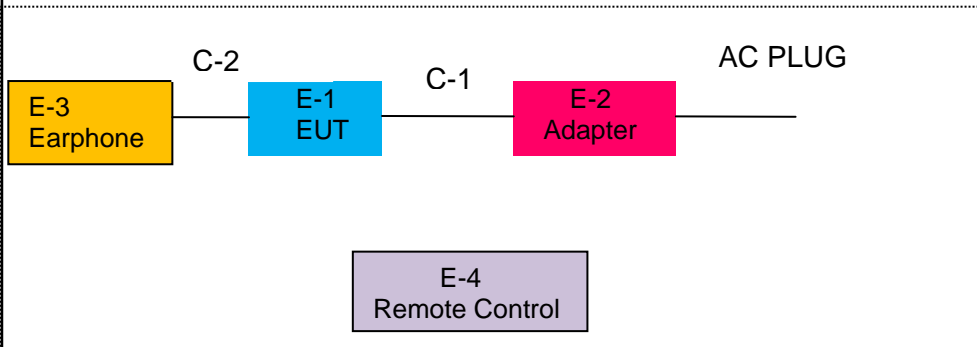

Radiated Spurious Emission Test

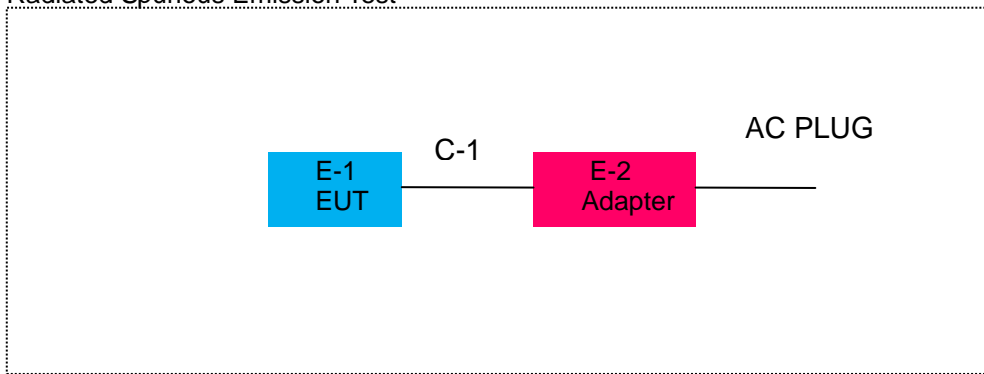

For Conducted Test Cases

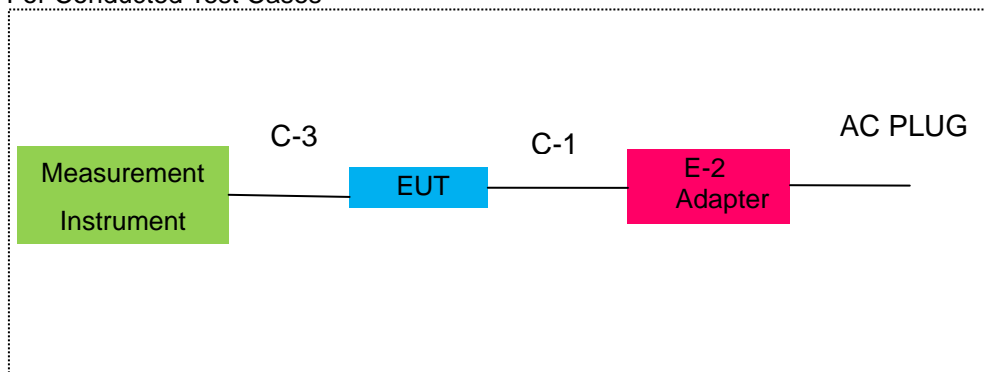

2.4 DESCRIPTION OF SUPPORT UNITS(CONDUCTED MODE)

The EUT has been tested as an independent unit together with other necessary accessories or support units. The following support units or accessories were used to form a representative test configuration during the tests.

Item	Equipment	Brand	Model/Type No.	Series No.	Note
E-1	PIQS Virtual Touch Projector	PIQS	Q1	N/A	EUT
E-2	Adapter	N/A	ADP-120ZB BB	N/A	Peripherals
E-3	Earphone	N/A	N/A	N/A	Peripherals
E-4	Remote Control	N/A	N/A	N/A	Peripherals

Item	Cable Type	Shielded Type	Ferrite Core	Length	Note
C-1	Power Cable	NO	YES	1.2m	
C-2	Earphone Cable	NO	NO	0.8m	
C-3	RF Cable	NO	NO	0.5m	

Note:

- (1) The support equipment was authorized by Declaration of Confirmation.
- (2) For detachable type I/O cable should be specified the length in cm in 『Length』 column.

2.5 EQUIPMENTS LIST FOR ALL TEST ITEMS

Radiation & Conducted Test equipment

Item	Kind of Equipment	Manufacturer	Type No.	Serial No.	Last calibration	Calibrated until	Calibration period
1	Spectrum Analyzer	Agilent	E4407B	MY45108040	2018.05.19	2019.05.18	1 year
2	Spectrum Analyzer	Agilent	N9020A	MY49100060	2017.10.26	2018.10.25	1 year
3	Spectrum Analyzer	R&S	FSV40	101417	2017.10.26	2018.10.25	1 year
4	Test Receiver	R&S	ESPI7	101318	2018.05.19	2019.05.18	1 year
5	Bilog Antenna	TESEQ	CBL6111D	31216	2018.04.08	2019.04.07	1 year
6	50Ω Coaxial Switch	Anritsu	MP59B	6200983705	2018.05.19	2020.05.18	2 year
7	Horn Antenna	EM	EM-AH-10180	2011071402	2018.04.08	2019.04.07	1 year
8	Amplifier	EMC	EMC051835SE	980246	2018.08.08	2019.08.07	1 year
9	Active Loop Antenna	SCHWARZBECK	FMZB 1519B	055	2017.12.06	2018.12.06	1 year
10	Power Meter	DARE	RPR3006W	15100041SN084	2018.08.06	2019.08.05	1 year
11	Test Cable (9KHz-30MHz)	N/A	R-01	N/A	2017.04.21	2020.04.20	3 year
12	Test Cable (30MHz-1GHz)	N/A	R-02	N/A	2017.04.21	2020.04.20	3 year
13	High Test Cable(1G-40GHz)	N/A	R-03	N/A	2017.04.21	2020.04.20	3 year
14	High Test Cable(1G-40GHz)	N/A	R-04	N/A	2017.04.21	2020.04.20	3 year
15	Filter	TRILTHIC	2400MHz	29	2017.04.19	2020.04.18	3 year
16	temporary antenna connector (Note)	NTS	R001	N/A	N/A	N/A	N/A

Note:

We will use the temporary antenna connector (soldered on the FPCB board) When conducted test
 And this temporary antenna connector is listed within the instrument list

AC Conduction Test equipment

Item	Kind of Equipment	Manufacturer	Type No.	Serial No.	Last calibration	Calibrated until	Calibration period
1	Test Receiver	R&S	ESCI	101160	2018.05.19	2019.05.18	1 year
2	LISN	R&S	ENV216	101313	2018.04.18	2019.04.19	1 year
3	LISN	SCHWARZBECK	NNLK 8129	8129245	2018.05.19	2019.05.18	1 year
4	50Ω Coaxial Switch	ANRITSU CORP	MP59B	6200983704	2018.05.19	2020.05.18	3 year
5	Test Cable (9KHz-30MHz)	N/A	C01	N/A	2017.04.21	2020.04.20	3 year
6	Test Cable (9KHz-30MHz)	N/A	C02	N/A	2017.04.21	2020.04.20	3 year
7	Test Cable (9KHz-30MHz)	N/A	C03	N/A	2017.04.21	2020.04.20	3 year

Note: Each piece of equipment is scheduled for calibration once a year except the Test Cable which is scheduled for calibration every 3 years.

3. EMC EMISSION TEST

3.1 CONDUCTED EMISSION MEASUREMENT

3.1.1 POWER LINE CONDUCTED EMISSION Limits (Frequency Range 150KHz-30MHz)

FREQUENCY (MHz)	Conducted Emission Limit		Standard
	Quasi-peak	Average	
0.15 -0.5	66 - 56 *	56 - 46 *	CISPR
0.50 -5.0	56.00	46.00	CISPR
5.0 -30.0	60.00	50.00	CISPR

0.15 -0.5	66 - 56 *	56 - 46 *	FCC/ RSS-247
0.50 -5.0	56.00	46.00	FCC/ RSS-247
5.0 -30.0	60.00	50.00	FCC/ RSS-247

Note:

- (1) The tighter limit applies at the band edges.
- (2) The limit of " * " marked band means the limitation decreases linearly with the logarithm of the frequency in the range.

The following table is the setting of the receiver

Receiver Parameters	Setting
Attenuation	10 dB
Start Frequency	0.15 MHz
Stop Frequency	30 MHz
IF Bandwidth	9 kHz

3.1.2 TEST PROCEDURE

- a. The EUT was placed 0.8 meters from the horizontal ground plane with EUT being connected to the power mains through a line impedance stabilization network (LISN). All other support equipments powered from additional LISN(s). The LISN provide 50 Ohm/ 50uH of coupling impedance for the measuring instrument.
- b. Interconnecting cables that hang closer than 40 cm to the ground plane shall be folded back and forth in the center forming a bundle 30 to 40 cm long.
- c. I/O cables that are not connected to a peripheral shall be bundled in the center. The end of the cable may be terminated, if required, using the correct terminating impedance. The overall length shall not exceed 1 m.
- d. LISN at least 80 cm from nearest part of EUT chassis.
- e. For the actual test configuration, please refer to the related Item –EUT Test Photos.

3.1.3 DEVIATION FROM TEST STANDARD

No deviation

3.1.4 TEST SETUP

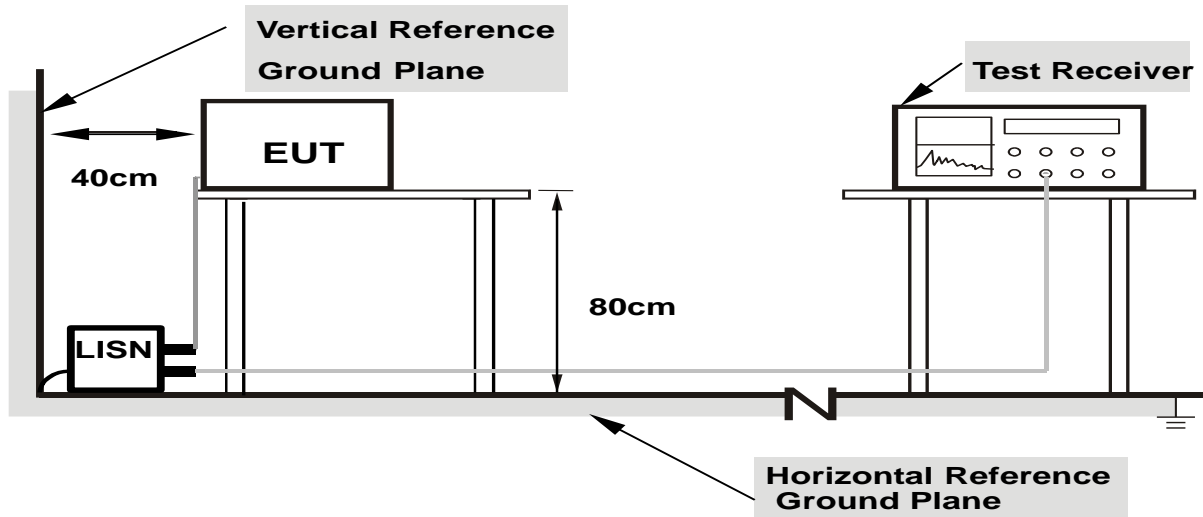

- Note:**
1. Support units were connected to second LISN.
 2. Both of LISNs (AMN) are 80 cm from EUT and at least 80 cm from other units and other metal planes

3.1.5 EUT OPERATING CONDITIONS

The EUT was configured for testing in a typical fashion (as a customer would normally use it). The EUT has been programmed to continuously transmit during test. This operating condition was tested and used to collect the included data.

EUT :	PIQS Virtual Touch Projector	Model Name. :	Q1
Temperature :	26 °C	Relative Humidity :	56%
Pressure :	1010hPa	Phase :	L
Test Voltage :	DC 19V from Adapter AC 120V/60Hz	Test Mode :	Mode 1

Frequency (MHz)	Reading Level (dBμV)	Correct Factor (dB)	Measurement (dBμV)	Limits (dBμV)	Margin (dB)	Remark
0.1700	47.63	9.76	57.39	64.96	-7.57	QP
0.1700	36.57	9.76	46.33	54.96	-8.63	AVG
0.1859	45.28	9.76	55.04	64.21	-9.17	QP
0.1859	31.49	9.76	41.25	54.21	-12.96	AVG
0.2058	44.00	9.76	53.76	63.37	-9.61	QP
0.2058	30.82	9.76	40.58	53.37	-12.79	AVG
0.3180	38.46	9.74	48.20	59.76	-11.56	QP
0.3180	28.48	9.74	38.22	49.76	-11.54	AVG
0.4620	34.70	9.74	44.44	56.66	-12.22	QP
0.4620	26.28	9.74	36.02	46.66	-10.64	AVG
0.7217	31.48	9.74	41.22	56.00	-14.78	QP
0.7217	20.37	9.74	30.11	46.00	-15.89	AVG

Remark:

1. All readings are Quasi-Peak and Average values.
2. Factor = Insertion Loss + Cable Loss.

100.0 dBuV

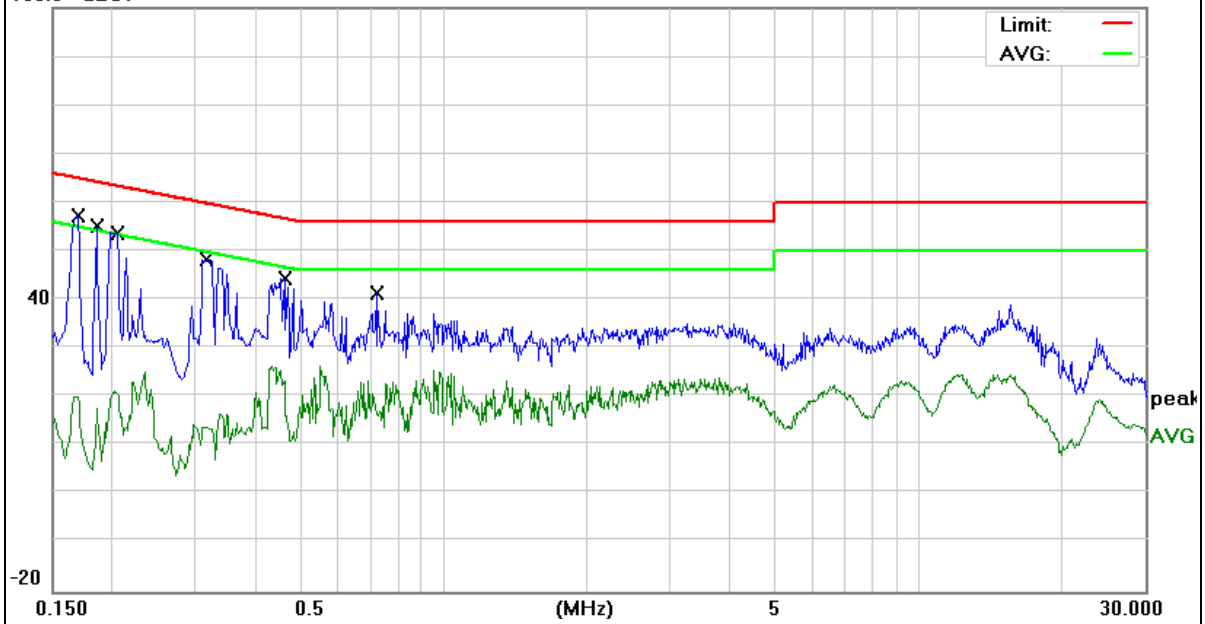

EUT :	PIQS Virtual Touch Projector	Model Name. :	Q1
Temperature :	26 °C	Relative Humidity :	56%
Pressure :	1010hPa	Phase :	N
Test Voltage :	DC 19V from Adapter AC 120V/60Hz	Test Mode :	Mode 1

Frequency (MHz)	Reading Level (dBμV)	Correct Factor (dB)	Measure-ment (dBμV)	Limits (dBμV)	Margin (dB)	Remark
0.1660	48.36	9.73	58.09	65.15	-7.06	QP
0.1660	32.52	9.73	42.25	55.15	-12.90	AVG
0.1779	44.74	9.73	54.47	64.58	-10.11	QP
0.1779	30.29	9.73	40.02	54.58	-14.56	AVG
0.2979	39.09	9.74	48.83	60.30	-11.47	QP
0.2979	27.41	9.74	37.15	50.30	-13.15	AVG
0.4339	34.97	9.75	44.72	57.18	-12.46	QP
0.4339	23.47	9.75	33.22	47.18	-13.96	AVG
0.9619	28.82	9.75	38.57	56.00	-17.43	QP
0.9619	18.39	9.75	28.14	46.00	-17.86	AVG
3.2580	27.94	9.88	37.82	56.00	-18.18	QP
3.2580	16.71	9.88	26.59	46.00	-19.41	AVG

Remark:

1. All readings are Quasi-Peak and Average values.
2. Factor = Insertion Loss + Cable Loss.

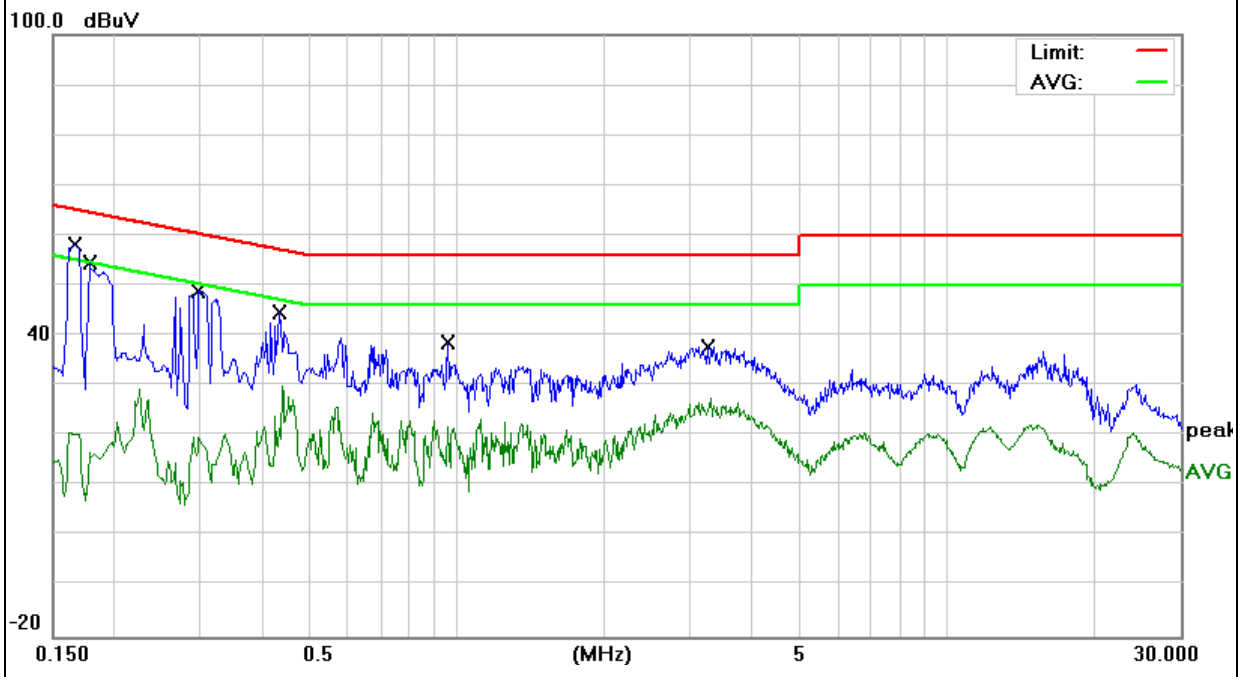

EUT :	PIQS Virtual Touch Projector	Model Name. :	Q1
Temperature :	26 °C	Relative Humidity :	56%
Pressure :	1010hPa	Phase :	L
Test Voltage :	DC 19V from Adapter AC 240V/60Hz	Test Mode :	Mode 1

Frequency (MHz)	Reading Level (dBμV)	Correct Factor (dB)	Measurement (dBμV)	Limits (dBμV)	Margin (dB)	Remark
0.1620	50.64	9.76	60.40	65.36	-4.96	QP
0.1620	40.26	9.76	50.02	55.36	-5.34	AVG
0.1819	47.20	9.76	56.96	64.39	-7.43	QP
0.1819	38.56	9.76	48.32	54.39	-6.07	AVG
0.2020	47.24	9.76	57.00	63.52	-6.52	QP
0.2020	35.90	9.76	45.66	53.52	-7.86	AVG
0.2220	45.19	9.76	54.95	62.74	-7.79	QP
0.2220	31.59	9.76	41.35	52.74	-11.39	AVG
0.2379	44.37	9.76	54.13	62.17	-8.04	QP
0.2379	34.39	9.76	44.15	52.17	-8.02	AVG
0.2580	42.96	9.76	52.72	61.49	-8.77	QP
0.2580	35.26	9.76	45.02	51.49	-6.47	AVG

Remark:

1. All readings are Quasi-Peak and Average values.
2. Factor = Insertion Loss + Cable Loss.

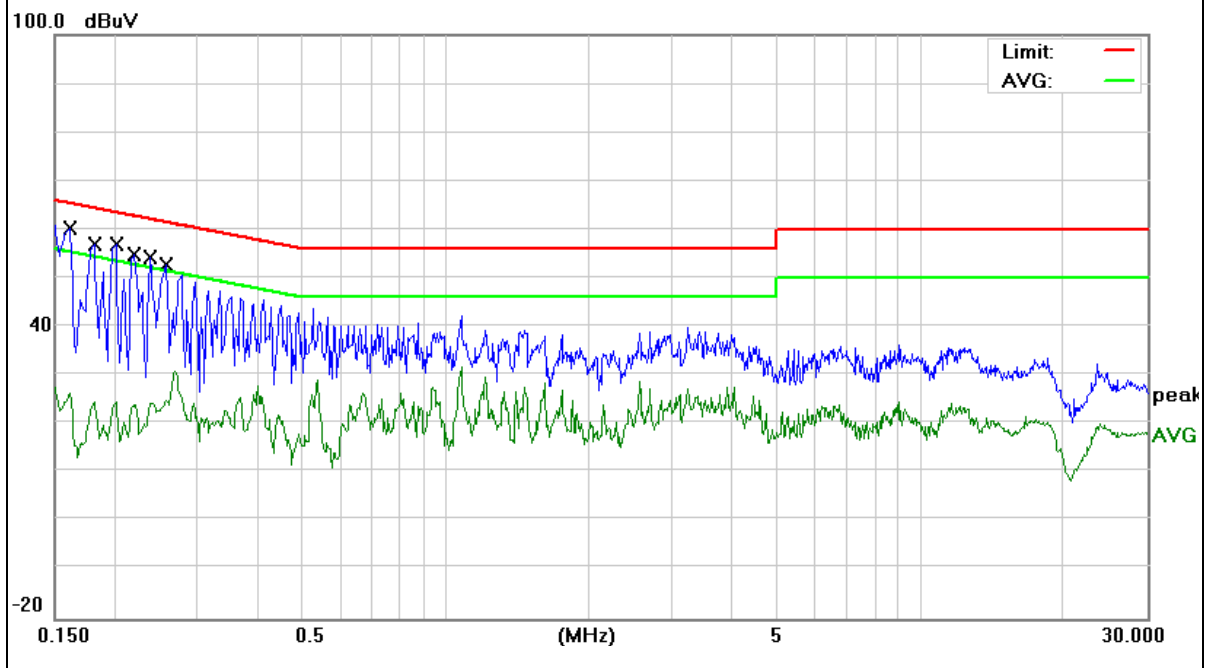

EUT :	PIQS Virtual Touch Projector	Model Name. :	Q1
Temperature :	26 °C	Relative Humidity :	56%
Pressure :	1010hPa	Phase :	N
Test Voltage :	DC 19V from Adapter AC 240V/60Hz	Test Mode :	Mode 1

Frequency (MHz)	Reading Level (dBμV)	Correct Factor (dB)	Measure-ment (dBμV)	Limits (dBμV)	Margin (dB)	Remark
0.1539	52.03	9.74	61.77	65.78	-4.01	QP
0.1539	37.26	9.74	47.00	55.78	-8.78	AVG
0.1700	49.21	9.73	58.94	64.96	-6.02	QP
0.1700	32.49	9.73	42.22	54.96	-12.74	AVG
0.1900	47.65	9.73	57.38	64.03	-6.65	QP
0.1900	30.29	9.73	40.02	54.03	-14.01	AVG
0.2099	46.66	9.73	56.39	63.21	-6.82	QP
0.2099	32.63	9.73	42.36	53.21	-10.85	AVG
0.2260	44.88	9.73	54.61	62.59	-7.98	QP
0.2260	35.42	9.73	45.15	52.59	-7.44	AVG
0.2500	43.78	9.74	53.52	61.75	-8.23	QP
0.2500	30.54	9.74	40.28	51.75	-11.47	AVG

Remark:

1. All readings are Quasi-Peak and Average values.
2. Factor = Insertion Loss + Cable Loss.

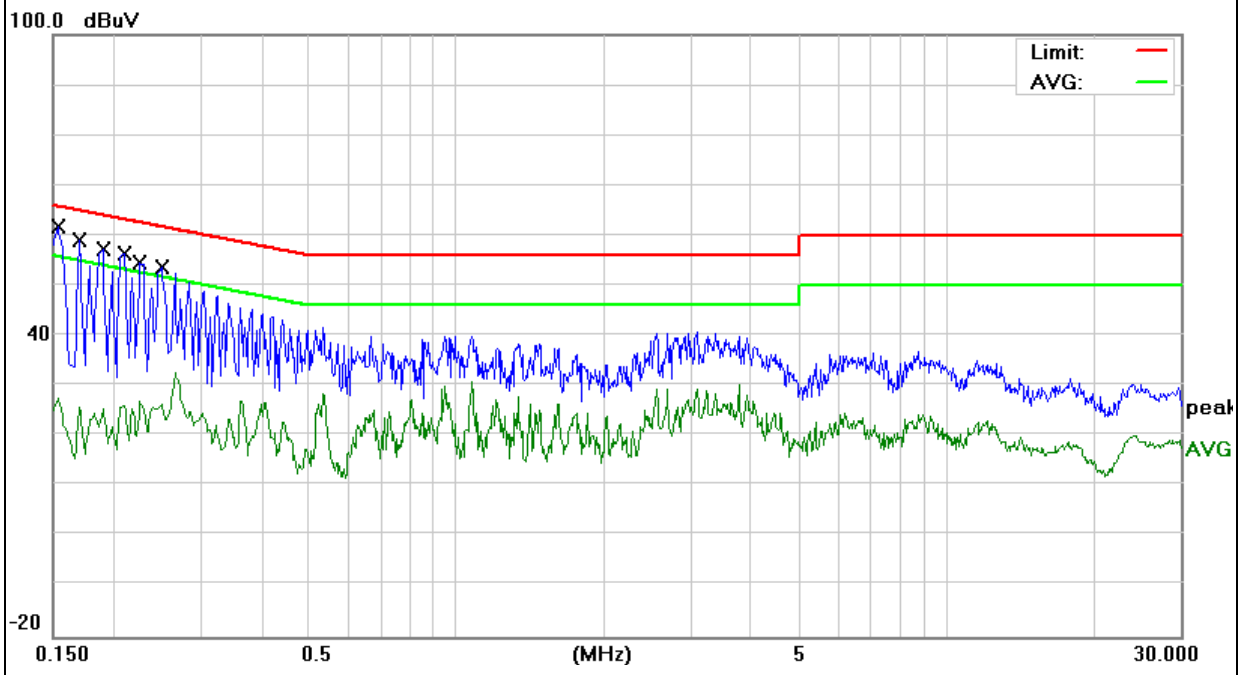

3.2 RADIATED EMISSION MEASUREMENT

3.2.1 APPLICABLE STANDARD

According to FCC Part 15.407(d) and 15.209

3.2.2 CONFORMANCE LIMIT

According to FCC Part 15.407(b)(7): radiated emissions which fall in the restricted bands, as defined in §15.205(a), must also comply with the radiated emission limits specified in §15.209(a) (see §15.205(c)).
According to FCC Part 15.205, Restricted bands

MHz	MHz	MHz	GHz
0.090-0.110	16.42-16.423	399.9-410	4.5-5.15
10.495-0.505	16.69475-16.69525	608-614	5.35-5.46
2.1735-2.1905	16.80425-16.80475	960-1240	7.25-7.75
4.125-4.128	25.5-25.67	1300-1427	8.025-8.5
4.17725-4.17775	37.5-38.25	1435-1626.5	9.0-9.2
4.20725-4.20775	73-74.6	1645.5-1646.5	9.3-9.5
6.215-6.218	74.8-75.2	1660-1710	10.6-12.7
6.26775-6.26825	123-138	2200-2300	14.47-14.5
8.291-8.294	149.9-150.05	2310-2390	15.35-16.2
8.362-8.366	156.52475-156.52525	2483.5-2500	17.7-21.4
8.37625-8.38675	156.7-156.9	2690-2900	22.01-23.12
8.41425-8.41475	162.0125-167.17	3260-3267	23.6-24.0
12.29-12.293	167.72-173.2	3332-3339	31.2-31.8
12.51975-12.52025	240-285	3345.8-3358	36.43-36.5
12.57675-12.57725	322-335.4	3600-4400	(2)
13.36-13.41			

20dBc in any 100 kHz bandwidth outside the operating frequency band. In case the emission fall within the restricted band specified on 15.205(a), then the 15.209(a) limit in the table below has to be followed.

Restricted Frequency(MHz)	Field Strength (µV/m)	Field Strength (dBµV/m)	Measurement Distance
0.009~0.490	2400/F(KHz)	20 log (uV/m)	300
0.490~1.705	2400/F(KHz)	20 log (uV/m)	30
1.705~30.0	30	29.5	30
30-88	100	40	3
88-216	150	43.5	3
216-960	200	46	3
Above 960	500	54	3

Limits of Radiated Emission Measurement(Above 1000MHz)

Frequency(MHz)	Class B (dBuV/m) (at 3M)	
	PEAK	AVERAGE
Above 1000	74	54

- Remark : 1. Emission level in dBuV/m=20 log (uV/m)
 2. Measurement was performed at an antenna to the closed point of EUT distance of meters.
 3. Distance extrapolation factor =40log(Specific distance/ test distance)(dB);
 Limit line=Specific limits(dBuV) + distance extrapolation factor.

3.2.3 MEASURING INSTRUMENTS

The Measuring equipment is listed in the section 6.3 of this test report.

3.2.4 TEST CONFIGURATION

(a) For radiated emissions below 30MHz

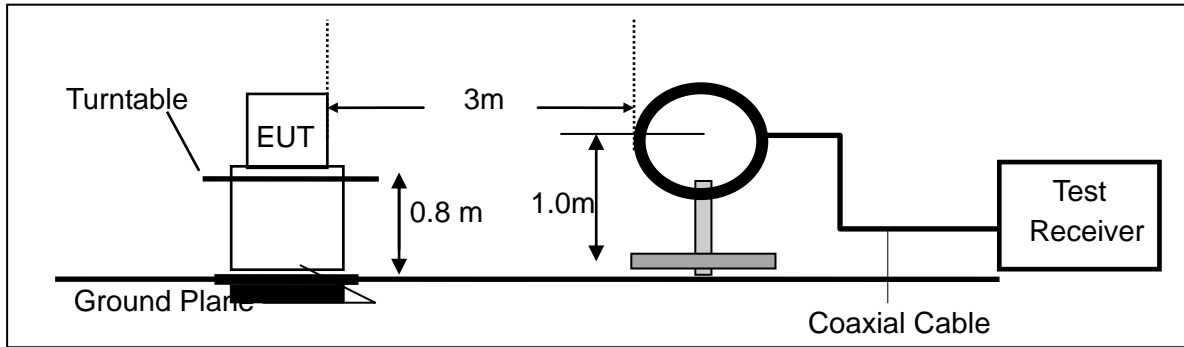

(b) For radiated emissions from 30MHz to 1000MHz

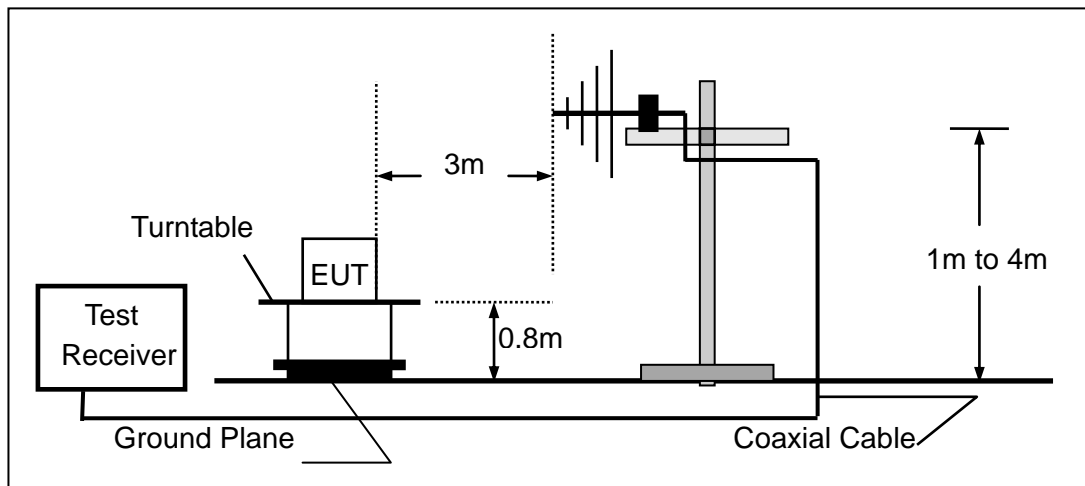

(c) For radiated emissions above 1000MHz

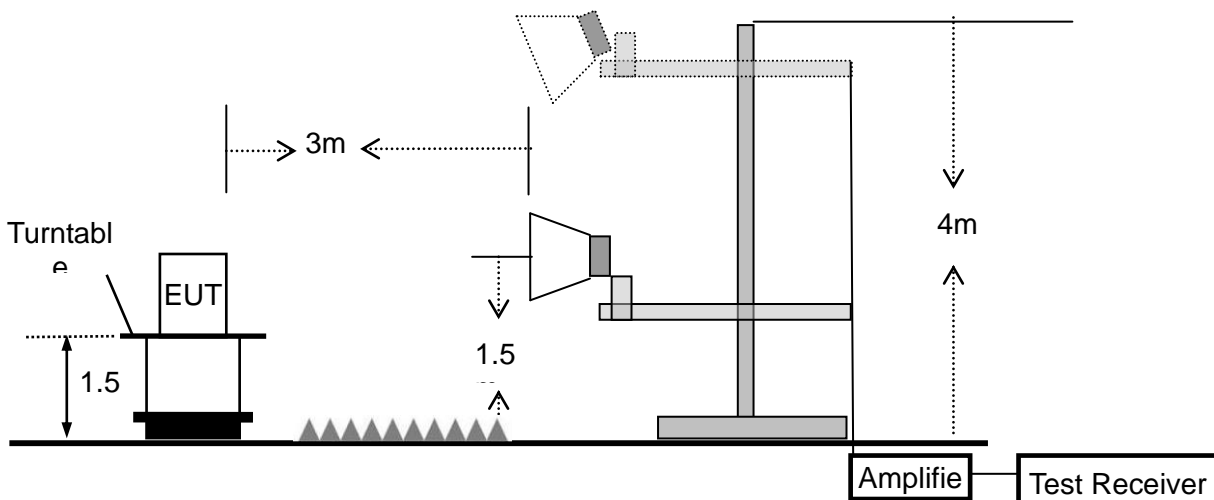

3.2.5 TEST PROCEDURE

The test site semi-anechoic chamber has met the requirement of NSA tolerance 4 dB according to the standards: ANSI C63.10-2013. The test distance is 3m. The setup is according to the requirements in Section 13.1.4.1 of ANSI C63.10-2013 and CAN/CSA-CEI/IEC CISPR 22.

This test is required for any spurious emission that falls in a Restricted Band, as defined in Section 15.205. It must be performed with the highest gain of each type of antenna proposed for use with the EUT.

Use the following spectrum analyzer settings:

Spectrum Parameter	Setting
Attenuation	Auto
Start Frequency	1000 MHz
Stop Frequency	10th carrier harmonic
RB / VB (emission in restricted band)	1 MHz / 1 MHz for Peak, 1 MHz / 10Hz for Average

Receiver Parameter	Setting
Attenuation	Auto
Start ~ Stop Frequency	9kHz~150kHz / RB 200Hz for QP
Start ~ Stop Frequency	150kHz~30MHz / RB 9kHz for QP
Start ~ Stop Frequency	30MHz~1000MHz / RB 120kHz for QP

- The measuring distance of at 3 m shall be used for measurements at frequency up to 1GHz. For frequencies above 1GHz, any suitable measuring distance may be used.
- The EUT was placed on the top of a rotating table 0.8 m for below 1GHz and 1.5m for above 1GHz the ground at a 3 meter. The table was rotated 360 degrees to determine the position of the highest radiation.
- The height of the equipment or of the substitution antenna shall be 0.8 m for below 1GHz and 1.5m for above 1GHz; the height of the test antenna shall vary between 1 m to 4 m. Both horizontal and vertical polarizations of the antenna are set to make the measurement.
- The initial step in collecting conducted emission data is a spectrum analyzer peak detector mode pre-scanning the measurement frequency range. Significant peaks are then marked and then Quasi Peak detector mode re-measured.
- If the Peak Mode measured value compliance with and lower than Quasi Peak Mode Limit, the EUT shall be deemed to meet QP Limits and then no additional QP Mode measurement performed.
- For the actual test configuration, please refer to the related Item –EUT Test Photos.

Note:

Both horizontal and vertical antenna polarities were tested and performed pretest to three orthogonal axis. The worst case emissions were reported

During the radiated emission test, the Spectrum Analyzer was set with the following configurations:

Frequency Band (MHz)	Function	Resolution bandwidth	Video Bandwidth
30 to 1000	QP	120 kHz	300 kHz
Above 1000	Peak	1 MHz	1 MHz
	Average	1 MHz	10 Hz

Note: for the frequency ranges below 30 MHz, a narrower RBW is used for these ranges but the measured value should add a RBW correction factor (RBWCF) where $RBWCF [dB] = 10 \cdot \lg(100 [kHz] / \text{narrower RBW [kHz]})$. , the narrower RBW is 1 kHz and RBWCF is 20 dB for the frequency 9 kHz to 150 kHz, and the narrower RBW is 10 kHz and RBWCF is 10 dB for the frequency 150 kHz to 30 MHz.

3.2.6 TEST RESULTS (9KHZ – 30 MHZ)

EUT:	PIQS Virtual Touch Projector	Model Name. :	Q1
Temperature:	20 °C	Relative Humidity:	48%
Pressure:	1010 hPa	Test Voltage :	DC 19V
Test Mode :	TX	Polarization :	--

Freq. (MHz)	Reading (dBuV/m)	Limit (dBuV/m)	Margin (dB)	State P/F
--	--	--	--	N/A
--	--	--	--	N/A

NOTE:

The amplitude of spurious emissions which are attenuated by more than 20dB below the permissible value has no need to be reported.

Distance extrapolation factor = $40 \log(\text{specific distance/test distance})(\text{dB})$;

Limit line = specific limits(dBuv) + distance extrapolation factor.

3.2.7 TEST RESULTS (30MHZ – 1GHZ)

EUT :	PIQS Virtual Touch Projector	Model Name. :	Q1
Temperature :	20 °C	Relative Humidity :	48%
Pressure :	1010 hPa	Test Voltage :	DC 19V
Test Mode :	TX(5.2G)		

Polar (H/V)	Frequency	Meter Reading	Factor	Emission Level	Limits	Margin	Remark
	(MHz)	(dBuV)	(dB)	(dBuV/m)	(dBuV/m)	(dB)	
V	67.2022	24.89	6.51	31.40	40.00	-8.60	QP
V	148.9625	27.26	12.84	40.10	43.50	-3.40	QP
V	478.8456	20.85	21.35	42.20	46.00	-3.80	QP
V	586.8437	18.02	23.51	41.53	46.00	-4.47	QP
V	672.8444	16.48	25.02	41.50	46.00	-4.50	QP
V	793.3958	14.93	27.28	42.21	46.00	-3.79	QP

Remark:

Absolute Level= ReadingLevel+ Factor, Margin= Absolute Level - Limit

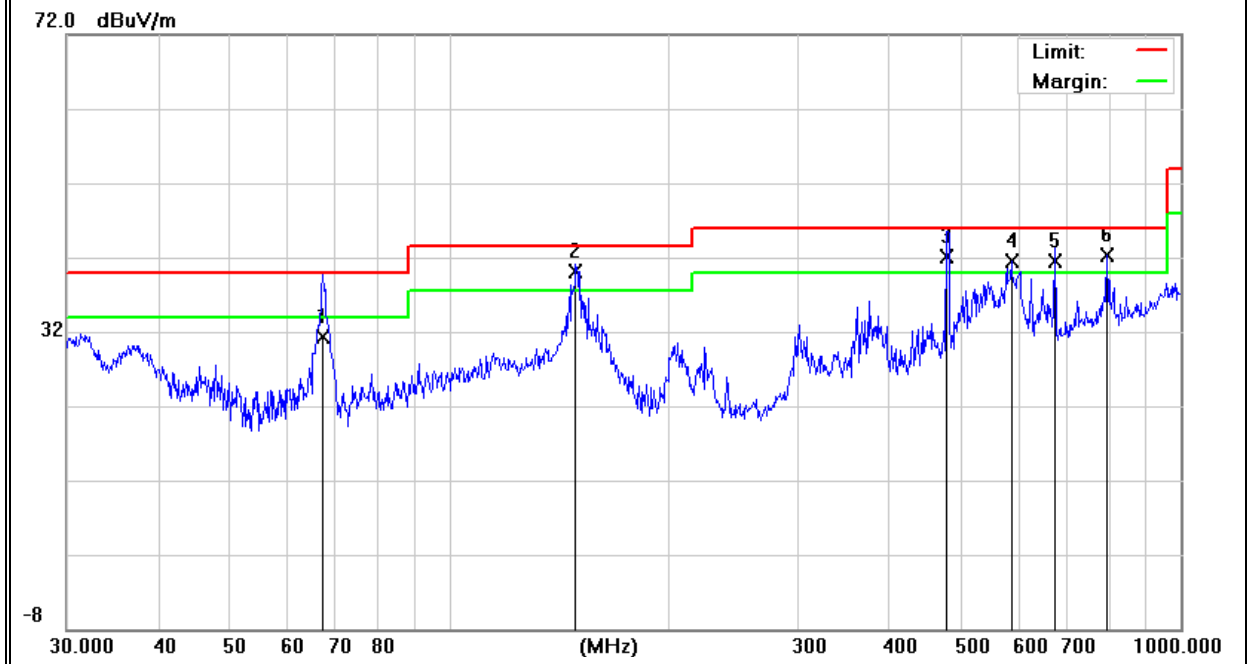

Polar (H/V)	Frequency	Meter Reading	Factor	Emission Level	Limits	Margin	Remark
	(MHz)	(dBuV)	(dB)	(dBuV/m)	(dBuV/m)	(dB)	
H	67.2022	28.18	6.51	34.69	40.00	-5.31	QP
H	150.0108	26.14	12.77	38.91	43.50	-4.59	QP
H	202.1005	25.48	10.11	35.59	43.50	-7.91	QP
H	480.5276	19.29	21.41	40.70	46.00	-5.30	QP
H	729.3582	11.60	27.23	38.83	46.00	-7.17	QP
H	912.8619	10.34	29.67	40.01	46.00	-5.99	QP

Remark:

Absolute Level= ReadingLevel+ Factor, Margin= Absolute Level - Limit

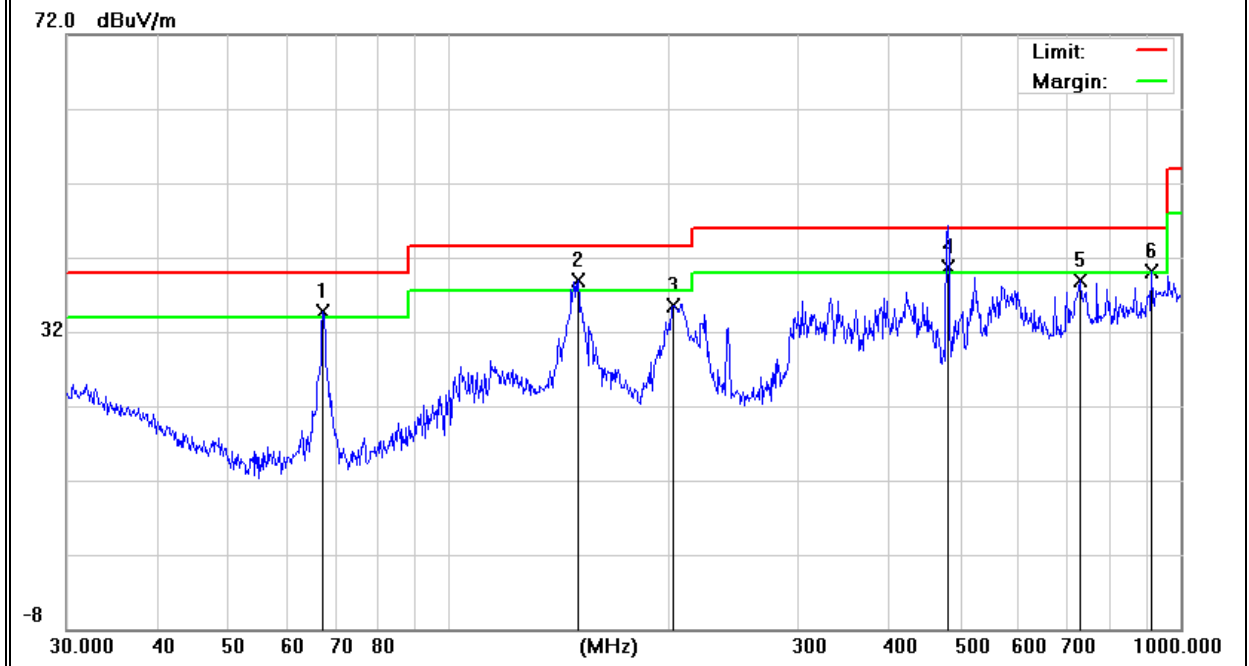

EUT :	PIQS Virtual Touch Projector	Model Name. :	Q1
Temperature :	20 °C	Relative Humidity :	48%
Pressure :	1010 hPa	Test Voltage :	DC 19V
Test Mode :	TX(5.8G)		

Polar (H/V)	Frequency	Meter Reading	Factor	Emission Level	Limits	Margin	Remark
	(MHz)	(dBuV)	(dB)	(dBuV/m)	(dBuV/m)	(dB)	
V	67.2022	26.19	6.51	32.70	40.00	-7.30	QP
V	146.8876	21.26	13.00	34.26	43.50	-9.24	QP
V	478.8456	21.45	21.35	42.80	46.00	-3.20	QP
V	595.1327	18.38	23.67	42.05	46.00	-3.95	QP
V	672.8444	17.03	25.02	42.05	46.00	-3.95	QP
V	893.8567	10.85	28.64	39.49	46.00	-6.51	QP

Remark:

Absolute Level= ReadingLevel+ Factor, Margin= Absolute Level - Limit

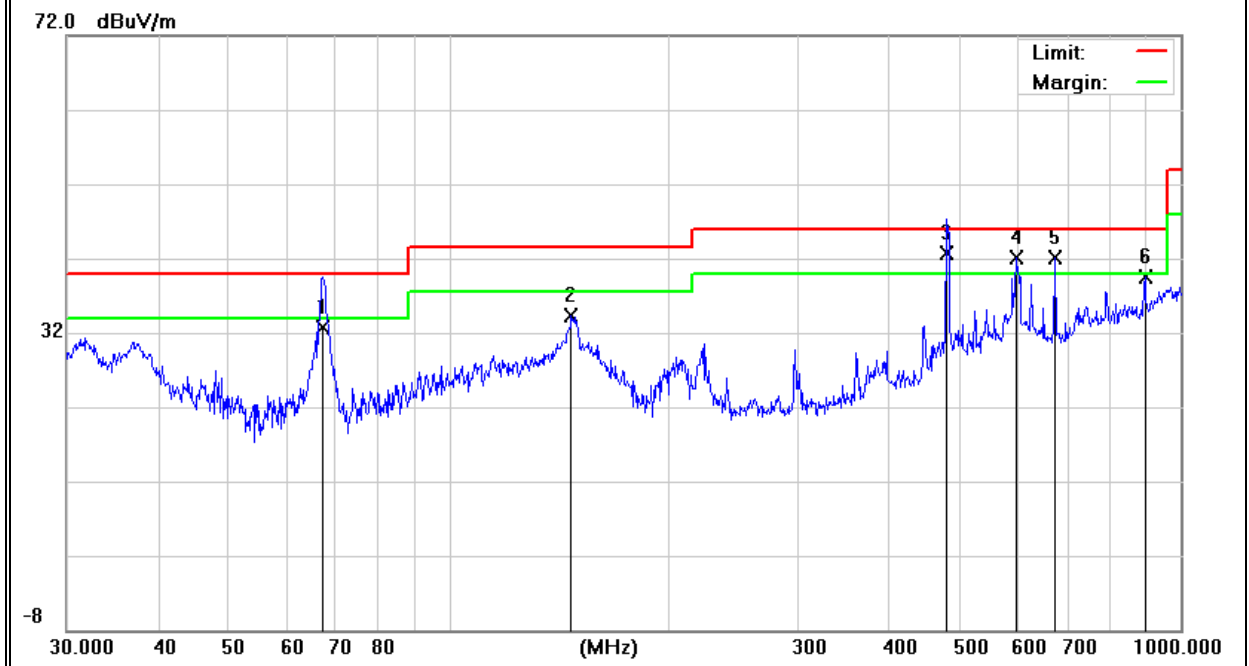

Polar (H/V)	Frequency	Meter Reading	Factor	Emission Level	Limits	Margin	Remark
	(MHz)	(dBuV)	(dB)	(dBuV/m)	(dBuV/m)	(dB)	
H	67.4382	26.50	6.50	33.00	40.00	-7.00	QP
H	148.9625	25.64	12.84	38.48	43.50	-5.02	QP
H	204.9550	27.58	10.58	38.16	43.50	-5.34	QP
H	478.8456	17.94	21.35	39.29	46.00	-6.71	QP
H	866.0878	10.53	28.65	39.18	46.00	-6.82	QP
H	912.8619	11.28	29.67	40.95	46.00	-5.05	QP

Remark:

Absolute Level= ReadingLevel+ Factor, Margin= Absolute Level - Limit

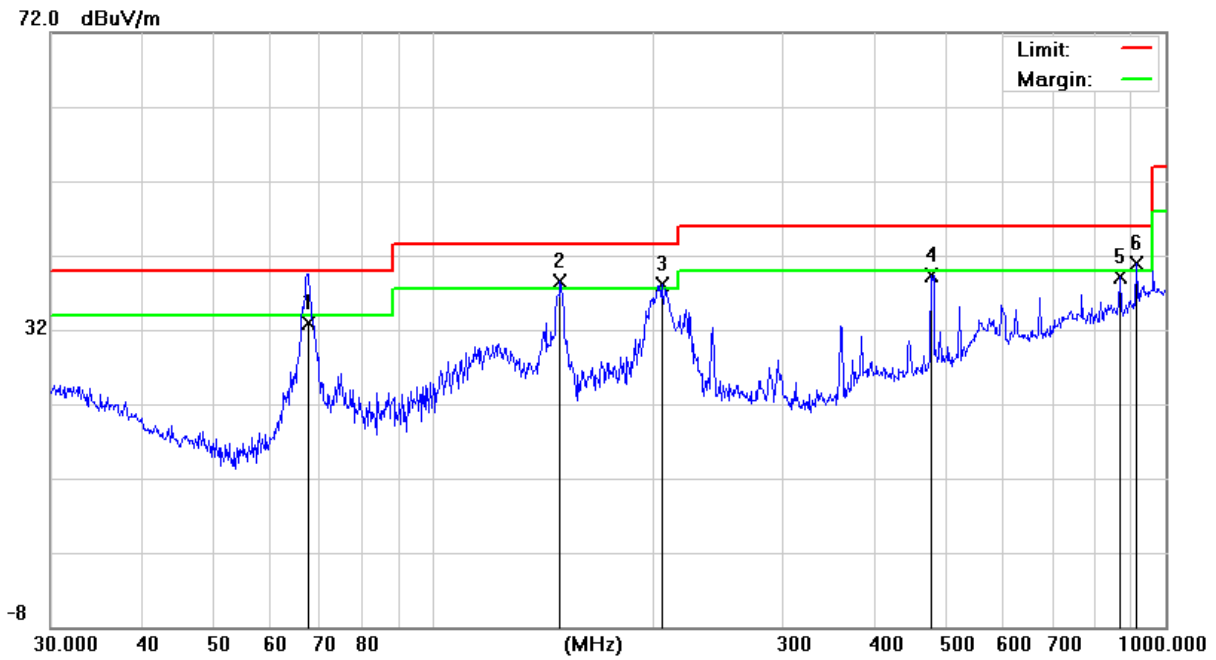

3.2.8 TEST RESULTS (1GHz-26GHz)

EUT :	PIQS Virtual Touch Projector	Model Name. :	Q1
Temperature :	20 °C	Relative Humidity :	48%
Pressure :	1010 hPa	Test Voltage :	DC 19V
Test Mode :	TX(5.2G)- 802.11ac20		

Polar	Frequency	Meter Reading	Cable loss	Antenna Factor	Preamp Factor	Emission Level	Limits	Margin
(H/V)	(MHz)	(dBuV)	(dB)	dB/m	(dB)	(dBuV/m)	(dBuV/m)	(dB)
Low Channel (5180 MHz)-Above 1G								
Vertical	3689.23	62.26	5.94	35.4	44	59.6	74	-14.4
Vertical	3689.23	43.42	5.94	35.4	44	40.76	54	-13.24
Vertical	10360.196	59.95	8.46	39.75	44.5	63.66	74	-10.34
Vertical	10360.196	42.23	8.46	39.75	44.5	45.94	54	-8.06
Vertical	15540.252	60.08	10.12	38.8	44.1	64.9	74	-9.1
Vertical	15540.252	38.92	10.12	38.8	42.7	45.14	54	-8.86
Horizontal	3689.216	65.62	5.94	35.18	44	62.74	74	-11.26
Horizontal	3689.216	45.41	5.94	35.18	44	42.53	54	-11.47
Horizontal	10360.259	58.92	8.46	38.71	44.5	61.59	74	-12.41
Horizontal	10360.259	41.19	8.46	38.71	44.5	43.86	54	-10.14
Horizontal	10540.344	57.75	10.12	38.38	44.1	62.15	74	-11.85
Horizontal	10540.344	38.56	10.12	38.38	44.1	42.96	54	-11.04
Middle Channel (5200 MHz)-Above 1G								
Vertical	5025.152	59.46	6.48	36.35	44.05	58.24	74	-15.76
Vertical	5025.152	41.85	6.48	36.35	44.05	40.63	54	-13.37
Vertical	10400.161	59.47	8.47	37.88	44.51	61.31	74	-12.69
Vertical	10400.161	43.35	8.47	37.88	44.51	45.19	54	-8.81
Vertical	15600.147	56.81	10.12	38.8	44.1	61.63	74	-12.37
Vertical	15600.147	39.17	10.12	38.8	42.7	45.39	54	-8.61
Horizontal	5025.138	59.53	6.48	36.37	44.05	58.33	74	-15.67
Horizontal	5025.138	42.55	6.48	36.37	44.05	41.35	54	-12.65
Horizontal	10400.166	58.92	8.47	38.64	44.5	61.53	74	-12.47
Horizontal	10400.166	41.19	8.47	38.64	44.5	43.8	54	-10.2
Horizontal	15600.331	59.49	10.12	38.38	44.1	63.89	74	-10.11
Horizontal	15600.331	38.55	10.12	38.38	44.1	42.95	54	-11.05
High Channel (5240 MHz)-Above 1G								
Vertical	4258.428	63.35	7.1	37.24	43.5	64.19	74	-9.81
Vertical	4258.428	45.59	7.1	37.24	43.5	46.43	54	-7.57
Vertical	10480.43	62.32	8.46	37.68	44.5	63.96	74	-10.04
Vertical	10480.43	39.1	8.46	37.68	44.5	40.74	54	-13.26
Vertical	15720.201	59.53	10.12	38.8	44.1	64.35	74	-9.65
Vertical	15720.201	38.59	10.12	38.8	42.7	44.81	54	-9.19
Horizontal	4258.416	62.26	7.1	37.24	43.5	63.1	74	-10.9
Horizontal	4258.416	41.16	7.1	37.24	43.5	42	54	-12
Horizontal	10481.13	58.92	8.46	38.57	44.5	61.45	74	-12.55
Horizontal	10481.13	42.58	8.46	38.57	44.5	45.11	54	-8.89
Horizontal	15720.203	59.51	10.12	38.38	44.1	63.91	74	-10.09
Horizontal	15720.203	41.25	10.12	38.38	44.1	45.65	54	-8.35

Note: "802.11ac20 (5G)" mode is the worst mode. PK value is lower than the Average value limit, So average didn't record.

The amplitude of spurious emissions that are attenuated by more than 20dB below the permissible value has no need to be reported.

Emission level (dBuV/m) = 20 log Emission level (uV/m).

Corrected Reading: Antenna Factor + Cable Loss + Read Level - Preamp Factor = Level.

EUT :	PIQS Virtual Touch Projector	Model Name. :	Q1
Temperature :	20 °C	Relative Humidity :	48%
Pressure :	1010 hPa	Test Voltage :	DC 19V
Test Mode :	TX (5.8G)- 802.11ac40		

Polar	Frequency	Meter Reading	Cable loss	Antenna Factor	Preamp Factor	Emission Level	Limits	Margin	Detector Type
(H/V)	(MHz)	(dBuV)	(dB)	dB/m	(dB)	(dBuV/m)	(dBuV/m)	(dB)	
Low Channel (5755 MHz)-Above 1G									
Vertical	4566.322	62.86	5.94	35.40	44.00	60.20	74.00	-13.80	Pk
Vertical	4566.322	45.04	5.94	35.40	44.00	42.38	54.00	-11.62	AV
Vertical	11490.265	59.68	8.46	39.75	44.50	63.39	74.00	-10.61	Pk
Vertical	11490.265	41.16	8.46	39.75	44.50	44.87	54.00	-9.13	AV
Vertical	17235.335	60.68	10.12	38.80	44.10	65.50	74.00	-8.50	Pk
Vertical	17235.335	38.43	10.12	38.80	42.70	44.65	54.00	-9.35	AV
Horizontal	4566.256	58.87	5.94	35.18	44.00	55.99	74.00	-18.01	Pk
Horizontal	4566.256	41.36	5.94	35.18	44.00	38.48	54.00	-15.52	AV
Horizontal	11490.128	55.12	8.46	38.71	44.50	57.79	74.00	-16.21	Pk
Horizontal	11490.128	39.68	8.46	38.71	44.50	42.35	54.00	-11.65	AV
Horizontal	17235.069	60.82	10.12	38.38	44.10	65.22	74.00	-8.78	Pk
Horizontal	17235.069	38.56	10.12	38.38	44.10	42.96	54.00	-11.04	AV
High Channel (5795 MHz)-Above 1G									
Vertical	5320.447	60.68	7.10	37.24	43.50	61.52	74.00	-12.48	Pk
Vertical	5320.447	42.10	7.10	37.24	43.50	42.94	54.00	-11.06	AV
Vertical	11650.421	59.95	8.46	37.68	44.50	61.59	74.00	-12.41	Pk
Vertical	11650.421	41.71	8.46	37.68	44.50	43.35	54.00	-10.65	AV
Vertical	17475.512	58.43	10.12	38.80	44.10	63.25	74.00	-10.75	Pk
Vertical	17475.512	38.56	10.12	38.80	42.70	44.78	54.00	-9.22	AV
Horizontal	5320.389	61.82	7.10	37.24	43.50	62.66	74.00	-11.34	Pk
Horizontal	5320.389	41.71	7.10	37.24	43.50	42.55	54.00	-11.45	AV
Horizontal	11650.711	60.03	8.46	38.57	44.50	62.56	74.00	-11.44	Pk
Horizontal	11650.711	41.74	8.46	38.57	44.50	44.27	54.00	-9.73	AV
Horizontal	17475.522	59.01	10.12	38.38	44.10	63.41	74.00	-10.59	Pk
Horizontal	17475.522	39.58	10.12	38.38	44.10	43.98	54.00	-10.02	AV

Note:"802.11ac40 (5G)" mode is the worst mode. PK value is lower than the Average value limit, So average didn't record.

The amplitude of spurious emissions that are attenuated by more than 20dB below the permissible value has no need to be reported.

Emission level (dBuV/m) = 20 log Emission level (uV/m).

Corrected Reading: Antenna Factor + Cable Loss + Read Level - Preamp Factor = Level.

3.2.9 TEST RESULTS (26.5GHZ-40GHZ)

EUT :	PIQS Virtual Touch Projector	Model Name. :	Q1
Temperature :	20 °C	Relative Humidity :	48%
Pressure :	1010 hPa	Test Voltage :	DC 19V
Test Mode :	TX (5.2G)-802.11ac20 5180MHz~5240MHz , TX (5.8G)-802.11ac40 5755MHz~5795MHz		

All the modulation modes have been tested, and the worst result was report as below:

Low Channel (5180 MHz)-Above 1G

Horizontal

FCC Electric Field Strength 26.5-40GHz

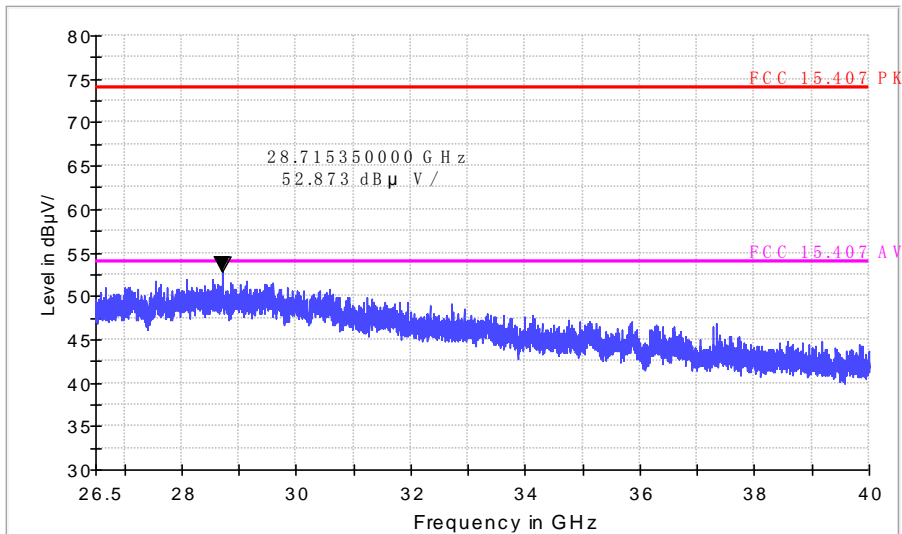

Vertical

FCC Electric Field Strength 26.5-40GHz

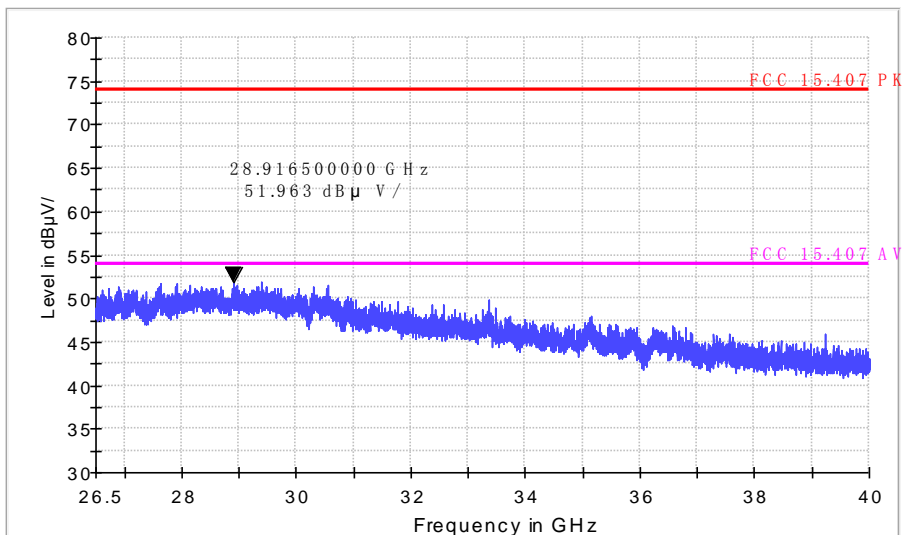

High Channel (5240 MHz)-Above 1G

Horizontal

FCC Electric Field Strength 26.5-40GHz

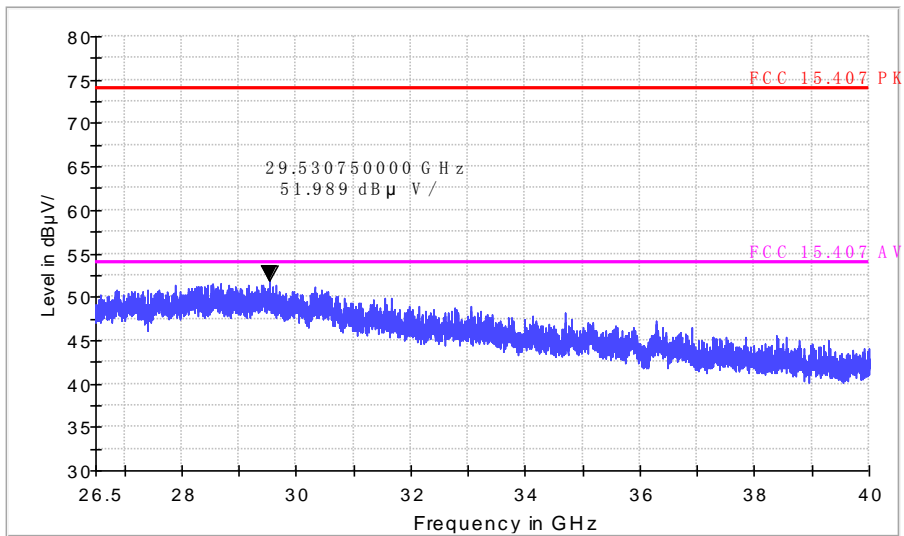

Vertical

FCC Electric Field Strength 26.5-40GHz

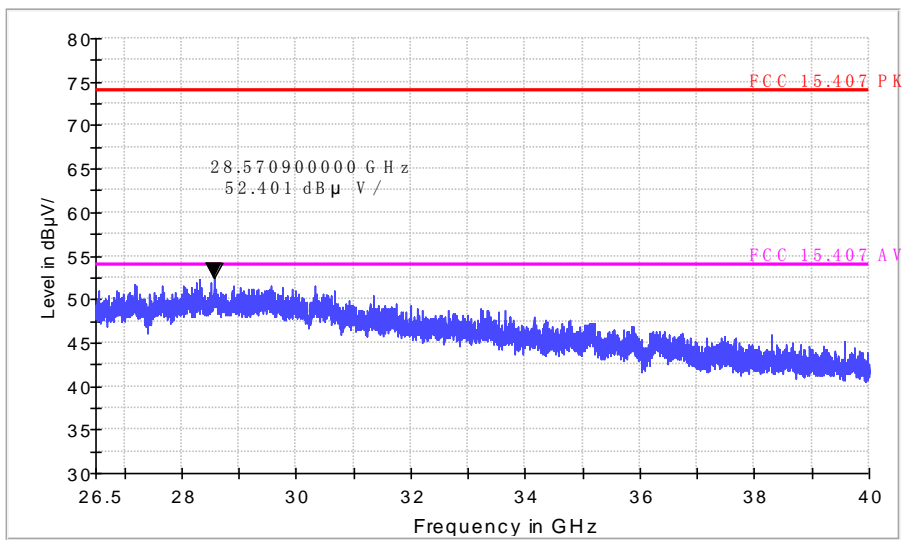

Low Channel (5755 MHz)-Above 1G

Horizontal

FCC Electric Field Strength 26.5-40GHz

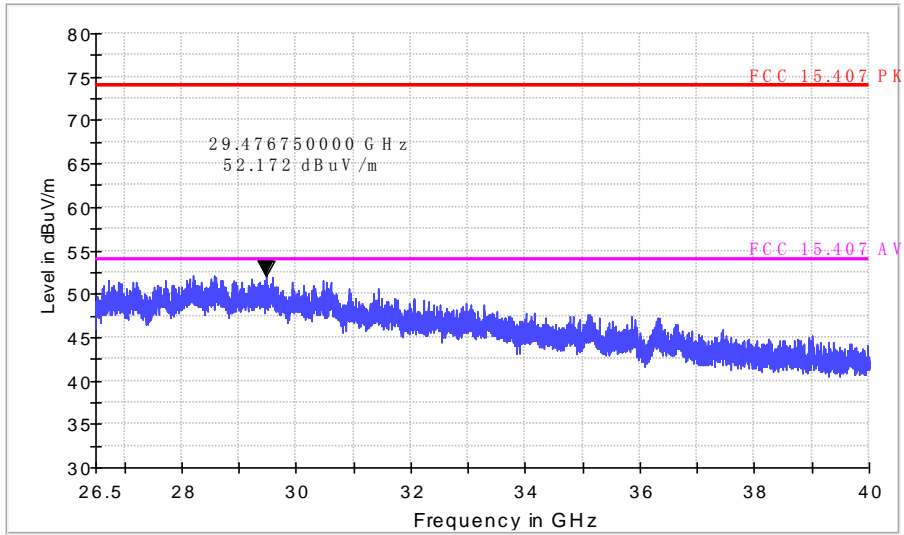

Vertical

FCC Electric Field Strength 26.5-40GHz

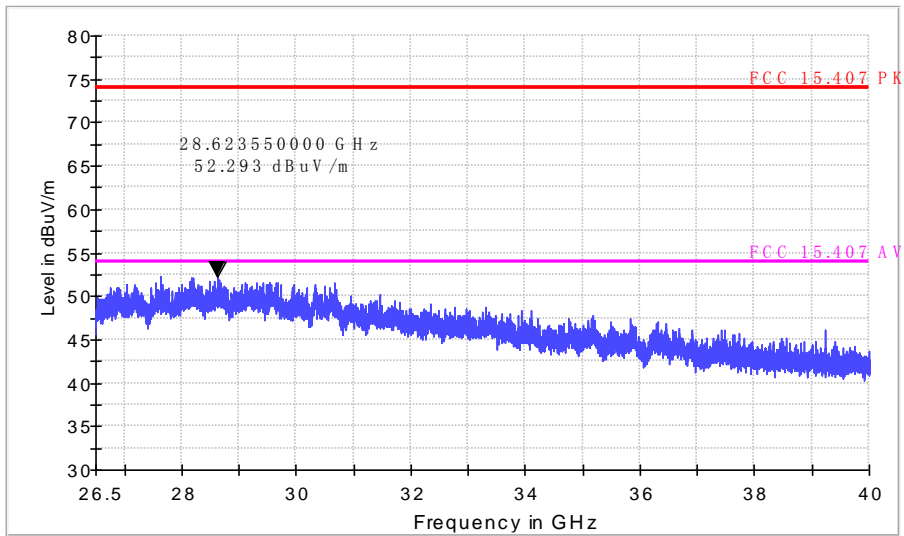

High Channel (5795 MHz)-Above 1G

Horizontal

FCC Electric Field Strength 26.5-40GHz

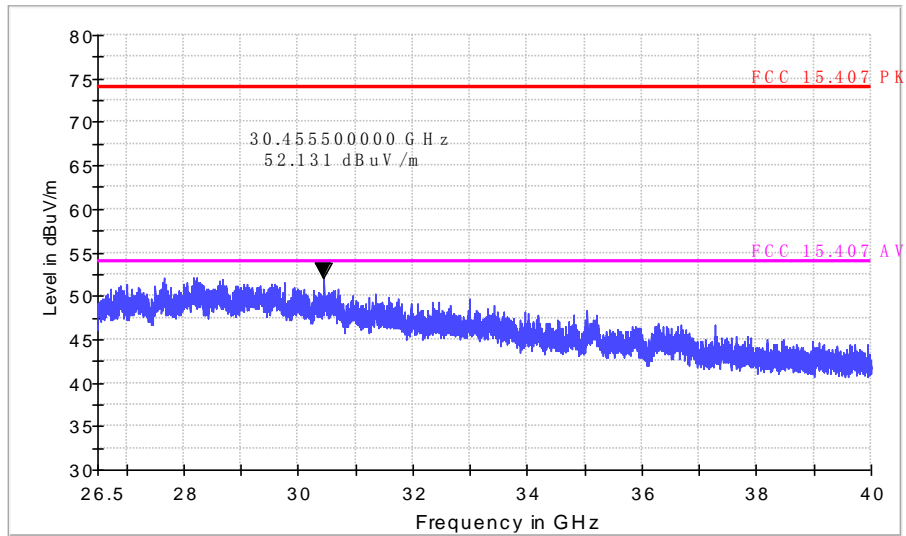

Vertical

FCC Electric Field Strength 26.5-40GHz

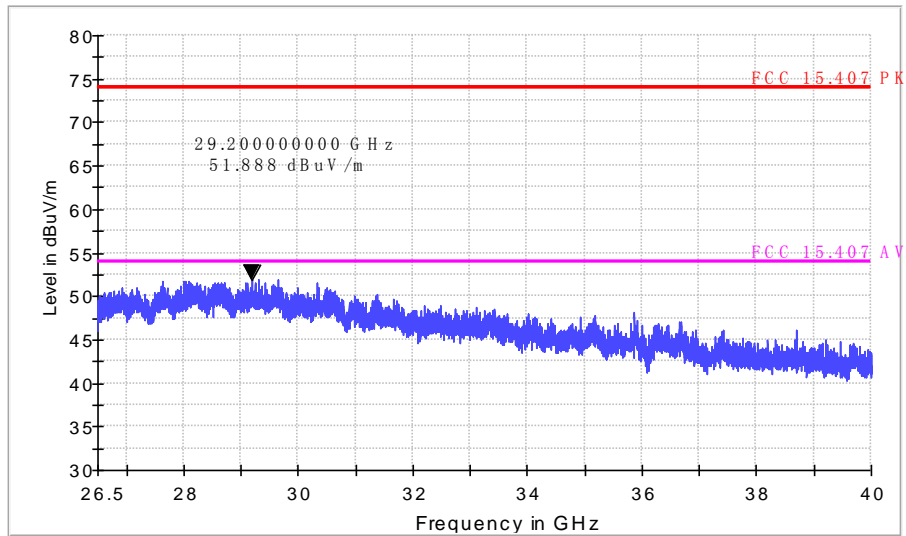

4. POWER SPECTRAL DENSITY TEST

4.1 APPLIED PROCEDURES / LIMIT

According to FCC §15.407(a)(3)

For the band 5.15-5.25 GHz,

(i) For an outdoor access point operating in the band 5.15-5.25 GHz, the maximum power spectral density shall not exceed 17 dBm in any 1 megahertz band. If transmitting antennas of directional gain greater than 6 dBi are used, both the maximum conducted output power and the maximum power spectral density shall be reduced by the amount in dB that the directional gain of the antenna exceeds 6 dBi. The maximum e.i.r.p. at any elevation angle above 30 degrees as measured from the horizon must not exceed 125 mW (21 dBm).

(ii) For an indoor access point operating in the band 5.15-5.25 GHz, the maximum power spectral density shall not exceed 17 dBm in any 1 megahertz band. If transmitting antennas of directional gain greater than 6 dBi are used, both the maximum conducted output power and the maximum power spectral density shall be reduced by the amount in dB that the directional gain of the antenna exceeds 6 dBi.

(iii) For fixed point-to-point access points operating in the band 5.15-5.25 GHz, the maximum power spectral density shall not exceed 17 dBm in any 1 megahertz band. Fixed point-to-point U-NII devices may employ antennas with directional gain up to 23 dBi without any corresponding reduction in the maximum conducted output power or maximum power spectral density. For fixed point-to-point transmitters that employ a directional antenna gain greater than 23 dBi, a 1 dB reduction in maximum conducted output power and maximum power spectral density is required for each 1 dB of antenna gain in excess of 23 dBi. Fixed, point-to-point operations exclude the use of point-to-multipoint systems, omnidirectional applications, and multiple collocated transmitters transmitting the same information. The operator of the U-NII device, or if the equipment is professionally installed, the installer, is responsible for ensuring that systems employing high gain directional antennas are used exclusively for fixed, point-to-point operations.

(iv) For client devices in the 5.15-5.25 GHz band, the maximum power spectral density shall not exceed 11 dBm in any 1 megahertz band. If transmitting antennas of directional gain greater than 6 dBi are used, both the maximum conducted output power and the maximum power spectral density shall be reduced by the amount in dB that the directional gain of the antenna exceeds 6 dBi.

For the band 5.725-5.85 GHz

(3) For the band 5.725-5.85 GHz, the maximum power spectral density shall not exceed 30 dBm in any 500-kHz band. If transmitting antennas of directional gain greater than 6 dBi are used, both the maximum conducted output power and the maximum power spectral density shall be reduced by the amount in dB that the directional gain of the antenna exceeds 6 dBi.

,

4.2 TEST PROCEDURE

For devices operating in the bands 5.15-5.25 GHz, 5.25-5.35 GHz, and 5.47-5.725 GHz, the above procedures make use of 1 MHz RBW to satisfy directly the 1 MHz reference bandwidth specified in § 15.407(a)(5). For devices operating in the band 5.725-5.85 GHz, the rules specify a measurement bandwidth of 500 kHz. Many spectrum analyzers do not have 500 kHz RBW, thus a narrower RBW may need to be used. The rules permit the use of a RBWs less than 1 MHz, or 500 kHz, “provided that the measured power is integrated over the full reference bandwidth” to show the total power over the specified measurement bandwidth (i.e., 1 MHz, or 500 kHz). If measurements are performed using a reduced resolution bandwidth (< 1 MHz, or < 500 kHz) and integrated over 1 MHz, or 500 KHz bandwidth, the following adjustments to the procedures apply:

- a) Set $RBW \geq 1/T$, where T is defined in section II.B.I.a).
- b) Set $VBW \geq 3 RBW$.
- c) If measurement bandwidth of Maximum PSD is specified in 500 kHz, add $10\log(500\text{kHz}/RBW)$ to the measured result, whereas $RBW (< 500 \text{ KHz})$ is the reduced resolution bandwidth of the spectrum analyzer set during measurement.
- d) If measurement bandwidth of Maximum PSD is specified in 1 MHz, add $10\log(1\text{MHz}/RBW)$ to the measured result, whereas $RBW (< 1 \text{ MHz})$ is the reduced resolution bandwidth of spectrum analyzer set during measurement.
- e) Care must be taken to ensure that the measurements are performed during a period of continuous transmission or are corrected upward for duty cycle.

Note: As a practical matter, it is recommended to use reduced RBW of 100 KHz for the sections 5.c) and 5.d) above, since $RBW=100 \text{ KHz}$ is available on nearly all spectrum analyzers.

4.3 DEVIATION FROM STANDARD

No deviation.

4.4 TEST SETUP

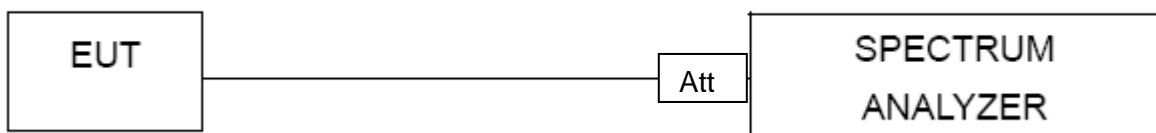

4.5 EUT OPERATION CONDITIONS

The EUT tested system was configured as the statements of 2.1 Unless otherwise a special operating condition is specified in the follows during the testing.

4.6 TEST RESULTS

EUT :	PIQS Virtual Touch Projector	Model Name. :	Q1
Temperature :	25 °C	Relative Humidity :	56%
Pressure :	1015 hPa	Test Voltage :	DC 19V
Test Mode :	TX Frequency Band I (5150-5250MHz)		

Note: A(B) Represent the value of antenna A and B, The worst data is Antenna B, only shown Antenna B Plot.

EUT has two antennas, and different modes support different transmit mode what describe as Following form:

Mode	Tx/Rx
802.11a	1Tx, 2Rx
802.11n/ac	1Tx /2Tx, 2Rx

Mode	Frequency	Measured Power Density (dBm)		Total power density (dBm)	Calculate power density (dBm)(Note 1)		Limit (dBm)	Result
		ANT A	ANT B		ANT A	ANT B		
802.11 a	5185 MHz	0.77	-0.01	-	0.77	-0.01	11	PASS
	5200 MHz	0.96	0.26	-	0.96	0.26	11	PASS
	5240 MHz	1.19	0.07	-	1.19	0.07	11	PASS
802.11 n20	5185 MHz	0.59	-0.37	3.15	3.15		11	PASS
	5200 MHz	0.15	0.15	3.16	3.16		11	PASS
	5240 MHz	0.72	1.77	4.29	4.29		11	PASS
802.11 n40	5190 MHz	-2.05	-3.64	0.24	0.24		11	PASS
	5230 MHz	-2.77	-3.67	-0.19	-0.19		11	PASS
802.11 ac20	5185 MHz	0.95	-0.62	3.25	3.25		11	PASS
	5200 MHz	0.67	0.30	3.50	3.50		11	PASS
	5240 MHz	0.43	0.36	3.41	3.41		11	PASS
802.11 ac40	5190 MHz	-2.63	-3.02	0.19	0.19		11	PASS
	5230 MHz	-3.00	-2.83	0.10	0.10		11	PASS
802.11 ac80	5210 MHz	-6.97	-7.02	-3.98	-3.98		11	PASS

Note: 1. Calculate power density= Measured Power Density+10log(1MHz/RBW)

RBW=1MHz

2. For 802.11n/ac 5GHz has MIMO mode. Directional gain=5.01dbi
 5.01dbi < 6.0 dbi so power density limit= 11dBm/MHz

(802.11a) PSD plot on channel 36

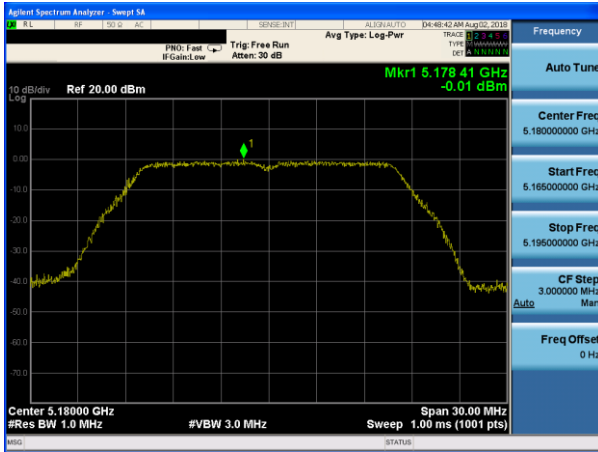

(802.11n20) PSD plot on channel 36

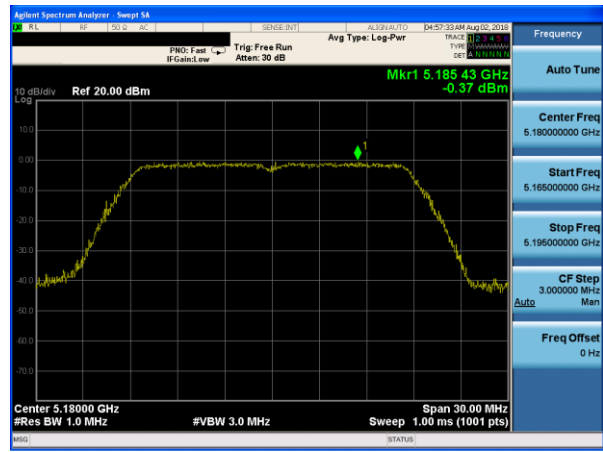

(802.11a) PSD plot on channel 40

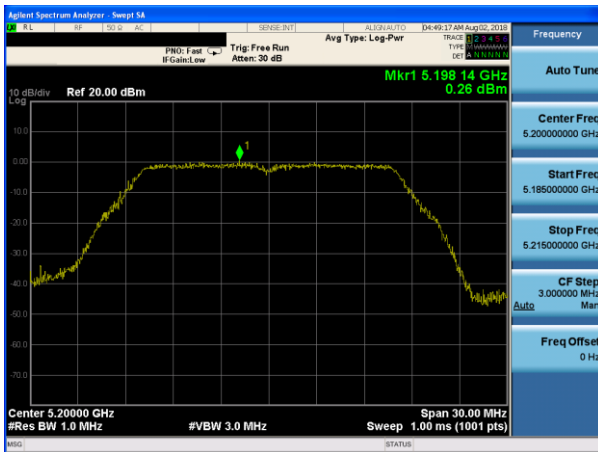

(802.11n20) PSD plot on channel 40

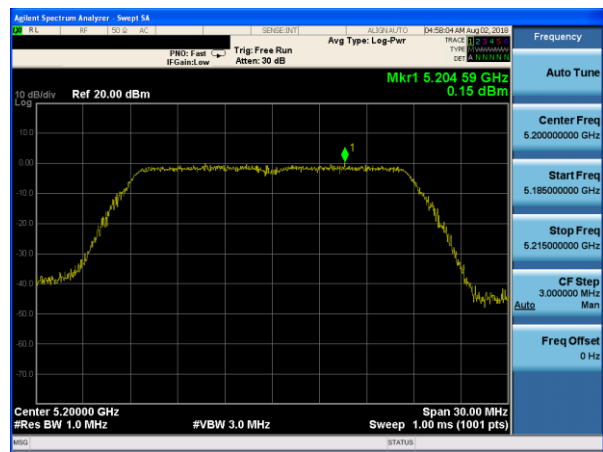

(802.11a) PSD plot on channel 48

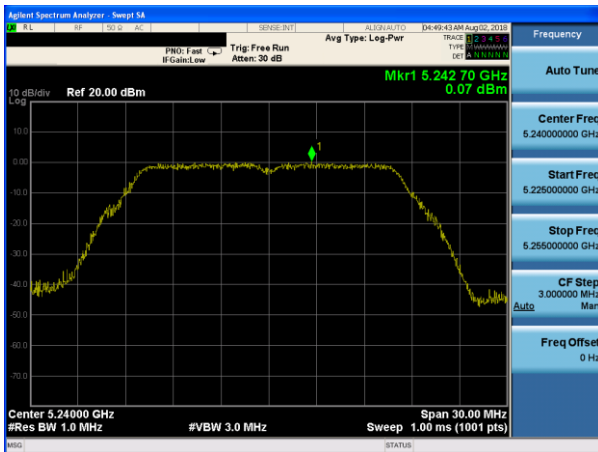

(802.11n20) PSD plot on channel 48

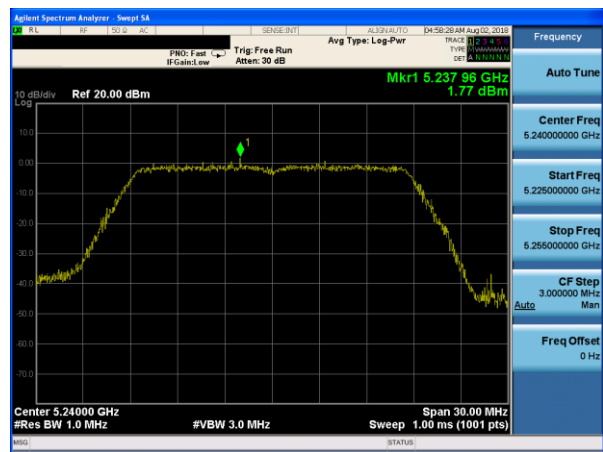

(802.11n40) PSD plot on channel 38

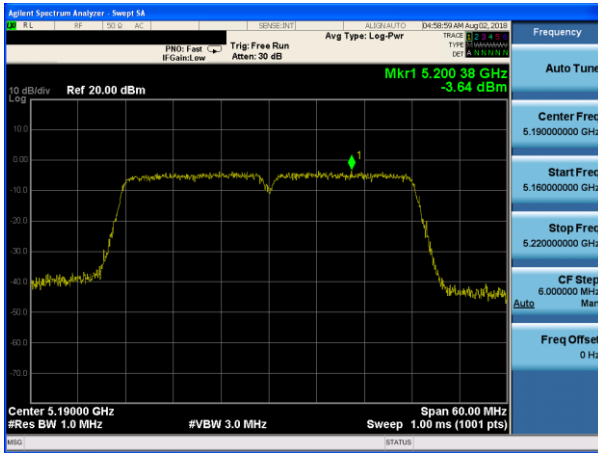

(802.11ac20) PSD plot on channel 36

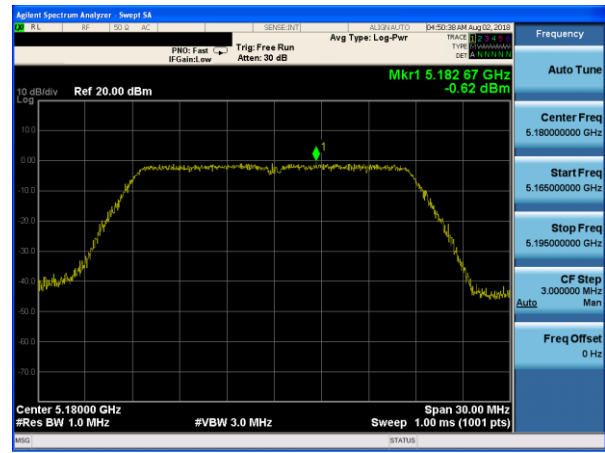

(802.11n40) PSD plot on channel 46

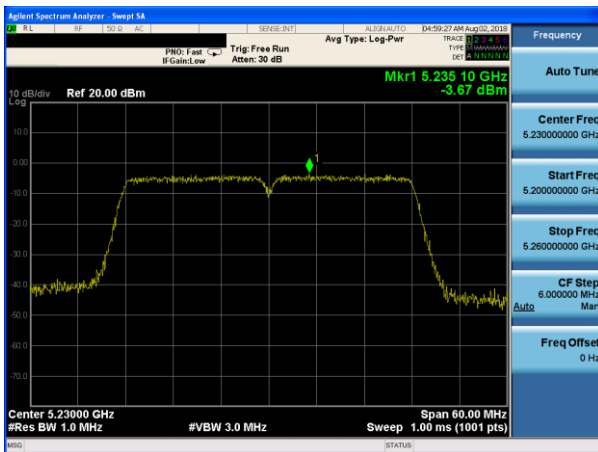

(802.11ac20) PSD plot on channel 40

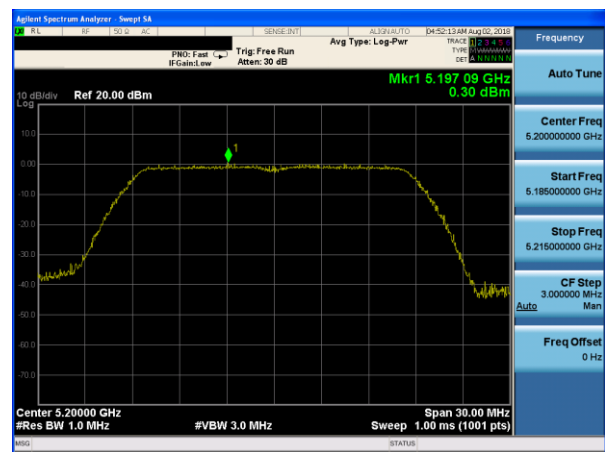

(802.11ac20) PSD plot on channel 48

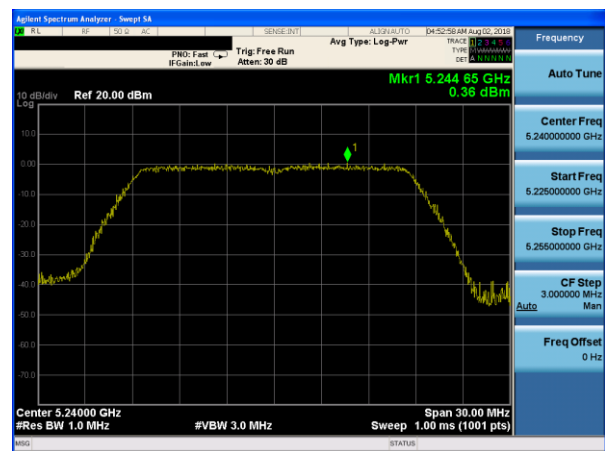

(802.11ac40) PSD plot on channel 38

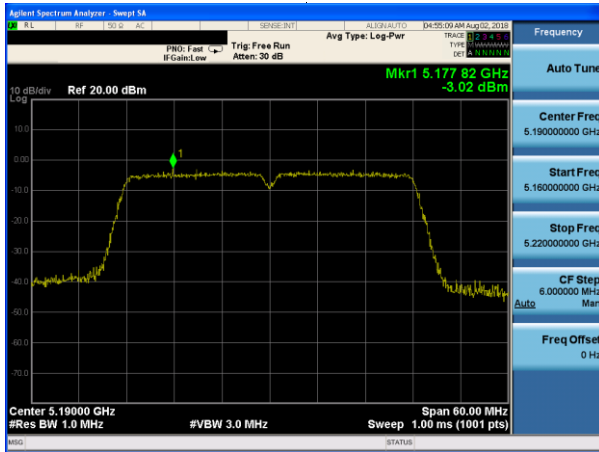

(802.11ac80) PSD plot on channel 42

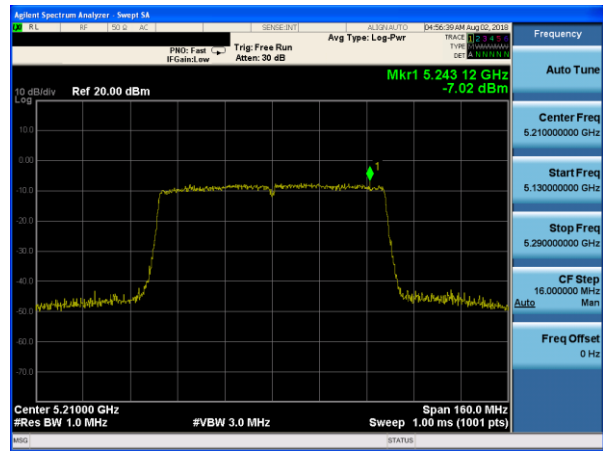

(802.11ac40) PSD plot on channel 46

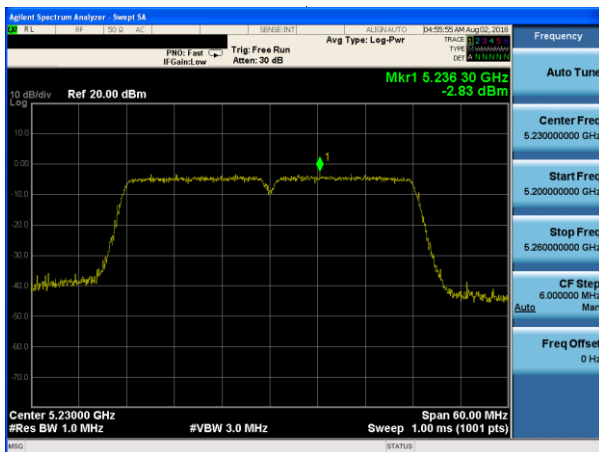

EUT :	PIQS Virtual Touch Projector	Model Name. :	Q1
Temperature :	25 °C	Relative Humidity :	56%
Pressure :	1015 hPa	Test Voltage :	DC 19V
Test Mode :	TX Frequency Band IV (5745-5825MHz)		

Note: A(B) Represent the value of antenna A and B, The worst data is Antenna A, only shown Antenna A Plot.

EUT has two antennas, and different modes support different transmit mode what describe as Following form:

Mode	Tx/Rx
802.11a	1Tx, 2Rx
802.11n/ac	1Tx /2Tx, 2Rx

Mode	Frequency	Measured Power Density (dBm)		Total power density (dBm)	Calculate power density (dBm)(Note 1)		Limit (dBm)	Result
		ANT A	ANT B		ANT A	ANT B		
802.11 a	5745 MHz	-1.83	-3.04	-	-1.92	-3.13	30	PASS
	5785 MHz	-2.70	-4.18	-	-2.79	-4.27	30	PASS
	5825 MHz	-3.93	-3.16	-	-4.02	-3.25	30	PASS
802.11 n20	5745 MHz	-1.55	-3.11	0.75	0.66		30	PASS
	5785 MHz	-2.62	-3.64	-0.09	-0.18		30	PASS
	5825 MHz	-4.08	-2.84	-0.41	-0.50		30	PASS
802.11 n40	5755 MHz	-3.43	-4.80	-1.05	-1.14		30	PASS
	5795 MHz	-4.29	-6.22	-2.14	-2.23		30	PASS
802.11 ac20	5745 MHz	-1.04	-3.56	0.89	0.80		30	PASS
	5785 MHz	-2.01	-3.87	0.17	0.08		30	PASS
	5825 MHz	-4.33	-3.18	-0.71	-0.80		30	PASS
802.11 ac40	5755 MHz	-3.44	-5.18	-1.21	-1.30		30	PASS
	5795 MHz	-4.46	-5.59	-1.98	-2.07		30	PASS
802.11 ac80	5775 MHz	-7.48	-8.94	-5.14	-5.23		30	PASS

Note:

- (1) Calculate power density= Measured Power Density+10log(500kHz/RBW)
RBW=0.51MHz
- (2) For 802.11n/ac 5GHz has MIMO mode. Directional gain=5.01dbi

5.01 dbi < 6.0 dbi so power density limit= 30

(802.11a) PSD plot on channel 149

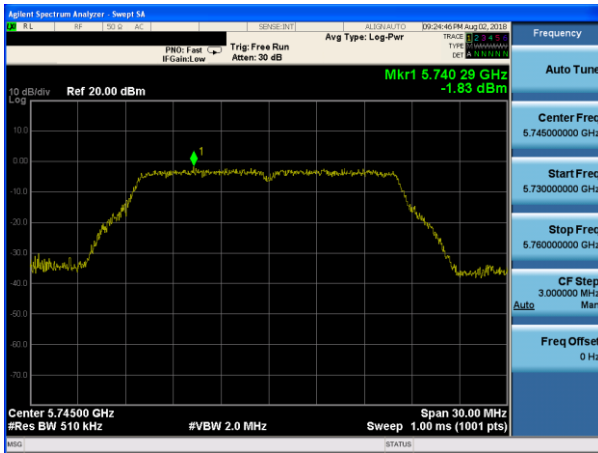

(802.11n20) PSD plot on channel 149

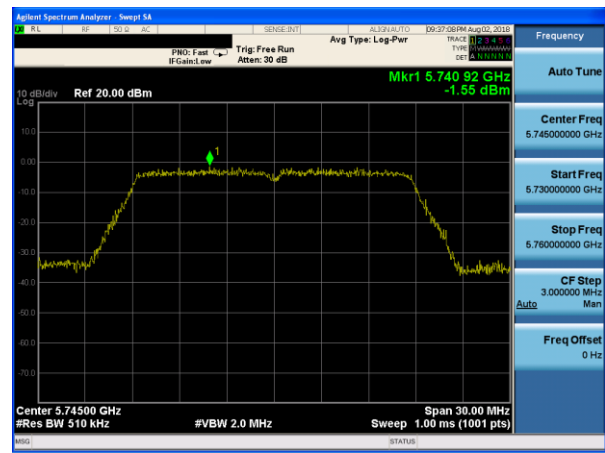

(802.11a) PSD plot on channel 157

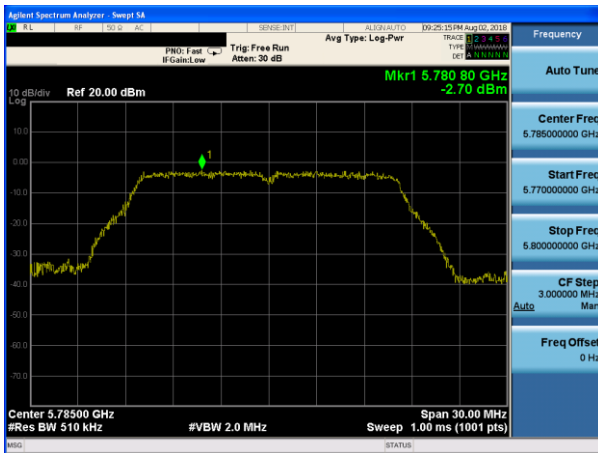

(802.11n20) PSD plot on channel 157

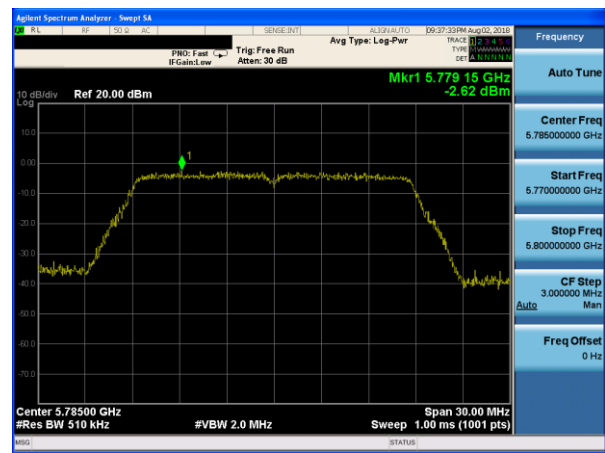

(802.11a) PSD plot on channel 165

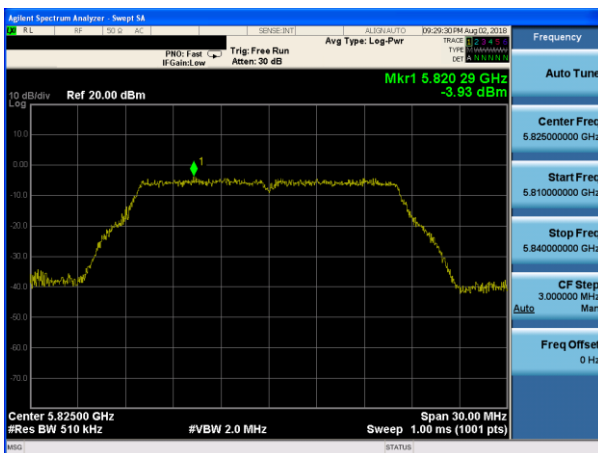

(802.11n20) PSD plot on channel 165

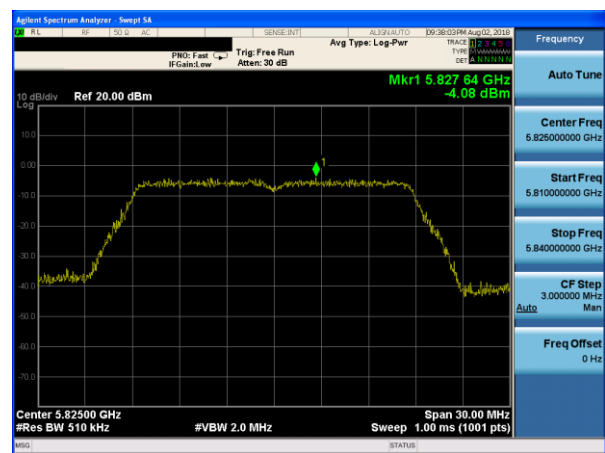

(802.11n40) PSD plot on channel 151

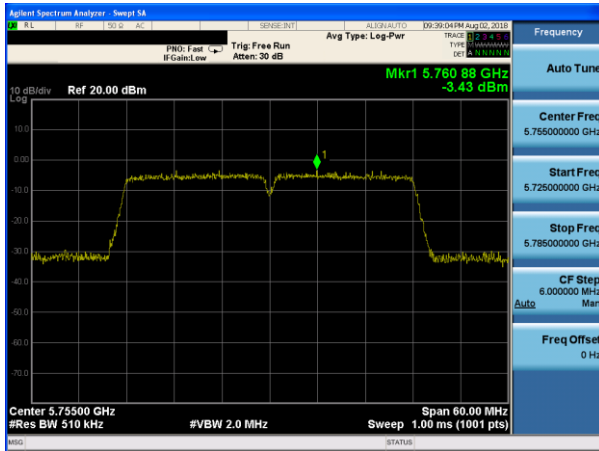

(802.11ac20) PSD plot on channel 149

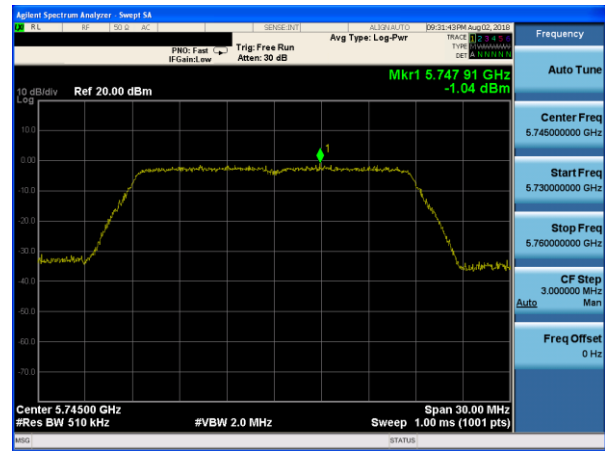

(802.11n40) PSD plot on channel 159

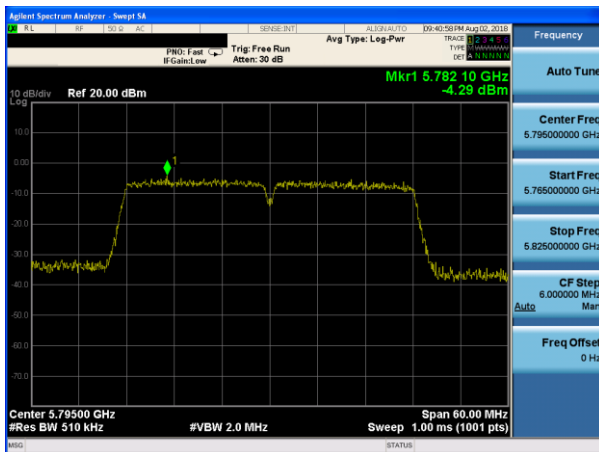

(802.11ac20) PSD plot on channel 157

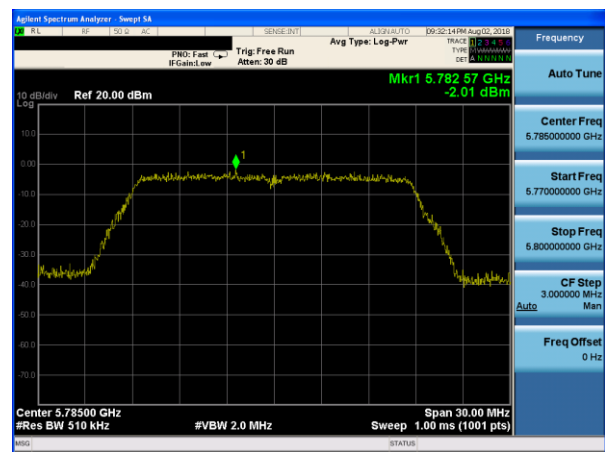

(802.11ac20) PSD plot on channel 165

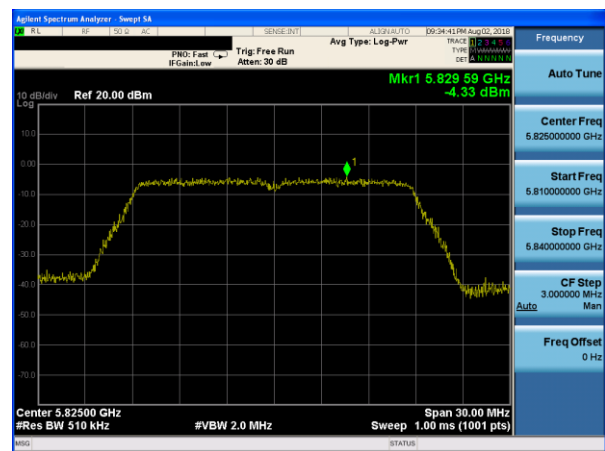

(802.11ac40) PSD plot on channel 151

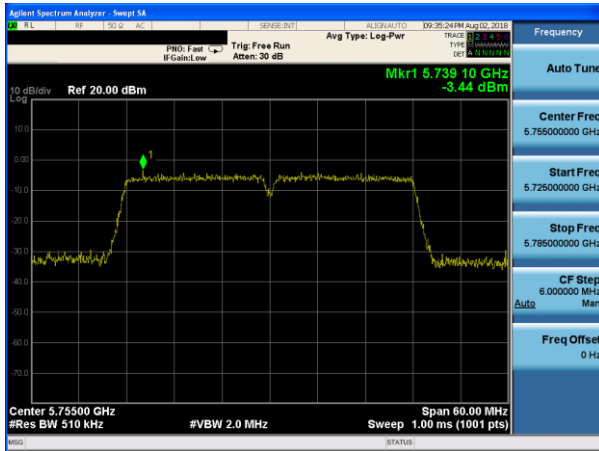

(802.11ac80) PSD plot on channel 155

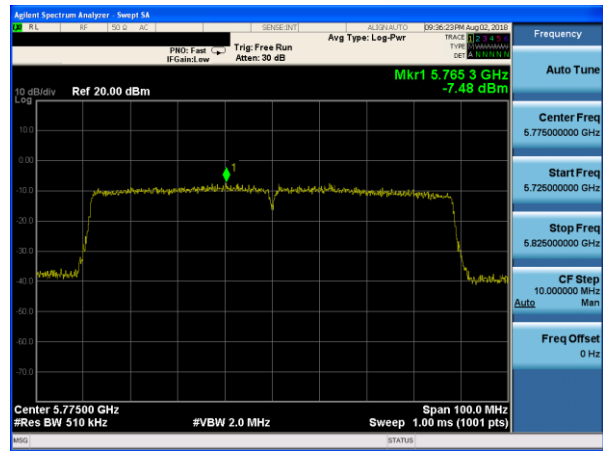

(802.11ac40) PSD plot on channel 159

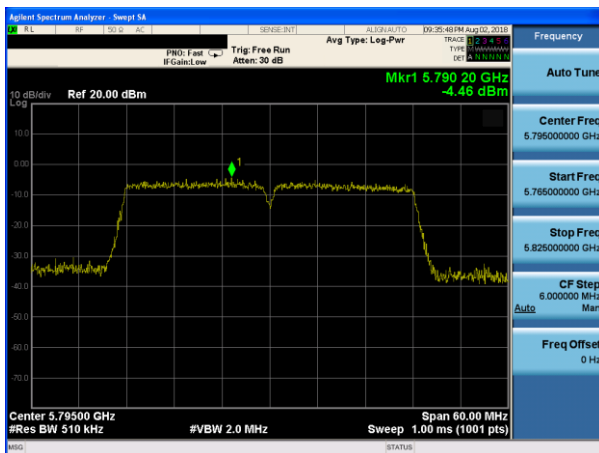

5. 26DB & 99% EMISSION BANDWIDTH

5.1 APPLIED PROCEDURES / LIMIT

The maximum power spectral density is measured as a conducted emission by direct connection of a calibrated test instrument to the equipment under test. If the device cannot be connected directly, alternative techniques acceptable to the Commission may be used. Measurements in the 5.725-5.85 GHz band are made over a reference bandwidth of 500 kHz or the 26 dB emission bandwidth of the device, whichever is less. Measurements in the 5.15-5.25 GHz, 5.25-5.35 GHz, and the 5.47-5.725 GHz bands are made over a bandwidth of 1 MHz or the 26 dB emission bandwidth of the device, whichever is less. A narrower resolution bandwidth can be used, provided that the measured power is integrated over the full reference bandwidth.

5.2 TEST PROCEDURE

- a) Set RBW = approximately 1% of the emission bandwidth.
- b) Set the VBW > RBW.
- c) Detector = Peak.
- d) Trace mode = max hold.
- e) Measure the maximum width of the emission that is 26 dB down from the maximum of the emission. Compare this with the RBW setting of the analyzer. Readjust RBW and repeat measurement as needed until the RBW/EBW ratio is approximately 1%.

The following procedure shall be used for measuring (99 %) power bandwidth:

1. Set center frequency to the nominal EUT channel center frequency.
2. Set span = 1.5 times to 5.0 times the OBW.
3. Set RBW = 1 % to 5 % of the OBW
4. Set VBW $\geq 3 \cdot$ RBW
5. Video averaging is not permitted. Where practical, a sample detection and single sweep mode shall be used. Otherwise, peak detection and max hold mode (until the trace stabilizes) shall be used.
6. Use the 99 % power bandwidth function of the instrument (if available).
7. If the instrument does not have a 99 % power bandwidth function, the trace data points are recovered and directly summed in power units. The recovered amplitude data points, beginning at the lowest frequency, are placed in a running sum until 0.5 % of the total is reached; that frequency is recorded as the lower frequency. The process is repeated until 99.5 % of the total is reached; that frequency is recorded as the upper frequency. The 99% occupied bandwidth is the difference between these two frequencies.

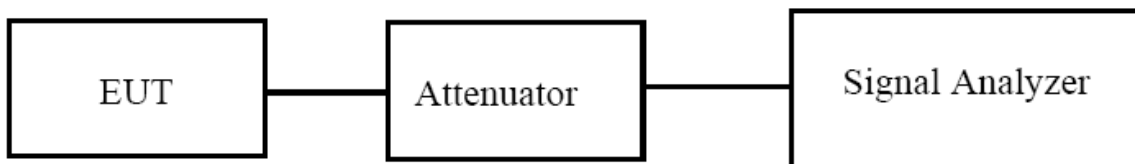

5.3 EUT OPERATION CONDITIONS

The EUT tested system was configured as the statements of 2.4 Unless otherwise a special operating condition is specified in the follows during the testing.

5.4 TEST RESULTS

EUT :	PIQS Virtual Touch Projector	Model Name. :	Q1
Temperature :	25 °C	Relative Humidity :	56%
Pressure :	1012 hPa	Test Voltage :	DC 19V
Test Mode :	TX Frequency Band I (5150-5250MHz)		

Note: A(B) Represent the value of antenna A and B, The worst data is Antenna B, only shown Antenna B Plot.

EUT has two antennas, and different modes support different transmit mode what describe as Following form:

Mode	Tx/Rx
802.11a	1Tx, 2Rx
802.11n/ac	1Tx /2Tx, 2Rx

Mode	Channel	Frequency (MHz)	99% bandwidth(MHz)	99% bandwidth(MHz)	26dB bandwidth (MHz)	26dB bandwidth (MHz)	Result
			Antenna A	Antenna B	Antenna A	Antenna B	
802.11a	CH36	5180	17.130	17.100	21.79	21.92	Pass
	CH40	5200	17.104	17.131	21.68	21.79	Pass
	CH48	5240	17.078	17.058	21.81	21.89	Pass
802.11 n20	CH36	5180	18.136	18.185	22.15	21.85	Pass
	CH40	5200	18.180	18.140	22.10	21.86	Pass
	CH48	5240	18.178	18.165	21.98	22.04	Pass
802.11 n40	CH 38	5190	36.493	36.485	40.39	40.34	Pass
	CH 46	5230	36.435	36.523	40.19	40.43	Pass
802.11 ac20	CH36	5180	18.176	18.194	22.18	21.97	Pass
	CH40	5200	18.152	18.210	21.89	22.06	Pass
	CH48	5240	18.240	18.186	22.18	21.94	Pass
802.11 ac40	CH 38	5190	36.447	36.500	40.28	40.68	Pass
	CH 46	5230	36.450	36.465	40.69	40.31	Pass
802.11 ac80	CH 42	5210	75.780	75.840	81.74	82.00	Pass

Test plot

(802.11a) -26dB&99%Bandwidth plot on channel 36

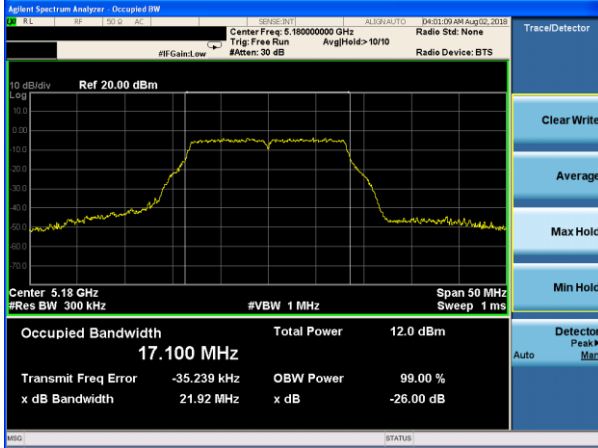

(802.11 n20) -26dB&99%Bandwidth plot on channel 36

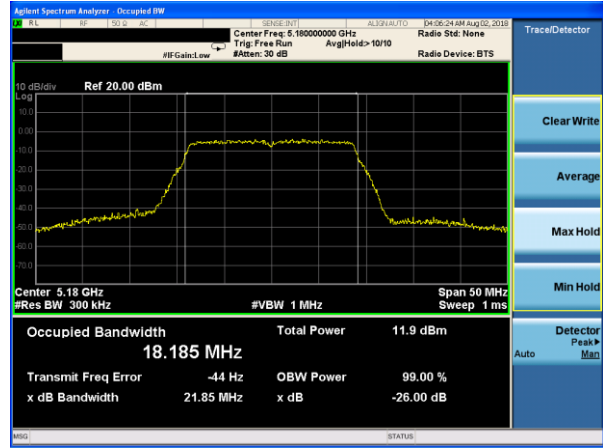

(802.11a) -26dB&99%Bandwidth plot on channel 40

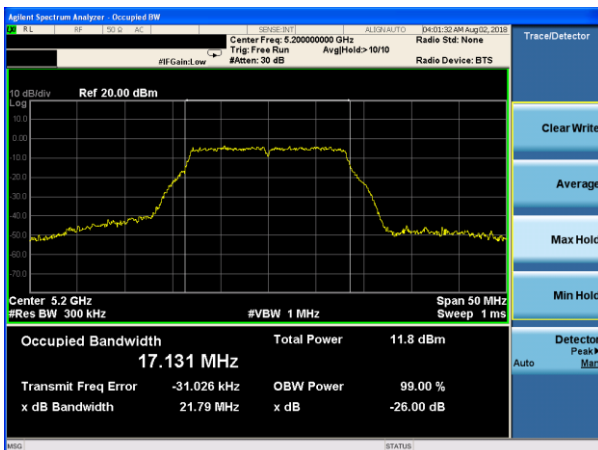

(802.11 n20) -26dB&99%Bandwidth plot on channel 40

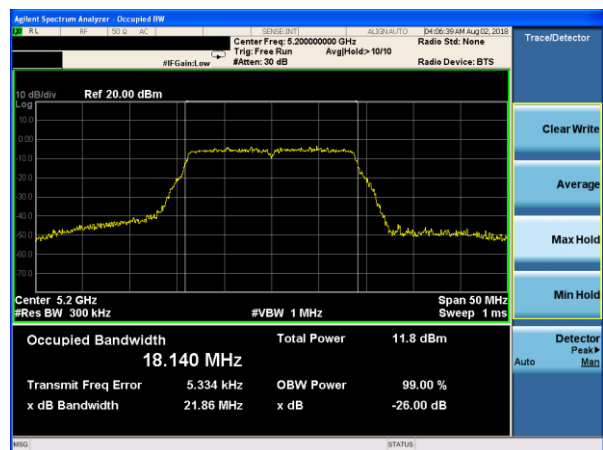

(802.11a) -26dB&99%Bandwidth plot on channel 48

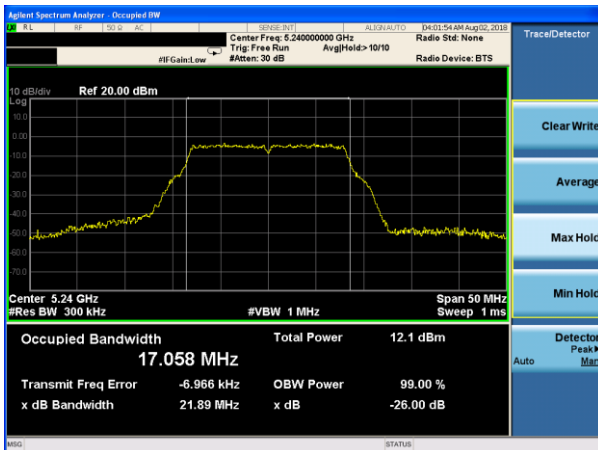

(802.11 n20) -26dB&99%Bandwidth plot on channel 48

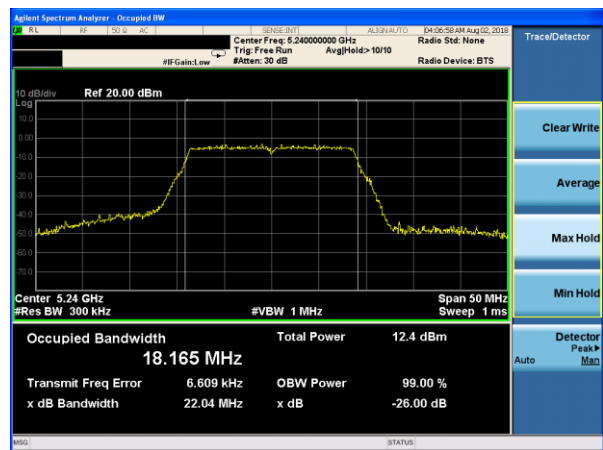

Test plot

(802.11 n40) -26dB&99%Bandwidth plot on channel 38

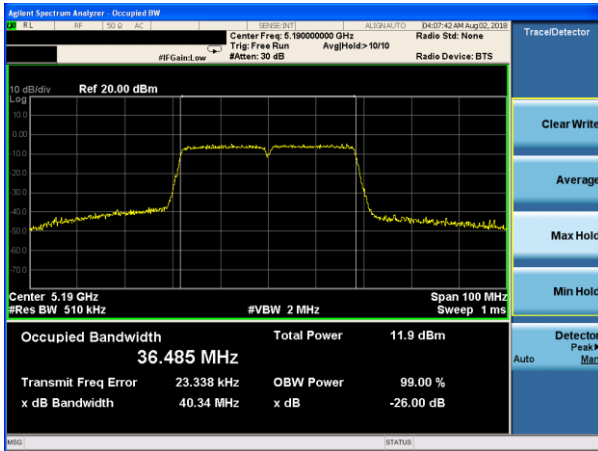

(802.11 ac20) -26dB&99%Bandwidth plot on channel 36

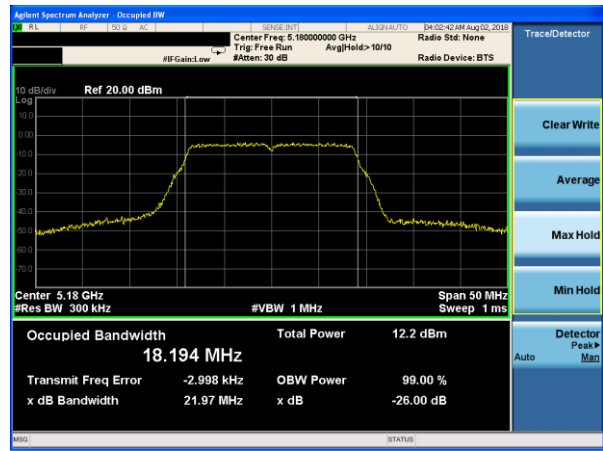

(802.11 n40) -26dB&99%Bandwidth plot on channel 46

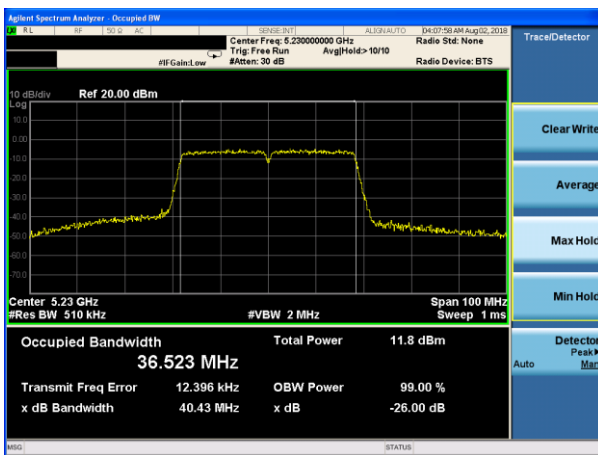

(802.11 ac20) -26dB&99%Bandwidth plot on channel 40

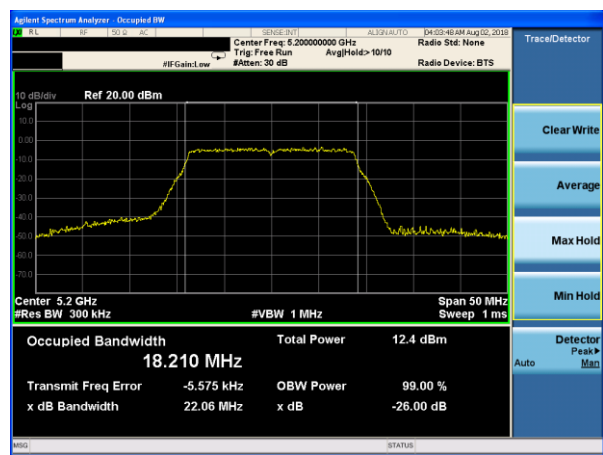

(802.11 ac20) -26dB&99%Bandwidth plot on channel 48

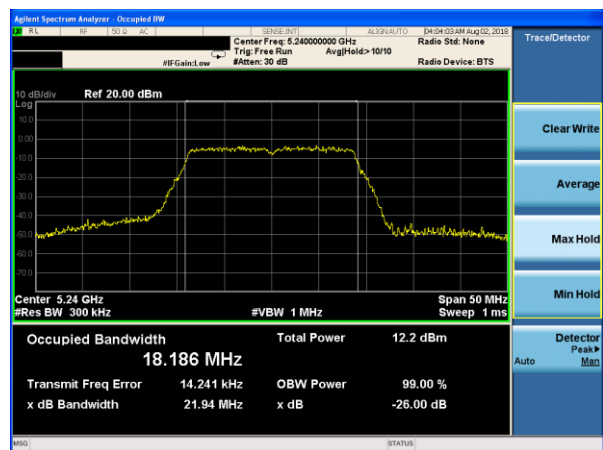

Test plot

(802.11 ac40) -26dB&99%Bandwidth plot on channel 38

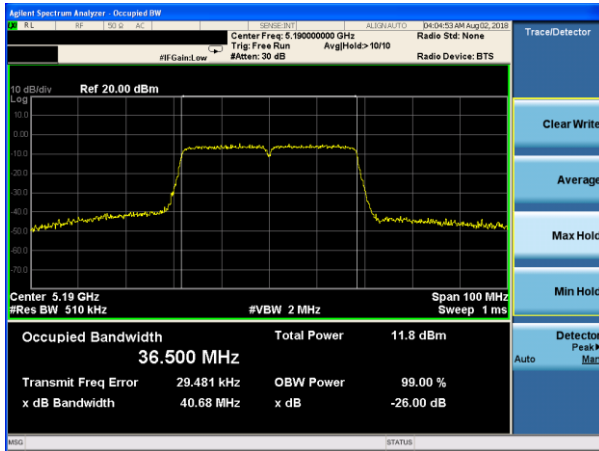

(802.11 ac80) -26dB&99%Bandwidth plot on channel 42

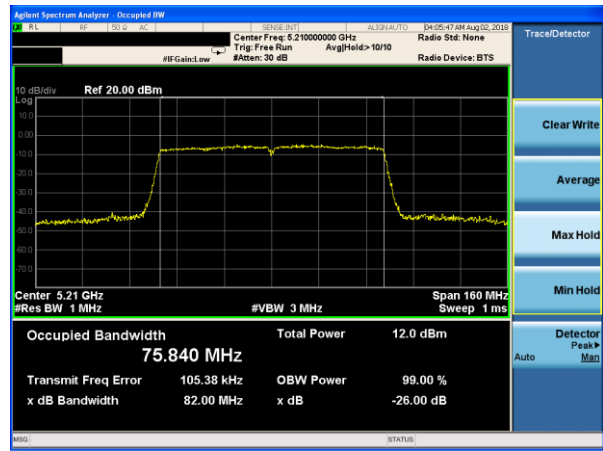

(802.11 ac40) -26dB&99%Bandwidth plot on channel 46

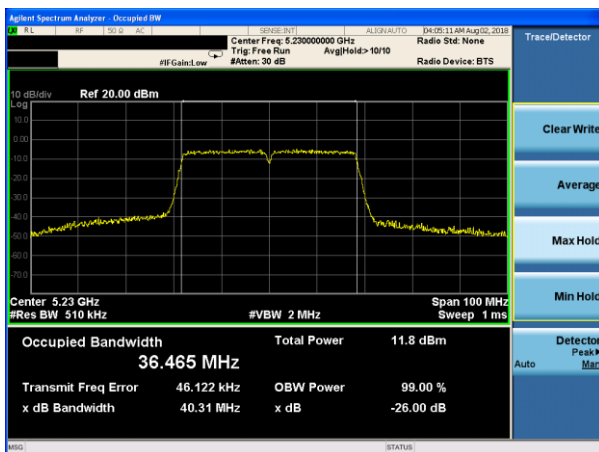

EUT :	PIQS Virtual Touch Projector	Model Name. :	Q1
Temperature :	25 °C	Relative Humidity :	56%
Pressure :	1012 hPa	Test Voltage :	DC 19V
Test Mode :	TX Frequency Band IV(5745-5850MHz)		

Note: A(B) Represent the value of antenna A and B, The worst data is Antenna B, only shown Antenna B Plot.

EUT has two antennas, and different modes support different transmit mode what describe as Following form:

Mode	Tx/Rx
802.11a	1Tx, 2Rx
802.11n/ac	1Tx /2Tx, 2Rx

Mode	Channel	Frequency (MHz)	99% bandwidth(MHz)	99% bandwidth(MHz)	26dB bandwidth (MHz)	26dB bandwidth (MHz)	Result
			Antenna A	Antenna B	Antenna A	Antenna B	
802.11a	CH149	5745	17.199	17.357	21.84	21.91	Pass
	CH157	5785	17.133	17.385	21.79	21.92	Pass
	CH165	5825	17.240	17.210	21.76	21.76	Pass
802.11 n20	CH149	5745	18.236	18.387	22.14	22.00	Pass
	CH157	5785	18.167	18.354	21.87	21.87	Pass
	CH165	5825	18.178	18.265	22.04	21.99	Pass
802.11 n40	CH151	5755	36.682	37.057	40.08	83.53	Pass
	CH159	5795	36.548	36.948	49.49	78.63	Pass
802.11 ac20	CH149	5745	18.208	18.322	21.89	21.91	Pass
	CH157	5785	18.144	18.362	21.64	22.23	Pass
	CH165	5825	18.199	18.251	22.03	21.87	Pass
802.11 ac40	CH151	5755	36.710	37.003	47.01	73.24	Pass
	CH159	5795	36.605	37.023	48.91	71.86	Pass
802.11 ac80	CH155	5775	75.760	76.348	82.04	84.13	Pass

Test plot

(802.11a) -26dB&99%Bandwidth plot on channel 149

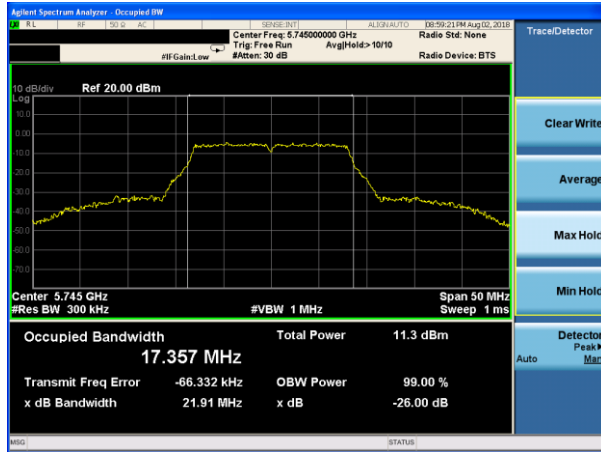

(802.11 n20) -26dB&99%Bandwidth plot on channel 149

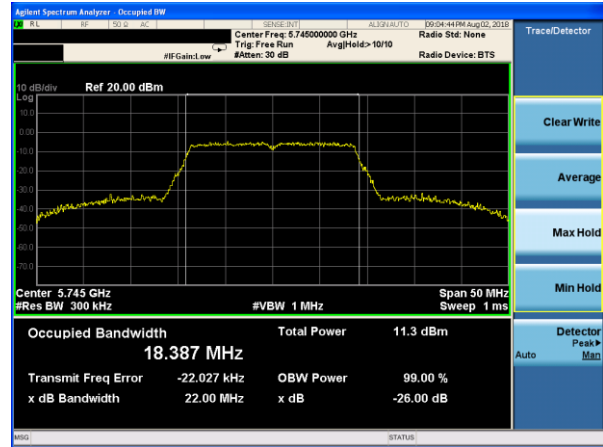

(802.11a) -26dB&99%Bandwidth plot on channel 157

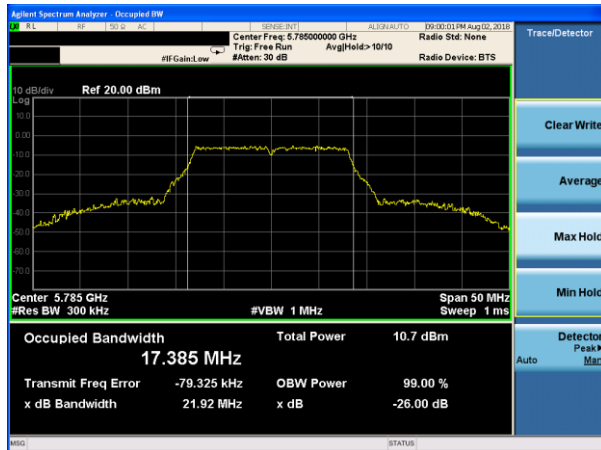

(802.11 n20) -26dB&99%Bandwidth plot on channel 157

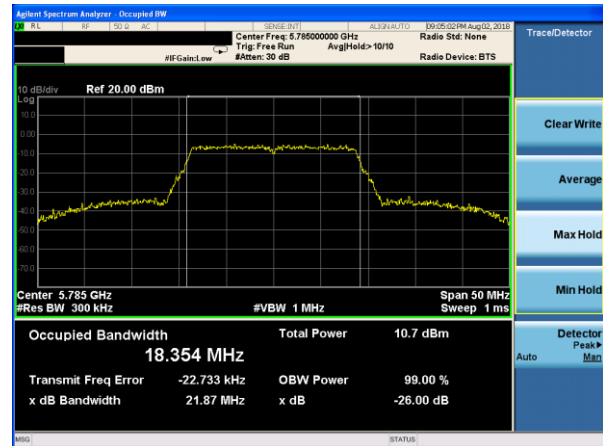

(802.11a) -26dB&99%Bandwidth plot on channel 165

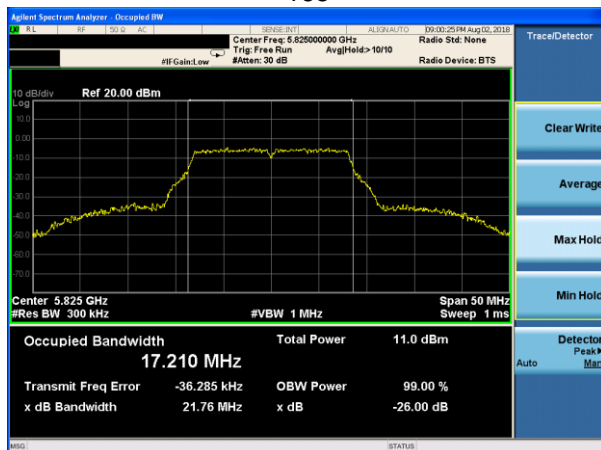

(802.11 n20) -26dB&99%Bandwidth plot on channel 165

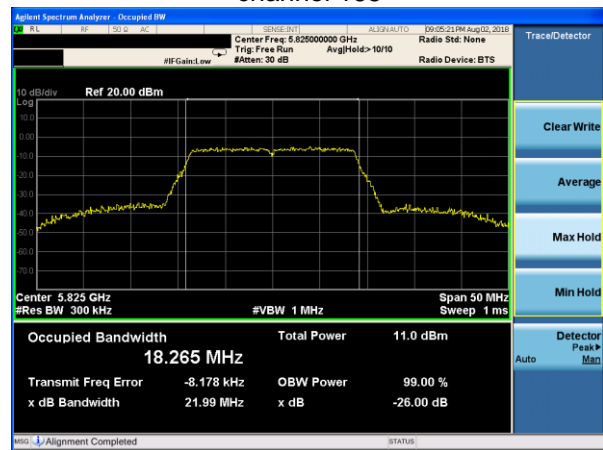

Test plot

(802.11 n40) -26dB&99%Bandwidth plot on channel 151

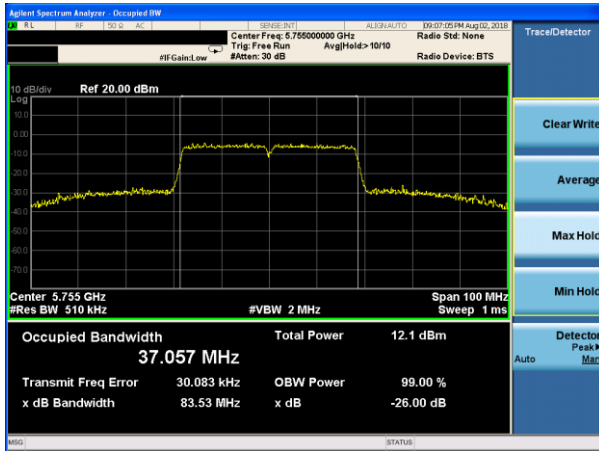

(802.11 ac20) -26dB&99%Bandwidth plot on channel 149

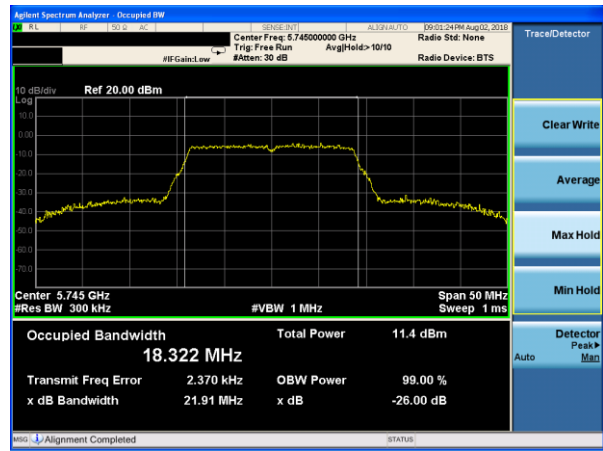

(802.11 n40) -26dB&99%Bandwidth plot on channel 159

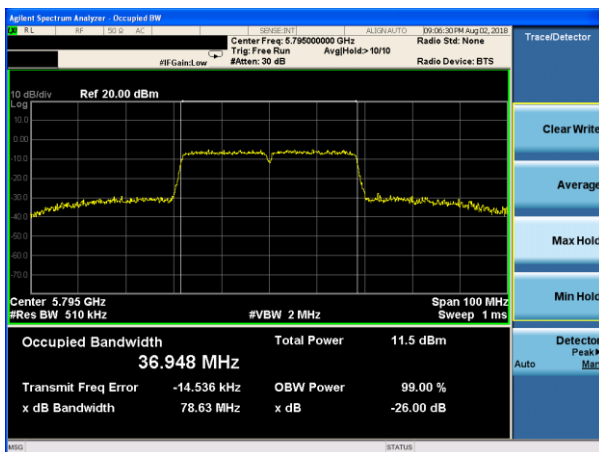

(802.11 ac20) -26dB&99%Bandwidth plot on channel 157

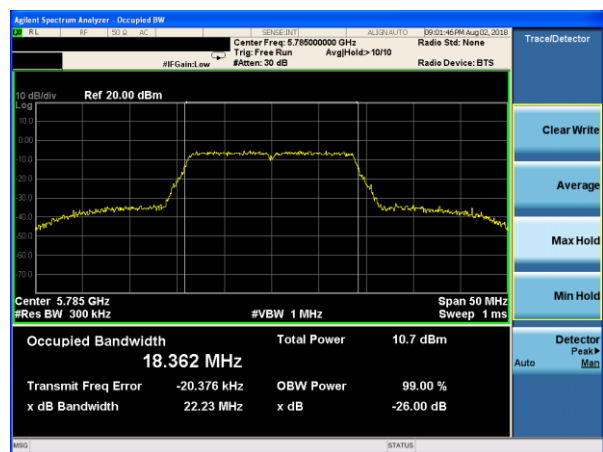

(802.11 ac20) -26dB&99%Bandwidth plot on channel 165

