



# TEST REPORT

## FCC PART 15.247

**Report Reference No.:** CTL1712152052-WF01

Compiled by: ( position+printed name+signature)	Allen Wang (File administrators)	<u>Allen Wang</u>
Tested by: ( position+printed name+signature)	Nice Nong (Test Engineer)	<u>Nice Nong</u>
Approved by: ( position+printed name+signature)	Ivan Xie (Manager)	<u>Ivan Xie</u>

**Product Name**.....: Sports Bluetooth Headset

**Model/Type reference** .....: LQ-S1

**List Model(s)**.....: N/A

**Trade Mark**.....: Aptoyu

**FCC ID**.....: 2ALGX-LQ-S1

---

**Applicant's name** .....: **Shenzhen Bighouse Electronics Commerce Co.,Ltd**

**Address of applicant** .....: Room 1319, Dongming Building, Minkang RD, MinZhi Street, Baoan District, ShenZhen, China

---

**Test Firm** .....: **Shenzhen CTL Testing Technology Co., Ltd.**

**Address of Test Firm** .....: Floor 1-A, Baisha Technology Park, No.3011, Shahexi Road, Nanshan District, Shenzhen, China 518055

---

**Test specification**.....:

Standard.....: **FCC Part 15.247:** Operation within the bands 902-928 MHz, 2400-2483.5 MHz and 5725-5850 MHz.

TRF Originator .....: Shenzhen CTL Testing Technology Co., Ltd.

Master TRF .....: Dated 2011-01

---

**Date of Receipt**.....: Dec. 23, 2017

**Date of Test Date**.....: Dec. 23, 2017–Mar. 19, 2018

**Data of Issue**.....: Mar. 19, 2018

**Result**.....: Pass

**Shenzhen CTL Testing Technology Co., Ltd. All rights reserved.**

This publication may be reproduced in whole or in part for non-commercial purposes as long as the Shenzhen CTL Testing Technology Co., Ltd. is acknowledged as copyright owner and source of the material. Shenzhen CTL Testing Technology Co., Ltd. takes no responsibility for and will not assume liability for damages resulting from the reader's interpretation of the reproduced material due to its placement and context.

# TEST REPORT

<b>Test Report No. :</b>	<b>CTL1712152052-WF01</b>	Mar. 19, 2018
		Date of issue

Equipment under Test : Sports Bluetooth Headset

Model /Type : LQ-S1

Listed Models : N/A

**Applicant** : **Shenzhen Bighouse Electronics Commerce Co.,Ltd**

Address : Room 1319, Dongming Building, Minkang RD, MinZhi Street, Baoan District, ShenZhen, China

**Manufacturer** : **Shenzhen Bighouse Electronics Commerce Co.,Ltd**

Address : Room 1319, Dongming Building, Minkang RD, MinZhi Street, Baoan District, ShenZhen, China

<b>Test result</b>	<b>Pass *</b>
--------------------	---------------

\*In the configuration tested, the EUT complied with the standards specified page 5.

The test report merely corresponds to the test sample.

It is not permitted to copy extracts of these test result without the written permission of the test laboratory.



## Table of Contents

Page

<b>1. SUMMARY.....</b>	<b>5</b>
1.1. TEST STANDARDS.....	5
1.2. TEST DESCRIPTION.....	5
1.3. TEST FACILITY.....	6
<b>FCC-REGISTRATION NO.: 399832 .....</b>	<b>6</b>
1.4. STATEMENT OF THE MEASUREMENT UNCERTAINTY.....	6
<b>2. GENERAL INFORMATION.....</b>	<b>7</b>
2.1. ENVIRONMENTAL CONDITIONS .....	7
2.2. GENERAL DESCRIPTION OF EUT .....	7
2.3. DESCRIPTION OF TEST MODES AND TEST FREQUENCY.....	7
2.4. EQUIPMENTS USED DURING THE TEST .....	8
2.5. RELATED SUBMITTAL(S) / GRANT (S).....	9
2.6. MODIFICATIONS.....	9
<b>3. TEST CONDITIONS AND RESULTS .....</b>	<b>10</b>
3.1. CONDUCTED EMISSIONS TEST .....	10
3.2. RADIATED EMISSIONS AND BAND EDGE .....	13
3.3. MAXIMUM PEAK OUTPUT POWER .....	20
3.4. 20dB BANDWIDTH.....	24
3.5. FREQUENCY SEPARATION .....	28
3.6. NUMBER OF HOPPING FREQUENCY.....	30
3.7. TIME OF OCCUPANCY (DWELL TIME).....	32
3.8. OUT-OF-BAND EMISSIONS .....	36
3.9. PSEUDORANDOM FREQUENCY HOPPING SEQUENCE.....	44
3.10. ANTENNA REQUIREMENT.....	45
<b>4. TEST SETUP PHOTOS OF THE EUT .....</b>	<b>46</b>
<b>5. PHOTOS OF THE EUT.....</b>	<b>47</b>

# 1. SUMMARY

## 1.1. TEST STANDARDS

The tests were performed according to following standards:

[FCC Rules Part 15.247](#): Frequency Hopping, Direct Spread Spectrum and Hybrid Systems that are in operation within the bands of 902-928 MHz, 2400-2483.5 MHz, and 5725-5850 MHz

[ANSI C63.10: 2013](#): American National Standard for Testing Unlicensed Wireless Devices

[ANSI C63.4: 2014](#): –American National Standard for Methods of Measurement of Radio-Noise Emissions from Low-Voltage Electrical and Electronic Equipment in the Range of 9 kHz to 40GHz  
Range of 9 kHz to 40GHz

[KDB558074 D01 V03r03](#): Guidance for Performing Compliance Measurements on Digital Transmission Systems (DTS) Operating Under §15.247

## 1.2. Test Description

<b>FCC PART 15.247</b>		
FCC Part 15.207	AC Power Conducted Emission	PASS
FCC Part 15.247(a)(1)(i)	20dB Bandwidth	PASS
FCC Part 15.247(d)	Spurious RF Conducted Emission	PASS
FCC Part 15.247(b)	Maximum Peak Output Power	PASS
FCC Part 15.247(b)	Pseudorandom Frequency Hopping Sequence	PASS
FCC Part 15.247(a)(1)(iii)	Number of hopping frequency& Time of Occupancy	PASS
FCC Part 15.247(a)(1)	Frequency Separation	PASS
FCC Part 15.205/15.209	Radiated Emissions	PASS
FCC Part 15.247(d)	Band Edge Compliance of RF Emission	PASS
FCC Part 15.203/15.247 (b)	Antenna Requirement	PASS

## 1.3. Test Facility

### 1.3.1 Address of the test laboratory

Shenzhen CTL Testing Technology Co., Ltd.

Floor 1-A, Baisha Technology Park, No. 3011, Shahexi Road, Nanshan, Shenzhen 518055 China

There is one 3m semi-anechoic chamber and two line conducted labs for final test. The Test Sites meet the requirements in documents ANSI C63.4 and CISPR 32/EN 55032 requirements.

### 1.3.2 Laboratory accreditation

The test facility is recognized, certified, or accredited by the following organizations:

#### IC Registration No.: 9618B

The 3m alternate test site of Shenzhen CTL Testing Technology Co., Ltd. EMC Laboratory has been registered by Certification and Engineer Bureau of Industry Canada for the performance of with Registration No.: 9618B on November 13, 2013.

#### FCC-Registration No.: 399832

Shenzhen CTL Testing Technology Co., Ltd. EMC Laboratory has been registered and fully described in a report filed with the (FCC) Federal Communications Commission. The acceptance letter from the FCC is maintained in our files. Registration 399832, December 08, 2017.

## 1.4. Statement of the measurement uncertainty

The data and results referenced in this document are true and accurate. The reader is cautioned that there may be errors within the calibration limits of the equipment and facilities. The measurement uncertainty was calculated for all measurements listed in this test report acc. to CISPR 16 - 4 "Specification for radio disturbance and immunity measuring apparatus and methods – Part 4: Uncertainty in EMC Measurements" and is documented in the Shenzhen CTL Testing Technology Co., Ltd. quality system acc. to DIN EN ISO/IEC 17025. Furthermore, component and process variability of devices similar to that tested may result in additional deviation. The manufacturer has the sole responsibility of continued compliance of the device.

Hereafter the best measurement capability for CTL laboratory is reported:

Test	Measurement Uncertainty	Notes
Transmitter power conducted	±0.57 dB	(1)
Transmitter power Radiated	±2.20 dB	(1)
Conducted spurious emission 9KHz-40 GHz	±2.20 dB	(1)
Occupied Bandwidth	±0.01ppm	(1)
Radiated Emission 30~1000MHz	±4.10dB	(1)
Radiated Emission Above 1GHz	±4.32dB	(1)
Conducted Disturbance0.15~30MHz	±3.20dB	(1)

- (1) This uncertainty represents an expanded uncertainty expressed at approximately the 95% confidence level using a coverage factor of k=2.

## 2. GENERAL INFORMATION

### 2.1. Environmental conditions

During the measurement the environmental conditions were within the listed ranges:

Normal Temperature:	25°C
Relative Humidity:	55 %
Air Pressure:	101 kPa

### 2.2. General Description of EUT

Product Name:	Sports Bluetooth Headset
Model/Type reference:	LQ-S1
Power supply:	DC 3.7V from battery
<b>Bluetooth :</b>	
Supported type:	Bluetooth BR/EDR
Modulation:	GFSK, $\pi/4$ DQPSK, 8DPSK
Operation frequency:	2402MHz~2480MHz
Channel number:	79
Channel separation:	1MHz
Antenna type:	PCB antenna
Antenna gain:	0dBi

Note: For more details, please refer to the user's manual of the EUT.

### 2.3. Description of Test Modes and Test Frequency

The Applicant provides communication tools software to control the EUT for staying in continuous transmitting (Duty Cycle more than 98%) and receiving mode for testing .There are 79 channels provided to the EUT and Channel 00/39/78 were selected to test.

#### Operation Frequency :

Channel	Frequency (MHz)
00	2402
01	2403
:	:
38	2440
39	2441
40	2442
:	:
77	2479
78	2480

Preliminary tests were performed in each mode and packet length of BT, and found worst case as below, finally test were conducted at those mode and recorded in this report.

Test Items	Worst case
Conducted Emissions	3DH5 Middle channel
Radiated Emissions and Band Edge	3DH5
Maximum Conducted Output Power	DH5/2DH5/3DH5
20dB Bandwidth	DH5/2DH5/3DH5
Frequency Separation	DH5/2DH5/3DH5 Middle channel
Number of hopping frequency	DH5/2DH5/3DH5
Time of Occupancy (Dwell Time)	DH1/DH3/DH5 Middle channel 2DH1/2DH3/2DH5 Middle channel 3DH1/3DH3/3DH5 Middle channel
Out-of-band Emissions	DH5/2DH5/3DH5

## 2.4. Equipments Used during the Test

Test Equipment	Manufacturer	Model No.	Serial No.	Calibration Date	Calibration Due Date
LISN	R&S	ENV216	3560.6550.1 2	2017/06/02	2018/06/01
LISN	R&S	ESH2-Z5	860014/010	2017/06/02	2018/06/01
Bilog Antenna	Sunol Sciences Corp.	JB1	A061713	2017/06/02	2018/06/01
EMI Test Receiver	R&S	ESCI	103710	2017/06/02	2018/06/01
Spectrum Analyzer	Agilent	E4407B	MY41440676	2017/05/21	2018/05/20
Spectrum Analyzer	Agilent	N9020	US46220290	2018/01/16	2019/01/17
Controller	EM Electronics	Controller EM 1000	N/A	2017/05/21	2018/05/20
Horn Antenna	Sunol Sciences Corp.	DRH-118	A062013	2017/05/19	2018/05/18
Active Loop Antenna	SCHWARZBECK	FMZB1519	1519-037	2017/05/19	2018/05/18
Amplifier	Agilent	8449B	3008A02306	2017/05/19	2018/05/18
Amplifier	Agilent	8447D	2944A10176	2017/05/19	2018/05/18
Temperature/Humidity Meter	Gangxing	CTH-608	02	2017/05/20	2018/05/19
High-Pass Filter	K&L	9SH10-2700/X1 2750-O/O	N/A	2017/05/20	2018/05/19
High-Pass Filter	K&L	41H10-1375/U1 2750-O/O	N/A	2017/05/20	2018/05/19
Coaxial Cables	HUBER+SUHNER	SUCOFLEX 104PEA-10M	10m	2017/06/02	2018/06/01
Coaxial Cables	HUBER+SUHNER	SUCOFLEX 104PEA-3M	3m	2017/06/02	2018/06/01
Coaxial Cables	HUBER+SUHNER	SUCOFLEX 104PEA-3M	3m	2017/06/02	2018/06/01



RF Cable	Megalon	RF-A303	N/A	2017/06/02	2018/06/01
----------	---------	---------	-----	------------	------------

The calibration interval was one year

## 2.5. Related Submittal(s) / Grant (s)

This submittal(s) (test report) is intended to comply with Section 15.247 of the FCC Part 15, Subpart C Rules.

## 2.6. Modifications

No modifications were implemented to meet testing criteria.



### 3. TEST CONDITIONS AND RESULTS

#### 3.1. Conducted Emissions Test

##### LIMIT

FCC CFR Title 47 Part 15 Subpart C Section 15.207

Frequency range (MHz)	Limit (dBuV)	
	Quasi-peak	Average
0.15-0.5	66 to 56*	56 to 46*
0.5-5	56	46
5-30	60	50

\* Decreases with the logarithm of the frequency.

##### TEST CONFIGURATION

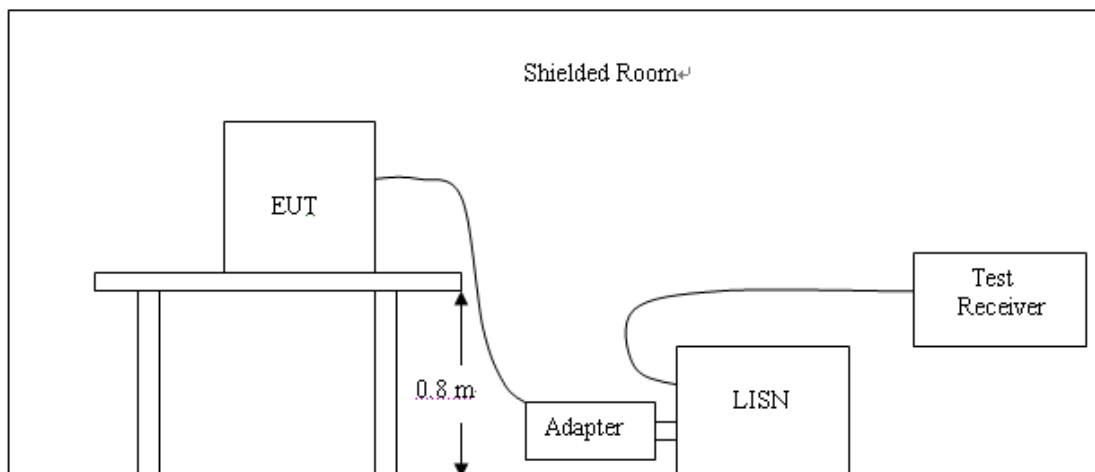

##### TEST PROCEDURE

1. The equipment was set up as per the test configuration to simulate typical actual usage per the user's manual. The EUT is a tabletop system; a wooden table with a height of 0.8 meters is used and is placed on the ground plane as per ANSI C63.10:2013.
2. Support equipment, if needed, was placed as per ANSI C63.10:2013.
3. All I/O cables were positioned to simulate typical actual usage as per ANSI C63.10:2013.
4. The adapter received AC120V/60Hz power through a Line Impedance Stabilization Network (LISN) which supplied power source and was grounded to the ground plane.
5. All support equipments received AC power from a second LISN, if any.
6. The EUT test program was started. Emissions were measured on each current carrying line of the EUT using a spectrum Analyzer / Receiver connected to the LISN powering the EUT. The LISN has two monitoring points: Line 1 (Hot Side) and Line 2 (Neutral Side). Two scans were taken: one with Line 1 connected to Analyzer / Receiver and Line 2 connected to a 50 ohm load; the second scan had Line 1 connected to a 50 ohm load and Line 2 connected to the Analyzer / Receiver.
7. Analyzer / Receiver scanned from 150 KHz to 30MHz for emissions in each of the test modes.
8. During the above scans, the emissions were maximized by cable manipulation.

**TEST RESULTS**

Remark: All modes of GFSK, Pi/4 DQPSK, and 8DPSK were test at Low, Middle, and High channel; only the worst result of 8DPSK Middle Channel was reported as below:

**SCAN TABLE: "Voltage (9K-30M) FIN"**  
 Short Description: 150K-30M Voltage

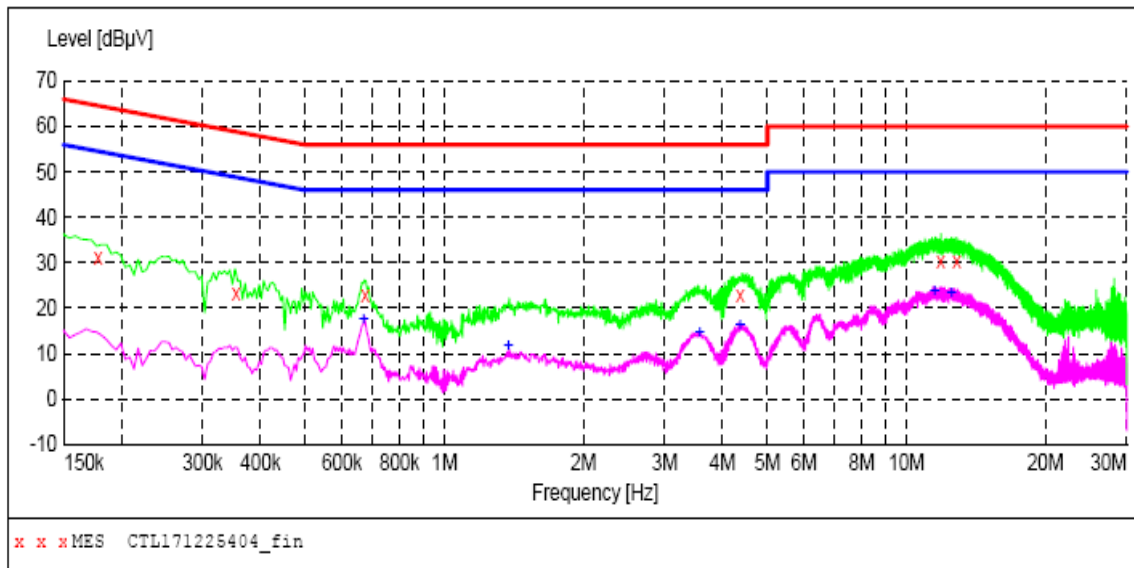

**MEASUREMENT RESULT: "CTL171225404\_fin"**

25/12/2017 14:19

Frequency MHz	Level dBµV	Transd dB	Limit dBµV	Margin dB	Detector	Line	PE
0.178000	31.30	10.2	65	33.3	QP	L1	GND
0.354000	23.20	10.2	59	35.7	QP	L1	GND
0.674000	22.70	10.2	56	33.3	QP	L1	GND
4.364000	22.90	10.4	56	33.1	QP	L1	GND
11.858000	30.40	10.6	60	29.6	QP	L1	GND
12.842000	30.20	10.6	60	29.8	QP	L1	GND

**MEASUREMENT RESULT: "CTL171225404\_fin2"**

25/12/2017 14:19

Frequency MHz	Level dBµV	Transd dB	Limit dBµV	Margin dB	Detector	Line	PE
0.668000	17.50	10.2	46	28.5	AV	L1	GND
1.376000	11.50	10.3	46	34.5	AV	L1	GND
3.566000	14.60	10.4	46	31.4	AV	L1	GND
4.370000	16.20	10.4	46	29.8	AV	L1	GND
11.516000	23.60	10.6	50	26.4	AV	L1	GND
12.524000	23.20	10.6	50	26.8	AV	L1	GND

**SCAN TABLE: "Voltage (9K-30M) FIN"**  
 Short Description: 150K-30M Voltage

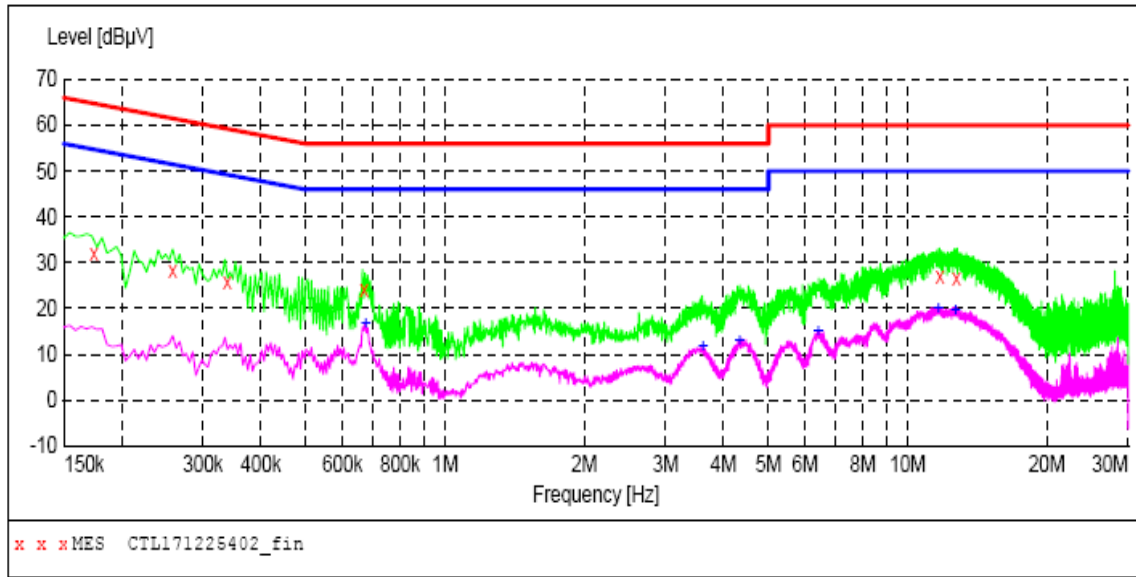

**MEASUREMENT RESULT: "CTL171225402\_fin"**

25/12/2017 14:13

Frequency MHz	Level dBµV	Transd dB	Limit dBµV	Margin dB	Detector	Line	PE
0.174000	32.00	10.2	65	32.8	QP	N	GND
0.258000	28.30	10.2	62	33.2	QP	N	GND
0.338000	25.70	10.2	59	33.6	QP	N	GND
0.668000	23.90	10.2	56	32.1	QP	N	GND
11.744000	27.10	10.6	60	32.9	QP	N	GND
12.746000	26.80	10.6	60	33.2	QP	N	GND

**MEASUREMENT RESULT: "CTL171225402\_fin2"**

25/12/2017 14:13

Frequency MHz	Level dBµV	Transd dB	Limit dBµV	Margin dB	Detector	Line	PE
0.674000	16.80	10.2	46	29.2	AV	N	GND
3.614000	11.70	10.4	46	34.3	AV	N	GND
4.328000	12.90	10.4	46	33.1	AV	N	GND
6.416000	15.10	10.4	50	34.9	AV	N	GND
11.654000	20.10	10.6	50	29.9	AV	N	GND
12.686000	19.60	10.6	50	30.4	AV	N	GND

## 3.2. Radiated Emissions and Band Edge

### Limit

For intentional device, according to § 15.209(a), the general requirement of field strength of radiated emission out of authorized band shall not exceed the following table at a 3 meters measurement distance.

In addition, radiated emissions which fall in the restricted bands, as defined in §15.205(a), must also comply with the radiated emission limits specified in §15.209(a)

Radiated emission limits

Frequency (MHz)	Distance (Meters)	Radiated (dB $\mu$ V/m)	Radiated ( $\mu$ V/m)
0.009-0.49	3	$20\log(2400/F(\text{KHz}))+40\log(300/3)$	$2400/F(\text{KHz})$
0.49-1.705	3	$20\log(24000/F(\text{KHz}))+40\log(30/3)$	$24000/F(\text{KHz})$
1.705-30	3	$20\log(30)+40\log(30/3)$	30
30-88	3	40.0	100
88-216	3	43.5	150
216-960	3	46.0	200
Above 960	3	54.0	500

### TEST CONFIGURATION

(A) Radiated Emission Test Set-Up, Frequency Below 30MHz

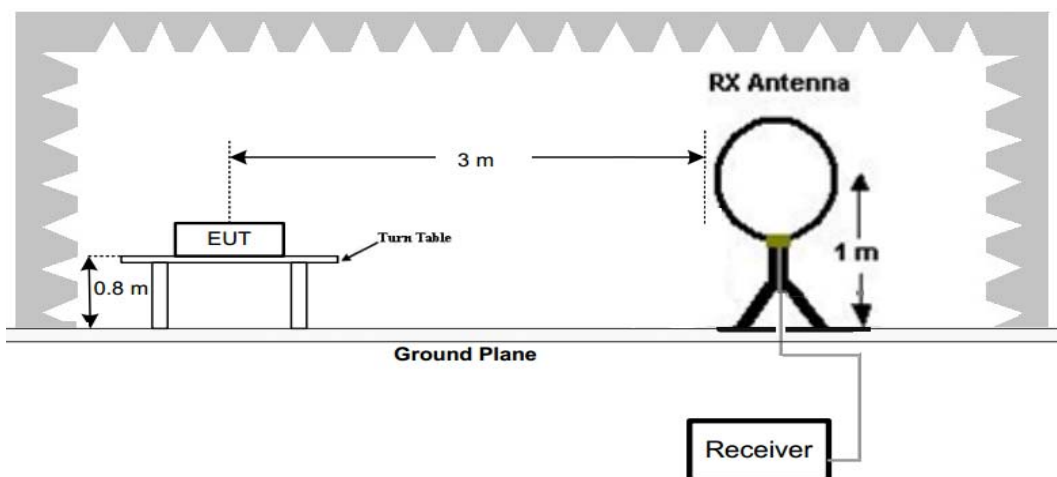

(B) Radiated Emission Test Set-Up, Frequency below 1000MHz

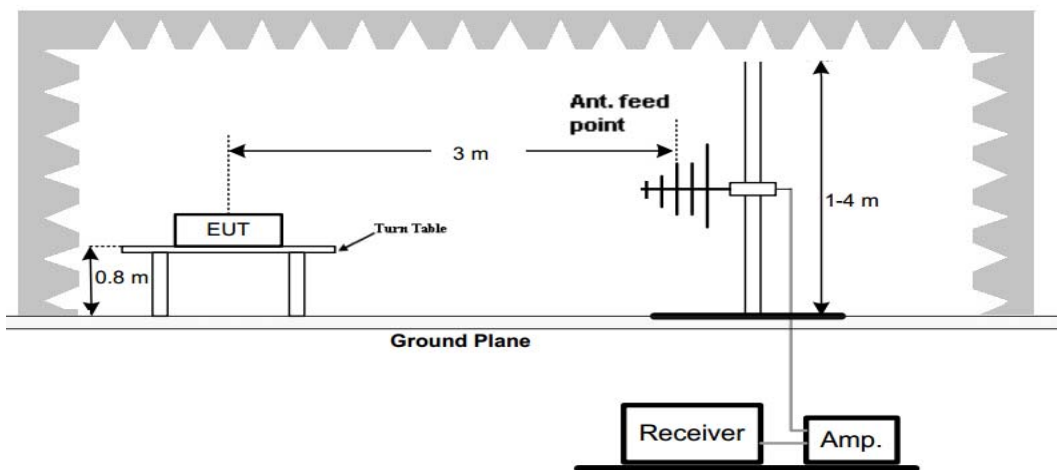

(C) Radiated Emission Test Set-Up, Frequency above 1000MHz

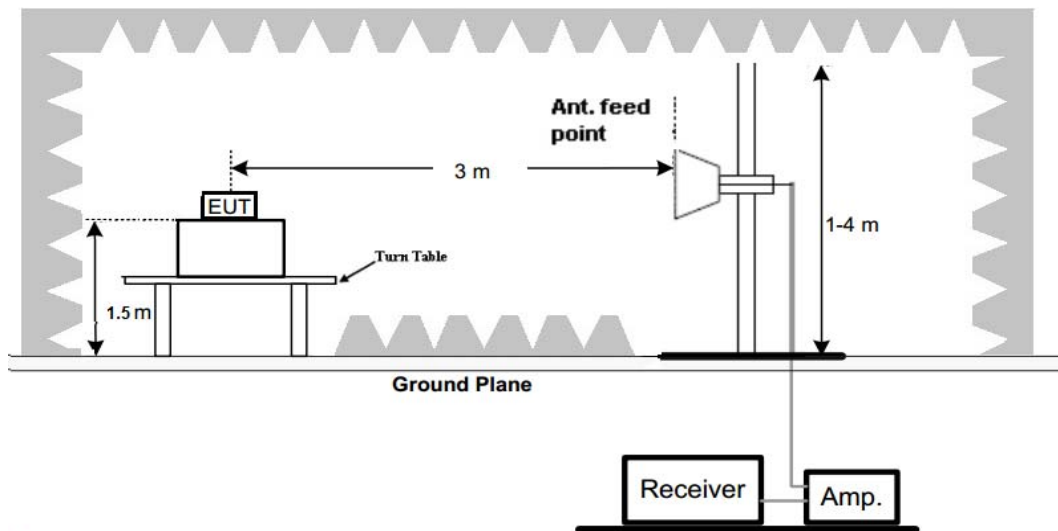

### Test Procedure

1. Below 1GHz measurement the EUT is placed on a turntable which is 0.8m above ground plane, and above 1GHz measurement EUT was placed on a low permittivity and low loss tangent turn table which is 1.5m above ground plane.
2. Maximum procedure was performed by raising the receiving antenna from 1m to 4m and rotating the turn table from 0° to 360° to acquire the highest emissions from EUT
3. And also, each emission was to be maximized by changing the polarization of receiving antenna both horizontal and vertical.
4. Repeat above procedures until all frequency measurements have been completed.

### TEST RESULTS

Remark:

1. We measured Radiated Emission at GFSK,  $\pi/4$  DQPSK and 8DPSK mode from 9 KHz to 25GHz and recorded worst case at 8DPSK 3DH5 mode.
2. For below 1GHz testing recorded worst at 8DPSK 3DH5 low channel.
3. Radiated emission test from 9 KHz to 10th harmonic of fundamental was verified, and no emission found except system noise floor in 9 KHz to 30MHz and not recorded in this report.

For 30MHz-1GHz

Horizontal

**SWEEP TABLE: "test (30M-1G)"**

Short Description:		Field Strength			
Start	Stop	Detector	Meas. Time	IF Bandw.	Transducer
Frequency 30.0 MHz	Frequency 1.0 GHz	MaxPeak	300.0 ms	100 kHz	VULB 9168

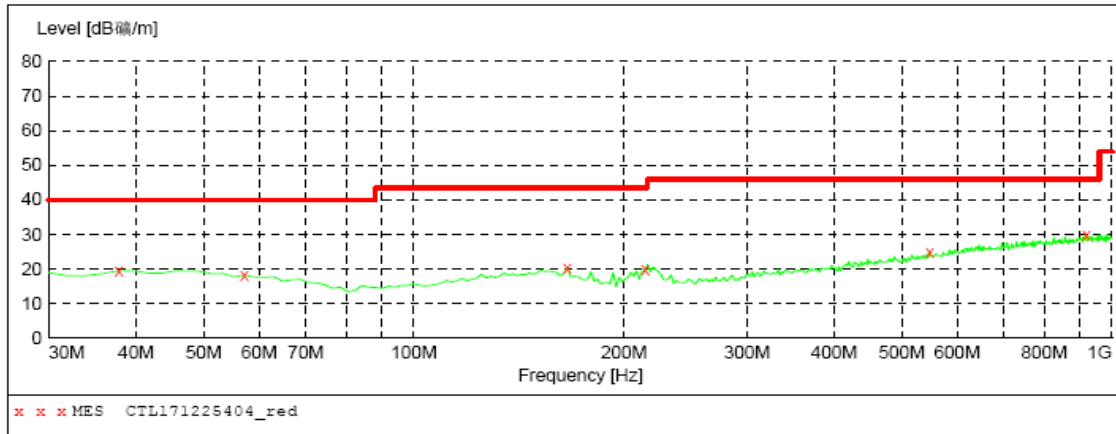

**MEASUREMENT RESULT: "CTL171225404\_red"**

2017-12-25 9:03

Frequency MHz	Level dBμV/m	Transd dB	Limit dBμV/m	Margin dB	Det.	Height cm	Azimuth deg	Polarization
37.760000	19.60	15.5	40.0	20.4	---	0.0	0.00	HORIZONTAL
57.160000	18.20	14.6	40.0	21.8	---	0.0	0.00	HORIZONTAL
165.800000	20.40	15.6	43.5	23.1	---	0.0	0.00	HORIZONTAL
214.300000	19.90	12.5	43.5	23.6	---	0.0	0.00	HORIZONTAL
547.980000	24.90	20.2	46.0	21.1	---	0.0	0.00	HORIZONTAL
918.520000	29.90	25.2	46.0	16.1	---	0.0	0.00	HORIZONTAL

Vertical

**SWEEP TABLE: "test (30M-1G)"**

Short Description:		Field Strength			
Start	Stop	Detector	Meas. Time	IF Bandw.	Transducer
Frequency 30.0 MHz	Frequency 1.0 GHz	MaxPeak	300.0 ms	100 kHz	VULB 9168

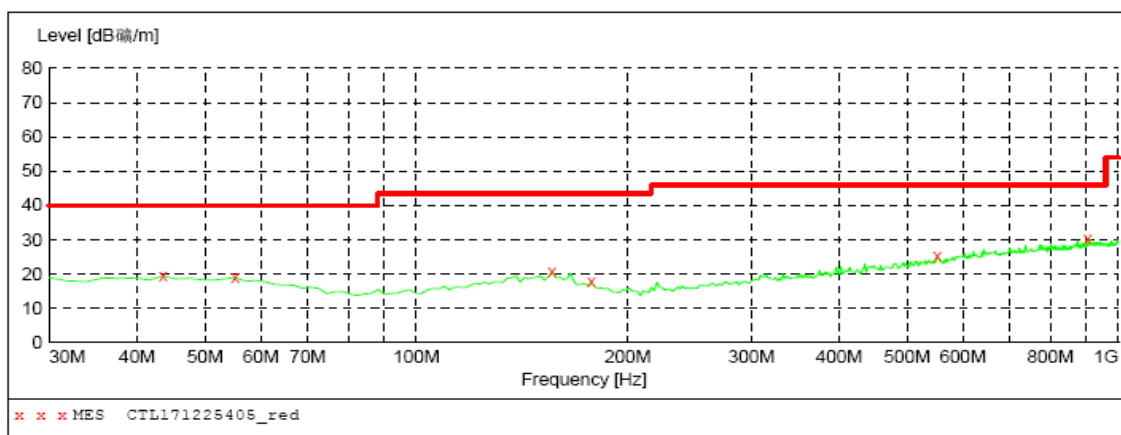

**MEASUREMENT RESULT: "CTL171225405\_red"**

2017-12-25 9:05

Frequency MHz	Level dBμV/m	Transd dB	Limit dBμV/m	Margin dB	Det.	Height cm	Azimuth deg	Polarization
43.580000	19.50	15.4	40.0	20.5	---	0.0	0.00	VERTICAL
55.220000	19.00	14.7	40.0	21.0	---	0.0	0.00	VERTICAL
156.100000	20.80	16.2	43.5	22.7	---	0.0	0.00	VERTICAL
177.440000	17.70	14.1	43.5	25.8	---	0.0	0.00	VERTICAL
551.860000	25.40	20.3	46.0	20.6	---	0.0	0.00	VERTICAL
903.000000	30.10	25.0	46.0	15.9	---	0.0	0.00	VERTICAL

**For 1GHz to 25GHz****Note : GFSK, Pi/4 DQPSK and 8DPSK all have been tested, only worse case 8DPSK is reported.****8DPSK (above 1GHz)**

Frequency(MHz):			2402		Polarity:			HORIZONTAL	
Frequency (MHz)	Emission Level (dBuV/m)		Limit (dBuV/m)	Margin (dB)	Raw Value (dBuV)	Antenna Factor (dB/m)	Cable Factor (dB)	Pre-amplifier (dB)	Correction Factor (dB/m)
4804.00	55.03	PK	74	18.97	50.52	33.49	6.91	35.89	4.51
4804.00	45.58	AV	54	8.42	41.07	33.49	6.91	35.89	4.51
7024.00	44.34	PK	74	29.66	34.01	36.29	9.11	35.07	10.33
7024.00	--	AV	54	--	--	--	--	--	--
7206.00	47.11	PK	74	26.89	36.00	36.95	9.18	35.03	11.11
7206.00	--	AV	54	--	--	--	--	--	--

Frequency(MHz):			2402		Polarity:			VERTICAL	
Frequency (MHz)	Emission Level (dBuV/m)		Limit (dBuV/m)	Margin (dB)	Raw Value (dBuV)	Antenna Factor (dB/m)	Cable Factor (dB)	Pre-amplifier (dB)	Correction Factor (dB/m)
4804.00	54.62	PK	74	19.38	50.11	33.49	6.91	35.89	4.51
4804.00	43.89	AV	54	10.11	39.38	33.49	6.91	35.89	4.51
6731.26	42.10	PK	74	31.90	32.48	35.88	8.69	34.95	9.62
6731.26	--	AV	54	--	--	--	--	--	--
7206.00	45.37	PK	74	28.63	34.26	36.95	9.18	35.03	11.11
7206.00	--	AV	54	--	--	--	--	--	--

Frequency(MHz):			2441		Polarity:			HORIZONTAL	
Frequency (MHz)	Emission Level (dBuV/m)		Limit (dBuV/m)	Margin (dB)	Raw Value (dBuV)	Antenna Factor (dB/m)	Cable Factor (dB)	Pre-amplifier (dB)	Correction Factor (dB/m)
4882.00	55.93	PK	74	18.07	51.28	33.60	6.95	35.90	4.65
4882.00	46.90	AV	54	7.10	42.25	33.60	6.95	35.90	4.65
5852.45	44.32	PK	74	29.68	36.54	34.81	7.51	34.54	7.78
5852.45	--	AV	54	--	--	--	--	--	--
7323.00	48.05	PK	74	25.95	36.35	37.46	9.23	35.00	11.70
7323.00	--	AV	54	--	--	--	--	--	--

Frequency(MHz):			2441		Polarity:			VERTICAL	
Frequency (MHz)	Emission Level (dBuV/m)		Limit (dBuV/m)	Margin (dB)	Raw Value (dBuV)	Antenna Factor (dB/m)	Cable Factor (dB)	Pre-amplifier (dB)	Correction Factor (dB/m)
4882.00	54.79	PK	74	19.21	50.14	33.60	6.95	35.90	4.65
4882.00	45.22	AV	54	8.78	40.57	33.60	6.95	35.90	4.65
5705.30	43.16	PK	74	30.84	35.43	34.79	7.42	34.48	7.73
5705.30	--	AV	54	--	--	--	--	--	--
7323.00	46.73	PK	74	27.27	35.03	37.46	9.23	35.00	11.70
7323.00	--	AV	54	--	--	--	--	--	--



Frequency(MHz):			2480		Polarity:			HORIZONTAL	
Frequency (MHz)	Emission Level (dBuV/m)		Limit (dBuV/m)	Margin (dB)	Raw Value (dBuV)	Antenna Factor (dB/m)	Cable Factor (dB)	Pre-amplifier (dB)	Correction Factor (dB/m)
4960.00	57.78	PK	74	16.22	52.86	33.84	7.00	35.92	4.92
4960.00	47.42	AV	54	6.58	42.50	33.84	7.00	35.92	4.92
7016.00	44.80	PK	74	29.20	34.49	36.28	9.11	35.08	10.31
7016.00	--	AV	54	--	--	--	--	--	--
7440.00	49.33	PK	74	24.67	37.38	37.64	9.28	34.97	11.95
7440.00	--	AV	54	--	--	--	--	--	--

Frequency(MHz):			2480		Polarity:			VERTICAL	
Frequency (MHz)	Emission Level (dBuV/m)		Limit (dBuV/m)	Margin (dB)	Raw Value (dBuV)	Antenna Factor (dB/m)	Cable Factor (dB)	Pre-amplifier (dB)	Correction Factor (dB/m)
4960.00	55.91	PK	74	18.09	50.99	33.84	7.00	35.92	4.92
4960.00	44.96	AV	54	9.04	40.04	33.84	7.00	35.92	4.92
6300.50	42.36	PK	74	31.64	33.86	35.19	8.05	34.74	8.50
6300.50	--	AV	54	--	--	--	--	--	--
7440.00	47.07	PK	74	26.93	35.12	37.64	9.28	34.97	11.95
7440.00	--	AV	54	--	--	--	--	--	--

## REMARKS:

1. Emission level (dBuV/m) =Raw Value (dBuV)+Correction Factor (dB/m)
2. Correction Factor (dB/m) = Antenna Factor (dB/m)+Cable Factor (dB)-Pre-amplifier Factor
3. Margin value = Limit value- Emission level.
4. -- Mean the PK detector measured value is below average limit.
5. The other emission levels were very low against the limit.
6. RBW1MHz VBW3MHz Peak detector is for PK value; RBW 1MHz VBW10Hz Peak detector is for AV value.

**Results of Band Edges Test (Radiated)****Note : GFSK, Pi/4 DQPSK and 8DPSK all have been tested, only worse case 8DPSK is reported.**

Frequency(MHz):			2402		Polarity:			HORIZONTAL	
Frequency (MHz)	Emission Level (dBuV/m)		Limit (dBuV/m)	Margin (dB)	Raw Value (dBuV)	Antenna Factor (dB/m)	Cable Factor (dB)	Pre-amplifier (dB)	Correction Factor (dB/m)
2402.00	93.37	PK	--	--	59.97	28.78	4.61	0.00	33.40
2402.00	82.94	AV	--	--	49.54	28.78	4.61	0.00	33.40
2384.00	41.19	PK	74	32.81	7.92	28.68	4.59	0.00	33.27
2384.00	--	AV	54	--	--	--	--	--	--
2390.00	40.61	PK	74	33.39	7.29	28.72	4.60	0.00	33.32
2390.00	--	AV	54	--	--	--	--	--	--
2400.00	44.21	PK	74	29.79	10.82	28.78	4.61	0.00	33.39
2400.00	--	AV	54	--	--	--	--	--	--

Frequency(MHz):			2402		Polarity:			VERTICAL	
Frequency (MHz)	Emission Level (dBuV/m)		Limit (dBuV/m)	Margin (dB)	Raw Value (dBuV)	Antenna Factor (dB/m)	Cable Factor (dB)	Pre-amplifier (dB)	Correction Factor (dB/m)
2402.00	92.24	PK	--	--	58.84	28.78	4.61	0.00	33.40
2402.00	81.75	AV	--	--	48.35	28.78	4.61	0.00	33.40
2384.00	40.02	PK	74	33.98	6.75	28.68	4.59	0.00	33.27
2384.00	--	AV	54	--	--	--	--	--	--
2390.00	39.26	PK	74	34.74	5.94	28.72	4.60	0.00	33.32
2390.00	--	AV	54	--	--	--	--	--	--
2400.00	42.92	PK	74	31.08	9.53	28.78	4.61	0.00	33.39
2400.00	--	AV	54	--	--	--	--	--	--

Frequency(MHz):			2480		Polarity:			HORIZONTAL	
Frequency (MHz)	Emission Level (dBuV/m)		Limit (dBuV/m)	Margin (dB)	Raw Value (dBuV)	Antenna Factor (dB/m)	Cable Factor (dB)	Pre-amplifier (dB)	Correction Factor (dB/m)
2480.00	97.62	PK	--	--	64.00	28.92	4.70	0.00	33.62
2480.00	86.97	AV	--	--	53.35	28.92	4.70	0.00	33.62
2483.50	42.09	PK	74	31.91	8.46	28.93	4.70	0.00	33.63
2483.50	--	AV	54	--	--	--	--	--	--
2495.00	41.80	PK	74	32.20	8.13	28.95	4.71	0.00	33.67
2495.00	--	AV	54	--	--	--	--	--	--
2500.00	40.75	PK	74	33.25	7.07	28.96	4.72	0.00	33.68
2500.00	--	AV	54	--	--	--	--	--	--

Frequency(MHz):			2480		Polarity:			VERTICAL	
Frequency (MHz)	Emission Level (dBuV/m)		Limit (dBuV/m)	Margin (dB)	Raw Value (dBuV)	Antenna Factor (dB/m)	Cable Factor (dB)	Pre-amplifier (dB)	Correction Factor (dB/m)
2480.00	95.87	PK	--	--	62.25	28.92	4.70	0.00	33.62
2480.00	85.18	AV	--	--	51.56	28.92	4.70	0.00	33.62
2483.50	41.76	PK	74	32.24	8.13	28.93	4.70	0.00	33.63
2483.50	--	AV	54	--	--	--	--	--	--
2495.00	40.74	PK	74	33.26	7.07	28.95	4.71	0.00	33.67
2495.00	--	AV	54	--	--	--	--	--	--
2500.00	40.08	PK	74	33.92	6.40	28.96	4.72	0.00	33.68
2500.00	--	AV	54	--	--	--	--	--	--

## REMARKS:

1. Emission level (dBuV/m) =Raw Value (dBuV)+Correction Factor (dB/m)
2. Correction Factor (dB/m) = Antenna Factor (dB/m)+Cable Factor (dB)-Pre-amplifier Factor
3. Margin value = Limit value- Emission level.
4. -- Mean the PK detector measured value is below average limit.
5. The other emission levels were very low against the limit.
6. RBW1MHz VBW3MHz Peak detector is for PK value; RBW 1MHz VBW10Hz Peak detector is for AV value.

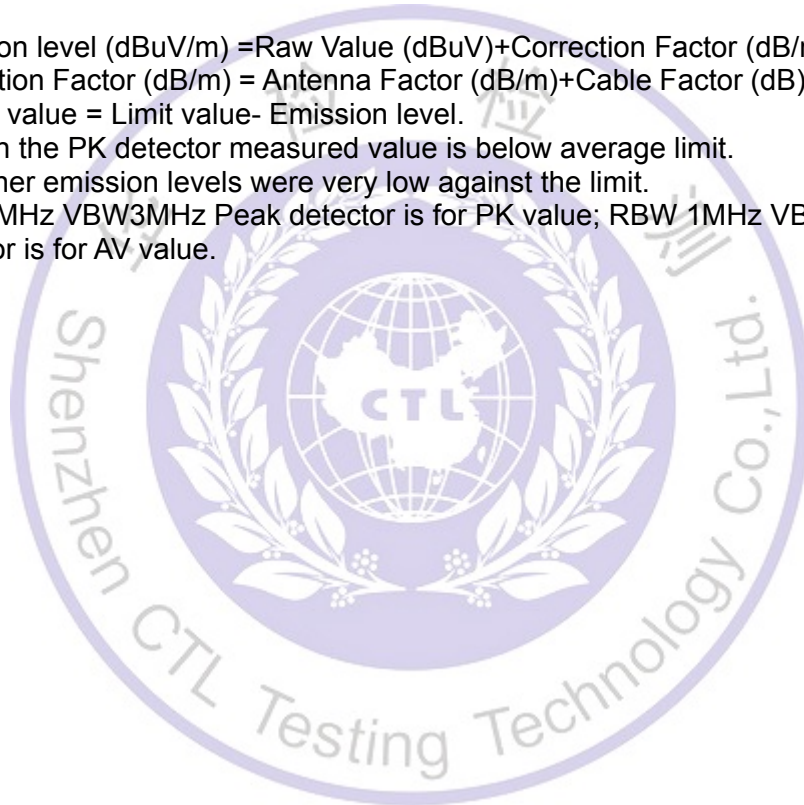

### 3.3. Maximum Peak Output Power

#### Limit

The Maximum Peak Output Power Measurement is 125mW(20.97).

#### Test Procedure

Remove the antenna from the EUT and then connect a low loss RF cable from the antenna port to the spectrum.

#### Test Configuration

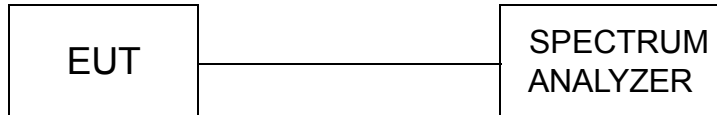

#### Test Results

Type	Channel	Output power (dBm)	Limit (dBm)	Result
GFSK	00	-1.820	20.97	Pass
	39	0.517		
	78	2.320		
π/4DQPSK	00	-0.711	20.97	Pass
	39	1.651		
	78	3.427		
8DPSK	00	-0.311	20.97	Pass
	39	2.030		
	78	3.834		

Note: 1.The test results including the cable lose.

Test plot as follows:

### GFSK Modulation



### CH00

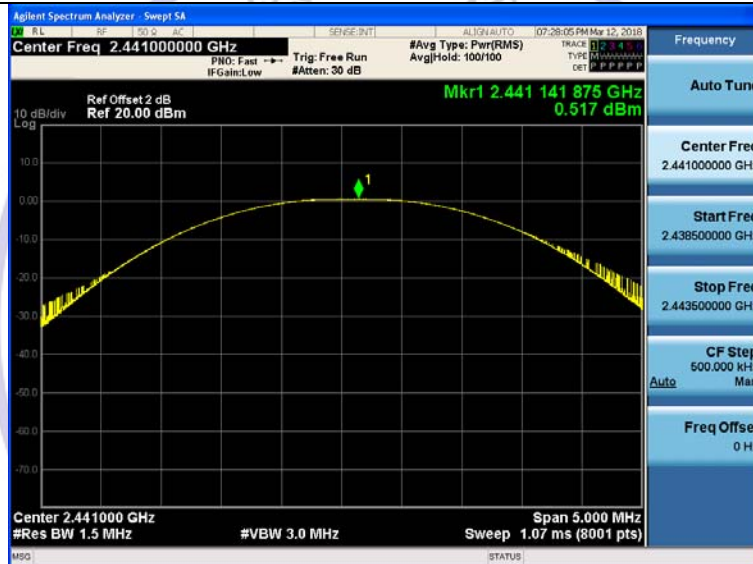

### CH39



### CH78

$\pi/4$ DQPSK Modulation

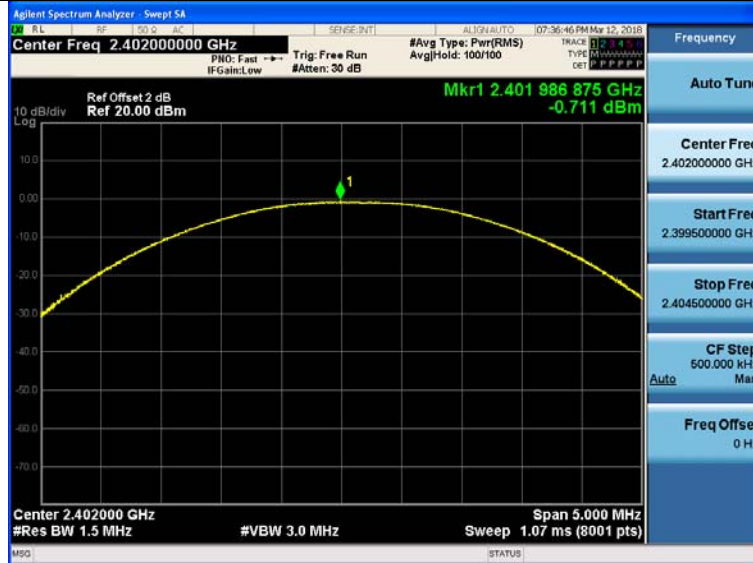

CH00

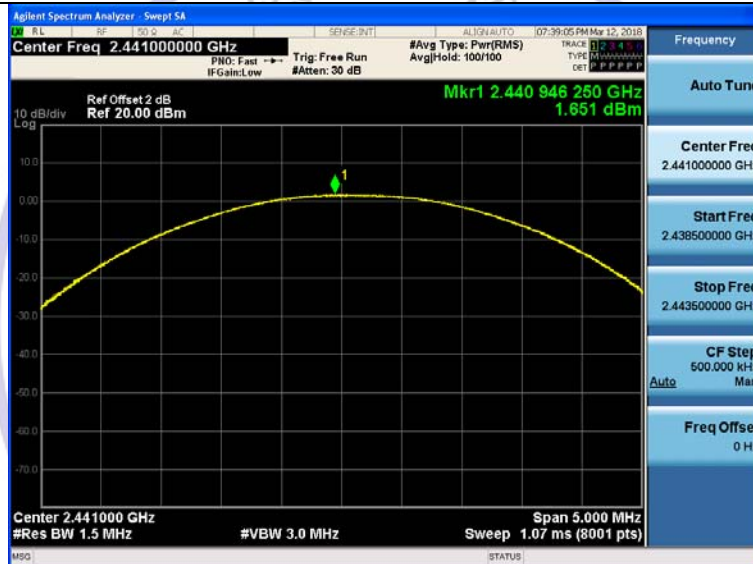

CH39

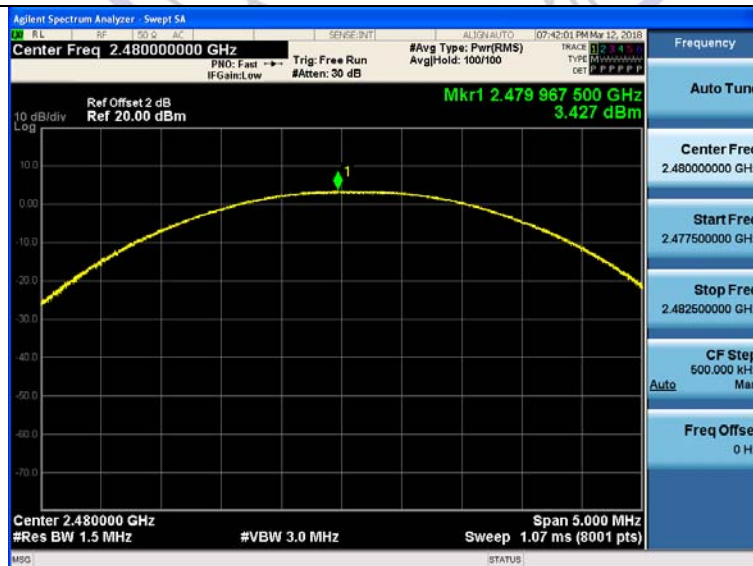

CH78

### 8DPSK Modulation

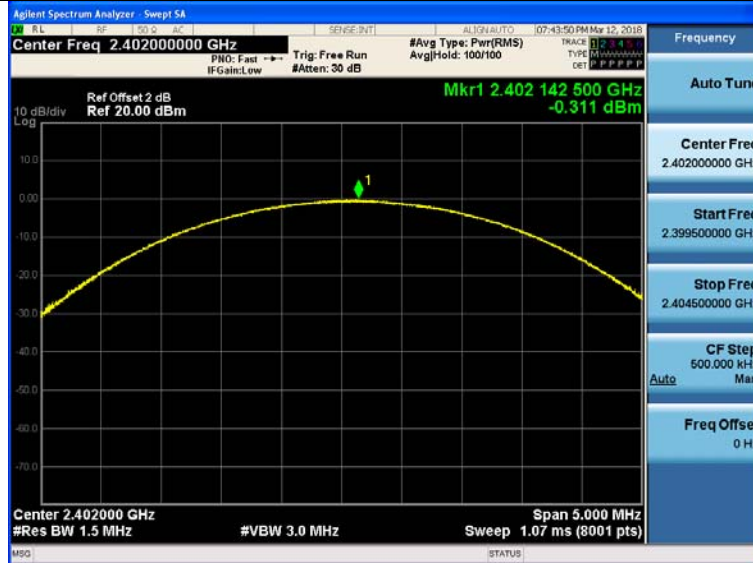

### CH00

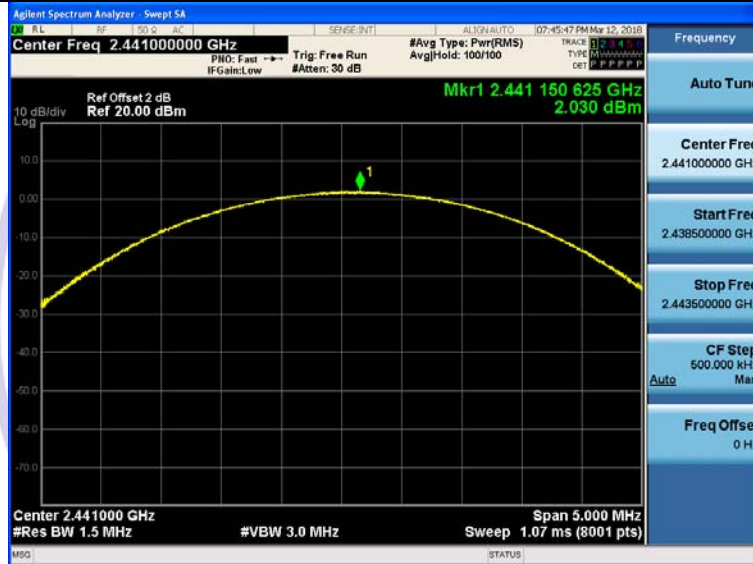

### CH39



### CH78

### 3.4. 20dB Bandwidth

#### Limit

For frequency hopping systems operating in the 2400MHz-2483.5MHz no limit for 20dB bandwidth.

#### Test Procedure

The transmitter output was connected to the spectrum analyzer through an attenuator. The bandwidth of the fundamental frequency was measured by spectrum analyzer with 30 KHz RBW and 100 KHz VBW.

The 20dB bandwidth is defined as the total spectrum the power of which is higher than peak power minus 20dB.

#### Test Configuration



#### Test Results

Modulation	Channel	20dB bandwidth (MHz)	99% OBW (MHz)	Result
GFSK	CH00	0.9747	0.90421	Pass
	CH39	0.9906	0.91528	
	CH78	0.9868	0.91848	
$\pi/4$ DQPSK	CH00	1.293	1.1824	
	CH39	1.305	1.1875	
	CH78	1.275	1.1846	
8DPSK	CH00	1.278	1.1783	
	CH39	1.280	1.1765	
	CH78	1.291	1.1792	

Test plot as follows:



GFSK Modulation

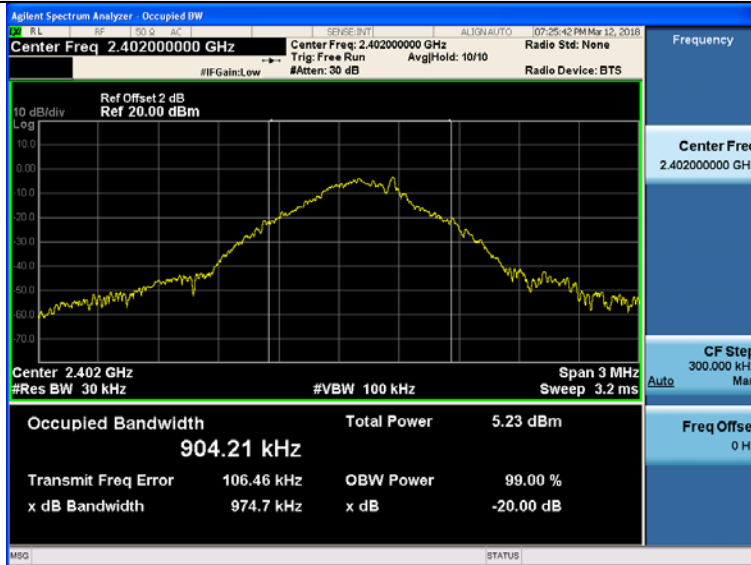

CH00

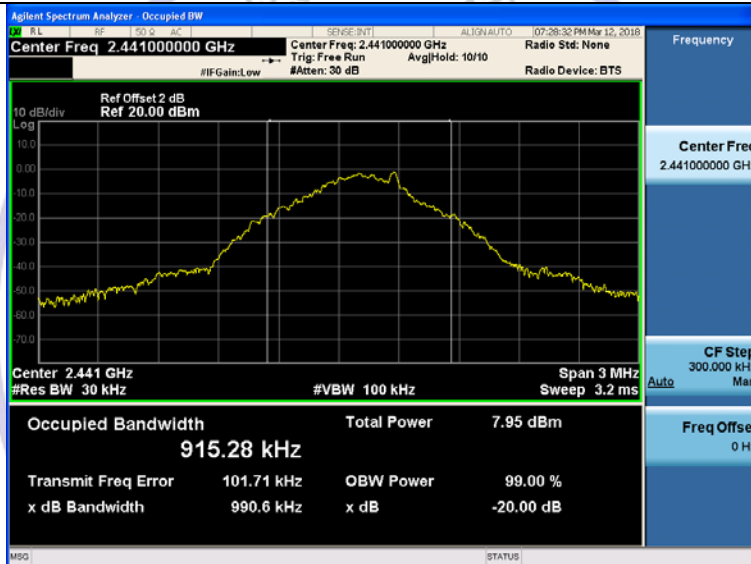

CH39

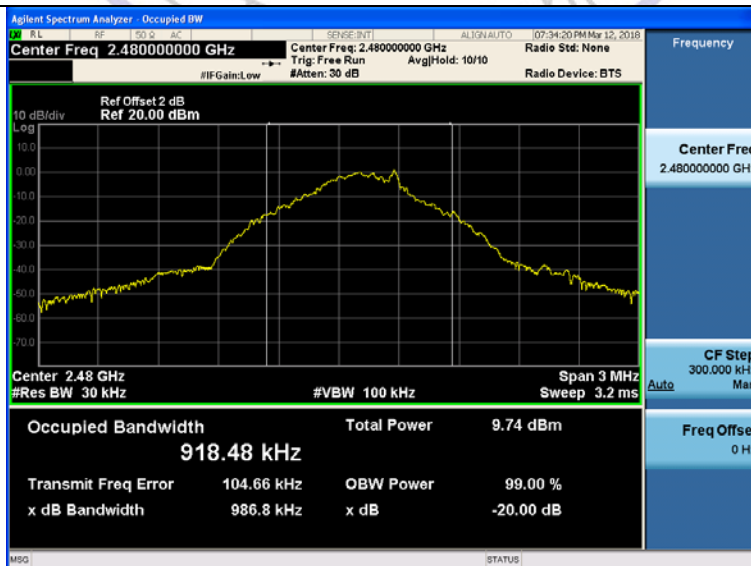

CH78

$\pi/4$ DQPSK Modulation

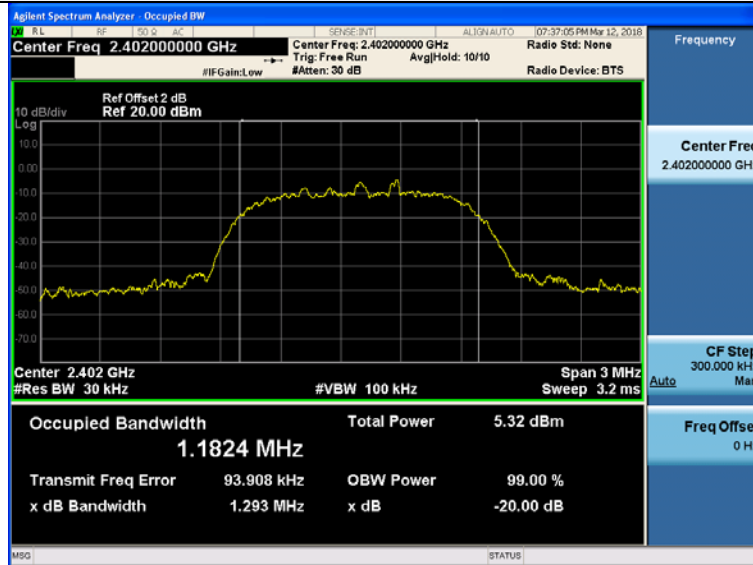

CH00

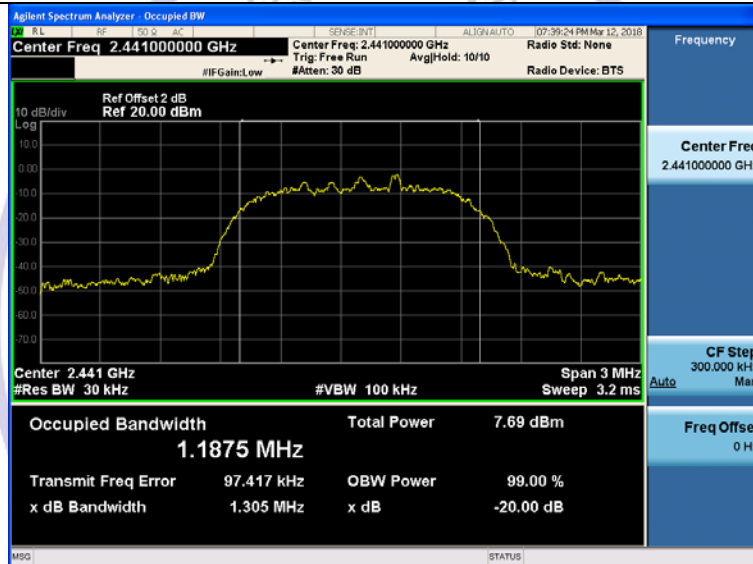

CH39

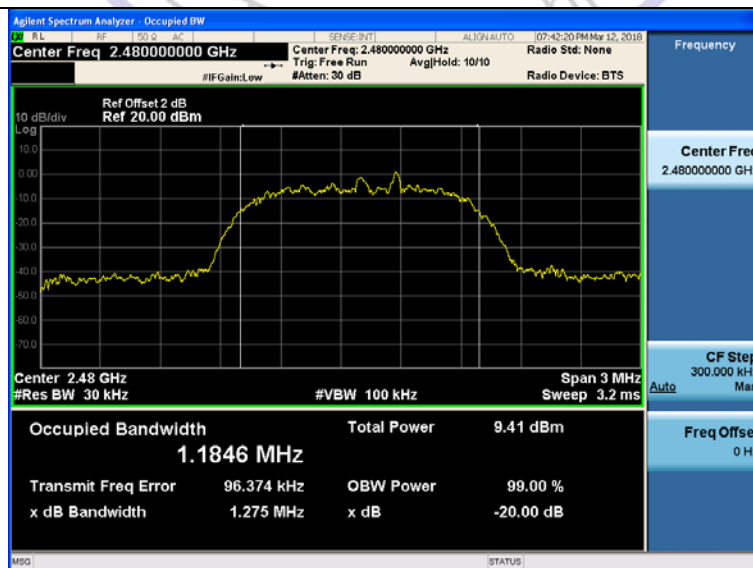

CH78

8DPSK Modulation

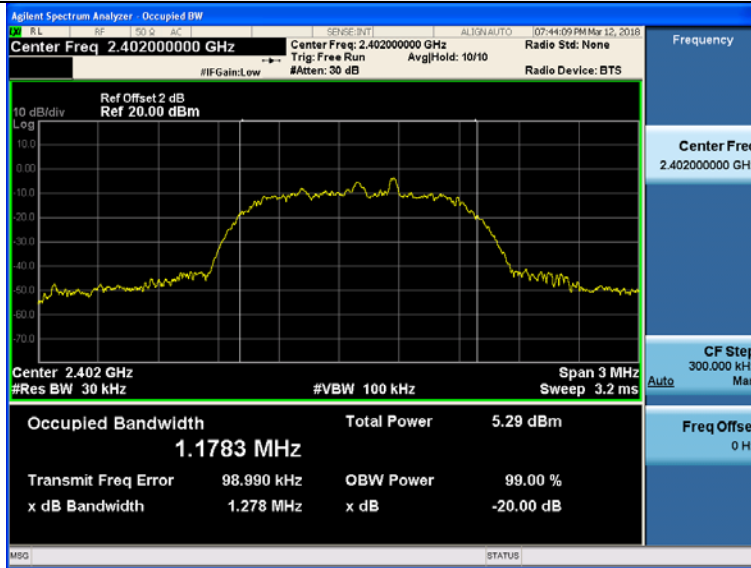

CH00

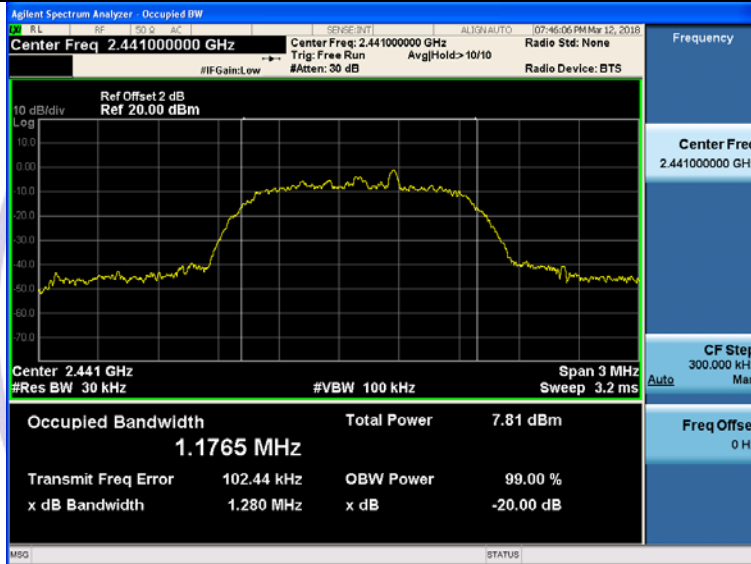

CH39

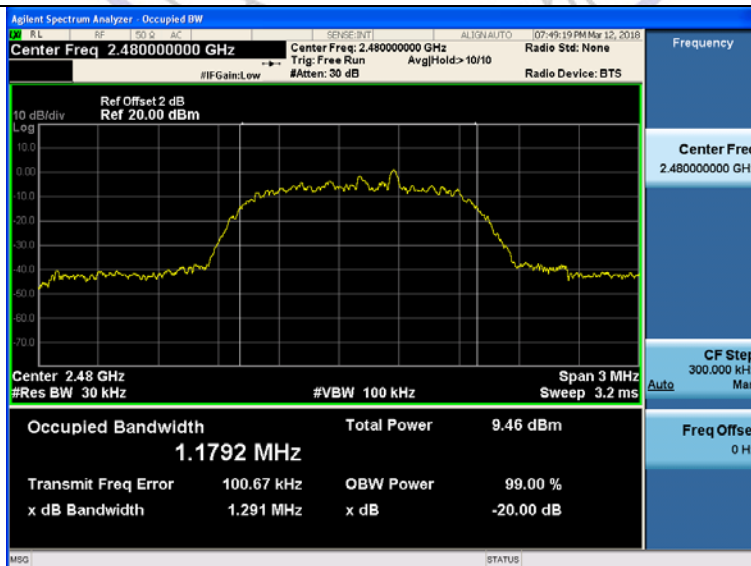

CH78

### 3.5. Frequency Separation

#### LIMIT

According to 15.247(a)(1), frequency hopping systems shall have hopping channel carrier frequencies separated by minimum of 25KHz or the  $2/3 \times 20\text{dB}$  bandwidth of the hopping channel, whichever is greater.

#### TEST PROCEDURE

The transmitter output was connected to the spectrum analyzer through an attenuator. The bandwidth of the fundamental frequency was measured by spectrum analyzer with 100 KHz RBW and 300 KHz VBW.

#### TEST CONFIGURATION



#### TEST RESULTS

Modulation	Channel	Channel Separation (MHz)	Limit(MHz)	Result
GFSK	CH39	1.133	25KHz or $2/3 \times 20\text{dB}$ bandwidth	Pass
	CH40			
$\pi/4$ DQPSK	CH39	1.038	25KHz or $2/3 \times 20\text{dB}$ bandwidth	Pass
	CH40			
8DPSK	CH39	1.035	25KHz or $2/3 \times 20\text{dB}$ bandwidth	Pass
	CH40			

Note:

We have tested all mode at high, middle and low channel, and recorded worst case at middle

Test plot as follows:

### GFSK Modulation



### $\pi/4$ DQPSK Modulation

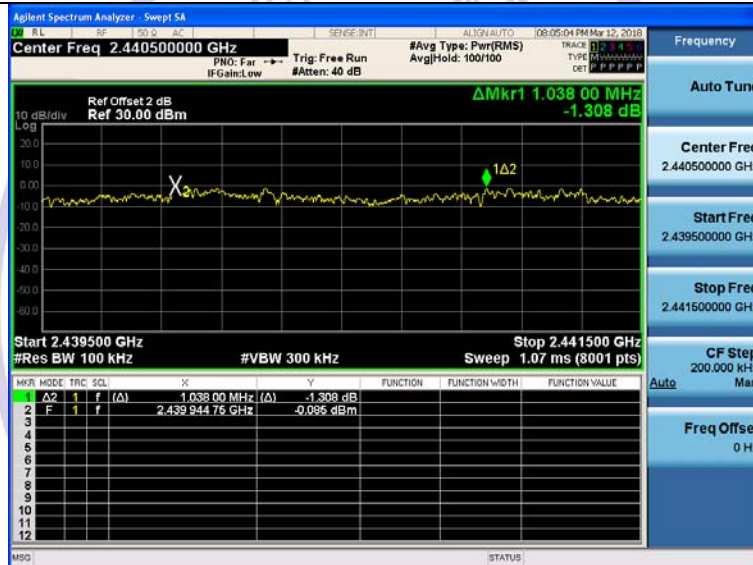

### 8DPSK Modulation



### 3.6. Number of hopping frequency

#### Limit

Frequency hopping systems in the 2400–2483.5 MHz band shall use at least 15 channels.

#### Test Procedure

The transmitter output was connected to the spectrum analyzer through an attenuator. Set spectrum analyzer start 2400MHz to 2483.5MHz with 100 KHz RBW and 300 KHz VBW.

#### Test Configuration

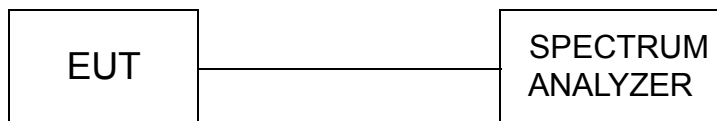

#### Test Results

Modulation	Number of Hopping Channel	Limit	Result
GFSK	79	≥15	Pass
$\pi/4$ DQPSK	79		
8DPSK	79		

#### Test plot as follows:

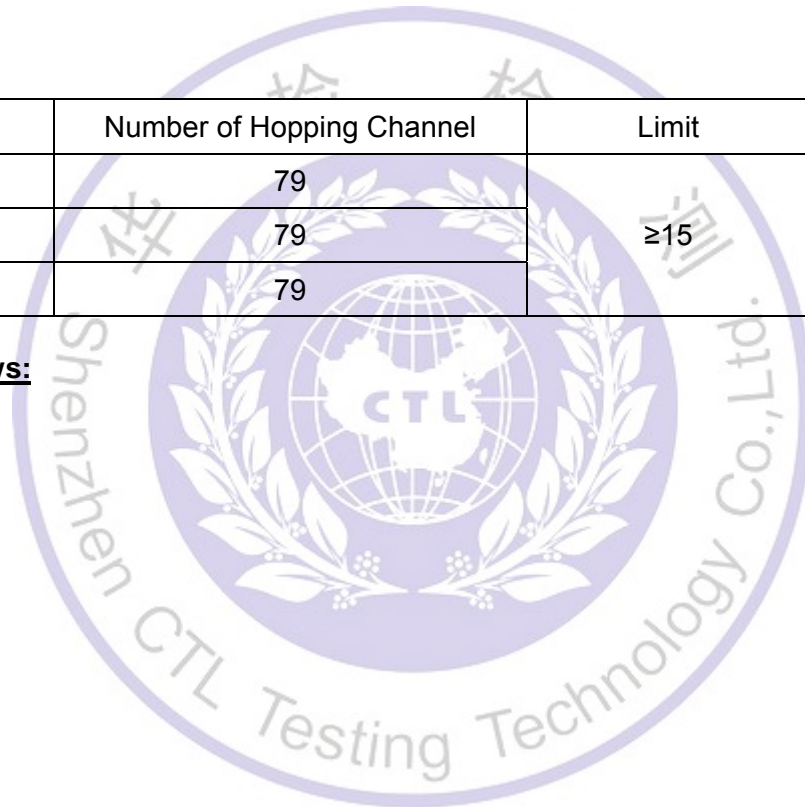

### GFSK Modulation

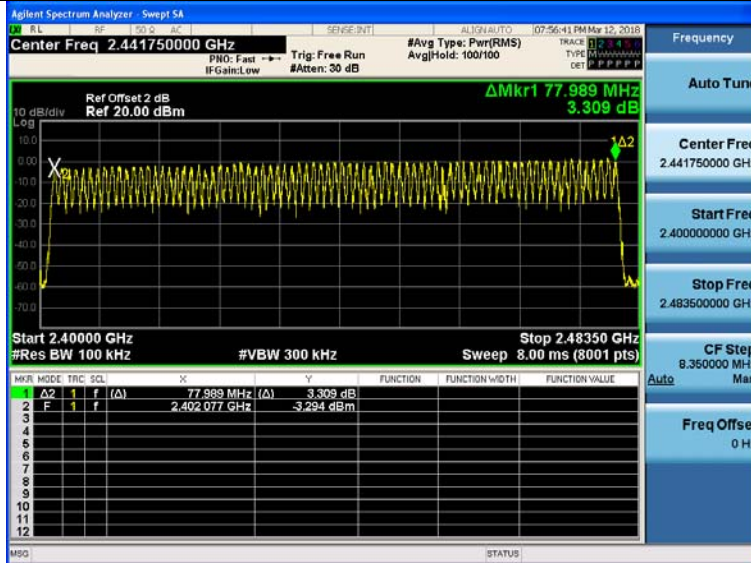

### $\pi/4$ DQPSK Modulation

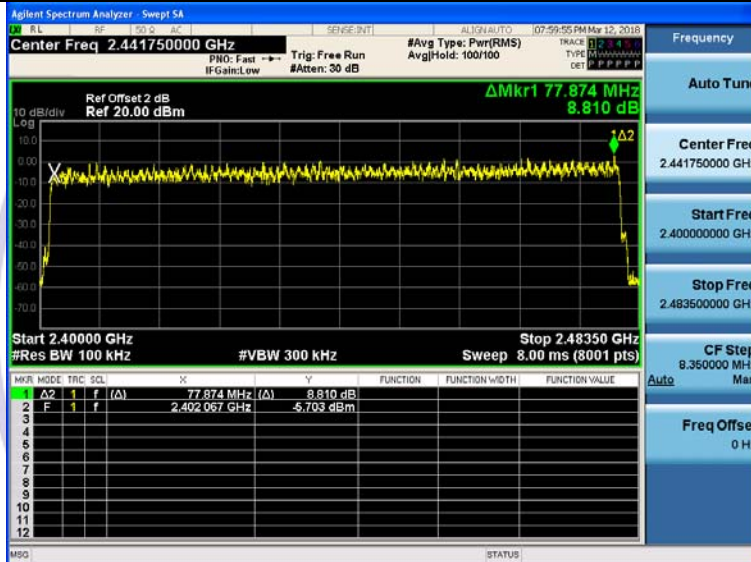

### 8DPSK Modulation

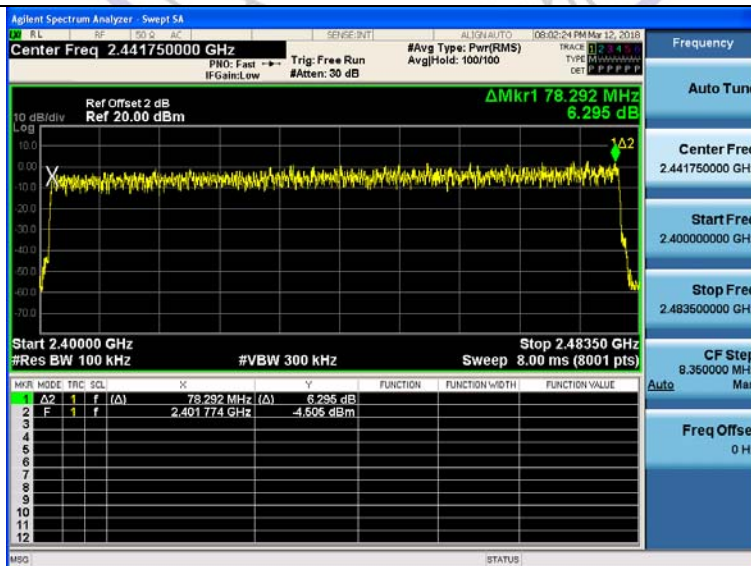

### 3.7. Time of Occupancy (Dwell Time)

#### Limit

The average time of occupancy on any channel shall not be greater than 0.4 seconds within a period of 0.4 seconds multiplied by the number of hopping channels employed.

#### Test Procedure

The transmitter output was connected to the spectrum analyzer through an attenuator. Set center frequency of spectrum analyzer=operating frequency with 1MHz RBW and 1MHz VBW, Span 0Hz.

#### Test Configuration

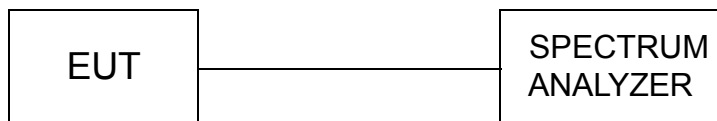

#### Test Results

Modulation	Packet	Pulse time (ms)	Dwell time (s)	Limit (s)	Result
GFSK	DH1	0.365	0.117	0.40	Pass
	DH3	1.620	0.259		
	DH5	2.886	0.308		
π/4DQPSK	2-DH1	0.382	0.122	0.40	Pass
	2-DH3	1.633	0.261		
	2-DH5	2.880	0.307		
8DPSK	3-DH1	0.385	0.123	0.40	Pass
	3-DH3	1.635	0.262		
	3-DH5	2.884	0.308		

Note:

- We have tested all mode at high,middle and low channel,and recoreded worst case at middle channel.
- $\text{Dwell time} = \text{Pulse time (ms)} \times (1600 \div 2 \div 79) \times 31.6 \text{ Second}$  for DH1, 2-DH1, 3-DH1  
 $\text{Dwell time} = \text{Pulse time (ms)} \times (1600 \div 4 \div 79) \times 31.6 \text{ Second}$  for DH3, 2-DH3, 3-DH3  
 $\text{Dwell time} = \text{Pulse time (ms)} \times (1600 \div 6 \div 79) \times 31.6 \text{ Second}$  for DH5, 2-DH5, 3-DH5

#### Test plot as follows:



GFSK Modulation

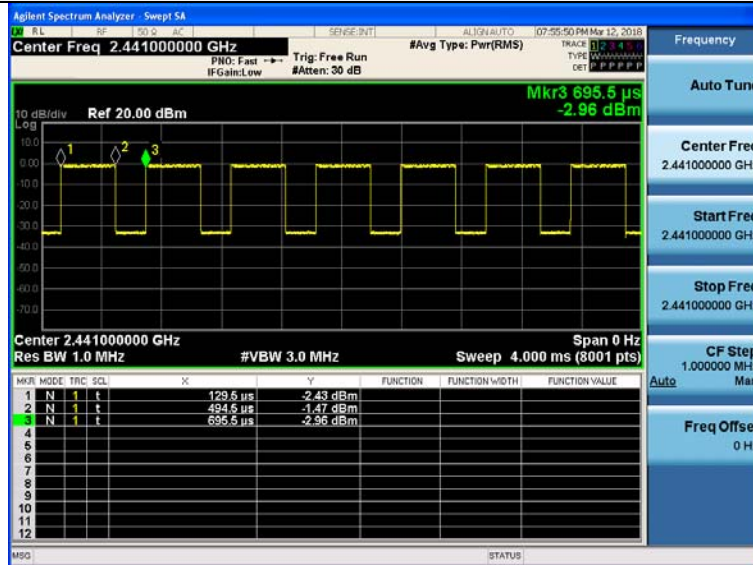

DH1

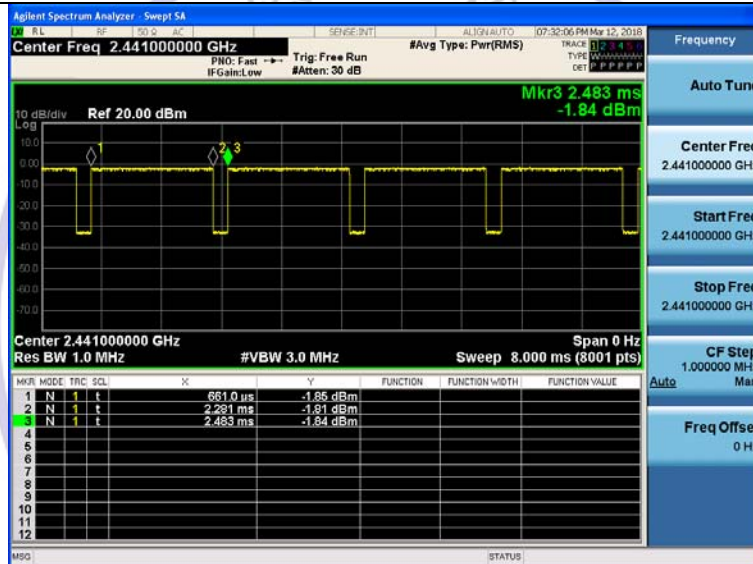

DH3

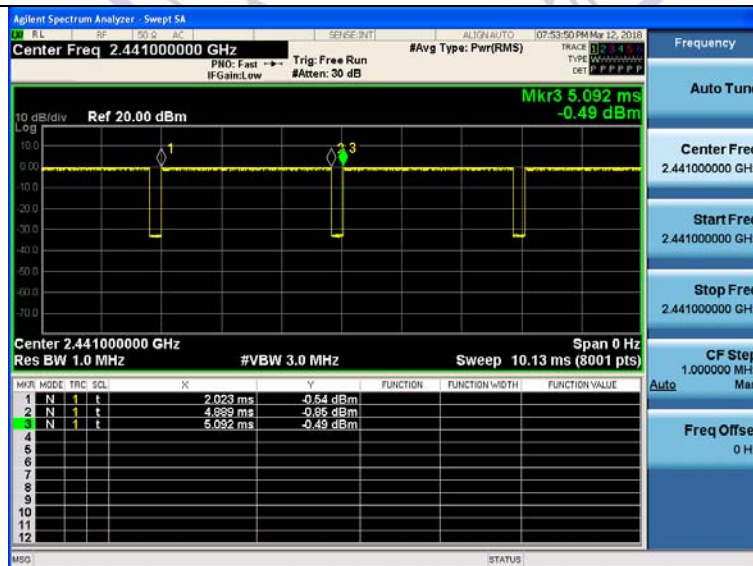

DH5

$\pi/4$ DQPSK Modulation

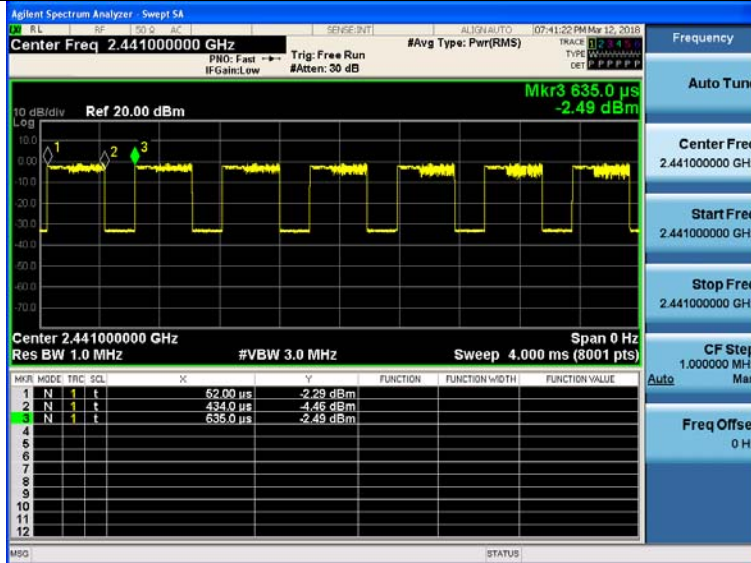

2-DH1

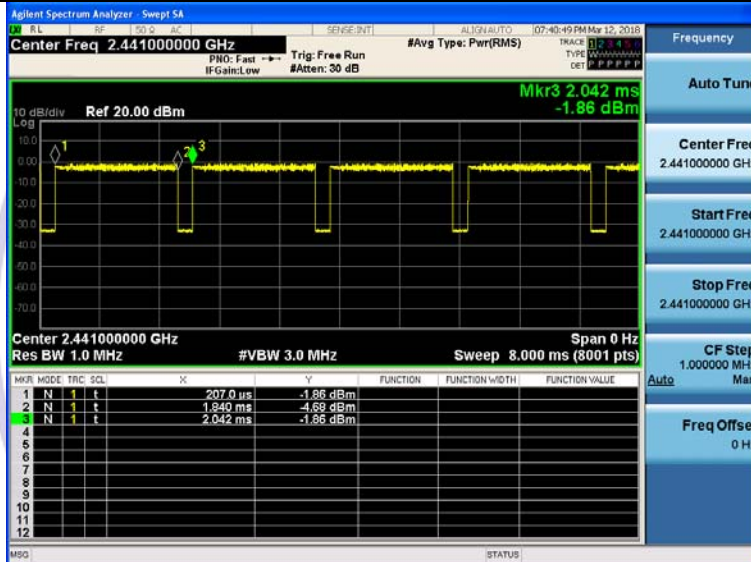

2-DH3

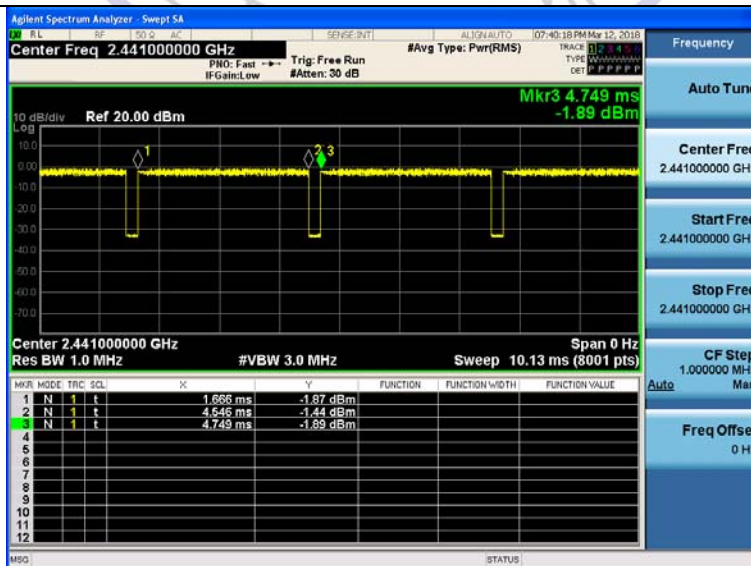

2-DH5

8DPSK Modulation

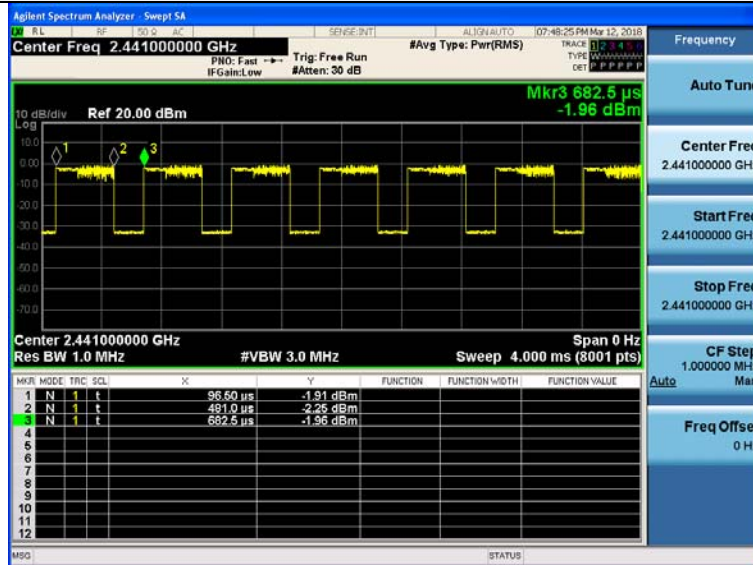

3-DH1

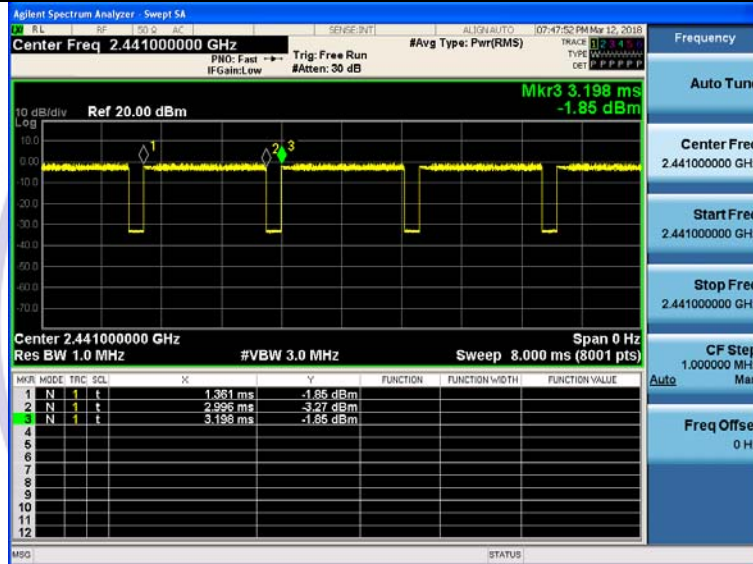

3-DH3

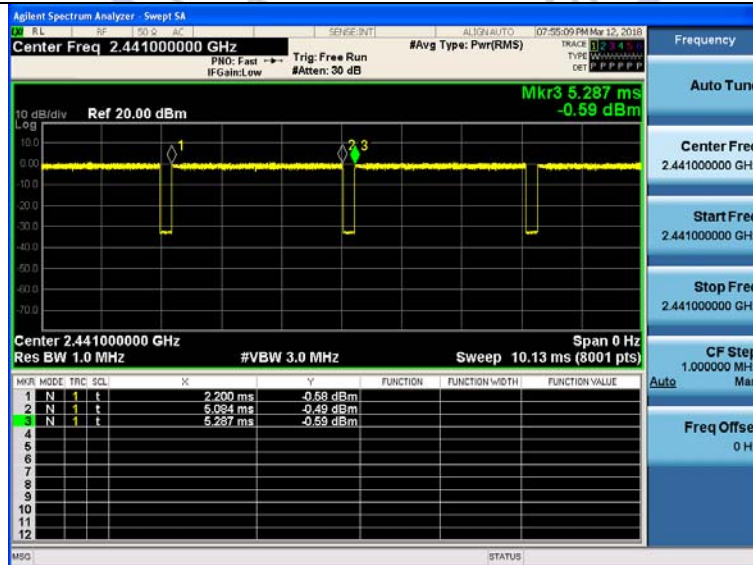

3-DH5

### 3.8. Out-of-band Emissions

#### Limit

In any 100 kHz bandwidth outside the frequency band in which the spread spectrum or digitally modulated intentional radiator is operating, the radio frequency power that is produced by the intentional radiator shall be at least 20 dB below that in the 100 kHz bandwidth within the band that contains the highest level of the desired power, based on either an RF conducted or a radiated measurement, provided the transmitter demonstrates compliance with the peak conducted power limits. If the transmitter complies with the conducted power limits based on the use of RMS averaging over a time interval, as permitted under paragraph (b)(3) of this section, the attenuation required under this paragraph shall be 30 dB instead of 20 dB. Attenuation below the general limits specified in §15.209(a) is not required.

#### Test Procedure

Connect the transmitter output to spectrum analyzer using a low loss RF cable, and set the spectrum analyzer to RBW=100 kHz, VBW= 300 kHz, peak detector, and max hold. Measurements utilizing these settings are made of the in-band reference level, band-edge and out-of-band emissions.

#### Test Configuration



#### Test Results

Remark: The measurement frequency range is from 30MHz to the 10th harmonic of the fundamental frequency. The lowest, middle and highest channels are tested to verify the spurious emissions and band-edge measurement data.

We measured all conditions (DH1, DH3, DH5) and recorded worst case at DH5

Test plot as follows:



GFSK CH78



$\pi/4$ DQPSK CH00



Reference

Reference

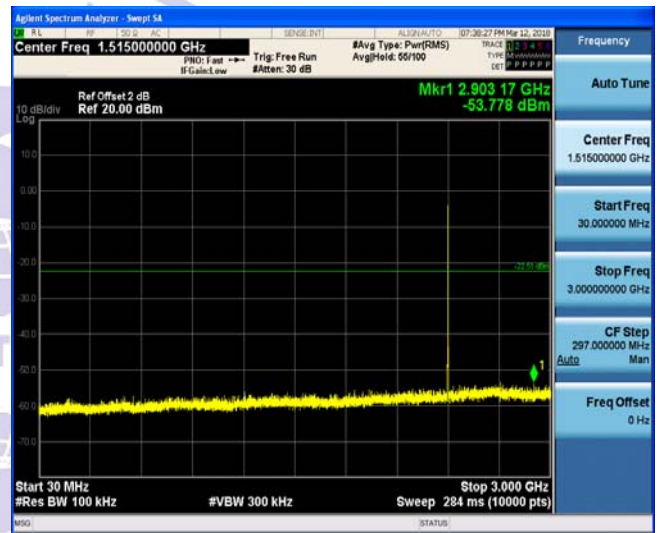
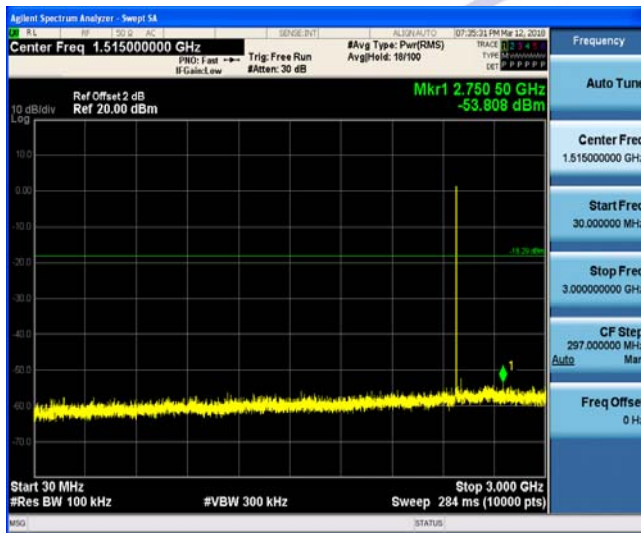

30MHz-3GHz

30MHz-3GHz

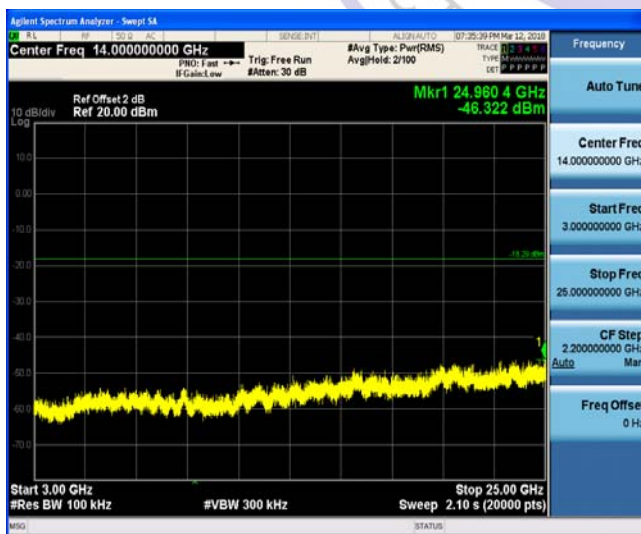

3GHz-25GHz

3GHz-25GHz

$\pi/4$ DQPSK CH39



$\pi/4$ DQPSK CH78



Reference

Reference

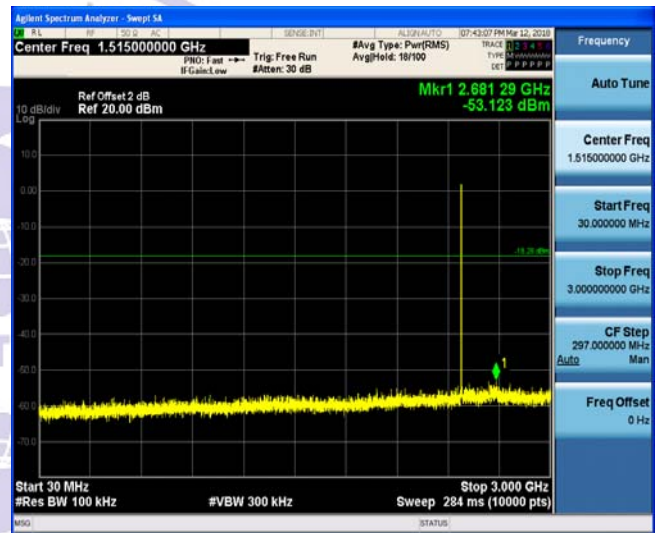
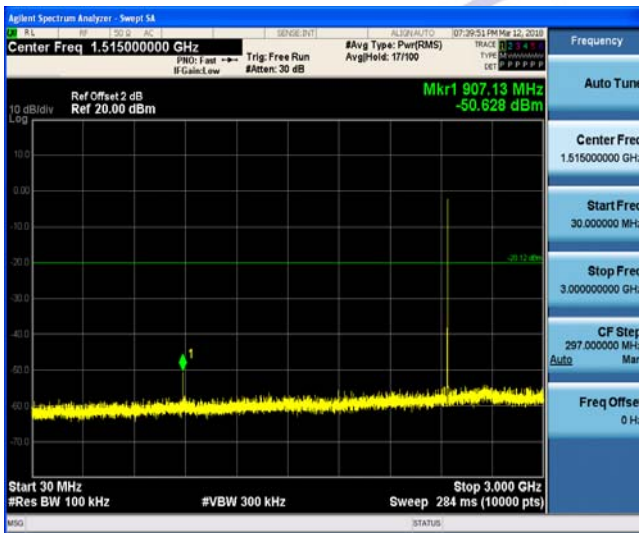

30MHz-3GHz

30MHz-3GHz

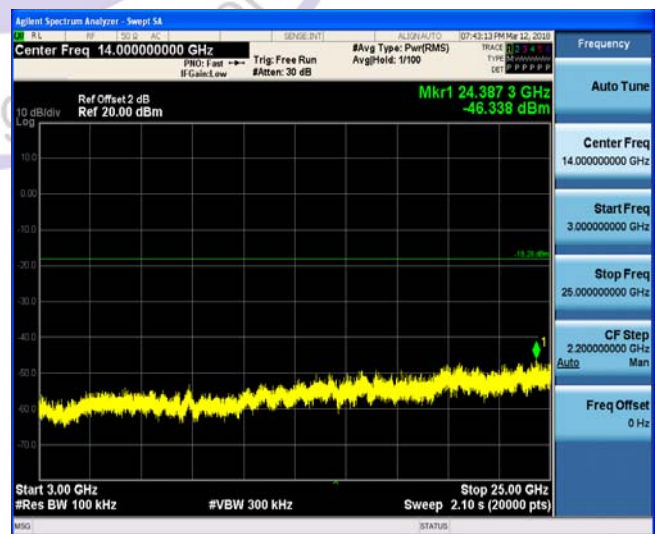
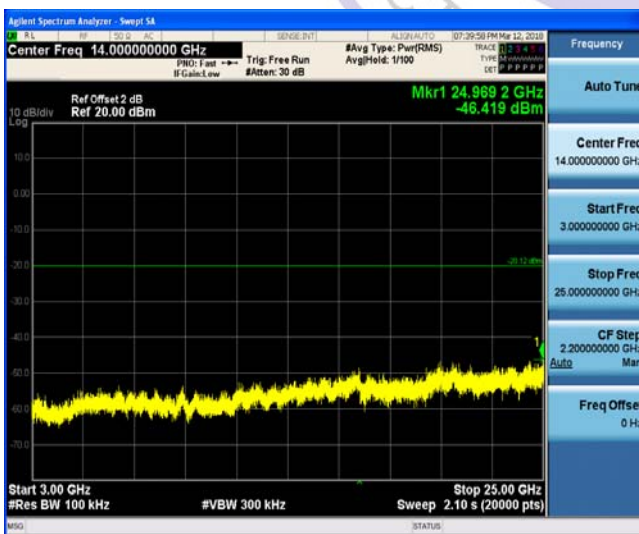

3GHz-25GHz

3GHz-25GHz

8DPSK CH00



8DPSK CH39



Reference

Reference

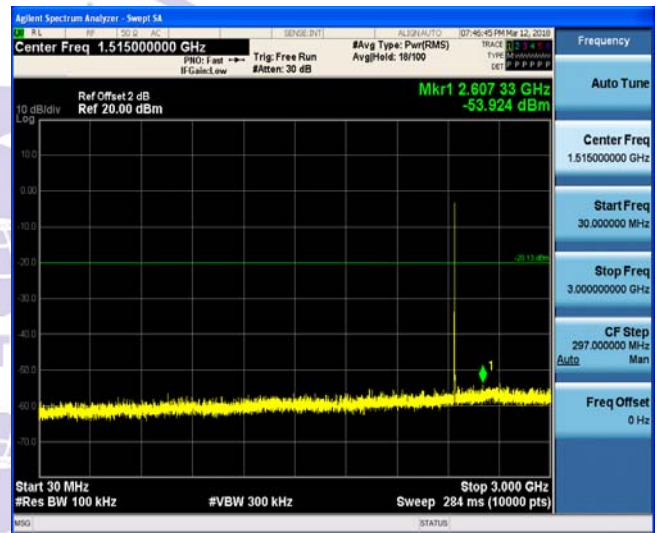
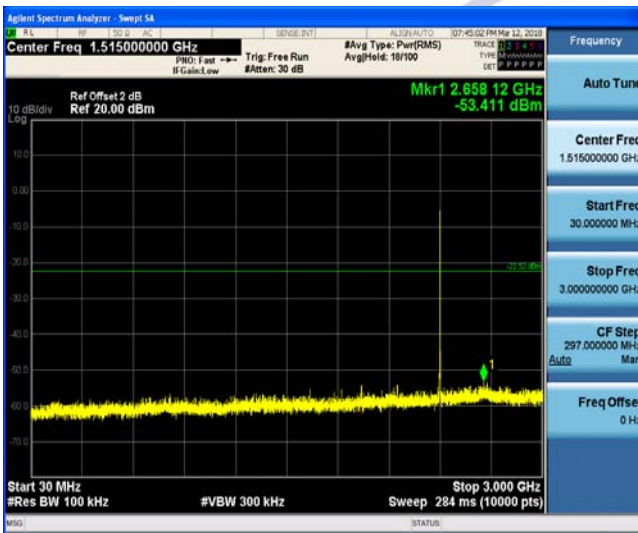

30MHz-3GHz

30MHz-3GHz

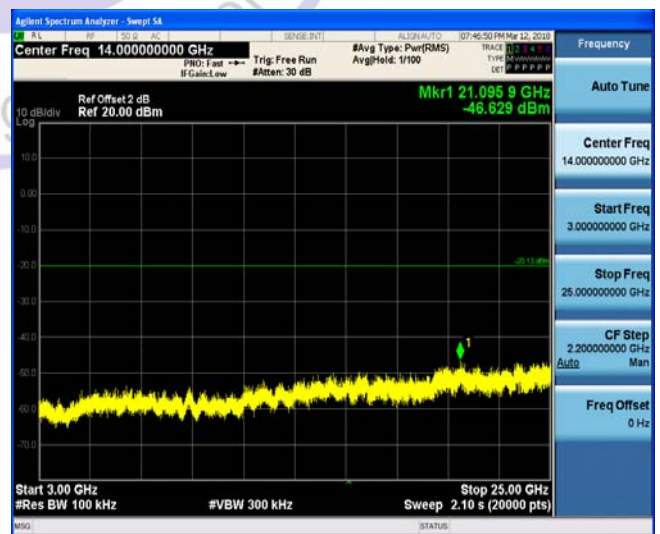
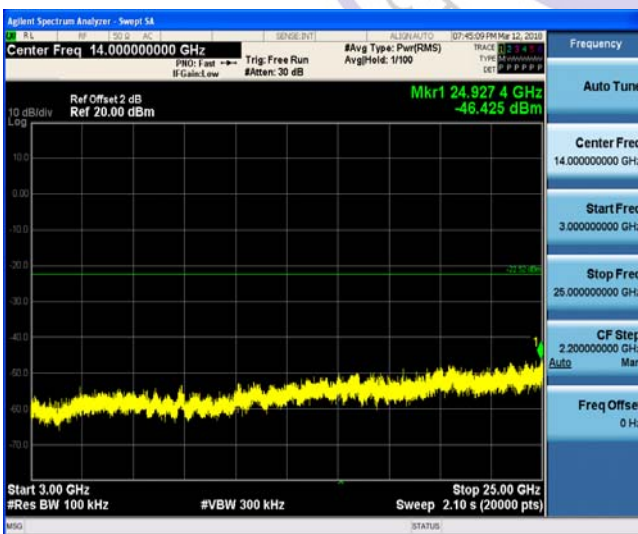

3GHz-25GHz

3GHz-25GHz



### 8DPSK CH78



Reference

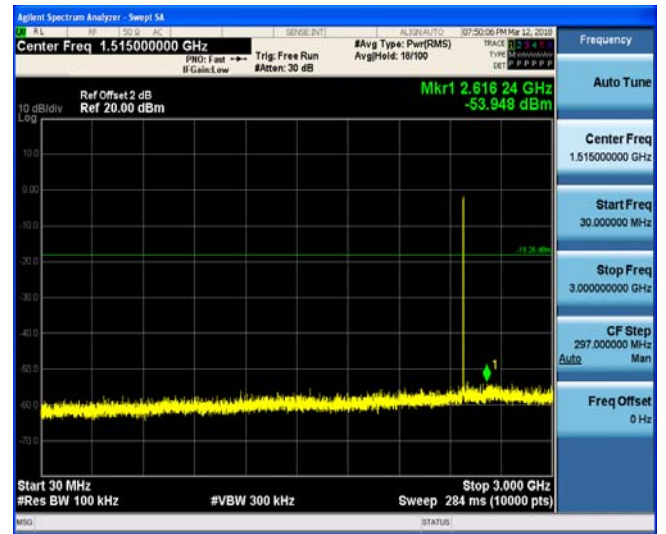

30MHz-3GHz

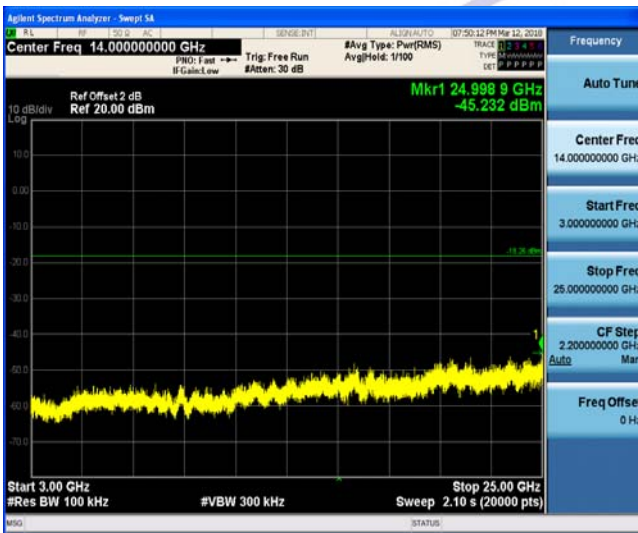

3GHz-25GHz

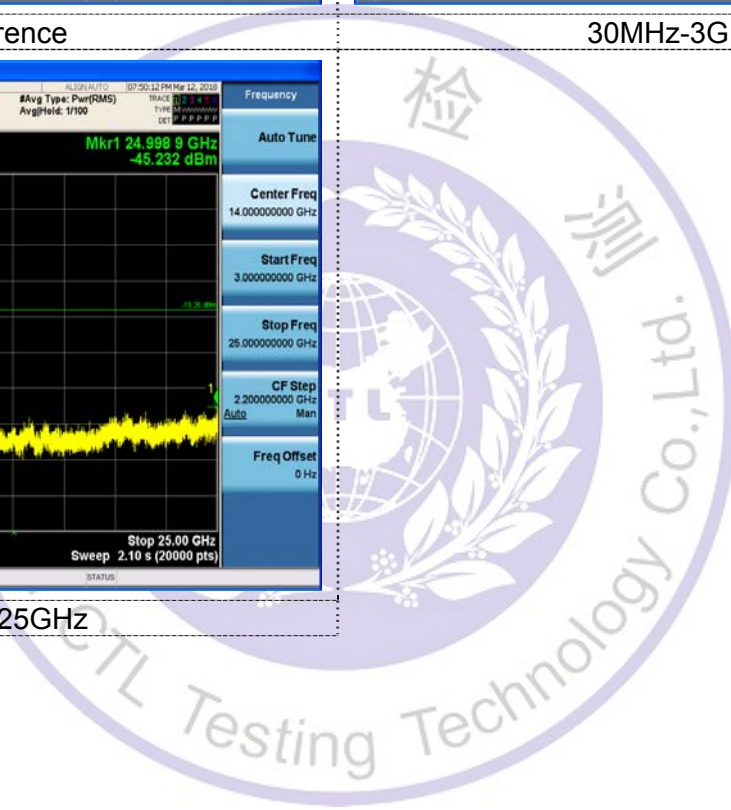

Band-edge Measurements for RF Conducted Emissions:

GFSK

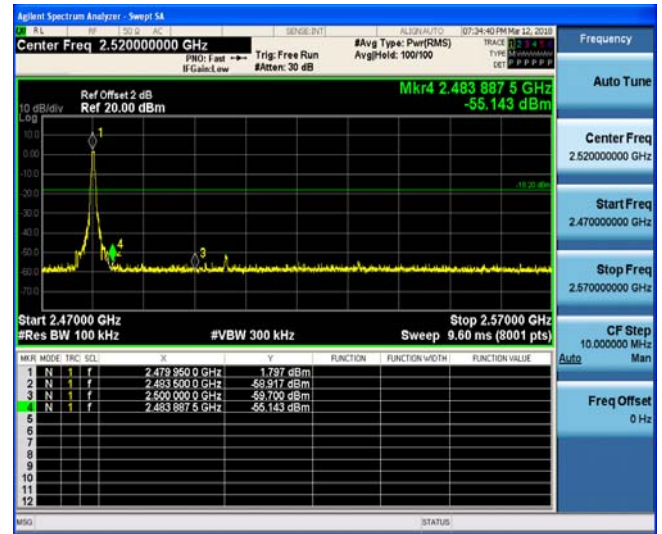
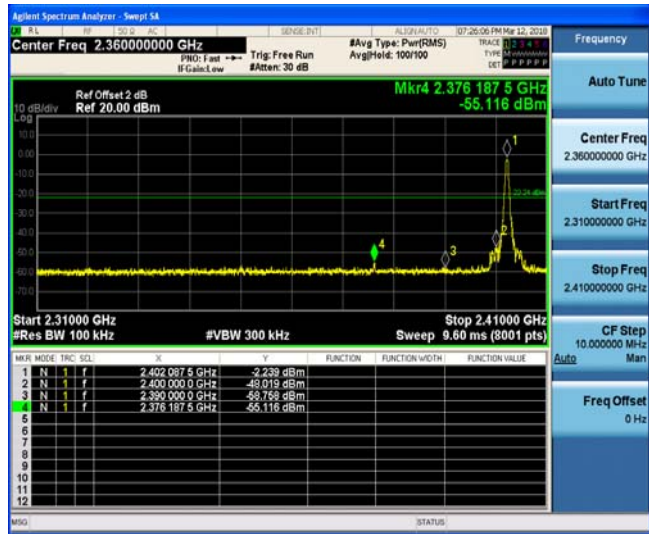

Left Band edge hopping off

Right Band edge hopping off

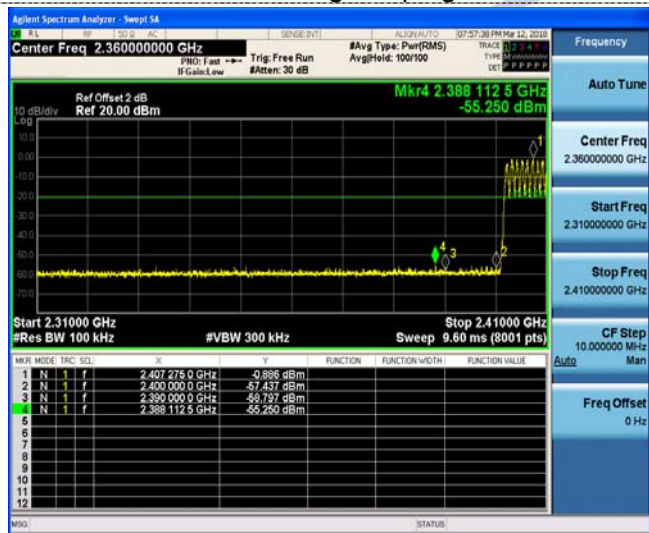

Left Band edge hopping on

Right Band edge hopping on

$\pi$ /4DQPSK

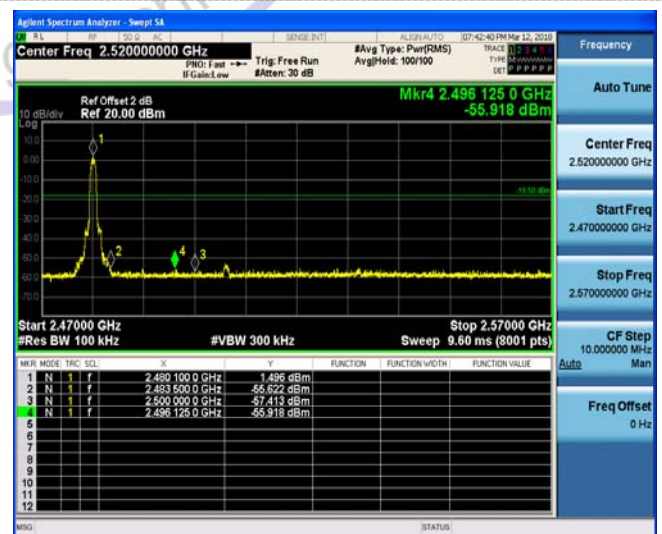

Left Band edge hopping off

Right Band edge hopping off

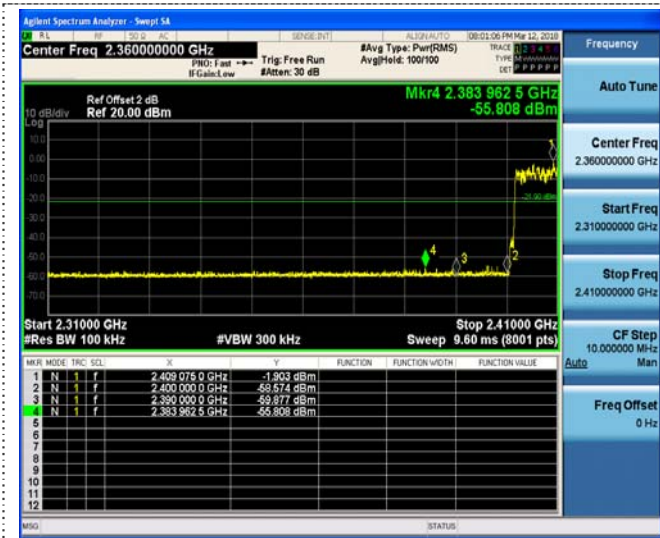

Left Band edge hopping on

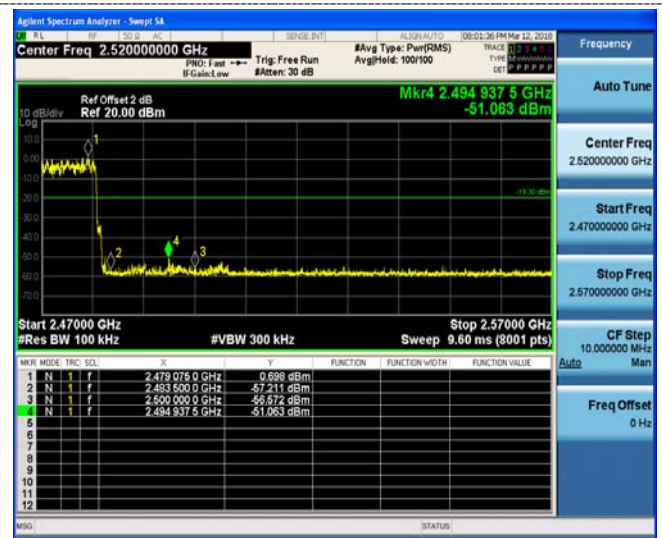

Right Band edge hopping on

8DPSK



Left Band edge hopping off

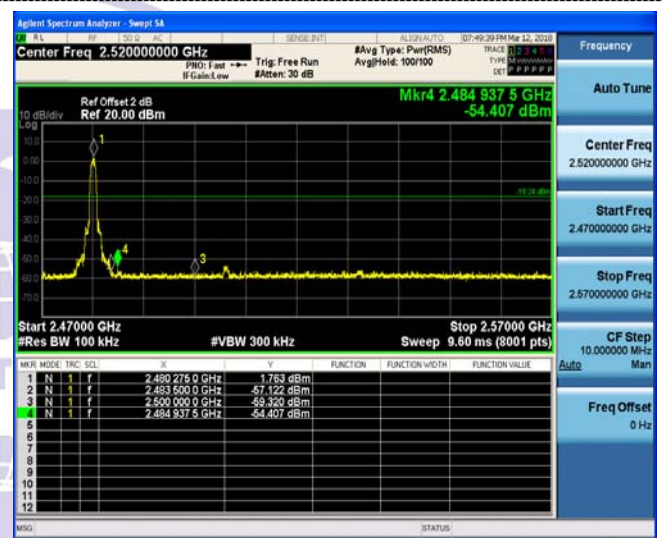

Right Band edge hopping off

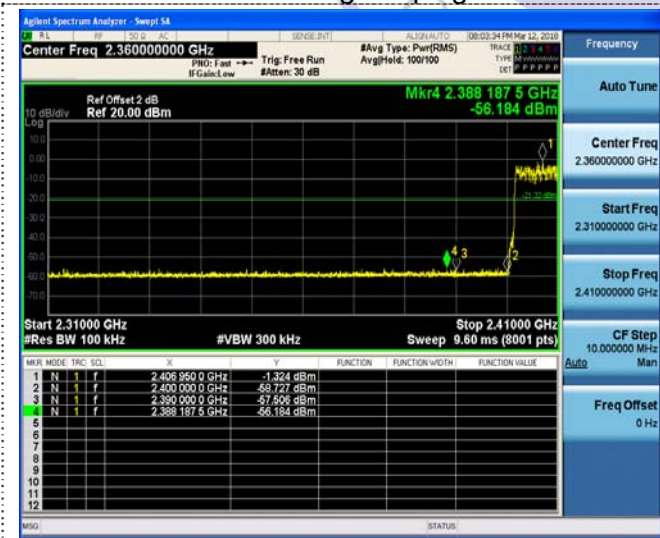

Left Band edge hopping on

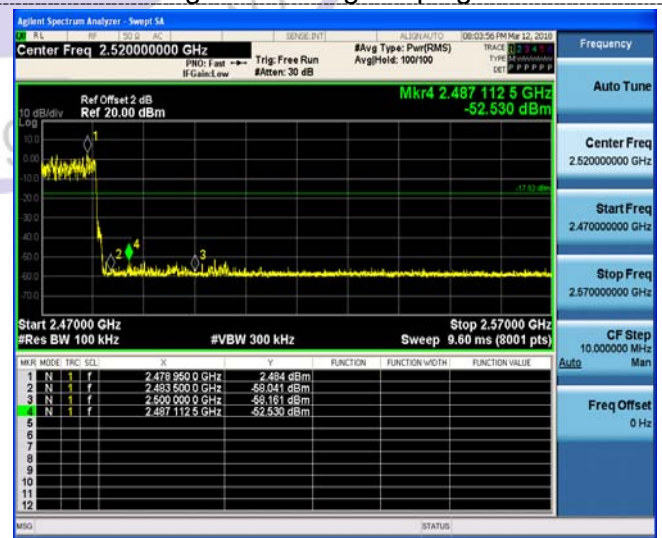

Right Band edge hopping on

### 3.9. Pseudorandom Frequency Hopping Sequence

#### TEST APPLICABLE

**For 47 CFR Part 15C section 15.247 (a) (1) requirement:**

Frequency hopping systems shall have hopping channel carrier frequencies separated by a minimum of 25 kHz or the 20 dB bandwidth of the hop-ping channel, whichever is greater. Alternatively, frequency hopping systems operating in the 2400–2483.5 MHz band may have hopping channel carrier frequencies that are separated by 25 kHz or two-thirds of the 20 dB bandwidth of the hopping channel, whichever is greater, provided the systems operate with an output power no greater than 125 mW. The system shall hop to channel frequencies that are selected at the system hopping rate from a pseudo randomly ordered list of hopping frequencies. Each frequency must be used equally on the average by each transmitter. The system receivers shall have input bandwidths that match the hop-ping channel bandwidths of their corresponding transmitters and shall shift frequencies in synchronization with the transmitted signals.

#### EUT Pseudorandom Frequency Hopping Sequence Requirement

The pseudorandom frequency hopping sequence may be generated in a nine-stage shift register whose 5<sup>th</sup> and 9<sup>th</sup> stage outputs are added in a modulo-two addition stage. And the result is fed back to the input of the first stage. The sequence begins with the first one of 9 consecutive ones, for example: the shift register is initialized with nine ones.

- Number of shift register stages:9
- Length of pseudo-random sequence:29-1=511 bits
- Longest sequence of zeros:8(non-inverted signal)

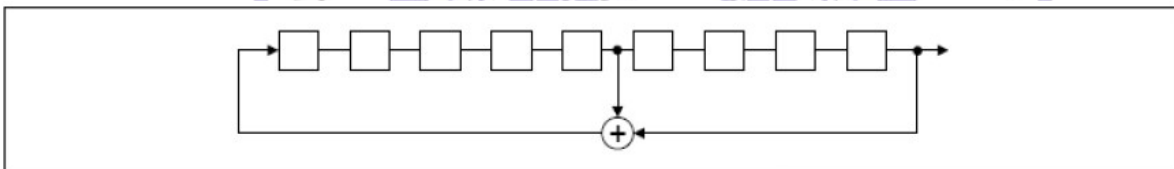

*Linear Feedback Shift Register for Generation of the PRBS sequence*

An example of pseudorandom frequency hopping sequence as follows:

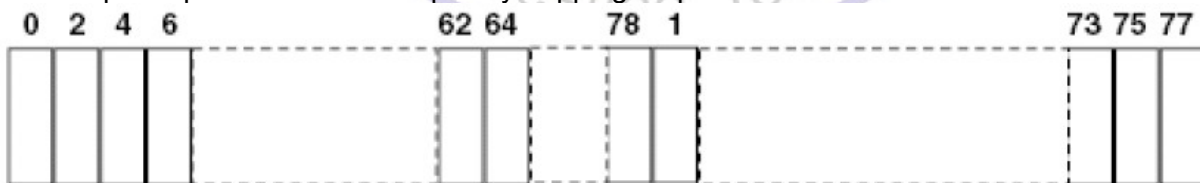

Each frequency used equally one the average by each transmitter.

The system receiver have input bandwidths that match the hopping channel bandwidths of their corresponding transmitter and shift frequencies in synchronization with the transmitted signals.

### 3.10. Antenna Requirement

#### Standard Applicable

For intentional device, according to FCC 47 CFR Section 15.203, an intentional radiator shall be designed to ensure that no antenna other than that furnished by the responsible party shall be used with the device.

And according to FCC 47 CFR Section 15.247 (c), if transmitting antennas of directional gain greater than 6dBi are used, the power shall be reduced by the amount in dB that the directional gain of the antenna exceeds 6dBi.

#### **Refer to statement below for compliance**

The manufacturer may design the unit so that the user can replace a broken antenna, but the use of a standard antenna jack or electrical connector is prohibited. Further, this requirement does not apply to intentional radiators that must be professionally installed.

#### Antenna Connected Construction

The maximum gain of antenna was 0dBi.

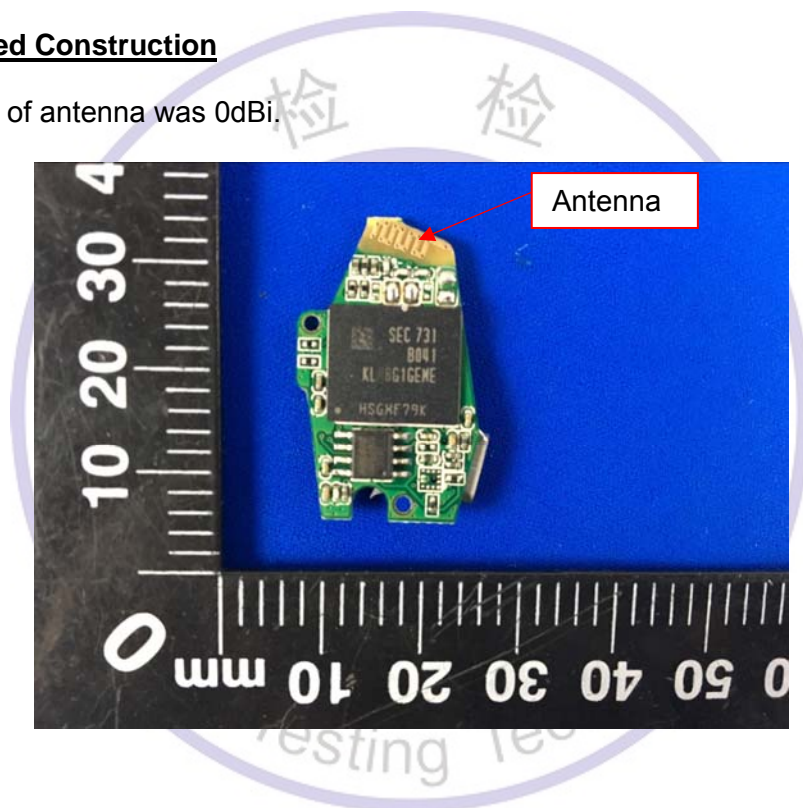

### 4. Test Setup Photos of the EUT

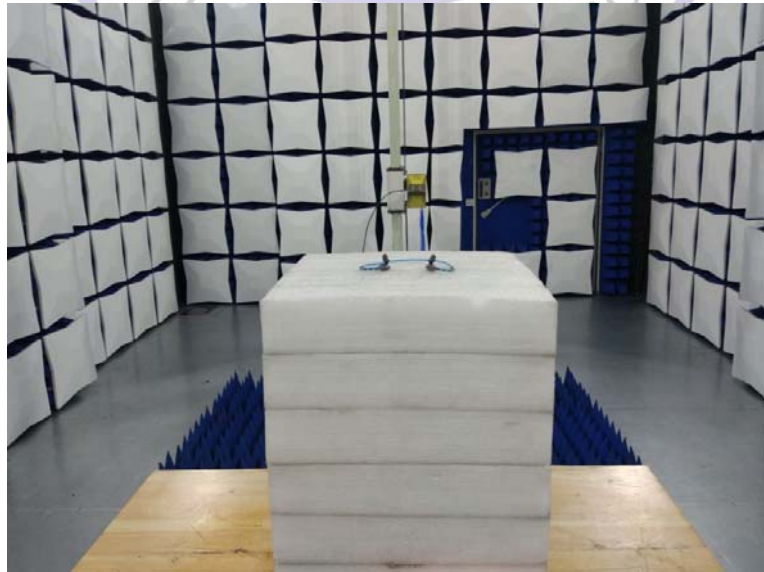
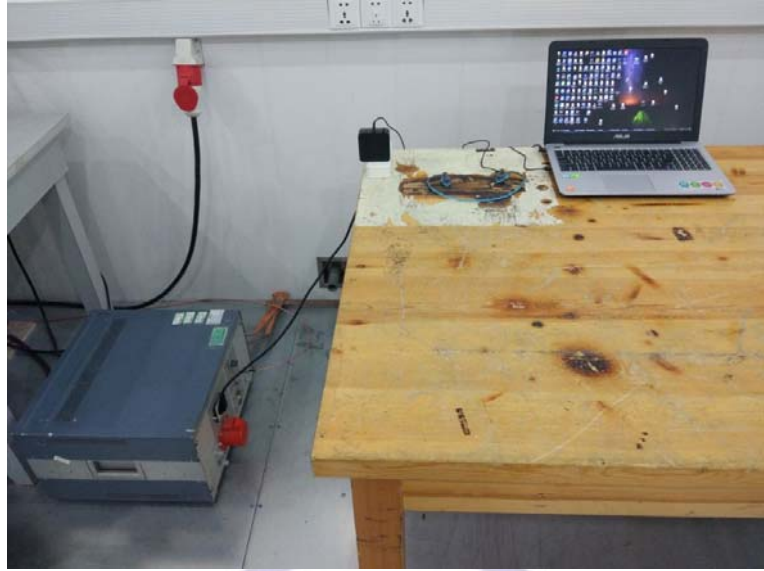

## 5. Photos of the EUT

### External Photos of EUT



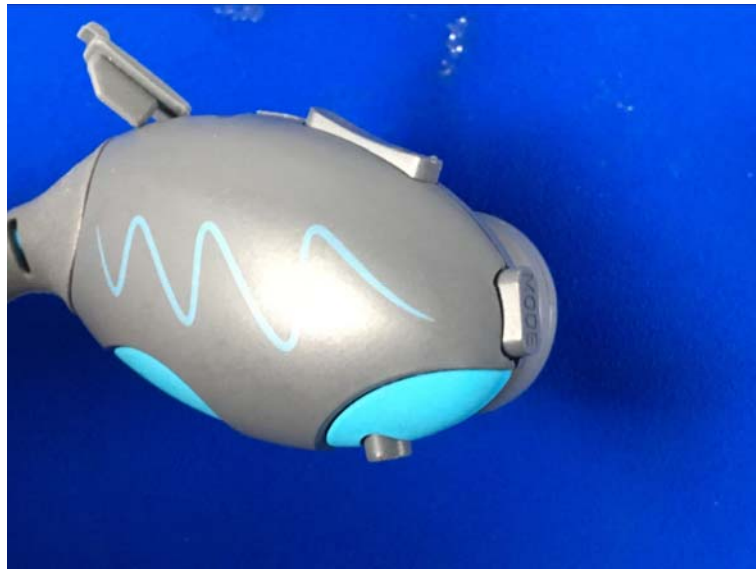



**Internal Photos of EUT**

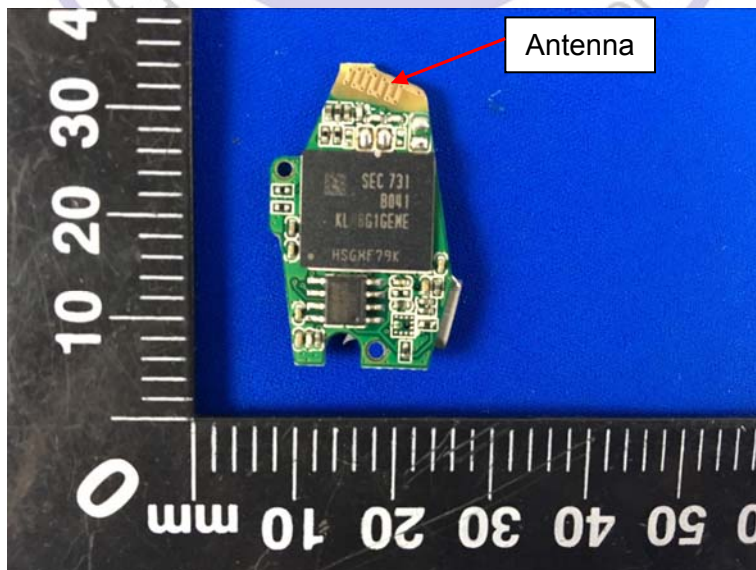
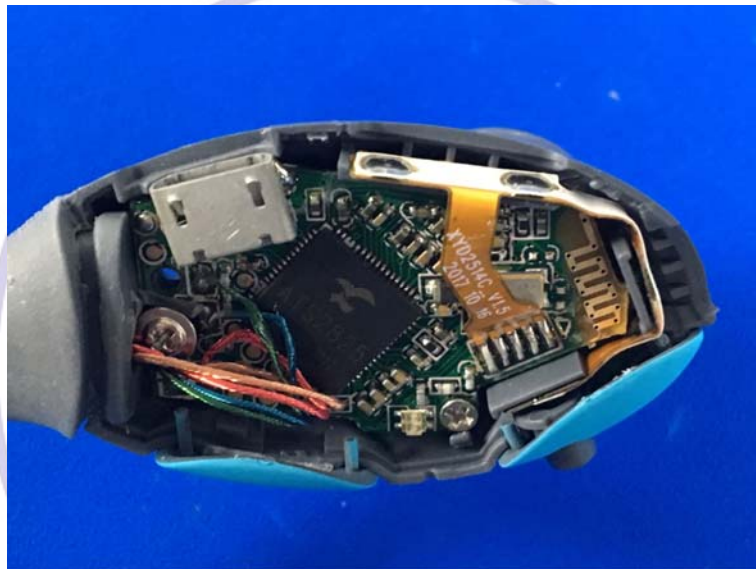

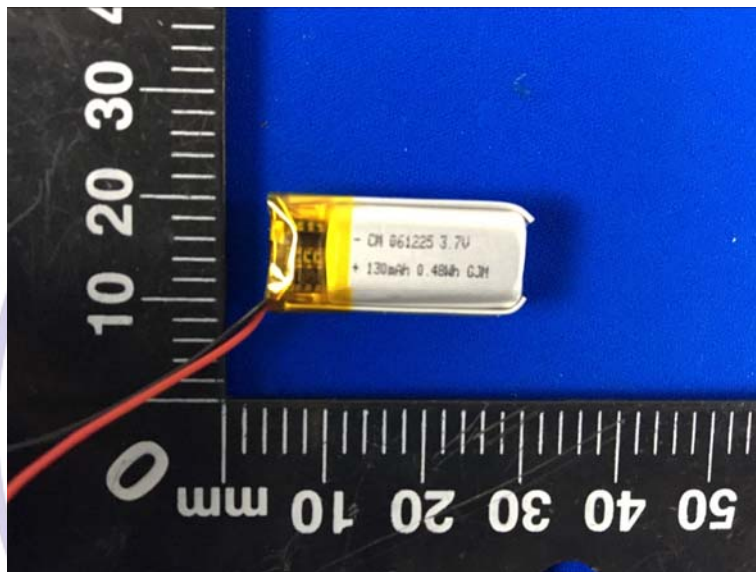
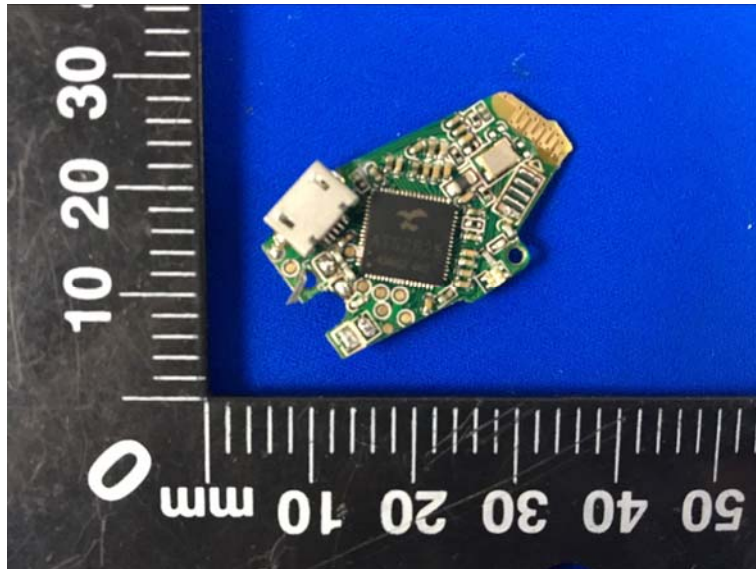

\*\*\*\*\* End of Report \*\*\*\*\*

