

User Manual

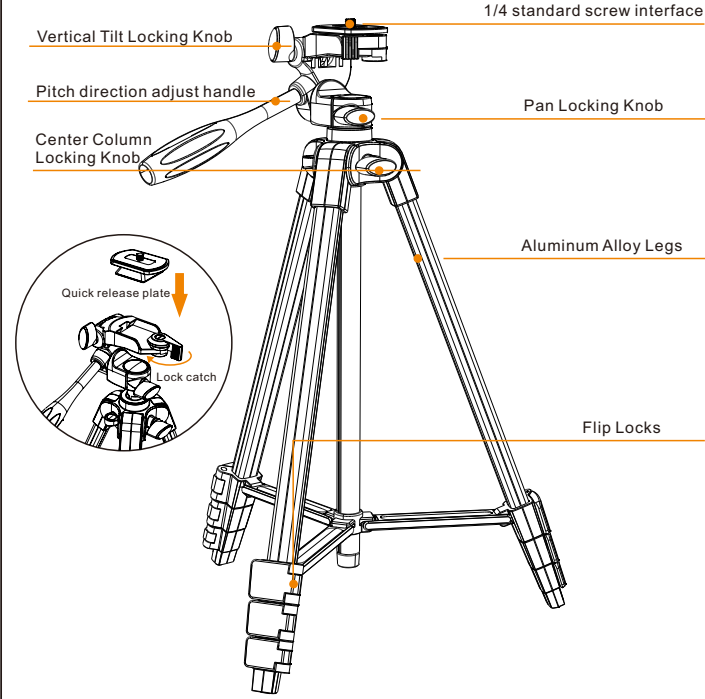

Remote Shutter Instructions

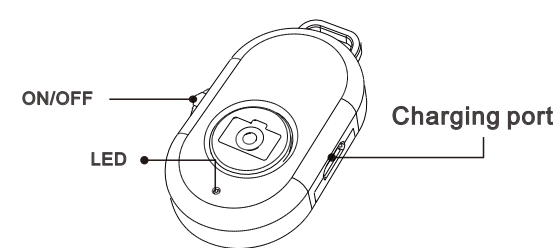

About wireless connection

1. Turn on the remote control switch, the blue light flashes and enter into the pairing state.
2. Turn on the phone wireless and search for "LQ-001" to pair.
3. After the pairing is successful, turn on the camera function of the mobile phone and short press to take the photo.
4. No operation more than 2 minutes in the connected state, the remote control will enter into the sleep state. Please restart the remote control switch for the next time using, the remote control will automatically connect to the mobile phone.
5. The indicator light is red when the remote control is charging, and the indicator light will turn off after it is full charged.

Parameter

Model: LQ-001
 Material: Aluminum alloy and ABS
 Folded length : 16.5in
 Maximum height: 54 in
 Loading capacity: 4.4 lbs

Photography tripod introduction

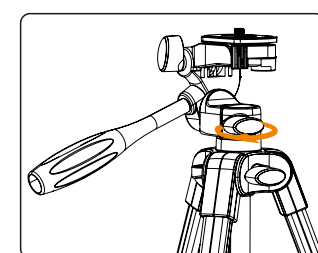
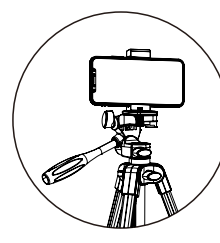
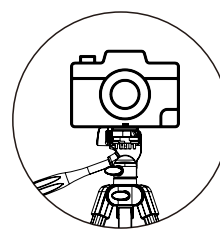

1. Panorama Shot: Rotate the Pan Locking Knob counter-clockwise and move the handle for smooth 360° panorama shot.

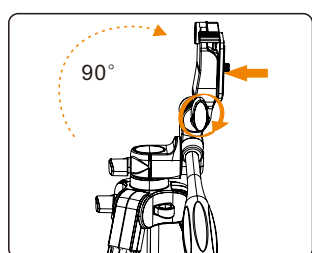

2. The platform plate usage: loosen the vertical tilt lock knob to reach the 90 degree of the platform.

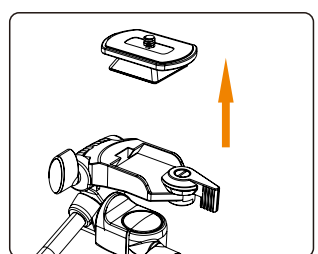

3. Open the lock catch and take off the quick release plate from the device or the quick release plate from the device.

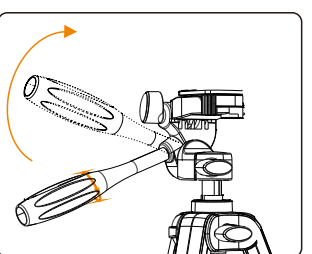

4. Pitch angle adjust: Rotate the handle counter-clockwise and tilt that in head, allow maximum 90° for vertical use. Clockwise rotate the handle to lock.

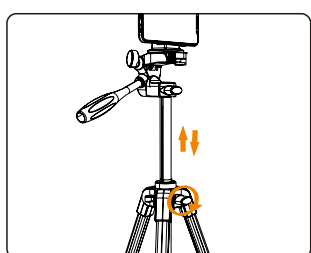

5. Adjust the tripod leg up and down, fix the tripod leg by rotating the screw clockwise (counterclockwise loosened).

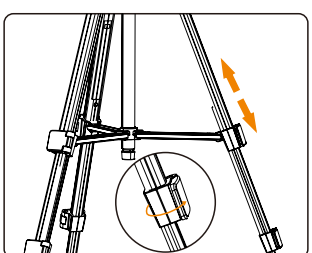

6. Extending the legs: Flip open the leg lock lever and gently pull on the leg segment to the desired length.

Cellphone Assemble Instruction

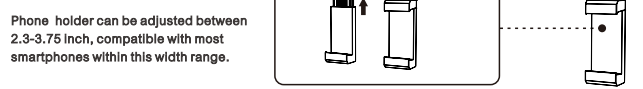

Phone holder can be adjusted between 2.2-3.1 inch, compatible with most smartphones within this width range.

1. Take out the tripod and phone holder
2. Open the lock catch and take off the quick release plate
3. Tighten the buckle under the quick release plate to fit the phone holder
4. Put the quick release plate with the phone clip installed back into the card slot and lock it.
5. Mount your phone into Phone holder
6. Adjust the tripod to the desired angle and enjoy your shooting

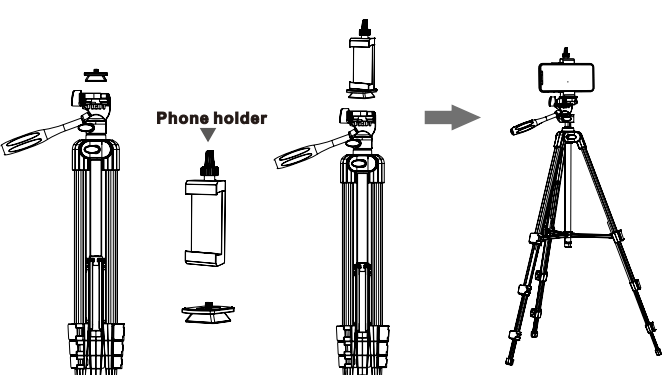

Notice:

1. When you receive this product, please check that everything is complete.
2. Completely unfold the tripod when using it, make sure every lock knob is fixed and locked, avoid accidental damage to mobile phones and other electronic products.
3. Do not use a tripod in an unstable place.

4. When you change the photography scene, you must remove the electronic equipment from the tripod.
5. Avoid using at temperatures under -22°F or over 158°F.
6. Please pay attention to cleaning after use, especially after use in wet and sandy places. Not suitable for use in sea water.
7. The tripod is equipped with a safe load. Do not load equipment that exceeds 4.4 lbs to avoid damage to the stability of the tripod then affect the photographic effect.
8. The tripod is made of conductive material. For safety, please do not use it in dangerous places such as lightning weather or near the high voltage lines

Package Includes:

- Tripod*1
- Phone Holder*1
- Remote Control*1
- USB charging cable*1
- Tripod Carry Bag*1
- User Manual*1

FCC Statement

This device complies with Part 15 of the FCC rules. Operation is subject to the following two conditions: 1) this device may not cause harmful interference, and 2) this device must accept any interference received, including interference that may cause undesired operation.

Note: This equipment has been tested and found to comply with the limits for a Class B digital device, pursuant to part 15 of the FCC rules. These limits are designed to provide reasonable protection against harmful interference in a residential installation. This equipment generates uses and can radiate radio frequency energy and, if not installed and used in accordance with the instructions, may cause harmful interference to radio communications. However, there is no guarantee that interference will not occur in particular installations. If the equipment does cause harmful interference to radio or television reception, which can be determined by turning the equipment off and on, the user is encouraged to try to correct the interference by one or more of the following measures:

- Reorient or relocate the receiving antenna.
 - Increase the separation between the equipment and receiver.
 - Connect the equipment into an outlet on a circuit different from that to which the receiver is connected.
 - Consult the dealer or an experienced radio/TV technician for help.
- Changes or modifications not expressly approved by the party responsible for compliance could void the user's authority to operate the equipment.

Radiation Exposure Statement

This device complies with RF radiation exposure limits set forth for an uncontrolled environment. The transmitter must not be co-located or operating in conjunction with any other antenna or transmitter.