



TEST REPORT

FCC ID :	2ALGR-YA70	
Test Report No :	TCT220402E011	
Date of issue :	May 16, 2022	
Testing laboratory	SHENZHEN TONGCE TESTING LAB	
Testing location/ address:	TCT Testing Industrial Park Fuqiao 5th Industrial Zone, Fuhai Street, Bao'an District Shenzhen, Guangdong, 518103, People's Republic of China	
Applicant's name :	Shenzhen Fuzhixing Electronics Co., Ltd.	
Address :	5/F, Block C, Penglongpan Hi-technology Park, Dafu Ind. Zone, Guanlan, Longhua New Dist., Shenzhen, Guangdong, China	
Manufacturer's name ... :	Shenzhen Fuzhixing Electronics Co., Ltd.	
Address :	5/F, Block C, Penglongpan Hi-technology Park, Dafu Ind. Zone, Guanlan, Longhua New Dist., Shenzhen, Guangdong, China	
Standard(s)	FCC CFR Title 47 Part 20.21 KDB935210 D03 Signal Booster Measurements v04r04	
Product Name :	cell phone signal booster	
Trade Mark	N/A	
Model/Type reference :	YA70, YWA70, YBA70	
Rating(s) :	Adapter Information: Model: FZX-12-2 Input: AC 100-240V, 50/60Hz, 0.3A Output: DC 12V, 2A	
Date of receipt of test item	Apr. 02, 2022	
Date (s) of performance of test :	Apr. 02, 2022 - May 16, 2022	
Tested by (+signature) ... :	Aaron MO	
Check by (+signature) :	Beryl ZHAO	
Approved by (+signature):	Tomsin	

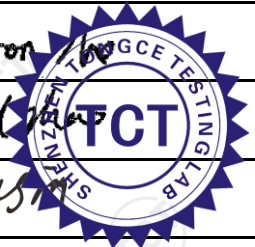

General disclaimer:

This report shall not be reproduced except in full, without the written approval of SHENZHEN TONGCE TESTING LAB. This document may be altered or revised by SHENZHEN TONGCE TESTING LAB personnel only, and shall be noted in the revision section of the document. The test results in the report only apply to the tested sample.

Table of Contents

1. General Product Information	3
1.1. EUT description	3
1.2. Model(s) list.....	3
2. Test Result Summary	4
3. General Information.....	5
3.1. Test environment.....	5
3.2. Description of Support Units.....	5
4. Facilities and Accreditations	6
4.1. Facilities	6
4.2. Location	6
4.3. Measurement Uncertainty.....	6
5. Test Results and Measurement Data	7
5.1. Authorized Frequency Band Verification	7
5.2. Maximum Power	10
5.3. Intermodulation Product.....	15
5.4. Out of Band Emission	19
5.5. Conducted Spurious Emission	33
5.6. Noise Limits	38
5.7. Uplink Inactivity	43
5.8. Variable Booster Gain	45
5.9. Occupied Bandwidth.....	49
5.10.Oscillation Detection and Mitigation.....	58
6. Radiation Spurious Emission	66
Appendix A: Photographs of Test Setup	
Appendix B: Photographs of EUT	

1. General Product Information

1.1. EUT description

Product Name.....:	cell phone signal booster
Model/Type reference.....:	YA70
Sample Number.....:	TCT220402E011-0101
Operation Frequency	Lower700MHz Uplink: 698MHz - 716MHz, Downlink: 728MHz - 746MHz
Signal Booster Type.....:	Fixed Consumer Signal Booster
Emission Designator	G7D, W7D
FCC Classification	B2W/Wideband Consumer Booster(CMRS)
Rating(s).....:	Adapter Information: Model: FZX-12-2 Input: AC 100-240V, 50/60Hz, 0.3A Output: DC 12V, 2A

Note: The antenna gain listed in this report is provided by applicant, and the test laboratory is not responsible for this parameter.

1.2. Model(s) list

No.	Model No.	Tested with
1	YA70	<input checked="" type="checkbox"/>
Other models	YWA70, YBA70	<input type="checkbox"/>

Note: YA70 is tested model, other models are derivative models. The models are identical in circuit and PCB layout, only different on the model names appearance and colour . So the test data of YA70 can represent the remaining models.

2. Test Result Summary

Requirement	CFR 47 Section	Result
Authorized Frequency Band Verification Test	§20.21(e)(3)	PASS
Maximum Power Measurement Procedure	§2.1046/20.21(e)(8)(i)(D)	PASS
Maximum Booster Gain Computation	§20.21(e)(8)(i)(B)	PASS
Intermodulation Product	§20.21(e)(8)(i)(F)	PASS
Out of Band Emissions	§20.21(e)(8)(i)(E)	PASS
Conducted Spurious Emission	§2.1051/§27	PASS
Noise Limit Procedure Variable Noise Variable Noise Timing	§20.21(e)(8)(i)(A)(2)(i) §20.21(e)(8)(i)(A)(1) §20.21(e)(8)(i)(H)	PASS
Uplink inactivity	§20.21(e)(8)(i)(I)	PASS
Variable Booster Gain Variable Uplink Gain Timing	§20.21(e)(8)(i)(C) (1), (2)(i) §20.21(e)(8)(i)(H)	PASS
Occupied Band Width	§2.1049/§27	PASS
Anti-Oscillation	§20.21(e)(8)(ii)(A)	PASS
Radiated Spurious Emission	§2.1053/§27	PASS
Spectrum Block Filter	N/A	N/A

Note:

1. PASS: Test item meets the requirement.
2. Fail: Test item does not meet the requirement.
3. N/A: Test case does not apply to the test object.
4. The test result judgment is decided by the limit of test standard.

3. General Information

3.1. Test environment

Operating Environment:	
Temperature:	25.0 °C
Humidity:	56 % RH
Atmospheric Pressure:	1010 mbar

3.2. Description of Support Units

The EUT has been tested as an independent unit together with other necessary accessories or support units. The following support units or accessories were used to form a representative test configuration during the tests.

Equipment	Model No.	Serial No.	FCC ID	Trade Name
/	/	/	/	/

4. Facilities and Accreditations

4.1. Facilities

The test facility is recognized, certified, or accredited by the following organizations:

- FCC - Registration No.: 645098

SHENZHEN TONGCE TESTING LAB

Designation Number: CN1205

The testing lab has been registered and fully described in a report with the (FCC) Federal Communications Commission. The acceptance letter from the FCC is maintained in our files.

- IC - Registration No.: 10668A-1

SHENZHEN TONGCE TESTING LAB

CAB identifier: CN0031

The testing lab has been registered by Certification and Engineering Bureau of Industry Canada for radio equipment testing.

4.2. Location

SHENZHEN TONGCE TESTING LAB

Address: TCT Testing Industrial Park Fuqiao 5th Industrial Zone, Fuhai Street, Bao'an District Shenzhen, Guangdong, 518103, People's Republic of China

TEL: +86-755-27673339

4.3. Measurement Uncertainty

The reported uncertainty of measurement $y \pm U$, where expanded uncertainty U is based on a standard uncertainty multiplied by a coverage factor of $k=2$, providing a level of confidence of approximately 95 %.

No.	Item	MU
1	Conducted Emission	± 3.10 dB
2	RF power, conducted	± 0.12 dB
3	Spurious emissions, conducted	± 0.11 dB
4	All emissions, radiated(<1 GHz)	± 4.56 dB
5	All emissions, radiated(1 GHz - 18 GHz)	± 4.22 dB
6	All emissions, radiated(18 GHz- 40 GHz)	± 4.36 dB

5. Test Results and Measurement Data

5.1. Authorized Frequency Band Verification

5.1.1. Test Specification

Test Requirement:	FCC Part20 Section 20.21(e)(3)
Test Method:	KDB935210 D03 Signal Booster Measurements v04r04
Limit	Lower700MHz Uplink: 698MHz - 716MHz, Downlink: 728MHz - 746MHz
Test Setup:	<pre> graph LR SG[Signal Generator] --> EUT[EUT] EUT --> RA[RF Attenuator (if required)] RA --> SA[Spectrum Analyzer] </pre>
Test Procedure:	<p>935210 D03 Signal Booster Measurement v04r04</p> <ol style="list-style-type: none"> Connect the EUT to the test equipment as shown in Figure 1. Begin with the uplink output (donor) port connected to the spectrum analyzer. Set the spectrum analyzer resolution bandwidth (RBW) for 100 kHz with the video bandwidth (VBW) $\geq 3 \times$ the RBW, using a PEAK detector with the MAX HOLD function. Set the center frequency of the spectrum analyzer to the center of the operational band under test with a span of 1 MHz. Set the signal generator for CW mode and tune to the center frequency of the operational band under test. Set the initial signal generator power to a level that is at least 6 dB below the AGC level specified by the manufacturer. Slowly increase the signal generator power level until the output signal reaches the AGC operational level. Reduce the signal generator power to a level that is 3 dB below the level noted above, then manually reset the EUT (e.g., cycle ac/dc power). Reset the spectrum analyzer span to 2xthe width of the CMRS band under test. Adjust the tuned frequency of the signal generator to sweep 2xthe width of the CMRS band using the sweep function. The AGC must be deactivated throughout the entire sweep. Using three markers, identify the CMRS band edges and the frequency with the highest power. Affirm that the values of all markers are visible on the display of the spectrum analyzer (e.g., marker table set to on). Capture the spectrum analyzer trace for inclusion in the test report. Repeat 7.1c) to 7.1j) for all operational uplink and downlink bands.
Test Result:	PASS

5.1.2. Test Instruments

Equipment	Manufacturer	Model	Serial Number	Calibration Date	Calibration Due
Signal Generator	Agilent	N5182A	MY47070282	Jul. 19, 2021	Jul. 18, 2022
Spectrum Analyzer	Agilent	N9020A	MY49100619	Jul. 19, 2021	Jul. 18, 2022
Attenuator	50FP-006-H3	JFW	907763	N/A	N/A



5.1.3. Test data

Test Plots

Uplink

Lower700MHz

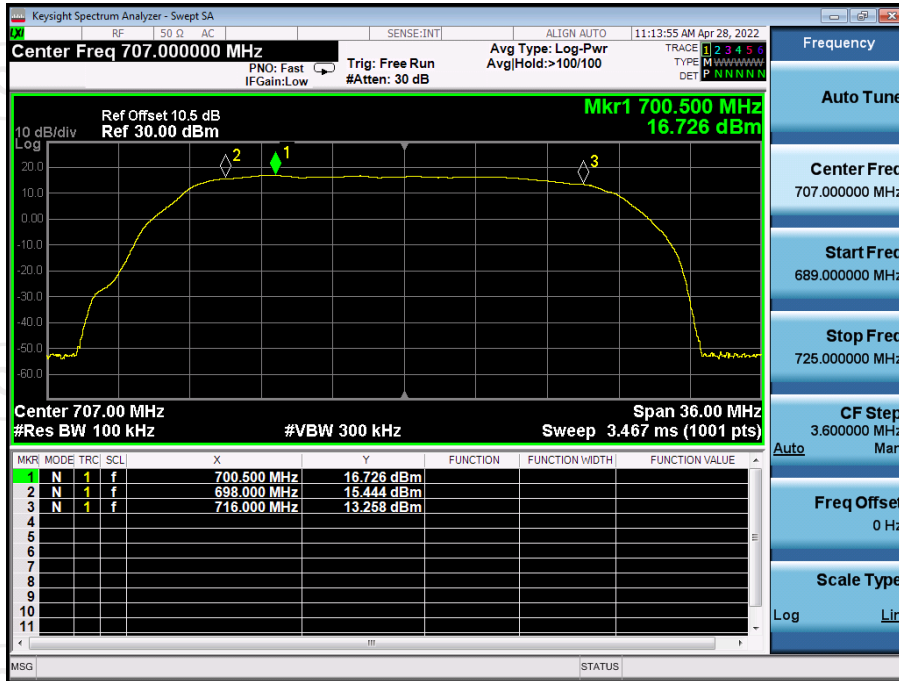

Downlink

Lower700MHz

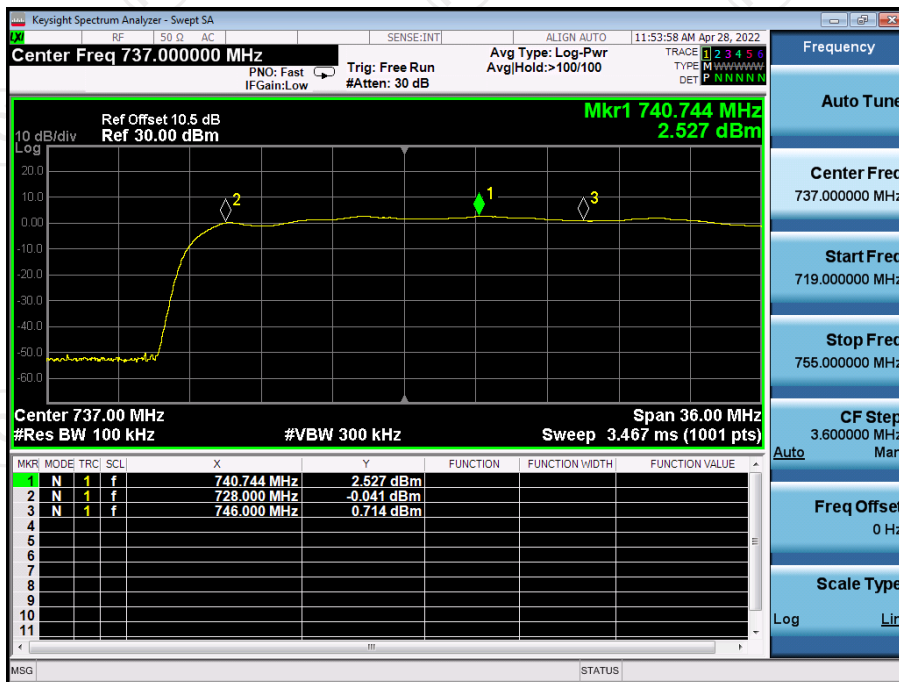

5.2. Maximum Power

5.2.1. Test Specification

Test Requirement:	FCC Part 20.21 (e)(8)(i)(B); FCC Part 20.21 (e)(8)(i)(D)
Test Method:	KDB935210 D03 Signal Booster Measurements v04r04
Limit:	Gain: Fixed Booster maximum gain shall not exceed 6.5 dB + 20 Log ₁₀ (Frequency) Where, Frequency is the uplink mid-band frequency of the supported spectrum bands in MHz. Conducted Output Power: 17dBm < P _{uplink} < 30dBm, P _{downlink} < 17dBm. EIRP: Uplink < 30dBm, Downlink < 17dBm.
Test Setup:	<pre> graph LR SG[Signal Generator] --> EUT[EUT] EUT --> RA[RF Attenuator (if required)] RA --> SA[Spectrum Analyzer] </pre>
Test Procedure:	<ol style="list-style-type: none"> Connect the EUT to the test equipment as shown in Set-Up. Begin with the uplink output (donor port) connected to the spectrum analyzer. Configure the signal generator and spectrum analyzer for operation on the frequency determined in Frequency Band with the highest power level, but with the center frequency of the signal no closer than 2.5 MHz from the band edge. The spectrum analyzer span shall be set to at least 10 MHz. Set the initial signal generator power to a level well below that which causes AGC control. Slowly increase the signal generator power level until the output signal reaches the AGC operational limit (from observation of signal behavior on the spectrum analyzer; e.g., no further increase in output power as input power is increased). Reduce power sufficiently on the signal generator to ensure that the AGC is not controlling the power output. Slowly increase the signal generator power to a level just below (within 0.5 dB of) the AGC limit without triggering the AGC. Note the signal generator power level as (P_{in}). Measure the output power (P_{out}) with the spectrum analyzer as follows. Set RBW = 100 kHz for AWGN signal type and 300 kHz for CW or GSM signal type Set VBW ≥ 3X RBW Select either the BURST POWER or CHANNEL POWER measurement tool, as required for each signal type. The channel power integration bandwidth shall be 99% occupied bandwidth (4.1 MHz). Select the RMS (power averaging) detector. Ensure that the number of measurement points per sweep ≥ (2 x span)/RBW (Note: This requirement does not apply for BURST power measurement mode). Set sweep time = auto couple, or as necessary (but no less than auto couple value). Trace average at least 100 traces in power averaging (i.e., RMS) mode. Record the measured power level as P_{out} with one set of results for the GSM or CW input stimulus and another set of results for the AWGN input stimulus. Repeat the procedure for each operational uplink and downlink frequency band supported by the booster.

Test Result: PASS**5.2.2. Test Instruments**

Equipment	Manufacturer	Model	Serial Number	Calibration Date	Calibration Due
Signal Generator	Agilent	N5182A	MY47070282	Jul. 19, 2021	Jul. 18, 2022
Spectrum Analyzer	Agilent	N9020A	MY49100619	Jul. 19, 2021	Jul. 18, 2022
Attenuator	50FP-006-H3	JFW	907763	N/A	N/A

5.2.3. Test Data

Max. Gain

Frequency Band	Signal Type	Pre AGC Input Level (dBm)	Conducted Output Level (dBm)	Gain (dB)	Gain Limit (dB)
Lower700M Hz Uplink	CW	-39.42	17.71	57.13	63.49
	AWGN	-37.52	19.67	57.19	
Lower700M Hz Downlink	CW	-45.68	3.90	49.58	63.49
	AWGN	-44.58	5.74	50.32	

Note: Fixed Booster maximum gain shall not exceed $6.5 \text{ dB} + 20 \text{ Log}_{10}(\text{Frequency})$, where Frequency is the uplink mid-band frequency of the supported spectrum bands in MHz.

Conducted output power at max. Input test level

Frequency Band	Signal Type	Input Level (dBm)	Conducted Output Level (dBm)	Lower Limit(dBm)	Upper Limit(dBm)
Lower700M Hz Uplink	CW	-20.92	17.09	17	30
	AWGN	-19.32	18.88		
Lower700M Hz Downlink	CW	-20.78	3.09	N/A	17
	AWGN	-19.18	5.41		

Max. EIRP

Frequency Band	Signal Type	Max Conducted Output Level (dBm)	Max. Antenna Gain (dBi)	Min. Cable Loss (dB)	EIRP (dBm)	EIRP Limit (dBm)
Lower700M Hz Uplink	CW	17.71	8	3.5	22.21	<30
	AWGN	19.67	8	3.5	24.17	
Lower700M Hz Downlink	CW	3.90	6	1.2	8.70	<17
	AWGN	5.74	6	1.2	10.54	

Uplink Gain VS Downlink Gain

Band	Signal Type	Uplink Gain (dB)	Downlink Gain (dB)	D-value	Limit (dB)
Lower700MHz	CW	57.13	49.58	7.55	<9
	AWGN	57.19	50.32	6.87	

Test Plots

Lower700MHz AWGN, UL

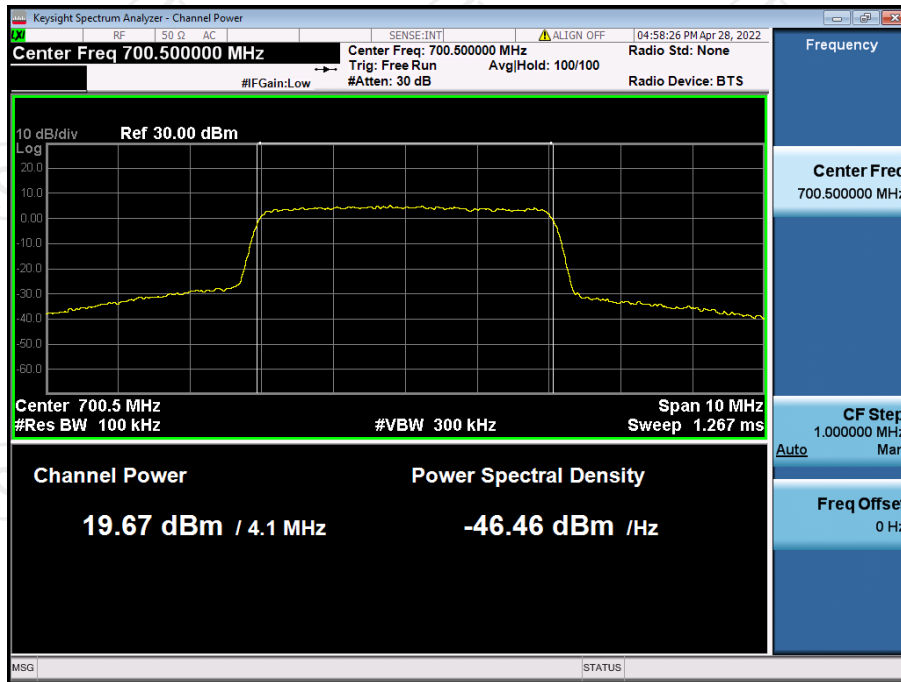

Lower700MHz CW, UL

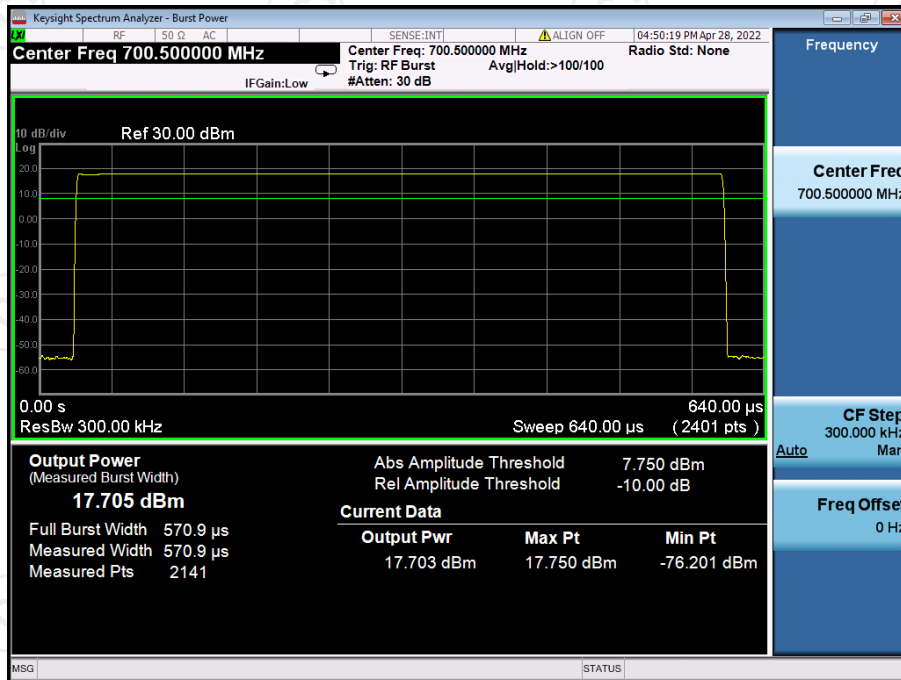

Lower700MHz AWGN, DL

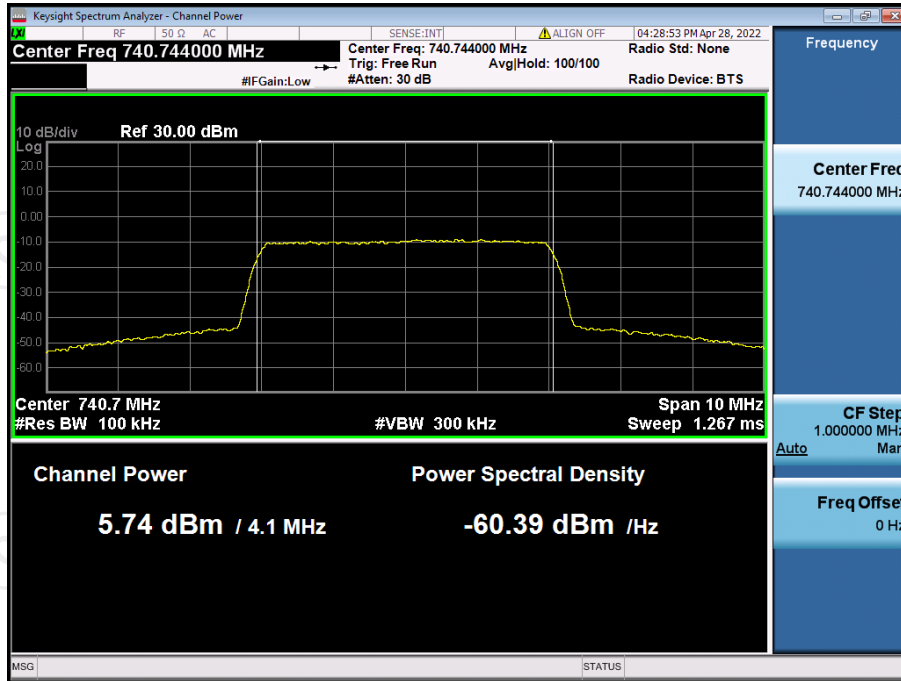

Lower700MHz CW, DL

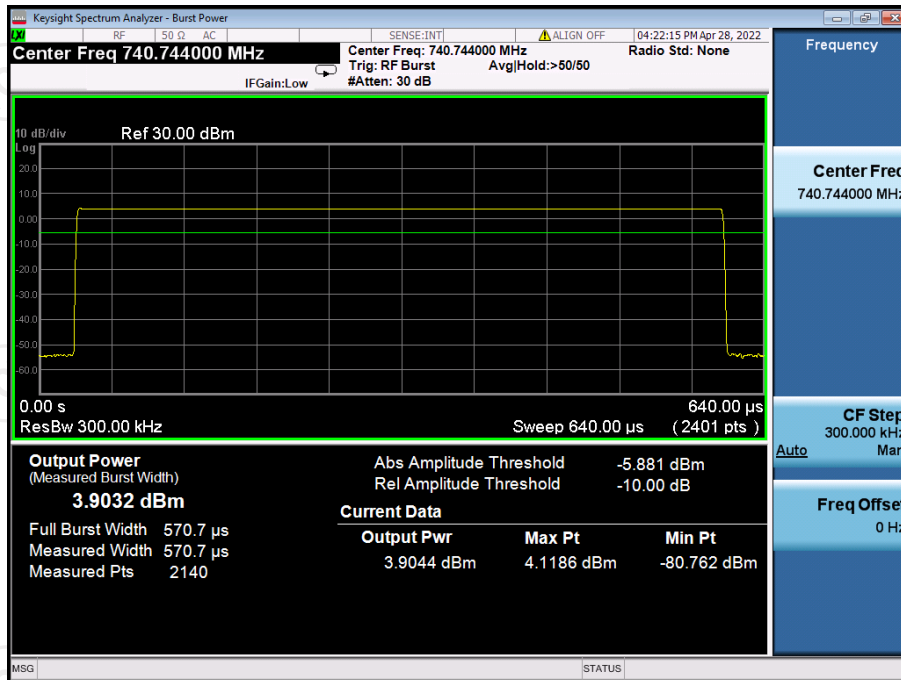

5.3. Intermodulation Product

5.3.1. Test Specification

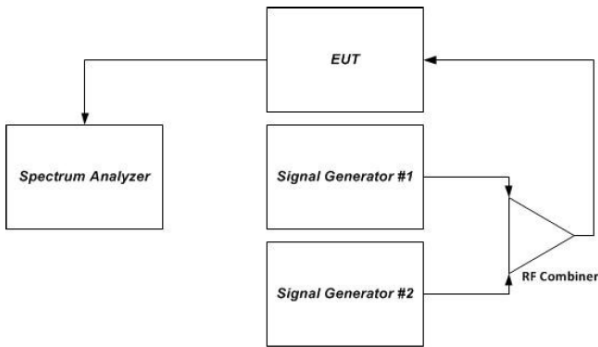
Test Requirement:	FCC Part20 Section 20.21(e)(8)(i)(F)
Test Method:	KDB935210 D03 Signal Booster Measurements v04r04
Limit:	-19dBm
Test Setup:	 <p style="text-align: center;">Figure 2 – Intermodulation product instrumentation test setup</p>
Test Procedure:	<p>a) Connect the signal booster to the test equipment as shown in Set-Up. Begin with the uplink output connected to the spectrum analyzer.</p> <p>b) Set the spectrum analyzer RBW = 3 kHz.</p> <p>c) Set the VBW $\geq 3 \times$ the RBW.</p> <p>d) Select the RMS detector.</p> <p>e) Set the spectrum analyzer center frequency to the center of the supported operational band under test.</p> <p>f) Set the span to 5 MHz.</p> <p>g) Configure the two signal generators for CW operation with generator 1 tuned 300 kHz below the operational band center frequency and generator 2 tuned 300 kHz above the operational band center frequency.</p> <p>h) Set the signal generator amplitudes so that the power from each into the RF combiner is equivalent and turn on the RF output.</p> <p>i) Increase the signal generators' amplitudes equally until just before the EUT begins AGC and ensure that all intermodulation products (if any exist), are below the specified limit of -19 dBm.</p> <p>j) Utilize the trace averaging function of the spectrum analyzer and wait for the trace to stabilize. Place a marker at the highest amplitude intermodulation product.</p> <p>k) Record the maximum intermodulation product amplitude level that is observed.</p> <p>l) Capture the spectrum analyzer trace for inclusion in the test report.</p> <p>m) Repeat steps e) to l) for all uplink and downlink operational bands.</p> <p>Note: If using a single signal generator with dual outputs, ensure that intermodulation products are not the result of the generator.</p> <p>n) Increase the signal generator amplitude in 2 dB steps to 10 dB above the AGC threshold determined in i) to ensure that the EUT maintains compliance with the intermodulation</p>
Test Result:	PASS

5.3.2. Test Instruments

Equipment	Manufacturer	Model	Serial Number	Calibration Date	Calibration Due
Signal Generator	Agilent	E4421B	GB39340839	Jul. 19, 2021	Jul. 18, 2022
Signal Generator	Agilent	N5182A	MY47070282	Jul. 19, 2021	Jul. 18, 2022
Spectrum Analyzer	Agilent	N9020A	MY49100619	Jul. 19, 2021	Jul. 18, 2022
RF Combiner	SUNVNDN	SUD-CS 0800	16230009	N/A	N/A
Attenuator	50FP-006-H3	JFW	907763	N/A	N/A

5.3.3. Test data

Test Plots

Lower700MHz Pre AGC, UL

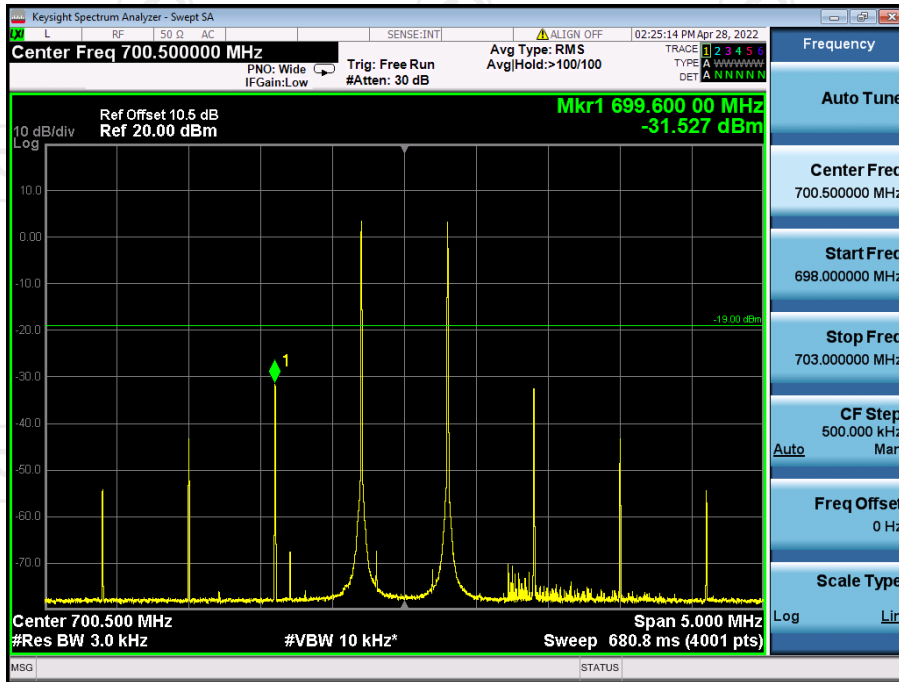

Lower700MHz AGC +10dB , UL

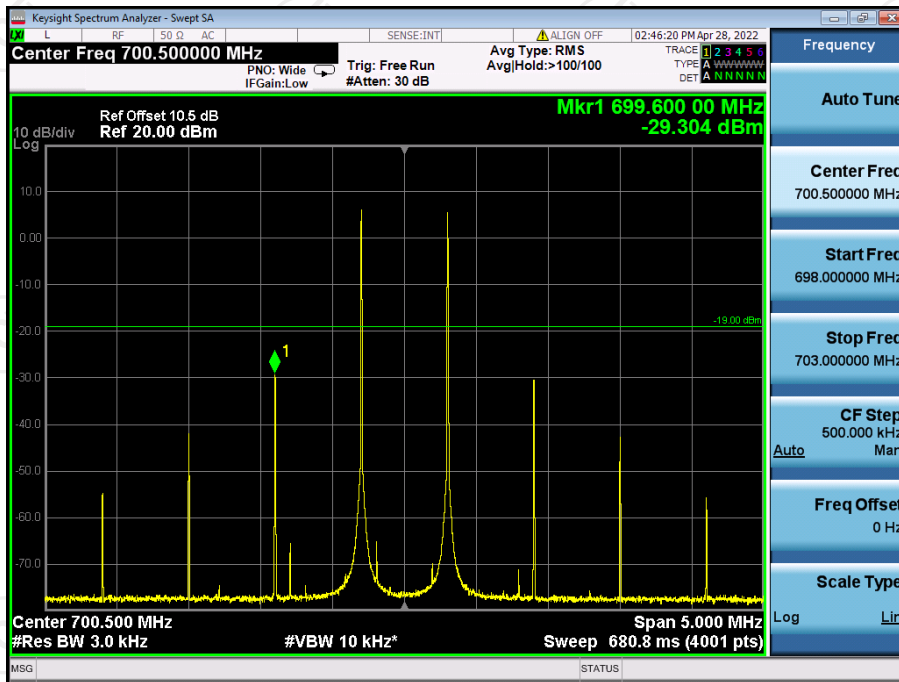

Lower700MHz Pre AGC, DL

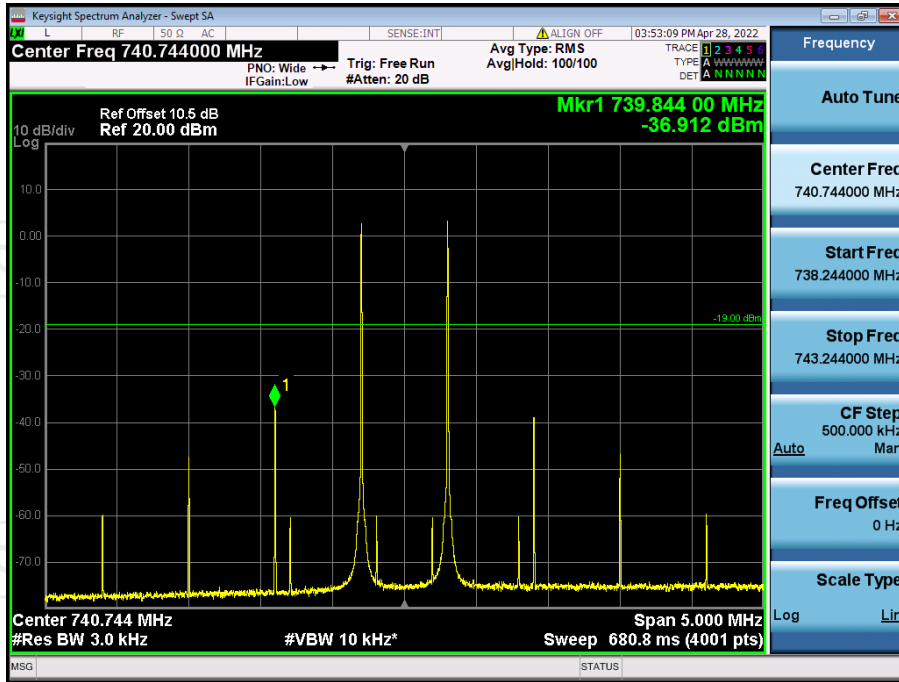

Lower700MHz AGC +10dB, DL

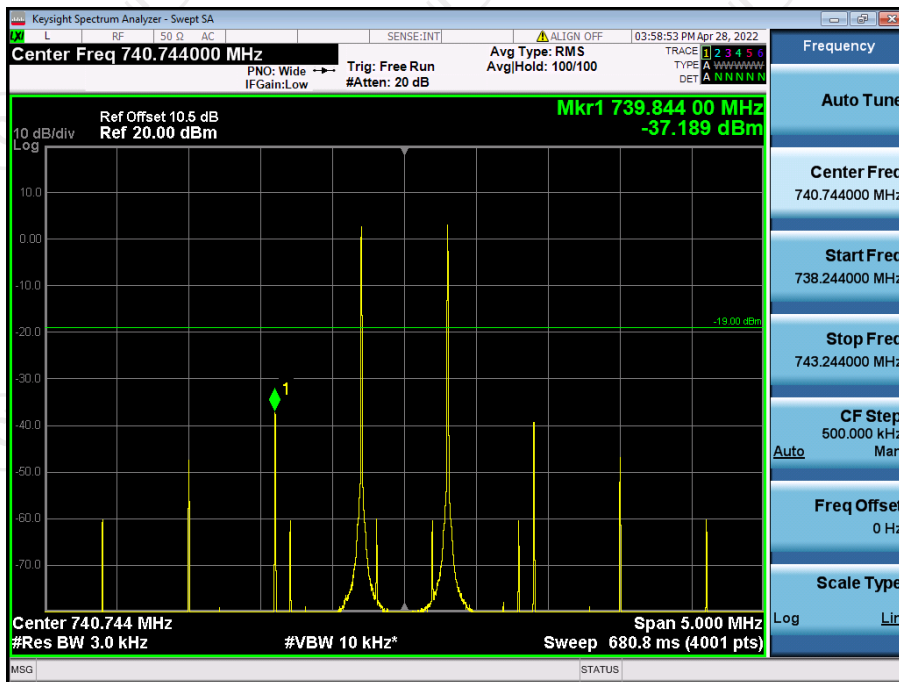

5.4. Out of Band Emission

5.4.1. Test Specification

Test Requirement:	FCC Part20 Section 20.21(e)(8)(i)(E)
Test Method:	KDB935210 D03 Signal Booster Measurements v04r04
Limit:	-19dBm
Test Setup:	<pre> graph LR SG[Signal Generator] --> EUT[EUT] EUT --> RA[RF Attenuator (if required)] RA --> SA[Spectrum Analyzer] </pre>
Test Procedure:	<p>a) Connect the EUT to the test equipment as shown in Set-Up. Begin with the uplink output connected to the spectrum analyzer.</p> <p>b) Configure the signal generator for the appropriate operation for all uplink and downlink bands:</p> <ul style="list-style-type: none"> i) GSM: 0.2 MHz from upper and lower band edge ii) LTE (5 MHz): 2.5 MHz from upper and lower band edge iii) CDMA: 1.25 MHz from upper and lower band edge, except for cellular as follows (only the upper and lower frequencies need to be tested): 824.88 MHz, 845.73 MHz, 836.52 MHz, 848.10 MHz, 869.88 MHz, 890.73 MHz, 881.52 MHz, 893.10 MHz. <p>Note 1: Alternative test modulation types:</p> <ul style="list-style-type: none"> • CDMA (alternative 1.25 MHz AWGN) • LTE 5 MHz (alternative W-CDMA or 4.1 MHz AWGN) <p>Note 2: For LTE, the signal generator should utilize the uplink and downlink signal types for these modulations in uplink and downlink tests, respectively. LTE shall use 5 MHz signal 25 resource blocks transmitting.</p> <p>Note 3: AWGN is the measured 99% occupied bandwidth.</p> <p>c) Set the signal generator amplitude to the maximum power level prior to AGC similar to the procedures in method of Maximum power d) to f) of power measurement procedure for appropriate modulations.</p> <p>d) Set RBW = measurement bandwidth specified in the applicable rule section for the supported frequency band.</p> <p>e) Set VBW = 3 x RBW.</p> <p>f) Select the RMS (power averaging) detector.</p> <p>g) Sweep time = auto-couple.</p> <p>h) Set the analyzer start frequency to the upper band/block edge frequency and the stop frequency to the upper band/block edge frequency plus 300 kHz (when operational frequency is < 1 GHz) or 3 MHz (when operational frequency is ≥ 1 GHz).</p> <p>i) Trace average at least 100 traces in power averaging (i.e., RMS) mode.</p> <p>j) Use peak marker function to find the maximum power level.</p> <p>k) Capture the spectrum analyzer trace of the power level for inclusion in the test report.</p> <p>l) Increase the signal generator amplitude in 2 dB steps until the maximum input level indicated in 5.4 is reached. Ensure that the EUT maintains compliance with the OOB limits.</p> <p>m) Reset the analyzer start frequency to the lower band/block edge frequency minus 100 kHz or 1 MHz, as per applicable rule part, and the stop frequency to the lower band/block edge frequency and repeat steps j) to l).</p>

	n) Repeat steps b) through m) for each uplink and downlink operational band.
Test Result:	PASS

5.4.2. Test Instruments

Equipment	Manufacturer	Model	Serial Number	Calibration Date	Calibration Due
Signal Generator	Agilent	N5182A	MY47070282	Jul. 19, 2021	Jul. 18, 2022
Spectrum Analyzer	R&S	FSU	200054	Jul. 19, 2021	Jul. 18, 2022
Attenuator	50FP-006-H3	JFW	907763	N/A	N/A

5.4.3. Test data

Test Plots

Lower700MHz GSM UL Left Side Pre AGC

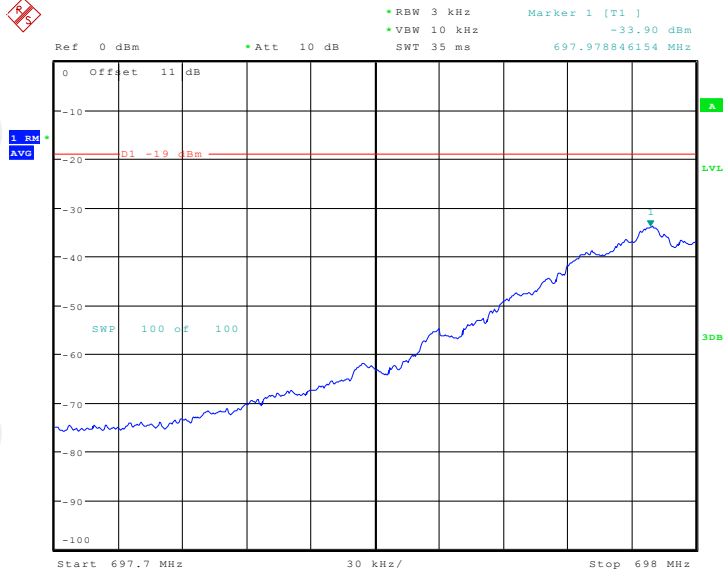

Date: 7.MAY.2022 13:35:48

Lower700MHz GSM UL Left Side Pre AGC+10dB

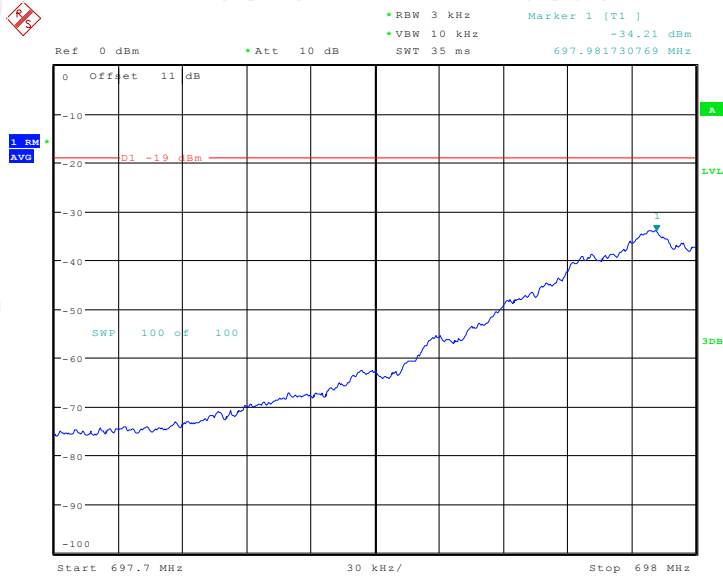

Date: 7.MAY.2022 13:36:04

Lower700MHz GSM UL Right Side Pre AGC

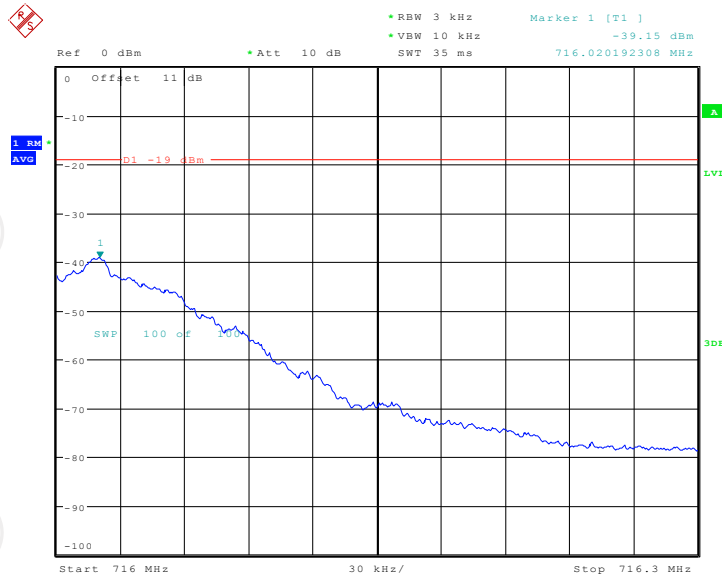

Date: 7.MAY.2022 13:30:36

Lower700MHz GSM UL Right Side Pre AGC+10dB

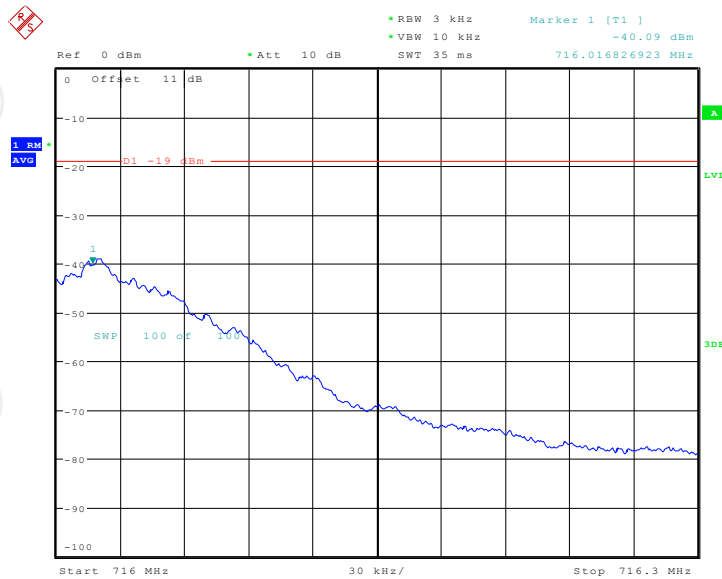

Date: 7.MAY.2022 13:30:51

Lower700MHz CDMA UL Left Side Pre AGC

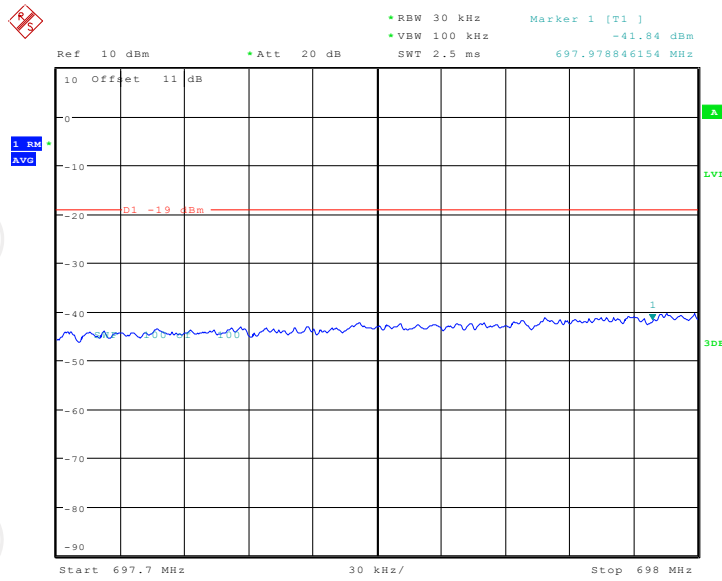

Date: 7.MAY.2022 13:44:35

Lower700MHz CDMA UL Left Side Pre AGC+10dB

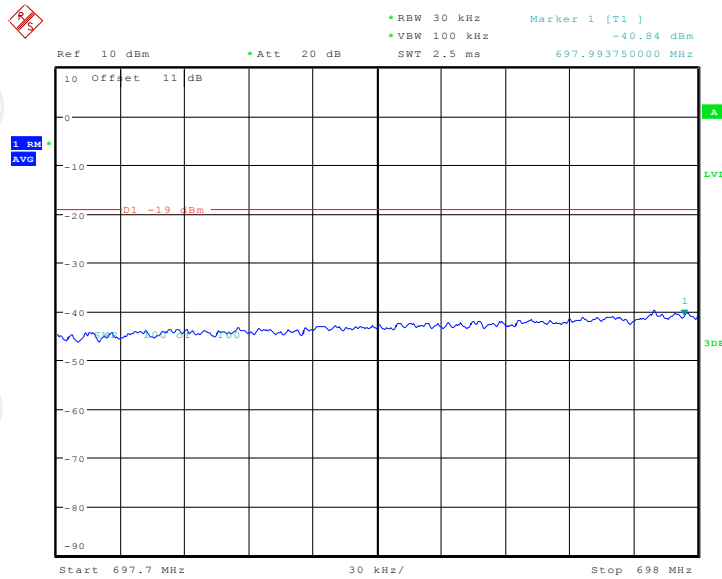

Date: 7.MAY.2022 13:44:48

Lower700MHz CDMA UL Right Side Pre AGC

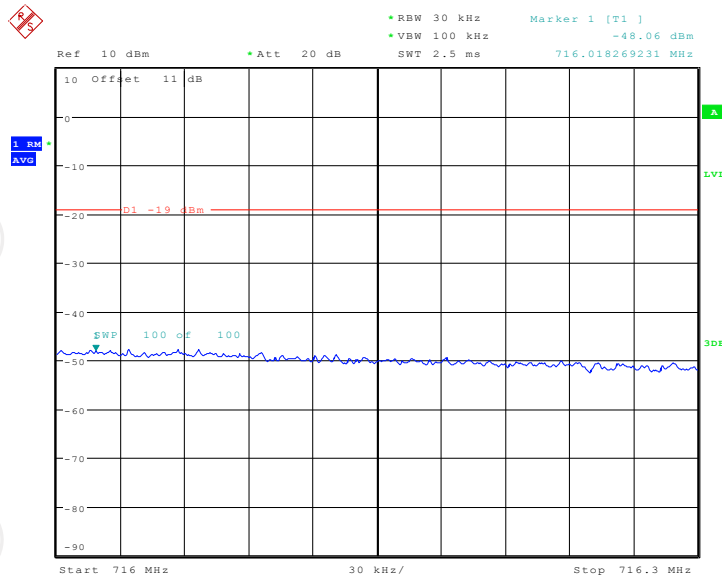

Date: 7.MAY.2022 13:52:46

Lower700MHz CDMA UL Right Side Pre AGC+10dB

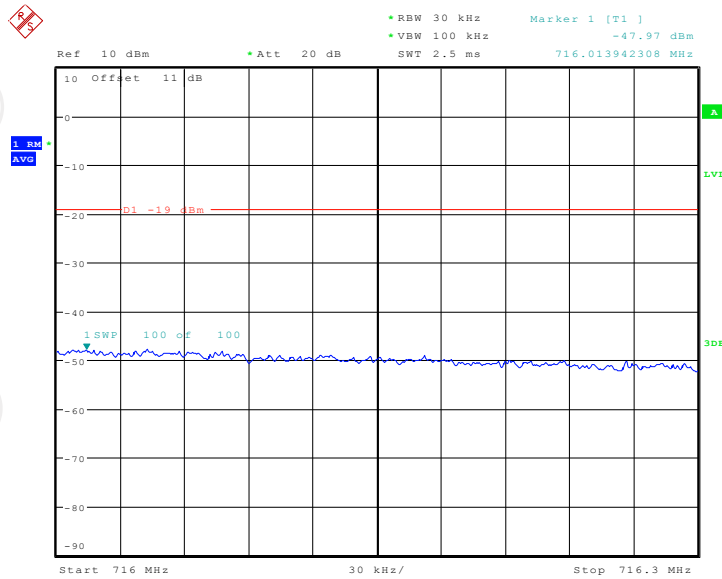

Date: 7.MAY.2022 13:53:02

Lower700MHz LTE UL Left Side Pre AGC

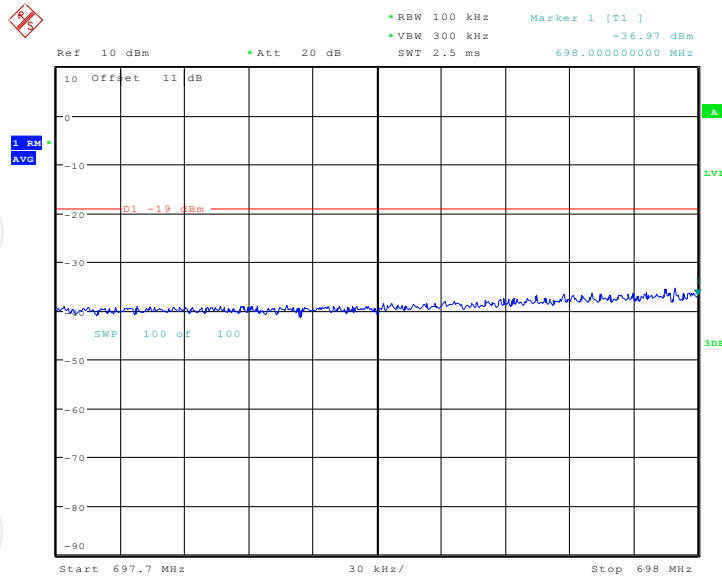

Date: 7.MAY.2022 13:57:14

Lower700MHz LTE UL Left Side Pre AGC+10dB

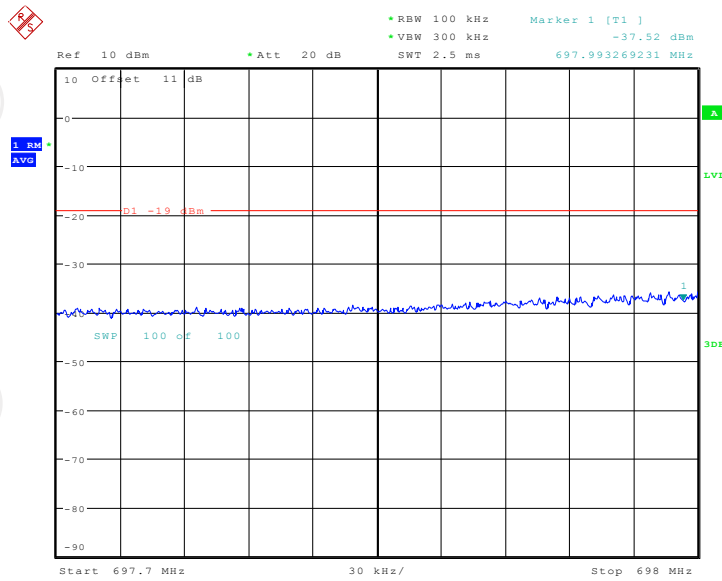

Date: 7.MAY.2022 13:57:23

Lower700MHz LTE UL Right Side Pre AGC

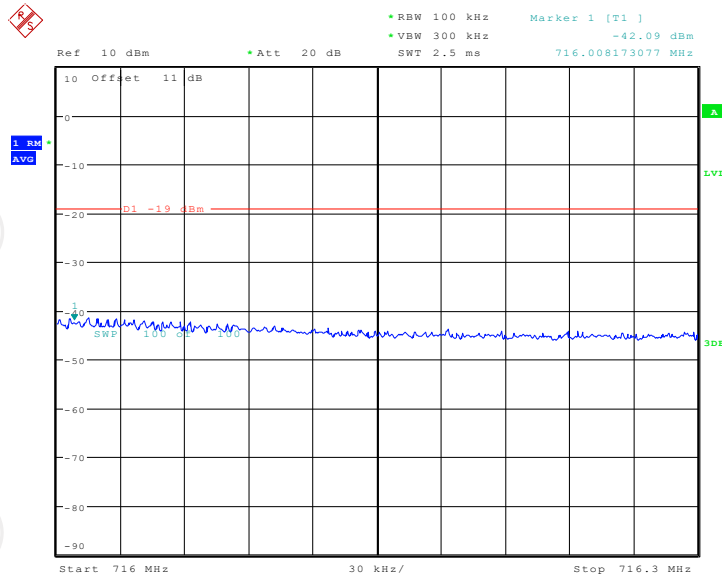

Date: 7.MAY.2022 13:55:56

Lower700MHz LTE UL Right Side Pre AGC+10dB

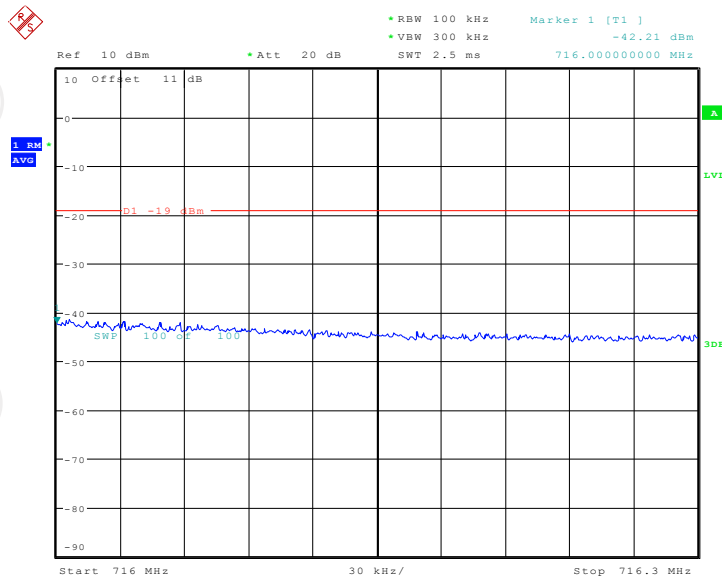

Date: 7.MAY.2022 13:56:07

Lower700MHz GSM DL Left Side Pre AGC

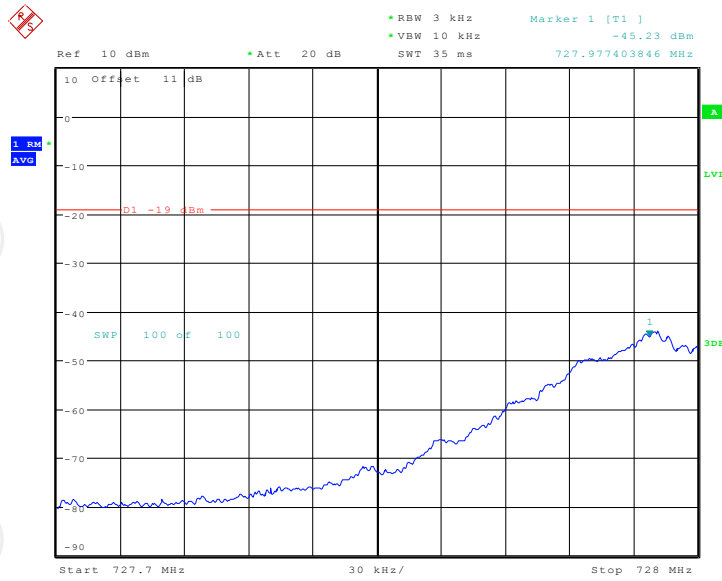

Date: 7.MAY.2022 14:11:13

Lower700MHz GSM DL Left Side Pre AGC+10dB

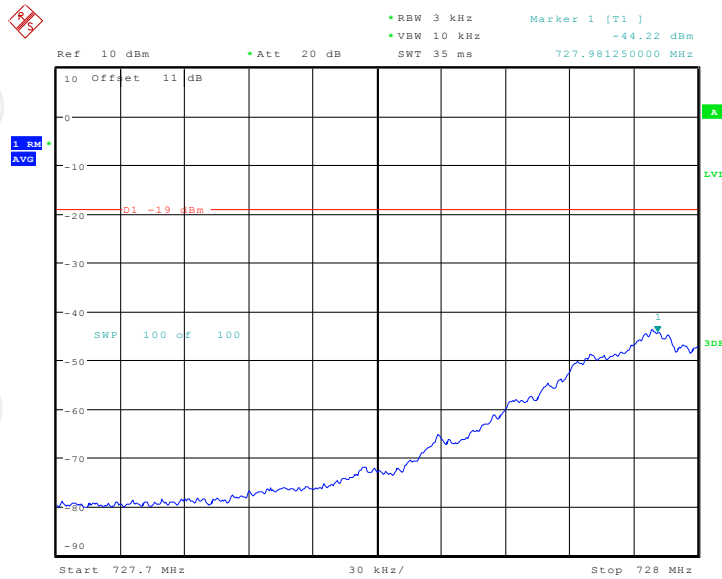

Date: 7.MAY.2022 14:11:18

Lower700MHz GSM DL Right Side Pre AGC

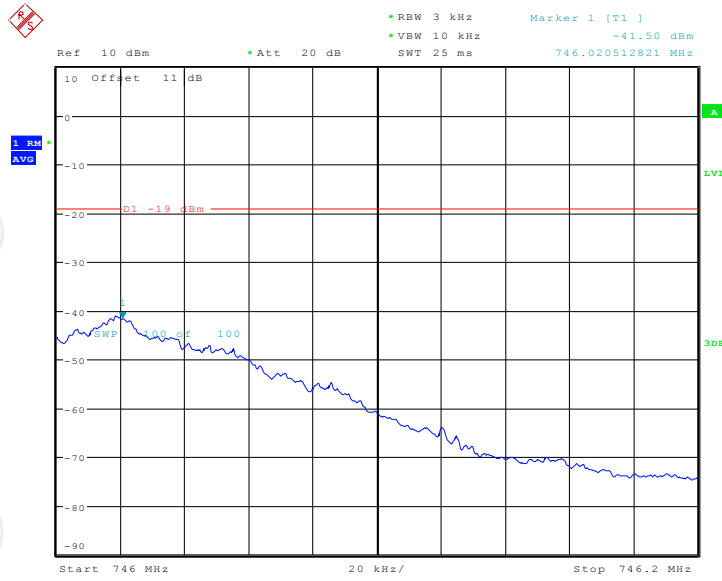

Date: 7.MAY.2022 14:12:18

Lower700MHz GSM DL Right Side Pre AGC+10dB

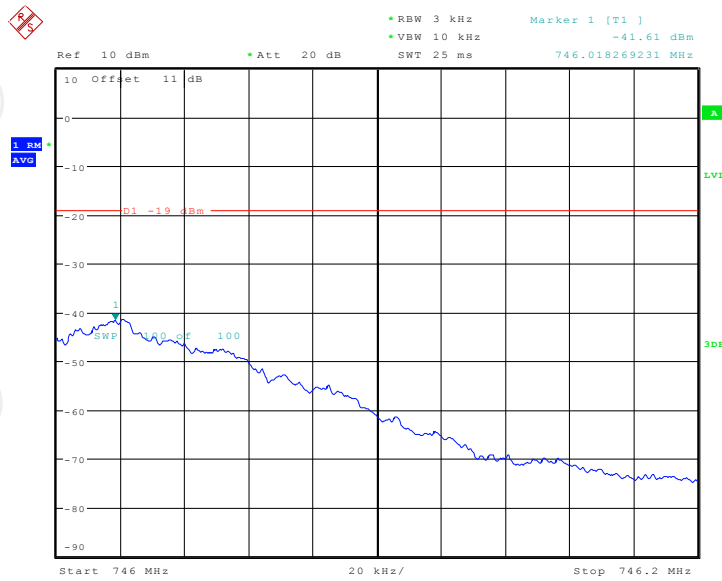

Date: 7.MAY.2022 14:12:25

Lower700MHz CDMA DL Left Side Pre AGC

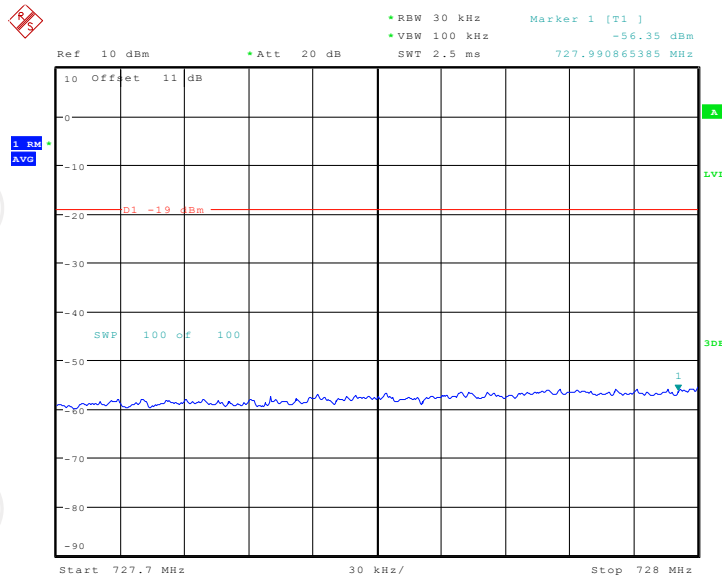

Date: 7.MAY.2022 14:09:19

Lower700MHz CDMA DL Left Side Pre AGC+10dB

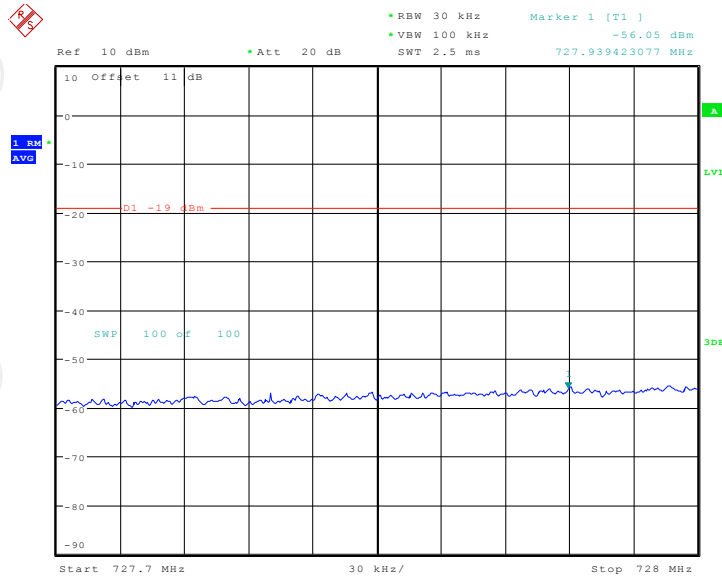

Date: 7.MAY.2022 14:09:28

Lower700MHz CDMA DL Right Side Pre AGC

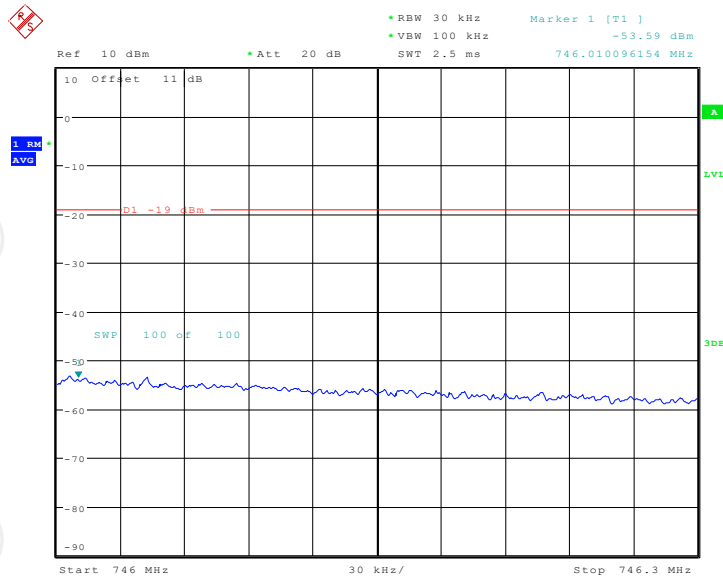

Date: 7.MAY.2022 14:07:50

Lower700MHz CDMA DL Right Side Pre AGC+10dB

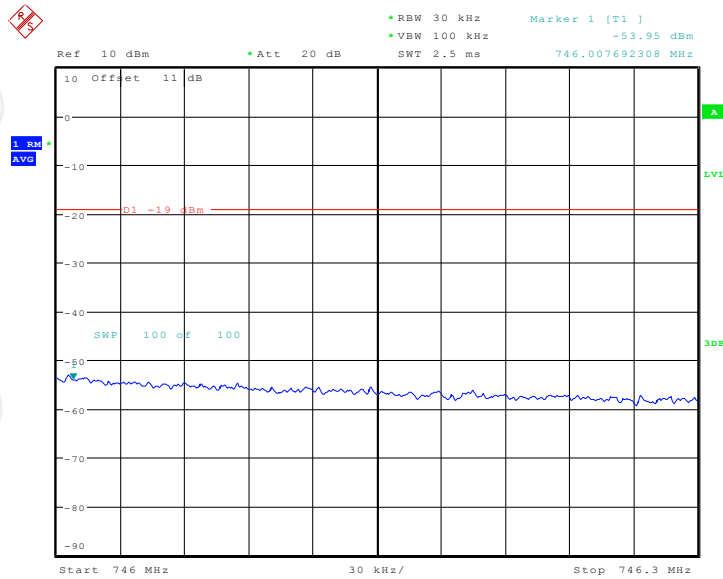

Date: 7.MAY.2022 14:07:58

Lower700MHz LTE DL Left Side Pre AGC

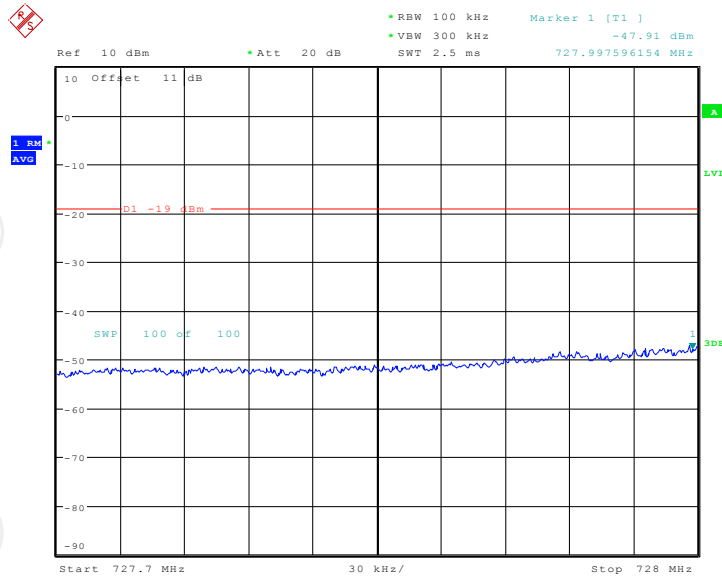

Date: 7.MAY.2022 14:02:22

Lower700MHz LTE DL Left Side Pre AGC+10dB

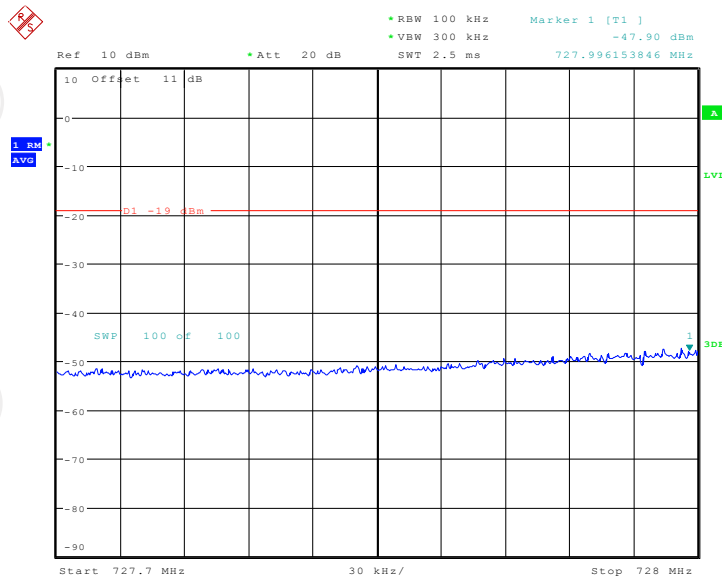

Date: 7.MAY.2022 14:02:32

Lower700MHz LTE DL Right Side Pre AGC

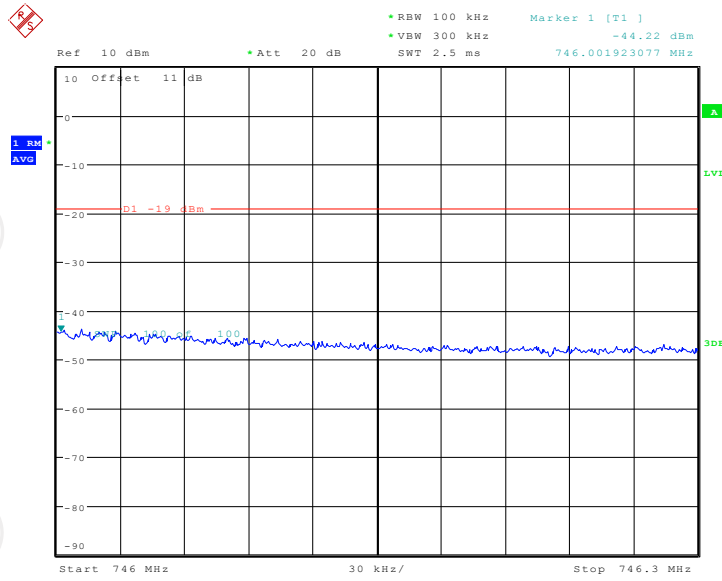

Date: 7.MAY.2022 14:04:24

Lower700MHz LTE DL Right Side Pre AGC+10dB

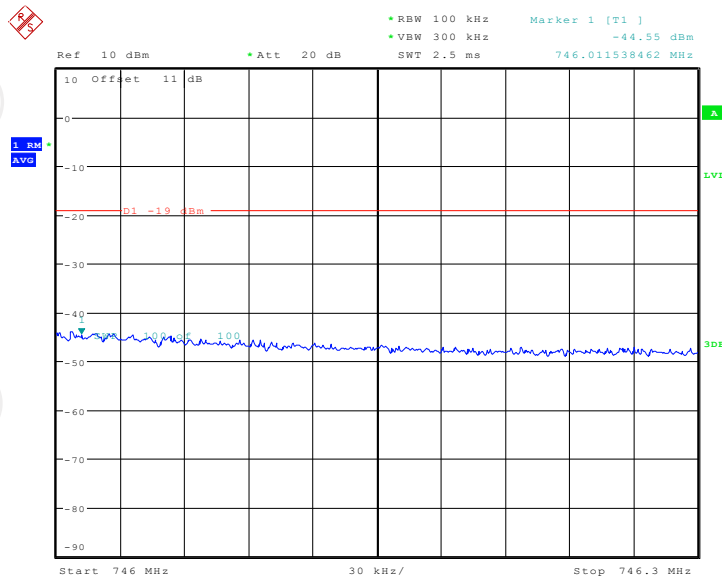

Date: 7.MAY.2022 14:04:33

5.5. Conducted Spurious Emission

5.5.1. Test Specification

Test Requirement:	FCC Part2 Section 1051; FCC Rules Part 27 Subpart C, Section 27.53
Test Method:	KDB 935210 D03 Signal Booster Measurements v04r04
Limit:	-13 dBm
Test Setup:	<pre> graph LR SG[Signal Generator] --> EUT[EUT] EUT --> RA[RF Attenuator (if required)] RA --> SA[Spectrum Analyzer] </pre>
Test Procedure:	<p>a) Connect the EUT to the test equipment as shown in Set-Up. Begin with the uplink output connected to the spectrum analyzer.</p> <p>b) Configure the signal generator for AWGN with a 99% occupied bandwidth of 4.1 MHz operation with a center frequency corresponding to the center of the CMRS band under test.</p> <p>c) Set the signal generator amplitude to the level determined in the power measurement procedure in Maximum power.</p> <p>d) Turn on the signal generator RF output and measure the spurious emission power levels with an appropriate measurement instrument as follows.</p> <p>e) Set RBW = measurement bandwidth specified in the applicable rule section for the operational frequency band under consideration (see Annex A for relevant cross-references). Note that many of the individual rule sections permit the use of a narrower RBW (typically $\geq 1\%$ of the emission bandwidth) to enhance measurement accuracy, but the result must then be integrated over the specified measurement bandwidth.</p> <p>f) Set VBW = 3 X RBW.</p> <p>g) Select the power averaging (RMS) detector. (See above note regarding the use of a peak detector for preliminary measurements.)</p> <p>h) Sweep time = auto-couple.</p> <p>i) Set the analyzer start frequency to the lowest radio frequency signal generated in the equipment, without going below 9 kHz, and the stop frequency to the lower band/block edge frequency minus 100 kHz or 1 MHz, as specified in the applicable rule part. Note that the number of measurement points in each sweep must be $\geq (2 \times \text{span}/\text{RBW})$ which may require that the measurement range defined by the start and stop frequencies above be subdivided, depending on the available number of measurement points provided by the spectrum analyzer. Trace average at least 10 traces in power averaging (i.e., RMS) mode.</p> <p>j) Use the peak marker function to identify the highest amplitude level over each measured frequency range Record the frequency and amplitude and capture a Test Plots for inclusion in the test report.</p> <p>k) Reset the analyzer start frequency to the upper band/block edge frequency plus 100 kHz or 1 MHz, as specified in the applicable rule part, and the analyzer stop frequency to 10 times the highest frequency of the fundamental emission. Note that the number of measurement points in each sweep must be $\geq (2 \times \text{span}/\text{RBW})$ which may require that the measurement range defined by the start and stop frequencies above be subdivided, depending on the available number of measurement points provided by the</p>

	<p>spectrum analyzer. l) Use the peak marker function to identify the highest amplitude level over each of the measured frequency ranges. Record the frequency and amplitude and capture a Test Plots for inclusion in the test report. m) Repeat steps b) through l) for each supported frequency band of operation.</p>
Test Result:	PASS

5.5.2. Test Instruments

Equipment	Manufacturer	Model	Serial Number	Calibration Date	Calibration Due
Signal Generator	Agilent	N5182A	MY47070282	Jul. 19, 2021	Jul. 18, 2022
Spectrum Analyzer	R&S	FSU	200054	Jul. 19, 2021	Jul. 18, 2022
Attenuator	50FP-006-H3	JFW	907763	N/A	N/A

5.5.3. Test data

Test Plots

Lower700MHz Uplink

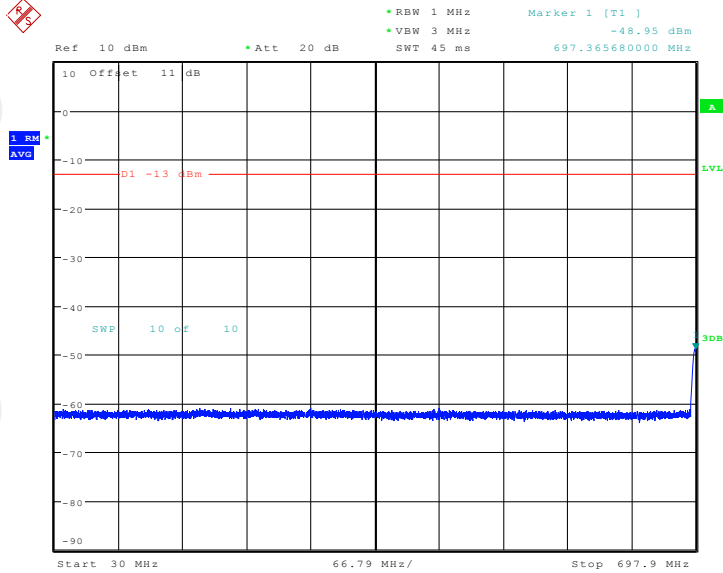

Date: 7.MAY.2022 14:31:36

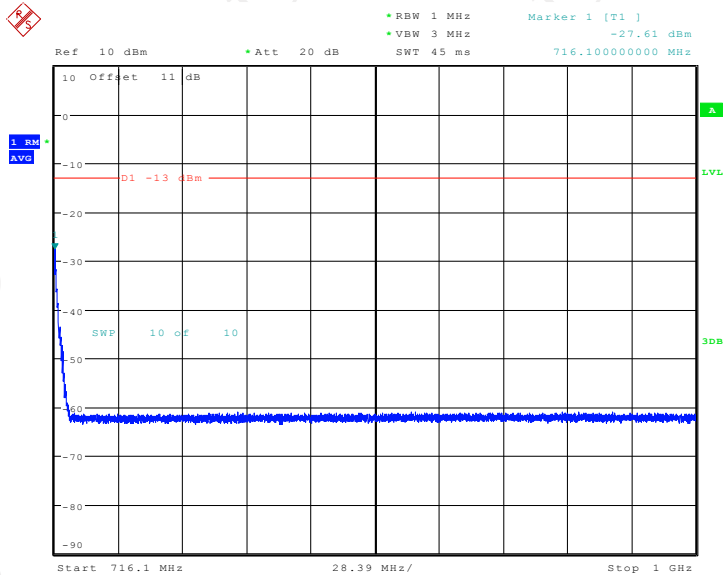

Date: 7.MAY.2022 14:30:37

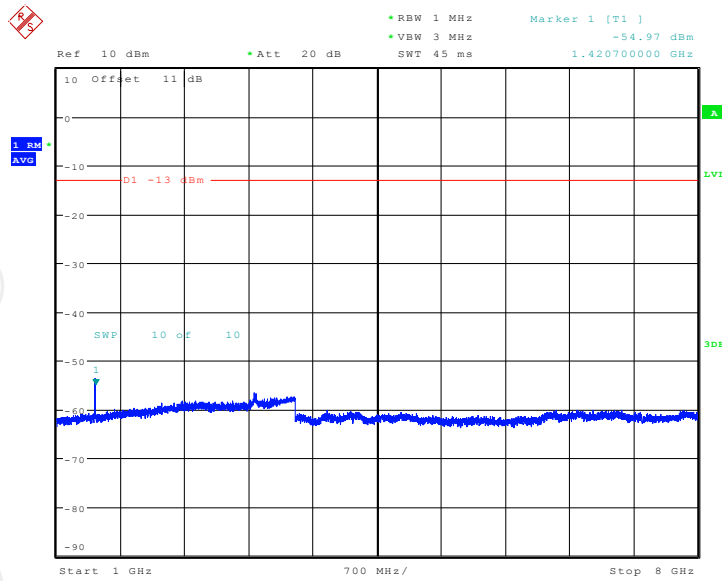

Date: 7.MAY.2022 14:30:04

Lower700MHz Downlink

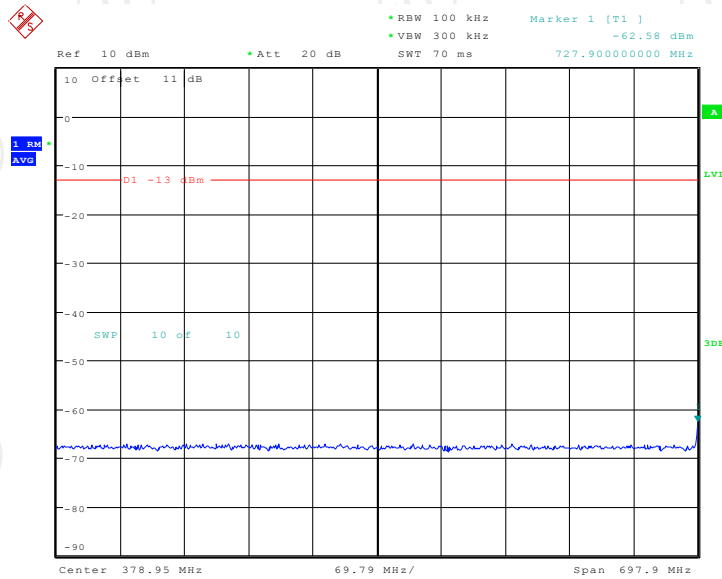

Date: 7.MAY.2022 14:26:17

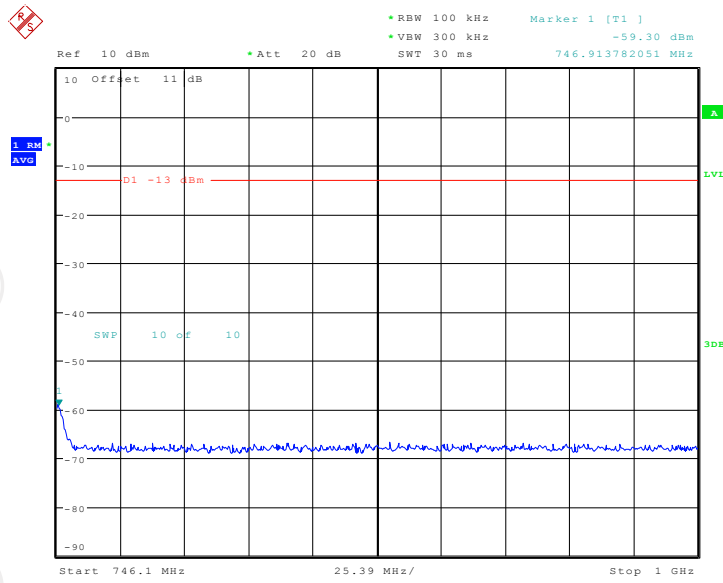

Date: 7.MAY.2022 14:27:01

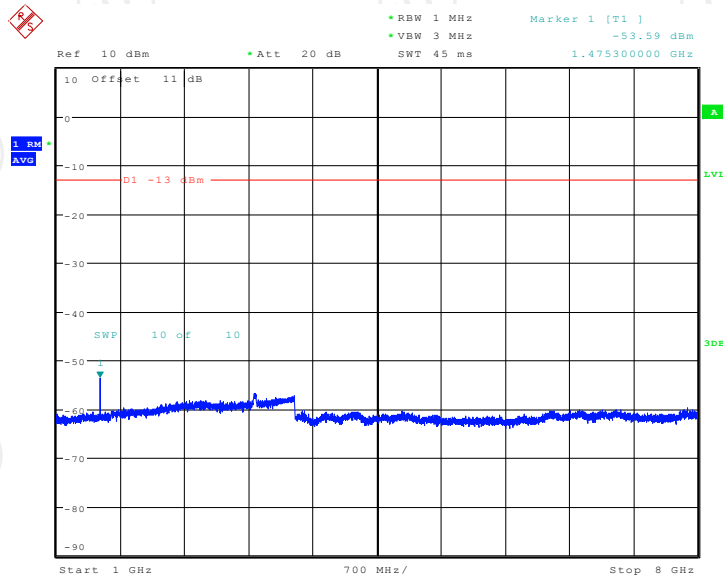

Date: 7.MAY.2022 14:27:46

5.6. Noise Limits

5.6.1. Test Specification

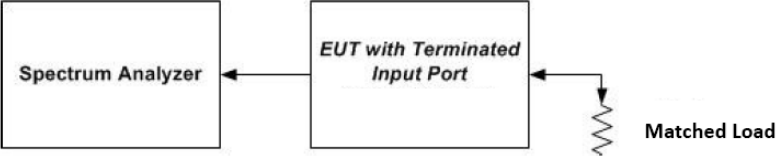
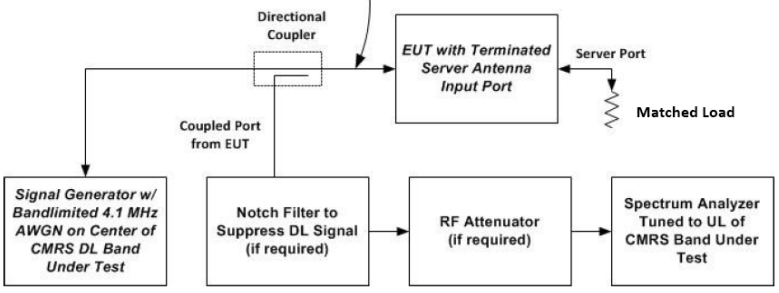
Test Requirement:	FCC Part20 Section 20.21(e)(8)(i)(A); 20.21(e)(8)(i)(H)
Test Method:	KDB935210 D03 Signal Booster Measurements v04r04
Limit:	not exceed -103 dBm/MHz—RSSI. not exceed -102.5 dBm/MHz + $20 \log (F)$, where Frequency is the uplink mid-band frequency of the supported spectrum bands in MHz.
Test Setup:	 <p style="text-align: center;">Figure 3 – Noise limit test setup (also used for 7.8)</p>  <p style="text-align: center;">Figure 4 – Test setup for uplink noise power measurement in the presence of a downlink signal</p>
Test Procedure:	<ol style="list-style-type: none"> a) Connect the EUT to the test equipment as shown in Figure 3. Begin with the uplink output (donor) port connected to the spectrum analyzer. When measuring downlink noise, connect the downlink output (server) port to the spectrum analyzer. b) Set the spectrum analyzer RBW to 1 MHz with the VBW $\geq 3 \cdot$ RBW. c) Select the power averaging (rms) detector and trace average over at least 100 traces. d) Set the center frequency of the spectrum analyzer to the center of the CMRS band under test with the span $\geq 2 \cdot$ the CMRS band. e) Measure the maximum transmitter noise power level. f) Save the spectrum analyzer Test Plots as necessary for inclusion in the final test report. g) Repeat 7.7b) to 7.7f) for all operational uplink and downlink bands. h) Connect the EUT to the test equipment as shown in Figure 4 for uplink noise power measurement in the presence a downlink signal. Affirm the coupled path of the RF coupler is connected to the spectrum analyzer. i) Configure the signal generator for AWGN operation with a 99% OBW of 4.1 MHz. j) Set the spectrum analyzer RBW for 1 MHz, VBW $\geq 3 \cdot$ RBW, with a power averaging (rms) detector with at least 100 trace averages. k) Set the center frequency of the spectrum analyzer to the center of

	<p>the CMRS band under test, with the span ≥ 2 \times the CMRS band. This shall include all spectrum blocks in the particular CMRS band under test (see Appendix A).</p> <p>l) For uplink noise measurements, set the spectrum analyzer center frequency for the uplink band under test, and tune the signal generator to the center of the paired downlink band.</p> <p>m) Measure the maximum transmitter noise power level while varying the downlink signal generator output level from -90 dBm to -20 dBm, as measured at the input port (i.e., downlink signal level at the booster donor port node of Figure 4), in 1 dB steps inside the RSSI-dependent region, and in 10 dB steps outside the RSSI-dependent region. Report the six values closest to the limit, with at least two points within the RSSI-dependent region of the limit. See Appendix D for noise limits graphs.</p> <p>n) Repeat 7.7.1h) through 7.7.1m) for all operational uplink bands.</p> <p>Variable uplink noise timing Variable uplink noise timing is to be measured as follows, using the test setup shown in Figure 4.</p> <p>a) Set the spectrum analyzer to the uplink frequency to be measured.</p> <p>b) Set the span to 0 Hz, with a sweep time of 10 seconds.</p> <p>c) Set the power level of signal generator to the lowest level of the RSSI-dependent noise [see 7.7.1m)].</p> <p>d) Select MAX HOLD and increase the power level of signal generator by 10 dB for mobile boosters, and 20 dB for fixed boosters.</p> <p>e) Confirm that the uplink noise decreases to the specified level within 1 second for mobile devices, and within 3 seconds for fixed devices.¹²</p> <p>f) Repeat 7.7.2a) to 7.7.2e) for all operational uplink bands.</p> <p>g) Include Test Plots and summary table in test report.</p>
Test Result:	PASS

5.6.2. Test Instruments

Equipment	Manufacturer	Model	Serial Number	Calibration Date	Calibration Due
Signal Generator	Agilent	N5182A	MY47070282	Jul. 19, 2021	Jul. 18, 2022
Spectrum Analyzer	Agilent	N9020A	MY49100619	Jul. 19, 2021	Jul. 18, 2022
RF Combiner	SUNVNDN	SUD-CS 0800	16230009	N/A	N/A
Attenuator	50FP-006-H3	JFW	907763	N/A	N/A

5.6.3. Test Data

Max Noise Power			
Frequency Band (MHz)	Measured dBm/MHz	Limit dBm/MHz	Result (dB)
Lower700MHz Uplink	-50.09	-45.51	PASS
Lower700MHz Downlink	-49.75	-45.51	PASS

Note: Fixed booster maximum noise power shall not exceed $-102.5 \text{ dBm/MHz} + 20 \log (F)$, where Frequency is the uplink mid-band frequency of the supported spectrum bands in MHz.

Variable Uplink Noise				
Operation Bands	RSSI dBm	Measured dBm/MHz	Limit dBm/MHz	Results
Lower700MHz	-70	-47.53	-45.51	PASS
	-67	-49.94	-45.51	PASS
	-62	-54.12	-45.51	PASS
	-60	-55.85	-45.51	PASS
	-58	-58.05	-45.51	PASS
	-55	-60.22	-48.00	PASS

Note: According to the KDB 935210 D03 Signal Booster Measurements v04r04 APPENDIX D, when outside of RSSI Dependent limit (20.21.e.8.1.A.1), fixed booster maximum noise power shall not exceed $-102.5 \text{ dBm/MHz} + 20 \log (F)$. RSSI limit not exceed $-103 \text{ dBm/MHz-RSSI}$.

Variable Uplink Noise Timing

Operation Bands	Measured Sec	Limit Sec	Results
Lower700MHz	0.03	3	PASS

Test Plots

Lower700MHz



Uplink Noise

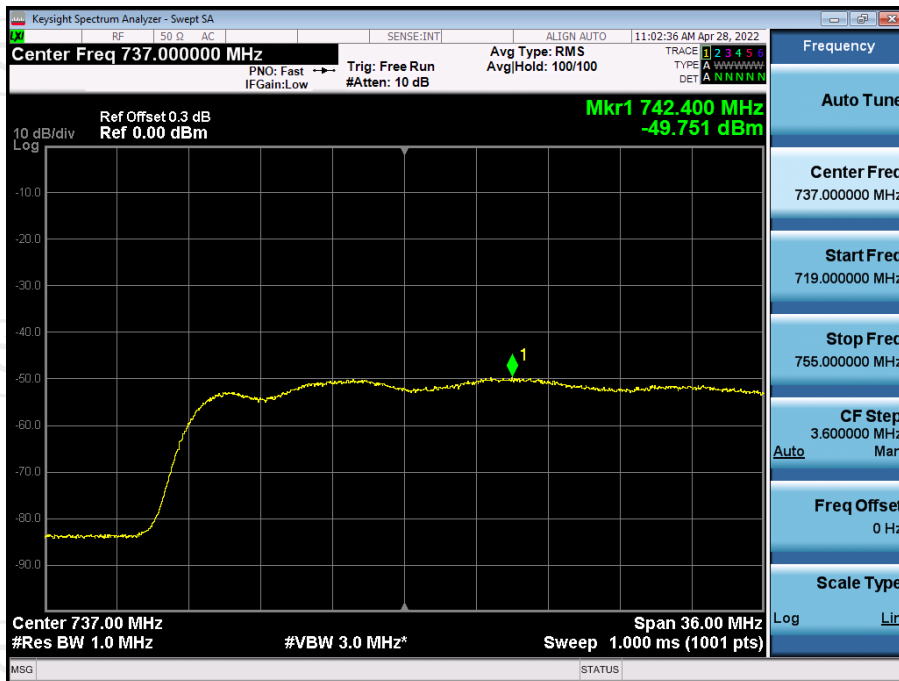

Downlink Noise

Variable Noise Timing Test Plots

Lower700MHz

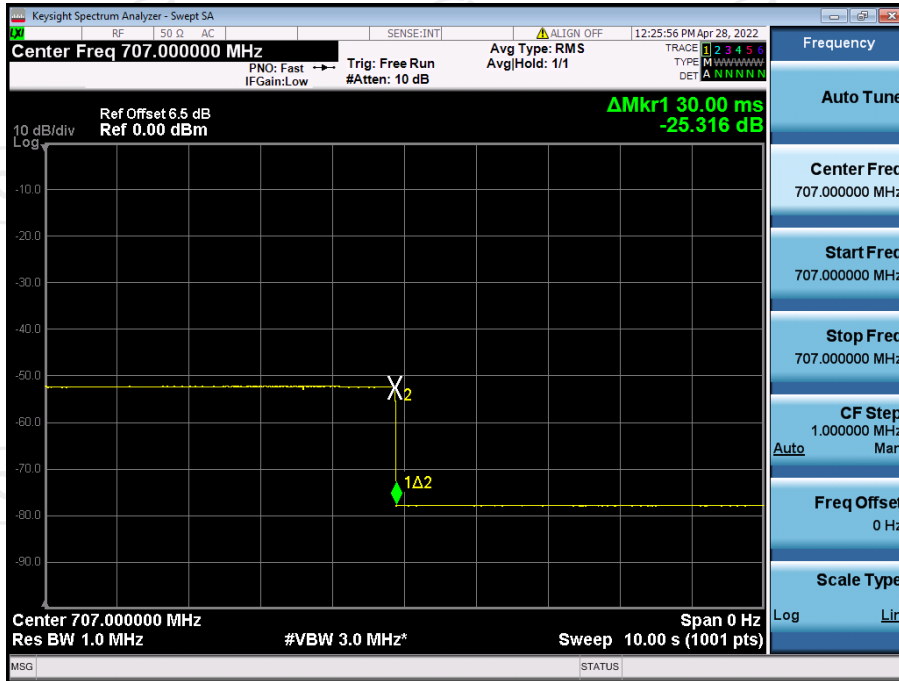

5.7. Uplink Inactivity

5.7.1. Test Specification

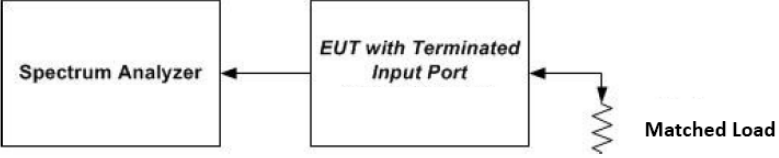
Test Requirement:	FCC Part20 Section 20.21(e)(8)(i)(I)
Test Method:	KDB935210 D03 Signal Booster Measurements v04r04
Limit:	20.21(e), When a consumer booster is not serving an active device connection after 5 minutes the uplink noise power shall not exceed -70 dBm/MHz.
Test Setup:	 <p style="text-align: center;">Figure 3 – Noise limit test setup (also used for 7.8)</p>
Test Procedure:	<ol style="list-style-type: none"> a) Connect the EUT to the test equipment as shown in Set-Up with the uplink output connected to the spectrum analyzer. b) Select the RMS power averaging detector. c) Set the spectrum analyzer RBW for 1 MHz with the VBW \geq 3X RBW. d) Set the center frequency of the spectrum analyzer to the center of the uplink operational band. e) Set the span for 0 Hz with a single sweep time for a minimum of 330 seconds. f) Start to capture a new trace using MAX HOLD. g) After approximately 15 seconds turn on the EUT power. h) Once the full spectrum analyzer trace is complete place a MARKER on the leading edge of the pulse and use the DELTA MARKER METHOD to measure the time until the uplink was squelched. i) Ensure the noise level for the squelched signal is below the uplink inactivity noise power limit, as specified by the rules. j) Capture the Test Plots for inclusion in the test report. k) Measure noise using procedures in a) to e). l) Repeat steps c) to k) for all operational uplink bands.
Test Result:	PASS

5.7.2. Test Instruments

Equipment	Manufacturer	Model	Serial Number	Calibration Date	Calibration Due
Spectrum Analyzer	Agilent	N9020A	MY49100619	Jul. 19, 2021	Jul. 18, 2022

5.7.3. Test Data

Uplink Inactivity			
Operation Bands	Measured (s)	Limit (s)	Result
Lower700MHz	263.0	300.0	PASS

Test Plots

Lower700MHz



5.8. Variable Booster Gain

5.8.1. Test Specification

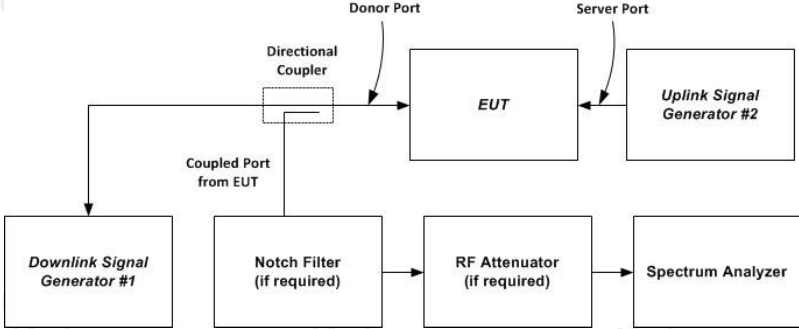
Test Requirement:	FCC Part20 Section 120.21(e)(8)(i)(C)(1) FCC Part20 Section 120.21(e)(8)(i)(H)
Test Method:	KDB935210 D03 Signal booster Measurements v04r04
Limit:	-34 dB - RSSI + MSCL
Test Setup:	 <p>Figure 5 – Variable gain instrumentation test setup</p>
Test Procedure:	<p>Variable gain:</p> <ol style="list-style-type: none"> Connect the EUT to the test equipment as shown in Figure 5 with the uplink output (donor) port connected to signal generator #1. Affirm that the coupled path of the RF coupler is connected to the spectrum analyzer. Configure downlink signal generator #1 for AWGN operation with a 99% OBW of 4.1 MHz, tuned to the center of the operational band. Set the power level and frequency of signal generator #2 to a value that is 5 dB below the AGC level determined from 7.2. The signal type is AWGN with a 99% OBW of 4.1 MHz. Set RBW = 100 kHz. Set VBW ≥ 300 kHz. Select the CHANNEL POWER measurement mode. Select the power averaging (rms) detector. Affirm that the number of measurement points per sweep ≥ (2 . span)/RBW. Sweep time = auto couple or as necessary (but no less than auto couple value). Trace average at least 10 traces in power averaging (i.e., rms) mode. Measure the maximum channel power and compute maximum gain when varying the signal generator #1 output to a level from .90 dBm to .20 dBm, as measured at the input port (i.e., downlink signal level at the booster donor port node of Figure 5), in 1 dB steps inside the RSSI-dependent region, and 10 dB steps outside the RSSI-dependent region. Report the six values closest to the limit, including at least two points from within the RSSI-dependent region of operation. See gain limit in charts in Appendix D for uplink gain requirements. Additionally, document that the EUT provides equivalent uplink and downlink gain, and when operating in shutoff mode that the uplink and downlink gain is within the transmit power off mode gain limits. Repeat 7.9.1b) to 7.9.1k) for all operational uplink bands. <p>Variable uplink gain timing: Variable uplink gain timing is to be measured as follows, using the test setup shown in Figure 5.</p> <ol style="list-style-type: none"> Set the spectrum analyzer to the uplink frequency to be

	<p>measured.</p> <p>b) Set the span to 0 Hz with a sweep time of 10 seconds.</p> <p>c) Set the power level of signal generator #1 to the lowest level of the RSSI-dependent gain [see 7.9.1k)].</p> <p>d) Select MAX HOLD and increase the power level of signal generator #1 by 10 dB for mobile boosters, and by 20 dB for fixed indoor boosters. Signal generator #2 remains same, as described in 7.9.1c).</p> <p>e) Confirm that the uplink gain decreases to the specified levels, within 1 second for mobile devices, and within 3 seconds for fixed devices.13</p> <p>f) Repeat 7.9.2a) to 7.9.2e) for all operational uplink bands.</p>
Test Result:	PASS

5.8.2. Test Instruments

Equipment	Manufacturer	Model	Serial Number	Calibration Date	Calibration Due
Signal Generator	Agilent	E4421B	GB39340839	Jul. 19, 2021	Jul. 18, 2022
Signal Generator	Agilent	N5182A	MY47070282	Jul. 19, 2021	Jul. 18, 2022
Spectrum Analyzer	Agilent	N9020A	MY49100619	Jul. 19, 2021	Jul. 18, 2022
RF Combiner	SUNVNDN	SUD-CS 0800	16230009	N/A	N/A
Attenuator	50FP-006-H3	JFW	907763	N/A	N/A

5.8.3. Test Data

Mobile station coupling loss (MSCL): the minimum coupling loss (in dB) between the wireless device and the input (server) port of the consumer booster. MSCL must be calculated or measured for each band of operation and provided in compliance test reports. MSCL includes the path loss from the wireless device, and the booster's server antenna gain and cable loss. The wireless device is assumed to be an isotropic (0 dBi) antenna reference. Minimum standoff distances from inside wireless devices to the booster's server antenna must be reasonable and specified by the manufacturer in customer provided installation manuals.

MSCL Calculation							
Operation Bands	Frequency (MHz)	Distance (m)	Path loss (dB)	Indoor Antenna Gain(dBi)	Indoor Cable Loss(dB)	Polarity Loss(dB)	MSCL (dB)
Lower700 MHz	698	2	35.40	6	1.2	3.01	33.61

Note : Path loss = $20\log f + 20\log d - 27.5$

Polarity loss = $20\text{Log} (1/\text{Sin} (45\text{deg})) \text{ dB} = 3.01\text{dB}$

Variable booster gain							
Operation Band	RSSI (dBm)	Input Power (dBm)	Output Power (dBm)	Measured Gain (dB)	MSCL	Limit	Results
Lower700MHz	-70	-42.52	13.29	55.81	33.61	63.49	PASS
	-68	-42.52	12.80	55.32	33.61	63.49	PASS
	-63	-42.52	8.05	50.57	33.61	62.61	PASS
	-60	-42.52	4.68	47.20	33.61	59.61	PASS
	-58	-42.52	3.46	45.98	33.61	57.61	PASS
	-56	-42.52	1.41	43.93	33.61	55.61	PASS

Variable Uplink Gain Timing

Operation Band	Measured Sec	Limit Sec	Result
Lower700MHz	0.04	3.0	PASS

Variable Uplink Gain Timing Test Plots

Lower700MHz

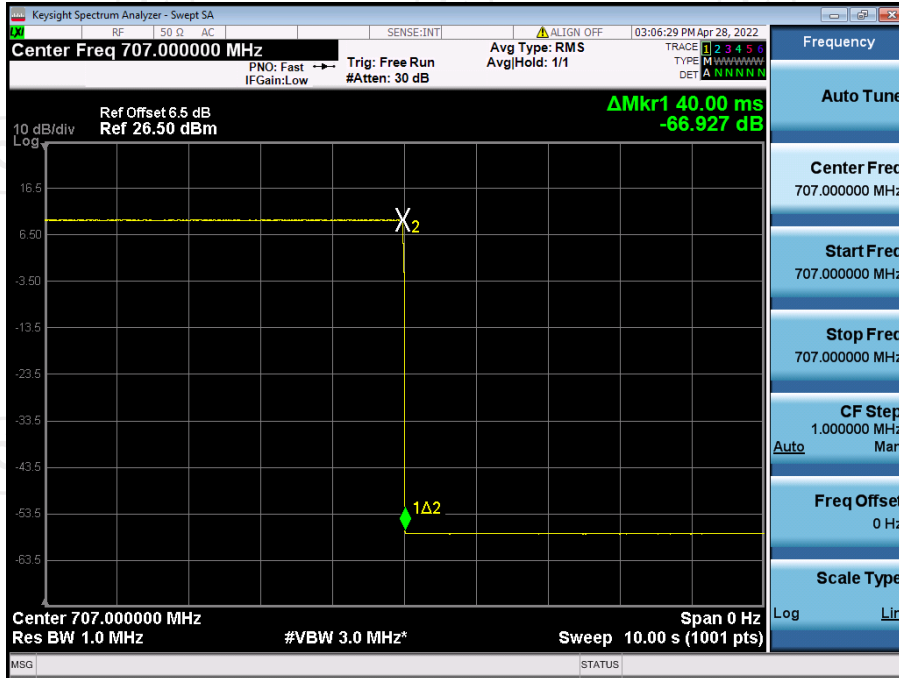

5.9. Occupied Bandwidth

5.9.1. Test Specification

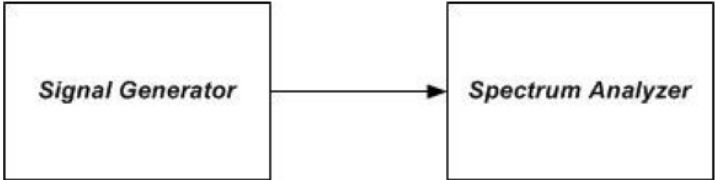
Test Requirement:	FCC Part2 Section 2.1049
Test Method:	KDB935210 D03 Signal booster Measurements v04r04
Limit:	N/A
Test setup:	 <p>Figure 6 – Test setup for measuring characteristics of test signals used for subsequent EUT occupied bandwidth testing</p>
Test Procedure:	<ol style="list-style-type: none"> a) Connect the test equipment as shown in Figure 6 to firstly measure the characteristics of the test signals produced by the signal generator. b) Set VBW \geq 3 RBW. c) Set the center frequency of the spectrum analyzer to the center of the operational band. The span will be adjusted for each modulation type and OBW as necessary for accurately viewing the signals. d) Set the signal generator for power level to match the values obtained from the tests of 7.2. e) Set the signal generator modulation type for GSM with a PRBS pattern and allow the trace on the signal generator to stabilize adjusting the span as necessary. f) Set the spectrum analyzer RBW for 1% to 5% of the EBW. g) Capture the spectrum analyzer trace for inclusion in the test report. h) Repeat 7.10c) to 7.10g) for CDMA and W-CDMA modulation, adjusting the span as necessary. AWGN or LTE may be used in place of W-CDMA, as an option. i) Repeat 7.10c) to 7.10h) for all uplink and downlink operational bands. j) Connect the test equipment as shown in Figure 1, with the uplink output (donor) port connected to the spectrum analyzer, and the server port connected to the signal generator. k) Repeat 7.10c) to 7.10i) with this EUT uplink path test setup. l) Connect the test equipment as shown in Figure 1, with the downlink output (server) port connected to the spectrum analyzer, and the donor port connected to the signal generator. m) Repeat 7.10c) to 7.10j) with this EUT downlink path test setup.
Test results:	PASS

5.9.2. Test Instruments

Equipment	Manufacturer	Model	Serial Number	Calibration Date	Calibration Due
Signal Generator	Agilent	N5182A	MY47070282	Jul. 19, 2021	Jul. 18, 2022
Spectrum Analyzer	R&S	FSU	200054	Jul. 19, 2021	Jul. 18, 2022

5.9.3. Test Data

Operation Band		Signal Type	Input OBW [MHz]	Output OBW [MHz]	Results
Uplink	Lower700M Hz	GSM	0.245	0.245	PASS
		CDMA	1.245	1.240	PASS
		LTE	4.567	4.519	PASS
Downlink	Lower700M Hz	GSM	0.256	0.245	PASS
		CDMA	1.269	1.236	PASS
		LTE	4.583	4.551	PASS

Test Plots

Lower700MHz GSM UL Input

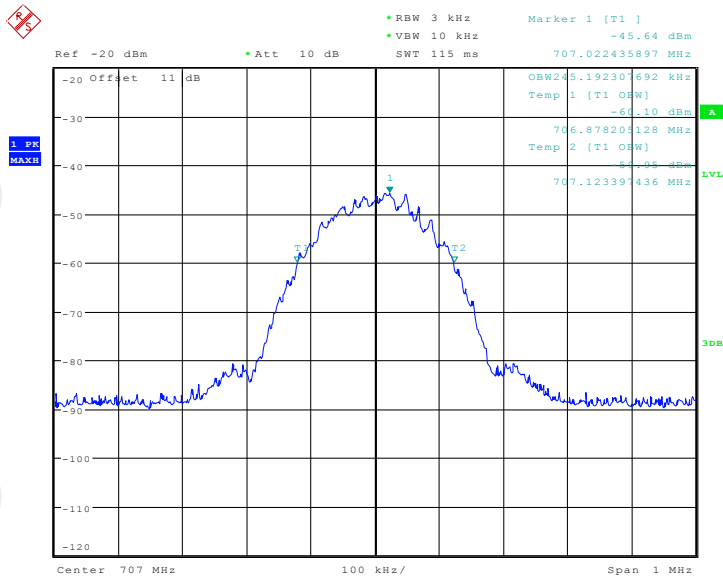

Date: 7.MAY.2022 08:55:11

Lower700MHz GSM UL output

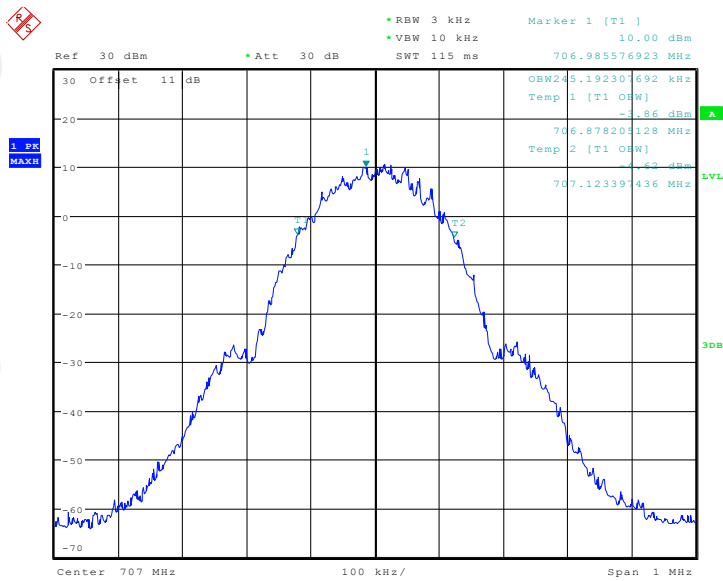

Date: 7.MAY.2022 12:47:24

Lower700MHz GSM DL Input

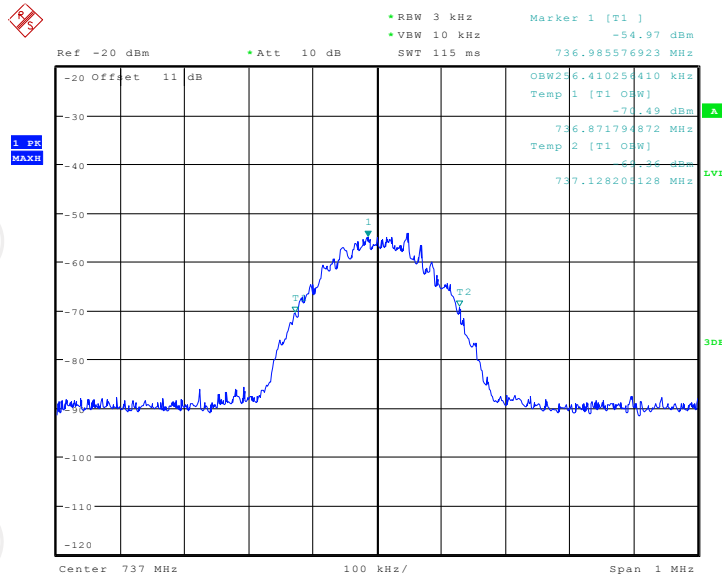

Date: 7.MAY.2022 08:57:37

Lower700MHz GSM DL Output

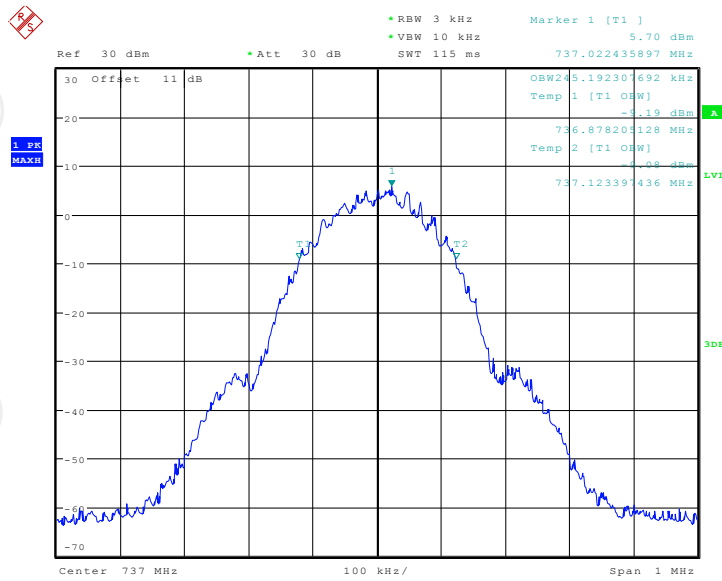

Date: 7.MAY.2022 12:44:43

Lower700MHz CDMA UL Input

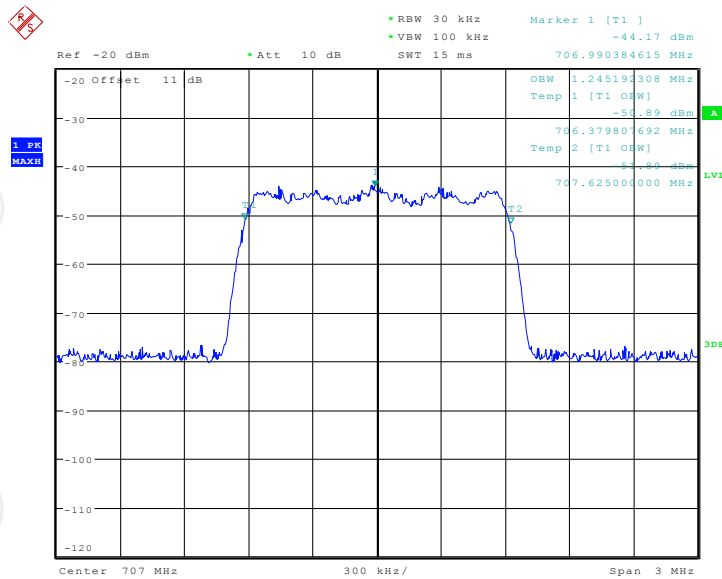

Date: 7.MAY.2022 08:59:31

Lower700MHz CDMA UL output

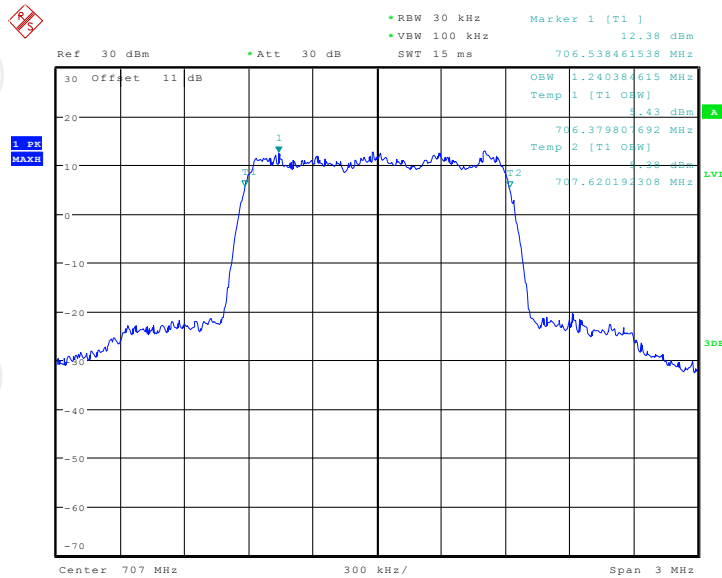

Date: 7.MAY.2022 12:42:05

Lower700MHz CDMA DL Input

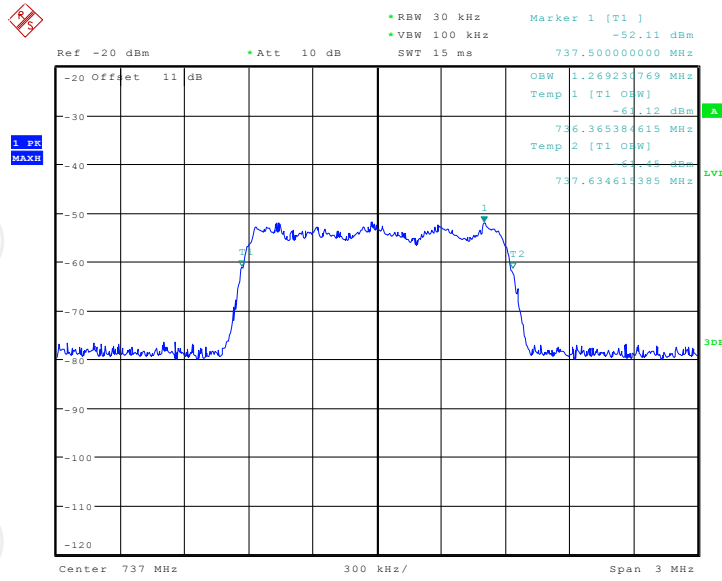

Date: 7.MAY.2022 08:58:46

Lower700MHz CDMA DL Output

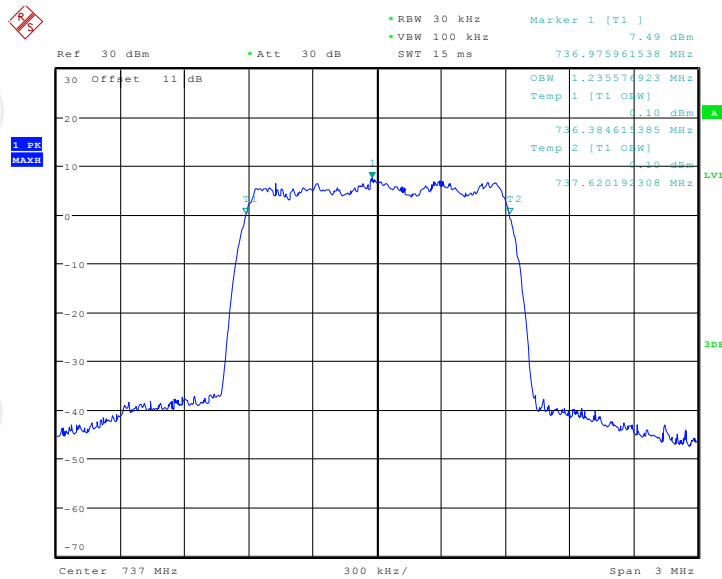

Date: 7.MAY.2022 12:43:43

Lower700MHz LTE UL Input

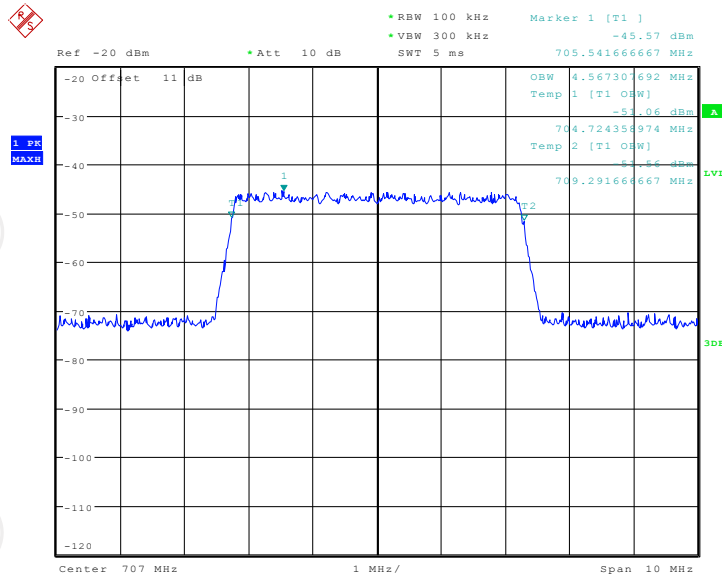

Date: 7.MAY.2022 09:00:38

Lower700MHz LTE UL output

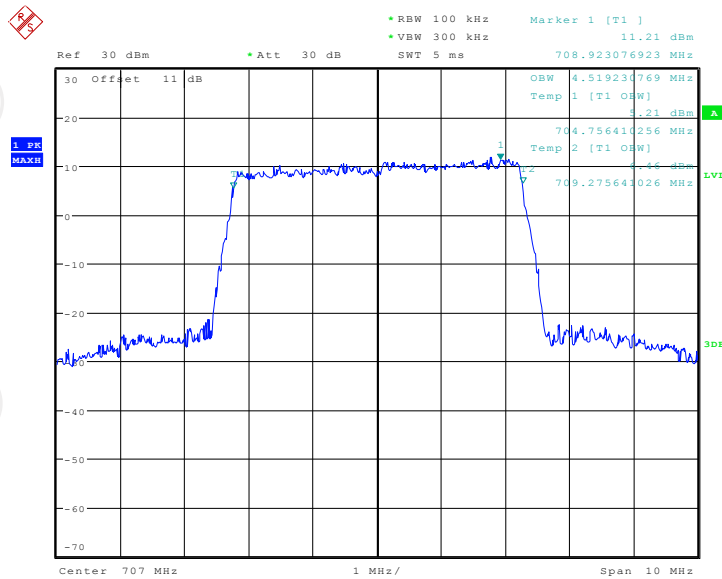

Date: 7.MAY.2022 12:41:04

Lower700MHz LTE DL Input

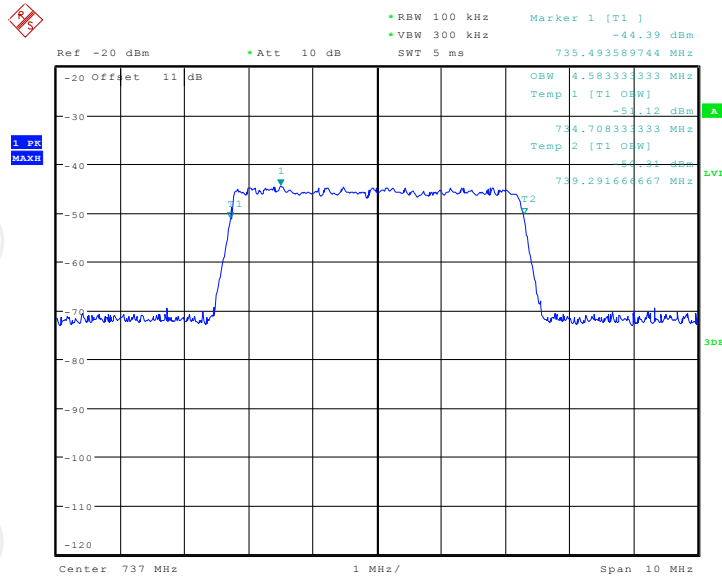

Date: 7.MAY.2022 09:07:10

Lower700MHz LTE DL Output

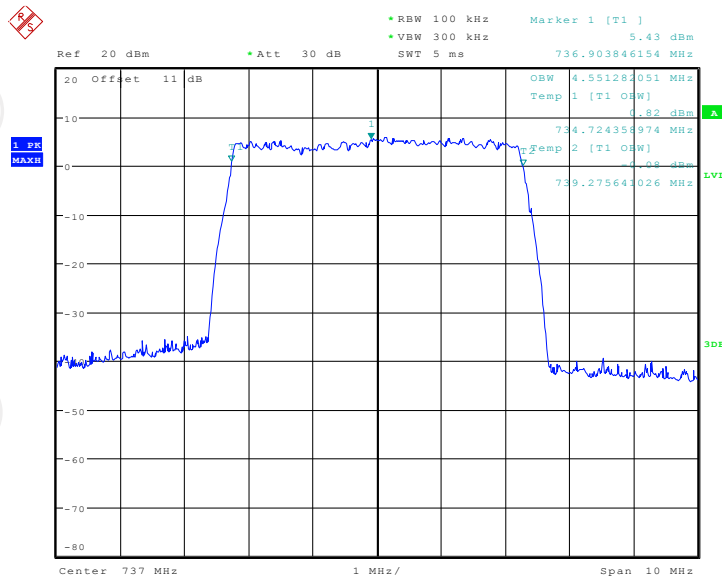

Date: 7.MAY.2022 12:38:05

5.10. Oscillation Detection and Mitigation

5.10.1. Test Specification

Test Requirement:	FCC Part20 Section 20.21(e)(8)(ii)(A)
Test Method:	KDB935210 D03 Signal booster Measurements v04r04
Limit:	Reference to test data bellow

Test setup:

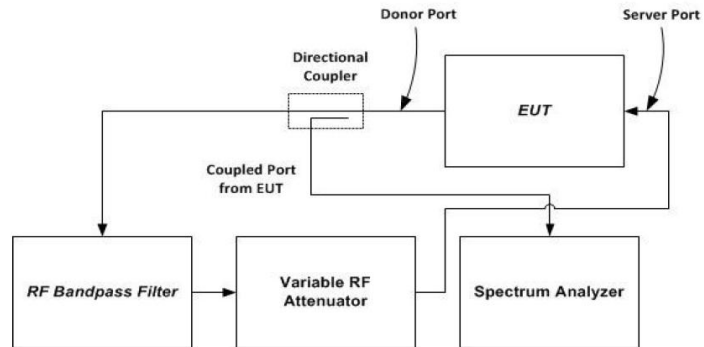

NOTE—This figure shows the test setup for uplink bands transmission path tests; i.e., signal flow is out from the donor port into the directional coupler. For downlink bands transmission path tests, the feedback signal flow path direction and equipment connections shall be reversed, i.e., signal flow is out from the server port into the directional coupler, and signal flow is into the donor port from the variable RF attenuator.

Figure 7 – Oscillation detection (7.11.2) test setup

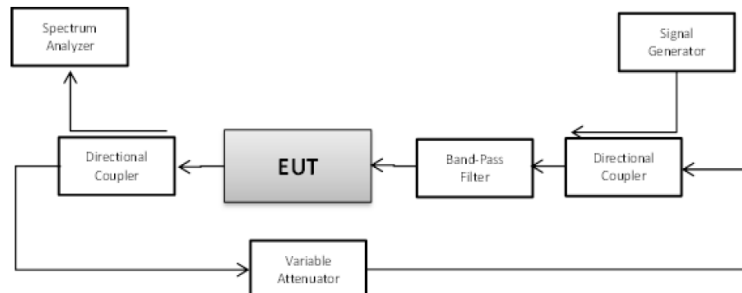

Figure 8 – Oscillation mitigation/shutdown test setup

Test Procedure:

Oscillation restart tests

- a) Connect the normal-operating mode EUT to the test equipment as shown in Figure 7 beginning with the spectrum analyzer on the uplink output (donor) port. Confirm that the RF coupled path is connected to the spectrum analyzer.
NOTE—The band-pass filter shall provide sufficient out-of-band rejection to prevent oscillations from occurring in bands not under test.
- b) Spectrum analyzer settings:
 - 1) Center frequency at the center of the band under test
 - 2) Span equal or slightly exceeding the width of the band under test
 - 3) Continuous sweep, max-hold
 - 4) RBW \geq 1 MHz, VBW > 3xRBW
- c) Decrease the variable attenuator until the spectrum analyzer displays a signal within the band under test. Using a marker, identify the approximate center frequency of this signal on the max-hold display, increase the attenuation by 10 dB, then reset the EUT (e.g., cycle ac/dc power).
- d) Repeat 7.11.2c) twice to ensure that the center of the signal

- created by the booster remains within 250 kHz of the spectrum analyzer display center frequency. If the frequency of the signal is unstable, confirm that the spectrum analyzer display is centered between the frequency extremes observed. If the signal is wider than 1 MHz, ensure that the spectrum analyzer display is centered on the signal by increasing the RBW. Reset the EUT (e.g., cycle ac/dc power) after each oscillation event, if necessary. Set the spectrum analyzer sweep trigger level to just below the peak amplitude of the displayed EUT oscillation signal.
- e) Set the spectrum analyzer to zero-span, with a sweep time of 5 seconds, and single-sweep with max-hold. The spectrum analyzer sweep trigger level in this and the subsequent steps shall be the level identified in 7.11.2d).
 - f) Decrease the variable attenuator until the spectrum analyzer sweep is triggered, increase the attenuation by 10 dB, then reset the EUT (e.g., cycle ac/dc power).
 - g) Reset the zero-span trigger of the spectrum analyzer, then repeat 7.11.2f) twice to ensure that the spectrum analyzer is reliably triggered, resetting the EUT (e.g., cycle ac/dc power) after each oscillation event if necessary.
 - h) Reset the zero-span sweep trigger of the spectrum analyzer, and reset the EUT (e.g., cycle ac/dc power).
 - i) Force the EUT into oscillation by reducing the attenuation.
 - j) Use the marker function of the spectrum analyzer to measure the time from the onset of oscillation until the EUT turns off, by setting Marker 1 on the leading edge of the oscillation signal and Marker 2 on the trailing edge. The spectrum analyzer sweep time may be adjusted to improve the time resolution of these cursors.
 - k) Capture the spectrum analyzer zero-span trace for inclusion in the test report. Report the power level associated with the oscillation separately if it can't be displayed on the trace.
 - l) Repeat 7.11.2b) to 7.11.2k) for all operational uplink and downlink bands.
 - m) Set the spectrum analyzer zero-span sweep time for longer than 60 seconds, then measure the restart time for each operational uplink and downlink band.
 - n) Replace the normal-operating mode EUT with the EUT that supports an anti-oscillation test mode.
 - o) Set the spectrum analyzer zero-span time for a minimum of 120 seconds, and a single sweep.
 - p) Manually trigger the spectrum analyzer zero-span sweep, and manually force the booster into oscillation as described in 7.11.2i).
 - q) When the sweep is complete, place cursors between the first two oscillation detections, and save the Test Plots for inclusion in the test report. The time between restarts must match the manufacturer's timing for the test mode, and there shall be no more than 5 restarts.
 - r) Repeat 7.11.2m) to 7.11.2q) for all operational uplink and downlink bands.

Test procedure for measuring oscillation mitigation or shutdown

- a) Connect the normal-operating mode EUT to the test equipment as shown in Figure 8.
- b) Set the spectrum analyzer center frequency to the center of band under test, and use the following settings:
 - 1) RBW=30 kHz, VBW $\geq 3 \times$ RBW,
 - 2) power averaging (rms) detector,
 - 3) trace averages ≥ 100 ,
 - 4) span $\geq 120\%$ of operational band under test

	<p>5) number of sweep points $\geq 2 \times \text{Span/RBW}$.</p> <p>c) Configure the signal generator for AWGN operation with a 99% OBW of 4.1 MHz, tuned to the frequency of 2.5 MHz above the lower edge or below the upper edge of the operating band under test. Adjust the RF output level of the signal generator such that the measured power level of the AWGN signal at the output port of the booster is 30 dB less than the maximum power of the booster for the band under test. Affirm that the input signal is not obstructing the measurement of the strongest oscillation peak in the band, and is not included within the span in the measurement.</p> <p>1) Boosters with operating spectrum passbands of 10 MHz or less may use a CW signal source at the band edge rather than AWGN.</p> <p>2) For device passbands greater than 10 MHz, standard CMRS signal sources (i.e., CDMA, W-CDMA, LTE) may be used instead of AWGN at the band edge.</p> <p>d) Set the variable attenuator to a high attenuation setting such that the booster will operate at maximum gain when powered on. Reset the the EUT (e.g., cycle ac/dc power). Allow the EUT to complete its boot-up process, to reach full operational gain, and to stabilize its operation.</p> <p>e) Set the variable attenuator such that the insertion loss for the center of the band under test (isolation) between the booster donor port and server port is 5 dB greater than the maximum gain, as recorded in the maximum gain test procedure (see 7.3), for the band under test.</p> <p>f) Verify the EUT shuts down, i.e., to mitigate the oscillations. If the booster does not shut down, measure and verify the peak oscillation level as follows.</p> <p>1) Allow the spectrum analyzer trace to stabilize.</p> <p>2) Place the marker at the highest oscillation level occurring within the span, and record its output level and frequency.</p> <p>3) Set the spectrum analyzer center frequency to the frequency with the highest oscillation signal level, and reduce the span such that the upper and lower adjacent oscillation peaks are within the span.</p> <p>4) Use the Minimum Search Marker function to find the lowest output level that is within the span, and within the operational band under test, and record its output level and frequency.</p> <p>5) Affirm that the peak oscillation level measured in 7.11.3f2), does not exceed by 12.0 dB the minimal output level measured in 7.11.3f)4). Record the measurement results of 7.11.3f2) and 7.11.3f4) in tabular format for inclusion in the test report.</p> <p>6) The procedure of 7.11.3f1) to 7.11.3f5) allows the spectrum analyzer trace to stabilize, and verification of shutdown or oscillation level measurement must occur within 300 seconds.14</p> <p>g) Decrease the variable attenuator in 1 dB steps, and repeat step 7.11.3f) for each 1 dB step. Continue testing to the level when the insertion loss for the center of band under test (isolation) between the booster donor port and server port is 5 dB lower than the maximum gain (see 7.3).</p> <p>h) Repeat 7.11.3a) to 7.11.3g) for all operational uplink and downlink bands.</p>
--	---

Test results:	PASS
----------------------	-------------

5.10.2. Test Instruments

Equipment	Manufacturer	Model	S/N	Calibration Date	Calibration Due
Spectrum Analyzer	Agilent	N9020A	MY49100619	Jul. 19, 2021	Jul. 18, 2022
Attenuation	AF115A-09-34	JFW	907763	N/A	N/A
RF Combiner	SUNVNDN	SUD-CS0800	16230009	N/A	N/A
AN03468	Band Pass Filter	4CS10-781.5/E12.2-O/O	N/A	N/A	N/A
AN03469	Band Pass Filter	4CS10-751.5/E12-O/O	N/A	N/A	N/A
AN02475	1 dB step Attenuator	8494B	N/A	N/A	N/A
AN03429	10dB step Attenuator	8496B	N/A	N/A	N/A
ANC00082	RF Coupler	722-10-1.500V	N/A	N/A	N/A

5.10.3. Test Data

Test results of detection time				
Operation Bands		Detection Time (s)	Limit (s)	Result
Uplink	Lower700MHz	0.035	0.300	PASS
Downlink	Lower700MHz	0.115	1.000	PASS

Test results of restarting time						
Operation Bands		Restarting Time(s)	Limit (s)	Restarting Counts	Limit	Result
Uplink	Lower700 MHz	/	60	0	5	PASS
Downlink	Lower700 MHz	65.67	60	1	5	PASS

Test Plots of detection time

Lower700MHz UL

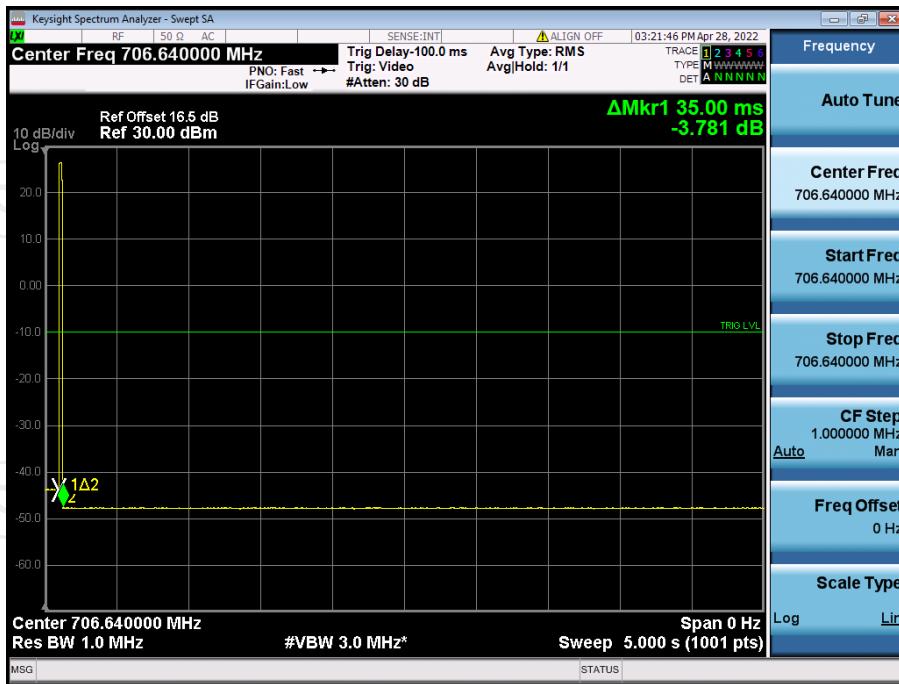

Lower700MHz DL

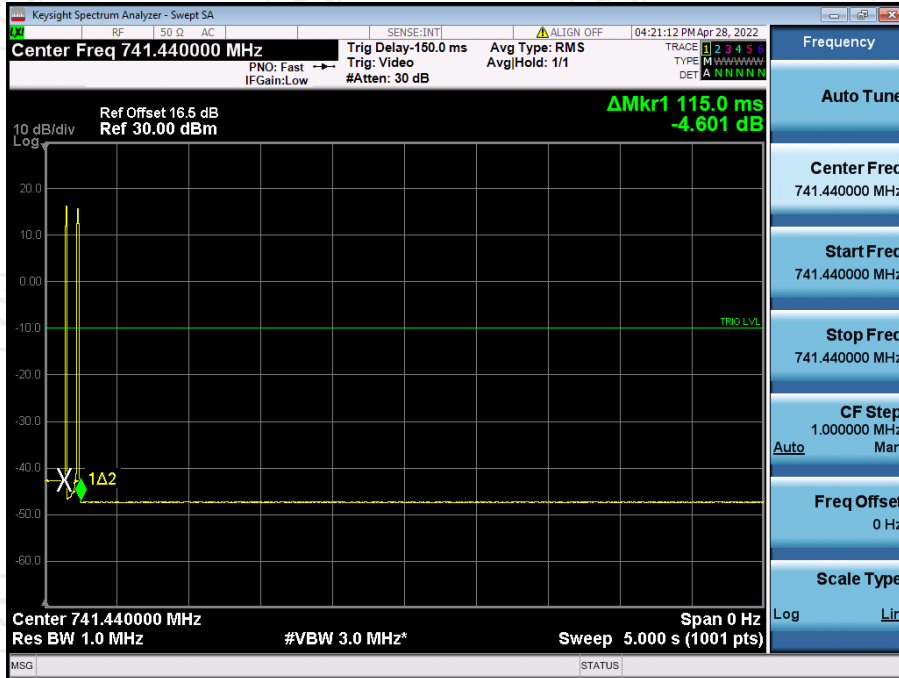

Test Plots of restarting time

Lower700MHz UL

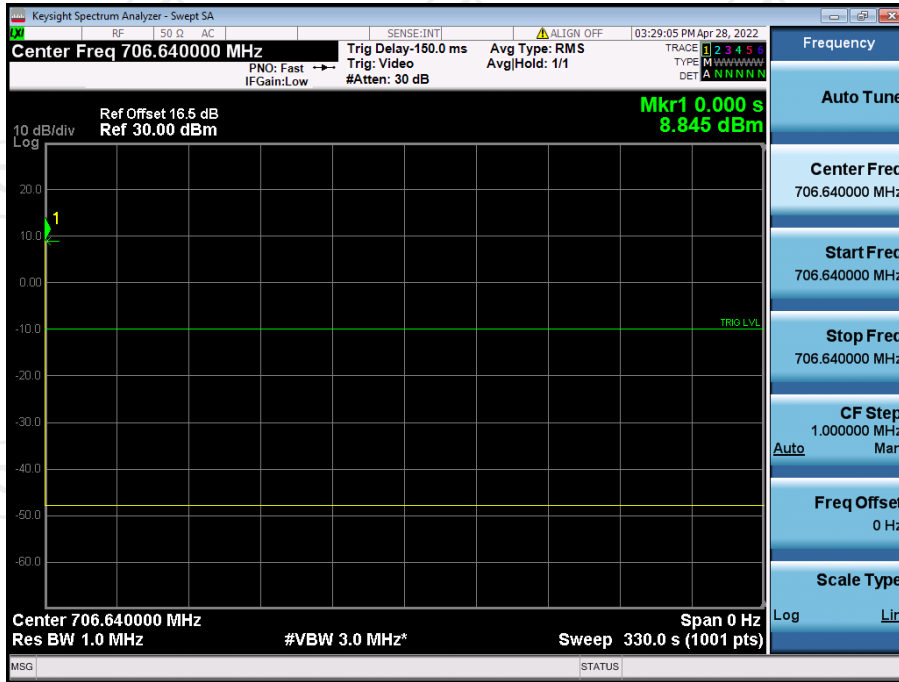

Lower700MHz DL

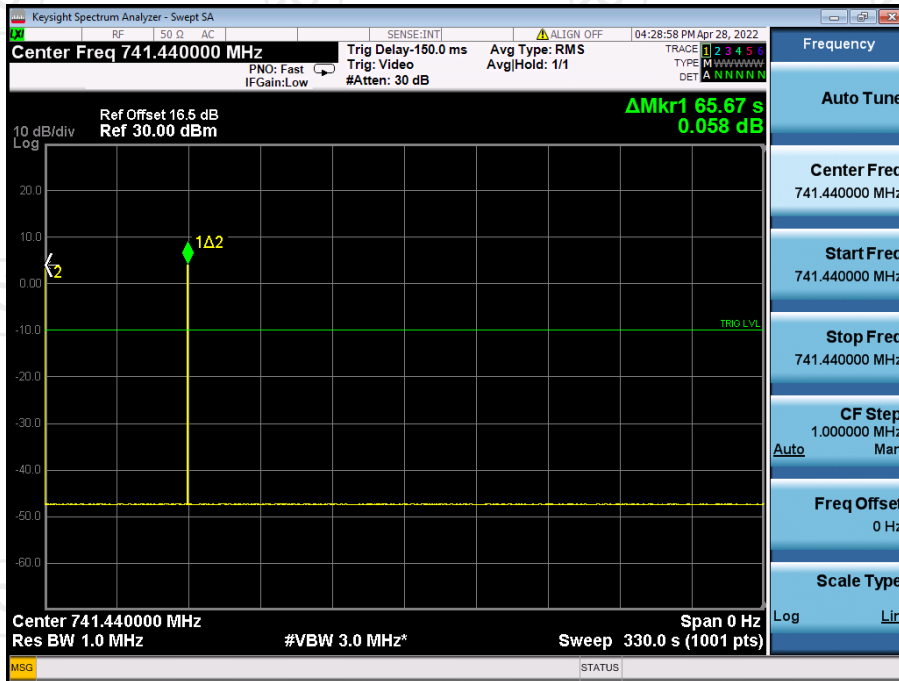

Test results of Mitigation or Shutdown

Lower700M Hz	Uplink(698-716MHz)								
Signal Type	AWGN								
Isolation	Peak Oscillations		Minimal Level		Delta Value	Limit	Time to Mitigate Oscillation	Mitigation Time Limit	Result
	Freq.	Level	Freq.	Level					
dB	MHz	dBm	MHz	dBm	dB	dB	sec	sec	
+5	712.56	-52.72	710.45	-66.34	13.62	<12	126	300	Pass
+4	712.56	-50.20	710.45	-66.99	16.79	<12	127	300	Pass
+3	712.56	-46.78	710.45	-67.47	20.69	<12	125	300	Pass
+2	712.56	-37.89	710.45	-67.63	29.74	<12	128	300	Pass
+1	EUT Shutdown								

Lower700M Hz	Downlink(728-746MHz)								
Signal Type	AWGN								
Isolation	Peak Oscillations		Minimal Level		Delta Value	Limit	Time to Mitigate Oscillation	Mitigation Time Limit	Result
	Freq.	Level	Freq.	Level					
dB	MHz	dBm	MHz	dBm	dB	dB	sec	sec	
+5	731.67	-55.18	730.24	-67.76	12.58	<12	125	300	Pass
+4	731.67	-52.78	730.24	-68.44	15.66	<12	120	300	Pass
+3	731.67	-49.83	730.24	-68.64	18.81	<12	128	300	Pass
+2	731.67	-45.30	730.24	-68.34	23.04	<12	122	300	Pass
+1	731.67	-43.15	730.24	-68.79	25.64	<12	124	300	Pass
+0	731.67	-40.39	730.24	-69.91	29.52	<12	127	300	Pass
-1	EUT Shutdown								

6. Radiation Spurious Emission

6.1.1. Test Specification

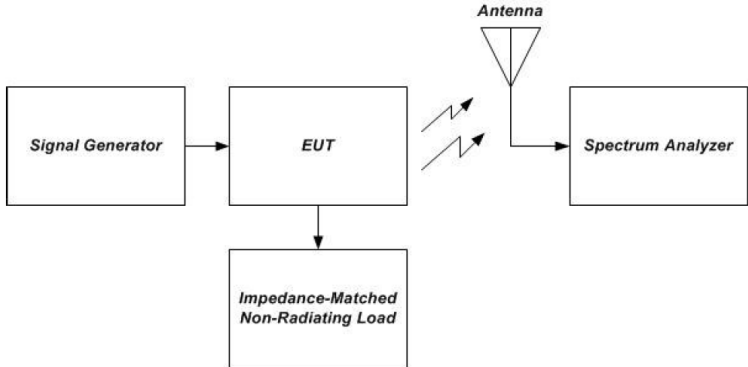
Test Requirement:	FCC Part2 Section 2.1053
Test Method:	KDB935210 D03 Signal booster Measurements v04r04
Limit:	-13dBm
Test setup:	 <p style="text-align: center;">Figure 10 – Radiated spurious emissions test and instrumentation setup</p>
Test Procedure:	<ol style="list-style-type: none"> a) Place the EUT on an OATS or semi-anechoic chamber turntable 3 m from the receiving antenna.15 b) Connect the EUT to the test equipment as shown in Figure 10 beginning with the uplink output (donor) port. c) Set the signal generator to produce a CW signal with the frequency set to the center of the operational band under test, and the power level set at PIN as determined from measurement results per 7.2. d) Measure the radiated spurious emissions from the EUT from the lowest to the highest frequencies as specified in § 2.1057. Maximize the radiated emissions by using the procedures described in ANSI C63.4. e) Capture the peak emissions Test Plotss using a peak detector with Max-Hold for inclusion in the test report. Tabular data is acceptable in lieu of spectrum analyzer Test Plotss. f) Repeat 7.12c) through 7.12e) for all uplink and downlink operational bands.
Test results:	PASS

6.1.2. Test Instruments

Radiated Emission				
Name	Model No.	Manufacturer	Date of Cal.	Due Date
EMI Test Receiver	ESIB7	R&S	Jul. 08, 2021	Jul. 07, 2022
Spectrum Analyzer	FSQ40	R&S	Jul. 08, 2021	Jul. 07, 2022
Pre-amplifier	8447D	HP	Jul. 08, 2021	Jul. 07, 2022
Pre-amplifier	LNPA_0118G-45	SKET	Feb. 25, 2022	Feb. 24, 2023
Pre-amplifier	LNPA_1840G-50	SKET	Feb. 25, 2022	Feb. 24, 2023
Broadband Antenna	VULB9163	Schwarzbeck	Sep. 05, 2020	Sep. 04, 2022
Horn Antenna	BBHA 9120D	Schwarzbeck	Sep. 05, 2020	Sep. 04, 2022
Horn Antenna	BBHA 9170	Schwarzbeck	Apr. 11, 2021	Apr. 10, 2023
Coaxial cable	RC_DC18G-N	SKET	Feb. 25, 2022	Feb. 24, 2023
Coaxial cable	RC-DC18G-N	SKET	Feb. 25, 2022	Feb. 24, 2023
Coaxial cable	RC-DC40G-N	SKET	Jul. 08, 2021	Jul. 07, 2022
Loop antenna	ZN30900A	ZHINAN	Sep. 06, 2020	Sep. 05, 2022
Signal Generator	N5182A	Agilent	Jul. 19, 2021	Jul. 18, 2022

6.1.3. Test data

Frequency [MHz]	Antenna polarity [H/V]	Reading Level	Substitution factor	Measurement Level [dBm]	Limit [dBm]	Margin [dB]
Lower700MHz Uplink						
170.23	H	-45.54	-8.84	-54.38	-13.00	-41.38
553.61	V	-57.67	5.91	-51.76		-38.76
1414.00	H	-45.32	-0.37	-45.69		-32.69
1414.00	V	-46.69	1.25	-45.44		-32.44
Lower700MHz Downlink						
173.26	H	-47.50	-7.01	-54.51	-13.00	-41.51
555.49	V	-57.06	5.28	-51.78		-38.78
1474.36	H	-49.92	-0.19	-50.11		-37.11
1474.36	V	-47.54	1.38	-46.16		-33.16

Appendix A: Photographs of Test Setup

Product: cell phone signal booster

Model: YA70

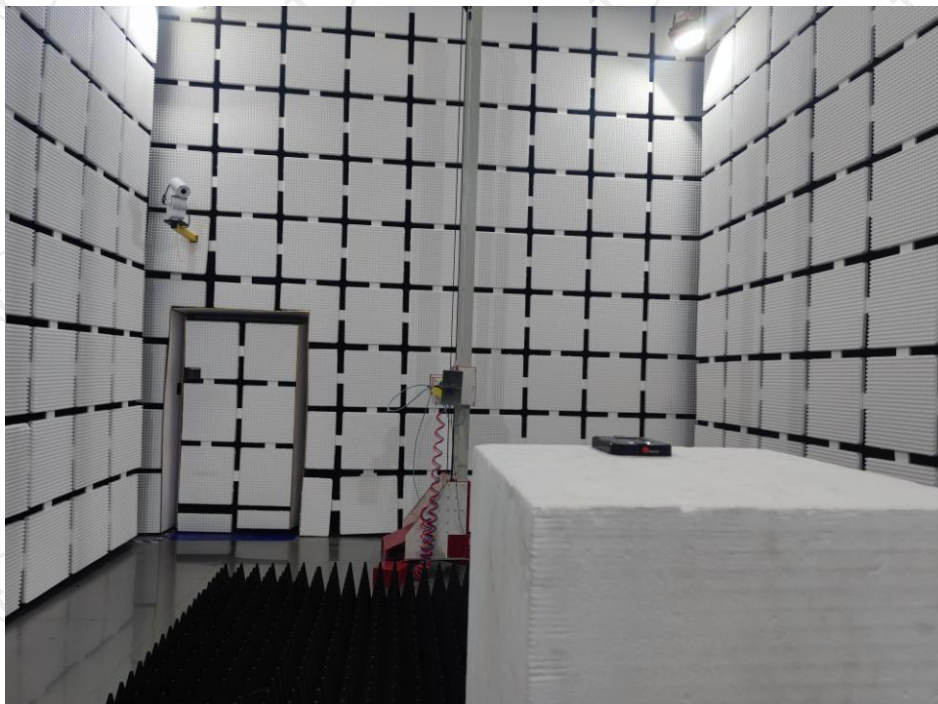
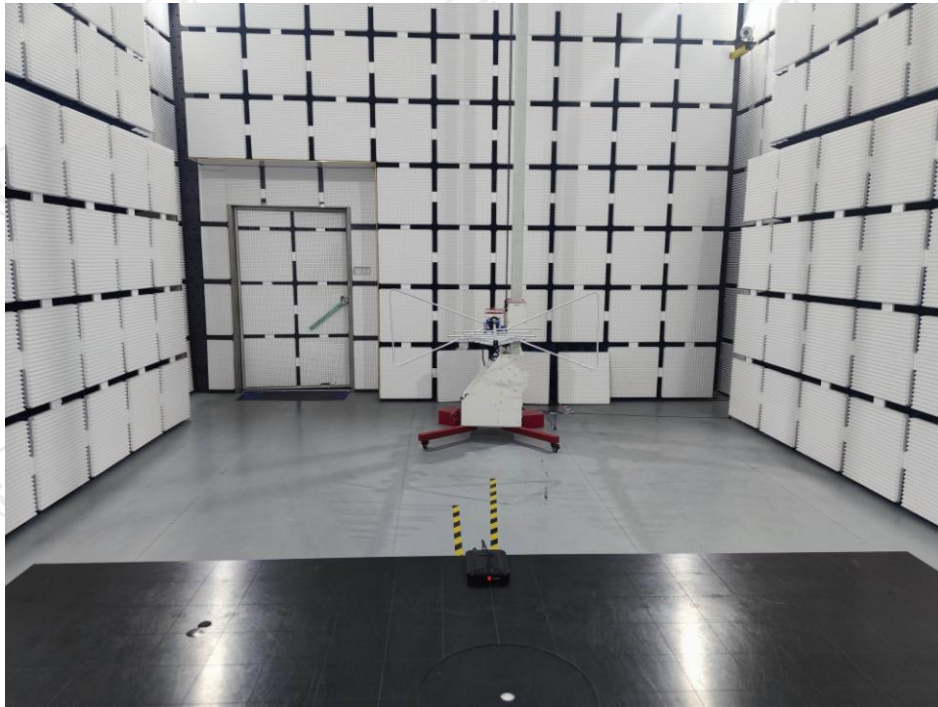

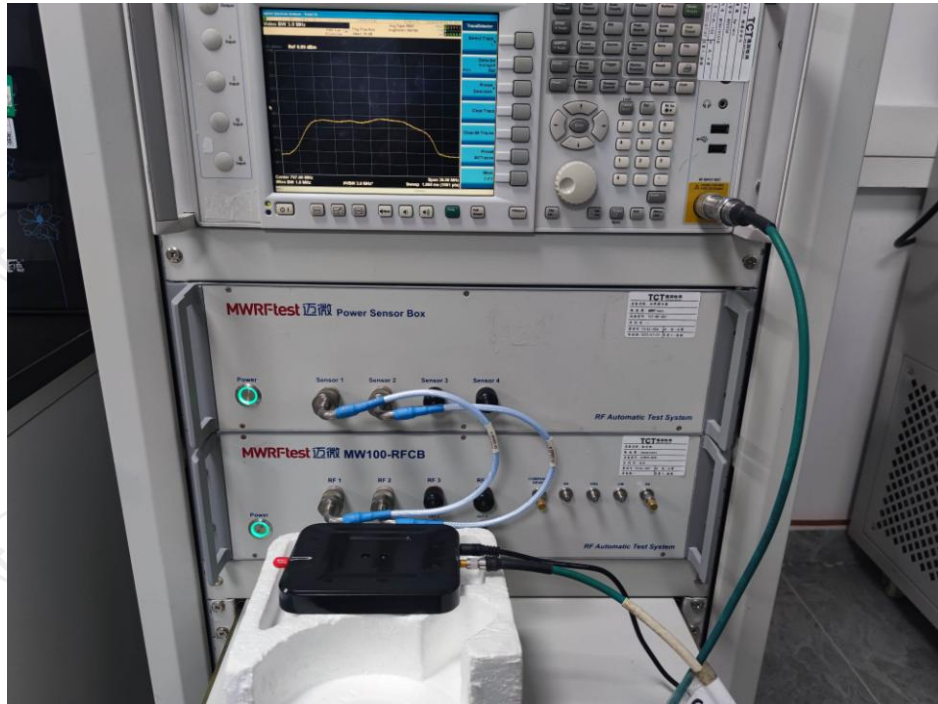

Appendix B: Photographs of EUT
Product: cell phone signal booster
Model: YA70
External Photos

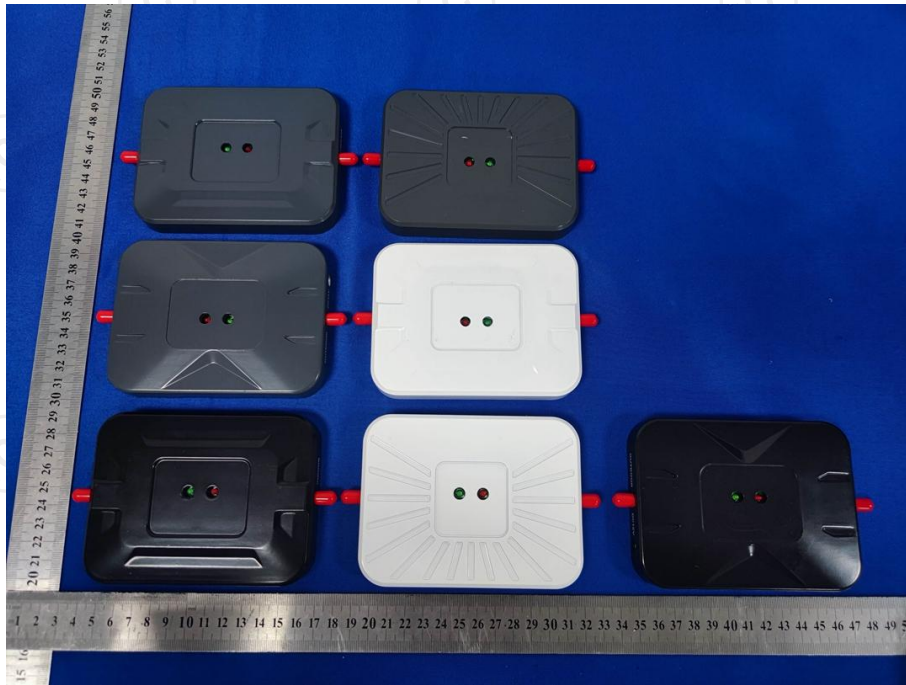

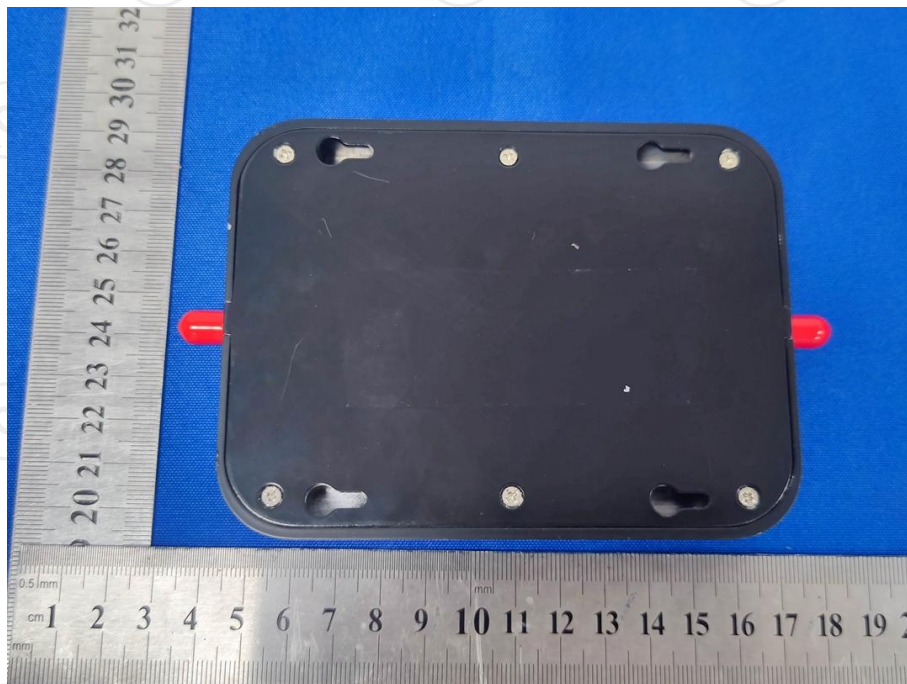





Product: cell phone signal booster
Model: YA70
Internal Photos

