



FCC TEST REPORT  
FOR  
Shenzhen Fuzhixing Electronics Co., Ltd  
cell phone signal booster  
Test Model: NDH05  
Additional Model No.: NDHW05,NDHB05

Prepared for : Shenzhen Fuzhixing Electronics Co., Ltd  
Address : 5/F, Block C, Penglongpan Hi-technology Park, Dafu Ind.  
Zone,Guanlan, Longhua New Dist., Shenzhen, Guangdong , China

Prepared by : Shenzhen LCS Compliance Testing Laboratory Ltd.  
Address : 101, 201 Bldg A & 301 Bldg C, Juji Industrial Park Shajing Street,  
Baoan District, Shenzhen, China

Tel : (+86)755-82591330  
Fax : (+86)755-82591332  
Web : www.LCS-cert.com  
Mail : webmaster@LCS-cert.com

Date of receipt of test sample : October 19, 2023  
Number of tested samples : 2  
Serial number : Prototype  
Date of Test : October 19, 2023 ~ December 25,2023  
Date of Report : December 26,2023



Scan code to check authenticity



<b>FCC TEST REPORT</b>	
<b>FCC CFR 47 PART 20.21</b>	
<b>Report Reference No.</b> .....	<b>LCSA10173059EA</b>
<b>Date of Issue</b> .....	December 26,2023
<b>Testing Laboratory Name</b> .....	<b>Shenzhen LCS Compliance Testing Laboratory Ltd.</b>
<b>Address</b> .....	101, 201 Bldg A & 301 Bldg C, Juji Industrial Park Shajing Street, Baoan District, Shenzhen, China
<b>Testing Location/ Procedure</b> .....	<input checked="" type="checkbox"/> Full application of Harmonised standards ■ <input type="checkbox"/> Partial application of Harmonised standards □ <input type="checkbox"/> Other standard testing method □
<b>Applicant's Name</b> .....	<b>Shenzhen Fuzhixing Electronics Co., Ltd</b>
<b>Address</b> .....	5/F, Block C, Penglongpan Hi-technology Park, Dafu Ind. Zone, Guanlan, Longhua New Dist., Shenzhen, Guangdong , China
<b>Test Specification</b>	
<b>Standard</b> .....	FCC CFR Title 47 Part 20.21
<b>Test Report Form No.</b> .....	LCSEMC-1.0
<b>TRF Originator</b> .....	Shenzhen LCS Compliance Testing Laboratory Ltd.
<b>Master TRF</b> .....	Dated 2011-03
<b>Shenzhen LCS Compliance Testing Laboratory Ltd. All rights reserved.</b>	
This publication may be reproduced in whole or in part for non-commercial purposes as long as the Shenzhen LCS Compliance Testing Laboratory Ltd. is acknowledged as copyright owner and source of the material. Shenzhen LCS Compliance Testing Laboratory Ltd. takes no responsibility for and will not assume liability for damages resulting from the reader's interpretation of the reproduced material due to its placement and context.	
<b>Test Item Description</b> .....	<b>cell phone signal booster</b>
<b>Trade Mark</b> .....	N/A
<b>Test Model</b> .....	NDH05
<b>Ratings</b> .....	For AC Adapter(model: 65W): Input: AC 100-240V,50/60Hz,1.5A Output: DC 12.0V=5.0A
<b>Result</b> .....	<b>Positive</b>

Compiled by:

Jack Liu/ Administrator

Supervised by:

Cary Luo/ Technique principal

Approved by:

Gavin Liang/ Manager



### FCC -- TEST REPORT

<b>Test Report No. :</b>	<b>LCSA10173059EA</b>	<u>December 26,2023</u> Date of issue
--------------------------	-----------------------	--

Test Model.....	: NDH05
EUT.....	: cell phone signal booster
<b>Applicant.....</b>	<b>: Shenzhen Fuzhixing Electronics Co., Ltd</b>
Address.....	: 5/F, Block C, Penglongpan Hi-technology Park, Dafu Ind. Zone, Guanlan, Longhua New Dist., Shenzhen, Guangdong , China
Telephone.....	: /
Fax.....	: /
<b>Manufacturer.....</b>	<b>: Shenzhen Fuzhixing Electronics Co., Ltd</b>
Address.....	: 5/F, Block C, Penglongpan Hi-technology Park, Dafu Ind. Zone, Guanlan, Longhua New Dist., Shenzhen, Guangdong , China
Telephone.....	: /
Fax.....	: /
<b>Factory.....</b>	<b>: Shenzhen Fuzhixing Electronics Co., Ltd</b>
Address.....	: 5/F, Block C, Penglongpan Hi-technology Park, Dafu Ind. Zone, Guanlan, Longhua New Dist., Shenzhen, Guangdong , China
Telephone.....	: /
Fax.....	: /

<b>Test Result</b>	<b>Positive</b>
--------------------	-----------------

The test report merely corresponds to the test sample.  
It is not permitted to copy extracts of these test result without the written permission of the test laboratory.



## Revision History

Revision	Issue Date	Revisions	Revised By
000	December 26,2023	Initial Issue	Gavin Liang



## TABLE OF CONTENTS

Description	Page
<b>1.GENERAL INFORMATION</b> .....	<b>6</b>
1.1 Description of Device (EUT).....	6
1.2 Support equipment List.....	8
1.3 External I/O Cable.....	8
1.4 Description of Test Facility.....	8
1.5 Statement of the Measurement Uncertainty.....	9
1.6 Measurement Uncertainty.....	9
1.7 Operation Band.....	9
<b>2. TEST METHODOLOGY</b> .....	<b>10</b>
2.1 EUT Configuration.....	10
2.2 General Test Procedures.....	10
<b>3. SYSTEM TEST CONFIGURATION</b> .....	<b>11</b>
3.1 Justification.....	11
3.2 EUT Exercise Software.....	11
3.3 Special Accessories.....	11
3.4 Block Diagram/Schematics.....	11
3.5 Equipment Modifications.....	11
3.6 Test Setup.....	11
<b>4. SUMMARY OF TEST RESULTS</b> .....	<b>12</b>
<b>5. SUMMARY OF TEST EQUIPMENT</b> .....	<b>13</b>
<b>6. MEASUREMENT RESULTS</b> .....	<b>14</b>
6.1 Authorized Frequency Band Verification.....	14
6.2 Maximum power measurement.....	17
6.3 Maximum booster gain computation.....	22
6.4 Intermodulation Product.....	24
6.5 Out of Band Emission.....	30
6.6. Conducted Spurious Emission.....	46
6.7. Noise Limits.....	54
6.8. Uplink Inactivity.....	59
6.9. Variable Booster Gain.....	61
6.10. Occupied Bandwidth.....	67
6.11. Oscillation Detection and Mitigation.....	77
<b>7. RADIATION SPURIOUS EMISSION</b> .....	<b>90</b>
<b>8. TEST SETUP PHOTOGRAPHS OF EUT</b> .....	<b>90</b>
<b>9. EXTERIOR PHOTOGRAPHS OF THE EUT</b> .....	<b>90</b>
<b>10. INTERIOR PHOTOGRAPHS OF THE EUT</b> .....	<b>90</b>



## 1. GENERAL INFORMATION

### 1.1 Description of Device (EUT)

EUT	:	cell phone signal booster
Equipment Type	:	Fixed Wideband Consumer Signal Booster
Test Model	:	NDH05
Additional Model No.	:	NDHW05, NDHB05
Model Declaration	:	PCB board, structure and internal of these model(s) are the same, So no additional models were tested
Power Supply	:	For AC Adapter(model: 65W): Input: AC 100-240V, 50/60Hz, 1.5A Output: DC 12.0V $\pm$ 5.0A
Hardware Version	:	/
Software Version	:	/
Frequency Range	:	Lower 700MHz Band(B12) Uplink: 698~716MHz, Downlink: 728~746 MHz Lower 700MHz Band(B17) Uplink: 704~716MHz, Downlink: 734~746 MHz Upper 700MHz Band(B13) Uplink: 776~787MHz, Downlink: 746~757 MHz Cellular Band(B5) Uplink: 824~849MHz, Downlink: 869~894 MHz PCS Band(B2& B25) Uplink: 1850~1915MHz, Downlink: 1930~1995 MHz AWS Band(B4&B66) Uplink: 1710~1755MHz, Downlink: 2110~2155 MHz
Max .Gain	:	$\leq$ 65dB
Max. Antenna Port Output power	:	Uplink: 18dBm Downlink: 10dBm
Emission Designator	:	F9W, G7D, G7W, GXW, W7D
FCC Classification	:	B2W/Wideband Consumer Booster(CMRS)
Operating Temperature	:	-25 $^{\circ}$ C~+55 $^{\circ}$ C



Outdoor Antenna	Outdoor Antenna Gain				
	Lower 700MHz	Upper 700MHz	Celluler	PCS	AWS
Yagi antenna	6.0	6.0	6.0	5.0	5.0
Log-periodic antenna	8.0	8.0	8.0	7.0	7.0
Tubular antenna	4.0	3.5	3.5	3.0	3.0
Panel Antenna	5.0	5.0	4.5	4.0	4.0
Outdoor Cable					
Outdoor cable	Outdoor Cable Loss				
	Lower 700MHz	Upper 700MHz	Celluler	PCS	AWS
15m 4D-FB	3.5	3.7	3.7	4.5	4.3
Indoor Antenna					
Indoor Antenna	Indoor Antenna Gain				
	Lower 700MHz	Upper 700MHz	Celluler	PCS	AWS
Right angle Antenna	3.0	3.0	3.0	2.0	2.0
Sucker antenna	4.0	3.5	3.0	2.0	2.0
Omni-directional ceiling antenna	4.0	3.5	3.0	2.0	2.0
Panel Antenna	6.0	5.5	5.0	4.0	4.0
Indoor Cable					
Indoor Cable	Indoor Cable Loss				
	Lower 700MHz	Upper 700MHz	Celluler	PCS	AWS
5m 4D-FB	1.3	1.3	1.5	2.2	2.3



### 1.2 Support equipment List

Manufacturer	Description	Model	Serial Number	Certificate
--	AC/DC Adapter	65W	---	FCC SDoC

### 1.3 External I/O Cable

I/O Port Description	Quantity	Cable
Antenna Port	2	N/A
DC IN Port	1	N/A

### 1.4 Description of Test Facility

FCC Registration Number is 254912.  
NVLAP Accreditation Code is 600167-0.  
FCC Designation Number is CN5024.  
CAB identifier is CN0071.  
CNAS Registration Number is L4595.  
Industry Canada Registration Number is 9642A.

The 3m-Semi anechoic test site fulfils CISPR 16-1-4 according to ANSI C63.10:2013 and CISPR 16-1-4:2010 VSWR requirement for radiated emission above 1GHz.





## 1.5 Statement of the Measurement Uncertainty

The data and results referenced in this document are true and accurate. The reader is cautioned that there may be errors within the calibration limits of the equipment and facilities. The measurement uncertainty was calculated for all measurements listed in this test report acc. To CISPR 16 – 4 “Specification for radio disturbance and immunity measuring apparatus and methods – Part 4: Uncertainty in EMC Measurements” and is documented in the LCS quality system acc. To DIN EN ISO/IEC 17025. Furthermore, component and process variability of devices similar to that tested may result in additional deviation. The manufacturer has the sole responsibility of continued compliance of the device.

## 1.6 Measurement Uncertainty

Test Item	Frequency Range	Uncertainty	Note
Radiation Uncertainty	9KHz~30MHz	3.10dB	(1)
	30MHz~200MHz	2.96dB	(1)
	200MHz~1000MHz	3.10dB	(1)
	1GHz~26.5GHz	3.80dB	(1)
	26.5GHz~40GHz	3.90dB	(1)
Conduction Uncertainty	150kHz~30MHz	1.63dB	(1)
Power disturbance	30MHz~300MHz	1.60dB	(1)

(1). This uncertainty represents an expanded uncertainty expressed at approximately the 95% confidence level using a coverage factor of k=2.

## 1.7 Operation Band

Uplink Frequency(MHz)	Downlink Frequency(MHz)
698-716(Lower 700 Band)	728-746(Lower 700 Band)
776-787(Upper 700 Band)	746-757(Upper 700 Band)
824-849(Cellular Band)	869-894(Cellular Band)
1850-1915(PCS Band)	1930-1995(PCS Band)
1710-1755(AWS Band)	2110-2155(AWS Band)



## 2. TEST METHODOLOGY

All tests and measurements indicated in this document were performed in accordance with:

- 1) The Code of federal Regulations Title 47, Part 2, Part 22, Part 24, Part 27, Part 20.21;
- 2) ANSI C63.26-2015, American National Standard for Compliance Testing of Transmitters Used in Licensed Radio Services;
- 3) KDB 935210 D03 Signal Booster Measurements v04r04.

### 2.1 EUT Configuration

The EUT configuration for testing is installed on RF field strength measurement to meet the Commissions requirement and operating in a manner that intends to maximize its emission characteristics in a continuous normal application.

### 2.2 General Test Procedures

#### 2.2.1 Radiated spurious emissions

The EUT is placed on the turntable, which is 1.5 m above ground plane. The turntable shall rotate 360 degrees to determine the position of maximum emission level. EUT is set 3m away from the receiving antenna. And also, each emission was to be maximized by changing the polarization of receiving antenna both horizontal and vertical. In order to find out the maximum emissions, exploratory radiated spurious emissions measurements were made according to the requirements in Section 6.3 of ANSI C63.10-2013



### 3. SYSTEM TEST CONFIGURATION

#### 3.1 Justification

The system was configured for testing in a continuous transmits condition.

#### 3.2 EUT Exercise Software

N/A

#### 3.3 Special Accessories

Manufacturer	Description	Model	Serial Number	Certificate
--	--	--	--	--

#### 3.4 Block Diagram/Schematics

Please refer to the related document.

#### 3.5 Equipment Modifications

Shenzhen LCS Compliance Testing Laboratory Ltd. has not done any modification on the EUT.

#### 3.6 Test Setup

Please refer to the test setup photo.



#### 4. SUMMARY OF TEST RESULTS

Requirement	CFR 47 Section	Result
Authorized Frequency Band Verification Test	§20.21(e)(3)	PASS
Maximum Power Measurement Procedure	§20.21(e)(8)(i)(D) §20.21(e)(8)(i)(B)&§20.21(e)(4)	PASS
Maximum Booster Gain Computation	§20.21(e)(8)(i)(C)(2) §20.21(e)(8)(i)(B)&§20.21(e)(4)	PASS
Intermodulation Product	§20.21(e)(8)(i)(F)	PASS
Out of Band Emissions	§20.21(e)(8)(i)(E)	PASS
Conducted Spurious Emission	§2.1051	PASS
Noise Limit Procedure Variable Noise Variable Noise Timing	§20.21(e)(8)(i)(A)(2)(i) §20.21(e)(8)(i)(A)(1) §20.21(e)(8)(i)(H)&§20.21(e)(4)	PASS
Uplink inactivity	§20.21(e)(8)(i)(I) &§20.21(e)(4)	PASS
Variable Booster Gain Variable Uplink Gain Timing	§20.21(e)(8)(i)(C) (1), (2)(i) §20.21(e)(8)(i)(H)	PASS
Occupied Band Width	§2.1049	PASS
Anti-Oscillation	§20.21(e)(8)(ii)(A)&§20.21(e)(4)	PASS
Radiated Spurious Emission	§2.1053	PASS
Spectrum Block Filter	N/A	N/A

**Note:**

1. PASS: Test item meets the requirement.
2. Fail: Test item does not meet the requirement.
3. N/A: Test case does not apply to the test object.
4. The test result judgment is decided by the limit of test standard.



## 5. SUMMARY OF TEST EQUIPMENT

Item	Equipment	Manufacturer	Model No.	Serial No.	Cal Date	Due Date
1	Power Meter	R&S	NRVS	100444	2023-06-09	2024-06-08
2	Power Sensor	R&S	NRV-Z81	100458	2023-06-09	2024-06-08
3	Power Sensor	R&S	NRV-Z32	10057	2023-06-09	2024-06-08
4	LTE Test Software	Tonscend	JS1120-1	N/A	N/A	N/A
5	RF Control Unit	Tonscend	JS0806-1	158060009	2022-10-29	2023-10-28
					2023-10-28	2024-10-27
6	MXA Signal Analyzer	Agilent	N9020A	MY51250905	2022-10-29	2023-10-28
					2023-10-28	2024-10-27
7	WIDEBAND RADIO COMMUNICATION TESTER	R&S	CMW 500	103818	2023-06-09	2024-06-08
8	DC Power Supply	Agilent	E3642A	N/A	2022-10-29	2023-10-28
					2023-10-28	2024-10-27
9	EMI Test Software	AUDIX	E3	/	N/A	N/A
10	3m Semi Anechoic Chamber	SIDT FRANKONIA	SAC-3M	03CH03-HY	2023-06-09	2024-06-08
11	Positioning Controller	Max-Full	MF7802BS	MF780208586	N/A	N/A
12	Active Loop Antenna	SCHWARZBECK	FMZB 1519B	00005	2021-08-29	2024-08-28
13	By-log Antenna	SCHWARZBECK	VULB9163	9163-470	2021-09-12	2024-09-11
14	By-log Antenna	SCHWARZBECK	VULB9163	9163-471	2021-09-12	2024-09-11
15	Horn Antenna	SCHWARZBECK	BBHA 9120D	9120D-1925	2021-09-05	2024-09-04
16	Horn Antenna	SCHWARZBECK	BBHA 9120D	9120D-1926	2021-09-05	2024-09-04
17	Broadband Horn Antenna	SCHWARZBECK	BBHA 9170	791	2021-08-29	2024-08-28
18	Broadband Horn Antenna	SCHWARZBECK	BBHA 9170	792	2021-08-29	2024-08-28
19	Broadband Preamplifier	SCHWARZBECK	BBV9719	9719-025	2023-06-09	2024-06-08
20	EMI Test Receiver	R&S	ESR 7	101181	2023-06-09	2024-06-08
21	RS SPECTRUM ANALYZER	R&S	FSP40	100503	2022-10-29	2023-10-28
					2023-10-28	2024-10-27
22	Broadband Preamplifier	/	BP-01M18G	P190501	2023-06-09	2024-06-08
23	6dB Attenuator	/	100W/6dB	1172040	2023-06-09	2024-06-08
24	3dB Attenuator	/	2N-3dB	/	2022-10-29	2023-10-28
					2023-10-28	2024-10-27
26	Temperature & Humidity Chamber	GUANGZHOU GOGNWN	GDS-100	70932	2023-10-05	2024-10-04
27	EMI Test Software	Farad	EZ	/	N/A	N/A

## 6. MEASUREMENT RESULTS

### 6.1 Authorized Frequency Band Verification

#### Applicable Standard

According to § 20.21(e)(3) Frequency Bands.

This test is intended to confirm that the signal booster only operates on the CMRS frequency bands authorized for use by the NPS. In other words, the signal booster shall reject amplification of other signals outside of its passband. In addition, this test will identify the frequency at which the maximum gain is realized within each CMRS operational band, which then serves as a basis for subsequent tests.

#### Test Procedure

According to section 7.1 of KDB 935210 D03 Signal Booster Measurement v04r04:

- a) Connect the EUT to the test equipment as shown in Figure 1. Begin with the uplink output (donor) port connected to the spectrum analyzer.
- b) Set the spectrum analyzer resolution bandwidth (RBW) for 100 kHz with the video bandwidth (VBW)  $\geq 3$  the RBW, using a PEAK detector with the MAX HOLD function.
- c) Set the center frequency of the spectrum analyzer to the center of the operational band under test with a span of 1 MHz.
- d) Set the signal generator for CW mode and tune to the center frequency of the operational band under test.
- e) Set the initial signal generator power to a level that is at least 6 dB below the AGC level specified by the manufacturer.
- f) Slowly increase the signal generator power level until the output signal reaches the AGC operational level.
- g) Reduce the signal generator power to a level that is 3 dB below the level noted above, then manually reset the EUT (e.g., cycle ac/dc power).
- h) Reset the spectrum analyzer span to 2 the width of the CMRS band under test. Adjust the tuned frequency of the signal generator to sweep 2 the width of the CMRS band using the sweep function. The AGC must be deactivated throughout the entire sweep.
- i) Using three markers, identify the CMRS band edges and the frequency with the highest power. Affirm that the values of all markers are visible on the display of the spectrum analyzer (e.g., marker table set to on).
- j) Capture the spectrum analyzer trace for inclusion in the test report.
- k) Repeat 7.1.c) to 7.1.j) for all operational uplink and downlink bands.

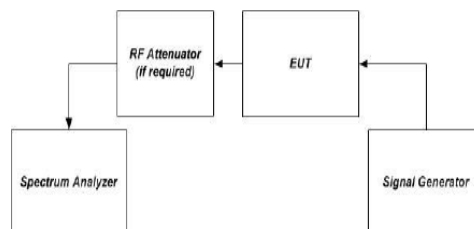

Figure 1 – Band verification test instrumentation setup



Test Data

Temperature	23.4°C	Humidity	53.2%
Test Engineer	Nick Peng	Test Mode	Transmitting

Test Graphs

Uplink

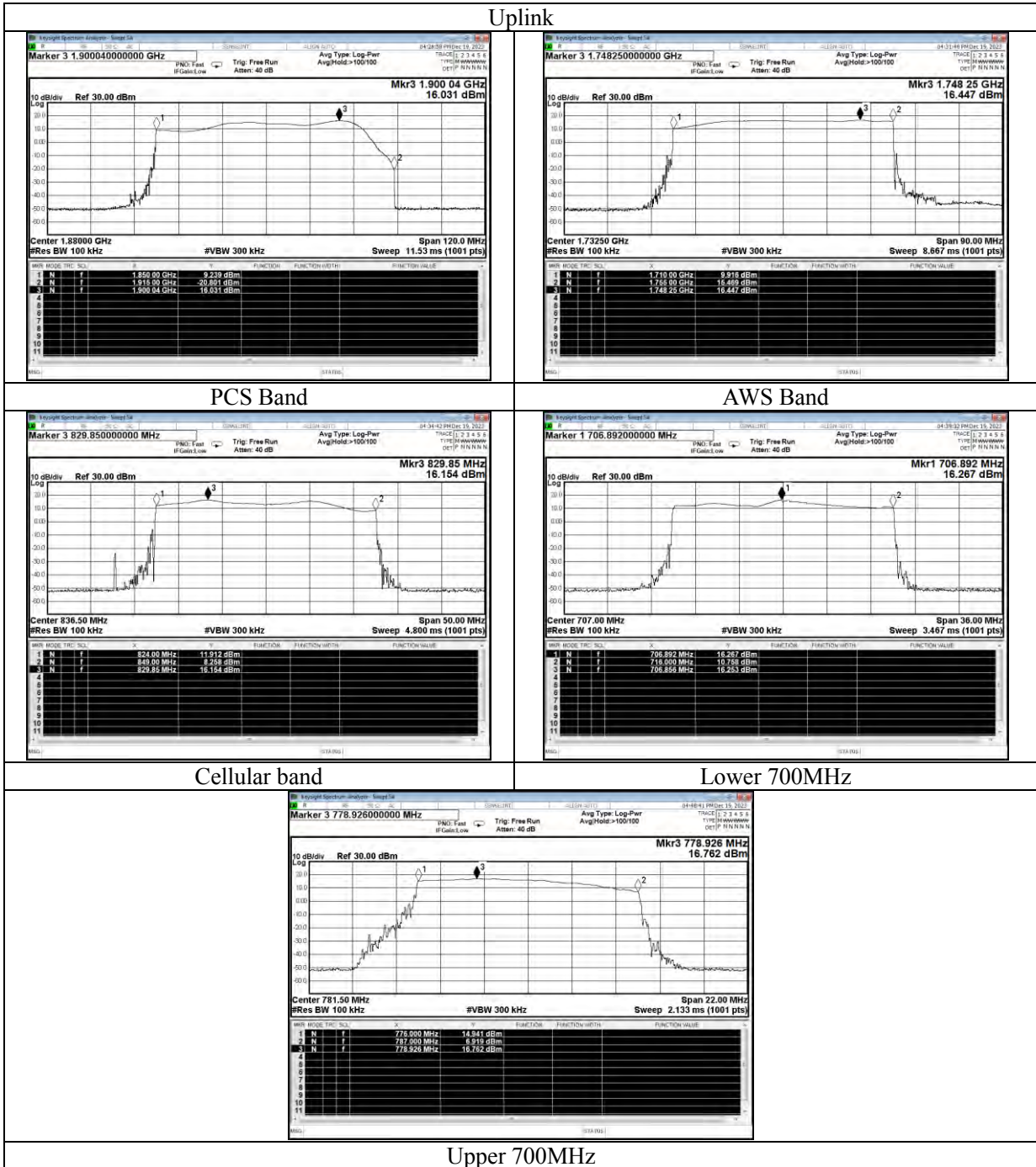





Downlink

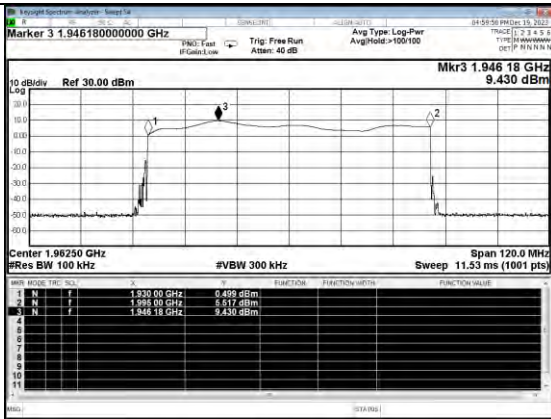

PCS Band

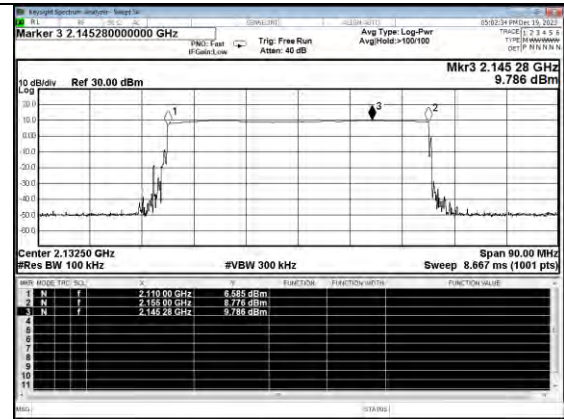

AWS Band

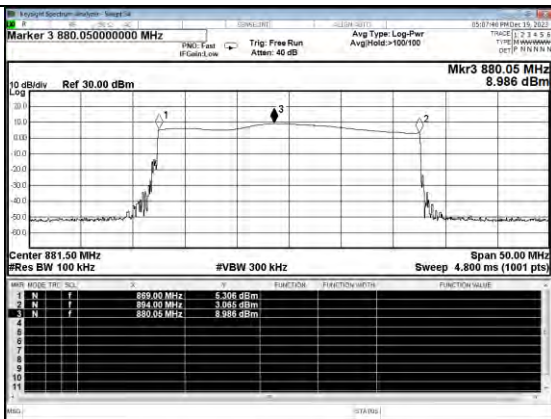

Cellular band

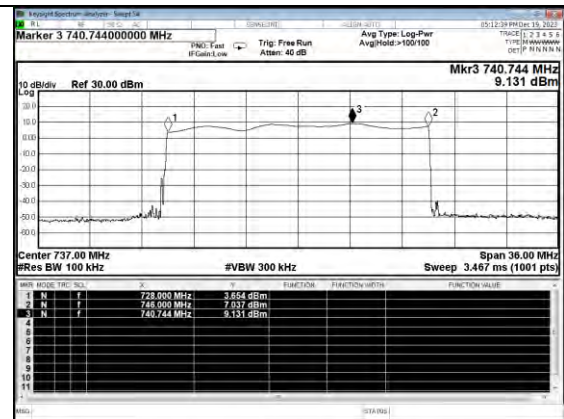

Lower 700MHz

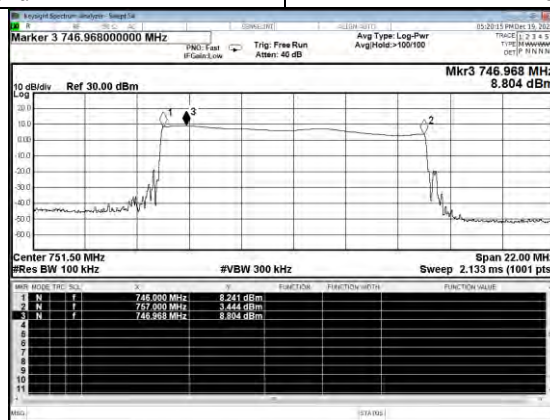

Upper 700MHz





## 6.2 Maximum power measurement

### Applicable Standard

According to §20.21(e)(8)(i)(D) Power Limits; §20.21(e)(8)(i)(B) Bidirectional Capability (uplink minimum conducted power output); §20.21(e)(4) Self-monitoring:

1. A booster's uplink power must not exceed 1 watt composite conducted power and equivalent isotropic radiated power (EIRP) for each band of operation. Composite downlink power shall not exceed 0.05 watt (17 dBm) conducted and EIRP for each band of operation.
2. Consumer Boosters must be able to provide equivalent uplink and downlink gain and conducted uplink power output that is at least 0.05 watts

This procedure shall be used to demonstrate compliance to the signal booster power limits and requirements as specified in Sections 20.21(e)(8)(i)(D) and 20.21(e)(8)(i)(B) for wideband consumer signal boosters.

### Test Procedure

According to section 7.2.1 of KDB 935210 D03 Signal Booster Measurement v04r04:

- a) Compliance to applicable EIRP limits must be shown using the highest gains from the list of antennas, cabling, and coupling devices declared by the manufacturer for use with the consumer booster.
- b) In addition, the maximum power levels measured in this procedure will be used in calculating the maximum gain as described in the next subclause.
- c) The frequency with the highest power level in each operational band as determined in 7.1 is to be measured discretely by applying the following procedure using the stated emission and power detector types independently.
- d) Use a signal generator to create a pulsed CW or GSM signal with a pulse width of 570  $\mu$ s and a duty cycle of 12.5% (i.e., one GSM timeslot), then measure using the burst power function of the measuring instrument.
- e) Use a signal generator to create an AWGN signal with a 99% occupied bandwidth (OBW) of 4.1 MHz, then measure using the channel power or band power function of the measuring instrumentation.
- f) All modes of operation must be verified to maintain operation within applicable limits at the maximum uplink and downlink test levels per device type as defined in 5.5, by increasing the power level in 2 dB steps from the AGC level to the maximum input level specified in 5.5.

According to section 7.2.2 of KDB 935210 D03 Signal Booster Measurement v04r04:

- a) Connect the EUT to the test equipment as shown in Figure 1. Begin with the uplink output (donor) port connected to the spectrum analyzer.
- b) Configure the signal generator and spectrum analyzer for operation on the frequency determined in 7.1 with the highest power level, but with the center frequency of the signal no closer than 2.5 MHz from the band edge. The spectrum analyzer span shall be set to at least 10 MHz.
- c) Set the initial signal generator power to a level well below that which causes AGC activation.
- d) Slowly increase the signal generator power level until the output signal reaches the AGC operational limit (from observation of signal behavior on the spectrum analyzer; i.e., no further increase in output power as input power is increased).
- e) Reduce power sufficiently on the signal generator to ensure that the AGC is not controlling the power output.
- f) Slowly increase the signal generator power to a level just below (and within 0.5 dB of) the AGC limit without triggering the AGC. Note the signal generator power level as  $P_{in}$ .
- g) Measure the output power,  $P_{out}$ , with the spectrum analyzer as follows.



- 1) Set RBW = 100 kHz for AWGN signal type, or 300 kHz for CW or GSM signal type.
- 2) Set VBW  $\geq$  3 RBW.
- 3) Select either the BURST POWER or CHANNEL POWER measurement mode, as required for each signal type. For AWGN, the channel power integration bandwidth shall be the 99% OBW of the 4.1 MHz signal.
- 4) Select the power averaging (rms) detector.
- 5) Affirm that the number of measurement points per sweep  $\geq$  (2 span)/RBW.  
NOTE—This requirement does not apply for BURST power measurement mode.
- 6) Set sweep time = auto couple, or as necessary (but no less than auto couple value).
- 7) Trace average at least 100 traces in power averaging (i.e., rms) mode.
- 8) Record the measured power level  $P_{out}$ , with one set of results for the GSM or CW input stimulus, and another set of results for the AWGN input stimulus.

## Test Data

Temperature	23.4°C	Humidity	53.2%
Test Engineer	Nick Peng	Test Mode	Transmitting



Mode	Antenna	Operation Band	Signal Type	Conducted Output Level (dBm)	Conducted Output Limit (dBm)	Max. Antenna Gain (dB)	Min. Cable Loss (dB)	EIRP (dBm)	EIRP Limit (dBm)	
Uplink	Yagi antenna	PCS	CW	17.87	17-30	5.0	4.5	18.37	≤30	
			AWG	18.48		5.0	4.5	18.98		
		AWS	CW	18.62		5.0	4.3	19.32		
			AWG	18.29		5.0	4.3	18.99		
		Cellular	CW	18.10		6.0	3.7	20.40		
			AWG	18.44		6.0	3.7	20.74		
		Lower	CW	18.50		6.0	3.5	21.00		
			AWG	18.15		6.0	3.5	20.65		
		Upper	CW	18.48		6.0	3.7	20.78		
			AWG	18.64		6.0	3.7	20.94		
		Log-periodic antenna	PCS	CW		18.15	7.0	4.5		20.65
				AWG		18.07	7.0	4.5		20.57
	AWS		CW	18.63		7.0	4.3	21.33		
			AWG	18.36		7.0	4.3	21.06		
	Cellular		CW	18.10		8.0	3.7	22.40		
			AWG	18.33		8.0	3.7	22.63		
	Lower		CW	18.46		8.0	3.5	22.96		
			AWG	17.99		8.0	3.5	22.49		
	Upper		CW	18.18		8.0	3.7	22.48		
			AWG	17.92		8.0	3.7	22.22		
	Tubular antenna		PCS	CW		18.49	3.0	4.5		16.99
				AWG		17.94	3.0	4.5		16.44
		AWS	CW	18.68		3.0	4.3	17.38		
			AWG	17.93		3.0	4.3	16.63		
		Cellular	CW	18.12		3.5	3.7	17.92		
			AWG	17.96		3.5	3.7	17.76		
		Lower	CW	18.32		4.0	3.5	18.82		
			AWG	18.30		4.0	3.5	18.80		
		Upper	CW	18.04		3.5	3.7	17.84		
			AWG	17.88		3.5	3.7	17.68		
		Panel Antenna	PCS	CW		18.30	4.0	4.5		17.80
				AWG		18.18	4.0	4.5		17.68
	AWS		CW	17.90		4.0	4.3	17.60		
			AWG	18.24		4.0	4.3	17.94		
	Cellular		CW	18.63		4.5	3.7	19.43		
			AWG	18.67		4.5	3.7	19.47		
	Lower		CW	18.52		5.0	3.5	20.02		
			AWG	18.48		5.0	3.5	19.98		
	Upper		CW	18.55		5.0	3.7	19.85		
			AWG	17.87		5.0	3.7	19.17		



Mode	Antenna	Operation Band	Signal Type	Conducted Output Level (dBm)	Max. Antenna Gain (dB)	Min. Cable Loss (dB)	EIRP (dBm)	Limit (dBm)	
Downlink	Right angle Antenna	PCS	CW	11.18	2	2.2	10.98	≤17	
			AWGN	11.43	2	2.2	11.23		
		AWS	CW	10.38	2	2.3	10.08		
			AWGN	11.39	2	2.3	11.09		
		Cellular	CW	9.99	3	1.5	11.49		
			AWGN	10.02	3	1.5	11.52		
		Lower 700	CW	10.54	3	1.3	12.24		
			AWGN	10.51	3	1.3	12.21		
		Upper 700	CW	11.16	3	1.3	12.86		
			AWGN	10.36	3	1.3	12.06		
		Sucker antenna	PCS	CW	9.93	2	2.2		9.73
				AWGN	10.76	2	2.2		10.56
	AWS		CW	10.43	2	2.3	10.13		
			AWGN	10.67	2	2.3	10.37		
	Cellular		CW	11.26	3	1.5	12.76		
			AWGN	10.57	3	1.5	12.07		
	Lower 700		CW	11.18	4	1.3	13.88		
			AWGN	11.44	4	1.3	14.14		
	Upper 700		CW	10.45	3.5	1.3	12.65		
			AWGN	11.27	3.5	1.3	13.47		
	Omni-directional ceiling antenna		PCS	CW	10.07	2	2.2		9.87
				AWGN	11.43	2	2.2		11.23
		AWS	CW	11.73	2	2.3	11.43		
			AWGN	10.43	2	2.3	10.13		
		Cellular	CW	10.50	3	1.5	12.00		
			AWGN	10.25	3	1.5	11.75		
		Lower 700	CW	10.25	4	1.3	12.95		
			AWGN	9.97	4	1.3	12.67		
		Upper 700	CW	10.73	3.5	1.3	12.93		
			AWGN	10.28	3.5	1.3	12.48		
Panel Antenna		PCS	CW	10.31	4	2.2	12.11		
			AWGN	11.64	4	2.2	13.44		
	AWS	CW	11.19	4	2.3	12.89			
		AWGN	10.19	4	2.3	11.89			
	Cellular	CW	10.45	5	1.5	13.95			
		AWGN	10.64	5	1.5	14.14			
	Lower 700	CW	10.12	6	1.3	14.82			
		AWGN	10.89	6	1.3	15.59			
	Upper 700	CW	11.28	5.5	1.3	15.48			
		AWGN	10.48	5.5	1.3	14.68			

Note: EIRP(dBm) = Conducted Output Level + Max. Antenna Gain - Min. Cable Loss



Max. Input test level								
Mode	Operation Band	Signal Type	Max. Input Level (dBm)	Max. Input Level limit(dBm)	Conducted Output Level(dBm)	Verdict		
Uplink	PCS	CW	-21.65	≤27	17.87	PASS		
		AWGN	-24.07		18.48	PASS		
	AWS	CW	-24.11		18.62	PASS		
		AWGN	-22.01		18.29	PASS		
	Cellular	CW	-21.78		18.10	PASS		
		AWGN	-23.75		18.44	PASS		
	Lower 700	CW	-22.03		18.50	PASS		
		AWGN	-23.15		18.15	PASS		
	Upper 700	CW	-24.18		18.48	PASS		
		AWGN	-22.71		18.64	PASS		
	Downlink	PCS	CW		-35.67	≤-20	10.07	PASS
			AWGN		-35.22		11.43	PASS
AWS		CW	-34.90	11.73	PASS			
		AWGN	-35.77	10.43	PASS			
Cellular		CW	-35.05	10.50	PASS			
		AWGN	-34.63	10.25	PASS			
Lower 700		CW	-37.44	10.25	PASS			
		AWGN	-36.53	9.97	PASS			
Upper 700		CW	-35.29	10.73	PASS			
		AWGN	-35.61	10.28	PASS			



## 6.3 Maximum booster gain computation

### Applicable Standard

According to §20.21(e)(8)(i)(C)(2) Booster Gain Limits (maximum gain); §20.21(e)(8)(i)(B) Bidirectional Capability (equivalent uplink and downlink gain):

The uplink and downlink maximum gain of a Consumer Booster referenced to its input and output ports shall not exceed the following limits:

- (i) Fixed Booster maximum gain shall not exceed  $6.5 \text{ dB} + 20 \text{ Log}_{10}(\text{Frequency})$ ;
- (ii) Where, Frequency is the uplink mid-band frequency of the supported spectrum bands in MHz.

According to section 7.3 of KDB 935210 D03 Signal Booster Measurement v04r04:

This subclause provides guidance for the calculation of the maximum gain, based on the results obtained from the 7.1 and 7.2 measurements. The NPS limits on maximum gain for fixed and mobile wideband consumer signal boosters are provided in §20.21(e)(8)(i)(C)(2). Additionally, §20.21(e)(8)(i)(B) requires that wideband consumer signal boosters be able to provide equivalent uplink and downlink gain, i.e., within 9 dB.

- a) Calculate the maximum gain of the booster as follows to demonstrate compliance to the applicable gain limits as specified.
- b) For both the uplink and downlink in each supported frequency band, use each of the POUT and PIN result pairs for all signal types used in 7.2 in the following equation to obtain the maximum gain, G:

$$G \text{ (dB)} = \text{POUT(dBm)} - \text{PIN(dBm)}.$$

- c) Record the maximum gain of the uplink and downlink paths for each supported frequency band, and verify that the each gain value complies with the applicable limit.
- d) Provide tabulated results in the test report

### Test Data

Temperature	23.4°C	Humidity	53.2%
Test Engineer	Nick Peng	Test Mode	Transmitting



Max. Gain								
Mode	Operation Band	Signal Type	Pre AGC Input Level (dBm)	Conducted Output Level (dBm)	Gain (dB)	Gain Limit (dB)	Verdict	
Uplink	PCS	CW	-42.49	17.87	59.45	≤ 71.99	PASS	
		AWGN	-42.10	18.48	61.60		PASS	
	AWS	CW	-42.62	18.62	62.82	≤ 71.27	PASS	
		AWGN	-41.54	18.29	62.19		PASS	
	Cellular	CW	-43.29	18.10	60.43	≤ 64.95	PASS	
		AWGN	-43.34	18.44	61.14		PASS	
	Lower 700	CW	-43.22	18.50	60.23	≤ 63.49	PASS	
		AWGN	-44.04	18.15	61.09		PASS	
	Upper 700	CW	-41.41	18.48	61.55	≤ 64.36	PASS	
		AWGN	-42.70	18.64	60.93		PASS	
	Downlink	PCS	CW	-45.55	10.07	58.44	≤ 71.99	PASS
			AWGN	-48.00	11.43	59.16		PASS
AWS		CW	-48.60	11.73	58.91	≤ 71.27	PASS	
		AWGN	-45.79	10.43	56.93		PASS	
Cellular		CW	-48.57	10.50	59.15	≤ 64.95	PASS	
		AWGN	-46.22	10.25	58.06		PASS	
Lower 700		CW	-49.25	10.25	55.86	≤ 63.49	PASS	
		AWGN	-46.25	9.97	56.44		PASS	
Upper 700		CW	-48.10	10.73	59.01	≤ 64.36	PASS	
		AWGN	-48.99	10.28	56.84		PASS	

**Note:** Fixed Booster maximum gain shall not exceed  $6.5 \text{ dB} + 20 \text{ Log}_{10}(\text{Frequency})$ , where Frequency is the uplink mid-band frequency of the supported spectrum bands in MHz.

Uplink Gain VS Downlink Gain						
Band	Signal Type	Uplink Gain (dB)	Downlink Gain (dB)	Calculated value(dBc)	Limit (dBc)	Verdict
PCS	CW	59.45	58.44	1.01	<9	PASS
	AWGN	61.60	59.16	2.44		PASS
AWS	CW	62.82	58.91	3.91		PASS
	AWGN	62.19	56.93	5.26		PASS
Cellular	CW	60.43	59.15	1.28		PASS
	AWGN	61.14	58.06	3.08		PASS
Lower 700	CW	60.23	55.86	4.37		PASS
	AWGN	61.09	56.44	4.65		PASS
Upper 700	CW	61.55	59.01	2.54		PASS
	AWGN	60.93	56.84	4.09		PASS

## 6.4 Intermodulation Product

### Applicable Standard

According to §20.21(e)(8)(i)(F) Intermodulation Limits:

The transmitted intermodulation products of a consumer booster at its uplink and downlink ports shall not exceed the power level of  $-19$  dBm for the supported bands of operation.

### Test Procedure

According to section 7.4 of KDB 935210 D03 Signal Booster Measurement v04r04:

- a) Connect the signal booster to the test equipment as shown in Figure 2. Begin with the uplink output (donor) port connected to the spectrum analyzer.
  - b) Set the spectrum analyzer RBW = 3 kHz.
  - c) Set the VBW  $\geq 3$  RBW.
  - d) Select the rms detector.
  - e) Set the spectrum analyzer center frequency to the center of the supported operational band under test.
  - f) Set the span to 5 MHz. Affirm that the number of measurement points per sweep  $\geq (2 \times \text{span})/\text{RBW}$ .
  - g) Configure the two signal generators for CW operation with generator #1 tuned 300 kHz below the operational band center frequency and generator #2 tuned 300 kHz above the operational band center frequency. If the maximum output power is not at the operational-band (booster pass band) center frequency, configure the test signal pair around the frequency with maximum output power as determined per 7.2.
  - h) Set the signal generator amplitudes so that the power from each into the EUT is equivalent, then turn on the RF output.
  - i) Simultaneously increase each signal generators' amplitude equally until just before the EUT begins AGC, then affirm that all intermodulation-product emissions (if any occur) are below the specified limit of  $-19$  dBm.
  - j) Use the trace averaging function of the spectrum analyzer, and wait for the trace to stabilize. Place a marker at the highest amplitude intermodulation-product emission.
  - k) Record the maximum intermodulation product amplitude level that is observed.
  - l) Capture the spectrum analyzer trace for inclusion in the test report.
  - m) Repeat 7.4e) to 7.4l) for all uplink and downlink operational bands.
- NOTE—If using a single signal generator with dual outputs, affirm that intermodulation products are not the result of the generator.
- n) Increase the signal generator amplitude in 2 dB steps to 10 dB above the AGC threshold determined in 7.4i), but not exceeding the maximum input level of 5.5, to affirm that the EUT maintains compliance with the intermodulation limit. The test report shall include either a statement describing that the device complies at 10 dB above AGC or at the 5.5 power levels, or a table showing compliance at the additional input power(s) required.

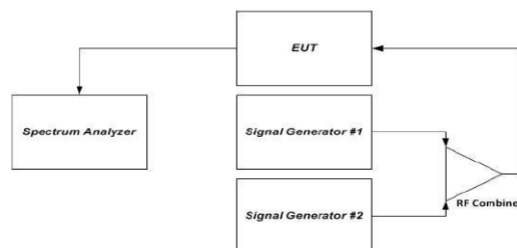

Figure 2 – Intermodulation product instrumentation test setup





Test Data

Temperature	23.4°C	Humidity	53.2%
Test Engineer	Nick Peng	Test Mode	Transmitting

Test Graphs

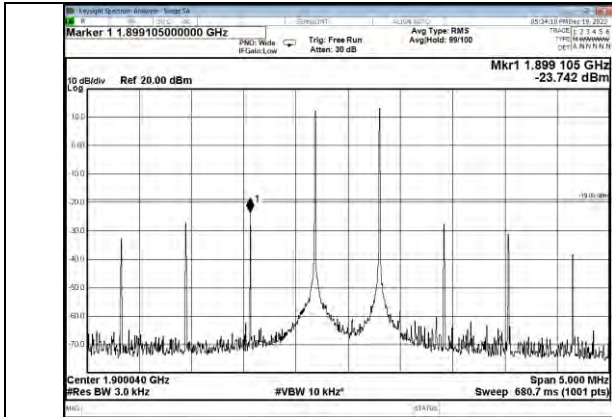

PCS Band Pre AGC, UL

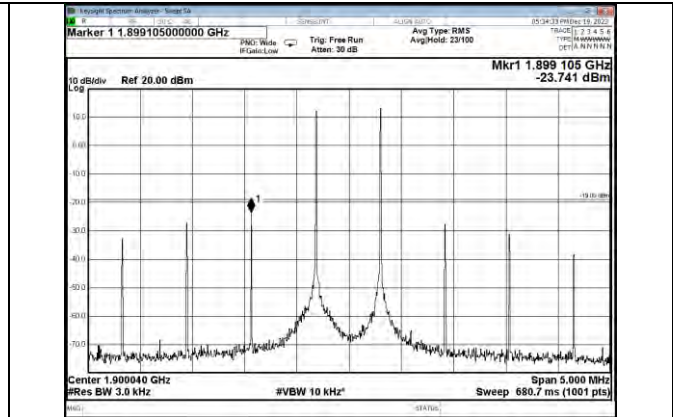

PCS Band AGC+10dB, UL

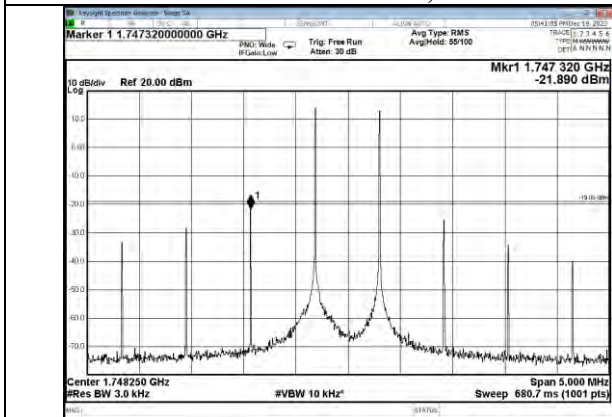

AWS Band Pre AGC, UL

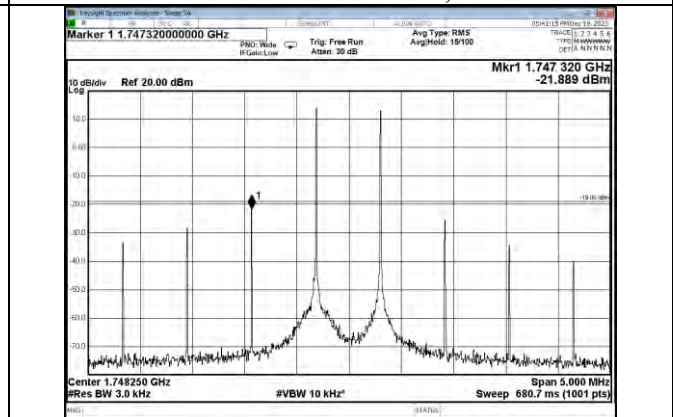

AWS Band AGC+10dB, UL

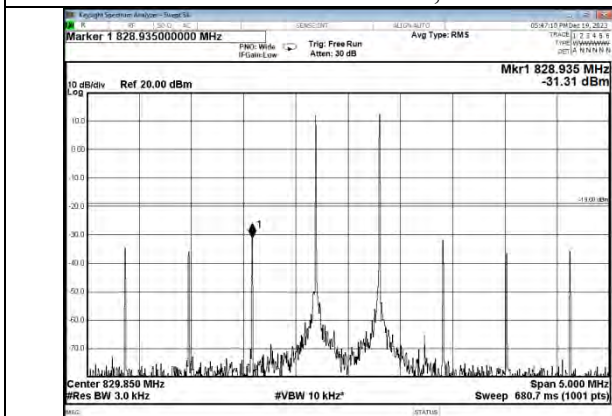

Cellular Band Pre AGC, UL

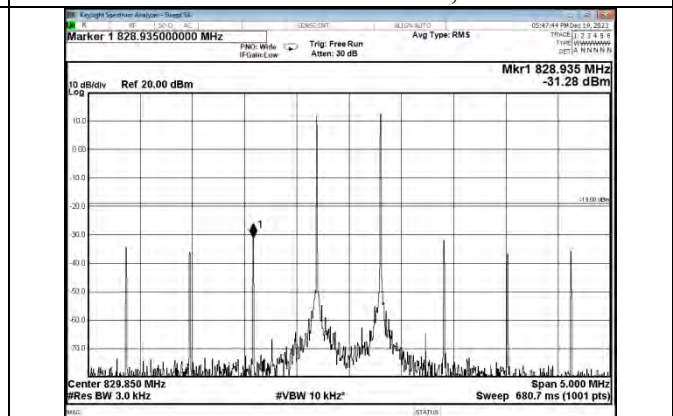

Cellular Band AGC+10dB, UL

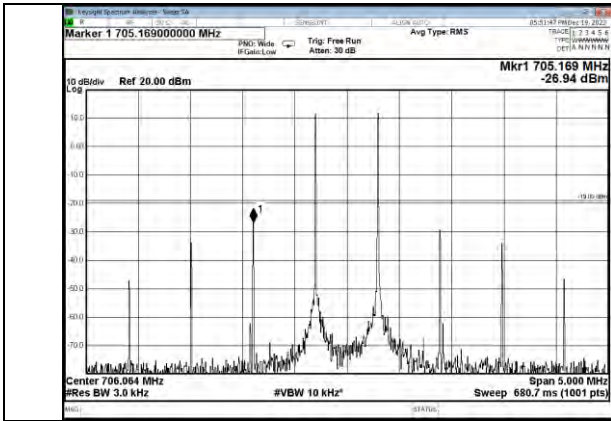

Lower 700MHz band Pre AGC, UL

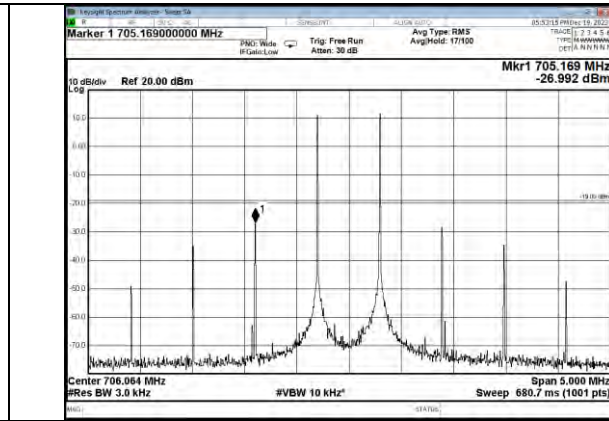

Lower 700MHz band AGC+10dB, UL

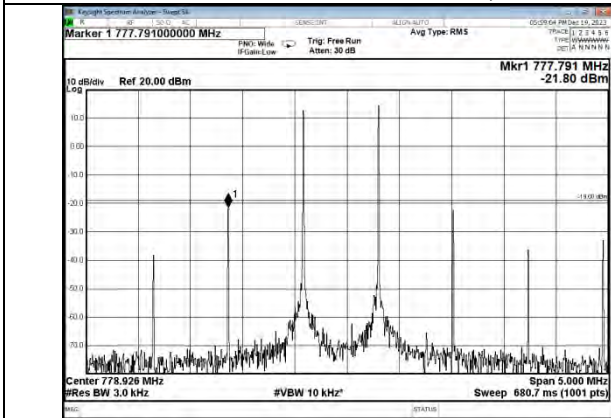

Upper 700MHz band Pre AGC, UL

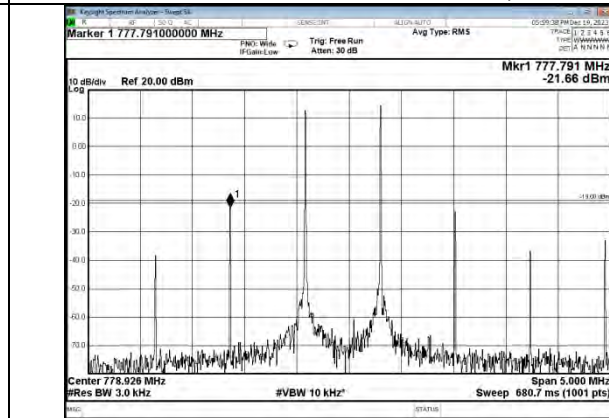

Upper 700MHz band AGC+10dB, UL

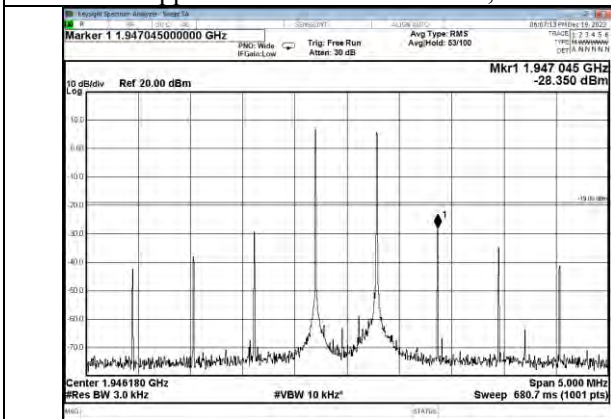

PCS Band Pre AGC, DL

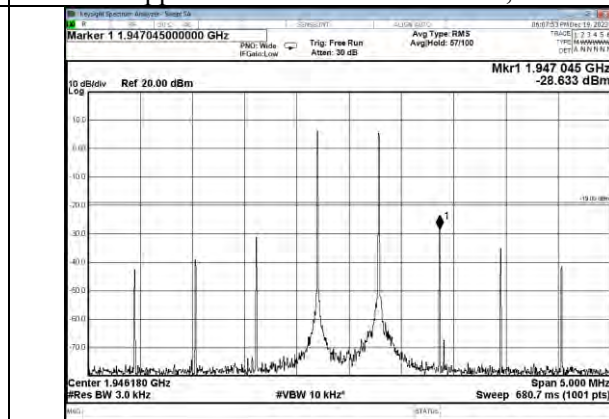

PCS Band AGC+10dB, DL

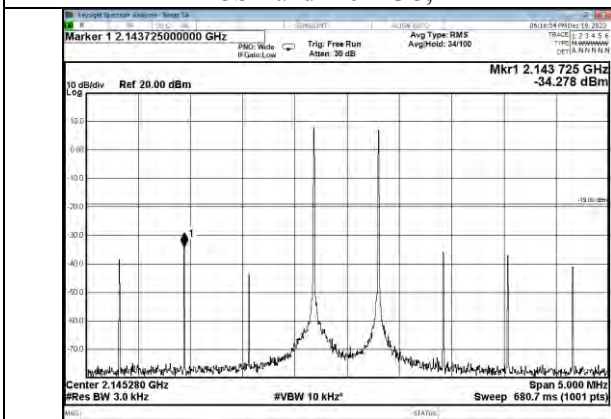

AWS Band Pre AGC, DL

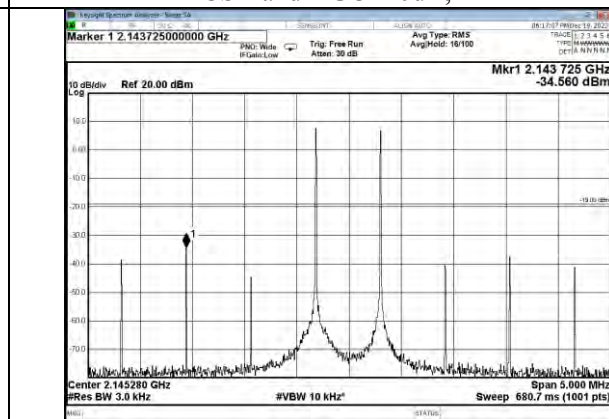

AWS Band AGC+10dB, DL

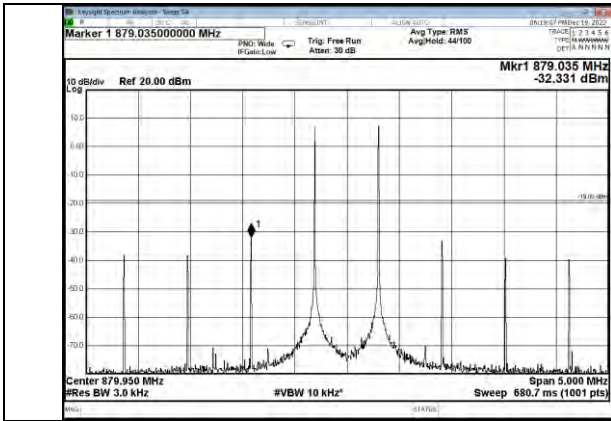

Cellular Band Pre AGC, DL

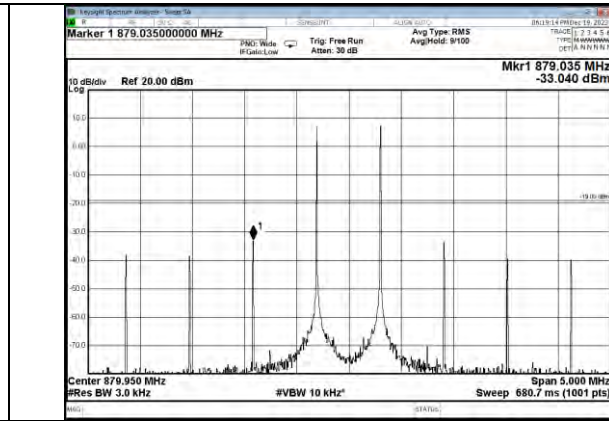

Cellular Band AGC+10dB, DL

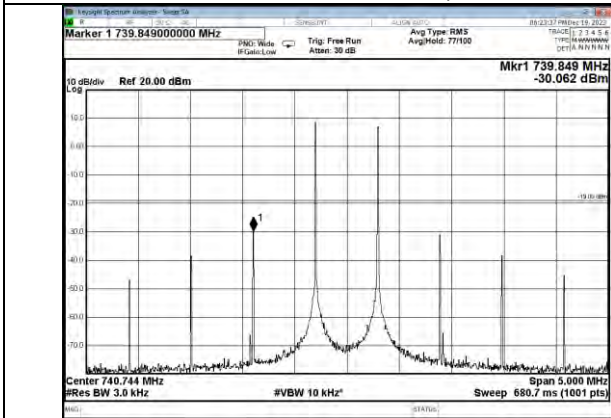

Lower 700MHz band Pre AGC, DL

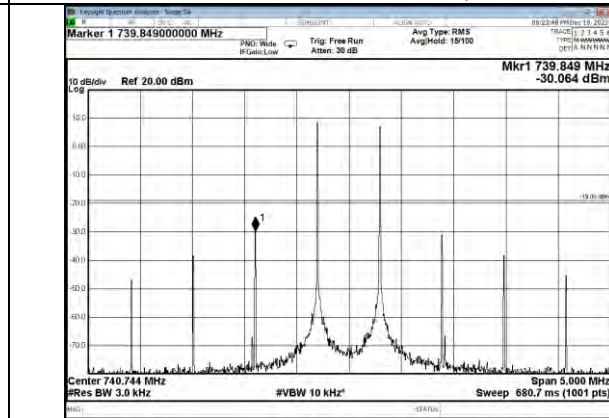

Lower 700MHz band AGC+10dB, DL

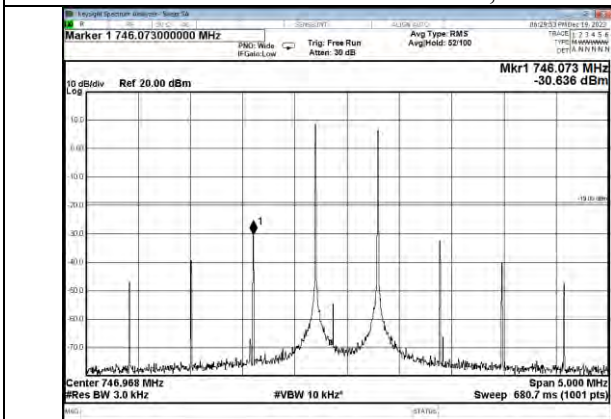

Upper 700MHz band Pre AGC, DL

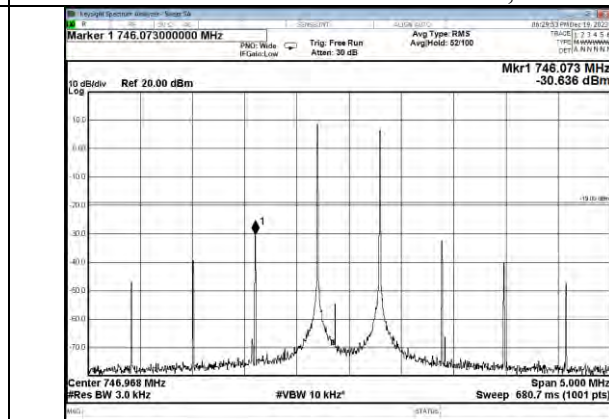

Upper 700MHz band AGC+10dB, DL





## 6.5 Out of Band Emission

### Applicable Standard

According to § 20.21(e)(8)(i)(E) Out of Band Emission Limits:

Booster out of band emissions (OOBE) shall be at least 6 dB below the FCC's mobile emission limits for the supported bands of operation. Compliance to OOBE limits will utilize high peak-to-average CMRS signal types.

For B2: Per FCC §24.238 the power of any emission outside of the authorized operating frequency ranges must be attenuated below the transmitting power (P) by a factor of at least  $43 + 10\log(P)$  dB.

For B4: Per §27.53(h): For operations in the 1710–1755 MHz and 2110–2155 MHz bands, the power of any emission outside a licensee's frequency block shall be attenuated below the transmitter power (P) by at least  $43 + 10 \log_{10}(P)$  dB.

For B5: Per FCC §22.917 the power of any emission outside of the authorized operating frequency ranges must be attenuated below the transmitting power (P) by a factor of at least  $43 + 10\log(P)$  dB.

For B12: Per §27.53 (g): For operations in the 698–746 MHz band, the power of any emission outside a licensee's frequency band(s) of operation shall be attenuated below the transmitter power (P) within the licensed band(s) of operation, measured in watts, by at least  $43 + 10 \log (P)$  dB.

For B13: Per §27.53 (c): For operations in the 776–788 MHz band, the power of any emission outside the licensee's frequency band(s) of operation shall be attenuated below the transmitter power (P) within the licensed band(s) of operation, measured in watts, in accordance with the following: On any frequency outside the 776–788 MHz band, the power of any emission shall be attenuated outside the band below the transmitter power (P) by at least  $43 + 10 \log (P)$  dB.

Calculation: Limit (dBm) =  $[P - 43 + 10 \log (P)] - 6 = -19$  dBm

### Test Procedure

According to section 7.5 of KDB 935210 D03 Signal Booster Measurement v04r04:

a) Connect the EUT to the test equipment as shown in Figure 1. Begin with the uplink output (donor) port connected to the spectrum analyzer.

b) Configure the signal generator for the appropriate operation for all uplink and downlink bands:

1) GSM: 0.2 MHz from upper and lower band edges.

2) LTE (5 MHz): 2.5 MHz from upper and lower band edges.

3) CDMA: 1.25 MHz from upper and lower band edges, except for cellular band as follows (only the upper and lower frequencies need to be tested):

824.88 MHz, 845.73 MHz, 836.52 MHz, 848.10 MHz,

869.88 MHz, 890.73 MHz, 881.52 MHz, 893.10 MHz.

NOTE 1—Alternative test modulation types:

• CDMA (alternative 1.25 MHz AWGN)

• LTE 5 MHz (alternative W-CDMA or 4.1 MHz AWGN)

NOTE 2—For LTE, the signal generator should use the uplink and downlink signal types for these modulations in uplink and downlink tests, respectively. LTE shall use 5 MHz signal, 25 resource blocks transmitting.

NOTE 3—When using an AWGN test signal, the bandwidth shall be the measured 99% OBW.

c) Set the signal generator amplitude to the maximum power level prior to AGC similar to 7.2.2e)



to 7.2.2f) of the power measurement procedures for the appropriate modulations.

d) Set RBW = measurement bandwidth specified in the applicable rule section for the supported frequency band (see Appendix A for cross-reference to applicable rule section).

e) NOTE 3—Within 300 kHz and 3 MHz away from band edge, if smaller RBW is used (i.e., RBW < 100 kHz or 1 MHz, for above and below 1 GHz, respectively), per Parts 24 and 27 the smaller RBW is applicable only for frequencies within 100 kHz or 1 MHz (for above and below 1 GHz, respectively) away from the band edge.

f) Set VBW = 3 RBW.

g) Select the power averaging (rms) detector.

h) Sweep time = auto-couple.

i) Set the analyzer start frequency to the upper band/block edge frequency and the stop frequency to the upper band/block edge frequency plus: 300 kHz (when operational frequency is < 1 GHz), or 3 MHz (when operational frequency is  $\geq$  1 GHz).

j) Trace average at least 100 traces in power averaging (i.e., rms) mode.

k) Use peak marker function to find the maximum power level.

l) Capture the spectrum analyzer trace of the power level for inclusion in the test report.

m) Increase the signal generator amplitude in 2 dB steps until the maximum input level per 5.5 is reached. Affirm that the EUT maintains compliance with the OOB limits. The test report shall include either a statement describing that the device complies at 10 dB above AGC or at the 5.5 power levels, or a table showing compliance at the additional input power(s) required.

n) Reset the analyzer start frequency to the lower band/block edge frequency minus: 300 kHz (when operational frequency is < 1 GHz), or 3 MHz (when operational frequency is  $\geq$  1 GHz), and the stop frequency to the lower band/block edge frequency, then repeat 7.5i) to 7.5l).

Repeat 7.5b) through 7.5m) for each uplink and downlink operational band.



Test data

Temperature	23.4°C	Humidity	53.2%
Test Engineer	Nick Peng	Test Mode	Transmitting

Test Graphs

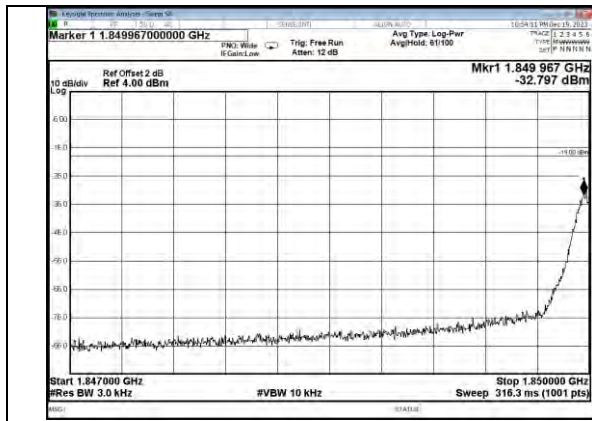

PCS Band GSM UL Left Side Pre AGC

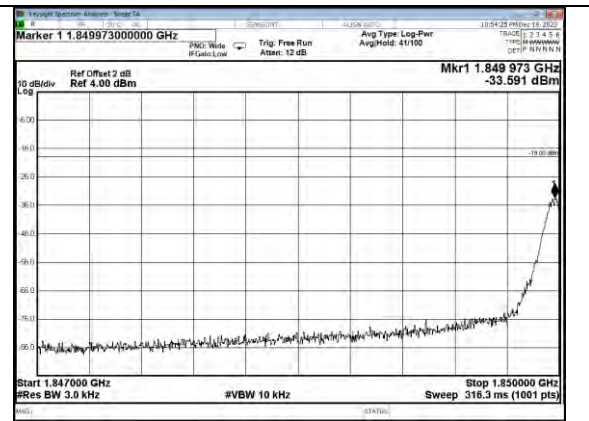

PCS Band GSM UL Left Side 10dB Above AGC

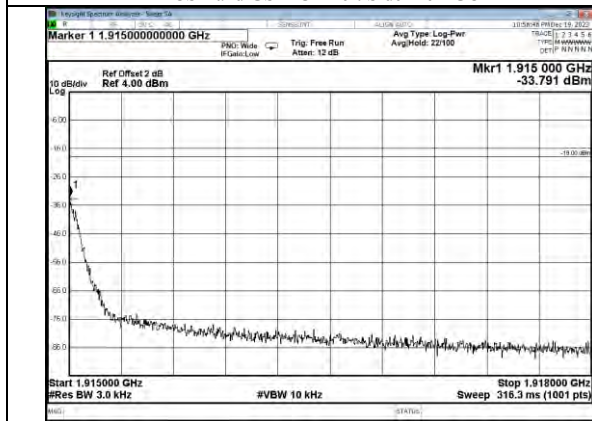

PCS Band GSM UL Right Side Pre AGC

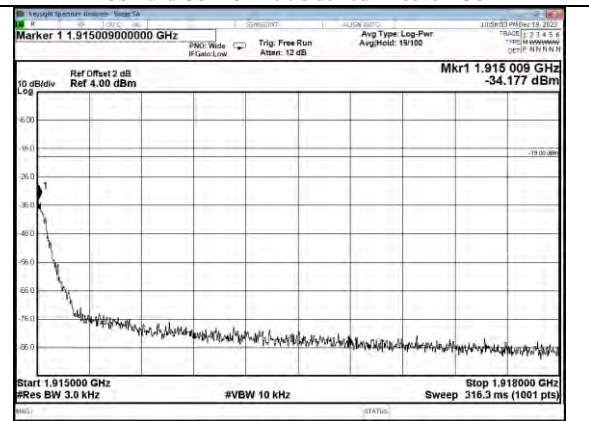

PCS Band GSM UL Right Side 10dB Above AGC

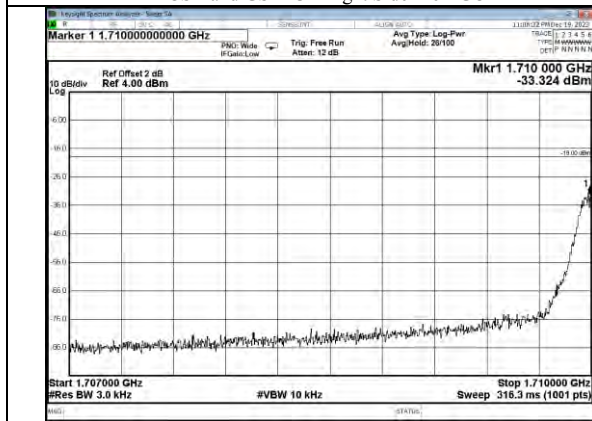

AWS Band GSM UL Left Side Pre AGC

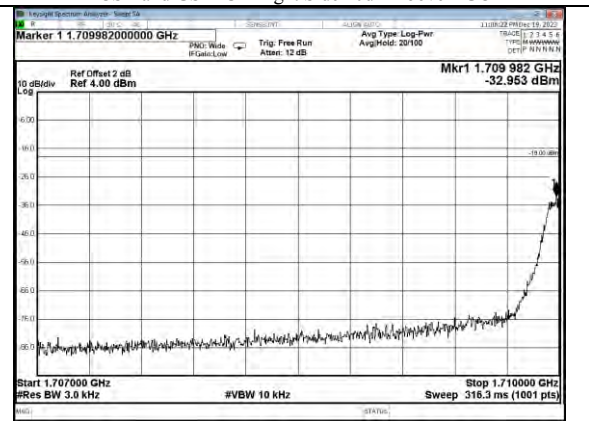

AWS Band GSM UL Left Side 10dB Above AGC

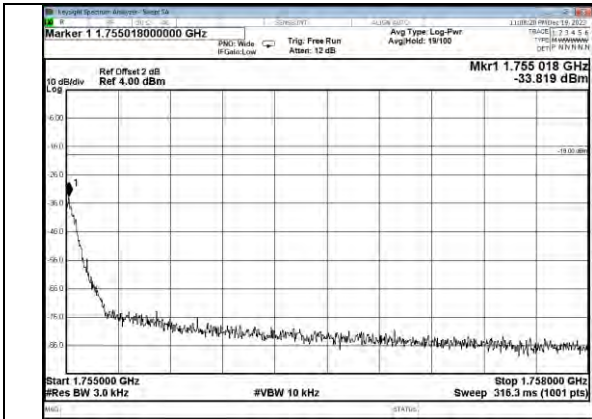

AWS Band GSM UL Right Side Pre AGC

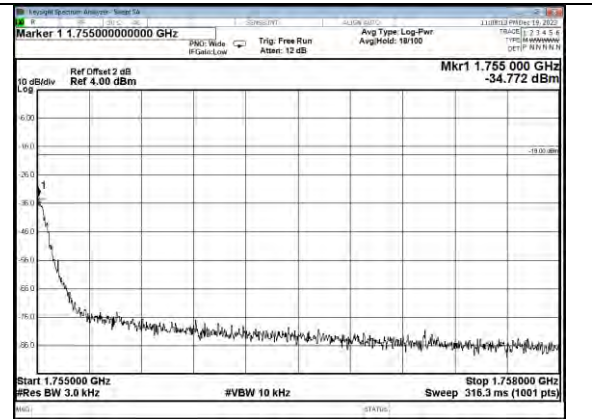

AWS Band GSM UL Right Side 10dB Above AGC

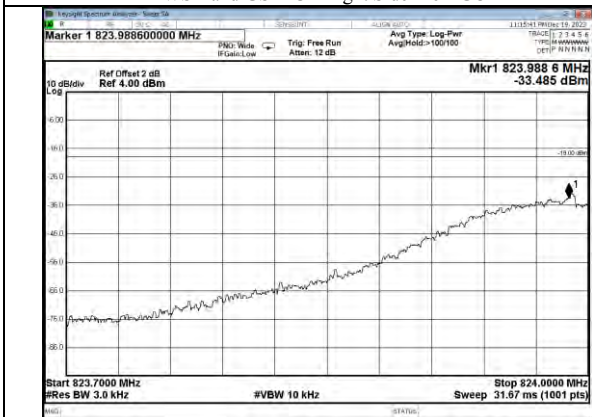

Cellular Band GSM UL Left Side Pre AGC



Cellular Band GSM UL Left Side 10dB Above AGC

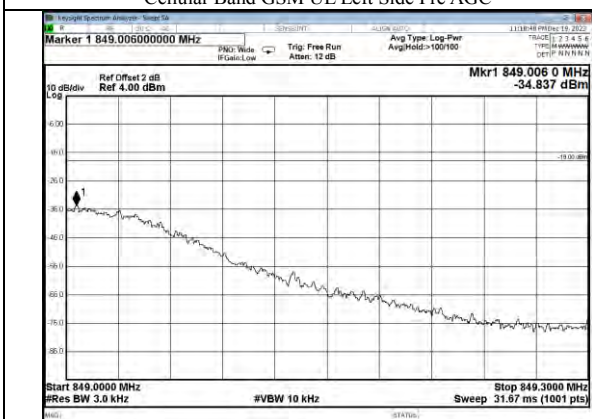

Cellular Band GSM UL Right Side Pre AGC

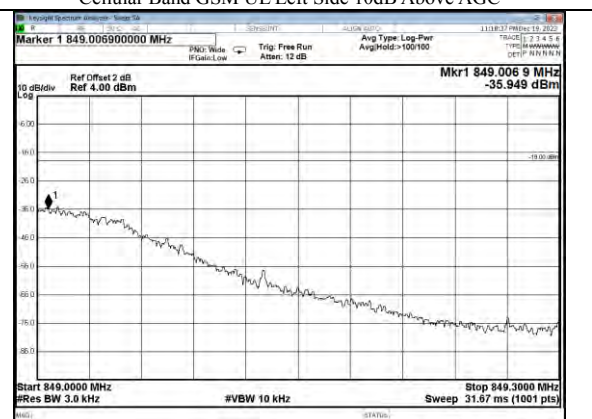

Cellular Band GSM UL Right Side 10dB Above AGC

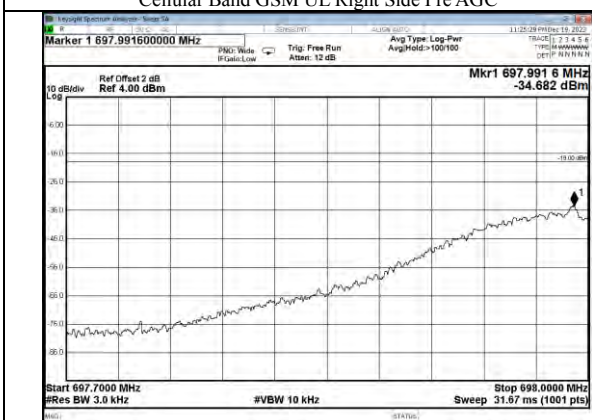

Lower 700MHz band GSM UL Left Side Pre AGC



Lower 700MHz band GSM UL Left Side 10dB Above AGC



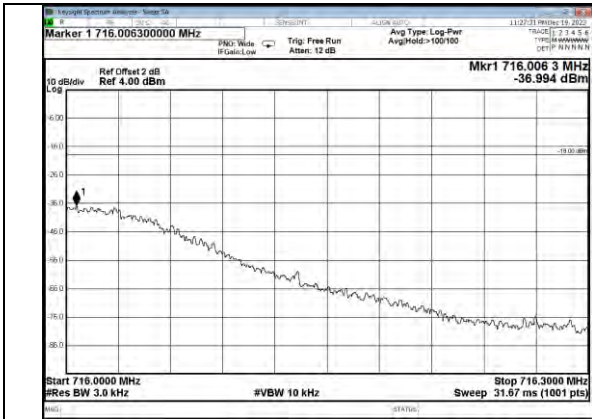

Lower 700MHz band GSM UL Right Side Pre AGC



Lower 700MHz band GSM UL Right Side 10dB Above AGC

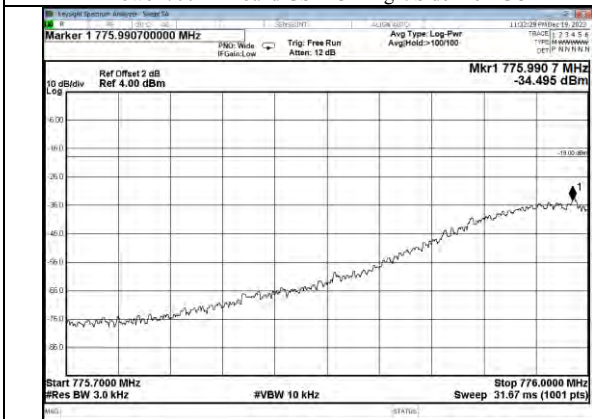

Upper 700MHz band GSM UL Left Side Pre AGC



Upper 700MHz band UL Left Side 10dB Above AGC

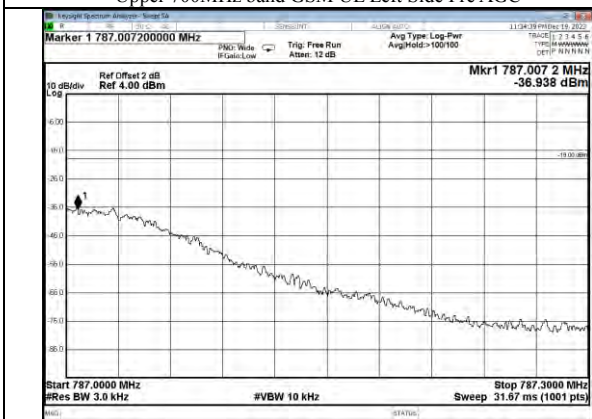

Upper 700MHz band GSM UL Right Side Pre AGC

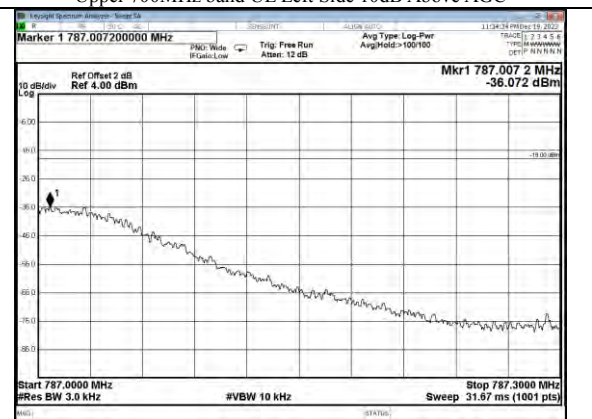

Upper 700MHz band GSM UL Right Side 10dB Above AGC



PCS Band CDMA UL Left Side Pre AGC



PCS Band CDMA UL Left Side 10dB Above AGC



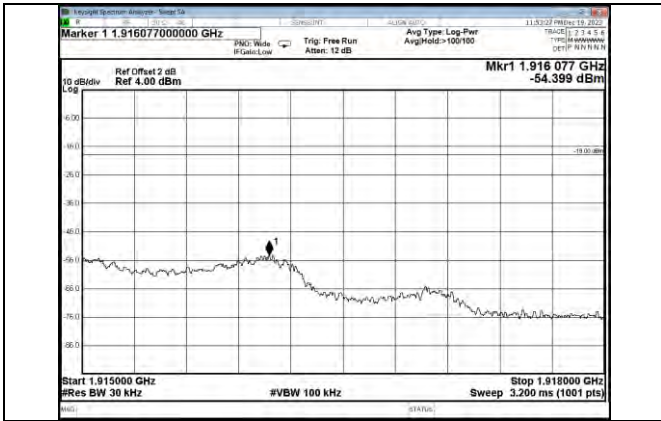

PCS Band CDMA UL Right Side Pre AGC



PCS Band CDMA UL Right Side 10dB Above AGC



AWS Band CDMA UL Left Side Pre AGC



AWS Band CDMA UL Left Side 10dB Above AGC

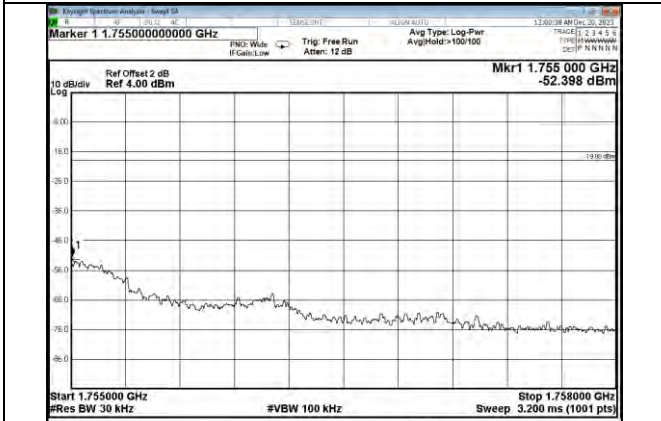

AWS Band CDMA UL Right Side Pre AGC



AWS Band CDMA UL Right Side 10dB Above AGC

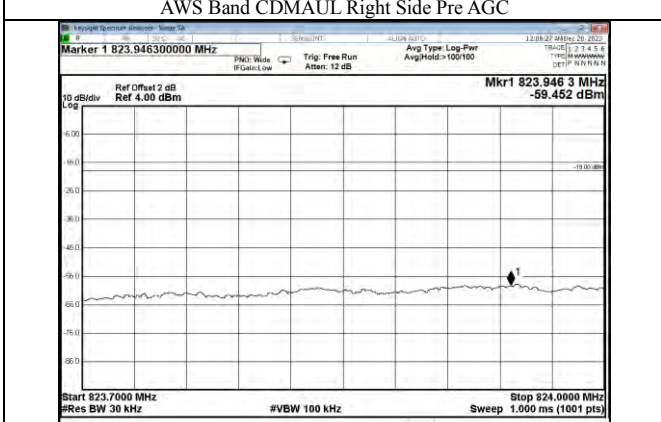

Cellular Band CDMA UL Left Side Pre AGC

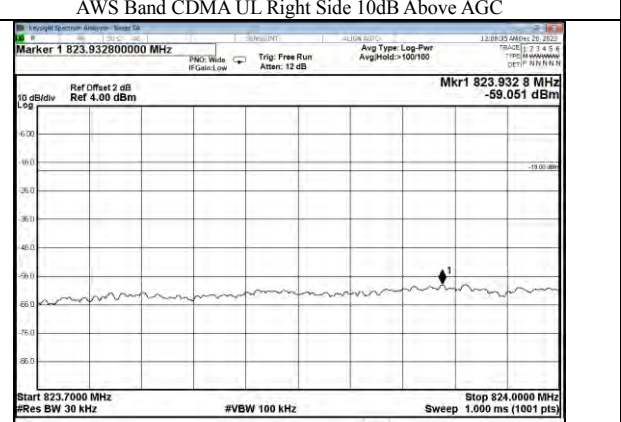

Cellular Band CDMA UL Left Side 10dB Above AGC

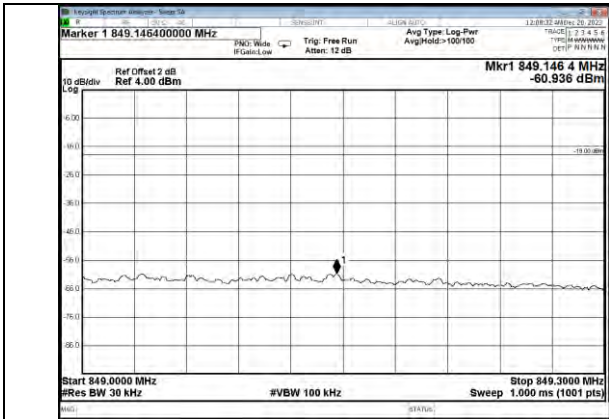

Cellular Band CDMA UL Right Side Pre AGC

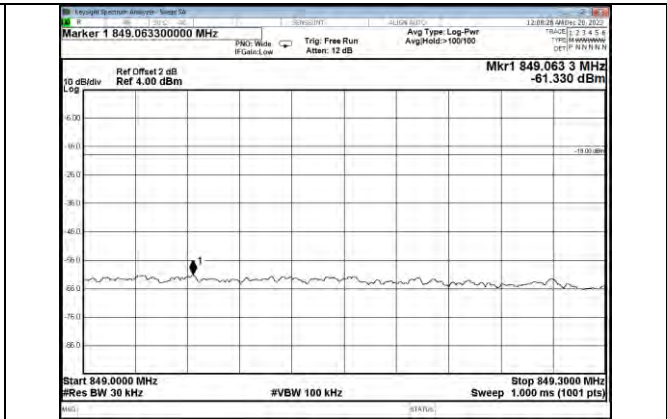

Cellular Band CDMA UL Right Side 10dB Above AGC

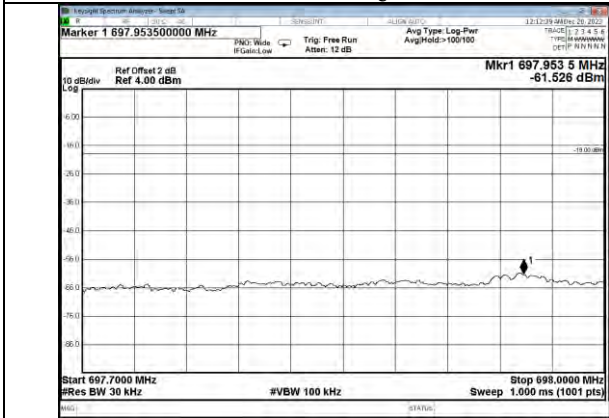

Lower 700MHz band CDMA UL Left Side Pre AGC

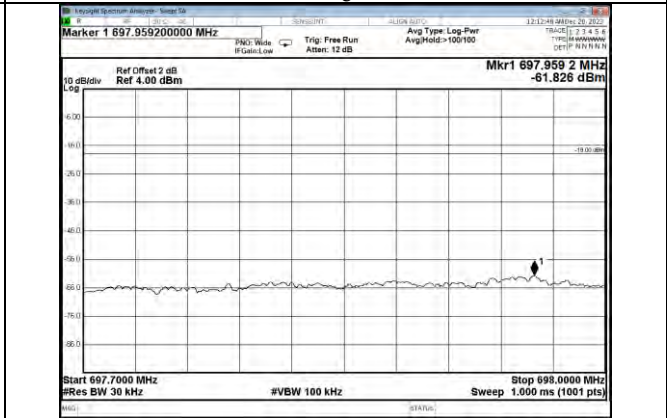

Lower 700MHz band CDMA UL Left Side 10dB Above AGC

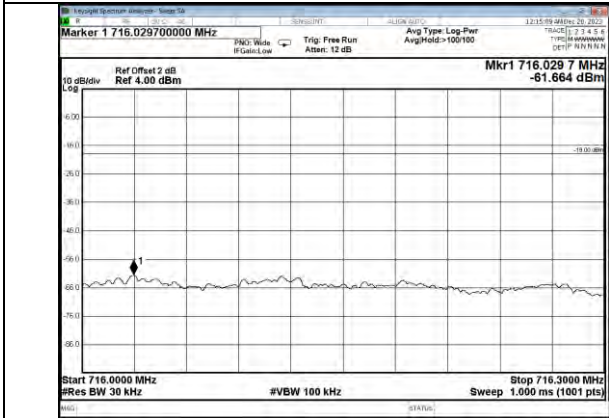

Lower 700MHz band CDMA UL Right Side Pre AGC

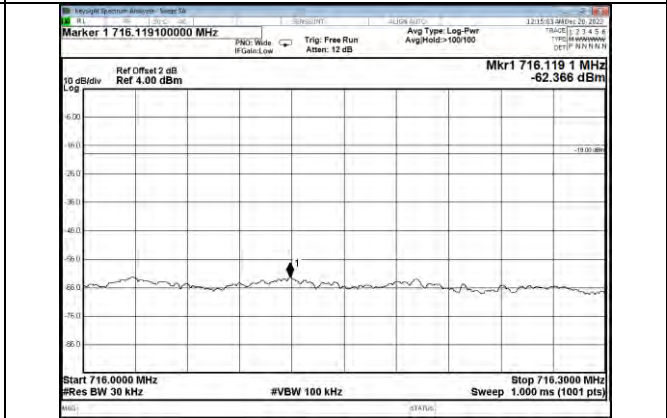

Lower 700MHz band CDMA UL Right Side 10dB Above AGC

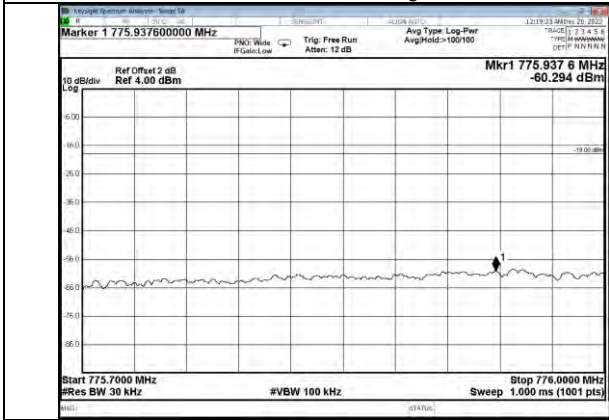

Upper 700MHz band CDMA UL Left Side Pre AGC

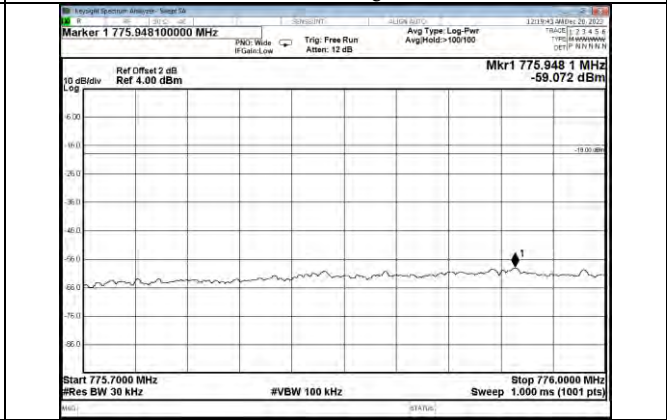

Upper 700MHz band CDMA UL Left Side 10dB Above AGC

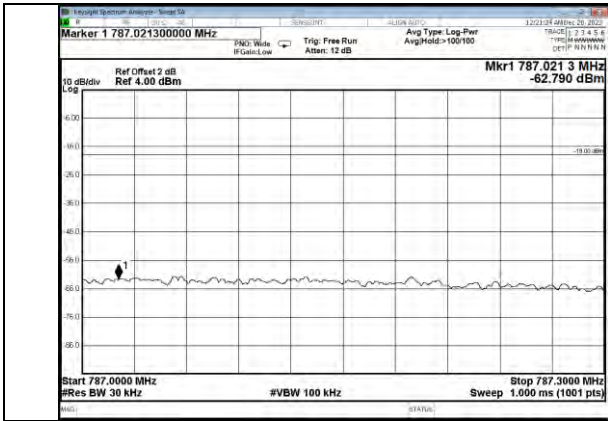

Upper 700MHz band CDMA UL Right Side Pre AGC

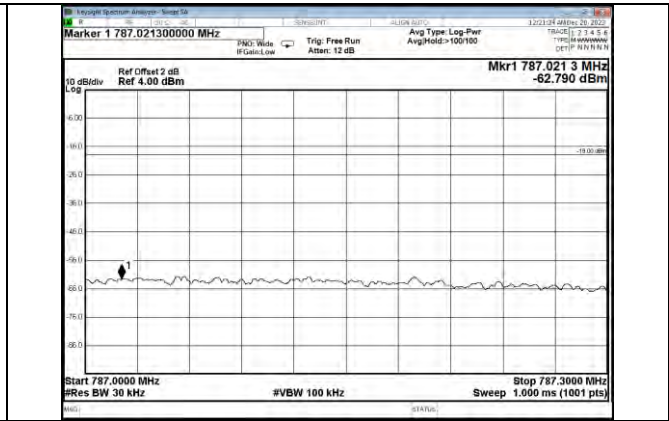

Upper 700MHz band CDMA UL Right Side 10dB Above AGC

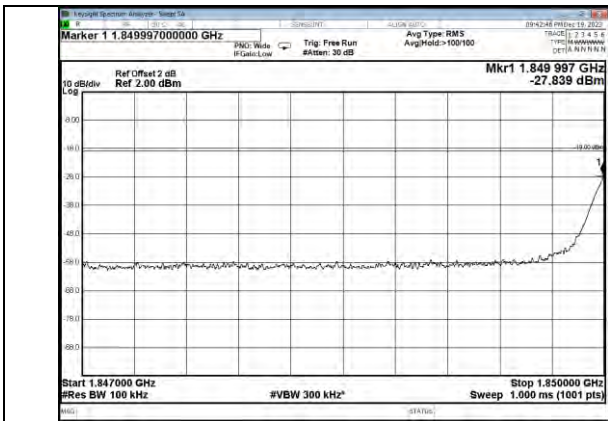

PCS Band LTE UL Left Side Pre AGC

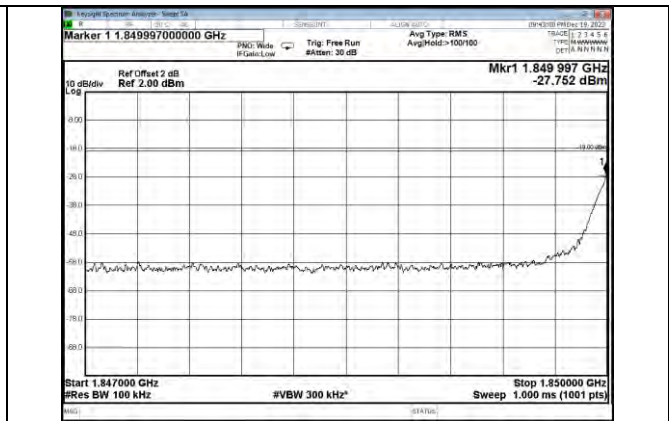

PCS Band LTE UL Left Side 10dB Above AGC

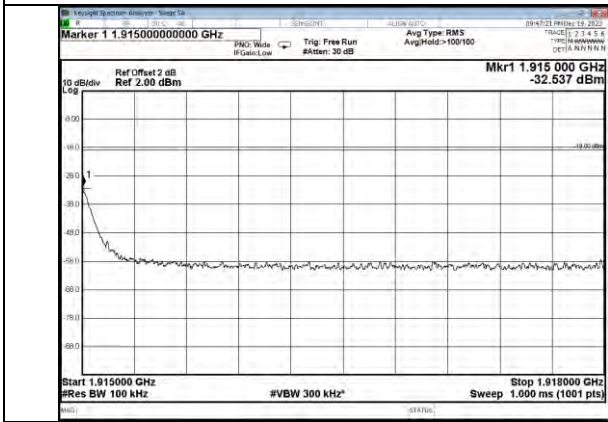

PCS Band LTE UL Right Side Pre AGC

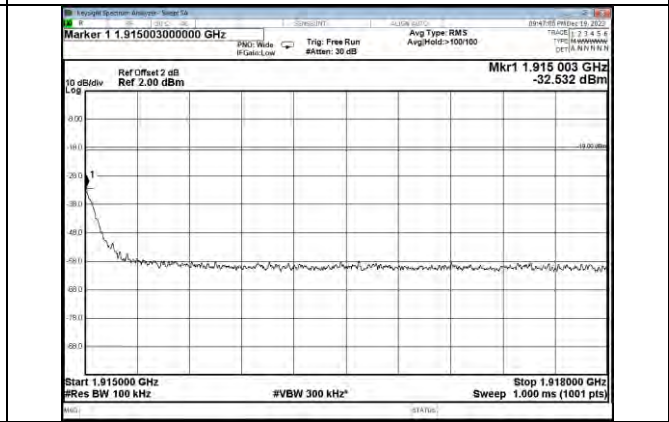

PCS Band LTE UL Right Side 10dB Above AGC

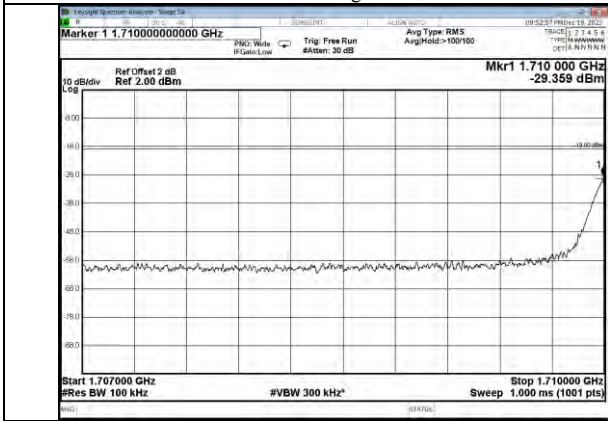

AWS Band LTE UL Left Side Pre AGC

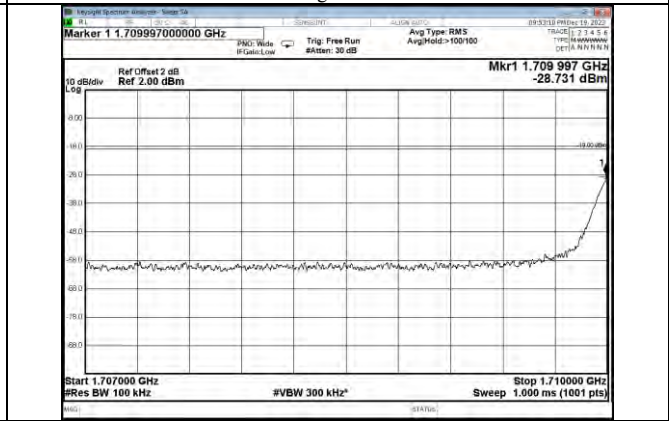

AWS Band LTE UL Left Side 10dB Above AGC



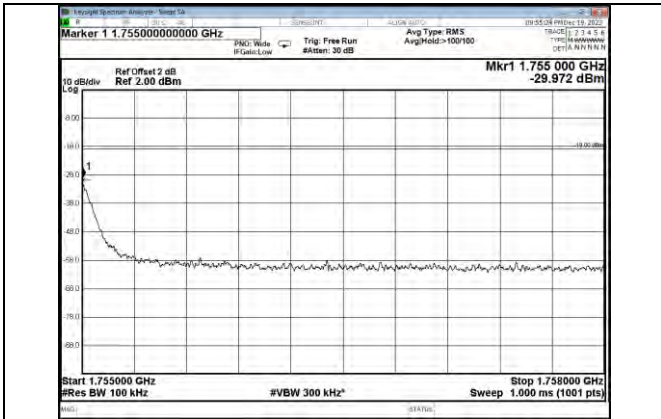

AWS Band LTE UL Right Side Pre AGC

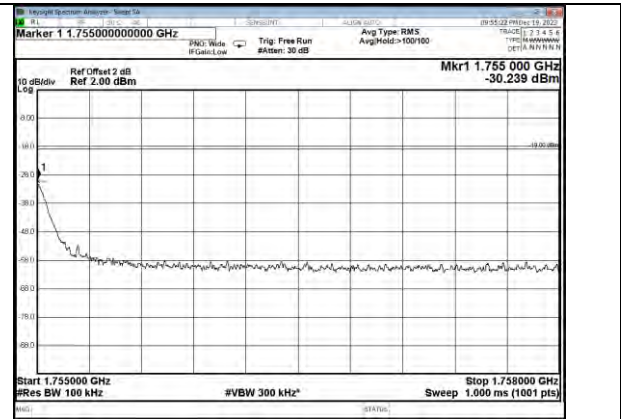

AWS Band LTE UL Right Side 10dB Above AGC

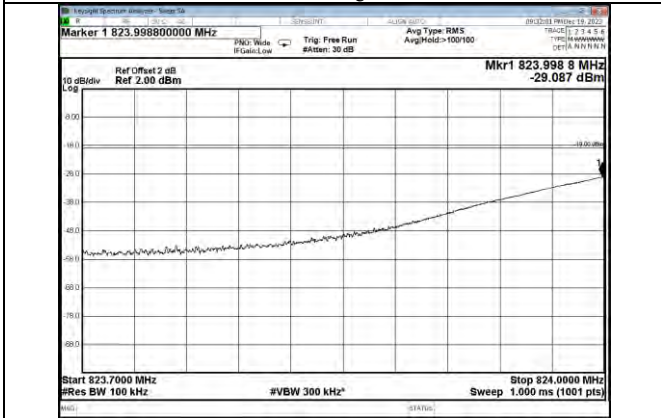

Cellular Band LTE UL Left Side Pre AGC

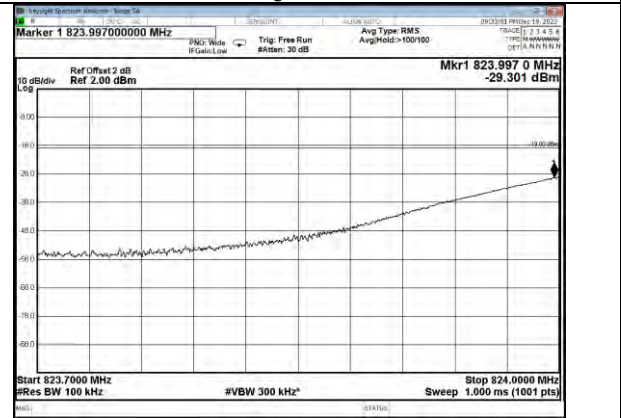

Cellular Band LTE UL Left Side 10dB Above AGC

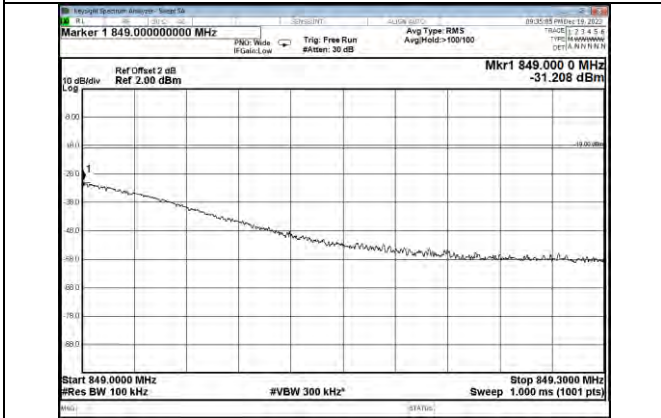

Cellular Band LTE UL Right Side Pre AGC



Cellular Band LTE UL Right Side 10dB Above AGC

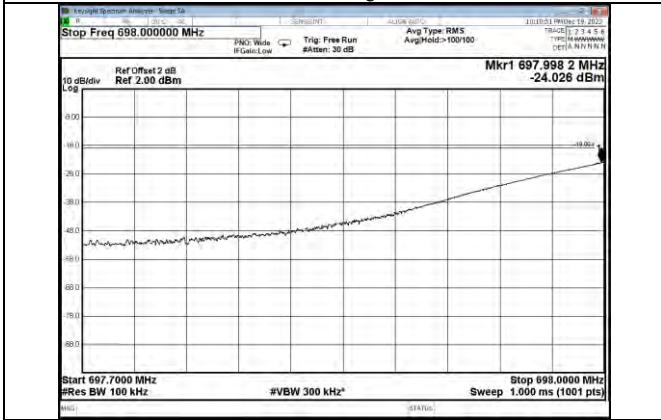

Lower 700MHz band LTE UL Left Side Pre AGC



Lower 700MHz band LTE UL Left Side 10dB Above AGC



Lower 700MHz band LTE UL Right Side Pre AGC

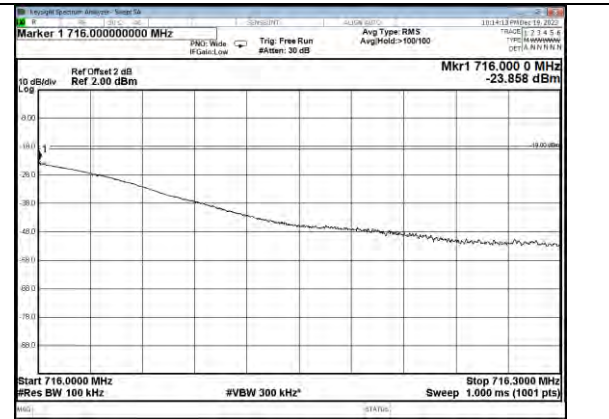

Lower 700MHz band LTE UL Right Side 10dB Above AGC



Upper 700MHz band LTE UL Left Side Pre AGC

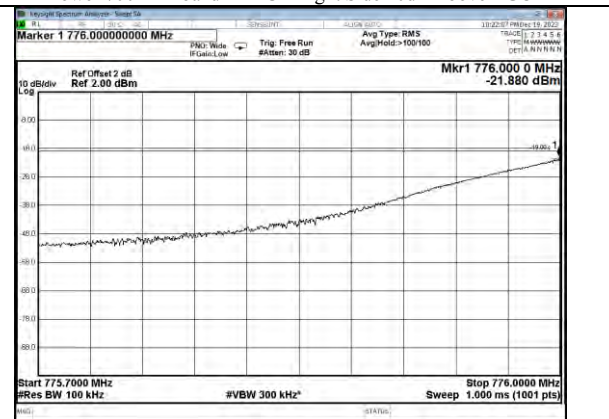

Upper 700MHz band LTE UL Left Side 10dB Above AGC

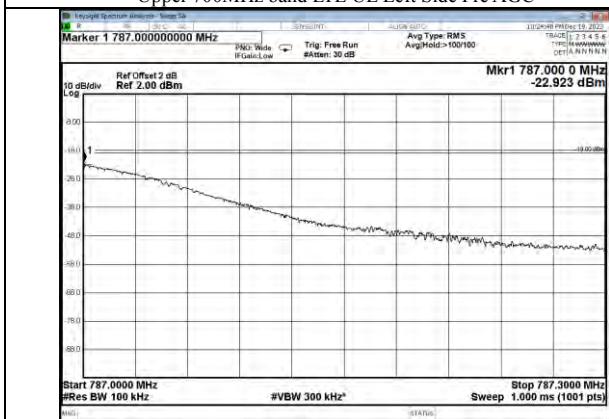

Upper 700MHz band LTE UL Right Side Pre AGC

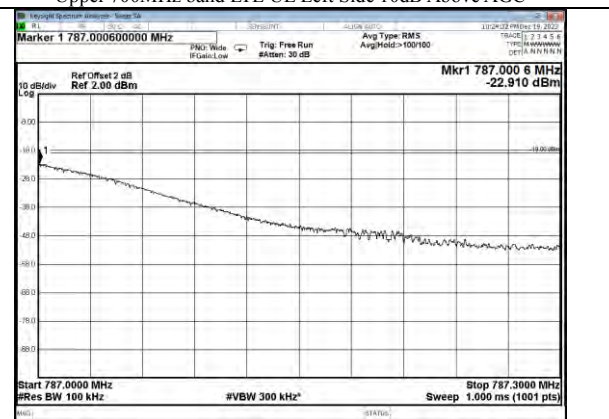

Upper 700MHz band3 LTE UL Right Side 10dB Above AGC

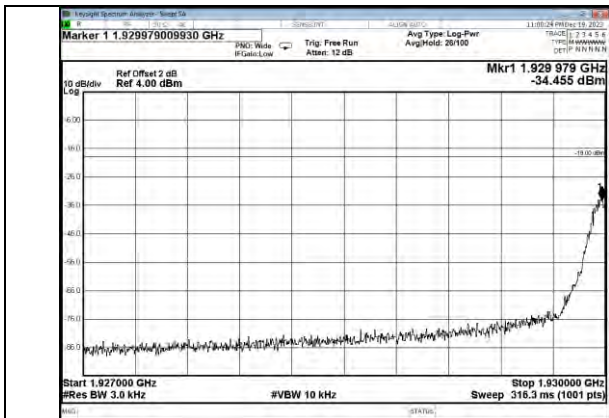

PCS Band GSM DL Left Side Pre AGC

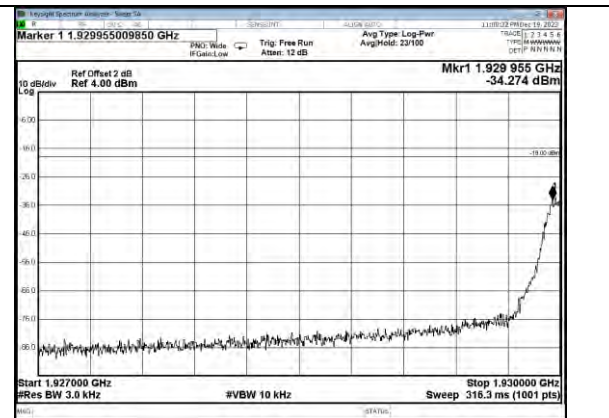

PCS Band GSM DL Left Side 10dB Above AGC

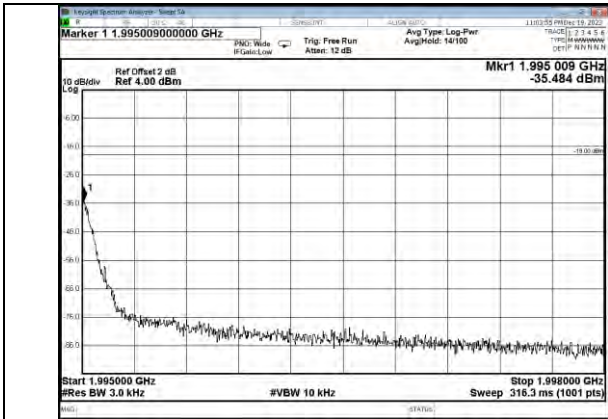

PCS Band GSM DL Right Side Pre AGC

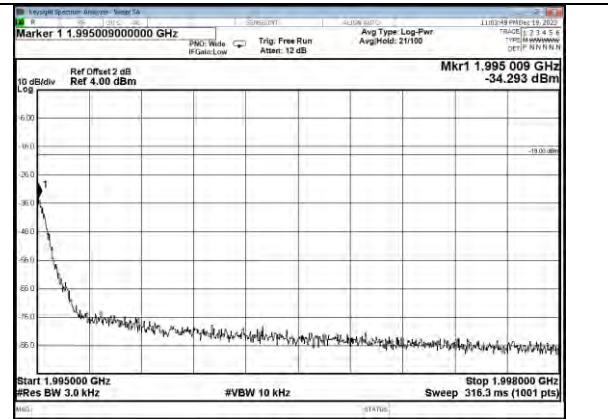

PCS Band GSM DL Right Side 10dB Above AGC

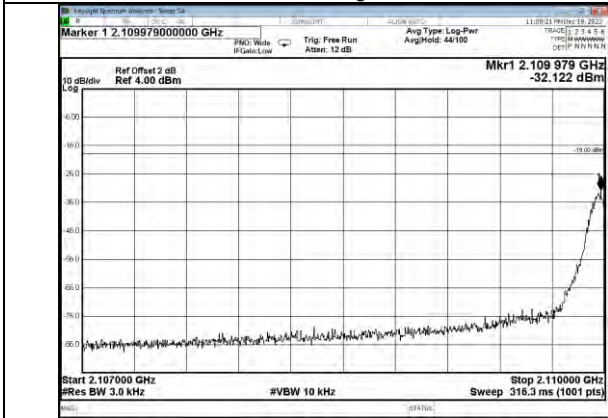

AWS Band GSM DL Left Side Pre AGC

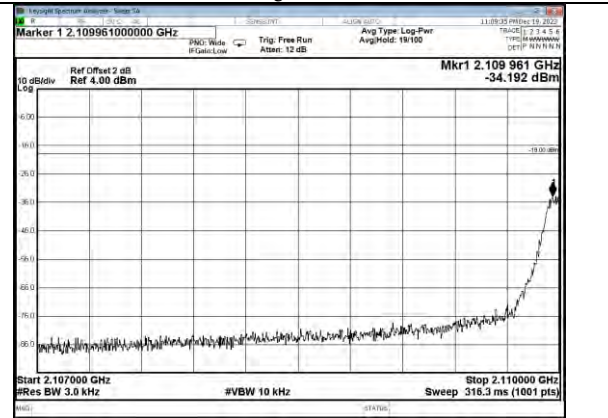

AWS Band GSM DL Left Side 10dB Above AGC

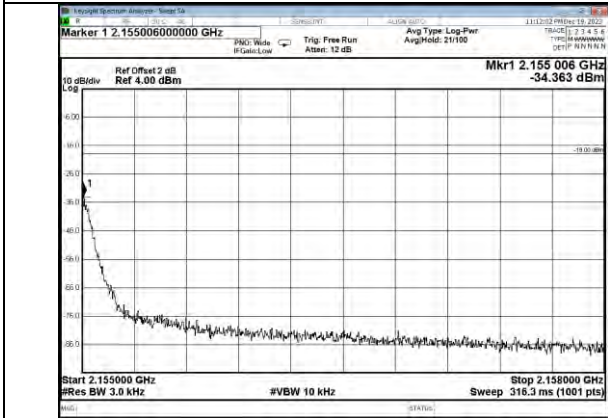

AWS Band GSM DL Right Side Pre AGC

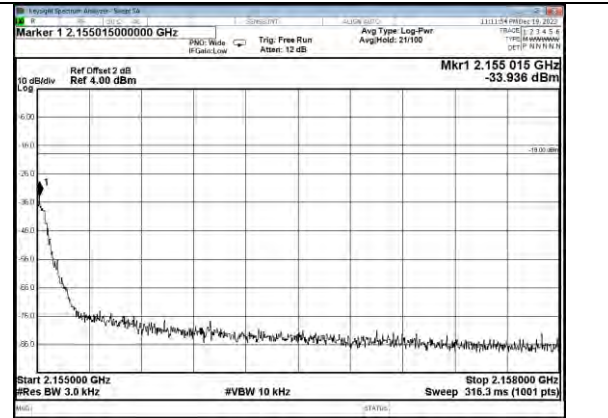

AWS Band GSM DL Right Side 10dB Above AGC



Cellular Band GSM DL Left Side Pre AGC



Cellular Band GSM DL Left Side 10dB Above AGC





Cellular Band GSM DL Right Side Pre AGC

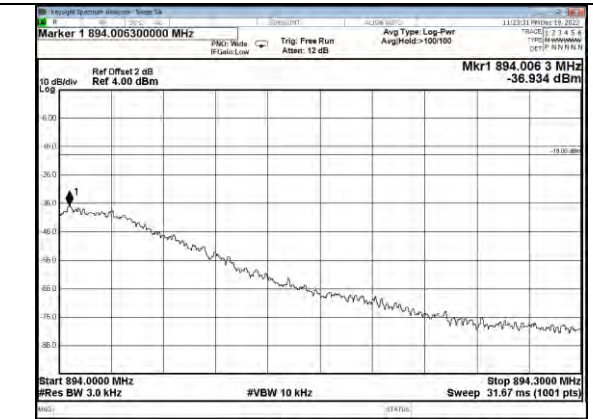

Cellular Band GSM DL Right Side 10dB Above AGC



Lower 700MHz band GSM DL Left Side Pre AGC

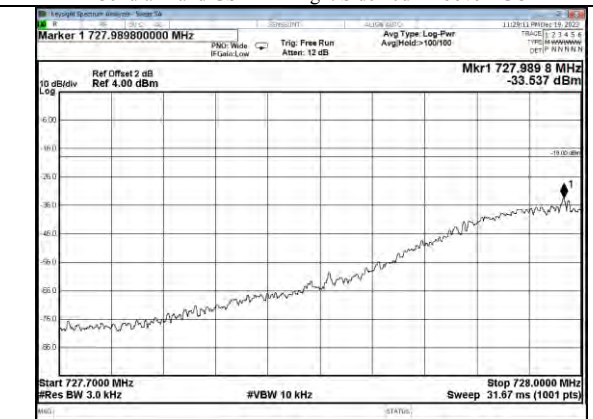

Lower 700MHz band GSM DL Left Side 10dB Above AGC

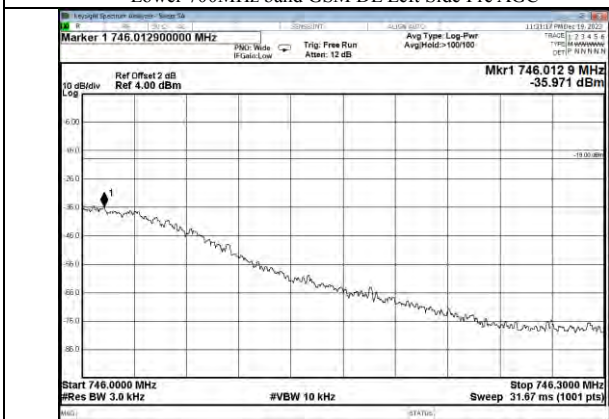

Lower 700MHz band GSM DL Right Side Pre AGC

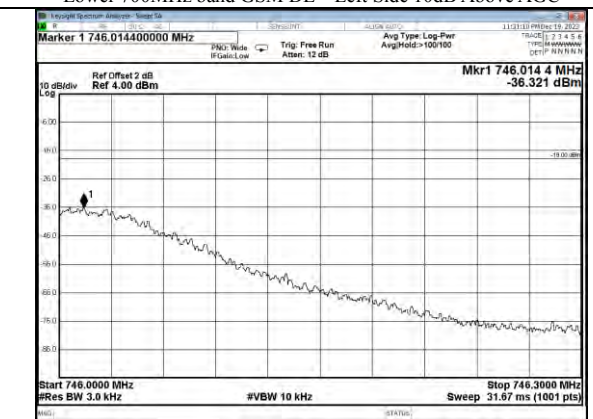

Lower 700MHz band2 GSM DL Right Side 10dB Above AGC



Upper 700MHz band GSM DL Left Side Pre AGC

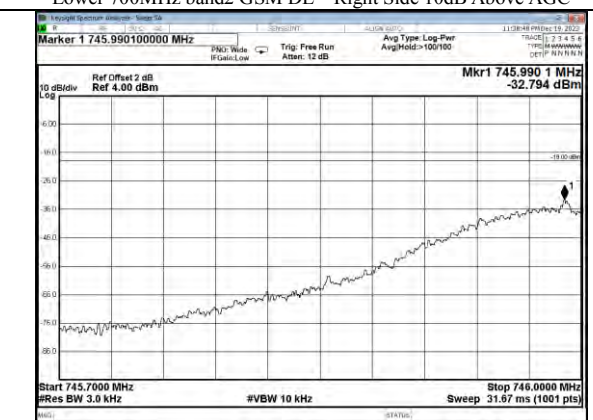

Upper 700MHz band GSM DL Left Side 10dB Above AGC

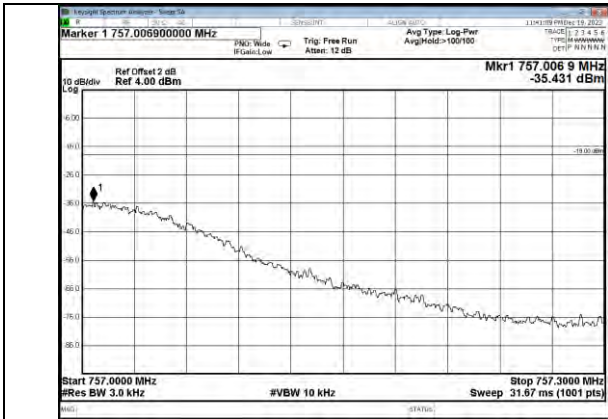

Upper 700MHz band GSM DL Right Side Pre AGC



Upper 700MHz band GSM DL Right Side 10dB Above AGC



PCS Band CDMA DL Left Side Pre AGC



PCS Band CDMA DL Left Side 10dB Above AGC

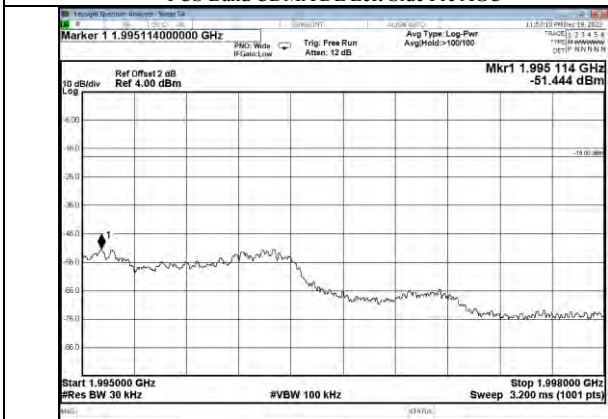

PCS Band CDMA DL Right Side Pre AGC

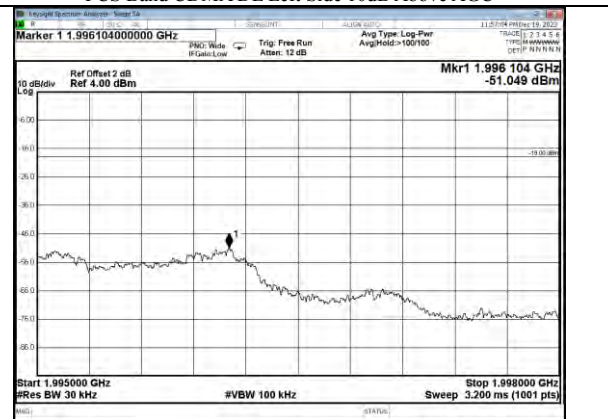

PCS Band CDMA DL Right Side 10dB Above AGC



AWS Band CDMA UL Left Side Pre AGC



AWS Band CDMA DL Left Side 10dB Above AGC





AWS Band CDMA DL Right Side Pre AGC



AWS Band CDMA DL Right Side 10dB Above AGC

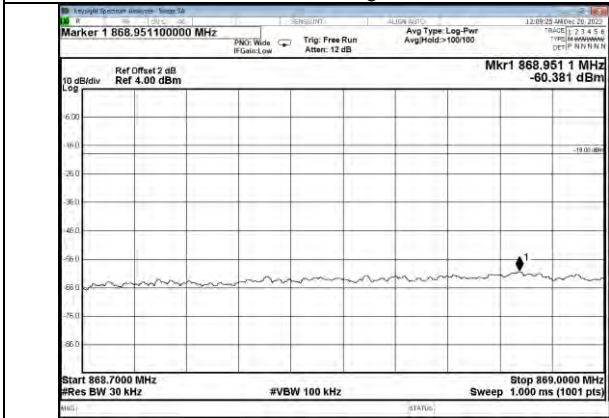

Cellular Band CDMA DL Left Side Pre AGC

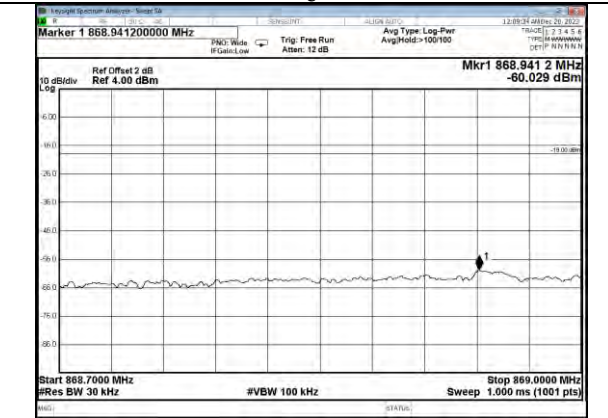

Cellular Band CDMA DL Left Side 10dB Above AGC

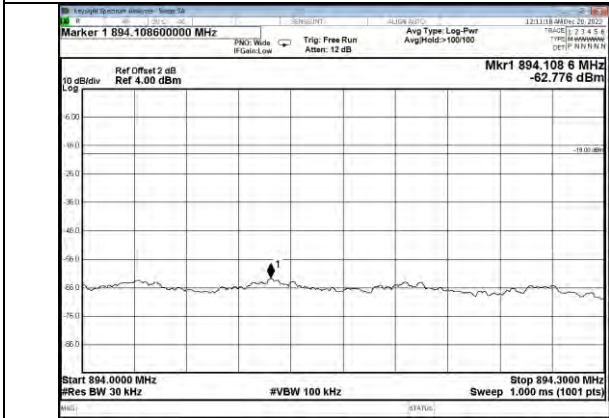

Cellular Band CDMA DL Right Side Pre AGC

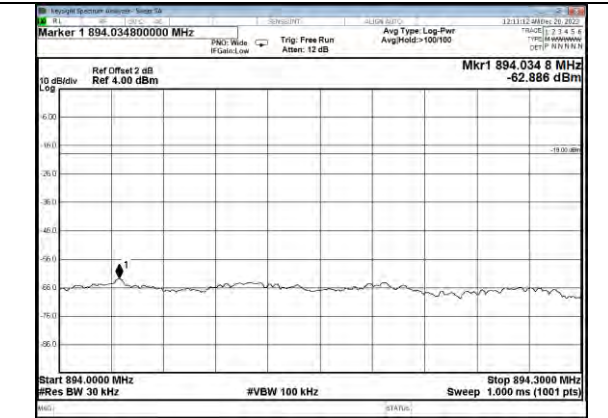

Cellular Band CDMA DL Right Side 10dB Above AGC

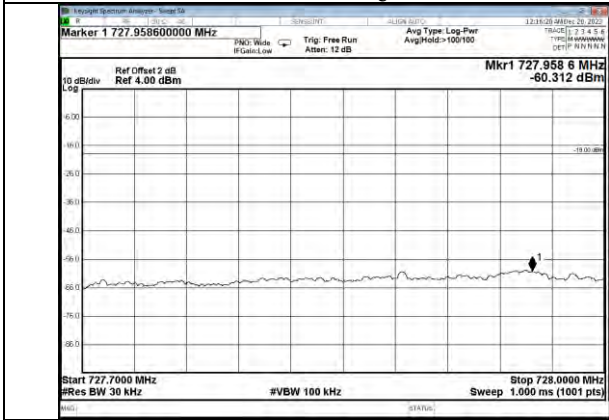

Lower 700MHz band CDMA DL Left Side Pre AGC

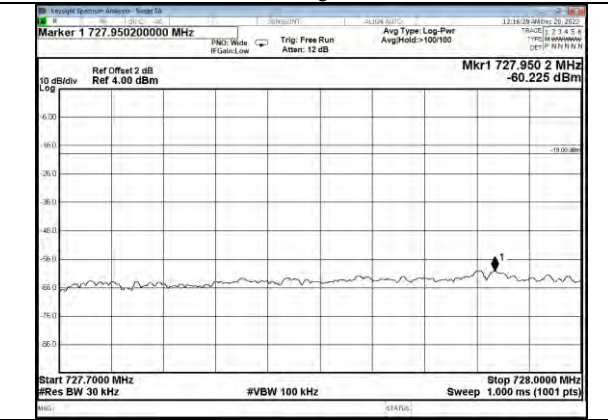

Lower 700MHz band CDMA DL Left Side 10dB Above AGC

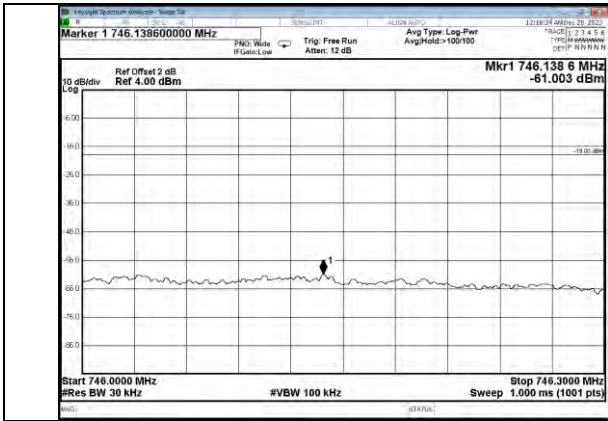

Lower 700MHz band CDMA DL Right Side Pre AGC

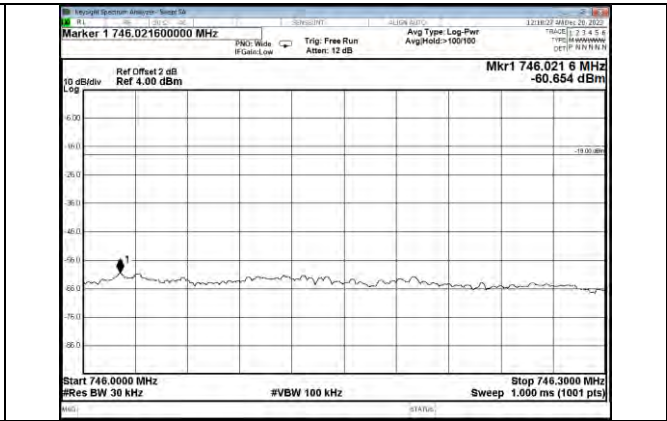

Lower 700MHz band CDMA DL Right Side 10dB Above AGC

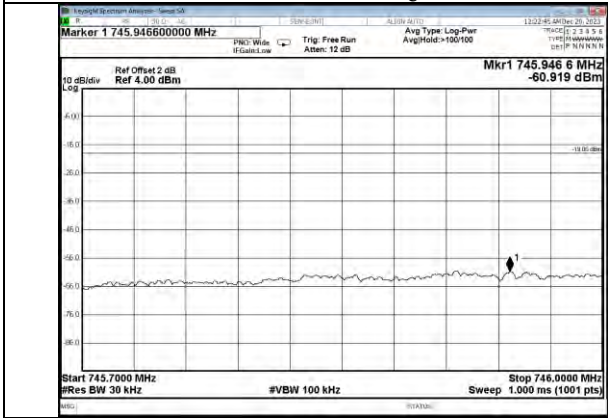

Upper 700MHz band CDMA DL Left Side Pre AGC

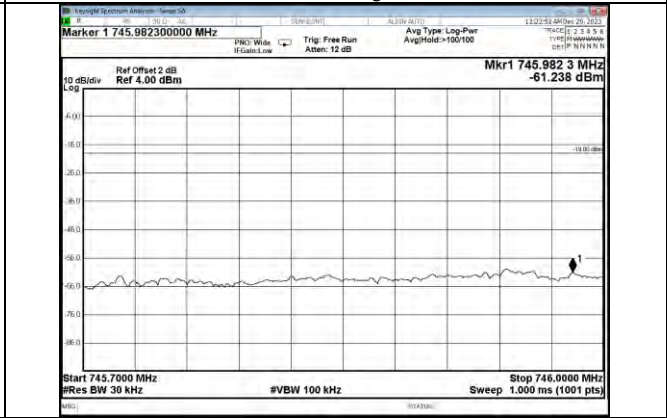

Upper 700MHz band CDMA DL Left Side 10dB Above AGC

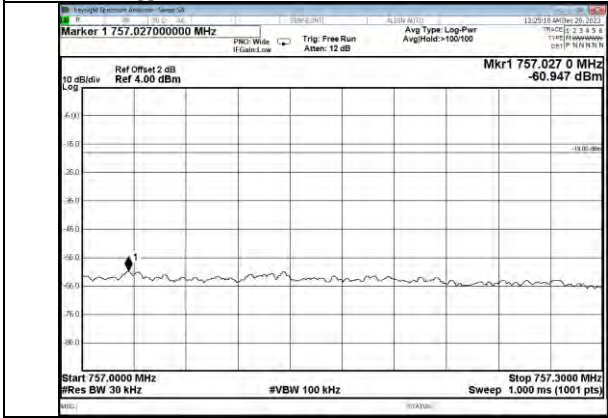

Upper 700MHz band CDMA DL Right Side Pre AGC

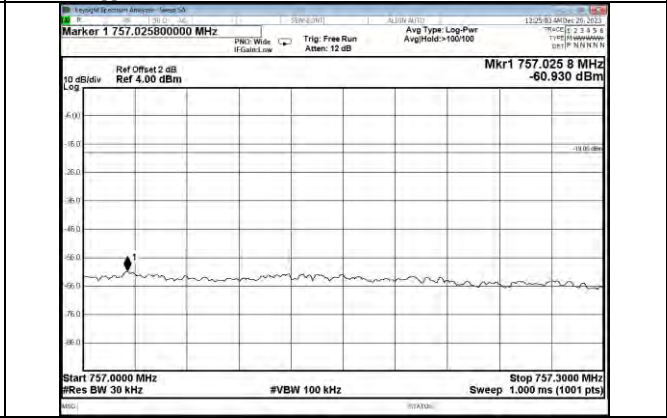

Upper 700MHz band CDMA DL Right Side 10dB Above AGC

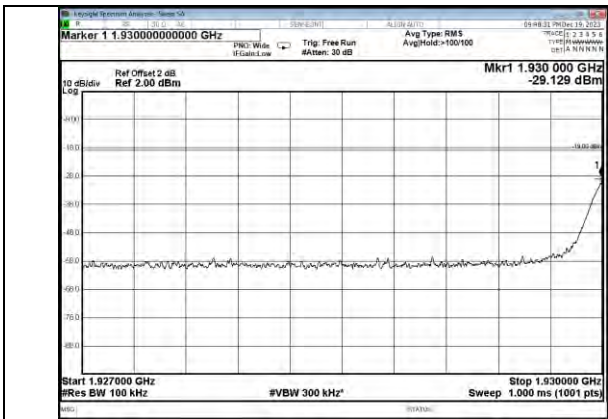

PCS Band LTE DL Left Side Pre AGC

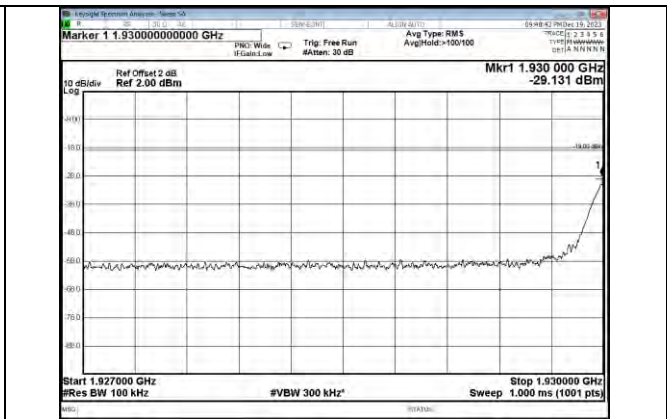

PCS Band LTE DL Left Side 10dB Above AGC

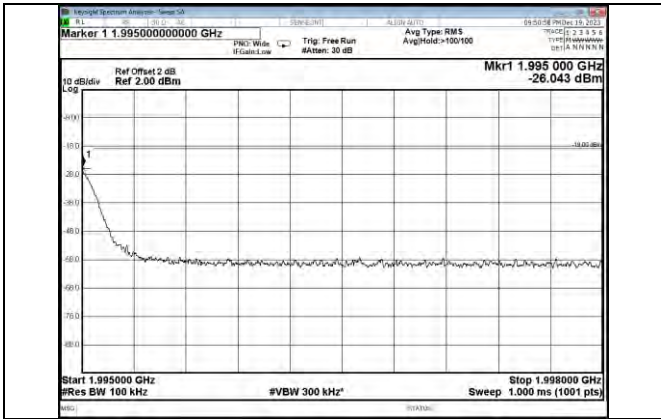

PCS Band LTE DL Right Side Pre AGC

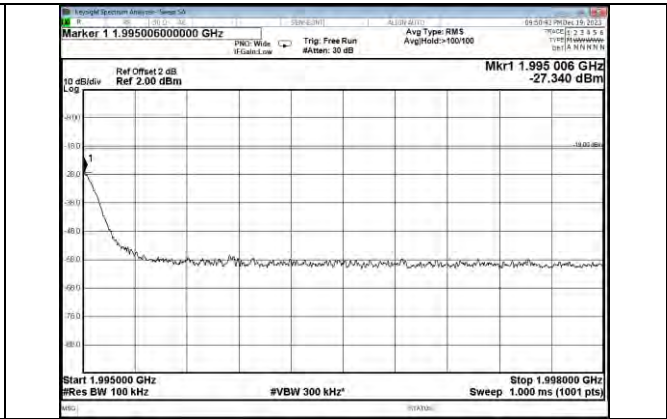

PCS Band LTE DL Right Side 10dB Above AGC

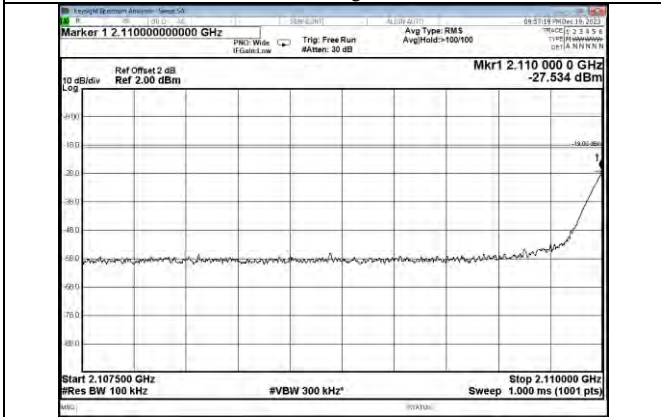

AWS Band LTE DL Left Side Pre AGC

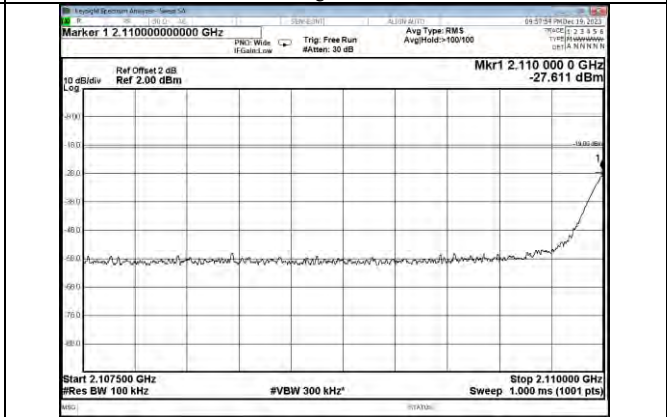

AWS Band LTE DL Left Side 10dB Above AGC

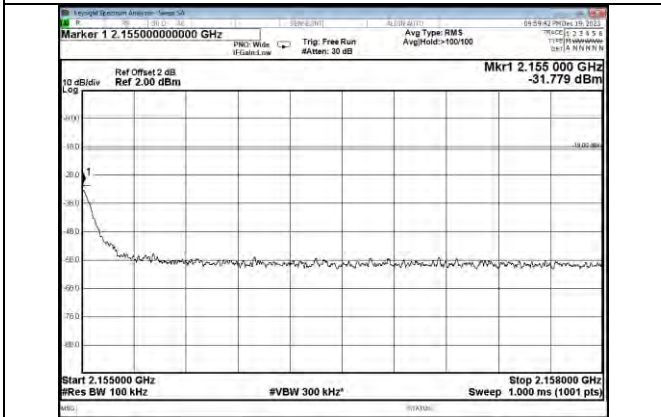

AWS Band LTE DL Right Side Pre AGC

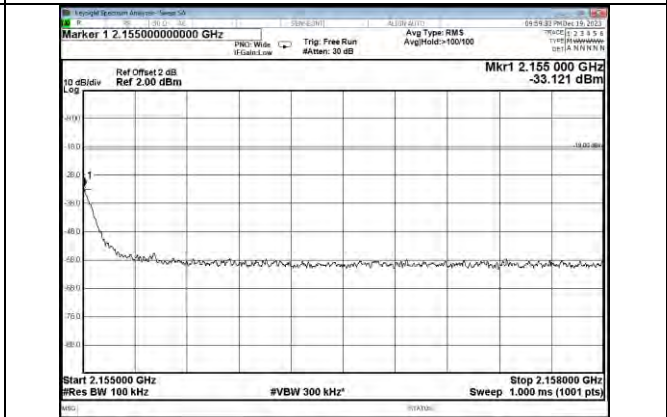

AWS Band LTE DL Right Side 10dB Above AGC

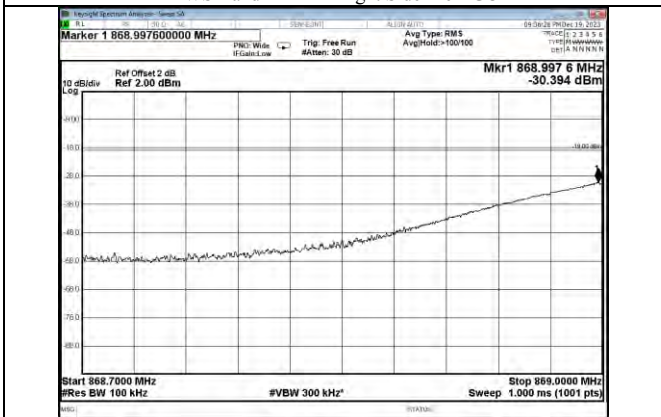

Cellular Band LTE DL Left Side Pre AGC

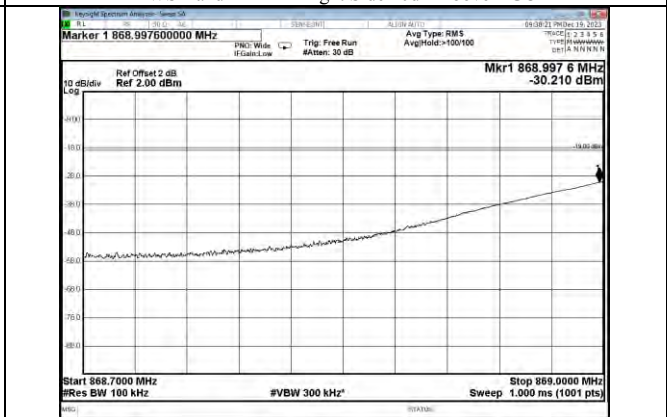

Cellular Band LTE DL Left Side 10dB Above AGC



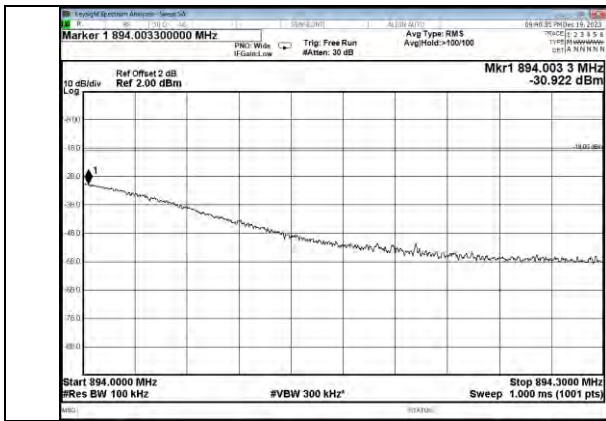

Cellular Band LTE DL Right Side Pre AGC

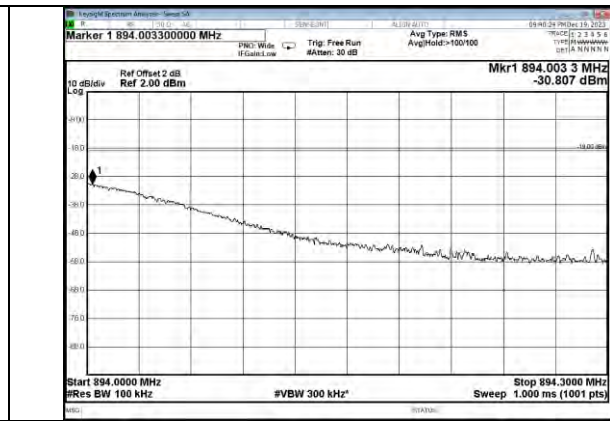

Cellular Band LTE DL Right Side 10dB Above AGC

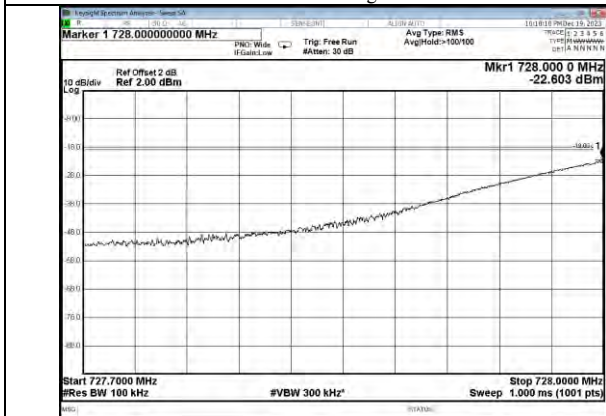

Lower 700MHz band LTE DL Left Side Pre AGC

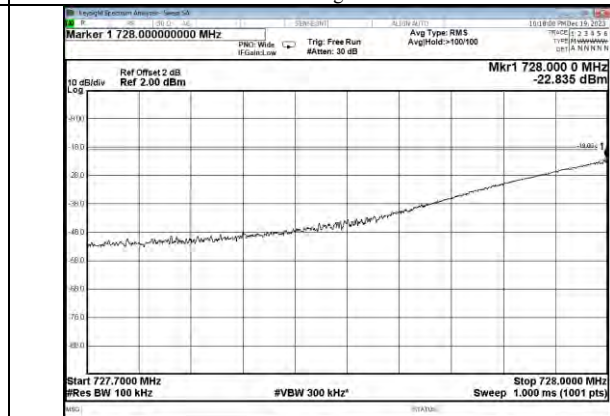

Lower 700MHz band LTE DL Left Side 10dB Above AGC

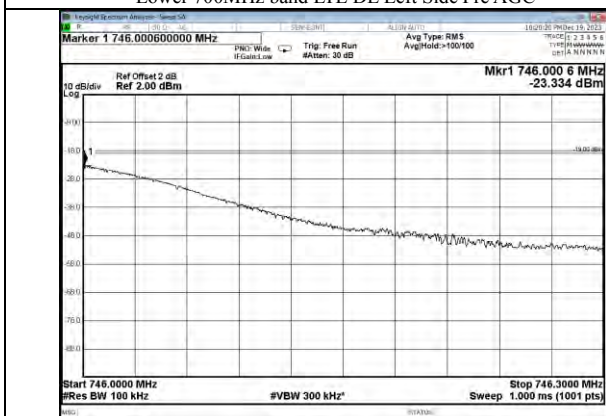

Lower 700MHz band LTE DL Right Side Pre AGC

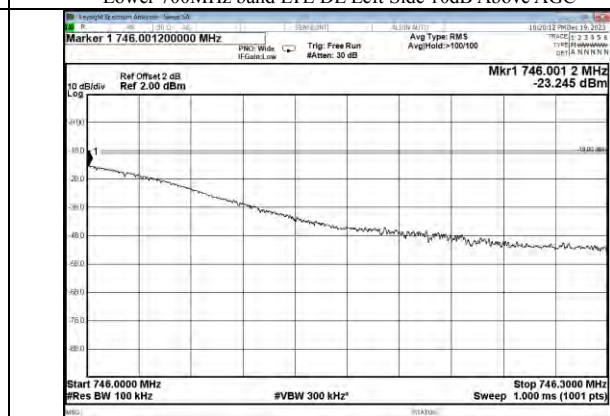

Lower 700MHz band LTE DL Right Side 10dB Above AGC

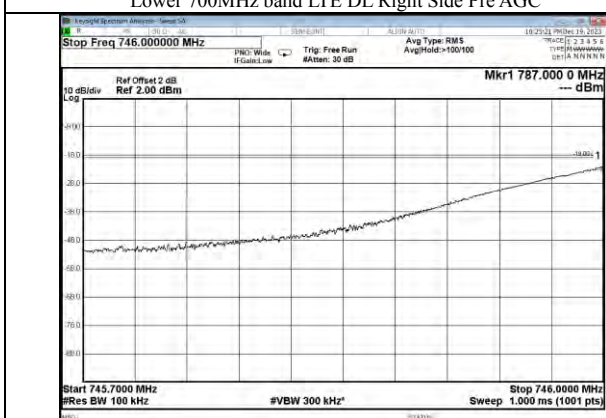

Upper 700MHz band LTE DL Left Side Pre AGC

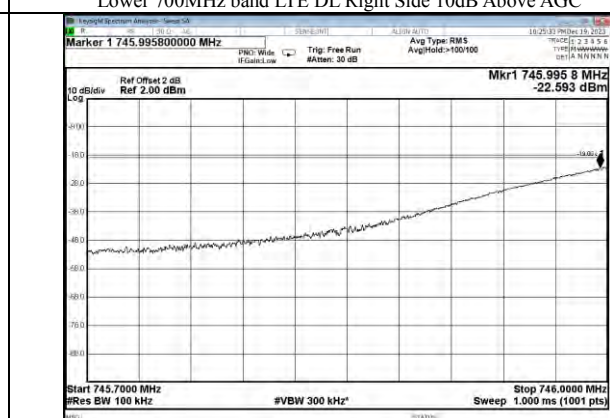

Upper 700MHz band LTE DL Left Side 10dB Above AGC

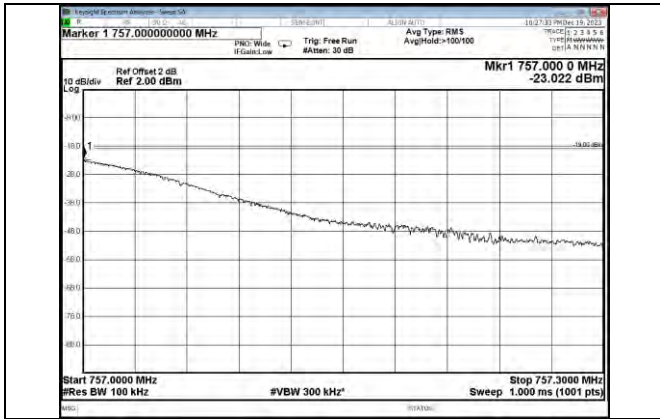

Upper 700MHz band LTE DL Right Side Pre AGC

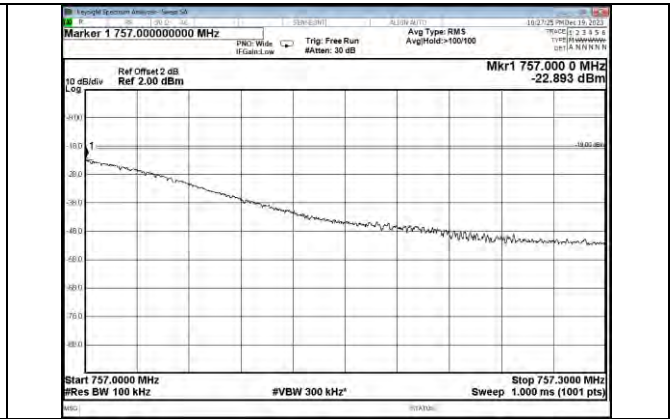

Upper 700MHz band LTE DL Right Side 10dB Above AGC



## 6.6. Conducted Spurious Emission

### Applicable Standard

According to § 2.1051 Spurious emissions at antenna terminals:

The power of any emission outside a licensee's frequency block shall be attenuated below the transmitter power (P) by at least  $43 + 10 \log_{10}(P)$  dB.

So the Conducted emissions limit = -13 dBm

### Test Procedure

According to section 7.6 of KDB 935210 D03 Signal Booster Measurement v04r04:

The following procedures shall be used to demonstrate compliance to the applicable conducted spurious emissions limits as per Section 2.1051.

*NOTE—For frequencies below 1 GHz, an RBW of 1 MHz may be used in a preliminary measurement. If non-compliant emissions are detected, a final measurement shall be made with a 100 kHz RBW. Additionally, a peak detector may also be used for the preliminary measurement. If non-compliant emissions are detected then a final measurement of these emissions shall be made with the power averaging (rms) detector.*

- a) Connect the EUT to the test equipment as shown in Figure 1. Begin with the uplink output (donor) port connected to the spectrum analyzer.
- b) Configure the signal generator for AWGN with a 99% OBW of 4.1 MHz, with a center frequency corresponding to the center of the CMRS band under test.
- c) Set the signal generator amplitude to the level determined in the power measurement procedure in 7.2.
- d) Turn on the signal generator RF output and measure the spurious emission power levels with an appropriate measuring instrument as follows.
  - 1) Set RBW = measurement bandwidth specified in the applicable rule section for the operational frequency band under consideration (see Appendix A for relevant cross-references). Note that many of the individual rule sections permit the use of a narrower RBW [typically  $\geq 1\%$  of the emission bandwidth (EBW)] to enhance measurement accuracy, but the result must then be integrated over the specified measurement bandwidth.
  - 2) Set VBW = 3 RBW.
  - 3) Select the power averaging (rms) detector. (See above note regarding the use of a peak detector for preliminary measurements.)
  - 4) Sweep time = auto-couple.
  - 5) Set the analyzer start frequency to the lowest radio frequency signal generated in the equipment, without going below 9 kHz, and the stop frequency to the lower band/block edge frequency minus 100 kHz or 1 MHz, as specified in the applicable rule part. Note that the number of measurement points in each sweep must be  $\geq (2 \text{ span/RBW})$ , which may require that the measurement range defined by the preceding start and stop frequencies be subdivided, depending on the available number of measurement points of the spectrum analyzer. Trace average at least 10 traces in power averaging (i.e., rms) mode.
  - 6) Sweep time = auto-couple.
  - 7) Use the peak marker function to identify the highest amplitude level over each measured frequency range. Record the frequency and amplitude and capture a plot for inclusion in the test report.
  - 8) Reset the analyzer start frequency to the upper band/block edge frequency plus 100 kHz or 1 MHz, as specified in the applicable rule part, and the analyzer stop frequency to 10 times the highest frequency of the fundamental emission. Note that the number of measurement points in each sweep must be  $\geq (2 \text{ span/RBW})$  which may require that the measurement range defined by the start and stop frequencies above be subdivided, depending on the available number of measurement points provided by the spectrum analyzer.
  - 9) Use the peak marker function to identify the highest amplitude level over each of the measured frequency ranges. Record the frequency and amplitude and capture a plot for inclusion in the test report.
- e) Repeat 7.6b) through 7.6d) for each supported frequency band of operation.





Test data

Temperature	23.4°C	Humidity	53.2%
Test Engineer	Nick Peng	Test Mode	Transmitting

Test Graphs

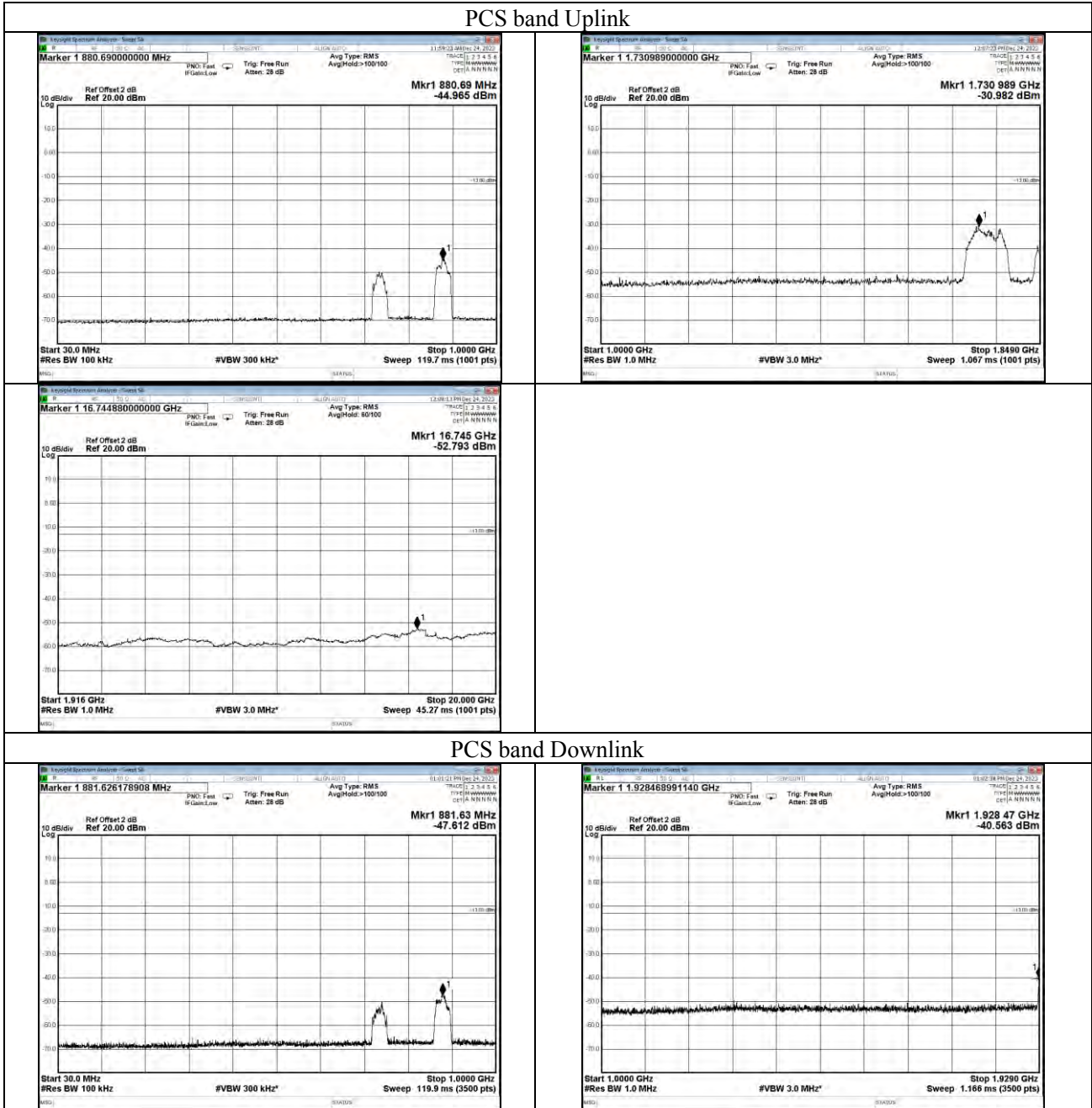



### AWS Band UL

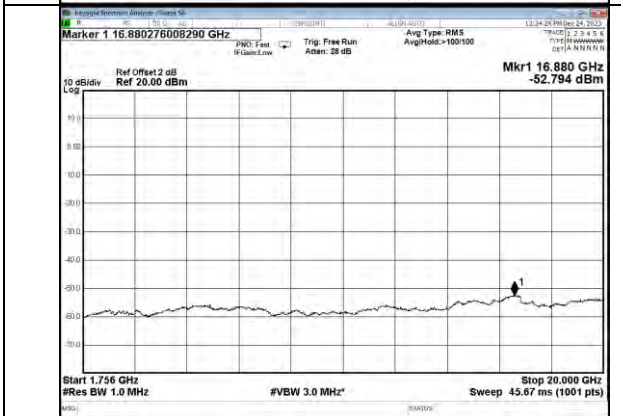
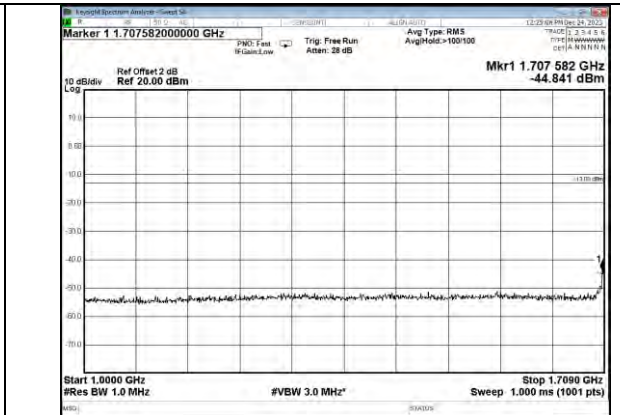
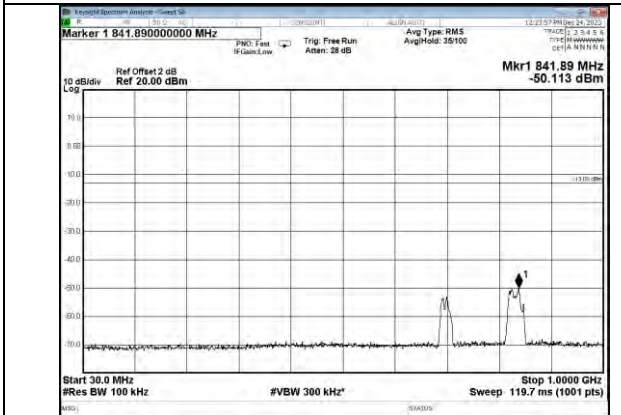

### AWS Band DL

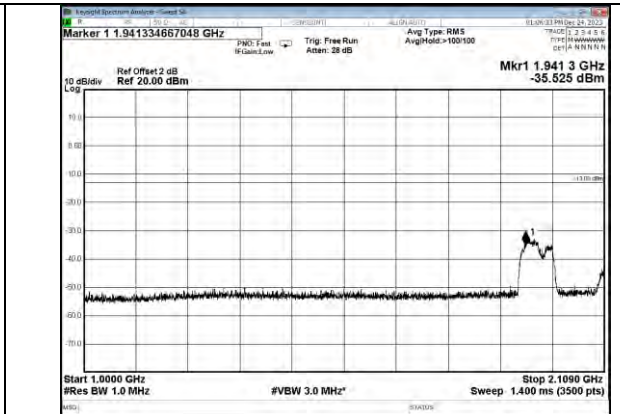
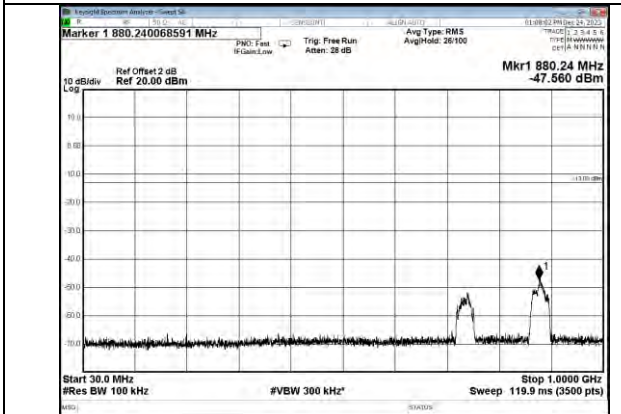

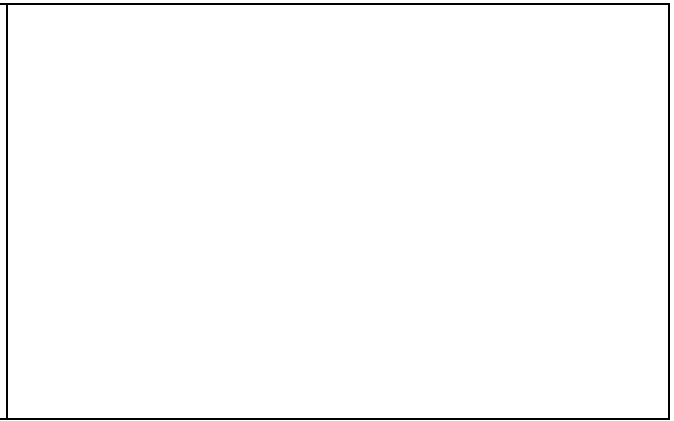
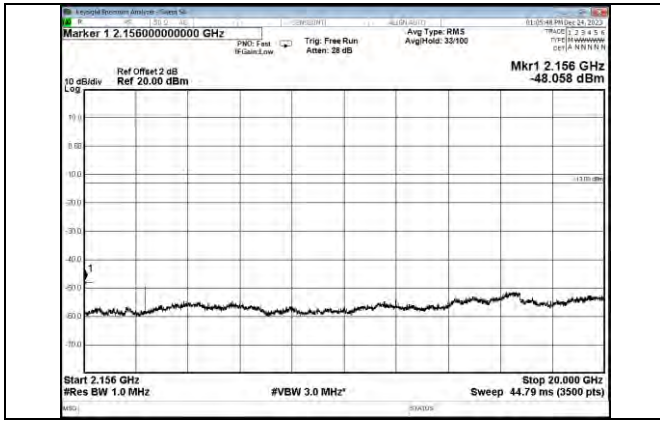

### Cellular Band UL

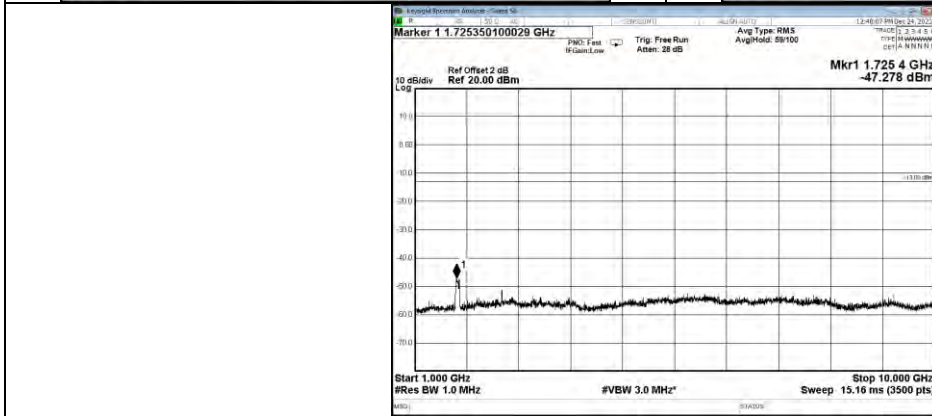
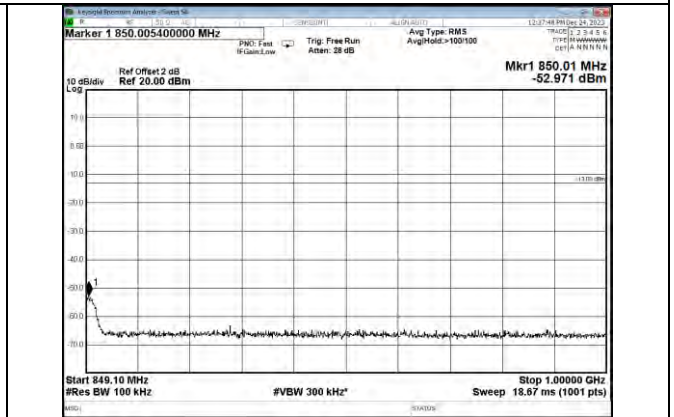
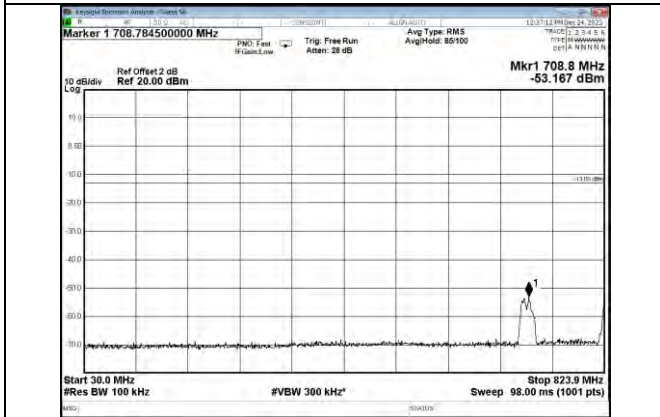

### Cellular Band DL

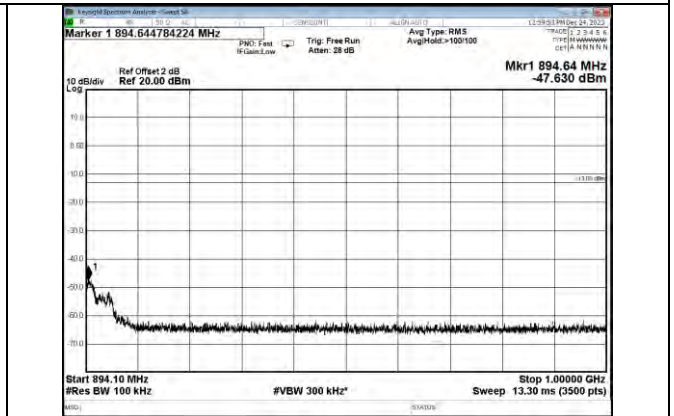
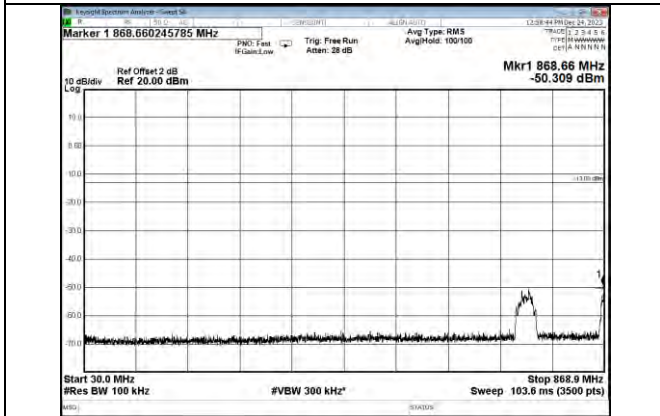



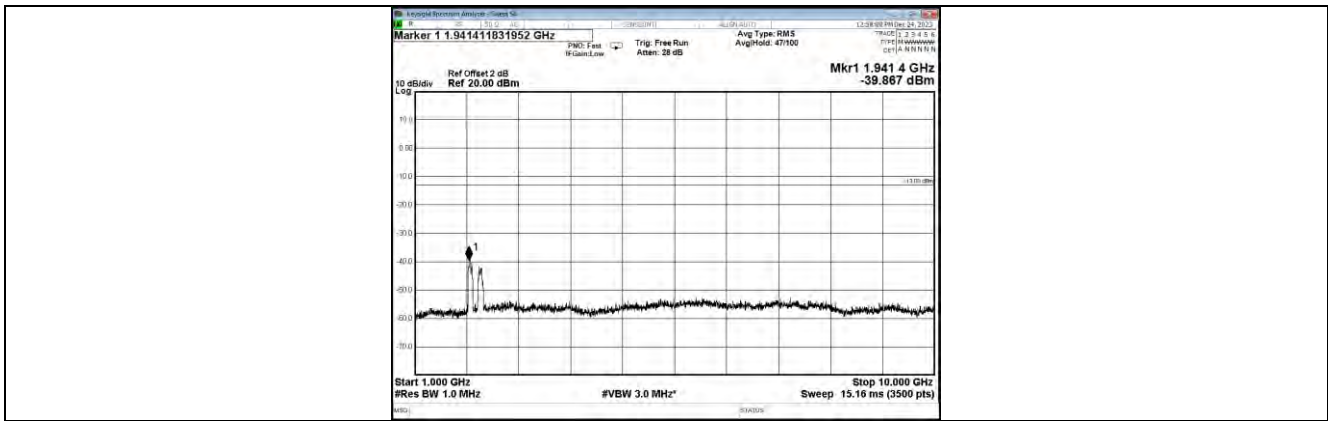

### Lower 700MHz band UL

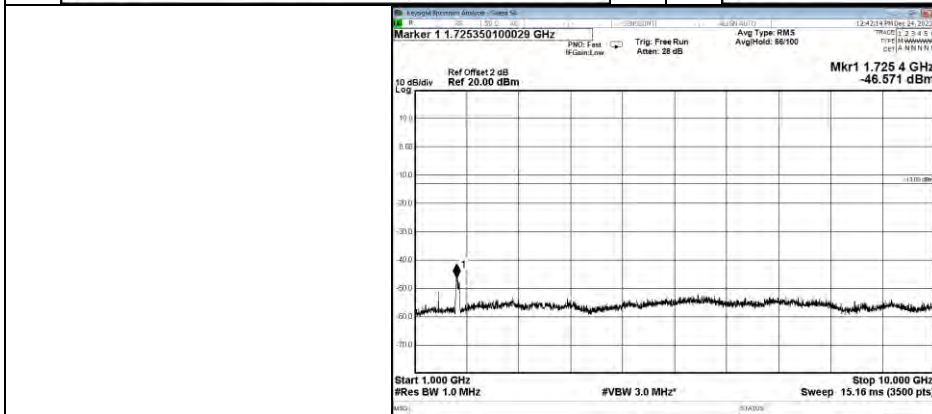
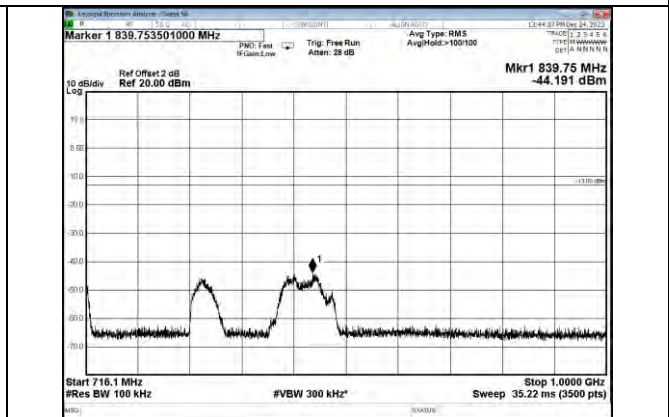
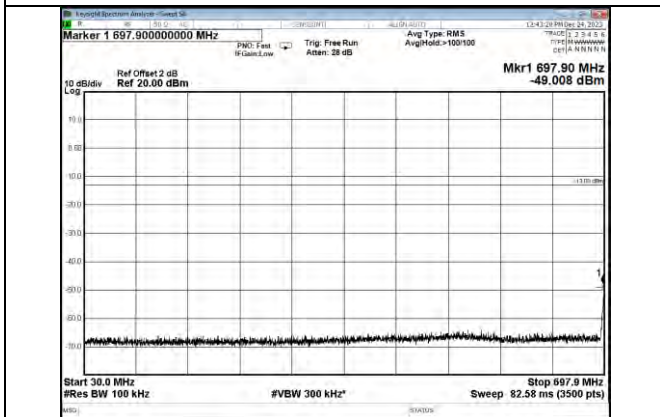

### Lower 700MHz band DL

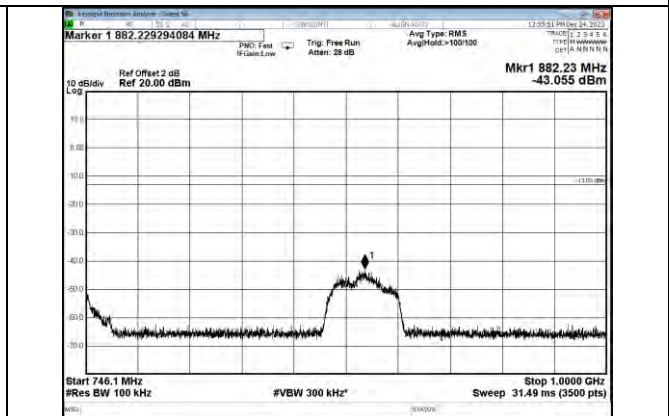
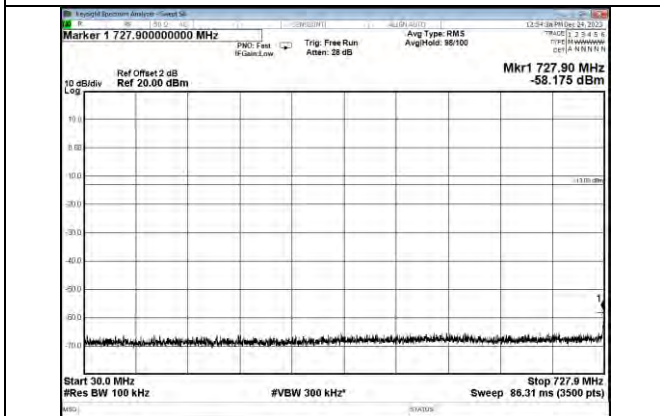



### Upper 700MHz band UL

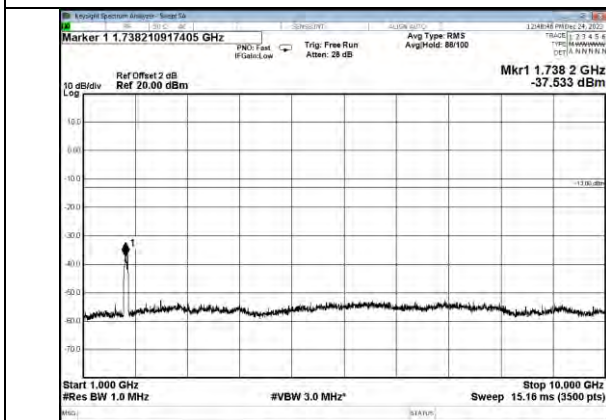
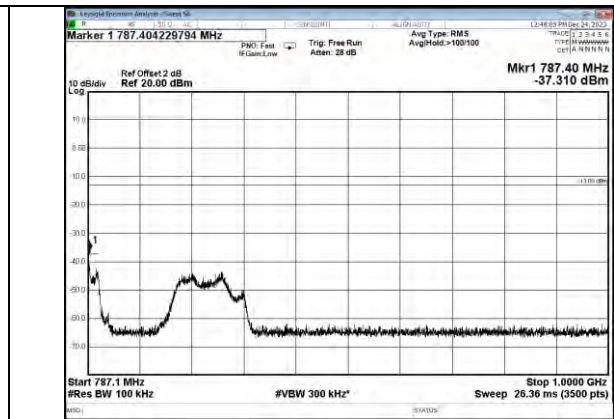
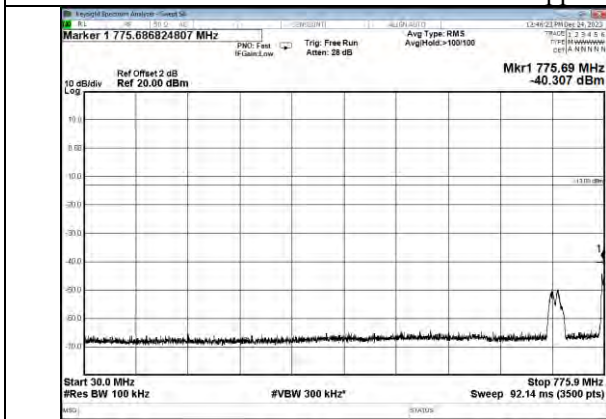



### Upper 700MHz band DL

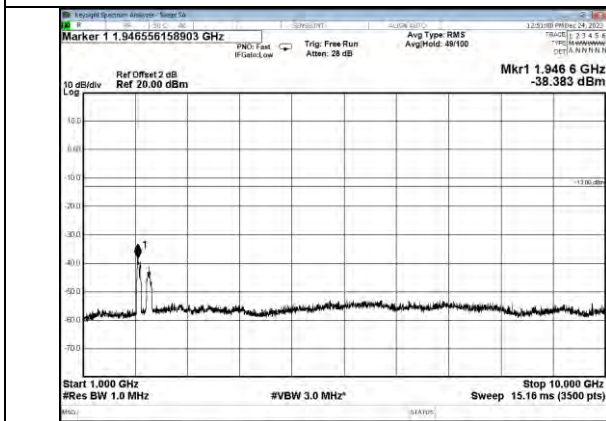
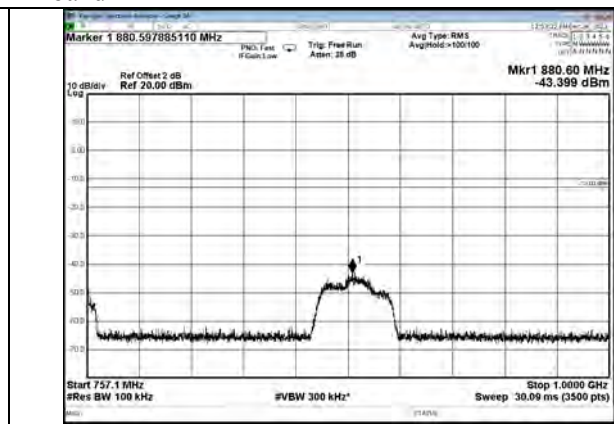
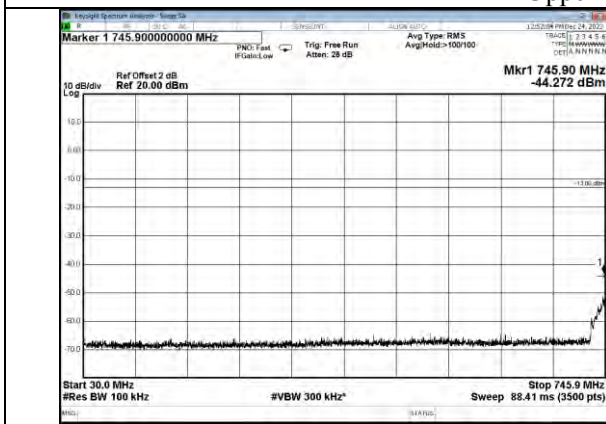





## 6.7 Noise Limits

### Applicable Standard

According to §20.21(e)(8)(i)(A) Noise Limits (uplink); §20.21(e)(8)(i)(H) Transmit Power Off Mode (uplink and downlink noise power):

1. The transmitted maximum noise power in dBm/MHz of consumer boosters at their uplink and downlink ports shall not exceed the following limits:

Fixed booster maximum noise power shall not exceed  $-102.5 \text{ dBm/MHz} + 20 \text{ Log}_{10}(\text{Frequency})$ , where Frequency is the uplink mid-band frequency of the supported spectrum bands in MHz.

2. The transmitted noise power in dBm/MHz of consumer boosters at their uplink port shall not exceed  $-103 \text{ dBm/MHz} - \text{RSSI}$ .

### Test Procedure

Maximum transmitter noise power level

According to section 7.7.1 of KDB 935210 D03 Signal Booster Measurement v04r04:

- a) Connect the EUT to the test equipment as shown in Figure 3. Begin with the uplink output (donor) port connected to the spectrum analyzer. When measuring downlink noise, connect the downlink output (server) port to the spectrum analyzer.
- b) Set the spectrum analyzer RBW to 1 MHz with the VBW  $\geq 3$  RBW.
- c) Select the power averaging (rms) detector and trace average over at least 100 traces.
- d) Set the center frequency of the spectrum analyzer to the center of the CMRS band under test with the span  $\geq 2$  the CMRS band.
- e) Measure the maximum transmitter noise power level.
- f) Save the spectrum analyzer plot as necessary for inclusion in the final test report.
- g) Repeat 7.7b) to 7.7f) for all operational uplink and downlink bands.
- h) Connect the EUT to the test equipment as shown in Figure 4 for uplink noise power measurement in the presence a downlink signal. Affirm the coupled path of the RF coupler is connected to the spectrum analyzer.
  - i) Configure the signal generator for AWGN operation with a 99% OBW of 4.1 MHz.
  - j) Set the spectrum analyzer RBW for 1 MHz, VBW  $\geq 3$  RBW, with a power averaging (rms) detector with at least 100 trace averages.
  - k) Set the center frequency of the spectrum analyzer to the center of the CMRS band under test, with the span  $\geq 2$  the CMRS band. This shall include all spectrum blocks in the particular CMRS band under test (see Appendix A).
  - l) For uplink noise measurements, set the spectrum analyzer center frequency for the uplink band under test, and tune the signal generator to the center of the paired downlink band.
  - m) Measure the maximum transmitter noise power level while varying the downlink signal generator output level from  $-90 \text{ dBm}$  to  $-20 \text{ dBm}$ , as measured at the input port (i.e., downlink signal level at the booster donor port node of Figure 4), in 1 dB steps inside the RSSI-dependent region, and in 10 dB steps outside the RSSI-dependent region. Report the six values closest to the limit, with at least two points within the RSSI-dependent region of the limit. See Appendix D for noise limits graphs.
  - n) Repeat 7.7.1h) through 7.7.1m) for all operational uplink bands.

*NOTE—Some signal boosters will require a signal generator input because they will not operate unless a signal is received at the input terminals. If this is the case, for the setups shown in Figure 3 and Figure 4 connect a second signal generator at the server port, then cycle the RF output of the second signal generator to simulate this function.*

*NOTE—Some signal boosters have a maximum transmitter noise power level that is less than the Transmit Power Off Mode of -70 dBm. For these boosters it is still necessary to confirm that the uplink noise power limits are met in the presence of a downlink signal. Test reports should show measurement data demonstrating compliance. Alternatively the applicant may provide attestation with detailed design information and explanation justifying the omission of the variable uplink testing.*

**Variable uplink noise timing**

According to section 7.7.2 of KDB 935210 D03 Signal Booster Measurement v04r04:

Variable uplink noise timing is to be measured as follows, using the test setup shown in Figure 4.

- a) Set the spectrum analyzer to the uplink frequency to be measured.
- b) Set the span to 0 Hz, with a sweep time of 10 seconds.
- c) Set the power level of signal generator to the lowest level of the RSSI-dependent noise [see 7.7.1m)].
- d) Select MAX HOLD and increase the power level of signal generator by 10 dB for mobile boosters, and 20 dB for fixed boosters.
- e) Confirm that the uplink noise decreases to the specified level within 1 second for mobile devices, and within 3 seconds for fixed devices.18
- f) Repeat 7.7.2a) to 7.7.2e) for all operational uplink bands.
- g) Include plots and summary table in test report.

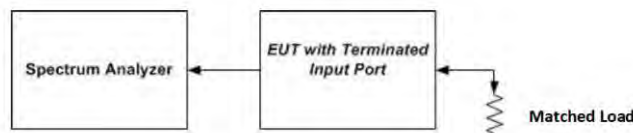

**Figure 3 – Noise limit test setup**

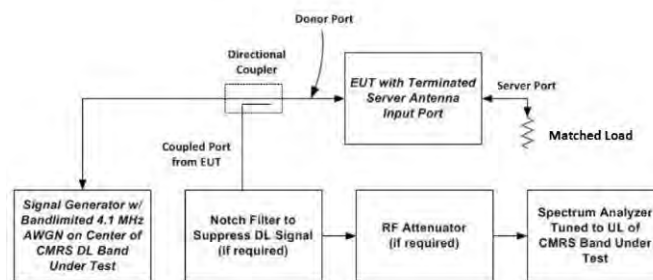

**Figure 4 – Test setup for uplink noise power measurement in the presence of a downlink signal**

**Test Data**

Temperature	23.4°C	Humidity	53.2%
Test Engineer	Nick Peng	Test Mode	Transmitting

Max Noise Power			
Frequency Band (MHz)	Measured dBm/MHz	Limit dBm/MHz	Result (dB)
PCS Band Uplink	-45.111	-37.01	PASS
AWS Band Uplink	-44.687	-37.73	PASS
Cellular Band Uplink	-46.655	-44.05	PASS
Lower 700MHz band Uplink	-47.095	-45.51	PASS
Band13 Uplink	-46.749	-44.64	PASS
PCS Band Downlink	-45.069	-37.01	PASS
AWS Band Downlink	-48.371	-37.73	PASS
Cellular Band Downlink	-53.931	-44.05	PASS
Lower 700MHz band Downlink	-52.785	-45.51	PASS
Band13 Downlink	-46.738	-44.64	PASS



Variable Uplink Noise				
Operation Bands	RSSI dBm	Measured dBm/MHz	Limit dBm/MHz	Results
PCS	-80	-47.89	-37.01	PASS
	-70	-48.32	-37.01	PASS
	-60	-53.18	-43	PASS
	-44	-63.14	-59	PASS
	-43	-65.36	-60	PASS
	-42	-63.93	-61	PASS
AWS	-80	-47.89	-37.73	PASS
	-70	-48.32	-37.73	PASS
	-60	-53.18	-43	PASS
	-39	-67.14	-64	PASS
	-38	-70.36	-65	PASS
	-37	-70.93	-66	PASS
Cellular	-80	-48.28	-44.05	PASS
	-70	-48.32	-44.05	PASS
	-60	-54.03	-44.05	PASS
	-50	-56.11	-53	PASS
	-49	-58.78	-54	PASS
	-48	-59.37	-55	PASS
Lower 700 MHz	-80	-48.24	-45.51	PASS
	-70	-48.18	-45.51	PASS
	-60	-54.29	-45.51	PASS
	-50	-56.50	-53	PASS
	-49	-59.64	-54	PASS
	-48	-59.03	-55	PASS
Upper 700 MHz	-80	-47.89	-44.64	PASS
	-70	-48.33	-44.64	PASS
	-60	-51.42	-44.64	PASS
	-50	-57.99	-53	PASS
	-49	-58.92	-54	PASS
	-48	-58.24	-55	PASS



Variable Uplink Noise Timing			
Operation Bands	Measured Sec	Limit Sec	Results
PCS	0.03	3	PASS
AWS	0.04	3	PASS
Cellular	0.04	3	PASS
Lower 700	0.02	3	PASS
Upper 700	0.03	3	PASS

Test Graphs

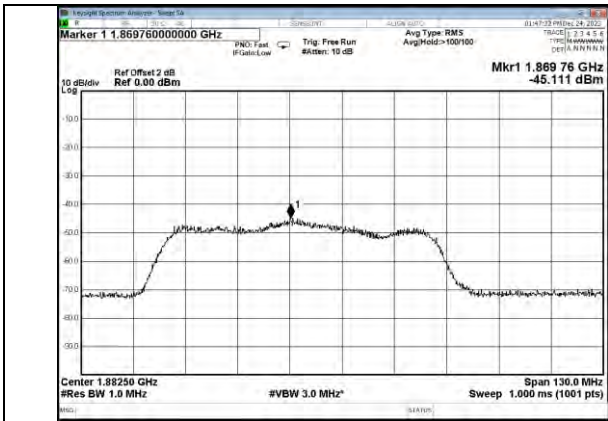

PCS band UL

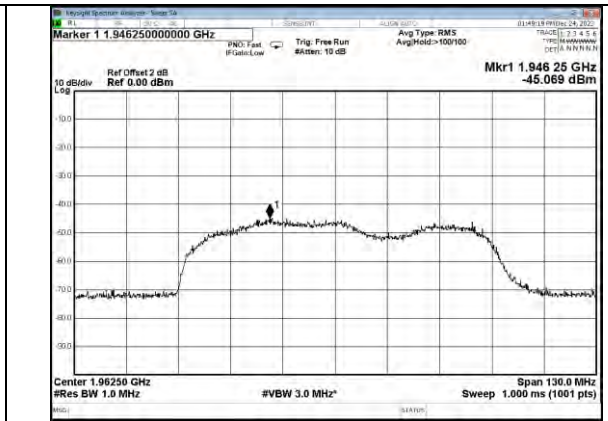

PCS band DL

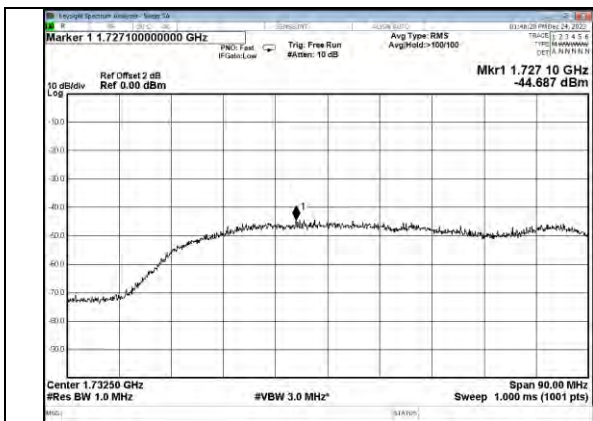

AWS band UL



AWS band DL



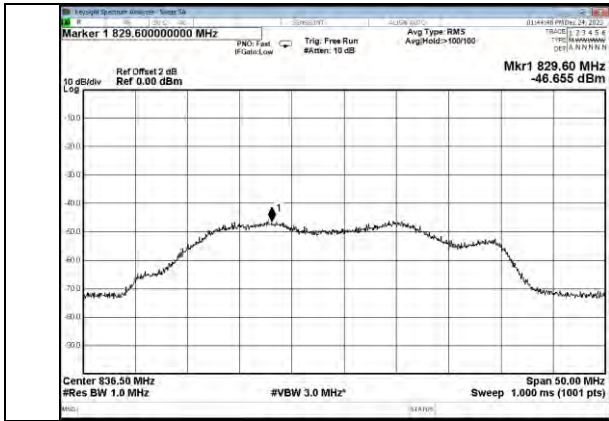

Cellular band UL

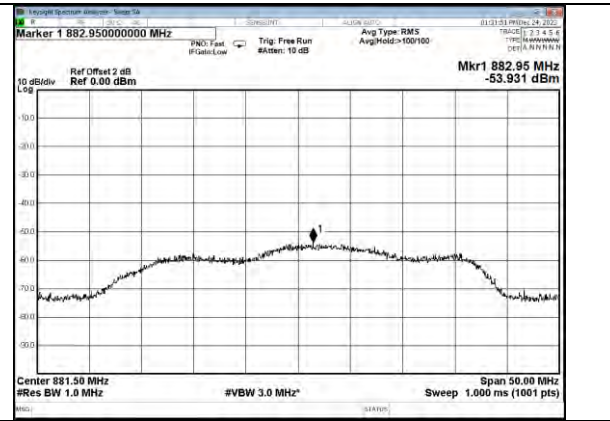

Cellular band DL

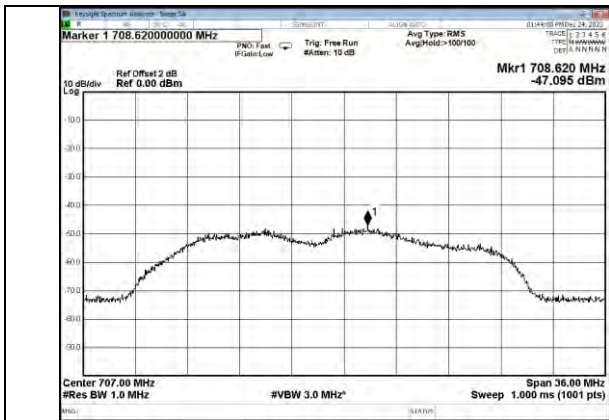

Lower 700MHz band UL

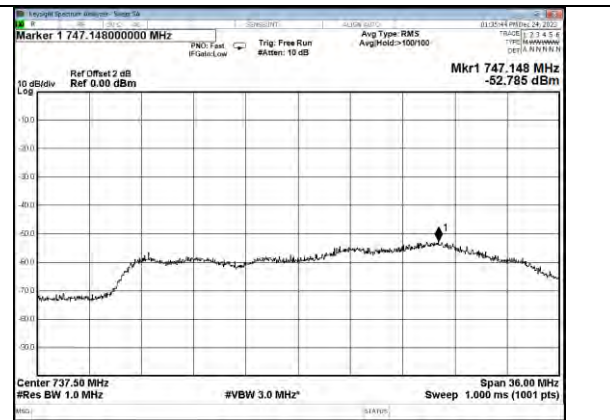

Lower 700MHz band DL

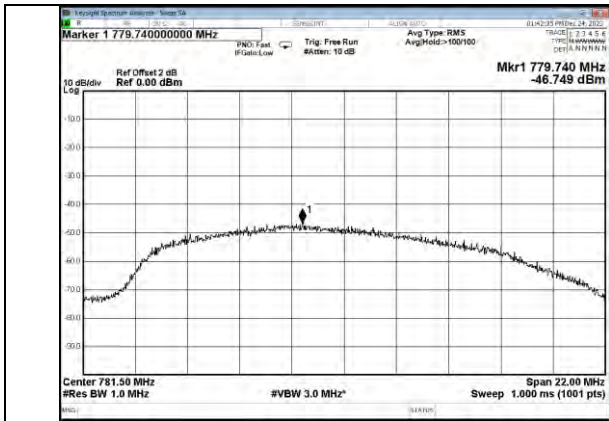

Upper 700MHz band UL

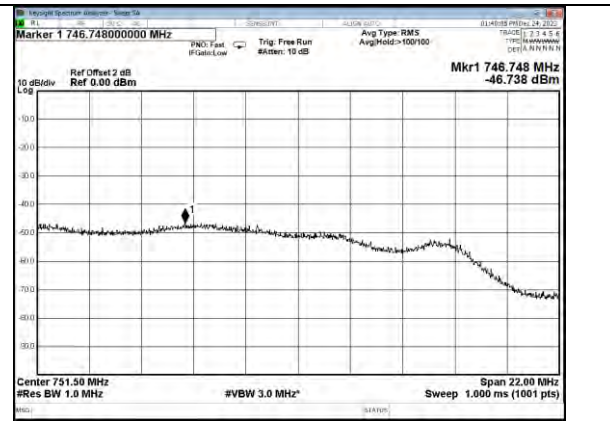

Upper 700MHz band DL



## 6.8 Uplink Inactivity

### Applicable Standard

According to §20.21(e)(8)(i)(I) Uplink Inactivity:

When a consumer booster is not serving an active device connection after 5 minutes the uplink noise power shall not exceed  $-70$  dBm/MHz.

### Test Procedure

According to section 7.8 of KDB 935210 D03 Signal Booster Measurement v04r04:

- a. Connect the EUT to the test equipment as shown in Figure 3 with the uplink output (donor) port connected to the spectrum analyzer.
  - b. Select the power averaging (rms) detector.
  - c. Set the spectrum analyzer RBW for 1 MHz with the  $VBW \geq 3$  RBW.
  - d. Set the center frequency of the spectrum analyzer to the center of the uplink operational band.
  - e. Set the span for 0 Hz with a single sweep time for a minimum of 330 seconds.
  - f. Start to capture a new trace using MAX HOLD.
  - g. After approximately 15 seconds, turn on the EUT power.
  - h. After the full spectrum analyzer trace is complete, place a MARKER on the leading edge of the pulse, then use the DELTA MARKER METHOD to measure the time until the uplink becomes inactive.
  - i. Affirm that the noise level is below the uplink inactivity noise power limit, as specified by the rules.
  - j. Capture the plot for inclusion in the test report.
  - k. Measure noise using procedures in 7.7.1a) to 7.7.1f).
- Repeat 7.8d) through 7.8k) for all operational uplink bands.



**Test Data**

Temperature	23.4°C	Humidity	53.2%
Test Engineer	Nick Peng	Test Mode	Transmitting

Uplink Inactivity			
Operation Bands	Measured (s)	Limit (s)	Result
PCS Band	261.4	300.0	PASS
AWS Band	261.0	300.0	PASS
Cellular Band	269.0	300.0	PASS
Lower 700MHz Band	261.0	300.0	PASS
Upper 700 Mhz Band	261.4	300.0	PASS



Test Graphs

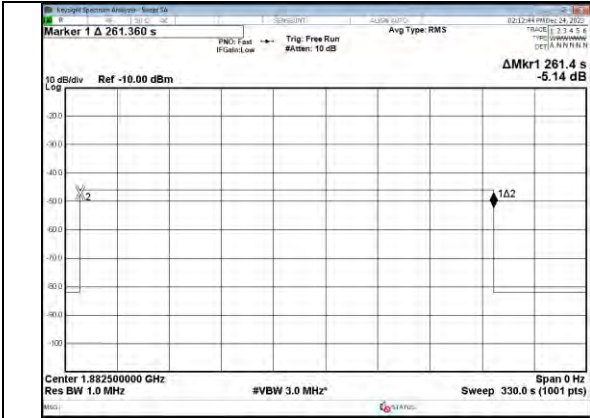

PCS band

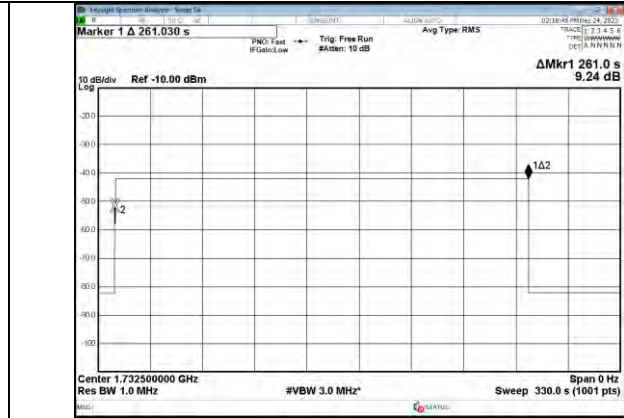

AWS band

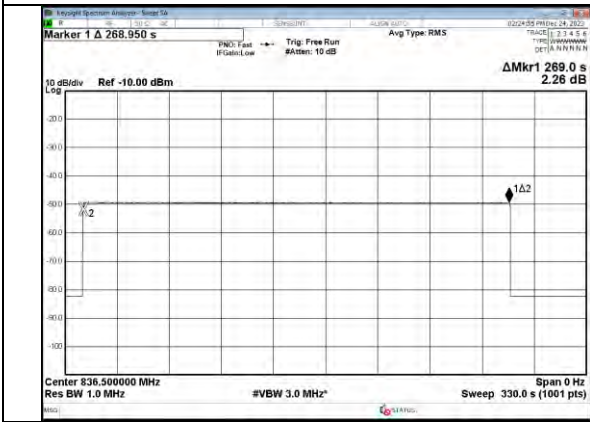

Cellular band

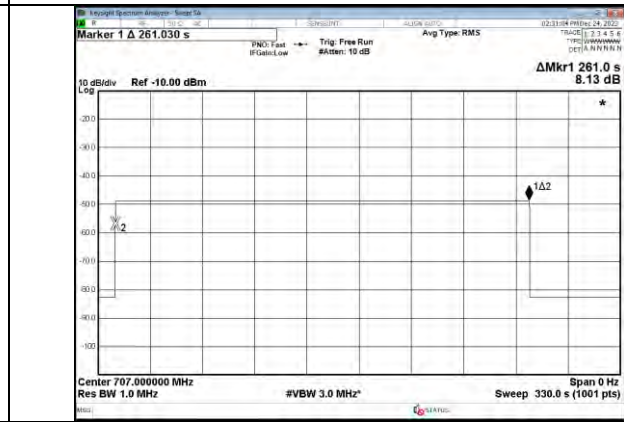

Lower 700MHz band

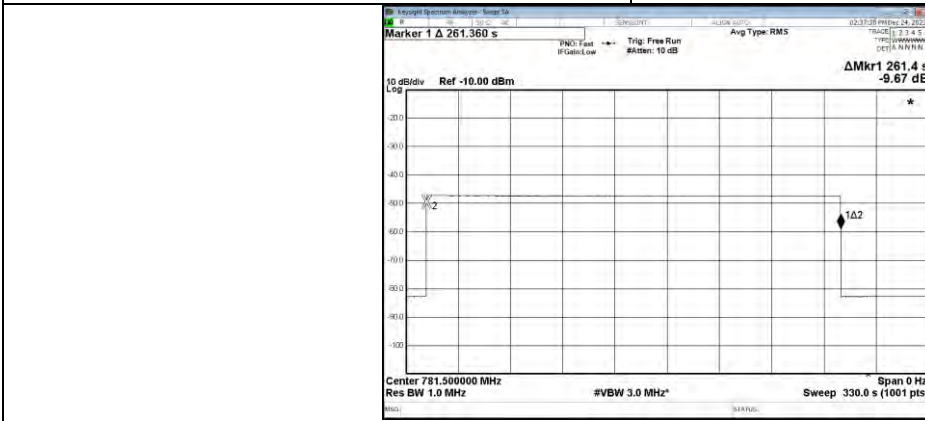

Upper 700MHz band



## 6.9 Variable Booster Gain

### Applicable Standard

According to §20.21(e)(8)(i)(C)(1) Booster Gain Limits (variable gain); §20.21(e)(8)(i)(H) Transmit Power Off Mode (uplink gain):

The uplink gain in dB of a consumer booster referenced to its input and output ports shall not exceed  $-34 \text{ dB} - \text{RSSI} + \text{MSCL}$ .

(i) Where RSSI is the downlink composite received signal power in dBm at the booster donor port for all base stations in the band of operation. RSSI is expressed in negative dB units relative to 1 mW.

(ii) Where MSCL (Mobile Station Coupling Loss) is the minimum coupling loss in dB between the wireless device and input port of the consumer booster. MSCL must be calculated or measured for each band of operation and provided in compliance test reports.

### Test Procedure

#### Variable gain

According to section 7.9.1 of KDB 935210 D03 Signal Booster Measurement v04r04:

- a) Connect the EUT to the test equipment as shown in Figure 5 with the uplink output (donor) port connected to signal generator #1. Affirm that the coupled path of the RF coupler is connected to the spectrum analyzer.
- b) Configure downlink signal generator #1 for AWGN operation with a 99% OBW of 4.1 MHz, tuned to the center of the operational band.
- c) Set the power level and frequency of signal generator #2 to a value that is 5 dB below the AGC level determined from 7.2. The signal type is AWGN with a 99% OBW of 4.1 MHz.
- d) Set RBW = 100 kHz.
- e) Set VBW  $\geq$  300 kHz.
- f) Select the CHANNEL POWER measurement mode.
- g) Select the power averaging (rms) detector.
- h) Affirm that the number of measurement points per sweep  $\geq$  (2 span)/RBW.
- i) Sweep time = auto couple or as necessary (but no less than auto couple value).
- j) Trace average at least 10 traces in power averaging (i.e., rms) mode.
- k) Measure the maximum channel power and compute maximum gain when varying the signal generator #1 output to a level from  $-90 \text{ dBm}$  to  $-20 \text{ dBm}$ , as measured at the input port (i.e., downlink signal level at the booster donor port node of Figure 5), in 1 dB steps inside the RSSI-dependent region, and 10 dB steps outside the RSSI-dependent region. Report the six values closest to the limit, including at least two points from within the RSSI-dependent region of operation. See gain limit in charts in Appendix D for uplink gain requirements. Additionally, document that the EUT provides equivalent uplink and downlink gain, and when operating in shutoff mode that the uplink and downlink gain is within the transmit power off mode gain limits.
- l) Repeat 7.9.1b) to 7.9.1k) for all operational uplink bands.



### Variable uplink gain timing

According to section 7.9.2 of KDB 935210 D03 Signal Booster Measurement v04r04:

Variable uplink gain timing is to be measured as follows, using the test setup shown in Figure 5.

- a) Set the spectrum analyzer to the uplink frequency to be measured.
- b) Set the span to 0 Hz with a sweep time of 10 seconds.
- c) Set the power level of signal generator #1 to the lowest level of the RSSI-dependent gain [see 7.9.1k)].
- d) Select MAX HOLD and increase the power level of signal generator #1 by 10 dB for mobile boosters, and by 20 dB for fixed indoor boosters. Signal generator #2 remains same, as described in 7.9.1c).
- e) Confirm that the uplink gain decreases to the specified levels, within 1 second for mobile devices, and within 3 seconds for fixed devices.19
- f) Repeat 7.9.2a) to 7.9.2e) for all operational uplink bands.

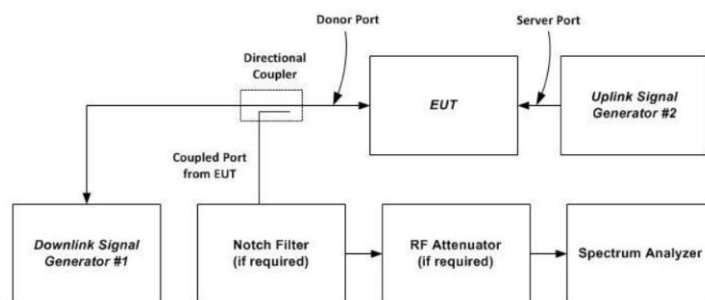

**Figure 5–Variable gain instrumentation test setup**

Mobile station coupling loss (MSCL): the minimum coupling loss (in dB) between the wireless device and the input (server) port of the consumer booster. MSCL must be calculated or measured for each band of operation and provided in compliance test reports. MSCL includes the path loss from the wireless device, and the booster's server antenna gain and cable loss. The wireless device is assumed to be an isotropic (0 dBi) antenna reference. Minimum standoff distances from inside wireless devices to the booster's server antenna must be reasonable and specified by the manufacturer in customer provided installation manuals.

**Test data**

Temperature	23.4°C	Humidity	53.2%
Test Engineer	Nick Peng	Test Mode	Transmitting

**Panel Antenna**

MSCL Calculation							
Operation Frequency (MHz)	Frequency (MHz)	Distance (m)	Path loss (dB)	Indoor Antenna Gain(dBi)	Indoor Cable Loss(dB)	Polarity Loss(dB)	MSCL(dB)
PCS band	1882.5	1.5	41.52	4.0	2.2	3.01	42.73
Cellular band	836.5	1.5	34.47	5.0	0.8	3.01	33.28
Lower 700MHz band	707	1.5	33.01	6.0	1.5	3.01	31.52
Upper 700MHz band	781.5	1.5	33.88	5.5	1.3	3.01	32.69
AWS band	1732.5	1.5	40.80	4.0	2.3	3.01	42.11

Note :Path loss =  $20\log f + 20\log d - 27.5$

Polarity loss =  $20\log (1/\sin (45\text{deg})) \text{ dB} = 3.0\text{dB}$

d=1.5m,used in User Manual

**Right angle Antenna**

MSCL Calculation							
Operation Frequency (MHz)	Frequency (MHz)	Distance (m)	Path loss (dB)	Indoor Antenna Gain(dBi)	Indoor Cable Loss(dB)	Polarity Loss(dB)	MSCL(dB)
PCS band	1882.5	1.0	37.99	2.0	1.4	3.01	40.40
Cellular band	836.5	1.0	30.95	3.0	0.8	3.01	31.76
Lower 700MHz band	707	1.0	29.49	3.0	0.8	3.01	30.30
Upper 700MHz band	781.5	1.0	30.36	3.0	0.8	3.01	31.17
AWS band	1732.5	1.0	37.27	2.0	1.4	3.01	39.68

Note :Path loss =  $20\log f + 20\log d - 27.5$

Polarity loss =  $20\log (1/\sin (45\text{deg})) \text{ dB} = 3.0\text{dB}$

d=1.0m,used in User Manual



Variable booster gain							
Operation Band	RSSI (dBm)	Input Power (dBm)	Output Power (dBm)	Measured Gain (dB)	MSCL	Limit	Results
PCS band	-60	-38.2	7.52	45.72	42.73	52.30	PASS
	-50	-38.4	1.51	39.91	42.73	42.30	PASS
	-46	-38.5	-5.53	32.97	42.73	38.30	PASS
	-43	-38.5	-6.24	32.26	42.73	35.30	PASS
	-42	-38.4	-7.53	30.87	42.73	34.30	PASS
	-40	-38.6	-9.17	29.43	42.73	32.30	PASS
Cellular band	-60	-38.2	7.35	45.55	33.28	53.76	PASS
	-50	-37.6	1.15	38.75	33.28	43.76	PASS
	-46	-36.3	-5.84	30.46	33.28	39.76	PASS
	-43	-37.4	-6.13	31.27	33.28	36.76	PASS
	-42	-37.3	-7.14	30.16	33.28	35.76	PASS
	-40	-37.2	-10.31	26.89	33.28	33.76	PASS
Lower 700MHz band	-60	-37.8	6.53	44.33	31.52	52.30	PASS
	-50	-37.4	1.14	38.54	31.52	42.30	PASS
	-46	-37.3	-6.11	31.19	31.52	38.30	PASS
	-43	-37.2	-6.11	31.09	31.52	35.30	PASS
	-42	-37.8	-7.16	30.64	31.52	34.30	PASS
	-40	-37.4	-10.21	27.19	31.52	32.30	PASS
Upper 700MHz band	-60	-36.6	6.50	43.1	32.69	53.17	PASS
	-50	-36.8	0.27	37.07	32.69	43.17	PASS
	-46	-36.5	-6.35	30.15	32.69	39.17	PASS
	-43	-36.5	-7.51	28.99	32.69	36.17	PASS
	-42	-36.6	-8.31	28.29	32.69	35.17	PASS
	-40	-36.6	-9.23	27.37	32.69	33.17	PASS
AWS band	-60	-37.8	7.15	44.95	42.11	58.68	PASS



	-50	-37.9	1.26	39.16	42.11	48.68	PASS
	-46	-37.4	-6.31	31.09	42.11	44.68	PASS
	-43	-37.2	-6.05	31.15	42.11	41.68	PASS
	-42	-37.6	-7.35	30.25	42.11	40.68	PASS
	-40	-37.7	-8.25	29.45	42.11	38.68	PASS



Variable Uplink Gain Timing			
Operation Band	Measured Sec	Limit Sec	Result
PCS band	0.04	3.0	PASS
AWS band	0.02	3.0	PASS
Cellular band	0.02	3.0	PASS
Lower 700MHz band	0.03	3.0	PASS
Upper 700MHz band	0.02	3.0	PASS



## 6.10 Occupied Bandwidth

### Applicable Standard

According to §2.1049 Measurements required: Occupied bandwidth.

This measurement is required to compare the consistency of the output signal relative to the input signal, and to satisfy the requirements of Section 2.1049.

### Test Procedure

According to section 7.10 of KDB 935210 D03 Signal Booster Measurement v04r04:

- a) Connect the test equipment as shown in Figure 6 to firstly measure the characteristics of the test signals produced by the signal generator.
- b) Set  $VBW \geq 3 RBW$ .
- c) Set the center frequency of the spectrum analyzer to the center of the operational band. The span will be adjusted for each modulation type and OBW as necessary for accurately viewing the signals.
- d) Set the signal generator for power level to match the values obtained from the tests of 7.2.
- e) Set the signal generator modulation type for GSM with a PRBS pattern and allow the trace on the signal generator to stabilize adjusting the span as necessary.
- f) Set the spectrum analyzer RBW for 1% to 5% of the EBW.
- g) Capture the spectrum analyzer trace for inclusion in the test report.
- h) Repeat 7.10c) to 7.10g) for CDMA and W-CDMA modulation, adjusting the span as necessary. AWGN or LTE may be used in place of W-CDMA, as an option.
- i) Repeat 7.10c) to 7.10h) for all uplink and downlink operational bands.
- j) Connect the test equipment as shown in Figure 1, with the uplink output (donor) port connected to the spectrum analyzer, and the server port connected to the signal generator.
- k) Repeat 7.10c) to 7.10i) with this EUT uplink path test setup.
- l) Connect the test equipment as shown in Figure 1, with the downlink output (server) port connected to the spectrum analyzer, and the donor port connected to the signal generator.
- m) Repeat 7.10c) to 7.10i) with this EUT downlink path test setup.

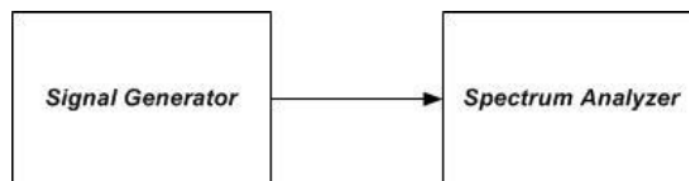

**Figure 6 – Test setup for measuring characteristics of test signals used for subsequent EUT occupied bandwidth testing**



**Test data**

Temperature	23.4°C	Humidity	53.2%
Test Engineer	Nick Peng	Test Mode	Transmitting

Operation Band		Signal Type	Input OBW [MHz]	Output OBW [MHz]
Uplink	PCS	GSM	0.244	0.247
		CDMA	1.2297	1.2417
		AWGN	4.2330	4.3315
	AWS	GSM	0.246	0.247
		CDMA	1.2289	1.2295
		AWGN	4.2309	4.3301
	Cellular	GSM	0.246	0.244
		CDMA	1.2409	1.2349
		AWGN	4.2317	4.3528
	Lower 700	GSM	0.245	0.246
		CDMA	1.2392	1.2390
		AWGN	4.2275	4.3184
Upper 700	GSM	0.245	0.247	
	CDMA	1.2364	1.2448	
	AWGN	4.2259	4.3187	
Downlink	PCS	GSM	0.244	0.245
		CDMA	1.2322	1.2239
		AWGN	4.2256	4.3151
	AWS	GSM	0.246	0.244
		CDMA	1.2060	1.2305
		AWGN	4.2382	4.3152
	Cellular	GSM	0.246	0.245
		CDMA	1.2476	1.2352
		AWGN	4.2375	4.3133
	Lower 700	GSM	0.246	0.245
		CDMA	1.2419	1.2408
		AWGN	4.2405	4.3079
Upper 700	GSM	0.247	0.245	
	CDMA	1.2377	1.2360	
	AWGN	4.2318	4.3088	



### Test Graphs

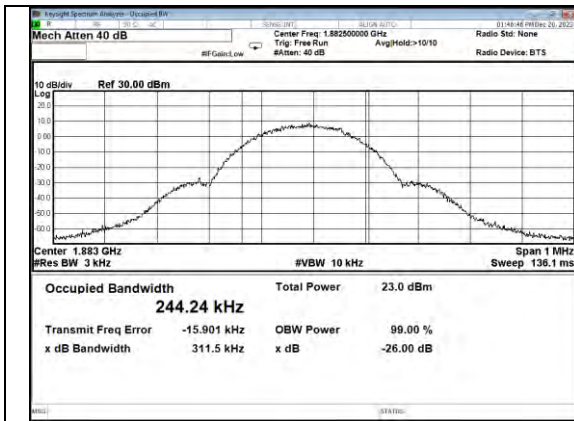

GSM-PCS band UL input

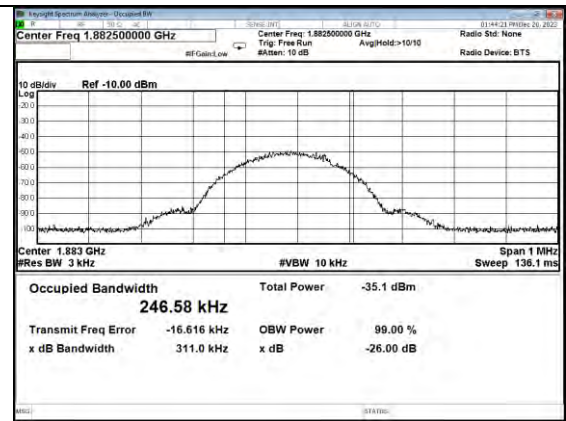

GSM-PCS band UL output

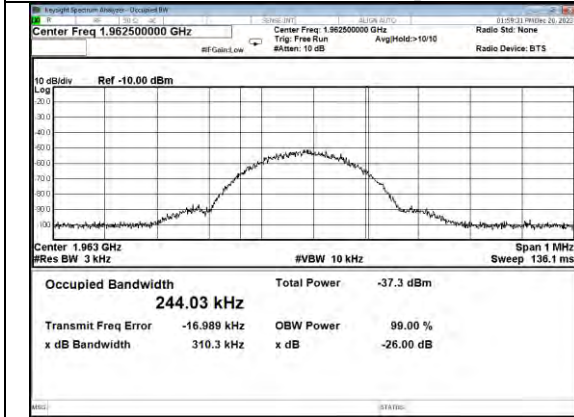

GSM-PCS band DL input

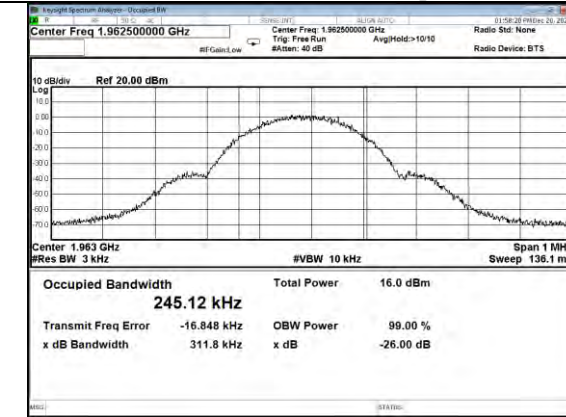

GSM-PCS band DL output

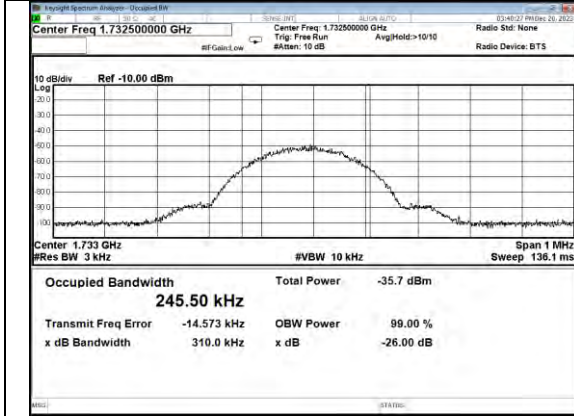

GSM-AWS band UL input

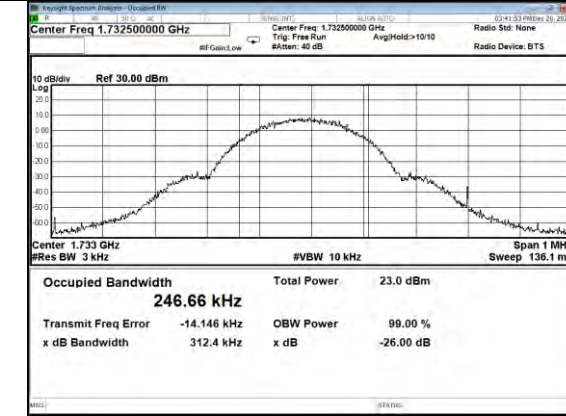

GSM-AWS band UL output

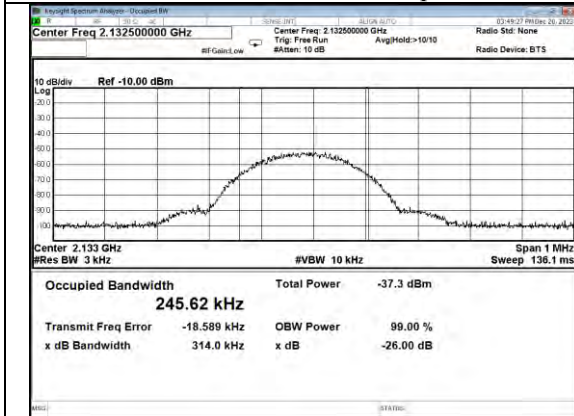

GSM-AWS band DL input

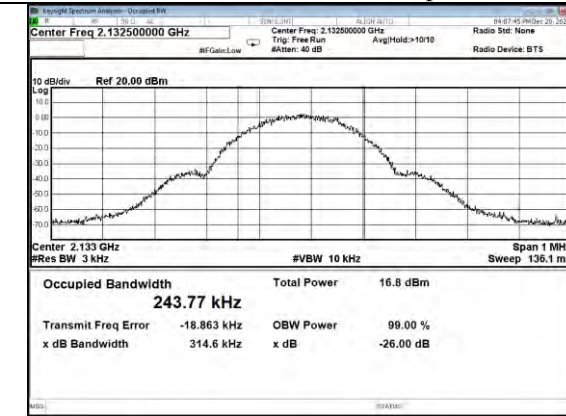

GSM-AWS band DL output

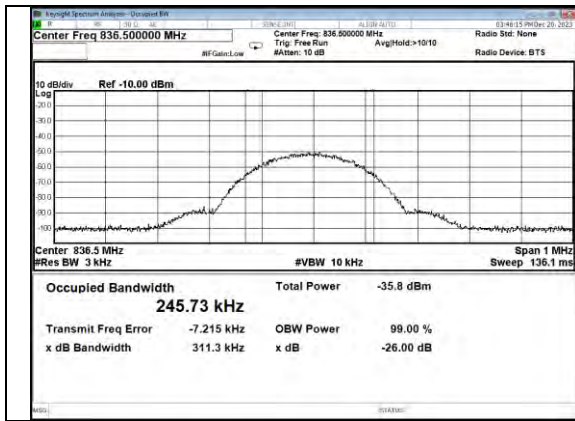

GSM-Cellular band UL input

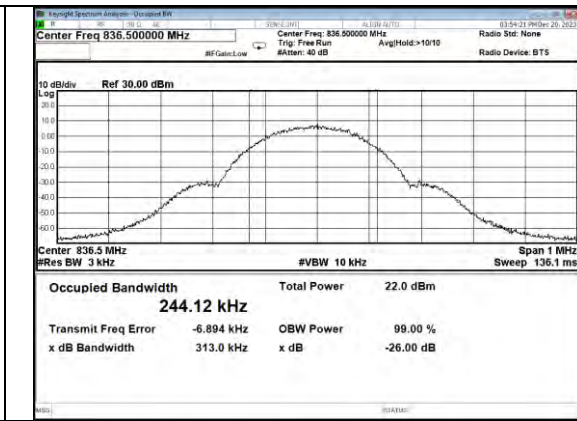

GSM-Cellular band UL output

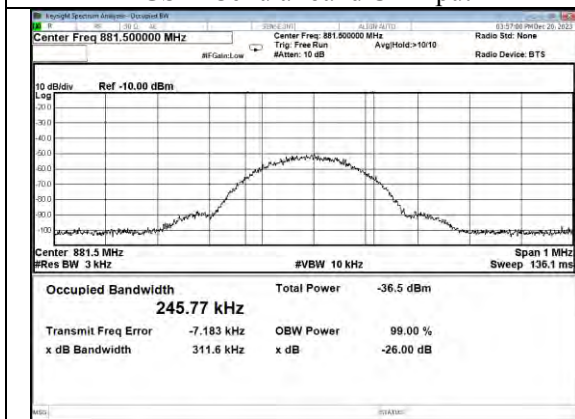

GSM-Cellular band DL input

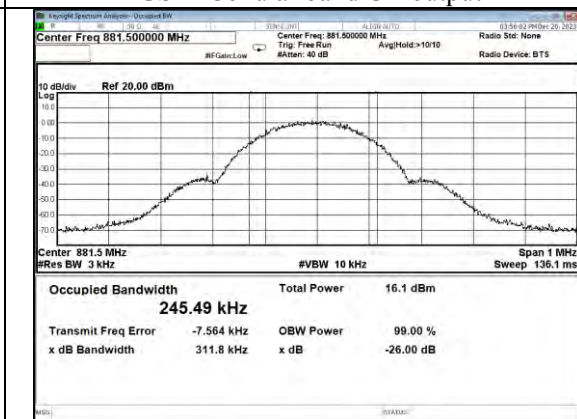

GSM-Cellular band DL output

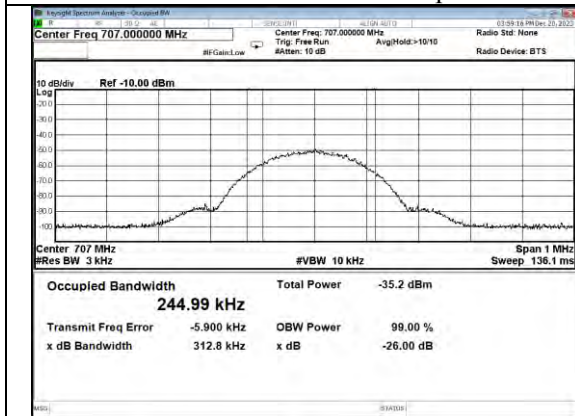

GSM-Lower 700 band UL input

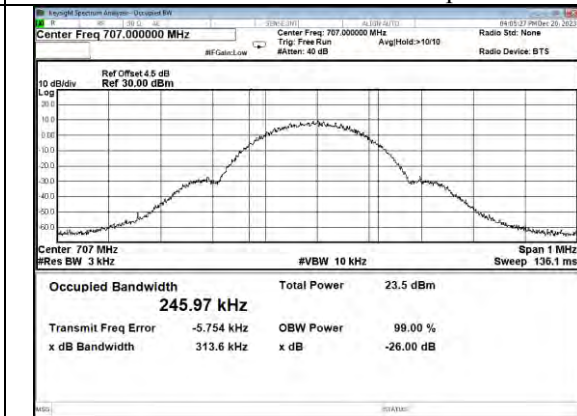

GSM-Lower 700 band UL output

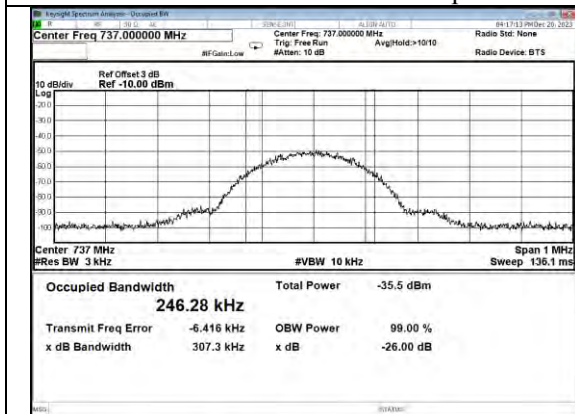

GSM-Lower 700 band DL input

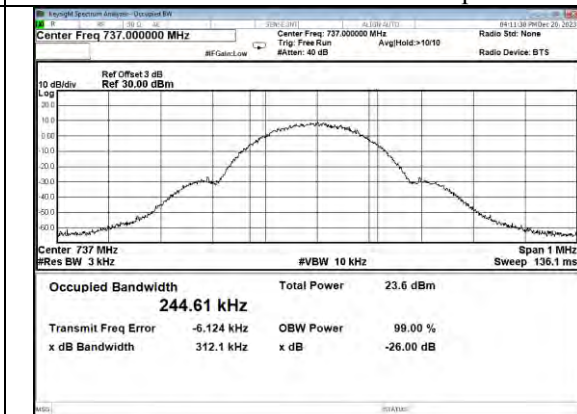

GSM-Lower 700 band DL output



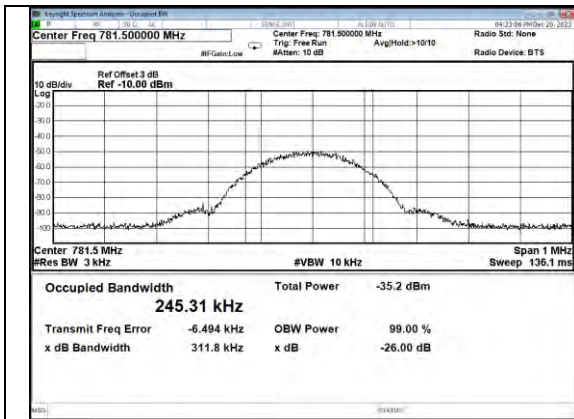

GSM-Upper 700MHz band UL input

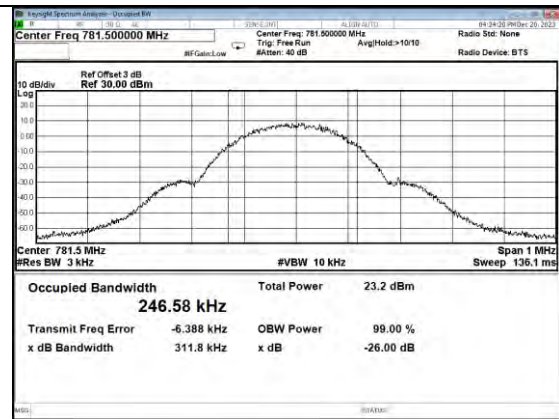

GSM-Upper 700 band UL output

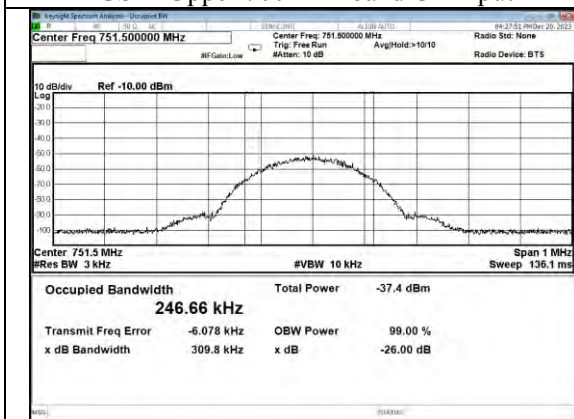

GSM-Upper 700 band DL input

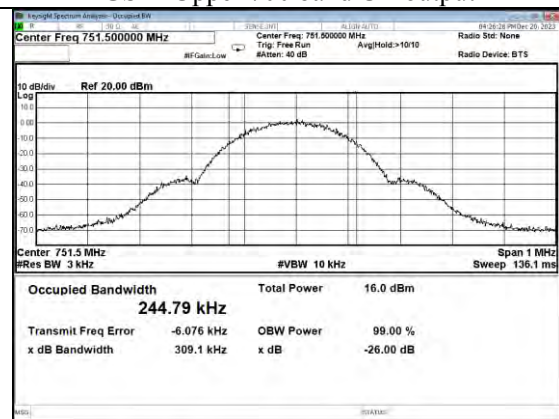

GSM-Upper 700 band DL output

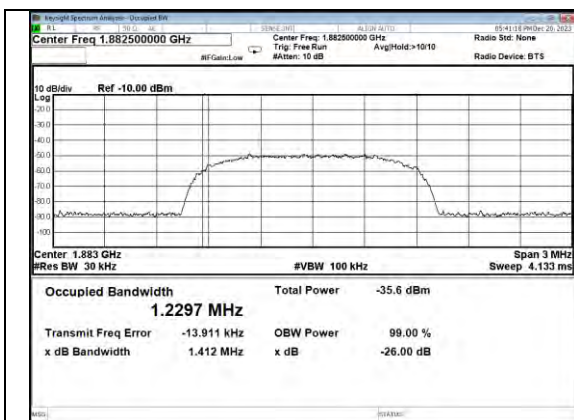

CDMA-PCS band UL input

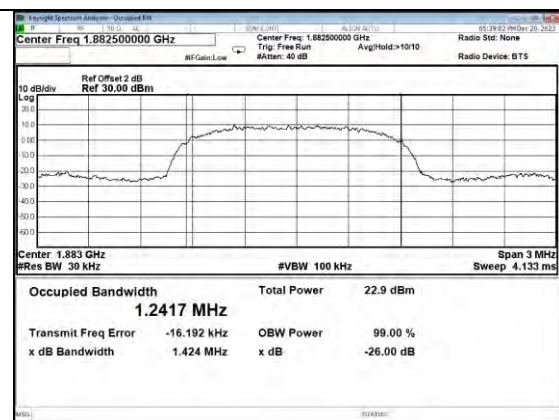

CDMA-PCS band UL output

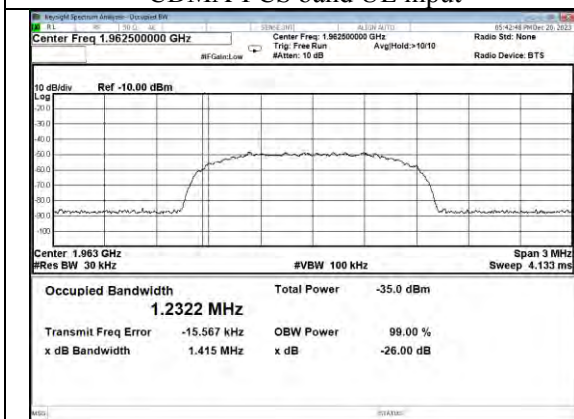

CDMA-PCS band DL input

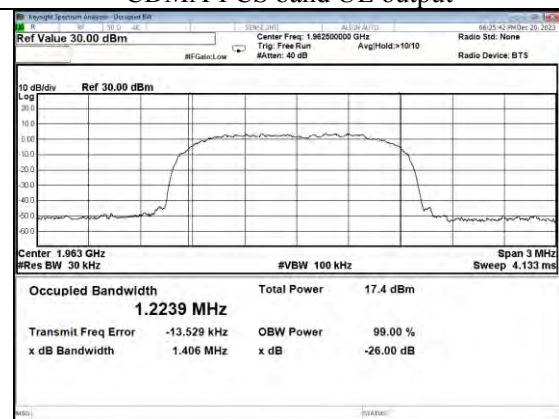

CDMA-PCS band DL output



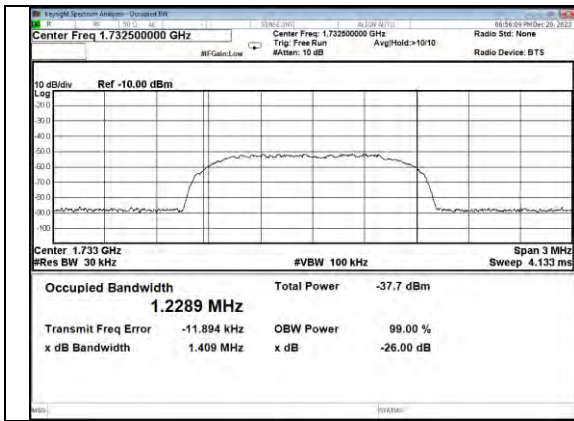

CDMA-AWS band UL input

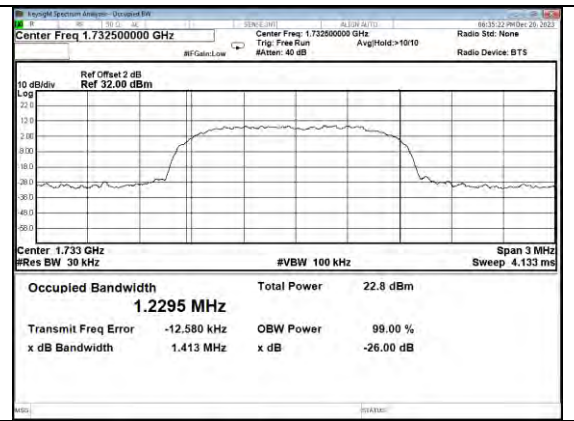

CDMA-AWS band UL output

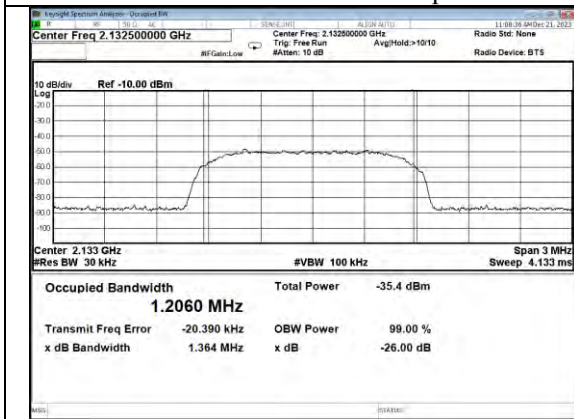

CDMA-AWS band DL input

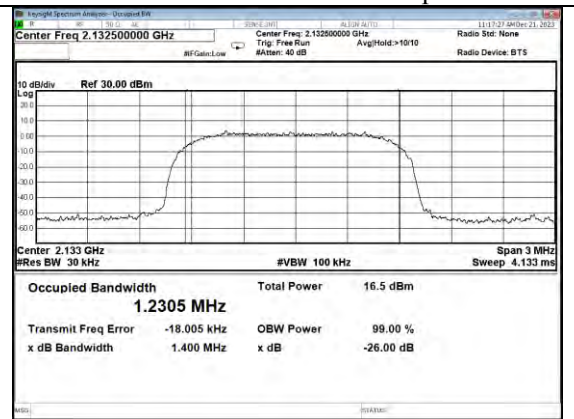

CDMA-AWS band DL output

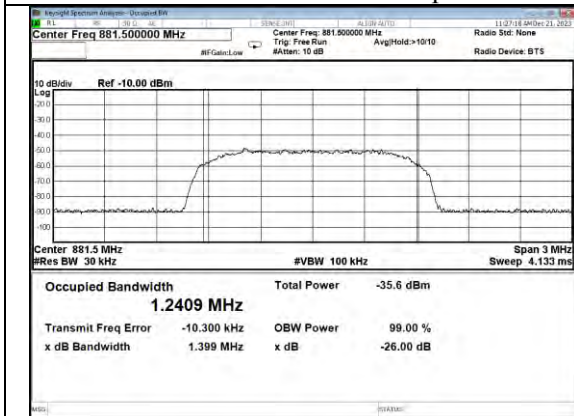

CDMA-Cellular band UL input

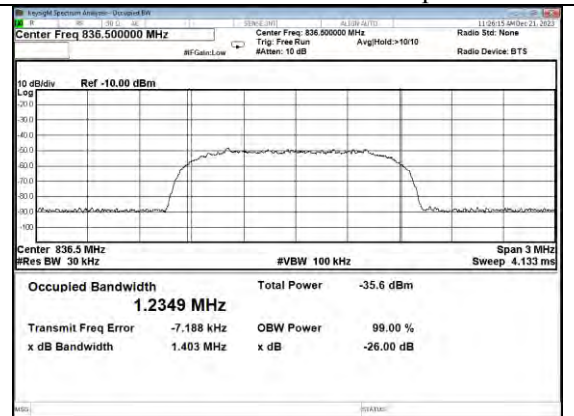

CDMA-Cellular band UL output

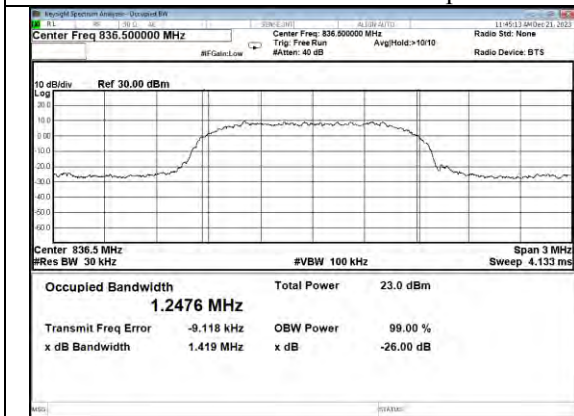

Cellular band DL input

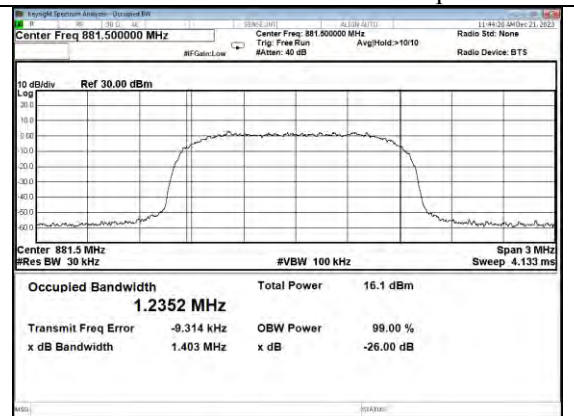

Cellular band DL output

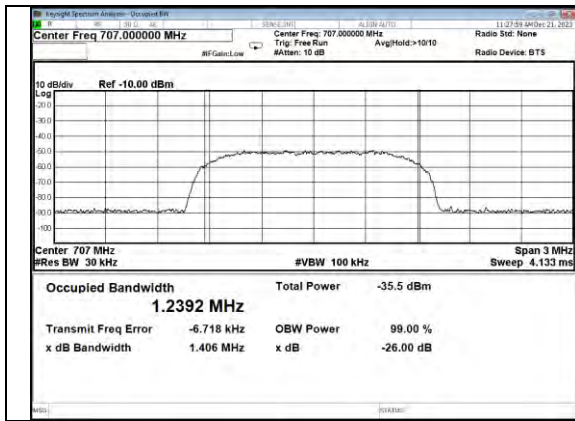

CDMA-Lower 700 band UL input

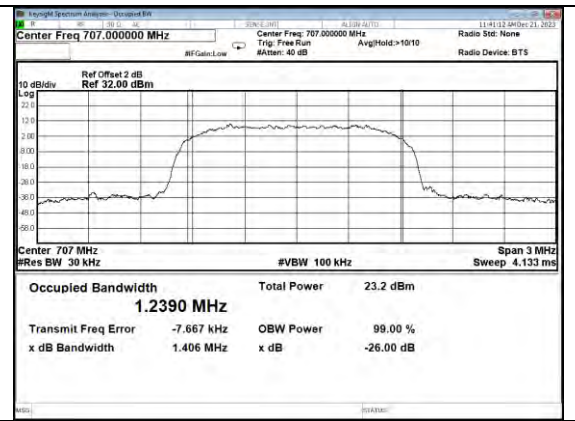

CDMA-Lower 700 band UL output

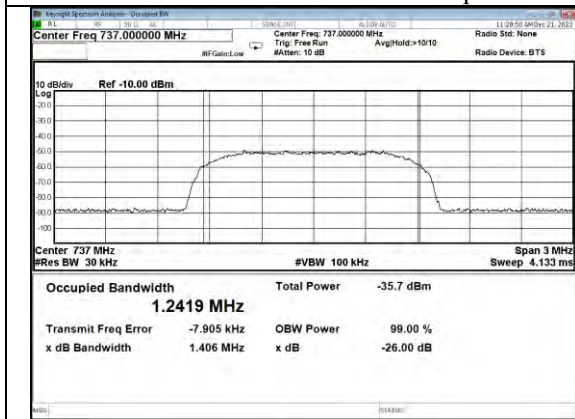

CDMA-Lower 700 band DL input

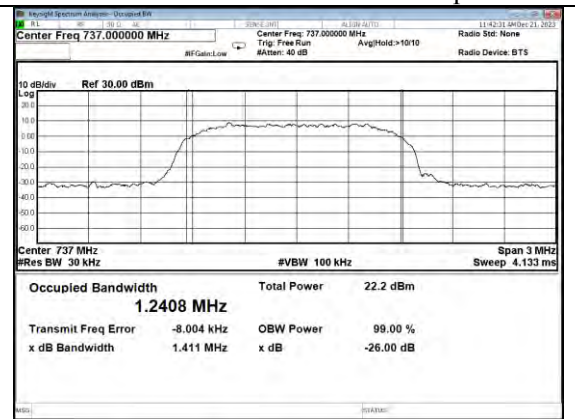

CDMA-Lower 700 band DL output

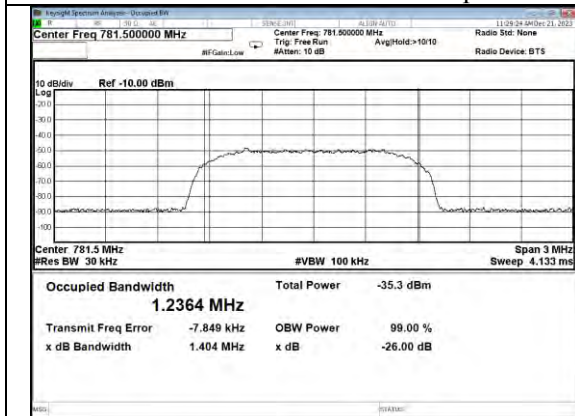

CDMA-Upper 700 band UL input

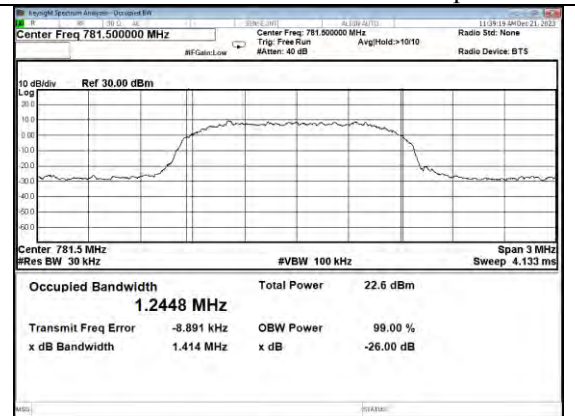

CDMA-Upper 700 band UL output

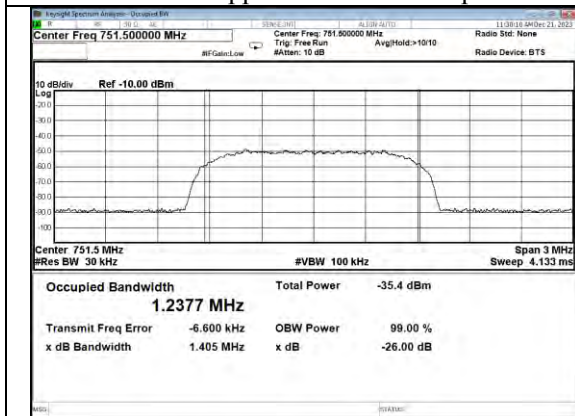

CDMA-Upper 700 band DL input

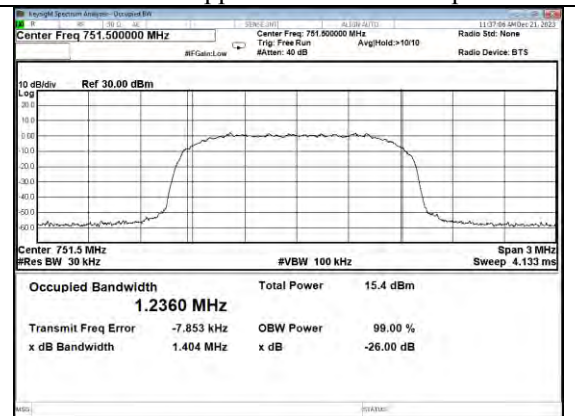

CDMA-Upper 700 band DL output



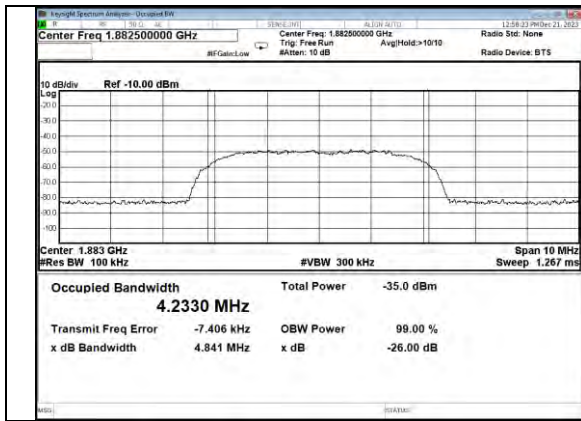

LTE-PCS band UL input

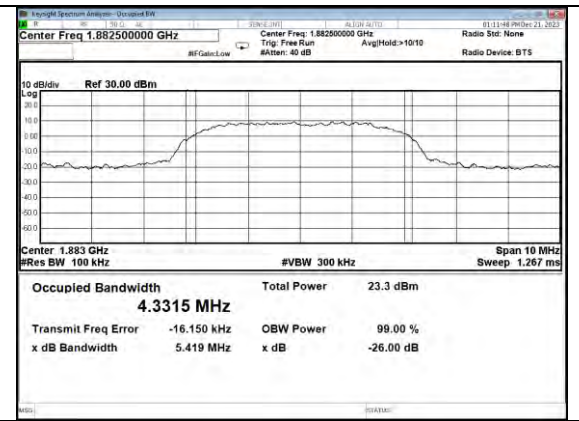

LTE-PCS band UL output

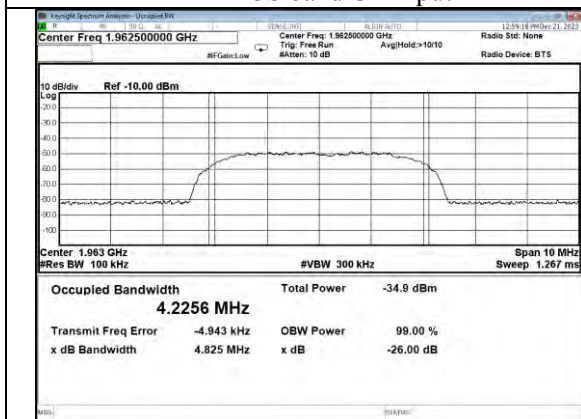

LTE-PCS band DL input

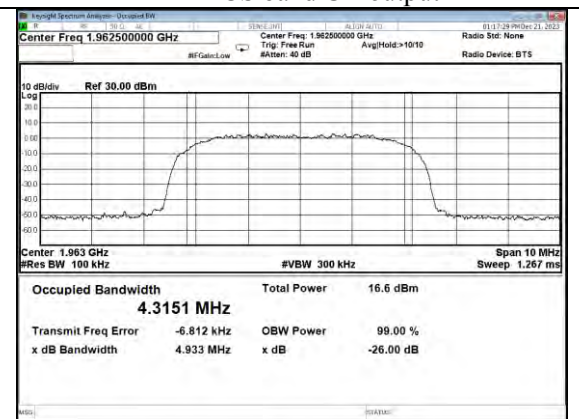

LTE-PCS band DL output

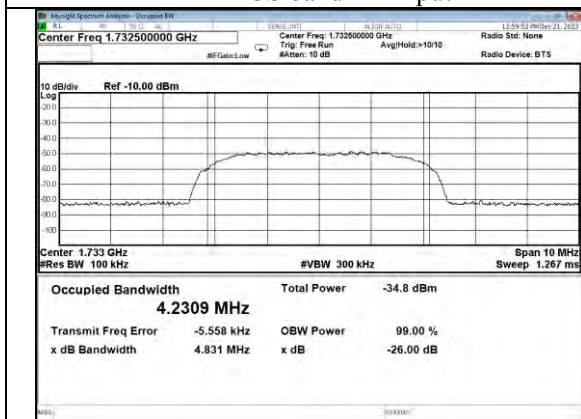

LTE-AWS band UL input

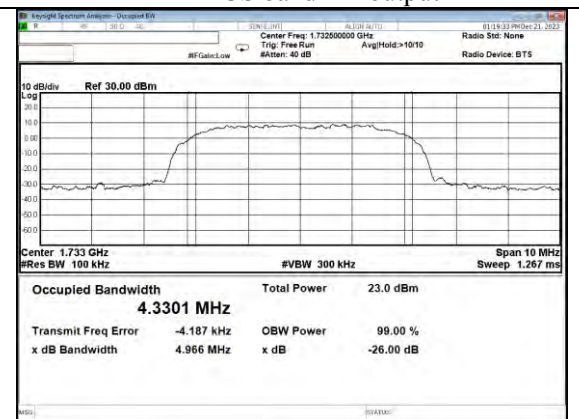

LTE-AWS band UL output

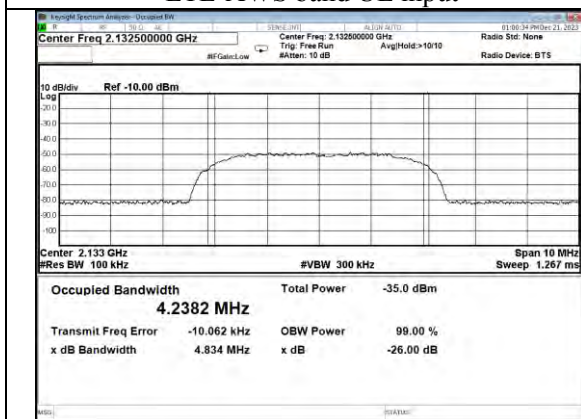

LTE-AWS band DL input

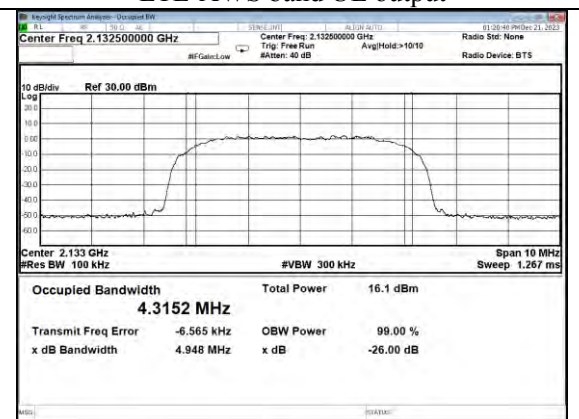

LTE-AWS band DL output

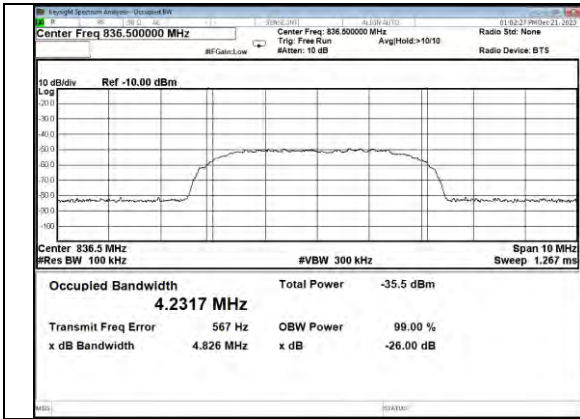

LTE-Cellular band UL input

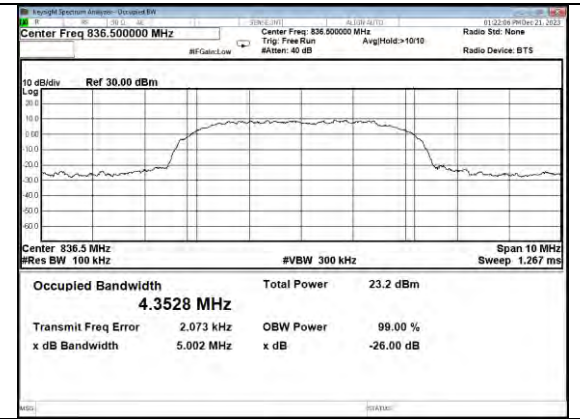

LTE-Cellular band UL output

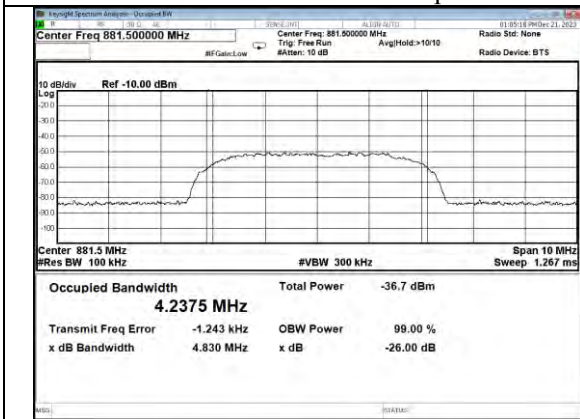

LTE-Cellular band DL input

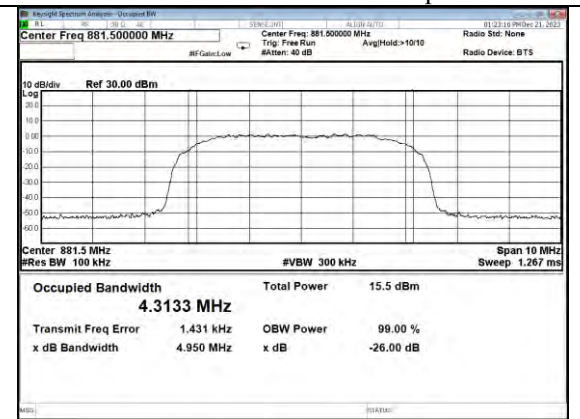

LTE-Cellular band DL output

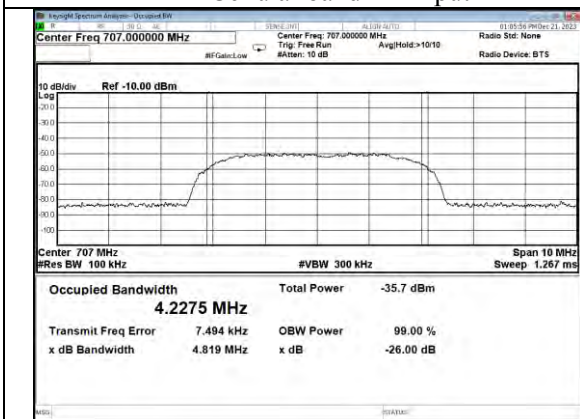

LTE-Lower 700 band UL input

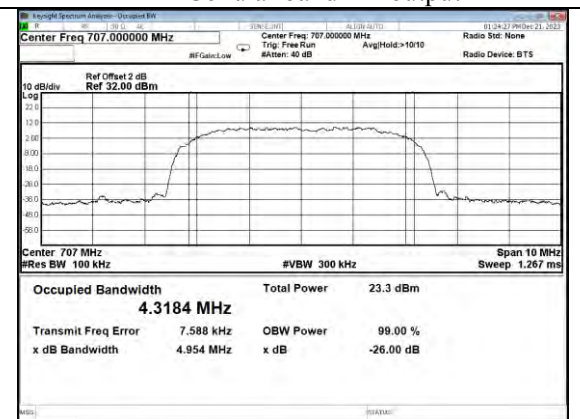

LTE-Lower 700 band UL output

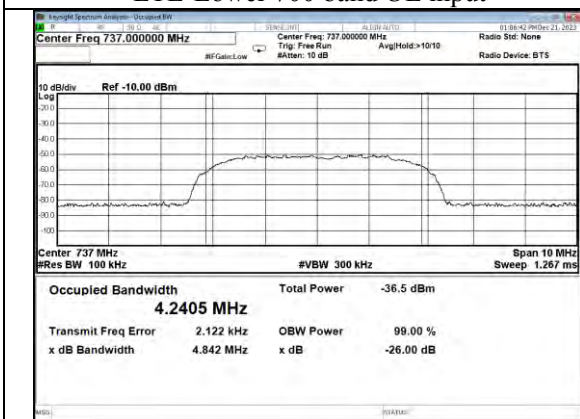

LTE-Lower 700 band DL input

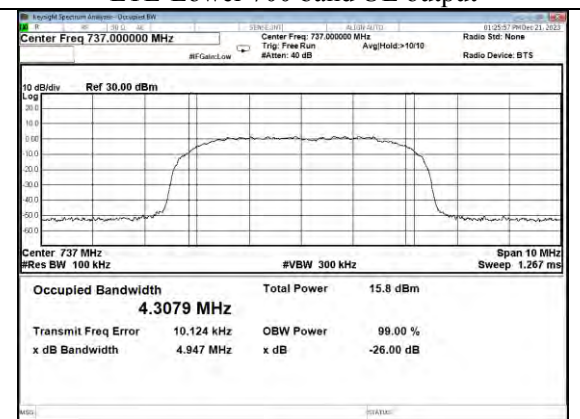

LTE-Lower 700 band DL output

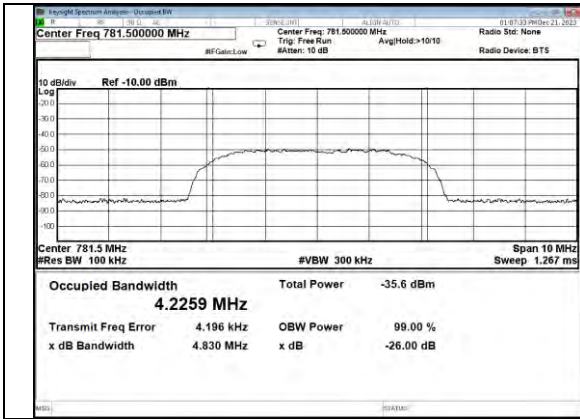

LTE-Upper 700MHz band UL input

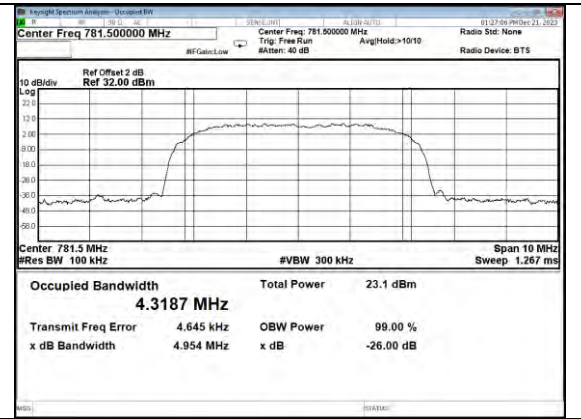

LTE-Upper 700MHz UL output

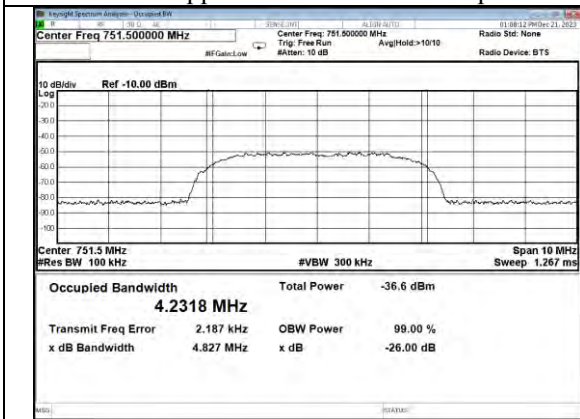

LTE-Upper 700 band DL input

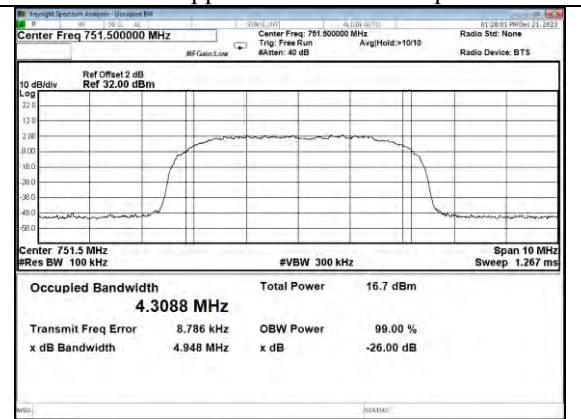

LTE-Upper 700 band DL output





## 6.11 Oscillation Detection and Mitigation

### Applicable Standard

According to §20.21(e)(8)(ii)(A) Anti-Oscillation:

1. Consumer boosters must be able to detect and mitigate (i.e., by automatic gain reduction or shut down), any oscillations in uplink and downlink bands. Oscillation detection and mitigation must occur automatically within 0.3 seconds in the uplink band and within 1 second in the downlink band. In cases where oscillation is detected, the booster must continue mitigation for at least one minute before restarting. After five such restarts, the booster must not resume operation until manually reset.
2. Use of two EUTs is permitted for this measurement, which can greatly reduce the test time required. One EUT shall operate in a normal mode, and the second EUT shall operate in a test mode that is capable of disabling the uplink inactivity function and/or allows a reduction to 5 seconds of the time between restarts.

The procedures in 7.11.3 and 7.11.4 do not apply for devices that operate only as direct-connection mobile boosters having gain of less than or equal to 15 dB.

### Test Procedure

Oscillation restart tests

According to section 7.11.2 of KDB 935210 D03 Signal Booster Measurement v04r04:

a) Connect the normal-operating mode EUT to the test equipment as shown in Figure 7 beginning with the spectrum analyzer on the uplink output (donor) port. Confirm that the RF coupled path is connected to the spectrum analyzer.

NOTE—The band-pass filter shall provide sufficient out-of-band rejection to prevent oscillations from occurring in bands not under test.

b) Spectrum analyzer settings:

- 1) Center frequency at the center of the band under test
- 2) Span equal or slightly exceeding the width of the band under test
- 3) Continuous sweep, max-hold
- 4)  $RBW \cong 1 \text{ MHz}$ ,  $VBW > 3 \text{ RBW}$

c) Decrease the variable attenuator until the spectrum analyzer displays a signal within the band under test. Using a marker, identify the approximate center frequency of this signal on the max-hold display, increase the attenuation by 10 dB, then reset the EUT (e.g., cycle ac/dc power).

d) Repeat 7.11.2c) twice to ensure that the center of the signal created by the booster remains within 250 kHz of the spectrum analyzer display center frequency. If the frequency of the signal is unstable, confirm that the spectrum analyzer display is centered between the frequency extremes observed. If the signal is wider than 1 MHz, ensure that the spectrum analyzer display is centered on the signal by increasing the RBW. Reset the EUT (e.g., cycle ac/dc power) after each oscillation event, if necessary. Set the spectrum analyzer sweep trigger level to just below the peak amplitude of the displayed EUT oscillation signal.

e) Set the spectrum analyzer to zero-span, with a sweep time of 5 seconds, and single-sweep with max-hold. The spectrum analyzer sweep trigger level in this and the subsequent steps shall be the level identified in 7.11.2d).

f) Decrease the variable attenuator until the spectrum analyzer sweep is triggered, increase the attenuation by 10 dB, then reset the EUT (e.g., cycle ac/dc power).

g) Reset the zero-span trigger of the spectrum analyzer, then repeat 7.11.2f) twice to ensure that the spectrum analyzer is reliably triggered, resetting the EUT (e.g., cycle ac/dc power) after each oscillation event if necessary.

h) Reset the zero-span sweep trigger of the spectrum analyzer, and reset the EUT (e.g., cycle ac/dc power).



- i) Force the EUT into oscillation by reducing the attenuation.
- j) Use the marker function of the spectrum analyzer to measure the time from the onset of oscillation until the EUT turns off, by setting Marker 1 on the leading edge of the oscillation signal and Marker 2 on the trailing edge. The spectrum analyzer sweep time may be adjusted to improve the time resolution of these cursors.
- k) Capture the spectrum analyzer zero-span trace for inclusion in the test report. Report the power level associated with the oscillation separately if it can't be displayed on the trace.
- l) Repeat 7.11.2b) to 7.11.2k) for all operational uplink and downlink bands.
- m) Set the spectrum analyzer zero-span sweep time for longer than 60 seconds, then measure the restart time for each operational uplink and downlink band.
- n) Replace the normal-operating mode EUT with the EUT that supports an anti-oscillation test mode.
- o) Set the spectrum analyzer zero-span time for a minimum of 120 seconds, and a single sweep.
- p) Manually trigger the spectrum analyzer zero-span sweep, and manually force the booster into oscillation as described in 7.11.2i).
- q) When the sweep is complete, place cursors between the first two oscillation detections, and save the plot for inclusion in the test report. The time between restarts must match the manufacturer's timing for the test mode, and there shall be no more than 5 restarts.
- r) Repeat 7.11.2m) to 7.11.2q) for all operational uplink and downlink bands.

oscillation mitigation or shutdown

According to section 7.11.3 of KDB 935210 D03 Signal Booster Measurement v04r04:

- a) Connect the normal-operating mode EUT to the test equipment as shown in Figure 8.
- b) Set the spectrum analyzer center frequency to the center of band under test, and use the following settings:
  - 1)  $RBW=30\text{ kHz}$ ,  $VBW \geq 3 \times RBW$ ,
  - 2) power averaging (rms) detector,
  - 3) trace averages  $\geq 100$ ,
  - 4) span  $\geq 120\%$  of operational band under test,
  - 5) number of sweep points  $\geq 2 \times \text{Span}/RBW$ .
- c) Configure the signal generator for AWGN operation with a 99% OBW of 4.1 MHz, tuned to the frequency of 2.5 MHz above the lower edge or below the upper edge of the operating band under test. Adjust the RF output level of the signal generator such that the measured power level of the AWGN signal at the output port of the booster is 30 dB less than the maximum power of the booster for the band under test. Affirm that the input signal is not obstructing the measurement of the strongest oscillation peak in the band, and is not included within the span in the measurement.
  - 1) Boosters with operating spectrum passbands of 10 MHz or less may use a CW signal source at the band edge rather than AWGN.
  - 2) For device passbands greater than 10 MHz, standard CMRS signal sources (i.e., CDMA, W-CDMA, LTE) may be used instead of AWGN at the band edge.
- d) Set the variable attenuator to a high attenuation setting such that the booster will operate at maximum gain when powered on. Reset the EUT (e.g., cycle ac/dc power). Allow the EUT to complete its boot-up process, to reach full operational gain, and to stabilize its operation.
- e) Set the variable attenuator such that the insertion loss for the center of the band under test (isolation) between the booster donor port and server port is 5 dB greater than the maximum gain, as recorded in the maximum gain test procedure (see 7.3), for the band under test.
- f) Verify the EUT shuts down, i.e., to mitigate the oscillations. If the booster does not shut down, measure and verify the peak oscillation level as follows.
  - 1) Allow the spectrum analyzer trace to stabilize.
  - 2) Place the marker at the highest oscillation level occurring within the span, and record its output level and frequency.
  - 3) Set the spectrum analyzer center frequency to the frequency with the highest oscillation signal level,

- and reduce the span such that the upper and lower adjacent oscillation peaks are within the span.
- 4) Use the Minimum Search Marker function to find the lowest output level that is within the span, and within the operational band under test, and record its output level and frequency.
  - 5) Affirm that the peak oscillation level measured in 7.11.3f2), does not exceed by 12.0 dB the minimal output level measured in 7.11.3f4). Record the measurement results of 7.11.3f2) and 7.11.3f4) in tabular format for inclusion in the test report.
  - 6) The procedure of 7.11.3f1) to 7.11.3f5) allows the spectrum analyzer trace to stabilize, and verification of shutdown or oscillation level measurement must occur within 300 seconds.20
  - g) Decrease the variable attenuator in 1 dB steps, and repeat step 7.11.3f) for each 1 dB step. Continue testing to the level when the insertion loss for the center of band under test (isolation) between the booster donor port and server port is 5 dB lower than the maximum gain (see 7.3).
  - h) Repeat 7.11.3a) to 7.11.3g) for all operational uplink and downlink bands.

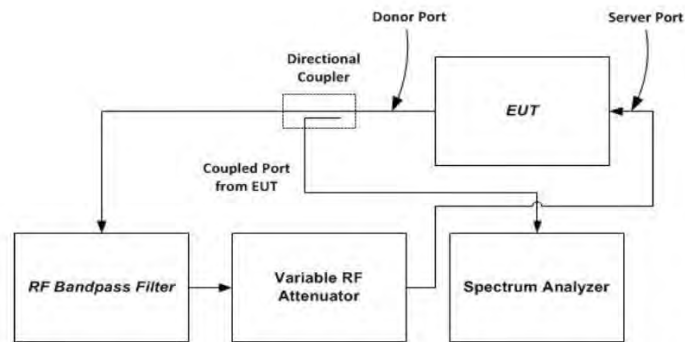

NOTE—This figure shows the test setup for uplink bands transmission path tests; i.e., signal flow is out from the donor port into the directional coupler. For downlink bands transmission path tests, the feedback signal flow path direction and equipment connections shall be reversed, i.e., signal flow is out from the server port into the directional coupler, and signal flow is into the donor port from the variable RF attenuator.

**Figure 7 – Oscillation detection (7.11.2) test setup**

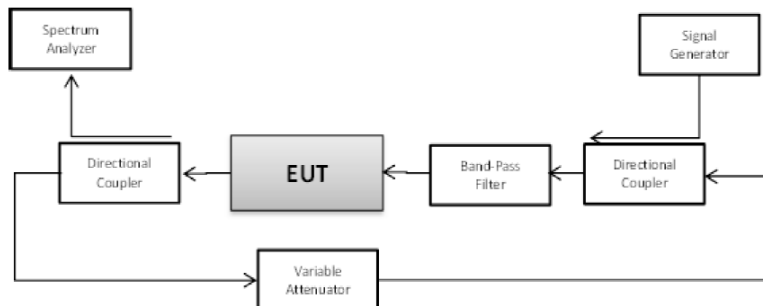

**Figure 8 – Oscillation mitigation/shutdown test setup**

**Test data**

Temperature	23.4°C	Humidity	53.2%
Test Engineer	Nick Peng	Test Mode	Transmitting

<b>Test results of detection time</b>					
Operation Bands		Detection Time (s)	Limit (s)	Result	
Uplink	PCS	0.026	0.300	PASS	
	AWS	0.031	0.300	PASS	
	Cellular	0.028	0.300	PASS	
	Lower 700	0.035	0.300	PASS	
	Upper 700	0.036	0.300	PASS	
Downlink	PCS	0.031	1.000	PASS	
	AWS	0.026	1.000	PASS	
	Cellular	0.040	1.000	PASS	
	Lower 700	0.035	1.000	PASS	
	Upper 700	0.052	1.000	PASS	

<b>Test results of detection time</b>						
Operation Bands		Restarting Time(s)	Limit (s)	Restarting Counts	Limit	Result
Uplink	PCS	61.32	60	3	5	PASS
	AWS	63.36	60	3	5	PASS
	Cellular	63.52	60	3	5	PASS
	Lower 700	64.32	60	2	5	PASS
	Upper 700	63.25	60	2	5	PASS
Downlink	PCS	67.52	60	4	5	PASS
	AWS	65.32	60	3	5	PASS
	Cellular	64.32	60	3	5	PASS
	Lower 700	63.52	60	2	5	PASS
	Upper 700	65.63	60	3	5	PASS

**oscillation mitigation or shutdown:**

PCS Band	Uplink(1850-1915MHz)		
Signal Type	AWGN		
Isolation	Deffrence	Limit	Result
dB	dB	dB	
+5	8.63	<12	Pass
+4	9.34	<12	Pass
+3	9.26	<12	Pass
+2	10.35	<12	Pass
+1	10.05	<12	Pass
0	11.37	<12	Pass
-1	shutdown		

PCS Band	Downlink(1930-1995MHz)		
Signal Type	AWGN		
Isolation	Deffrence	Limit	Result
dB	dB	dB	
+5	7.48	<12	Pass
+4	7.29	<12	Pass
+3	7.36	<12	Pass
+2	8.93	<12	Pass
+1	10.26	<12	Pass
0	11.14	<12	Pass
-1	shutdown		

AWS band	Uplink(1710-1755MHz)		
Signal Type	AWGN		
Isolation	Deffrence	Limit	Result
dB	dB	dB	
+5	7.63	<12	Pass
+4	8.78	<12	Pass
+3	8.63	<12	Pass
+2	9.36	<12	Pass
+1	10.63	<12	Pass
0	11.52	<12	Pass
-1	shutdown		





AWS band	Downlink(2110-2155MHz)		
Signal Type	AWGN		
Isolation	Deffrence	Limit	Result
dB	dB	dB	
+5	6.89	<12	Pass
+4	6.36	<12	Pass
+3	6.46	<12	Pass
+2	6.36	<12	Pass
+1	6.75	<12	Pass
0	6.52	<12	Pass
-1	shutdown		

Cellular Band	Uplink(824-849MHz)		
Signal Type	AWGN		
Isolation	Deffrence	Limit	Result
dB	dB	dB	
+5	7.15	<12	Pass
+4	8.63	<12	Pass
+3	8.63	<12	Pass
+2	9.26	<12	Pass
+1	10.75	<12	Pass
0	11.64	<12	Pass
-1	shutdown		

Cellular Band	Downlink(869-894MHz)		
Signal Type	AWGN		
Isolation	Deffrence	Limit	Result
dB	dB	dB	
+5	7.63	<12	Pass
+4	8.72	<12	Pass
+3	8.29	<12	Pass
+2	9.36	<12	Pass
+1	10.41	<12	Pass
0	11.53	<12	Pass
-1	shutdown		



Lower700MHz band	Uplink(698-716MHz)		
Signal Type	AWGN		
Isolation	Deffrence	Limit	Result
dB	dB	dB	
+5	8.12	<12	Pass
+4	9.29	<12	Pass
+3	9.36	<12	Pass
+2	9.71	<12	Pass
+1	10.23	<12	Pass
0	11.63	<12	Pass
-1	shutdown		

Lower700MHz band	Downlink(728-746MHz)		
Signal Type	AWGN		
Isolation	Deffrence	Limit	Result
dB	dB	dB	
+5	8.13	<12	Pass
+4	9.39	<12	Pass
+3	9.26	<12	Pass
+2	9.64	<12	Pass
+1	11.41	<12	Pass
0	11.71	<12	Pass
-1	shutdown		

Upper 700Mhz Band	Uplink(776-787MHz)		
Signal Type	AWGN		
Isolation	Deffrence	Limit	Result
dB	dB	dB	
+5	8.62	<12	Pass
+4	9.54	<12	Pass
+3	10.53	<12	Pass
+2	10.03	<12	Pass
+1	11.23	<12	Pass
0	11.39	<12	Pass
-1	shutdown		



Upper 700Mhz Band	Downlink(746-757MHz)		
Signal Type	AWGN		
Isolation	Deffrence	Limit	Result
dB	dB	dB	
+5	9.26	<12	Pass
+4	9.18	<12	Pass
+3	10.26	<12	Pass
+2	10.36	<12	Pass
+1	11.85	<12	Pass
0	11.52	<12	Pass
-1	shutdown		

## 7. RADIATION SPURIOUS EMISSION

### Applicable Standard

According to §2.1053 Measurements required: Field strength of spurious radiation.

The power of any emission outside a licensee's frequency block shall be attenuated below the transmitter power (P) by at least  $43 + 10 \log_{10}(P)$  dB.

So the Conducted emissions limit = -13 dBm

### Test Procedure

According to section 7.12 of KDB 935210 D03 Signal Booster Measurement v04r04:

This procedure is intended to satisfy the requirements specified in Section 2.1053. The applicable limits are those specified for mobile station emissions in the rule part appropriate to the band of operation (see Appendix A).

Separate compliance requirements are applicable for any digital device circuitry that controls additional functions or capabilities and that is not used only to enable operation of the transmitter in a booster device [i.e., Section 15.3(k) digital device definition]. Separate compliance requirements are applicable for any receiver components/functions that tune within 30 MHz to 960 MHz contained in booster devices [Section 15.101(b)].

- a) Place the EUT on an OATS or semi-anechoic chamber turntable 3 m from the receiving antenna.
- b) Connect the EUT to the test equipment as shown in Figure 10 beginning with the uplink output (donor) port.
- c) Set the signal generator to produce a CW signal with the frequency set to the center of the operational band under test, and the power level set at PIN as determined from measurement results per 7.2.
- d) Measure the radiated spurious emissions from the EUT from the lowest to the highest frequencies as specified in Section 2.1057. Maximize the radiated emissions by using the procedures described in ANSI C63.26.
- e) Capture the peak emissions plots using a peak detector with Max-Hold for inclusion in the test report. Tabular data is acceptable in lieu of spectrum analyzer plots.
- f) Repeat 7.12c) through 7.12e) for all uplink and downlink operational bands.

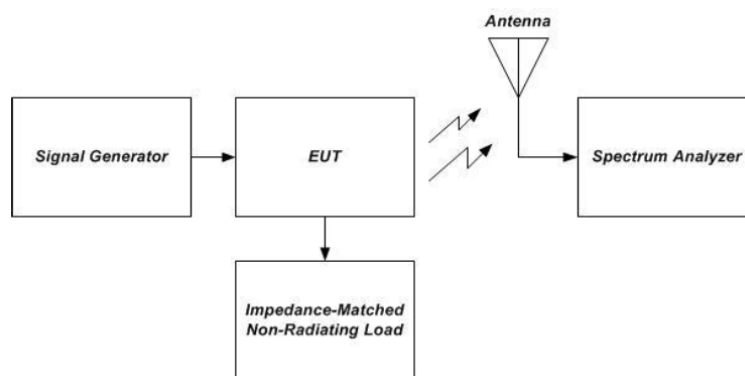

Figure 10 – Radiated spurious emissions test and instrumentation setup

**Test Data**

Temperature	23.4°C	Humidity	53.2%
Test Engineer	Nick Peng	Test Mode	Transmitting

## Uplink, Test Frequency 1882.5MHz

Frequency (MHz)	PMea (dBm)	Pcl (dB)	Diatance	Ga Antenna Gain(dB)	Peak EIRP (dBm)	Limit (dBm)	Margin	Polarization
834.29	-45.57	2.32	3	10.03	-37.86	-19.00	18.86	H
3765.23	-47.22	6.19	3	11.41	-42.00	-19.00	23.00	H
834.29	-43.83	2.32	3	10.03	-36.12	-19.00	17.12	V
3765.23	-45.98	6.19	3	11.41	-40.76	-19.00	21.76	V

## Uplink, Test Frequency 1732.5MHz

Frequency (MHz)	PMea (dBm)	Pcl (dB)	Diatance	Ga Antenna Gain(dB)	Peak EIRP (dBm)	Limit (dBm)	Margin	Polarization
776.24	-43.75	2.63	3	7.84	-38.54	-19.00	19.54	H
3465.23	-48.49	5.94	3	10.86	-43.57	-19.00	24.57	H
776.24	-44.66	2.63	3	7.84	-39.45	-19.00	20.45	V
3465.23	-42.27	5.94	3	10.86	-37.35	-19.00	18.35	V

## Uplink, Test Frequency 836.5MHz

Frequency (MHz)	PMea (dBm)	Pcl (dB)	Diatance	Ga Antenna Gain(dB)	Peak ERP (dBm)	Limit (dBm)	Margin	Polarization
634.77	-42.62	1.98	3	11.12	-33.48	-19.00	14.48	H
1670.36	-44.16	4.45	3	12.02	-36.59	-19.00	17.59	H
634.77	-44.43	1.98	3	11.12	-35.29	-19.00	16.29	V
1670.36	-46.20	4.45	3	12.02	-38.63	-19.00	19.63	V

## Uplink, Test Frequency 707.5MHz

Frequency (MHz)	PMea (dBm)	Pcl (dB)	Diatance	Ga Antenna Gain(dB)	Peak ERP (dBm)	Limit (dBm)	Margin	Polarization
823.19	-45.32	1.75	3	10.44	-36.63	-19.00	17.63	H
1415.38	-48.37	4.66	3	12.33	-40.70	-19.00	21.70	H
823.19	-42.65	1.75	3	10.44	-33.96	-19.00	14.96	V
1415.38	-42.34	4.66	3	12.33	-34.67	-19.00	15.67	V





## Uplink, Test Frequency 782MHz

Frequency (MHz)	PMea (dBm)	Pcl (dB)	Diatance	Ga Antenna Gain(dB)	Peak ERP (dBm)	Limit (dBm)	Margin	Polarization
588.24	-47.82	1.99	3	11.12	-38.69	-19.00	19.69	H
1564.21	-47.02	4.85	3	12.02	-39.85	-19.00	20.85	H
588.24	-43.71	1.99	3	11.12	-34.58	-19.00	15.58	V
1564.21	-42.64	4.85	3	12.02	-35.47	-19.00	16.47	V

## Downlink, Test Frequency1962.5MHz

Frequency (MHz)	PMea (dBm)	Pcl (dB)	Diatance	Ga Antenna Gain(dB)	Peak EIRP (dBm)	Limit (dBm)	Margin	Polarization
833.52	-44.03	2.36	3	9.62	-36.77	-19.00	17.77	H
3925.664	-47.80	6.24	3	11.46	-42.58	-19.00	23.58	H
833.52	-47.92	2.36	3	9.62	-40.66	-19.00	21.66	V
3925.664	-47.60	6.24	3	11.46	-42.38	-19.00	23.38	V

## Downlink, Test Frequency2132.5MHz

Frequency (MHz)	PMea (dBm)	Pcl (dB)	Diatance	Ga Antenna Gain(dB)	Peak EIRP (dBm)	Limit (dBm)	Margin	Polarization
741.88	-46.22	2.65	3	9.9	-38.97	-19.00	19.97	H
4265.21	-47.51	5.95	3	10.91	-42.55	-19.00	23.55	H
741.88	-47.24	2.65	3	9.9	-39.99	-19.00	20.99	V
4265.21	-47.47	5.95	3	10.91	-42.51	-19.00	23.51	V

## Downlink, Test Frequency 881.5MHz

Frequency (MHz)	PMea (dBm)	Pcl (dB)	Diatance	Ga Antenna Gain(dB)	Peak ERP (dBm)	Limit (dBm)	Margin	Polarization
569.14	-42.93	2.95	3	9.98	-35.90	-19.00	16.90	H
1763.28	-46.78	6.63	3	11.66	-41.75	-19.00	22.75	H
569.14	-46.35	2.95	3	9.98	-39.32	-19.00	20.32	V
1763.28	-42.69	6.63	3	11.66	-37.66	-19.00	18.66	V

## Downlink, Test Frequency 737MHz

Frequency (MHz)	PMea (dBm)	Pcl (dB)	Diatance	Ga Antenna Gain(dB)	Peak ERP (dBm)	Limit (dBm)	Margin	Polarization
596.28	-43.51	1.77	3	10.45	-34.83	-19.00	15.83	H
1474.38	-42.85	5.69	3	12.36	-36.18	-19.00	17.18	H
596.28	-44.65	1.77	3	10.45	-35.97	-19.00	16.97	V
1474.38	-43.48	5.69	3	12.36	-36.81	-19.00	17.81	V



## Downlink, Test Frequency 751.5MHz

Frequency (MHz)	P <sub>Mea</sub> (dBm)	P <sub>cl</sub> (dB)	Diatance	G <sub>a</sub> Antenna Gain(dB)	Peak ERP (dBm)	Limit (dBm)	Margin	Polarization
469.25	-51.52	2.12	3.00	9.98	-43.66	-19.00	24.66	H
1503.68	-46.12	5.93	3.00	11.66	-40.39	-19.00	21.39	H
469.25	-45.62	2.12	3.00	9.98	-37.76	-19.00	18.76	V
1503.68	-40.57	5.93	3.00	11.66	-34.84	-19.00	15.84	V

**Remark:**

1. We were not recorded other points as values lower than limits.

2.  $Peak(EIRP) = P_{Mea} - P_{cl} + G_a$

3.  $Margin = EIRP - Limit$

4. For Outdoor Antenna(Yagi antenna), Outdoor Antenna(Tubular antenna), Outdoor Antenna(Log-periodic antenna), Outdoor Antenna(Panel Antenna); Indoor Antenna(Right angle Antenna), Indoor Antenna(Sucker antenna), Indoor Antenna(Omni-directional ceiling antenna), Indoor Antenna(Panel Antenna) were estimated, the report recorded the worst result of Outdoor Antenna (Log-periodic antenna), Indoor Antenna(Panel Antenna).



## **8. TEST SETUP PHOTOGRAPHS OF EUT**

Please refer to separated files for Test Setup Photos of the EUT.

## **9. EXTERIOR PHOTOGRAPHS OF THE EUT**

Please refer to separated files for External Photos of the EUT.

## **10. INTERIOR PHOTOGRAPHS OF THE EUT**

Please refer to separated files for Internal Photos of the EUT.

-----THE END OF TEST REPORT-----