

User's Manual



CONTENTS

1. The Repeater System.....	1
2. Package Contents.....	2
3. Installation.....	3
3.1. Installation Location Requirement.....	14
3.2. Installation of Outdoor Antenna.....	15
3.3. Cable Layout and Connector Assembly.....	17
3.4. Switch on the Power.....	18
3.5. Check Coverage.....	18
4. Attention.....	20
5. Troubleshooting.....	22
6. Safety Reminder & Warning	24
7. Warranty.....	25

1. THE REPEATER SYSTEM

Connect to Indoor Antenna

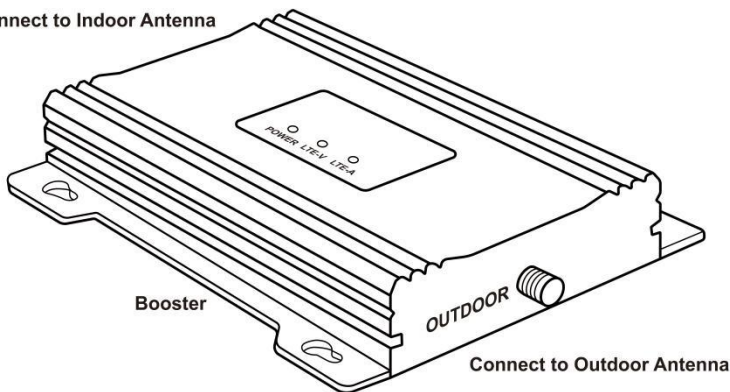

Introduction:

The booster is designed to realize the wireless forwarding and bidirectional amplifying of the base station's signal, expand the coverage of communication signal and cover its blind zone. When booster is working, the outside antenna (connecting to the OUTDOOR or BTS Port of booster) will receive the cell signal from signal tower and send the signal to the booster through coaxial cable; then the booster amplifies the signal and send the boosted signal to the inside antenna (connecting to the INDOOR or MS Port of booster); finally, the inside antenna could transmit the signal into your house.

The cell phone signal booster will only make a weak signal stronger, it can't create a signal. It won't work if the outdoor antenna can't receive any signal.

The outdoor antenna should receive 2-3 bars of stable signal in the location where the outdoor antenna is fixed; otherwise, the booster won't work very well.

2.Package Contents

- 1.Signal Booster
- 2.Indoor Antenna
- 3.Outdoor Antenna
- 4.50 feet Coaxial Cable
- 5.Power Adapter
- 6.User Manual
- 7.Screws Accessories

You should receive the Mobile Booster kit which includes the similar above-mentioned fittings. Before installing, please confirm your purchased booster's frequency is corresponding with your cell phone frequency; if not corresponding, the booster would not amplify any signal.

The Dual Band operator's frequency is as follows:

Band	Uplink (UL)		Downlink (DL)	
	UL_low	UL_high	DL_low	DL_high
12	698 MHz	716 MHz	728 MHz	746 MHz
13	776 MHz	787 MHz	746 MHz	757 MHz
17	704 MHz	716 MHz	734 MHz	746 MHz

3. INSTALLATION

Step 1: Connect Inside Antenna To Booster Option A: Mount the Whip Antenna

Installation Steps:

1. Connect the whip antenna to the Booster INDOOR port.
2. Gently rotate the whip antenna, place Inside Antenna in weak signal area.

Note:

1. The whip antenna is suitable to be installed in small room or apartment.
2. The whip antenna should be oriented vertically whether you choose to mount the booster on a wall or set on a table.

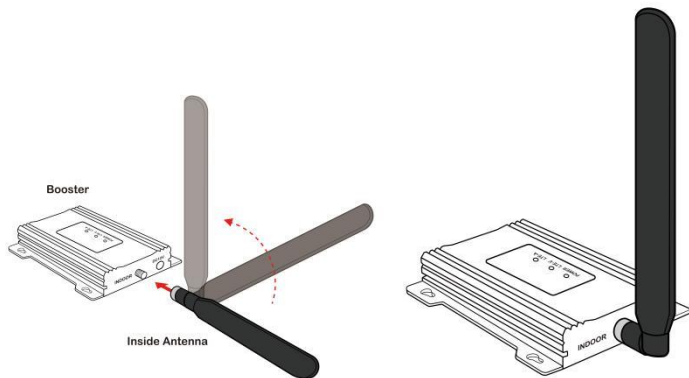

Option B: Mount the Indoor Ceiling Antenna

Installation Steps:

1. Drill a 20mm diameter hole in the ceiling. The ceiling thickness should be 30mm maximum.
2. Unscrew fixing nut from the antenna. Place antenna cable through the hole. Screw the fixing nut back onto the antenna, and go through the cable from the crawl space side of the ceiling and fasten.
3. Attach the connection from the indoor antenna to the connector labeled INDOOR on your booster.
4. Tighten fixing nut to secure antenna (do not over-tighten).

Note: The Ceiling Antenna is suitable for central locations with 360-degree coverage, please mount it on the ceiling in a central location.

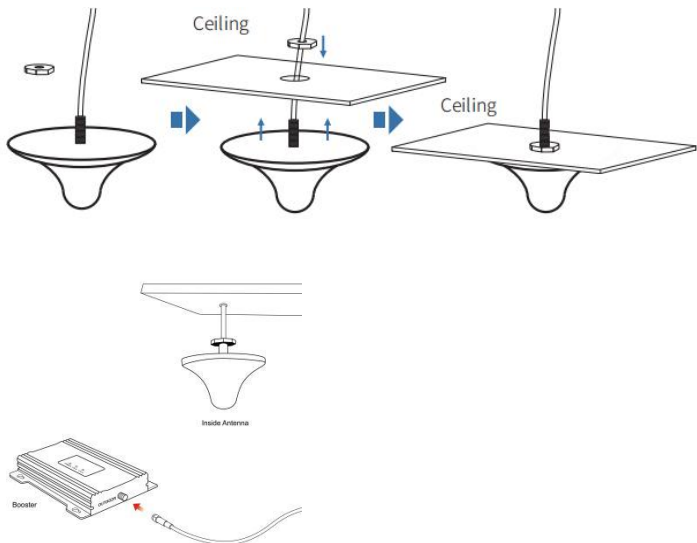

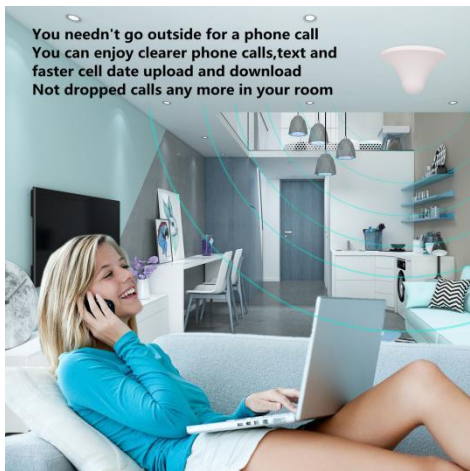

Option C: Mount the Indoor Panel Antenna

Installation Steps:

1. Using the plate mark the position of desired screw placement.
2. Screw mounting plate into place with the slide protruding towards up.
3. Hang the antenna securely onto the mounting plate.
4. Connect the antenna short cable to the 15ft cable and run to the planned location of your booster.
5. Place the booster on a flat surface or mounted to a wall and connect the remaining end of the cable to booster port marked INDOOR.

Note:

1. The Inside Panel Antenna should be facing the area signal is needed and away from the outdoor antenna (See "Aiming Panel Antenna" below).

2. The installation location is the approximate height of normal cell phone use.
3. The Inside Panel Antenna is directional with a 180-degree reach, it should be mounted on a vertical surface or wall where there are no materials that could obstruct signals.
4. It is better to use a directional panel antenna when the shape of coverage is long and narrow (corridors, long row of houses in tow sides, tunnels, elevators or rural open space).
5. Do not connect booster to power until the system is fully installed.

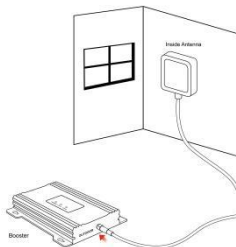
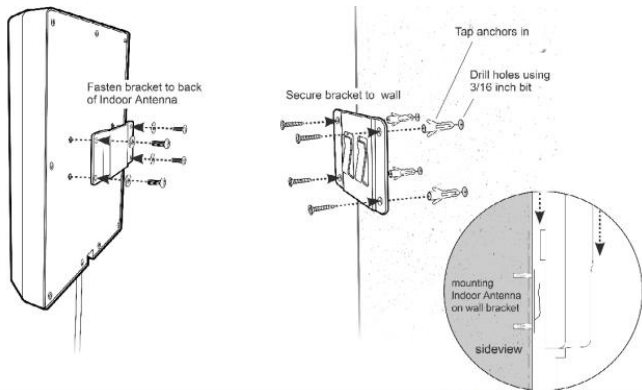

Step 2 : Install the Outdoor Antenna

The directional Yagi, Panel or LPDA Antenna should be mounted at the highest possible location above the roof line – at least 25 feet above the indoor antenna – aimed in the direction of your nearest carrier's cell tower. To find the location of your closest carrier's cell tower, Or adjust the direction of the outdoor antenna according to the location of the cell tower of the different mobile phone operator used

go to www.antennasearch.com.

Ensure that the mounting area has at least a 12 inches radius clear of obstructions, other radiating elements and metal objects such as pipes or metal siding. Once you have identified your install location, assemble the u-bolt, bracket, nuts and washers onto a pole (available separately) as shown in the illustration. Keep the connections loose enough to allow the antenna to rotate until the optimum direction is found. Run the cable along route to planned location of your booster.

Option A: Mount the Directional Outdoor Panel Antenna

Find a best signal place at a high location outdoor.

Installation Steps:

1. Attach the L-Bracket to the Outside Panel Antenna and use the U-Bolts/Pole Bracket to attach the L-Bracket to a pole.
Let the peak of Panel antenna pointed to the cell tower.

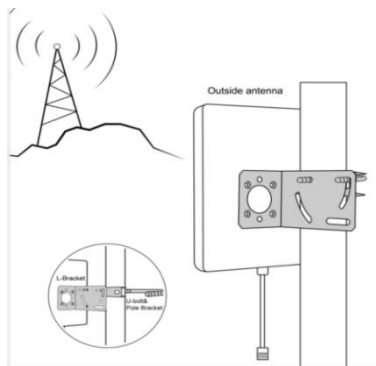

Option B: Mount the Directional Outdoor LPDA Antenna

Installation steps:

1. A drill hole at the LPDA antenna bottom , and the drill hole should be face the bottom side.
2. Fix the LPDA antenna on a long pole/mast/tube with U-bolt and Brackets, tighten the the L-bracket with each washers nuts .
3. Fix the LPDA antenna at the L-bracket with screws
4. Let the peak of LPDA antenna pointed to the cell tower .

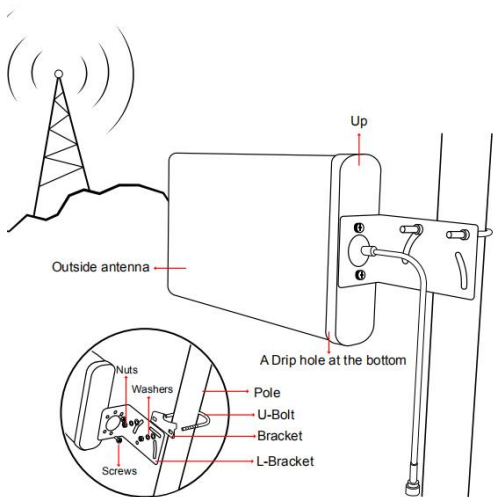

Option C: Mount the Directional Outdoor Yagi Antenna

Installation Steps:

1. Fix the Yagi antenna on a long pole/mast/tube with 2 U-bolt s, tighten them with each washers nuts .
2. Let the peak of Yagi antenna pointed to the cell tower .

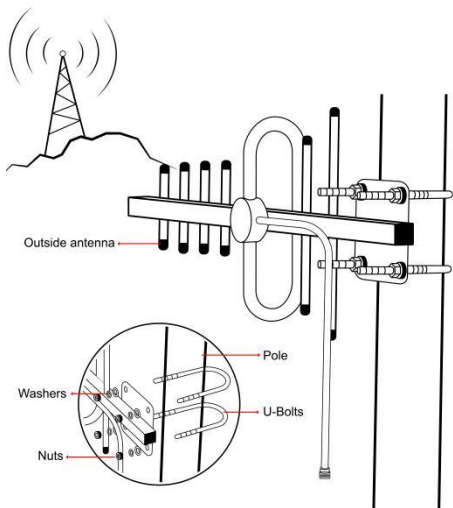

Option D: Mount the Omni-directional Antenna

Installation Steps:

1. Assemble the u-bolt, bracket, nuts and washers onto a mast (not provided) as shown in the illustration.
2. Connect one end of the provided coax cable to the antenna and tighten the connection.

Note:

1. The Omni Antenna receives and sends signals in a 360-degree radius. Mount the antenna at the highest possible elevation and in an upright position.
2. Ensure that the entire outside antenna is above the roof line of the building and is at least 12 inches away from any metal obstructions and other radiating elements.
3. The minimum distance between outdoor antenna and indoor antenna shall be more than 39ft; and the direction of outdoor and indoor antennas shall be opposite.

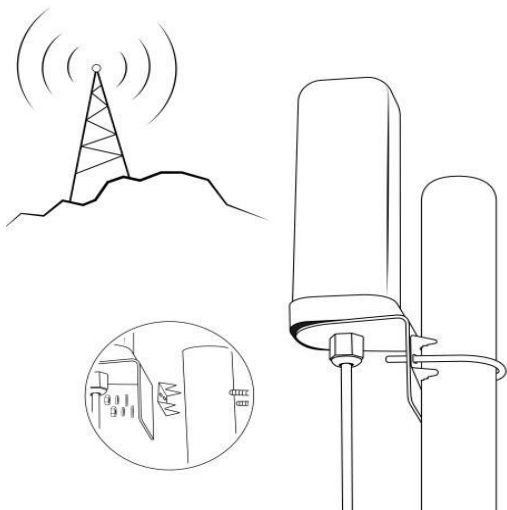

Step 3: Route & Connect Cable To System

Connect the white 50ft Coaxial Cable to the Outdoor Antenna and route cable into the home. All connections should be hand tightened only

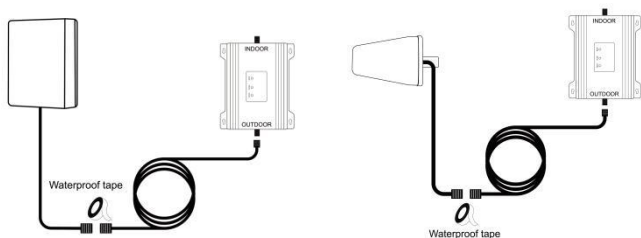

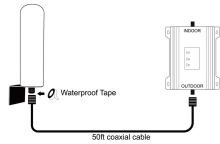
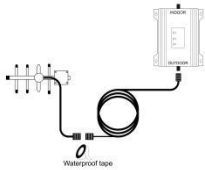

Note: The connector need to add waterproof tape

Step 4: Power Up The Booster & Optimize The System

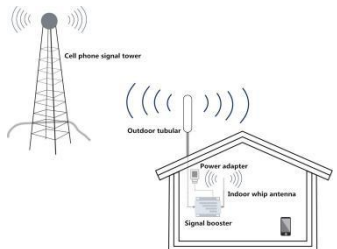
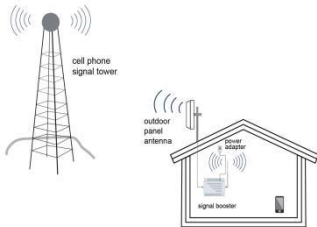
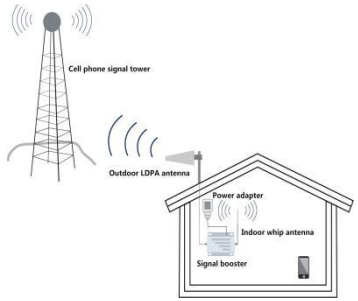
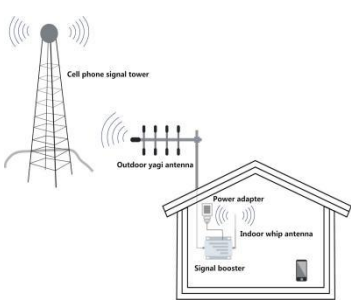

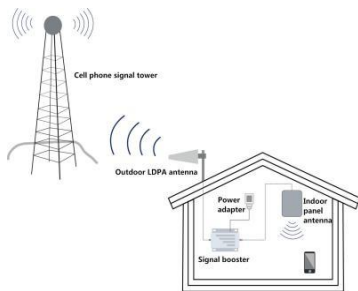
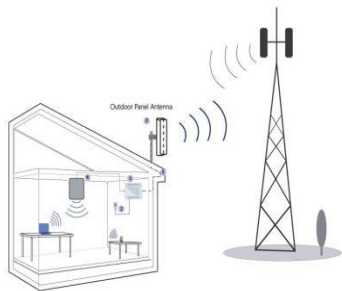
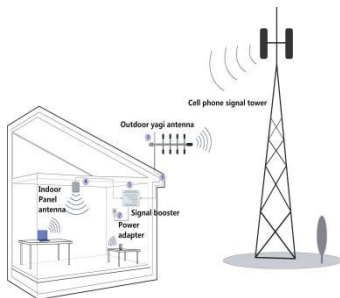
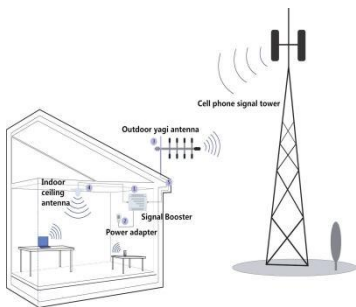

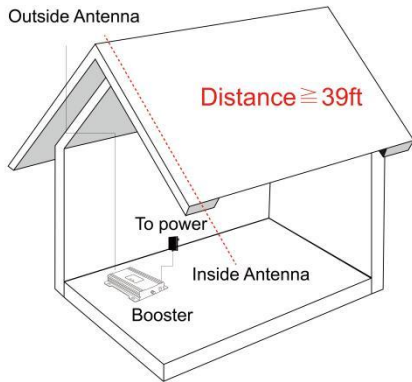
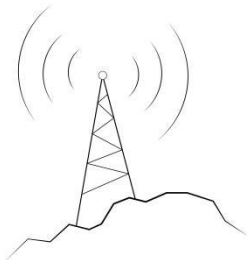

Plug the Power Supply into wall outlet then connect to Booster. The minimum distance between outdoor antenna and indoor antenna shall be more than 39ft, again.

The repeaters should be used to cover the indoor area. Humidity and temperature of working environment can affect the reliability of repeater. so, temperature, humidity, dust, interference, power, space requirements and other factors should be considered during installation of repeater.

3.1 Installation Location Requirement

- (1) It is important that the repeater is installed in a place where is away from excessive heat, direct sunlight, moisture and with proper ventilation. Do not place the repeater in an air-tight enclosure.
- (2) Installation height should be easy for RF cable wiring, heat dissipation, security and maintenance.
- (3) There should be an independent and stable power supply.
- (4) Lightning protection is recommended for all in-building installations. Take extreme care to ensure neither you nor the antenna come in contact with any electrical power lines. stability.

3.2 Installation of Outdoor antenna

The repeater's main function is improve weak RF signals of an area. A simple formula: $\text{Input power} + \text{Gain} = \text{output power}$. The signal strength from the outdoor antenna directly affects the efficiency of the indoor coverage. it is very important to choose the outdoor antenna location in order to get the best signals.

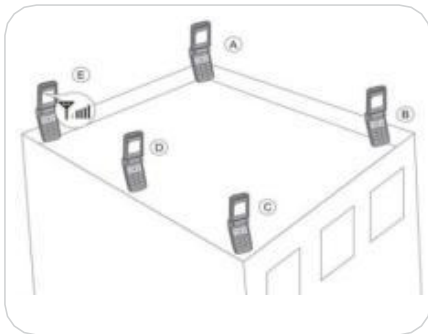

- Testing the signal strength received from outdoor antenna by mobile phone:
- Select an outside antenna location on the roof of the building to install the outdoor antenna, using a cell phone to find the strongest signal from the cell tower. The phone calls or data transmission shall be smooth and stable by 3 times testing in location
- Fix the outdoor antenna after selecting the best position, and adjust height or angles slightly in order to get the best signal with suitable input power level and calling quality.

Test the call quality of Outdoor antenna (for professional installation team only)

- Selecting the installation direction of outdoor antenna.
 - The outdoor antenna should point in the direction of the tower, and it is much better to keep line of sight.
 - Select opposite directions for outdoor antenna and indoor antennas. Please test the signal quality and make sure to avoid self-oscillation first, if have to install Outdoor and Indoor antennas in the same direction. If the directional antenna is selected, the main directional angle should point to the tower antenna.
- If the performance is poor due to weak signals or poor phone call quality, please adjust the
- direction of outdoor antenna or change its position in order to obtain the best calling effect.
 - The wide band repeater supports all mobile operators or different mobile systems, so please adjust the outdoor antenna direction to have a balance between signals of different mobile operators or various mobile systems.

Outdoor antenna installation---Notes:

- Do not install the outdoor antenna during the rainy day with lightning. Please follow the instructions to install the outdoor antenna.
- It is very important to waterproof the connectors of outdoor antenna and feeder lines.
- In order to avoid interference, please note that the outdoor antenna should be far away from objects of metal, high voltage line, RF antennas and high voltage transformer.
- Repeater is a tow-way signal amplifier. So proper isolation between outdoor antenna and indoor antenna is necessary to avoid self oscillation. (About the definition for self oscillation, take the MIC and loudspeaker for example, if it is too close for each other, it could make loud noise.)
- As shown in the below illustration, the booster amplifies the downlink signal from the tower and send to the indoor antenna hereafter. If the distance between outdoor antenna and indoor antenna is less than the required distance, the amplified signal R will go back from indoor antenna to outdoor antenna. So it will lead to self oscillation and reduce the coverage area, also the bad calling quality could happen at the same time, and the worse is that mobile network could be influenced badly and the operators will finally come to shut off the repeater system.
- The minimum distance between outdoor antenna and indoor antenna shall be more than 39ft; again, the direction of outdoor and indoor antennas shall be opposite. The Outdoor antenna shouldn't point to the interior house, for avoiding signals interfered. For example,



3.3 Cable layout and connector assembly

Connect cables to the booster's ports after installing and fixing outside and inside antennas. Steps as below:

- (1) Open the cable package and make it bend naturally and smoothly.
- (2) Keep horizontal cables straight and fasten them with a fixing clip every 1 to 1.5 meters.
- (3) The cable should be bent naturally and smoothly to avoid cable damage caused by strong pulling.
- (4) RF cables should be separated from power cables; If the site condition are limited, installing RF cables and power cables together may affect product performance.
- (5) Tighten all cable connections to ensure a good contact.
- (6) Offer waterproof treatment to the exposed cable ends to avoid oxidation.
- (7) Finish the cable layout

At last, plug the Power Supply into wall outlet and enjoy your boosted cell signal!

The Specification of Boosters' Ports:

Port Name	Port Description
DC12V	12V Input
OUTDOOR/BTS	The reception of base station downlink signal, and the transmission of cell phone uplink signal
INDOOR/MS	The transmission of base station downlink signal, and the reception of cell phone uplink signal

3.4.Switch on the power

After power is on, first check the alarm and power LEDs.

The status and definition of POWER indicators:

Status	Definition	Solution
POWER(Green) LTE-V(Yellow) LTE-A(Yellow)	This indicates that your booster is functioning properly and there are no issues with installation.	
Light Off	DC power problem	verify your power supply has power
POWER(Green) LTE-V(Red) LTE-A(Red)	Band has shutoff. This is due to a feedback loop condition called oscillation. This is a built in safety feature that causes a band to shut off to prevent harmful interference with a nearby cell tower.	Verify Outside Antenna faces away from the Inside Antenna.Un-plug power supply. Tighten all cable connections (be sure to handtighten only, do NOT use tools). Increase the distance (horizontally or vertically) between the Outside and Inside antenna. Add included cable if needed. Re-plug in power supply.

3.5. Check Coverage

(1) Perform a test with a mobile phone or data card Check below:

- - A weak input signal leads to the low output power. Need to change the direction of outdoor antenna or its installation position or replace outdoor antenna with higher gain antenna to increase input signal power level.
- Check whether it is necessary to add more Indoor antennas' sine barriers to block the signal penetration, and check whether the repeater's power is enough.
- Install more Indoor antennas or replace with a repeater of higher power level.

(2) If the signals in small part of the areas have not been improved, please check below:

- - Check whether the service antenna is installed correctly or not, you may need to move the antenna location to improve coverage.
- - Check if it is necessary to adjust the direction of the service antenna.
- - Check whether it is necessary to add one or more antennas to enhance the coverage of special areas.

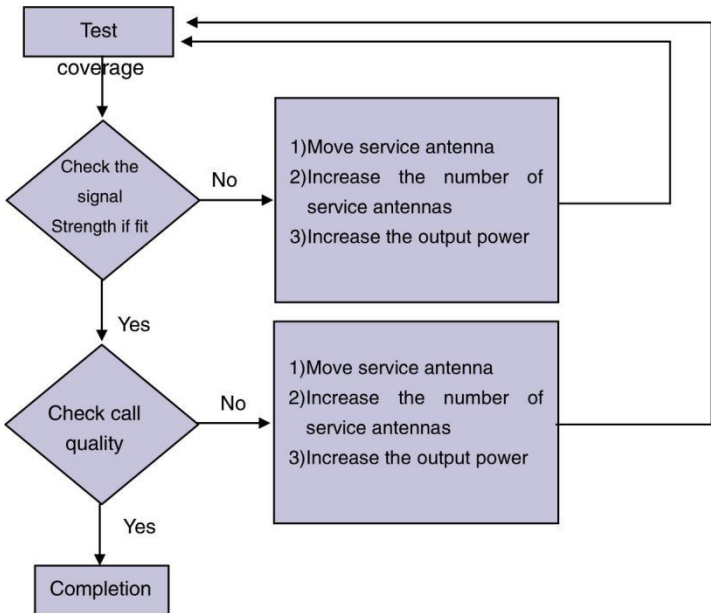

4. Attention

1. The signal booster will only work with the correct frequency, so please make sure your phone signal is with the same frequency as the signal booster.
2. This cell phone signal booster will only make a weak signal stronger, it can't create a signal. That means it won't work if the outdoor antenna can't receive any signal.
3. The outdoor antenna should receive 2-3 bars of stable signal in the location where the outdoor antenna is fixed; otherwise, the booster won't work very well.
4. Must connect the antennas first, and then switch on the power; otherwise, may damage the repeater.
5. Determine the best location where the highest signal strength is received on your phone (most amount of bars). Once you ascertain the best location, then permanently mount the outdoor antenna. Keep the distance between the outdoor antenna and indoor antenna more than **39ft** and make sure that there is a proper physical separation between the outdoor antenna and indoor antenna. The above things are of critical importance to the boosters' normal working .

Reason 1: There are loose or wrong connections in the repeater system.

Solution: Check that the connections between the different parts of the system are hooked up correctly and tightly.

Reason 2: The signals of other operators nearby received by outdoor antenna are too strong. (For example, the other operator's signals are 10 db stronger than the needed signals).

Solution 1: Change the direction of outdoor antenna or its installation position, so that the gap of signal strength is reduced between operators.

Solution 2: Use barriers (like buildings) to block signals of other operators.

FCC Statement

Changes or modifications not expressly approved by the party responsible for compliance could void the user's authority to operate the equipment.

This equipment has been tested and found to comply with the limits for a Class B digital device, pursuant to Part 15 of the FCC Rules. These limits are designed to provide reasonable protection against harmful interference in a residential installation. This equipment generates uses and can radiate radio frequency energy and, if not installed and used in accordance with the instructions, may cause harmful interference to radio communications. However, there is no guarantee that interference will not occur in a particular installation. If this equipment does cause harmful interference to radio or television reception, which can be determined by turning the equipment off and on, the user is encouraged to try to correct the interference by one or more of the following measures:

- Reorient or relocate the receiving antenna.
- Increase the separation between the equipment and receiver.
- Connect the equipment into an outlet on a circuit different from that to which the receiver is connected.
- Consult the dealer or an experienced radio/TV technician for help

This device complies with part 15 of the FCC rules. Operation is subject to the following two conditions (1) this device may not cause harmful interference, and (2) this device must accept any interference received, including interference that may cause undesired operation.



Remark:

Increase the output power*---Recommended ways: adjust the outdoor antenna direction/location, or replace with a higher gain antenna to increase input signal strength.

You should receive the Mobile Booster kit which includes the similar above-

5. Troubleshooting :

mentioned fittings. Before using it, please confirm that your Booster's frequency range is the same as your service provider's network, otherwise, the amplifier will not work properly.

Q1: Red Light on Booster Means the Self-oscillating Alarm.

- A. Increase the distance (horizontally or vertically) between the Outside and Inside antenna; Verify there is wall isolation between them.Unplug and re-plug in power supply.
- B. Tighten all cable connections (be sure to hand-tighten only, do NOT use tools).Unplug and re-plug in power supply.
- C. Verify the receiving antenna if be damaged.
- D. Adjust the location of outside antenna.Unplug and re-plug in power supply.

Q2: The booster's light is not on.

- A.Unplug and re-plug in power supply.
- B.Re-connect the DC12V port on booster

Q3: All lights is normal, but there is not any change with signal strength.

- A.Verify the receiving antenna if be damaged.
- B.Tighten all cable connections (be sure to hand-tighten only, do NOT use tools).
- C.Verify whether the outside and inside antennas connects to correct booster's port.
- D.Verify whether the booster's frequency is corresponding with cell phone frequency.

Q4: After finishing the installation, cell phone signal is improved but can't make a call.

- A. Verify outside antenna is mounted correctly.
- B. Verify the location mounting outside antenna has stable signal, and confirm the direction of outside antenna is pointed towards to the cell tower.
- C. Verify whether the local operator's communication frequency is consistent with booster's frequency.

Q5: Phone calls and Internet access are in poor quality.

- A. Adjust the direction of outside antenna and keep it point towards the nearest cell tower.
- B. Re-route the cable from outside antenna to booster (Don't bend the cable too much, trying to choose straight line).
- C. Verify the distance between outside and inside antennas is over 40 feet (Too close distance may result in self-oscillating), and there should have wall isolation between them. It is recommended that inside and outside antennas don't be mounted on the same horizontal level.

Q6. Cell phone signal is improved but the coverage is unsatisfied.

- A. Adjust the angle of whip antenna.
- B. Verify the place mounting outside antenna receives a strong enough signal.
- C. Tighten all cable connections.

Q7. How to register the booster with Serial Number ?

Not all of consumers require to register the booster . It depends on your area location requirement. with registration steps for your reference

Step 1: Open the following registration Link given



www.waveform.com/pages/guide-to-signal-booster-registration

Step 2: Find out mobile phone service provider that compatible with your booster.
Click and Enter

Step 3: Fill in your Location information and Booster's Serial Number,
The Serial Number is the FCC ID,(on the label on the back of Booster unit)

6.Safety Reminder & Warning:

The Federal Communications Commission (FCC) has tested this product and found it to comply with their RF Exposure Requirements, pursuant to FCC Part 22 and 24.

Don't expose this product to extreme low or high temperature (-20°C and 55°C).

There are no consumer serviceable or modifiable parts inside this booster product. Alteration or abuse of the booster or other components will void this product's warranty, and could be dangerous to the user.



Repeater should follow system requirement of communication equipment, assure good grounding and lightning protection.



The power supply voltage of repeater should meet the standards of security requirement; any operation shall be carried out only after cutting off only the professional is authorized for the operation.



Do not dismantle machine, maintain or displace accessories by yourself, because in this way, the repeater, touch the module of repeater, or module to touch the electronic component. The components will be damaged due to electrostatic.



Do not open the repeater, touch the module of repeater, or module to the electronic component. The components will be damaged due to electrostatic.

This is a CONSUMER device.

BEFORE USE, you **MUST REGISTER THIS DEVICE** with your wireless provider and have your provider's consent to the use of signal boosters. Most wireless providers consent to the use of signal boosters. Some providers may not consent to the use of this device on their network. If you are unsure, contact your provider.

You **MUST** operate this device with approved antennas and cables as specified by the manufacturer. Antennas **MUST** be installed at least 20 cm (8 inches) from any person.

You **MUST** cease operating this device immediately if requested by the **FCC** or a licensed wireless service provider.





WARNING. E911 location information may not be provided or may be inaccurate for calls served by using this device.



This device may be operated **ONLY** in a fixed location for in-building use.







7. Warranty



30-day money-back guarantee, 3-month free replacement, 2-year manufacturer warranty

Our Signal Boosters are warranted for 2 years against defects in workmanship or materials. Warranty cases may be resolved by returning the product directly to the manufacturer at the consumer's expense, with a dated proof of purchase and an Order Number supplied. We shall either repair or replace the product at its option. This warranty does not apply to any Signal Boosters determined by us to have been subjected to misuse, abuse, neglect, or mishandling that alters or damages physical or electronic properties. Replacement products may include refurbished products that have been re-certified to conform with product specifications.

Photo	Name	Frequency(MHz)	Gain(dBi)	Cabel Loss(dB)
	Indoor Whip Antenna	698-716	3	/
		728-746	3	/
		746-757	3	/
		776-787	3	/
	Indoor Panel Antenna	698-716	6	1.2
		728-746	6	1.3
		746-757	5.5	1.3
		776-787	5.5	1.3
	Outdoor Yagi Antenna	698-716	6	3.5
		728-746	6	3.6
		746-757	6	3.7
		776-787	6	3.7
	Outdoor Panel Antenna	698-716	5	3.5
		728-746	5	3.6
		746-757	5	3.7
		776-787	5	3.7

	Outdoor Omni Antenna	698-716	4	3.5
		728-746	4	3.6
		746-757	3.5	3.7
		776-787	3.5	3.7
	Outdoor LPDA Antenna	698-716	8	3.5
		728-746	8	3.6
		746-757	8	3.7
		776-787	8	3.7

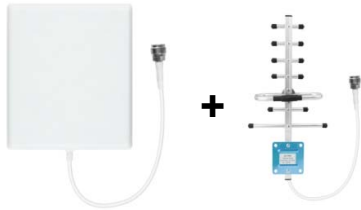
Default matching Antenna			
	+		Indoor Whip Antenna + Outdoor Yagi Antenna
	+		Indoor Whip Antenna + Outdoor Omni Antenna
	+		Indoor Whip Antenna + Outdoor LPDA Antenna

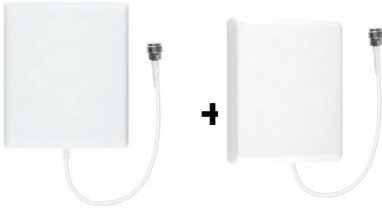
	<p>Indoor Panel Antenna + Outdoor Yagi Antenna</p>
	<p>Indoor Panel Antenna + Outdoor Omni Antenna</p>
	<p>Indoor Panel Antenna + Outdoor LPDA Antenna</p>
	<p>Indoor Panel Antenna + Outdoor Panel Antenna</p>

Warning : Unauthorized antennas , , cables and/or coupling devices are prohibited by FCC rules. Please contact FCC for details : 1-888-CALL-FCC