

802.11ac-VHT40 6dB Bandwidth

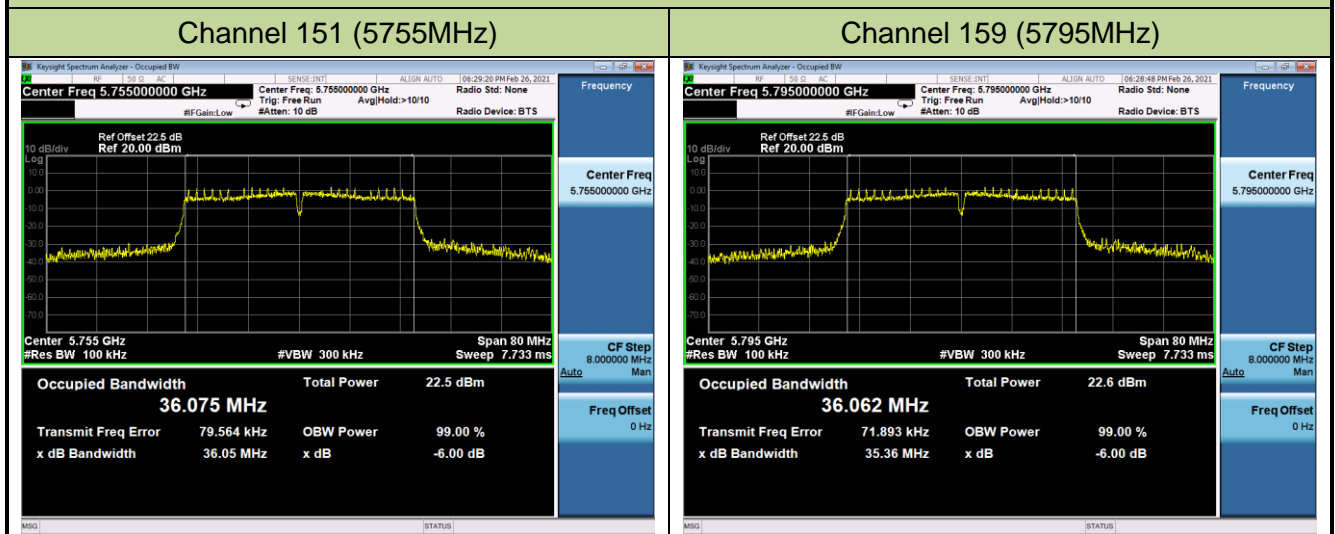

802.11ac-VHT80 6dB Bandwidth

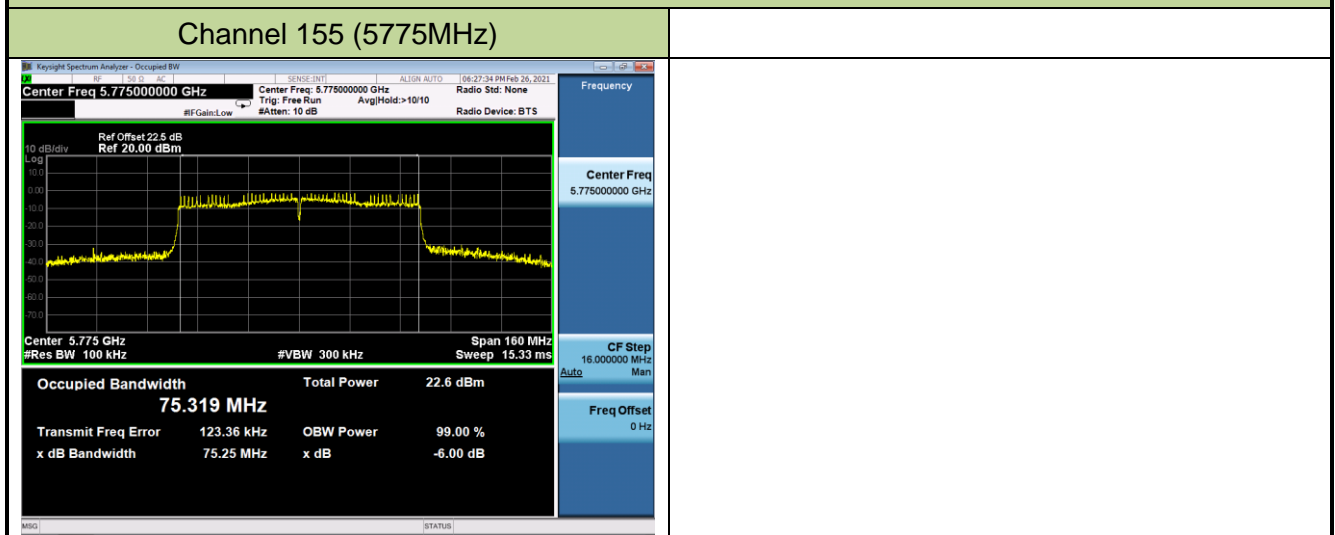

7.4. Output Power Measurement

7.4.1. Test Limit

For an outdoor access point operating in the band 5.15-5.25 GHz, the maximum conducted output power over the frequency band of operation shall not exceed 1 W provided the maximum antenna gain does not exceed 6 dBi. In addition, the maximum power spectral density shall not exceed 17 dBm in any 1 megahertz band. If transmitting antennas of directional gain greater than 6 dBi are used, both the maximum conducted output power and the maximum power spectral density shall be reduced by the amount in dB that the directional gain of the antenna exceeds 6 dBi. The maximum e.i.r.p. at any elevation angle above 30 degrees as measured from the horizon must not exceed 125 mW (21 dBm)

For the 5.25-5.35 GHz and 5.47-5.725 GHz bands, the maximum conducted output power over the frequency bands of operation shall not exceed the lesser of 250 mW or $11 \text{ dBm} + 10 \log B$, where B is the 26 dB emission bandwidth in megahertz.

For the band 5.725-5.85 GHz, the maximum conducted output power over the frequency band of operation shall not exceed 1 W (30dBm).

If transmitting antennas of directional gain greater than 6dBi are used, the maximumconducted output power shall be reduced by the amount in dB that the directional gain of theantenna exceeds 6dBi.

7.4.2. Test Procedure Used

KDB 789033D02v02r01- Section E)3)b) Method PM-G

7.4.3. Test Setting

Average power measurements were perform only when the EUT was transmitting at its maximum power control level using a broadband power meter with a pulse sensor. The power meter implemented triggering and gating capabilities which were set up such that power measurements were recorded only during the ON time of the transmitter.

7.4.4. Test Setup

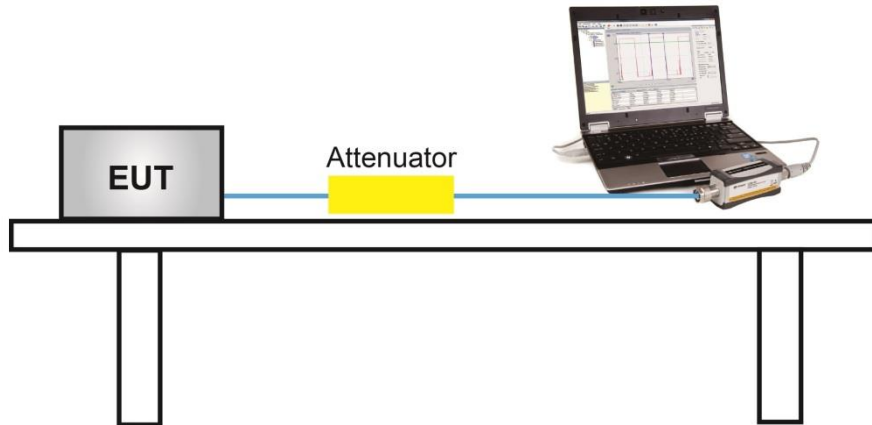

7.4.5. Test Result

Product	Cassia Bluetooth Router	Test Engineer	Eric Lin
Test Site	SR1	Test Date	2021/02/25

Test Mode	Data Rate/ MCS	Channel No.	Freq. (MHz)	Average Power (dBm)	Power Limit (dBm)	Result
11a	6Mbps	36	5180	12.70	≤ 29.40	Pass
11a	6Mbps	44	5220	15.17	≤ 29.40	Pass
11a	6Mbps	48	5240	15.15	≤ 29.40	Pass
11a	6Mbps	52	5260	15.15	≤ 23.38	Pass
11a	6Mbps	60	5300	15.01	≤ 23.38	Pass
11a	6Mbps	64	5320	12.59	≤ 23.38	Pass
11a	6Mbps	100	5500	11.82	≤ 23.38	Pass
11a	6Mbps	116	5580	15.52	≤ 23.38	Pass
11a	6Mbps	140	5700	10.25	≤ 23.38	Pass
11a	6Mbps	144	5720	15.73	≤ 22.32	Pass
11a	6Mbps	149	5745	15.92	≤ 28.70	Pass
11a	6Mbps	157	5785	15.72	≤ 28.70	Pass
11a	6Mbps	165	5825	15.70	≤ 28.70	Pass
11ac-VHT20	MCS0	36	5180	13.21	≤ 29.40	Pass
11ac-VHT20	MCS0	40	5220	14.81	≤ 29.40	Pass
11ac-VHT20	MCS0	48	5240	14.78	≤ 29.40	Pass
11ac-VHT20	MCS0	52	5260	14.90	≤ 23.38	Pass
11ac-VHT20	MCS0	60	5300	14.77	≤ 23.38	Pass
11ac-VHT20	MCS0	64	5320	12.99	≤ 23.38	Pass
11ac-VHT20	MCS0	100	5500	12.28	≤ 23.38	Pass
11ac-VHT20	MCS0	116	5580	15.03	≤ 23.38	Pass
11ac-VHT20	MCS0	140	5700	11.93	≤ 23.38	Pass
11ac-VHT20	MCS0	144	5720	15.28	≤ 22.41	Pass
11ac-VHT20	MCS0	149	5745	15.38	≤ 28.70	Pass
11ac-VHT20	MCS0	157	5785	15.41	≤ 28.70	Pass
11ac-VHT20	MCS0	165	5825	15.17	≤ 28.70	Pass

Test Mode	Data Rate/ MCS	Channel No.	Freq. (MHz)	Average Power (dBm)	Power Limit (dBm)	Result
11ac-VHT40	MCS0	38	5190	12.67	≤ 29.40	Pass
11ac-VHT40	MCS0	46	5230	14.29	≤ 29.40	Pass
11ac-VHT40	MCS0	54	5270	14.36	≤ 23.38	Pass
11ac-VHT40	MCS0	62	5310	10.88	≤ 23.38	Pass
11ac-VHT40	MCS0	102	5510	11.14	≤ 23.38	Pass
11ac-VHT40	MCS0	110	5550	14.72	≤ 23.38	Pass
11ac-VHT40	MCS0	134	5670	15.05	≤ 23.38	Pass
11ac-VHT40	MCS0	142	5710	15.18	≤ 23.38	Pass
11ac-VHT40	MCS0	151	5755	15.09	≤ 28.70	Pass
11ac-VHT40	MCS0	159	5795	15.14	≤ 28.70	Pass
11ac-VHT80	MCS0	42	5210	6.43	≤ 29.40	Pass
11ac-VHT80	MCS0	58	5290	6.35	≤ 23.38	Pass
11ac-VHT80	MCS0	106	5530	5.79	≤ 23.38	Pass
11ac-VHT80	MCS0	122	5610	13.95	≤ 23.38	Pass
11ac-VHT80	MCS0	138	5690	14.06	≤ 23.38	Pass
11ac-VHT80	MCS0	155	5775	14.19	≤ 28.70	Pass

Note:

For 5150 – 5250MHz, Power Limit (dBm) = $30 - (6.6 - 6) = 29.40\text{dBm}$

For 5250 - 5350MHz and 5470 - 5725MHz Band: Power Limit (dBm) = $23.98 - (6.6 - 6) = 23.38\text{dBm}$.

For 5725 - 5850MHz Bands: Power Limit (dBm) = $30 - (7.3 - 6) = 28.70\text{dBm}$.

For Channel 144 (5720MHz), Power Limit (dBm) = $11 + 10 \cdot \log(5\text{MHz} + \text{BW}_{26\text{dB}}/2) - (6.6 - 6)$

7.5. Transmit Power Control

7.5.1. Test Limit

The U-NII device is required to have the capability to operate at least 6 dB below the mean EIRP value of 30 dBm.

7.5.2. Test Procedure Used

KDB 789033 D02v01- Section E)3)b) Method PM-G

7.5.3. Test Setting

Average power measurements were performed only when the EUT was transmitting at its maximum power control level using a broadband power meter with a pulse sensor. The power meter implemented triggering and gating capabilities which were set up such that power measurements were recorded only during the ON time of the transmitter. The trace was averaged over 100 traces to obtain the final measured average power.

7.5.4. Test Setup

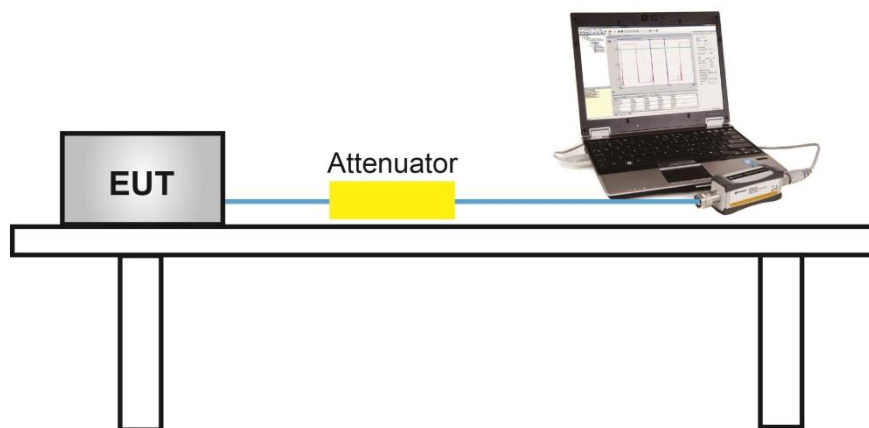

7.5.5. Test Result

A TPC mechanism is not required for systems with an e.i.r.p. of less than 500 mW.

7.6. Power Spectral Density Measurement

7.6.1. Test Limit

For the band 5.15-5.25 GHz, the maximum power spectral density shall not exceed 17 dBm in any 1 megahertz band.

For the 5.25-5.35 GHz and 5.47-5.725 GHz bands, the maximum power spectral density shall not exceed 11 dBm in any 1 megahertz band.

For the band 5.725-5.85 GHz, the maximum power spectral density shall not exceed 30 dBm in any 500-kHz band.

If transmitting antennas of directional gain greater than 6dBi are used, the peak power spectral density shall be reduced by the amount in dB that the directional gain of the antenna exceeds 6dBi.

7.6.2. Test Procedure Used

KDB 789033 D02v02r01-SectionF

7.6.3. Test Setting

1. Analyzer was set to the center frequency of the UNII channel under investigation
2. Span was set to encompass the entire 26dB EBW of the signal.
3. RBW = 1MHz, if measurement bandwidth of Maximum PSD is specified in 500 kHz,
RBW = 510 kHz
4. VBW = 3MHz
5. Number of sweep points $\geq 2 \times (\text{span} / \text{RBW})$
6. Detector = power averaging (Average)
7. Sweep time = auto
8. Trigger = free run
9. Use the peak search function on the instrument to find the peak of the spectrum and record its value.
10. Add $10 \cdot \log(1/x)$, where x is the duty cycle, to the measured power in order to compute the average power during the actual transmission times (because the measurement represents an average over both the on and off times of the transmission). For example, add $10 \cdot \log(1/0.25) = 6$ dB if the duty cycle is 25 percent.

7.6.4. Test Setup

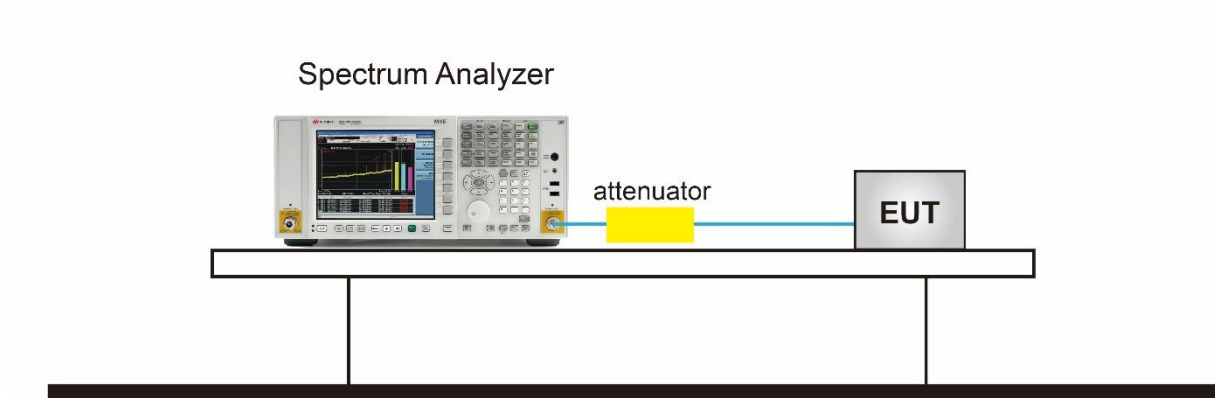

7.6.5. Test Result

Product	Cassia Bluetooth Router	Test Engineer	Eric Lin
Test Site	SR1	Test Date	2021/02/25 ~2021/02/26
Mode	Power Spectral Density (U-NII- 1/-2a / -2c)		

Test Mode	Data Rate /MCS	Ch. No.	Freq. (MHz)	PSD (dBm/ MHz)	Duty Cycle (%)	Total PSD (dBm/ MHz)	PSD Limit (dBm/MHz)	Result
11a	6Mbps	36	5180	2.55	93.27	2.85	≤ 16.40	Pass
11a	6Mbps	44	5220	5.41	93.27	5.72	≤ 16.40	Pass
11a	6Mbps	48	5240	5.20	93.27	5.50	≤ 16.40	Pass
11a	6Mbps	52	5260	5.55	93.27	5.85	≤ 10.40	Pass
11a	6Mbps	60	5300	5.56	93.27	5.87	≤ 10.40	Pass
11a	6Mbps	64	5320	2.38	93.27	2.68	≤ 10.40	Pass
11a	6Mbps	100	5500	1.98	93.27	2.29	≤ 10.40	Pass
11a	6Mbps	116	5580	6.14	93.27	6.44	≤ 10.40	Pass
11a	6Mbps	140	5700	0.71	93.27	1.01	≤ 10.40	Pass
11a	6Mbps	144	5720	6.31	93.27	6.61	≤ 10.40	Pass
11ac-VHT20	MCS0	36	5180	2.69	93.02	2.69	≤ 16.40	Pass
11ac-VHT20	MCS0	40	5220	4.19	93.02	4.19	≤ 16.40	Pass
11ac-VHT20	MCS0	48	5240	4.57	93.02	4.57	≤ 16.40	Pass
11ac-VHT20	MCS0	52	5260	4.70	93.02	4.70	≤ 10.40	Pass
11ac-VHT20	MCS0	60	5300	5.08	93.02	5.08	≤ 10.40	Pass
11ac-VHT20	MCS0	64	5320	3.40	93.02	3.40	≤ 10.40	Pass
11ac-VHT20	MCS0	100	5500	2.19	93.02	2.19	≤ 10.40	Pass
11ac-VHT20	MCS0	116	5580	4.87	93.02	4.87	≤ 10.40	Pass
11ac-VHT20	MCS0	140	5700	1.69	93.02	1.69	≤ 10.40	Pass
11ac-VHT20	MCS0	144	5720	5.29	93.02	5.29	≤ 10.40	Pass
11ac-VHT40	MCS0	38	5190	0.30	92.81	0.62	≤ 16.40	Pass
11ac-VHT40	MCS0	46	5230	1.48	92.81	1.80	≤ 16.40	Pass
11ac-VHT40	MCS0	54	5270	1.32	92.81	1.65	≤ 10.40	Pass
11ac-VHT40	MCS0	62	5310	-2.23	92.81	-1.90	≤ 10.40	Pass
11ac-VHT40	MCS0	102	5510	-1.81	92.81	-1.49	≤ 10.40	Pass
11ac-VHT40	MCS0	110	5550	1.64	92.81	1.96	≤ 10.40	Pass
11ac-VHT40	MCS0	134	5670	1.98	92.81	2.31	≤ 10.40	Pass
11ac-VHT40	MCS0	142	5710	2.07	92.81	2.39	≤ 10.40	Pass

Test Mode	Data Rate /MCS	Ch. No.	Freq. (MHz)	PSD (dBm/ MHz)	Duty Cycle (%)	Total PSD (dBm/ MHz)	PSD Limit (dBm/MHz)	Result
11ac-VHT80	MCS0	42	5210	-9.98	76.57	-8.82	≤ 16.40	Pass
11ac-VHT80	MCS0	58	5290	-9.48	76.57	-8.32	≤ 10.40	Pass
11ac-VHT80	MCS0	106	5530	-10.35	76.57	-9.19	≤ 10.40	Pass
11ac-VHT80	MCS0	122	5610	-1.88	76.57	-0.72	≤ 10.40	Pass
11ac-VHT80	MCS0	138	5690	-1.79	76.57	-0.63	≤ 10.40	Pass

Note 1: When EUT duty cycle ≥ 98%, the total PSD (dBm/MHz) = PSD (dBm/MHz).

When EUT duty cycle < 98%, the total PSD (dBm/MHz) = PSD (dBm/MHz) + 10*log (1/Duty Cycle)(dBm/MHz).

Note 2:

For 5150 - 5250MHzBand: PSD Limit (dBm/MHz) = 17 - (6.6 - 6) = 16.40dBm/MHz.

For 5250 - 5350MHz and 5470 - 5725MHz Band: PSD Limit (dBm/MHz) = 11 - (6.6 - 6) = 10.40dBm/MHz.

Product	Cassia Bluetooth Router	Test Engineer	Eric Lin
Test Site	SR2	Test Date	2021/02/26
Test Item	Power Spectral Density (U-NII-3)		

Test Mode	Data Rate /MCS	Ch. No.	Freq. (MHz)	PSD (dBm/510kHz)	Duty Cycle (%)	Total PSD (dBm/510kHz)	Limit (dBm/500kHz)	Result
11a	6Mbps	149	5745	3.52	93.27	3.83	≤ 28.70	Pass
11a	6Mbps	157	5785	3.32	93.27	3.62	≤ 28.70	Pass
11a	6Mbps	165	5825	3.19	93.27	3.49	≤ 28.70	Pass
11ac-VHT20	MCS0	149	5745	2.59	93.02	2.59	≤ 28.70	Pass
11ac-VHT20	MCS0	157	5785	2.77	93.02	2.77	≤ 28.70	Pass
11ac-VHT20	MCS0	165	5825	2.45	93.02	2.45	≤ 28.70	Pass
11ac-VHT40	MCS0	151	5755	-0.66	92.81	-0.33	≤ 28.70	Pass
11ac-VHT40	MCS0	159	5795	-0.63	92.81	-0.30	≤ 28.70	Pass
11ac-VHT80	MCS0	155	5775	-3.87	76.57	-2.71	≤ 28.70	Pass

Note 1: When EUT duty cycle ≥ 98%, the total PSD (dBm/500kHz) = PSD (dBm/510kHz).

When EUT duty cycle < 98%, the total PSD (dBm/500kHz) = PSD (dBm/510kHz) + 10*log (1/Duty Cycle).

Note 2: PSD Limit (dBm/500kHz) = 30 - (7.3 - 6) = 28.70dBm/500kHz.

802.11a Power Spectral Density

Channel 36 (5180MHz)

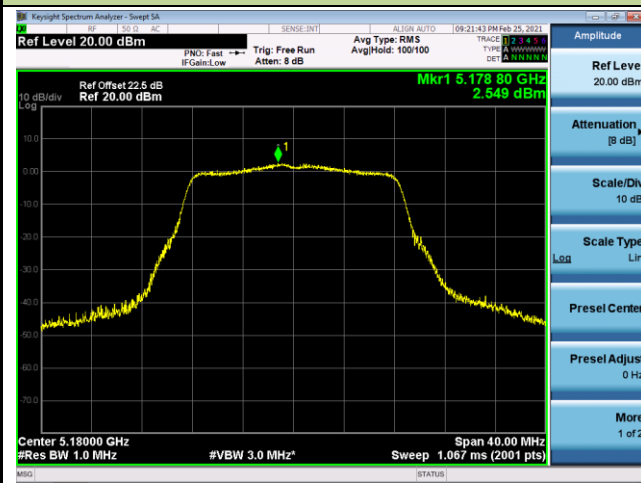

Channel 44 (5220MHz)



Channel 48 (5240MHz)



Channel 52 (5260MHz)

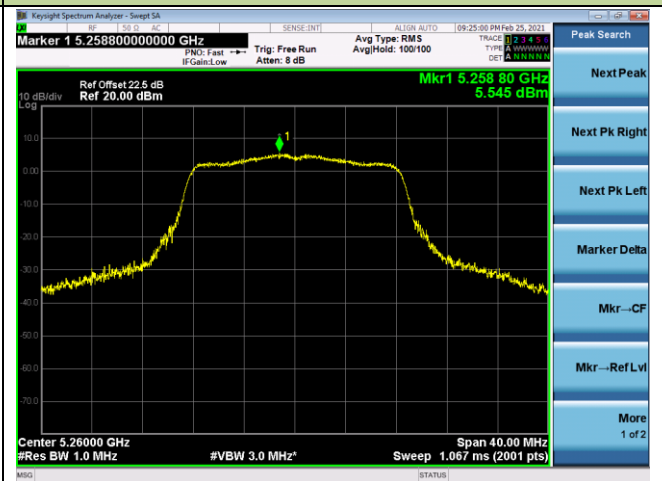

Channel 60 (5300MHz)

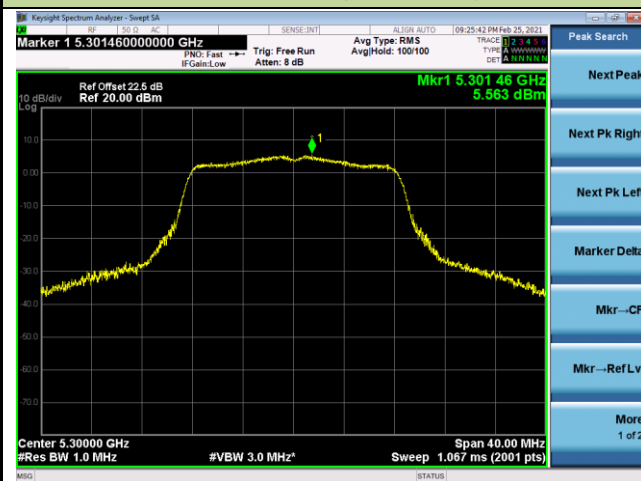

Channel 64 (5320MHz)

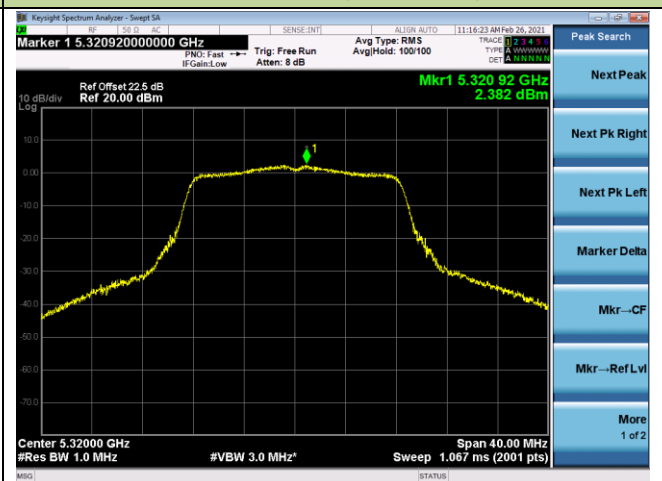

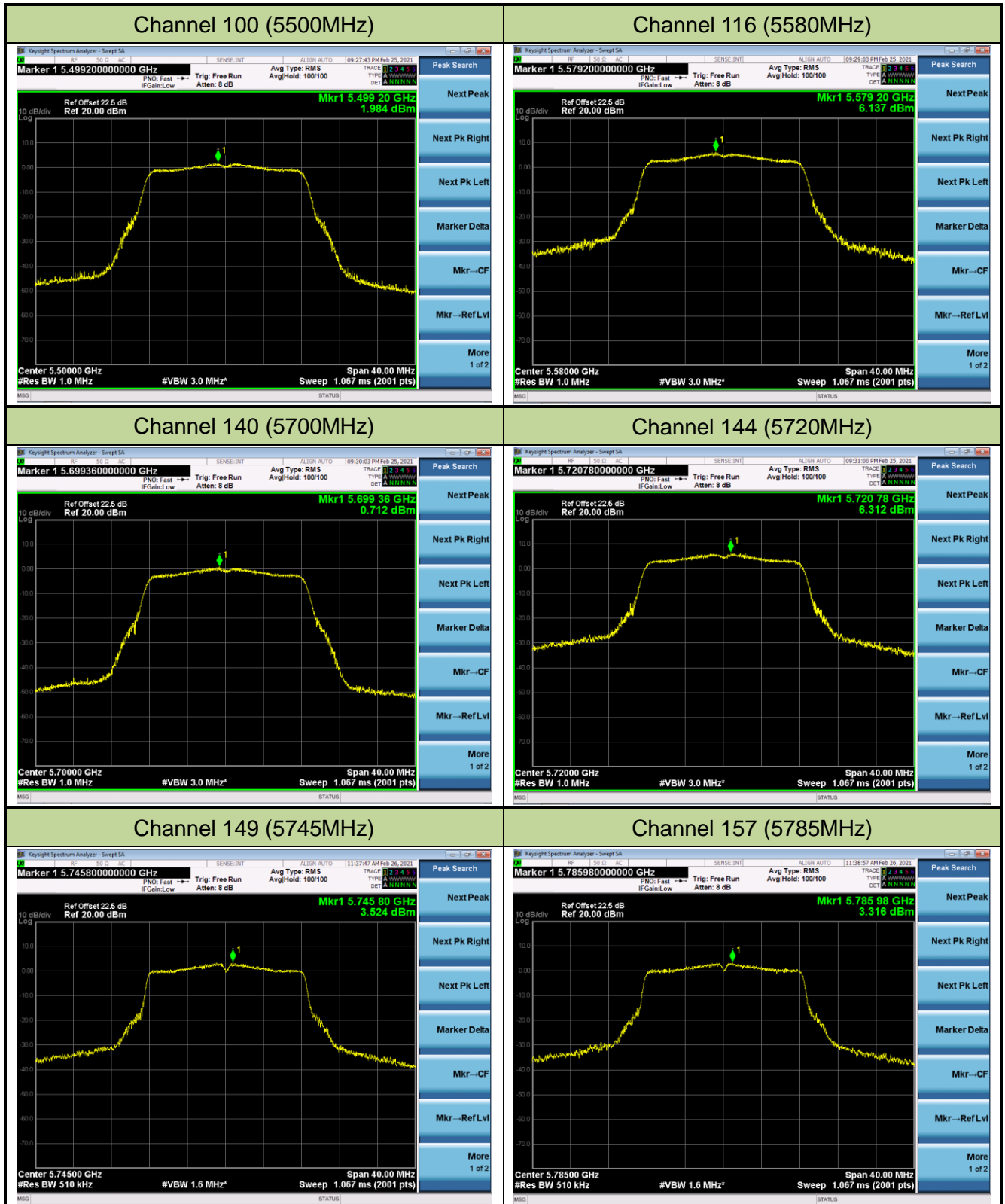

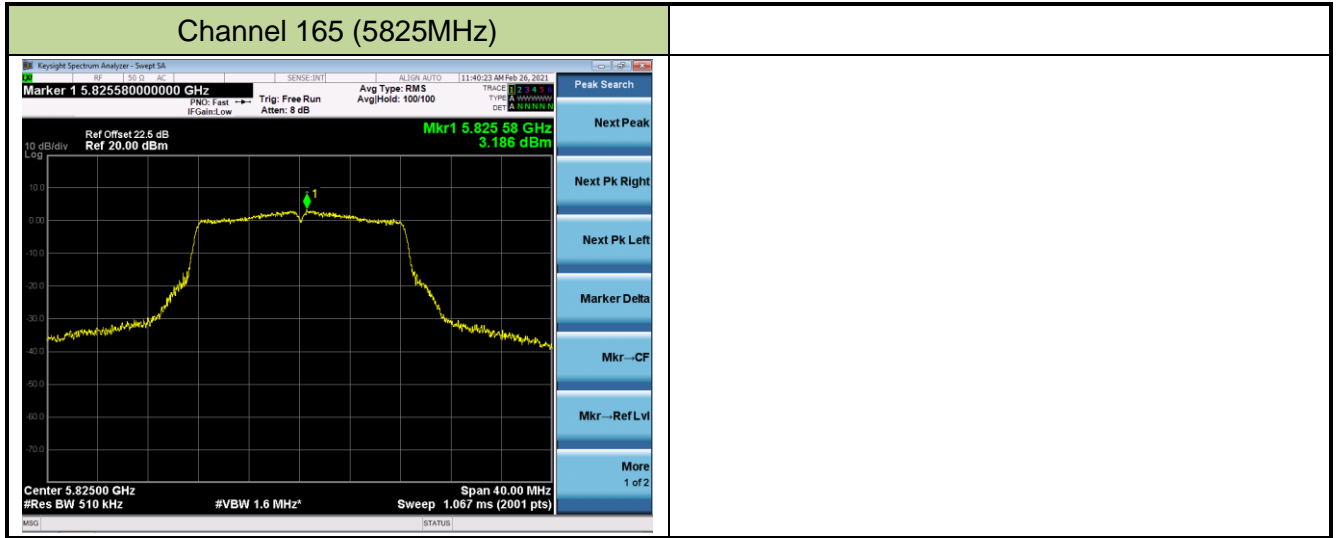

802.11ac-VHT20 Power Spectral Density

Channel 36 (5180MHz)

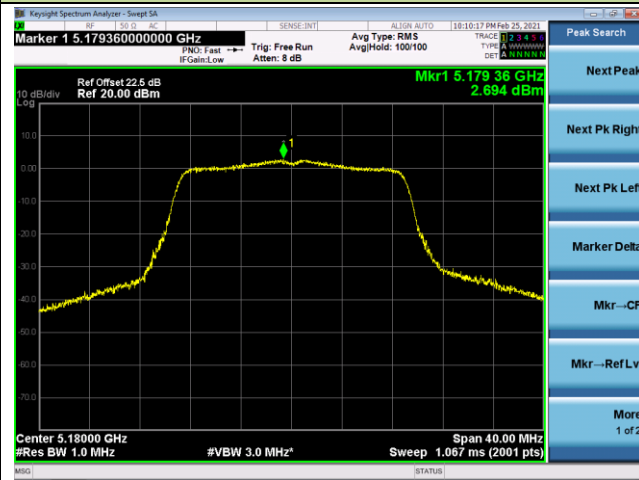

Channel 44 (5220MHz)



Channel 48 (5240MHz)

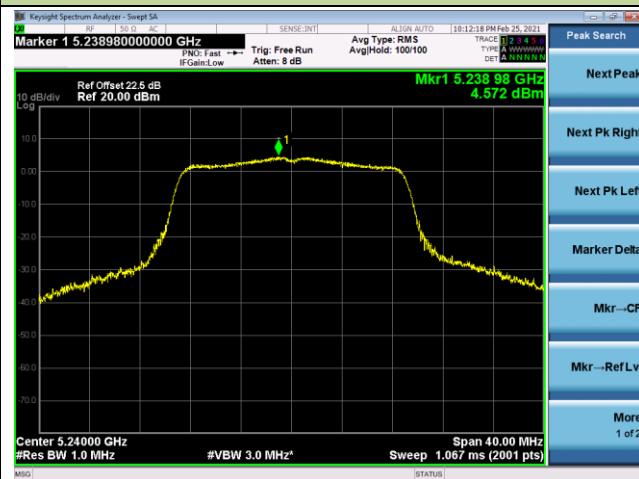

Channel 52 (5260MHz)



Channel 60 (5300MHz)

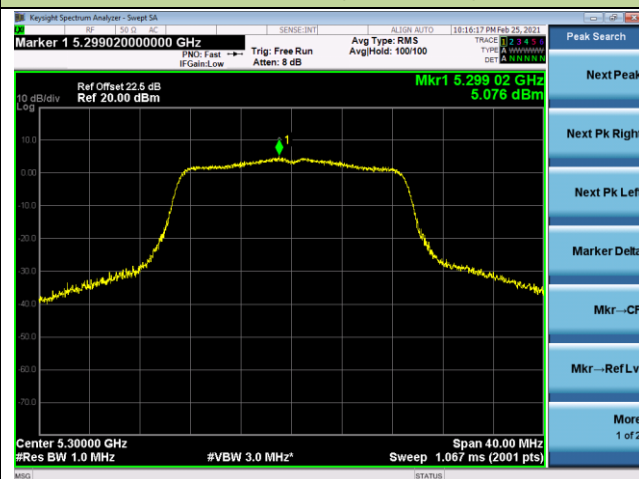

Channel 64 (5320MHz)

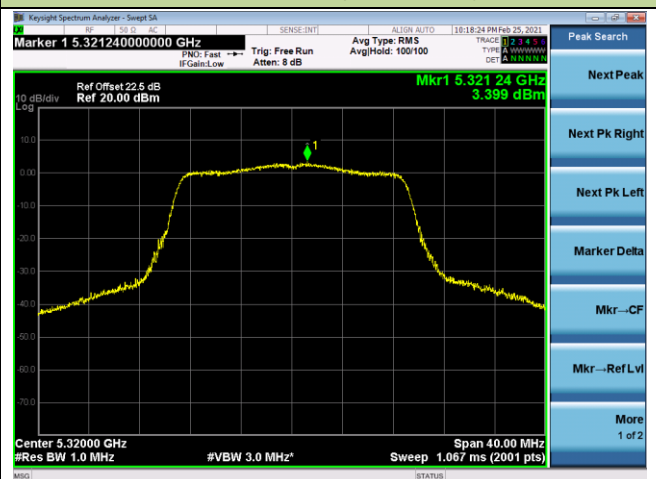

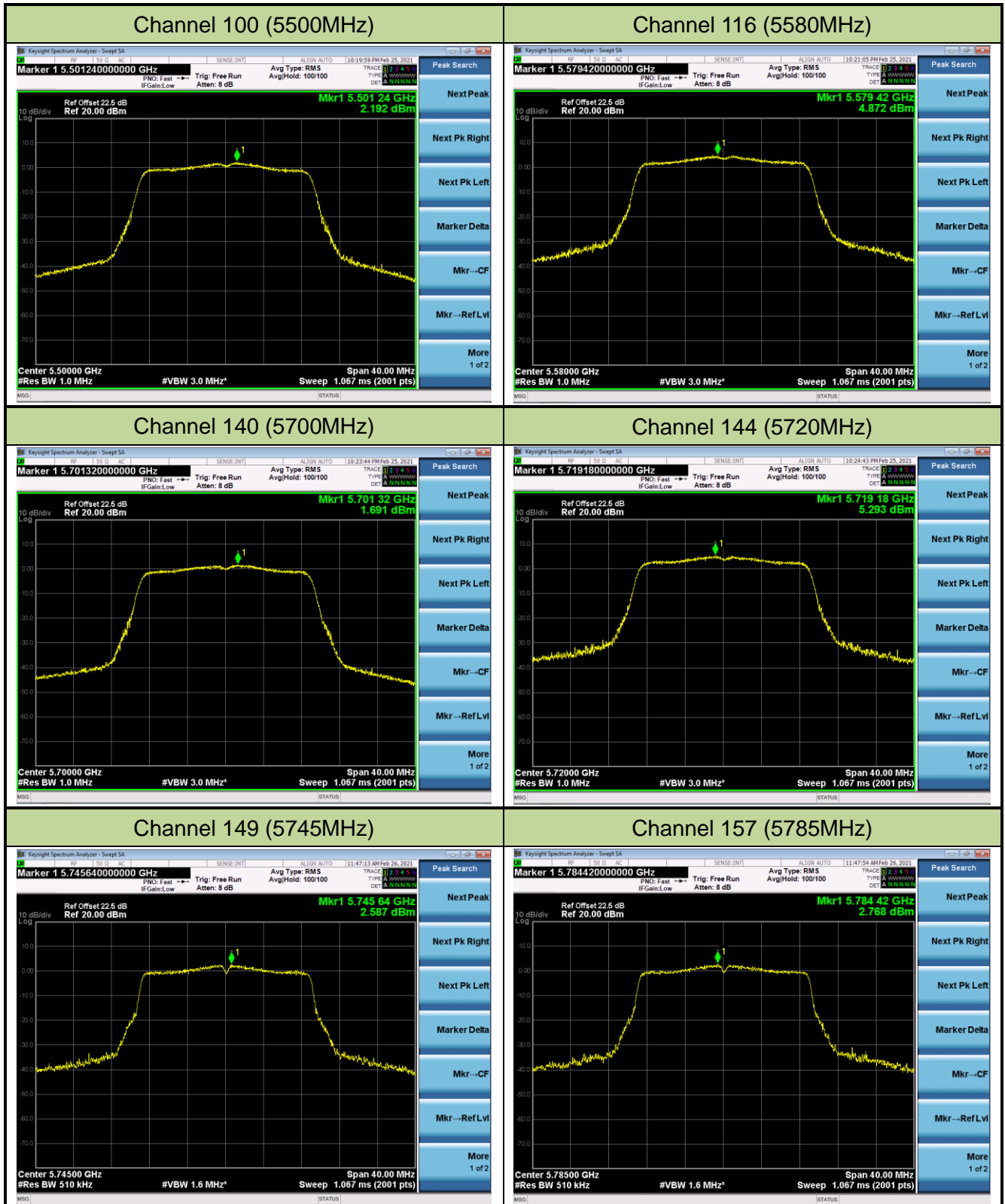

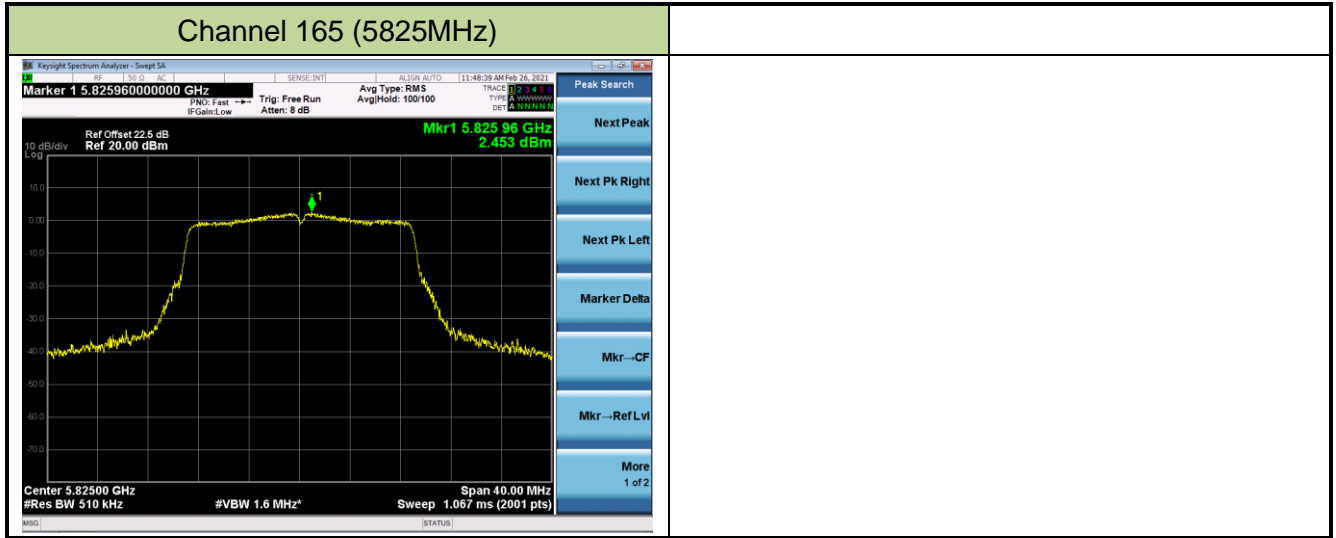

802.11ac-VHT40 Power Spectral Density

Channel 38 (5190MHz)

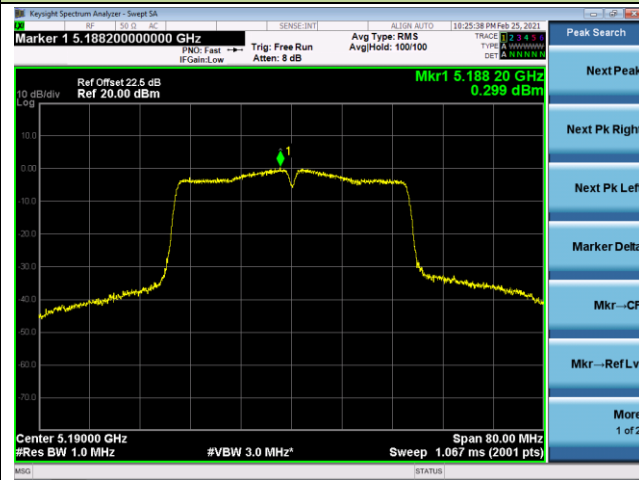

Channel 46 (5230MHz)

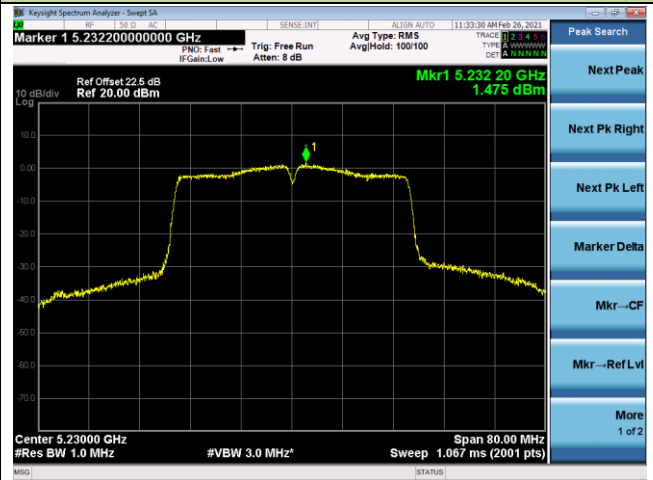

Channel 54 (5270MHz)



Channel 62 (5310MHz)

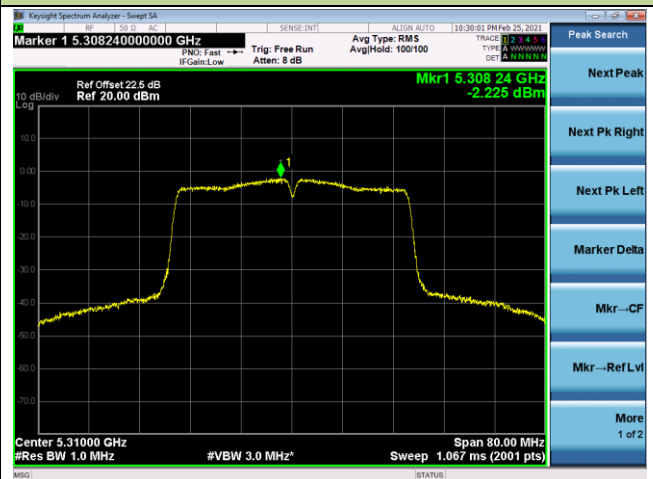

Channel 102 (5510MHz)

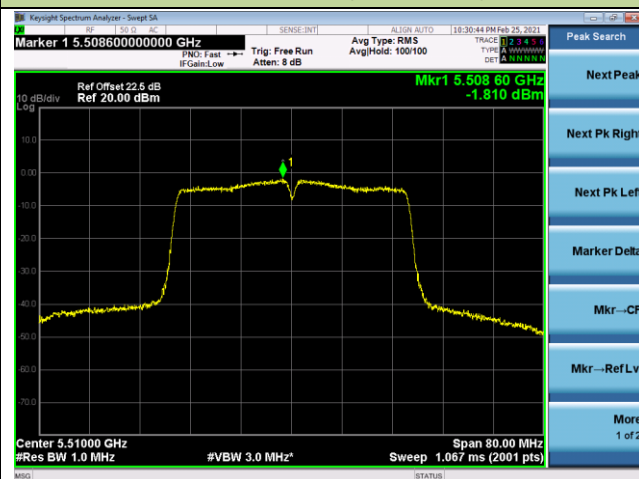

Channel 110 (5550MHz)

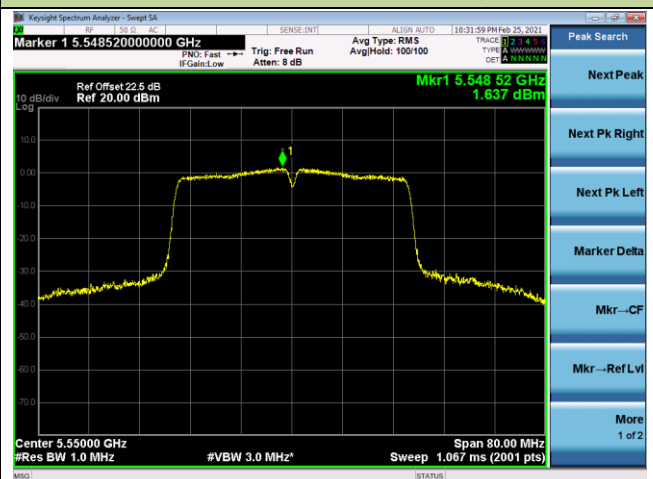

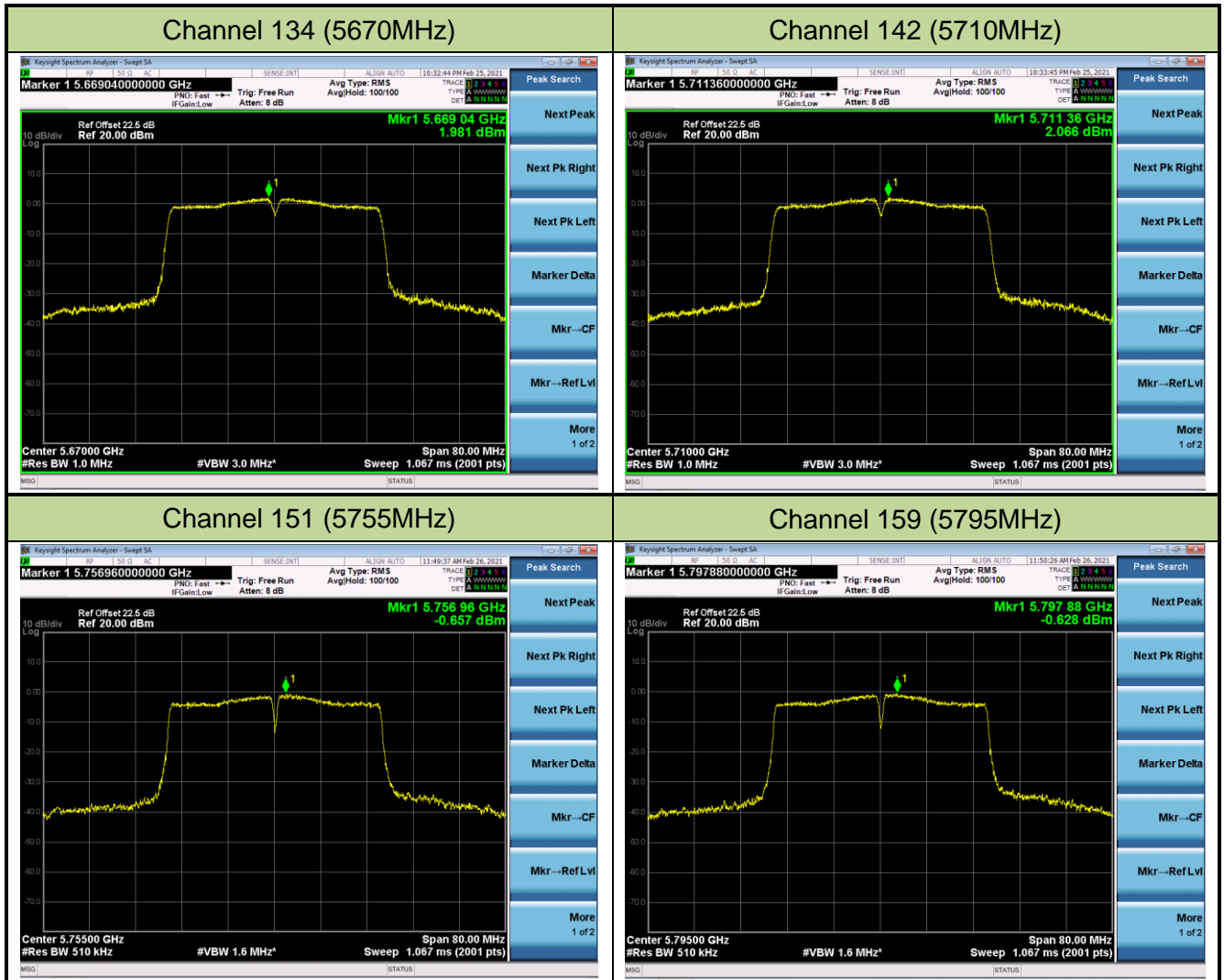

802.11ac-VHT80 Power Spectral Density

Channel 42 (5210MHz)

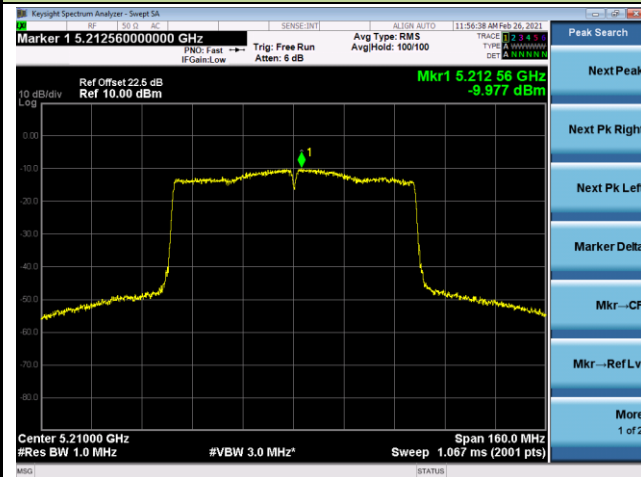

Channel 58 (5290MHz)

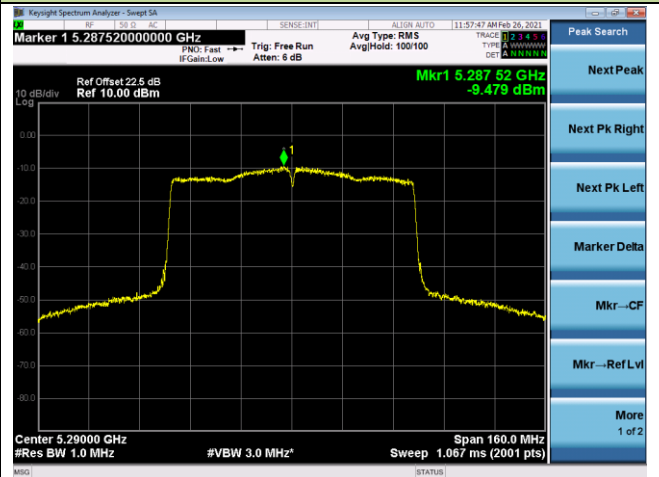

Channel 106 (5530MHz)

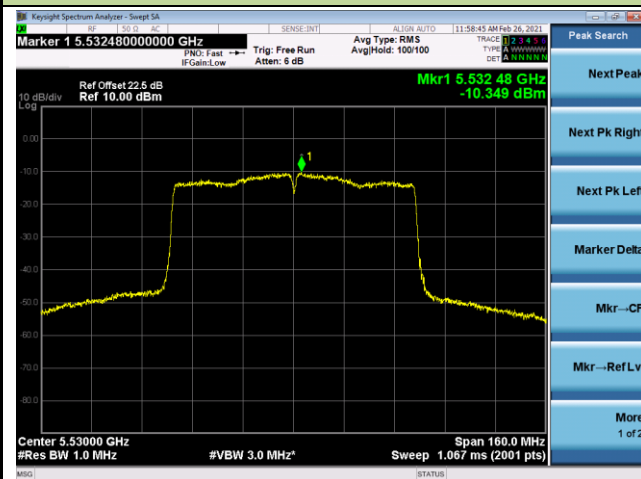

Channel 122 (5610MHz)



Channel 138 (5690MHz)

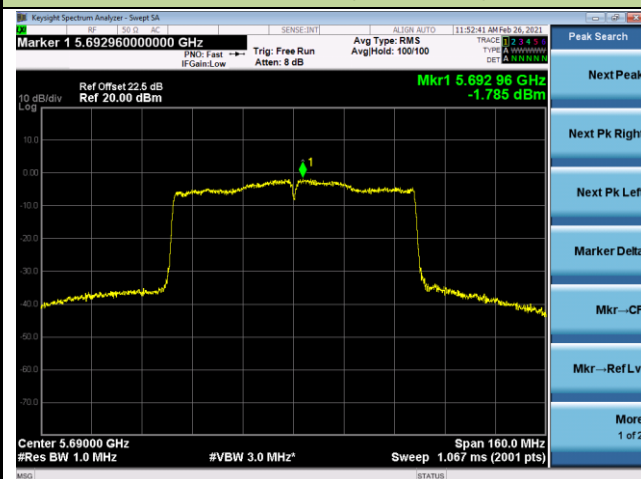

Channel 155 (5775MHz)

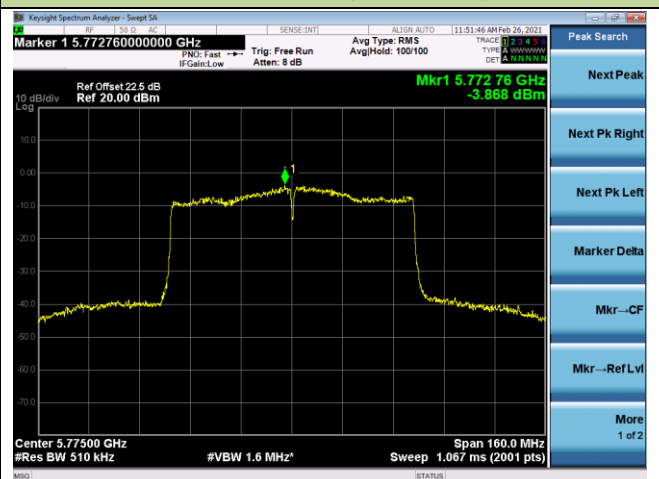

7.7. Frequency Stability Measurement

7.7.1. Test Limit

Manufacturers of U-NII devices are responsible for ensuring frequency stability such that an emission is maintained within the band of operation under all conditions of normal operation as specified in the user's manual.

The transmitter center frequency tolerance shall be ± 20 ppm maximum for the 5GHz band (IEEE 802.11 specification).

7.7.2. Test Procedure Used

Frequency Stability Under Temperature Variations:

The equipment under test was connected to an external AC or DC power supply and input rated voltage. RF output was connected to a frequency counter or spectrum analyzer via feed through attenuators. The EUT was placed inside the temperature chamber. Set the spectrum analyzer RBW low enough to obtain the desired frequency resolution and measure EUT 20°C operating frequency as reference frequency. Turn EUT off and set the chamber temperature to highest. After the temperature stabilized for approximately 30 minutes recorded the frequency. Repeat step measure with 10°C decreased per stage until the lowest temperature reached.

Frequency Stability Under Voltage Variations:

Set chamber temperature to 20°C. Use a variable AC power supply / DC power source to power the EUT and set the voltage to rated voltage. Set the spectrum analyzer RBW low enough to obtain the desired frequency resolution and recorded the frequency.

Reduce the input voltage to specify extreme voltage variation ($\pm 15\%$) and endpoint, record the maximum frequency change.

7.7.3. Test Setup

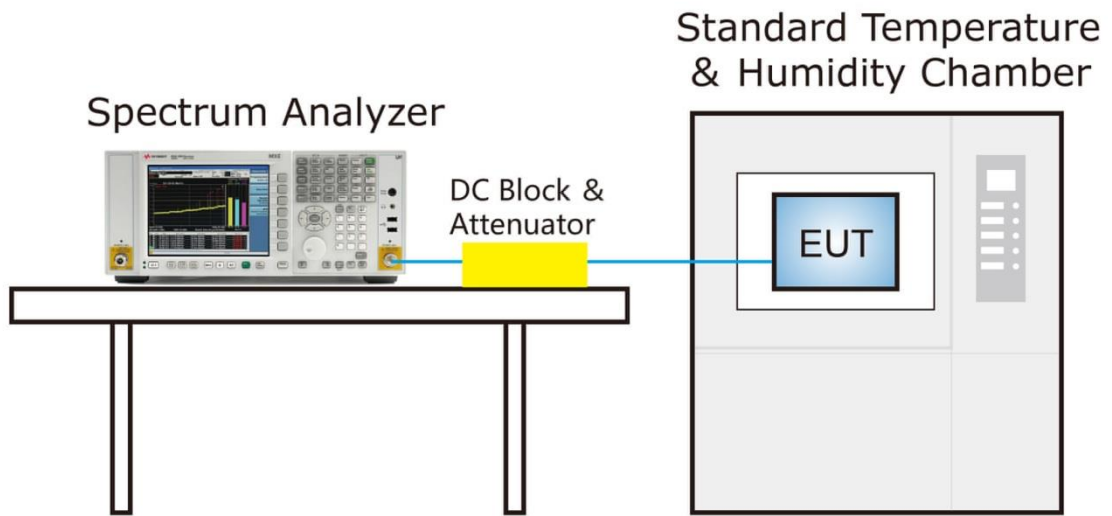

7.7.4. Test Result

Product	Cassia Bluetooth Router	Test Engineer	Eric Lin
Test Site	SR2	Test Time	2021/02/28
Test Mode	5180MHz (Carrier Mode)		

Voltage (%)	Power (VAC)	Temp (°C)	Frequency Tolerance (ppm)			
			0 minutes	2 minutes	5 minutes	10 minutes
100%	120	- 30	8.69	8.68	8.69	8.69
		- 20	8.68	8.67	8.69	8.69
		- 10	8.68	8.67	8.69	8.68
		0	8.68	8.66	8.66	8.69
		+ 10	8.71	8.69	8.71	8.68
		+ 20 (Ref)	8.90	8.77	8.72	8.87
		+ 30	8.22	8.45	8.54	8.58
		+ 40	8.57	8.59	8.57	8.59
		+ 50	8.19	8.40	8.48	8.52
115%	138	+ 20	8.59	8.57	8.56	8.56
85%	102	+ 20	8.28	8.46	8.52	8.53

Note: Frequency Tolerance (ppm) = {[Measured Frequency (Hz) - Declared Frequency (Hz)] / Declared Frequency (Hz)} * 10⁶.

7.8. Radiated Spurious Emission Measurement

7.8.1. Test Limit

All out of band emissions appearing in a restricted band as specified in Section 15.205 of the Title 47CFR must not exceed the limits shown in Table per Section 15.209.

FCC Part 15 Subpart C Paragraph 15.209		
Frequency [MHz]	Field Strength [uV/m]	Measured Distance [Meters]
0.009 - 0.490	2400/F (kHz)	300
0.490 - 1.705	24000/F (kHz)	30
1.705 - 30	30	30
30 - 88	100	3
88 - 216	150	3
216 - 960	200	3
Above 960	500	3

7.8.2. Test Procedure Used

KDB 789033 D02v02r01 – Section G

7.8.3. Test Setting

Table 1 - RBW as a function of frequency

Frequency	RBW
9 ~ 150 kHz	200 ~ 300 Hz
0.15 ~ 30 MHz	9 ~ 10 kHz
30 ~ 1000 MHz	100 ~ 120 kHz
>1000 MHz	1 MHz

Quasi-Peak Measurements below 1GHz

1. Analyzer center frequency was set to the frequency of the radiated spurious emission of interest
2. Span was set greater than 1MHz
3. RBW = as specified in Table 1
4. Detector = CISPR quasi-peak
5. Sweep time = auto couple
6. Trace was allowed to stabilize

Peak Measurements above 1GHz

1. Analyzer center frequency was set to the frequency of the radiated spurious emission of interest
2. RBW = 1MHz
3. VBW = 3MHz
4. Detector = peak
5. Sweep time = auto couple
6. Trace mode = max hold
7. Trace was allowed to stabilize

Average Measurements above 1GHz (Method VB)

1. Analyzer center frequency was set to the frequency of the radiated spurious emission of interest
2. RBW = 1MHz
3. VBW; If the EUT is configured to transmit with duty cycle $\geq 98\%$, set VBW = 10 Hz.
If the EUT duty cycle is $< 98\%$, set VBW $\geq 1/T$. T is the minimum transmission duration.
4. Detector = Peak
5. Sweep time = auto
6. Trace mode = max hold
7. Trace was allowed to stabilize

7.8.4. Test Setup

Below 1GHz Test Setup:

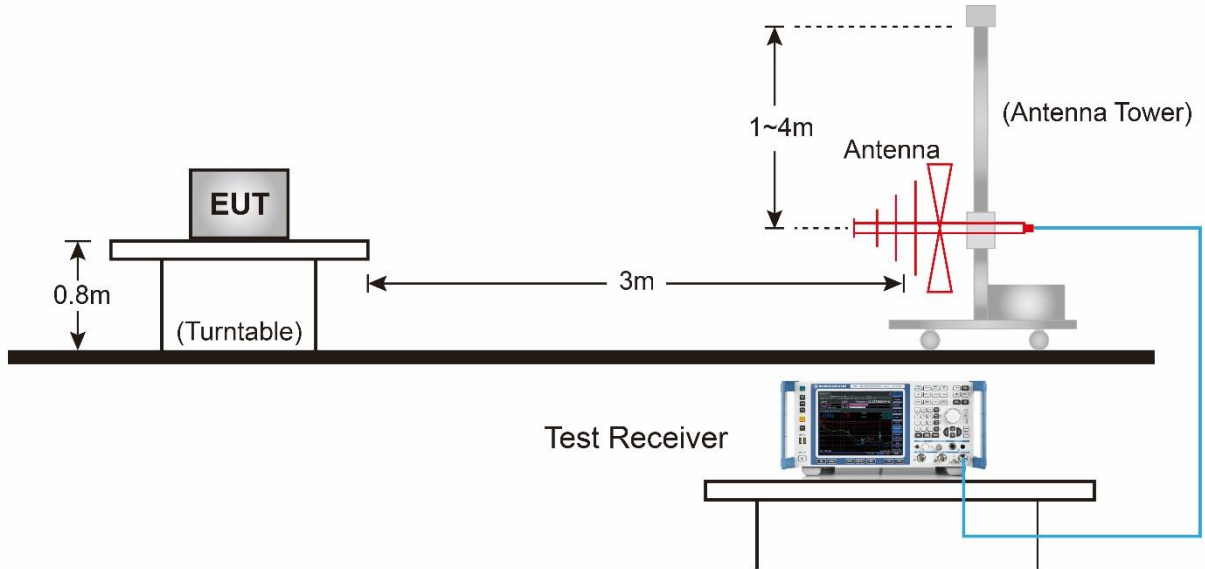

Above 1GHz Test Setup:

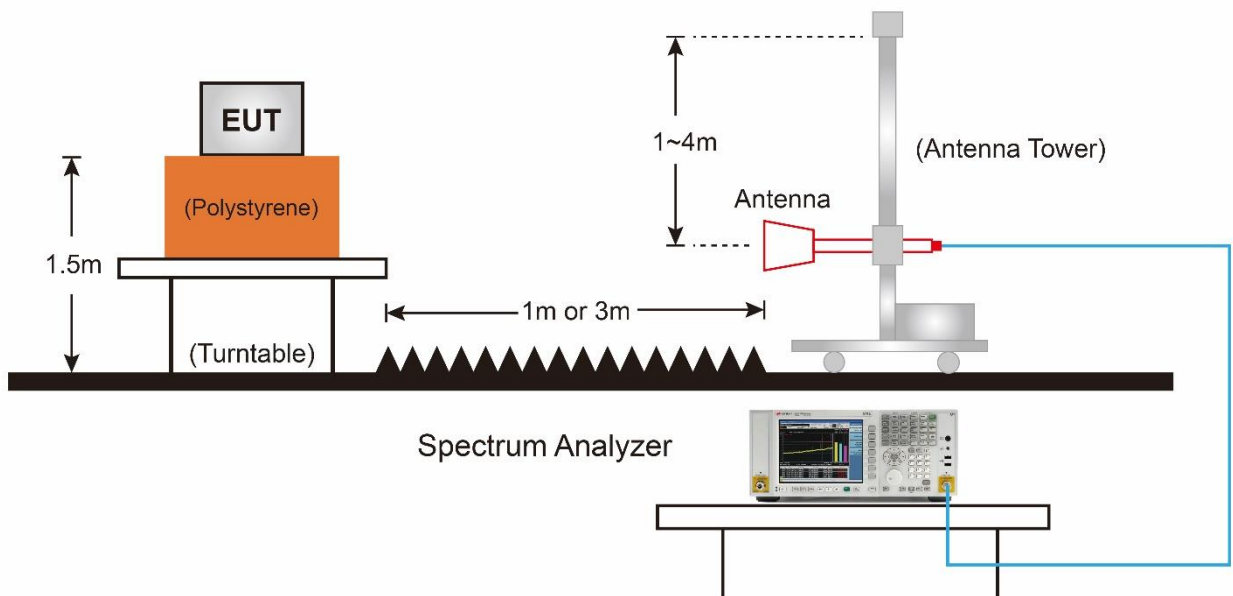

7.8.5. Test Result

EUT	Cassia Bluetooth Router	Date of Test	2021-03-01
Factor	BBHA 9120D	Temp. / Humidity	35.9°C/22.2%
Polarity	Horizontal	Site / Test Engineer	AC1 / Jay Chou
Test Mode	Transmit by 802.11a at Channel 5180MHz	Test Voltage	120V/60Hz

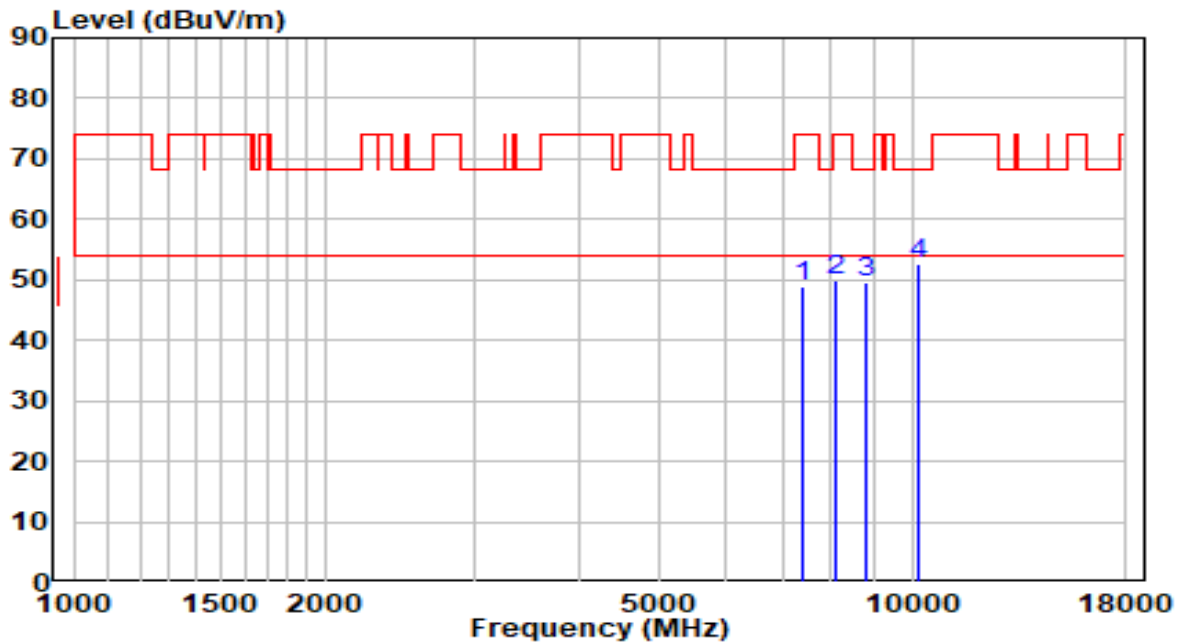

No	Frequency (MHz)	Reading (dBuV)	C.F (dB)	Measurement (dBuV/m)	Margin (dB)	Limit (dBuV/m)	Remark (QP/PK/AV)
1	7392.000	37.46	11.41	48.87	-25.13	74.00	Peak
2	8106.000	37.33	12.51	49.85	-24.15	74.00	Peak
3	8811.500	36.28	13.22	49.50	-18.70	68.20	Peak
4	* 10197.000	36.58	16.03	52.61	-15.59	68.20	Peak

Note:

- "*", means this data is the worst emission level.
- C.F (Correction Factor) = Antenna Factor (dB)+ Cable Loss (dB)– Preamplifier(dB).
- Measurement(dBuV/m) = Reading(dBuV) + C.F (Correction Factor).
- The emission levels of other frequencies are very lower than the limit and not show in test report.

EUT	Cassia Bluetooth Router	Date of Test	2021-03-01
Factor	BBHA 9120D	Temp. / Humidity	35.9°C/22.2%
Polarity	Vertical	Site / Test Engineer	AC1 / Jay Chou
Test Mode	Transmit by 802.11a at Channel 5180MHz	Test Voltage	120V/60Hz

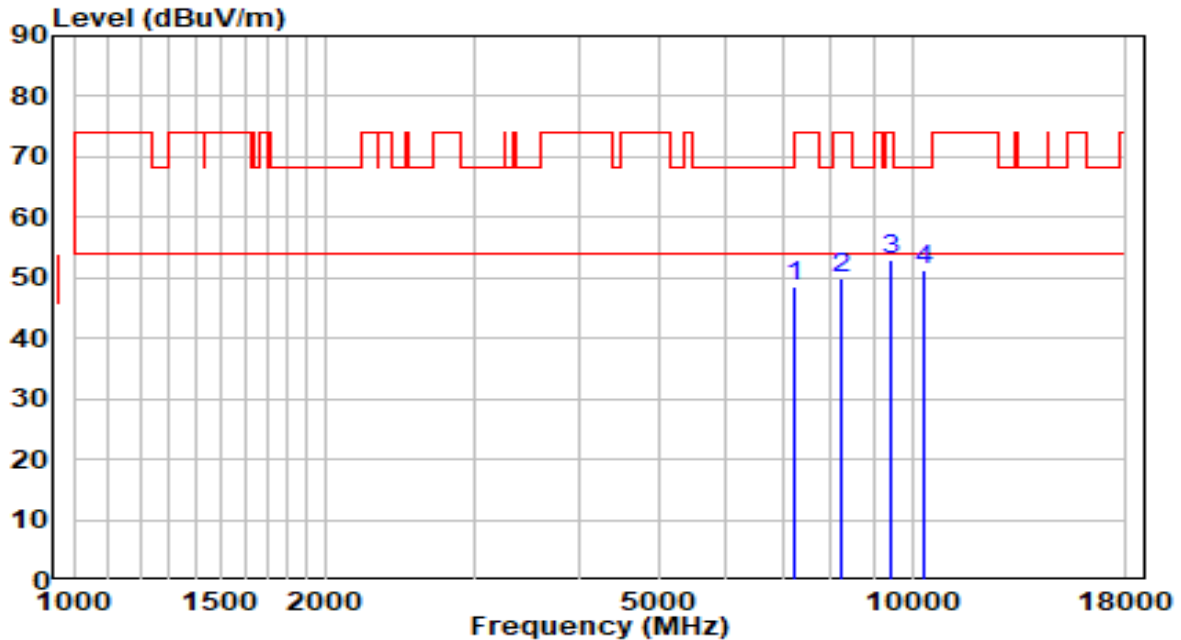

No	Frequency (MHz)	Reading (dBUV)	C.F (dB)	Measurement (dBUV/m)	Margin (dB)	Limit (dBUV/m)	Remark (QP/PK/AV)
1	7230.500	37.52	10.95	48.47	-19.73	68.20	Peak
2	8225.000	37.43	12.50	49.92	-24.08	74.00	Peak
3	9432.000	38.65	14.32	52.97	-21.03	74.00	Peak
4	* 10341.500	34.77	16.53	51.30	-16.90	68.20	Peak

Note:

1. " *", means this data is the worst emission level.
2. C.F (Correction Factor) = Antenna Factor (dB)+ Cable Loss (dB)– Preamplifier(dB).
3. Measurement(dBUV/m) = Reading(dBUV) + C.F (Correction Factor).
- 4.The emission levels of other frequencies are very lower than the limit and not show in test report.

EUT	Cassia Bluetooth Router	Date of Test	2021-03-01
Factor	BBHA 9120D	Temp. / Humidity	35.9°C/22.2%
Polarity	Horizontal	Site / Test Engineer	AC1 / Jay Chou
Test Mode	Transmit by 802.11a at Channel 5240MHz	Test Voltage	120V/60Hz

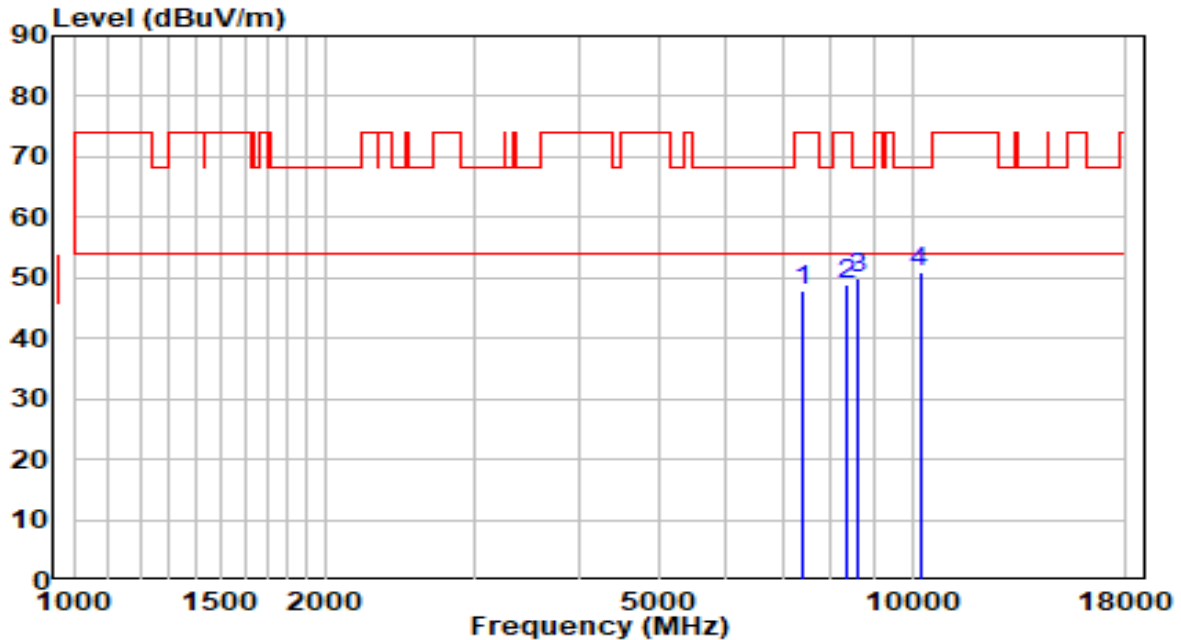

No	Frequency (MHz)	Reading (dBUV)	C.F (dB)	Measurement (dBUV/m)	Margin (dB)	Limit (dBUV/m)	Remark (QP/PK/AV)
1	7426.000	36.32	11.51	47.82	-26.18	74.00	Peak
2	8344.000	36.39	12.48	48.87	-25.13	74.00	Peak
3	8633.000	37.06	12.78	49.84	-18.36	68.20	Peak
4	* 10214.000	34.80	16.09	50.89	-17.31	68.20	Peak

Note:

1. " *", means this data is the worst emission level.
2. C.F (Correction Factor) = Antenna Factor (dB)+ Cable Loss (dB)– Preamplifier(dB).
3. Measurement(dBUV/m) = Reading(dBUV) + C.F (Correction Factor).
- 4.The emission levels of other frequencies are very lower than the limit and not show in test report.

EUT	Cassia Bluetooth Router	Date of Test	2021-03-01
Factor	BBHA 9120D	Temp. / Humidity	35.9°C/22.2%
Polarity	Vertical	Site / Test Engineer	AC1 / Jay Chou
Test Mode	Transmit by 802.11a at Channel 5240MHz	Test Voltage	120V/60Hz

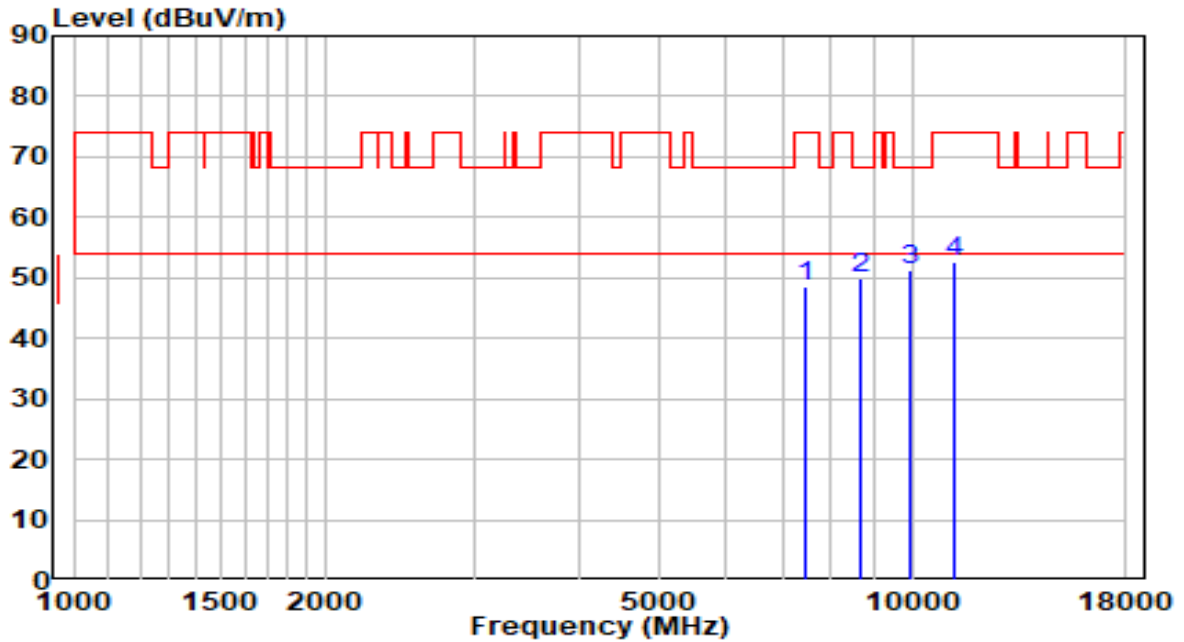

No	Frequency (MHz)	Reading (dBUV)	C.F (dB)	Measurement (dBUV/m)	Margin (dB)	Limit (dBUV/m)	Remark (QP/PK/AV)
1	7443.000	37.05	11.55	48.60	-25.40	74.00	Peak
2	8684.000	37.03	12.91	49.94	-18.26	68.20	Peak
3	* 9942.000	36.01	15.25	51.26	-16.94	68.20	Peak
4	11242.500	34.51	18.10	52.61	-21.39	74.00	Peak

Note:

1. " *", means this data is the worst emission level.
2. C.F (Correction Factor) = Antenna Factor (dB)+ Cable Loss (dB)– Preamplifier(dB).
3. Measurement(dBUV/m) = Reading(dBUV) + C.F (Correction Factor).
- 4.The emission levels of other frequencies are very lower than the limit and not show in test report.

EUT	Cassia Bluetooth Router	Date of Test	2021-03-01
Factor	BBHA 9120D	Temp. / Humidity	35.9°C/22.2%
Polarity	Horizontal	Site / Test Engineer	AC1 / Jay Chou
Test Mode	Transmit by 802.11a at Channel 5220MHz	Test Voltage	120V/60Hz

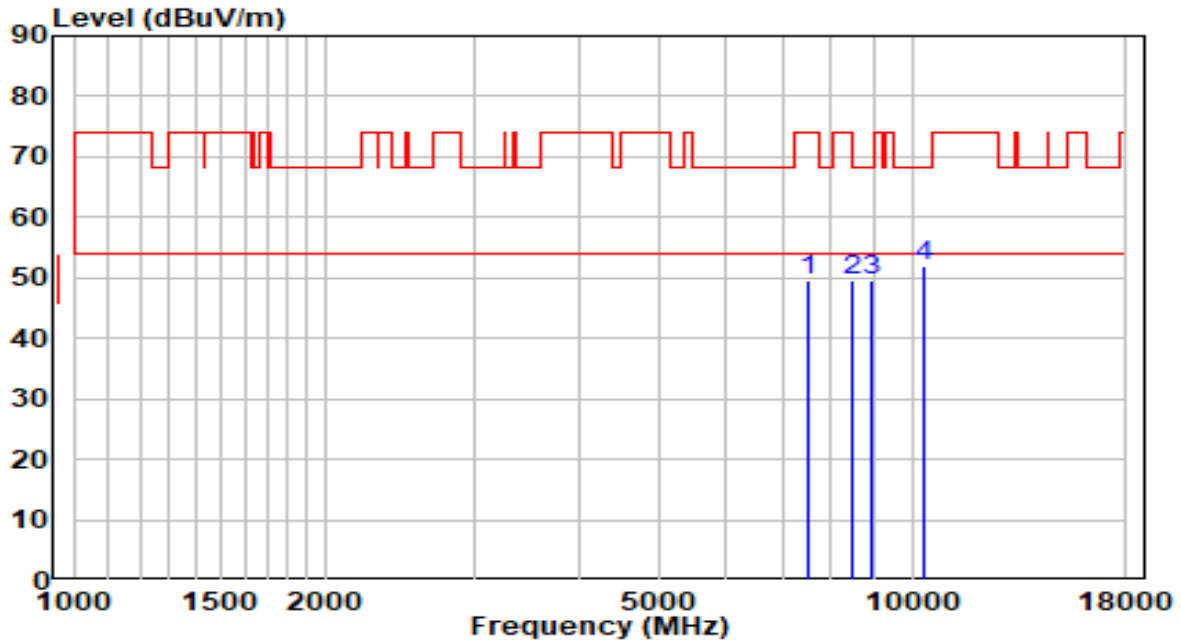

No	Frequency (MHz)	Reading (dBuV)	C.F (dB)	Measurement (dBuV/m)	Margin (dB)	Limit (dBuV/m)	Remark (QP/PK/AV)
1	7502.500	37.70	11.72	49.42	-24.58	74.00	Peak
2	8463.000	37.19	12.46	49.65	-24.35	74.00	Peak
3	8973.000	36.06	13.61	49.68	-18.52	68.20	Peak
4	* 10350.000	35.37	16.56	51.93	-16.27	68.20	Peak

Note:

1. " *", means this data is the worst emission level.
2. C.F (Correction Factor) = Antenna Factor (dB)+ Cable Loss (dB)– Preamplifier(dB).
3. Measurement(dBuV/m) = Reading(dBuV) + C.F (Correction Factor).
- 4.The emission levels of other frequencies are very lower than the limit and not show in test report.

EUT	Cassia Bluetooth Router	Date of Test	2021-03-01
Factor	BBHA 9120D	Temp. / Humidity	35.9°C/22.2%
Polarity	Vertical	Site / Test Engineer	AC1 / Jay Chou
Test Mode	Transmit by 802.11a at Channel 5220MHz	Test Voltage	120V/60Hz

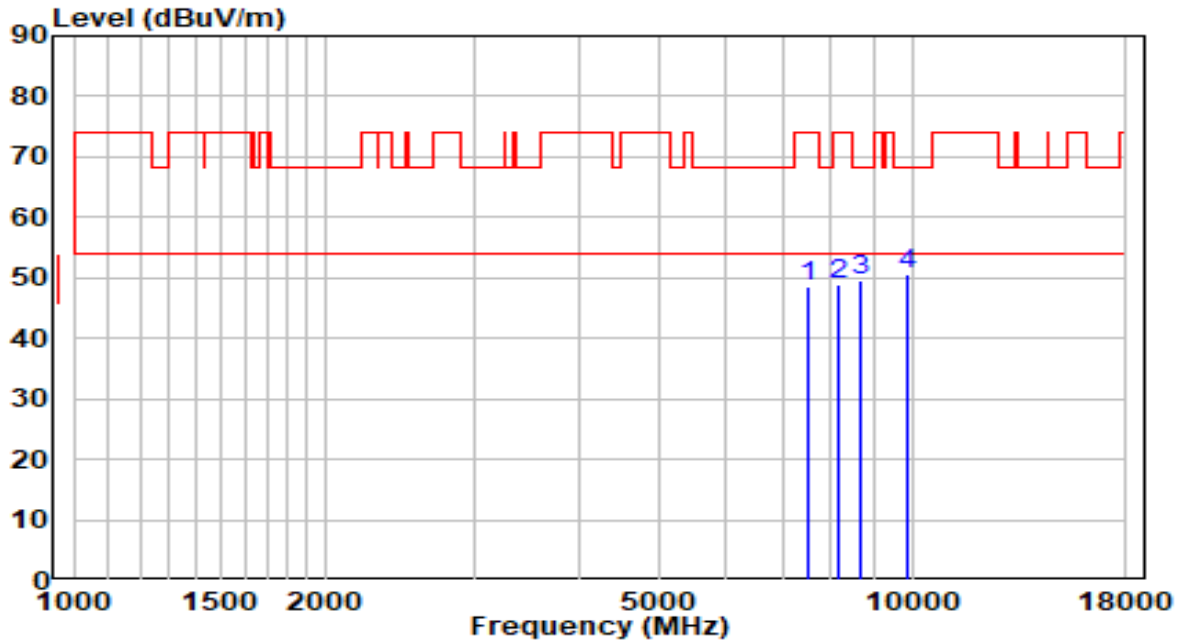

No	Frequency (MHz)	Reading (dBuV)	C.F (dB)	Measurement (dBuV/m)	Margin (dB)	Limit (dBuV/m)	Remark (QP/PK/AV)
1	7494.000	36.95	11.70	48.65	-25.35	74.00	Peak
2	8157.000	36.27	12.51	48.78	-25.22	74.00	Peak
3	8658.500	36.63	12.84	49.47	-18.73	68.20	Peak
4	* 9848.500	35.43	15.08	50.51	-17.69	68.20	Peak

Note:

1. " *", means this data is the worst emission level.
2. C.F (Correction Factor) = Antenna Factor (dB)+ Cable Loss (dB)– Preamplifier(dB).
3. Measurement(dBuV/m) = Reading(dBuV) + C.F (Correction Factor).
- 4.The emission levels of other frequencies are very lower than the limit and not show in test report.

EUT	Cassia Bluetooth Router	Date of Test	2021-03-01
Factor	BBHA 9120D	Temp. / Humidity	35.9°C/22.2%
Polarity	Horizontal	Site / Test Engineer	AC1 / Jay Chou
Test Mode	Transmit by 802.11a at Channel 5260MHz	Test Voltage	120V/60Hz

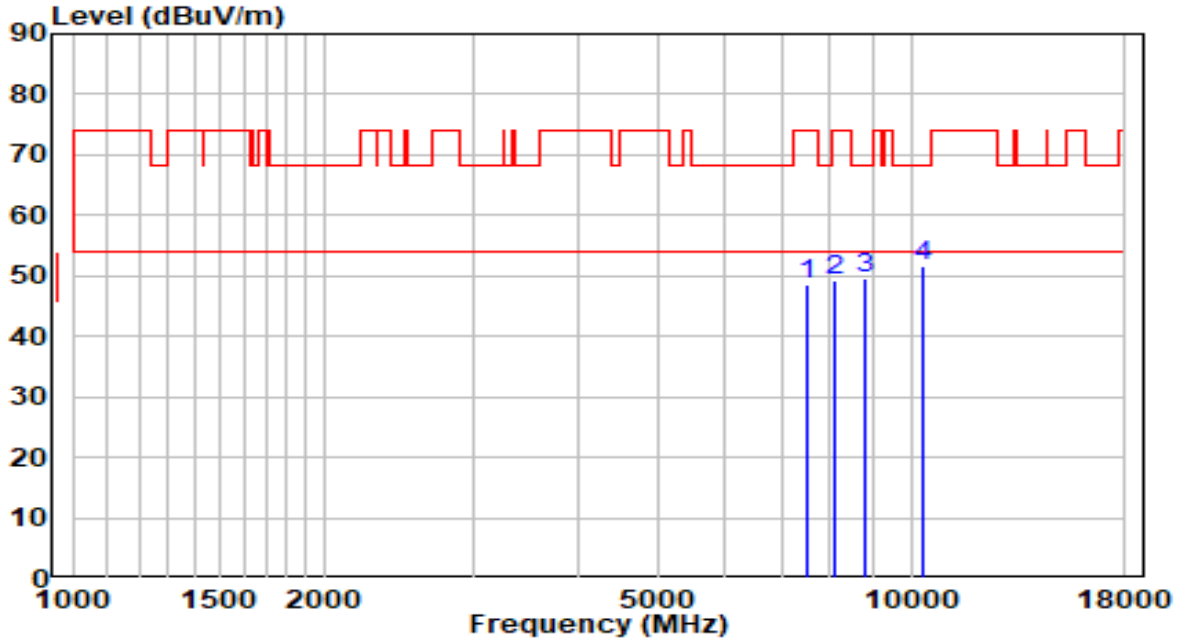

No	Frequency (MHz)	Reading (dBUV)	C.F (dB)	Measurement (dBUV/m)	Margin (dB)	Limit (dBUV/m)	Remark (QP/PK/AV)
1	7494.000	36.80	11.70	48.49	-25.51	74.00	Peak
2	8097.500	36.86	12.52	49.37	-24.63	74.00	Peak
3	8820.000	36.39	13.24	49.62	-18.58	68.20	Peak
4	* 10299.000	35.28	16.38	51.67	-16.53	68.20	Peak

Note:

1. " *", means this data is the worst emission level.
2. C.F (Correction Factor) = Antenna Factor (dB)+ Cable Loss (dB)– Preamplifier(dB).
3. Measurement(dBUV/m) = Reading(dBUV) + C.F (Correction Factor).
- 4.The emission levels of other frequencies are very lower than the limit and not show in test report.

EUT	Cassia Bluetooth Router	Date of Test	2021-03-01
Factor	BBHA 9120D	Temp. / Humidity	35.9°C/22.2%
Polarity	Vertical	Site / Test Engineer	AC1 / Jay Chou
Test Mode	Transmit by 802.11a at Channel 5260MHz	Test Voltage	120V/60Hz

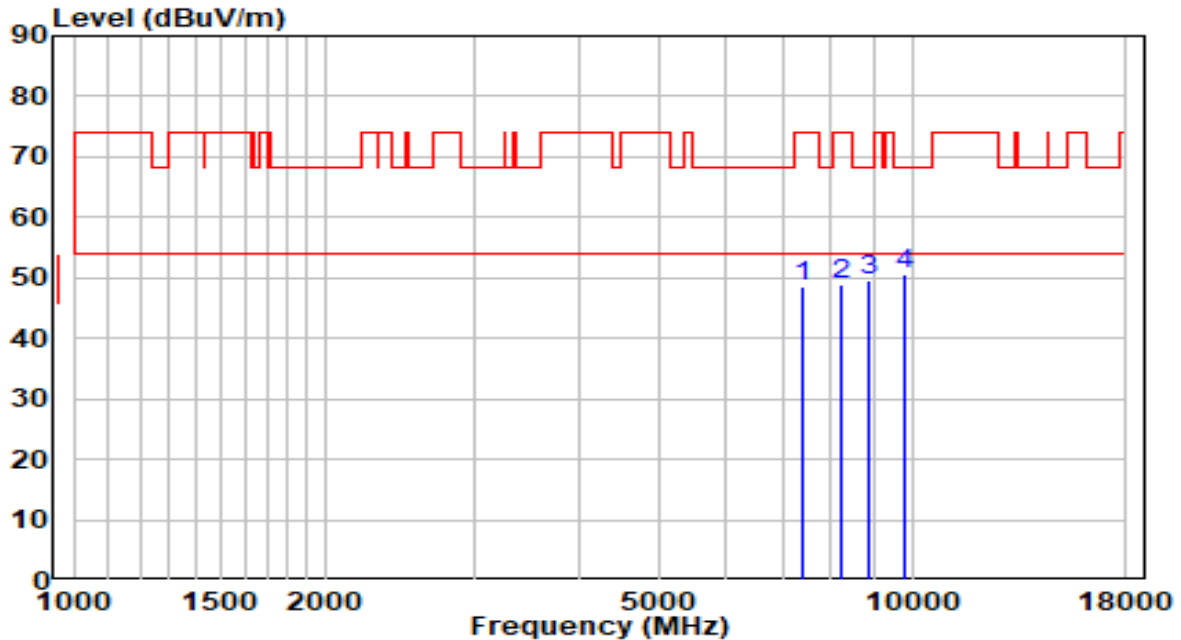

No	Frequency (MHz)	Reading (dBuV)	C.F (dB)	Measurement (dBuV/m)	Margin (dB)	Limit (dBuV/m)	Remark (QP/PK/AV)
1	7417.500	37.20	11.48	48.68	-25.32	74.00	Peak
2	8259.000	36.49	12.49	48.98	-25.02	74.00	Peak
3	8888.000	36.22	13.41	49.63	-18.57	68.20	Peak
4	* 9780.500	35.70	14.95	50.65	-17.55	68.20	Peak

Note:

1. " *", means this data is the worst emission level.
2. C.F (Correction Factor) = Antenna Factor (dB)+ Cable Loss (dB)– Preamplifier(dB).
3. Measurement(dBuV/m) = Reading(dBuV) + C.F (Correction Factor).
- 4.The emission levels of other frequencies are very lower than the limit and not show in test report.

EUT	Cassia Bluetooth Router	Date of Test	2021-03-01
Factor	BBHA 9120D	Temp. / Humidity	35.9°C/22.2%
Polarity	Horizontal	Site / Test Engineer	AC1 / Jay Chou
Test Mode	Transmit by 802.11a at Channel 5300MHz	Test Voltage	120V/60Hz

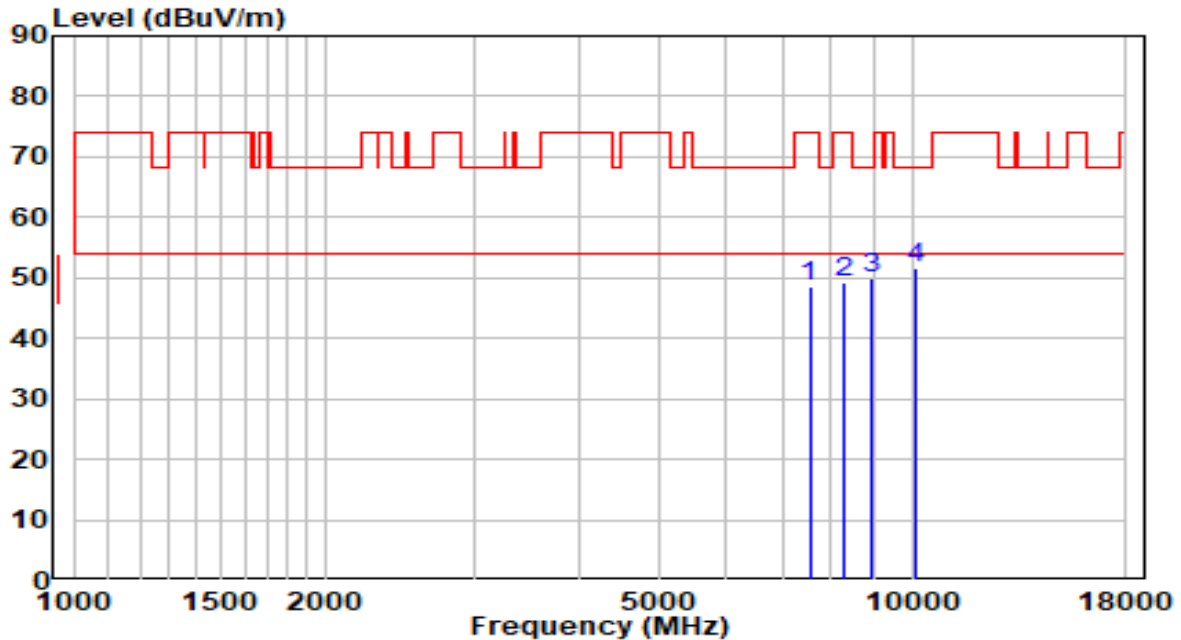

No	Frequency (MHz)	Reading (dBuV)	C.F (dB)	Measurement (dBuV/m)	Margin (dB)	Limit (dBuV/m)	Remark (QP/PK/AV)
1	7545.000	36.73	11.79	48.52	-25.48	74.00	Peak
2	8284.500	36.81	12.49	49.30	-24.70	74.00	Peak
3	8947.500	36.33	13.55	49.88	-18.32	68.20	Peak
4	* 10129.000	35.70	15.80	51.51	-16.69	68.20	Peak

Note:

1. " *", means this data is the worst emission level.
2. C.F (Correction Factor) = Antenna Factor (dB)+ Cable Loss (dB)– Preamplifier(dB).
3. Measurement(dBuV/m) = Reading(dBuV) + C.F (Correction Factor).
- 4.The emission levels of other frequencies are very lower than the limit and not show in test report.

EUT	Cassia Bluetooth Router	Date of Test	2021-03-01
Factor	BBHA 9120D	Temp. / Humidity	35.9°C/22.2%
Polarity	Vertical	Site / Test Engineer	AC1 / Jay Chou
Test Mode	Transmit by 802.11a at Channel 5300MHz	Test Voltage	120V/60Hz

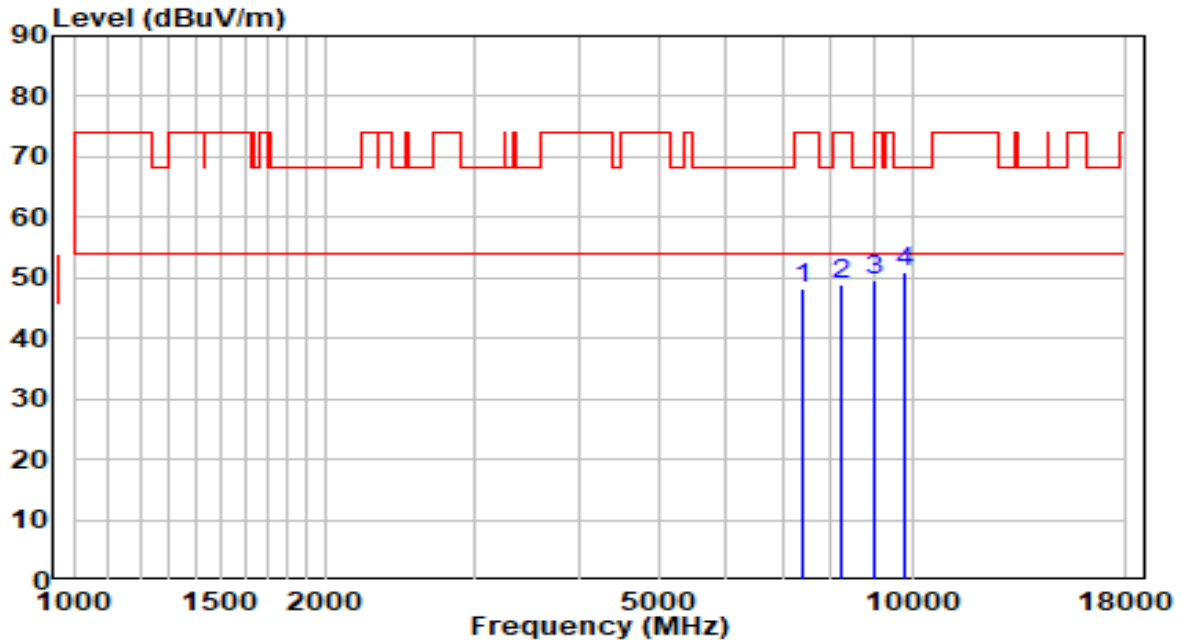

No	Frequency (MHz)	Reading (dBuV)	C.F (dB)	Measurement (dBuV/m)	Margin (dB)	Limit (dBuV/m)	Remark (QP/PK/AV)
1	7400.500	36.84	11.43	48.28	-25.72	74.00	Peak
2	8216.500	36.58	12.50	49.07	-24.93	74.00	Peak
3	8981.500	35.86	13.63	49.50	-18.70	68.20	Peak
4	* 9772.000	36.15	14.93	51.08	-17.12	68.20	Peak

Note:

1. " *", means this data is the worst emission level.
2. C.F (Correction Factor) = Antenna Factor (dB)+ Cable Loss (dB)– Preamplifier(dB).
3. Measurement(dBuV/m) = Reading(dBuV) + C.F (Correction Factor).
- 4.The emission levels of other frequencies are very lower than the limit and not show in test report.

EUT	Cassia Bluetooth Router	Date of Test	2021-03-01
Factor	BBHA 9120D	Temp. / Humidity	35.9°C/22.2%
Polarity	Horizontal	Site / Test Engineer	AC1 / Jay Chou
Test Mode	Transmit by 802.11a at Channel 5320MHz	Test Voltage	120V/60Hz

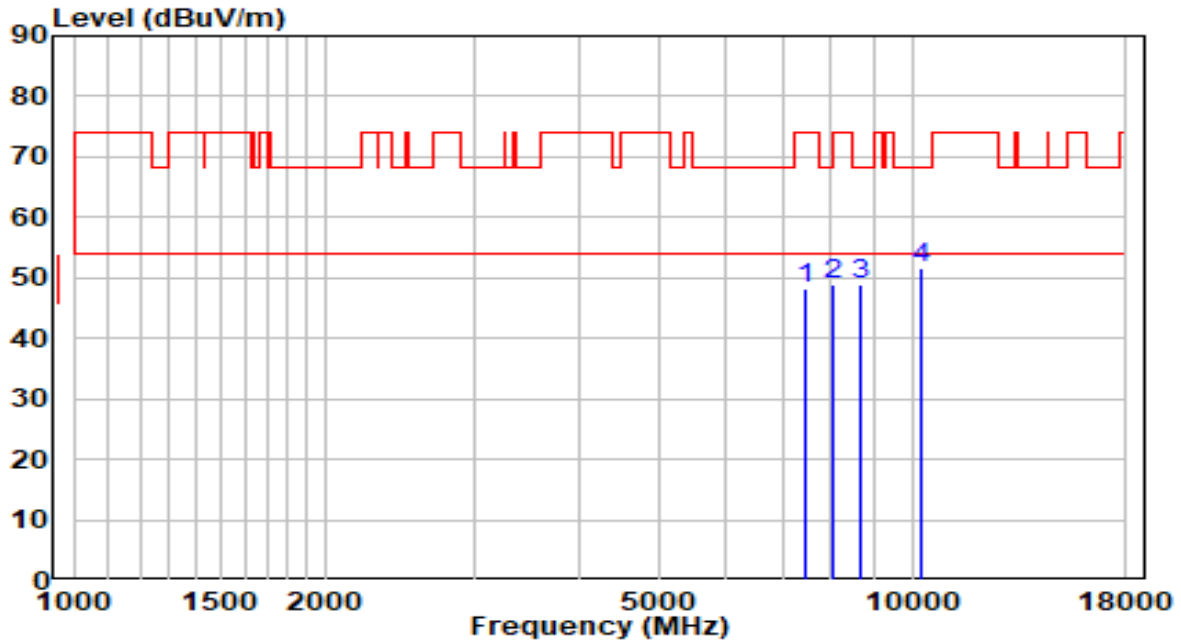

No	Frequency (MHz)	Reading (dBUV)	C.F (dB)	Measurement (dBUV/m)	Margin (dB)	Limit (dBUV/m)	Remark (QP/PK/AV)
1	7468.500	36.73	11.63	48.36	-25.64	74.00	Peak
2	8038.000	36.37	12.52	48.89	-25.11	74.00	Peak
3	8709.500	36.09	12.97	49.06	-19.14	68.20	Peak
4	* 10239.500	35.43	16.18	51.61	-16.59	68.20	Peak

Note:

1. " *", means this data is the worst emission level.
2. C.F (Correction Factor) = Antenna Factor (dB)+ Cable Loss (dB)– Preamplifier(dB).
3. Measurement(dBUV/m) = Reading(dBUV) + C.F (Correction Factor).
- 4.The emission levels of other frequencies are very lower than the limit and not show in test report.

EUT	Cassia Bluetooth Router	Date of Test	2021-03-01
Factor	BBHA 9120D	Temp. / Humidity	35.9°C/22.2%
Polarity	Vertical	Site / Test Engineer	AC1 / Jay Chou
Test Mode	Transmit by 802.11a at Channel 5320MHz	Test Voltage	120V/60Hz

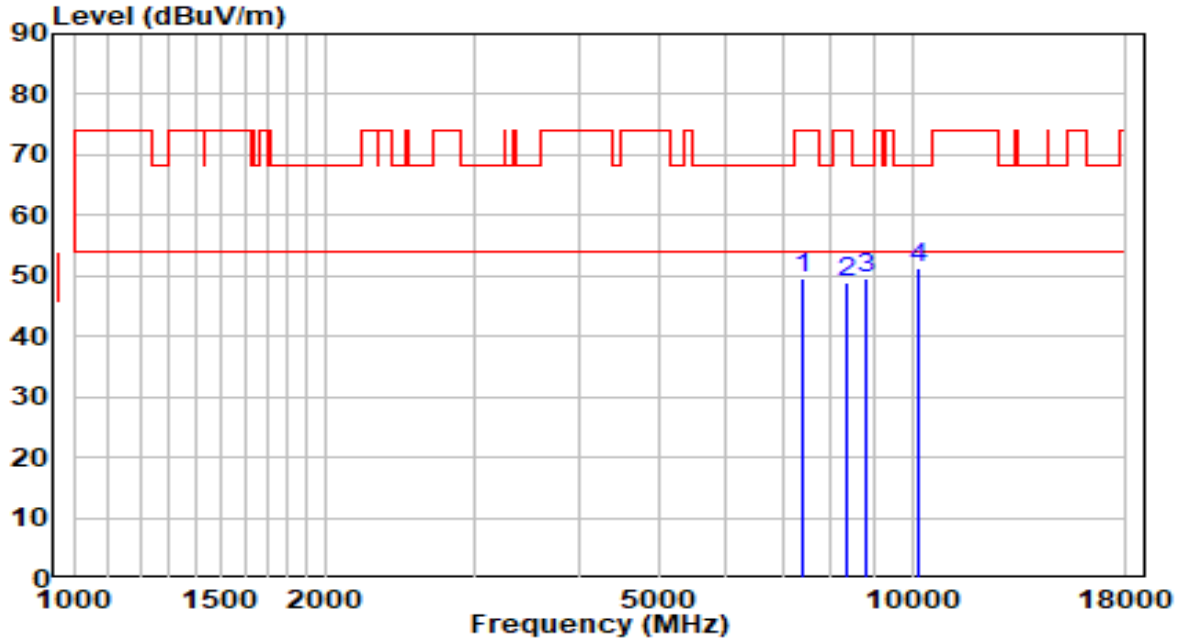

No	Frequency (MHz)	Reading (dBUV)	C.F (dB)	Measurement (dBUV/m)	Margin (dB)	Limit (dBUV/m)	Remark (QP/PK/AV)
1	7417.500	38.10	11.48	49.58	-24.42	74.00	Peak
2	8344.000	36.59	12.48	49.07	-24.93	74.00	Peak
3	8820.000	36.50	13.24	49.73	-18.47	68.20	Peak
4	* 10171.500	35.26	15.95	51.21	-16.99	68.20	Peak

Note:

1. " *", means this data is the worst emission level.
2. C.F (Correction Factor) = Antenna Factor (dB)+ Cable Loss (dB)– Preamplifier(dB).
3. Measurement(dBUV/m) = Reading(dBUV) + C.F (Correction Factor).
- 4.The emission levels of other frequencies are very lower than the limit and not show in test report.

EUT	Cassia Bluetooth Router	Date of Test	2021-03-01
Factor	BBHA 9120D	Temp. / Humidity	35.9°C/22.2%
Polarity	Horizontal	Site / Test Engineer	AC1 / Jay Chou
Test Mode	Transmit by 802.11a at Channel 5500MHz	Test Voltage	120V/60Hz

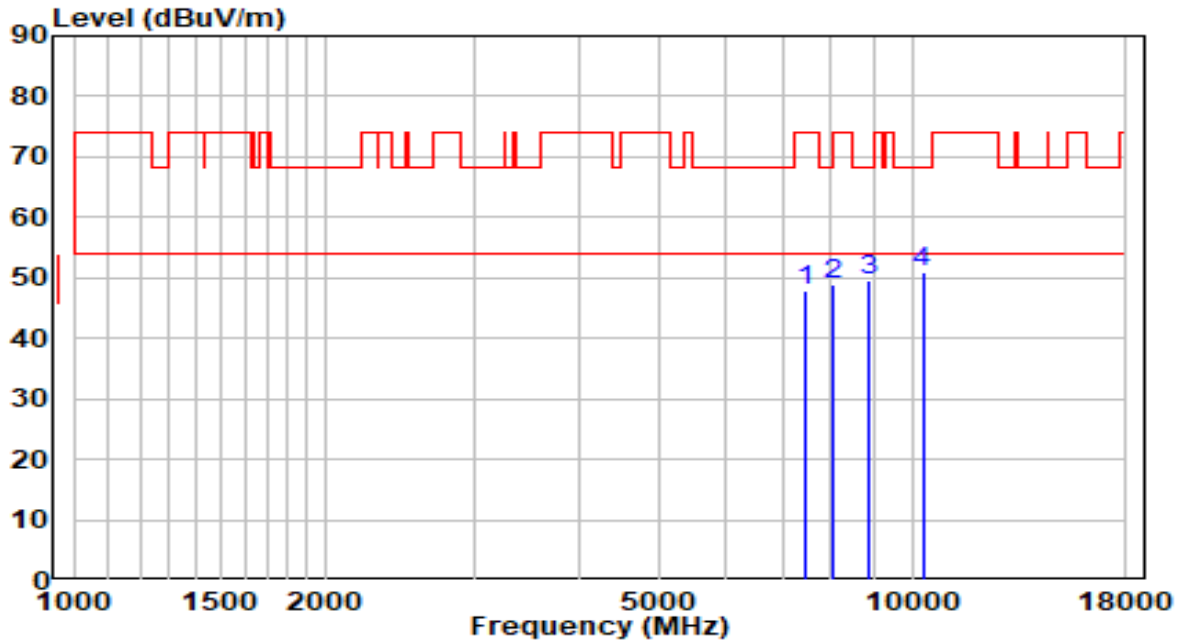

No	Frequency (MHz)	Reading (dBUV)	C.F (dB)	Measurement (dBUV/m)	Margin (dB)	Limit (dBUV/m)	Remark (QP/PK/AV)
1	7460.000	36.31	11.60	47.91	-26.09	74.00	Peak
2	8038.000	36.44	12.52	48.96	-25.04	74.00	Peak
3	8905.000	36.20	13.45	49.64	-18.56	68.20	Peak
4	* 10290.500	34.74	16.35	51.09	-17.11	68.20	Peak

Note:

1. " *", means this data is the worst emission level.
2. C.F (Correction Factor) = Antenna Factor (dB)+ Cable Loss (dB)– Preamplifier(dB).
3. Measurement(dBUV/m) = Reading(dBUV) + C.F (Correction Factor).
- 4.The emission levels of other frequencies are very lower than the limit and not show in test report.

EUT	Cassia Bluetooth Router	Date of Test	2021-03-01
Factor	BBHA 9120D	Temp. / Humidity	35.9°C/22.2%
Polarity	Vertical	Site / Test Engineer	AC1 / Jay Chou
Test Mode	Transmit by 802.11a at Channel 5500MHz	Test Voltage	120V/60Hz

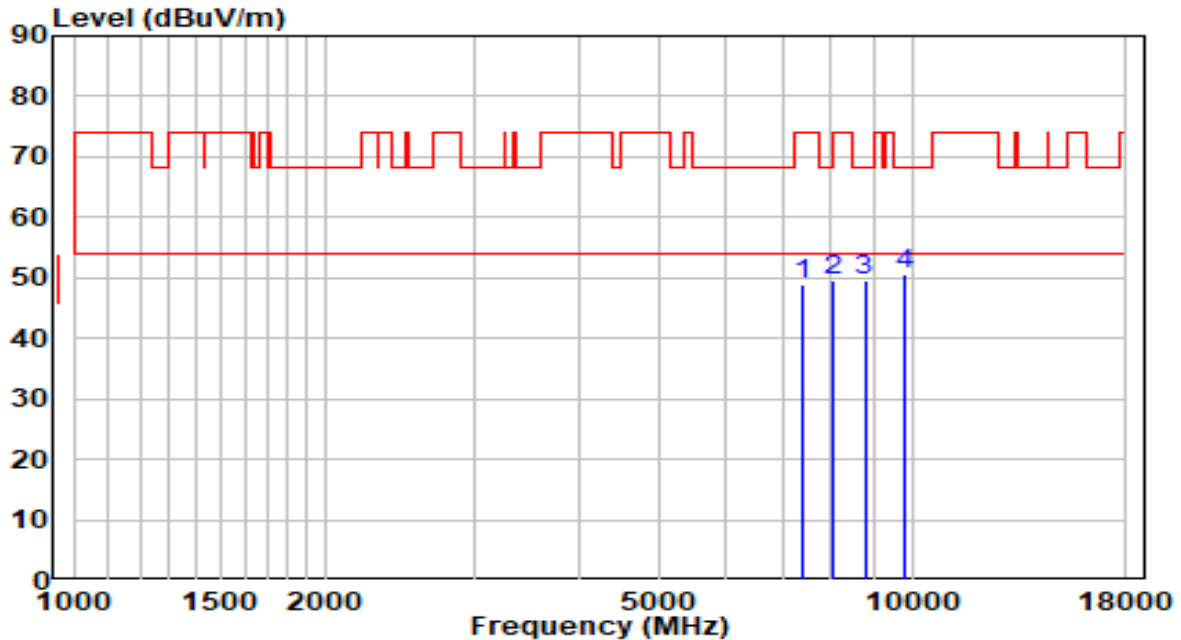

No	Frequency (MHz)	Reading (dBUV)	C.F (dB)	Measurement (dBUV/m)	Margin (dB)	Limit (dBUV/m)	Remark (QP/PK/AV)
1	7409.000	37.37	11.46	48.82	-25.18	74.00	Peak
2	8072.000	36.95	12.52	49.47	-24.53	74.00	Peak
3	8777.500	36.34	13.13	49.48	-18.72	68.20	Peak
4	* 9780.500	35.81	14.95	50.76	-17.44	68.20	Peak

Note:

1. " *", means this data is the worst emission level.
2. C.F (Correction Factor) = Antenna Factor (dB)+ Cable Loss (dB)– Preamplifier(dB).
3. Measurement(dBUV/m) = Reading(dBUV) + C.F (Correction Factor).
- 4.The emission levels of other frequencies are very lower than the limit and not show in test report.

EUT	Cassia Bluetooth Router	Date of Test	2021-03-01
Factor	BBHA 9120D	Temp. / Humidity	35.9°C/22.2%
Polarity	Horizontal	Site / Test Engineer	AC1 / Jay Chou
Test Mode	Transmit by 802.11a at Channel 5580MHz	Test Voltage	120V/60Hz

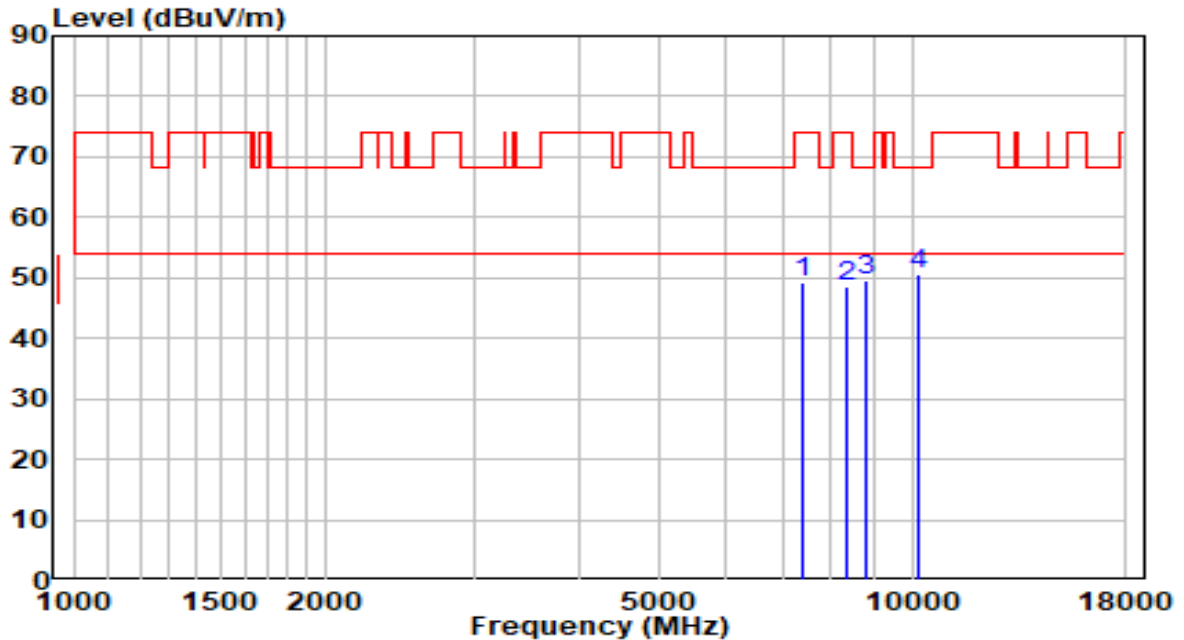

No	Frequency (MHz)	Reading (dBuV)	C.F (dB)	Measurement (dBuV/m)	Margin (dB)	Limit (dBuV/m)	Remark (QP/PK/AV)
1	7426.000	37.60	11.51	49.11	-24.89	74.00	Peak
2	8344.000	36.01	12.48	48.49	-25.51	74.00	Peak
3	8803.000	36.47	13.20	49.67	-18.53	68.20	Peak
4	* 10154.500	34.74	15.89	50.63	-17.57	68.20	Peak

Note:

1. " *", means this data is the worst emission level.
2. C.F (Correction Factor) = Antenna Factor (dB)+ Cable Loss (dB)– Preamplifier(dB).
3. Measurement(dBuV/m) = Reading(dBuV) + C.F (Correction Factor).
- 4.The emission levels of other frequencies are very lower than the limit and not show in test report.

EUT	Cassia Bluetooth Router	Date of Test	2021-03-01
Factor	BBHA 9120D	Temp. / Humidity	35.9°C/22.2%
Polarity	Vertical	Site / Test Engineer	AC1 / Jay Chou
Test Mode	Transmit by 802.11a at Channel 5580MHz	Test Voltage	120V/60Hz

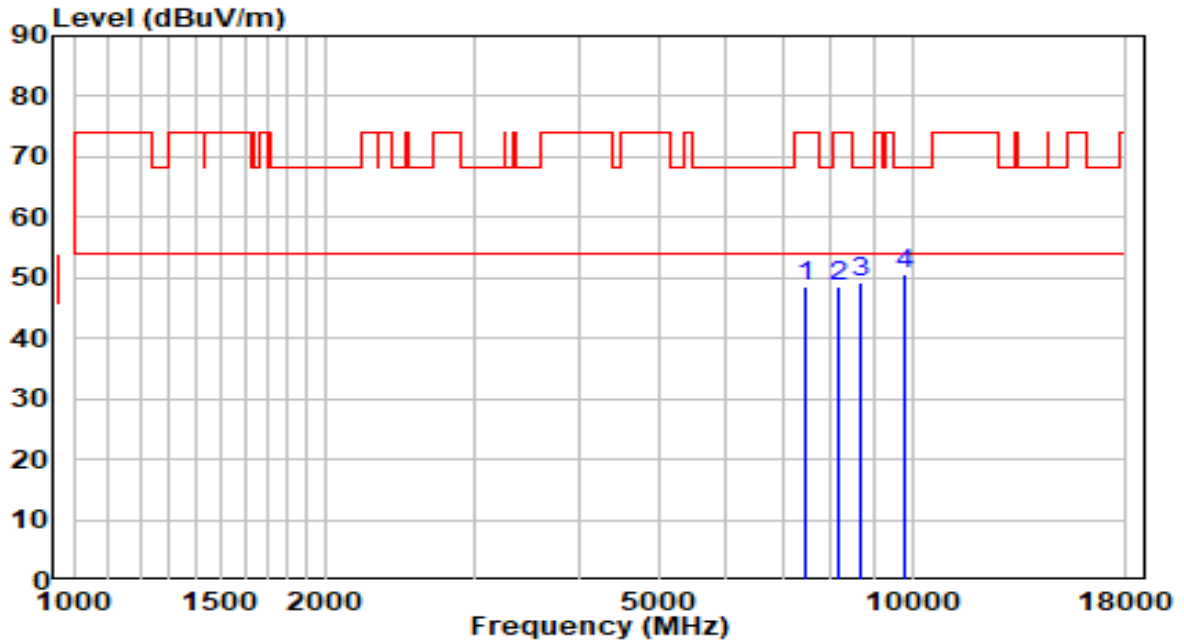

No	Frequency (MHz)	Reading (dBuV)	C.F (dB)	Measurement (dBuV/m)	Margin (dB)	Limit (dBuV/m)	Remark (QP/PK/AV)
1	7477.000	36.90	11.65	48.55	-25.45	74.00	Peak
2	8157.000	36.11	12.51	48.61	-25.39	74.00	Peak
3	8684.000	36.23	12.91	49.14	-19.06	68.20	Peak
4	* 9780.500	35.76	14.95	50.71	-17.49	68.20	Peak

Note:

1. " *", means this data is the worst emission level.
2. C.F (Correction Factor) = Antenna Factor (dB)+ Cable Loss (dB)– Preamplifier(dB).
3. Measurement(dBuV/m) = Reading(dBuV) + C.F (Correction Factor).
- 4.The emission levels of other frequencies are very lower than the limit and not show in test report.

EUT	Cassia Bluetooth Router	Date of Test	2021-03-01
Factor	BBHA 9120D	Temp. / Humidity	35.9°C/22.2%
Polarity	Horizontal	Site / Test Engineer	AC1 / Jay Chou
Test Mode	Transmit by 802.11a at Channel 5700MHz	Test Voltage	120V/60Hz

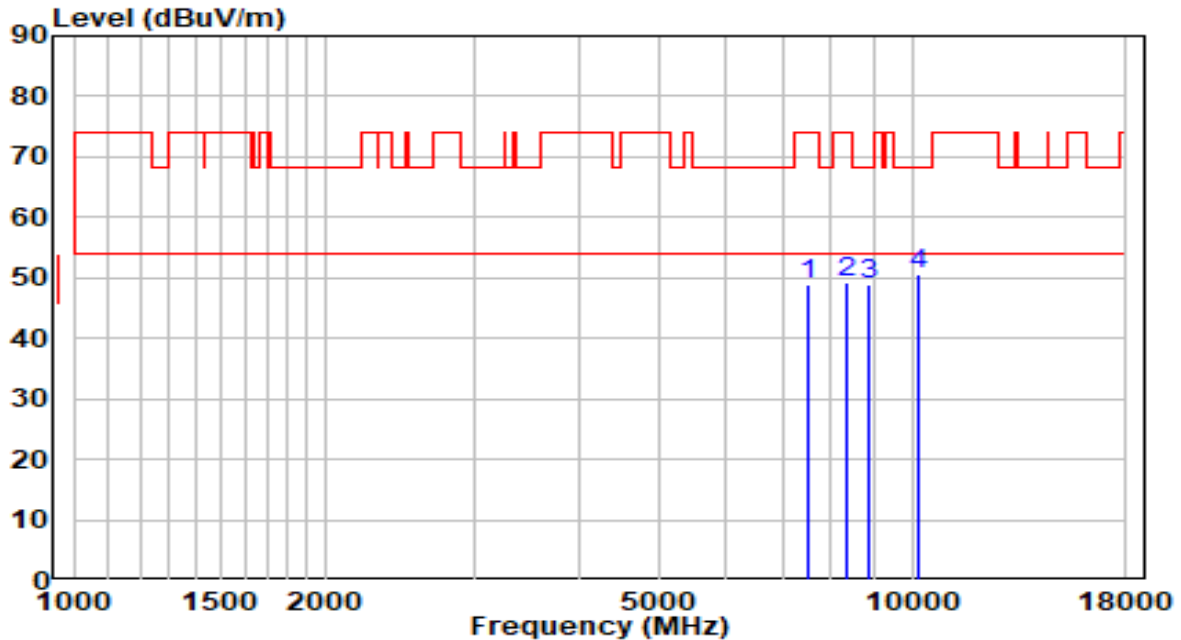

No	Frequency (MHz)	Reading (dBuV)	C.F (dB)	Measurement (dBuV/m)	Margin (dB)	Limit (dBuV/m)	Remark (QP/PK/AV)
1	7494.000	37.37	11.70	49.07	-24.93	74.00	Peak
2	8352.500	36.89	12.48	49.36	-24.64	74.00	Peak
3	8888.000	35.43	13.41	48.84	-19.36	68.20	Peak
4	* 10180.000	34.63	15.98	50.60	-17.60	68.20	Peak

Note:

1. " *", means this data is the worst emission level.
2. C.F (Correction Factor) = Antenna Factor (dB)+ Cable Loss (dB)– Preamplifier(dB).
3. Measurement(dBuV/m) = Reading(dBuV) + C.F (Correction Factor).
- 4.The emission levels of other frequencies are very lower than the limit and not show in test report.

EUT	Cassia Bluetooth Router	Date of Test	2021-03-01
Factor	BBHA 9120D	Temp. / Humidity	35.9°C/22.2%
Polarity	Vertical	Site / Test Engineer	AC1 / Jay Chou
Test Mode	Transmit by 802.11a at Channel 5700MHz	Test Voltage	120V/60Hz

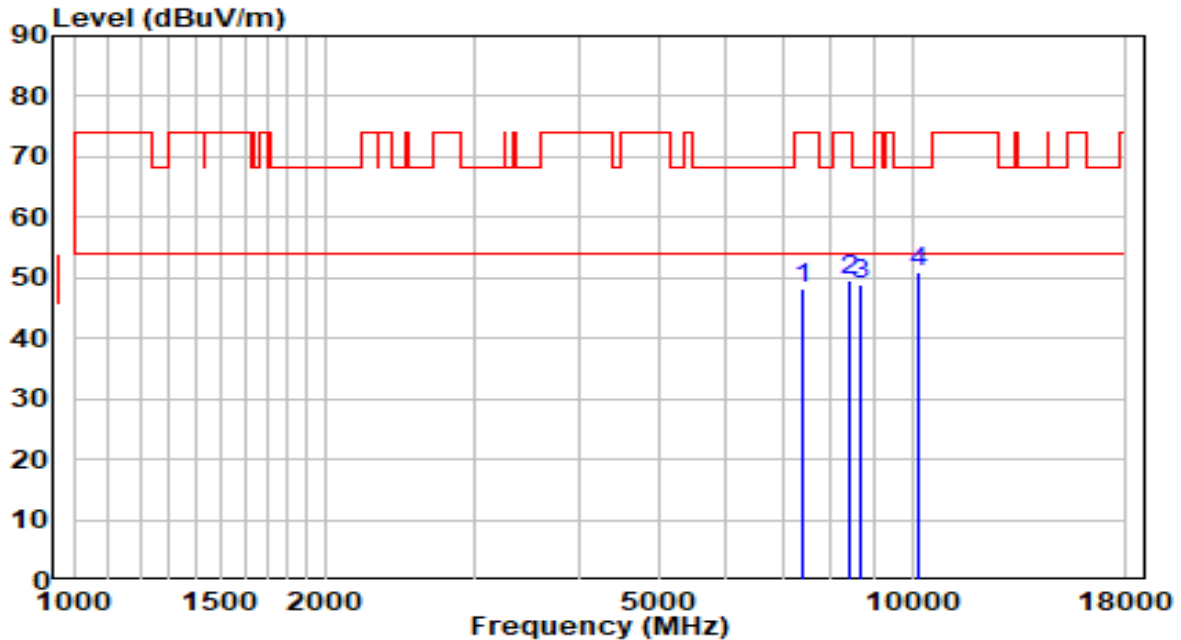

No	Frequency (MHz)	Reading (dBuV)	C.F (dB)	Measurement (dBuV/m)	Margin (dB)	Limit (dBuV/m)	Remark (QP/PK/AV)
1	7417.500	36.91	11.48	48.39	-25.61	74.00	Peak
2	8395.000	37.16	12.47	49.63	-24.37	74.00	Peak
3	8701.000	35.97	12.95	48.92	-19.28	68.20	Peak
4	* 10180.000	34.83	15.98	50.81	-17.39	68.20	Peak

Note:

1. " *", means this data is the worst emission level.
2. C.F (Correction Factor) = Antenna Factor (dB)+ Cable Loss (dB)– Preamplifier(dB).
3. Measurement(dBuV/m) = Reading(dBuV) + C.F (Correction Factor).
- 4.The emission levels of other frequencies are very lower than the limit and not show in test report.

EUT	Cassia Bluetooth Router	Date of Test	2021-03-01
Factor	BBHA 9120D	Temp. / Humidity	35.9°C/22.2%
Polarity	Horizontal	Site / Test Engineer	AC1 / Jay Chou
Test Mode	Transmit by 802.11a at Channel 5720MHz 4	Test Voltage	120V/60Hz

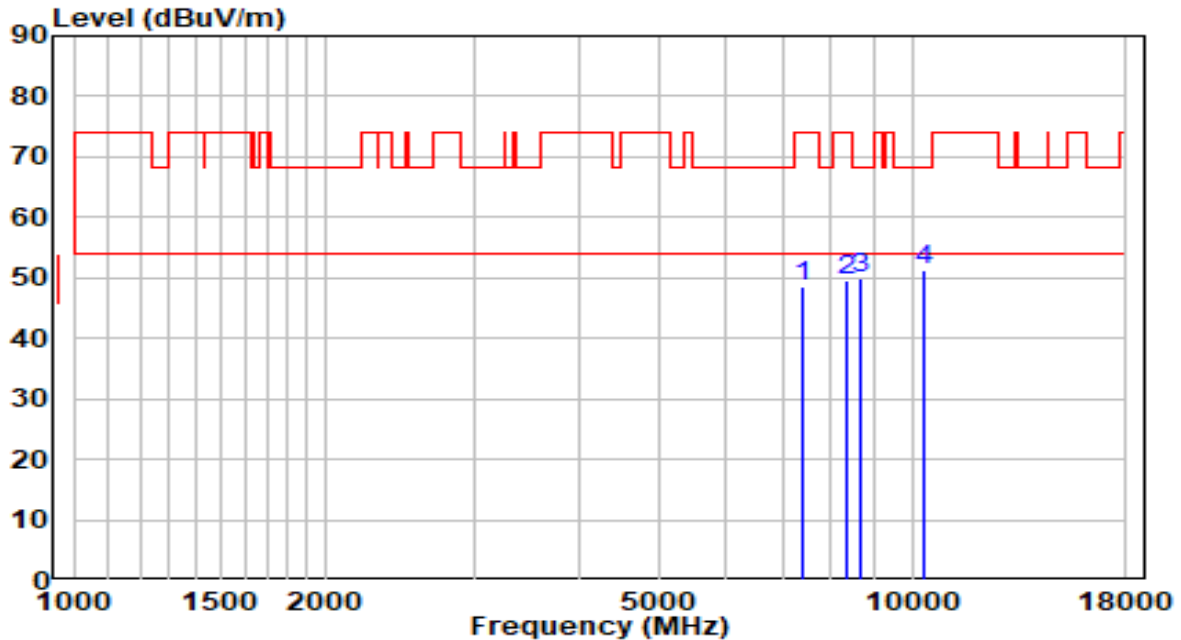

No	Frequency (MHz)	Reading (dBUV)	C.F (dB)	Measurement (dBUV/m)	Margin (dB)	Limit (dBUV/m)	Remark (QP/PK/AV)
1	7392.000	37.08	11.41	48.49	-25.51	74.00	Peak
2	8335.500	37.02	12.48	49.50	-24.50	74.00	Peak
3	8675.500	36.88	12.88	49.77	-18.43	68.20	Peak
4	* 10358.500	34.68	16.59	51.27	-16.93	68.20	Peak

Note:

1. " *", means this data is the worst emission level.
2. C.F (Correction Factor) = Antenna Factor (dB)+ Cable Loss (dB)– Preamplifier(dB).
3. Measurement(dBUV/m) = Reading(dBUV) + C.F (Correction Factor).
- 4.The emission levels of other frequencies are very lower than the limit and not show in test report.

EUT	Cassia Bluetooth Router	Date of Test	2021-03-01
Factor	BBHA 9120D	Temp. / Humidity	35.9°C/22.2%
Polarity	Vertical	Site / Test Engineer	AC1 / Jay Chou
Test Mode	Transmit by 802.11a at Channel 5720MHz 4	Test Voltage	120V/60Hz

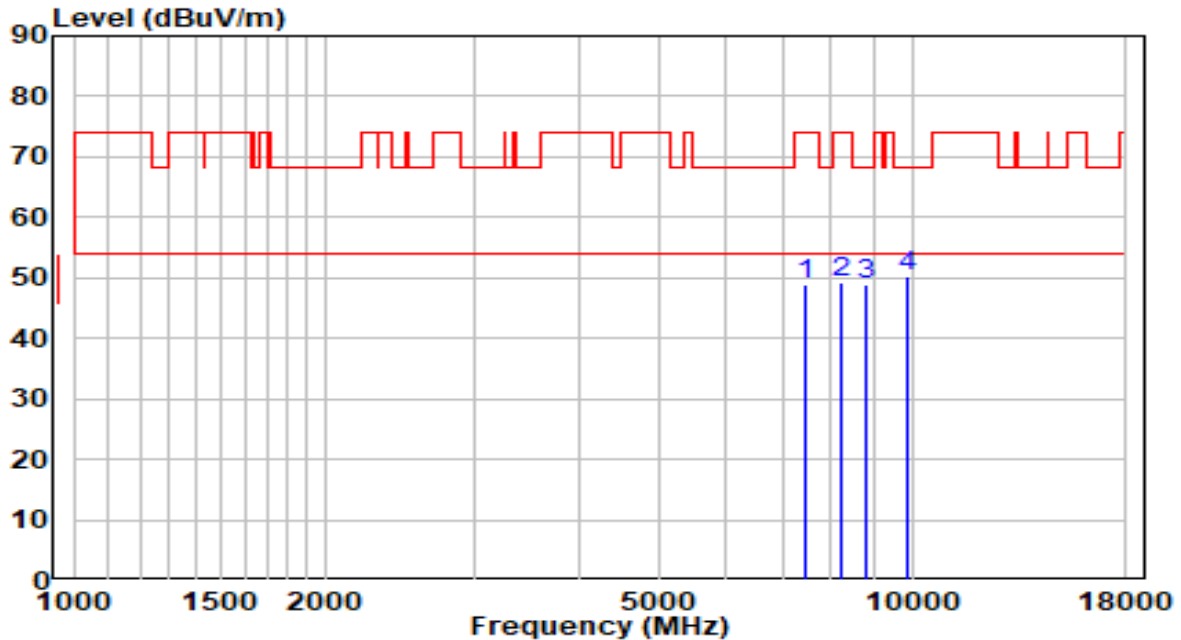

No	Frequency (MHz)	Reading (dBUV)	C.F (dB)	Measurement (dBUV/m)	Margin (dB)	Limit (dBUV/m)	Remark (QP/PK/AV)
1	7485.500	37.22	11.67	48.90	-25.10	74.00	Peak
2	8259.000	36.67	12.49	49.16	-24.84	74.00	Peak
3	8811.500	35.64	13.22	48.86	-19.34	68.20	Peak
4	* 9865.500	35.21	15.11	50.32	-17.88	68.20	Peak

Note:

1. " *", means this data is the worst emission level.
2. C.F (Correction Factor) = Antenna Factor (dB)+ Cable Loss (dB)– Preamplifier(dB).
3. Measurement(dBUV/m) = Reading(dBUV) + C.F (Correction Factor).
- 4.The emission levels of other frequencies are very lower than the limit and not show in test report.

EUT	Cassia Bluetooth Router	Date of Test	2021-03-01
Factor	BBHA 9120D	Temp. / Humidity	35.9°C/22.2%
Polarity	Horizontal	Site / Test Engineer	AC1 / Jay Chou
Test Mode	Transmit by 802.11a at Channel 5745MHz	Test Voltage	120V/60Hz

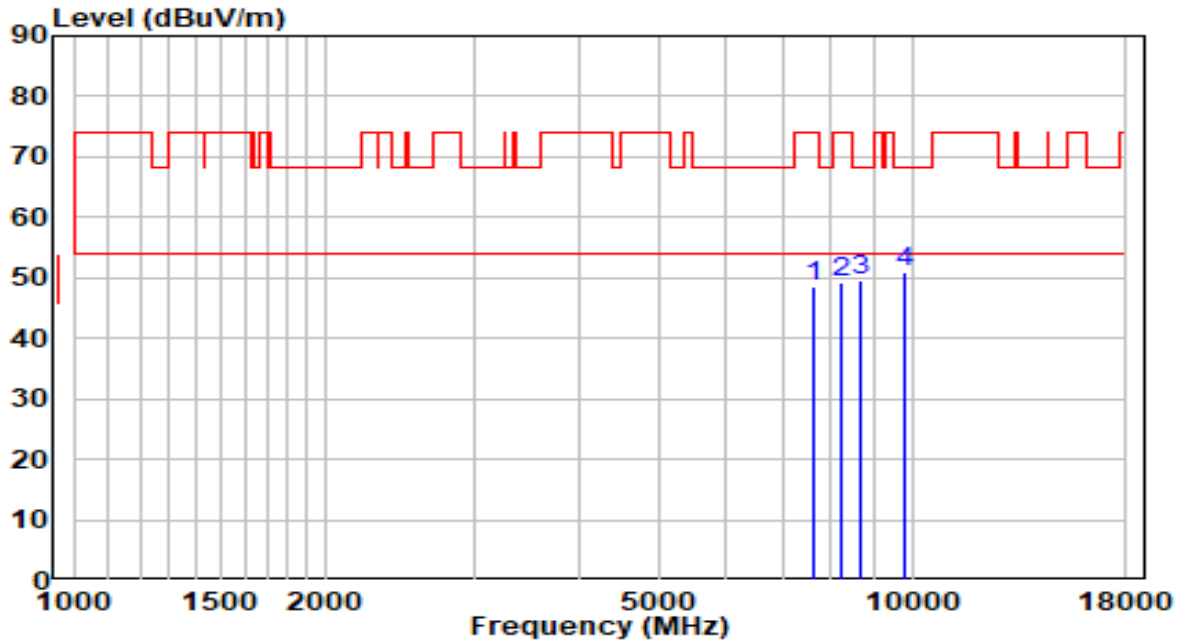

No	Frequency (MHz)	Reading (dBuV)	C.F (dB)	Measurement (dBuV/m)	Margin (dB)	Limit (dBuV/m)	Remark (QP/PK/AV)
1	7638.500	36.53	11.94	48.47	-25.53	74.00	Peak
2	8250.500	36.69	12.49	49.18	-24.82	74.00	Peak
3	8709.500	36.48	12.97	49.45	-18.75	68.20	Peak
4	* 9780.500	35.92	14.95	50.87	-17.33	68.20	Peak

Note:

1. " *", means this data is the worst emission level.
2. C.F (Correction Factor) = Antenna Factor (dB)+ Cable Loss (dB)– Preamplifier(dB).
3. Measurement(dBuV/m) = Reading(dBuV) + C.F (Correction Factor).
- 4.The emission levels of other frequencies are very lower than the limit and not show in test report.

EUT	Cassia Bluetooth Router	Date of Test	2021-03-01
Factor	BBHA 9120D	Temp. / Humidity	35.9°C/22.2%
Polarity	Vertical	Site / Test Engineer	AC1 / Jay Chou
Test Mode	Transmit by 802.11a at Channel 5745MHz	Test Voltage	120V/60Hz

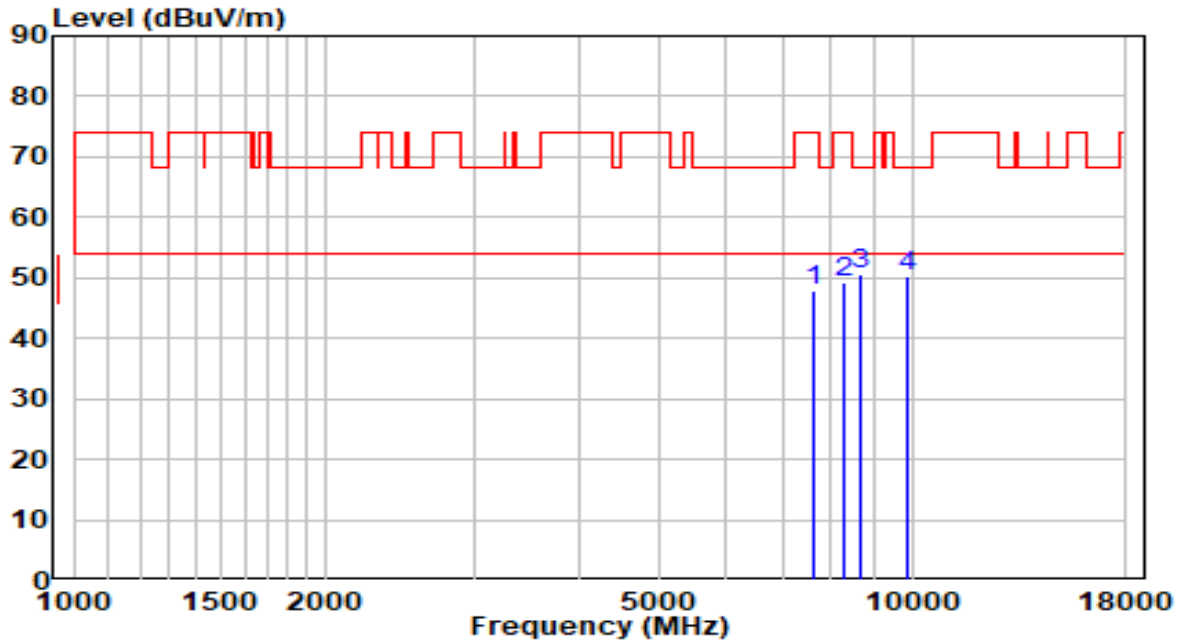

No	Frequency (MHz)	Reading (dBUV)	C.F (dB)	Measurement (dBUV/m)	Margin (dB)	Limit (dBUV/m)	Remark (QP/PK/AV)
1	7613.000	35.98	11.90	47.88	-26.12	74.00	Peak
2	8276.000	36.79	12.49	49.28	-24.72	74.00	Peak
3	* 8701.000	37.72	12.95	50.67	-17.53	68.20	Peak
4	9857.000	35.24	15.09	50.33	-17.87	68.20	Peak

Note:

1. " *", means this data is the worst emission level.
2. C.F (Correction Factor) = Antenna Factor (dB)+ Cable Loss (dB)– Preamplifier(dB).
3. Measurement(dBUV/m) = Reading(dBUV) + C.F (Correction Factor).
- 4.The emission levels of other frequencies are very lower than the limit and not show in test report.

EUT	Cassia Bluetooth Router	Date of Test	2021-03-01
Factor	BBHA 9120D	Temp. / Humidity	35.9°C/22.2%
Polarity	Horizontal	Site / Test Engineer	AC1 / Jay Chou
Test Mode	Transmit by 802.11a at Channel 5785MHz	Test Voltage	120V/60Hz

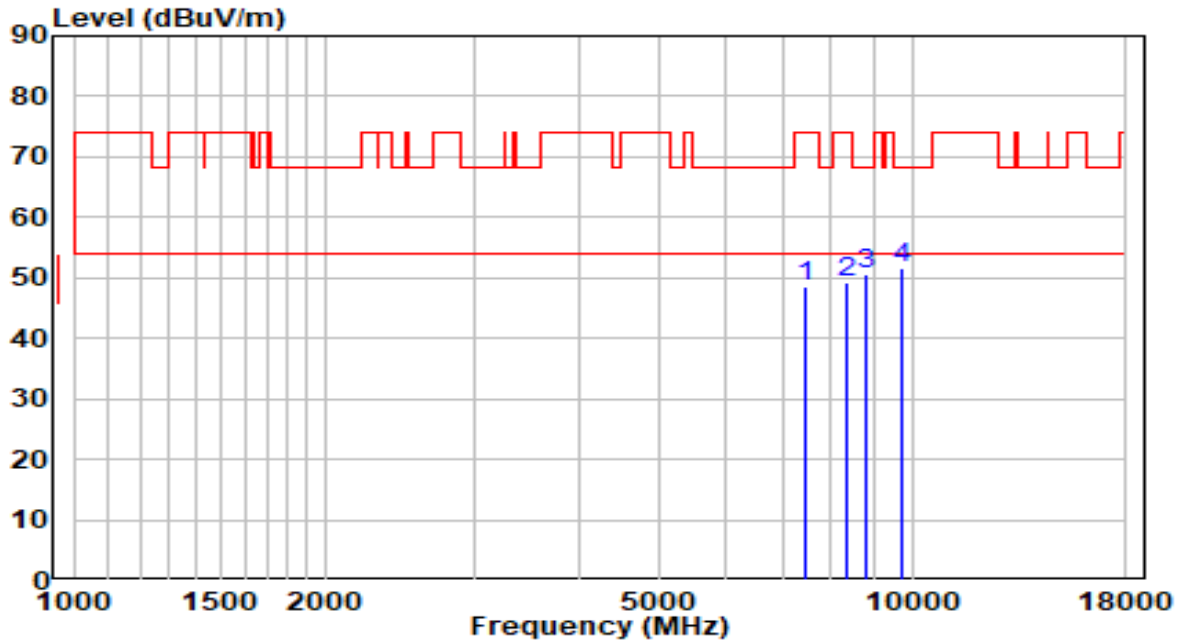

No	Frequency (MHz)	Reading (dBuV)	C.F (dB)	Measurement (dBuV/m)	Margin (dB)	Limit (dBuV/m)	Remark (QP/PK/AV)
1	7460.000	37.09	11.60	48.69	-25.31	74.00	Peak
2	8378.000	36.92	12.47	49.40	-24.60	74.00	Peak
3	8794.500	37.31	13.18	50.48	-17.72	68.20	Peak
4	* 9746.500	36.73	14.88	51.61	-16.59	68.20	Peak

Note:

1. " *", means this data is the worst emission level.
2. C.F (Correction Factor) = Antenna Factor (dB)+ Cable Loss (dB)– Preamplifier(dB).
3. Measurement(dBuV/m) = Reading(dBuV) + C.F (Correction Factor).
- 4.The emission levels of other frequencies are very lower than the limit and not show in test report.

EUT	Cassia Bluetooth Router	Date of Test	2021-03-01
Factor	BBHA 9120D	Temp. / Humidity	35.9°C/22.2%
Polarity	Vertical	Site / Test Engineer	AC1 / Jay Chou
Test Mode	Transmit by 802.11a at Channel 5785MHz	Test Voltage	120V/60Hz

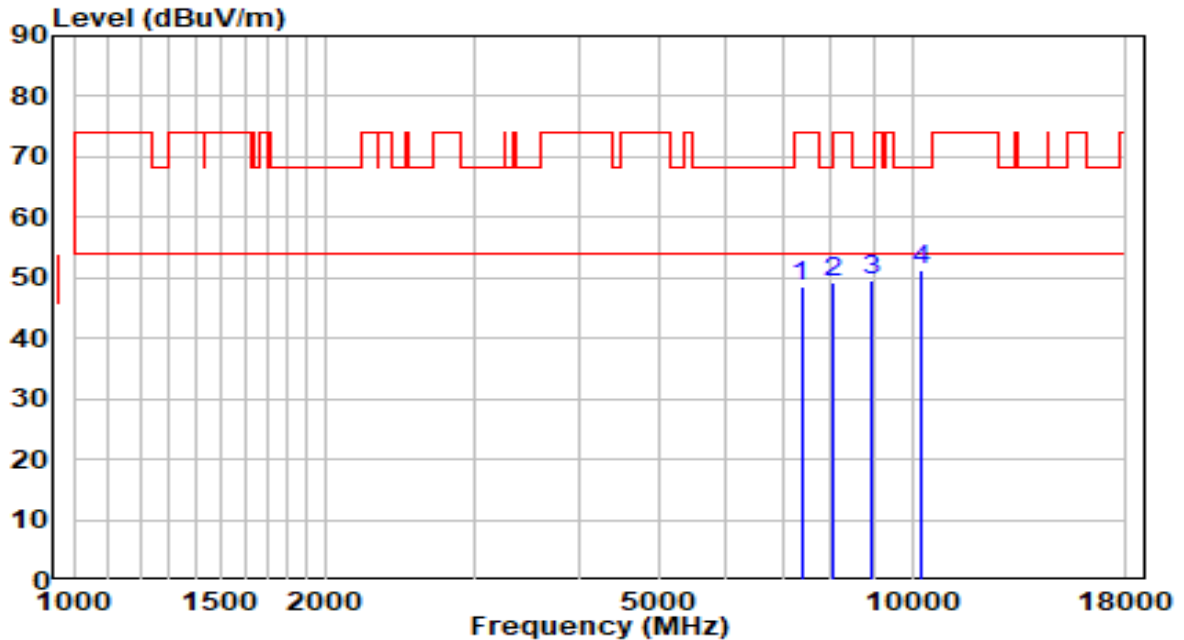

No	Frequency (MHz)	Reading (dBuV)	C.F (dB)	Measurement (dBuV/m)	Margin (dB)	Limit (dBuV/m)	Remark (QP/PK/AV)
1	7375.000	37.25	11.36	48.61	-25.39	74.00	Peak
2	8055.000	36.86	12.52	49.38	-24.62	74.00	Peak
3	8956.000	36.02	13.57	49.59	-18.61	68.20	Peak
4	* 10265.000	35.06	16.27	51.33	-16.87	68.20	Peak

Note:

1. " *", means this data is the worst emission level.
2. C.F (Correction Factor) = Antenna Factor (dB)+ Cable Loss (dB)– Preamplifier(dB).
3. Measurement(dBuV/m) = Reading(dBuV) + C.F (Correction Factor).
- 4.The emission levels of other frequencies are very lower than the limit and not show in test report.

EUT	Cassia Bluetooth Router	Date of Test	2021-03-01
Factor	BBHA 9120D	Temp. / Humidity	35.9°C/22.2%
Polarity	Horizontal	Site / Test Engineer	AC1 / Jay Chou
Test Mode	Transmit by 802.11a at Channel 5825MHz	Test Voltage	120V/60Hz

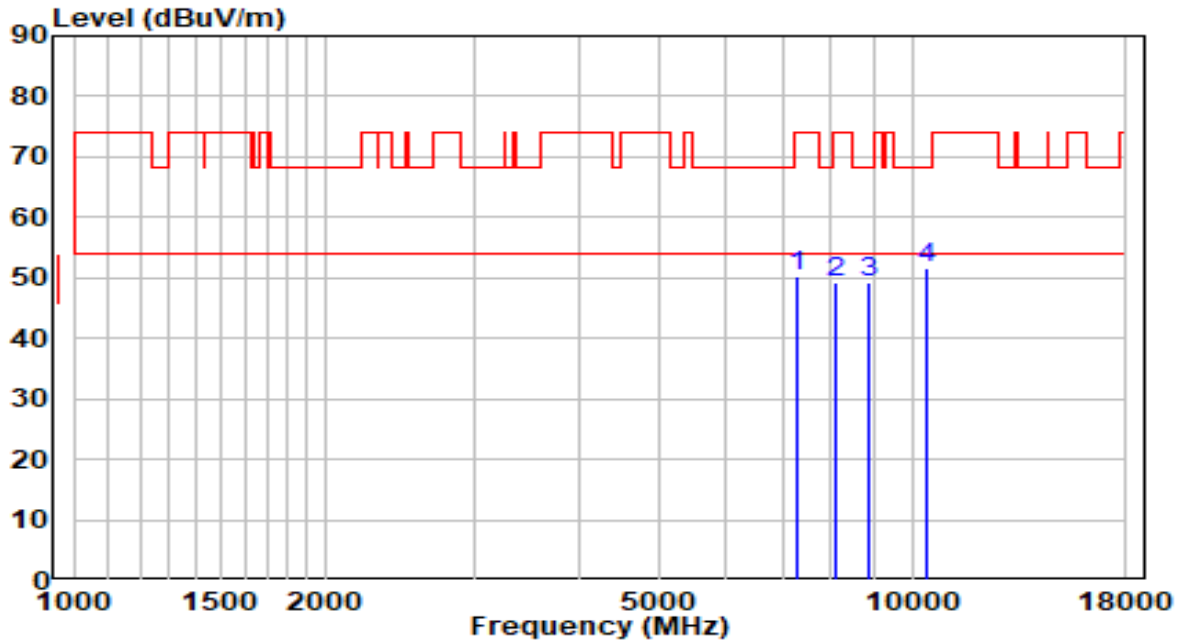

No	Frequency (MHz)	Reading (dBuV)	C.F (dB)	Measurement (dBuV/m)	Margin (dB)	Limit (dBuV/m)	Remark (QP/PK/AV)
1	7307.000	39.04	11.17	50.21	-23.79	74.00	Peak
2	8080.500	36.58	12.52	49.10	-24.90	74.00	Peak
3	8896.500	35.68	13.43	49.11	-19.09	68.20	Peak
4	* 10435.000	34.82	16.85	51.67	-16.53	68.20	Peak

Note:

1. " *", means this data is the worst emission level.
2. C.F (Correction Factor) = Antenna Factor (dB)+ Cable Loss (dB)– Preamplifier(dB).
3. Measurement(dBuV/m) = Reading(dBuV) + C.F (Correction Factor).
- 4.The emission levels of other frequencies are very lower than the limit and not show in test report.

EUT	Cassia Bluetooth Router	Date of Test	2021-03-01
Factor	BBHA 9120D	Temp. / Humidity	35.9°C/22.2%
Polarity	Vertical	Site / Test Engineer	AC1 / Jay Chou
Test Mode	Transmit by 802.11a at Channel 5825MHz	Test Voltage	120V/60Hz

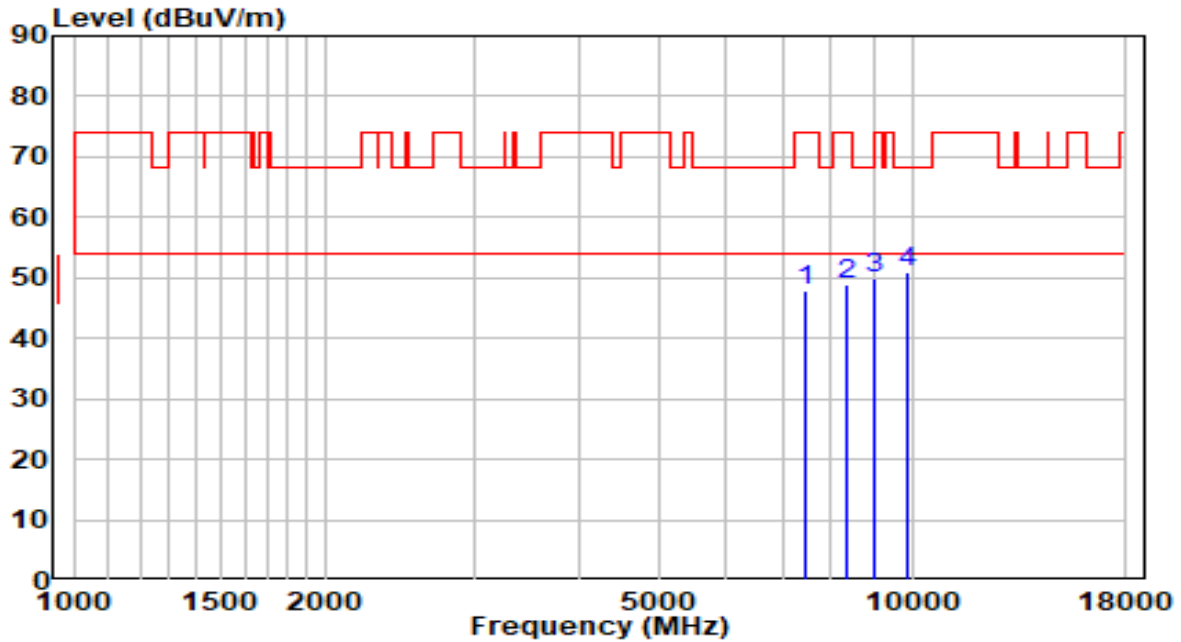

No	Frequency (MHz)	Reading (dBuV)	C.F (dB)	Measurement (dBuV/m)	Margin (dB)	Limit (dBuV/m)	Remark (QP/PK/AV)
1	7451.500	36.42	11.58	48.00	-26.00	74.00	Peak
2	8361.000	36.56	12.48	49.04	-24.96	74.00	Peak
3	8981.500	36.45	13.63	50.09	-18.11	68.20	Peak
4	* 9882.500	35.89	15.14	51.03	-17.17	68.20	Peak

Note:

1. " *", means this data is the worst emission level.
2. C.F (Correction Factor) = Antenna Factor (dB)+ Cable Loss (dB)– Preamplifier(dB).
3. Measurement(dBuV/m) = Reading(dBuV) + C.F (Correction Factor).
- 4.The emission levels of other frequencies are very lower than the limit and not show in test report.

EUT	Cassia Bluetooth Router	Date of Test	2021-03-01
Factor	BBHA 9120D	Temp. / Humidity	35.9°C/22.2%
Polarity	Horizontal	Site / Test Engineer	AC1 / Jay Chou
Test Mode	Transmit by 802.11ac-VHT20 at Channel 5180MHz	Test Voltage	120V/60Hz

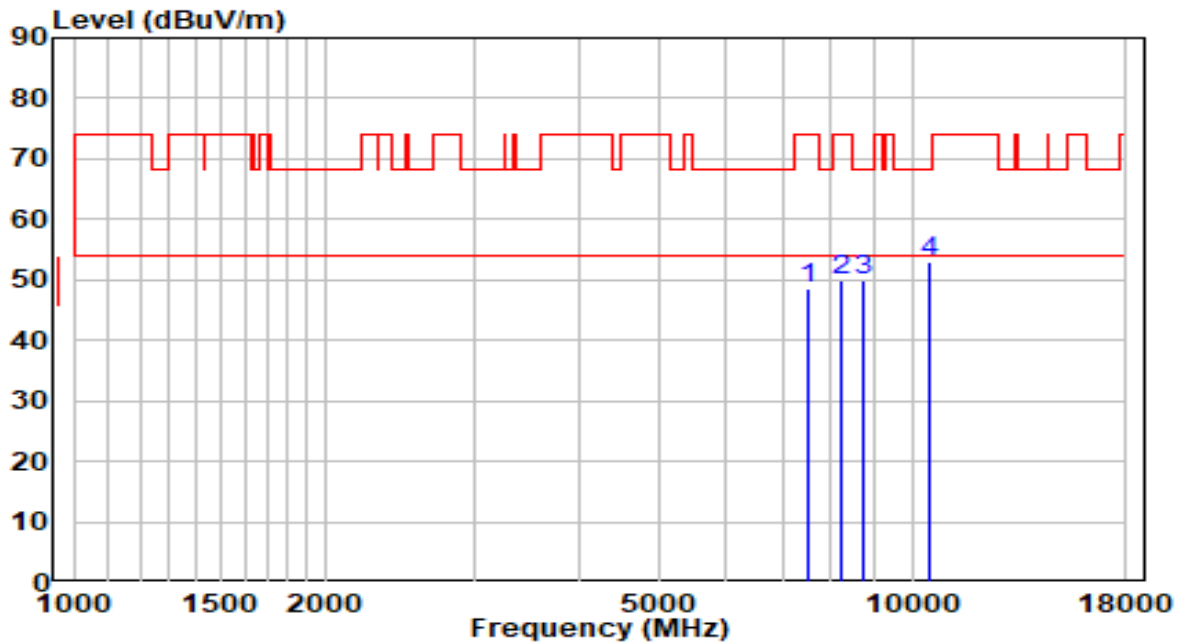

No	Frequency (MHz)	Reading (dBuV)	C.F (dB)	Measurement (dBuV/m)	Margin (dB)	Limit (dBuV/m)	Remark (QP/PK/AV)
1	7528.000	36.93	11.76	48.69	-25.31	74.00	Peak
2	8250.500	37.42	12.49	49.92	-24.08	74.00	Peak
3	8743.500	36.73	13.05	49.78	-18.42	68.20	Peak
4	* 10511.500	35.97	17.09	53.06	-15.14	68.20	Peak

Note:

- "*" means this data is the worst emission level.
- C.F (Correction Factor) = Antenna Factor (dB)+ Cable Loss (dB)– Preamplifier(dB).
- Measurement(dBuV/m) = Reading(dBuV) + C.F (Correction Factor).
- The emission levels of other frequencies are very lower than the limit and not show in test report.

EUT	Cassia Bluetooth Router	Date of Test	2021-03-01
Factor	BBHA 9120D	Temp. / Humidity	35.9°C/22.2%
Polarity	Vertical	Site / Test Engineer	AC1 / Jay Chou
Test Mode	Transmit by 802.11ac-VHT20 at Channel 5180MHz	Test Voltage	120V/60Hz

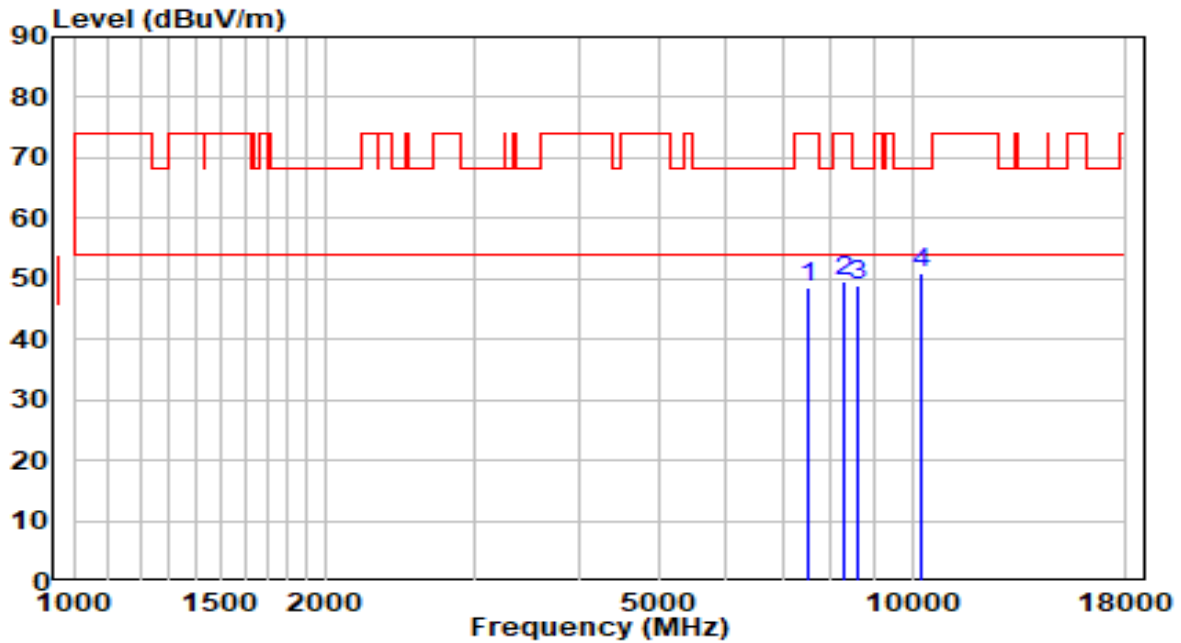

No	Frequency (MHz)	Reading (dBUV)	C.F (dB)	Measurement (dBUV/m)	Margin (dB)	Limit (dBUV/m)	Remark (QP/PK/AV)
1	7494.000	36.97	11.70	48.67	-25.33	74.00	Peak
2	8276.000	37.01	12.49	49.50	-24.50	74.00	Peak
3	8624.500	36.26	12.76	49.02	-19.18	68.20	Peak
4	* 10282.000	34.57	16.32	50.90	-17.30	68.20	Peak

Note:

- "*", means this data is the worst emission level.
- C.F (Correction Factor) = Antenna Factor (dB)+ Cable Loss (dB)– Preamplifier(dB).
- Measurement(dBUV/m) = Reading(dBUV) + C.F (Correction Factor).
- The emission levels of other frequencies are very lower than the limit and not show in test report.

EUT	Cassia Bluetooth Router	Date of Test	2021-03-01
Factor	BBHA 9120D	Temp. / Humidity	35.9°C/22.2%
Polarity	Horizontal	Site / Test Engineer	AC1 / Jay Chou
Test Mode	Transmit by 802.11ac-VHT20 at Channel 5220MHz	Test Voltage	120V/60Hz

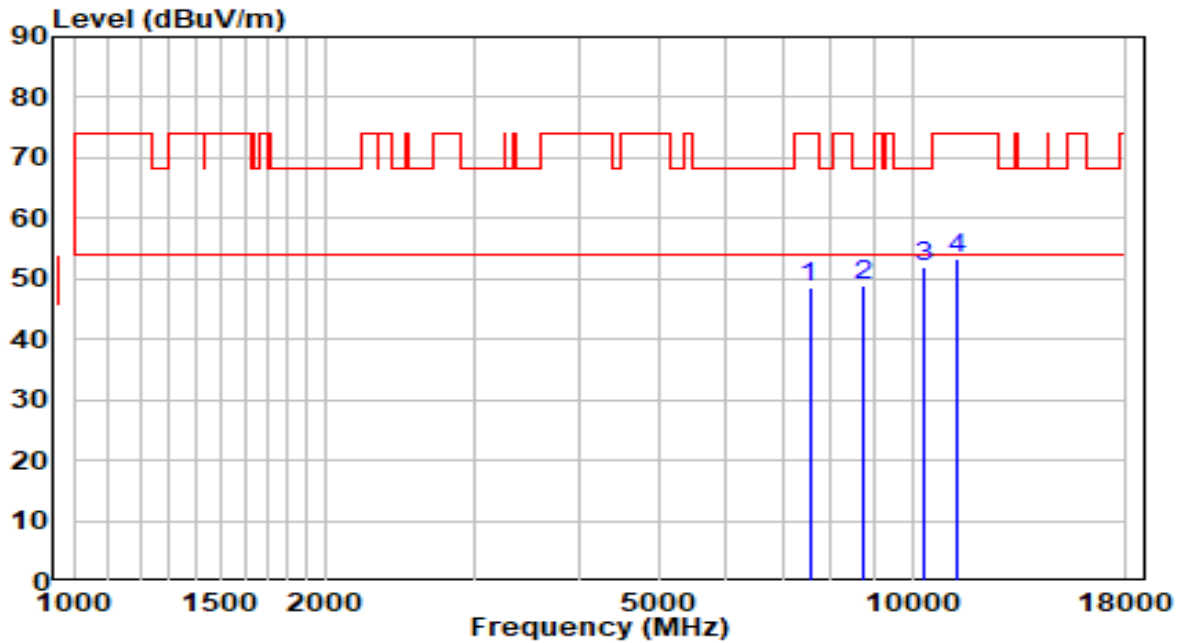

No	Frequency (MHz)	Reading (dBuV)	C.F (dB)	Measurement (dBuV/m)	Margin (dB)	Limit (dBuV/m)	Remark (QP/PK/AV)
1	7545.000	36.80	11.79	48.59	-25.41	74.00	Peak
2	8743.500	35.98	13.05	49.03	-19.17	68.20	Peak
3	* 10299.000	35.43	16.38	51.81	-16.39	68.20	Peak
4	11353.000	35.18	18.25	53.43	-20.57	74.00	Peak

Note:

- "*", means this data is the worst emission level.
- C.F (Correction Factor) = Antenna Factor (dB)+ Cable Loss (dB)– Preamplifier(dB).
- Measurement(dBuV/m) = Reading(dBuV) + C.F (Correction Factor).
- The emission levels of other frequencies are very lower than the limit and not show in test report.

EUT	Cassia Bluetooth Router	Date of Test	2021-03-01
Factor	BBHA 9120D	Temp. / Humidity	35.9°C/22.2%
Polarity	Vertical	Site / Test Engineer	AC1 / Jay Chou
Test Mode	Transmit by 802.11ac-VHT20 at Channel 5220MHz	Test Voltage	120V/60Hz

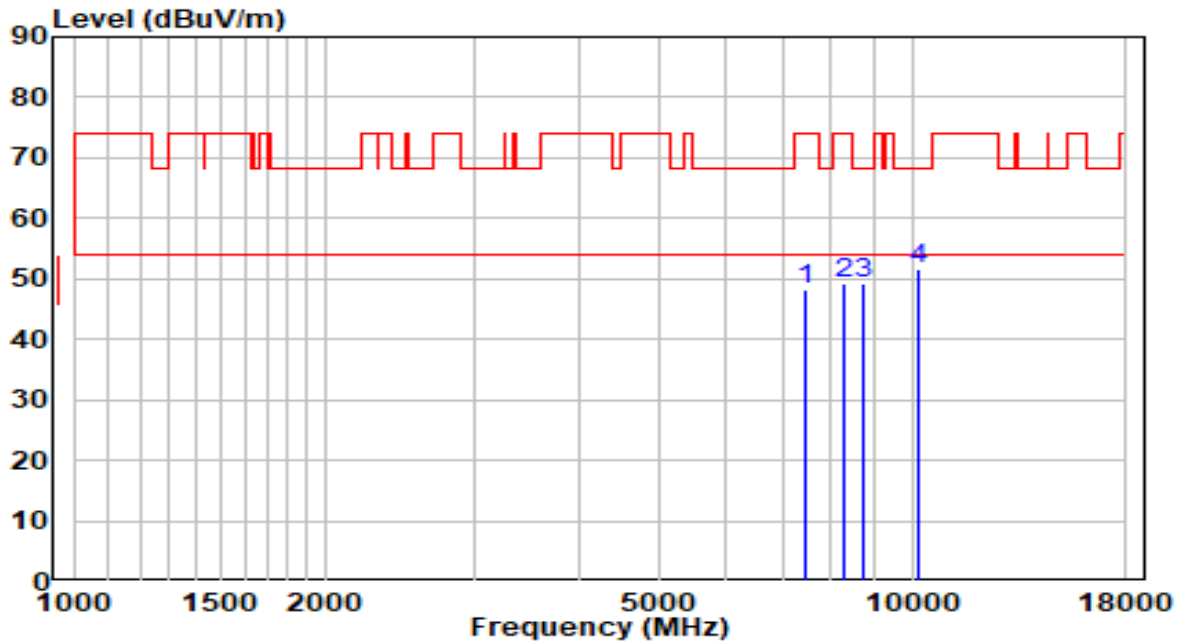

No	Frequency (MHz)	Reading (dBuV)	C.F (dB)	Measurement (dBuV/m)	Margin (dB)	Limit (dBuV/m)	Remark (QP/PK/AV)
1	7460.000	36.68	11.60	48.28	-25.72	74.00	Peak
2	8284.500	36.82	12.49	49.31	-24.69	74.00	Peak
3	8752.000	36.28	13.07	49.35	-18.85	68.20	Peak
4	* 10188.500	35.46	16.00	51.47	-16.73	68.20	Peak

Note:

- "*", means this data is the worst emission level.
- C.F (Correction Factor) = Antenna Factor (dB)+ Cable Loss (dB)– Preamplifier(dB).
- Measurement(dBuV/m) = Reading(dBuV) + C.F (Correction Factor).
- The emission levels of other frequencies are very lower than the limit and not show in test report.

EUT	Cassia Bluetooth Router	Date of Test	2021-03-01
Factor	BBHA 9120D	Temp. / Humidity	35.9°C/22.2%
Polarity	Horizontal	Site / Test Engineer	AC1 / Jay Chou
Test Mode	Transmit by 802.11ac-VHT20 at Channel 5240MHz	Test Voltage	120V/60Hz

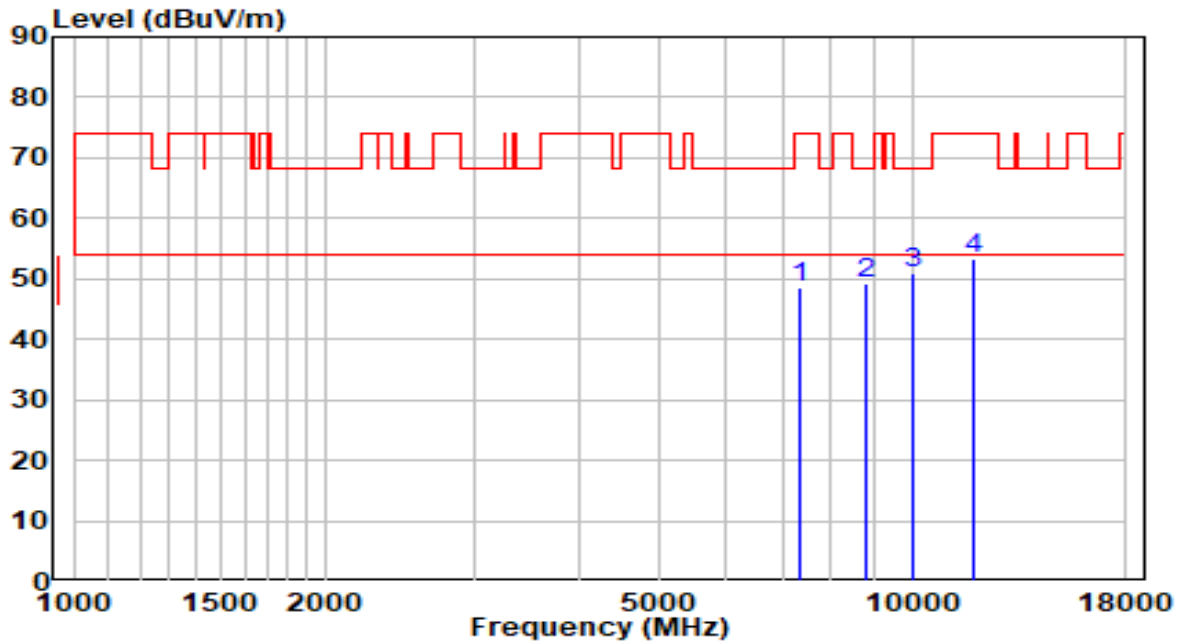

No	Frequency (MHz)	Reading (dBUV)	C.F (dB)	Measurement (dBUV/m)	Margin (dB)	Limit (dBUV/m)	Remark (QP/PK/AV)
1	7358.000	37.11	11.31	48.43	-25.57	74.00	Peak
2	8794.500	35.91	13.18	49.09	-19.11	68.20	Peak
3	* 10044.000	35.42	15.51	50.93	-17.27	68.20	Peak
4	11829.000	35.24	18.04	53.27	-20.73	74.00	Peak

Note:

- "*", means this data is the worst emission level.
- C.F (Correction Factor) = Antenna Factor (dB)+ Cable Loss (dB)– Preamplifier(dB).
- Measurement(dBUV/m) = Reading(dBUV) + C.F (Correction Factor).
- The emission levels of other frequencies are very lower than the limit and not show in test report.

EUT	Cassia Bluetooth Router	Date of Test	2021-03-01
Factor	BBHA 9120D	Temp. / Humidity	35.9°C/22.2%
Polarity	Vertical	Site / Test Engineer	AC1 / Jay Chou
Test Mode	Transmit by 802.11ac-VHT20 at Channel 5240MHz	Test Voltage	120V/60Hz

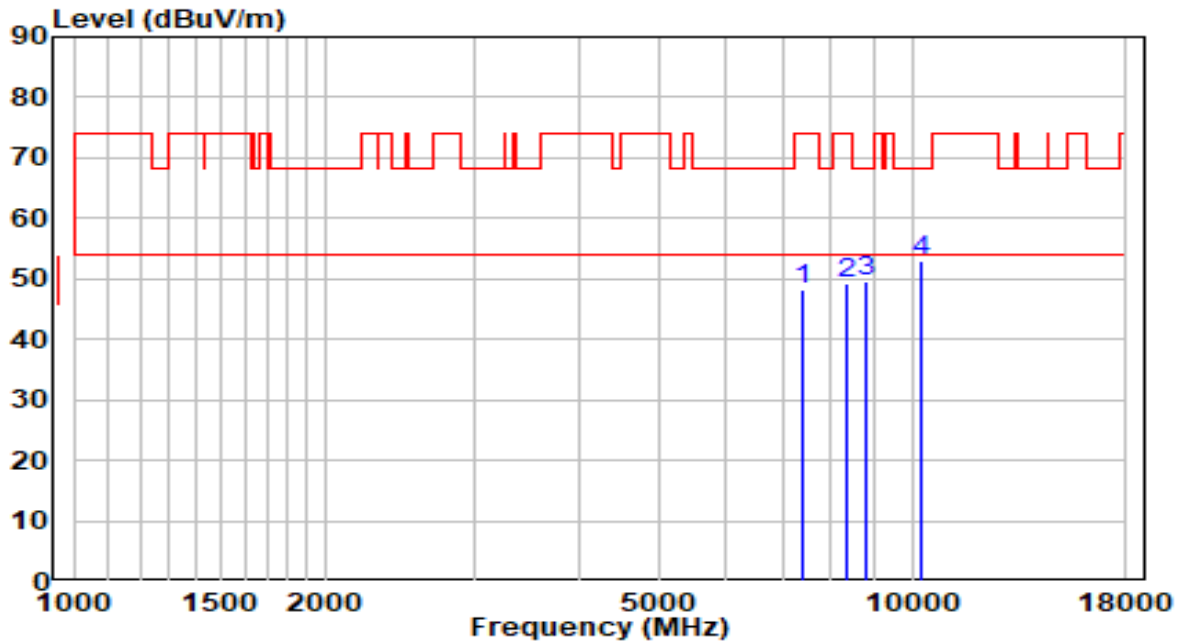

No	Frequency (MHz)	Reading (dBuV)	C.F (dB)	Measurement (dBuV/m)	Margin (dB)	Limit (dBuV/m)	Remark (QP/PK/AV)
1	7417.500	36.79	11.48	48.27	-25.73	74.00	Peak
2	8352.500	36.68	12.48	49.16	-24.84	74.00	Peak
3	8828.500	36.37	13.26	49.63	-18.57	68.20	Peak
4	* 10273.500	36.54	16.30	52.83	-15.37	68.20	Peak

Note:

- "*", means this data is the worst emission level.
- C.F (Correction Factor) = Antenna Factor (dB)+ Cable Loss (dB)– Preamplifier(dB).
- Measurement(dBuV/m) = Reading(dBuV) + C.F (Correction Factor).
- The emission levels of other frequencies are very lower than the limit and not show in test report.

EUT	Cassia Bluetooth Router	Date of Test	2021-03-01
Factor	BBHA 9120D	Temp. / Humidity	35.9°C/22.2%
Polarity	Horizontal	Site / Test Engineer	AC1 / Jay Chou
Test Mode	Transmit by 802.11ac-VHT20 at Channel 5260MHz	Test Voltage	120V/60Hz

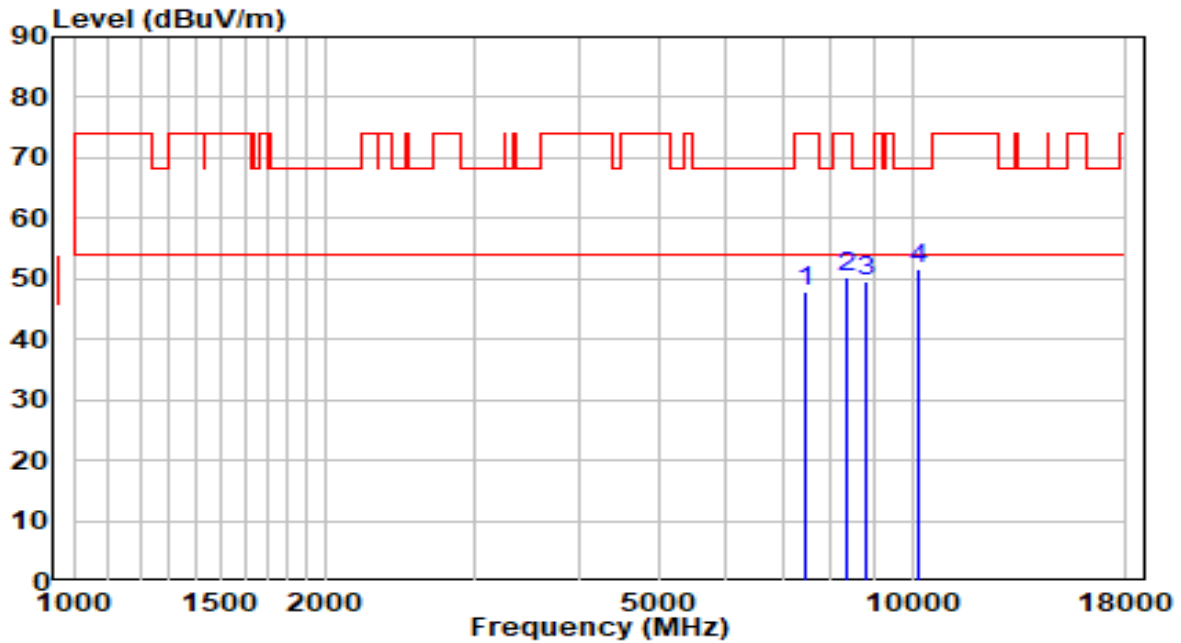

No	Frequency (MHz)	Reading (dBUV)	C.F (dB)	Measurement (dBUV/m)	Margin (dB)	Limit (dBUV/m)	Remark (QP/PK/AV)
1	7477.000	36.39	11.65	48.04	-25.96	74.00	Peak
2	8335.500	37.69	12.48	50.17	-23.83	74.00	Peak
3	8811.500	36.46	13.22	49.68	-18.52	68.20	Peak
4	* 10180.000	35.73	15.98	51.71	-16.49	68.20	Peak

Note:

1. " *", means this data is the worst emission level.
2. C.F (Correction Factor) = Antenna Factor (dB)+ Cable Loss (dB)– Preamplifier(dB).
3. Measurement(dBUV/m) = Reading(dBUV) + C.F (Correction Factor).
4. The emission levels of other frequencies are very lower than the limit and not show in test report.

EUT	Cassia Bluetooth Router	Date of Test	2021-03-01
Factor	BBHA 9120D	Temp. / Humidity	35.9°C/22.2%
Polarity	Vertical	Site / Test Engineer	AC1 / Jay Chou
Test Mode	Transmit by 802.11ac-VHT20 at Channel 5260MHz	Test Voltage	120V/60Hz

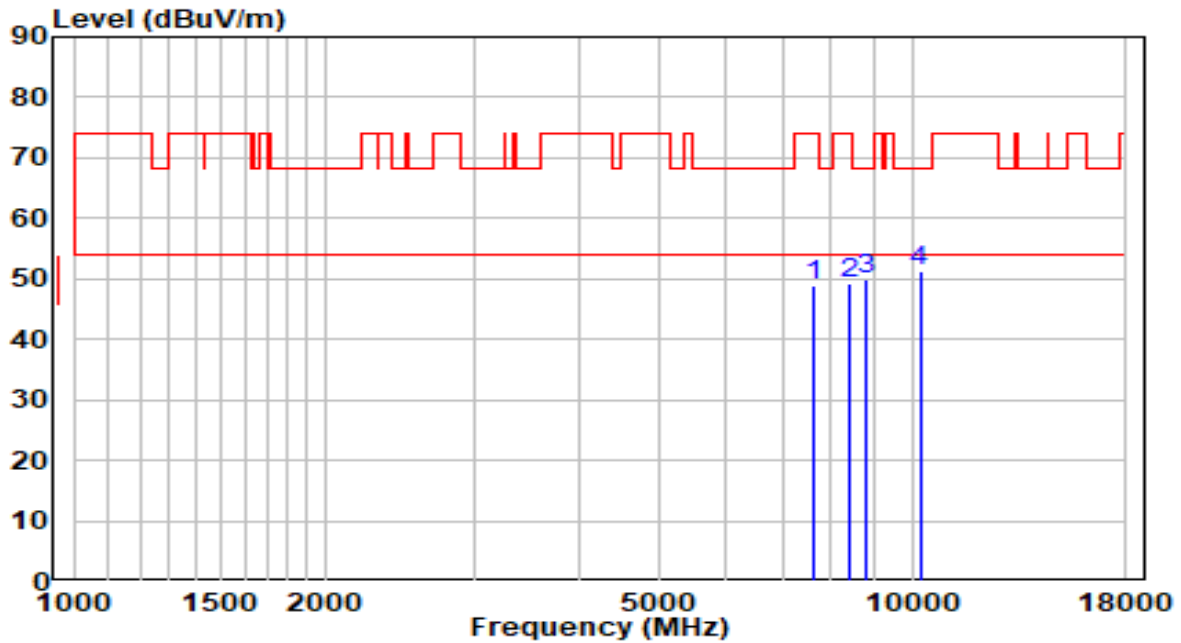

No	Frequency (MHz)	Reading (dBUV)	C.F (dB)	Measurement (dBUV/m)	Margin (dB)	Limit (dBUV/m)	Remark (QP/PK/AV)
1	7630.000	36.89	11.93	48.82	-25.18	74.00	Peak
2	8429.000	36.92	12.47	49.39	-24.61	74.00	Peak
3	8820.000	36.65	13.24	49.89	-18.31	68.20	Peak
4	* 10214.000	35.20	16.09	51.29	-16.91	68.20	Peak

Note:

- "*", means this data is the worst emission level.
- C.F (Correction Factor) = Antenna Factor (dB)+ Cable Loss (dB)– Preamplifier(dB).
- Measurement(dBUV/m) = Reading(dBUV) + C.F (Correction Factor).
- The emission levels of other frequencies are very lower than the limit and not show in test report.

EUT	Cassia Bluetooth Router	Date of Test	2021-03-01
Factor	BBHA 9120D	Temp. / Humidity	35.9°C/22.2%
Polarity	Horizontal	Site / Test Engineer	AC1 / Jay Chou
Test Mode	Transmit by 802.11ac-VHT20 at Channel 5300MHz	Test Voltage	120V/60Hz

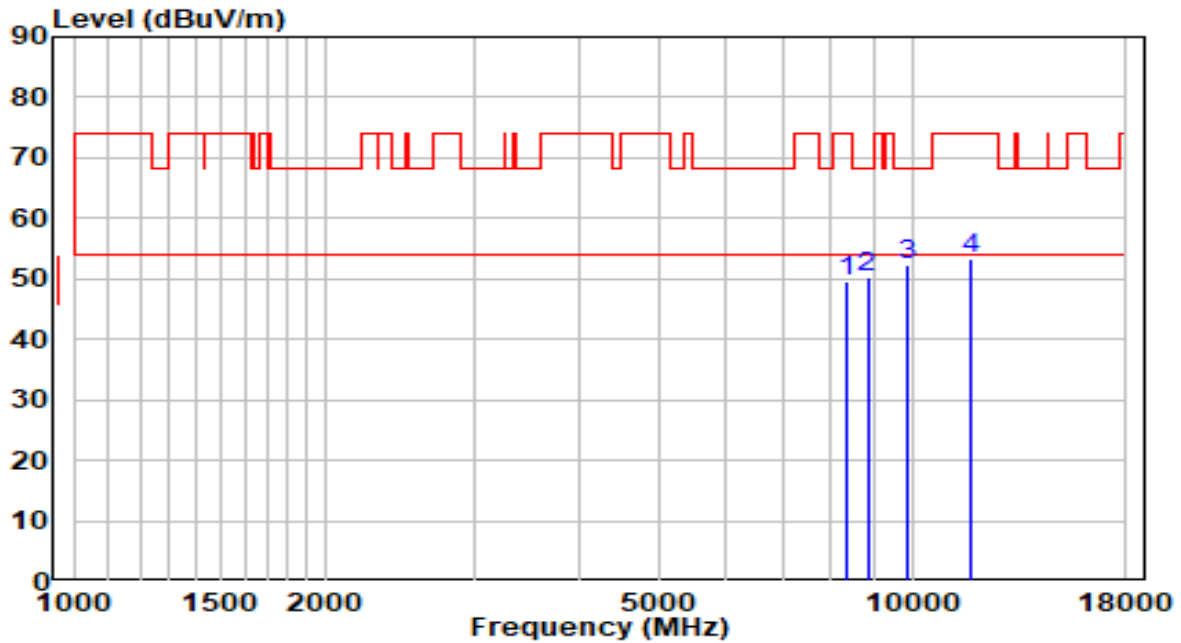

No	Frequency (MHz)	Reading (dBUV)	C.F (dB)	Measurement (dBUV/m)	Margin (dB)	Limit (dBUV/m)	Remark (QP/PK/AV)
1	8361.000	37.00	12.48	49.47	-24.53	74.00	Peak
2	8845.500	36.86	13.30	50.16	-18.04	68.20	Peak
3	* 9882.500	37.13	15.14	52.27	-15.93	68.20	Peak
4	11778.000	35.33	18.10	53.42	-20.58	74.00	Peak

Note:

- "*", means this data is the worst emission level.
- C.F (Correction Factor) = Antenna Factor (dB)+ Cable Loss (dB)– Preamplifier(dB).
- Measurement(dBUV/m) = Reading(dBUV) + C.F (Correction Factor).
- The emission levels of other frequencies are very lower than the limit and not show in test report.

EUT	Cassia Bluetooth Router	Date of Test	2021-03-01
Factor	BBHA 9120D	Temp. / Humidity	35.9°C/22.2%
Polarity	Vertical	Site / Test Engineer	AC1 / Jay Chou
Test Mode	Transmit by 802.11ac-VHT20 at Channel 5300MHz	Test Voltage	120V/60Hz

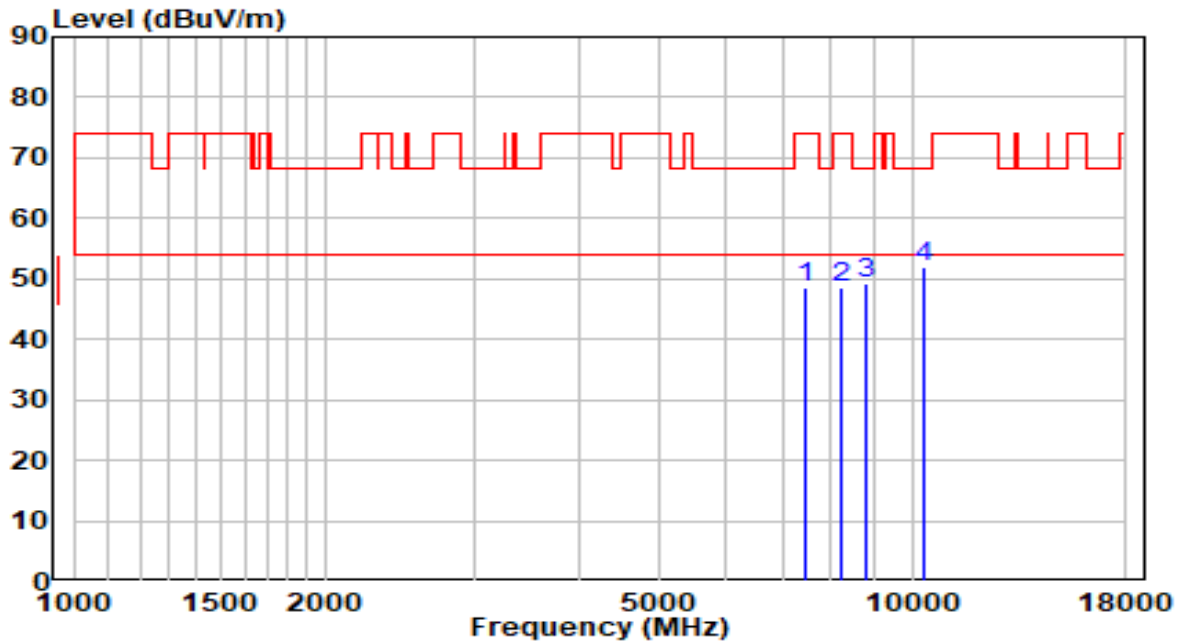

No	Frequency (MHz)	Reading (dBUV)	C.F (dB)	Measurement (dBUV/m)	Margin (dB)	Limit (dBUV/m)	Remark (QP/PK/AV)
1	7468.500	36.88	11.63	48.51	-25.49	74.00	Peak
2	8216.500	36.21	12.50	48.71	-25.29	74.00	Peak
3	8811.500	36.01	13.22	49.23	-18.97	68.20	Peak
4	* 10307.500	35.57	16.41	51.98	-16.22	68.20	Peak

Note:

1. " *", means this data is the worst emission level.
2. C.F (Correction Factor) = Antenna Factor (dB)+ Cable Loss (dB)– Preamplifier(dB).
3. Measurement(dBUV/m) = Reading(dBUV) + C.F (Correction Factor).
- 4.The emission levels of other frequencies are very lower than the limit and not show in test report.

EUT	Cassia Bluetooth Router	Date of Test	2021-03-01
Factor	BBHA 9120D	Temp. / Humidity	35.9°C/22.2%
Polarity	Horizontal	Site / Test Engineer	AC1 / Jay Chou
Test Mode	Transmit by 802.11ac-VHT20 at Channel 5320MHz	Test Voltage	120V/60Hz

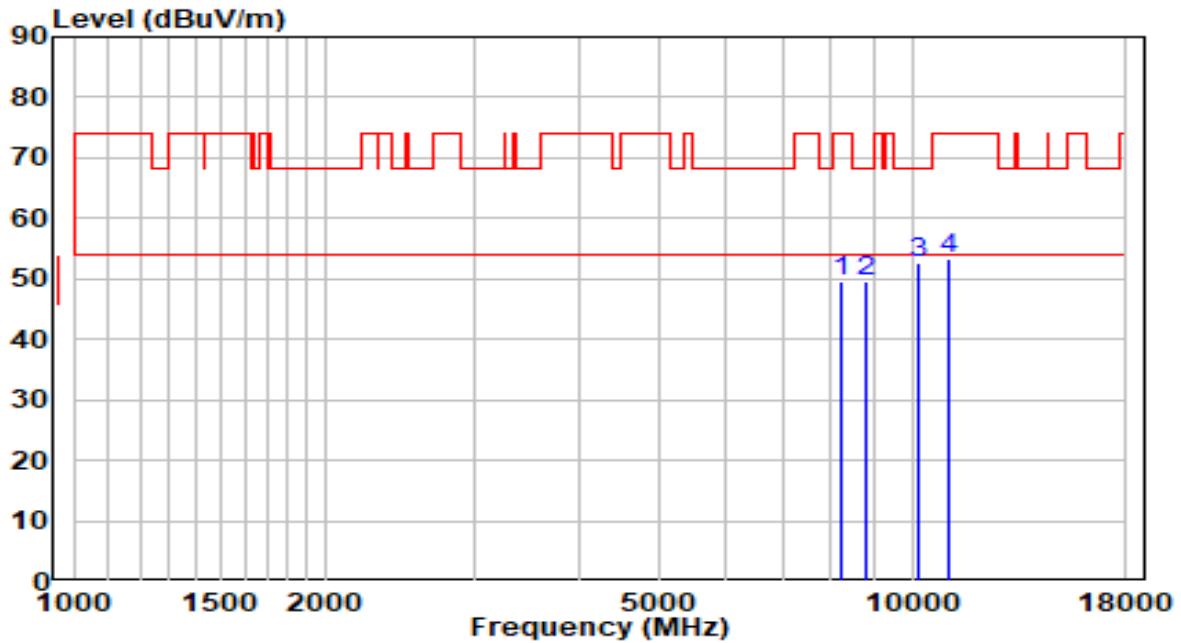

No	Frequency (MHz)	Reading (dBuV)	C.F (dB)	Measurement (dBuV/m)	Margin (dB)	Limit (dBuV/m)	Remark (QP/PK/AV)
1	8259.000	37.03	12.49	49.52	-24.48	74.00	Peak
2	8820.000	36.49	13.24	49.73	-18.47	68.20	Peak
3	* 10205.500	36.52	16.06	52.59	-15.61	68.20	Peak
4	11089.500	35.53	17.90	53.43	-20.57	74.00	Peak

Note:

- "*", means this data is the worst emission level.
- C.F (Correction Factor) = Antenna Factor (dB)+ Cable Loss (dB)– Preamplifier(dB).
- Measurement(dBuV/m) = Reading(dBuV) + C.F (Correction Factor).
- The emission levels of other frequencies are very lower than the limit and not show in test report.

EUT	Cassia Bluetooth Router	Date of Test	2021-03-01
Factor	BBHA 9120D	Temp. / Humidity	35.9°C/22.2%
Polarity	Vertical	Site / Test Engineer	AC1 / Jay Chou
Test Mode	Transmit by 802.11ac-VHT20 at Channel 5320MHz	Test Voltage	120V/60Hz

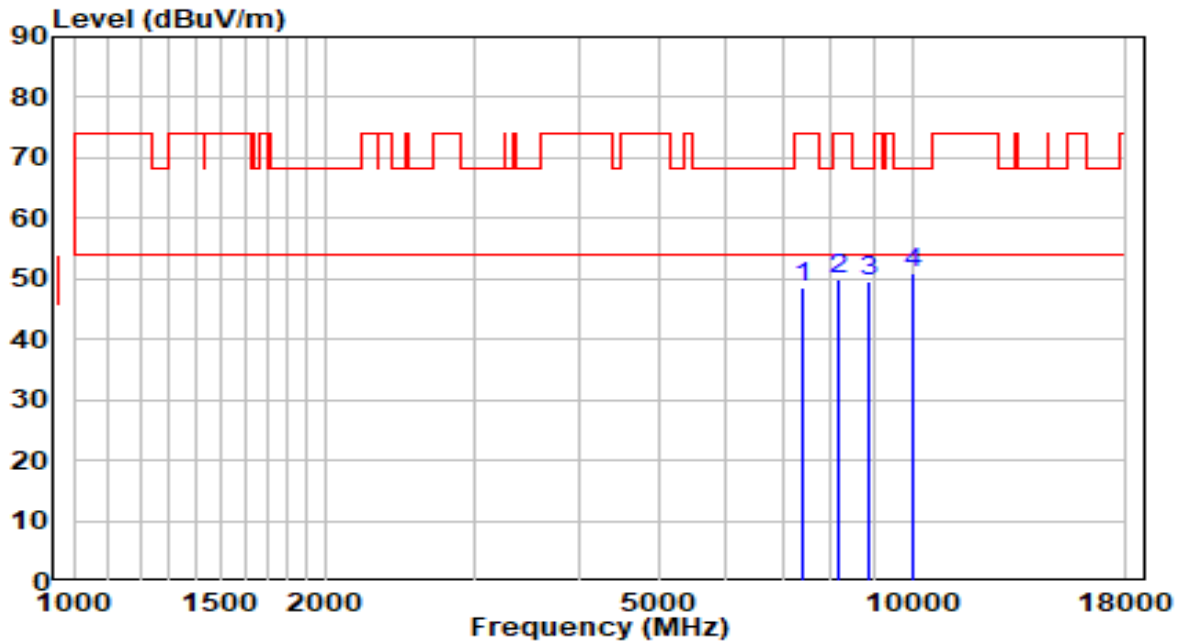

No	Frequency (MHz)	Reading (dBuV)	C.F (dB)	Measurement (dBuV/m)	Margin (dB)	Limit (dBuV/m)	Remark (QP/PK/AV)
1	7409.000	37.00	11.46	48.46	-25.54	74.00	Peak
2	8165.500	37.36	12.51	49.86	-24.14	74.00	Peak
3	8888.000	36.15	13.41	49.56	-18.64	68.20	Peak
4	* 10035.500	35.44	15.48	50.92	-17.28	68.20	Peak

Note:

1. " *", means this data is the worst emission level.
2. C.F (Correction Factor) = Antenna Factor (dB)+ Cable Loss (dB)– Preamplifier(dB).
3. Measurement(dBuV/m) = Reading(dBuV) + C.F (Correction Factor).
- 4.The emission levels of other frequencies are very lower than the limit and not show in test report.

EUT	Cassia Bluetooth Router	Date of Test	2021-03-01
Factor	BBHA 9120D	Temp. / Humidity	35.9°C/22.2%
Polarity	Horizontal	Site / Test Engineer	AC1 / Jay Chou
Test Mode	Transmit by 802.11ac-VHT20 at Channel 5500MHz	Test Voltage	120V/60Hz

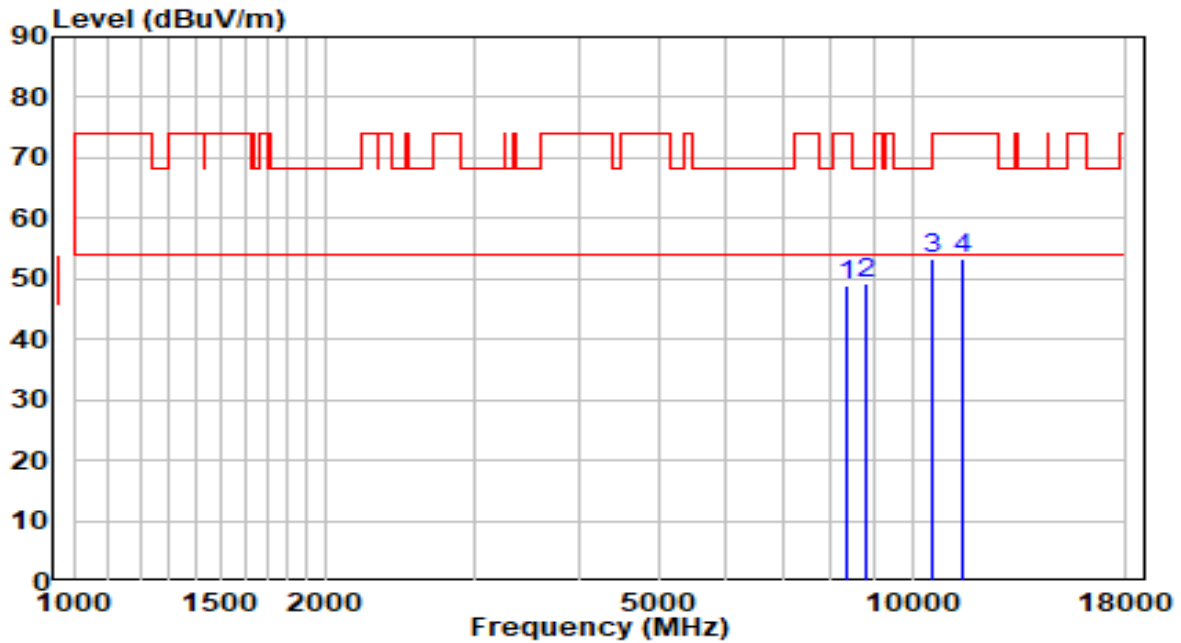

No	Frequency (MHz)	Reading (dBuV)	C.F (dB)	Measurement (dBuV/m)	Margin (dB)	Limit (dBuV/m)	Remark (QP/PK/AV)
1	8361.000	36.39	12.48	48.87	-25.13	74.00	Peak
2	8811.500	36.02	13.22	49.24	-18.96	68.20	Peak
3	* 10579.500	36.20	17.18	53.38	-14.82	68.20	Peak
4	11480.500	34.83	18.42	53.26	-20.74	74.00	Peak

Note:

- "*", means this data is the worst emission level.
- C.F (Correction Factor) = Antenna Factor (dB)+ Cable Loss (dB)– Preamplifier(dB).
- Measurement(dBuV/m) = Reading(dBuV) + C.F (Correction Factor).
- The emission levels of other frequencies are very lower than the limit and not show in test report.

EUT	Cassia Bluetooth Router	Date of Test	2021-03-01
Factor	BBHA 9120D	Temp. / Humidity	35.9°C/22.2%
Polarity	Vertical	Site / Test Engineer	AC1 / Jay Chou
Test Mode	Transmit by 802.11ac-VHT20 at Channel 5500MHz	Test Voltage	120V/60Hz

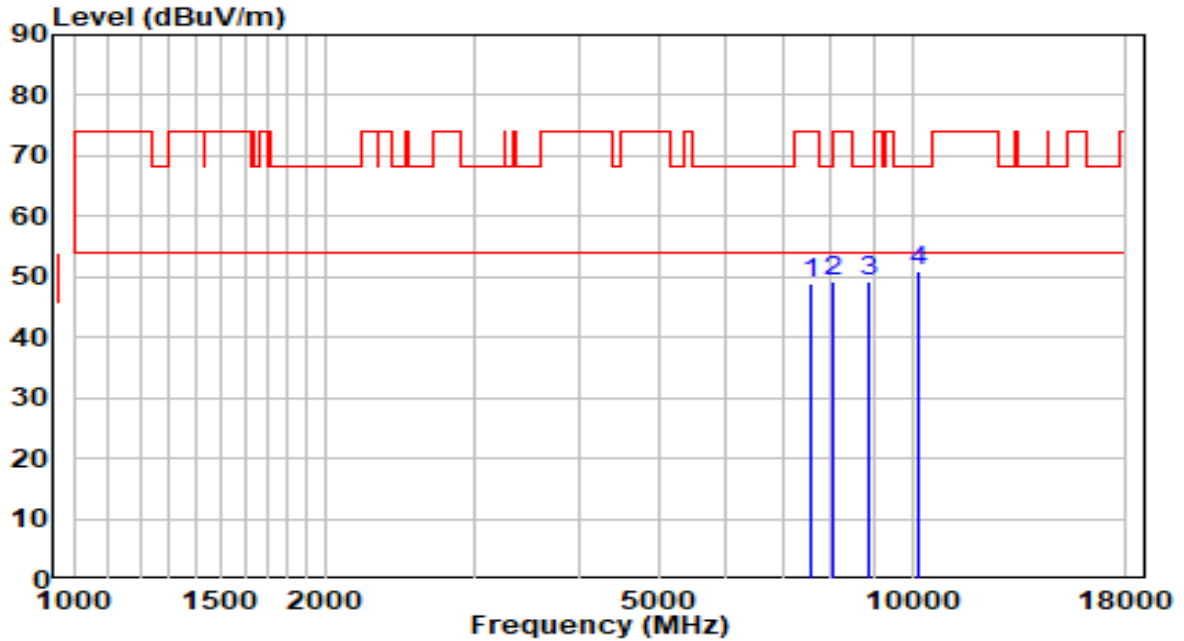

No	Frequency (MHz)	Reading (dBUV)	C.F (dB)	Measurement (dBUV/m)	Margin (dB)	Limit (dBUV/m)	Remark (QP/PK/AV)
1	7562.000	37.08	11.82	48.90	-25.10	74.00	Peak
2	8046.500	36.71	12.52	49.23	-24.77	74.00	Peak
3	8879.500	35.90	13.38	49.29	-18.91	68.20	Peak
4	* 10146.000	35.07	15.86	50.93	-17.27	68.20	Peak

Note:

1. " *", means this data is the worst emission level.
2. C.F (Correction Factor) = Antenna Factor (dB)+ Cable Loss (dB)– Preamplifier(dB).
3. Measurement(dBUV/m) = Reading(dBUV) + C.F (Correction Factor).
- 4.The emission levels of other frequencies are very lower than the limit and not show in test report.

EUT	Cassia Bluetooth Router	Date of Test	2021-03-01
Factor	BBHA 9120D	Temp. / Humidity	35.9°C/22.2%
Polarity	Horizontal	Site / Test Engineer	AC1 / Jay Chou
Test Mode	Transmit by 802.11ac-VHT20 at Channel 5580MHz	Test Voltage	120V/60Hz

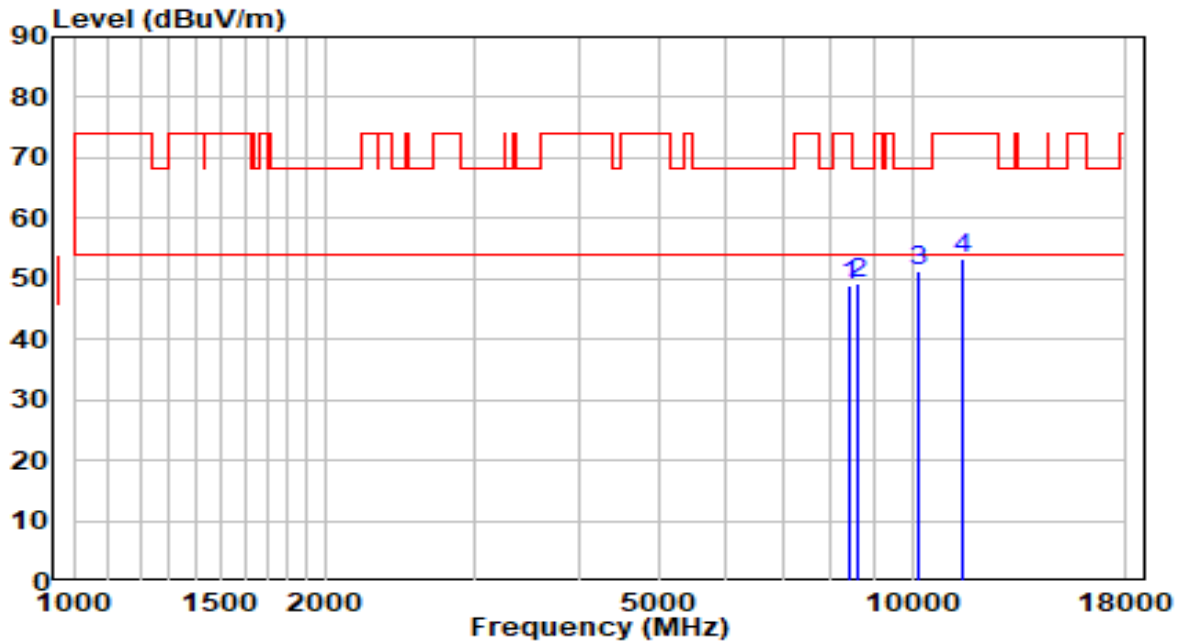

No	Frequency (MHz)	Reading (dBUV)	C.F (dB)	Measurement (dBUV/m)	Margin (dB)	Limit (dBUV/m)	Remark (QP/PK/AV)
1	8395.000	36.32	12.47	48.79	-25.21	74.00	Peak
2	8641.500	36.45	12.80	49.25	-18.95	68.20	Peak
3	* 10188.500	35.44	16.00	51.45	-16.75	68.20	Peak
4	11523.000	34.93	18.42	53.35	-20.65	74.00	Peak

Note:

- "*", means this data is the worst emission level.
- C.F (Correction Factor) = Antenna Factor (dB)+ Cable Loss (dB)– Preamplifier(dB).
- Measurement(dBUV/m) = Reading(dBUV) + C.F (Correction Factor).
- The emission levels of other frequencies are very lower than the limit and not show in test report.

EUT	Cassia Bluetooth Router	Date of Test	2021-03-01
Factor	BBHA 9120D	Temp. / Humidity	35.9°C/22.2%
Polarity	Vertical	Site / Test Engineer	AC1 / Jay Chou
Test Mode	Transmit by 802.11ac-VHT20 at Channel 5580MHz	Test Voltage	120V/60Hz

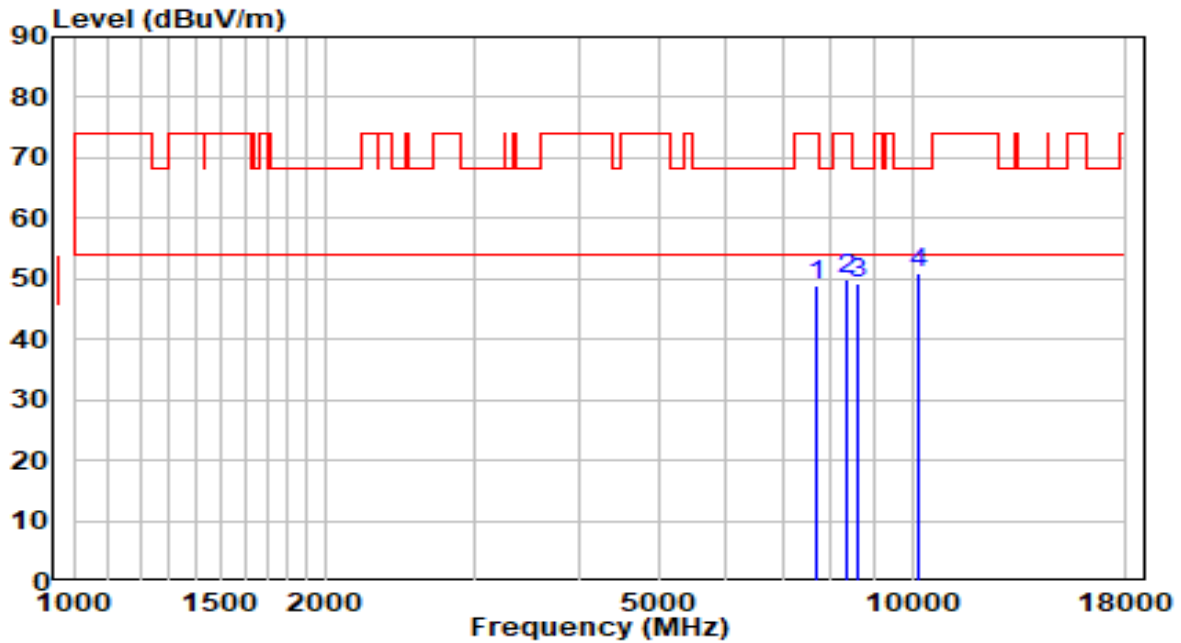

No	Frequency (MHz)	Reading (dBuV)	C.F (dB)	Measurement (dBuV/m)	Margin (dB)	Limit (dBuV/m)	Remark (QP/PK/AV)
1	7715.000	36.71	12.07	48.77	-25.23	74.00	Peak
2	8352.500	37.32	12.48	49.80	-24.20	74.00	Peak
3	8624.500	36.38	12.76	49.14	-19.06	68.20	Peak
4	* 10188.500	34.90	16.00	50.90	-17.30	68.20	Peak

Note:

- "*", means this data is the worst emission level.
- C.F (Correction Factor) = Antenna Factor (dB)+ Cable Loss (dB)– Preamplifier(dB).
- Measurement(dBuV/m) = Reading(dBuV) + C.F (Correction Factor).
- The emission levels of other frequencies are very lower than the limit and not show in test report.

EUT	Cassia Bluetooth Router	Date of Test	2021-03-01
Factor	BBHA 9120D	Temp. / Humidity	35.9°C/22.2%
Polarity	Horizontal	Site / Test Engineer	AC1 / Jay Chou
Test Mode	Transmit by 802.11ac-VHT20 at Channel 5700MHz	Test Voltage	120V/60Hz

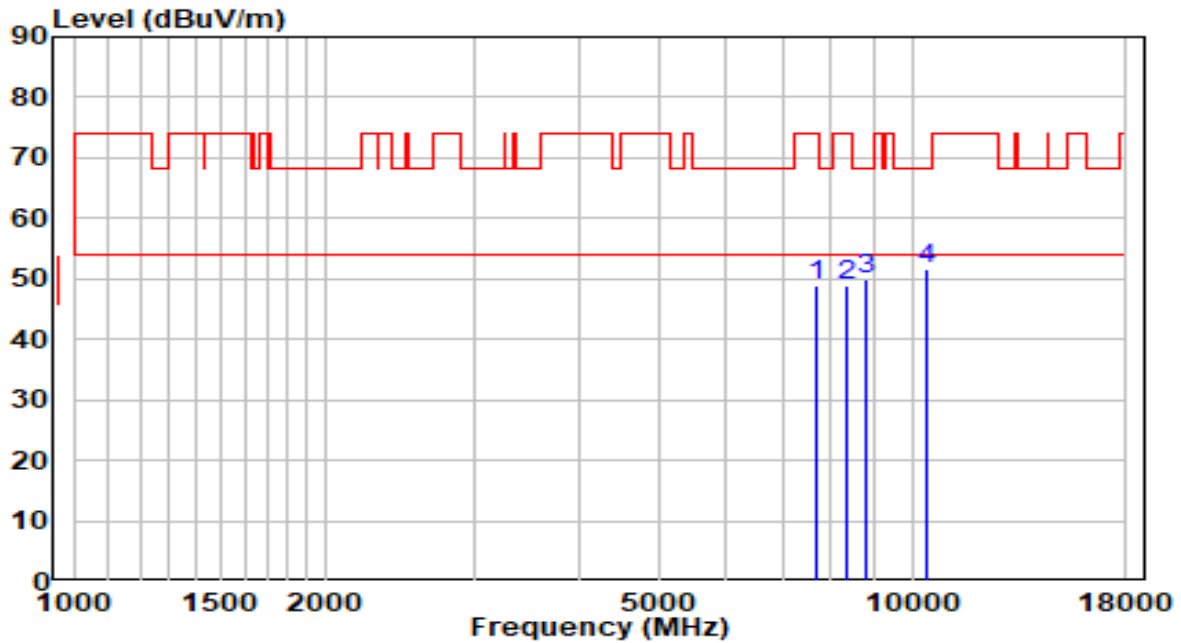

No	Frequency (MHz)	Reading (dBUV)	C.F (dB)	Measurement (dBUV/m)	Margin (dB)	Limit (dBUV/m)	Remark (QP/PK/AV)
1	7681.000	37.04	12.01	49.05	-24.95	74.00	Peak
2	8378.000	36.28	12.47	48.76	-25.24	74.00	Peak
3	8820.000	36.75	13.24	49.99	-18.21	68.20	Peak
4	* 10426.500	34.66	16.82	51.48	-16.72	68.20	Peak

Note:

1. " *", means this data is the worst emission level.
2. C.F (Correction Factor) = Antenna Factor (dB)+ Cable Loss (dB)– Preamplifier(dB).
3. Measurement(dBUV/m) = Reading(dBUV) + C.F (Correction Factor).
- 4.The emission levels of other frequencies are very lower than the limit and not show in test report.

EUT	Cassia Bluetooth Router	Date of Test	2021-03-01
Factor	BBHA 9120D	Temp. / Humidity	35.9°C/22.2%
Polarity	Vertical	Site / Test Engineer	AC1 / Jay Chou
Test Mode	Transmit by 802.11ac-VHT20 at Channel 5700MHz	Test Voltage	120V/60Hz

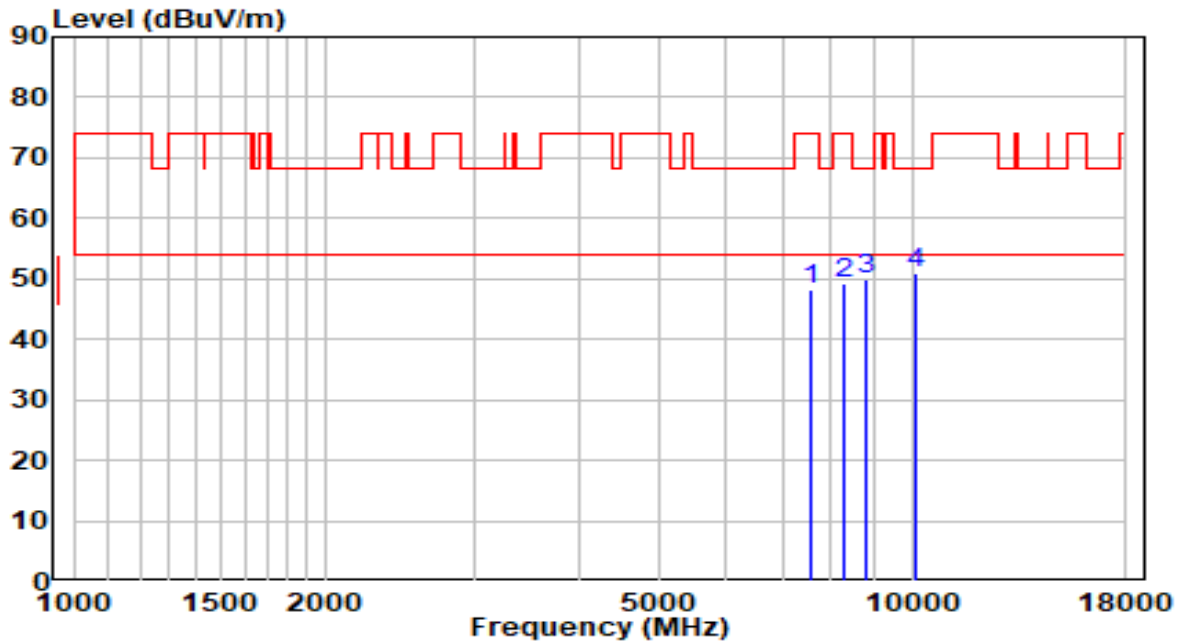

No	Frequency (MHz)	Reading (dBUV)	C.F (dB)	Measurement (dBUV/m)	Margin (dB)	Limit (dBUV/m)	Remark (QP/PK/AV)
1	7570.500	36.34	11.83	48.16	-25.84	74.00	Peak
2	8284.500	36.79	12.49	49.27	-24.73	74.00	Peak
3	8828.500	36.60	13.26	49.86	-18.34	68.20	Peak
4	* 10120.500	35.33	15.77	51.10	-17.10	68.20	Peak

Note:

1. " *", means this data is the worst emission level.
2. C.F (Correction Factor) = Antenna Factor (dB)+ Cable Loss (dB)– Preamplifier(dB).
3. Measurement(dBUV/m) = Reading(dBUV) + C.F (Correction Factor).
- 4.The emission levels of other frequencies are very lower than the limit and not show in test report.

EUT	Cassia Bluetooth Router	Date of Test	2021-03-01
Factor	BBHA 9120D	Temp. / Humidity	35.9°C/22.2%
Polarity	Horizontal	Site / Test Engineer	AC1 / Jay Chou
Test Mode	Transmit by 802.11ac-VHT20 at Channel 5720MHz	Test Voltage	120V/60Hz

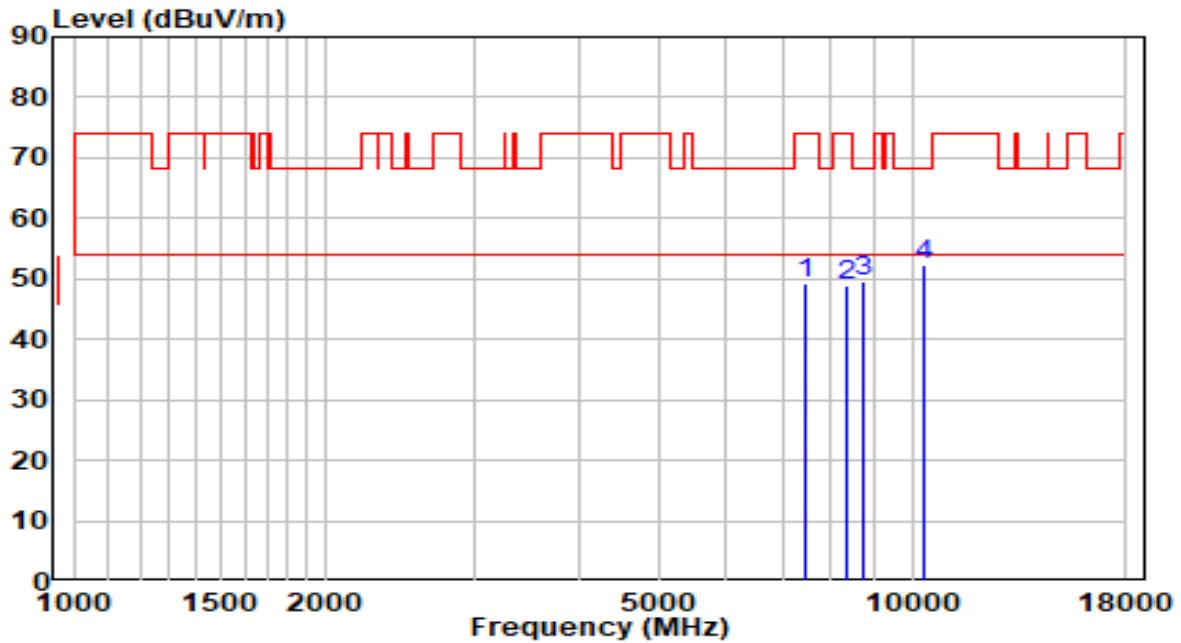

No	Frequency (MHz)	Reading (dBuV)	C.F (dB)	Measurement (dBuV/m)	Margin (dB)	Limit (dBuV/m)	Remark (QP/PK/AV)
1	7468.500	37.63	11.63	49.26	-24.74	74.00	Peak
2	8361.000	36.30	12.48	48.78	-25.22	74.00	Peak
3	8769.000	36.44	13.11	49.55	-18.65	68.20	Peak
4	* 10299.000	35.78	16.38	52.16	-16.04	68.20	Peak

Note:

- "*", means this data is the worst emission level.
- C.F (Correction Factor) = Antenna Factor (dB)+ Cable Loss (dB)– Preamplifier(dB).
- Measurement(dBuV/m) = Reading(dBuV) + C.F (Correction Factor).
- The emission levels of other frequencies are very lower than the limit and not show in test report.

EUT	Cassia Bluetooth Router	Date of Test	2021-03-01
Factor	BBHA 9120D	Temp. / Humidity	35.9°C/22.2%
Polarity	Vertical	Site / Test Engineer	AC1 / Jay Chou
Test Mode	Transmit by 802.11ac-VHT20 at Channel 5720MHz	Test Voltage	120V/60Hz

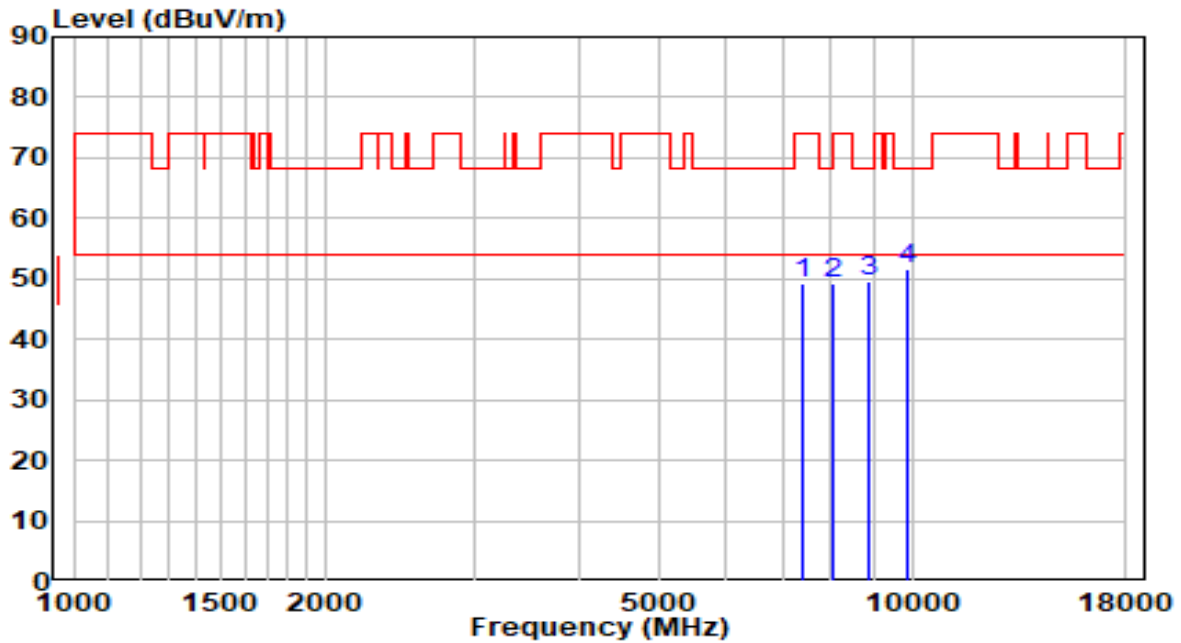

No	Frequency (MHz)	Reading (dBuV)	C.F (dB)	Measurement (dBuV/m)	Margin (dB)	Limit (dBuV/m)	Remark (QP/PK/AV)
1	7417.500	37.81	11.48	49.29	-24.71	74.00	Peak
2	8021.000	36.82	12.53	49.35	-18.85	68.20	Peak
3	8862.500	36.32	13.34	49.66	-18.54	68.20	Peak
4	* 9874.000	36.34	15.12	51.46	-16.74	68.20	Peak

Note:

1. " *", means this data is the worst emission level.
2. C.F (Correction Factor) = Antenna Factor (dB)+ Cable Loss (dB)– Preamplifier(dB).
3. Measurement(dBuV/m) = Reading(dBuV) + C.F (Correction Factor).
- 4.The emission levels of other frequencies are very lower than the limit and not show in test report.

EUT	Cassia Bluetooth Router	Date of Test	2021-03-01
Factor	BBHA 9120D	Temp. / Humidity	35.9°C/22.2%
Polarity	Horizontal	Site / Test Engineer	AC1 / Jay Chou
Test Mode	Transmit by 802.11ac-VHT20 at Channel 5745MHz	Test Voltage	120V/60Hz

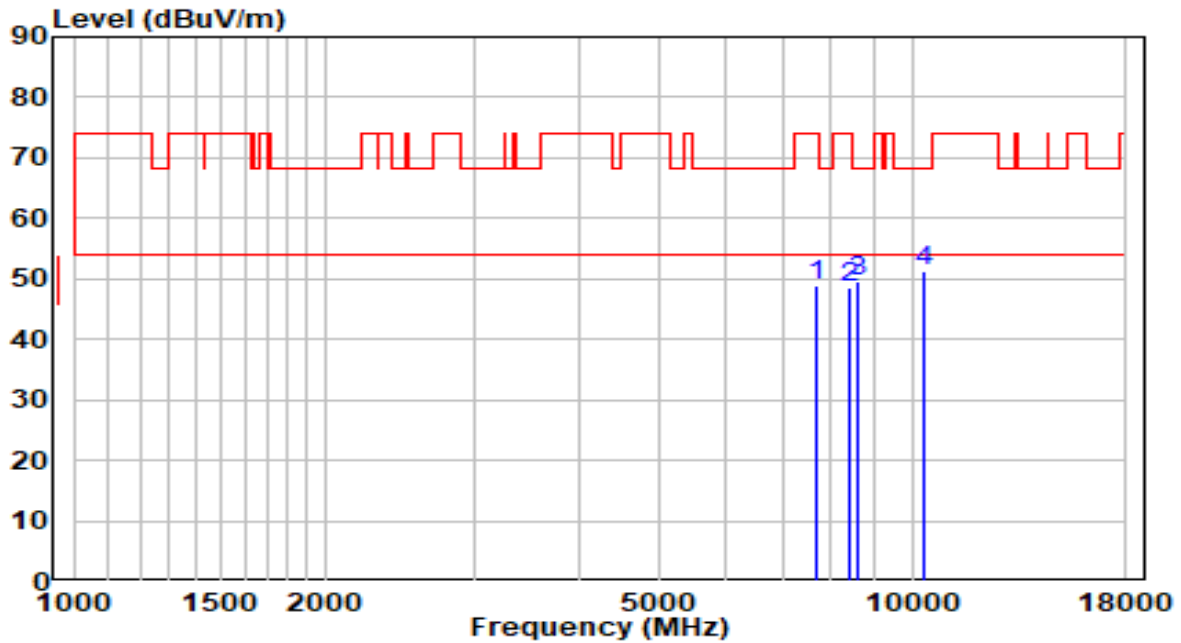

No	Frequency (MHz)	Reading (dBuV)	C.F (dB)	Measurement (dBuV/m)	Margin (dB)	Limit (dBuV/m)	Remark (QP/PK/AV)
1	7672.500	36.78	12.00	48.78	-25.22	74.00	Peak
2	8403.500	36.26	12.47	48.73	-25.27	74.00	Peak
3	8607.500	36.95	12.72	49.67	-18.53	68.20	Peak
4	* 10350.000	34.63	16.56	51.18	-17.02	68.20	Peak

Note:

- "*", means this data is the worst emission level.
- C.F (Correction Factor) = Antenna Factor (dB)+ Cable Loss (dB)– Preamplifier(dB).
- Measurement(dBuV/m) = Reading(dBuV) + C.F (Correction Factor).
- The emission levels of other frequencies are very lower than the limit and not show in test report.

EUT	Cassia Bluetooth Router	Date of Test	2021-03-01
Factor	BBHA 9120D	Temp. / Humidity	35.9°C/22.2%
Polarity	Vertical	Site / Test Engineer	AC1 / Jay Chou
Test Mode	Transmit by 802.11ac-VHT20 at Channel 5745MHz	Test Voltage	120V/60Hz

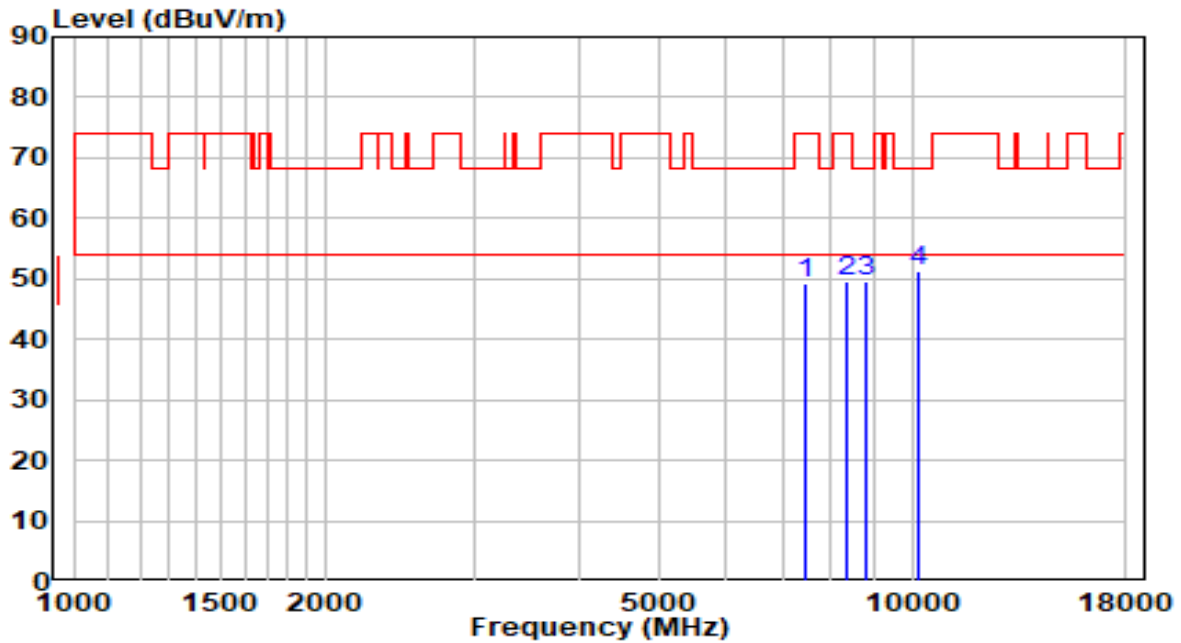

No	Frequency (MHz)	Reading (dBUV)	C.F (dB)	Measurement (dBUV/m)	Margin (dB)	Limit (dBUV/m)	Remark (QP/PK/AV)
1	7477.000	37.45	11.65	49.10	-24.90	74.00	Peak
2	8386.500	37.04	12.47	49.51	-24.49	74.00	Peak
3	8811.500	36.33	13.22	49.55	-18.65	68.20	Peak
4	* 10197.000	35.28	16.03	51.31	-16.89	68.20	Peak

Note:

- "*", means this data is the worst emission level.
- C.F (Correction Factor) = Antenna Factor (dB)+ Cable Loss (dB)– Preamplifier(dB).
- Measurement(dBUV/m) = Reading(dBUV) + C.F (Correction Factor).
- The emission levels of other frequencies are very lower than the limit and not show in test report.

EUT	Cassia Bluetooth Router	Date of Test	2021-03-01
Factor	BBHA 9120D	Temp. / Humidity	35.9°C/22.2%
Polarity	Horizontal	Site / Test Engineer	AC1 / Jay Chou
Test Mode	Transmit by 802.11ac-VHT20 at Channel 5785MHz	Test Voltage	120V/60Hz

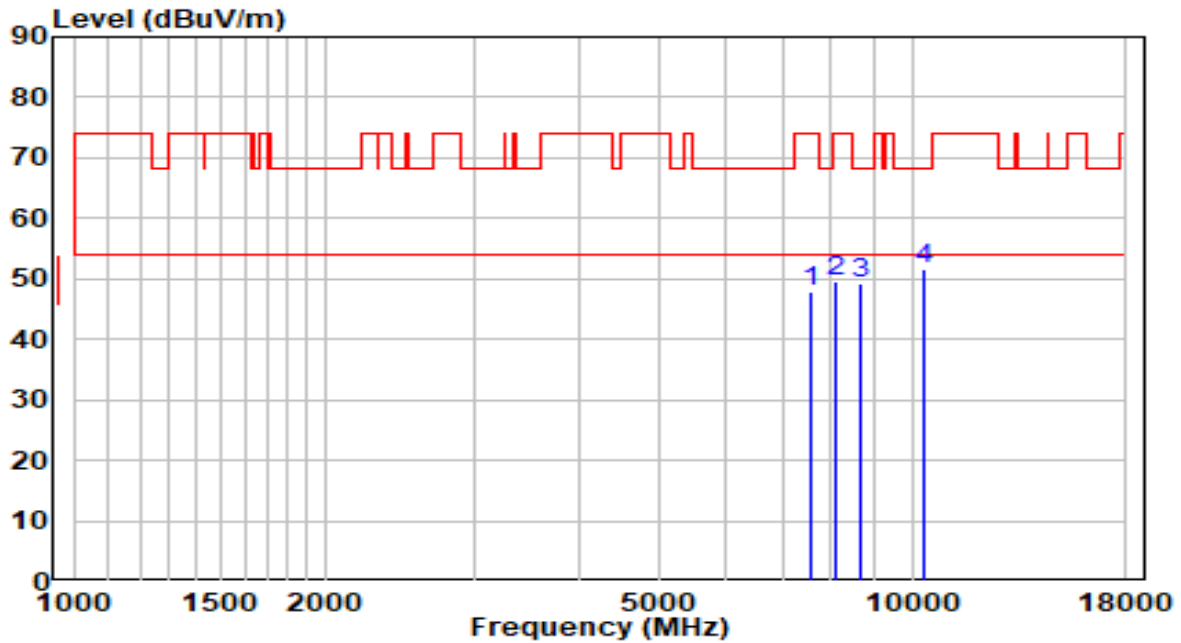

No	Frequency (MHz)	Reading (dBUV)	C.F (dB)	Measurement (dBUV/m)	Margin (dB)	Limit (dBUV/m)	Remark (QP/PK/AV)
1	7570.500	36.03	11.83	47.86	-26.14	74.00	Peak
2	8114.500	37.03	12.51	49.55	-24.45	74.00	Peak
3	8709.500	36.30	12.97	49.27	-18.93	68.20	Peak
4	* 10307.500	35.16	16.41	51.57	-16.63	68.20	Peak

Note:

1. " *", means this data is the worst emission level.
2. C.F (Correction Factor) = Antenna Factor (dB)+ Cable Loss (dB)– Preamplifier(dB).
3. Measurement(dBUV/m) = Reading(dBUV) + C.F (Correction Factor).
- 4.The emission levels of other frequencies are very lower than the limit and not show in test report.

EUT	Cassia Bluetooth Router	Date of Test	2021-03-01
Factor	BBHA 9120D	Temp. / Humidity	35.9°C/22.2%
Polarity	Vertical	Site / Test Engineer	AC1 / Jay Chou
Test Mode	Transmit by 802.11ac-VHT20 at Channel 5785MHz	Test Voltage	120V/60Hz

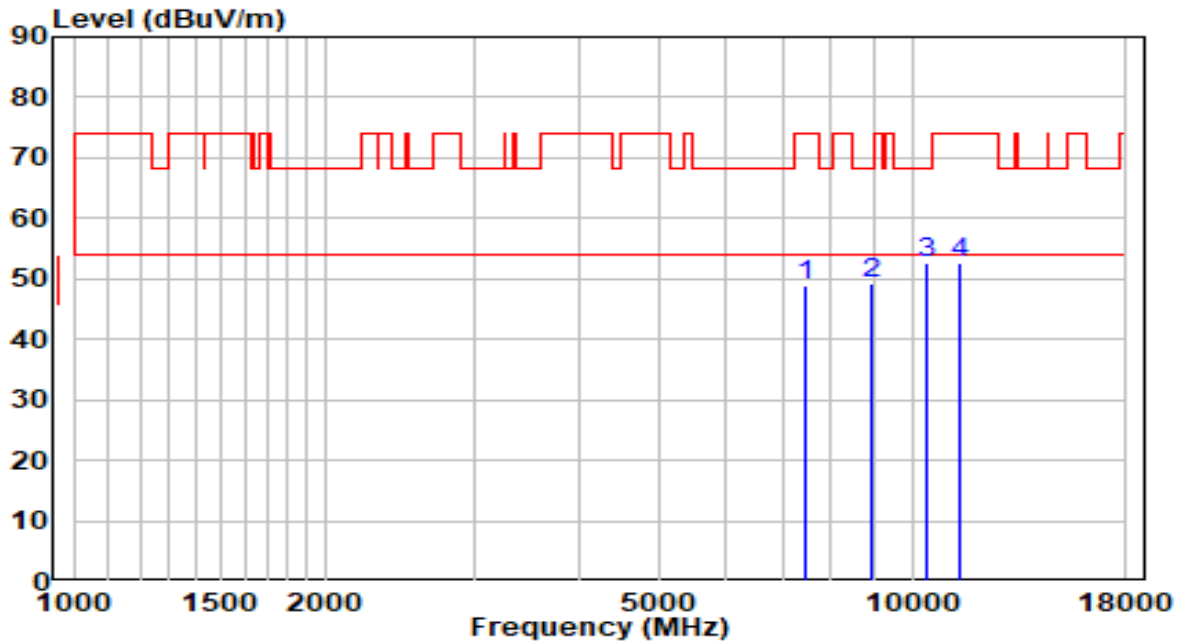

No	Frequency (MHz)	Reading (dBuV)	C.F (dB)	Measurement (dBuV/m)	Margin (dB)	Limit (dBuV/m)	Remark (QP/PK/AV)
1	7451.500	37.32	11.58	48.90	-25.10	74.00	Peak
2	8973.000	35.75	13.61	49.36	-18.84	68.20	Peak
3	* 10401.000	35.75	16.73	52.48	-15.72	68.20	Peak
4	11438.000	34.41	18.37	52.78	-21.22	74.00	Peak

Note:

- "*", means this data is the worst emission level.
- C.F (Correction Factor) = Antenna Factor (dB)+ Cable Loss (dB)– Preamplifier(dB).
- Measurement(dBuV/m) = Reading(dBuV) + C.F (Correction Factor).
- The emission levels of other frequencies are very lower than the limit and not show in test report.

EUT	Cassia Bluetooth Router	Date of Test	2021-03-01
Factor	BBHA 9120D	Temp. / Humidity	35.9°C/22.2%
Polarity	Horizontal	Site / Test Engineer	AC1 / Jay Chou
Test Mode	Transmit by 802.11ac-VHT20 at Channel 5825MHz	Test Voltage	120V/60Hz

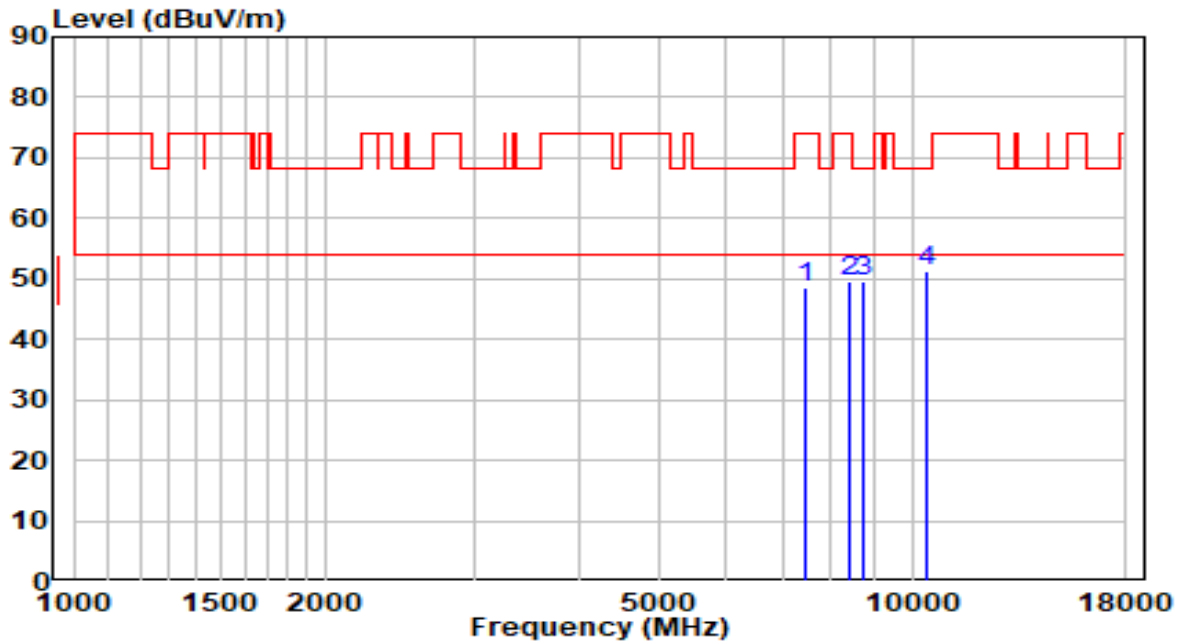

No	Frequency (MHz)	Reading (dBuV)	C.F (dB)	Measurement (dBuV/m)	Margin (dB)	Limit (dBuV/m)	Remark (QP/PK/AV)
1	7460.000	36.81	11.60	48.41	-25.59	74.00	Peak
2	8403.500	36.99	12.47	49.46	-24.54	74.00	Peak
3	8743.500	36.65	13.05	49.70	-18.50	68.20	Peak
4	* 10401.000	34.67	16.73	51.40	-16.80	68.20	Peak

Note:

- "*", means this data is the worst emission level.
- C.F (Correction Factor) = Antenna Factor (dB)+ Cable Loss (dB)– Preamplifier(dB).
- Measurement(dBuV/m) = Reading(dBuV) + C.F (Correction Factor).
- The emission levels of other frequencies are very lower than the limit and not show in test report.

EUT	Cassia Bluetooth Router	Date of Test	2021-03-01
Factor	BBHA 9120D	Temp. / Humidity	35.9°C/22.2%
Polarity	Vertical	Site / Test Engineer	AC1 / Jay Chou
Test Mode	Transmit by 802.11ac-VHT20 at Channel 5825MHz	Test Voltage	120V/60Hz

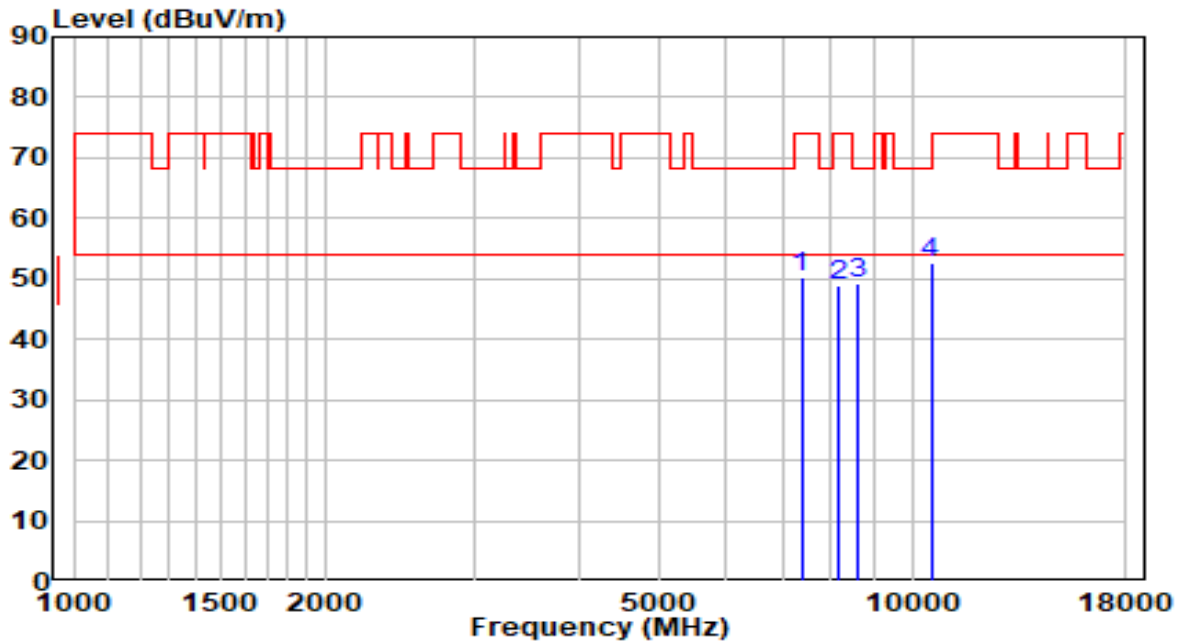

No	Frequency (MHz)	Reading (dBUV)	C.F (dB)	Measurement (dBUV/m)	Margin (dB)	Limit (dBUV/m)	Remark (QP/PK/AV)
1	7375.000	38.76	11.36	50.12	-23.88	74.00	Peak
2	8182.500	36.45	12.50	48.95	-25.05	74.00	Peak
3	8590.500	36.53	12.68	49.20	-19.00	68.20	Peak
4	* 10528.500	35.59	17.11	52.70	-15.50	68.20	Peak

Note:

- "*", means this data is the worst emission level.
- C.F (Correction Factor) = Antenna Factor (dB)+ Cable Loss (dB)– Preamplifier(dB).
- Measurement(dBUV/m) = Reading(dBUV) + C.F (Correction Factor).
- The emission levels of other frequencies are very lower than the limit and not show in test report.

EUT	Cassia Bluetooth Router	Date of Test	2021-03-01
Factor	BBHA 9120D	Temp. / Humidity	35.9°C/22.2%
Polarity	Horizontal	Site / Test Engineer	AC1 / Jay Chou
Test Mode	Transmit by 802.11n-HT40 at Channel 5795MHz	Test Voltage	120V/60Hz

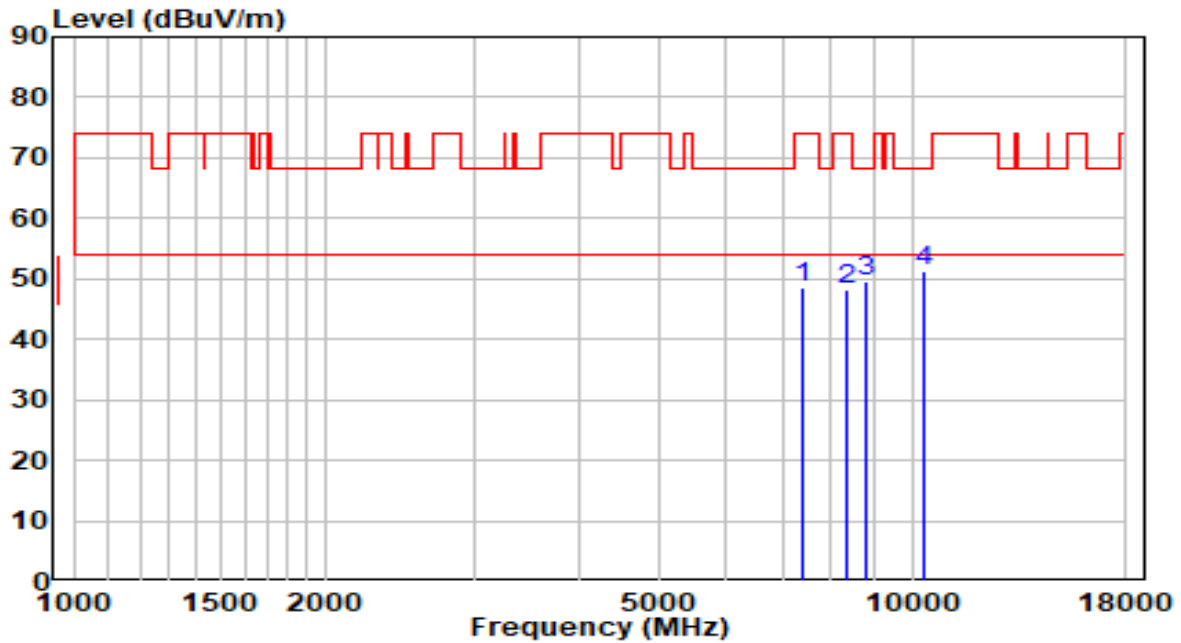

No	Frequency (MHz)	Reading (dBuV)	C.F (dB)	Measurement (dBuV/m)	Margin (dB)	Limit (dBuV/m)	Remark (QP/PK/AV)
1	7417.500	37.14	11.48	48.62	-25.38	74.00	Peak
2	8327.000	35.59	12.48	48.08	-25.92	74.00	Peak
3	8820.000	36.47	13.24	49.71	-18.49	68.20	Peak
4	* 10341.500	34.77	16.53	51.30	-16.90	68.20	Peak

Note:

1. " *", means this data is the worst emission level.
2. C.F (Correction Factor) = Antenna Factor (dB)+ Cable Loss (dB)– Preamplifier(dB).
3. Measurement(dBuV/m) = Reading(dBuV) + C.F (Correction Factor).
- 4.The emission levels of other frequencies are very lower than the limit and not show in test report.

EUT	Cassia Bluetooth Router	Date of Test	2021-03-01
Factor	BBHA 9120D	Temp. / Humidity	35.9°C/22.2%
Polarity	Vertical	Site / Test Engineer	AC1 / Jay Chou
Test Mode	Transmit by 802.11n-HT40 at Channel 5795MHz	Test Voltage	120V/60Hz

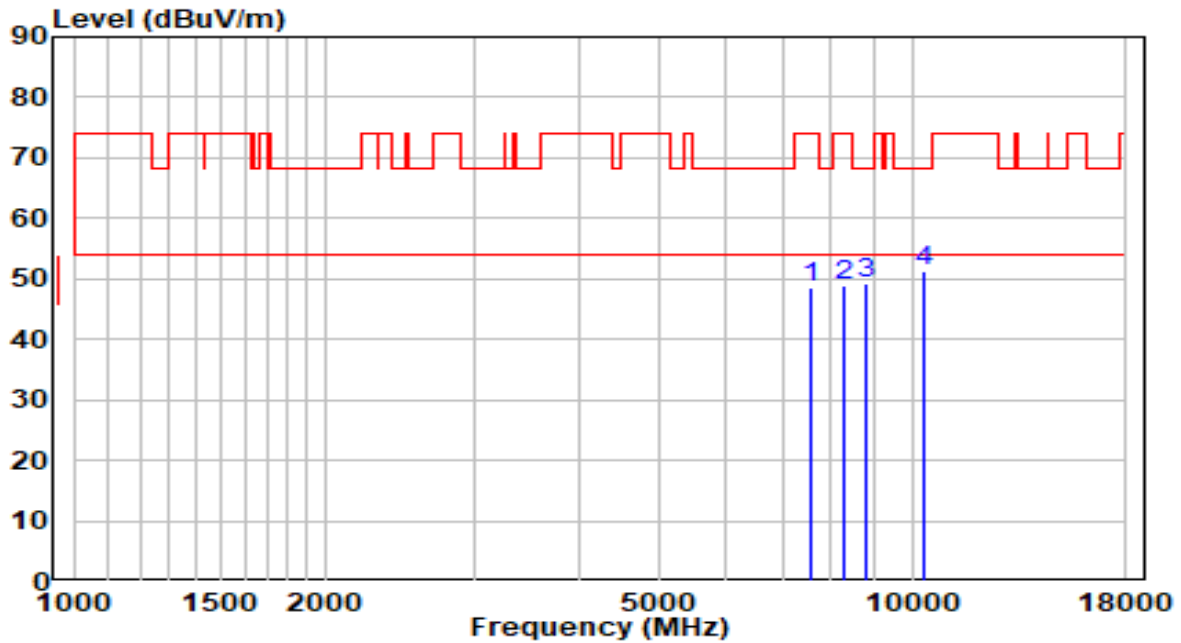

No	Frequency (MHz)	Reading (dBuV)	C.F (dB)	Measurement (dBuV/m)	Margin (dB)	Limit (dBuV/m)	Remark (QP/PK/AV)
1	7579.000	36.67	11.84	48.51	-25.49	74.00	Peak
2	8318.500	36.51	12.48	49.00	-25.00	74.00	Peak
3	8828.500	36.07	13.26	49.32	-18.88	68.20	Peak
4	* 10316.000	34.81	16.44	51.25	-16.95	68.20	Peak

Note:

1. " *", means this data is the worst emission level.
2. C.F (Correction Factor) = Antenna Factor (dB)+ Cable Loss (dB)– Preamplifier(dB).
3. Measurement(dBuV/m) = Reading(dBuV) + C.F (Correction Factor).
- 4.The emission levels of other frequencies are very lower than the limit and not show in test report.

EUT	Cassia Bluetooth Router	Date of Test	2021-03-01
Factor	BBHA 9120D	Temp. / Humidity	35.9°C/22.2%
Polarity	Horizontal	Site / Test Engineer	AC1 / Jay Chou
Test Mode	Transmit by 802.11ac-VHT40 at Channel 5190MHz	Test Voltage	120V/60Hz

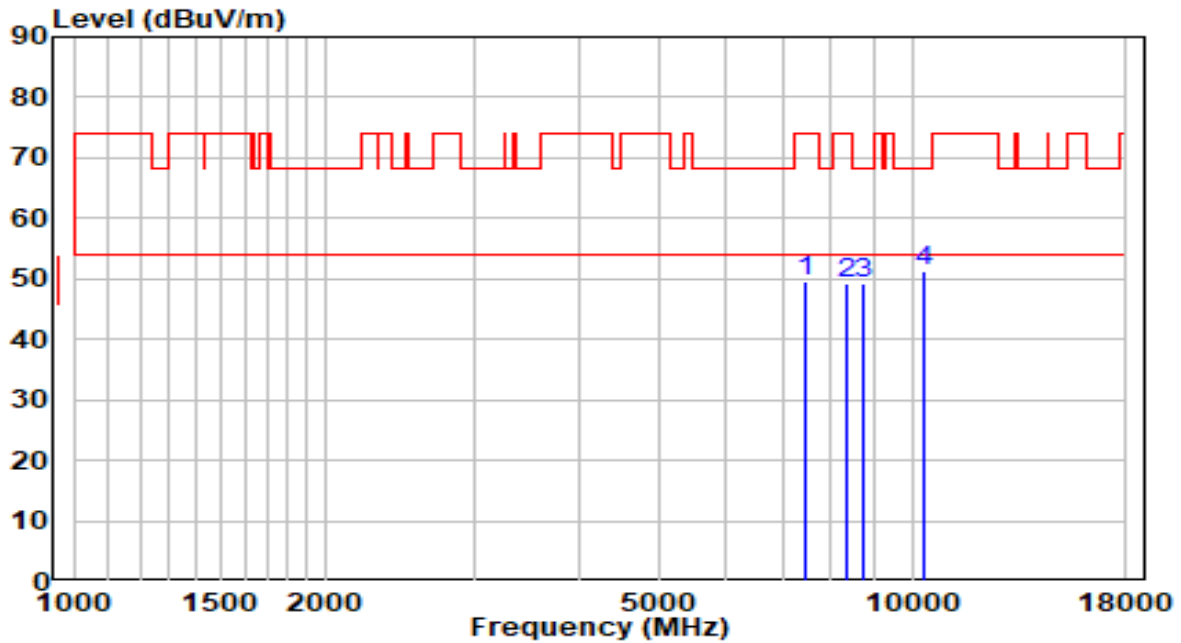

No	Frequency (MHz)	Reading (dBUV)	C.F (dB)	Measurement (dBUV/m)	Margin (dB)	Limit (dBUV/m)	Remark (QP/PK/AV)
1	7460.000	37.87	11.60	49.47	-24.53	74.00	Peak
2	8361.000	36.76	12.48	49.24	-24.76	74.00	Peak
3	8726.500	36.13	13.01	49.14	-19.06	68.20	Peak
4	* 10316.000	34.83	16.44	51.27	-16.93	68.20	Peak

Note:

- "*", means this data is the worst emission level.
- C.F (Correction Factor) = Antenna Factor (dB)+ Cable Loss (dB)– Preamplifier(dB).
- Measurement(dBUV/m) = Reading(dBUV) + C.F (Correction Factor).
- The emission levels of other frequencies are very lower than the limit and not show in test report.

EUT	Cassia Bluetooth Router	Date of Test	2021-03-01
Factor	BBHA 9120D	Temp. / Humidity	35.9°C/22.2%
Polarity	Vertical	Site / Test Engineer	AC1 / Jay Chou
Test Mode	Transmit by 802.11ac-VHT40 at Channel 5190MHz	Test Voltage	120V/60Hz

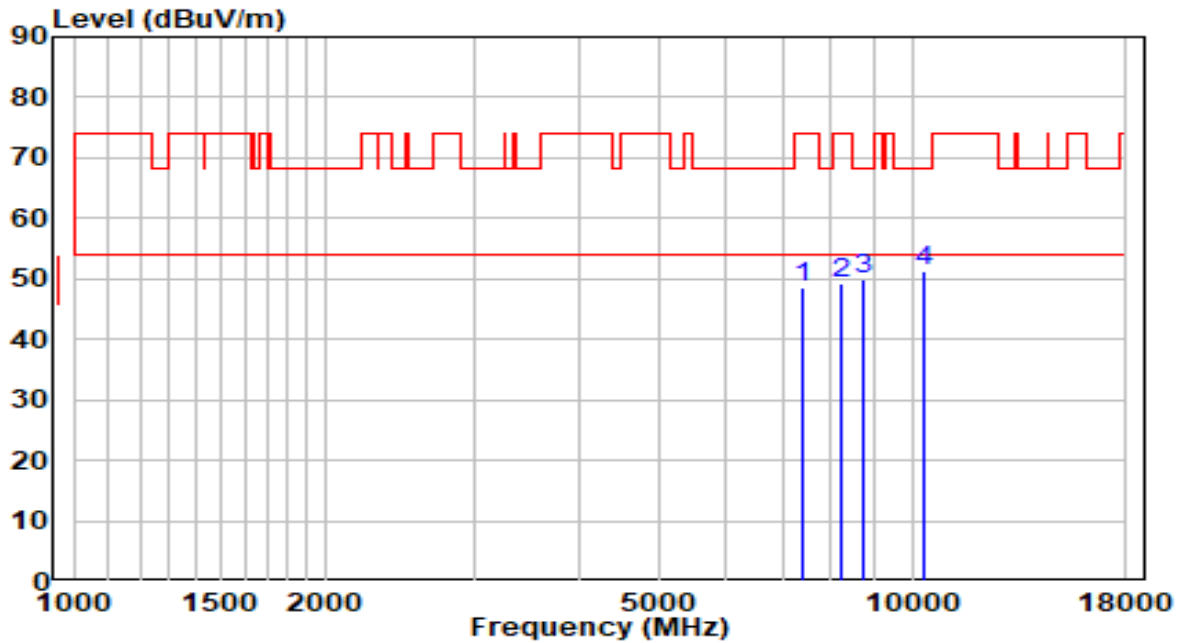

No	Frequency (MHz)	Reading (dBuV)	C.F (dB)	Measurement (dBuV/m)	Margin (dB)	Limit (dBuV/m)	Remark (QP/PK/AV)
1	7417.500	37.02	11.48	48.50	-25.50	74.00	Peak
2	8259.000	36.68	12.49	49.17	-24.83	74.00	Peak
3	8743.500	36.73	13.05	49.79	-18.41	68.20	Peak
4	* 10367.000	34.78	16.62	51.39	-16.81	68.20	Peak

Note:

- "*", means this data is the worst emission level.
- C.F (Correction Factor) = Antenna Factor (dB)+ Cable Loss (dB)– Preamplifier(dB).
- Measurement(dBuV/m) = Reading(dBuV) + C.F (Correction Factor).
- The emission levels of other frequencies are very lower than the limit and not show in test report.

EUT	Cassia Bluetooth Router	Date of Test	2021-03-01
Factor	BBHA 9120D	Temp. / Humidity	35.9°C/22.2%
Polarity	Horizontal	Site / Test Engineer	AC1 / Jay Chou
Test Mode	Transmit by 802.11ac-VHT40 at Channel 5230MHz	Test Voltage	120V/60Hz

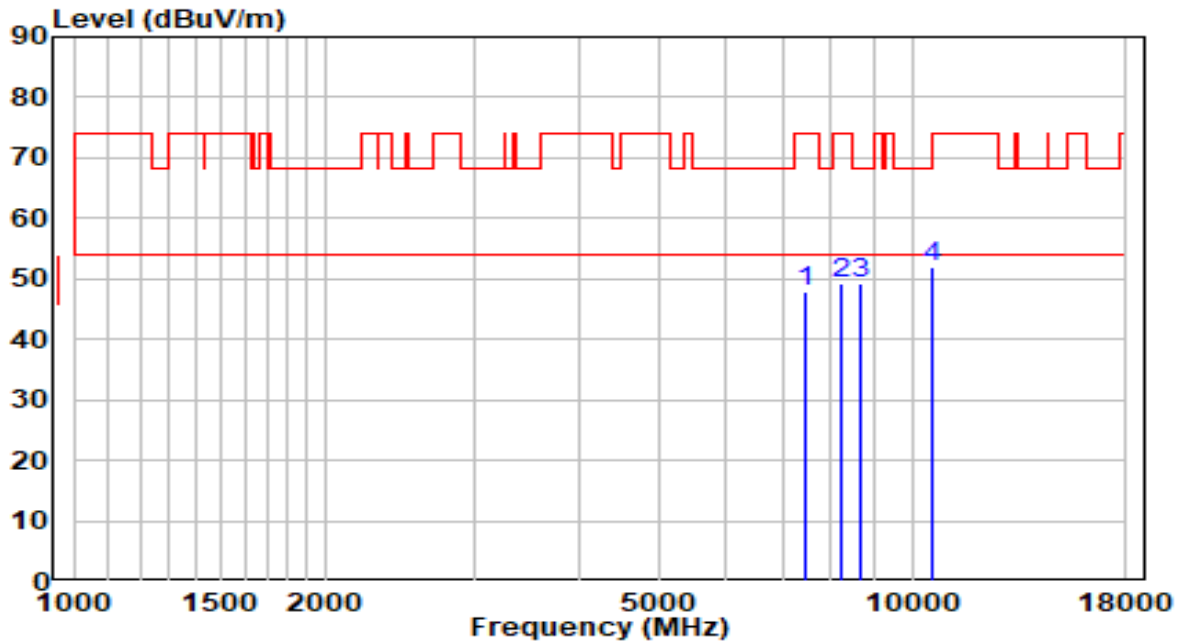

No	Frequency (MHz)	Reading (dBuV)	C.F (dB)	Measurement (dBuV/m)	Margin (dB)	Limit (dBuV/m)	Remark (QP/PK/AV)
1	7460.000	36.45	11.60	48.05	-25.95	74.00	Peak
2	8259.000	36.77	12.49	49.26	-24.74	74.00	Peak
3	8675.500	36.51	12.88	49.39	-18.81	68.20	Peak
4	* 10545.500	34.94	17.13	52.07	-16.13	68.20	Peak

Note:

- "*", means this data is the worst emission level.
- C.F (Correction Factor) = Antenna Factor (dB)+ Cable Loss (dB)– Preamplifier(dB).
- Measurement(dBuV/m) = Reading(dBuV) + C.F (Correction Factor).
- The emission levels of other frequencies are very lower than the limit and not show in test report.

EUT	Cassia Bluetooth Router	Date of Test	2021-03-01
Factor	BBHA 9120D	Temp. / Humidity	35.9°C/22.2%
Polarity	Vertical	Site / Test Engineer	AC1 / Jay Chou
Test Mode	Transmit by 802.11ac-VHT40 at Channel 5230MHz	Test Voltage	120V/60Hz

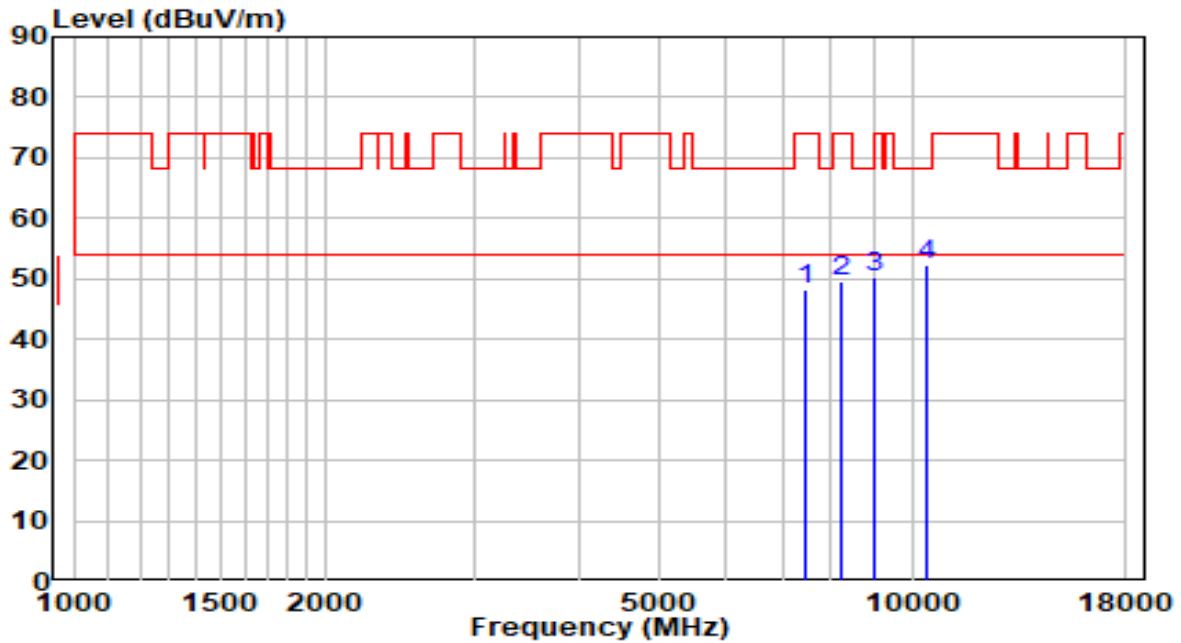

No	Frequency (MHz)	Reading (dBuV)	C.F (dB)	Measurement (dBuV/m)	Margin (dB)	Limit (dBuV/m)	Remark (QP/PK/AV)
1	7460.000	36.60	11.60	48.20	-25.80	74.00	Peak
2	8208.000	37.26	12.50	49.75	-24.25	74.00	Peak
3	8998.500	36.46	13.68	50.14	-18.06	68.20	Peak
4	* 10426.500	35.41	16.82	52.23	-15.97	68.20	Peak

Note:

- "*", means this data is the worst emission level.
- C.F (Correction Factor) = Antenna Factor (dB)+ Cable Loss (dB)– Preamplifier(dB).
- Measurement(dBuV/m) = Reading(dBuV) + C.F (Correction Factor).
- The emission levels of other frequencies are very lower than the limit and not show in test report.

EUT	Cassia Bluetooth Router	Date of Test	2021-03-01
Factor	BBHA 9120D	Temp. / Humidity	35.9°C/22.2%
Polarity	Horizontal	Site / Test Engineer	AC1 / Jay Chou
Test Mode	Transmit by 802.11ac-VHT40 at Channel 5270MHz	Test Voltage	120V/60Hz

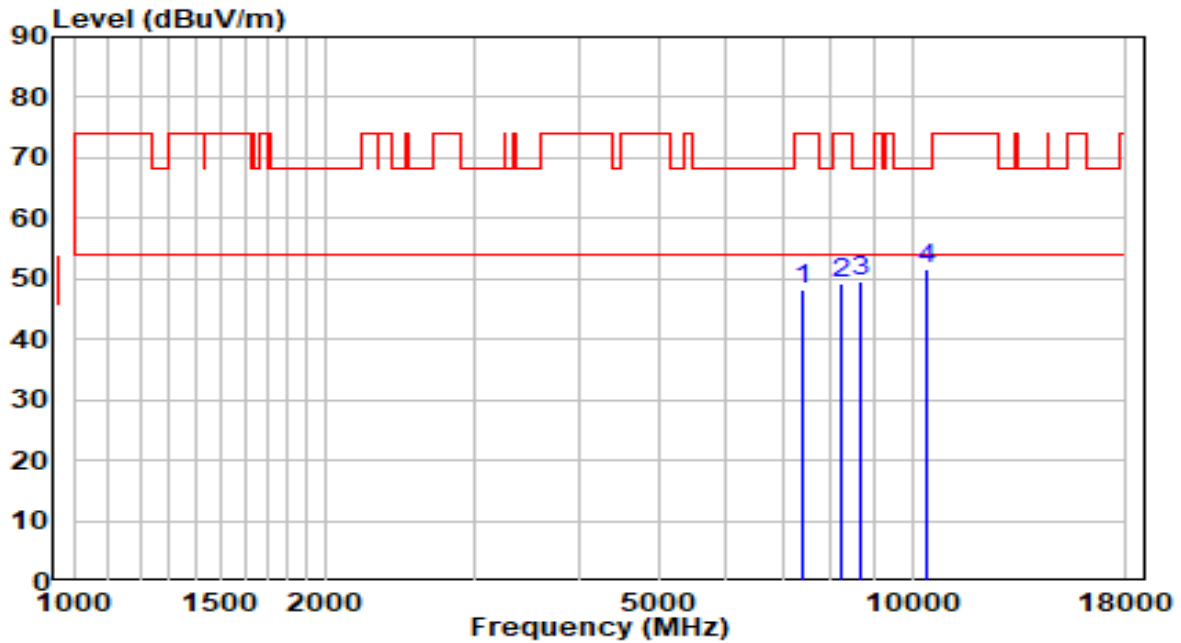

No	Frequency (MHz)	Reading (dBUV)	C.F (dB)	Measurement (dBUV/m)	Margin (dB)	Limit (dBUV/m)	Remark (QP/PK/AV)
1	7409.000	36.91	11.46	48.37	-25.63	74.00	Peak
2	8242.000	36.68	12.49	49.17	-24.83	74.00	Peak
3	8684.000	36.85	12.91	49.75	-18.45	68.20	Peak
4	* 10443.500	34.66	16.88	51.54	-16.66	68.20	Peak

Note:

- "*", means this data is the worst emission level.
- C.F (Correction Factor) = Antenna Factor (dB)+ Cable Loss (dB)– Preamplifier(dB).
- Measurement(dBUV/m) = Reading(dBUV) + C.F (Correction Factor).
- The emission levels of other frequencies are very lower than the limit and not show in test report.

EUT	Cassia Bluetooth Router	Date of Test	2021-03-01
Factor	BBHA 9120D	Temp. / Humidity	35.9°C/22.2%
Polarity	Vertical	Site / Test Engineer	AC1 / Jay Chou
Test Mode	Transmit by 802.11ac-VHT40 at Channel 5270MHz	Test Voltage	120V/60Hz

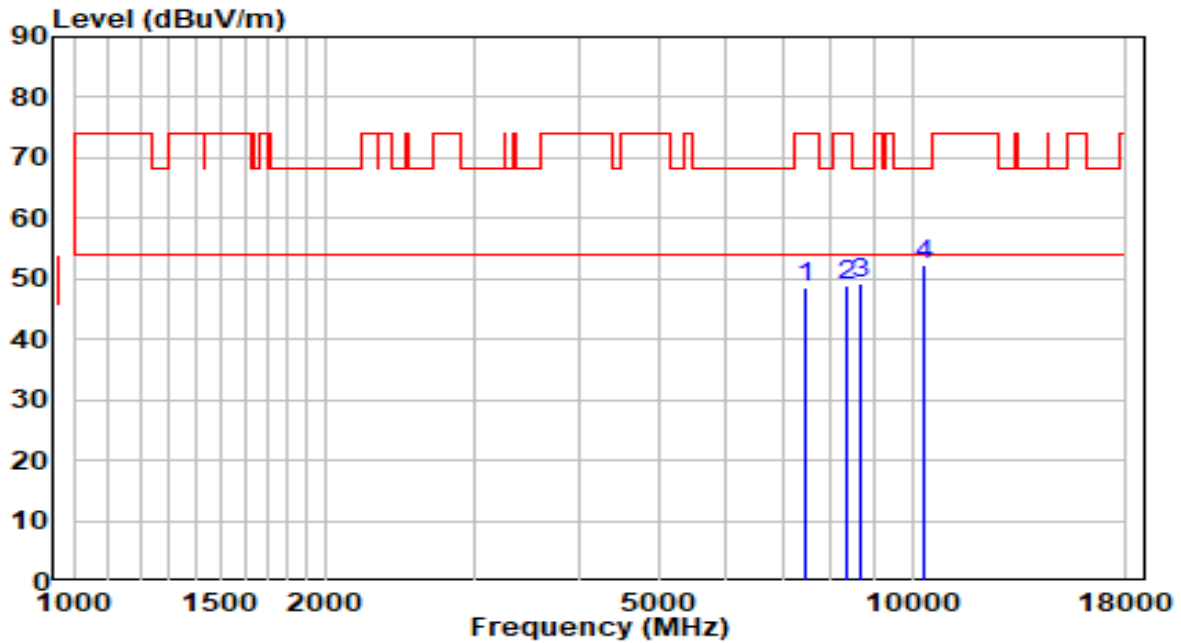

No	Frequency (MHz)	Reading (dBUV)	C.F (dB)	Measurement (dBUV/m)	Margin (dB)	Limit (dBUV/m)	Remark (QP/PK/AV)
1	7443.000	36.98	11.55	48.53	-25.47	74.00	Peak
2	8361.000	36.47	12.48	48.95	-25.05	74.00	Peak
3	8701.000	36.16	12.95	49.10	-19.10	68.20	Peak
4	* 10350.000	35.88	16.56	52.43	-15.77	68.20	Peak

Note:

1. " *", means this data is the worst emission level.
2. C.F (Correction Factor) = Antenna Factor (dB)+ Cable Loss (dB)– Preamplifier(dB).
3. Measurement(dBUV/m) = Reading(dBUV) + C.F (Correction Factor).
- 4.The emission levels of other frequencies are very lower than the limit and not show in test report.

EUT	Cassia Bluetooth Router	Date of Test	2021-03-01
Factor	BBHA 9120D	Temp. / Humidity	35.9°C/22.2%
Polarity	Horizontal	Site / Test Engineer	AC1 / Jay Chou
Test Mode	Transmit by 802.11ac-VHT40 at Channel 5310MHz	Test Voltage	120V/60Hz

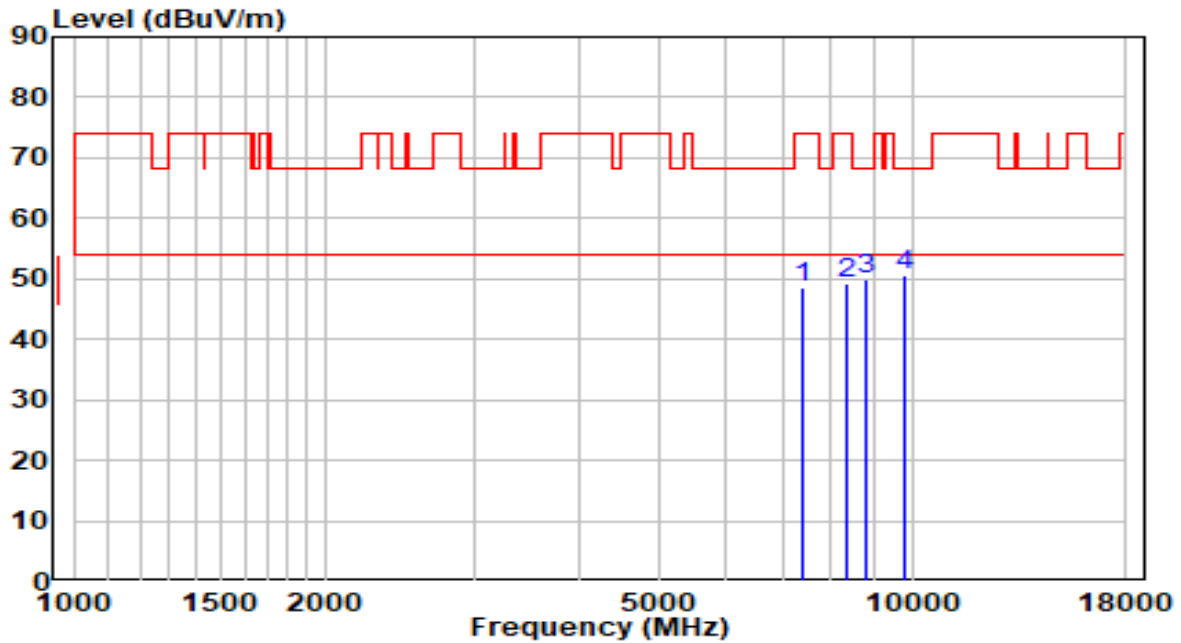

No	Frequency (MHz)	Reading (dBuV)	C.F (dB)	Measurement (dBuV/m)	Margin (dB)	Limit (dBuV/m)	Remark (QP/PK/AV)
1	7417.500	37.10	11.48	48.58	-25.42	74.00	Peak
2	8352.500	36.76	12.48	49.23	-24.77	74.00	Peak
3	8811.500	36.79	13.22	50.00	-18.20	68.20	Peak
4	* 9789.000	35.58	14.96	50.54	-17.66	68.20	Peak

Note:

- "*", means this data is the worst emission level.
- C.F (Correction Factor) = Antenna Factor (dB)+ Cable Loss (dB)– Preamplifier(dB).
- Measurement(dBuV/m) = Reading(dBuV) + C.F (Correction Factor).
- The emission levels of other frequencies are very lower than the limit and not show in test report.

EUT	Cassia Bluetooth Router	Date of Test	2021-03-01
Factor	BBHA 9120D	Temp. / Humidity	35.9°C/22.2%
Polarity	Vertical	Site / Test Engineer	AC1 / Jay Chou
Test Mode	Transmit by 802.11ac-VHT40 at Channel 5310MHz	Test Voltage	120V/60Hz

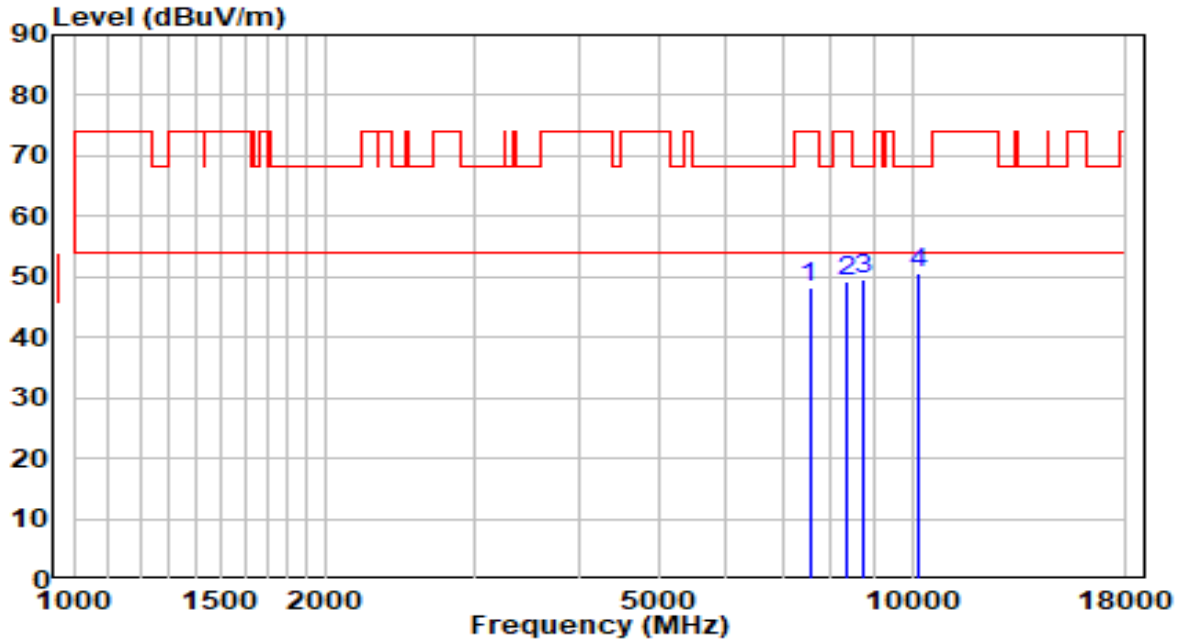

No	Frequency (MHz)	Reading (dBUV)	C.F (dB)	Measurement (dBUV/m)	Margin (dB)	Limit (dBUV/m)	Remark (QP/PK/AV)
1	7545.000	36.46	11.79	48.24	-25.76	74.00	Peak
2	8352.500	36.86	12.48	49.33	-24.67	74.00	Peak
3	8760.500	36.53	13.09	49.62	-18.58	68.20	Peak
4	* 10188.500	34.73	16.00	50.73	-17.47	68.20	Peak

Note:

- "*", means this data is the worst emission level.
- C.F (Correction Factor) = Antenna Factor (dB)+ Cable Loss (dB)– Preamplifier(dB).
- Measurement(dBUV/m) = Reading(dBUV) + C.F (Correction Factor).
- The emission levels of other frequencies are very lower than the limit and not show in test report.

EUT	Cassia Bluetooth Router	Date of Test	2021-03-01
Factor	BBHA 9120D	Temp. / Humidity	35.9°C/22.2%
Polarity	Horizontal	Site / Test Engineer	AC1 / Jay Chou
Test Mode	Transmit by 802.11ac-VHT40 at Channel 5510MHz	Test Voltage	120V/60Hz

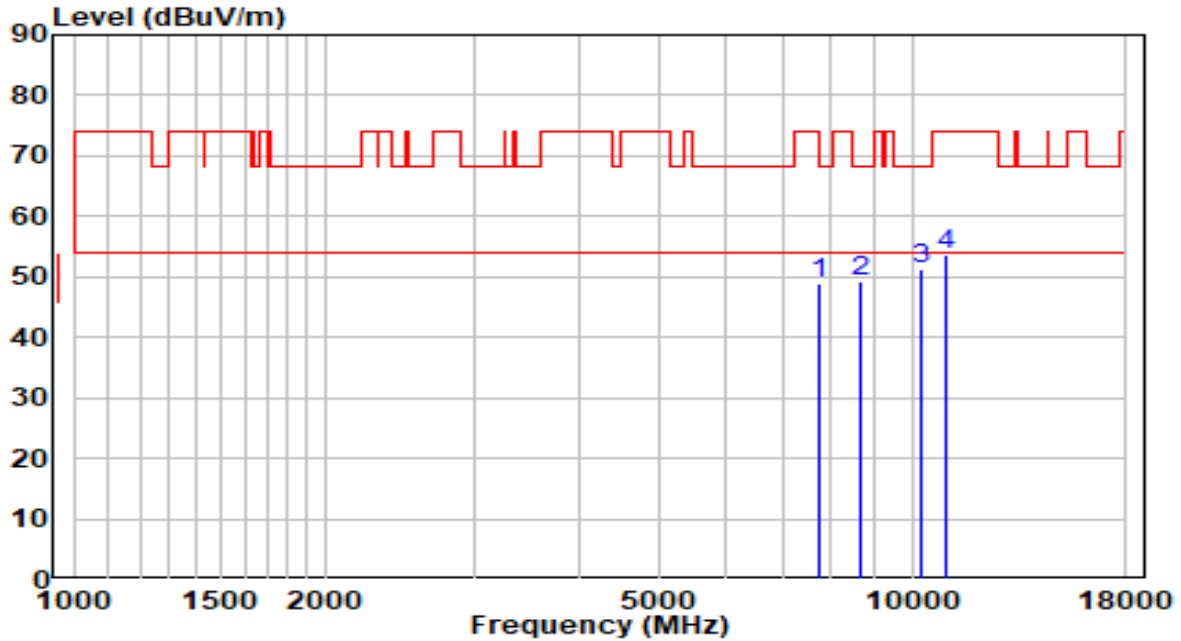

No	Frequency (MHz)	Reading (dBUV)	C.F (dB)	Measurement (dBUV/m)	Margin (dB)	Limit (dBUV/m)	Remark (QP/PK/AV)
1	7723.500	36.86	12.08	48.94	-25.06	74.00	Peak
2	8675.500	36.32	12.88	49.21	-18.99	68.20	Peak
3	* 10265.000	34.86	16.27	51.13	-17.07	68.20	Peak
4	11013.000	35.75	17.80	53.55	-20.45	74.00	Peak

Note:

- "*", means this data is the worst emission level.
- C.F (Correction Factor) = Antenna Factor (dB)+ Cable Loss (dB)– Preamplifier(dB).
- Measurement(dBUV/m) = Reading(dBUV) + C.F (Correction Factor).
- The emission levels of other frequencies are very lower than the limit and not show in test report.

EUT	Cassia Bluetooth Router	Date of Test	2021-03-01
Factor	BBHA 9120D	Temp. / Humidity	35.9°C/22.2%
Polarity	Vertical	Site / Test Engineer	AC1 / Jay Chou
Test Mode	Transmit by 802.11ac-VHT40 at Channel 5510MHz	Test Voltage	120V/60Hz

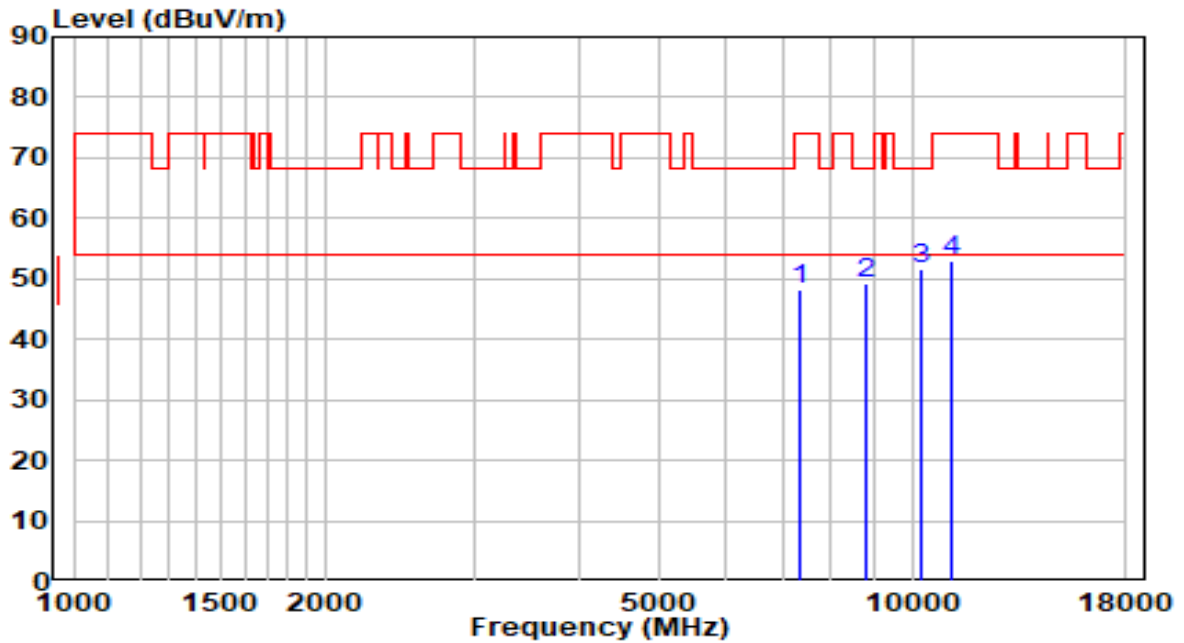

No	Frequency (MHz)	Reading (dBUV)	C.F (dB)	Measurement (dBUV/m)	Margin (dB)	Limit (dBUV/m)	Remark (QP/PK/AV)
1	7349.500	37.00	11.29	48.29	-25.71	74.00	Peak
2	8794.500	36.19	13.18	49.36	-18.84	68.20	Peak
3	* 10282.000	35.25	16.32	51.57	-16.63	68.20	Peak
4	11106.500	35.23	17.92	53.15	-20.85	74.00	Peak

Note:

- "*", means this data is the worst emission level.
- C.F (Correction Factor) = Antenna Factor (dB)+ Cable Loss (dB)– Preamplifier(dB).
- Measurement(dBUV/m) = Reading(dBUV) + C.F (Correction Factor).
- The emission levels of other frequencies are very lower than the limit and not show in test report.

EUT	Cassia Bluetooth Router	Date of Test	2021-03-01
Factor	BBHA 9120D	Temp. / Humidity	35.9°C/22.2%
Polarity	Horizontal	Site / Test Engineer	AC1 / Jay Chou
Test Mode	Transmit by 802.11ac-VHT40 at Channel 5550MHz	Test Voltage	120V/60Hz

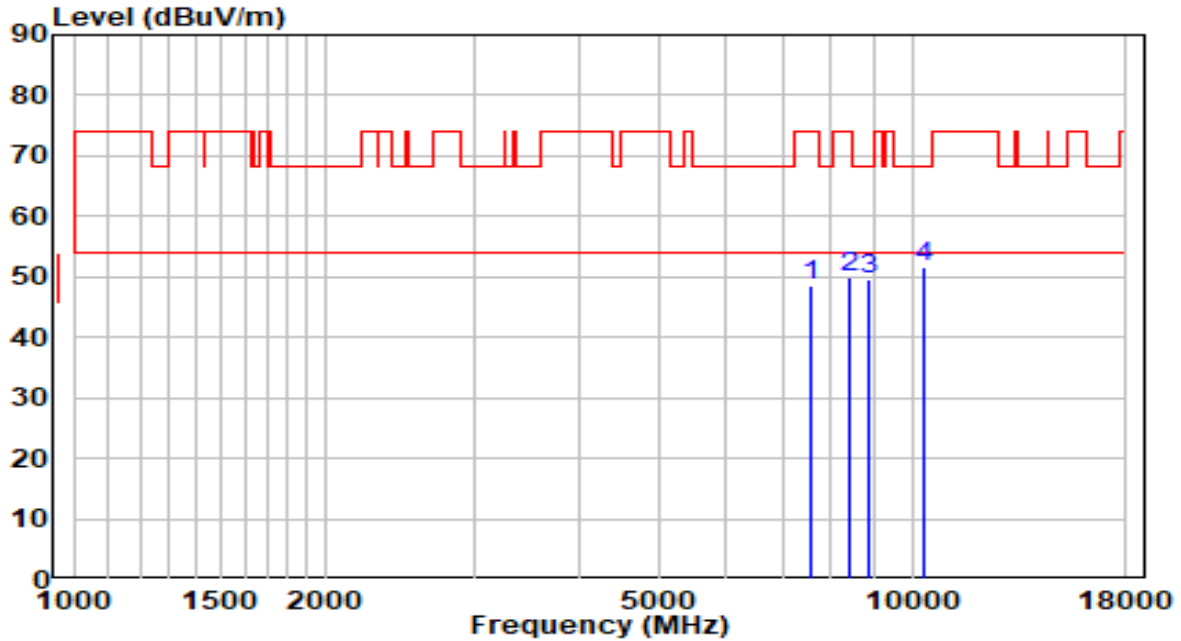

No	Frequency (MHz)	Reading (dBuV)	C.F (dB)	Measurement (dBuV/m)	Margin (dB)	Limit (dBuV/m)	Remark (QP/PK/AV)
1	7553.500	36.82	11.80	48.62	-25.38	74.00	Peak
2	8395.000	37.34	12.47	49.81	-24.19	74.00	Peak
3	8871.000	36.16	13.36	49.52	-18.68	68.20	Peak
4	* 10333.000	35.19	16.50	51.68	-16.52	68.20	Peak

Note:

1. " *", means this data is the worst emission level.
2. C.F (Correction Factor) = Antenna Factor (dB)+ Cable Loss (dB)– Preamplifier(dB).
3. Measurement(dBuV/m) = Reading(dBuV) + C.F (Correction Factor).
- 4.The emission levels of other frequencies are very lower than the limit and not show in test report.

EUT	Cassia Bluetooth Router	Date of Test	2021-03-01
Factor	BBHA 9120D	Temp. / Humidity	35.9°C/22.2%
Polarity	Vertical	Site / Test Engineer	AC1 / Jay Chou
Test Mode	Transmit by 802.11ac-VHT40 at Channel 5550MHz	Test Voltage	120V/60Hz

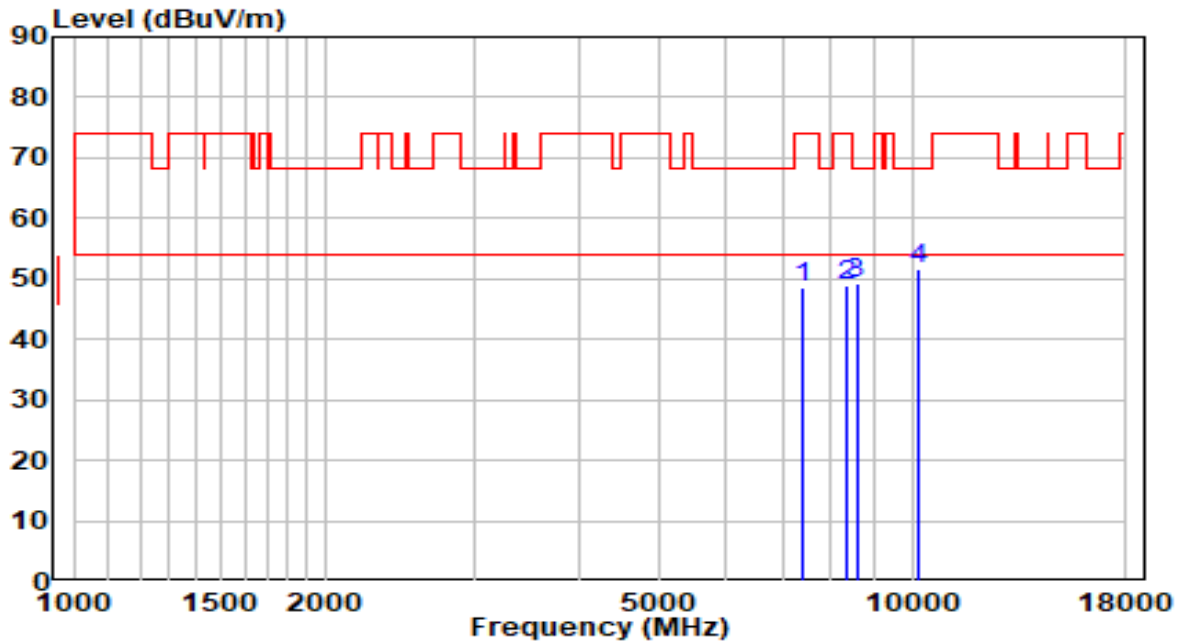

No	Frequency (MHz)	Reading (dBuV)	C.F (dB)	Measurement (dBuV/m)	Margin (dB)	Limit (dBuV/m)	Remark (QP/PK/AV)
1	7417.500	36.92	11.48	48.40	-25.60	74.00	Peak
2	8344.000	36.51	12.48	48.99	-25.01	74.00	Peak
3	8582.000	36.45	12.66	49.11	-19.09	68.20	Peak
4	* 10197.000	35.71	16.03	51.74	-16.46	68.20	Peak

Note:

1. " *", means this data is the worst emission level.
2. C.F (Correction Factor) = Antenna Factor (dB)+ Cable Loss (dB)– Preamplifier(dB).
3. Measurement(dBuV/m) = Reading(dBuV) + C.F (Correction Factor).
- 4.The emission levels of other frequencies are very lower than the limit and not show in test report.

EUT	Cassia Bluetooth Router	Date of Test	2021-03-01
Factor	BBHA 9120D	Temp. / Humidity	35.9°C/22.2%
Polarity	Horizontal	Site / Test Engineer	AC1 / Jay Chou
Test Mode	Transmit by 802.11ac-VHT40 at Channel 5670MHz	Test Voltage	120V/60Hz

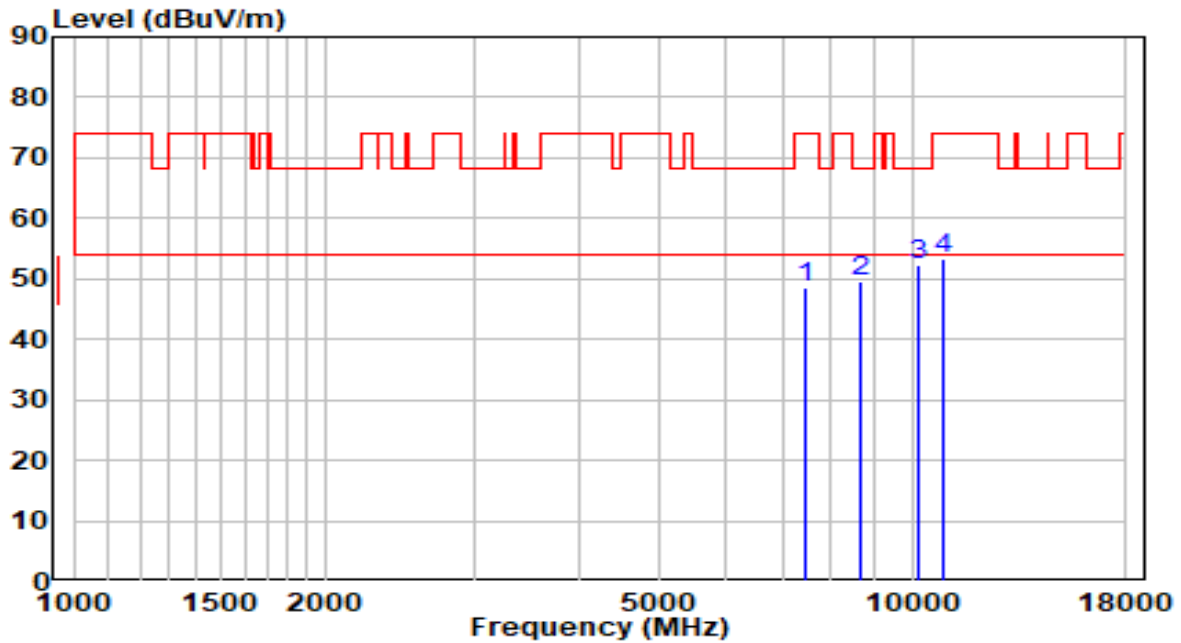

No	Frequency (MHz)	Reading (dBuV)	C.F (dB)	Measurement (dBuV/m)	Margin (dB)	Limit (dBuV/m)	Remark (QP/PK/AV)
1	7443.000	36.91	11.55	48.46	-25.54	74.00	Peak
2	8650.000	36.80	12.82	49.62	-18.58	68.20	Peak
3	* 10188.500	36.26	16.00	52.26	-15.94	68.20	Peak
4	10894.000	35.79	17.63	53.42	-20.58	74.00	Peak

Note:

- "*", means this data is the worst emission level.
- C.F (Correction Factor) = Antenna Factor (dB)+ Cable Loss (dB)– Preamplifier(dB).
- Measurement(dBuV/m) = Reading(dBuV) + C.F (Correction Factor).
- The emission levels of other frequencies are very lower than the limit and not show in test report.

EUT	Cassia Bluetooth Router	Date of Test	2021-03-01
Factor	BBHA 9120D	Temp. / Humidity	35.9°C/22.2%
Polarity	Vertical	Site / Test Engineer	AC1 / Jay Chou
Test Mode	Transmit by 802.11ac-VHT40 at Channel 5670MHz	Test Voltage	120V/60Hz

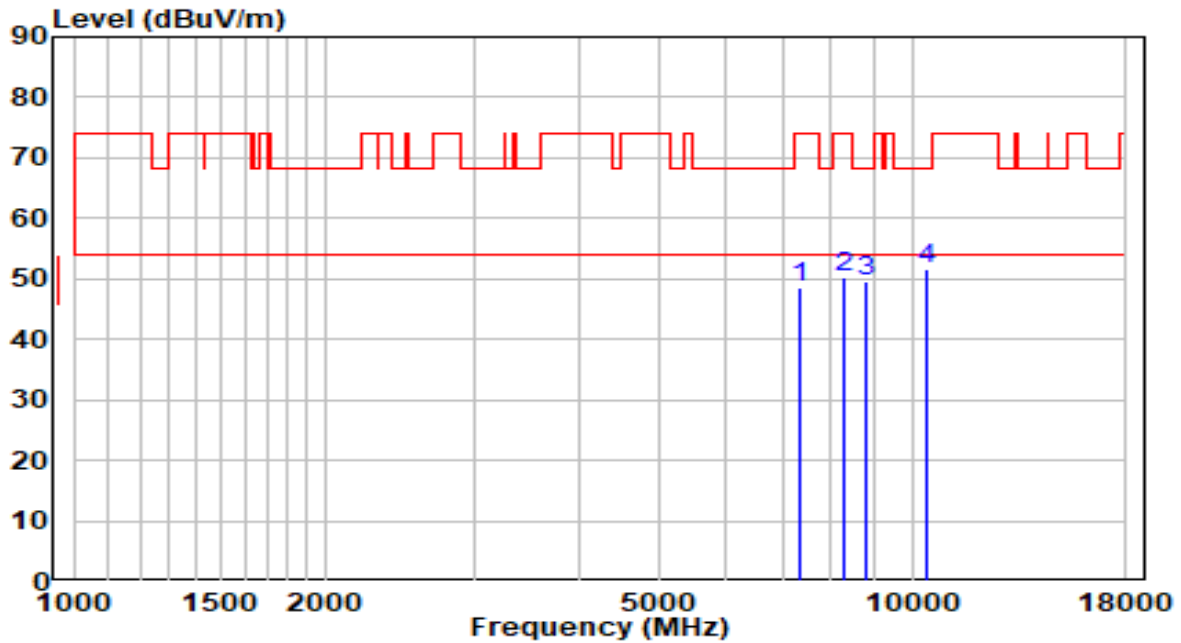

No	Frequency (MHz)	Reading (dBUV)	C.F (dB)	Measurement (dBUV/m)	Margin (dB)	Limit (dBUV/m)	Remark (QP/PK/AV)
1	7358.000	37.35	11.31	48.66	-25.34	74.00	Peak
2	8267.500	37.64	12.49	50.13	-23.87	74.00	Peak
3	8811.500	36.38	13.22	49.60	-18.60	68.20	Peak
4	* 10401.000	34.99	16.73	51.72	-16.48	68.20	Peak

Note:

1. " *", means this data is the worst emission level.
2. C.F (Correction Factor) = Antenna Factor (dB)+ Cable Loss (dB)– Preamplifier(dB).
3. Measurement(dBUV/m) = Reading(dBUV) + C.F (Correction Factor).
- 4.The emission levels of other frequencies are very lower than the limit and not show in test report.

EUT	Cassia Bluetooth Router	Date of Test	2021-03-01
Factor	BBHA 9120D	Temp. / Humidity	35.9°C/22.2%
Polarity	Horizontal	Site / Test Engineer	AC1 / Jay Chou
Test Mode	Transmit by 802.11ac-VHT40 at Channel 5710MHz	Test Voltage	120V/60Hz

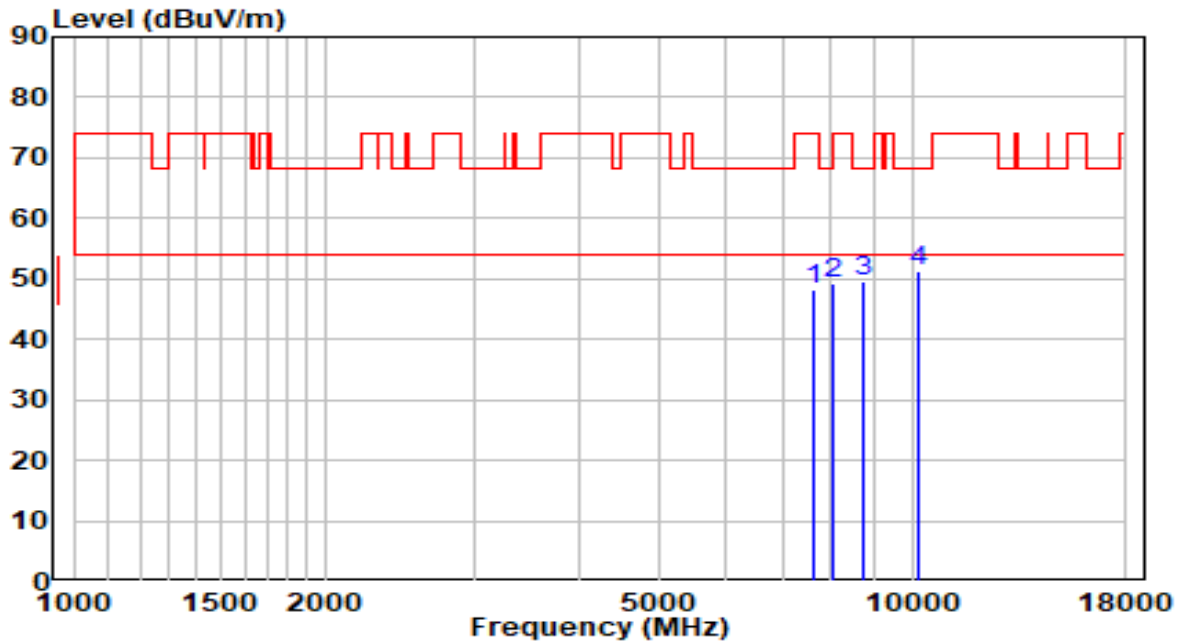

No	Frequency (MHz)	Reading (dBUV)	C.F (dB)	Measurement (dBUV/m)	Margin (dB)	Limit (dBUV/m)	Remark (QP/PK/AV)
1	7647.000	36.12	11.95	48.08	-25.92	74.00	Peak
2	8072.000	36.61	12.52	49.13	-24.87	74.00	Peak
3	8726.500	36.53	13.01	49.54	-18.66	68.20	Peak
4	* 10197.000	35.13	16.03	51.16	-17.04	68.20	Peak

Note:

1. " *", means this data is the worst emission level.
2. C.F (Correction Factor) = Antenna Factor (dB)+ Cable Loss (dB)– Preamplifier(dB).
3. Measurement(dBUV/m) = Reading(dBUV) + C.F (Correction Factor).
- 4.The emission levels of other frequencies are very lower than the limit and not show in test report.

EUT	Cassia Bluetooth Router	Date of Test	2021-03-01
Factor	BBHA 9120D	Temp. / Humidity	35.9°C/22.2%
Polarity	Vertical	Site / Test Engineer	AC1 / Jay Chou
Test Mode	Transmit by 802.11ac-VHT40 at Channel 5710MHz	Test Voltage	120V/60Hz

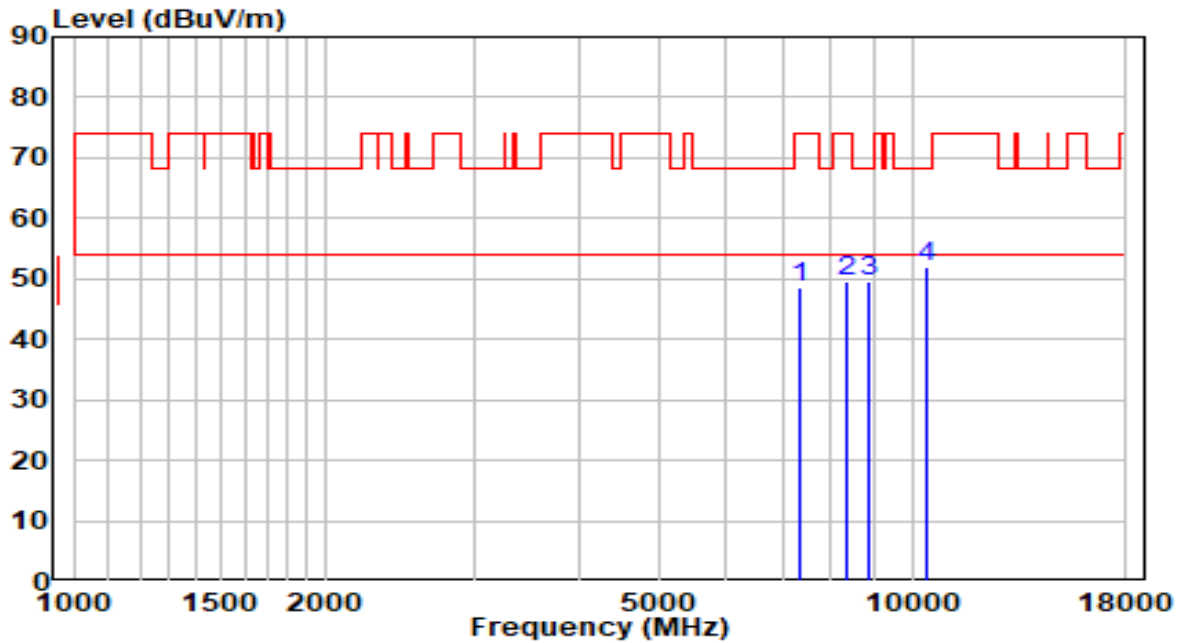

No	Frequency (MHz)	Reading (dBUV)	C.F (dB)	Measurement (dBUV/m)	Margin (dB)	Limit (dBUV/m)	Remark (QP/PK/AV)
1	7366.500	37.17	11.34	48.51	-25.49	74.00	Peak
2	8361.000	37.25	12.48	49.73	-24.27	74.00	Peak
3	8905.000	36.06	13.45	49.50	-18.70	68.20	Peak
4	* 10418.000	35.13	16.79	51.92	-16.28	68.20	Peak

Note:

- "*", means this data is the worst emission level.
- C.F (Correction Factor) = Antenna Factor (dB)+ Cable Loss (dB)– Preamplifier(dB).
- Measurement(dBUV/m) = Reading(dBUV) + C.F (Correction Factor).
- The emission levels of other frequencies are very lower than the limit and not show in test report.

EUT	Cassia Bluetooth Router	Date of Test	2021-03-01
Factor	BBHA 9120D	Temp. / Humidity	35.9°C/22.2%
Polarity	Horizontal	Site / Test Engineer	AC1 / Jay Chou
Test Mode	Transmit by 802.11ac-VHT40 at Channel 5755MHz	Test Voltage	120V/60Hz

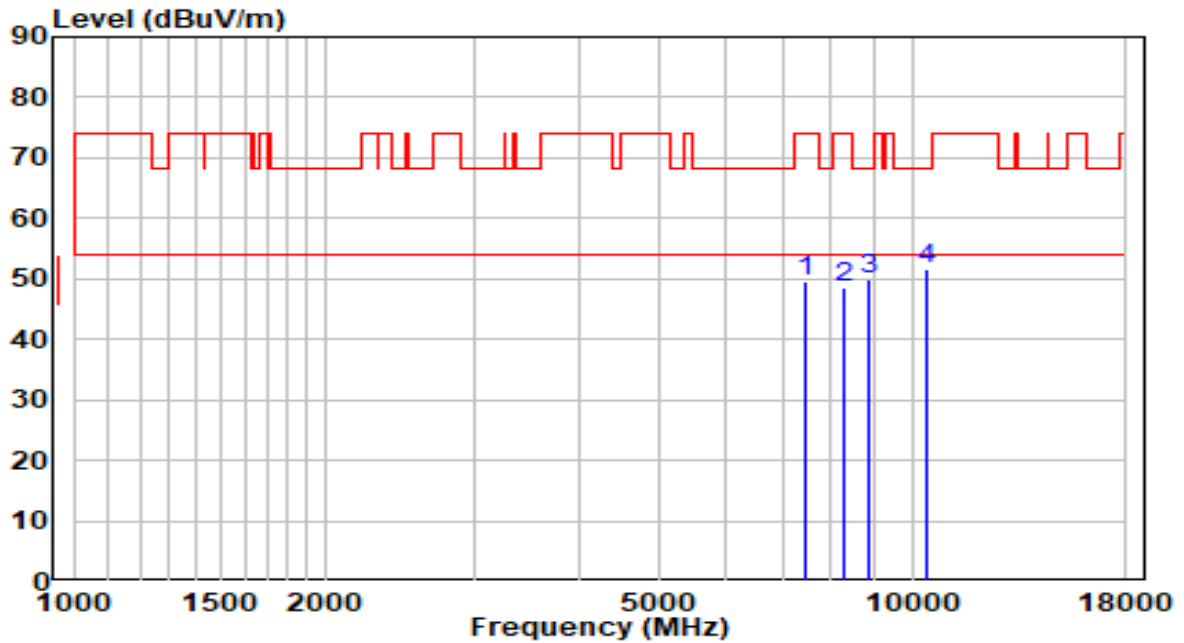

No	Frequency (MHz)	Reading (dBUV)	C.F (dB)	Measurement (dBUV/m)	Margin (dB)	Limit (dBUV/m)	Remark (QP/PK/AV)
1	7468.500	38.05	11.63	49.67	-24.33	74.00	Peak
2	8293.000	36.08	12.49	48.57	-25.43	74.00	Peak
3	8905.000	36.49	13.45	49.94	-18.26	68.20	Peak
4	* 10418.000	34.99	16.79	51.78	-16.42	68.20	Peak

Note:

- "*", means this data is the worst emission level.
- C.F (Correction Factor) = Antenna Factor (dB)+ Cable Loss (dB)– Preamplifier(dB).
- Measurement(dBUV/m) = Reading(dBUV) + C.F (Correction Factor).
- The emission levels of other frequencies are very lower than the limit and not show in test report.

EUT	Cassia Bluetooth Router	Date of Test	2021-03-01
Factor	BBHA 9120D	Temp. / Humidity	35.9°C/22.2%
Polarity	Vertical	Site / Test Engineer	AC1 / Jay Chou
Test Mode	Transmit by 802.11ac-VHT40 at Channel 5755MHz	Test Voltage	120V/60Hz

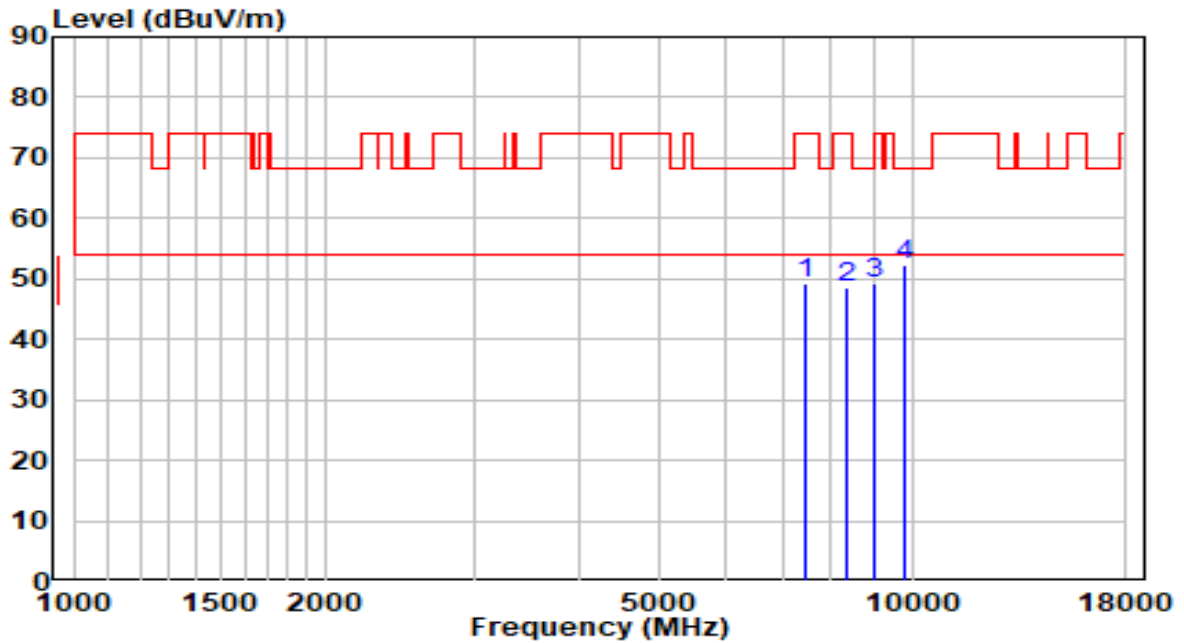

No	Frequency (MHz)	Reading (dBuV)	C.F (dB)	Measurement (dBuV/m)	Margin (dB)	Limit (dBuV/m)	Remark (QP/PK/AV)
1	7468.500	37.52	11.63	49.15	-24.85	74.00	Peak
2	8344.000	36.19	12.48	48.67	-25.33	74.00	Peak
3	8981.500	35.55	13.63	49.19	-19.01	68.20	Peak
4	* 9806.000	37.18	15.00	52.17	-16.03	68.20	Peak

Note:

- "*", means this data is the worst emission level.
- C.F (Correction Factor) = Antenna Factor (dB)+ Cable Loss (dB)– Preamplifier(dB).
- Measurement(dBuV/m) = Reading(dBuV) + C.F (Correction Factor).
- The emission levels of other frequencies are very lower than the limit and not show in test report.

EUT	Cassia Bluetooth Router	Date of Test	2021-03-01
Factor	BBHA 9120D	Temp. / Humidity	35.9°C/22.2%
Polarity	Horizontal	Site / Test Engineer	AC1 / Jay Chou
Test Mode	Transmit by 802.11ac-VHT80 at Channel 5795MHz	Test Voltage	120V/60Hz

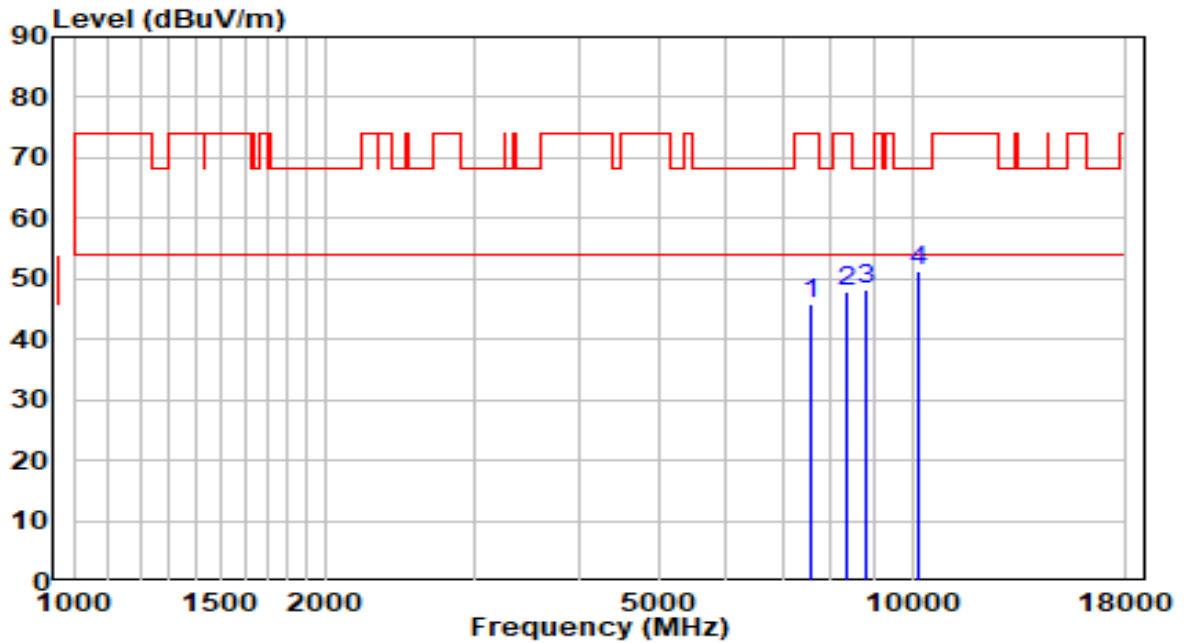

No	Frequency (MHz)	Reading (dBuV)	C.F (dB)	Measurement (dBuV/m)	Margin (dB)	Limit (dBuV/m)	Remark (QP/PK/AV)
1	7570.500	33.93	11.83	45.76	-28.24	74.00	Peak
2	8327.000	35.52	12.48	48.00	-26.00	74.00	Peak
3	8811.500	35.07	13.22	48.29	-19.91	68.20	Peak
4	* 10188.500	35.35	16.00	51.35	-16.85	68.20	Peak

Note:

1. " *", means this data is the worst emission level.
2. C.F (Correction Factor) = Antenna Factor (dB)+ Cable Loss (dB)– Preamplifier(dB).
3. Measurement(dBuV/m) = Reading(dBuV) + C.F (Correction Factor).
4. The emission levels of other frequencies are very lower than the limit and not show in test report.

EUT	Cassia Bluetooth Router	Date of Test	2021-03-01
Factor	BBHA 9120D	Temp. / Humidity	35.9°C/22.2%
Polarity	Vertical	Site / Test Engineer	AC1 / Jay Chou
Test Mode	Transmit by 802.11ac-VHT80 at Channel 5795MHz	Test Voltage	120V/60Hz

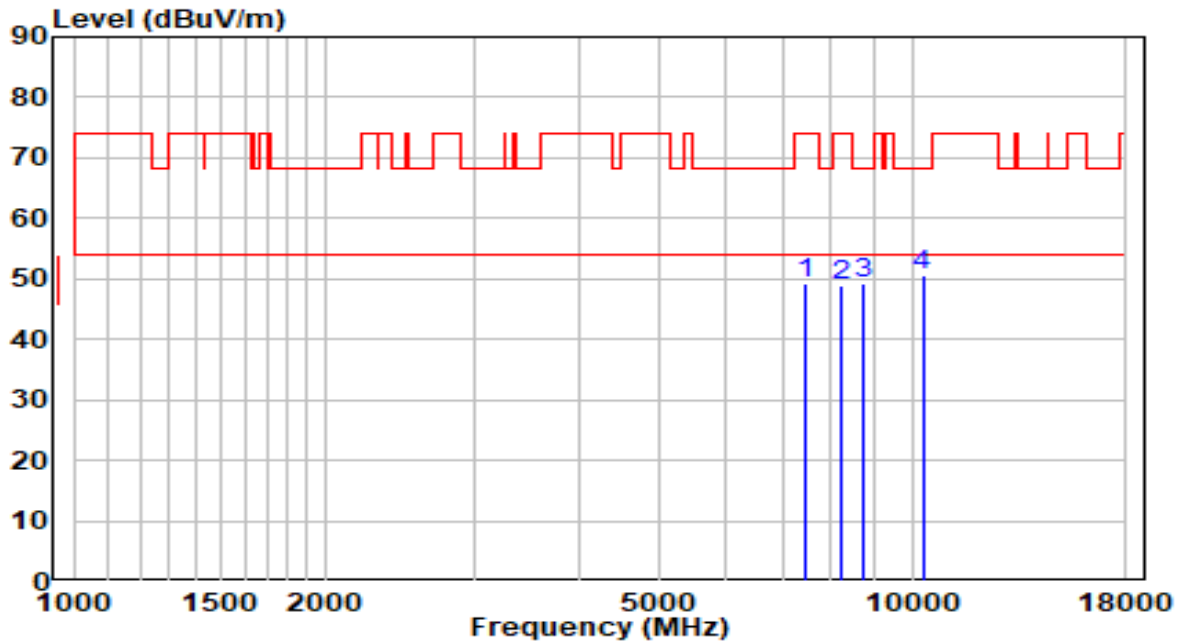

No	Frequency (MHz)	Reading (dBUV)	C.F (dB)	Measurement (dBUV/m)	Margin (dB)	Limit (dBUV/m)	Remark (QP/PK/AV)
1	7451.500	37.55	11.58	49.13	-24.87	74.00	Peak
2	8233.500	36.51	12.49	49.01	-24.99	74.00	Peak
3	8743.500	36.19	13.05	49.24	-18.96	68.20	Peak
4	* 10290.500	34.41	16.35	50.76	-17.44	68.20	Peak

Note:

- "*", means this data is the worst emission level.
- C.F (Correction Factor) = Antenna Factor (dB)+ Cable Loss (dB)– Preamplifier(dB).
- Measurement(dBUV/m) = Reading(dBUV) + C.F (Correction Factor).
- The emission levels of other frequencies are very lower than the limit and not show in test report.

EUT	Cassia Bluetooth Router	Date of Test	2021-03-01
Factor	BBHA 9120D	Temp. / Humidity	35.9°C/22.2%
Polarity	Horizontal	Site / Test Engineer	AC1 / Jay Chou
Test Mode	Transmit by 802.11ac-VHT80 at Channel 5210MHz	Test Voltage	120V/60Hz

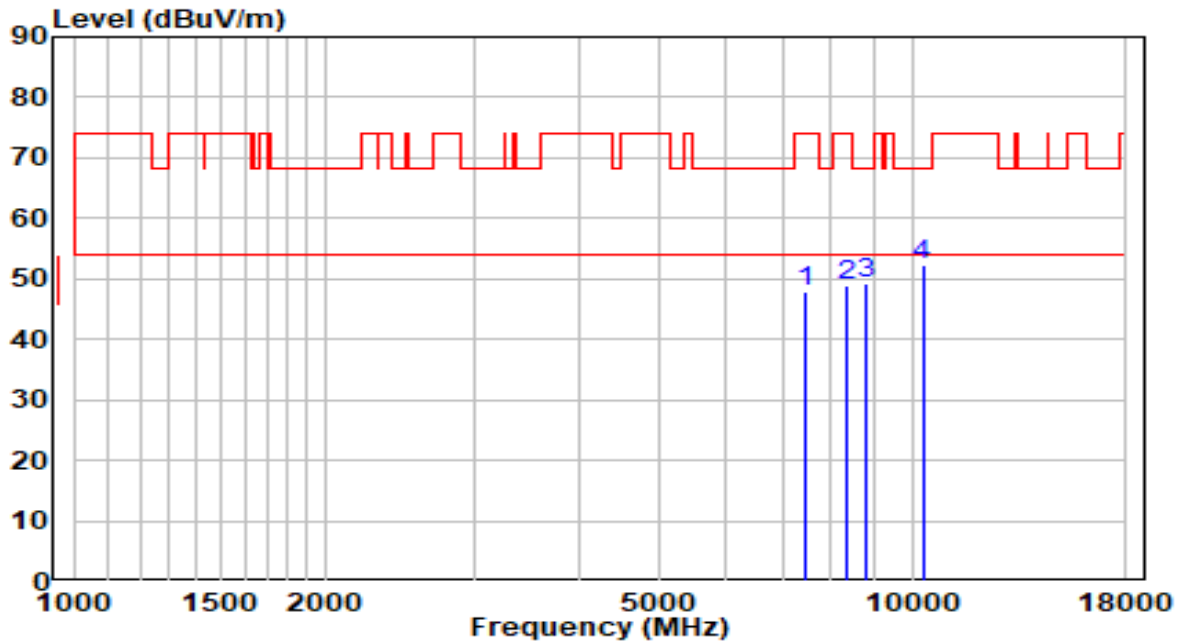

No	Frequency (MHz)	Reading (dBUV)	C.F (dB)	Measurement (dBUV/m)	Margin (dB)	Limit (dBUV/m)	Remark (QP/PK/AV)
1	7460.000	36.39	11.60	47.99	-26.01	74.00	Peak
2	8344.000	36.52	12.48	49.00	-25.00	74.00	Peak
3	8794.500	36.05	13.18	49.23	-18.97	68.20	Peak
4	* 10290.500	36.08	16.35	52.43	-15.77	68.20	Peak

Note:

- "*", means this data is the worst emission level.
- C.F (Correction Factor) = Antenna Factor (dB)+ Cable Loss (dB)– Preamplifier(dB).
- Measurement(dBUV/m) = Reading(dBUV) + C.F (Correction Factor).
- The emission levels of other frequencies are very lower than the limit and not show in test report.

EUT	Cassia Bluetooth Router	Date of Test	2021-03-01
Factor	BBHA 9120D	Temp. / Humidity	35.9°C/22.2%
Polarity	Vertical	Site / Test Engineer	AC1 / Jay Chou
Test Mode	Transmit by 802.11ac-VHT80 at Channel 5210MHz	Test Voltage	120V/60Hz

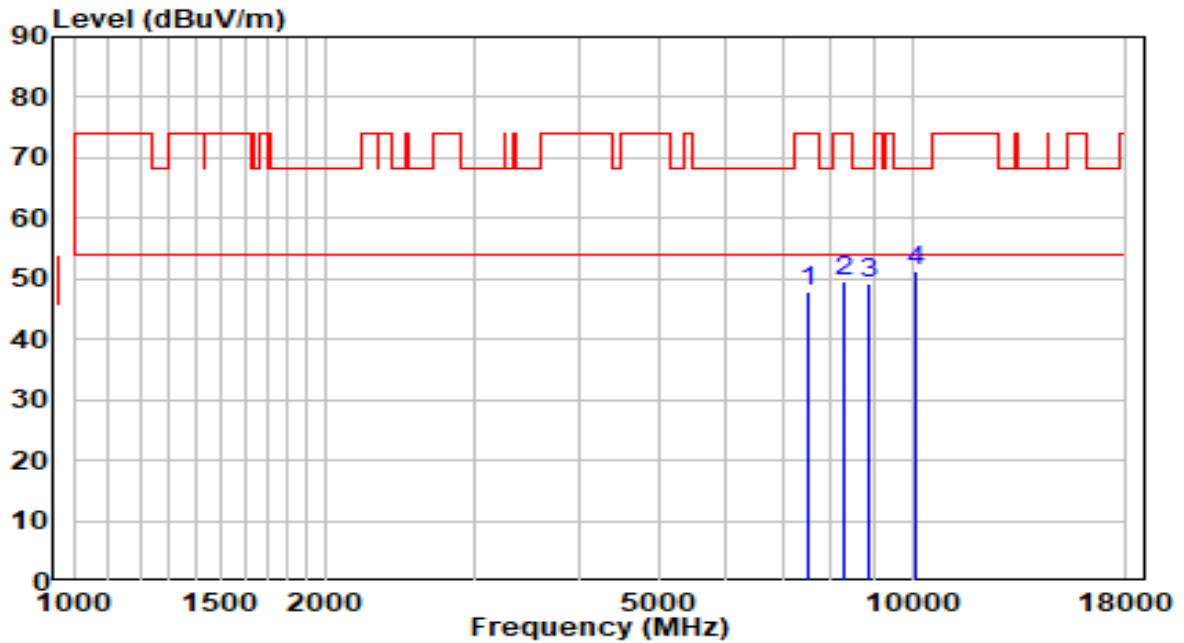

No	Frequency (MHz)	Reading (dBUV)	C.F (dB)	Measurement (dBUV/m)	Margin (dB)	Limit (dBUV/m)	Remark (QP/PK/AV)
1	7494.000	36.31	11.70	48.01	-25.99	74.00	Peak
2	8267.500	37.25	12.49	49.74	-24.26	74.00	Peak
3	8888.000	35.70	13.41	49.10	-19.10	68.20	Peak
4	* 10129.000	35.50	15.80	51.30	-16.90	68.20	Peak

Note:

1. " *", means this data is the worst emission level.
2. C.F (Correction Factor) = Antenna Factor (dB)+ Cable Loss (dB)– Preamplifier(dB).
3. Measurement(dBUV/m) = Reading(dBUV) + C.F (Correction Factor).
4. The emission levels of other frequencies are very lower than the limit and not show in test report.

EUT	Cassia Bluetooth Router	Date of Test	2021-03-01
Factor	BBHA 9120D	Temp. / Humidity	35.9°C/22.2%
Polarity	Horizontal	Site / Test Engineer	AC1 / Jay Chou
Test Mode	Transmit by 802.11ac-VHT80 at Channel 5290MHz	Test Voltage	120V/60Hz

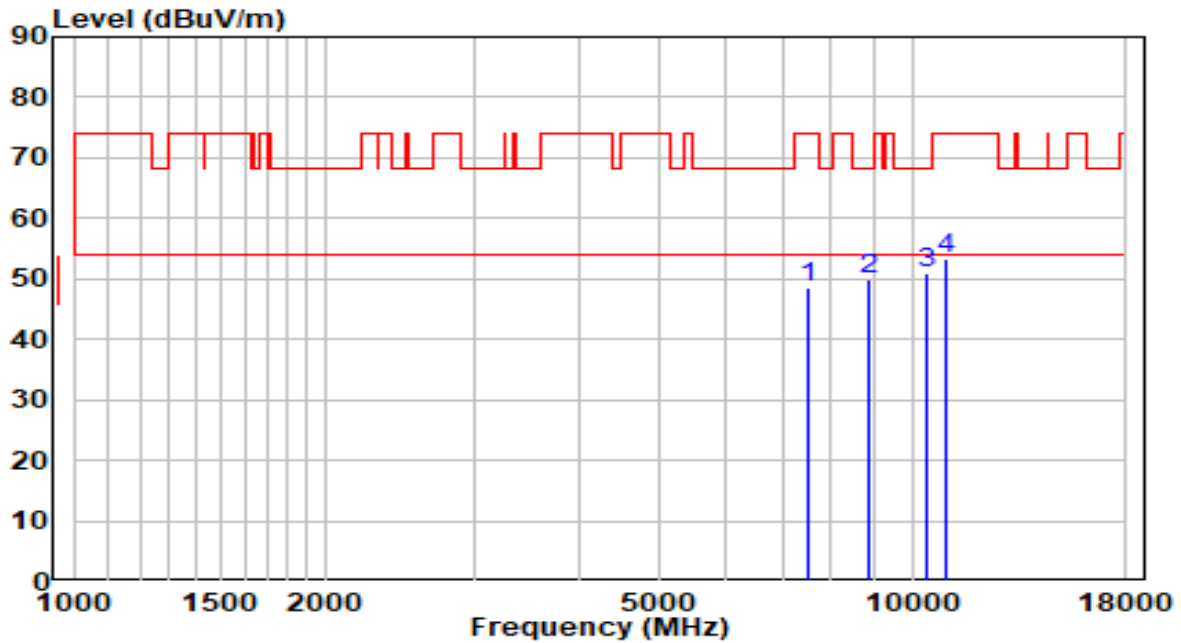

No	Frequency (MHz)	Reading (dBuV)	C.F (dB)	Measurement (dBuV/m)	Margin (dB)	Limit (dBuV/m)	Remark (QP/PK/AV)
1	7494.000	36.85	11.70	48.55	-25.45	74.00	Peak
2	8862.500	36.65	13.34	50.00	-18.20	68.20	Peak
3	* 10418.000	34.27	16.79	51.06	-17.14	68.20	Peak
4	11004.500	35.68	17.79	53.46	-20.54	74.00	Peak

Note:

- "*", means this data is the worst emission level.
- C.F (Correction Factor) = Antenna Factor (dB)+ Cable Loss (dB)– Preamplifier(dB).
- Measurement(dBuV/m) = Reading(dBuV) + C.F (Correction Factor).
- The emission levels of other frequencies are very lower than the limit and not show in test report.

EUT	Cassia Bluetooth Router	Date of Test	2021-03-01
Factor	BBHA 9120D	Temp. / Humidity	35.9°C/22.2%
Polarity	Vertical	Site / Test Engineer	AC1 / Jay Chou
Test Mode	Transmit by 802.11ac-VHT80 at Channel 5290MHz	Test Voltage	120V/60Hz

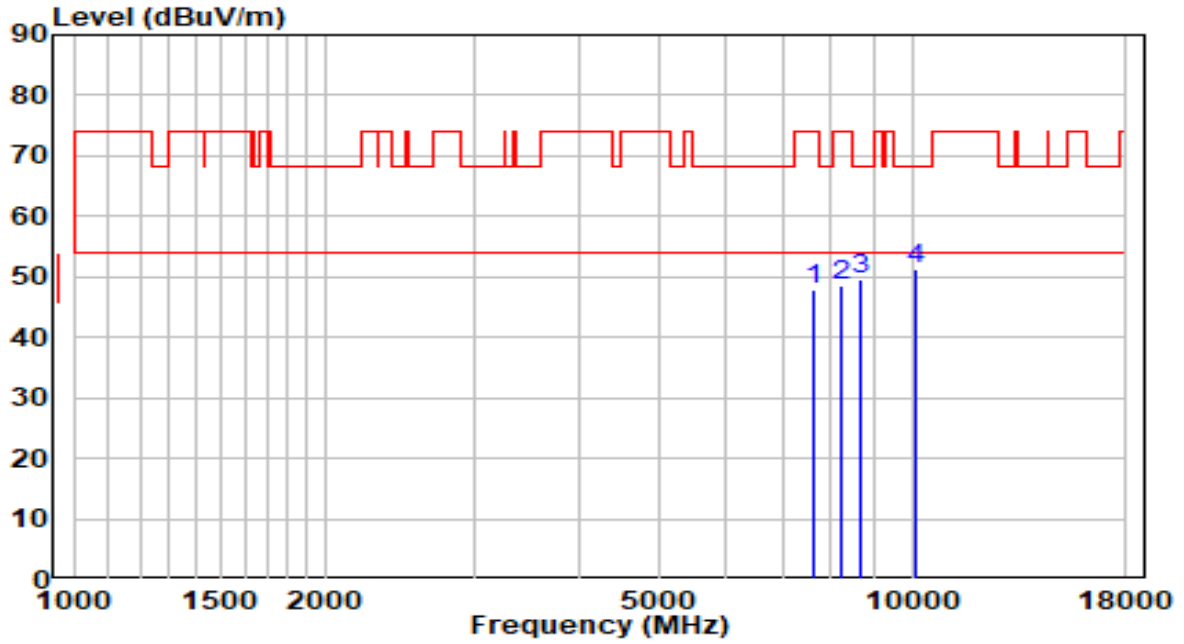

No	Frequency (MHz)	Reading (dBuV)	C.F (dB)	Measurement (dBuV/m)	Margin (dB)	Limit (dBuV/m)	Remark (QP/PK/AV)
1	7638.500	35.96	11.94	47.90	-26.10	74.00	Peak
2	8216.500	36.22	12.50	48.72	-25.28	74.00	Peak
3	8684.000	36.59	12.91	49.49	-18.71	68.20	Peak
4	* 10069.500	35.61	15.60	51.21	-16.99	68.20	Peak

Note:

1. " *", means this data is the worst emission level.
2. C.F (Correction Factor) = Antenna Factor (dB)+ Cable Loss (dB)– Preamplifier(dB).
3. Measurement(dBuV/m) = Reading(dBuV) + C.F (Correction Factor).
- 4.The emission levels of other frequencies are very lower than the limit and not show in test report.

EUT	Cassia Bluetooth Router	Date of Test	2021-03-01
Factor	BBHA 9120D	Temp. / Humidity	35.9°C/22.2%
Polarity	Horizontal	Site / Test Engineer	AC1 / Jay Chou
Test Mode	Transmit by 802.11ac-VHT40 at Channel 5530MHz	Test Voltage	120V/60Hz

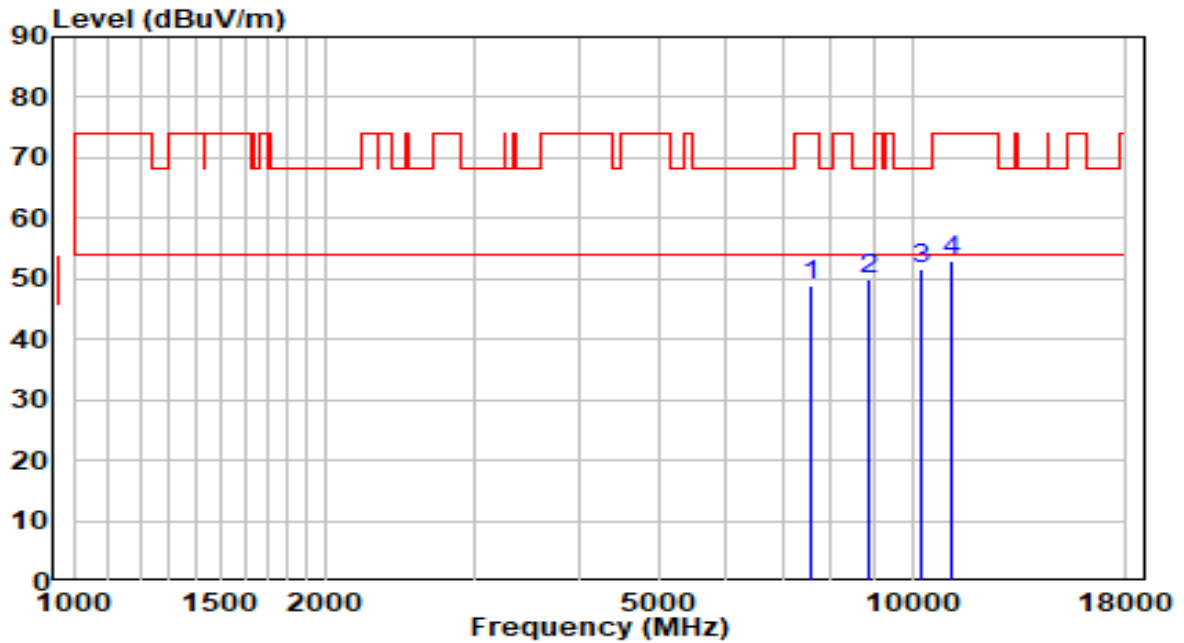

No	Frequency (MHz)	Reading (dBuV)	C.F (dB)	Measurement (dBuV/m)	Margin (dB)	Limit (dBuV/m)	Remark (QP/PK/AV)
1	7579.000	36.99	11.84	48.84	-25.16	74.00	Peak
2	8905.000	36.35	13.45	49.80	-18.40	68.20	Peak
3	* 10222.500	35.50	16.12	51.62	-16.58	68.20	Peak
4	11123.500	35.17	17.95	53.11	-20.89	74.00	Peak

Note:

- "*", means this data is the worst emission level.
- C.F (Correction Factor) = Antenna Factor (dB)+ Cable Loss (dB)– Preamplifier(dB).
- Measurement(dBuV/m) = Reading(dBuV) + C.F (Correction Factor).
- The emission levels of other frequencies are very lower than the limit and not show in test report.

EUT	Cassia Bluetooth Router	Date of Test	2021-03-01
Factor	BBHA 9120D	Temp. / Humidity	35.9°C/22.2%
Polarity	Vertical	Site / Test Engineer	AC1 / Jay Chou
Test Mode	Transmit by 802.11ac-VHT40 at Channel 5530MHz	Test Voltage	120V/60Hz

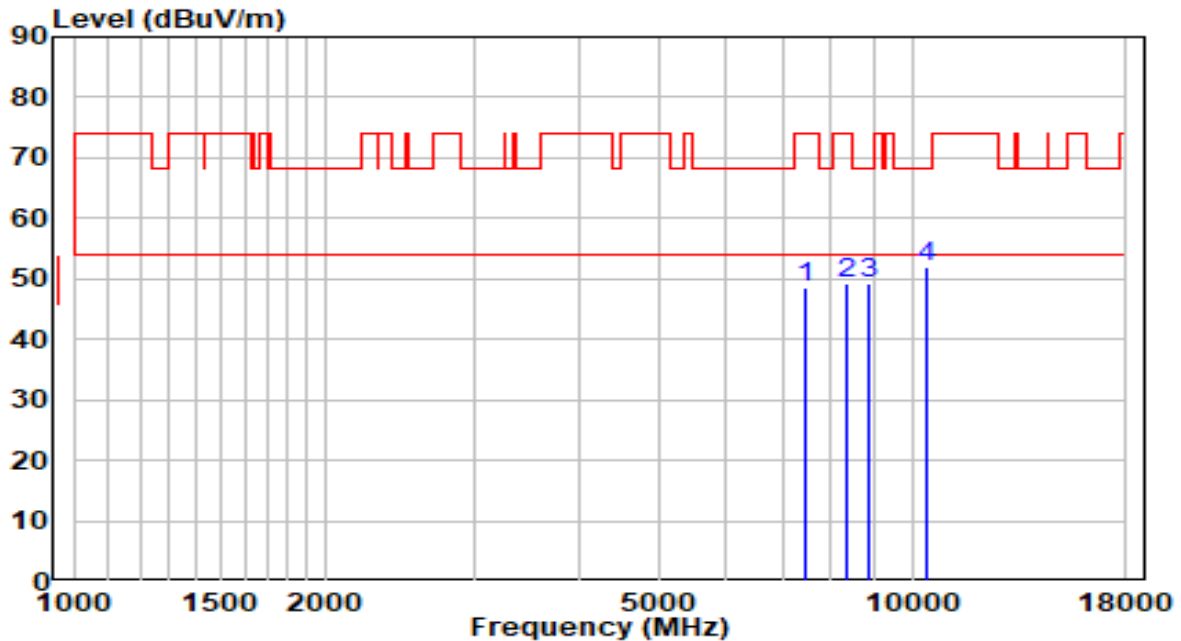

No	Frequency (MHz)	Reading (dBuV)	C.F (dB)	Measurement (dBuV/m)	Margin (dB)	Limit (dBuV/m)	Remark (QP/PK/AV)
1	7460.000	36.93	11.60	48.54	-25.46	74.00	Peak
2	8352.500	36.81	12.48	49.29	-24.71	74.00	Peak
3	8896.500	35.74	13.43	49.16	-19.04	68.20	Peak
4	* 10392.500	35.27	16.70	51.97	-16.23	68.20	Peak

Note:

- "*", means this data is the worst emission level.
- C.F (Correction Factor) = Antenna Factor (dB)+ Cable Loss (dB)– Preamplifier(dB).
- Measurement(dBuV/m) = Reading(dBuV) + C.F (Correction Factor).
- The emission levels of other frequencies are very lower than the limit and not show in test report.

EUT	Cassia Bluetooth Router	Date of Test	2021-03-01
Factor	BBHA 9120D	Temp. / Humidity	35.9°C/22.2%
Polarity	Horizontal	Site / Test Engineer	AC1 / Jay Chou
Test Mode	Transmit by 802.11ac-VHT80 at Channel 5610MHz	Test Voltage	120V/60Hz

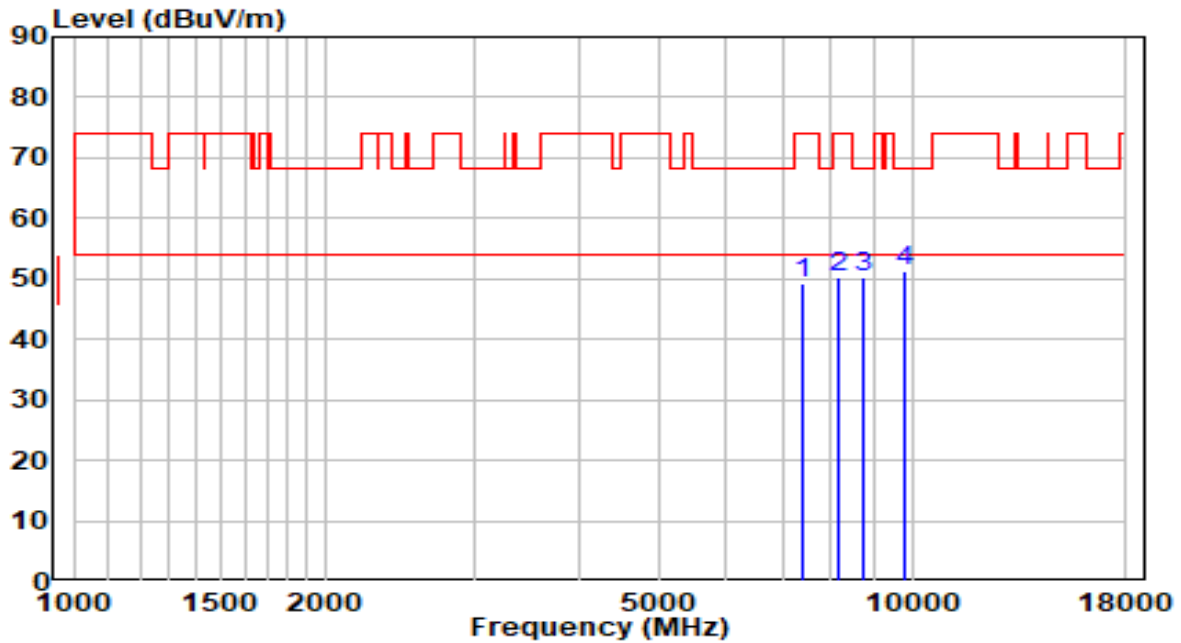

No	Frequency (MHz)	Reading (dBuV)	C.F (dB)	Measurement (dBuV/m)	Margin (dB)	Limit (dBuV/m)	Remark (QP/PK/AV)
1	7426.000	37.80	11.51	49.31	-24.69	74.00	Peak
2	8148.500	37.59	12.51	50.10	-23.90	74.00	Peak
3	8752.000	37.28	13.07	50.35	-17.85	68.20	Peak
4	* 9797.500	36.33	14.98	51.31	-16.89	68.20	Peak

Note:

- "*", means this data is the worst emission level.
- C.F (Correction Factor) = Antenna Factor (dB)+ Cable Loss (dB)– Preamplifier(dB).
- Measurement(dBuV/m) = Reading(dBuV) + C.F (Correction Factor).
- The emission levels of other frequencies are very lower than the limit and not show in test report.

EUT	Cassia Bluetooth Router	Date of Test	2021-03-01
Factor	BBHA 9120D	Temp. / Humidity	35.9°C/22.2%
Polarity	Vertical	Site / Test Engineer	AC1 / Jay Chou
Test Mode	Transmit by 802.11ac-VHT80 at Channel 5610MHz	Test Voltage	120V/60Hz

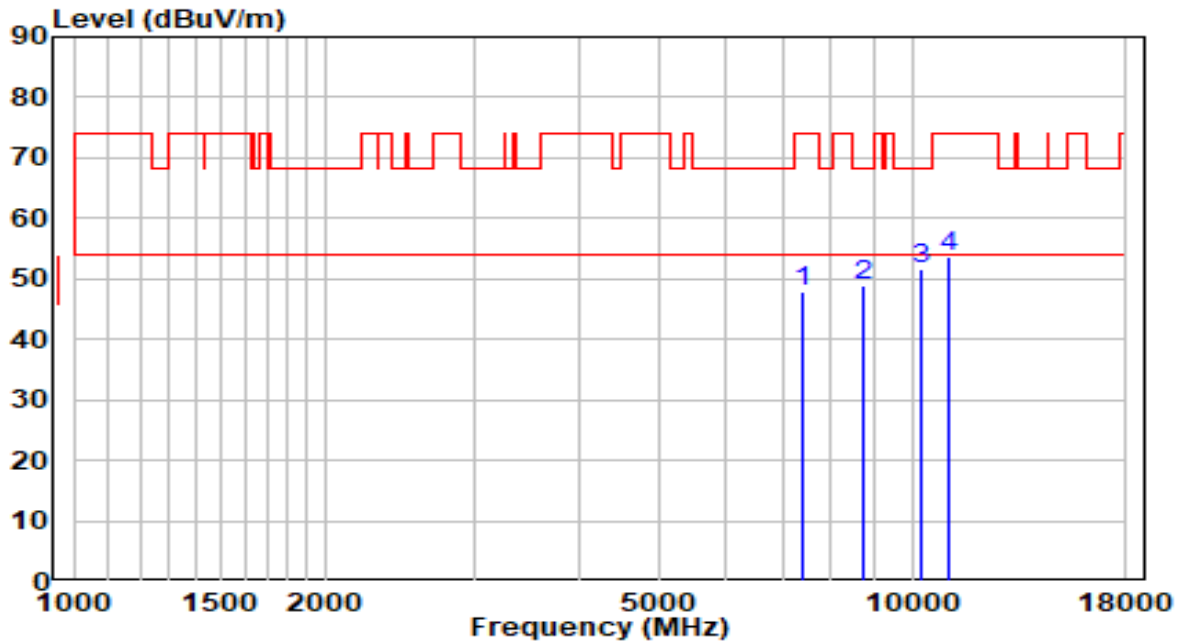

No	Frequency (MHz)	Reading (dBUV)	C.F (dB)	Measurement (dBUV/m)	Margin (dB)	Limit (dBUV/m)	Remark (QP/PK/AV)
1	7400.500	36.48	11.43	47.92	-26.08	74.00	Peak
2	8752.000	35.88	13.07	48.95	-19.25	68.20	Peak
3	* 10248.000	35.26	16.21	51.47	-16.73	68.20	Peak
4	11064.000	35.88	17.87	53.74	-20.26	74.00	Peak

Note:

- "*", means this data is the worst emission level.
- C.F (Correction Factor) = Antenna Factor (dB)+ Cable Loss (dB)– Preamplifier(dB).
- Measurement(dBUV/m) = Reading(dBUV) + C.F (Correction Factor).
- The emission levels of other frequencies are very lower than the limit and not show in test report.

EUT	Cassia Bluetooth Router	Date of Test	2021-03-01
Factor	BBHA 9120D	Temp. / Humidity	35.9°C/22.2%
Polarity	Horizontal	Site / Test Engineer	AC1 / Jay Chou
Test Mode	Transmit by 802.11ac-VHT80 at Channel 5690MHz	Test Voltage	120V/60Hz

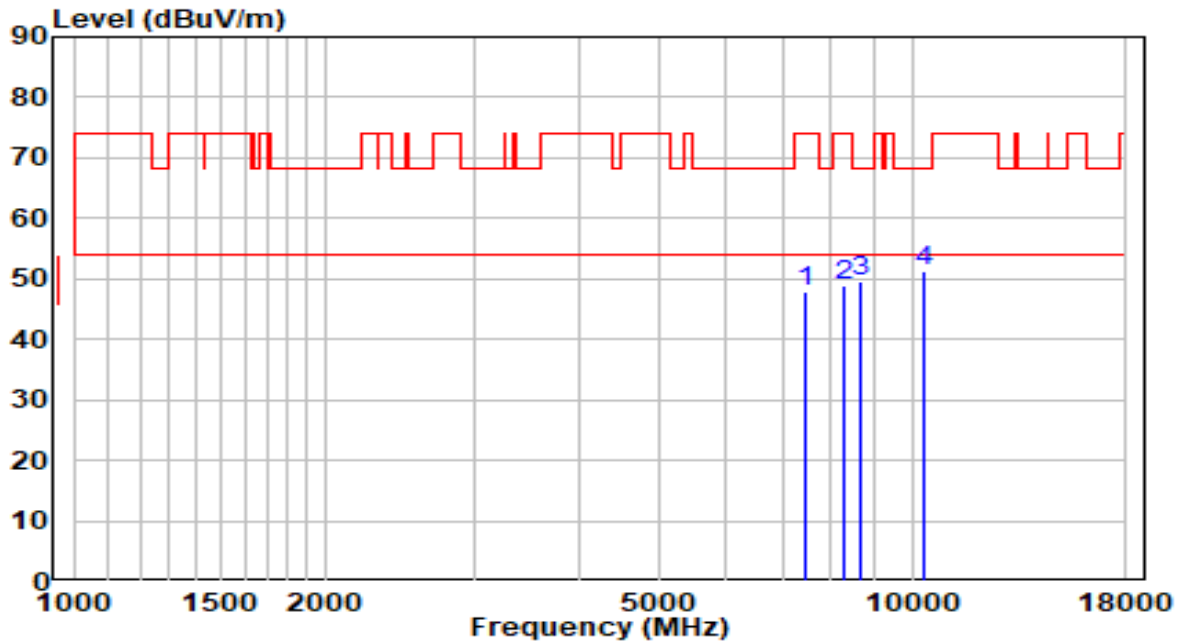

No	Frequency (MHz)	Reading (dBuV)	C.F (dB)	Measurement (dBuV/m)	Margin (dB)	Limit (dBuV/m)	Remark (QP/PK/AV)
1	7468.500	36.22	11.63	47.85	-26.15	74.00	Peak
2	8293.000	36.29	12.49	48.77	-25.23	74.00	Peak
3	8675.500	36.62	12.88	49.51	-18.69	68.20	Peak
4	* 10307.500	34.98	16.41	51.39	-16.81	68.20	Peak

Note:

- "*", means this data is the worst emission level.
- C.F (Correction Factor) = Antenna Factor (dB)+ Cable Loss (dB)– Preamplifier(dB).
- Measurement(dBuV/m) = Reading(dBuV) + C.F (Correction Factor).
- The emission levels of other frequencies are very lower than the limit and not show in test report.

EUT	Cassia Bluetooth Router	Date of Test	2021-03-01
Factor	BBHA 9120D	Temp. / Humidity	35.9°C/22.2%
Polarity	Vertical	Site / Test Engineer	AC1 / Jay Chou
Test Mode	Transmit by 802.11ac-VHT80 at Channel 5690MHz	Test Voltage	120V/60Hz

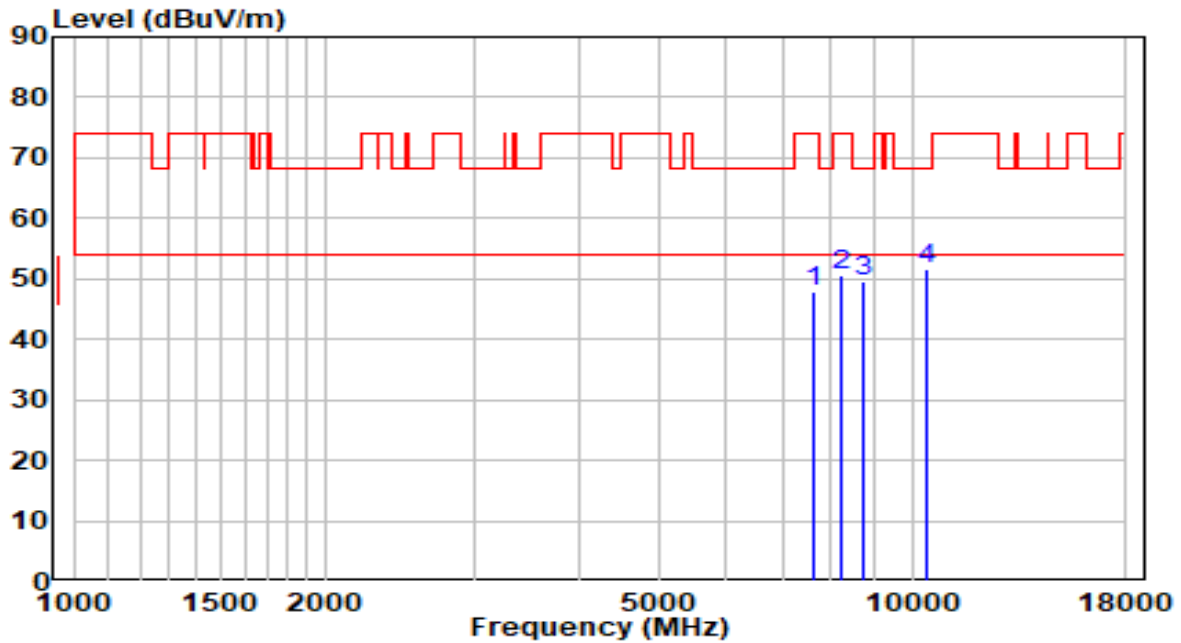

No	Frequency (MHz)	Reading (dBUV)	C.F (dB)	Measurement (dBUV/m)	Margin (dB)	Limit (dBUV/m)	Remark (QP/PK/AV)
1	7613.000	36.13	11.90	48.02	-25.98	74.00	Peak
2	8250.500	38.26	12.49	50.75	-23.25	74.00	Peak
3	8760.500	36.35	13.09	49.44	-18.76	68.20	Peak
4	* 10375.500	34.93	16.64	51.57	-16.63	68.20	Peak

Note:

- "*", means this data is the worst emission level.
- C.F (Correction Factor) = Antenna Factor (dB)+ Cable Loss (dB)– Preamplifier(dB).
- Measurement(dBUV/m) = Reading(dBUV) + C.F (Correction Factor).
- The emission levels of other frequencies are very lower than the limit and not show in test report.

EUT	Cassia Bluetooth Router	Date of Test	2021-03-01
Factor	BBHA 9120D	Temp. / Humidity	35.9°C/22.2%
Polarity	Horizontal	Site / Test Engineer	AC1 / Jay Chou
Test Mode	Transmit by 802.11ac-VHT80 at Channel 5775MHz	Test Voltage	120V/60Hz

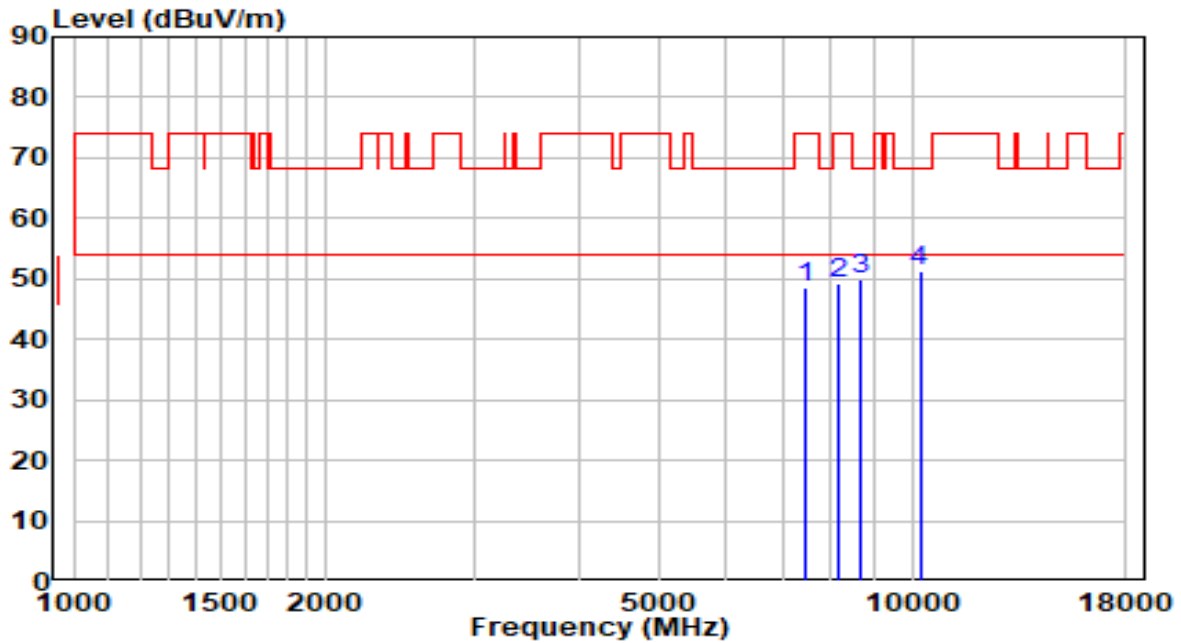

No	Frequency (MHz)	Reading (dBUV)	C.F (dB)	Measurement (dBUV/m)	Margin (dB)	Limit (dBUV/m)	Remark (QP/PK/AV)
1	7468.500	36.82	11.63	48.44	-25.56	74.00	Peak
2	8157.000	36.72	12.51	49.23	-24.77	74.00	Peak
3	8709.500	36.83	12.97	49.80	-18.40	68.20	Peak
4	* 10214.000	35.27	16.09	51.36	-16.84	68.20	Peak

Note:

- "*", means this data is the worst emission level.
- C.F (Correction Factor) = Antenna Factor (dB)+ Cable Loss (dB)– Preamplifier(dB).
- Measurement(dBUV/m) = Reading(dBUV) + C.F (Correction Factor).
- The emission levels of other frequencies are very lower than the limit and not show in test report.

EUT	Cassia Bluetooth Router	Date of Test	2021-03-01
Factor	BBHA 9120D	Temp. / Humidity	35.9°C/22.2%
Polarity	Vertical	Site / Test Engineer	AC1 / Jay Chou
Test Mode	Transmit by 802.11ac-VHT80 at Channel 5775MHz	Test Voltage	120V/60Hz

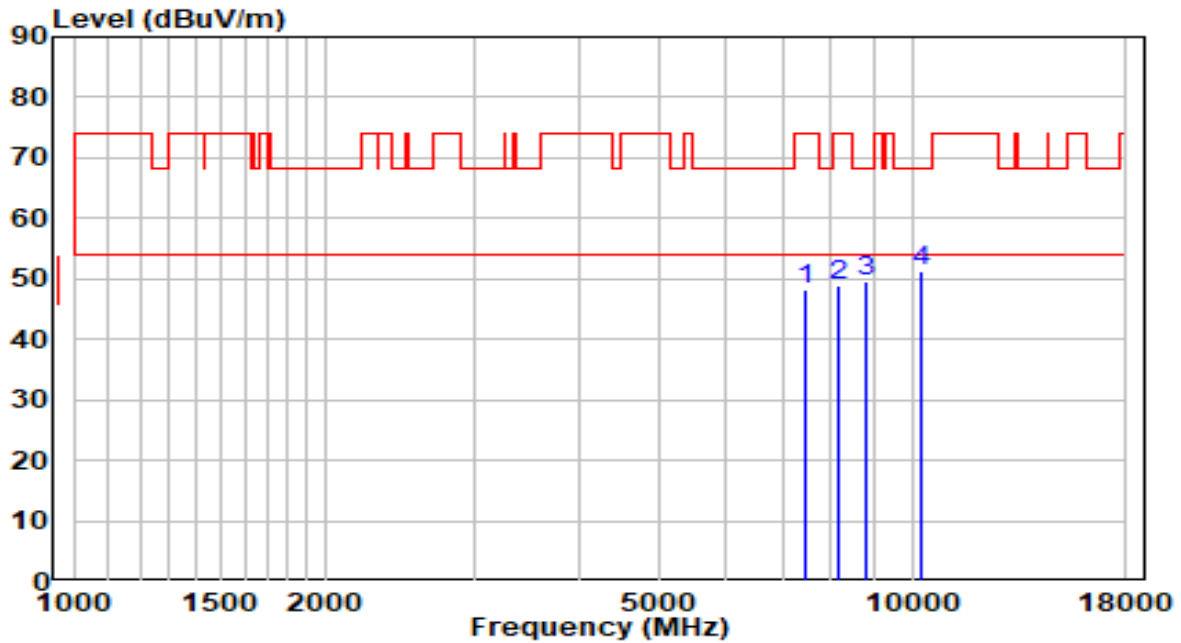

No	Frequency (MHz)	Reading (dBuV)	C.F (dB)	Measurement (dBuV/m)	Margin (dB)	Limit (dBuV/m)	Remark (QP/PK/AV)
1	7434.500	36.55	11.53	48.08	-25.92	74.00	Peak
2	8140.000	36.47	12.51	48.98	-25.02	74.00	Peak
3	8811.500	36.29	13.22	49.50	-18.70	68.20	Peak
4	* 10239.500	35.18	16.18	51.35	-16.85	68.20	Peak

Note:

- "*", means this data is the worst emission level.
- C.F (Correction Factor) = Antenna Factor (dB)+ Cable Loss (dB)– Preamplifier(dB).
- Measurement(dBuV/m) = Reading(dBuV) + C.F (Correction Factor).
- The emission levels of other frequencies are very lower than the limit and not show in test report.

The Worst Case of Radiated Emission below 1GHz:

EUT	Cassia Bluetooth Router	Date of Test	2021-03-02
Factor	VULB 9162 (30MHz~8GHz) + 6dB Attenuator	Temp. / Humidity	21.3°C /55%
Polarity	Horizontal	Site / Test Engineer	AC1 / Jay Chou
Test Mode	Transmit by 802.11a at channel 5320MHz	Test Voltage	120V/60Hz

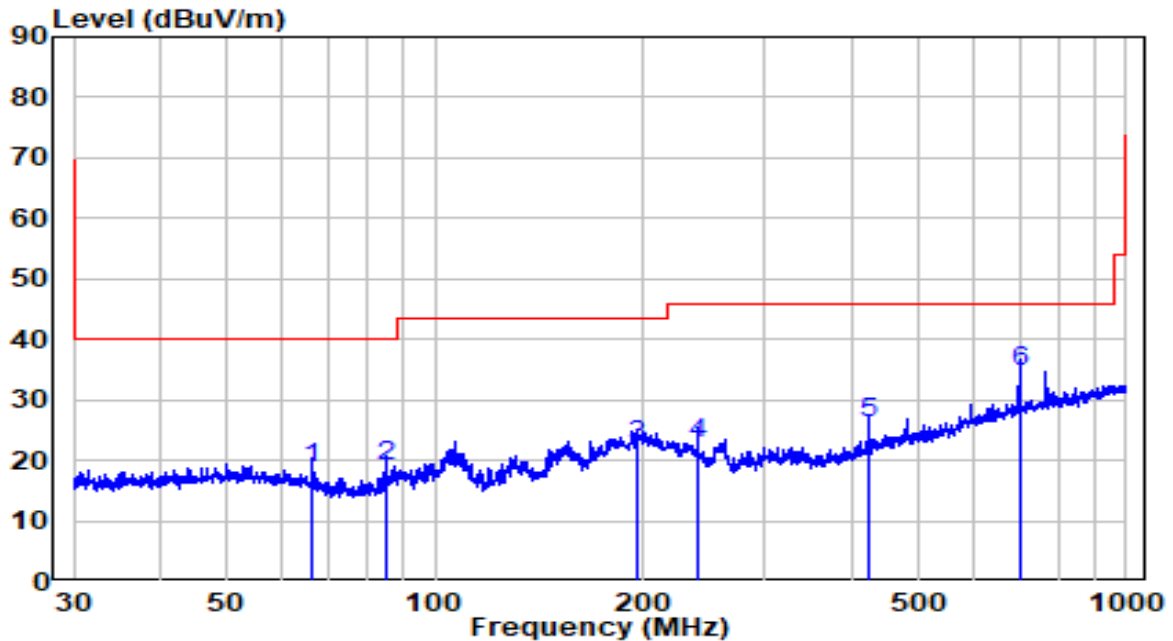

No	Frequency (MHz)	Reading (dBuV)	C.F (dB)	Measurement (dBuV/m)	Margin (dB)	Limit (dBuV/m)	Remark (QP/PK/AV)
1	66.616	0.56	18.07	18.63	-21.37	40.00	QP
2	84.999	3.27	15.62	18.89	-21.11	40.00	QP
3	196.510	3.39	19.13	22.52	-20.98	43.50	QP
4	239.987	2.44	20.20	22.64	-23.36	46.00	QP
5	425.028	1.51	24.48	25.99	-20.01	46.00	QP
6	* 700.532	5.33	29.33	34.66	-11.34	46.00	QP

Note:

1. " *", means this data is the worst emission level.
2. C.F (Correction Factor) = Antenna Factor (dB)+ Cable Loss (dB).
3. Measurement(dBuV/m) = Reading(dBuV) + C.F (Correction Factor).
4. The emission levels of other frequencies are very lower than the limit and not show in test report.
5. The amplitude of Radiated emissions (the test frequency range: 9kHz ~ 30MHz, 18GHz ~ 40GHz), is that proximity to ambient noise, which also are attenuated more than 20 dB below the permissible value. Therefore, the data is not presented in the report.

EUT	Cassia Bluetooth Router	Date of Test	2021-03-02
Factor	VULB 9162 (30MHz~8GHz) + 6dB Attenuator	Temp. / Humidity	21.3°C /55%
Polarity	Vertical	Site / Test Engineer	AC1 / Jay Chou
Test Mode	Transmit by 802.11a at channel 5320MHz	Test Voltage	120V/60Hz

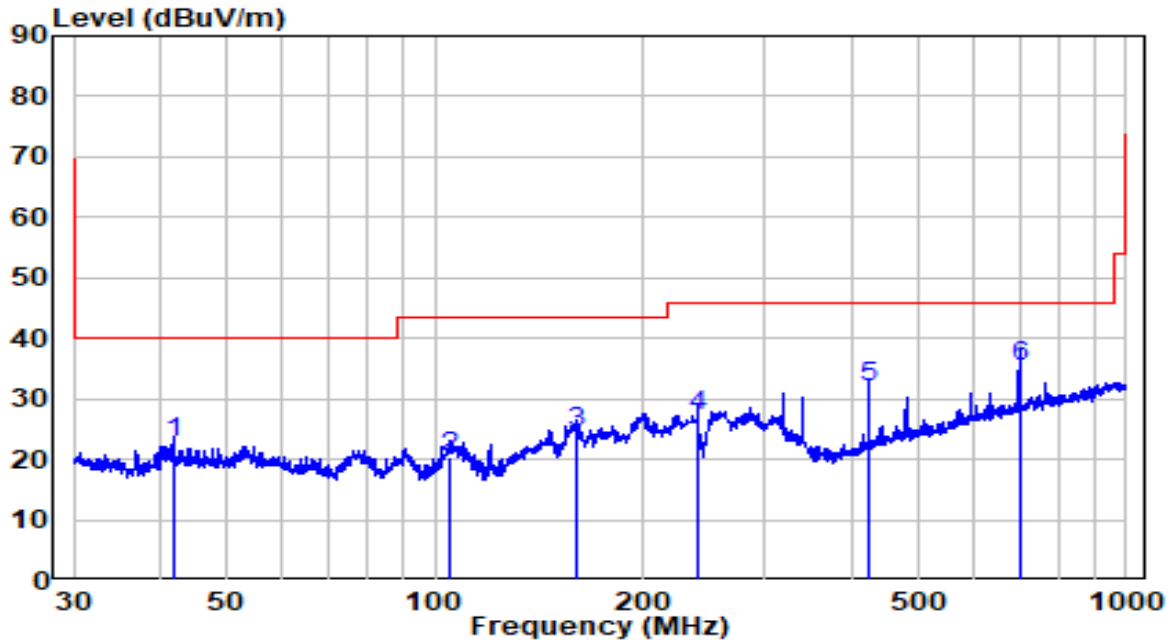

No	Frequency (MHz)	Reading (dBUV)	C.F (dB)	Measurement (dBUV/m)	Margin (dB)	Limit (dBUV/m)	Remark (QP/PK/AV)
1	41.786	1.33	21.33	22.66	-17.34	40.00	QP
2	105.087	1.50	18.94	20.44	-23.06	43.50	QP
3	160.065	8.20	16.32	24.52	-18.98	43.50	QP
4	239.987	6.97	20.20	27.17	-18.83	46.00	QP
5	425.028	7.32	24.48	31.80	-14.20	46.00	QP
6	* 700.532	6.12	29.33	35.45	-10.55	46.00	QP

Note:

1. " *", means this data is the worst emission level.
2. C.F (Correction Factor) = Antenna Factor (dB)+ Cable Loss (dB).
3. Measurement(dBUV/m) = Reading(dBUV) + C.F (Correction Factor).
4. The emission levels of other frequencies are very lower than the limit and not show in test report.
5. The amplitude of Radiated emissions (the test frequency range: 9kHz ~ 30MHz, 18GHz ~ 40GHz), is that proximity to ambient noise, which also are attenuated more than 20 dB below the permissible value. Therefore, the data is not presented in the report.

7.9. Radiated Restricted Band Edge Measurement

7.9.1. Test Limit

For 15.205 requirement:

Radiated emissions which fall in the restricted bands, as defined in Section 15.205(a) of FCC part 15, must also comply with the radiated emission limits specified in Section 15.209(a).

Frequency (MHz)	Frequency (MHz)	Frequency (MHz)	Frequency (GHz)
0.090 - 0.110	16.42-16.423	399.9 - 410	4.5-5.15
¹ 0.495 - 0.505	16.69475-16.69525	608 - 614	5.35-5.46
2.1735-2.1905	16.80425-16.80475	960 - 1240	7.25-7.75
4.125-4.128	25.5 -25.67	1300 - 1427	8.025 - 8.5
4.17725-4.17775	37.5-38.25	1435-1626.5	9.0-9.2
4.20725-4.20775	73-74.6	1645.5-1646.5	9.3-9.5
6.215-6.218	74.8-75.2	1660 - 1710	10.6-12.7
6.26775-6.26825	108-121.94	1718.8-1722.2	13.25-13.4
6.31175-6.31225	123 - 138	2200 - 2300	14.47-14.5
8.291-8.294	149.9-150.05	2310 - 2390	15.35-16.2
8.362-8.366	156.52475-156.525	2483.5 - 2500	17.7-21.4
8.37625-8.38675	156.7-156.9	2690 - 2900	22.01-23.12
8.41425-8.41475	162.0125-167.17	3260 - 3267	23.6-24.0
12.29-12.293	167.72-173.2	3332 - 3339	31.2-31.8
12.51975-12.52025	240 - 285	3345.8 - 3358	36.43-36.5
12.57675-12.57725	322-335.4	3600 - 4400	(²)
13.36-13.41	--	--	--

For 15.407(b) requirement:

For transmitters operating in the 5.15-5.25 GHz band: All emissions outside of the 5.15-5.35 GHz band shall not exceed an e.i.r.p. of -27 dBm/MHz.

For transmitters operating in the 5.25-5.35 GHz band: All emissions outside of the 5.15-5.35 GHz band shall not exceed an e.i.r.p. of -27 dBm/MHz.

For transmitters operating in the 5.47-5.725 GHz band: All emissions outside of the 5.47-5.725 GHz band shall not exceed an e.i.r.p. of -27 dBm/MHz.

For transmitters operating in the 5.725-5.85 GHz band: All emissions shall be limited to a level of -27 dBm/MHz at 75 MHz or more above or below the band edge increasing linearly to 10 dBm/MHz at 25 MHz above or below the band edge, and from 25 MHz above or below the band edge

increasing linearly to a level of 15.6 dBm/MHz at 5 MHz above or below the band edge, and from 5 MHz above or below the band edge increasing linearly to a level of 27 dBm/MHz at the band edge.

Refer to KDB 789033 D02v02r01 G)2)c), as specified in § 15.407(b), emissions above 1000 MHz that are outside of the restricted bands are subject to a maximum emission limit of -27 dBm/MHz (or -17 dBm/MHz as specified in § 15.407(b)(4)). However, an out-of-band emission that complies with both the peak and average limits of § 15.209 is not required to satisfy the -27 dBm/MHz or -17 dBm/MHz maximum emission limit.

All out of band emissions appearing in a restricted band as specified in Section 15.205 of the Title 47CFR must not exceed the limits shown in Table per Section 15.209.

FCC Part 15 Subpart C Paragraph 15.209		
Frequency [MHz]	Field Strength [uV/m]	Measured Distance [Meters]
0.009 - 0.490	2400/F (kHz)	300
0.490 - 1.705	24000/F (kHz)	30
1.705 - 30	30	30
30 - 88	100	3
88 - 216	150	3
216 - 960	200	3
Above 960	500	3

7.9.2. Test Procedure Used

KDB 789033 D02v02r01 – Section G

7.9.3. Test Setting

Peak Measurements above 1GHz

1. Analyzer center frequency was set to the frequency of the radiated spurious emission of interest
2. RBW = 1MHz
3. VBW = 3MHz
4. Detector = peak
5. Sweep time = auto couple
6. Trace mode = max hold
7. Trace was allowed to stabilize

Average Measurements above 1GHz (Method VB)

1. Analyzer center frequency was set to the frequency of the radiated spurious emission of interest
2. RBW = 1MHz
3. VBW If the EUT is configured to transmit with duty cycle $\geq 98\%$, set $VBW \leq RBW/100$ (i.e., 10 kHz) but not less than 10 Hz. If the EUT duty cycle is $< 98\%$, set $VBW \geq 1/T$.
4. Detector = Peak
5. Sweep time = auto
6. Allow max hold to run for at least 50 traces if the transmitted signal is continuous or has at least 98% duty cycle. For lower duty cycles, increase the minimum number of traces by a factor of $1/x$, where x is the duty cycle.

7.9.4. Test Setup

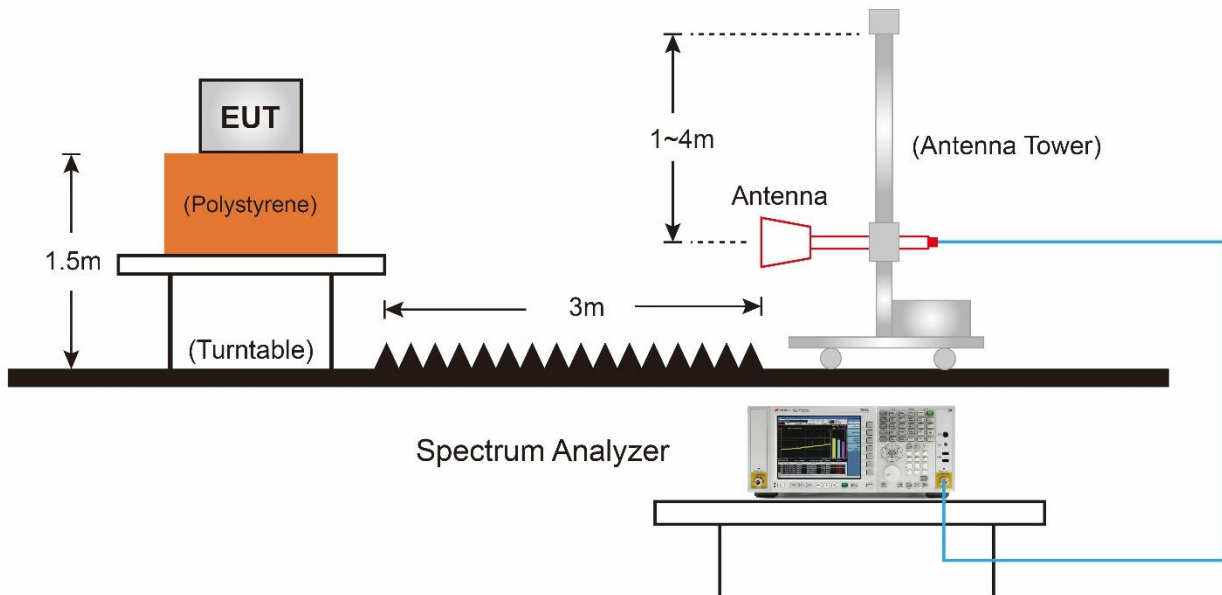

7.9.5. Test Result

EUT	Cassia Bluetooth Router	Date of Test	2021-03-01
Factor	BBHA 9120D	Temp. / Humidity	35.2°C/21.9%
Polarity	Horizontal	Site / Test Engineer	AC1 / Jay Chou
Test Mode	Transmit by 802.11a at Channel 5180MHz	Test Voltage	120V/60Hz

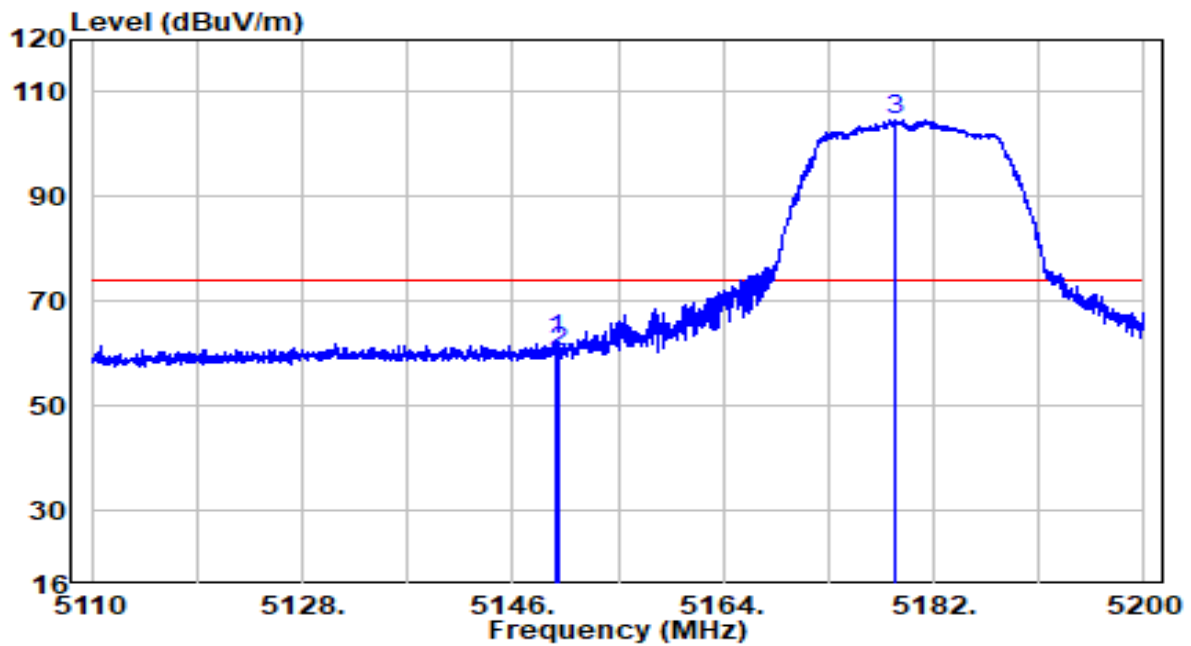

No	Frequency (MHz)	Reading (dBuV)	C.F (dB)	Measurement (dBuV/m)	Margin (dB)	Limit (dBuV/m)	Remark (QP/PK/AV)
1	5149.600	42.85	19.91	62.76	-11.24	74.00	Peak
2	5150.000	40.36	19.91	60.27	-13.73	74.00	Peak
3	* 5178.805	84.81	19.94	104.75	N/A	N/A	Peak

Note:

1. " *", means this data is the worst emission level.
2. C.F (Correction Factor) = Antenna Factor (dB)+ Cable Loss (dB)– Preamplifier(dB).
3. Measurement(dBuV/m) = Reading(dBuV) + C.F (Correction Factor).
4. The emission levels of other frequencies are very lower than the limit and not show in test report.

EUT	Cassia Bluetooth Router	Date of Test	2021-03-01
Factor	BBHA 9120D	Temp. / Humidity	35.2°C/21.9%
Polarity	Horizontal	Site / Test Engineer	AC1 / Jay Chou
Test Mode	Transmit by 802.11a at Channel 5180MHz	Test Voltage	120V/60Hz

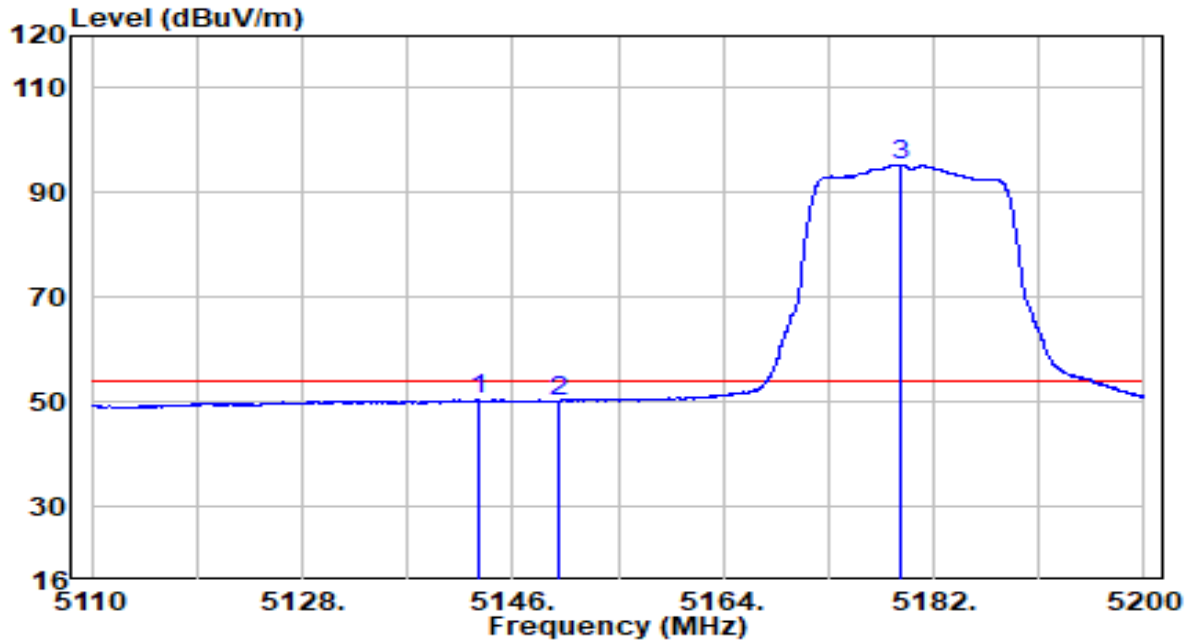

No	Frequency (MHz)	Reading (dBuV)	C.F (dB)	Measurement (dBuV/m)	Margin (dB)	Limit (dBuV/m)	Remark (QP/PK/AV)
1	5143.075	30.66	19.90	50.56	-3.44	54.00	Average
2	5150.000	30.35	19.91	50.25	-3.75	54.00	Average
3	* 5179.120	75.42	19.94	95.36	N/A	N/A	Average

Note:

1. " *", means this data is the worst emission level.
2. C.F (Correction Factor) = Antenna Factor (dB)+ Cable Loss (dB)– Preamplifier(dB).
3. Measurement(dBuV/m) = Reading(dBuV) + C.F (Correction Factor).
- 4.The emission levels of other frequencies are very lower than the limit and not show in test report.

EUT	Cassia Bluetooth Router	Date of Test	2021-03-01
Factor	BBHA 9120D	Temp. / Humidity	35.2°C/21.9%
Polarity	Vertical	Site / Test Engineer	AC1 / Jay Chou
Test Mode	Transmit by 802.11a at Channel 5180MHz	Test Voltage	120V/60Hz

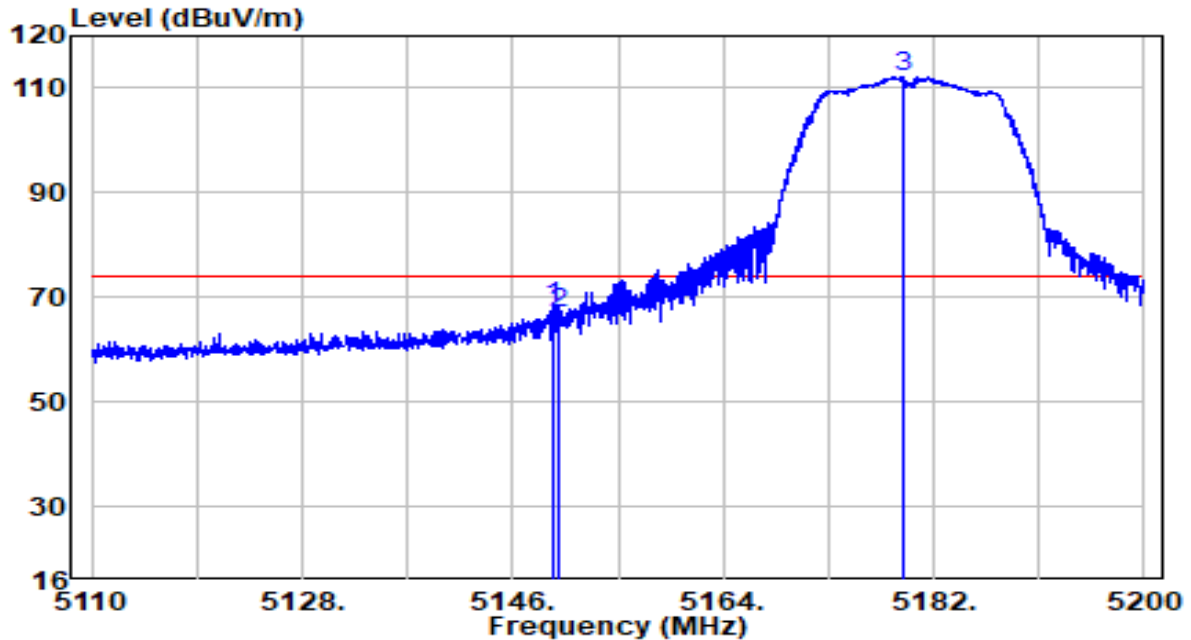

No	Frequency (MHz)	Reading (dBuV)	C.F (dB)	Measurement (dBuV/m)	Margin (dB)	Limit (dBuV/m)	Remark (QP/PK/AV)
1	5149.420	48.44	19.91	68.35	-5.65	74.00	Peak
2	5150.000	47.24	19.91	67.15	-6.85	74.00	Peak
3	* 5179.345	92.19	19.94	112.13	N/A	N/A	Peak

Note:

1. " *", means this data is the worst emission level.
2. C.F (Correction Factor) = Antenna Factor (dB)+ Cable Loss (dB)– Preamplifier(dB).
3. Measurement(dBuV/m) = Reading(dBuV) + C.F (Correction Factor).
- 4.The emission levels of other frequencies are very lower than the limit and not show in test report.

EUT	Cassia Bluetooth Router	Date of Test	2021-03-01
Factor	BBHA 9120D	Temp. / Humidity	35.2°C/21.9%
Polarity	Vertical	Site / Test Engineer	AC1 / Jay Chou
Test Mode	Transmit by 802.11a at Channel 5180MHz	Test Voltage	120V/60Hz

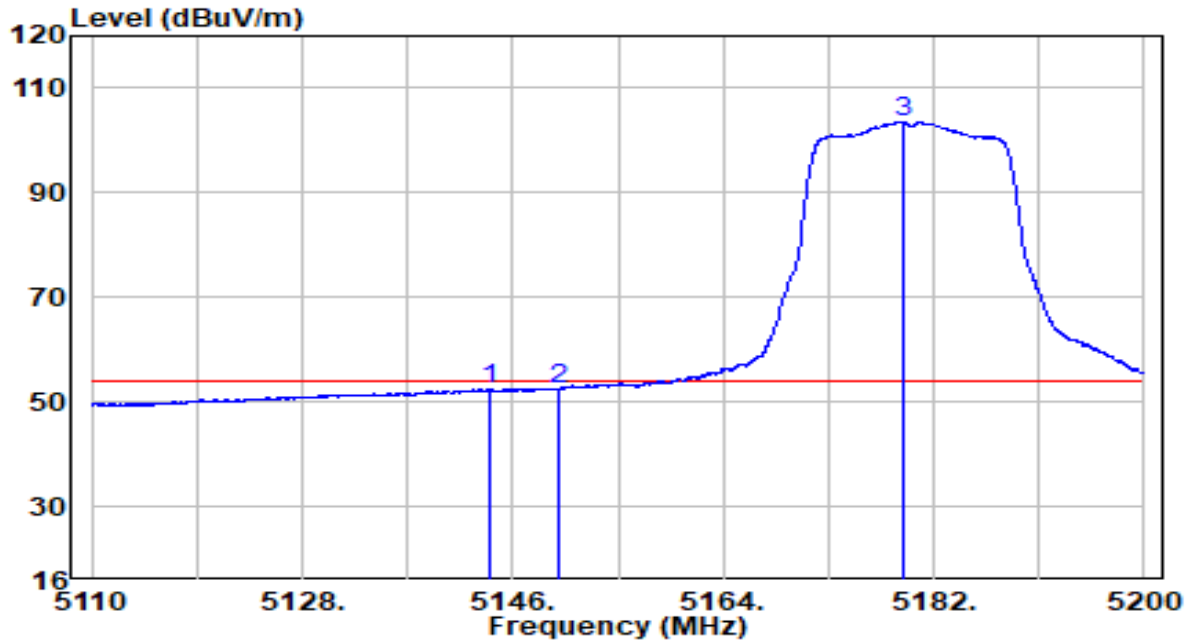

No	Frequency (MHz)	Reading (dBuV)	C.F (dB)	Measurement (dBuV/m)	Margin (dB)	Limit (dBuV/m)	Remark (QP/PK/AV)
1	5143.975	32.69	19.90	52.59	-1.41	54.00	Average
2	5150.000	32.59	19.91	52.50	-1.50	54.00	Average
3	* 5179.435	83.73	19.94	103.67	N/A	N/A	Average

Note:

1. " *", means this data is the worst emission level.
2. C.F (Correction Factor) = Antenna Factor (dB)+ Cable Loss (dB)– Preamplifier(dB).
3. Measurement(dBuV/m) = Reading(dBuV) + C.F (Correction Factor).
- 4.The emission levels of other frequencies are very lower than the limit and not show in test report.

EUT	Cassia Bluetooth Router	Date of Test	2021-03-01
Factor	BBHA 9120D	Temp. / Humidity	35.2°C/21.9%
Polarity	Horizontal	Site / Test Engineer	AC1 / Jay Chou
Test Mode	Transmit by 802.11a at Channel 5240MHz	Test Voltage	120V/60Hz

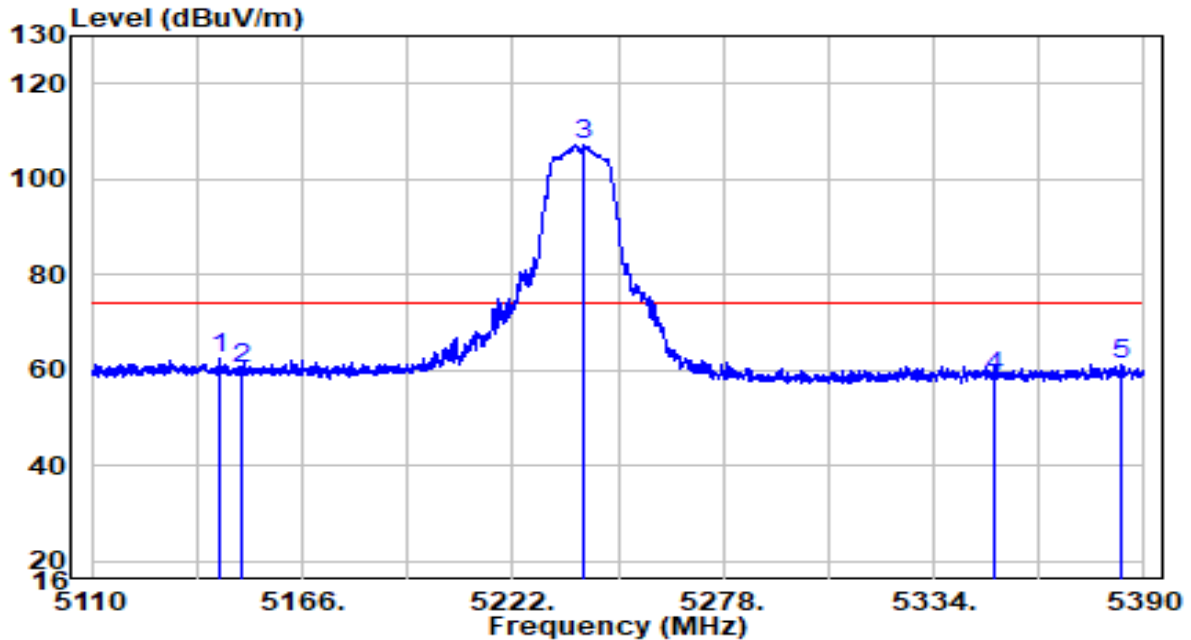

No	Frequency (MHz)	Reading (dBuV)	C.F (dB)	Measurement (dBuV/m)	Margin (dB)	Limit (dBuV/m)	Remark (QP/PK/AV)
1	5143.880	42.61	19.90	62.51	-11.49	74.00	Peak
2	5150.000	40.55	19.91	60.46	-13.54	74.00	Peak
3	* 5241.040	87.22	20.00	107.22	N/A	N/A	Peak
4	5350.000	38.28	20.11	58.40	-15.60	74.00	Peak
5	5383.980	40.98	20.15	61.13	-12.87	74.00	Peak

Note:

1. " *", means this data is the worst emission level.
2. C.F (Correction Factor) = Antenna Factor (dB)+ Cable Loss (dB)– Preamplifier(dB).
3. Measurement(dBuV/m) = Reading(dBuV) + C.F (Correction Factor).
- 4.The emission levels of other frequencies are very lower than the limit and not show in test report.

EUT	Cassia Bluetooth Router	Date of Test	2021-03-01
Factor	BBHA 9120D	Temp. / Humidity	35.2°C/21.9%
Polarity	Horizontal	Site / Test Engineer	AC1 / Jay Chou
Test Mode	Transmit by 802.11a at Channel 5240MHz	Test Voltage	120V/60Hz

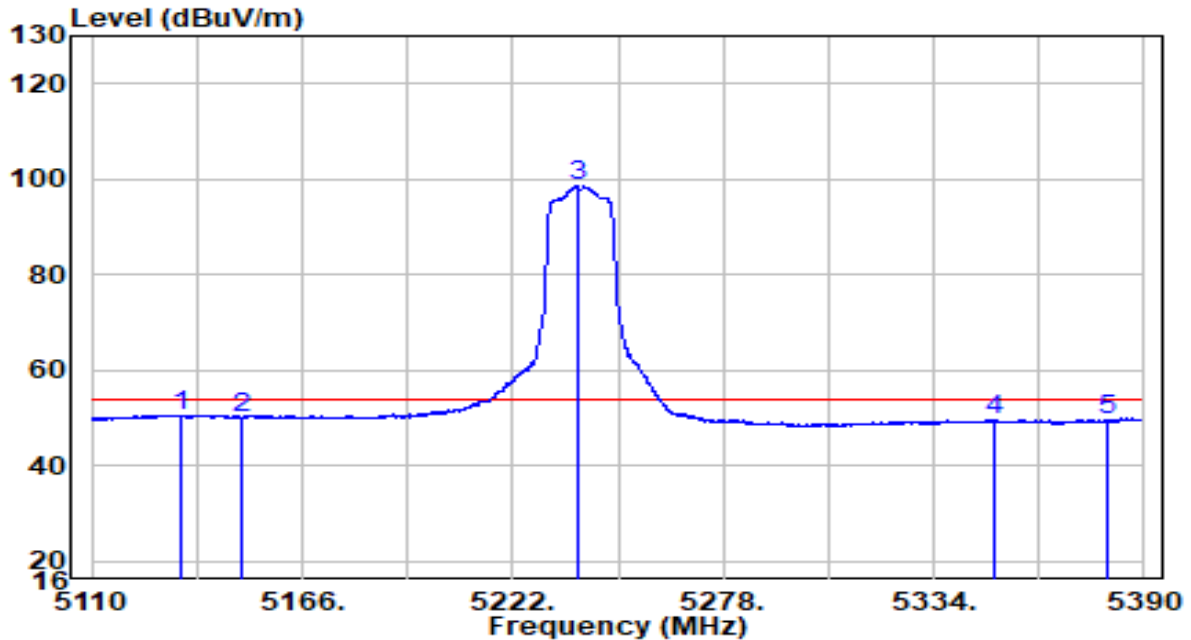

No	Frequency (MHz)	Reading (dBuV)	C.F (dB)	Measurement (dBuV/m)	Margin (dB)	Limit (dBuV/m)	Remark (QP/PK/AV)
1	5133.940	30.72	19.89	50.61	-3.39	54.00	Average
2	5150.000	30.14	19.91	50.05	-3.95	54.00	Average
3	* 5239.220	78.59	20.00	98.59	N/A	N/A	Average
4	5350.000	29.25	20.11	49.37	-4.63	54.00	Average
5	5380.060	29.41	20.15	49.56	-4.44	54.00	Average

Note:

- "*", means this data is the worst emission level.
- C.F (Correction Factor) = Antenna Factor (dB)+ Cable Loss (dB)– Preamplifier(dB).
- Measurement(dBuV/m) = Reading(dBuV) + C.F (Correction Factor).
- The emission levels of other frequencies are very lower than the limit and not show in test report.

EUT	Cassia Bluetooth Router	Date of Test	2021-03-01
Factor	BBHA 9120D	Temp. / Humidity	35.2°C/21.9%
Polarity	Vertical	Site / Test Engineer	AC1 / Jay Chou
Test Mode	Transmit by 802.11a at Channel 5240MHz	Test Voltage	120V/60Hz

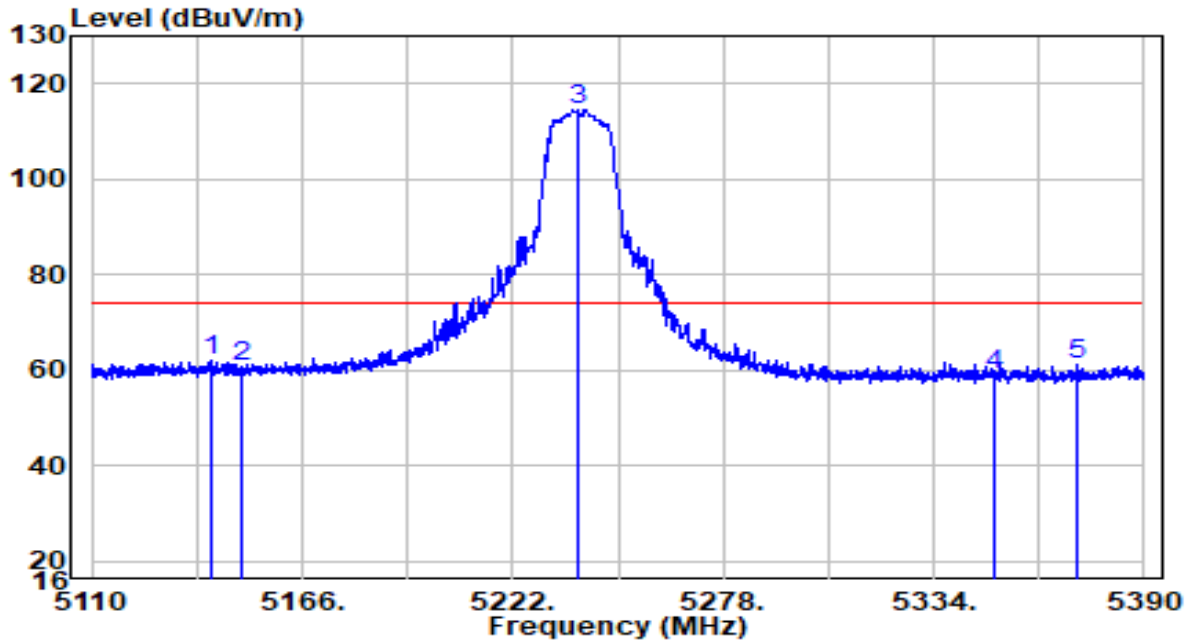

No	Frequency (MHz)	Reading (dBUV)	C.F (dB)	Measurement (dBUV/m)	Margin (dB)	Limit (dBUV/m)	Remark (QP/PK/AV)
1	5141.500	41.94	19.90	61.83	-12.17	74.00	Peak
2	5150.000	40.90	19.91	60.80	-13.20	74.00	Peak
3	* 5239.360	94.47	20.00	114.47	N/A	N/A	Peak
4	5350.000	38.93	20.11	59.04	-14.96	74.00	Peak
5	5372.220	41.13	20.14	61.27	-12.73	74.00	Peak

Note:

- "*", means this data is the worst emission level.
- C.F (Correction Factor) = Antenna Factor (dB)+ Cable Loss (dB)– Preamplifier(dB).
- Measurement(dBUV/m) = Reading(dBUV) + C.F (Correction Factor).
- The emission levels of other frequencies are very lower than the limit and not show in test report.

EUT	Cassia Bluetooth Router	Date of Test	2021-03-01
Factor	BBHA 9120D	Temp. / Humidity	35.2°C/21.9%
Polarity	Vertical	Site / Test Engineer	AC1 / Jay Chou
Test Mode	Transmit by 802.11a at Channel 5240MHz	Test Voltage	120V/60Hz

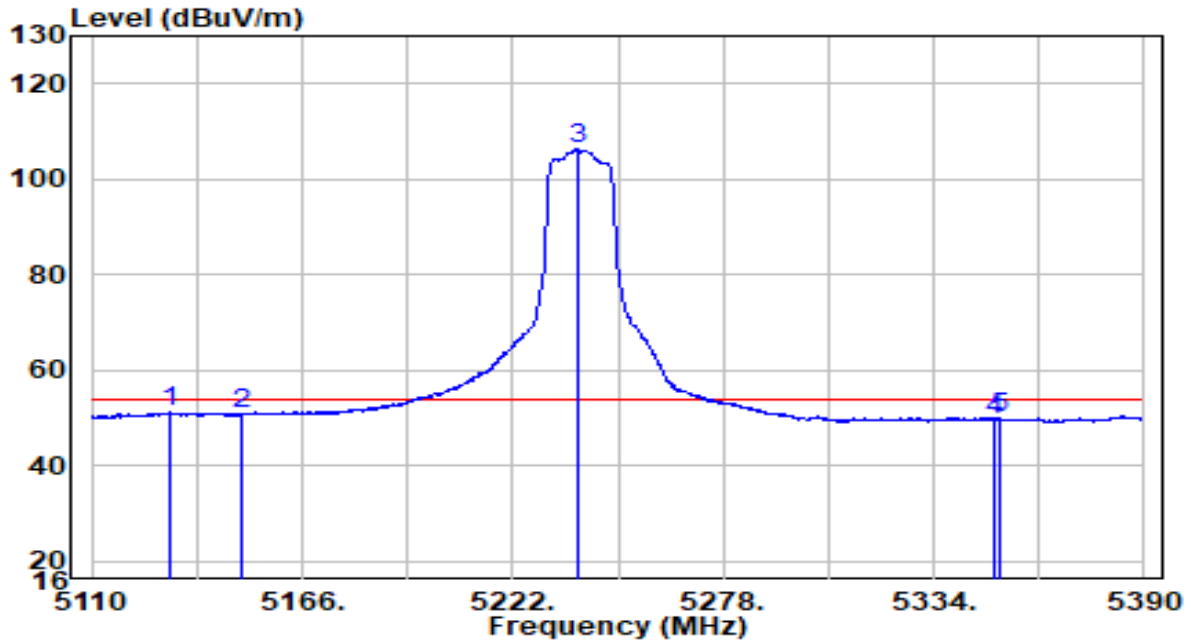

No	Frequency (MHz)	Reading (dBuV)	C.F (dB)	Measurement (dBuV/m)	Margin (dB)	Limit (dBuV/m)	Remark (QP/PK/AV)
1	5131.000	31.31	19.89	51.20	-2.80	54.00	Average
2	5150.000	30.75	19.91	50.66	-3.34	54.00	Average
3	* 5239.220	86.39	20.00	106.39	N/A	N/A	Average
4	5350.000	29.60	20.11	49.71	-4.29	54.00	Average
5	5351.360	30.01	20.12	50.13	-3.87	54.00	Average

Note:

- "*", means this data is the worst emission level.
- C.F (Correction Factor) = Antenna Factor (dB)+ Cable Loss (dB)– Preamplifier(dB).
- Measurement(dBuV/m) = Reading(dBuV) + C.F (Correction Factor).
- The emission levels of other frequencies are very lower than the limit and not show in test report.

EUT	Cassia Bluetooth Router	Date of Test	2021-03-01
Factor	BBHA 9120D	Temp. / Humidity	35.2°C/21.9%
Polarity	Horizontal	Site / Test Engineer	AC1 / Jay Chou
Test Mode	Transmit by 802.11a at Channel 5320MHz	Test Voltage	120V/60Hz

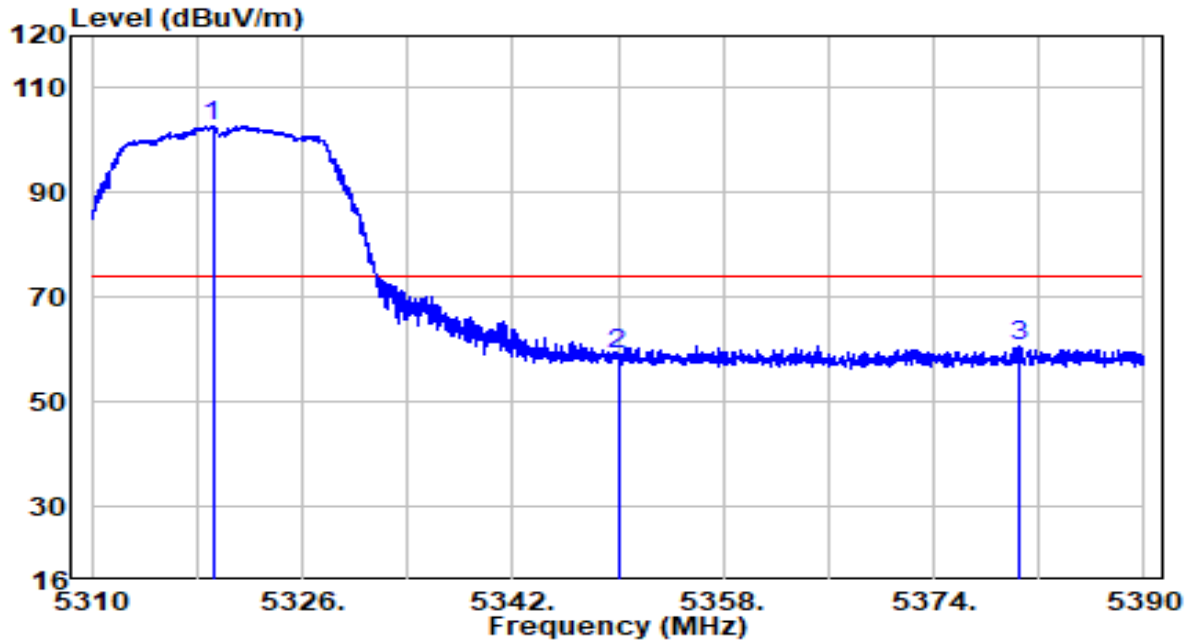

No	Frequency (MHz)	Reading (dBuV)	C.F (dB)	Measurement (dBuV/m)	Margin (dB)	Limit (dBuV/m)	Remark (QP/PK/AV)
1	* 5319.200	82.79	20.08	102.87	N/A	N/A	Peak
2	5350.000	39.16	20.11	59.27	-14.73	74.00	Peak
3	5380.480	40.72	20.15	60.87	-13.13	74.00	Peak

Note:

1. " *", means this data is the worst emission level.
2. C.F (Correction Factor) = Antenna Factor (dB)+ Cable Loss (dB)– Preamplifier(dB).
3. Measurement(dBuV/m) = Reading(dBuV) + C.F (Correction Factor).
- 4.The emission levels of other frequencies are very lower than the limit and not show in test report.

EUT	Cassia Bluetooth Router	Date of Test	2021-03-01
Factor	BBHA 9120D	Temp. / Humidity	35.2°C/21.9%
Polarity	Horizontal	Site / Test Engineer	AC1 / Jay Chou
Test Mode	Transmit by 802.11a at Channel 5320MHz	Test Voltage	120V/60Hz

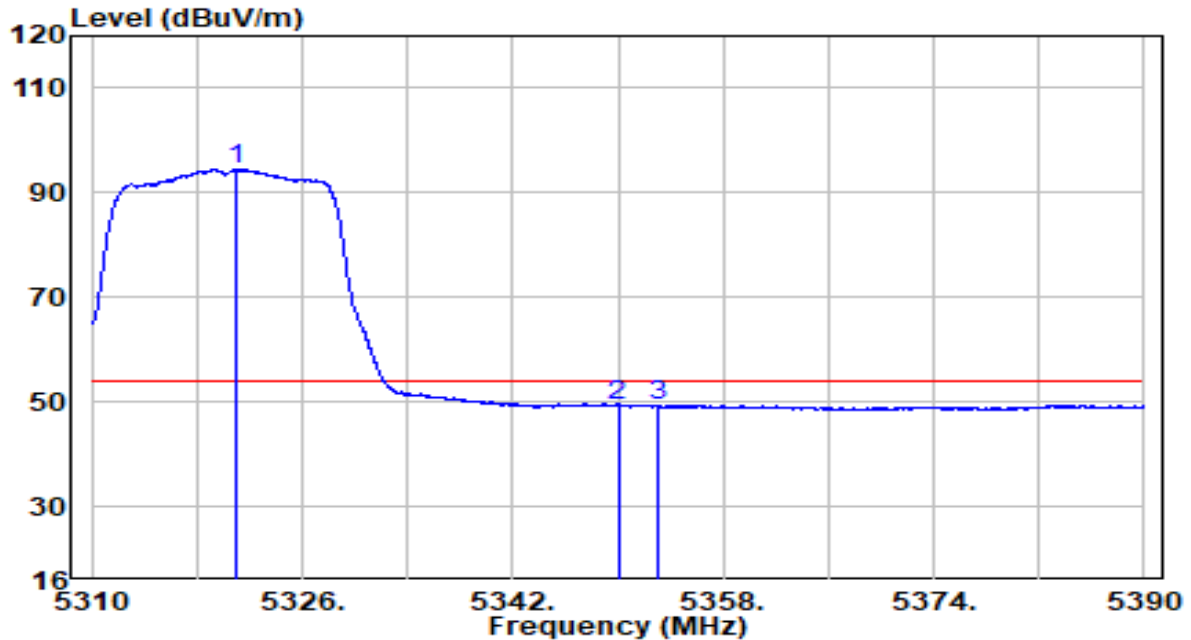

No	Frequency (MHz)	Reading (dBuV)	C.F (dB)	Measurement (dBuV/m)	Margin (dB)	Limit (dBuV/m)	Remark (QP/PK/AV)
1	* 5321.040	74.48	20.08	94.57	N/A	N/A	Average
2	5350.000	29.32	20.11	49.43	-4.57	54.00	Average
3	5353.000	29.35	20.12	49.47	-4.53	54.00	Average

Note:

1. " *", means this data is the worst emission level.
2. C.F (Correction Factor) = Antenna Factor (dB)+ Cable Loss (dB)– Preamplifier(dB).
3. Measurement(dBuV/m) = Reading(dBuV) + C.F (Correction Factor).
- 4.The emission levels of other frequencies are very lower than the limit and not show in test report.

EUT	Cassia Bluetooth Router	Date of Test	2021-03-01
Factor	BBHA 9120D	Temp. / Humidity	35.2°C/21.9%
Polarity	Vertical	Site / Test Engineer	AC1 / Jay Chou
Test Mode	Transmit by 802.11a at Channel 5320MHz	Test Voltage	120V/60Hz

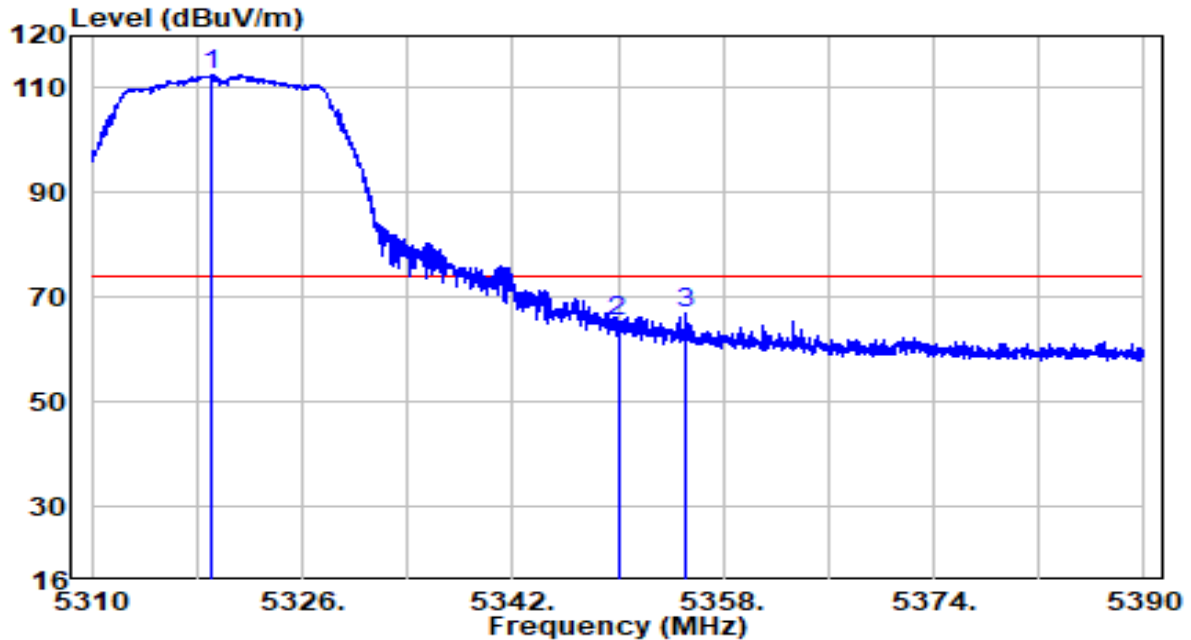

No	Frequency (MHz)	Reading (dBUV)	C.F (dB)	Measurement (dBUV/m)	Margin (dB)	Limit (dBUV/m)	Remark (QP/PK/AV)
1	* 5319.080	92.45	20.08	112.53	N/A	N/A	Peak
2	5350.000	45.46	20.11	65.57	-8.43	74.00	Peak
3	5355.160	46.82	20.12	66.94	-7.06	74.00	Peak

Note:

1. " *", means this data is the worst emission level.
2. C.F (Correction Factor) = Antenna Factor (dB)+ Cable Loss (dB)– Preamplifier(dB).
3. Measurement(dBUV/m) = Reading(dBUV) + C.F (Correction Factor).
- 4.The emission levels of other frequencies are very lower than the limit and not show in test report.

EUT	Cassia Bluetooth Router	Date of Test	2021-03-01
Factor	BBHA 9120D	Temp. / Humidity	35.2°C/21.9%
Polarity	Vertical	Site / Test Engineer	AC1 / Jay Chou
Test Mode	Transmit by 802.11a at Channel 5320MHz	Test Voltage	120V/60Hz

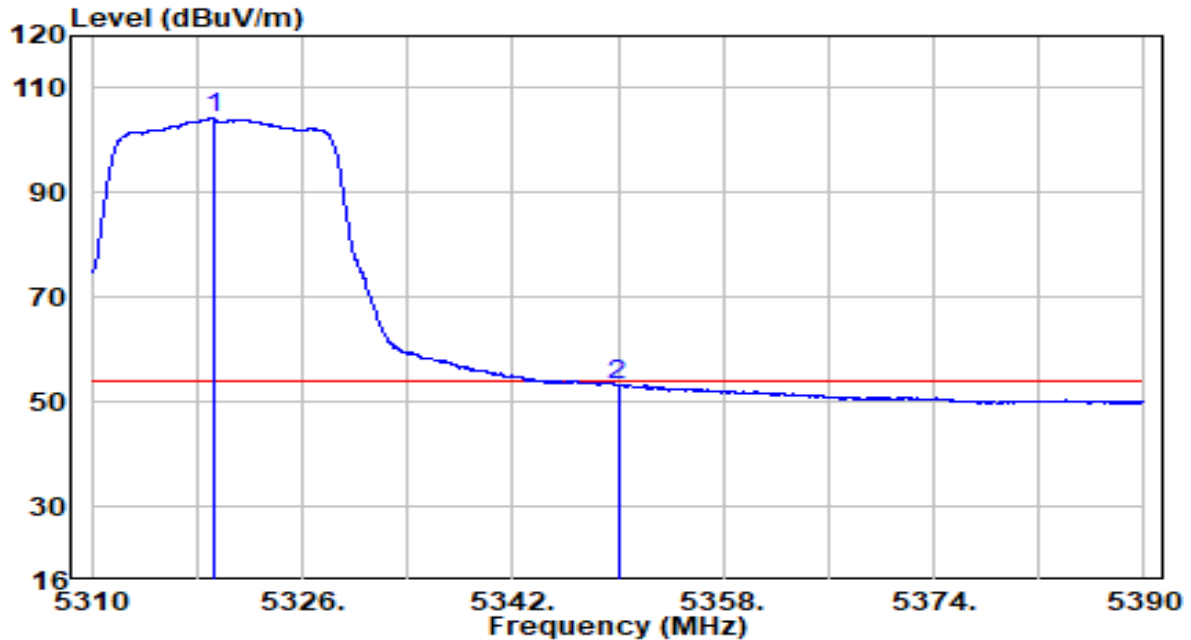

No	Frequency (MHz)	Reading (dBuV)	C.F (dB)	Measurement (dBuV/m)	Margin (dB)	Limit (dBuV/m)	Remark (QP/PK/AV)
1	* 5319.280	84.21	20.08	104.29	N/A	N/A	Average
2	5350.000	33.28	20.11	53.39	-0.61	54.00	Average

Note:

1. " *", means this data is the worst emission level.
2. C.F (Correction Factor) = Antenna Factor (dB)+ Cable Loss (dB)– Preamplifier(dB).
3. Measurement(dBuV/m) = Reading(dBuV) + C.F (Correction Factor).
- 4.The emission levels of other frequencies are very lower than the limit and not show in test report.

EUT	Cassia Bluetooth Router	Date of Test	2021-03-01
Factor	BBHA 9120D	Temp. / Humidity	35.2°C/21.9%
Polarity	Horizontal	Site / Test Engineer	AC1 / Jay Chou
Test Mode	Transmit by 802.11a at Channel 5500MHz	Test Voltage	120V/60Hz

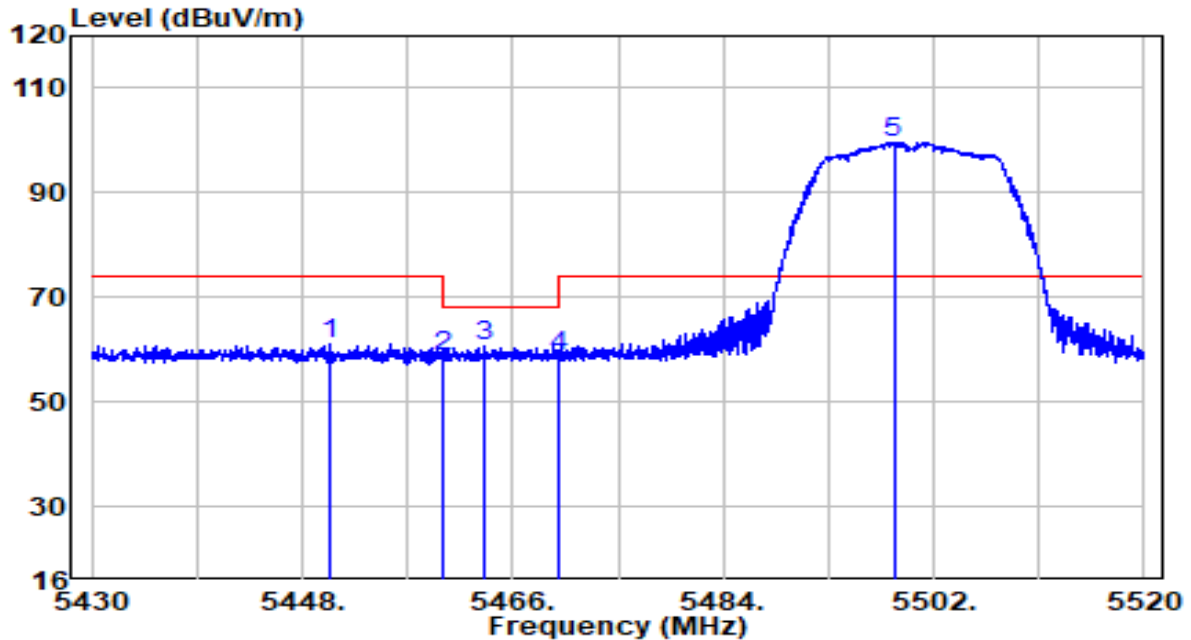

No	Frequency (MHz)	Reading (dBUV)	C.F (dB)	Measurement (dBUV/m)	Margin (dB)	Limit (dBUV/m)	Remark (QP/PK/AV)
1	5450.385	40.98	20.22	61.20	-12.80	74.00	Peak
2	5460.000	38.56	20.23	58.79	-9.41	68.20	Peak
3	5463.660	40.69	20.23	60.92	-7.28	68.20	Peak
4	5470.000	38.47	20.24	58.71	-9.49	68.20	Peak
5	* 5498.580	79.45	20.27	99.72	N/A	N/A	Peak

Note:

1. " *", means this data is the worst emission level.
2. C.F (Correction Factor) = Antenna Factor (dB)+ Cable Loss (dB)– Preamplifier(dB).
3. Measurement(dBUV/m) = Reading(dBUV) + C.F (Correction Factor).
- 4.The emission levels of other frequencies are very lower than the limit and not show in test report.

EUT	Cassia Bluetooth Router	Date of Test	2021-03-01
Factor	BBHA 9120D	Temp. / Humidity	35.2°C/21.9%
Polarity	Horizontal	Site / Test Engineer	AC1 / Jay Chou
Test Mode	Transmit by 802.11a at Channel 5500MHz	Test Voltage	120V/60Hz

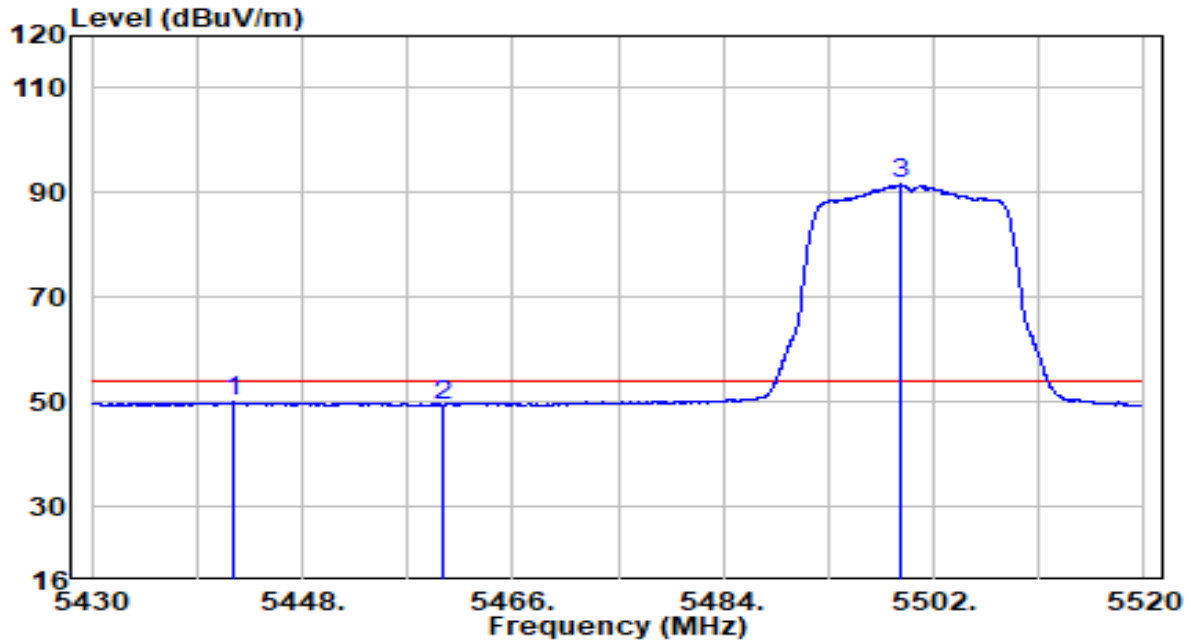

No	Frequency (MHz)	Reading (dBuV)	C.F (dB)	Measurement (dBuV/m)	Margin (dB)	Limit (dBuV/m)	Remark (QP/PK/AV)
1	5442.060	29.77	20.21	49.98	-4.02	54.00	Average
2	5460.000	29.24	20.23	49.47	-4.53	54.00	Average
3	* 5499.210	71.31	20.27	91.58	N/A	N/A	Average

Note:

1. " *", means this data is the worst emission level.
2. C.F (Correction Factor) = Antenna Factor (dB)+ Cable Loss (dB)– Preamplifier(dB).
3. Measurement(dBuV/m) = Reading(dBuV) + C.F (Correction Factor).
- 4.The emission levels of other frequencies are very lower than the limit and not show in test report.