

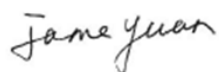

MEASUREMENT REPORT

FCC PART 15.247 / RSS-247 BLE

FCC ID: 2ALGLX1000
IC: 22505-X1000
APPLICANT: Cassia Networks Inc.
Application Type: Certification
Product: Cassia Bluetooth Router
Model No.: X1000, X1000-10, X1000-20
Brand Name: CASSIA
FCC Classification: Digital Transmission System (DTS)
FCC Rule Part(s): Part 15.247
IC Rule(s): RSS-247 Issue 2, RSS-GEN Issue 4
Test Procedure(s): ANSI C63.10-2013, KDB 558074 D01v04,
KDB 662911 D01v02r01
Test Date: May 15 ~ June 14, 2017

Reviewed By : 
(Jame Yuan)

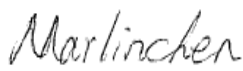
Approved By : 
(Marlin Chen)



The test results relate only to the samples tested.

This equipment has been shown to be capable of compliance with the applicable technical standards as indicated in the measurement report and was tested in accordance with the measurement procedures specified in KDB 558074 D01v04. Test results reported herein relate only to the item(s) tested.

The test report shall not be reproduced except in full without the written approval of MRT Technology (Suzhou) Co., Ltd.

Revision History

Report No.	Version	Description	Issue Date	Note
1705RSU01202	Rev. 01	Draft report	06-15-2017	Invalid
1705RSU01202	Rev. 02	Initial report	06-17-2017	Valid

CONTENTS

Description	Page
1. INTRODUCTION	6
1.1. Scope	6
1.2. MRT Test Location	6
2. PRODUCT INFORMATION	7
2.1. Feature of Equipment under Test	7
2.2. Product Specification Subjective to this Report.....	7
2.3. Description of Available Antennas	7
2.4. Operation Frequency / Channel List	8
2.5. Description of Antenna RF Port	9
2.6. Device Capabilities	9
2.7. Test Configuration	9
2.8. EMI Suppression Device(s)/Modifications.....	9
2.9. Labeling Requirements.....	10
2.10. Test Software	10
3. DESCRIPTION OF TEST	11
3.1. Evaluation Procedure	11
3.2. AC Line Conducted Emissions	11
3.3. Radiated Emissions	12
4. ANTENNA REQUIREMENTS	13
5. TEST EQUIPMENT CALIBRATION DATE	14
6. MEASUREMENT UNCERTAINTY	16
7. TEST RESULT	17
7.1. Summary	17
7.2. 6dB Bandwidth Measurement.....	18
7.2.1. Test Limit	18
7.2.2. Test Procedure used.....	18
7.2.3. Test Setting.....	18
7.2.4. Test Setup.....	18
7.2.5. Test Result.....	19
7.3. Output Power Measurement.....	21
7.3.1. Test Limit	21
7.3.2. Test Procedure Used	21
7.3.3. Test Setting.....	21

7.3.4.	Test Setup.....	21
7.3.5.	Test Result of Output Power	22
7.4.	Power Spectral Density Measurement	23
7.4.1.	Test Limit	23
7.4.2.	Test Procedure Used	23
7.4.3.	Test Setting.....	23
7.4.4.	Test Setup.....	23
7.4.5.	Test Result.....	24
7.5.	Conducted Band Edge and Out-of-Band Emissions.....	30
7.5.1.	Test Limit	30
7.5.2.	Test Procedure Used	30
7.5.3.	Test Setting.....	30
7.5.4.	Test Setup.....	31
7.5.5.	Test Result.....	32
7.6.	Radiated Spurious Emission Measurement	36
7.6.1.	Test Limit	36
7.6.2.	Test Procedure Used	36
7.6.3.	Test Setting.....	36
7.6.4.	Test Setup.....	38
7.6.5.	Test Result.....	40
7.7.	Radiated Restricted Band Edge Measurement	48
7.7.1.	Test Result.....	48
7.8.	AC Conducted Emissions Measurement.....	64
7.8.1.	Test Limit	64
7.8.2.	Test Setup.....	64
7.8.3.	Test Result.....	65
8.	CONCLUSION.....	67

§2.1033 General Information

Applicant:	Cassia Networks Inc.
Applicant Address:	1840 Majestic Way, San Jose, CA 95132
Manufacturer:	Cassia Networks Inc.
Manufacturer Address:	1840 Majestic Way, San Jose, CA 95132
Test Site:	MRT Technology (Suzhou) Co., Ltd
Test Site Address:	D8 Building, No.2 Tian'edang Rd., Wuzhong Economic Development Zone, Suzhou, China
FCC MRT Registration No.:	809388
IC MRT Registration No.:	11384A-1
Model No.:	X1000
FCC ID:	2ALGLX1000
IC:	22505- X1000
Test Device Serial No.:	N/A <input type="checkbox"/> Production <input checked="" type="checkbox"/> Pre-Production <input type="checkbox"/> Engineering
FCC Classification:	Digital Transmission System (DTS)

Test Facility / Accreditations

Measurements were performed at MRT Laboratory located in Tian'edang Rd., Suzhou, China.

- MRT facility is a FCC registered (MRT Reg. No. 809388) test facility with the site description report on file and has met all the requirements specified in Section 2.948 of the FCC Rules.
- MRT facility is an IC registered (MRT Reg. No. 11384A-1) test laboratory with the site description on file at Industry Canada.
- MRT facility is a VCCI registered (R-4179, G-814, C-4664, T-2206) test laboratory with the site description on file at VCCI Council.
- MRT Lab is accredited to ISO 17025 by the American Association for Laboratory Accreditation (A2LA) under the American Association for Laboratory Accreditation Program (A2LA Cert. No. 3628.01) in EMC, Telecommunications and Radio testing for FCC, Industry Canada, EU and TELEC Rules.



1. INTRODUCTION

1.1. Scope

Measurement and determination of electromagnetic emissions (EMC) of radio frequency devices including intentional and/or unintentional radiators for compliance with the technical rules and regulations of the Federal Communications Commission and the Industry Canada Certification and Engineering Bureau.

1.2. MRT Test Location

The map below shows the location of the MRT LABORATORY, its proximity to the Taihu Lake. These measurement tests were conducted at the MRT Technology (Suzhou) Co., Ltd. Facility located at D8 Building, Youxin Industrial Park, No.2 Tian'edang Rd., Wuzhong Economic Development Zone, Suzhou, China. The detailed description of the measurement facility was found to be in compliance with the requirements of § 2.948 according to ANSI C63.4-2009 on September 30, 2013.



2. PRODUCT INFORMATION

2.1. Feature of Equipment under Test

Product Name	Cassia Bluetooth Router
Model No.	X1000, X1000-10, X1000-20
Wi-Fi Specification	802.11b/g/n-HT20
Bluetooth Version	v4.0

Note: The EUT was powered by POE adapter (M/N: PoE35-54A) that provided by MRT lab.

2.2. Product Specification Subjective to this Report

Bluetooth Frequency	2402~2480MHz
Bluetooth Version	v4.0
Type of modulation	GFSK
Data Rate	1Mbps
Antenna Type	Directional Antenna
Antenna Gain	7.5dBi

Note: For other features of this EUT, test report will be issued separately.

2.3. Description of Available Antennas

Antenna Type	Frequency Band (MHz)	Manufacturer	Max Peak Gain (dBi)
Panel Antenna	2400 - 2483.5	AIRGAIN Inc.	2.44
Directional Antenna	2400 - 2483.5	SUNPARL Inc.	7.50 for per antenna

Note: For Bluetooth 3T_x, the directional gain = 7.50dBi.

2.4. Operation Frequency / Channel List

Channel List for BLE

Channel	Frequency	Channel	Frequency	Channel	Frequency
00	2402 MHz	01	2404 MHz	02	2406 MHz
03	2408 MHz	04	2410 MHz	05	2412 MHz
06	2414 MHz	07	2416 MHz	08	2418 MHz
09	2420 MHz	10	2422 MHz	11	2424 MHz
12	2426 MHz	13	2428 MHz	14	2430 MHz
15	2432 MHz	16	2434 MHz	17	2436 MHz
18	2438 MHz	19	2440 MHz	20	2442 MHz
21	2444 MHz	22	2446 MHz	23	2448 MHz
24	2450 MHz	25	2452 MHz	26	2454 MHz
27	2456 MHz	28	2458 MHz	29	2460 MHz
30	2462 MHz	31	2464 MHz	32	2466 MHz
33	2468 MHz	34	2470 MHz	35	2472 MHz
36	2474 MHz	37	2476 MHz	38	2478 MHz
39	2480 MHz	--	--	--	--

2.5. Description of Antenna RF Port

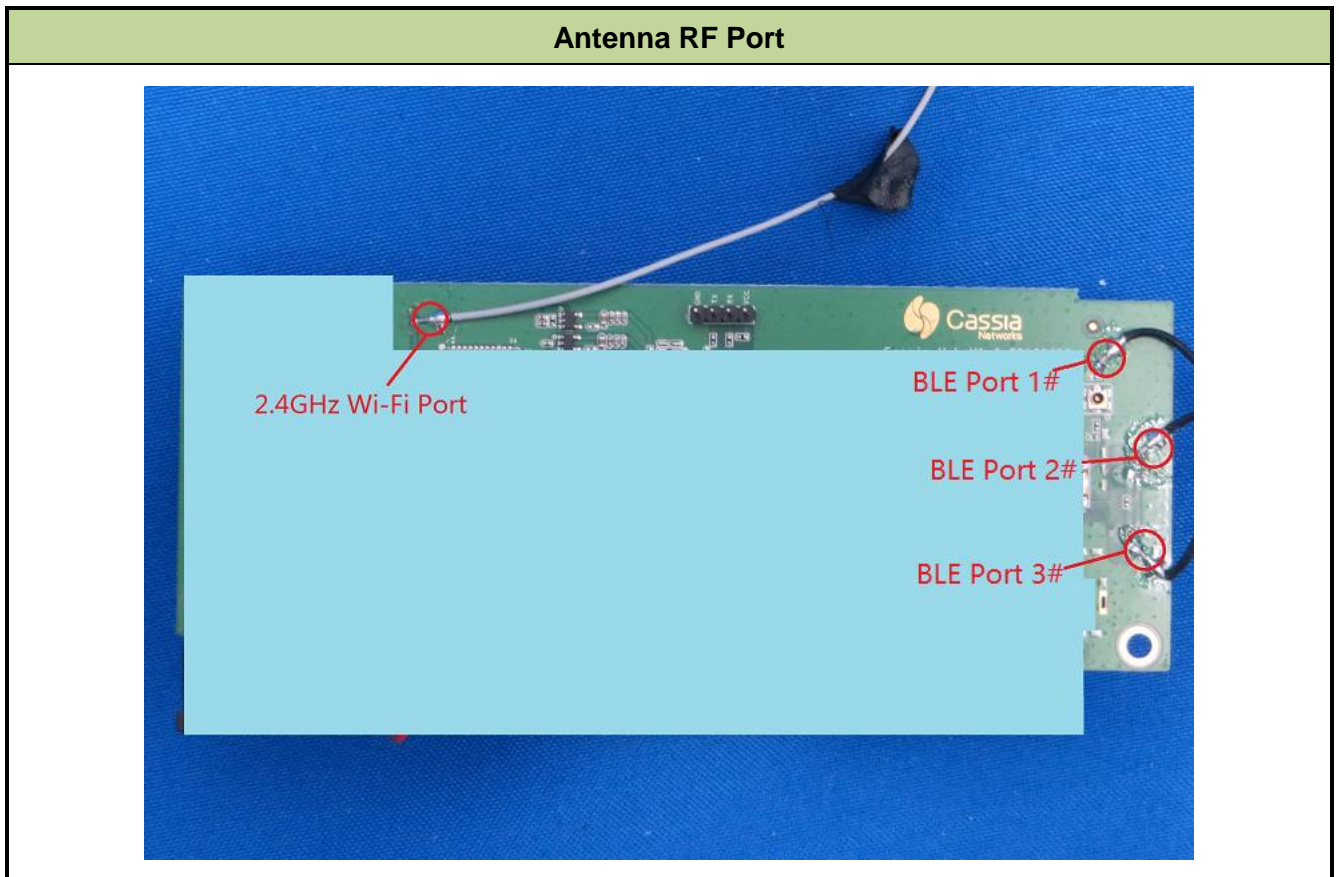

Note: The EUT has two Bluetooth modules (Module A & Module B) and they didn't transmit the same channel.

2.6. Device Capabilities

This device contains the following capabilities:

2.4GHz WLAN (DTS), Bluetooth (v4.0)

2.7. Test Configuration

The **Cassia Bluetooth Router** was tested per the guidance of KDB 558074 D01v04. ANSI C63.10-2013 was used to reference the appropriate EUT setup for radiated spurious emissions testing and AC line conducted testing.

2.8. EMI Suppression Device(s)/Modifications

No EMI suppression device(s) were added and/or no modifications were made during testing.

2.9. Labeling Requirements

Per 2.1074 & 15.19; Docket 95-19

The label shall be permanently affixed at a conspicuous location on the device; instruction manual or pamphlet supplied to the user and be readily visible to the purchaser at the time of purchase.

However, when the device is so small wherein placement of the label with specified statement is not practical, only the FCC ID must be displayed on the device per Section 15.19(a)(5). Please see attachment for FCC ID label and label location.

RSP-100 Issue 11 Section 3

The manufacturer, importer or distributor shall meet the labelling requirements set out in this section for every unit:

- (i) prior to marketing in Canada, for products manufactured in Canada
- (ii) prior to importation into Canada, for imported products

For information regarding the e-labelling option, see Notice 2014–DRS1003. The label for the certified product represents the manufacturer's or importer's compliance with Innovation, Science and Economic Development Canada's (ISED) regulatory requirements.

Please see attachment for IC label and label location.

2.10. Test Software

The test utility software used during testing was engineering directive order by Applicant.

3. DESCRIPTION OF TEST

3.1. Evaluation Procedure

The measurement procedures described in the American National Standard for Testing Unlicensed Wireless Devices (ANSI C63.10-2013), and the guidance provided in KDB 558074 D01v04 were used in the measurement of the **Cassia Bluetooth Router**.

Deviation from measurement procedure.....None

3.2. AC Line Conducted Emissions

The line-conducted facility is located inside an 8'x4'x4' shielded enclosure. A 1m x 2m wooden table 80cm high is placed 40cm away from the vertical wall and 80cm away from the sidewall of the shielded room. Two 10kHz-30MHz, 50Ω/50uH Line-Impedance Stabilization Networks (LISNs) are bonded to the shielded room floor. Power to the LISNs is filtered by external high-current high-insertion loss power line filters. These filters attenuate ambient signal noise from entering the measurement lines. These filters are also bonded to the shielded enclosure.

The EUT is powered from one LISN and the support equipment is powered from the second LISN. All interconnecting cables more than 1 meter were shortened to a 1 meter length by non-inductive bundling (serpentine fashion) and draped over the back edge of the test table. All cables were at least 40cm above the horizontal reference ground-plane. Power cables for support equipment were routed down to the second LISN while ensuring that that cables were not draped over the second LISN.

Sufficient time for the EUT, support equipment, and test equipment was allowed in order for them to warm up to their normal operating condition. The RF output of the LISN was connected to the receiver and exploratory measurements were made to determine the frequencies producing the maximum emission from the EUT. The receiver was scanned from 150kHz to 30MHz. The detector function was set to peak mode for exploratory measurements while the bandwidth of the analyzer was set to 9kHz. The EUT, support equipment, and interconnecting cables were arranged and manipulated to maximize each emission. Each emission was also maximized by varying: power lines, the mode of operation or data exchange speed, or support equipment whichever determined the worst-case emission. Once the worst case emissions have been identified, the one EUT cable configuration/arrangement and mode of operation that produced these emissions were used for final measurements on the same test site. The analyzer is set to CISPR quasi-peak and average detectors with a 9kHz resolution bandwidth for final measurements.

An extension cord was used to connect to a single LISN which powered by EUT. The extension cord was calibrated with LISN, the impedance and insertion loss are compliance with the requirements as stated in ANSI C63.10-2013.

Line conducted emissions test results are shown in Section 7.8.

3.3. Radiated Emissions

The radiated test facilities consisted of an indoor 3 meter semi-anechoic chamber used for final measurements and exploratory measurements, when necessary. The measurement area is contained within the semi-anechoic chamber which is shielded from any ambient interference. For measurements above 1GHz absorbers are arranged on the floor between the turn table and the Antenna mast in such a way so as to maximize the reduction of reflections. For measurements below 1GHz, the absorbers are removed. A MF Model 210SS turntable is used for radiated measurement. It is a continuously rotatable, remote controlled, metallic turntable and 2 meters (6.56 ft.) in diameter. The turn table is flush with the raised floor of the chamber in order to maintain its function as a ground plane. An 80cm high PVC support structure is placed on top of the turntable. For all measurements, the spectrum was scanned through all EUT azimuths and from 1 to 4 meter receive Antenna height using a broadband Antenna from 30MHz up to the upper frequency shown in 15.33(b)(1) depending on the highest frequency generated or used in the device or on which the device operates or tunes. For frequencies above 1GHz, linearly polarized double ridge horn Antennas were used. For frequencies below 30MHz, a calibrated loop Antenna was used. When exploratory measurements were necessary, they were performed at 1 meter test distance inside the semi-anechoic chamber using broadband Antennas, broadband amplifiers, and spectrum analyzers to determine the frequencies and modes producing the maximum emissions. Sufficient time for the EUT, support equipment, and test equipment was allowed in order for them to warm up to their normal operating condition. The test set-up for frequencies below 1GHz was placed on top of the 0.8 meter high, 1 x 1.5 meter table; and test set-up for frequencies 1-40GHz was placed on top of the 1.5 meter high, 1 x 1.5 meter table. The EUT, support equipment, and interconnecting cables were arranged and manipulated to maximize each emission. Appropriate precaution was taken to ensure that all emissions from the EUT were maximized and investigated. The system configuration, clock speed, mode of operation or video resolution, if applicable, turntable azimuth, and receive Antenna height was noted for each frequency found.

Final measurements were made in the semi-anechoic chamber using calibrated, linearly polarized broadband and horn Antennas. The test setup was configured to the setup that produced the worst case emissions. The spectrum analyzer was set to investigate all frequencies required for testing to compare the highest radiated disturbances with respect to the specified limits. The turntable containing the EUT was rotated through 360 degrees and the height of the receive Antenna was varied 1 to 4 meters and stopped at the azimuth and height producing the maximum emission. Each emission was maximized by changing the orientation of the EUT through three orthogonal planes and changing the polarity of the receive Antenna, whichever produced the worst-case emissions. According to 3dB Beam-Width of horn Antenna, the horn Antenna should be always directed to the EUT when rising height.

4. ANTENNA REQUIREMENTS

Excerpt from §15.203 of the FCC Rules/Regulations:

“An intentional radiator antenna shall be designed to ensure that no antenna other than that furnished by the responsible party can be used with the device. The use of a permanently attached antenna or of an antenna that uses a unique coupling to the intentional radiator shall be considered sufficient to comply with the provisions of this section.”

- The antenna of the **Cassia Bluetooth Router** is **permanently attached**.
- There are no provisions for connection to an external antenna.

Conclusion:

The **Cassia Bluetooth Router** unit complies with the requirement of §15.203.

5. TEST EQUIPMENT CALIBRATION DATE

Conducted Emissions - SR2

Instrument	Manufacturer	Type No.	Asset No.	Cali. Interval	Cali. Due Date
EMI Test Receiver	R&S	ESR7	MRTSUE06001	1 year	2017/06/20
Two-Line V-Network	R&S	ENV216	MRTSUE06002	1 year	2017/06/20
Two-Line V-Network	R&S	ENV216	MRTSUE06003	1 year	2017/06/20
Temperature/Humidity Meter	YuhuaZe	HTC-2	MRTSUE06181	1 year	2017/12/20
Shielding Anechoic Chamber	Mikebang	Chamber-SR2	MRTSUE06214	1 year	2018/05/10

Radiated Emission - AC1

Instrument	Manufacturer	Type No.	Asset No.	Cali. Interval	Cali. Due Date
MXE EMI Receiver	Agilent	N9038A	MRTSUE06125	1 year	2017/08/03
Microwave System Amplifier	Agilent	83017A	MRTSUE06076	1 year	2018/03/28
Loop Antenna	Schwarzbeck	FMZB1519	MRTSUE06025	1 year	2017/11/21
Bilog Period Antenna	Schwarzbeck	VULB 9168	MRTSUE06172	1 year	2017/11/19
Horn Antenna	Schwarzbeck	BBHA9120D	MRTSUE06023	1 year	2017/10/22
Broadband Horn Antenna	Schwarzbeck	BBHA9170	MRTSUE06024	1 year	2018/01/04
Temperature/Humidity Meter	YuhuaZe	HTC-2	MRTSUE06183	1 year	2017/12/20
Anechoic Chamber	TDK	Chamber-AC1	MRTSUE06212	1 year	2018/05/10
RF Cable	HUBER+SUHNER	Cable 01	MRTSUE06055-1	1 year	2018/03/29
RF Cable	HUBER+SUHNER	Cable 02	MRTSUE06055-2	1 year	2018/03/29

Conducted Test Equipment - TR3

Instrument	Manufacturer	Type No.	Asset No.	Cali. Interval	Cali. Due Date
MXE EMI Receiver	Agilent	N9038A	MRTSUE06125	1 year	2017/08/03
Power Meter	Agilent	U2021XA	MRTSUE06030	1 year	2017/12/06
RF Cable	HUBER+SUHNER	Cable 03	MRTSUE06055-3	1 year	2018/03/29
Attenuator	Woken	WATT-218FS-15	MRTSUE06220	1 year	2018/03/29
DC Block	Woken	00900A1A2A101A	MRTSUE06221	1 year	2018/03/29
Temperature/Humidity Meter	Yuhuaze	HTC-2	MRTSUE06180	1 year	2017/12/22

Software	Version	Function
e3	V8.3.5	EMI Test Software

6. MEASUREMENT UNCERTAINTY

Where relevant, the following test uncertainty levels have been estimated for tests performed on the EUT as specified in CISPR 16-4-2. This uncertainty represents an expanded uncertainty expressed at approximately the 95% confidence level using a coverage factor of $k = 2$.

AC Conducted Emission Measurement - SR2
Measuring Uncertainty for a Level of Confidence of 95% ($U=2Uc(y)$): 150kHz~30MHz: 3.46dB
Radiated Emission Measurement - AC1
Measuring Uncertainty for a Level of Confidence of 95% ($U=2Uc(y)$): 9kHz ~ 1GHz: 4.18dB 1GHz ~ 25GHz: 4.76dB
Spurious Emissions, Conducted - TR3
Measuring Uncertainty for a Level of Confidence of 95% ($U=2Uc(y)$): 0.78dB
Output Power - TR3
Measuring Uncertainty for a Level of Confidence of 95% ($U=2Uc(y)$): 1.13dB
Power Spectrum Density - TR3
Measuring Uncertainty for a Level of Confidence of 95% ($U=2Uc(y)$): 1.15dB
Occupied Bandwidth - TR3
Measuring Uncertainty for a Level of Confidence of 95% ($U=2Uc(y)$): 0.28%

7. TEST RESULT

7.1. Summary

Company Name: Cassia Networks Inc.
FCC ID: 2ALGLX1000
IC: 22505-X1000
FCC Classification: Digital Transmission System (DTS)
Data Rate(s) Tested: 1Mbps(GFSK) (BLE)

FCC Part Section(s)	RSS Section(s)	Test Description	Test Limit	Test Condition	Test Result	Reference
15.247(a)(2)	RSS-247 [5.2]	6dB Bandwidth	$\geq 500\text{kHz}$	Conducted	Pass	Section 7.2
15.247(b)(3)	RSS-247 [5.4(d)]	Output Power	$\leq 1\text{Watt}$ & $\text{EIRP} \leq 4\text{Watt}$		Pass	Section 7.3
15.247(e)	RSS-247 [5.2]	Power Spectral Density	$\leq 8\text{dBm} / 3\text{kHz}$		Pass	Section 7.4
15.247(d)	RSS-247 [5.5]	Band Edge / Out-of-Band Emissions	$\geq 20\text{dBc(Peak)}$		Pass	Section 7.5
15.205 15.209	RSS-247 [5.5]	General Field Strength Limits (Restricted Bands and Radiated Emission Limits)	Emissions in restricted bands must meet the radiated limits detailed in 15.209	Radiated	Pass	Section 7.6&7.7
15.207	RSS-Gen [8.8]	AC Conducted Emissions 150kHz - 30MHz	$< \text{FCC } 15.207$ limits	Line Conducted	Pass	Section 7.8

Notes:

- 1) All modes of operation and data rates were investigated. For radiated emission test, every axis (X, Y, Z) was also verified. The test results shown in the following sections represent the worst case emissions.
- 2) The analyzer plots shown in this section were all taken with a correction table loaded into the analyzer. The correction table was used to account for the losses of the cables and attenuators used as part of the system to connect the EUT to the analyzer at all frequencies of interest.
- 3) For “6dB Bandwidth” & “Band Edge / Out-of-Band Emissions”, we show the worst case port data in the report.

7.2. 6dB Bandwidth Measurement

7.2.1. Test Limit

The minimum 6dB bandwidth shall be at least 500 kHz.

7.2.2. Test Procedure used

KDB 558074 D01v04 - Section 8.2 Option 2

7.2.3. Test Setting

1. The Spectrum's automatic bandwidth measurement capability was used to perform the 6dB bandwidth measurement. The "X" dB bandwidth parameter was set to $X = 6$. The bandwidth measurement was not influenced by any intermediate power nulls in the fundamental emission.
2. Set RBW = 100 kHz
3. VBW $\geq 3 \times$ RBW
4. Detector = Peak
5. Trace mode = max hold
6. Sweep = auto couple
7. Allow the trace was allowed to stabilize

7.2.4. Test Setup

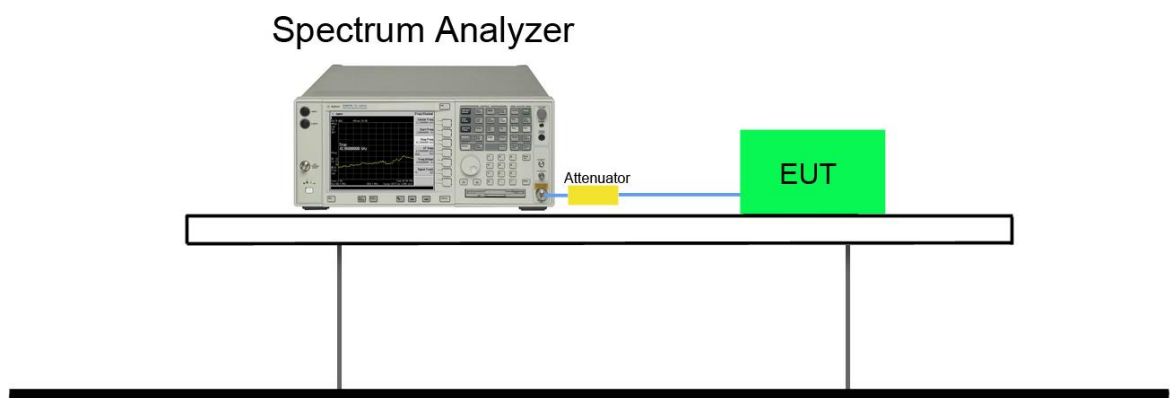

7.2.5. Test Result

For Module A

Test Mode	Data Rate (Mbps)	Channel No.	Frequency (MHz)	6dB Bandwidth (MHz)	Limit (MHz)	Result
BLE	1	00	2402	0.71	≥ 0.5	Pass
BLE	1	19	2440	0.71	≥ 0.5	Pass
BLE	1	39	2480	0.71	≥ 0.5	Pass

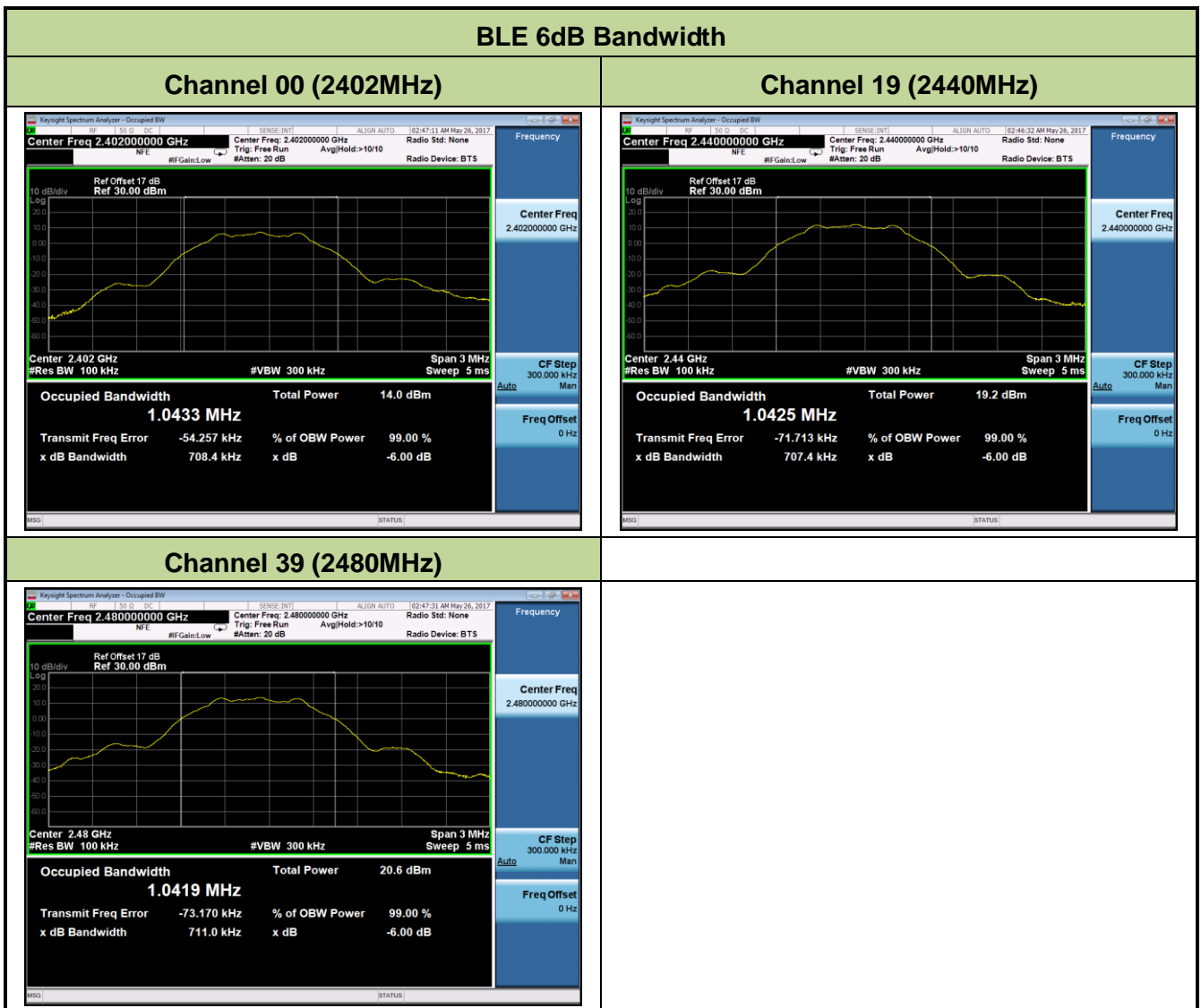

For Module B

Test Mode	Data Rate (Mbps)	Channel No.	Frequency (MHz)	6dB Bandwidth (MHz)	Limit (MHz)	Result
BLE	1	00	2402	0.70	≥ 0.5	Pass
BLE	1	19	2440	0.70	≥ 0.5	Pass
BLE	1	39	2480	0.70	≥ 0.5	Pass

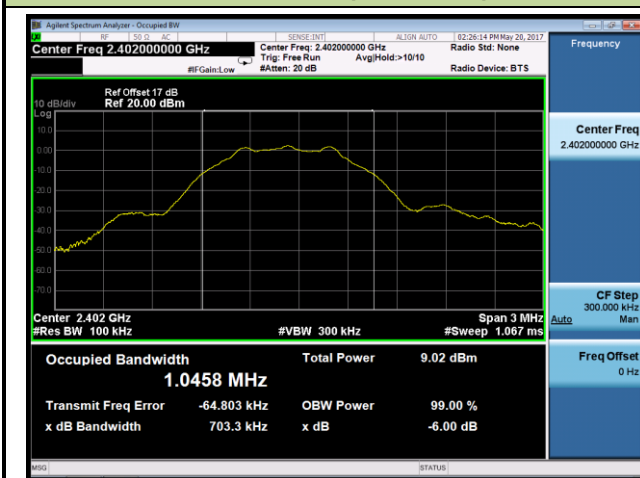
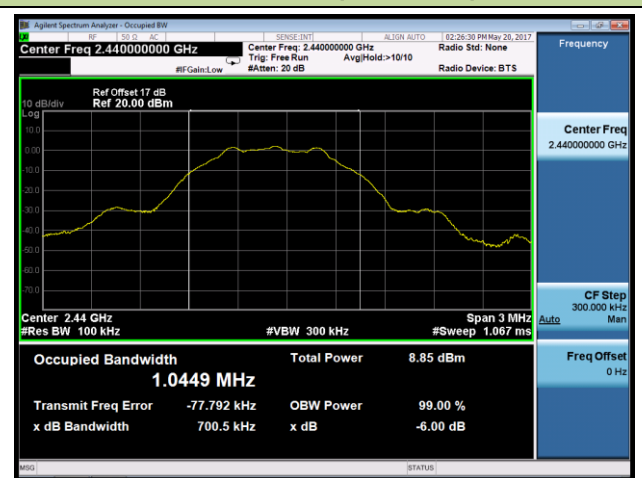
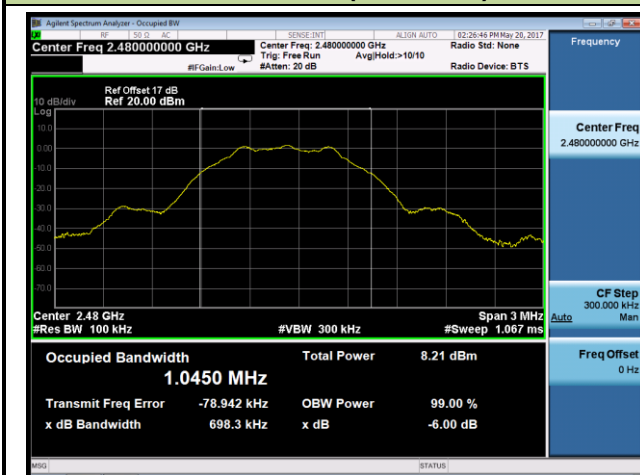
BLE 6dB Bandwidth
Channel 00 (2402MHz)

Channel 19 (2440MHz)

Channel 39 (2480MHz)

7.3. Output Power Measurement

7.3.1. Test Limit

The maximum conducted output power shall be exceed 1 Watt (30dBm) and the E.I.R.P shall not exceed 4 Watt (36dBm).

7.3.2. Test Procedure Used

KDB 558074 D01v04 - Section 9.1.2 PKPM1 - Peak Power Method

7.3.3. Test Setting

Method PKPM1 (Peak Power Measurement of Signals with DTS BW \leq 50MHz)

Peak power measurements were performed only when the EUT was transmitting at its maximum power control level using a broadband power meter with a pulse sensor. The pulse sensor employs a VBW = 50MHz so this method was only used for signals whose DTS bandwidth was less than or equal to 50MHz.

7.3.4. Test Setup

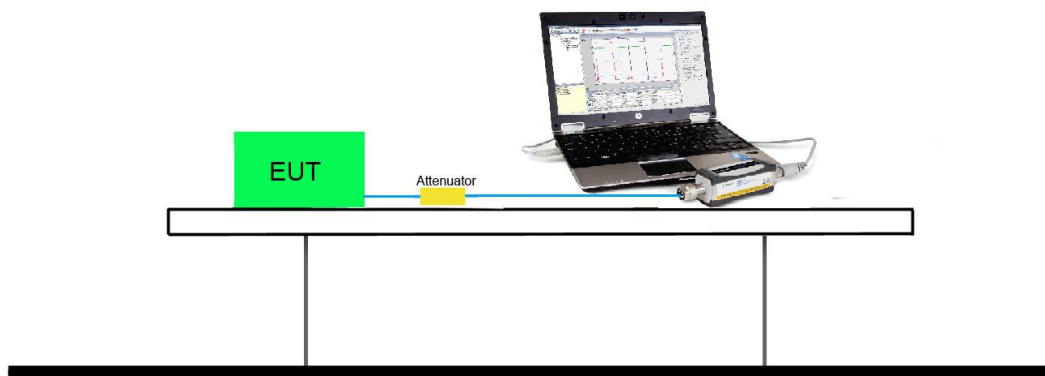

7.3.5. Test Result of Output Power

Test Result of Peak Output Power

Test Mode	Module	Data Rate (Mbps)	Channel No.	Frequency (MHz)	Peak Power (dBm)			Peak Power (dBm)	Limit (dBm)	Result
					Port 1	Port 2	Port 3			
BLE	A	1	00	2402	11.17	7.14	7.21	13.72	≤ 28.5	Pass
		1	19	2440	13.28	9.02	9.43	15.80	≤ 28.5	Pass
		1	39	2480	12.69	8.52	8.49	15.15	≤ 28.5	Pass
	B	1	00	2402	2.69	-1.57	-1.48	5.14	≤ 28.5	Pass
		1	19	2440	2.71	-1.63	-1.54	5.13	≤ 28.5	Pass
		1	39	2480	2.48	-1.61	-1.58	4.99	≤ 28.5	Pass

Note 1: Total Peak Power (dBm) = $10 \cdot \log\{10^{(\text{Port 1 Peak Power} / 10)} + 10^{(\text{Port 2 Peak Power} / 10)} + 10^{(\text{Port 3 Peak Power} / 10)}\}$.

Note 2: EIRP (dBm) = Conducted Power (dBm) + Antenna Gain (dBi), Antenna Gain = 7.5dBi.

Note 3: Max EIRP (dBm) = 15.80dBm + 7.5dBi = 23.30dBm < 36dBm.

Test Result of Average Output Power (Reporting Only)

Test Mode	Module	Data Rate (Mbps)	Channel No.	Frequency (MHz)	Average Power (dBm)			Average Power (dBm)	Limit (dBm)	Result
					Port 1	Port 2	Port 3			
BLE	A	1	00	2402	7.62	3.75	3.18	10.10	≤ 28.5	Pass
		1	19	2440	9.04	4.83	5.13	11.56	≤ 28.5	Pass
		1	39	2480	8.26	4.39	4.28	10.84	≤ 28.5	Pass
	B	1	00	2402	-1.87	-4.91	-4.83	1.15	≤ 28.5	Pass
		1	19	2440	-1.77	-4.86	-4.72	1.24	≤ 28.5	Pass
		1	39	2480	-1.92	-4.89	-4.93	1.10	≤ 28.5	Pass

Note 1: Total Average Power (dBm) = $10 \cdot \log\{10^{(\text{Port 1 Average Power} / 10)} + 10^{(\text{Port 2 Average Power} / 10)} + 10^{(\text{Port 3 Average Power} / 10)}\}$.

Note 2: EIRP (dBm) = Conducted Power (dBm) + Antenna Gain (dBi), Directional Antenna Gain = 7.5dBi.

Note 3: Max EIRP (dBm) = 11.56dBm + 7.5dBi = 19.06 dBm < 36 dBm.

7.4. Power Spectral Density Measurement

7.4.1. Test Limit

The maximum permissible power spectral density is 8dBm in any 3 kHz band.

7.4.2. Test Procedure Used

KDB 558074 D01v04 - Section 10.2 Method PKPSD

7.4.3. Test Setting

1. Analyzer was set to the center frequency of the DTS channel under investigation
2. Span = 1.5 times the DTS channel bandwidth
3. RBW = 3kHz
4. VBW = 10kHz
5. Detector = peak
6. Sweep time = auto couple
7. Trace mode = max hold
8. Trace was allowed to stabilize

7.4.4. Test Setup

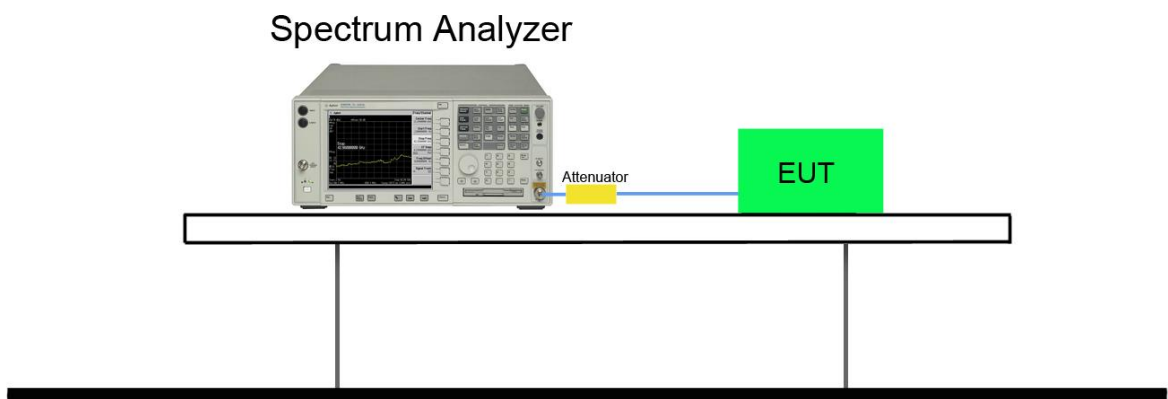

7.4.5. Test Result

For Module A

Test Mode	Data Rate (Mbps)	Channel No.	Frequency (MHz)	PSD Result (dBm / 3kHz)			Total PSD Result (dBm / 3kHz)	Limit (dBm)	Result
				Port 1	Port 2	Port 3			
BLE	1	00	2402	2.87	-1.25	-1.16	5.38	≤ 6.5	Pass
	1	19	2440	3.28	-0.15	-0.49	6.01	≤ 6.5	Pass
	1	39	2480	1.11	0.45	-0.62	5.14	≤ 6.5	Pass

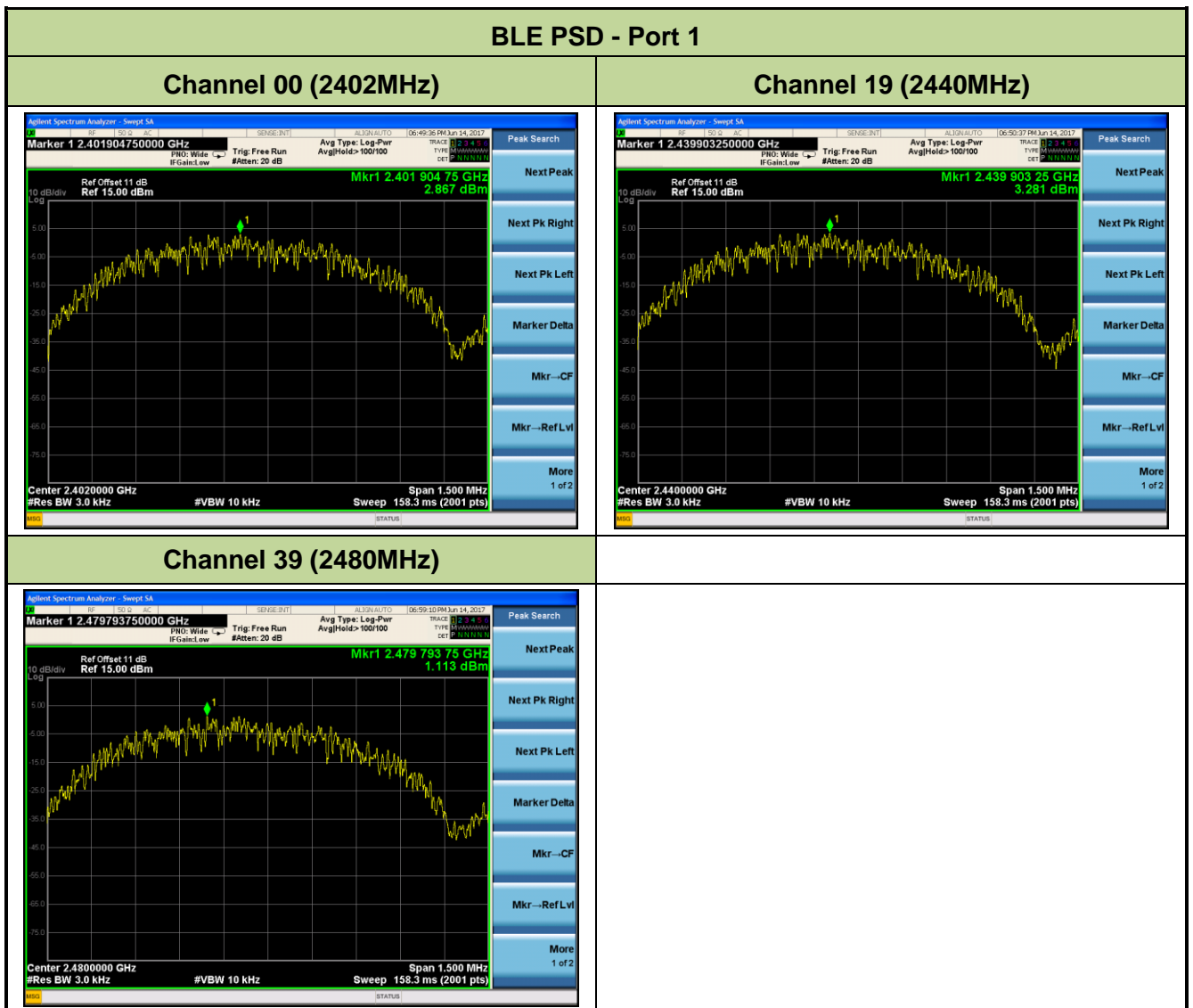

BLE PSD - Port 2

Channel 00 (2402MHz)

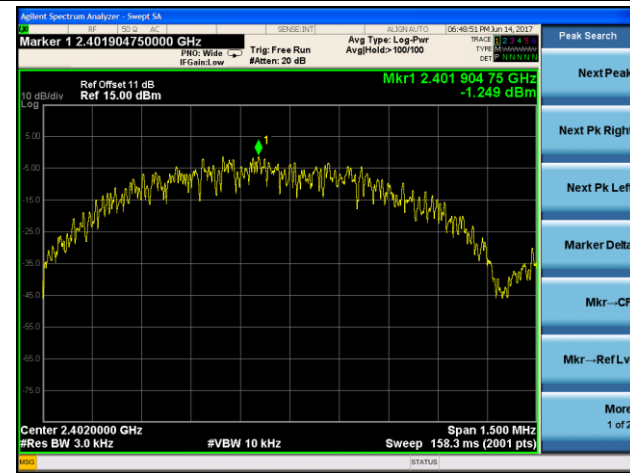

Channel 19 (2440MHz)

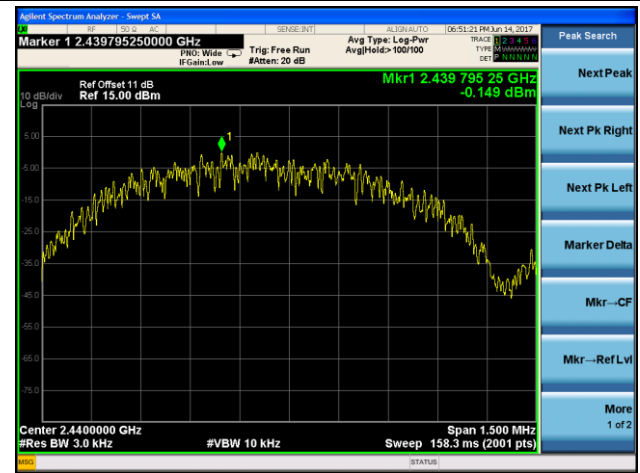

Channel 39 (2480MHz)

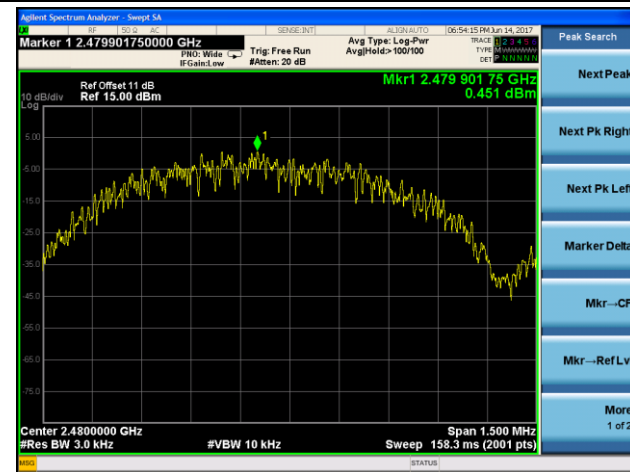

BLE PSD - Port 3

Channel 00 (2402MHz)



Channel 19 (2440MHz)

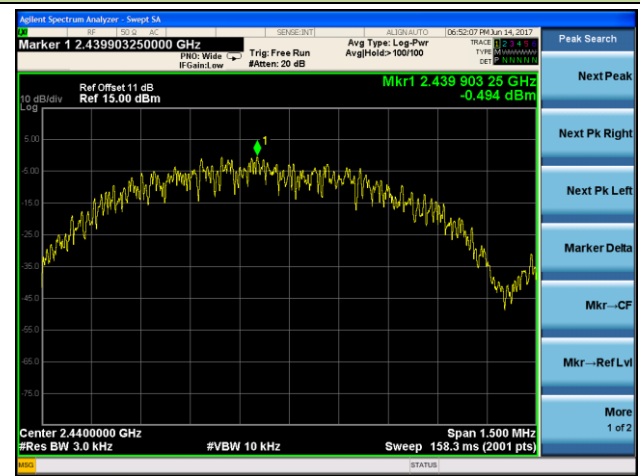

Channel 39 (2480MHz)

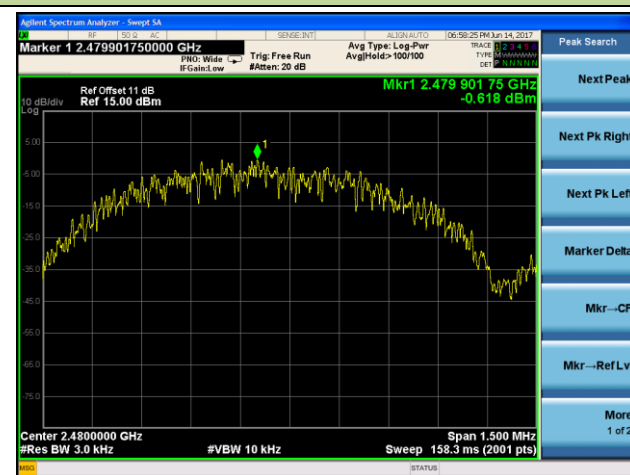

For Module B

Test Mode	Data Rate (Mbps)	Channel No.	Frequency (MHz)	PSD Result (dBm / 3kHz)			Total PSD Result (dBm / 3kHz)	Limit (dBm)	Result
				Port 1	Port 2	Port 3			
BLE	1	00	2402	-14.26	-18.45	-20.28	-12.14	≤ 6.5	Pass
	1	19	2440	-12.86	-16.21	-16.77	-10.14	≤ 6.5	Pass
	1	39	2480	-12.07	-14.68	-14.91	-8.91	≤ 6.5	Pass

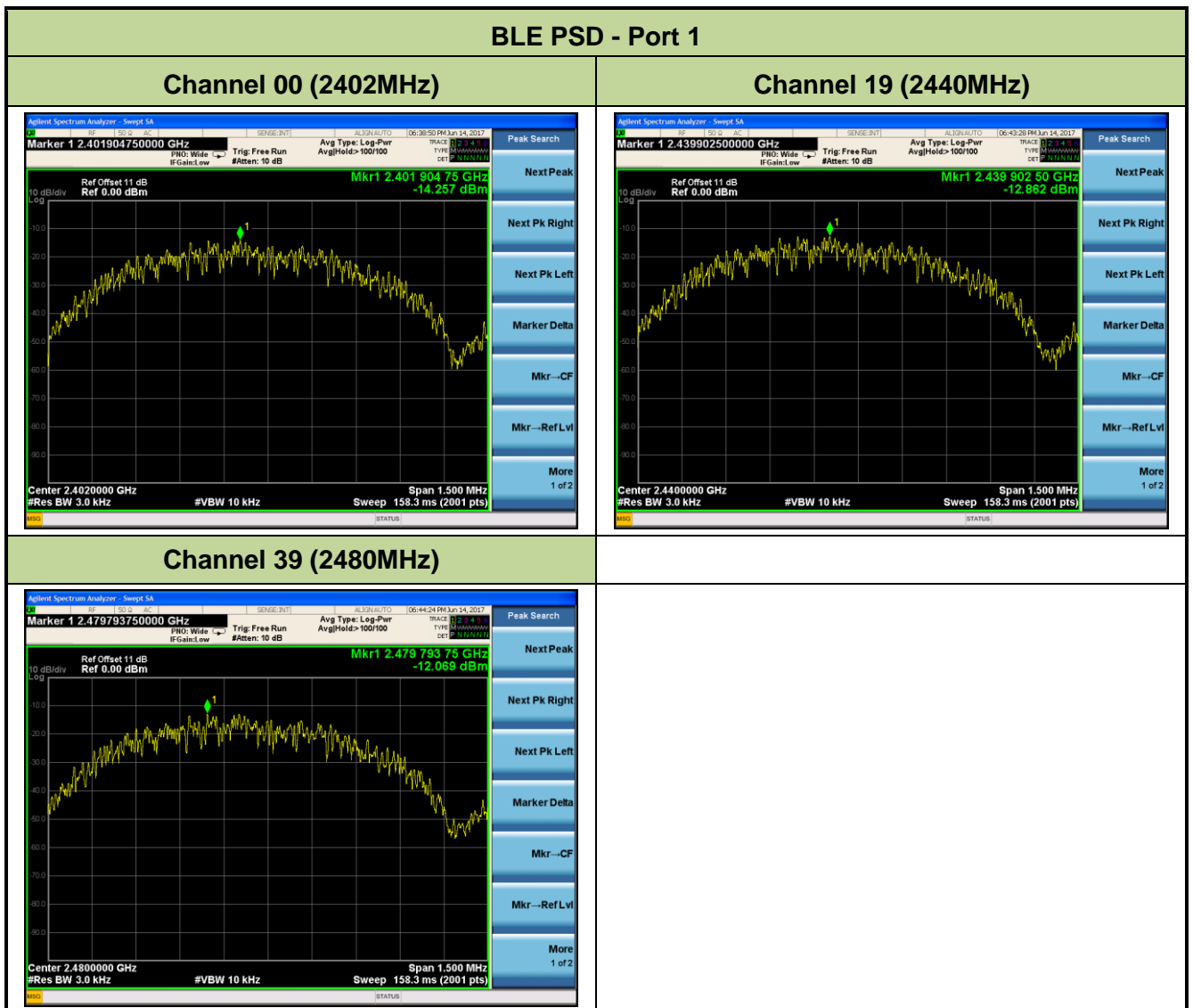

BLE PSD - Port 2

Channel 00 (2402MHz)

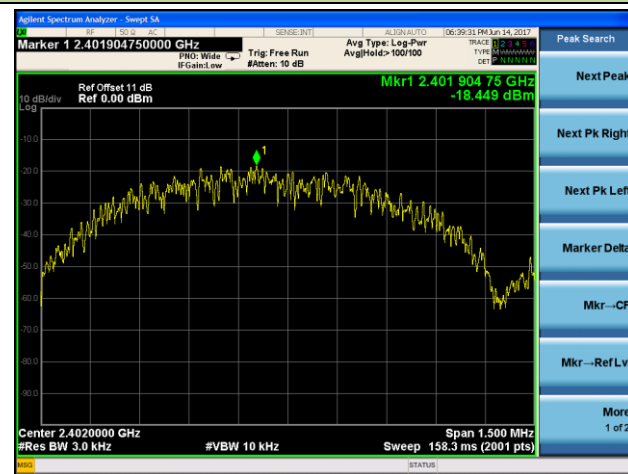

Channel 19 (2440MHz)

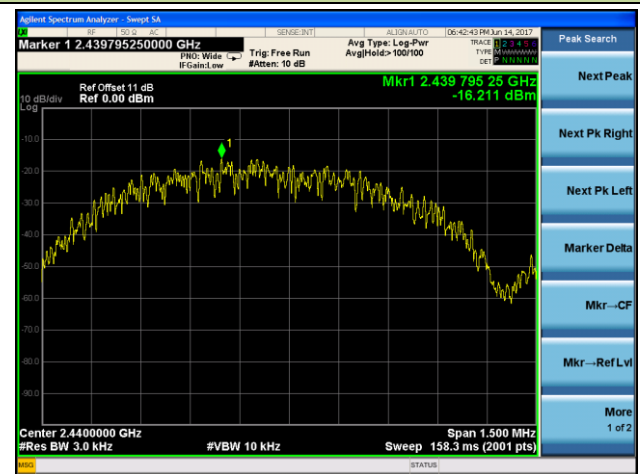

Channel 39 (2480MHz)

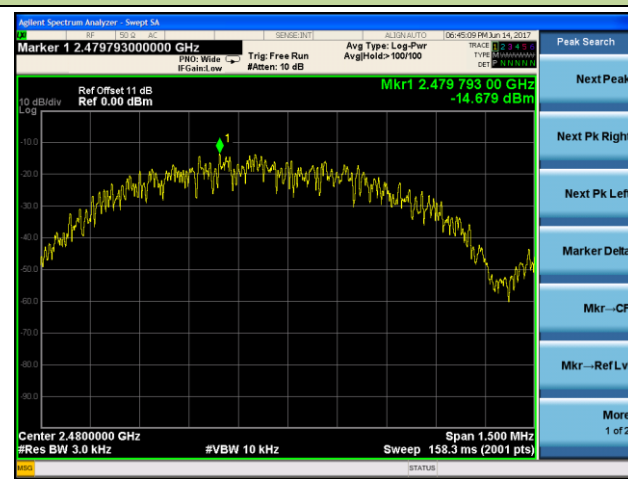

BLE PSD - Port 3

Channel 00 (2402MHz)

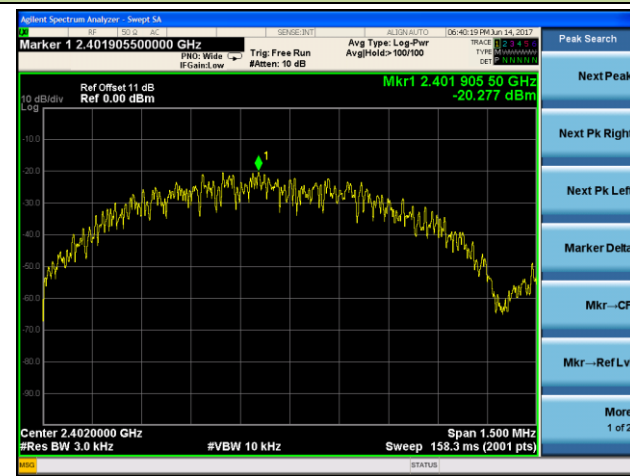

Channel 19 (2440MHz)

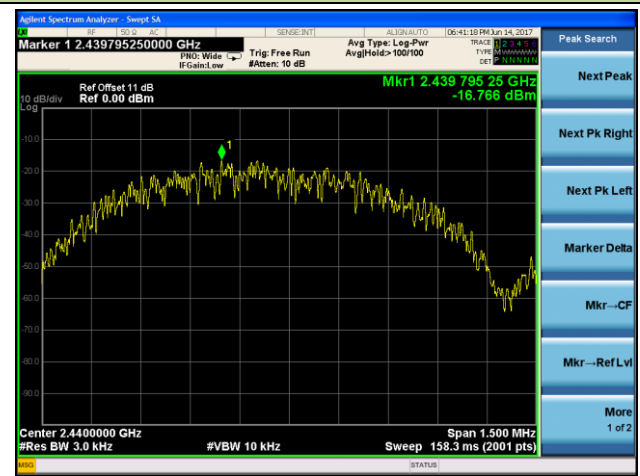

Channel 39 (2480MHz)

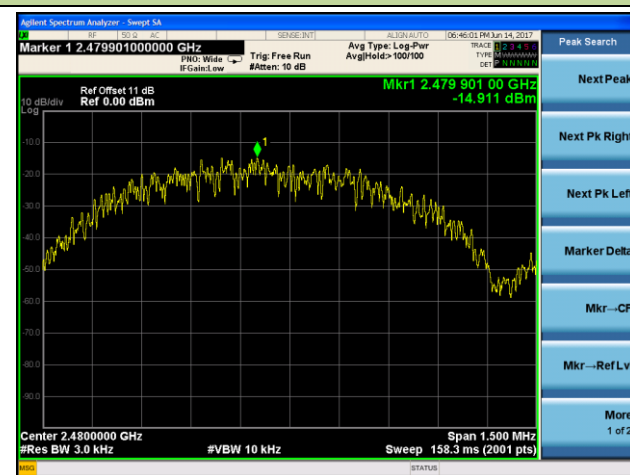

7.5. Conducted Band Edge and Out-of-Band Emissions

7.5.1. Test Limit

The limit for out-of-band spurious emissions at the band edge is 20dB below the fundamental emission level, as determined from the in-band power measurement of the DTS channel performed in a 100kHz bandwidth per the PSD procedure.

7.5.2. Test Procedure Used

KDB 558074 D01v04 - Section 11.2 & Section 11.3

7.5.3. Test Setting

1. Reference level measurement

- (a) Set instrument center frequency to DTS channel center frequency
- (b) Set the span to ≥ 1.5 times the DTS bandwidth
- (c) Set the RBW = 100 kHz
- (d) Set the VBW $\geq 3 \times$ RBW
- (e) Detector = peak
- (f) Sweep time = auto couple
- (g) Trace mode = max hold
- (h) Allow trace to fully stabilize

2. Emission level measurement

- (a) Set the center frequency and span to encompass frequency range to be measured
- (b) RBW = 100kHz
- (c) VBW = 300kHz
- (d) Detector = Peak
- (e) Number of sweep points $\geq 2 \times$ Span/RBW
- (f) Trace mode = max hold
- (g) Sweep time = auto couple
- (h) The trace was allowed to stabilize

7.5.4. Test Setup

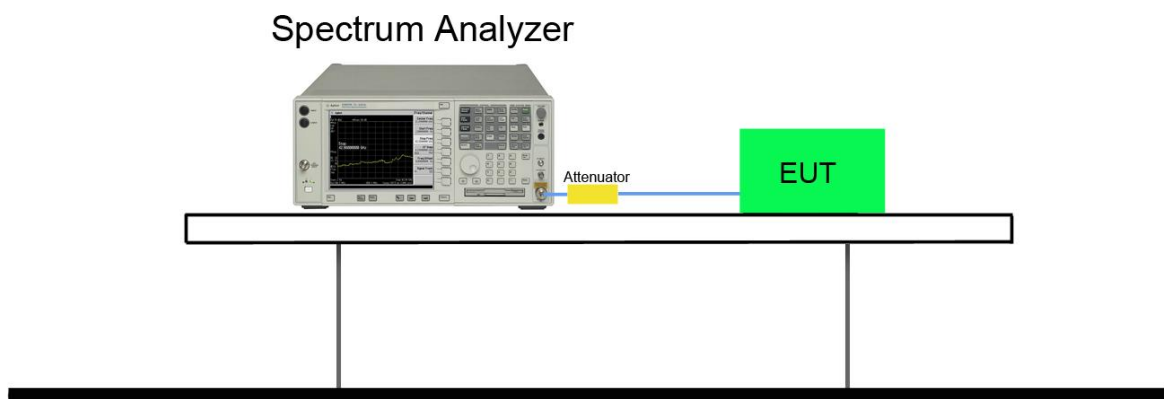

7.5.5. Test Result

Test Mode	Data Rate (Mbps)	Channel No.	Frequency (MHz)	Limit	Result
BLE	1	00	2402	20dBc	Pass
BLE	1	19	2440	20dBc	Pass
BLE	1	39	2480	20dBc	Pass

For Module A

BLE Out-of-Band Emissions

Channel 00 (2402MHz)

100kHz PSD reference Level



Low Band Edge

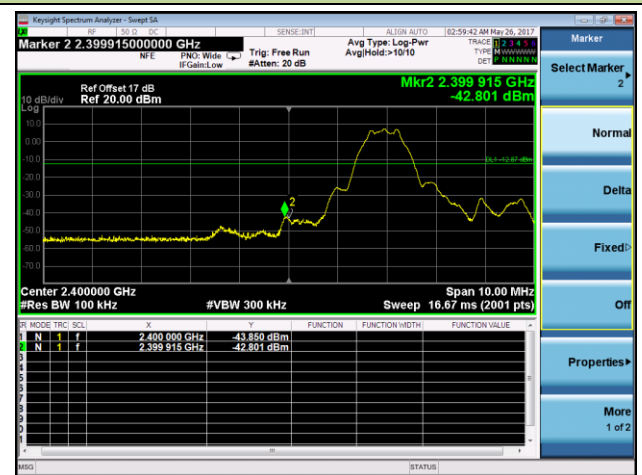

Spurious Emission 30MHz ~ 25GHz

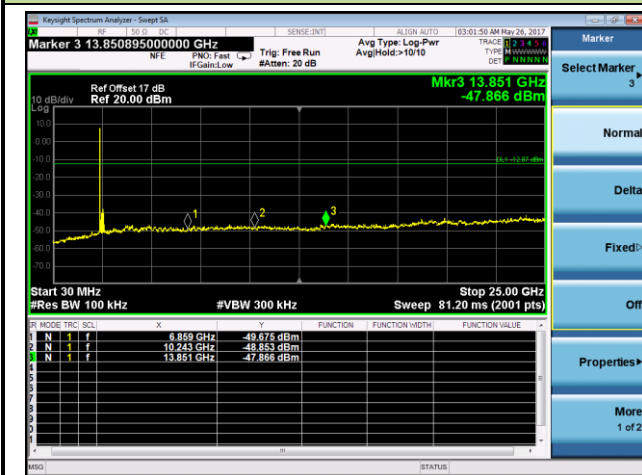

Channel 19 (2440MHz)

100kHz PSD reference Level



Spurious Emission 30MHz ~ 25GHz

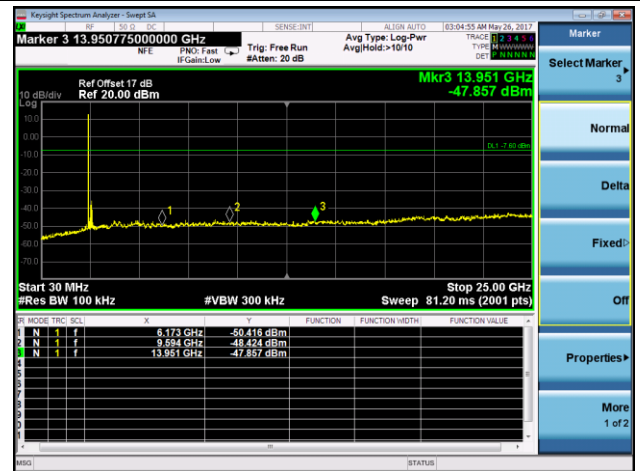

Channel 39 (2480MHz)

100kHz PSD reference Level



High Band Edge

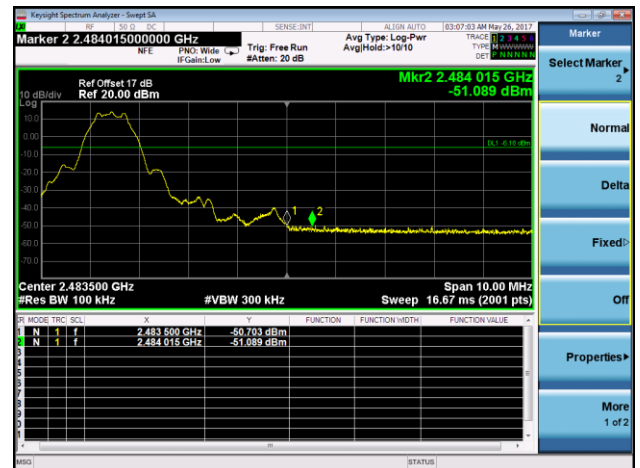

Spurious Emission 30MHz ~ 25GHz

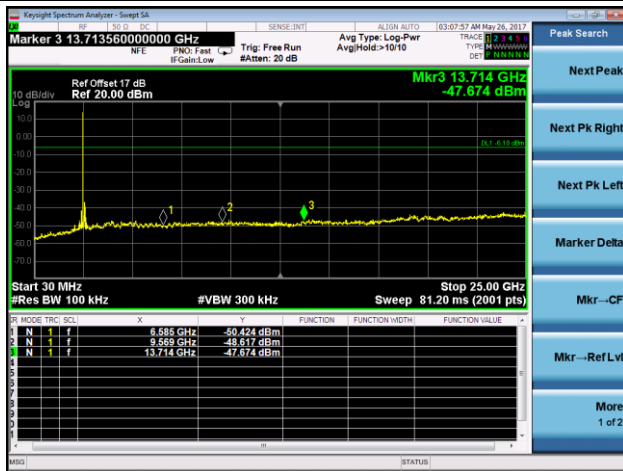

For Module B

BLE Out-of-Band Emissions

Channel 00 (2402MHz)

100kHz PSD reference Level

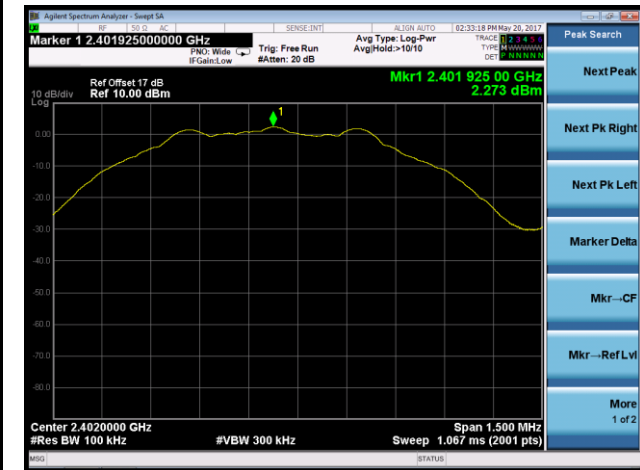

Low Band Edge

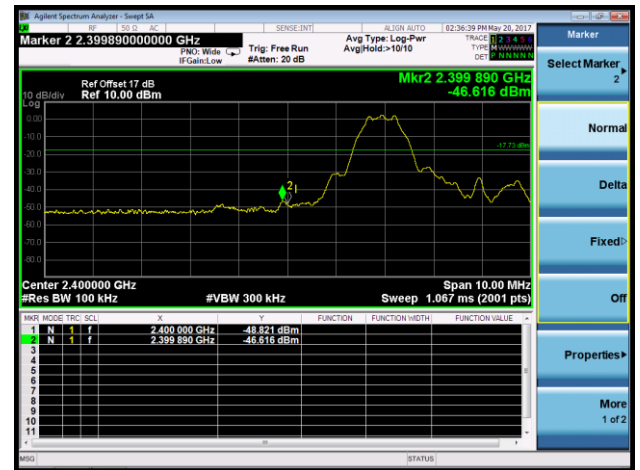

Spurious Emission 30MHz ~ 25GHz

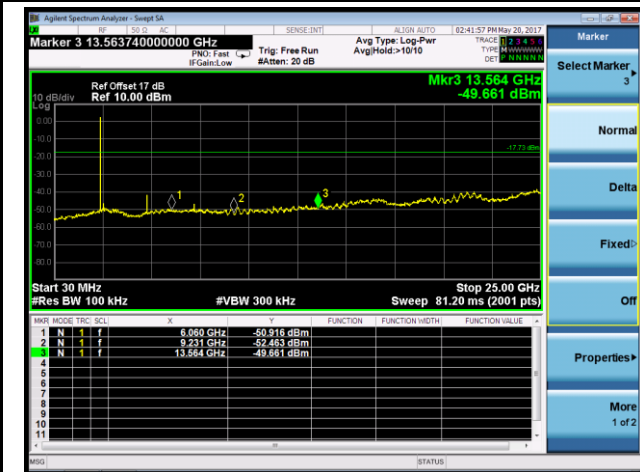

Channel 19 (2440MHz)

100kHz PSD reference Level



Spurious Emission 30MHz ~ 25GHz

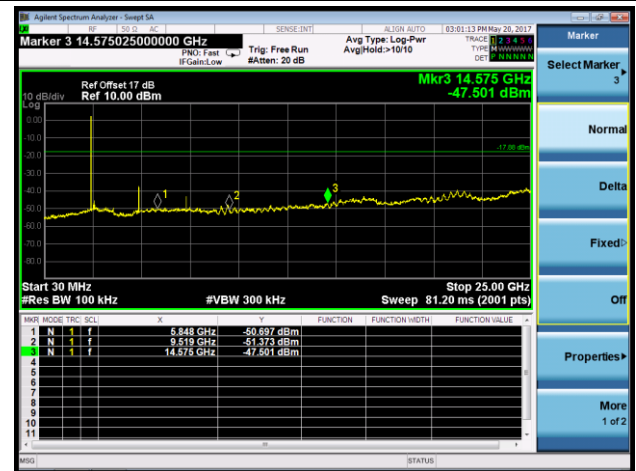

Channel 39 (2480MHz)

100kHz PSD reference Level



High Band Edge

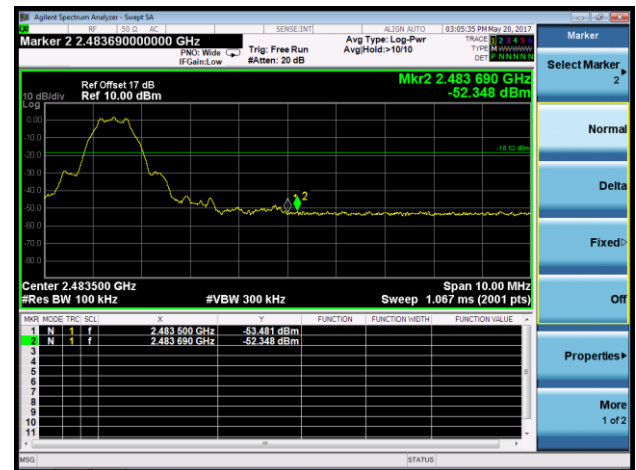

Spurious Emission 30MHz ~ 25GHz

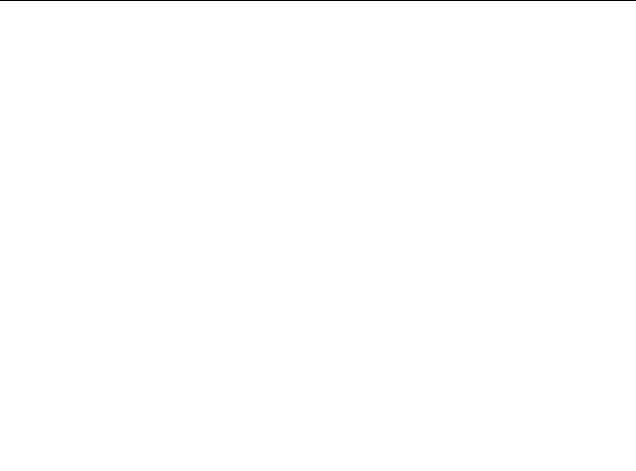
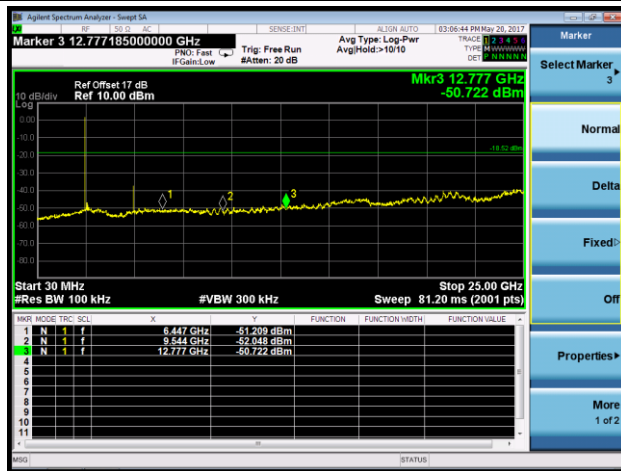

7.6. Radiated Spurious Emission Measurement

7.6.1. Test Limit

All out of band emissions appearing in a restricted band as specified in Section 15.205 of the Title 47 CFR must not exceed the limits shown in Table per Section 15.209.

FCC Part 15 Subpart C Paragraph 15.209		
Frequency [MHz]	Field Strength [$\mu\text{V}/\text{m}$]	Measured Distance [Meters]
0.009 - 0.490	2400/F (kHz)	300
0.490 - 1.705	24000/F (kHz)	30
1.705 - 30	30	30
30 - 88	100	3
88 - 216	150	3
216 - 960	200	3
Above 960	500	3

7.6.2. Test Procedure Used

KDB 558074 D01v04 - Section 12.2.3 (quasi-peak measurements)

KDB 558074 D01v04 - Section 12.2.4 (peak power measurements)

KDB 558074 D01v04 - Section 12.2.5 (average power measurements)

7.6.3. Test Setting

Peak Field Strength Measurements per Section 12.2.4 of KDB 558074 D01v04

1. Analyzer center frequency was set to the frequency of the radiated spurious emission of interest
2. RBW = as specified in Table 1
3. VBW = 3MHz
4. Detector = peak
5. Sweep time = auto couple

6. Trace mode = max hold
7. Trace was allowed to stabilize

Table 1 - RBW as a function of frequency

Frequency	RBW
9 ~ 150 kHz	200 ~ 300 Hz
0.15 ~ 30 MHz	9 ~ 10 kHz
30 ~ 1000 MHz	100 ~ 120 kHz
> 1000 MHz	1 MHz

Average Field Strength Measurements per Section 12.2.4 of KDB 558074 D01v04

1. Analyzer center frequency was set to the frequency of the radiated spurious emission of interest
2. RBW = 1MHz
3. VBW $\geq 1/T$
4. De As an alternative, the instrument may be set to linear detector mode. Ensure that video filtering is applied in linear voltage domain (rather than in a log or dB domain). Some instruments require linear display mode in order to accomplish this. Others have a setting for Average-VBW Type, which can be set to "Voltage" regardless of the display mode
5. Detector = Peak
6. Sweep time = auto
7. Trace mode = max hold
8. Allow max hold to run for at least 50 times (1/duty cycle) traces

7.6.4. Test Setup

9kHz ~ 30MHz Test Setup:

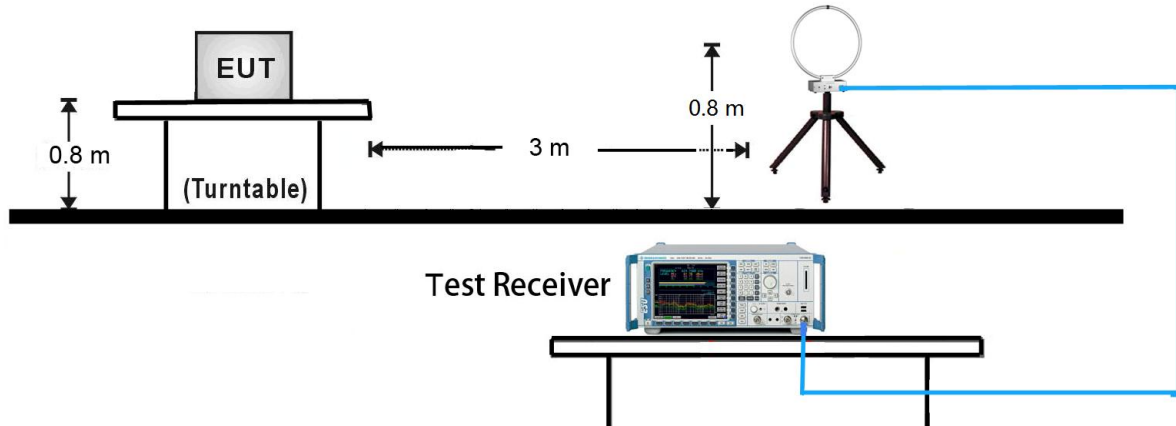

30MHz ~ 1GHz Test Setup:

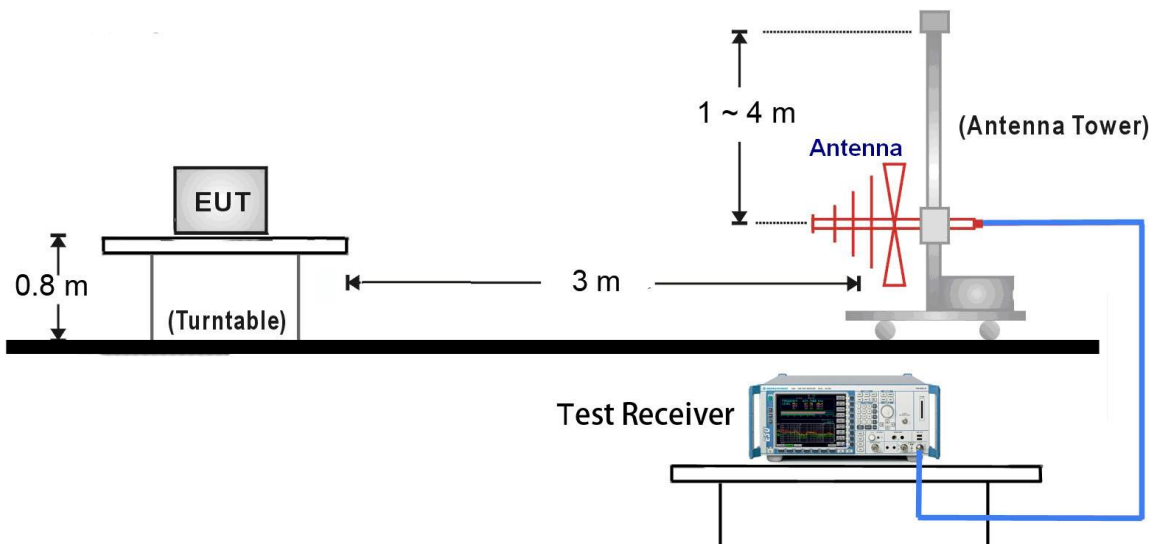

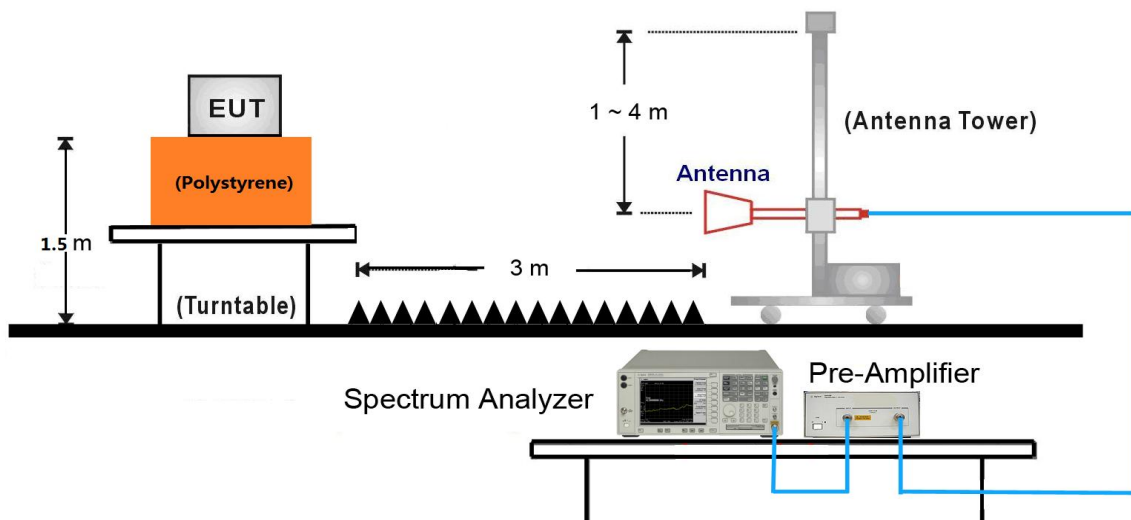
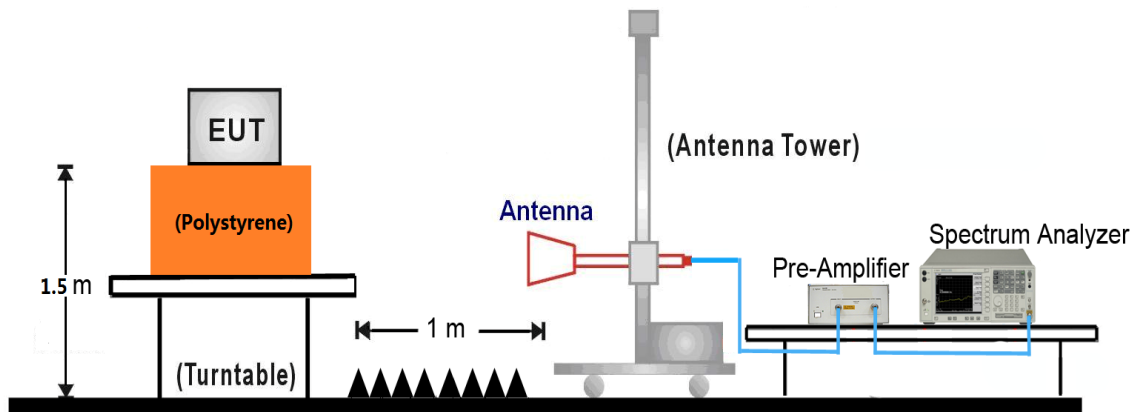
1GHz ~ 18GHz Test Setup:18GHz ~25GHz Test Setup:

7.6.5. Test Result

Remark: There are the ambient noise within frequency range 9 kHz ~ 30 MHz and 18GHz ~ 25GHz, the permissible value is not show in the report.

For Module A Test Data

Test Mode:	BLE	Test Site:	AC1
Test Channel:	00	Test Engineer:	Bruce Wang
Remark:	1. Average measurement was not performed if peak level lower than average limit. 2. Other frequency was 20dB below limit line within 1-18GHz, there is not show in the report.		

Mark	Frequency (MHz)	Reading Level (dBμV)	Factor (dB)	Measure Level (dBμV/m)	Limit (dBμV/m)	Margin (dB)	Detector	Polarization
	5411.5	34.7	3.2	37.9	74.0	-36.1	Peak	Horizontal
	7332.5	35.5	8.0	43.5	74.0	-30.5	Peak	Horizontal
*	9678.5	34.2	10.9	45.1	84.5	-39.4	Peak	Horizontal
*	12891.5	33.9	12.0	46.0	84.5	-38.5	Peak	Horizontal
	4927.0	35.2	2.8	38.0	74.0	-36.0	Peak	Vertical
	7434.5	34.5	8.0	42.5	74.0	-31.5	Peak	Vertical
*	8616.0	34.4	8.8	43.2	84.5	-41.3	Peak	Vertical
*	10265.0	34.0	12.0	46.0	84.5	-38.5	Peak	Vertical

Note 1: "*" is not in restricted band, its limit is 20dBc of the fundamental emission level (104.5dBμV/m) or 15.209 which is higher.

Note 2: Measure Level (dBμV/m) = Reading Level (dBμV) + Factor (dB)

Factor (dB) = Cable Loss (dB) + Antenna Factor (dB/m) - Pre_Amplifier Gain (dB)

Test Mode:	BLE	Test Site:	AC1
Test Channel:	19	Test Engineer:	Bruce Wang
Remark:	1. Average measurement was not performed if peak level lower than average limit. 2. Other frequency was 20dB below limit line within 1-18GHz, there is not show in the report.		

Mark	Frequency (MHz)	Reading Level (dB μ V)	Factor (dB)	Measure Level (dB μ V/m)	Limit (dB μ V/m)	Margin (dB)	Detector	Polarization
	4884.5	40.3	2.7	43.0	74.0	-31.0	Peak	Horizontal
	7502.5	35.9	8.3	44.2	74.0	-29.8	Peak	Horizontal
*	8769.0	34.9	8.9	43.8	92.3	-48.5	Peak	Horizontal
*	10401.0	34.2	12.3	46.5	92.3	-45.8	Peak	Horizontal
	4876.0	42.4	2.7	45.1	74.0	-28.9	Peak	Vertical
	7298.5	35.2	8.0	43.2	74.0	-30.8	Peak	Vertical
*	8888.0	33.8	9.2	43.0	92.3	-49.4	Peak	Vertical
*	10443.5	34.1	12.0	46.1	92.3	-46.2	Peak	Vertical

Note 1: "*" is not in restricted band, its limit is 20dBc of the fundamental emission level (112.3dB μ V/m) or 15.209 which is higher.

Note 2: Measure Level (dB μ V/m) = Reading Level (dB μ V) + Factor (dB)

Factor (dB) = Cable Loss (dB) + Antenna Factor (dB/m) - Pre_Amplifier Gain (dB)

Test Mode:	BLE	Test Site:	AC1
Test Channel:	39	Test Engineer:	Bruce Wang
Remark:	1. Average measurement was not performed if peak level lower than average limit. 2. Other frequency was 20dB below limit line within 1-18GHz, there is not show in the report.		

Mark	Frequency (MHz)	Reading Level (dBμV)	Factor (dB)	Measure Level (dBμV/m)	Limit (dBμV/m)	Margin (dB)	Detector	Polarization
	4961.0	41.3	2.9	44.2	74.0	-29.8	Peak	Horizontal
	7400.5	34.9	7.9	42.8	74.0	-31.2	Peak	Horizontal
*	8616.0	35.4	8.8	44.2	92.5	-48.3	Peak	Horizontal
*	9814.5	33.8	11.6	45.4	92.5	-47.1	Peak	Horizontal
	4961.0	43.3	2.9	46.2	74.0	-27.8	Peak	Vertical
	7298.5	35.7	8.0	43.7	74.0	-30.3	Peak	Vertical
*	8658.5	34.9	8.8	43.7	92.5	-48.7	Peak	Vertical
*	10171.5	33.8	11.7	45.6	92.5	-46.9	Peak	Vertical

Note 1: "*" is not in restricted band, its limit is 20dBc of the fundamental emission level (112.5dBμV/m) or 15.209 which is higher.

Note 2: Measure Level (dBμV/m) = Reading Level (dBμV) + Factor (dB)

Factor (dB) = Cable Loss (dB) + Antenna Factor (dB/m) - Pre_Amplifier Gain (dB)

For Module B Test Data

Test Mode:	BLE	Test Site:	AC1
Test Channel:	00	Test Engineer:	Bruce Wang
Remark:	1. Average measurement was not performed if peak level lower than average limit. 2. Other frequency was 20dB below limit line within 1-18GHz, there is not show in the report.		

Mark	Frequency (MHz)	Reading Level (dBμV)	Factor (dB)	Measure Level (dBμV/m)	Limit (dBμV/m)	Margin (dB)	Detector	Polarization
	3754.0	38.8	-0.4	38.4	74.0	-35.6	Peak	Horizontal
	4799.5	37.4	2.7	40.1	74.0	-33.9	Peak	Horizontal
*	6856.5	36.1	6.4	42.5	81.5	-39.0	Peak	Horizontal
*	8777.5	34.2	8.9	43.1	81.5	-38.4	Peak	Horizontal
	3839.0	37.0	0.0	37.0	74.0	-37.0	Peak	Vertical
	4808.0	41.6	2.7	44.3	74.0	-29.7	Peak	Vertical
*	6899.0	35.8	6.5	42.3	81.5	-39.2	Peak	Vertical
*	8769.0	34.3	8.9	43.2	81.5	-38.3	Peak	Vertical

Note 1: "*" is not in restricted band, its limit is 20dBc of the fundamental emission level (101.5dBμV/m) or 15.209 which is higher.

Note 2: Measure Level (dBμV/m) = Reading Level (dBμV) + Factor (dB)

Factor (dB) = Cable Loss (dB) + Antenna Factor (dB/m) - Pre_Amplifier Gain (dB)

Test Mode:	BLE	Test Site:	AC1
Test Channel:	19	Test Engineer:	Bruce Wang
Remark:	1. Average measurement was not performed if peak level lower than average limit. 2. Other frequency was 20dB below limit line within 1-18GHz, there is not show in the report.		

Mark	Frequency (MHz)	Reading Level (dBμV)	Factor (dB)	Measure Level (dBμV/m)	Limit (dBμV/m)	Margin (dB)	Detector	Polarization
	3754.0	38.1	-0.4	37.7	74.0	-36.3	Peak	Horizontal
	4876.0	39.0	2.7	41.7	74.0	-32.3	Peak	Horizontal
*	7018.0	35.9	6.9	42.8	83.7	-40.9	Peak	Horizontal
*	8769.0	34.5	8.9	43.4	83.7	-40.3	Peak	Horizontal
	3754.0	38.1	-0.4	37.7	74.0	-36.3	Peak	Vertical
	4876.0	39.1	2.7	41.8	74.0	-32.2	Peak	Vertical
*	7145.5	35.9	7.7	43.6	83.7	-40.1	Peak	Vertical
*	8675.5	35.4	8.9	44.3	83.7	-39.4	Peak	Vertical

Note 1: "*" is not in restricted band, its limit is 20dBc of the fundamental emission level (103.7dBμV/m) or 15.209 which is higher.

Note 2: Measure Level (dBμV/m) = Reading Level (dBμV) + Factor (dB)

Factor (dB) = Cable Loss (dB) + Antenna Factor (dB/m) - Pre_Amplifier Gain (dB)

Test Mode:	BLE	Test Site:	AC1
Test Channel:	39	Test Engineer:	Bruce Wang
Remark:	1. Average measurement was not performed if peak level lower than average limit. 2. Other frequency was 20dB below limit line within 1-18GHz, there is not show in the report.		

Mark	Frequency (MHz)	Reading Level (dB μ V)	Factor (dB)	Measure Level (dB μ V/m)	Limit (dB μ V/m)	Margin (dB)	Detector	Polarization
	3754.0	39.4	-0.4	39.0	74.0	-35.0	Peak	Horizontal
	4961.0	38.0	2.9	40.9	74.0	-33.1	Peak	Horizontal
*	7120.0	36.2	7.6	43.8	85.1	-41.3	Peak	Horizontal
*	8684.0	35.7	9.0	44.7	85.1	-40.4	Peak	Horizontal
	3839.0	37.0	0.0	37.0	74.0	-37.0	Peak	Vertical
	4961.0	39.9	2.9	42.8	74.0	-31.2	Peak	Vertical
*	7137.0	35.6	7.7	43.3	85.1	-41.8	Peak	Vertical
*	8769.0	35.0	8.9	43.9	85.1	-41.2	Peak	Vertical

Note 1: "*" is not in restricted band, its limit is 20dBc of the fundamental emission level (105.1dB μ V/m) or 15.209 which is higher.

Note 2: Measure Level (dB μ V/m) = Reading Level (dB μ V) + Factor (dB)

Factor (dB) = Cable Loss (dB) + Antenna Factor (dB/m) - Pre_Amplifier Gain (dB)

The worst case of Radiated Emission below 1GHz:

Site: AC1	Time: 2017/06/01 - 17:28
Limit: FCC_Part15.209_RE(3m)	Engineer: Bruce Wang
Probe: VULB9168_20-2000MHz	Polarity: Horizontal
EUT: Cassia Bluetooth Router	Power: By POE
Worse Case Mode: Transmit by BLE at channel 2402MHz	

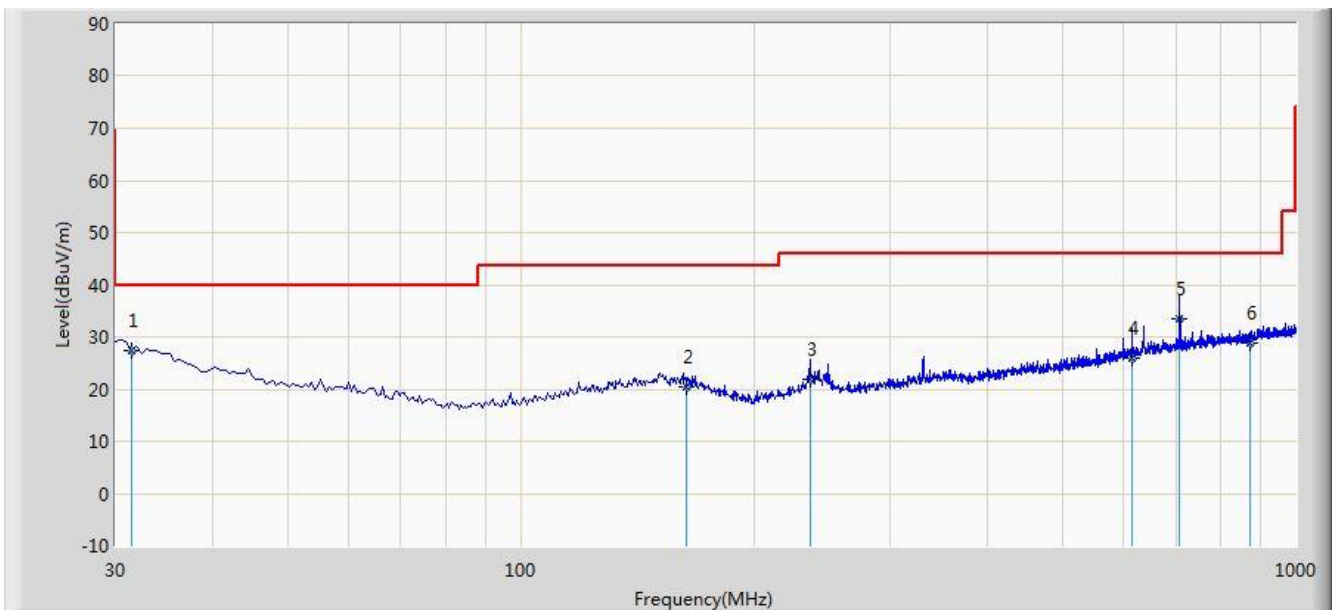

No	Flag	Mark	Frequency (MHz)	Measure Level (dBuV/m)	Reading Level (dBuV)	Over Limit (dB)	Limit (dBuV/m)	Factor (dB)	Type
1		*	31.455	27.352	13.682	-12.648	40.000	13.670	QP
2			163.860	20.452	5.601	-23.048	43.500	14.851	QP
3			236.125	21.899	9.235	-24.101	46.000	12.664	QP
4			615.395	26.014	5.210	-19.986	46.000	20.804	QP
5			706.515	33.336	11.254	-12.664	46.000	22.082	QP
6			873.900	28.925	4.961	-17.075	46.000	23.964	QP

Note: Measure Level (dB μ V/m) = Reading Level (dB μ V) + Factor (dB)

Factor (dB) = Cable Loss (dB) + Antenna Factor (dB/m)

Site: AC1	Time: 2017/06/01 - 17:30
Limit: FCC_Part15.209_RE(3m)	Engineer: Bruce Wang
Probe: VULB9168_20-2000MHz	Polarity: Vertical
EUT: Cassia Bluetooth Router	Power: By POE
Worse Case Mode: Transmit by BLE at channel 2402MHz	

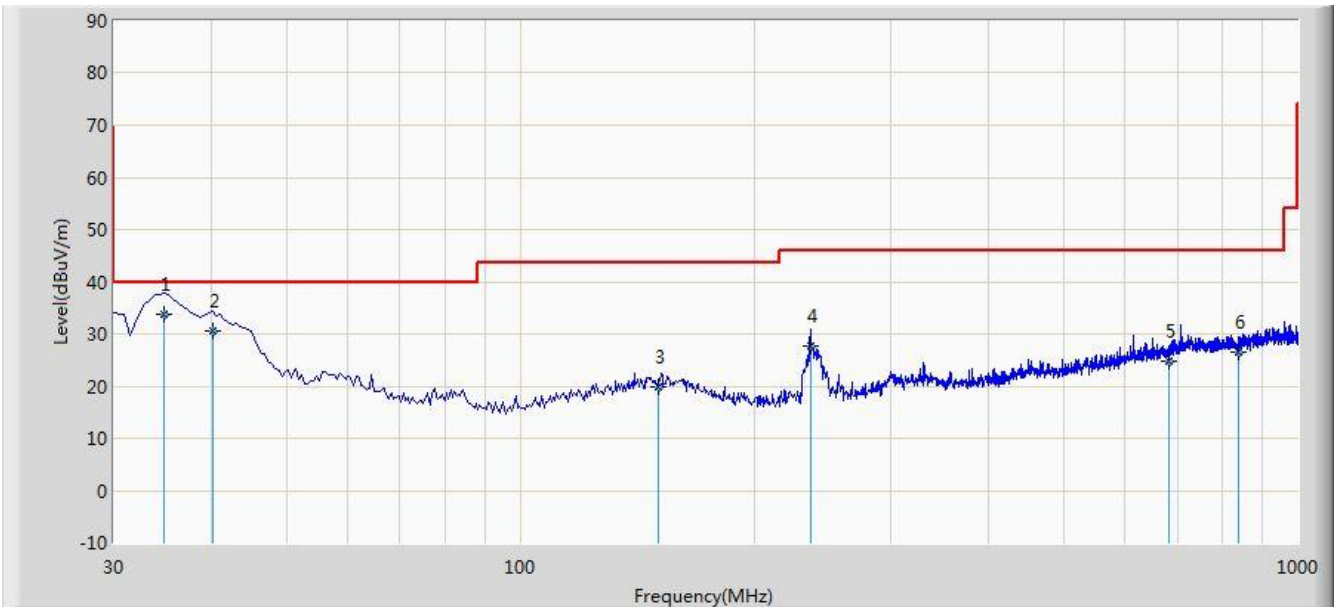

No	Flag	Mark	Frequency (MHz)	Measure Level (dBuV/m)	Reading Level (dBuV)	Over Limit (dB)	Limit (dBuV/m)	Factor (dB)	Type
1		*	34.850	33.873	20.025	-6.127	40.000	13.849	QP
2			40.185	30.528	16.025	-9.472	40.000	14.503	QP
3			150.280	19.864	4.702	-23.636	43.500	15.162	QP
4			236.125	27.718	15.054	-18.282	46.000	12.664	QP
5			683.780	24.819	3.043	-21.181	46.000	21.776	QP
6			839.465	26.627	3.069	-19.373	46.000	23.558	QP

Note: Measure Level (dB μ V/m) = Reading Level (dB μ V) + Factor (dB)

Factor (dB) = Cable Loss (dB) + Antenna Factor (dB/m)

7.7. Radiated Restricted Band Edge Measurement

7.7.1. Test Result

For Module A Test data

Site: AC1	Time: 2017/05/24 - 23:47
Limit: FCC_Part15.209_RE(3m)	Engineer: Will Yan
Probe: BBHA9120D_1-18GHz	Polarity: Horizontal
EUT: Cassia Bluetooth Router	Power: By POE
Test Mode: Transmit by BLE at channel 2402MHz	

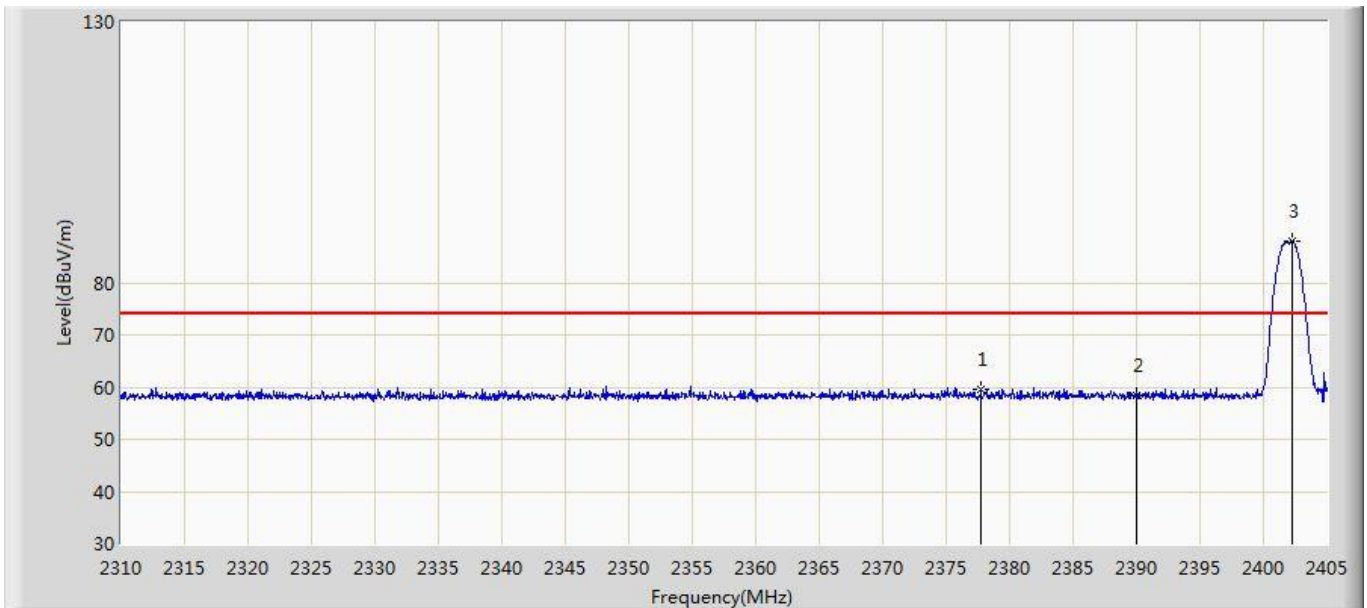

No	Flag	Mark	Frequency (MHz)	Measure Level (dBuV/m)	Reading Level (dBuV)	Over Limit (dB)	Limit (dBuV/m)	Factor (dB)	Type
1			2377.735	59.438	28.213	-14.562	74.000	31.226	PK
2			2390.000	58.436	27.233	-15.564	74.000	31.203	PK
3		*	2402.292	87.979	56.795	N/A	N/A	31.184	PK

Note: Measure Level (dB μ V/m) = Reading Level (dB μ V) + Factor (dB)

Factor (dB) = Cable Loss (dB) + Antenna Factor (dB) (dB/m)

Site: AC1	Time: 2017/05/24 - 23:51
Limit: FCC_Part15.209_RE(3m)	Engineer: Will Yan
Probe: BBHA9120D_1-18GHz	Polarity: Horizontal
EUT: Cassia Bluetooth Router	Power: By POE
Test Mode: Transmit by BLE at channel 2402MHz	

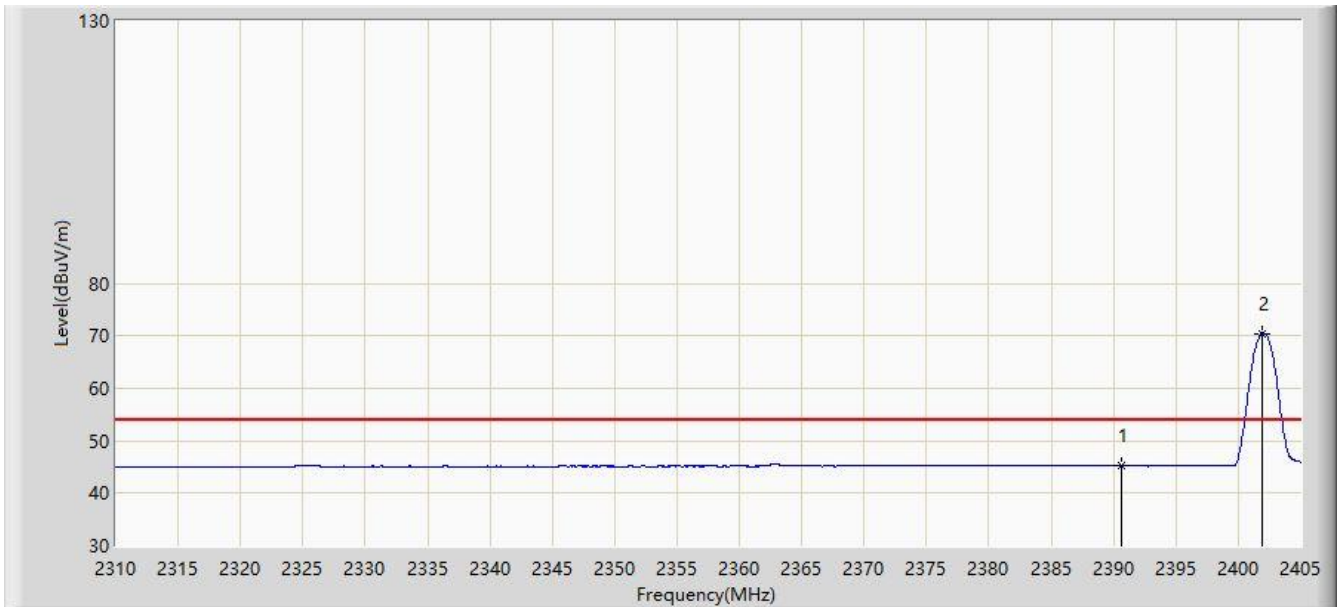

No	Flag	Mark	Frequency (MHz)	Measure Level (dBuV/m)	Reading Level (dBuV)	Over Limit (dB)	Limit (dBuV/m)	Factor (dB)	Type
1			2390.607	45.187	13.985	-8.813	54.000	31.201	AV
2		*	2401.865	70.383	39.199	N/A	N/A	31.184	AV

Note: Measure Level (dB μ V/m) = Reading Level (dB μ V) + Factor (dB)

Factor (dB) = Cable Loss (dB) + Antenna Factor (dB) (dB/m)

Site: AC1	Time: 2017/05/24 - 23:51
Limit: FCC_Part15.209_RE(3m)	Engineer: Will Yan
Probe: BBHA9120D_1-18GHz	Polarity: Vertical
EUT: Cassia Bluetooth Router	Power: By POE
Test Mode: Transmit by BLE at channel 2402MHz	

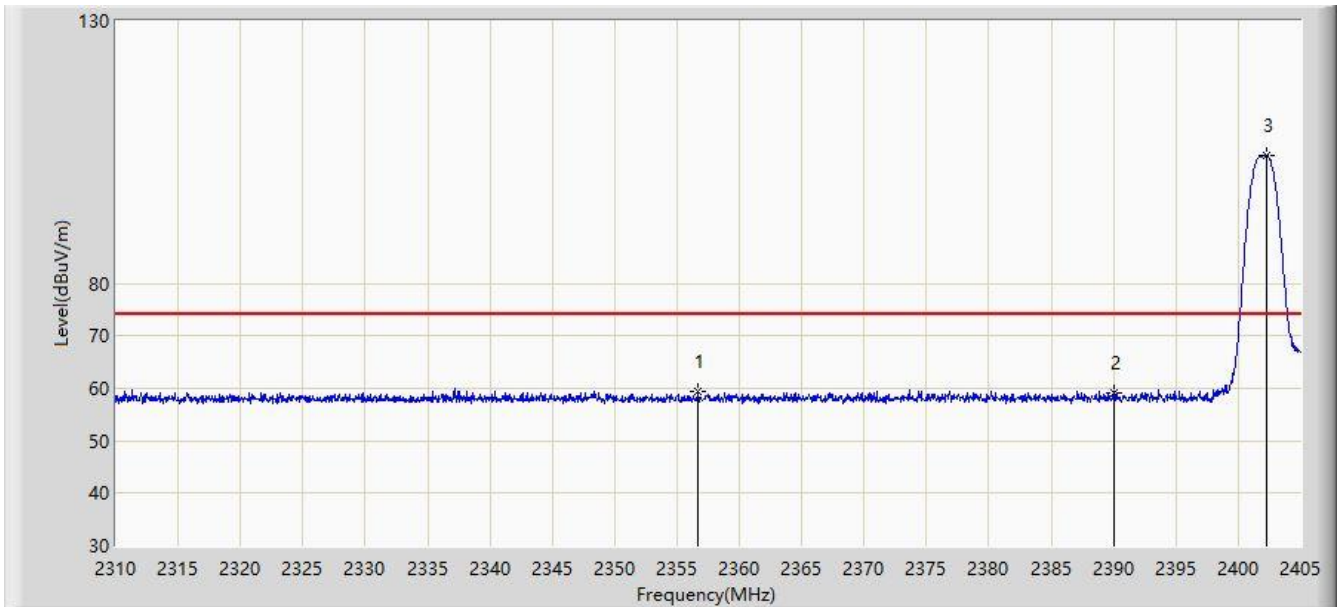

No	Flag	Mark	Frequency (MHz)	Measure Level (dBuV/m)	Reading Level (dBuV)	Over Limit (dB)	Limit (dBuV/m)	Factor (dB)	Type
1			2356.692	59.444	28.177	-14.556	74.000	31.267	PK
2			2390.000	59.203	28.000	-14.797	74.000	31.203	PK
3		*	2402.292	104.475	73.291	N/A	N/A	31.184	PK

Note: Measure Level (dB μ V/m) = Reading Level (dB μ V) + Factor (dB)

Factor (dB) = Cable Loss (dB) + Antenna Factor (dB) (dB/m)

Site: AC1	Time: 2017/05/24 - 23:53
Limit: FCC_Part15.209_RE(3m)	Engineer: Will Yan
Probe: BBHA9120D_1-18GHz	Polarity: Vertical
EUT: Cassia Bluetooth Router	Power: By POE
Test Mode: Transmit by BLE at channel 2402MHz	

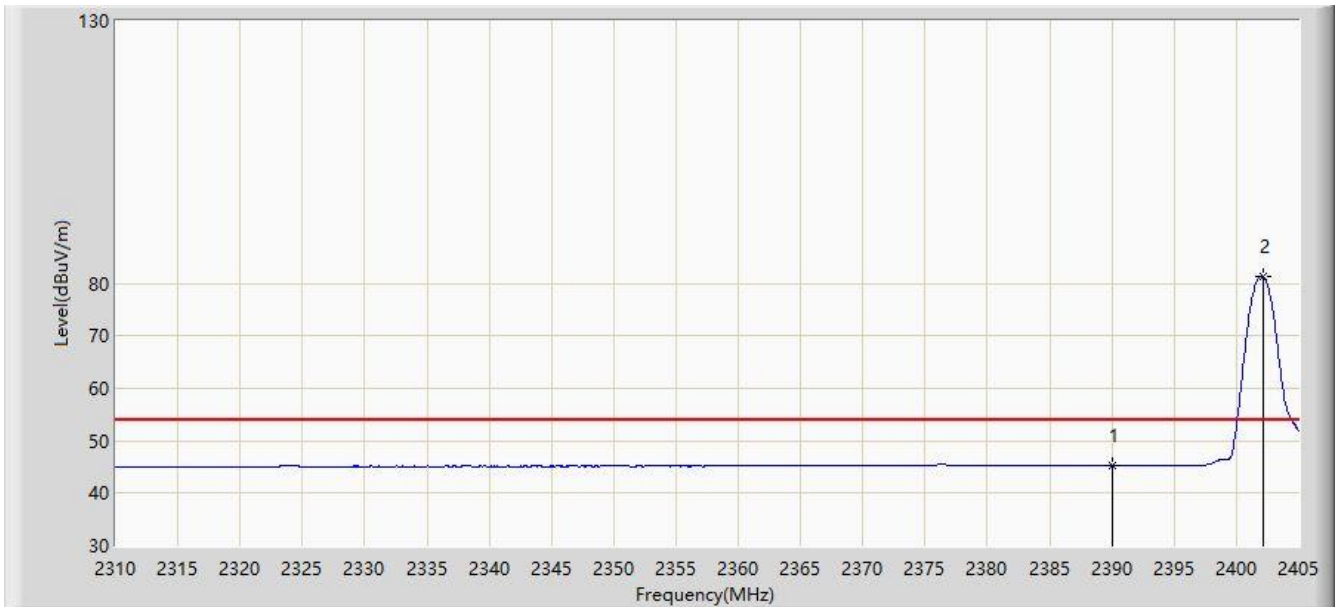

No	Flag	Mark	Frequency (MHz)	Measure Level (dBuV/m)	Reading Level (dBuV)	Over Limit (dB)	Limit (dBuV/m)	Factor (dB)	Type
1			2390.000	45.259	14.056	-8.741	54.000	31.203	AV
2		*	2402.150	81.242	50.058	N/A	N/A	31.184	AV

Note: Measure Level (dB μ V/m) = Reading Level (dB μ V) + Factor (dB)

Factor (dB) = Cable Loss (dB) + Antenna Factor (dB) (dB/m)

Site: AC1	Time: 2017/05/25 - 00:00
Limit: FCC_Part15.209_RE(3m)	Engineer: Will Yan
Probe: BBHA9120D_1-18GHz	Polarity: Horizontal
EUT: Cassia Bluetooth Router	Power: By POE
Test Mode: Transmit by BLE at channel 2480MHz	

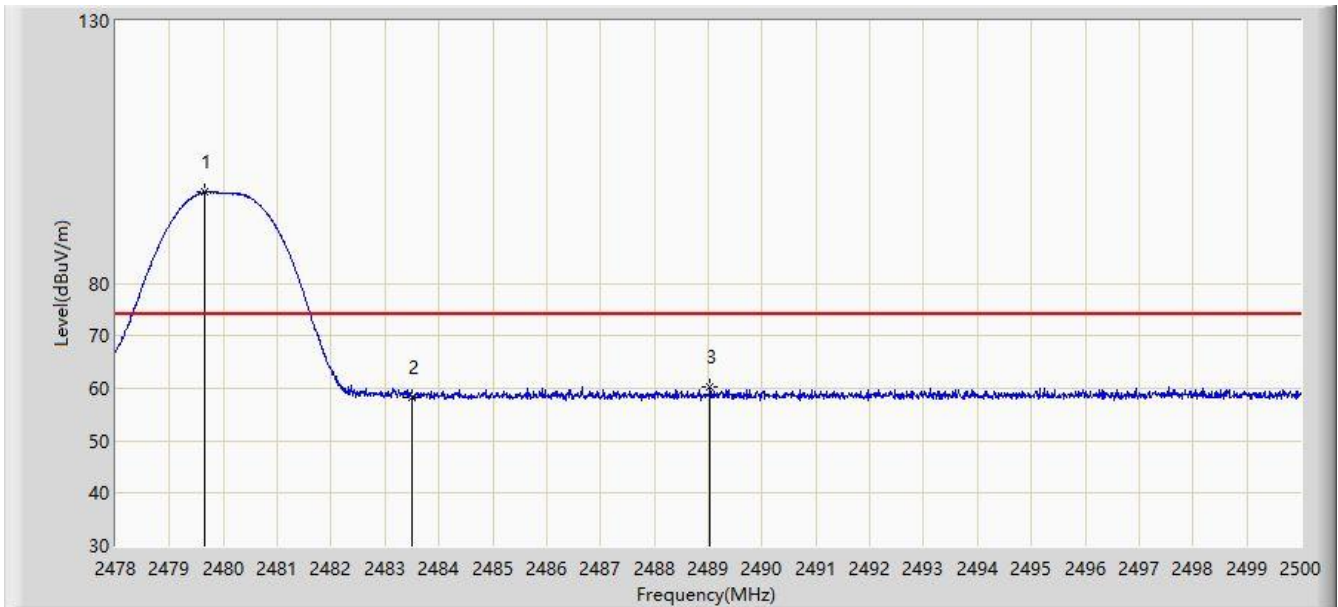

No	Flag	Mark	Frequency (MHz)	Measure Level (dBuV/m)	Reading Level (dBuV)	Over Limit (dB)	Limit (dBuV/m)	Factor (dB)	Type
1		*	2479.661	97.306	66.123	N/A	N/A	31.184	PK
2			2483.500	58.274	27.081	-15.726	74.000	31.194	PK
3			2489.033	60.133	28.925	-13.867	74.000	31.208	PK

Note: Measure Level (dB μ V/m) = Reading Level (dB μ V) + Factor (dB)

Factor (dB) = Cable Loss (dB) + Antenna Factor (dB) (dB/m)

Site: AC1	Time: 2017/05/25 - 00:02
Limit: FCC_Part15.209_RE(3m)	Engineer: Will Yan
Probe: BBHA9120D_1-18GHz	Polarity: Horizontal
EUT: Cassia Bluetooth Router	Power: By POE
Test Mode: Transmit by BLE at channel 2480MHz	

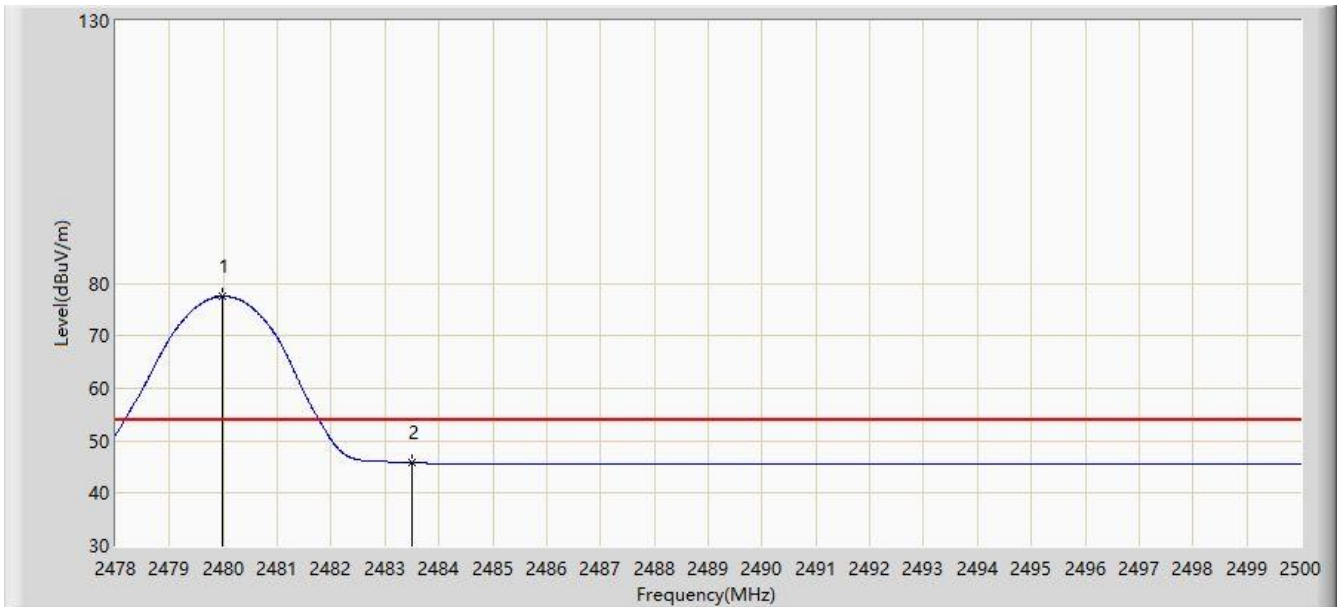

No	Flag	Mark	Frequency (MHz)	Measure Level (dBuV/m)	Reading Level (dBuV)	Over Limit (dB)	Limit (dBuV/m)	Factor (dB)	Type
1		*	2479.969	77.478	46.294	N/A	N/A	31.184	AV
2			2483.500	45.793	14.600	-8.207	54.000	31.194	AV

Note: Measure Level (dB μ V/m) = Reading Level (dB μ V) + Factor (dB)

Factor (dB) = Cable Loss (dB) + Antenna Factor (dB) (dB/m)

Site: AC1	Time: 2017/05/25 - 00:03
Limit: FCC_Part15.209_RE(3m)	Engineer: Will Yan
Probe: BBHA9120D_1-18GHz	Polarity: Vertical
EUT: Cassia Bluetooth Router	Power: By POE
Test Mode: Transmit by BLE at channel 2480MHz	

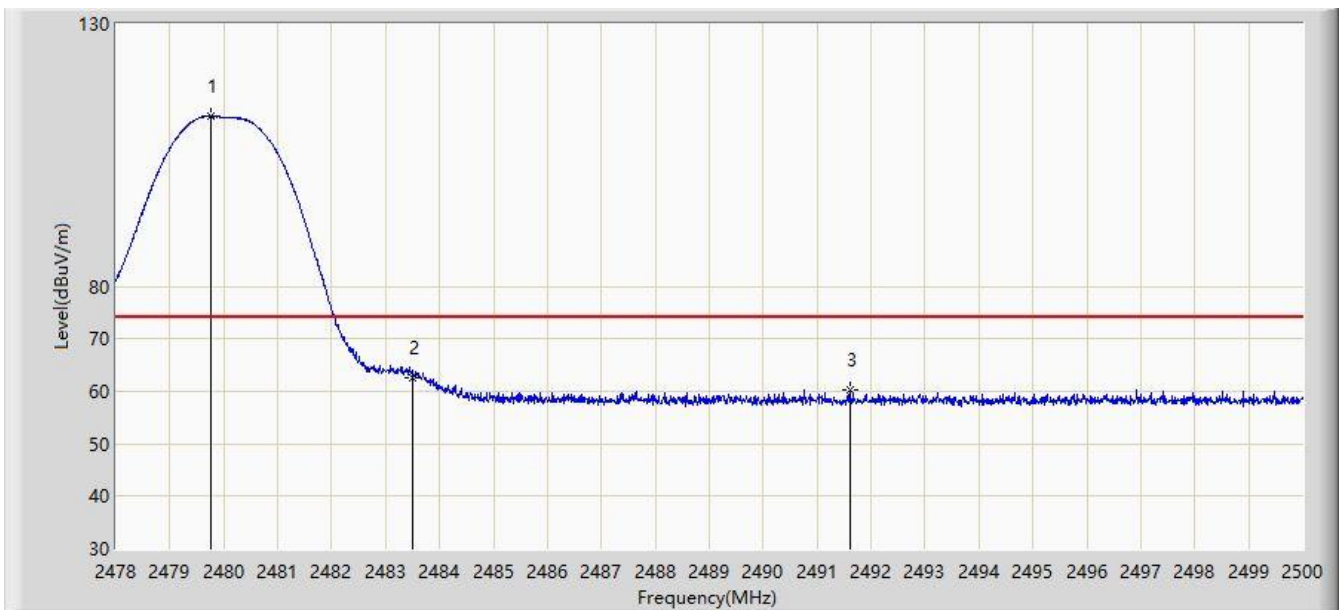

No	Flag	Mark	Frequency (MHz)	Measure Level (dBuV/m)	Reading Level (dBuV)	Over Limit (dB)	Limit (dBuV/m)	Factor (dB)	Type
1		*	2479.760	112.463	81.280	N/A	N/A	31.184	PK
2			2483.500	62.653	31.460	-11.347	74.000	31.194	PK
3			2491.607	60.360	29.145	-13.640	74.000	31.214	PK

Note: Measure Level (dB μ V/m) = Reading Level (dB μ V) + Factor (dB)

Factor (dB) = Cable Loss (dB) + Antenna Factor (dB) (dB/m)

Site: AC1	Time: 2017/05/25 - 00:04
Limit: FCC_Part15.209_RE(3m)	Engineer: Will Yan
Probe: BBHA9120D_1-18GHz	Polarity: Vertical
EUT: Cassia Bluetooth Router	Power: By POE
Test Mode: Transmit by BLE at channel 2480MHz	

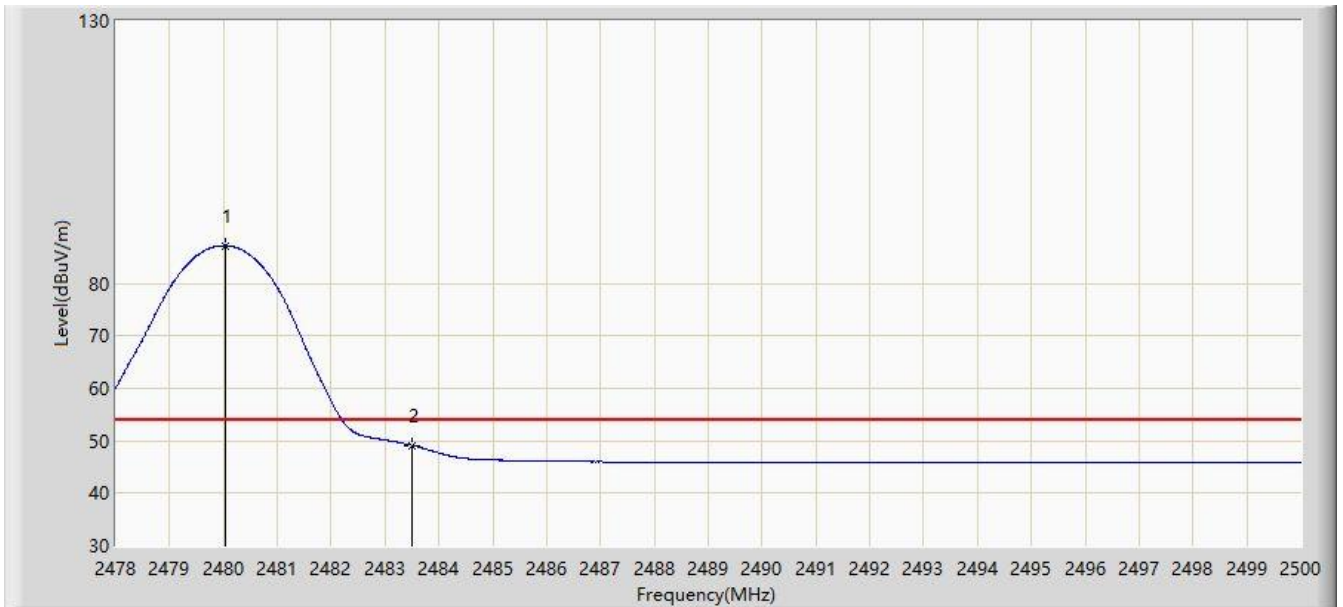

No	Flag	Mark	Frequency (MHz)	Measure Level (dBuV/m)	Reading Level (dBuV)	Over Limit (dB)	Limit (dBuV/m)	Factor (dB)	Type
1		*	2480.046	87.197	56.013	N/A	N/A	31.184	AV
2			2483.500	49.112	17.919	-4.888	54.000	31.194	AV

Note: Measure Level (dB μ V/m) = Reading Level (dB μ V) + Factor (dB)

Factor (dB) = Cable Loss (dB) + Antenna Factor (dB) (dB/m)

For Module B Test data

Site: AC1	Time: 2017/06/03 - 02:51
Limit: FCC_Part15.209_RE(3m)	Engineer: Will Yan
Probe: BBHA9120D_1-18GHz	Polarity: Horizontal
EUT: Cassia Bluetooth Router	Power: By POE
Test Mode: Transmit by BLE at channel 2402MHz	

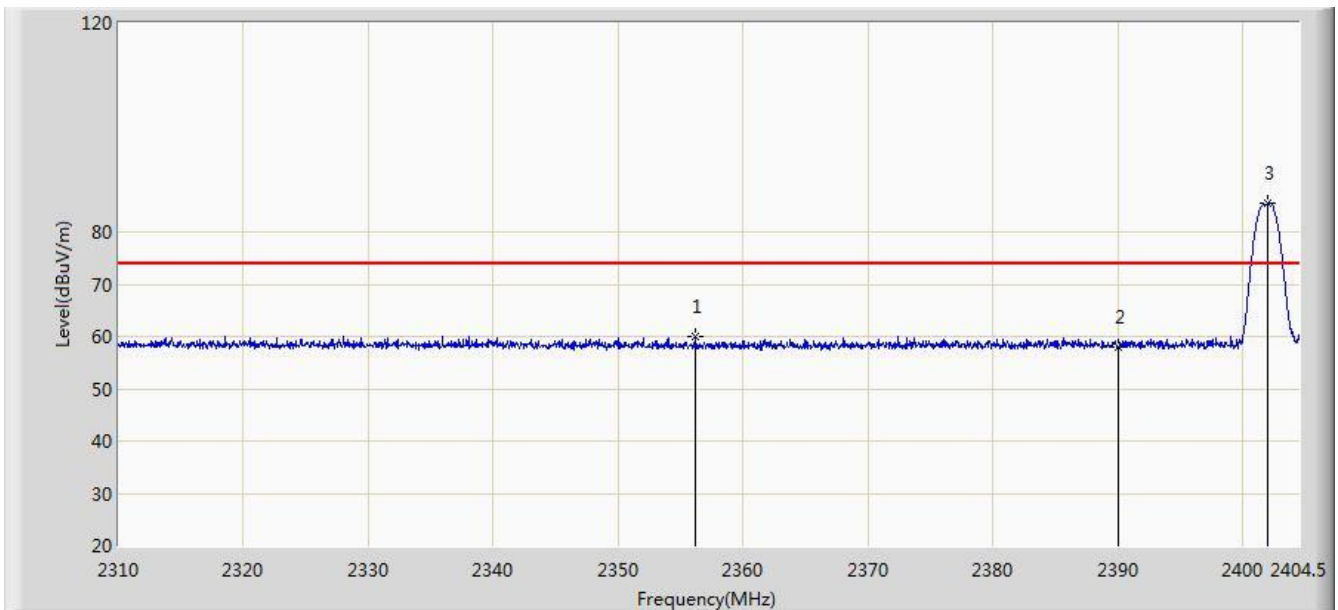

No	Flag	Mark	Frequency (MHz)	Measure Level (dBuV/m)	Reading Level (dBuV)	Over Limit (dB)	Limit (dBuV/m)	Factor (dB)	Type
1			2356.170	59.978	28.709	-14.022	74.000	31.269	PK
2			2390.000	58.051	26.848	-15.949	74.000	31.203	PK
3			2401.960	85.389	54.205	N/A	N/A	31.184	PK

Note: Measure Level (dB μ V/m) = Reading Level (dB μ V) + Factor (dB)

Factor (dB) = Cable Loss (dB) + Antenna Factor (dB) (dB/m)

Site: AC1	Time: 2017/06/03 - 02:55
Limit: FCC_Part15.209_RE(3m)	Engineer: Will Yan
Probe: BBHA9120D_1-18GHz	Polarity: Horizontal
EUT: Cassia Bluetooth Router	Power: By POE
Test Mode: Transmit by BLE at channel 2402MHz	

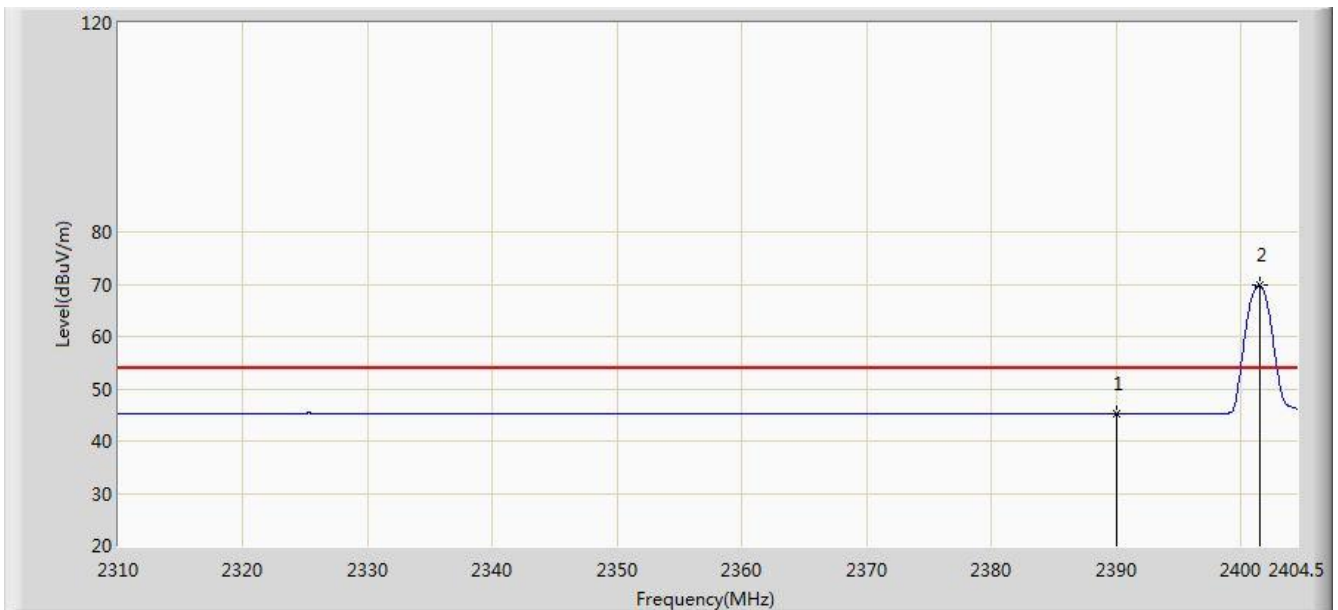

No	Flag	Mark	Frequency (MHz)	Measure Level (dBuV/m)	Reading Level (dBuV)	Over Limit (dB)	Limit (dBuV/m)	Factor (dB)	Type
1			2390.000	45.272	14.069	-8.728	54.000	31.203	AV
2			2401.523	69.775	38.590	N/A	N/A	31.185	AV

Note: Measure Level (dB μ V/m) = Reading Level (dB μ V) + Factor (dB)

Factor (dB) = Cable Loss (dB) + Antenna Factor (dB) (dB/m)

Site: AC1	Time: 2017/06/03 - 02:56
Limit: FCC_Part15.209_RE(3m)	Engineer: Will Yan
Probe: BBHA9120D_1-18GHz	Polarity: Vertical
EUT: Cassia Bluetooth Router	Power: By POE
Test Mode: Transmit by BLE at channel 2402MHz	

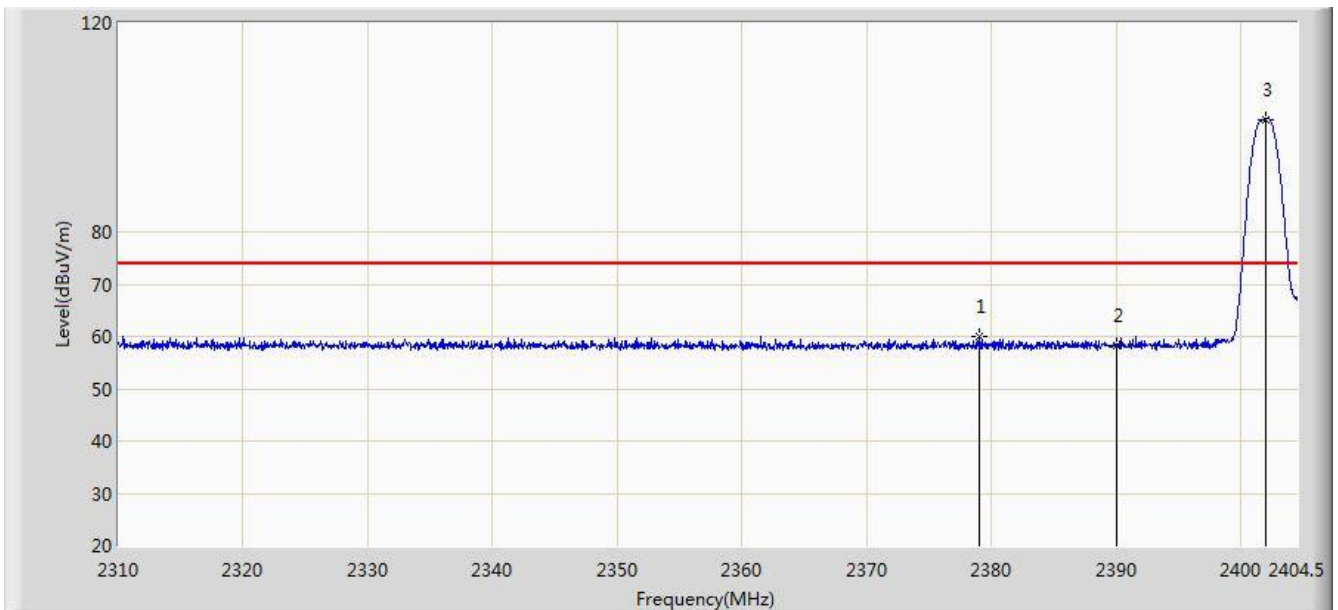

No	Flag	Mark	Frequency (MHz)	Measure Level (dBuV/m)	Reading Level (dBuV)	Over Limit (dB)	Limit (dBuV/m)	Factor (dB)	Type
1			2378.985	59.952	28.729	-14.048	74.000	31.223	PK
2			2390.000	58.314	27.111	-15.686	74.000	31.203	PK
3			2401.996	101.537	70.353	N/A	N/A	31.184	PK

Note: Measure Level (dB μ V/m) = Reading Level (dB μ V) + Factor (dB)

Factor (dB) = Cable Loss (dB) + Antenna Factor (dB) (dB/m)

Site: AC1	Time: 2017/06/03 - 02:58
Limit: FCC_Part15.209_RE(3m)	Engineer: Will Yan
Probe: BBHA9120D_1-18GHz	Polarity: Vertical
EUT: Cassia Bluetooth Router	Power: By POE
Test Mode: Transmit by BLE at channel 2402MHz	

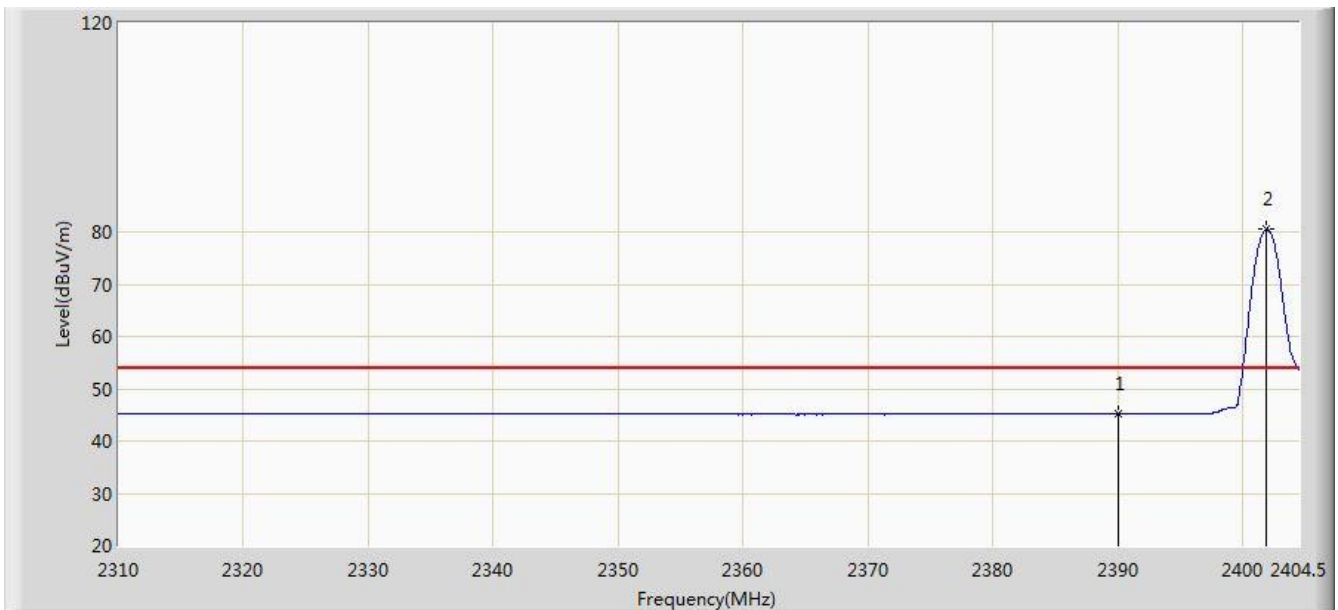

No	Flag	Mark	Frequency (MHz)	Measure Level (dBuV/m)	Reading Level (dBuV)	Over Limit (dB)	Limit (dBuV/m)	Factor (dB)	Type
1			2390.000	45.240	14.037	-8.760	54.000	31.203	AV
2			2401.901	80.515	49.331	N/A	N/A	31.184	AV

Note: Measure Level (dB μ V/m) = Reading Level (dB μ V) + Factor (dB)

Factor (dB) = Cable Loss (dB) + Antenna Factor (dB) (dB/m)

Site: AC1	Time: 2017/06/03 - 02:59
Limit: FCC_Part15.209_RE(3m)	Engineer: Will Yan
Probe: BBHA9120D_1-18GHz	Polarity: Horizontal
EUT: Cassia Bluetooth Router	Power: By POE
Test Mode: Transmit by BLE at channel 2480MHz	

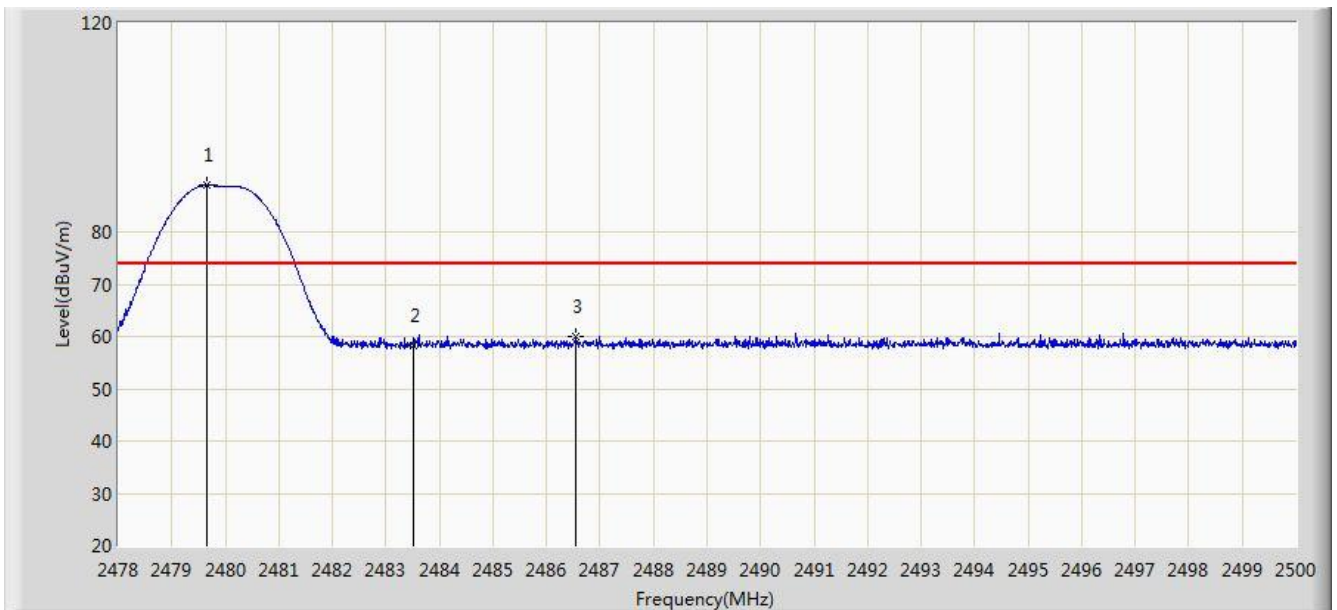

No	Flag	Mark	Frequency (MHz)	Measure Level (dBuV/m)	Reading Level (dBuV)	Over Limit (dB)	Limit (dBuV/m)	Factor (dB)	Type
1			2479.661	88.937	57.754	N/A	N/A	31.184	PK
2			2483.500	58.227	27.034	-15.773	74.000	31.194	PK
3			2486.558	60.084	28.883	-13.916	74.000	31.201	PK

Note: Measure Level (dB μ V/m) = Reading Level (dB μ V) + Factor (dB)

Factor (dB) = Cable Loss (dB) + Antenna Factor (dB) (dB/m)

Site: AC1	Time: 2017/06/03 - 03:03
Limit: FCC_Part15.209_RE(3m)	Engineer: Will Yan
Probe: BBHA9120D_1-18GHz	Polarity: Horizontal
EUT: Cassia Bluetooth Router	Power: By POE
Test Mode: Transmit by BLE at channel 2480MHz	

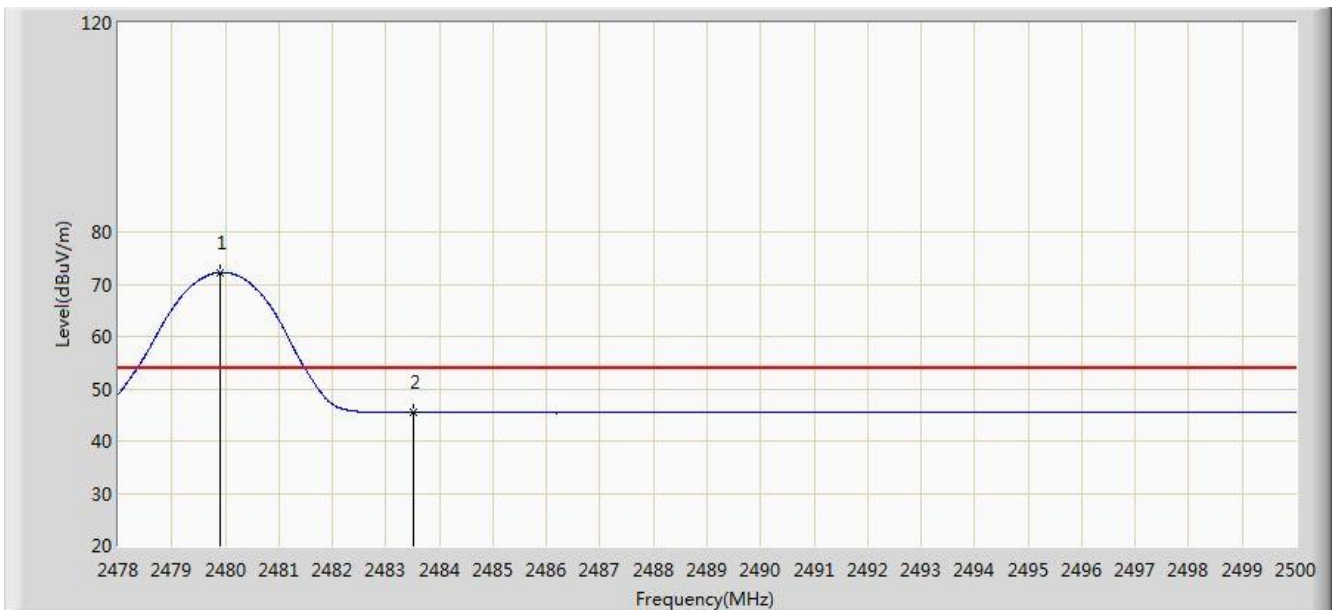

No	Flag	Mark	Frequency (MHz)	Measure Level (dBuV/m)	Reading Level (dBuV)	Over Limit (dB)	Limit (dBuV/m)	Factor (dB)	Type
1			2479.903	72.265	41.081	N/A	N/A	31.184	AV
2			2483.500	45.402	14.209	-8.598	54.000	31.194	AV

Note: Measure Level (dB μ V/m) = Reading Level (dB μ V) + Factor (dB)

Factor (dB) = Cable Loss (dB) + Antenna Factor (dB) (dB/m)

Site: AC1	Time: 2017/06/03 - 03:04
Limit: FCC_Part15.209_RE(3m)	Engineer: Will Yan
Probe: BBHA9120D_1-18GHz	Polarity: Vertical
EUT: Cassia Bluetooth Router	Power: By POE
Test Mode: Transmit by BLE at channel 2480MHz	

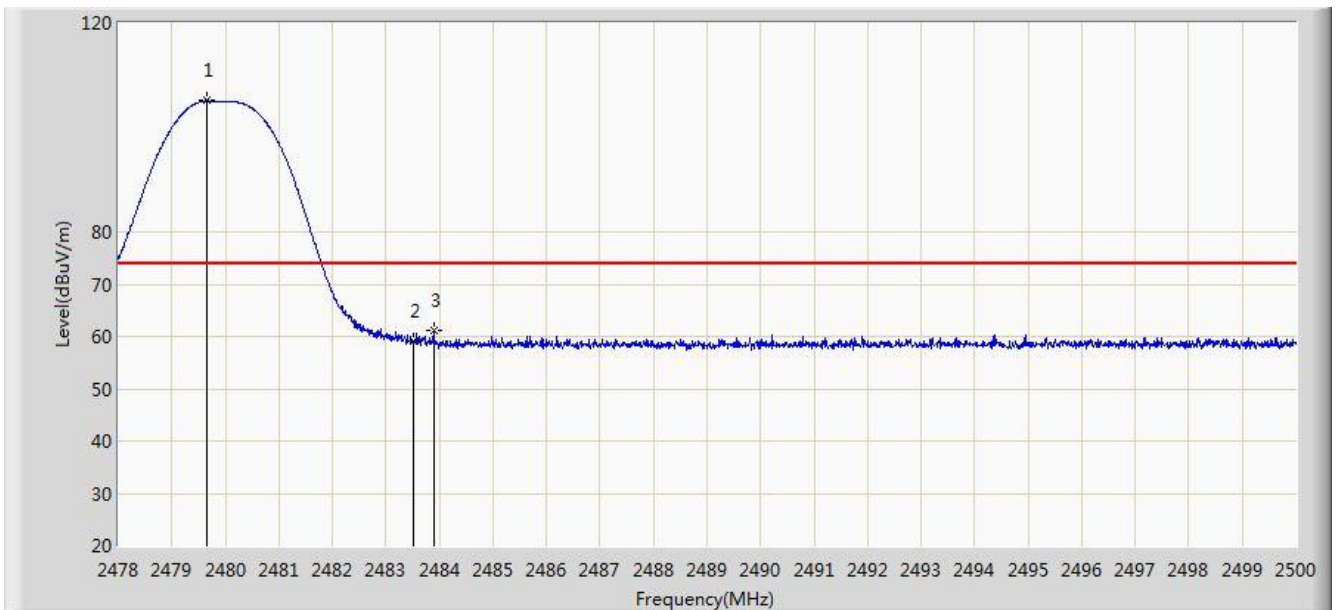

No	Flag	Mark	Frequency (MHz)	Measure Level (dBuV/m)	Reading Level (dBuV)	Over Limit (dB)	Limit (dBuV/m)	Factor (dB)	Type
1			2479.661	105.080	73.897	N/A	N/A	31.184	PK
2			2483.500	59.067	27.874	-14.933	74.000	31.194	PK
3			2483.896	61.150	29.956	-12.850	74.000	31.194	PK

Note: Measure Level (dB μ V/m) = Reading Level (dB μ V) + Factor (dB)

Factor (dB) = Cable Loss (dB) + Antenna Factor (dB) (dB/m)

Site: AC1	Time: 2017/06/03 - 03:05
Limit: FCC_Part15.209_RE(3m)	Engineer: Will Yan
Probe: BBHA9120D_1-18GHz	Polarity: Vertical
EUT: Cassia Bluetooth Router	Power: By POE
Test Mode: Transmit by BLE at channel 2480MHz	

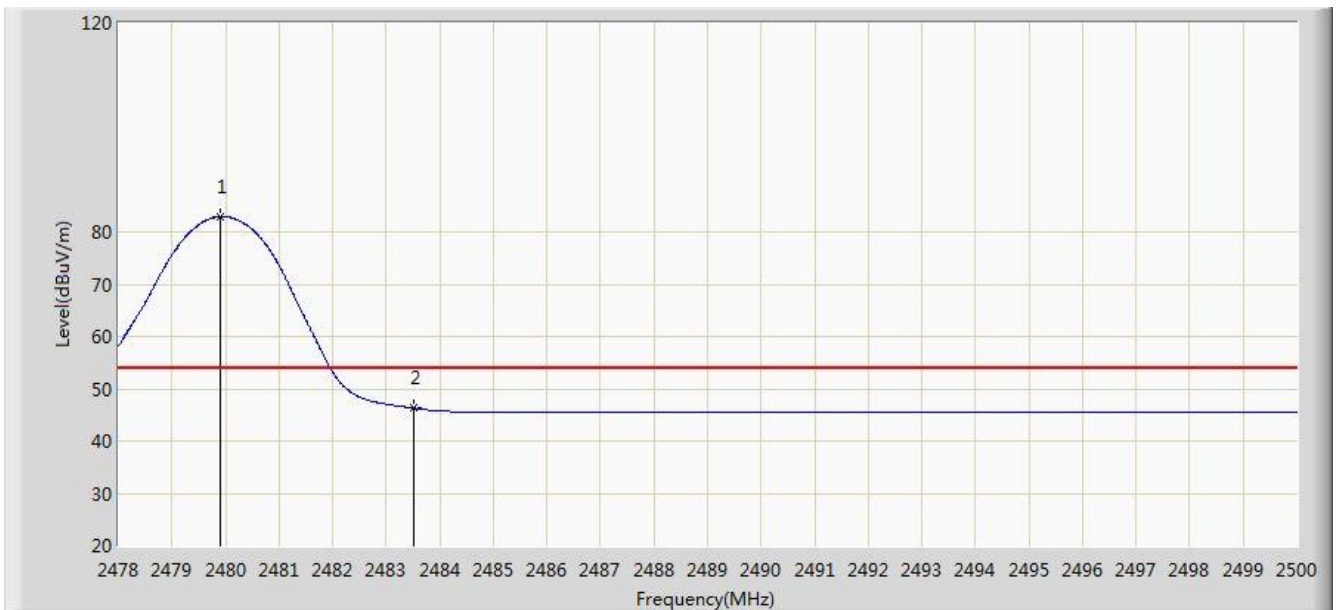

No	Flag	Mark	Frequency (MHz)	Measure Level (dBuV/m)	Reading Level (dBuV)	Over Limit (dB)	Limit (dBuV/m)	Factor (dB)	Type
1			2479.903	82.910	51.726	N/A	N/A	31.184	AV
2			2483.500	46.308	15.115	-7.692	54.000	31.194	AV

Note: Measure Level (dB μ V/m) = Reading Level (dB μ V) + Factor (dB)

Factor (dB) = Cable Loss (dB) + Antenna Factor (dB) (dB/m)

7.8. AC Conducted Emissions Measurement

7.8.1. Test Limit

FCC Part 15 Subpart C Paragraph 15.207 Limits		
Frequency (MHz)	QP (dBuV)	AV (dBuV)
0.15 - 0.50	66 - 56	56 - 46
0.50 - 5.0	56	46
5.0 - 30	60	50

Note 1: The lower limit shall apply at the transition frequencies.

Note 2: The limit decreases linearly with the logarithm of the frequency in the range 0.15MHz to 0.5MHz.

7.8.2. Test Setup

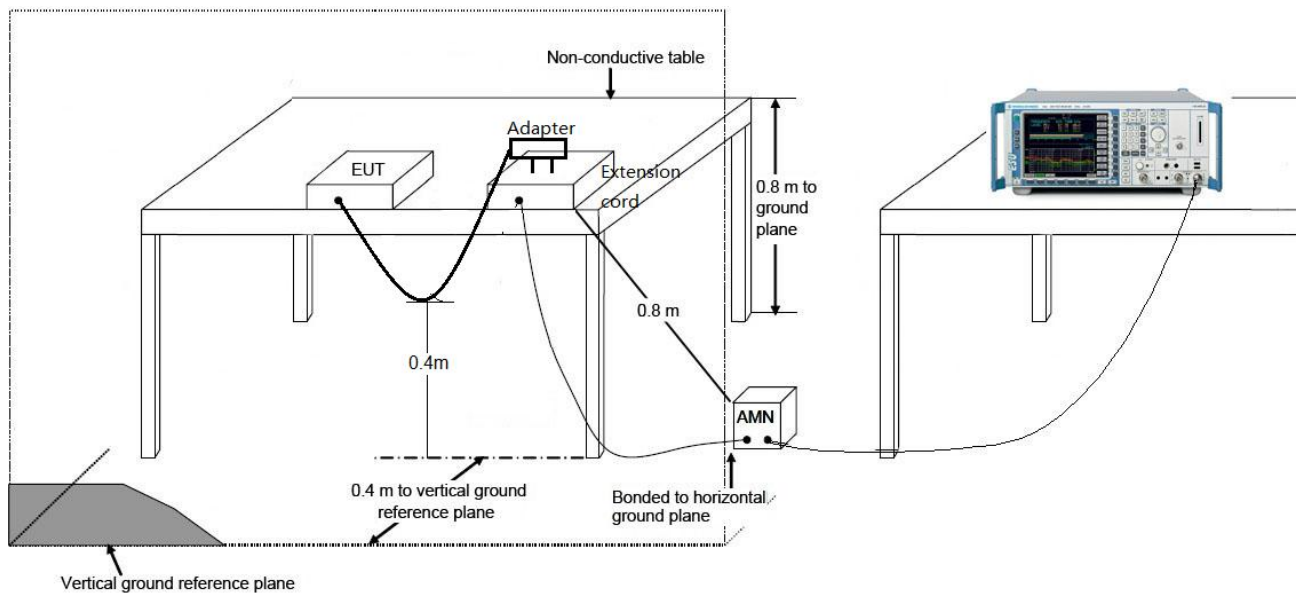

7.8.3. Test Result

Site: SR2	Time: 2017/05/27 - 14:04
Limit: FCC_Part15.207_CE_AC Power	Engineer: Vince Yu
Probe: ENV216_101683_Filter On	Polarity: Line
EUT: Cassia Bluetooth Router	Power: By POE
Worst Case Mode: Transmit by BLE at channel 2402MHz	

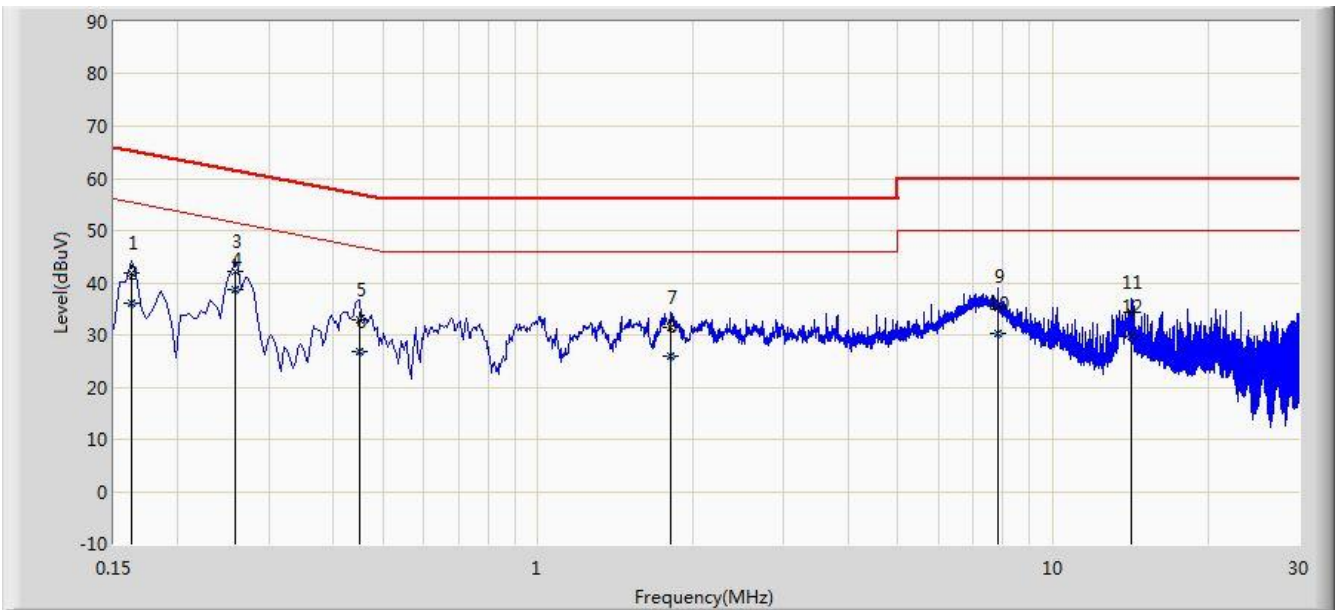

No	Flag	Mark	Frequency (MHz)	Measure Level (dBuV)	Reading Level (dBuV)	Over Limit (dB)	Limit (dBuV)	Factor (dB)	Type
1			0.162	41.903	31.750	-23.457	65.361	10.153	QP
2			0.162	36.158	26.006	-19.202	55.361	10.153	AV
3			0.258	42.299	32.280	-19.196	61.496	10.018	QP
4		*	0.258	38.816	28.797	-12.679	51.496	10.018	AV
5			0.450	32.832	22.695	-24.043	56.875	10.137	QP
6			0.450	26.917	16.780	-19.958	46.875	10.137	AV
7			1.814	31.321	21.381	-24.679	56.000	9.941	QP
8			1.814	25.835	15.895	-20.165	46.000	9.941	AV
9			7.802	35.509	25.448	-24.491	60.000	10.061	QP
10			7.802	30.391	20.331	-19.609	50.000	10.061	AV
11			14.154	34.215	24.368	-25.785	60.000	9.847	QP
12			14.154	29.639	19.792	-20.361	50.000	9.847	AV

Note: Measure Level (dBμV) = Reading Level (dBμV) + Factor (dB)

Factor (dB) = Cable Loss (dB) + LISN Factor (dB)

Site: SR2	Time: 2017/05/27 - 14:08
Limit: FCC_Part15.207_CE_AC Power	Engineer: Vince Yu
Probe: ENV216_101683_Filter On	Polarity: Neutral
EUT: Cassia Bluetooth Router	Power: By POE
Worst Case Mode: Transmit by BLE at channel 2402MHz	

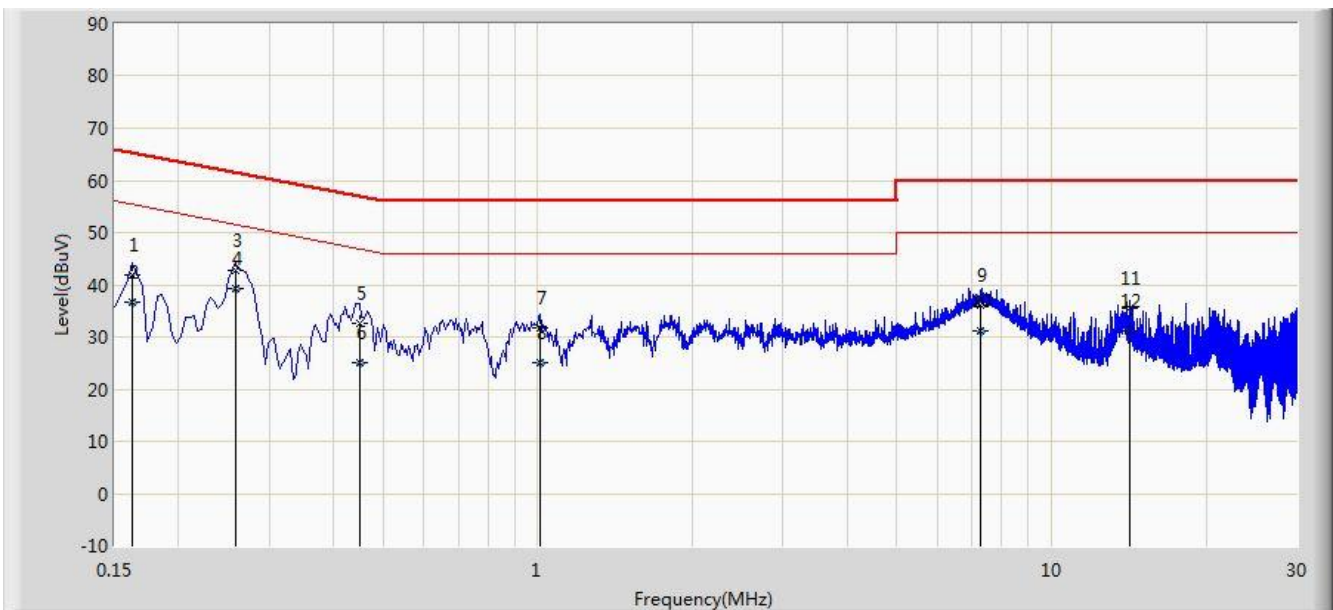

No	Flag	Mark	Frequency (MHz)	Measure Level (dBuV)	Reading Level (dBuV)	Over Limit (dB)	Limit (dBuV)	Factor (dB)	Type
1			0.162	41.790	31.656	-23.570	65.361	10.134	QP
2			0.162	36.679	26.545	-18.682	55.361	10.134	AV
3			0.258	42.750	32.695	-18.746	61.496	10.055	QP
4		*	0.258	39.365	29.310	-12.131	51.496	10.055	AV
5			0.450	32.588	22.428	-24.287	56.875	10.161	QP
6			0.450	25.140	14.979	-21.735	46.875	10.161	AV
7			1.010	31.687	21.790	-24.313	56.000	9.897	QP
8			1.010	25.206	15.309	-20.794	46.000	9.897	AV
9			7.290	35.946	25.899	-24.054	60.000	10.047	QP
10			7.290	31.106	21.059	-18.894	50.000	10.047	AV
11			14.154	35.413	25.522	-24.587	60.000	9.892	QP
12			14.154	31.169	21.277	-18.831	50.000	9.892	AV

Note: Measure Level (dBμV) = Reading Level (dBμV) + Factor (dB)

Factor (dB) = Cable Loss (dB) + LISN Factor (dB)

8. CONCLUSION

The data collected relate only the item(s) tested and show that the **Cassia Bluetooth Router FCC ID: 2ALGLX1000** is in compliance with Part 15C of the FCC Rules and ISED Rules.

————— The End —————