

FCC RADIO TEST REPORT

FCC ID: 2ALG4AIML20

Sample: Range finder

Trade Name: GolfBuddy

Main Model: aim L20

Additional Model: N/A

Report No.: UNIA22083022ER-61

Prepared for

GolfzonDeca Inc.

253, Pangyo-ro, Bundang-gu, Seongnam-si, Gyeonggi-do, 13517,
South Korea

Prepared by

Shenzhen United Testing Technology Co., Ltd.

2F, Annex Bldg, Jiahuangyuan Tech Park, #365 Baotian 1 Rd, Tiegang
Community, XixiangStr, Bao'an District, Shenzhen, China

TEST RESULT CERTIFICATION

Applicant : GolfzonDeca Inc.
Address : 253, Pangyo-ro, Bundang-gu, Seongnam-si, Gyeonggi-do, 13517,
South Korea
Manufacturer..... : JINHUA LANHAI PHOTOELECTRICITY TECHNOLOGY CO.,LTD.
Address : NO.358,JIDAO STREET,INDUSTRIAL DISTRICT,JINHUA,
ZHEJIANG,CHINA

Product description
Product..... : Range finder
Trade Name..... : GolfBuddy
Model Name..... : aim L20

Test Methods..... : FCC Rules and Regulations Part 15 Subpart C Section 15.247
ANSI C63.10: 2013

This device described above has been tested by Shenzhen United Testing Technology Co., Ltd., and the test results show that the equipment under test (EUT) is in compliance with the FCC requirements. And it is applicable only to the tested sample identified in the report. This report shall not be reproduced except in full, without the written approval of UNI, this document may be altered or revised by Shenzhen United Testing Technology Co., Ltd., personnel only, and shall be noted in the revision of the document.

Date (s) of performance of tests : Aug. 30, 2022 ~ Sep. 20, 2022
Date of Issue : Sep. 27, 2022
Test Result..... : Pass

Prepared by:

kahn.yang

Kahn yang/Supervisor

Reviewer:

kelly.cheng

Kelly Cheng/Supervisor

Approved & Authorized Signer:

liuze

Liuze/Manager

TABLE OF CONTENTS

1 GENERAL INFORMATION.....5

 1.1 PRODUCT DESCRIPTION5

 1.2 TABLE OF CARRIER FREQUENCYS6

 1.3 TEST METHODOLOGY6

 1.4 SPECIAL ACCESSORIES6

 1.5 EQUIPMENT MODIFICATIONS6

 1.6 ANTENNA REQUIREMENT6

2 MEASUREMENT UNCERTAINTY.....7

3 DESCRIPTION OF TEST MODES.....7

4 SYSTEM TEST CONFIGURATION.....8

 4.1 CONFIGURATION OF TESTED SYSTEM8

 4.2 EQUIPMENT USED IN TESTED SYSTEM8

 4.3 SUMMARY OF TEST RESULTS8

5 TEST FACILITY9

6 TEST EQUIPMENT OF RADIATED EMISSION TEST10

7 PEAK OUTPUT POWER12

 7.1 MEASUREMENT PROCEDURE12

 7.2 TEST SET-UP (BLOCK DIAGRAM OF CONFIGURATION)12

 7.3 LIMITS AND MEASUREMENT RESULT13

8 6DB BANDWIDTH17

 8.1 MEASUREMENT PROCEDURE17

 8.2 TEST SET-UP (BLOCK DIAGRAM OF CONFIGURATION)17

 8.3 LIMITS AND MEASUREMENT RESULTS17

9 CONDUCTED SPURIOUS EMISSION21

 9.1 MEASUREMENT PROCEDURE21

 9.2 TEST SET-UP (BLOCK DIAGRAM OF CONFIGURATION)21

 9.3 MEASUREMENT EQUIPMENT USED21

 9.4 LIMITS AND MEASUREMENT RESULT21

10 MAXIMUM CONDUCTED OUTPUT POWER SPECTRAL DENSITY30

 10.1 MEASUREMENT PROCEDURE30

 10.2 TEST SET-UP (BLOCK DIAGRAM OF CONFIGURATION)30

 10.3 MEASUREMENT EQUIPMENT USED30

 10.4 LIMITS AND MEASUREMENT RESULT30

11 RADIATED EMISSION34

 11.1 MEASUREMENT PROCEDURE34

 11.2 TEST SETUP35

 11.3 LIMITS AND MEASUREMENT RESULT36

 11.4 TEST RESULT36

12 FCC LINE CONDUCTED EMISSION TEST.....	45
12.1 LIMITS OF LINE CONDUCTED EMISSION TEST.....	45
12.2 BLOCK DIAGRAM OF LINE CONDUCTED EMISSION TEST.....	45
12.3 PRELIMINARY PROCEDURE OF LINE CONDUCTED EMISSION TEST.....	46
12.4 FINAL PROCEDURE OF LINE CONDUCTED EMISSION TEST.....	46
12.5 TEST RESULT OF LINE CONDUCTED EMISSION TEST.....	46
APPENDIX A: PHOTOGRAPHS OF TEST SETUP.....	49

1 GENERAL INFORMATION

1.1 PRODUCT DESCRIPTION

Product:	Range finder
Trade Name:	GolfBuddy
Main Model:	aim L20
Additional Model:	N/A
Model Difference:	N/A
FCC ID:	2ALG4AIML20
Operation Frequency:	2402MHz~2480MHz
Number of Channels:	40CH
Modulation Type:	GFSK
Antenna Type:	Chip Antenna
Antenna Gain:	2.72dBi
Battery:	DC 3.7V, 800mAh
Adapter:	N/A
Power Source:	DC 3.7V from Li-battery or DC 5.0V from adapter with AC 120(240)V/60Hz

1.2 TABLE OF CARRIER FREQUENCIES

Frequency Band	Channel Number	Frequency
2400~2483.5MHz	0	2402 MHz
	1	2404 MHz
	:	:
	38	2478 MHz
	39	2480 MHz

1.3 TEST METHODOLOGY

Both conducted and radiated testing was performed according to the procedures in ANSI C63.10 (2013). Radiated testing was performed at an antenna to EUT distance 3 meters.

1.4 SPECIAL ACCESSORIES

Refer to section 5.2.

1.5 EQUIPMENT MODIFICATIONS

Not available for this EUT intended for grant.

1.6 ANTENNA REQUIREMENT

This intentional radiator is designed with a permanently attached antenna of an antenna to ensure that no antenna other than that furnished by the responsible party shall be used with the device. For more information of the antenna, please refer to the PHOTOGRAPHS OF EUT.

2 MEASUREMENT UNCERTAINTY

The reported uncertainty of measurement $y \pm U$, where expanded uncertainty U is based on a standard uncertainty multiplied by a coverage factor of $k=2$, providing a level of confidence of approximately 95 %.

A. Conducted Measurement:

Test Site	Method	Measurement Frequency Range	U, (dB)	NOTE
UNI	ANSI	9kHz ~ 150kHz	2.96	
		150kHz ~ 30MHz	2.44	

B. Radiated Measurement:

Test Site	Method	Measurement Frequency Range	U, (dB)	NOTE
UNI	ANSI	9kHz ~ 30MHz	2.50	
		30MHz ~ 1000MHz	4.80	
		Above 1000MHz	4.13	

3 DESCRIPTION OF TEST MODES

NO.	TEST MODE DESCRIPTION
1	Low channel TX
2	Middle channel TX
3	High channel TX

- Note: 1. Only the result of the worst case was recorded in the report, if no other cases.
 2. For Radiated Emission, 3axis were chosen for testing for each applicable mode.
 3. ForConductedTestmethod,atemporaryantennaconnectorisprovidedbythemanufacture.

4 SYSTEM TEST CONFIGURATION

4.1 CONFIGURATION OF TESTED SYSTEM

Operation of EUT during Conducted and Radiation(Below 1GHz) testing:



Operation of EUT during Radiation(Above) testing:



4.2 EQUIPMENT USED IN TESTED SYSTEM

Item	Equipment	Model No.	ID or Specification	Remark
1	Range finder	aim L20	2ALG4AIML20	EUT
2	Adapter	MDY-08-EF	XIAOMI	AE
3	N/A	N/A	N/A	N/A
4	N/A	N/A	N/A	N/A

4.3 SUMMARY OF TEST RESULTS

FCC RULES	DESCRIPTION OF TEST	RESULT
15.247 (b)(3)	Peak Output Power	Compliant
15.247 (a)(2)	6 dB Bandwidth	Compliant
15.247 (d)	Conducted Spurious Emission	Compliant
15.247 (e)	Maximum Conducted Output Power Density	Compliant
15.209	Radiated Emission	Compliant
15.207	Conducted Emission	Compliant

5 TEST FACILITY

Test Laboratory: Shenzhen United Testing Technology Co., Ltd.

Address : 2F, Annex Bldg, Jiahuangyuan Tech Park, #365 Baotian 1 Rd, Tiegang Community, Xixiang Str, Bao'an District, Shenzhen, China

The testing quality ability of our laboratory meet with "Quality Law of People's Republic of China" Clause 19. The testing quality system of our laboratory meets with ISO/IEC-17025 requirements. This approval result is accepted by MRA of APLAC.

Our test facility is recognized, certified, or accredited by the following organizations:

A2LA Certificate Number: 4747.01

The EMC Laboratory has been accredited by A2LA, and in compliance with ISO/IEC 17025:2017 General Requirements for testing Laboratories.

FCC Registration Number: 674885

The EMC Laboratory has been registered and fully described in a report filed with the (FCC) Federal Communications commission.

IC Registration Number: 21947

The EMC Laboratory has been registered and fully described in a report filed with the (IC) Industry Canada.

6 TEST EQUIPMENT OF RADIATED EMISSION TEST

Item	Equipment	Manufacturer	Model No.	Serial No.	Calibrated until
Conduction Emissions Measurement					
1	Conducted Emission Test Software	EZ-EMC	Ver.CCS-3A1-CE	N/A	N/A
2	AMN	Schwarzbeck	NNLK8121	8121370	2022.09.22
3	AAN	TESEQ	T8-Cat6	38888	2022.09.22
4	Pulse Limiter	CYBRTEK	EM5010	E115010056	2023.05.30
5	EMI Test Receiver	Rohde&Schwarz	ESCI	101210	2022.09.22
Radiated Emissions Measurement					
1	Radiated Emission Test Software	EZ-EMC	Ver.CCS-03A1	N/A	N/A
2	Horn Antenna	Sunol	DRH-118	A101415	2022.09.27
3	Broadband Hybrid Antenna	Sunol	JB1	A090215	2024.02.26
4	PREAMP	HP	8449B	3008A00160	2022.09.22
5	PREAMP	HP	8447D	2944A07999	2023.05.30
6	EMI TEST RECEIVER	Rohde&Schwarz	ESR3	101891	2022.09.22
7	VECTOR Signal Generator	Rohde&Schwarz	SMU200A	101521	2022.09.22
8	Signal Generator	Agilent	E4421B	MY4335105	2022.09.22
9	MXA Signal Analyzer	Agilent	N9020A	MY50510140	2022.09.22
10	MXA Signal Analyzer	Keysight	N9020A	MY51110104	2022.09.22
11	RF Power sensor	DARE	RPR3006W	15I00041SNO88	2023.05.30
12	RF Power sensor	DARE	RPR3006W	15I00041SNO89	2023.05.30
13	RF power divider	Anritsu	K241B	992289	2022.09.22
14	Wideband radio communication tester	Rohde&Schwarz	CMW500	154987	2022.09.22
15	Active Loop Antenna	Com-Power	AL-130R	10160009	2023.05.30
16	Broadband Hybrid Antennas	Schwarzbeck	VULB9163	VULB9163#958	2022.09.22
17	Horn Antenna	Schwarzbeck	BBHA9120D	9120D-1680	2023.05.30
18	Horn Antenna	A-INFOMW	LB-180400-KF	J211060660	2022.09.27
19	Microwave Broadband Preamplifier	Schwarzbeck	BBV 9721	100472	2022.09.22
20	Signal Generator	Agilent	N5183A	MY47420153	2022.09.22
21	Spectrum Analyzer	Rohde&Schwarz	FSP 40	100501	2022.09.22
22	Power Meter	KEYSIGHT	N1911A	MY50520168	2022.09.22

23	Frequency Meter	VICTOR	VC2000	997406086	2022.09.22
24	DC Power Source	HYELEC	HY5020E	055161818	2022.09.22

7 PEAK OUTPUT POWER

7.1 MEASUREMENT PROCEDURE

For peak power test:

1. Connect EUT RF output port to the Spectrum Analyzer through an RF attenuator
2. $RBW \geq DTS$ bandwidth
3. $VBW \geq 3 * RBW$.
4. $SPAN \geq VBW$.
5. Sweep: Auto.
6. Detector function: Peak.
7. Trace: Max hold.

Allow trace to stabilize. Use the marker-to-peak function to set the marker to the peak of the emission. The indicated level is the peak output power, after any corrections for external attenuators and cables.

7.2 TEST SET-UP (BLOCK DIAGRAM OF CONFIGURATION) PEAK POWER TEST SETUP

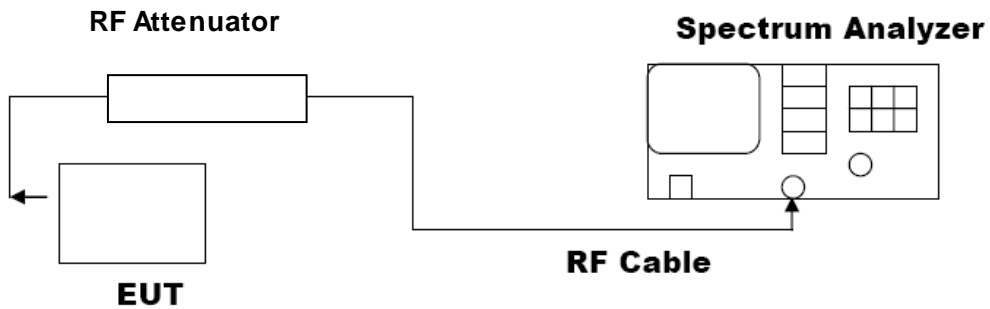

7.3 LIMITS AND MEASUREMENT RESULT

PEAK OUTPUT POWER MEASUREMENT RESULT FOR BLE 1M			
Frequency (GHz)	Peak Power (dBm)	Applicable Limits (dBm)	Pass or Fail
2.402	2.454	30	Pass
2.440	2.426	30	Pass
2.480	2.089	30	Pass

CH0

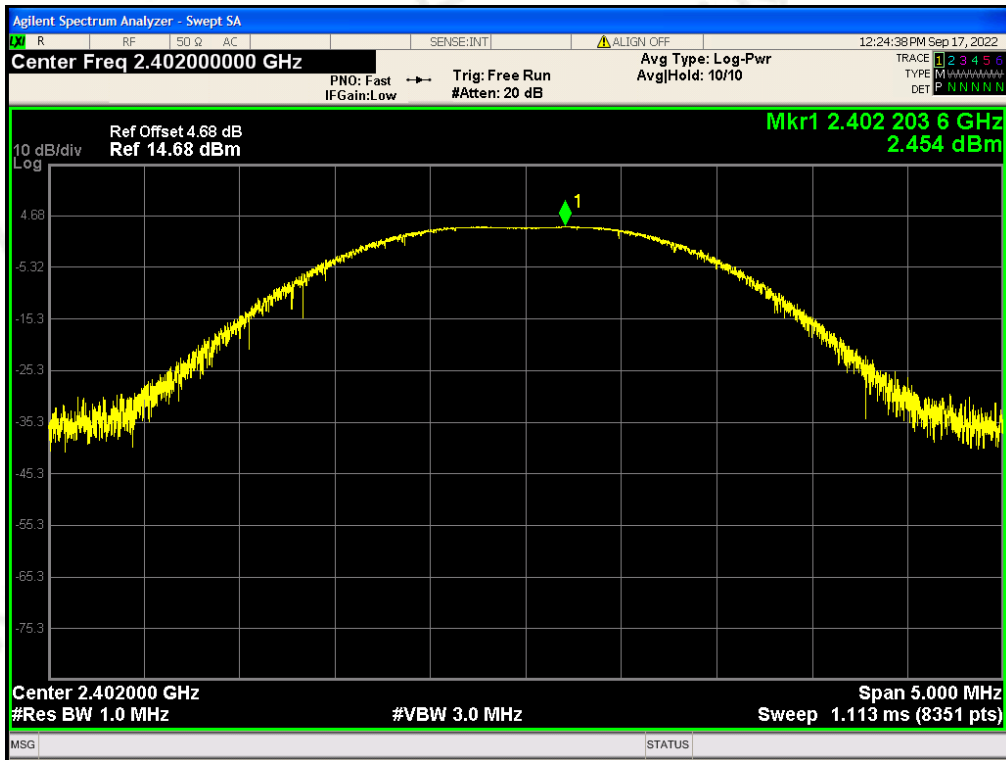

CH19

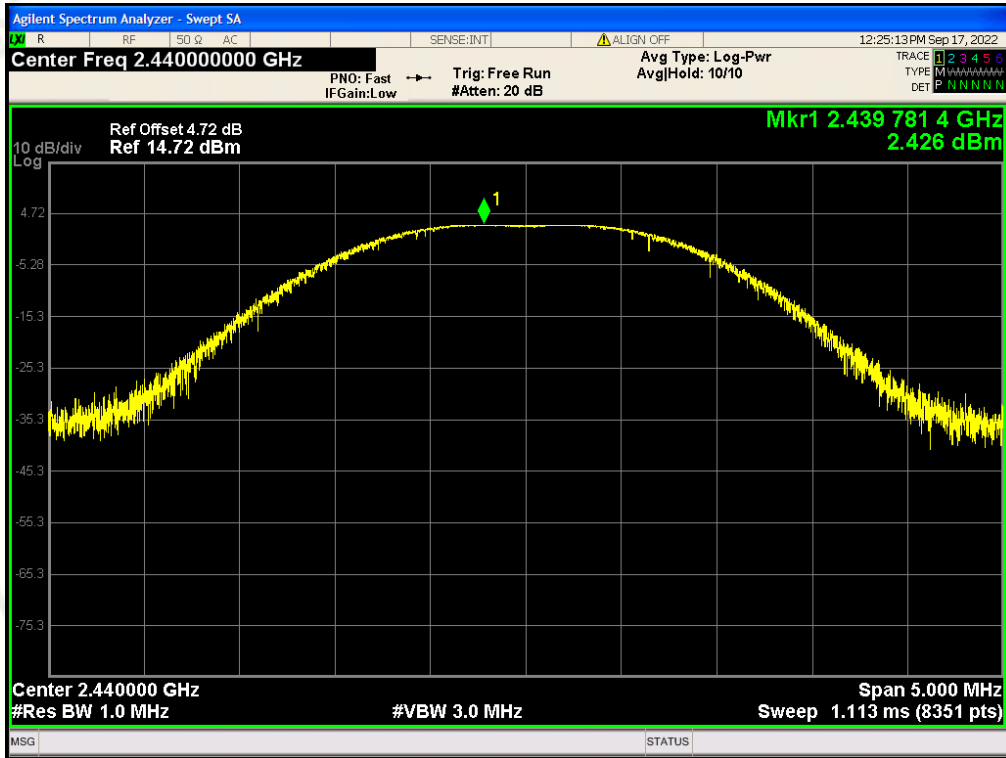

CH39

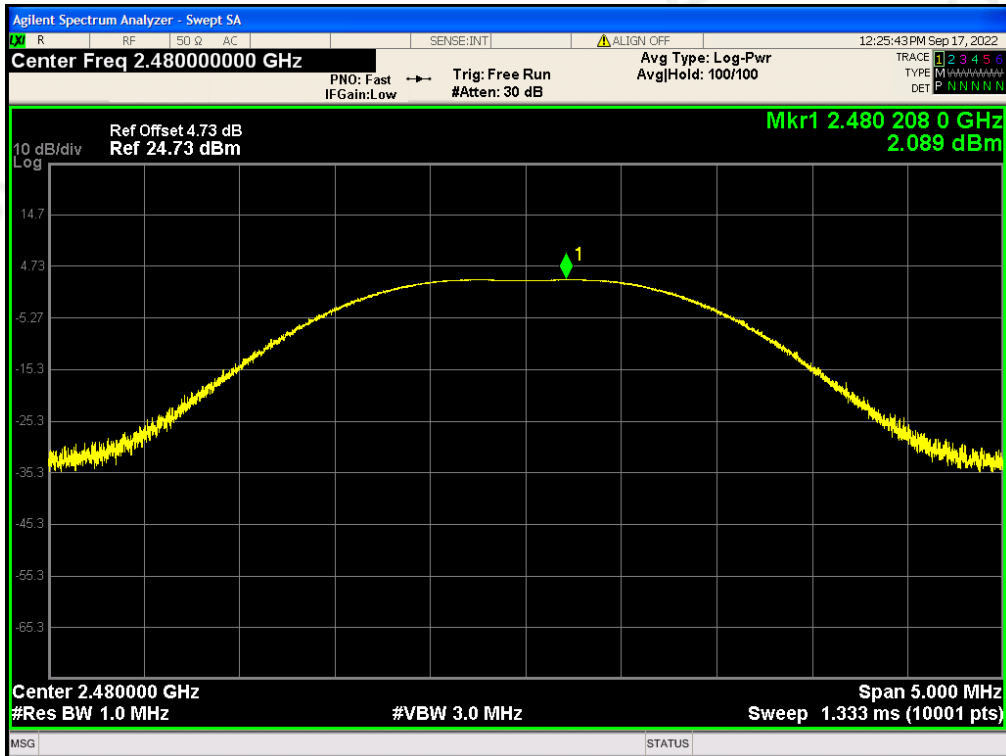

PEAK OUTPUT POWER MEASUREMENT RESULT FOR BLE 2M			
Frequency (GHz)	Peak Power (dBm)	Applicable Limits (dBm)	Pass or Fail
2.402	2.432	30	Pass
2.440	2.403	30	Pass
2.480	2.055	30	Pass

CH0

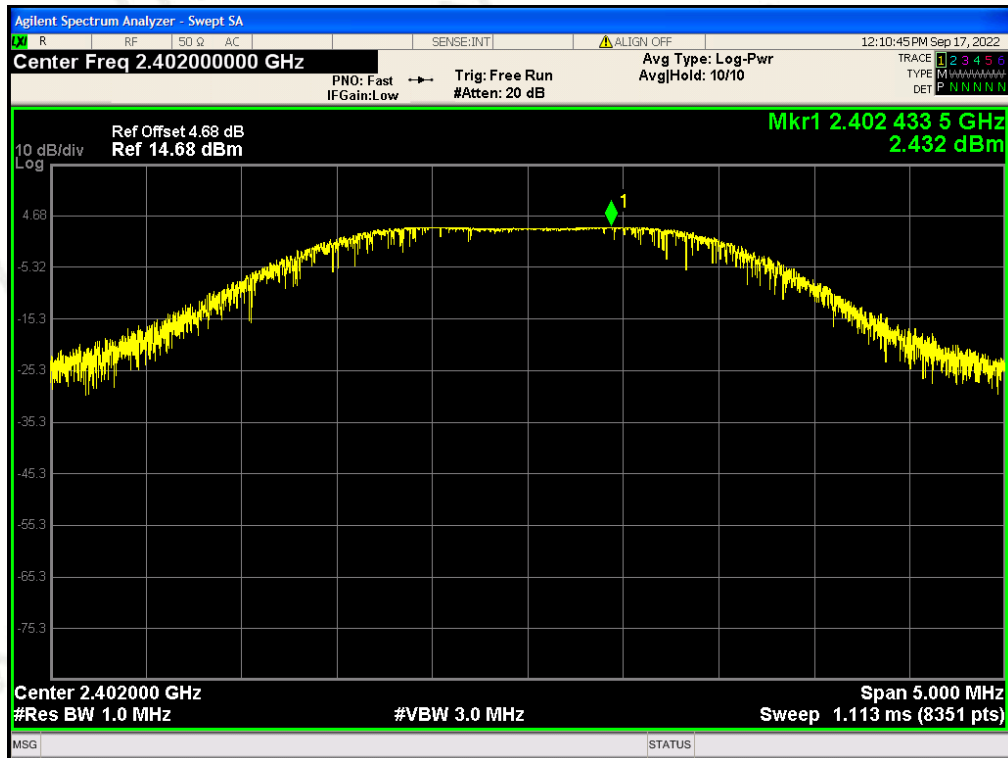

CH19

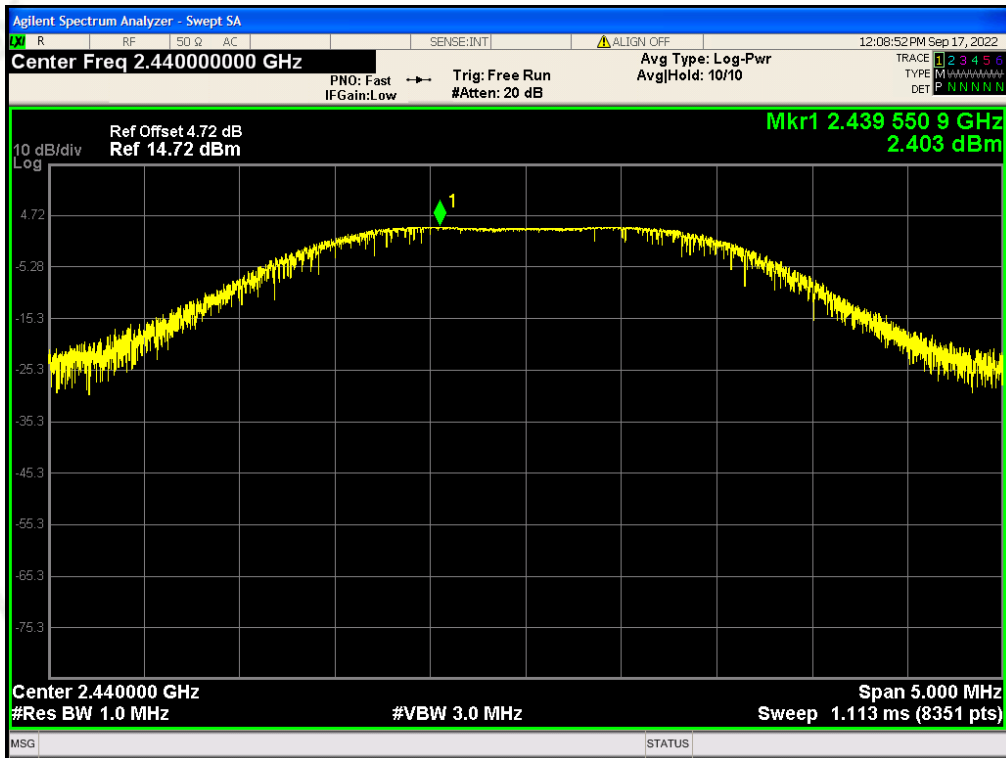

CH39

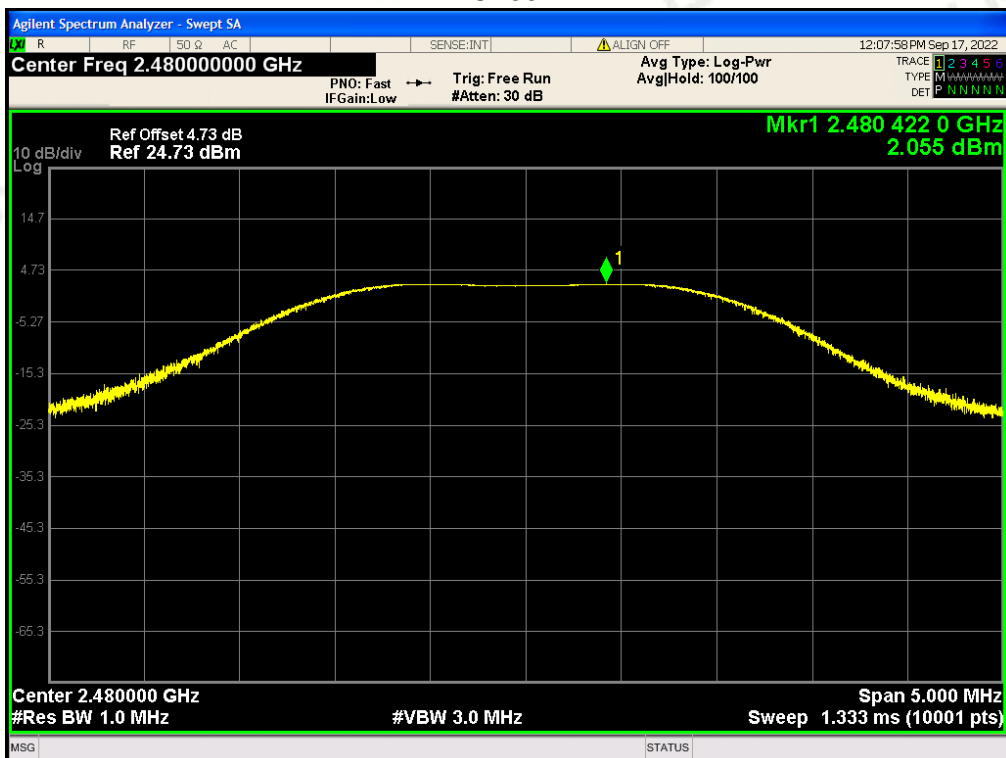

8 6DB BANDWIDTH

8.1 MEASUREMENT PROCEDURE

1. Connect EUT RF output port to the Spectrum Analyzer through an RF attenuator
2. Set the EUT Work on the top, the middle and the bottom operation frequency individually.
3. Set SPA Centre Frequency = Operation Frequency, RBW= 100 kHz,VBW \geq 3 \times RBW.
4. Set SPA Trace 1 Max hold, then View.

Note: The EUT was tested according to ANSI C63.10 for compliance to FCC PART 15.247 requirements.

8.2 TEST SET-UP (BLOCK DIAGRAM OF CONFIGURATION)

The same as described in section 7.2.

8.3 LIMITS AND MEASUREMENT RESULTS

LIMITS AND MEASUREMENT RESULT FOR BLE 1M			
Applicable Limits	Measurement Result		
	Test Data (MHz)		Criteria
>500KHZ	Low Channel	0.615	PASS
	Middle Channel	0.649	PASS
	High Channel	0.646	PASS

TEST PLOT OF BANDWIDTH FOR LOW CHANNEL

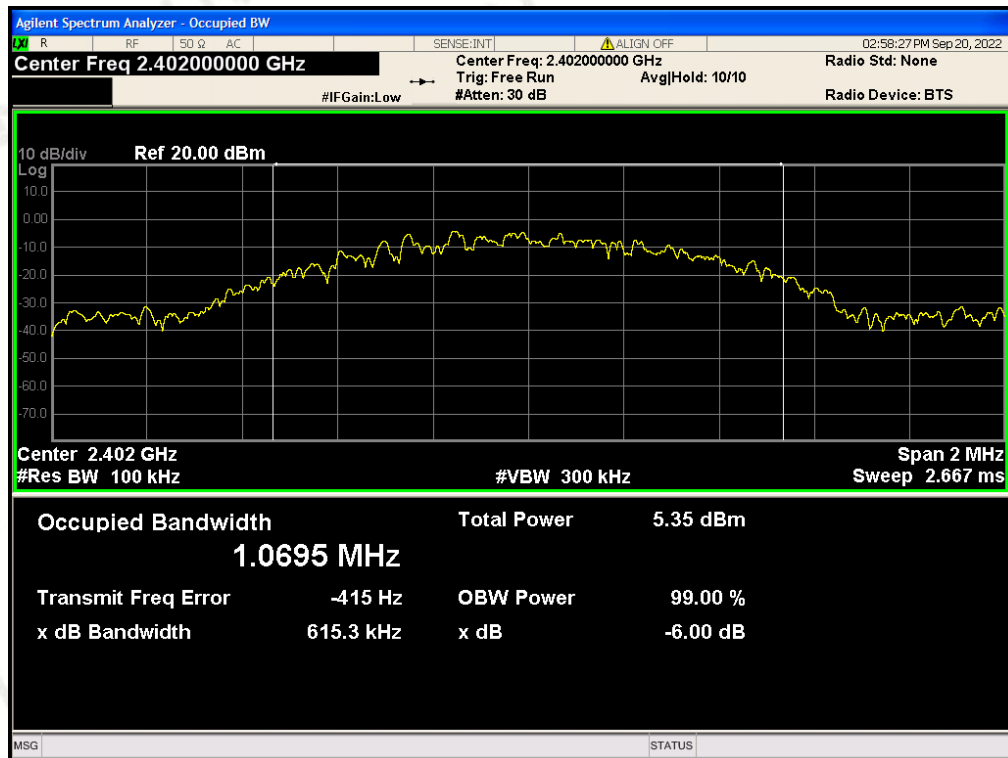

TEST PLOT OF BANDWIDTH FOR MIDDLE CHANNEL

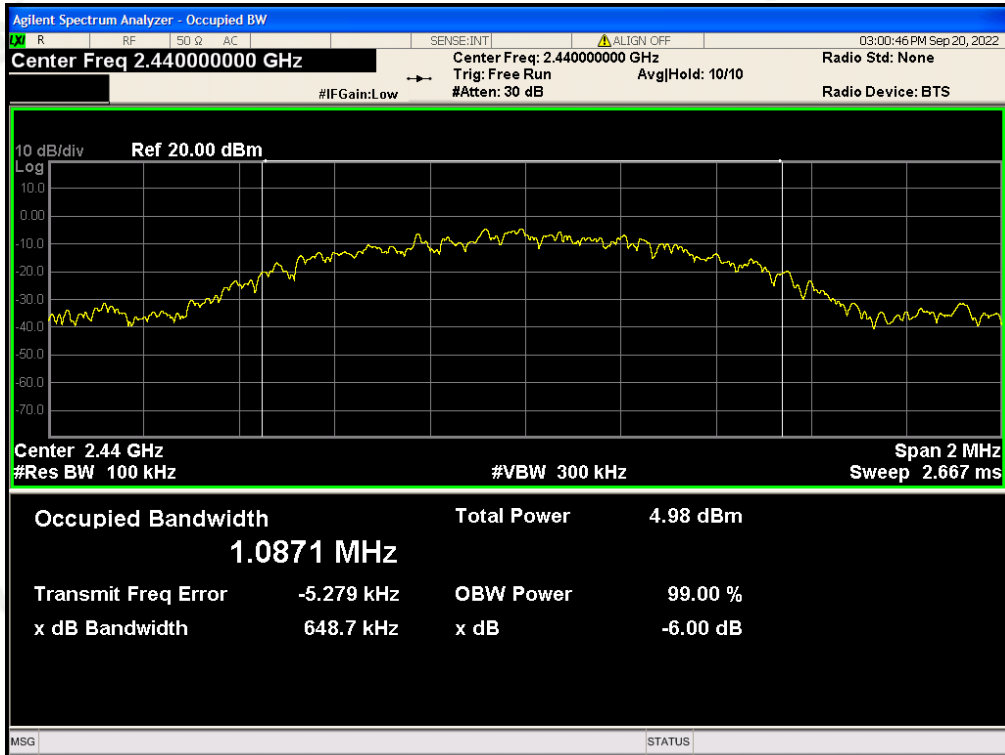

TEST PLOT OF BANDWIDTH FOR HIGH CHANNEL

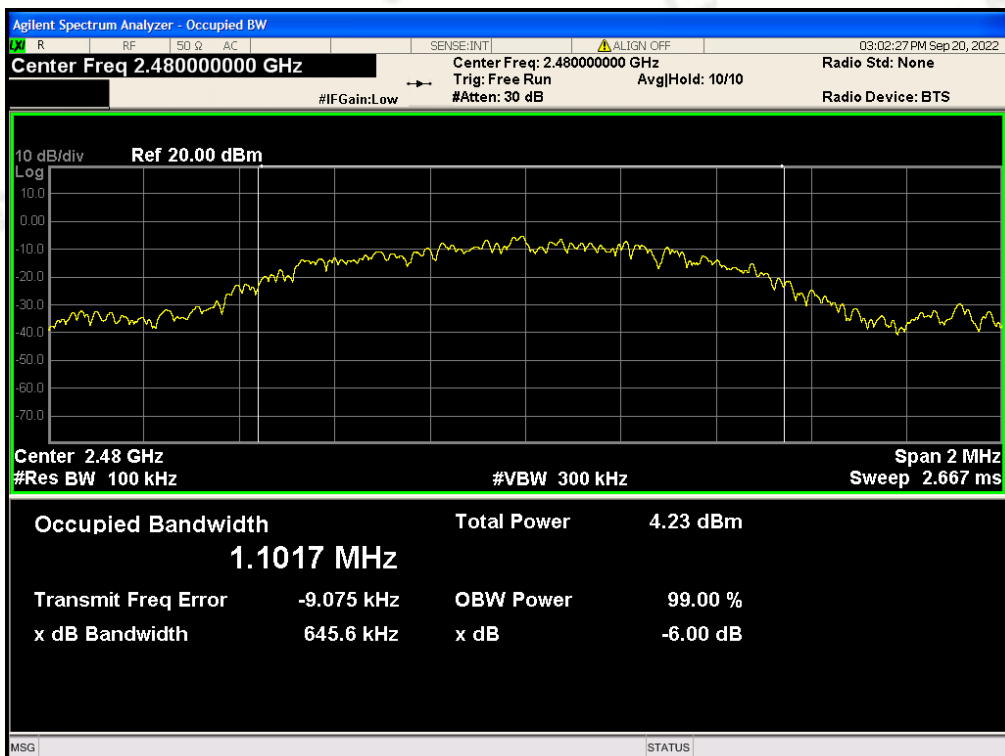

LIMITS AND MEASUREMENT RESULT FOR BLE 2M			
Applicable Limits	Measurement Result		
	Test Data (MHz)		Criteria
>500KHZ	Low Channel	1.092	PASS
	Middle Channel	1.157	PASS
	High Channel	1.055	PASS

TEST PLOT OF BANDWIDTH FOR LOW CHANNEL

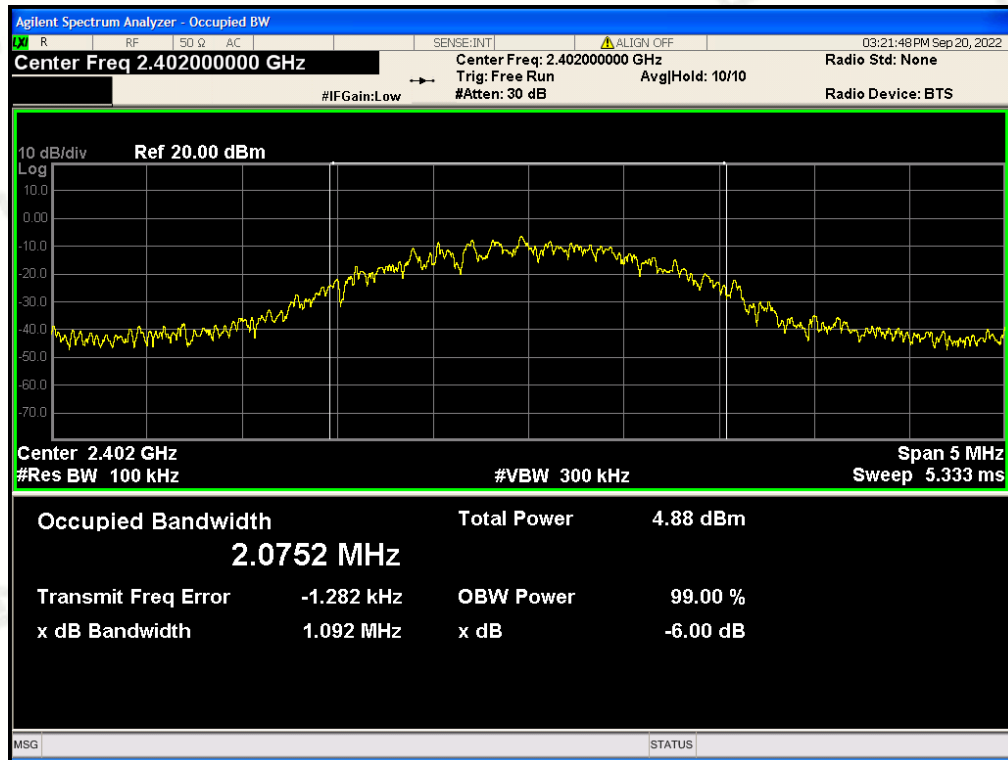

TEST PLOT OF BANDWIDTH FOR MIDDLE CHANNEL

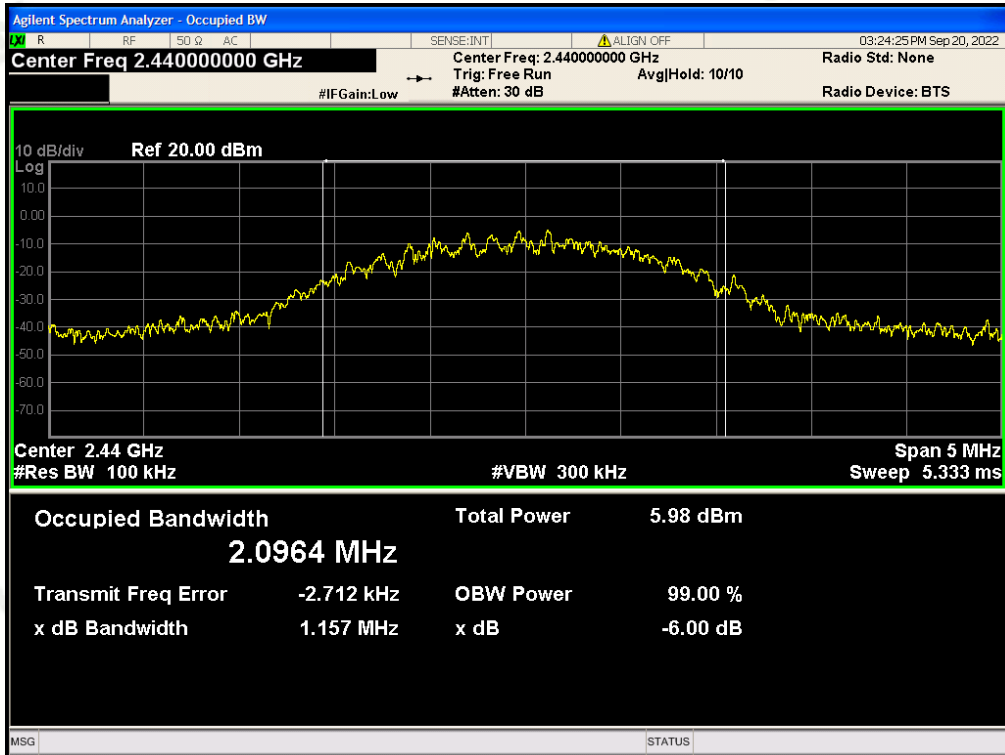

TEST PLOT OF BANDWIDTH FOR HIGH CHANNEL

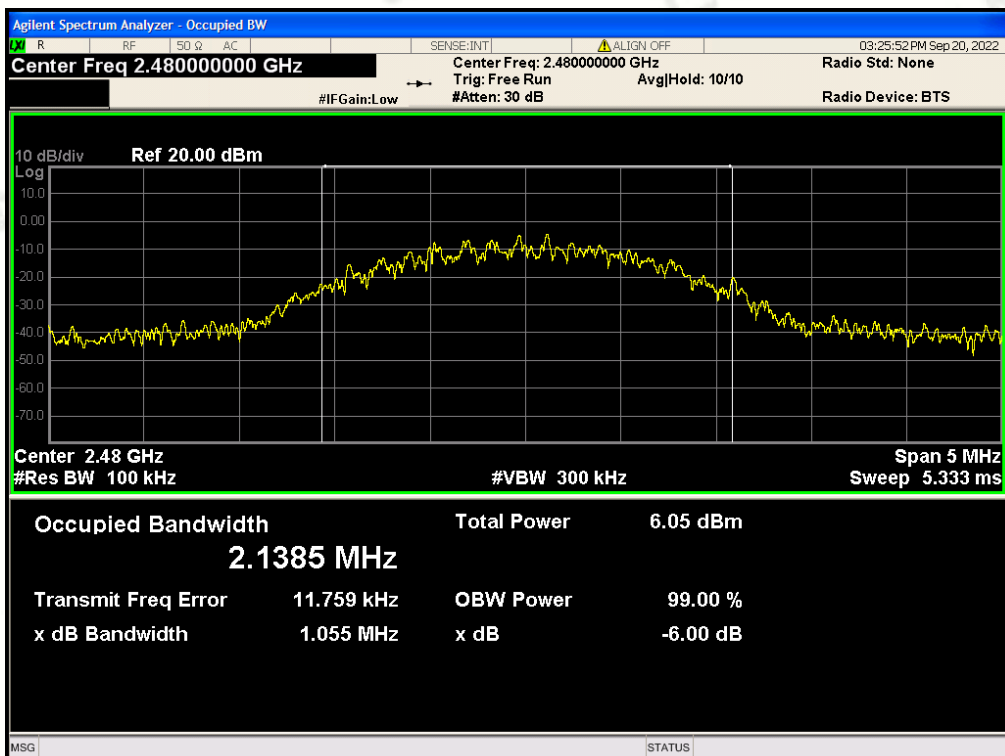

9 CONDUCTED SPURIOUS EMISSION

9.1 MEASUREMENT PROCEDURE

1. Connect EUT RF output port to the Spectrum Analyzer through an RF attenuator
2. Set the EUT Work on the top, the middle and the bottom operation frequency individually.
3. Set SPA Trace 1 Max hold, then View.

Note: The EUT was tested according to ANSI C63.10 for compliance to FCC PART 15.247 requirements.

9.2 TEST SET-UP (BLOCK DIAGRAM OF CONFIGURATION)

The same as described in section 7.2.

9.3 MEASUREMENT EQUIPMENT USED

The same as described in section 6.

9.4 LIMITS AND MEASUREMENT RESULT

LIMITS AND MEASUREMENT RESULT		
Applicable Limits	Measurement Result	
	Test Data	Criteria
In any 100 kHz Bandwidth Outside the frequency band in which the spread spectrum intentional radiator is operating, the radio frequency power that is produce by the intentional radiator shall be at least 20 dB below that in 100KHz bandwidth within the band that contains the highest level of the desired power.	At least -20dBc than the reference level	PASS

TEST RESULT FOR ENTIRE FREQUENCY RANGE FOR BLE 1M LOW CHANNEL

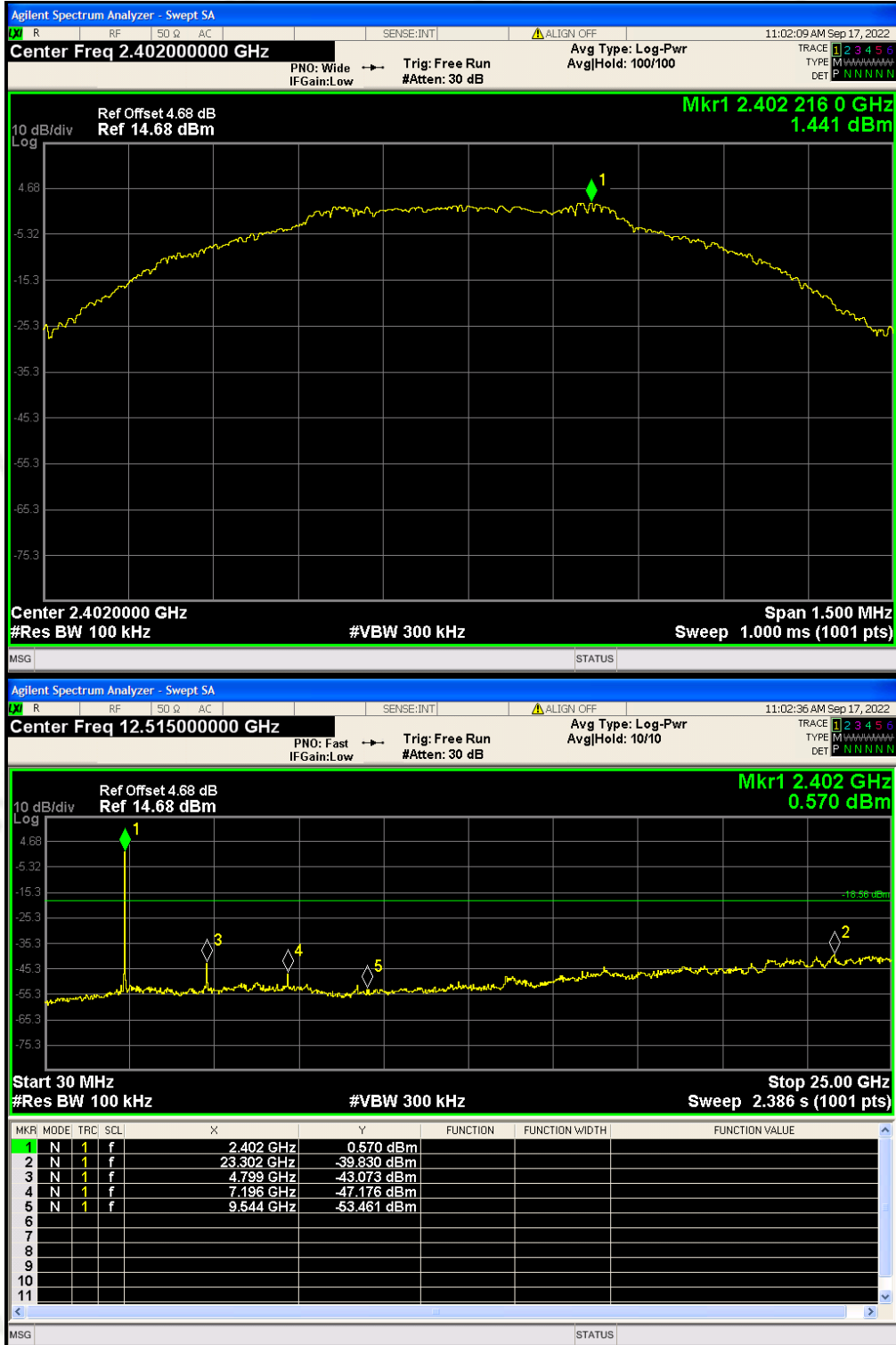

MIDDLE CHANNEL

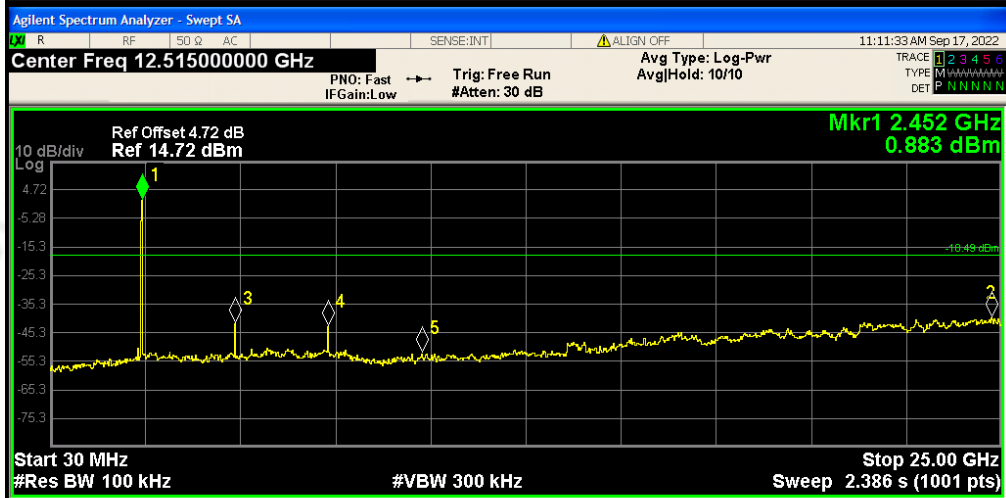
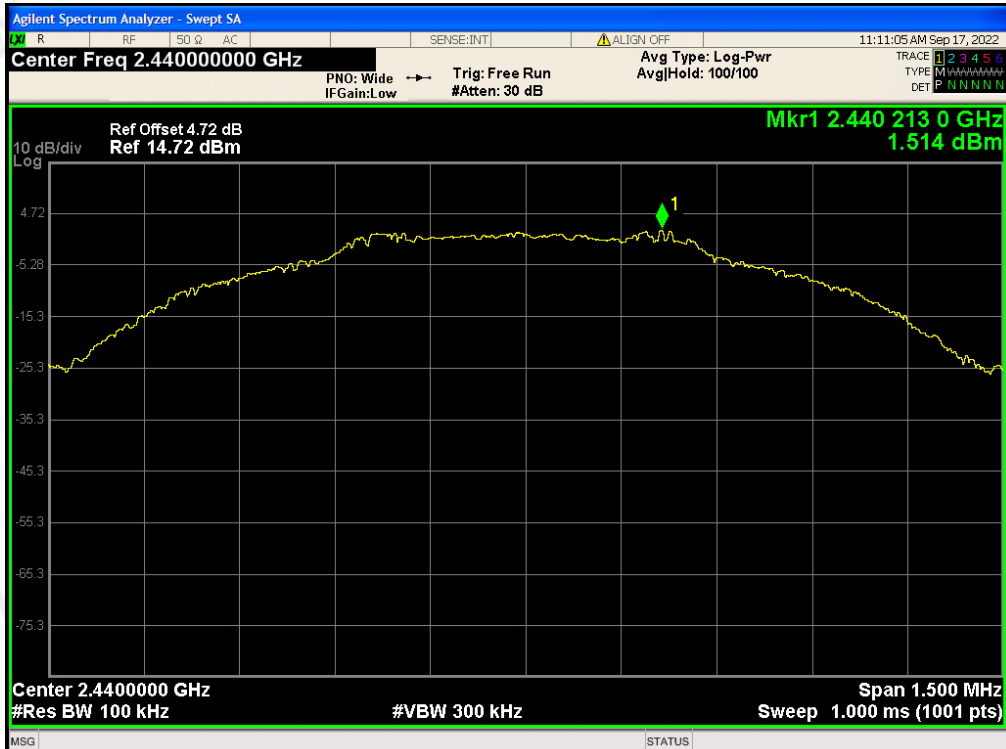

MKR	MODE	TRC	SCL	X	Y	FUNCTION	FUNCTION WIDTH	FUNCTION VALUE
1	N	1	f	2.452 GHz	0.883 dBm			
2	N	1	f	24.760 GHz	-40.215 dBm			
3	N	1	f	4.874 GHz	-42.176 dBm			
4	N	1	f	7.321 GHz	-43.321 dBm			
5	N	1	f	9.793 GHz	-52.666 dBm			
6								
7								
8								
9								
10								
11								

HIGH CHANNEL

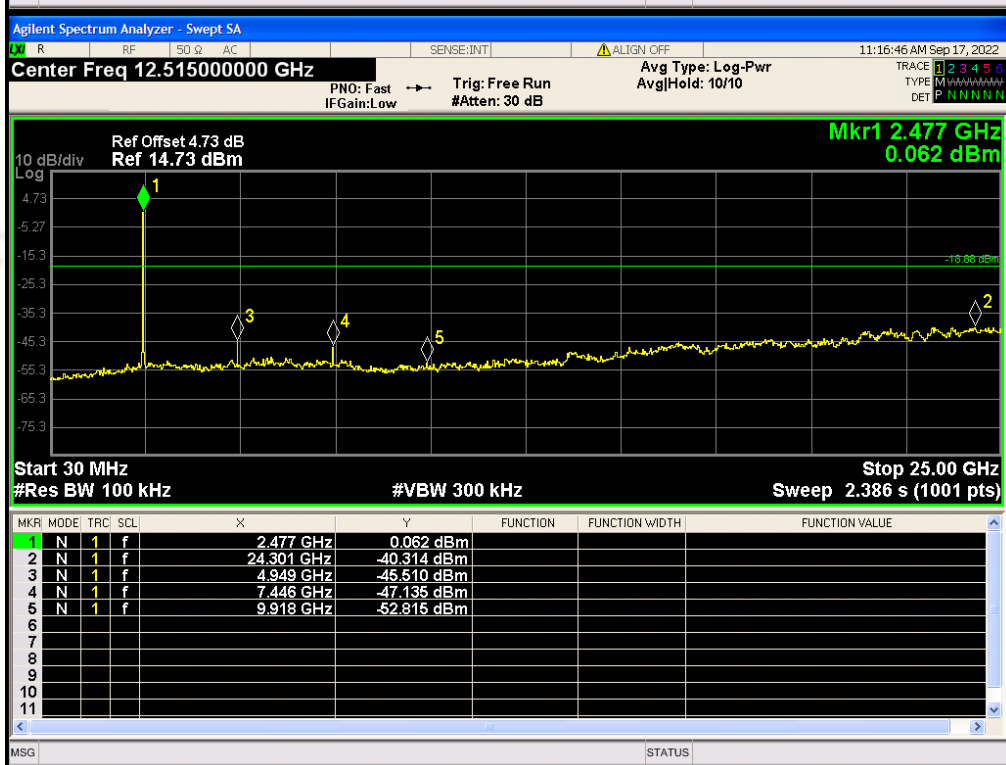
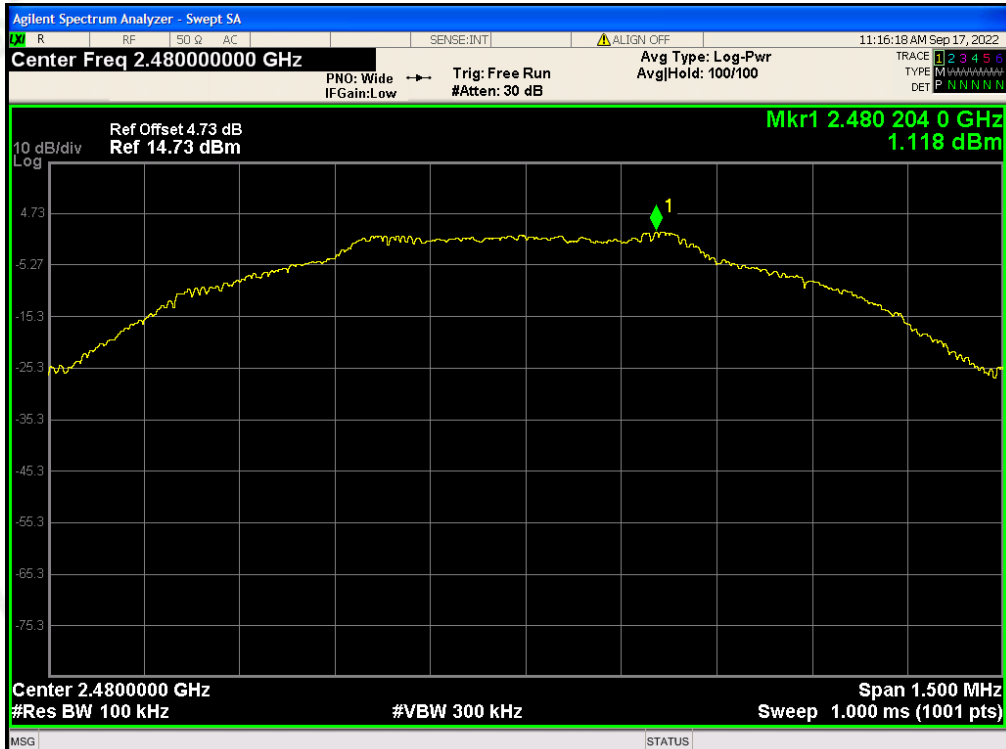

TEST RESULT FOR BAND EDGE FOR BLE 1M LOW CHANNEL

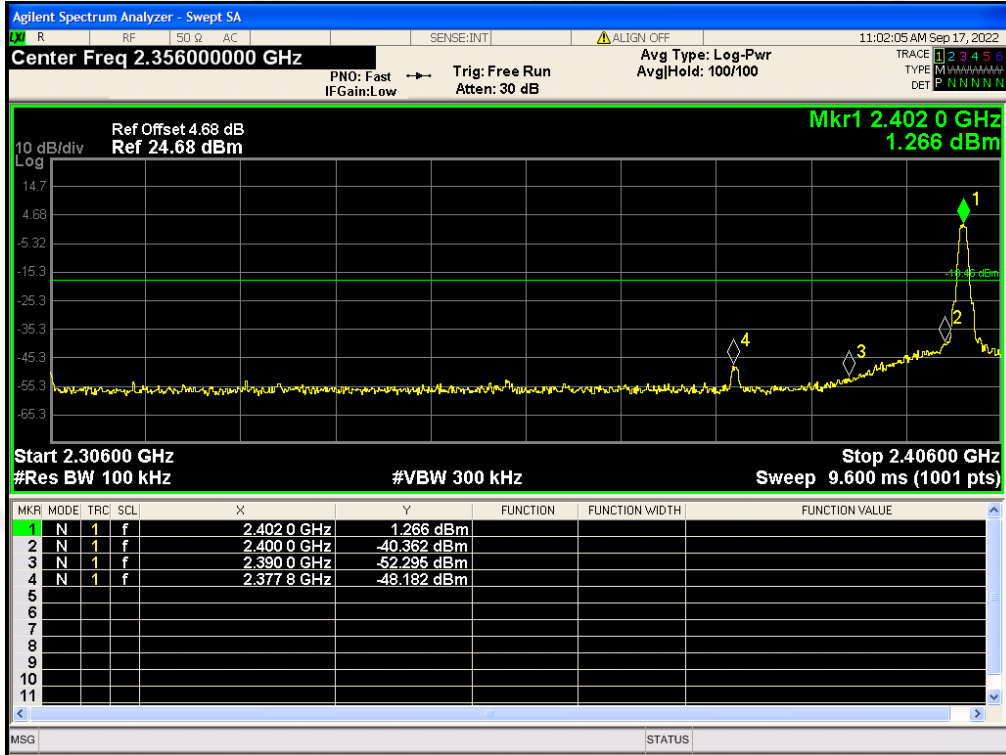

HIGH CHANNEL

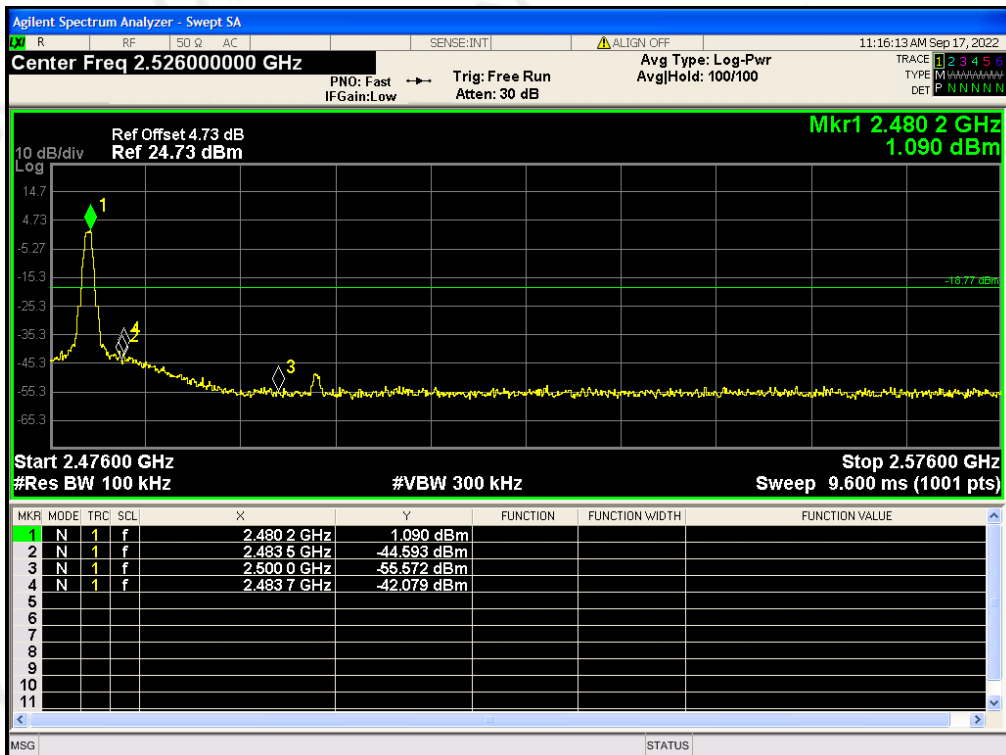

TEST RESULT FOR ENTIRE FREQUENCY RANGE FOR BLE 2M LOW CHANNEL

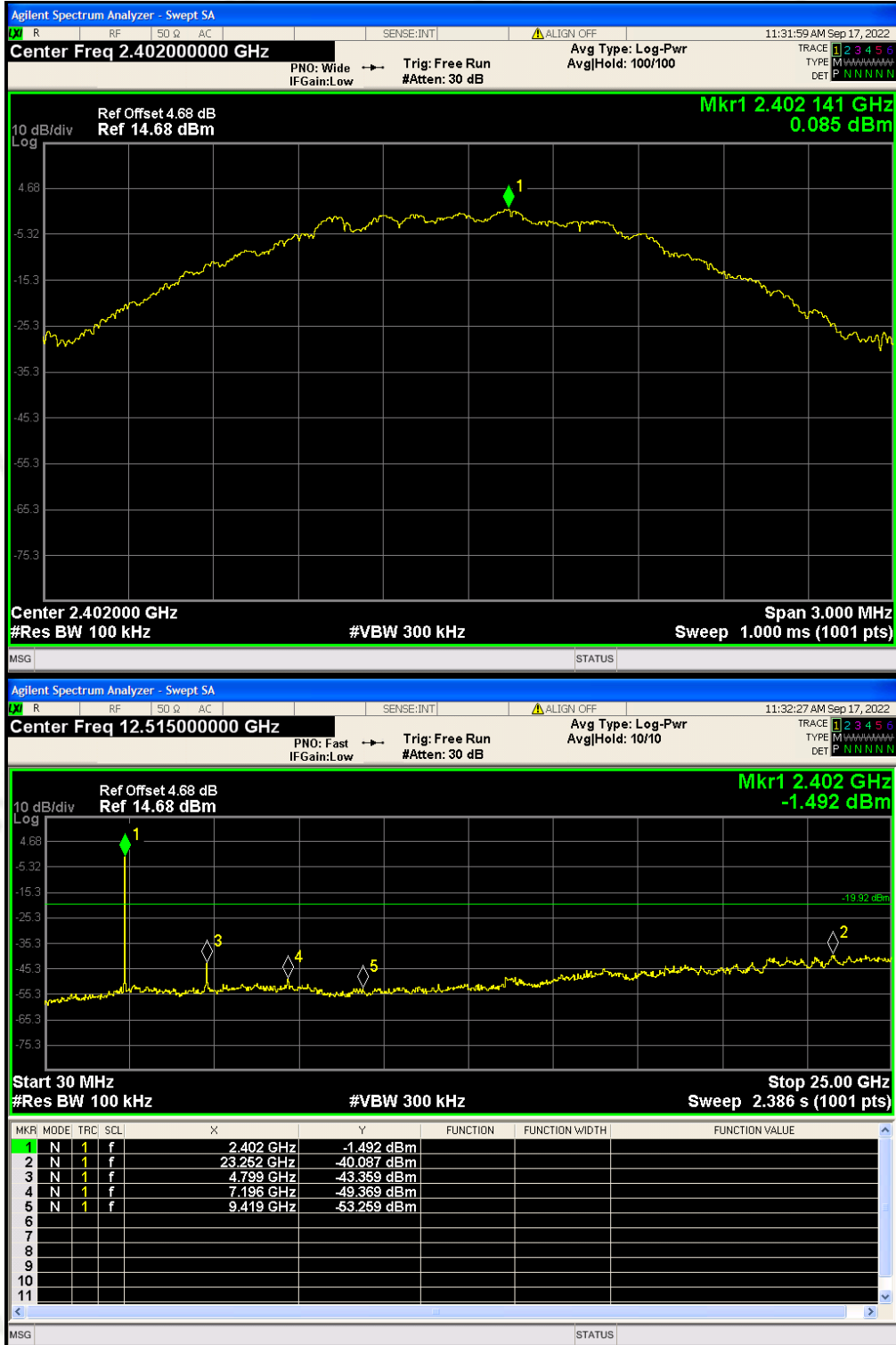

MIDDLE CHANNEL

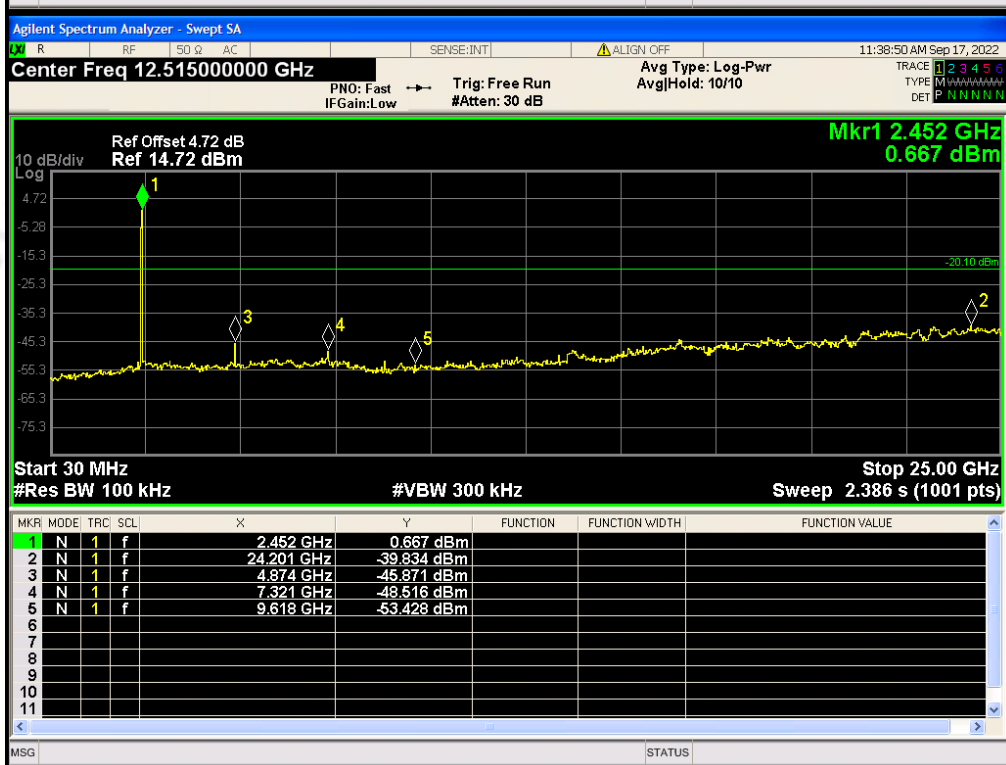

HIGH CHANNEL

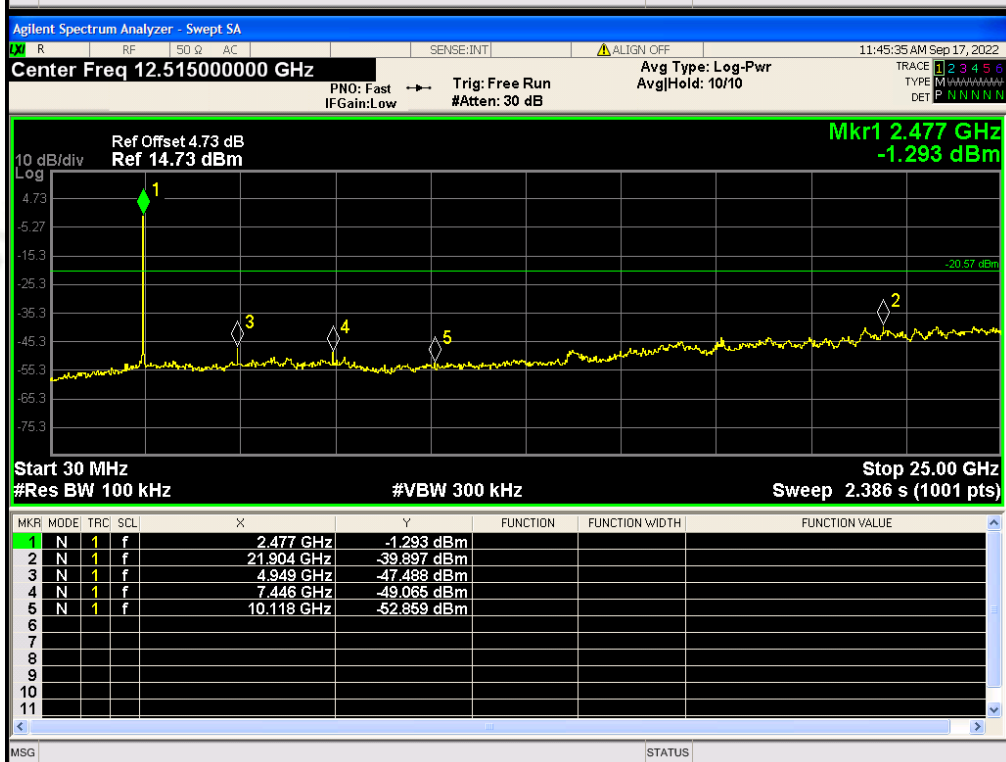

TEST RESULT FOR BAND EDGE FOR BLE 2M LOW CHANNEL

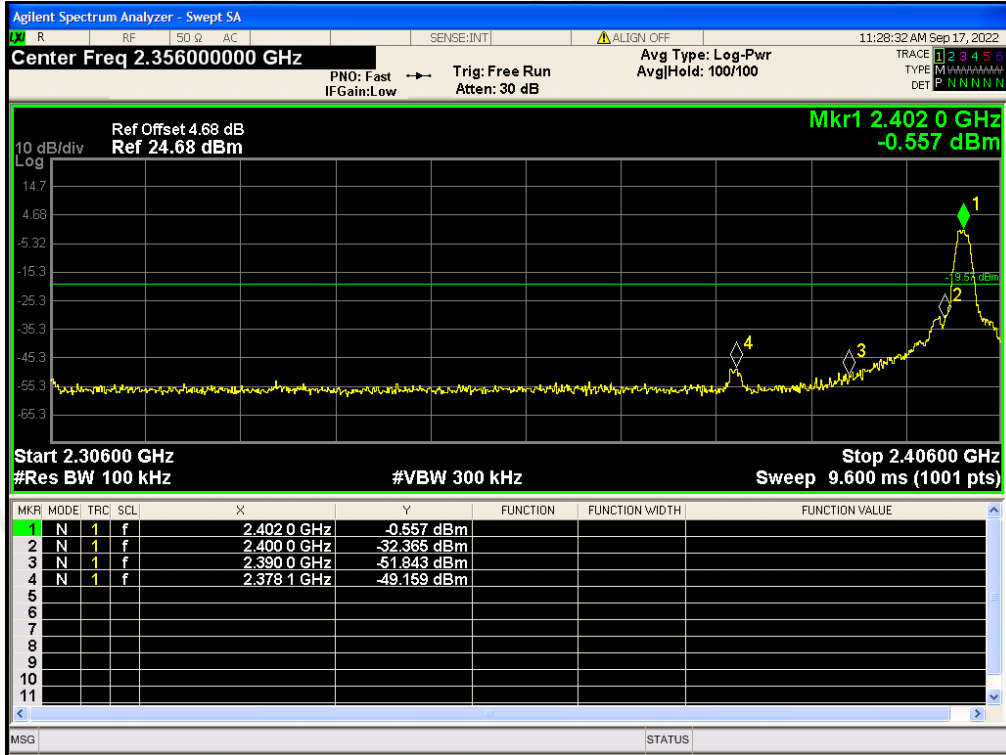

HIGH CHANNEL

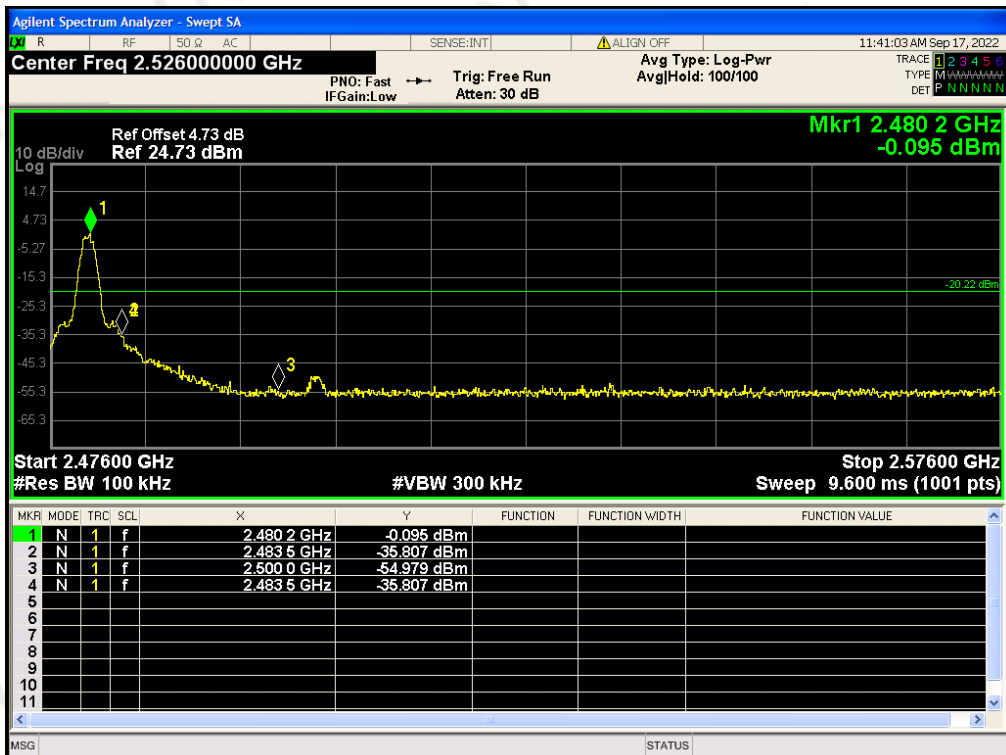

10 MAXIMUM CONDUCTED OUTPUT POWER SPECTRAL DENSITY

10.1 MEASUREMENT PROCEDURE

- (1). Connect EUT RF output port to the Spectrum Analyzer through an RF attenuator
- (2). Set the EUT Work on the top, the middle and the bottom operation frequency individually.
- (3). Set the SPA Trace 1 Max hold, then View.

10.2 TEST SET-UP (BLOCK DIAGRAM OF CONFIGURATION)

Refer to Section 7.2.

10.3 MEASUREMENT EQUIPMENT USED

Refer to Section 6.

10.4 LIMITS AND MEASUREMENT RESULT

LIMITS AND MEASUREMENT RESULT FOR BLE 1M			
Channel No.	PSD (dBm/3kHz)	Limit (dBm/3kHz)	Result
Low Channel	-11.633	8	Pass
Middle Channel	-11.628	8	Pass
High Channel	-11.973	8	Pass

TEST PLOT OF SPECTRAL DENSITY FOR LOW CHANNEL

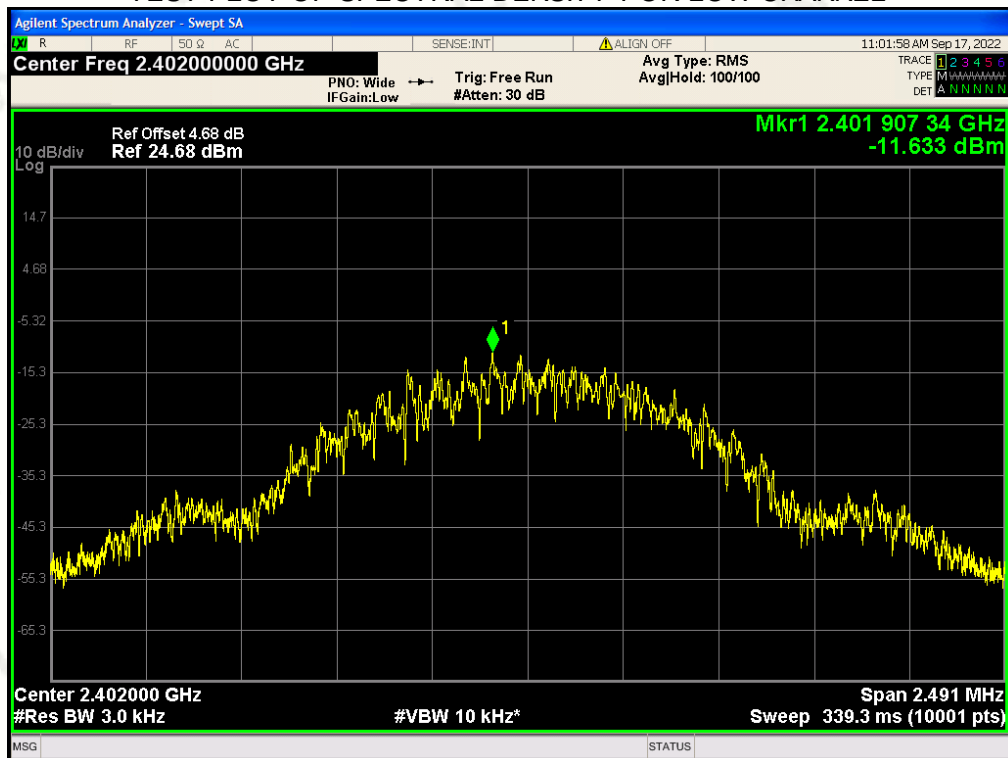

TEST PLOT OF SPECTRAL DENSITY FOR MIDDLE CHANNEL

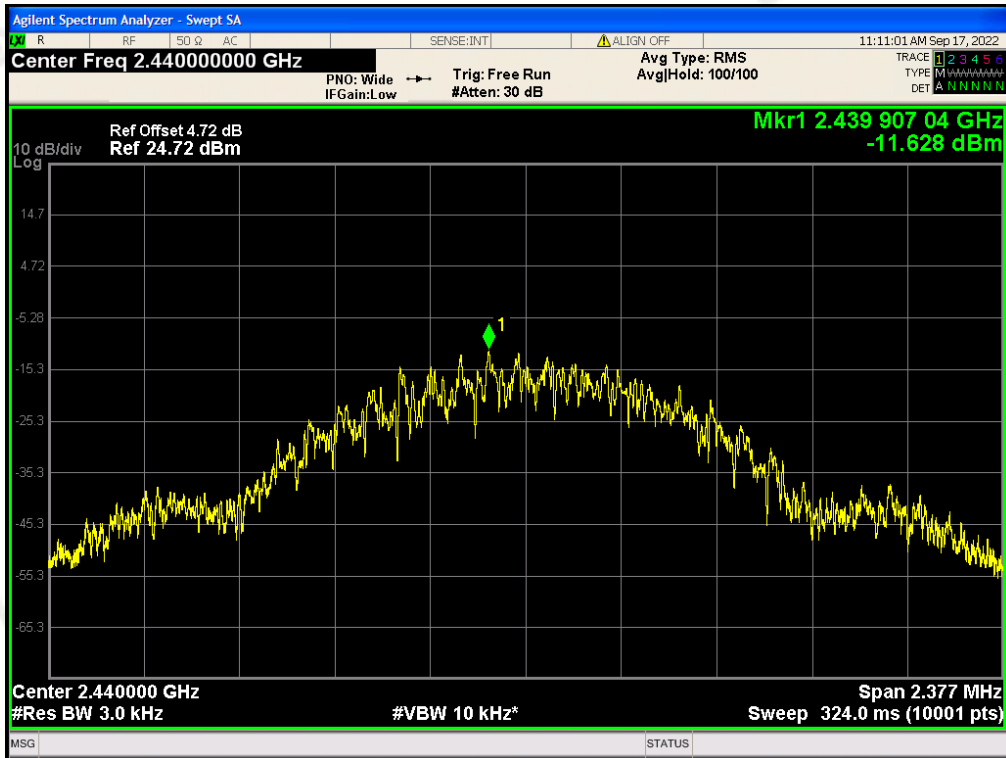

TEST PLOT OF SPECTRAL DENSITY FOR HIGH CHANNEL

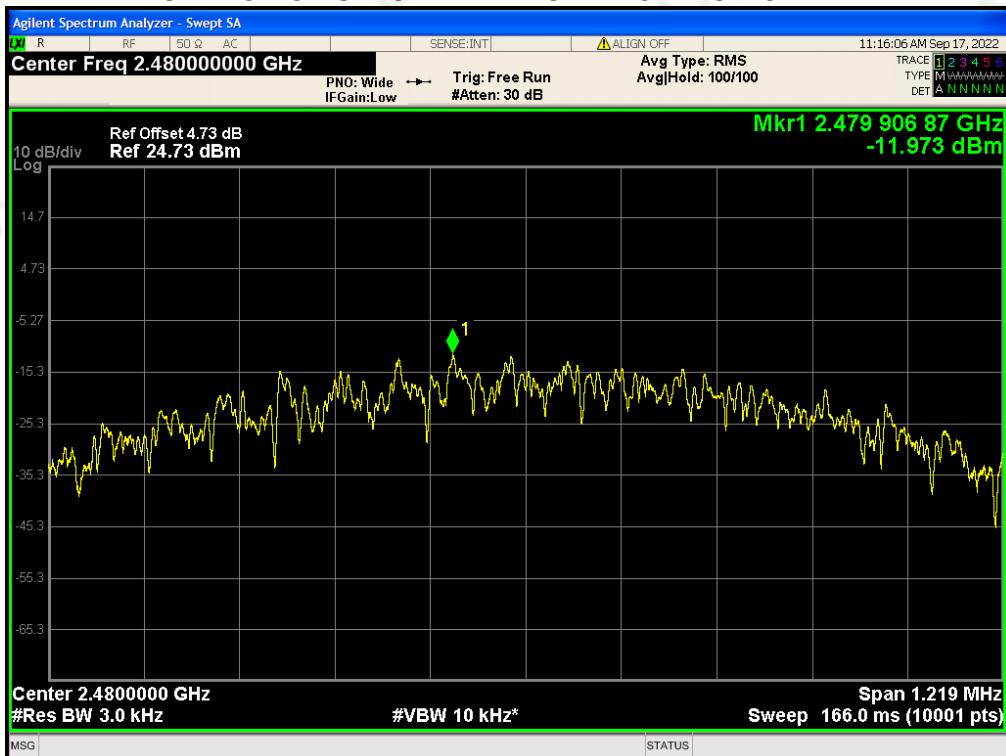

LIMITS AND MEASUREMENT RESULT FOR BLE 2M			
Channel No.	PSD (dBm/3kHz)	Limit (dBm/3kHz)	Result
Low Channel	-14.760	8	Pass
Middle Channel	-14.760	8	Pass
High Channel	-15.195	8	Pass

TEST PLOT OF SPECTRAL DENSITY FOR LOW CHANNEL

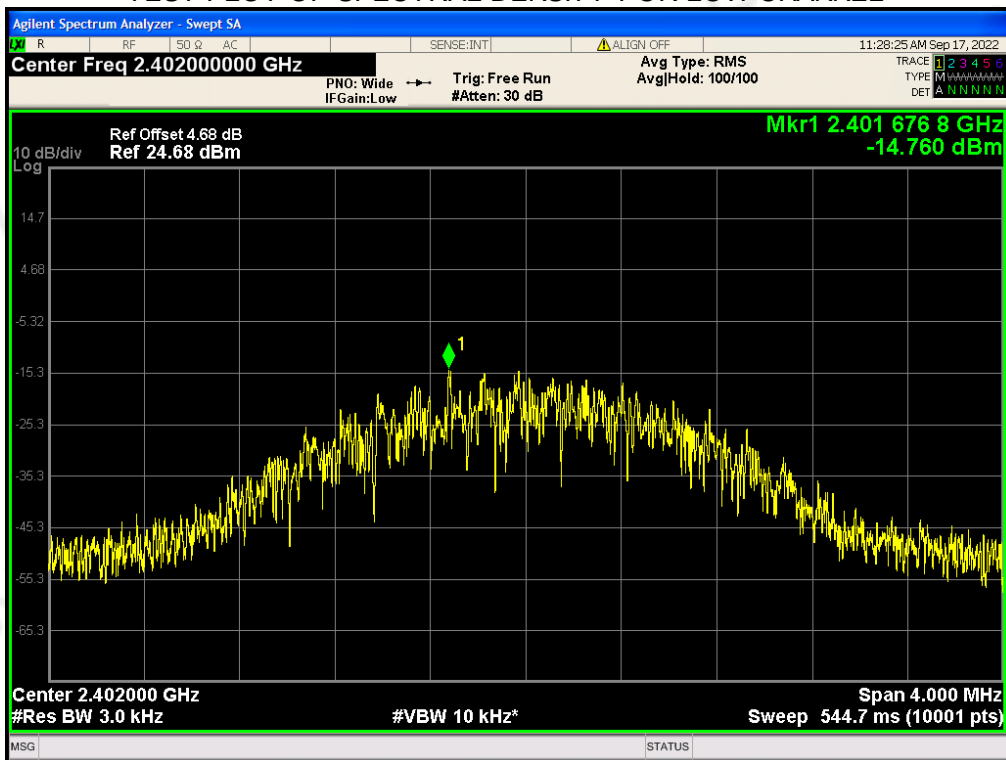

TEST PLOT OF SPECTRAL DENSITY FOR MIDDLE CHANNEL

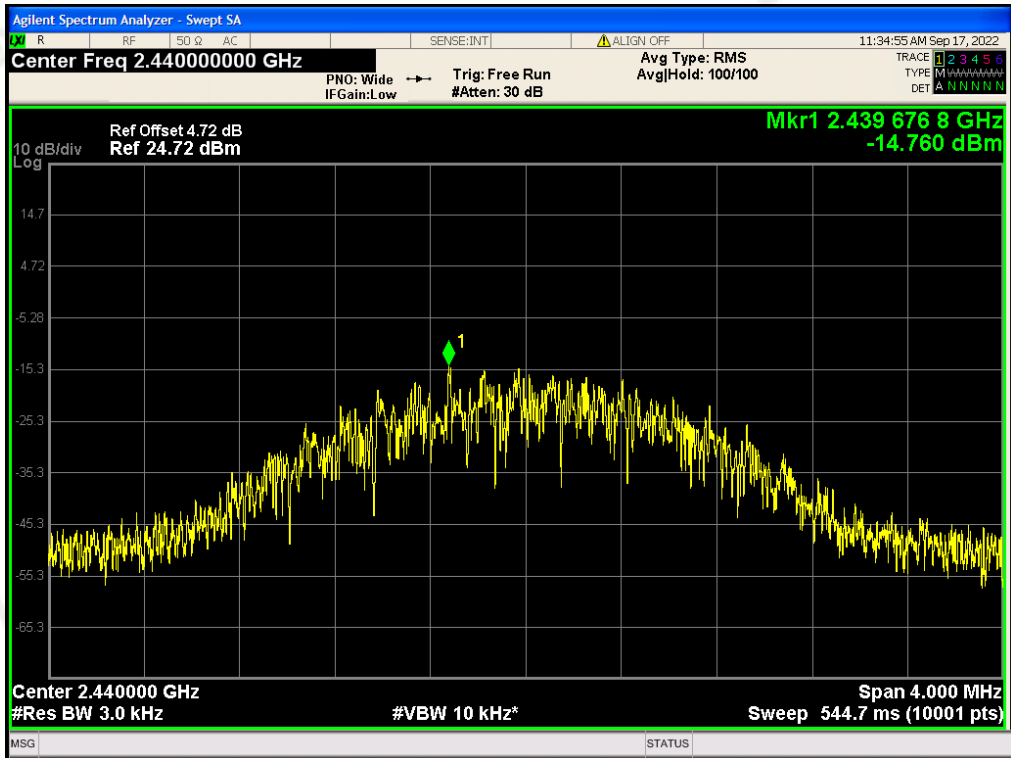

TEST PLOT OF SPECTRAL DENSITY FOR HIGH CHANNEL

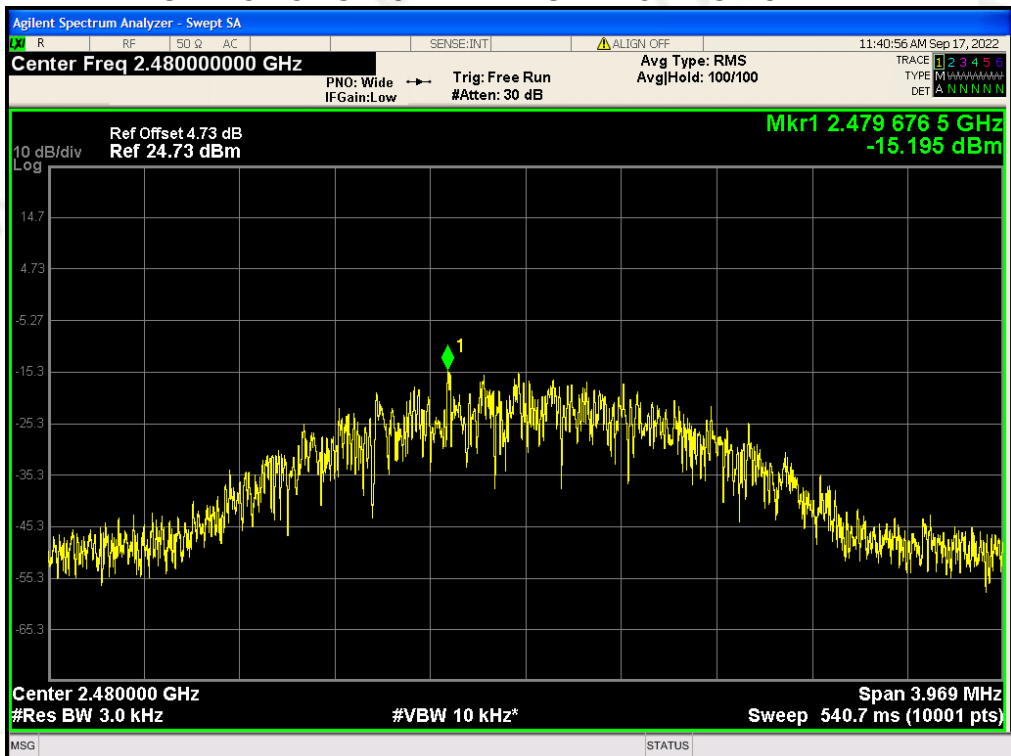

11 RADIATED EMISSION

11.1 MEASUREMENT PROCEDURE

1. The EUT was placed on the top of the turntable 0.8 or 1.5 meter above ground. The phase center of the receiving antenna mounted on the top of a height-variable antenna tower was placed 3 meters far away from the turntable.
2. Power on the EUT and all the supporting units. The turntable was rotated by 360 degrees to determine the position of the highest radiation.
3. The height of the broadband receiving antenna was varied between one meter and four meters above ground to find the maximum emissions field strength of both horizontal and vertical polarization.
4. For each suspected emission, the antenna tower was scan (from 1 M to 4 M) and then the turntable was rotated (from 0 degree to 360 degrees) to find the maximum reading.
5. Set the test-receiver system to Peak or CISPR quasi-peak Detect Function with specified bandwidth under Maximum Hold Mode.
6. For emissions above 1GHz, use 1MHz RBW and 3MHz VBW for peak reading. Place the measurement antenna away from each area of the EUT determined to be a source of emissions at the specified measurement distance, while keeping the measurement antenna aimed at the source of emissions at each frequency of significant emissions, with polarization oriented for maximum response. The measurement antenna may have to be higher or lower than the EUT, depending on the radiation pattern of the emission and staying aimed at the emission source for receiving the maximum signal. The final measurement antenna elevation shall be that which maximizes the emissions. The measurement antenna elevation for maximum emissions shall be restricted to a range of heights of from 1 m to 4 m above the ground or reference ground plane.
7. When the radiated emissions limits are expressed in terms of the average value of the emissions, and pulsed operation is employed, the measurement field strength shall be determined by averaging over one complete pulse train, including blanking intervals, as long as the pulse train does not exceed 0.1 seconds. As an alternative (provided the transmitter operates for longer than 0.1 seconds) or in cases where the pulse train exceeds 0.1 seconds, the measured field strength shall be determined from the average absolute voltage during a 0.1 second interval during which the field strength is at its maximum values.
8. If the emissions level of the EUT in peak mode was 3 dB lower than the average limit specified, then testing will be stopped and peak values of EUT will be reported, otherwise, the emissions which do not have 3 dB margin will be repeated one by one using the quasi-peak method for below 1GHz.
9. For testing above 1GHz, the emissions level of the EUT in peak mode was lower than average limit (that means the emissions level in peak mode also complies with the limit in average mode), then testing will be stopped and peak values of EUT will be reported, otherwise, the emissions will be measured in average mode again and reported.
10. In case the emission is lower than 30MHz, loop antenna has to be used for measurement and the recorded data should be QP measured by receiver. High - Low scan is not required in this case.

11.2 TEST SETUP

Radiated Emission Test-Setup Frequency Below 30MHz

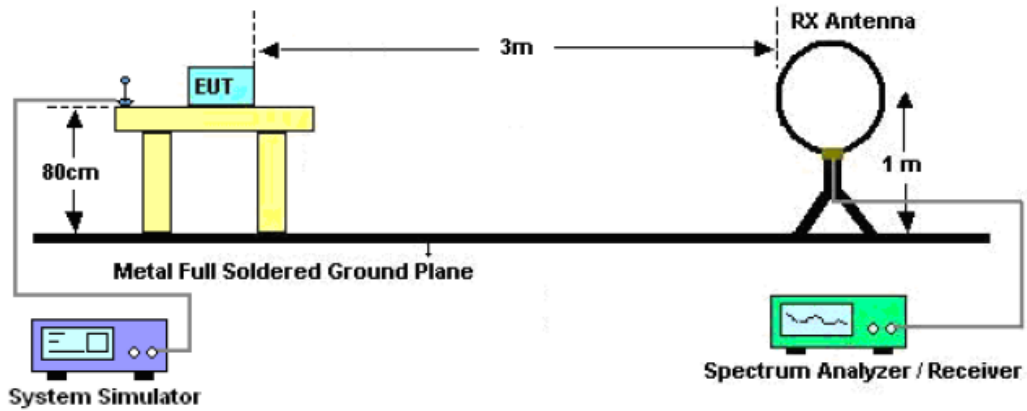

RADIATED EMISSION TEST SETUP 30MHz-1000MHz

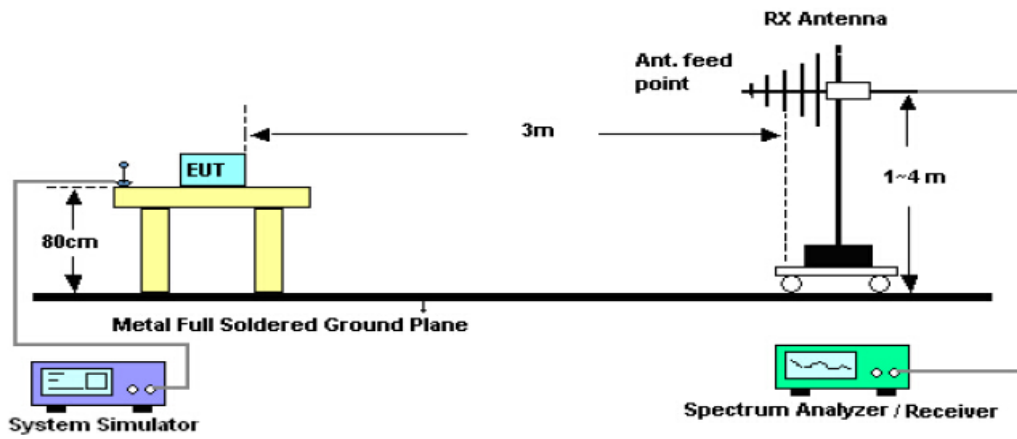

RADIATED EMISSION TEST SETUP ABOVE 1000MHz

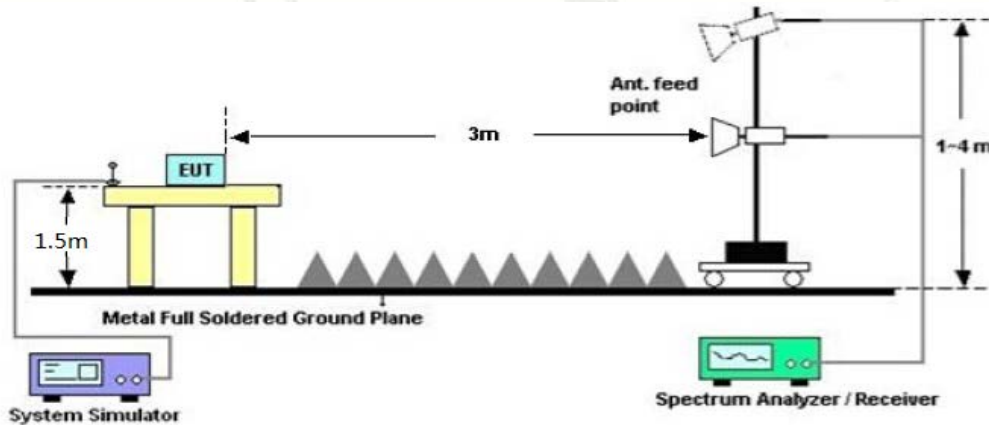

11.3 LIMITS AND MEASUREMENT RESULT

15.209 Limit in the below table has to be followed

Frequencies (MHz)	Field Strength (microvolts/meter)	Measurement Distance (meters)
0.009~0.490	2400/F (kHz)	300
0.490~1.705	24000/F (kHz)	30
1.705~30.0	30	30
30~88	100	3
88~216	150	3
216~960	200	3
Above 960	500	3

Note: All modes were tested for restricted band radiated emission, the test records reported below are the worst result compared to other modes.

11.4 TEST RESULT

RADIATED EMISSION BELOW 30MHz

The amplitude of spurious emissions from 9kHz to 30MHz which are attenuated more than 20 dB below the permissible value need not be reported.

RADIATED EMISSION BELOW 1GHZ

Temperature:	24°C	Relative Humidity:	48%
Test Date:	Sep. 02, 2022	Pressure:	1010hPa
Test Voltage:	DC 3.7V	Phase:	Horizontal
Test Mode:	Transmitting mode of GFSK 2402MHz		

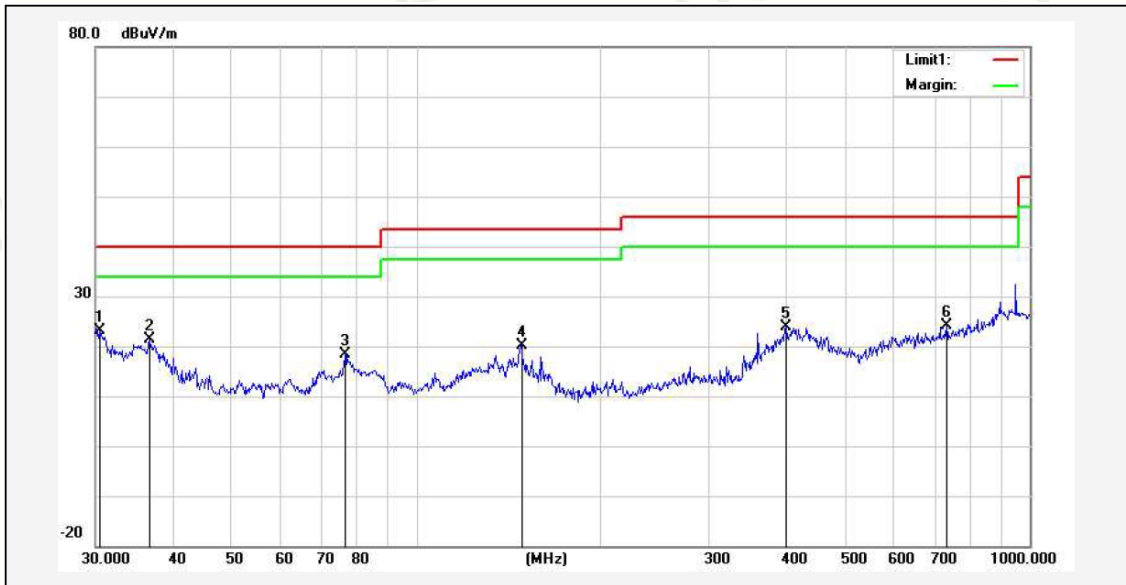

No.	Frequency (MHz)	Reading (dBuV)	Correction factor(dB/m)	Result (dBuV/m)	Limit (dBuV/m)	Margin (dB)	Degree (deg.)	Height (cm)	Remark
1*	30.4238	30.18	-6.94	23.24	40.00	-16.76	60	100	peak
2	36.7662	33.24	-11.83	21.41	40.00	-18.59	70	100	peak
3	76.5121	38.31	-19.91	18.40	40.00	-21.60	110	100	peak
4	148.4410	35.77	-15.55	20.22	43.50	-23.28	150	100	peak
5	400.4319	34.65	-10.72	23.93	46.00	-22.07	160	100	peak
6	731.9203	29.28	-5.06	24.22	46.00	-21.78	180	100	peak

Temperature:	24°C	Relative Humidity:	48%
Test Date:	Sep. 02, 2022	Pressure:	1010hPa
Test Voltage:	DC 3.7V	Phase:	Vertical
Test Mode:	Transmitting mode of GFSK 2402MHz		

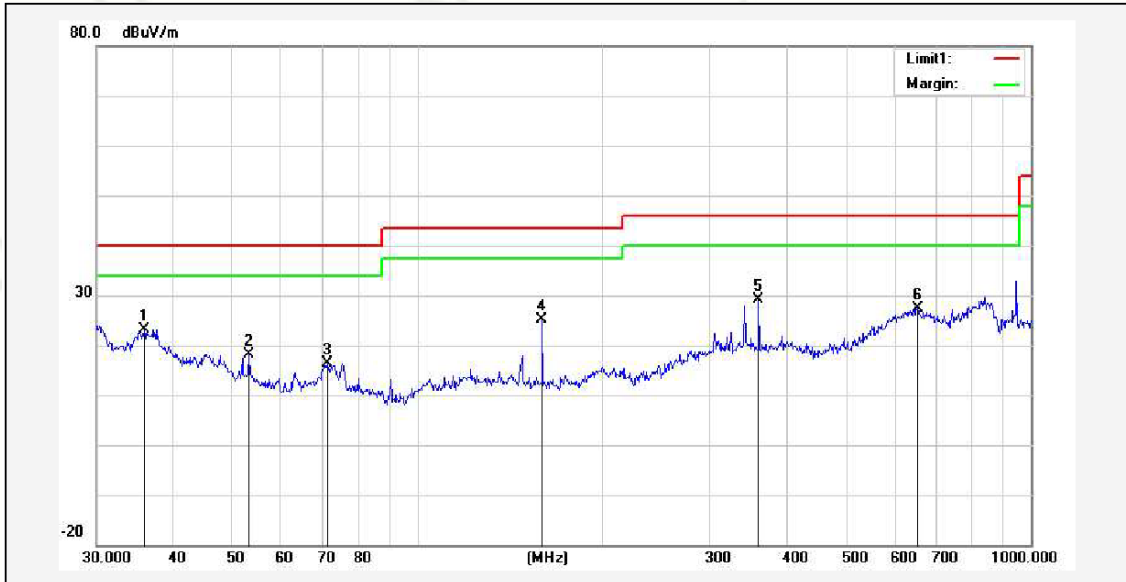

No.	Frequency (MHz)	Reading (dBuV)	Correction factor(dB/m)	Result (dBuV/m)	Limit (dBuV/m)	Margin (dB)	Degree (deg.)	Height (cm)	Remark
1*	35.8747	34.28	-11.08	23.20	40.00	-16.80	80	100	peak
2	53.1313	38.27	-20.11	18.16	40.00	-21.84	100	100	peak
3	71.3300	36.18	-19.86	16.32	40.00	-23.68	120	100	peak
4	159.7844	40.38	-15.36	25.02	43.50	-18.48	150	100	peak
5	360.4477	40.88	-11.87	29.01	46.00	-16.99	180	100	peak
6	654.2318	33.30	-5.96	27.34	46.00	-18.66	200	100	peak

RESULT: PASS

Note:

1. Factor=Antenna Factor+ Cable loss, Margin=Measurement-Limit.
2. All test modes had been tested. The mode of GFSK 2402MHz is the worst case and recorded in the report.

Above 1 GHz Test Results:

BLE 1M:
CH00 (2402MHz)

Horizontal:

Frequency (MHz)	Reading Result (dBμV)	Factor (dB)	Emission Level (dBμV/m)	Limits (dBμV/m)	Margin (dB)	Detector Type
4804	60.42	-3.64	56.78	74	-17.22	PK
4804	49.99	-3.64	46.35	54	-7.65	AV
7206	56.95	-0.95	56.00	74	-18.00	PK
7206	46.90	-0.95	45.95	54	-8.05	AV

Remark: Factor = Antenna Factor + Cable Loss – Pre-amplifier. Margin = Absolute Level – Limit

Vertical:

Frequency (MHz)	Reading Result (dBμV)	Factor (dB)	Emission Level (dBμV/m)	Limits (dBμV/m)	Margin (dB)	Detector Type
4804	60.39	-3.64	56.75	74	-17.25	PK
4804	49.91	-3.64	46.27	54	-7.73	AV
7206	56.93	-0.95	55.98	74	-18.02	PK
7206	46.88	-0.95	45.93	54	-8.07	AV

Remark: Factor = Antenna Factor + Cable Loss – Pre-amplifier. Margin = Absolute Level – Limit

CH19 (2440MHz)

Horizontal:

Frequency	Reading Result	Factor	Emission Level	Limits	Margin	Detector Type
(MHz)	(dBμV)	(dB)	(dBμV/m)	(dBμV/m)	(dB)	
4880	60.27	-3.51	56.76	74	-17.24	PK
4880	49.75	-3.51	46.24	54	-7.76	AV
7320	56.80	-0.82	55.98	74	-18.02	PK
7320	46.82	-0.82	46.00	54	-8.00	AV

Remark: Factor = Antenna Factor + Cable Loss – Pre-amplifier. Margin = Absolute Level – Limit

Vertical:

Frequency	Reading Result	Factor	Emission Level	Limits	Margin	Detector Type
(MHz)	(dBμV)	(dB)	(dBμV/m)	(dBμV/m)	(dB)	
4880	60.30	-3.51	56.79	74	-17.21	PK
4880	49.71	-3.51	46.20	54	-7.80	AV
7320	56.76	-0.82	55.94	74	-18.06	PK
7320	46.75	-0.82	45.93	54	-8.07	AV

Remark: Factor = Antenna Factor + Cable Loss – Pre-amplifier. Margin = Absolute Level – Limit

CH39 (2480MHz)

Horizontal:

Frequency (MHz)	Reading Result (dBμV)	Factor (dB)	Emission Level (dBμV/m)	Limits (dBμV/m)	Margin (dB)	Detector Type
4960	60.23	-3.43	56.80	74	-17.20	PK
4960	49.61	-3.43	46.18	54	-7.82	AV
7440	56.67	-0.75	55.92	74	-18.08	PK
7440	46.70	-0.75	45.95	54	-8.05	AV

Remark: Factor = Antenna Factor + Cable Loss – Pre-amplifier. Margin = Absolute Level – Limit

Vertical:

Frequency (MHz)	Reading Result (dBμV)	Factor (dB)	Emission Level (dBμV/m)	Limits (dBμV/m)	Margin (dB)	Detector Type
4960	60.20	-3.43	56.77	74	-17.23	PK
4960	49.71	-3.43	46.28	54	-7.72	AV
7440	56.65	-0.75	55.90	74	-18.10	PK
7440	46.73	-0.75	45.98	54	-8.02	AV

Remark: Factor = Antenna Factor + Cable Loss – Pre-amplifier. Margin = Absolute Level – Limit

BLE 2M:
CH00 (2402MHz)

Horizontal:

Frequency (MHz)	Reading Result (dBμV)	Factor (dB)	Emission Level (dBμV/m)	Limits (dBμV/m)	Margin (dB)	Detector Type
4804	60.34	-3.64	56.70	74	-17.30	PK
4804	49.77	-3.64	46.13	54	-7.87	AV
7206	56.75	-0.95	55.80	74	-18.20	PK
7206	46.80	-0.95	45.85	54	-8.15	AV

Remark: Factor = Antenna Factor + Cable Loss – Pre-amplifier. Margin = Absolute Level – Limit

Vertical:

Frequency (MHz)	Reading Result (dBμV)	Factor (dB)	Emission Level (dBμV/m)	Limits (dBμV/m)	Margin (dB)	Detector Type
4804	60.26	-3.64	56.62	74	-17.38	PK
4804	49.91	-3.64	46.27	54	-7.73	AV
7206	56.82	-0.95	55.87	74	-18.13	PK
7206	46.78	-0.95	45.83	54	-8.17	AV

Remark: Factor = Antenna Factor + Cable Loss – Pre-amplifier. Margin = Absolute Level – Limit

CH19 (2440MHz)

Horizontal:

Frequency	Reading Result	Factor	Emission Level	Limits	Margin	Detector Type
(MHz)	(dBμV)	(dB)	(dBμV/m)	(dBμV/m)	(dB)	
4880	60.19	-3.51	56.68	74	-17.32	PK
4880	49.65	-3.51	46.14	54	-7.86	AV
7320	56.67	-0.82	55.85	74	-18.15	PK
7320	46.70	-0.82	45.88	54	-8.12	AV

Remark: Factor = Antenna Factor + Cable Loss – Pre-amplifier. Margin = Absolute Level – Limit

Vertical:

Frequency	Reading Result	Factor	Emission Level	Limits	Margin	Detector Type
(MHz)	(dBμV)	(dB)	(dBμV/m)	(dBμV/m)	(dB)	
4880	60.14	-3.51	56.63	74	-17.37	PK
4880	49.71	-3.51	46.20	54	-7.80	AV
7320	56.66	-0.82	55.84	74	-18.16	PK
7320	46.60	-0.82	45.78	54	-8.22	AV

Remark: Factor = Antenna Factor + Cable Loss – Pre-amplifier. Margin = Absolute Level – Limit

CH39 (2480MHz)

Horizontal:

Frequency (MHz)	Reading Result (dBμV)	Factor (dB)	Emission Level (dBμV/m)	Limits (dBμV/m)	Margin (dB)	Detector Type
4960	60.08	-3.43	56.65	74	-17.35	PK
4960	49.61	-3.43	46.18	54	-7.82	AV
7440	56.57	-0.75	55.82	74	-18.18	PK
7440	46.58	-0.75	45.83	54	-8.17	AV

Remark: Factor = Antenna Factor + Cable Loss – Pre-amplifier. Margin = Absolute Level – Limit

Vertical:

Frequency (MHz)	Reading Result (dBμV)	Factor (dB)	Emission Level (dBμV/m)	Limits (dBμV/m)	Margin (dB)	Detector Type
4960	60.07	-3.43	56.64	74	-17.36	PK
4960	49.66	-3.43	46.23	54	-7.77	AV
7440	56.57	-0.75	55.82	74	-18.18	PK
7440	46.55	-0.75	45.80	54	-8.20	AV

Remark: Factor = Antenna Factor + Cable Loss – Pre-amplifier. Margin = Absolute Level – Limit

RESULT: PASS

Note:

The amplitude of other spurious emissions from 1 to 25 GHz which are attenuated more than 20 dB below the permissible value need not be reported.

Factor=Antenna Factor+ Cable loss-Amplifier gain, Over=Measure-Limit.

The “Factor” value can be calculated automatically by software of measurement system.

12 FCC LINE CONDUCTED EMISSION TEST

12.1 LIMITS OF LINE CONDUCTED EMISSION TEST

Frequency	Maximum RF Line Voltage	
	Q.P.(dBuV)	Average(dBuV)
150kHz~500kHz	66-56	56-46
500kHz~5MHz	56	46
5MHz~30MHz	60	50

Note: 1. The lower limit shall apply at the transition frequency.

2. The limit decreases linearly with the logarithm of the frequency in the range 0.15 MHz to 0.50 MHz.

12.2 BLOCK DIAGRAM OF LINE CONDUCTED EMISSION TEST

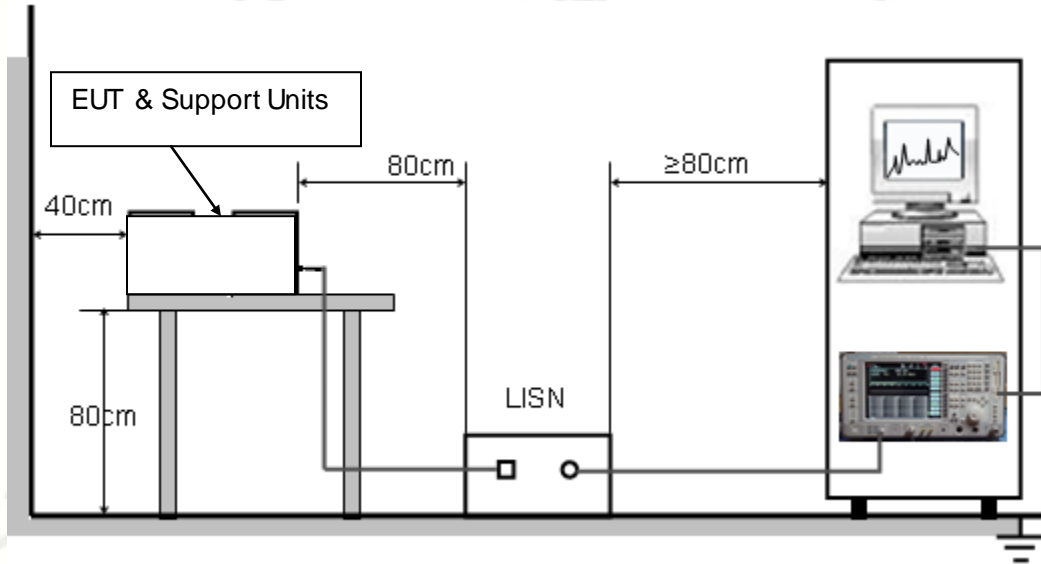

12.3 PRELIMINARY PROCEDURE OF LINE CONDUCTED EMISSION TEST

1. The equipment was set up as per the test configuration to simulate typical actual usage per the user's manual. When the EUT is a tabletop system, a wooden table with a height of 0.8 meters is used and is placed on the ground plane as per ANSI C63.10 (see Test Facility for the dimensions of the ground plane used). When the EUT is a floor-standing equipment, it is placed on the ground plane which has a 3-12 mm non-conductive covering to insulate the EUT from the ground plane.
2. Support equipment, if needed, was placed as per ANSI C63.10.
3. All I/O cables were positioned to simulate typical actual usage as per ANSI C63.10.
4. All support equipment received AC120V/60Hz power from a LISN, if any.
5. The EUT received DC 5V power from adapter which received AC120V/60Hz power from a LISN.
6. The test program was started. Emissions were measured on each current carrying line of the EUT using a spectrum Analyzer / Receiver connected to the LISN powering the EUT. The LISN has two monitoring points: Line 1 (Hot Side) and Line 2 (Neutral Side). Two scans were taken: one with Line 1 connected to Analyzer / Receiver and Line 2 connected to a 50 ohm load; the second scan had Line 1 connected to a 50 ohm load and Line 2 connected to the Analyzer / Receiver.
7. Analyzer / Receiver scanned from 150 kHz to 30MHz for emissions in each of the test modes.
8. During the above scans, the emissions were maximized by cable manipulation.
9. The test mode(s) were scanned during the preliminary test.

Then, the EUT configuration and cable configuration of the above highest emission level were recorded for reference of final testing.

12.4 FINAL PROCEDURE OF LINE CONDUCTED EMISSION TEST

1. EUT and support equipment was set up on the test bench as per step 2 of the preliminary test.
2. A scan was taken on both power lines, Line 1 and Line 2, recording at least the six highest emissions. Emission frequency and amplitude were recorded into a computer in which correction factors were used to calculate the emission level and compare reading to the applicable limit. If EUT emission level was less -2dB to the A.V. limit in Peak mode, then the emission signal was re-checked using Q.P and Average detector.
3. The test data of the worst case condition(s) was reported on the Summary Data page.

12.5 TEST RESULT OF LINE CONDUCTED EMISSION TEST

PASS

Remark:

1. All modes were tested at AC 120V and 240V, only the worst result of AC 120V was reported.
2. All modes were test at Low, Middle, and High channel, only the worst result of GFSK Low Channel was reported.

Temperature:	24°C	Relative Humidity:	48%
Test Date:	Sep. 02, 2022	Pressure:	1010hPa
Test Voltage:	AC 120V, 60Hz	Phase:	Line
Test Mode:	Transmitting mode of GFSK 2402MHz		

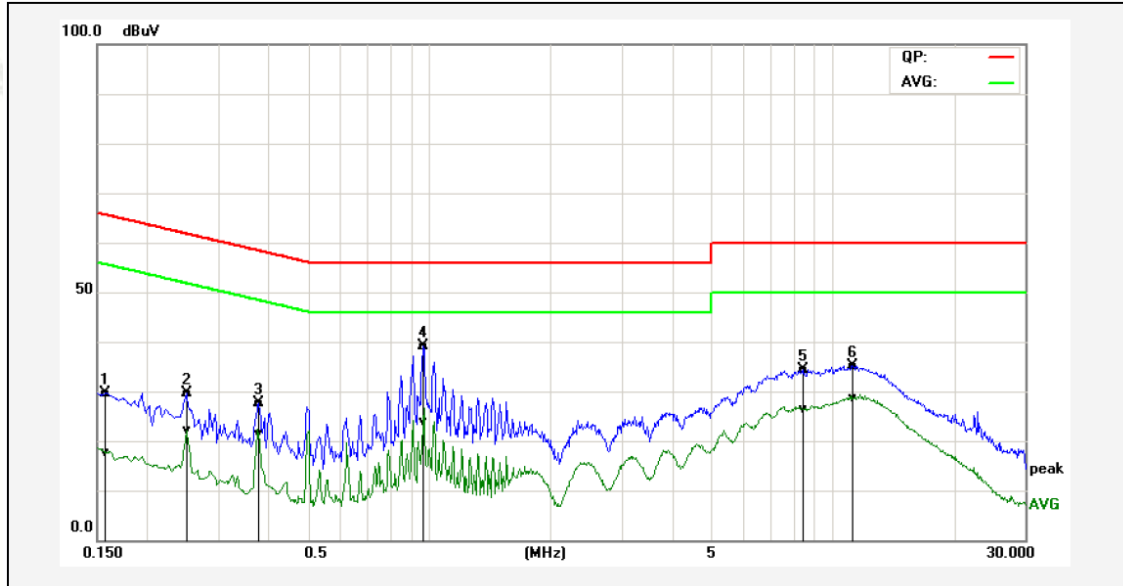

No.	Frequency (MHz)	QuasiPeak reading (dBuV)	Average reading (dBuV)	Correction factor (dB)	QuasiPeak result (dBuV)	Average result (dBuV)	QuasiPeak limit (dBuV)	Average limit (dBuV)	QuasiPeak margin (dB)	Average margin (dB)	Remark
1P	0.1580	19.58	7.45	10.12	29.70	17.57	65.57	55.57	-35.87	-38.00	Pass
2P	0.2500	19.43	11.92	10.12	29.55	22.04	61.76	51.76	-32.21	-29.72	Pass
3P	0.3780	17.62	11.21	10.10	27.72	21.31	58.32	48.32	-30.60	-27.01	Pass
4*	0.9660	29.06	13.67	10.12	39.18	23.79	56.00	46.00	-16.82	-22.21	Pass
5P	8.4460	24.14	16.16	10.17	34.31	26.33	60.00	50.00	-25.69	-23.67	Pass
6P	11.2060	24.93	18.54	10.15	35.08	28.69	60.00	50.00	-24.92	-21.31	Pass

Remark: Factor = Insertion Loss + Cable Loss, Result = Reading + Factor, Margin = Result – Limit.

Temperature:	24°C	Relative Humidity:	48%
Test Date:	Sep. 02, 2022	Pressure:	1010hPa
Test Voltage:	AC 120V, 60Hz	Phase:	Neutral
Test Mode:	Transmitting mode of GFSK 2402MHz		

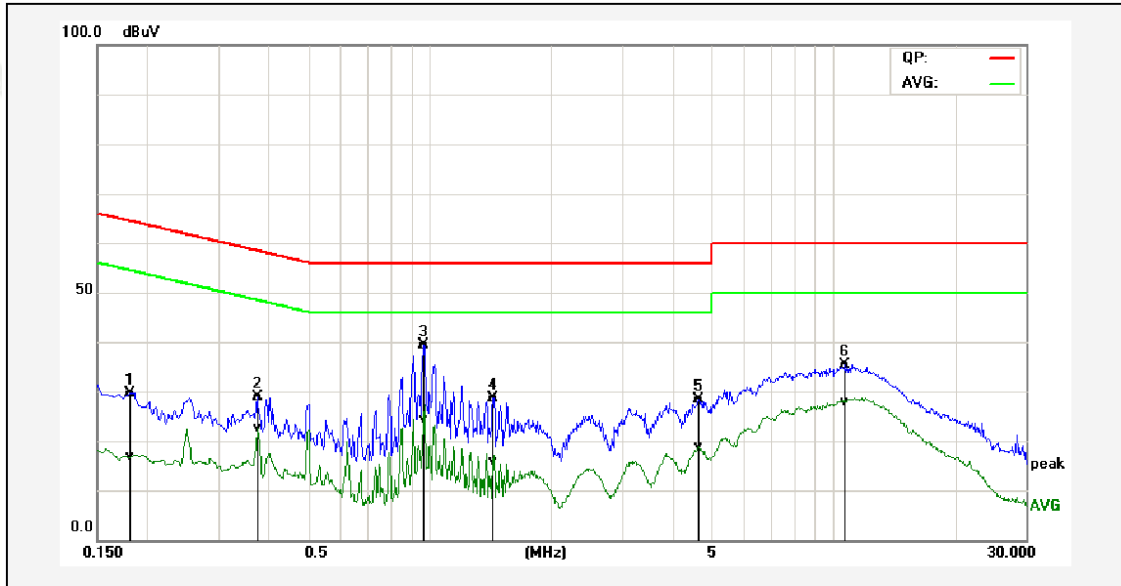

No.	Frequency (MHz)	QuasiPeak reading (dBuV)	Average reading (dBuV)	Correction factor (dB)	QuasiPeak result (dBuV)	Average result (dBuV)	QuasiPeak limit (dBuV)	Average limit (dBuV)	QuasiPeak margin (dB)	Average margin (dB)	Remark
1P	0.1820	19.54	6.65	10.13	29.67	16.78	64.39	54.39	-34.72	-37.61	Pass
2P	0.3740	18.67	12.58	10.10	28.77	22.68	58.41	48.41	-29.64	-25.73	Pass
3*	0.9660	29.20	14.17	10.12	39.32	24.29	56.00	46.00	-16.68	-21.71	Pass
4P	1.4380	18.44	5.76	10.15	28.59	15.91	56.00	46.00	-27.41	-30.09	Pass
5P	4.6380	18.31	8.67	10.17	28.48	18.84	56.00	46.00	-27.52	-27.16	Pass
6P	10.6780	25.14	17.63	10.15	35.29	27.78	60.00	50.00	-24.71	-22.22	Pass

Remark: Factor = Insertion Loss + Cable Loss, Result = Reading + Factor, Margin = Result – Limit.

APPENDIX A: PHOTOGRAPHS OF TEST SETUP

RADIATED EMISSION TEST SETUP BELOW 1GHZ



RADIATED EMISSION TEST SETUP ABOVE 1GHZ

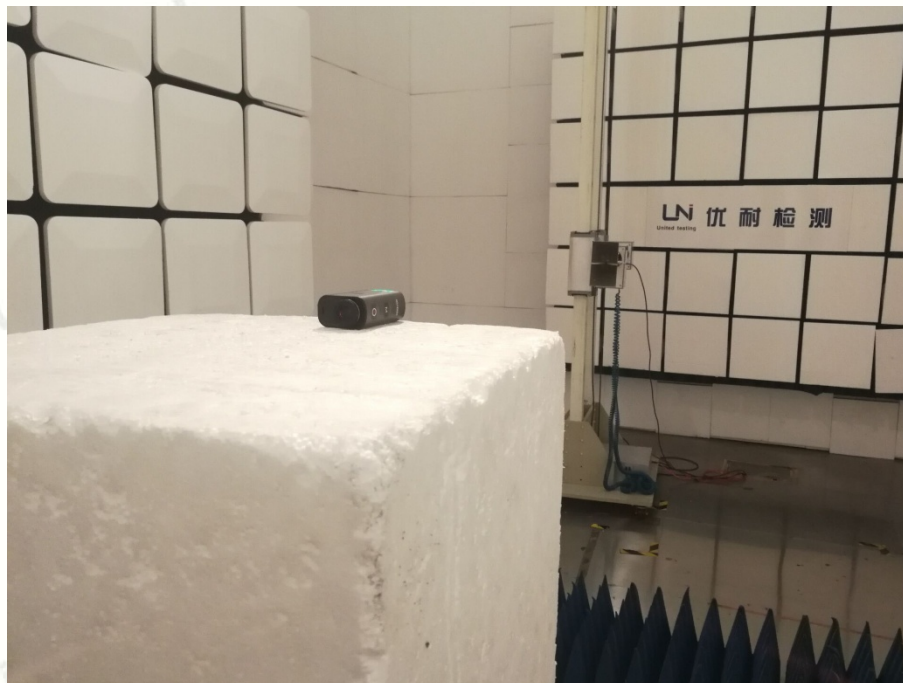

LINE CONDUCTED EMISSION TEST SETUP



----END OF REPORT----