

Test Report Prepared By:

Electronics Test Centre
27 East Lake Hill
Airdrie, Alberta
Canada
T4A 2K3

sales@etc-mpbtech.com
<http://www.etc-mpb.com>

Telephone: 1-403-912-0037

ETC Report #: t29e22a261-DSS Release1

Report date: October 27, 2022

**EMC testing of the Tektelic Communication Inc. Kona Mega Gateway in
accordance with FCC Part 15.247, and ANSI C63.10: 2013 as referenced by FCC
OET KDB 558074 D01 15.247 Measurement Guidance v05r02.**

FCC ID: 2ALEPT0008387

Test Dates: October 3 to October 20, 2022

Test Personnel: Imran Akram and Janet Mijares

Prepared for: Tektelic Communication Inc.

7657 10th Street NE
Calgary, Alberta
Canada
T2E 8X2

Telephone: 1-403-338-6910



Imran Akram
iakram@etc-mpbtech.com
EMC Technologist
Electronics Test Centre (Airdrie)



Marc Rousseau
marc.rousseau@mpbc.ca
QA Manager
Electronics Test Centre (Airdrie)

REVISION RECORD

ISSUE	DATE	AUTHOR	REVISIONS
DRAFT 1	2022-10-03	I. Akram / J. Mijares	Initial draft submitted for review.
DRAFT 2	2022-10-21	J. Mijares	Removed modem EM7430 results.
Release 1	2022-10-27	I. Akram	Sign Off

TABLE OF CONTENTS

1.0	INTRODUCTION	5
1.1	Scope	5
1.2	Applicant	5
1.3	Test Sample Description	5
1.4	General Test Conditions	5
1.5	Reference Standards	6
1.6	Test Methodology	6
1.6.1	Variations in Test Methodology	6
1.6.2	Test Sample Verification, Configuration & Modifications	6
1.6.3	Uncertainty of Measurement:	6
2.0	TEST CONCLUSION	7
2.1	AC Power Line Conducted Emissions: Transmit Mode	8
2.1.1	Test Guidance	8
2.1.2	Deviations From The Standard	9
2.1.3	Test Equipment	9
2.1.4	Test Sample Verification, Configuration & Modifications	9
2.1.5	Conducted Emissions Data	10
2.2	Channel Occupied Bandwidth	12
2.2.1	Test Guidance: ANSI C63.10-2013, Clause 6.9.2 & 6.9.3/ FCC OET KDB 558074	12
2.2.2	Deviations From The Standard:	12
2.2.3	Test Equipment	12
2.2.4	Test Sample Verification, Configuration & Modifications	13
2.2.5	Channel Occupied Bandwidth Data:	13
2.3	Max Average Output Power	17
2.3.1	Test Guidance: ANSI C63.10-2013, Clause 11.9.2.2 Clause 7.8.5 / FCC OET KDB 558074	17
2.3.2	Deviations From The Standard:	18
2.3.3	Test Equipment	18
2.3.4	Test Sample Verification, Configuration & Modifications	18
2.3.5	Max Average Output Power Data	19
2.4	Power Spectral Density	23
2.4.1	Test Guidance: ANSI C63.10-2013, Clause 11.10.3 / FCC OET KDB 558074	23
2.4.2	Deviations From The Standard:	23
2.4.3	Test Equipment	23
2.4.4	Test Sample Verification, Configuration & Modifications	24
2.4.5	Average PSD Data	24
2.5	Band Edge Attenuation	28
2.5.1	Test Guidance: ANSI C63.10-2013 Clause 6.10.4 & 7.8.6, 6.10.6 / FCC OET KDB 558074	28
2.5.2	Deviations From The Standard:	29
2.5.3	Test Equipment	29
2.5.4	Test Sample Verification, Configuration & Modifications	29
2.5.5	Band Edge Data	29
2.6	Conducted Spurious Emissions (Non- Restricted Band)	33

2.6.1	Test Guidance: ANSI C63.10-2013, Clause 6.7, 7.8.8 / 558074 D01 15.247 Measurement Guidance v05r02	33
2.6.2	Deviations From The Standard:.....	33
2.6.3	Test Equipment.....	34
2.6.4	Test Sample Verification, Configuration & Modifications.....	34
2.6.5	Conducted Emissions Data:	35
2.7	Channel Separation (Hybrid Mode)	41
2.7.1	Test Guidance: ANSI 63.10 Clause 7.8.2 / 558074 D01 15.247 Measurement Guidance v05r02	41
2.7.2	Deviations From The Standard:.....	41
2.7.3	Test Equipment.....	41
2.7.4	Test Sample Verification, Configuration & Modifications.....	41
2.7.5	Channel Separation Data:	42
2.8	Time of Occupancy (Hybrid Mode).....	43
2.8.1	Test Guidance: ANSI 63.10 Clause 7.8.4 / 558074 D01 15.247 Measurement Guidance v05r02	43
2.8.2	Deviations From The Standard:.....	43
2.8.3	Test Equipment.....	43
2.8.4	Test Sample Verification, Configuration & Modifications.....	43
2.8.5	Dwell Time Data:.....	44
2.9	EUT Positioning Assessment	45
2.10	Radiated Spurious Emissions (Restricted Band).....	46
2.8.1	Test Guidance: ANSI C63.10-2013, Clause 13.4.2.....	47
2.8.2	Deviations From The Standard:.....	47
2.8.3	Test Equipment.....	47
2.8.4	Test Sample Verification, Configuration & Modifications.....	48
2.8.5	Radiated Emissions Data: With LTE Modem EM7455	49
2.11	Radiated Emissions Receive Mode	54
2.11.1	Test Guidance:.....	54
2.11.2	Deviations From The Standard:.....	54
2.11.3	Test Equipment.....	55
2.11.4	Test Sample Verification, Configuration & Modifications.....	55
2.11.5	Radiated Emissions Data maximization: with LTE EM7455 Modem.....	56
2.12	AC Power Line Conducted Emissions Receive Mode.....	59
2.12.1	Test Guidance.....	59
2.12.2	Deviations From The Standard.....	60
2.12.3	Test Equipment.....	60
2.12.4	Test Sample Verification, Configuration & Modifications.....	60
2.12.5	Conducted Emissions Data	61
2.13	RF Exposure	63
3.0	TEST FACILITY	64
3.1	Location	64
3.2	Grounding Plan.....	64
3.3	Power Supply.....	64
Appendix A – EUT Family Information		65
Appendix B – Test Setup Block Diagram		66

1.0 INTRODUCTION

1.1 Scope

The purpose of this report is to present the results of compliance testing performed in accordance with FCC Part 15.247 and ANSI C63.10-2013 to gain FCC Certification Authorization for Low-Power License-Exempt transmitters. All test procedures, limits, criteria, and results described in this report apply only to the Tektelic Communication Inc. Kona Mega Gateway test sample, referred to herein as the EUT (Equipment Under Test).

This report does not imply product endorsement by the Electronics Test Centre, A2LA, nor any Canadian Government agency.

1.2 Applicant

This test report has been prepared for Tektelic Communication Inc., located in Calgary, Alberta, Canada.

1.3 Test Sample Description

As provided to ETC (Airdrie) by Tektelic Communication Inc.:

Product Name:		Kona Mega Gateway
Lora Radio	Frequency Band	902 – 928 MHz
	Frequency Range	915.2 – 927.8 MHz
	Type of Modulation	LoRa 125KHz DSS
LoRa Associated Antennas	1	Isotropic, Model# WTTX-OMNI920-8-NJ, 8 dBi antenna
EUT	Model#	T0005010
	Serial#	2239K0001
Pre-Certified LTE Modem	Model#	EM7455
	FCC ID#	N7NEM7455
Variant Model#	T0004978, T0004982, T0004988, T0004992, T0004996 T0005000, T0005004, T0005006, T0005008, T0005010	
Power supply:	DC Powered	

This Kona Mega Gateway model T0005010 contains all of the equipment options in this family of products. This model represents above variant model number. This model was chosen as a worst-case condition for emission testing.

Detail differences between the models are given in family information in Appendix A.

1.4 General Test Conditions

The EUT was set up and exercised using the configurations, modes of operation and arrangements defined in this report only. All inputs and outputs to and from other equipment associated with the EUT were adequately simulated.

Where relevant, the EUT was only tested using the monitoring methods and test criteria defined in this report.

The environmental conditions are recorded during each test, and are reported in the relevant sections of this document.

1.5 Reference Standards

Standards	Description
FCC, title 47 CFR § 15.247	Operation within the bands 902-928 MHz, 2400-2483.5 MHz, and 5725-5850 MHz.
FCC, title 47 CFR § 15.207	General Requirements for Compliance of Radio Apparatus
FCC, title 47 CFR § 15.209	Intentional radiator, conducted emission limits
ANSI C63.10-2013	American National Standard of Procedures for Compliance Testing of Unlicensed Wireless Devices
ANSI C63.4-2014	American National Standard for Methods of Measurement of Radio – Noise Emissions from Low-Voltage Electrical and Electronic Equipment in the range of 9 KHz to 40 GHz
558074 D01 15.247 Meas Guidance v05r02	Guidance For Compliance Measurements On Digital Transmission System, Frequency Hopping Spread Spectrum System, And Hybrid System Devices Operating Under Section 15.247 Of The FCC Rules

1.6 Test Methodology

Test methods are specified in the Basic Standard as referenced and/or modified by the Product Standard in the part of Section 2 of this report associated with each particular test case. Separate test report is provided to customer for RX mode under SDOC.

1.6.1 Variations in Test Methodology

Any variance in methodology or deviation from the reference Standard is documented in the part of Section 2 of this report associated with each particular Test Case.

1.6.2 Test Sample Verification, Configuration & Modifications

EUT setup, configuration, protocols for operation and monitoring of EUT functions, and any modifications performed in order to meet the requirements, are detailed in each Test Case of Section 2 of this report.

1.6.3 Uncertainty of Measurement:

The factors contributing to measurement uncertainty are identified and calculated in accordance with CISPR 16-4-2: 2011.

This uncertainty estimate represents an expanded uncertainty expressed at approximately 95% confidence using a coverage factor of $k = 2$.

Test Method	Uncertainty
Radiated Emissions Level (9 KHz – 1 GHz)	±5.8 dB
Radiated Emissions Level (1 GHz – 18 GHz)	±4.9 dB
Radiated Emissions Level (18 GHz – 26.5 GHz)	±5.0 dB
Conducted Emissions Level (150 KHz – 30 MHz)	±3.0 dB
Uncertainty Conducted Power level	±0.5 dB
Uncertainty Conducted Spurious emission level	±0.6 dB
Uncertainty for Bandwidth test	±1.5 %

2.0 TEST CONCLUSION

STATEMENT OF COMPLIANCE

The customer equipment referred to in this report was found to comply with the requirements, as summarized below.

The EUT was subjected to the following tests. Compliance status is reported as **Compliant** or **Non-compliant**. **N/A** indicates the test was Not Applicable to the EUT.

The measurement uncertainty is not accounted for determination of the statement of compliance. The statement of compliance is based only on the measurement value recorded.

Note: Maintenance of compliance is the responsibility of the Manufacturer. Any modifications to the product should be assessed to determine their potential impact on the compliance status of the EUT with respect to the standards detailed in this test report.

The following table summarizes the tests performed in terms of the specification, class or performance criterion applied, and the EUT modification state.

Test Case	Test Type	Specification	Test Sample	Mod.	Config.	Result
2.1	AC Conducted Emissions	15.207	Kona Mega Gateway	none	see § 2.1	Compliant
2.2	Occupied Bandwidth	15.247(a)(1) 15.247(2)(2)	Kona Mega Gateway	none	see § 2.2	Compliant
2.3	Max Output Average Power Conducted	15.247(b)	Kona Mega Gateway	none	see § 2.3	Compliant
2.4	Power Spectral Density	15.247(e) 15.247(f)	Kona Mega Gateway	none	see § 2.4	Compliant
2.5	Band Edge	15.247(d)	Kona Mega Gateway	none	see § 2.5	Compliant
2.6	Conducted Spurious Emission (Non-Restricted Band Operation)	15.247(d)	Kona Mega Gateway	none	see § 2.6	Compliant
2.7	Minimum channel separation	15.247(a)(1)	Kona Mega Gateway	none	see § 2.7	Compliant
2.8	Average time of Occupancy for hybrid System	15.247(f)	Kona Mega Gateway	none	see § 2.8	Compliant
2.9	EUT Position	ANSI C63.4	Kona Mega Gateway	-	see § 2.9	N/A Fix Position
2.10	Radiated Spurious Emission (Restricted Band Operation)	15.205, 15.209 15.247(d)	Kona Mega Gateway	none	see § 2.10	Compliant
2.11	Radiated Emission	15.109	Kona Mega Gateway	none	see § 2.11	Compliant
2.12	AC Conducted Emissions	15.107	Kona Mega Gateway	none	see § 2.12	Compliant
2.13	RF Exposure	15.247(i)	Kona Mega Gateway	none	see § 2.13	Compliant

Refer to the test data for applicable test conditions.

2.1 AC Power Line Conducted Emissions: Transmit Mode

Test Lab: Electronics Test Centre, Airdrie	EUT: Kona Mega Gateway
Test Personnel: Janet Mijares	Standard: FCC Part 15.207
Date: 2022-10-04 (20.7°C, 30.1% RH)	Basic Standard: ANSI C63.10: 2013

EUT status: Compliant

Specification:

Frequency (MHz)	Quasi-Peak Limit (dB μ V)	Average Limit (dB μ V)
0.15 – 0.5	66 to 56 *	56 to 46 *
0.5 – 5	56	46
5 – 30	60	50

Criteria: The conducted emissions produced by a device shall not exceed the limits as specified.

Limits decrease linearly with the logarithm of the frequency

2.1.1 Test Guidance

Before any testing is performed, the Ambient (measurement noise floor) is recorded, and a QC check is performed to show that the system is functioning correctly.

The EUT is powered through a 50 μ H Line Impedance Stabilizing Network (LISN) which is placed 80cm away from the EUT. For tabletop equipment, a vertical ground plane is placed 40cm from the edge of the table. Lastly, the spectrum analyzer is connected to the LISN via armored cable run from the control room to the test chamber. Both the LISN and vertical ground plane are grounded to the reference ground plane on the chamber floor.

Testing starts with a scan, performed under software control. After this is complete, the list of frequencies of interest is generated. These frequencies are then investigated for quasi-peak and average amplitude, as applicable. Emissions measured with a QP detector that fall below the Average limit are deemed to meet both requirements.

2.1.2 Deviations From The Standard

There were no deviations from the EUT setup or methodology specified in the standard.

2.1.3 Test Equipment

Testing was performed with the following equipment:

Equipment	Manufacturer	Model #	Asset #	Calibration Date	Calibration Due
EMC Software	UL	Ver. 9.5	ETC-SW-EMC 2.1	N/A	
EMI receiver	Agilent	N9038A FW A.25.05	6130	2022-07-12	2023-07-12
LISN 150kHz to 30MHz	Com-Power	LI-215A	6180	2022-08-09	2024-08-09
Temp/Humidity	Extech	42270	5892	2022-04-07	2023-04-07

2.1.4 Test Sample Verification, Configuration & Modifications

The EUT was set to transmit continuously on a selected channel with test-specific software. The output was modulated as in normal operation. EUT has option of POE. EUT tested for conducted emission on AC side of POE adaptor mode#PD-9501GO-ET/AC and serial#C19026674000302. Customer is not providing POE adaptor with EUT.

The EUT met the requirements without modification.

Diagram of setup for Conducted Emissions testing:

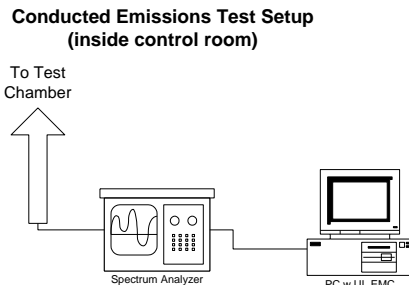
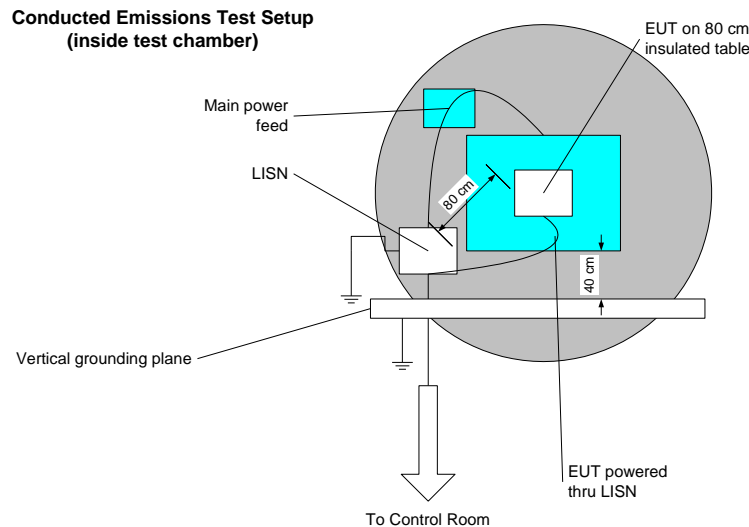

2.1.5 Conducted Emissions Data

The emissions data is presented in tabular form, showing the uncorrected spectrum analyzer reading, the correction factors applied, the net result, the value(s) of limit at the frequency measured, and the Delta between the result and the limit.

EUT with LTE EM7455

Freq. Marker	Freq. (MHz)	Raw reading (dBμV)	Det.	LISN Factor (dB/m)	Cable Loss (dB)	Corrected Reading (dBμV)	FCC 207 Limit (dBμV)	Delta (dB)	L / N
1	.50789	26.35	LnAv	0	9.8	36.15	46	-9.85	Line
2	4.82863	17.37	LnAv	0	10	27.37	46	-18.63	Line
3	13.41791	20.34	LnAv	0	10.4	30.74	50	-19.26	Line
1	.51162	29.55	LnAv	0	9.8	39.35	46	-6.65	Neutral
2	4.77271	24.2	LnAv	0	10	34.2	46	-11.8	Neutral
3	13.41791	19.71	LnAv	0	10.4	30.11	50	-19.89	Neutral

Meter Reading in dBμV + LISN Factor in dB + Gain/Loss Factor in dB = Corrected Emission Strength in dBμV.

Notes:

- When a preamp is used, the resulting gain is compensated, producing a negative value for the Cable Loss.
- LnAv = Linear Average detector

Negative values for Delta indicate compliance.

EUT with LTE EM7455
Plot of Conducted Emissions: LINE

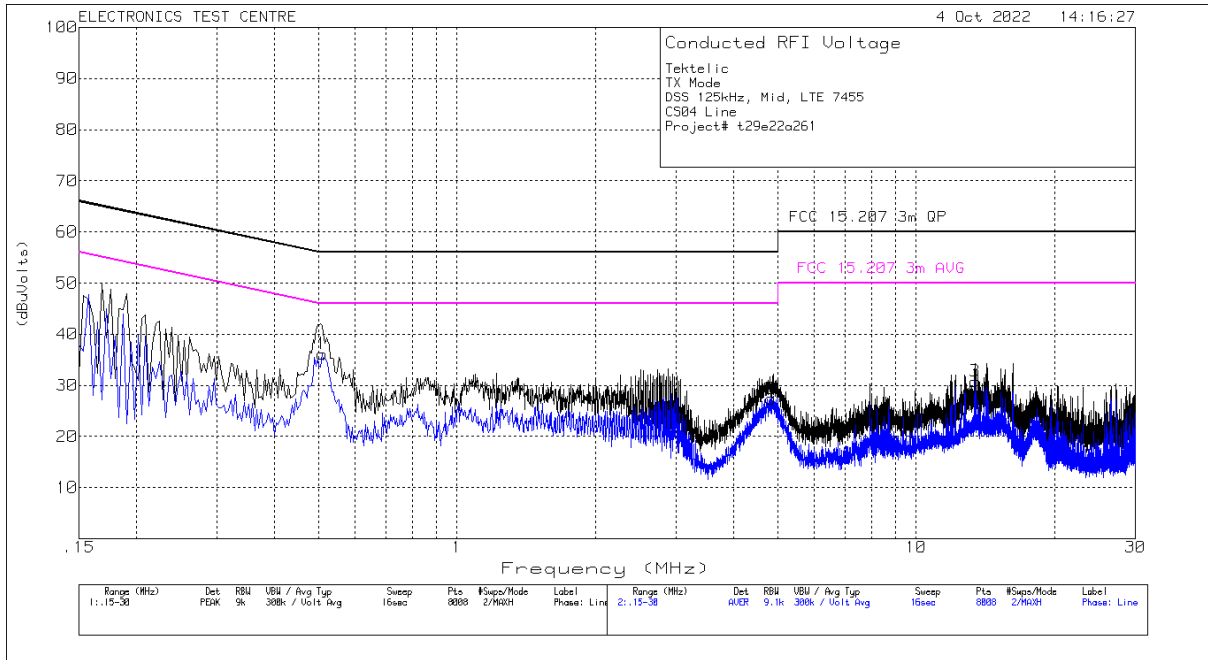

Plot of Conducted Emissions: Neutral

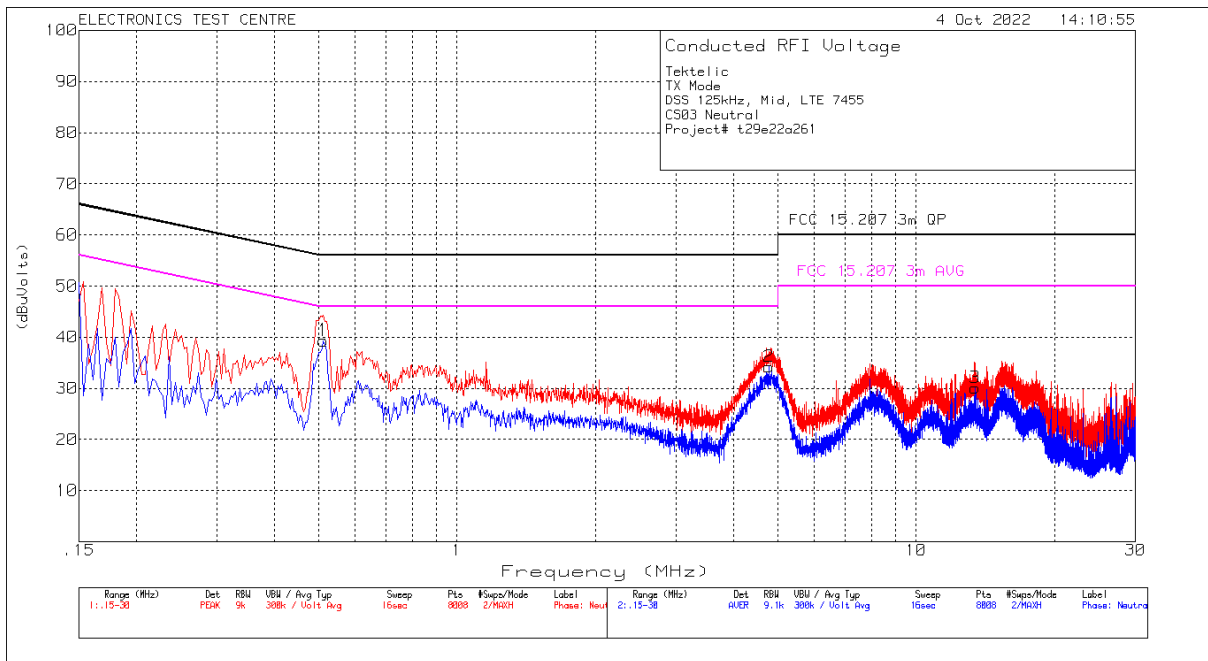

2.2 Channel Occupied Bandwidth

Test Lab: Electronics Test Centre, Airdrie	EUT: Kona Mega Gateway
Test Personnel: Imran Akram / Janet Mijares	Standard: FCC PART 15.247
Date: 2022-10-06/07 (20.5°C, 25.2% RH)	Basic Standard: ANSI C63.10-2013 FCC OET KDB 558074
EUT status: Compliant	

Specification: FCC Part 15.247 (a, 2), FCC 15.215 (c)

Criteria: There is no requirement for this type of hybrid system to comply with the 500 kHz minimum bandwidth normally associated with a DTS transmission.

2.2.1 Test Guidance: ANSI C63.10-2013, Clause 6.9.2 & 6.9.3/ FCC OET KDB 558074

This measurement is performed at low, mid and high frequencies, with modulation.

The RF output of EUT with an antenna connector is fed to the input of the spectrum analyzer through appropriate attenuation. The loss from the cable and the attenuator were added on the analyzer as gain offset setting there by allowing direct measurements, without the need for any further corrections.

Use the following spectrum analyzer setting:	
Span	Between two time and five times the channel center frequency OBW
RBW	1% to 5% of the OBW
VBW	Approximately three times of RBW
Sweep	Auto Couple
Detector Function	Peak
Trace	Max Hold
Allow the trace to stabilize. The automated 99% BW function of the spectrum analyzer is engaged, 20dB bandwidth is measured with the X dB function.	

2.2.2 Deviations From The Standard:

There were no deviations from the EUT setup or methodology specified in the standard.

2.2.3 Test Equipment

Testing was performed with the following equipment:

Equipment	Manufacturer	Model #	Asset #	Cal. Date	Cal. Due
MXE EMI Receiver	Agilent	N9010A FW A.25.05	6130	2022-07-12	2023-07-12
Temp/Humidity	Extech	42270	5892	2022-04-07	2023-04-07
Attenuator	Fairview Microwave	SA18N5WA-10	6886	Cal. before each use	
Coaxial Cables (RF)	W.L. Gore	Pgr10R01036.0	-	Cal. before each use	

2.2.4 Test Sample Verification, Configuration & Modifications

The EUT was set to transmit continuously on a selected channel with test-specific software. The output was modulated as in normal operation.

The EUT met the requirements without modification.

Test setup diagrams for Occupied Bandwidth testing:

Conducted:

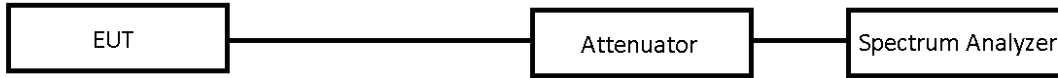

Mode of operation	Channel	Freq. [MHz]	Ant port 0		Ant port 1	
			20 dB OBW [kHz]	99% OBW [kHz]	20 dB OBW [kHz]	99% OBW [kHz]
LoRa 125KHz	Low	915.2	138.7	124.48	133.0	124.28
	Mid	921.4	137.5	124.47	135.4	124.24
	High	927.8	136.3	124.02	133.8	124.29

2.2.5 Channel Occupied Bandwidth Data:

Antenna Port 0

Screen Captures from the spectrum analyzer: Low Channel

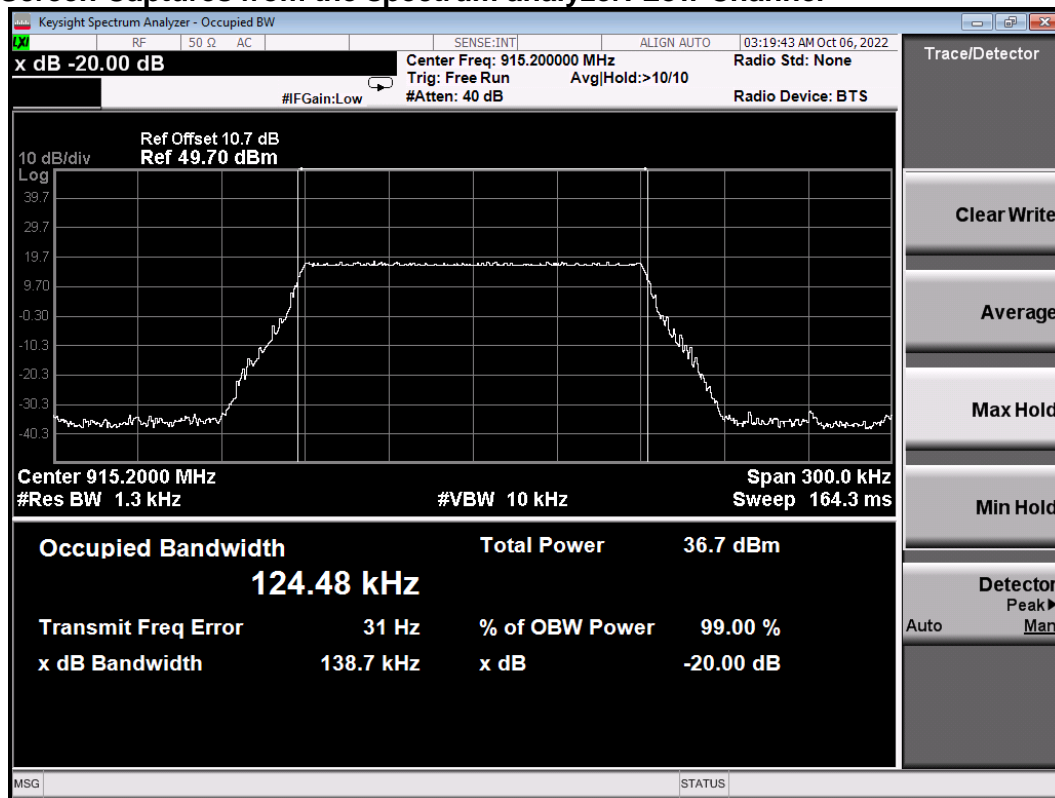

Screen Captures from the spectrum analyzer: MID Channel

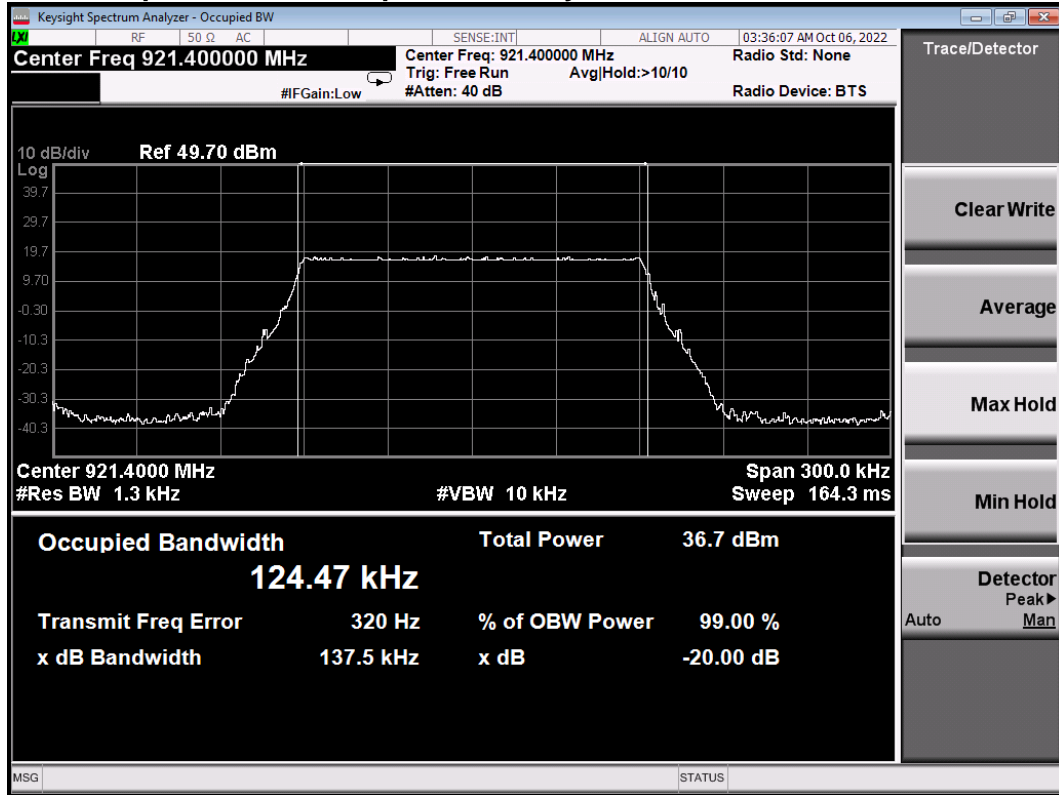

Screen Captures from the spectrum analyzer: High Channel

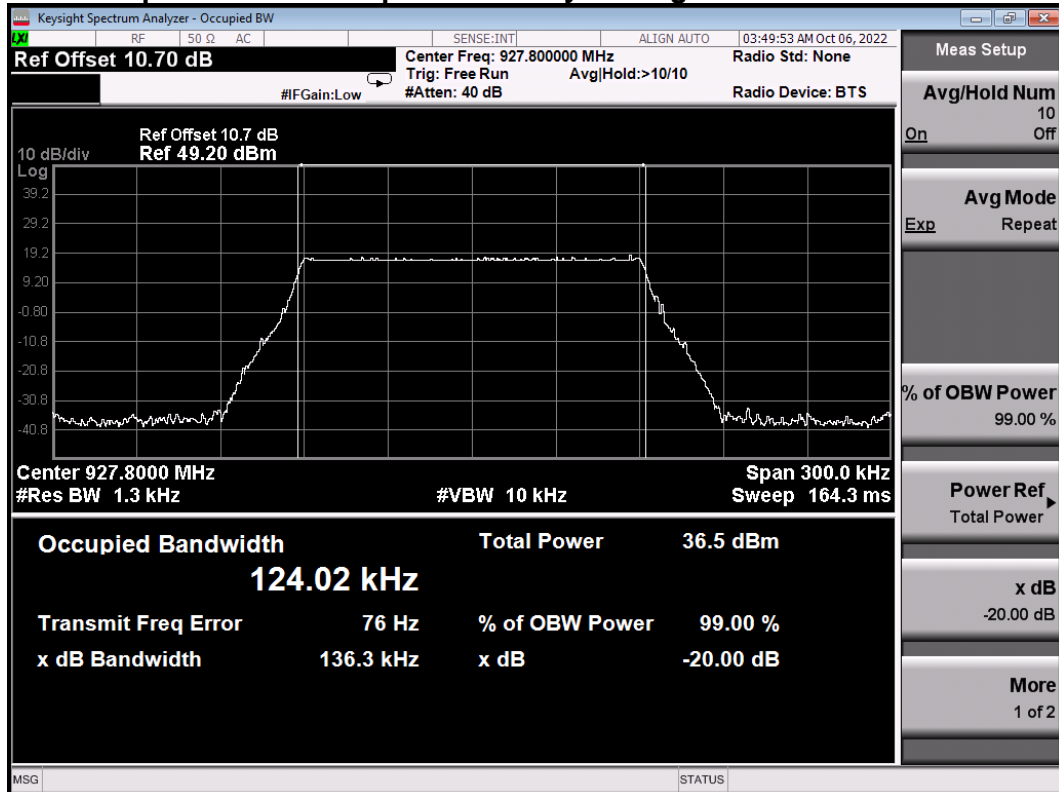

Antenna Port 1

Screen Captures from the spectrum analyzer: Low Channel

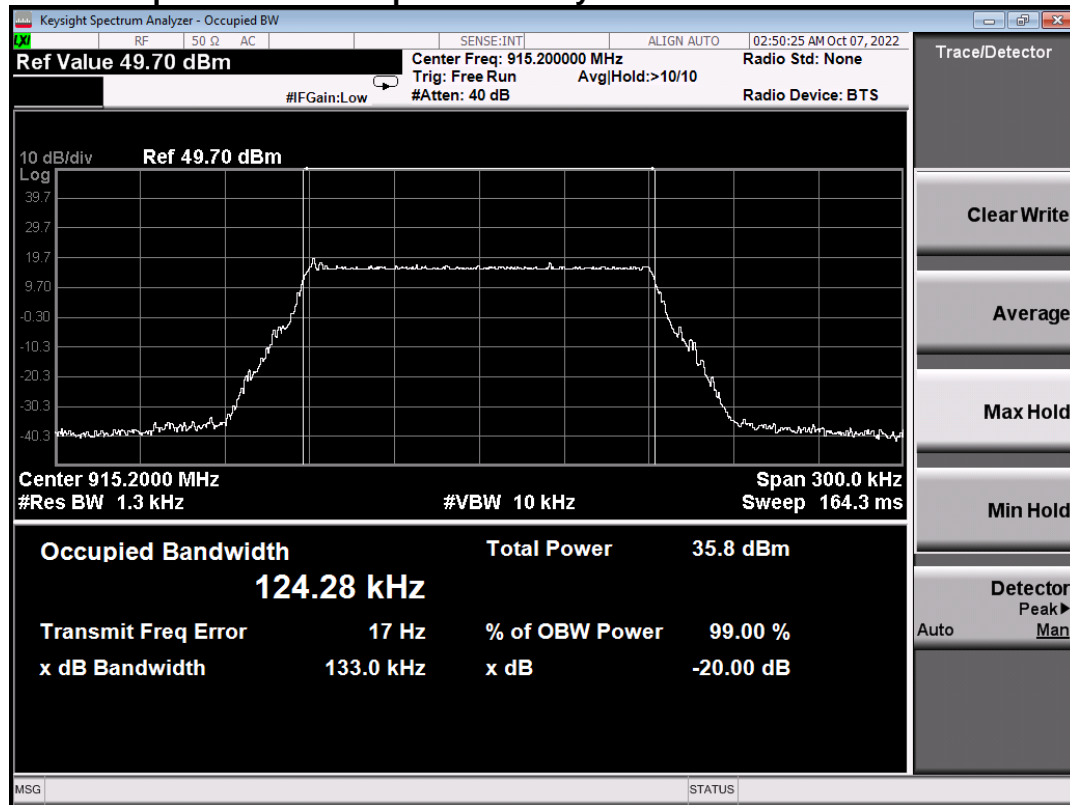

Screen Captures from the spectrum analyzer: MID Channel

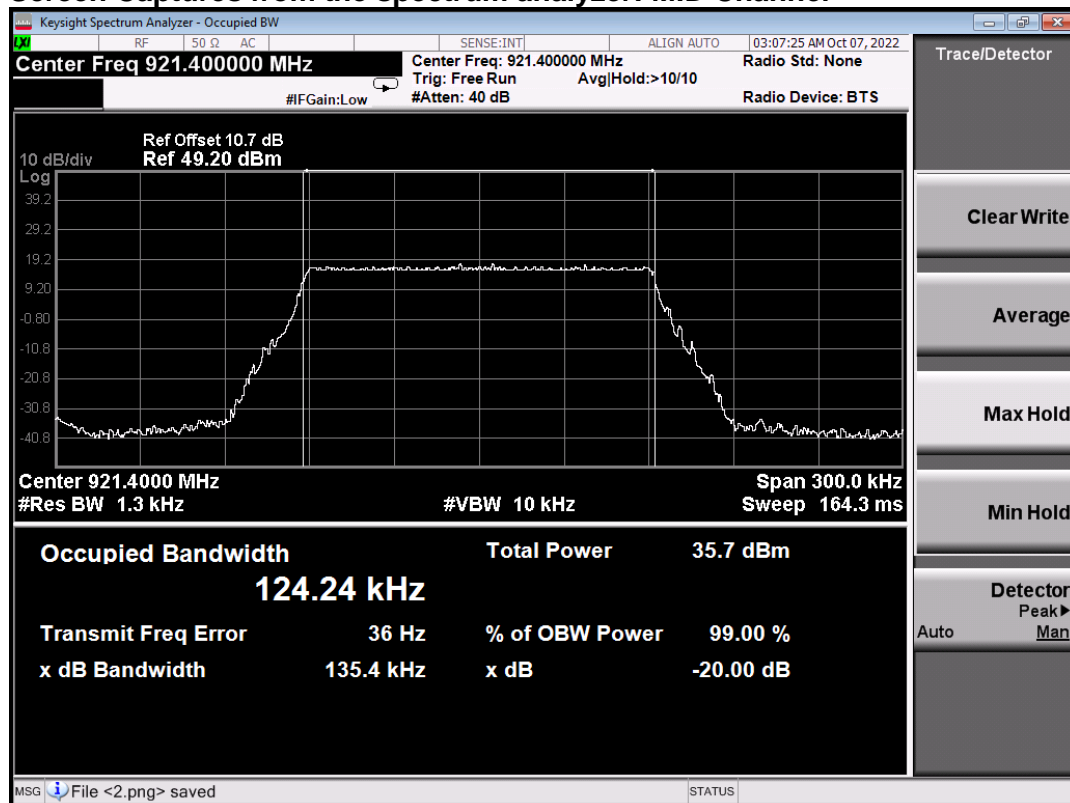

Screen Captures from the spectrum analyzer: High Channel

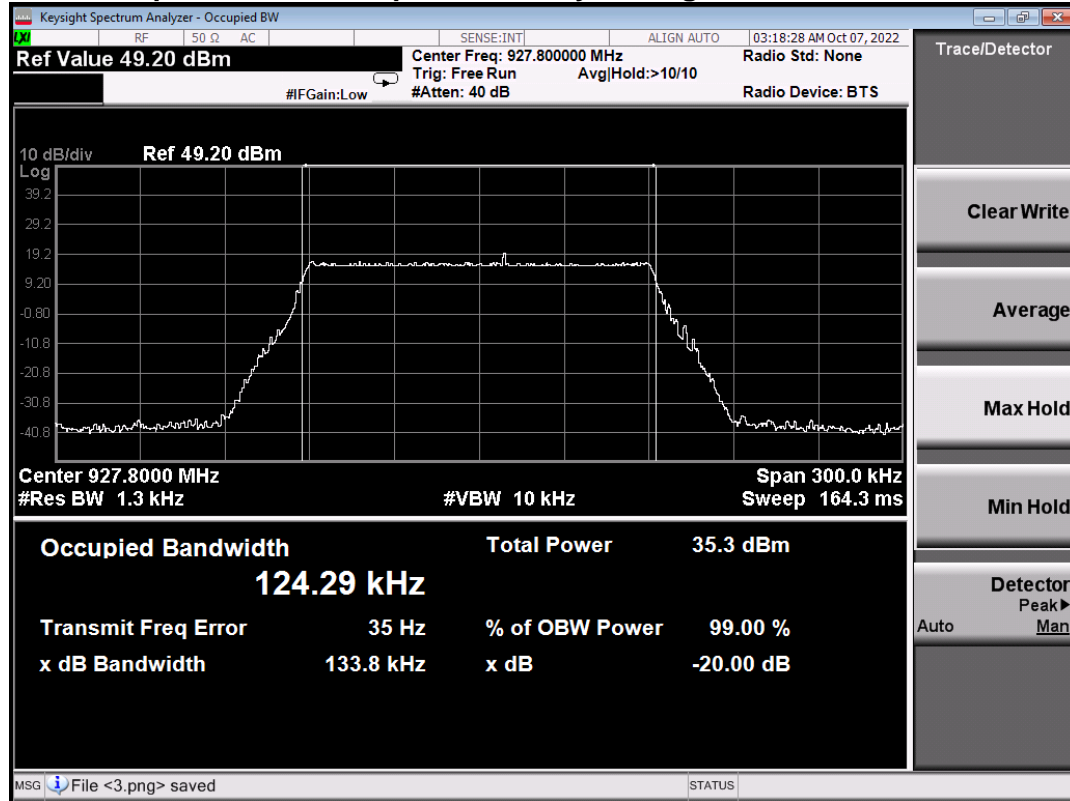

2.3 Max Average Output Power

Test Lab: Electronics Test Centre, Airdrie	EUT: Kona Mega Gateway
Test Personnel: Imran Akram/ Janet Mijares	Standard: FCC PART 15.247
Date: 2022-10-06/07 (20.5°C, 25.2% RH)	Basic Standard: ANSI C63.10: 2013 FCC OET KDB 558074
EUT status: Compliant	

Specification: FCC Part 15.247

Criteria	For systems using digital modulation / hybrid in the 902-928 MHz bands: 1 Watt.
-----------------	---

2.3.1 Test Guidance: ANSI C63.10-2013, Clause 11.9.2.2 Clause 7.8.5 / FCC OET KDB 558074

This measurement is performed at low, mid and high frequencies, with modulation.

The RF output of EUT with an antenna connector is fed to the input of the spectrum analyzer through appropriate attenuation. The loss from the cable and the attenuator were added on the analyzer as gain offset setting there by allowing direct measurements, without the need for any further corrections.

Output Power Method AVGSA-1	
Span	≥ 1.5 times the OBW
RBW	1 – 5 % of the OBW ≤ 1 MHz
VBW	≥ 3 x RBW
Number of Points in sweep	≥ 2 x Span / RBW
Sweep time	Auto Couple
Detector	RMS (Power Averaging)
Sweep trigger	Free Run (Duty Cycle ≥98%)
Trace Average	Minimum 100 traces in power Averaging (RMS)
Power measured	Integrated the spectrum across the OBW of the signal using the S/A band power measurement function, with band limit set equal to the OBW band edge.

2.3.2 Deviations From The Standard:

There were no deviations from the EUT setup or methodology specified in the standard.

2.3.3 Test Equipment

Testing was performed with the following equipment:

Equipment	Manufacturer	Model #	Asset #	Cal. Date	Cal. Due
MXE EMI Receiver	Agilent	N9010A FW A.25.05	6130	2022-07-12	2023-07-12
Temp/Humidity	Extech	42270	5892	2022-04-07	2023-04-07
Attenuator	Fairview Microwave	SA18N5WA-10	6886	Cal. before each use	
Coaxial Cables (RF)	W.L. Gore	Pgr10R01036.0	-	Cal. before each use	

2.3.4 Test Sample Verification, Configuration & Modifications

The EUT was set to a selected channel with test-specific software. The output was modulated as in normal operation.

The EUT met the requirements without modification.

Test setup diagrams for Peak Power testing:

Conducted:

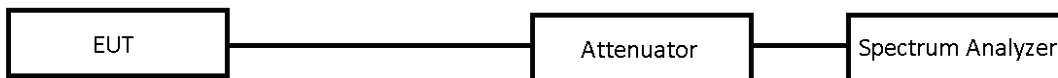

2.3.5 Max Average Output Power Data

Mode of Operation	Channel	Freq. [MHz]	Antenna Port 0	Antenna Port 1	Out Put Power Limit (dBm)
			Output Power (dBm)	Output Power (dBm)	
LoRa 125kHz	Low	915.2	22.26	21.09	30
	Mid	921.4	22.25	21.11	30
	High	927.8	22.07	20.80	30

Antenna Port 0

Screen Captures from the spectrum analyzer Low Channel

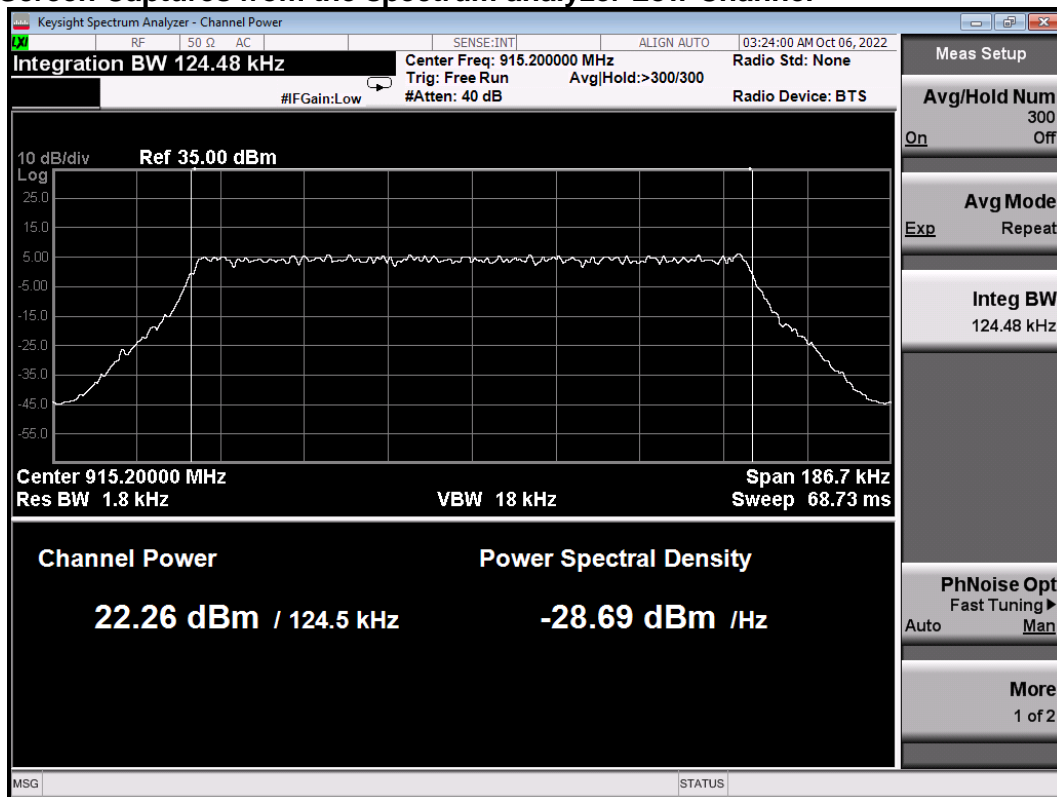

Screen Captures from the spectrum analyzer: MID Channel

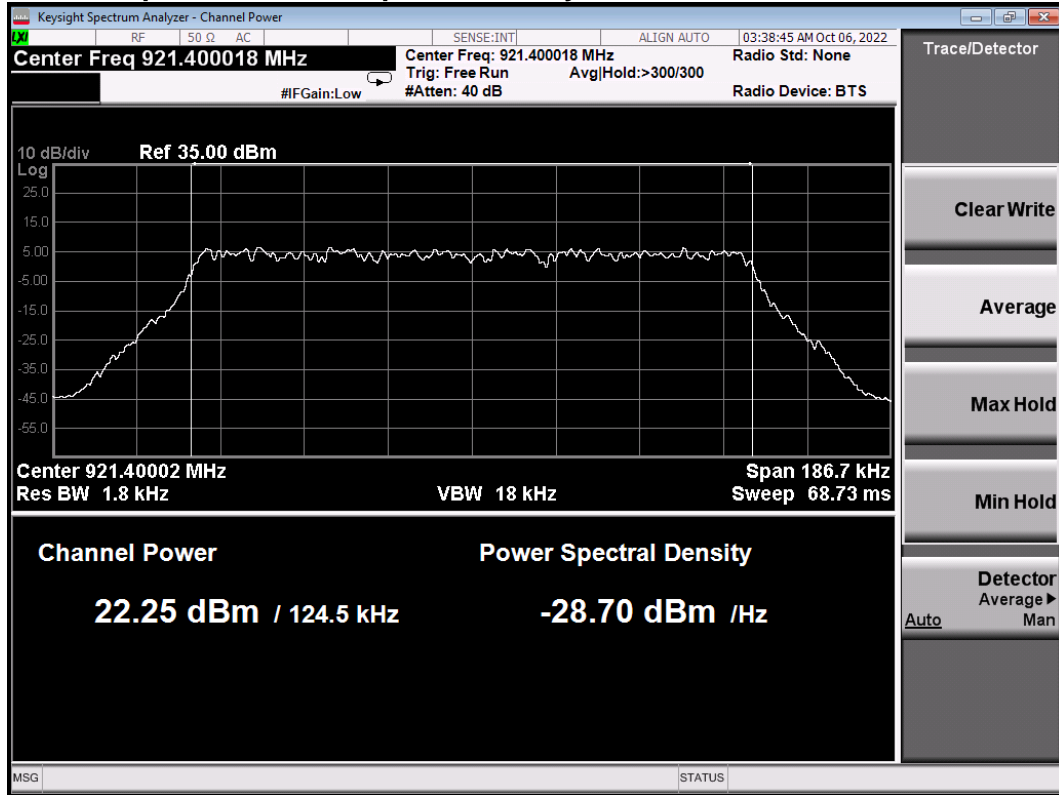

Screen Captures from the spectrum analyzer: High Channel

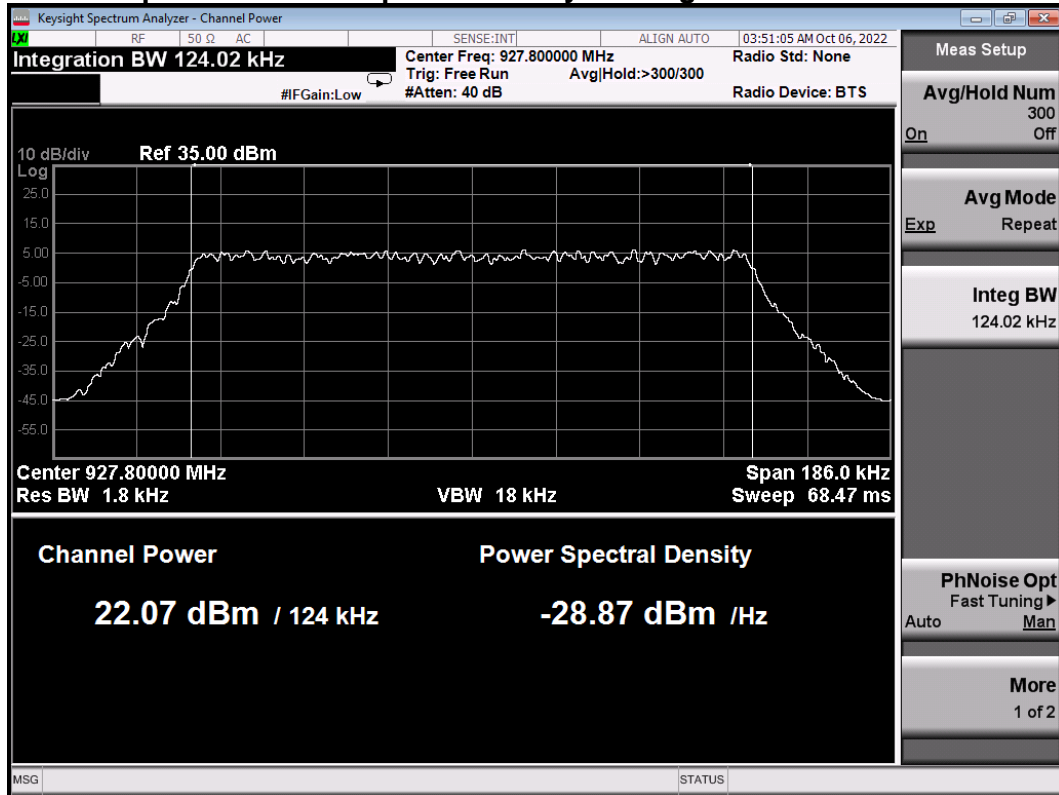

Antenna Port 1

Screen Captures from the spectrum analyzer Low Channel

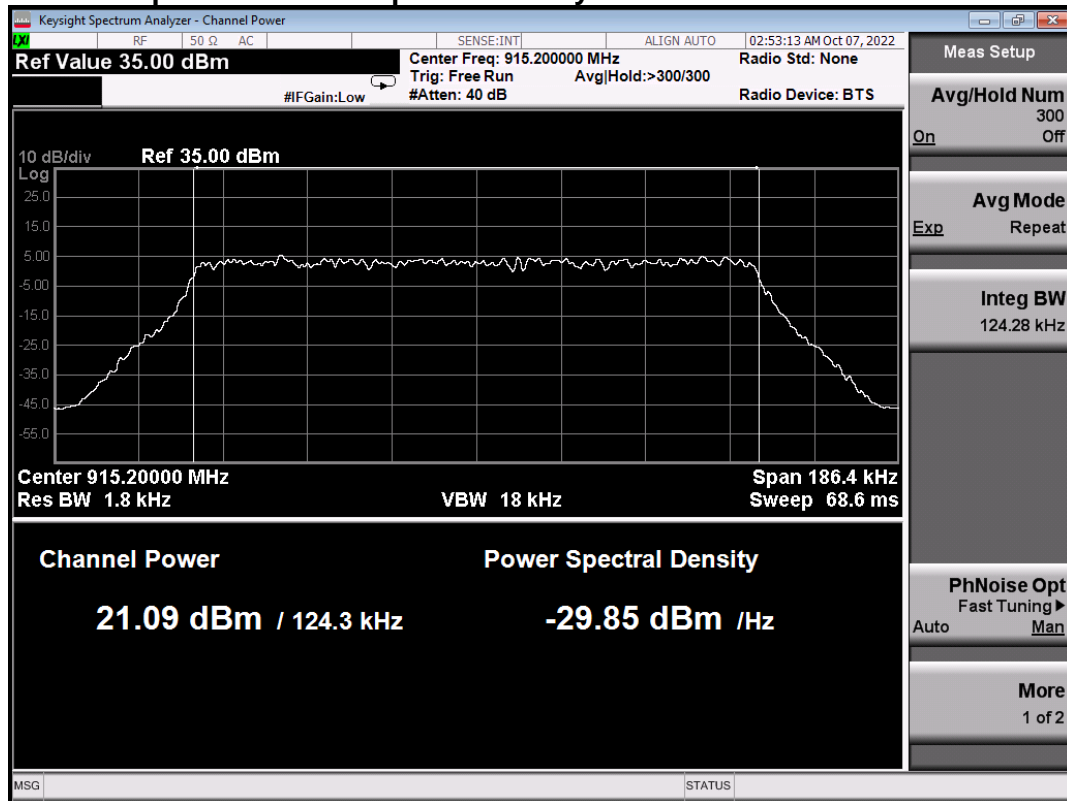

Screen Captures from the spectrum analyzer: MID Channel

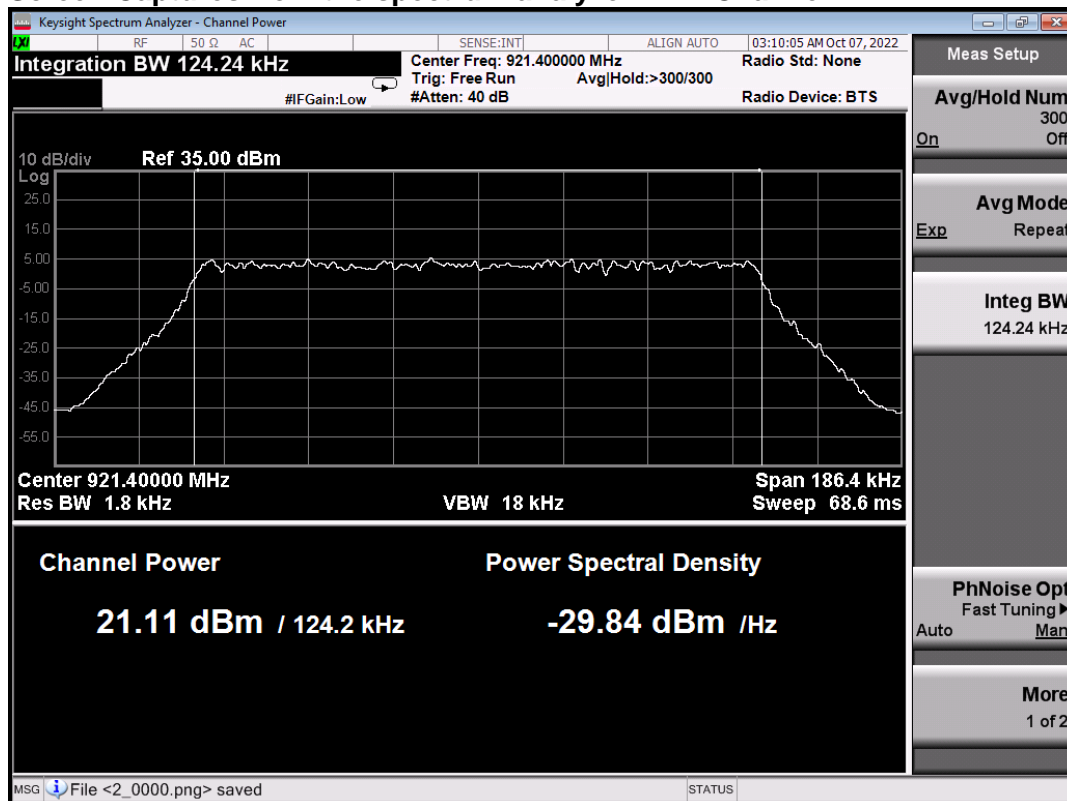

Screen Captures from the spectrum analyzer: High Channel

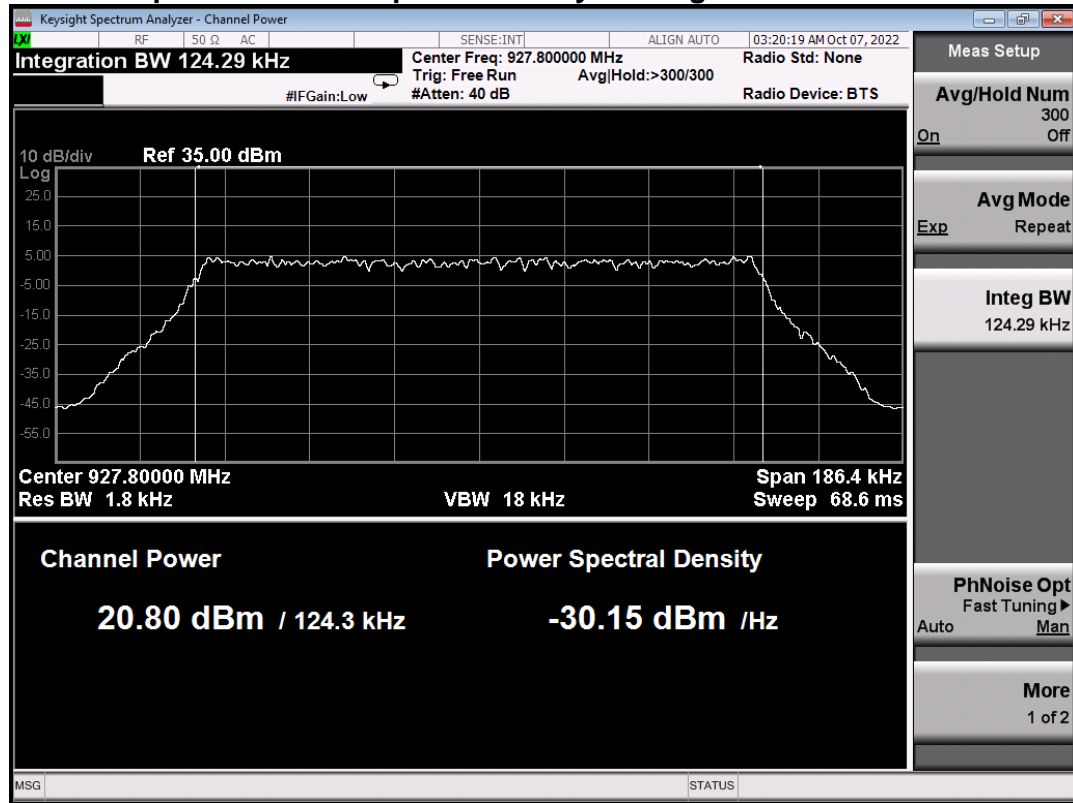

2.4 Power Spectral Density

Test Lab: Electronics Test Centre, Airdrie	EUT: Kona Mega Gateway
Test Personnel: Imran Akram/ Janet Mijares	Standard: FCC PART 15.247
Date: 2022-10-06/07 (20.5°C, 25.2% RH)	Basic Standard: ANSI C63.10: 2013
EUT status: Compliant	

Specification: FCC Part 15.247(f)

Criteria The power spectral density conducted from the intentional radiator to the antenna due to the digital modulation operation of the hybrid system, with the frequency hopping operation turned off, shall not be greater than 8 dBm in any 3kHz band during any time interval of continuous transmission.

2.4.1 Test Guidance: ANSI C63.10-2013, Clause 11.10.3 / FCC OET KDB 558074

This measurement is performed at low, mid and high frequencies, in continuous transmission, with modulation.

The RF output of EUT with an antenna connector is fed to the input of the spectrum analyzer through appropriate attenuation. The loss from the cable and the attenuator were added on the analyzer as gain offset setting there by allowing direct measurements, without the need for any further corrections.

Use the following Spectrum Analyzer settings	
Span	At least 1.5 times the OBW of channel center Frequency
RBW	3 kHz
VBW	≥ 3 x VBW
Sweep	Auto Couple
Detector Function	Power averaging (RMS) or Sample detector (when RMS not available).
Trace	Employ trace average (rms) mode over a minimum of 100 traces.
Ensure that the number of measurement points in the sweep ≥ [2 x span / RBW]. Allow the trace to stabilize. Use the peak marker function to determine the maximum amplitude level.	

2.4.2 Deviations From The Standard:

There were no deviations from the EUT setup or methodology specified in the standard.

2.4.3 Test Equipment

Testing was performed with this equipment:

Equipment	Manufacturer	Model #	Asset #	Cal. Date	Cal. Due
MXE EMI Receiver	Agilent	N9010A FW A.25.05	6130	2022-07-12	2023-07-12
Temp/Humidity	Extech	42270	5892	2022-04-07	2023-04-07
Attenuator	Fairview Microwave	SA18N5WA-10	6886	Cal. before each use	
Coaxial Cables (RF)	W.L. Gore	Pgr10R01036.0	-	Cal. before each use	

2.4.4 Test Sample Verification, Configuration & Modifications

The EUT was set to transmit continuously on a selected channel with test-specific software. The output was modulated as in normal operation. The EUT met the requirements without modification.

Test setup diagrams for Peak Power Spectral Density testing:
Conducted:

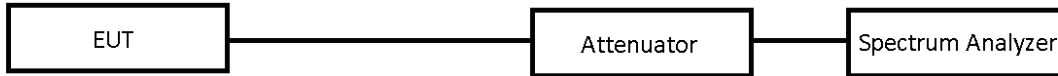

2.4.5 Average PSD Data

Mode of operation	Channel	Freq. [MHz]	Antenna Port 0	Antenna Port 1	PSD Limit (dBm)
			PSD (dBm)	PSD (dBm)	
LoRa 125 KHz	Low	915.2	7.853	7.104	8
	Mid	921.4	7.902	7.172	8
	High	927.8	7.850	7.476	8

Antenna Port 0

Screen Capture from Spectrum Analyzer: Low Channel

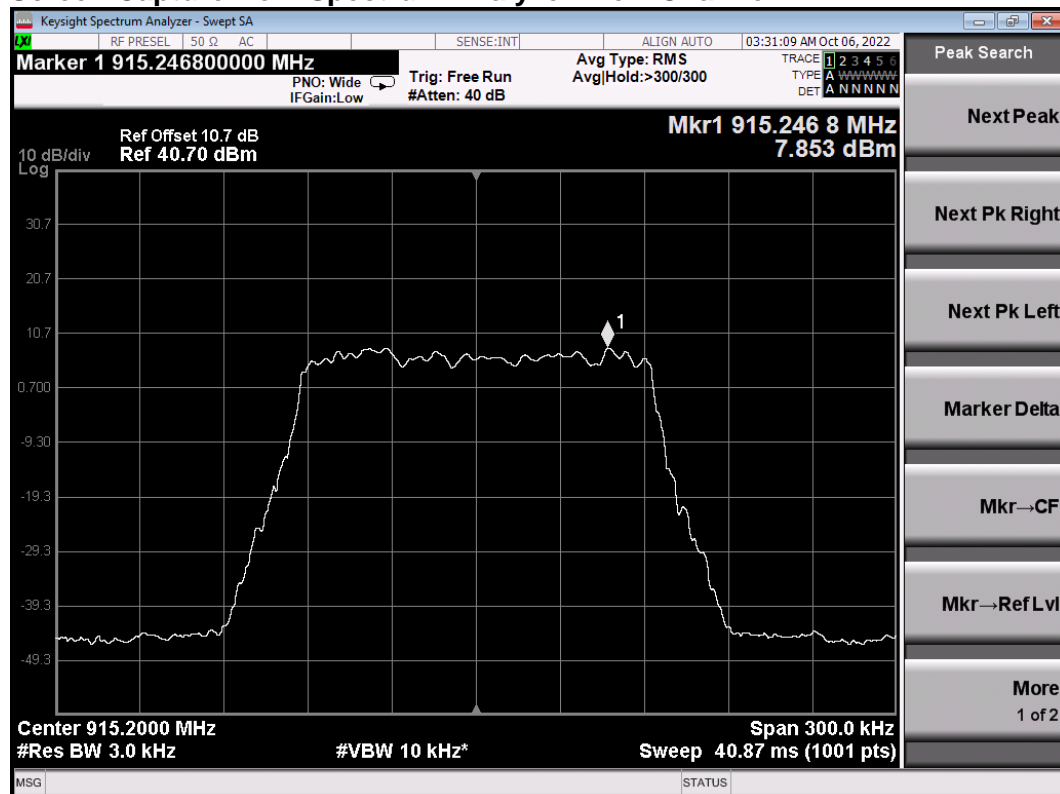

Screen Capture from Spectrum Analyzer: MID Channel

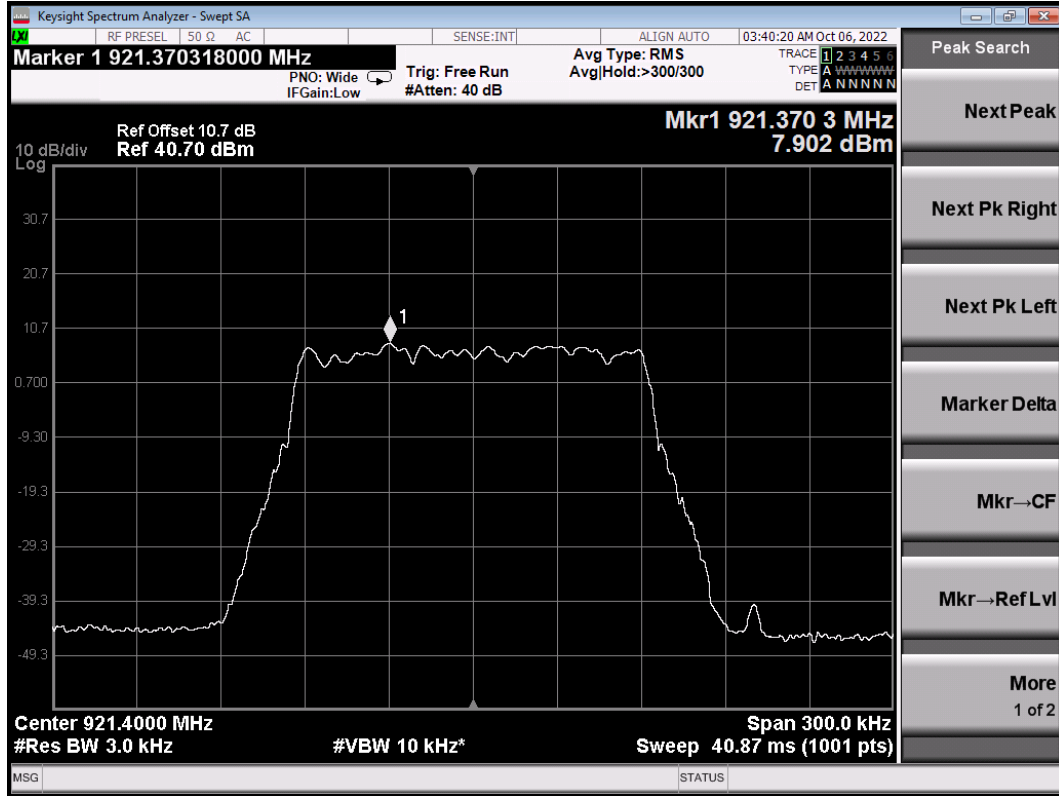

Screen Capture from Spectrum Analyzer: High Channel

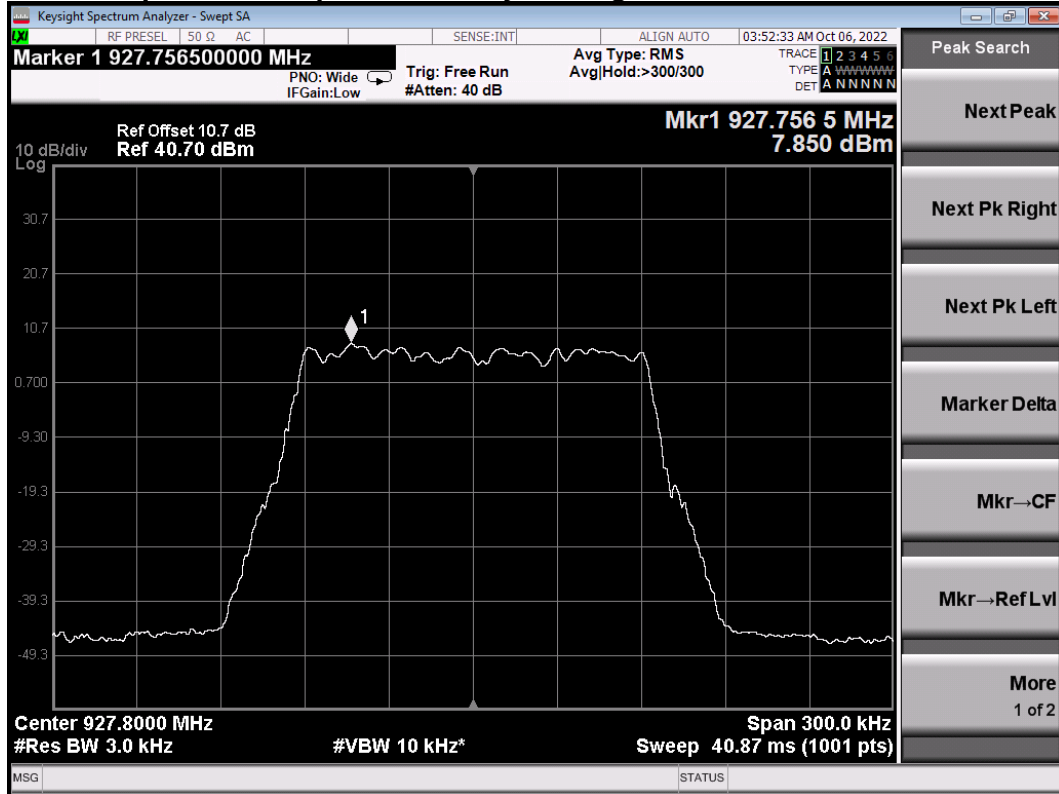

Antenna Port 1

Screen Capture from Spectrum Analyzer: Low Channel

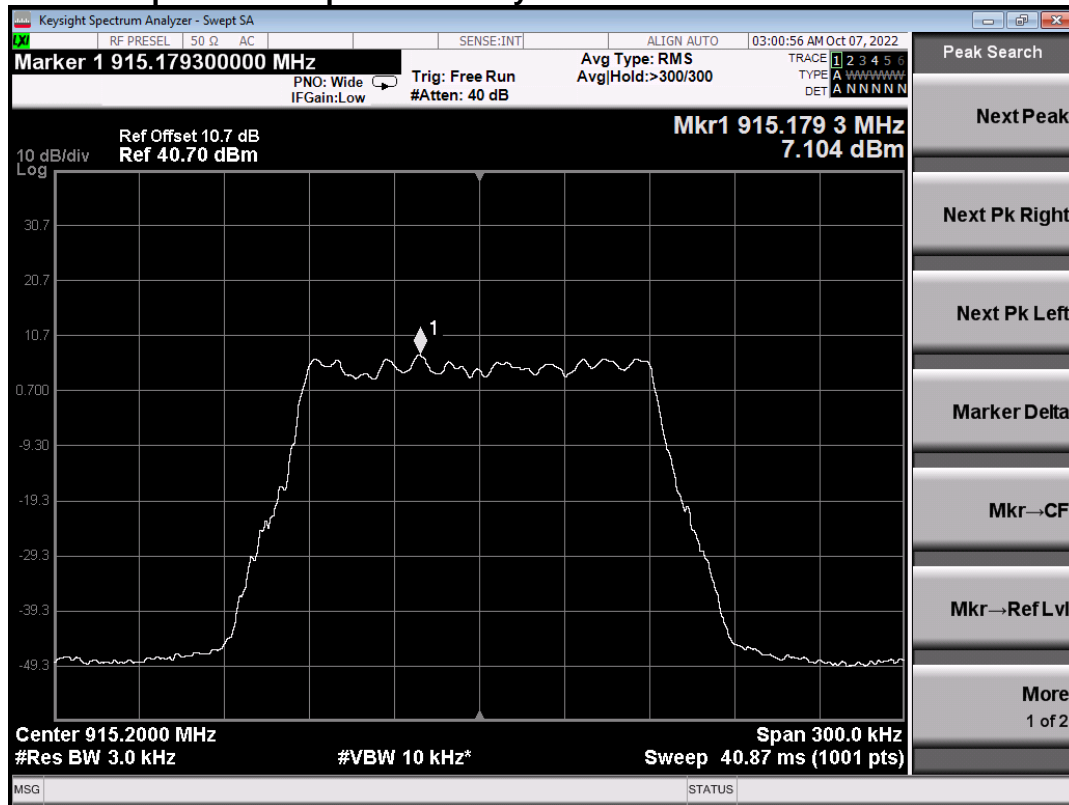

Screen Capture from Spectrum Analyzer: MID Channel

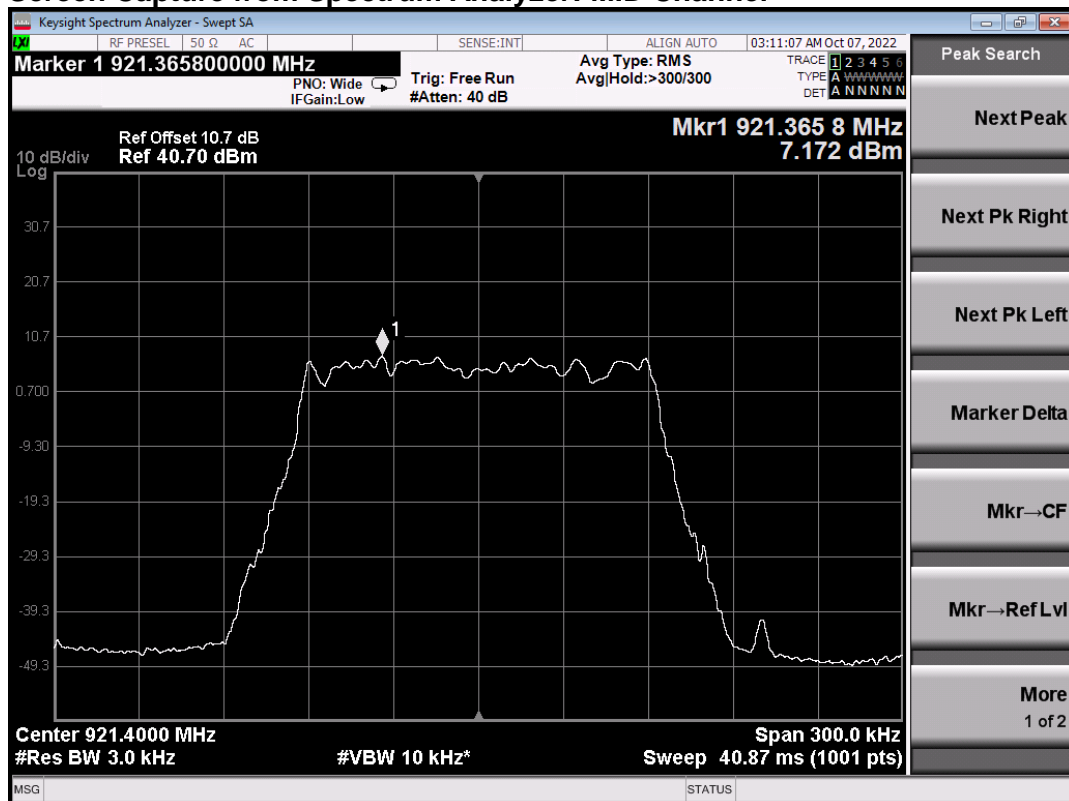

Screen Capture from Spectrum Analyzer: High Channel

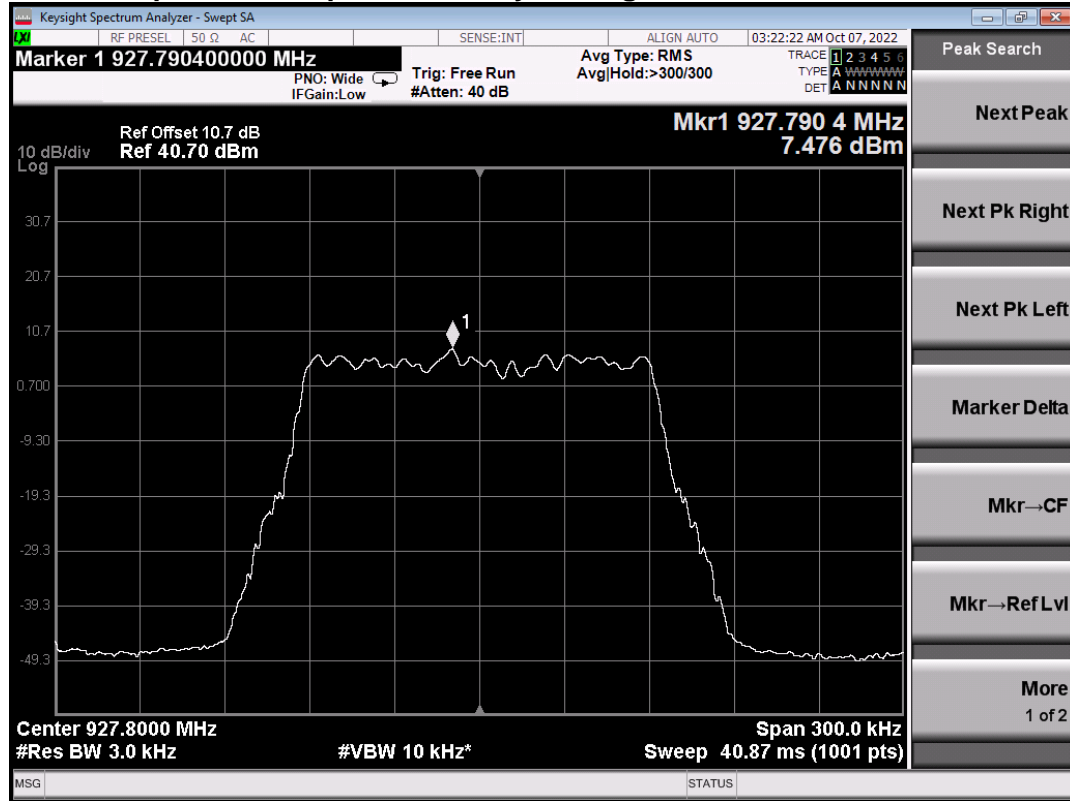

2.5 Band Edge Attenuation

Test Lab: Electronics Test Centre, Airdrie	EUT: Kona Mega Gateway
Test Personnel: Imran Akram/ Janet Mijares	Standard: FCC PART 15.247
Date: 2022-10-06/07 (20.7°C, 25.2% RH)	Basic Standard: ANSI C63.10: 2013
EUT status: Compliant	

Specification: FCC Part 15.247(d)

<p>Criteria: In any 100 kHz bandwidth outside the frequency band in which the spread spectrum or digitally modulated intentional radiator is operating, the radio frequency power that is produced by the intentional radiator shall be at least 20 dB below that in the 100 kHz bandwidth within the band that contains the highest level of the desired power, based on either an RF conducted or a radiated measurement, provided the transmitter demonstrates compliance with the peak conducted power limits. If the transmitter complies with the conducted power limits based on the use of RMS averaging over a time interval, as permitted under paragraph (b)(3) of this section, the attenuation required under this paragraph shall be 30 dB instead of 20 dB. Attenuation below the general limits specified in §15.209(a) is not required. In addition, radiated emissions which fall in the restricted bands, as defined in §15.205(a), must also comply with the radiated emission limits specified in §15.209(a) (see §15.205(c)).</p>
--

2.5.1 Test Guidance: ANSI C63.10-2013 Clause 6.10.4 & 7.8.6, 6.10.6 / FCC OET KDB 558074

This measurement is performed at the low and high frequencies, with modulation.

The RF output of EUT with an antenna connector is fed to the input of the spectrum analyzer through appropriate attenuation. The loss from the cable and the attenuator were added on the analyzer as gain offset setting there by allowing direct measurements, without the need for any further corrections.

Use the following spectrum analyzer settings:	
Span	Wide enough to capture the peak level of the emission operating on the channel closest to the band edge, as well as any modulation products that fall outside of the authorized band of operation.
Attenuation	Auto (at least 10 dB preferred).
RBW	100 kHz
VBW	300 kHz
Sweep	Coupled
Detector function	peak
Trace	max hold
Allow the trace to stabilize. Set the marker on the emission at the band edge, or on the highest modulation product outside of the band, if this level is greater than that at the band edge. Enable the marker-delta function, and then use the marker-to-peak function to move the marker to the peak of the in-band emission.	

2.5.2 Deviations From The Standard:

There were no deviations from the EUT setup or methodology specified in the standard.

2.5.3 Test Equipment

Testing was performed with the following equipment:

Equipment	Manufacturer	Model #	Asset #	Cal. Date	Cal. Due
MXE EMI Receiver	Agilent	N9010A FW A.25.05	6130	2022-07-12	2023-07-12
Temp/Humidity	Extech	42270	5892	2022-04-07	2023-04-07
Attenuator	Fairview Microwave	SA18N5WA-10	6886	Cal. before each use	
Coaxial Cables (RF)	W.L. Gore	Pgr10R01036.0	-	Cal. before each use	

2.5.4 Test Sample Verification, Configuration & Modifications

The EUT was set to transmit continuously on a selected channel with test-specific software. The output was modulated as in normal operation. The EUT met the requirements without modification.

Test setup diagrams for Band Edge Attenuation testing:

Conducted:



2.5.5 Band Edge Data

Worse Case Data

Mode of operation	Channel	Antenna Port 0	Antenna port 1	Attenuation Limit at Band Edge
		Attenuation at Band Edge	Attenuation at Band Edge	
Lora 125KHz (Non-Hopping)	915.2	63.903 dBc	62.1922 dBc	30 dBc
	927.8	40.569 dBc	39.886 dBc	30 dBc
Lora 125KHz (Hopping)	915.2	52.188 dBc		30 dBc
	927.8	54.236 dBc		30 dBc

Antenna Port 0

Screen Capture from the spectrum analyzer: Lower Band Edge (Non-Hopping)

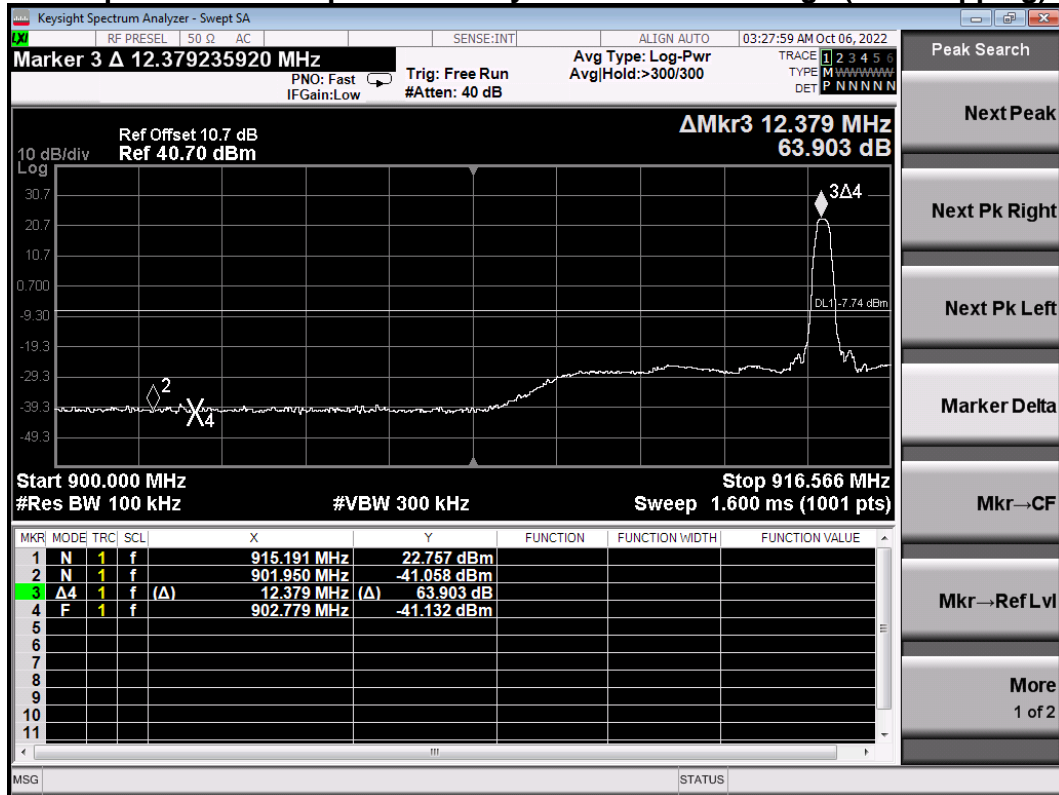

Screen Capture from the spectrum analyzer: Upper Band Edge (Non-Hopping)

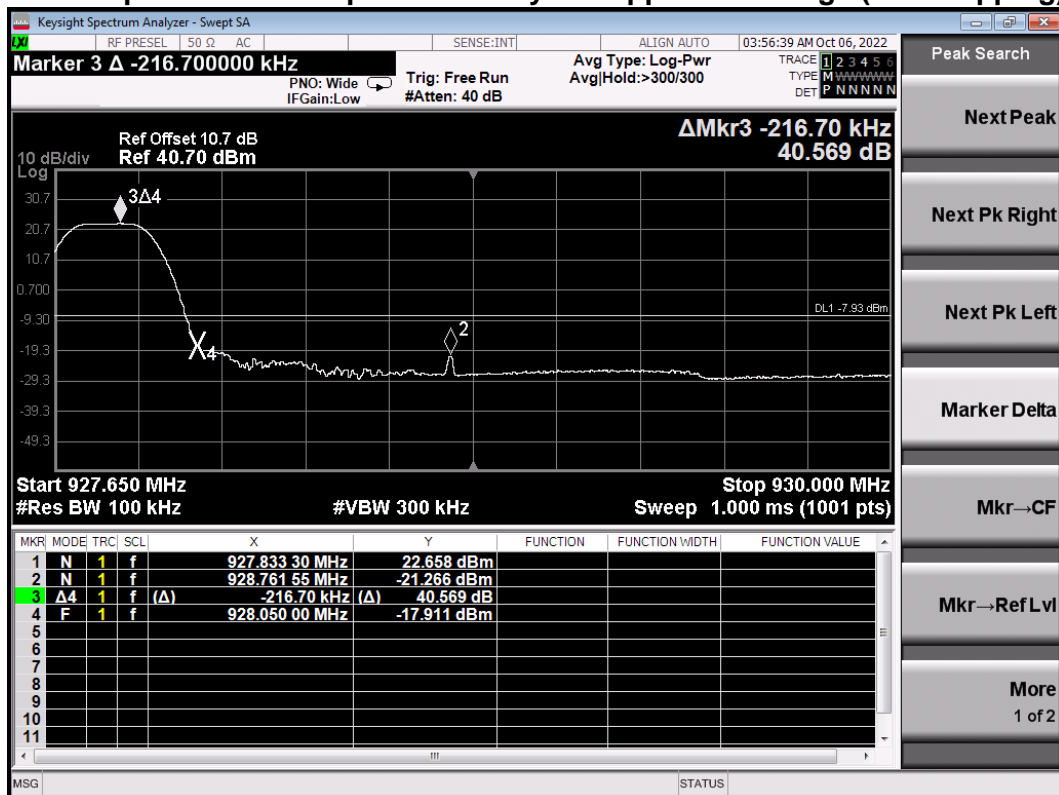

Antenna Port 1

Screen Capture from the spectrum analyzer: Lower Band Edge (Non-Hopping)

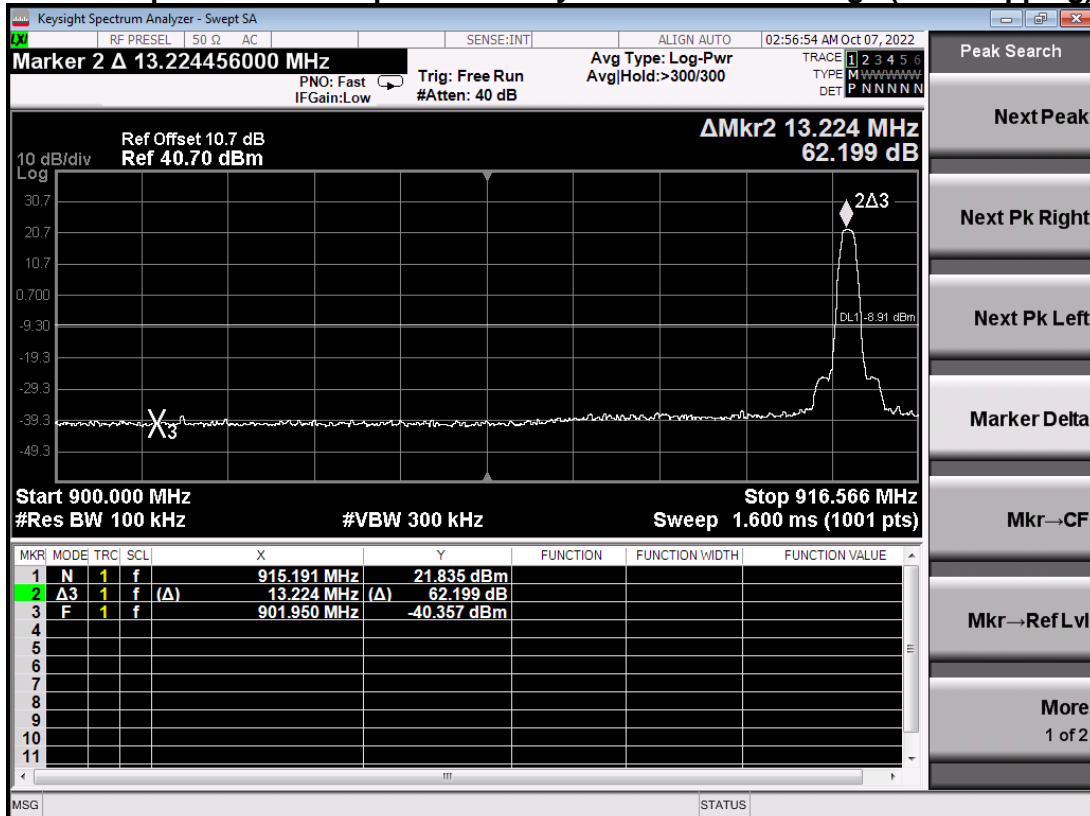

Screen Capture from the spectrum analyzer: Upper Band Edge (Non-Hopping)

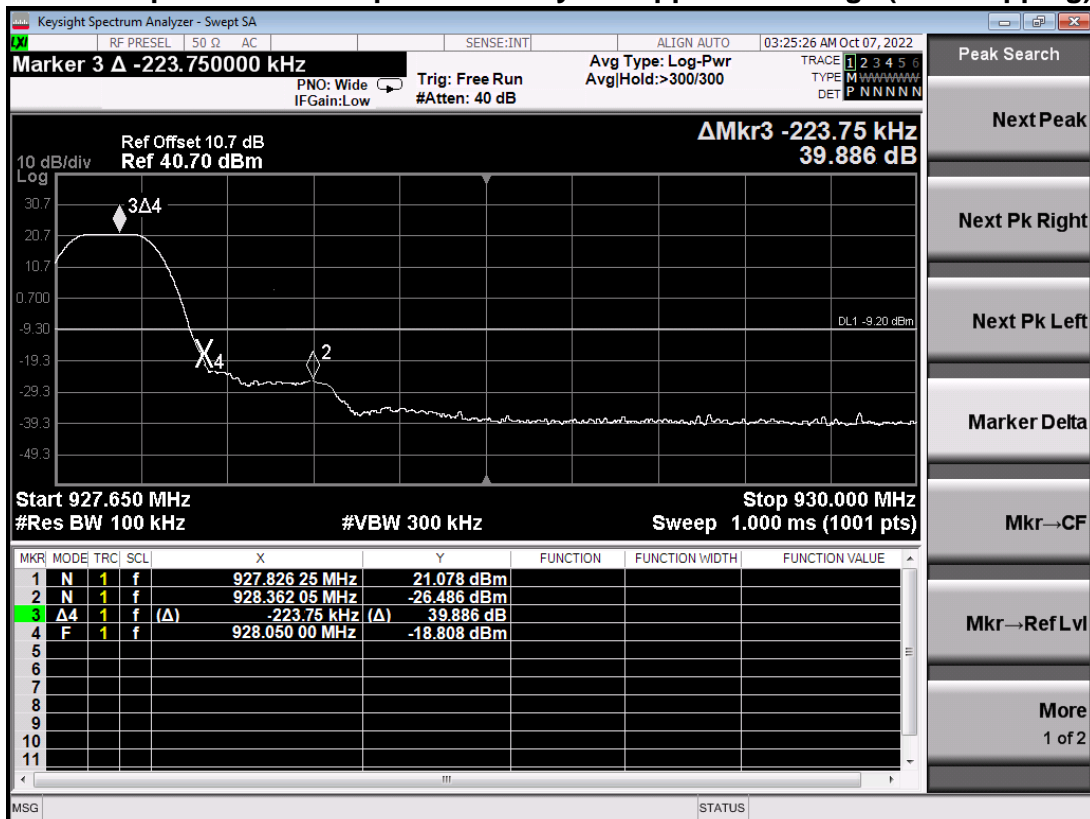

Screen Capture from the spectrum analyzer: Lower Band Edge (Hopping)

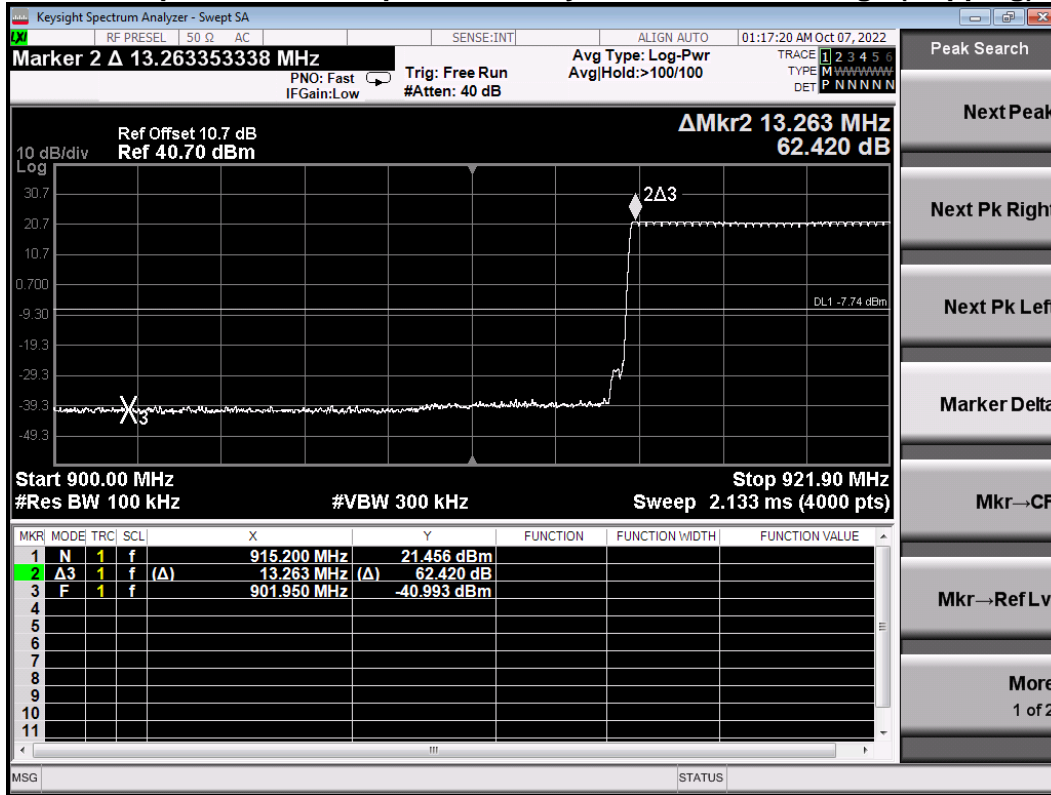

Screen Capture from the spectrum analyzer: Upper Band Edge (Hopping)

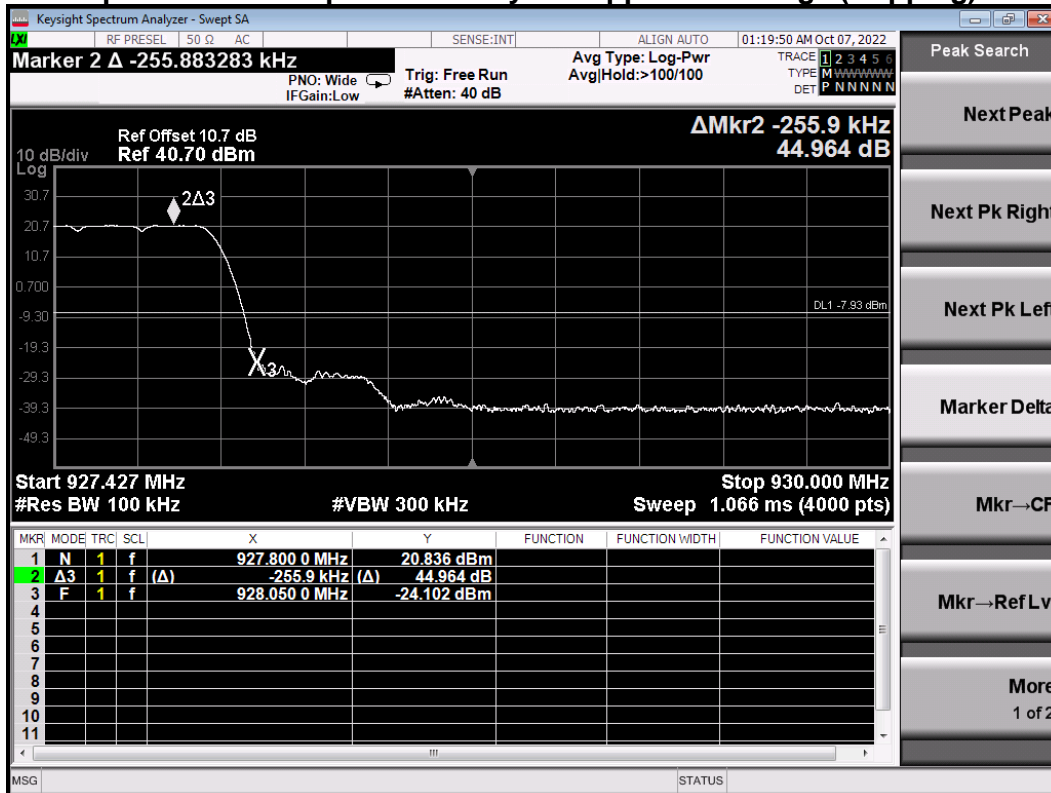

2.6 Conducted Spurious Emissions (Non- Restricted Band)

Test Lab: Electronics Test Centre, Airdrie	EUT: Kona Mega Gateway
Test Personnel: Imran Akram/ Janet Mijares	Standard: FCC PART 15.247
Date: 2022-10-06/07 (20.5°C,25.2% RH)	Basic Standard: ANSI C63.4-2014 FCC OET KDB 558470
EUT status: Compliant	

Specification: FCC Part 15.247(d)

In any 100kHz bandwidth outside the frequency band in which the spread spectrum or digitally modulated intentional radiator is operating, the radio frequency power that is produced by the intentional radiator shall be at least 20 dB below that in the 100 kHz bandwidth within the band that contains the highest level of the desired power, based on either an RF conducted or a radiated measurement, provided the transmitter demonstrates compliance with the peak conducted power limits. If the transmitter complies with the conducted power limits based on the use of RMS averaging over a time interval, as permitted under paragraph (b)(3) of this section, the attenuation required under this paragraph shall be 30 dB instead of 20 dB.

2.6.1 Test Guidance: ANSI C63.10-2013, Clause 6.7, 7.8.8 / 558074 D01 15.247 Measurement Guidance v05r02

This measurement is performed at the low, mid and high frequencies, with modulation. The RF output of EUT with an antenna connector is fed to the input of the spectrum analyzer through appropriate attenuation. The loss from the cable and the attenuator were added on the analyzer as gain offset setting there by allowing direct measurements, without the need for any further corrections.

Use the following spectrum analyzer settings:	
Span	Set the center frequency and span to encompass frequency range to be measured.
RBW	100 kHz
VBW	300 kHz
Sweep	Auto Coupled
Detector function	peak
Trace	max hold
Allow the trace to stabilize. Use the peak marker function to determine the maximum amplitude level. Ensure that the amplitude of all unwanted emissions outside of the authorized frequency band (excluding restricted frequency bands) is attenuated by at least the minimum requirements specified in	

2.6.2 Deviations From The Standard:

There were no deviations from the EUT setup or methodology specified in the standard.

2.6.3 Test Equipment

Testing was performed with the following equipment:

Equipment	Manufacturer	Model #	Asset #	Cal. Date	Cal. Due
MXE EMI Receiver	Agilent	N9010A FW A.25.05	6130	2022-07-12	2023-07-12
Temp/Humidity	Extech	42270	5892	2022-04-07	2023-04-07
Attenuator	Fairview Microwave	SA18N5WA-10	6886	Cal. before each use	
Coaxial Cables (RF)	W.L. Gore	Pgr10R01036.0	-	Cal. before each use	

2.6.4 Test Sample Verification, Configuration & Modifications

The EUT was set to a selected channel with test-specific software. The output was modulated as in normal operation. The EUT met the requirements without modification.

Test setup diagram for Conducted Spurious Emissions testing:



2.6.5 Conducted Emissions Data:
Antenna Port 0

Low Channel

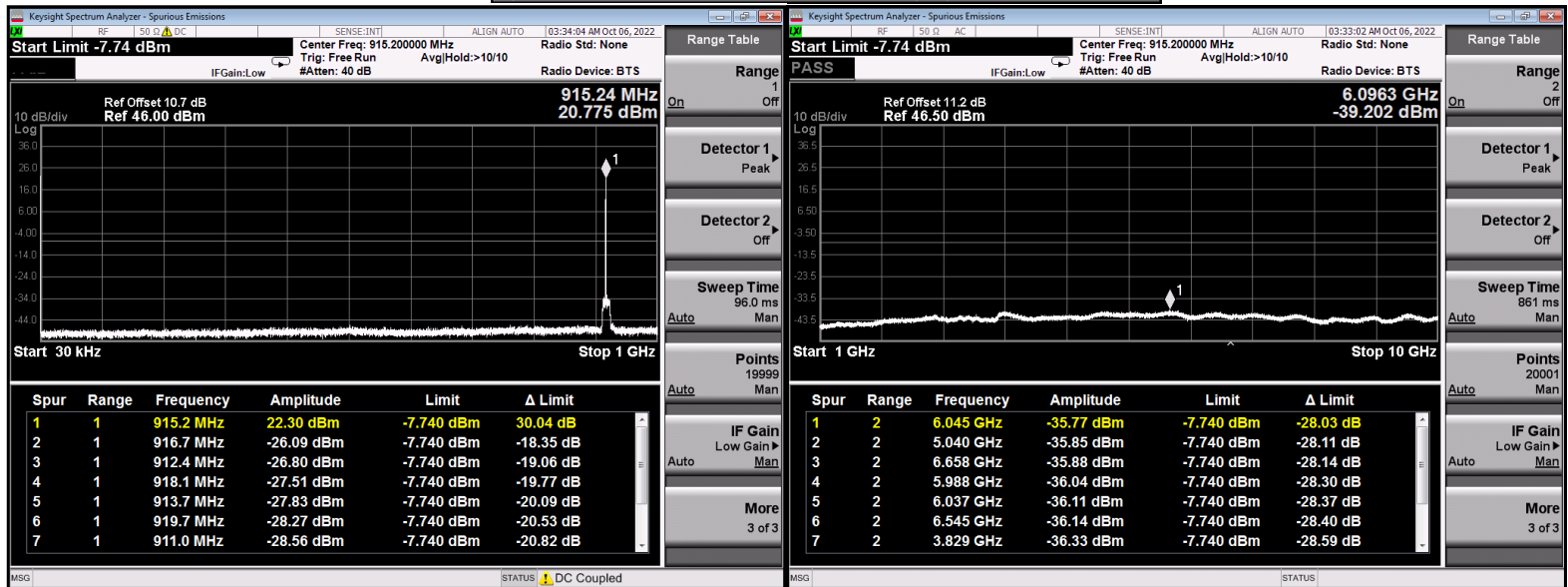
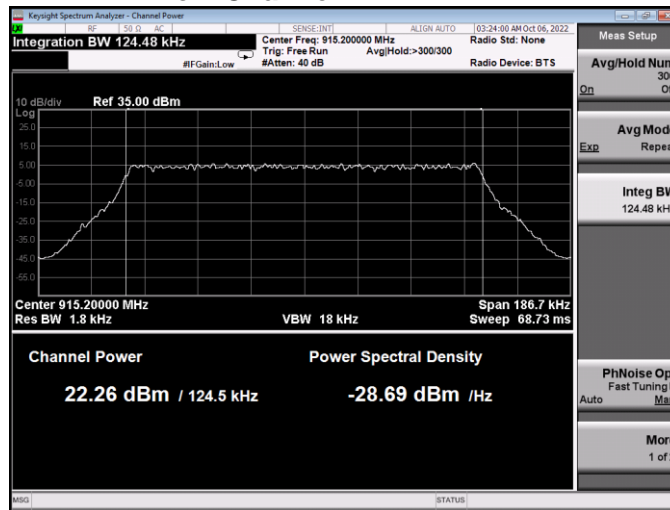

MID Channel

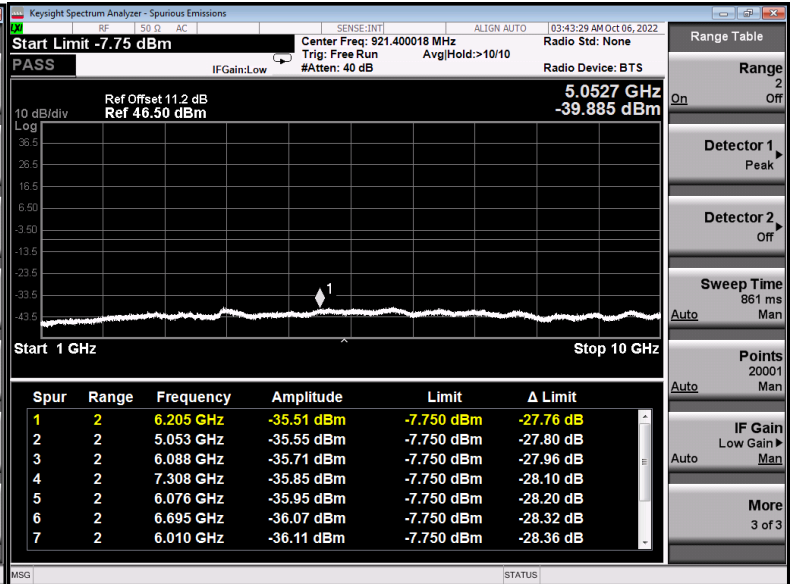
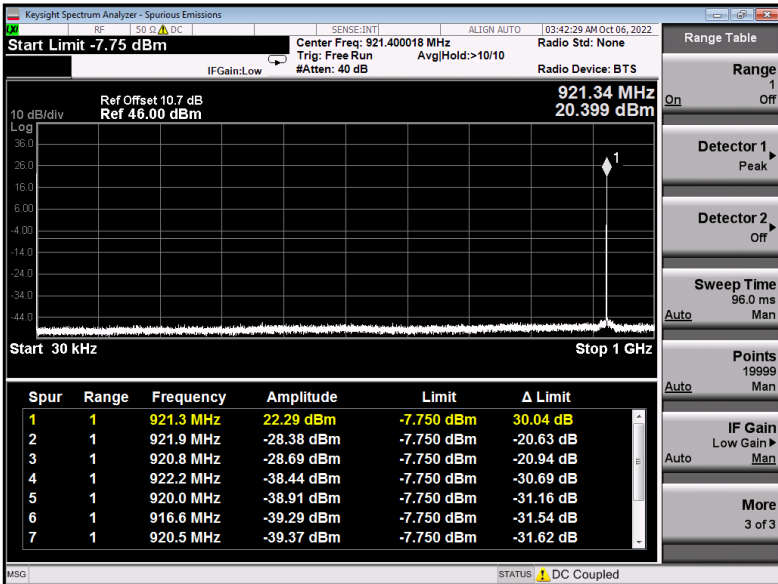
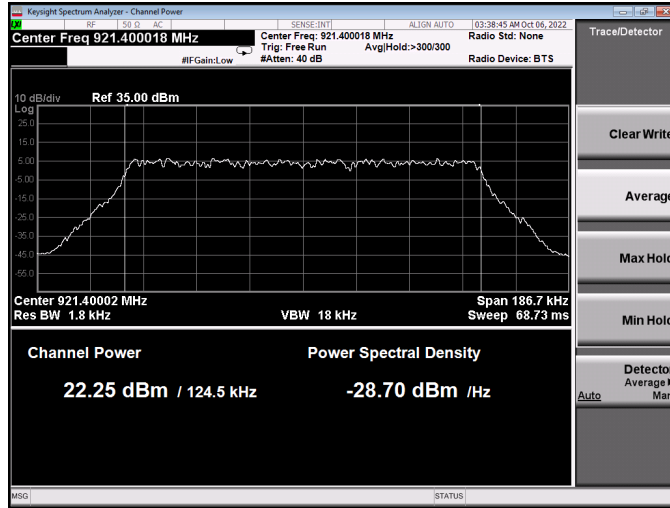

High Channel

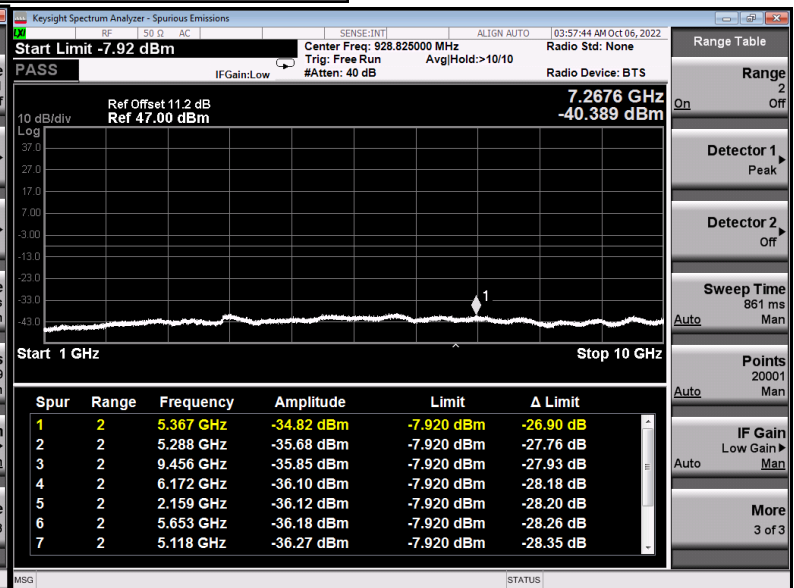
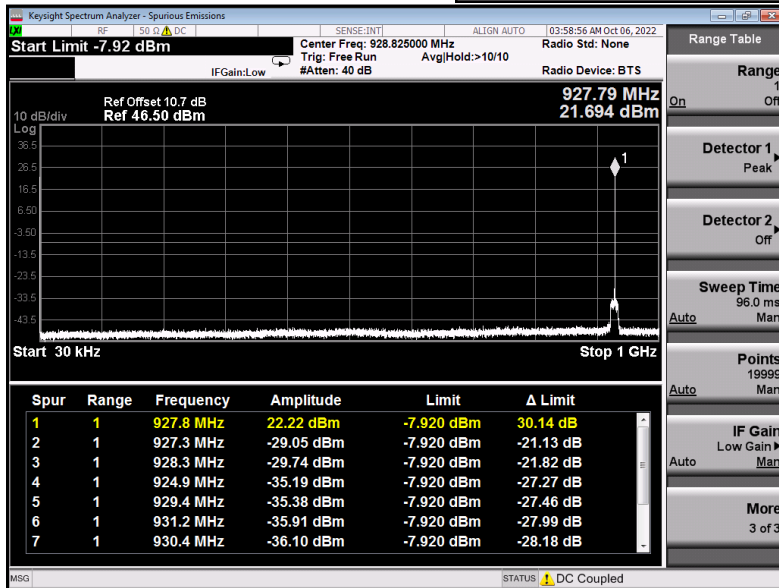
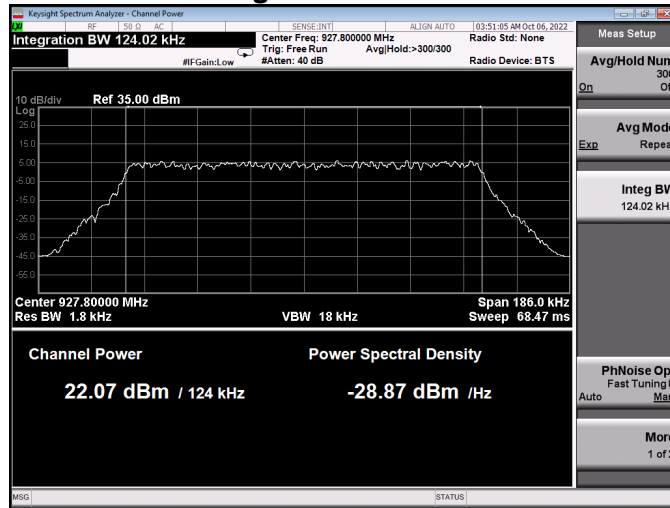

Antenna Port 1

Low Channel

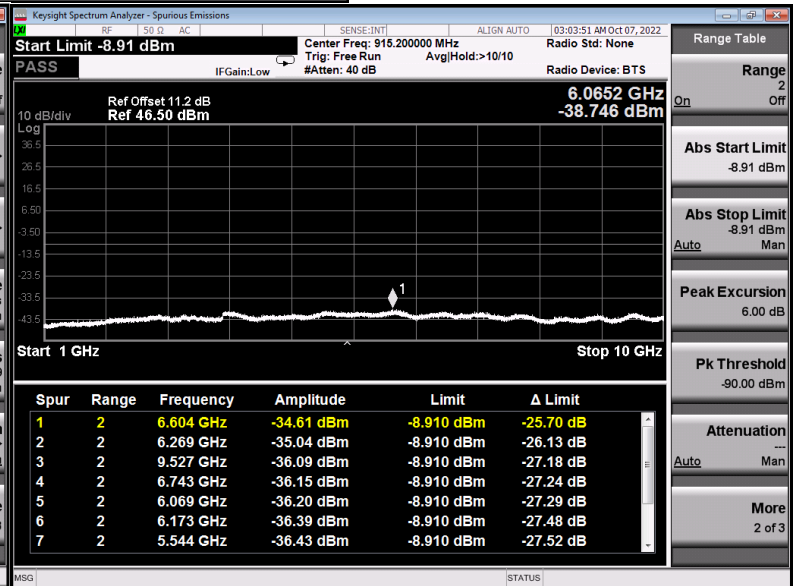
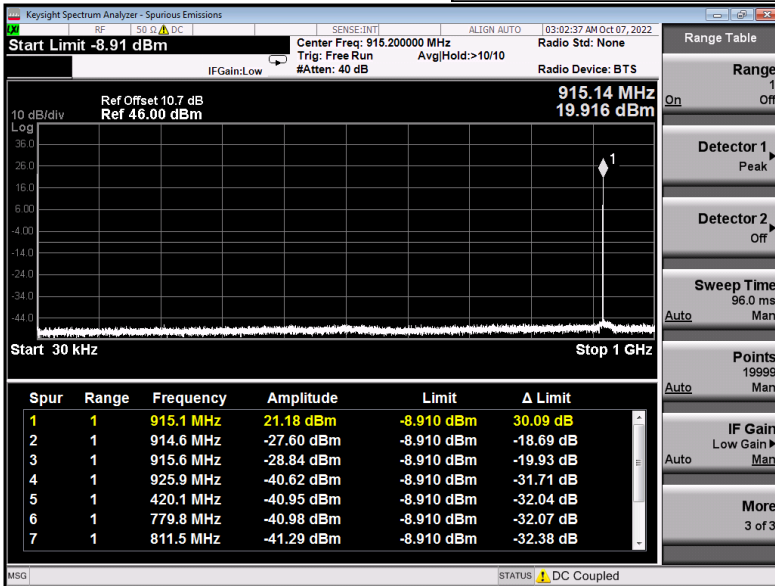
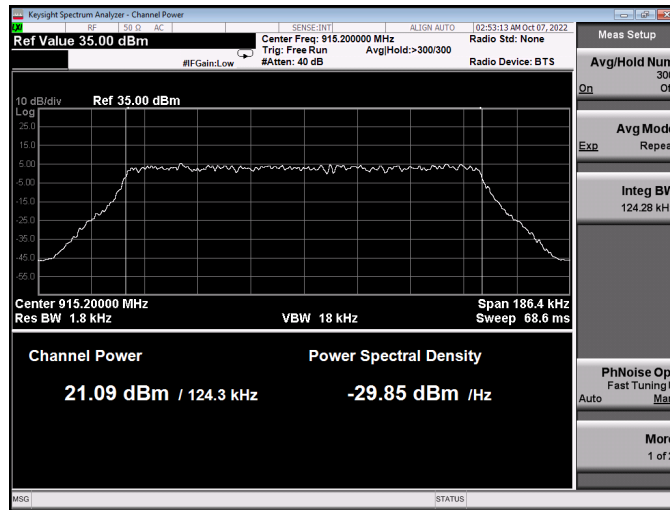

MID Channel

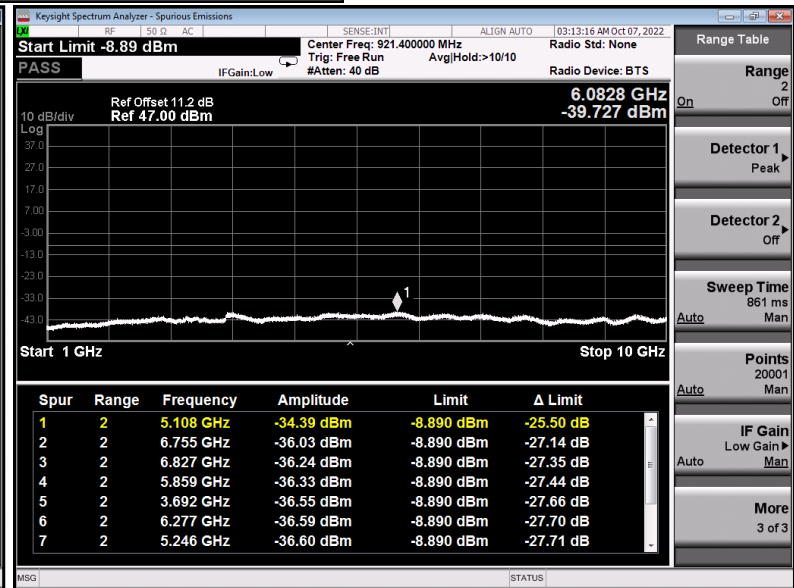
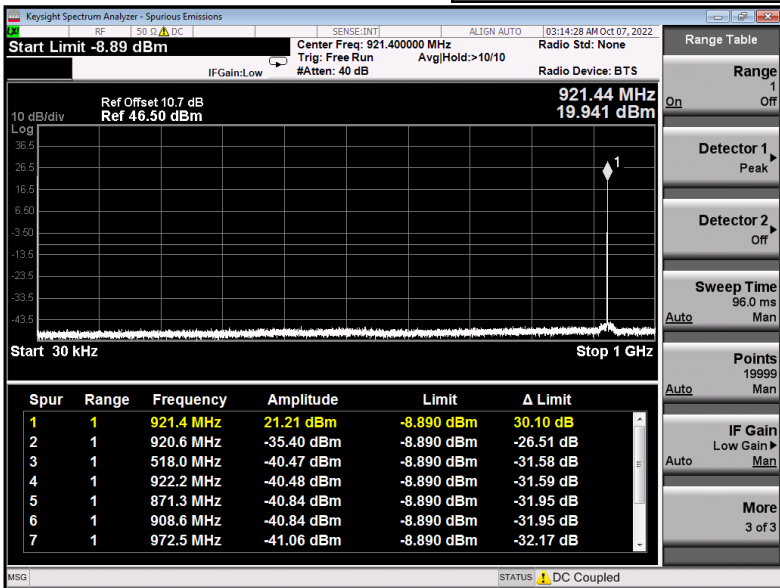
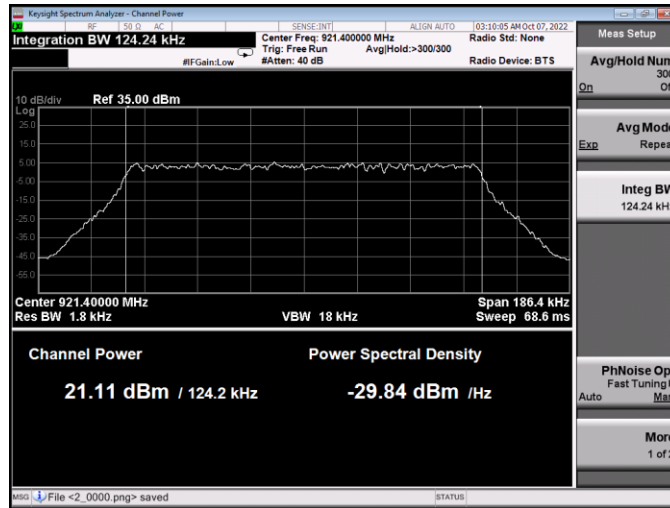

High Channel

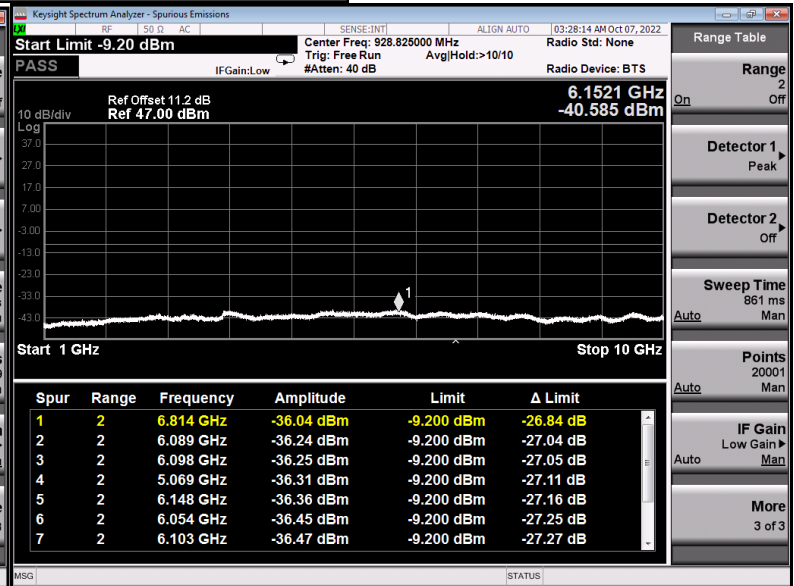
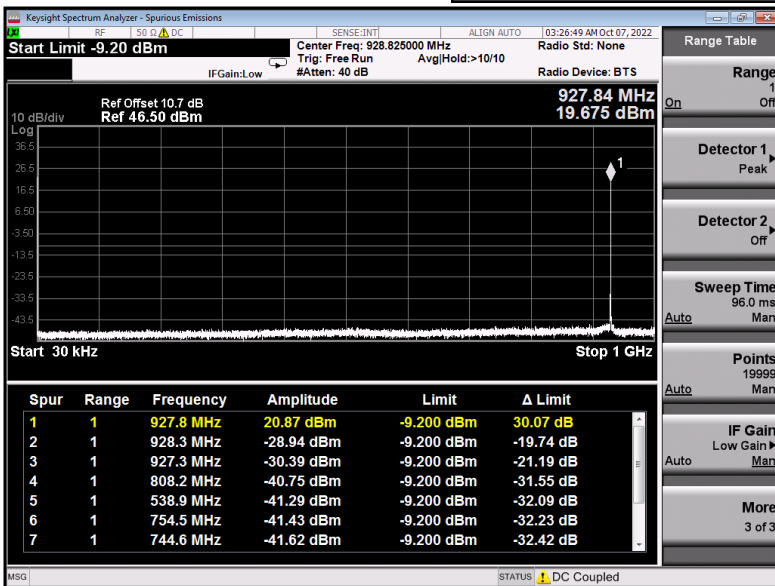
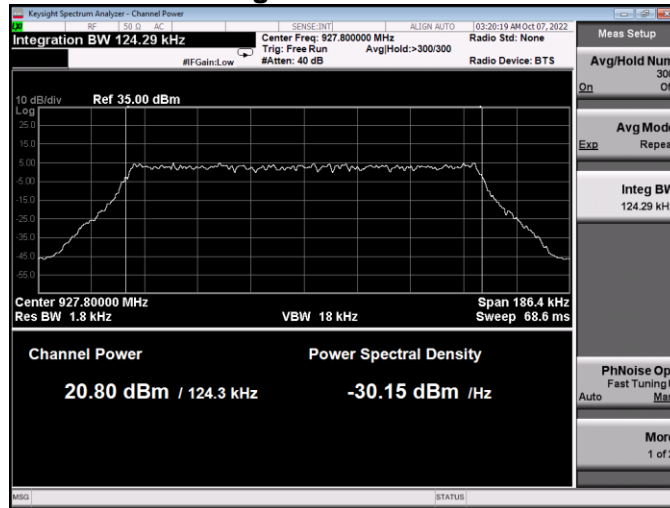

2.7 Channel Separation (Hybrid Mode)

Test Lab: Electronics Test Centre, Airdrie	EUT: Kona Mega Gateway
Test Personnel: Imran Akram / Janet Mijares	Standard: FCC Part 15.247
Date: 2022-10-07 (20.5°C, 25.2%RH)	Basic Standard: ANSI C63.10: 2013

EUT status: Compliant

Specification: FCC Part 15.247(a, 1)

Frequency hopping systems shall have hopping channel carrier frequencies separated by a minimum of 25 kHz or the 20dB bandwidth of the hopping channel, whichever is greater.

2.7.1 Test Guidance: ANSI 63.10 Clause 7.8.2 / 558074 D01 15.247 Measurement Guidance v05r02

This measurement is performed with the EUT transmitter frequency hopping function active.

The RF output of EUT with an antenna connector is fed to the input of the spectrum analyzer through appropriate attenuation. The loss from the cable and the attenuator were added on the analyzer as gain offset setting there by allowing direct measurements, without the need for any further corrections.

The spectrum analyzer is set for a frequency span wide enough to capture at least two adjacent channels. The RBW is set to at least 1% of the span. The Peak detector is used, with the trace set to Max Hold. Channel Separation is displayed with the Marker Delta function.

2.7.2 Deviations From The Standard:

There were no deviations from the EUT setup or methodology specified in the standard.

2.7.3 Test Equipment

Testing was performed with the following equipment:

Equipment	Manufacturer	Model #	Asset #	Cal. Date	Cal. Due
MXE EMI Receiver	Agilent	N9010A FW A.25.05	6130	2022-07-12	2023-07-12
Temp/Humidity	Extech	42270	5892	2022-04-07	2023-04-07
Attenuator	Fairview Microwave	SA18N5WA-10	6886	Cal. before each use	
Coaxial Cables (RF)	W.L. Gore	Pgr10R01036.0	-	Cal. before each use	

2.7.4 Test Sample Verification, Configuration & Modifications

EUT configuration for Channel Separation testing:

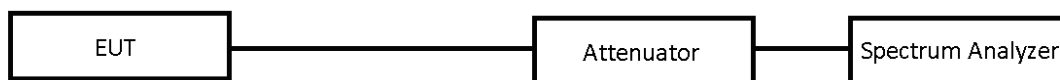

2.7.5 Channel Separation Data:

The channel separation **Compliant** for this device.

Channel separation measured = 200 KHz

Screen Captures from the spectrum analyzer:

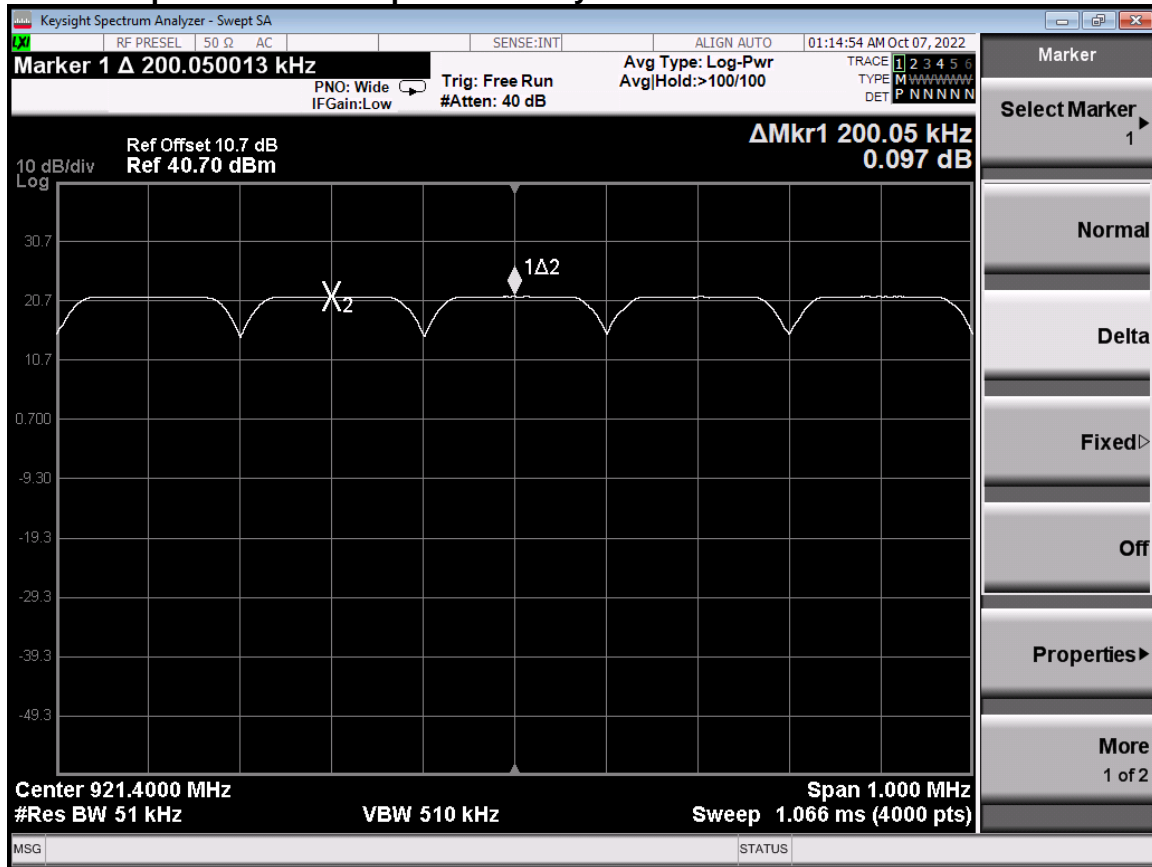

2.8 Time of Occupancy (Hybrid Mode)

Test Lab: Electronics Test Centre, Airdrie	EUT: Kona Mega Gateway
Test Personnel: Imran Akram / Janet Mijares	Standard: FCC PART 15.247
Date: 2022-10-07 (20.5°C, 2 5.2% RH)	Basic Standard: ANSI C63.10: 2013
EUT status: Compliant	

Specification: FCC Part 15.247 (f)

The frequency hopping operation of the hybrid system, with the direct sequence or digital modulation operation turned-off, shall have an average time of occupancy on any frequency not to exceed 0.4 seconds within a time period in seconds equal to the number of hopping frequencies employed multiplied by 0.4

2.8.1 Test Guidance: ANSI 63.10 Clause 7.8.4 / 558074 D01 15.247 Measurement Guidance v05r02

This measurement is performed with the EUT frequency hopping function active.

The RF output of EUT with an antenna connector is fed to the input of the spectrum analyzer through appropriate attenuation. The loss from the cable and the attenuator were added on the analyzer as gain offset setting there by allowing direct measurements, without the need for any further corrections.

The spectrum analyzer is set for Peak detection over a 0 Hz frequency span (time domain) centered on a hopping channel. The RBW shall be \leq Channel spacing and where possible RBW should be set $\gg 1/T$, where T is the expected dwell time per channel. VBW \geq RBW. The sweep time is adjusted to clearly capture one transmission. The Dwell time is measured with the Marker Delta function.

Another sweep is set to capture enough transmission events to calculate the number of events within the specified period of time. The Peak detector is used, with the trace set to Max Hold.

2.8.2 Deviations From The Standard:

There were no deviations from the EUT setup or methodology specified in the standard.

2.8.3 Test Equipment

Testing was performed with the following equipment:

Equipment	Manufacturer	Model #	Asset #	Cal. Date	Cal. Due
MXE EMI Receiver	Agilent	N9010A FW A.25.05	6130	2022-07-12	2023-07-12
Temp/Humidity	Extech	42270	5892	2022-04-07	2023-04-07
Attenuator	Fairview Microwave	SA18N5WA-10	6886	Cal. before each use	
Coaxial Cables (RF)	W.L. Gore	Pgr10R01036.0	-	Cal. before each use	

2.8.4 Test Sample Verification, Configuration & Modifications

The EUT was operating in normal mode. The EUT met the requirements without modification.

EUT configuration for Dwell Time testing:



2.8.5 Dwell Time Data:

Measured number of channels= 64

Measured Dwell time = 379.2 ms

Window of measurement is equal to number of hopping channels multiple by 400ms =
 $0.4 \times 64 = 25.6 \text{ Sec}$

Number of events in 25.6 Sec = 1

Screen Capture from the spectrum analyzer: sweep Time in 600 mSec

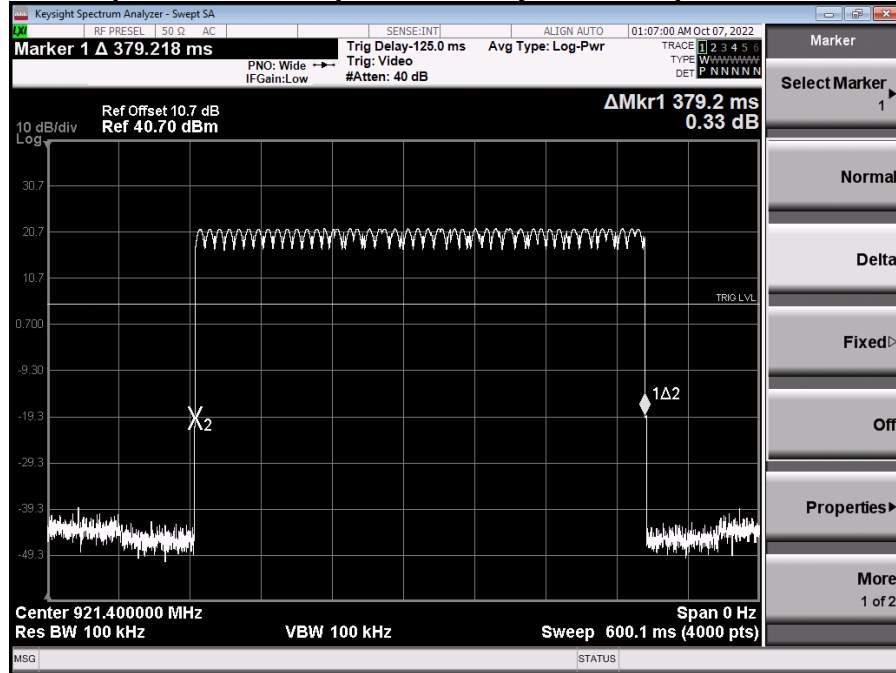

Screen Capture from the spectrum analyzer: sweep Time in 25.6 Sec

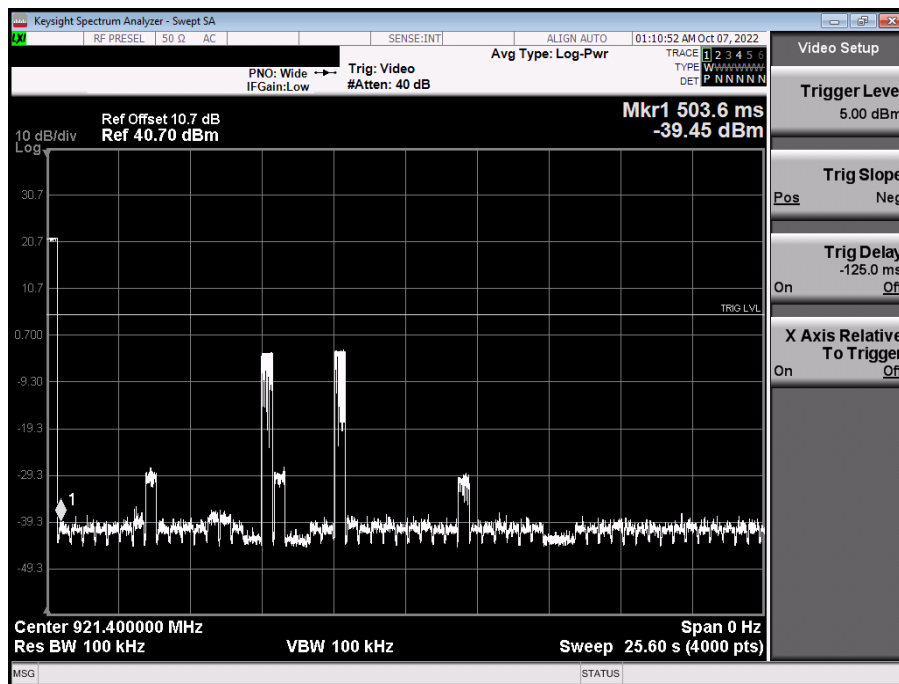

2.9 EUT Positioning Assessment

Test Lab: Electronics Test Centre, Airdrie

EUT: Kona Mega Gateway

Test Personnel:

Standard: FCC PART 15.247

Date:

Basic Standard: ANSI C63.4-2014

Comments: N/A. EUT installed in fix position

Specification: ANSI C63.4-2014, Clause 6.3.2.1

Portable, small, lightweight, or modular devices that may be handheld, worn on the body, or placed on a table during operation shall be positioned on a non-conducting platform, the top of which is 80 cm above the reference ground plane. The preferred area occupied by the EUT arrangement is 1 m by 1.5 m, but it may be larger or smaller to accommodate various sized EUTs (see Figure 6, Figure 7, and Figure 9). For testing purposes, ceiling- and wall-mounted devices also shall be positioned on a tabletop (see also 6.3.4 and 6.3.5). In making any tests involving handheld, body-worn, or ceiling-mounted equipment, it is essential to recognize that the measured levels may be dependent on the orientation (attitude) of the three orthogonal axes of the EUT. Thus, exploratory tests as specified in 8.3.1 shall be carried out for various axes orientations to determine the attitude having maximum or near-maximum emission level.

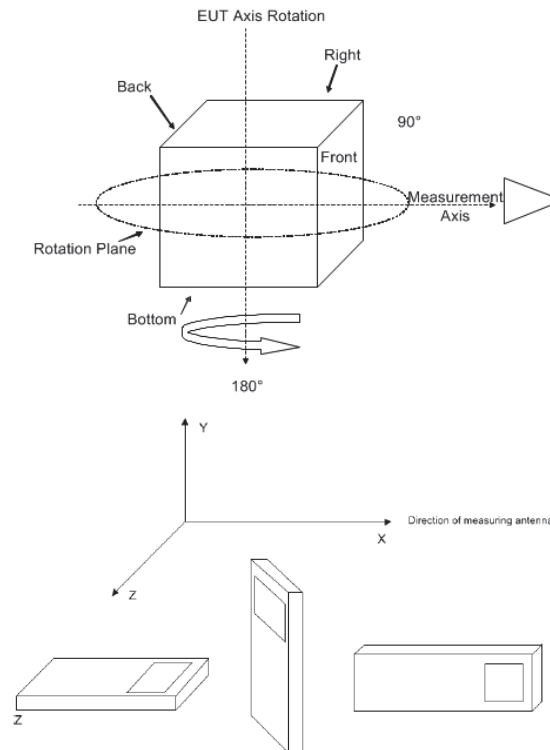

2.10 Radiated Spurious Emissions (Restricted Band)

Test Lab: Electronics Test Centre, Airdrie	EUT: Kona Mega Gateway
Test Personnel: Janet Mijares	Standard: FCC PART 15.247/15.209
Date: 2022-10-03/04 (20.6° C, 30.1% RH)	Basic Standard: ANSI C63.10-2013

EUT status: Compliant

Specification: FCC PART 15.247(d)

In any 100 kHz bandwidth outside the frequency band in which the spread spectrum or digitally modulated intentional radiator is operating, the radio frequency power that is produced by the intentional radiator shall be at least 20 dB below that in the 100 kHz bandwidth within the band that contains the highest level of the desired power, based on either an RF conducted or a radiated measurement, provided the transmitter demonstrates compliance with the peak conducted power limits. If the transmitter complies with the conducted power limits based on the use of RMS averaging over a time interval, as permitted under paragraph (b)(3) of this section, the attenuation required under this paragraph shall be 30 dB instead of 20 dB. Attenuation below the general limits specified in §15.209(a) is not required. In addition, radiated emissions which fall in the restricted bands, as defined in §15.205(a), must also comply with the radiated emission limits specified in §15.209(a) (see §15.205(c)).

Restricted Bands of Operation:

MHz	MHz	MHz	MHz	MHz	GHz	GHz
0.0900000 - 0.1100000	8.2910000 - 8.2940000	16.804250 - 16.804750	162.01250 - 167.17000	1660.0000 - 1710.0000	3.6000000 - 4.4000000	14.470000 - 14.500000
0.4950000 - 0.5050000	8.3620000 - 8.3660000	25.500000 - 25.670000	167.72000 - 173.20000	1718.8000 - 1722.2000	4.5000000 - 5.1500000	15.350000 - 16.200000
2.1735000 - 2.1905000	8.3762500 - 8.3867500	37.500000 - 38.250000	240.00000 - 285.00000	2200.0000 - 2300.0000	5.3500000 - 5.4600000	17.700000 - 21.400000
4.1250000 - 4.1280000	8.4142500 - 8.4147500	73.000000 - 74.600000	322.00000 - 335.40000	2310.0000 - 2390.0000	7.2500000 - 7.7500000	22.010000 - 23.120000
4.1772500 - 4.1777500	12.2900000 - 12.2930000	74.800000 - 75.200000	399.90000 - 410.00000	2483.5000 - 2500.0000	8.0250000 - 8.5000000	23.600000 - 24.000000
4.2072500 - 4.2077500	12.519750 - 12.520250	108.00000 - 121.94000	608.00000 - 614.00000	2655.0000 - 2900.0000	9.0000000 - 9.2000000	31.200000 - 31.800000
5.6770000 - 5.6830000	12.576750 - 12.577250	123.00000 - 138.00000	960.00000 - 1240.0000	3260.0000 - 3267.0000	9.3000000 - 9.5000000	36.430000 - 36.500000
6.2150000 - 6.2180000	13.360000 - 13.410000	149.90000 - 150.05000	1300.0000 - 1427.0000	3332.0000 - 3339.0000	10.600000 - 12.700000	Above 38.600000
6.2677500 - 6.2682500	16.420000 - 16.423000	156.52475 - 156.52525	1435.0000 - 1626.5000	3345.8000 - 3358.0000	13.250000 - 13.400000	
6.3117500 - 6.3122500	16.694750 - 16.695250	156.70000 - 156.90000	1645.5000 - 1646.5000	3500.0000 - 3600.0000		

■ US only
 ■ Canada 108 – 138 MHz
 ■ Canada 960 – 1427 MHz
 ■ Canada only

2.8.1 Test Guidance: ANSI C63.10-2013, Clause 13.4.2

From 9 kHz to 150 kHz (resolution bandwidth of 200 Hz) and from 150 kHz to 30 MHz (resolution bandwidth 9 kHz) measurements are performed with a loop antenna (as per KDB 460108).

From 30 MHz to 1000 MHz, measurements are performed with a broadband biconilog antenna and a resolution bandwidth of 120 kHz.

Above 1000 MHz, measurements are performed with a DRG Horn antenna or a Standard Gain horn, and a resolution bandwidth of 1 MHz. The EUT is raised to 150 cm above the ground plane, and the area between the EUT and the antenna mast is covered with RF absorbent material.

The scan is performed at discreet increments of turntable azimuth and antenna height, which are selected in accordance with the applicable standard in order to assure capture of frequencies of interest. Optimization is performed based on the scan data.

Frequencies having peak emissions within 10dB of the limits are optimized. The EUT is rotated in azimuth over 360 degrees and the direction of maximum emission is noted.

Antenna height is varied from 1 – 4 meters at this azimuth to obtain the maximum emission. Then the maximum level is measured with the appropriate detector and recorded. Up to 1 GHz, measurements are performed with a Quasi-Peak detector. Above 1 GHz, measurements are recorded with Peak and/or Average detectors, as applicable.

2.8.2 Deviations From The Standard:

There were no deviations from the EUT setup or methodology specified in the standard.

2.8.3 Test Equipment

Testing was performed with the following equipment:

Equipment	Manufacturer	Model #	Asset #	Cal. Date (yyyy-mm-dd)	Cal. Due (yyyy-mm-dd)
EMC Software	UL	Ver. 9.5	ETC-SW-EMC 2.1	N/A	
EMI receiver	Agilent	N9038A (FW A.25.05)	6130	2022-07-12	2023-07-12
Loop Antenna	EMCO	6502	10868	2021-05-11	2023-05-11
Biconilog Antenna	AR	JB1	6905	2021-10-29	2023-10-21
DRG Horn	Tensor	4105	9588	2021-05-10	2023-05-10
Humidity/Temp Logger	Extech Ins. Corp.	42270	5892	2022-04-07	2023-04-07
Low Noise Amplifier (1 – 18 GHz)	MITEQ	JS43-01001800-21-5P	4354	*2022-06-30	2023-06-30
Pre-Amplifier (30 – 1400 MHz)	HP	8447D	9291	*2022-06-22	2023-06-22
RE Cable below 1GHz	Insulated Wire Inc.	KPS-1501A-3600-KPA-01102006	4419	2022-06-28	2023-06-28
Re Cable Above 1 GHz	A.H. System Inc.	SAC-26G-8.23	6187	*2022-06-28	2023-06-28
0.9 GHz Notch Filter	Microtronics	BRM20784	6947	*2022-06-30	2023-06-30
1.4GHz HPF	K & L	4DH21-R1793/6000-0/0	6952	*2022-05-11	2023-05-11

* In house (Gain/loss) verification Performed.

2.8.4 Test Sample Verification, Configuration & Modifications

The EUT was set to a selected channel with test-specific software. The output was modulated as in normal operation. LoRa radio is transmitting at MID Channel 921.4 MHz.

The EUT met the requirements without modification.

Test setup diagram for Radiated Spurious Emissions testing (below 1GHz):

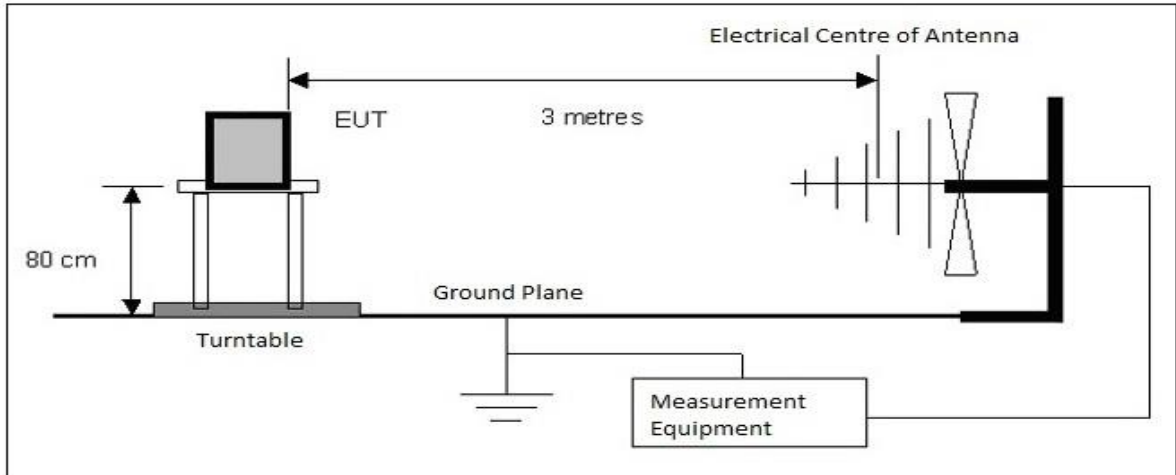

Test setup diagram for Radiated Spurious Emissions testing (above 1GHz):

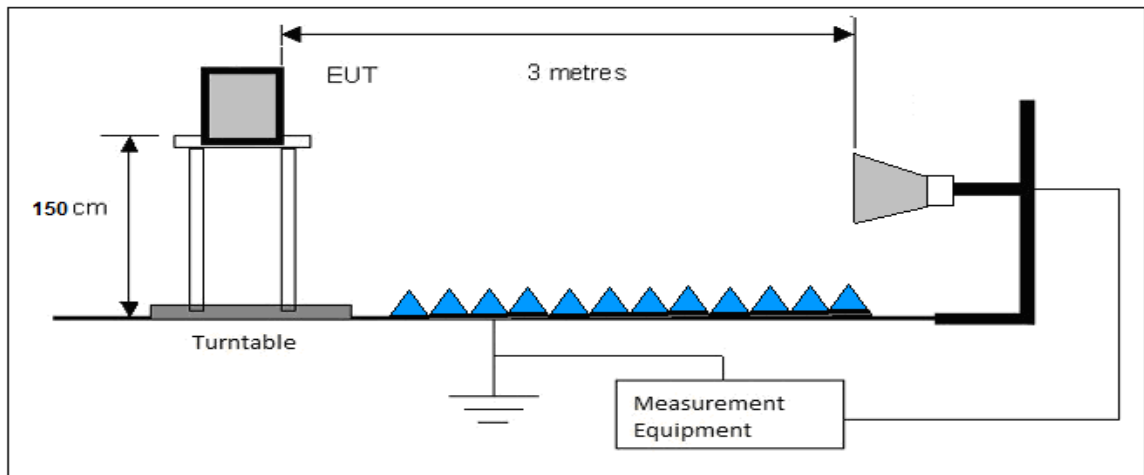

2.8.5 Radiated Emissions Data: With LTE Modem EM7455

The emissions data are presented in tabular form, showing turntable azimuth, antenna height and polarization, the uncorrected spectrum analyzer reading, the correction factors applied, the net result, the value of the limit at the frequency investigated, and the Delta between the result and the limit.

Meter Reading in dBμV + Antenna Factor in dB/m + Gain/Loss Factor in dB = Corrected Field Strength in dBμV/m.

Delta = Field Strength – Limit

Notes:

- When a preamp is used, the resulting gain is compensated, producing a negative value for the Cable Loss.
- Measurements reported are the result of adjusting the turntable azimuth and antenna height to obtain the maximum EUT emission. This may produce a different reading than the plot trace. The plot is a Peak Hold function obtained at discreet increments of height and azimuth, while the reported measurement is obtained with the appropriate Quasi Peak, Average detector and peak after the height and azimuth have been adjusted for maximum emission.
- Preliminary scans were performed for all channels in Transmit modes. The MID band channel 921.4 MHz was selected as the worst-case condition for detailed examination.
- In Transmit mode, the EUT was assessed up to 10.0 GHz.

Negative values for Delta indicate compliance.

Freq. Marker	Freq. [MHz]	Raw reading [dBμv]	Det	Antenna Factor [dB/m]	Pre amp Gain/Cable Loss [dB]	Corrected Reading [dBμv/m]	FCC 15.247/209 Limit [dBμv/m]	Delta [dB]	Azimuth [Deg]	Height [cm]	Polarization
C	921.4	90.44	PK	26.3	7.9	124.64	131.23	-6.59	258	198	Vertical
1	*38.05	34.45	QP	19	-24.5	28.95	40	-11.05	76	112	Vertical
2	*73.65	41.13	QP	12.1	-23.8	29.43	40	-10.57	61	105	Vertical
3	540.16	45.02	PK	22.4	-20.3	47.12	20dBc	77.52dBc	23	105	Vertical
1	1849.9	34.21	AV	27.1	-34.4	26.91	53.98	-27.07	321	105	Vertical
1	1849.9	45.65	PK	27.1	-34.4	38.35	73.98	-35.63	321	105	Vertical

Spurious Emission

* Restricted Band

Plot of Radiated Emissions: Measuring Antenna Parallel

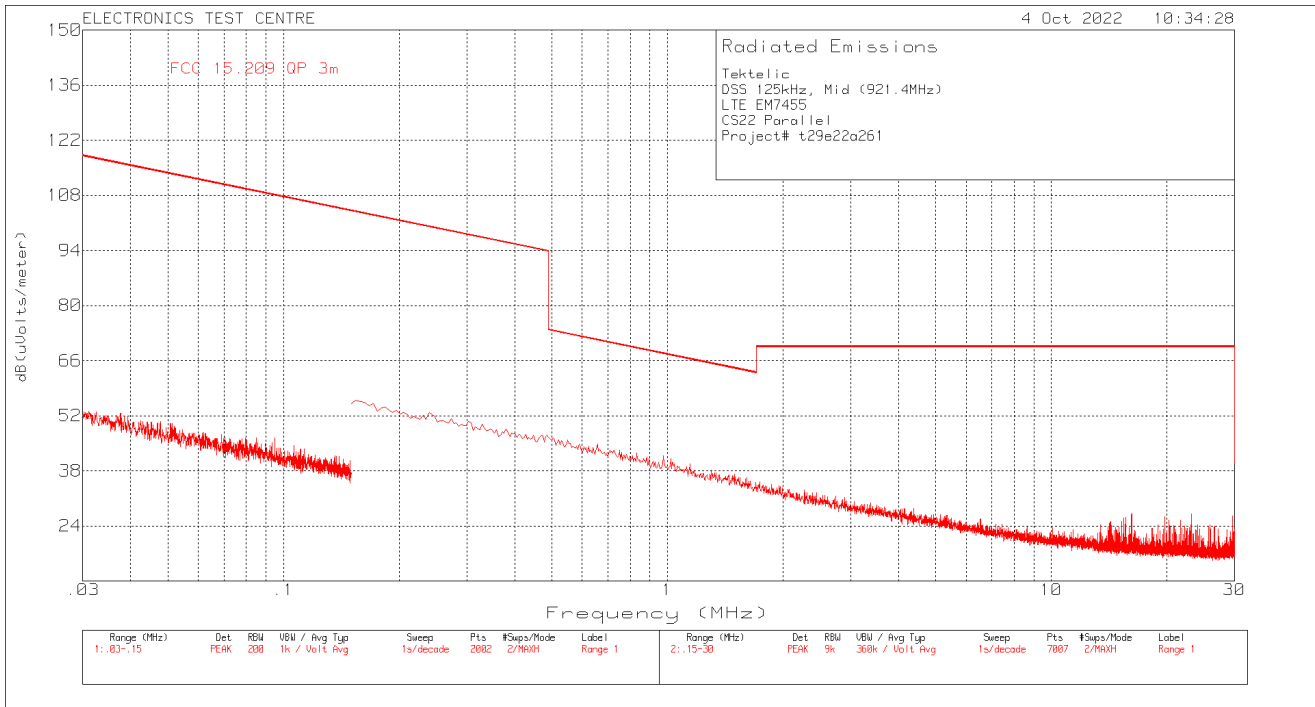

Plot of Radiated Emissions: Measuring Antenna Perpendicular

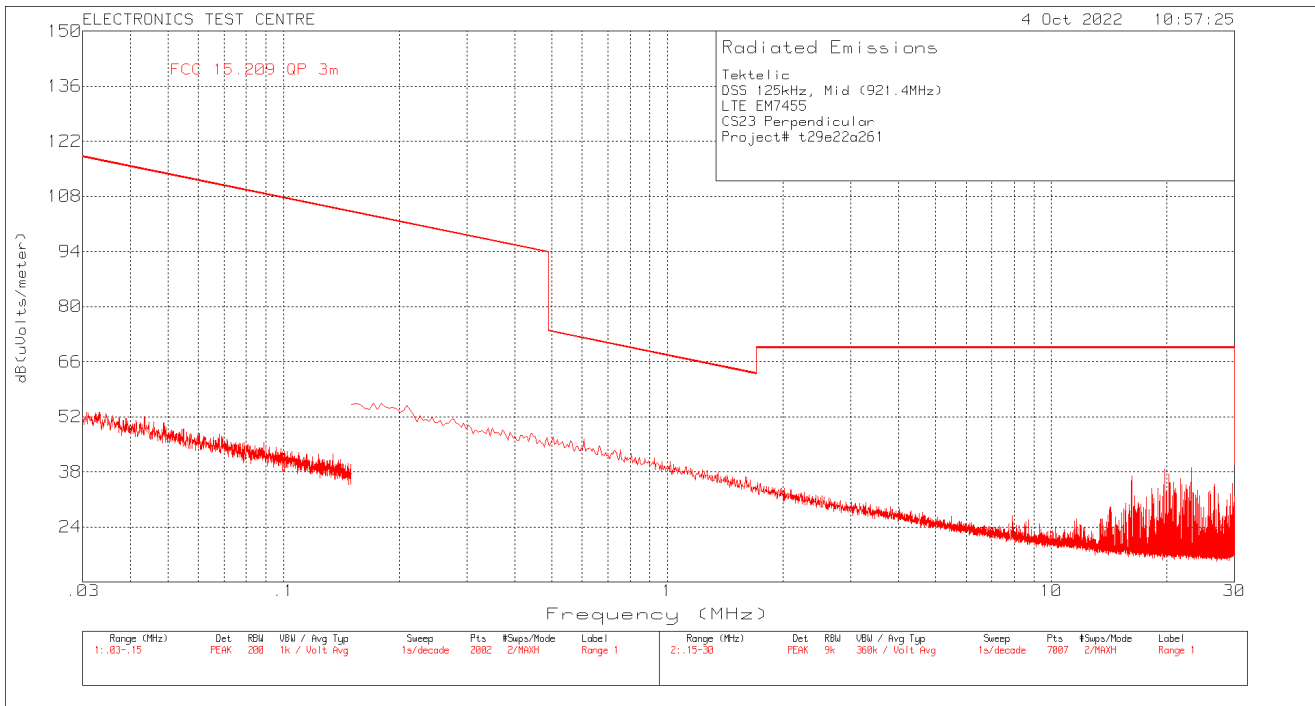

Plot of Radiated Emissions: Horizontal polarization

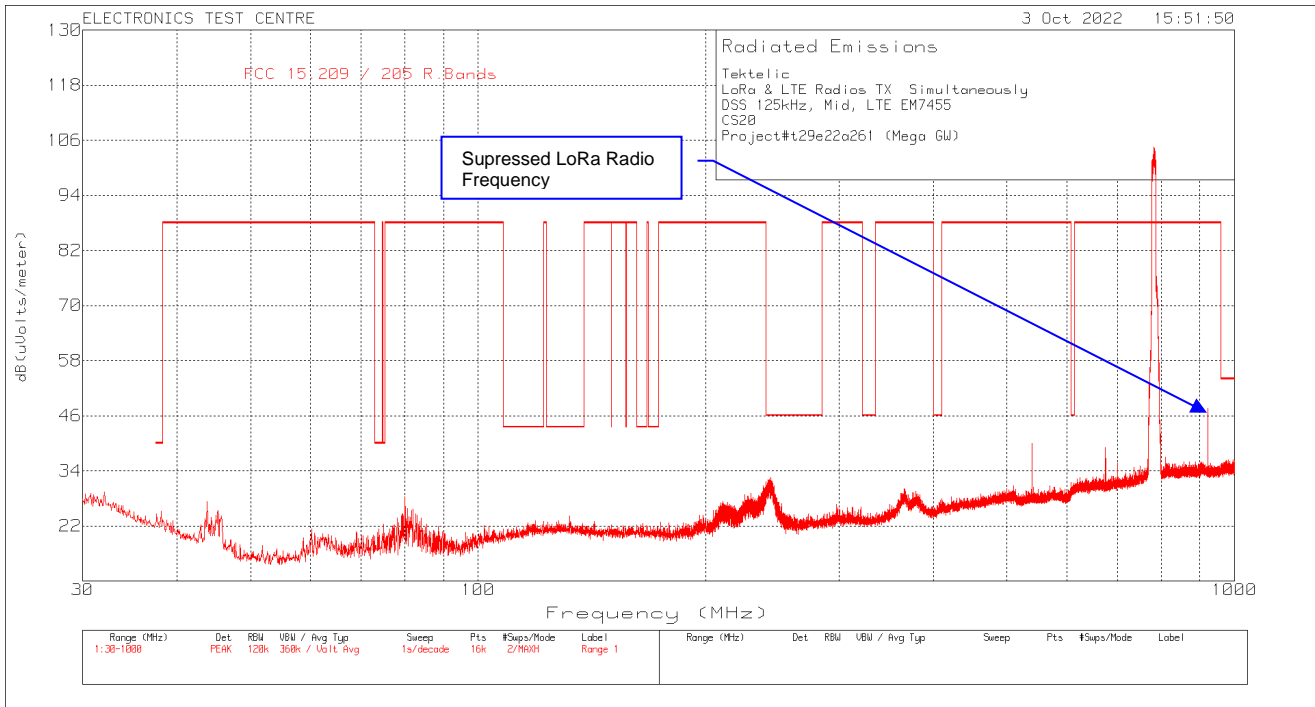

Plot of Radiated Emissions: Vertical polarization

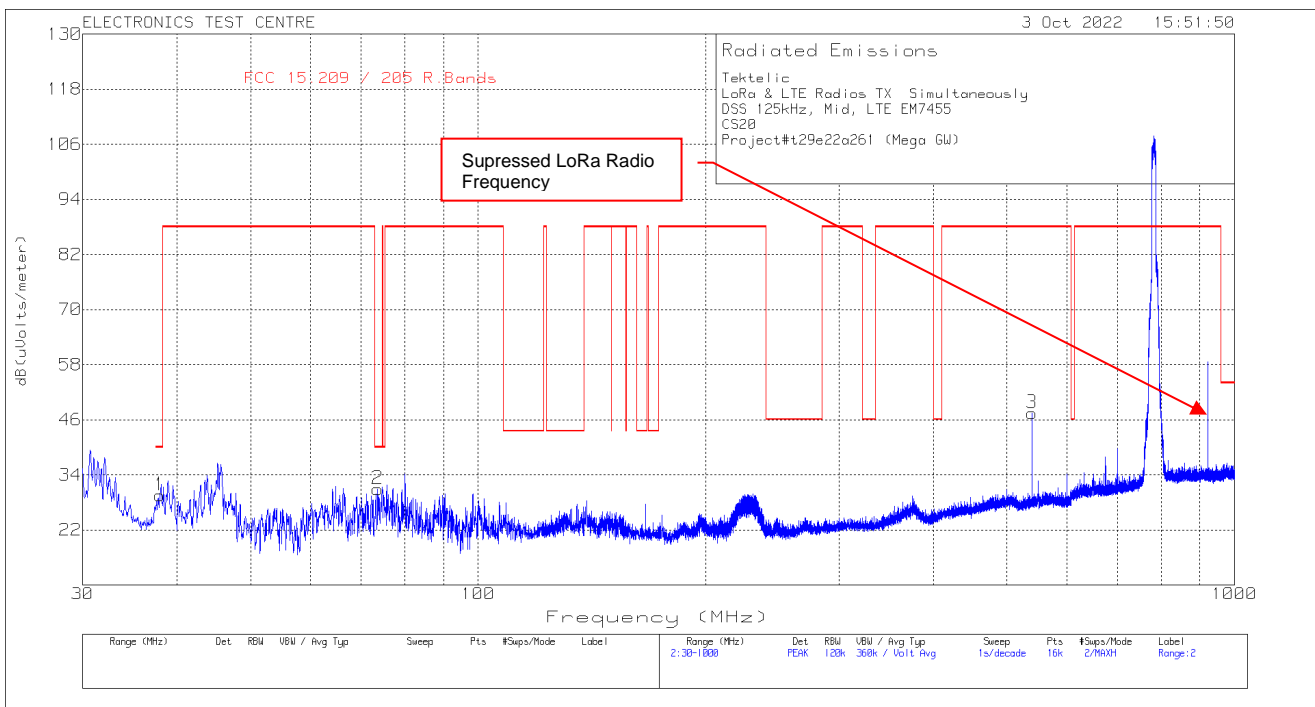

Plot of Radiated Emissions: Horizontal polarization

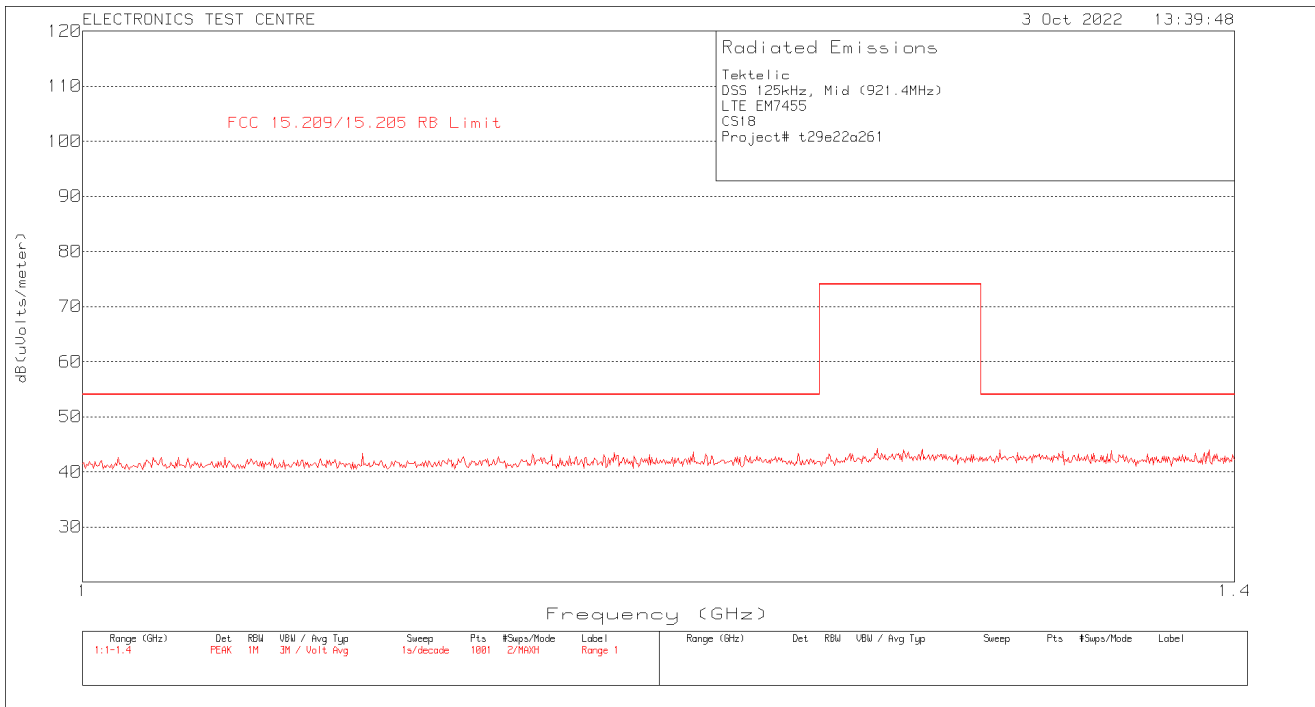

Plot of Radiated Emissions: Vertical polarization

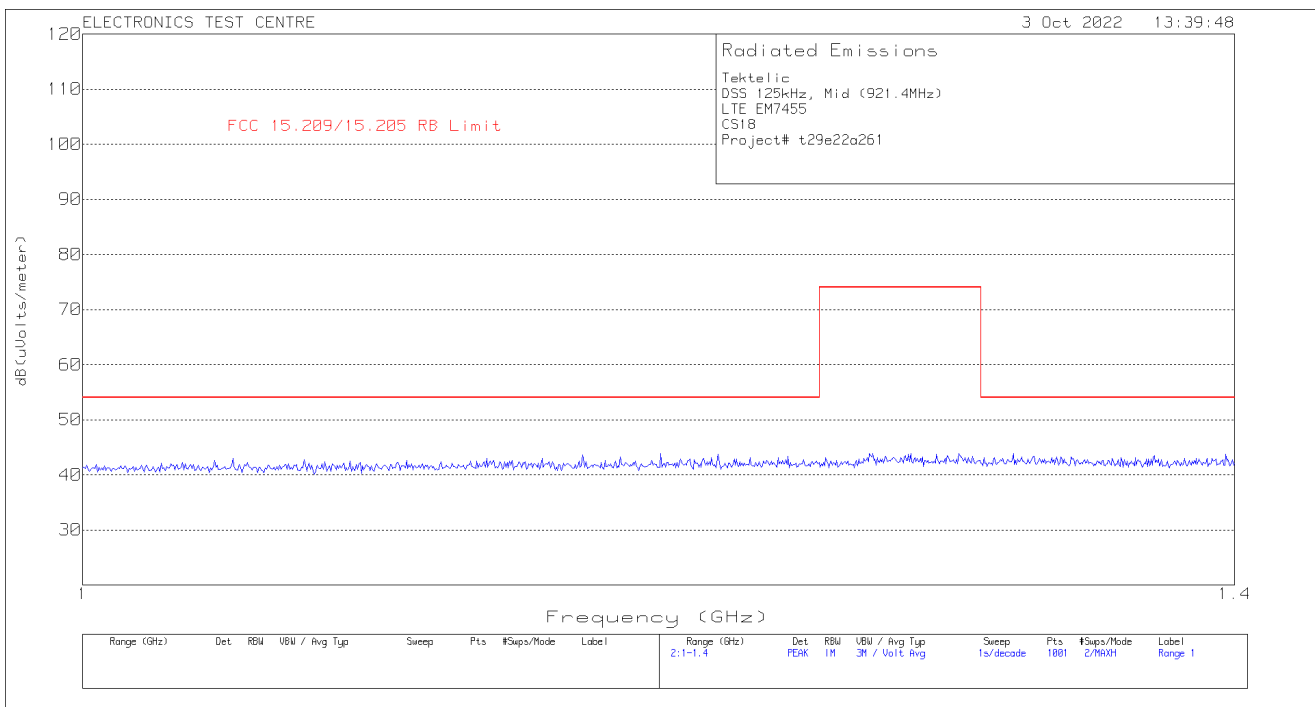

Plot of Radiated Emissions: Horizontal polarization

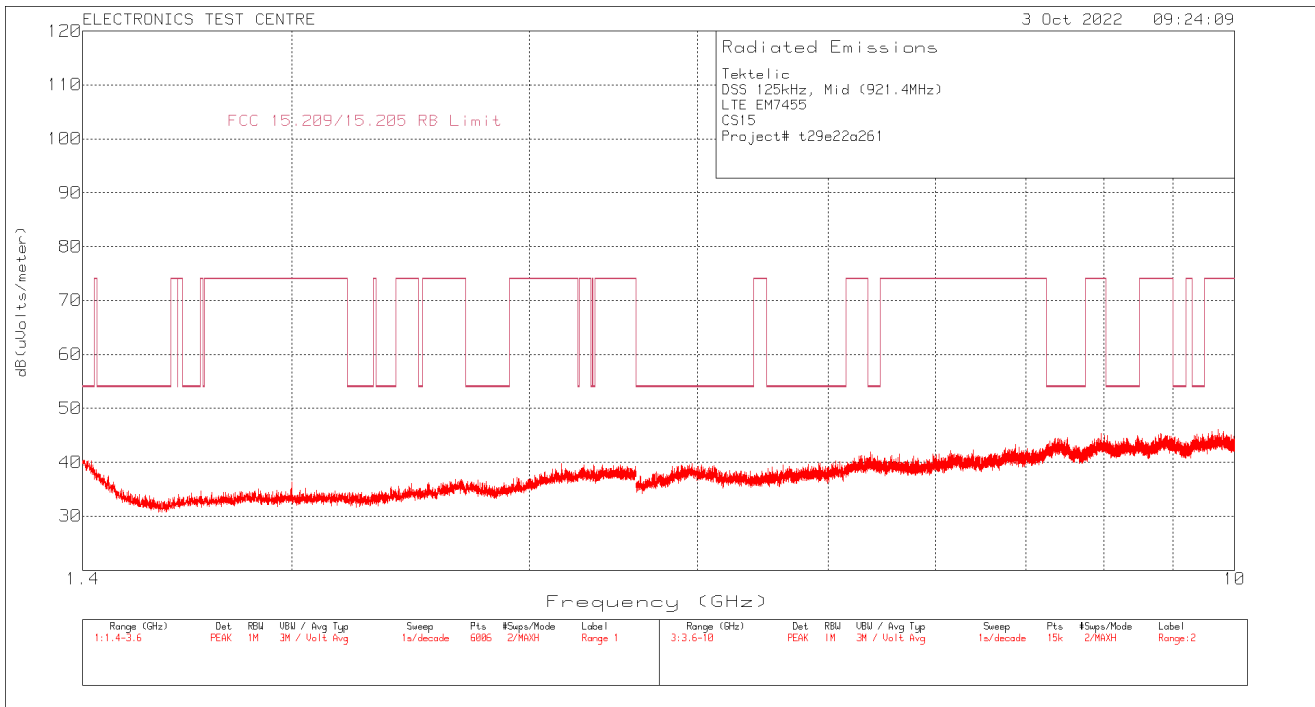

Plot of Radiated Emissions: Vertical polarization

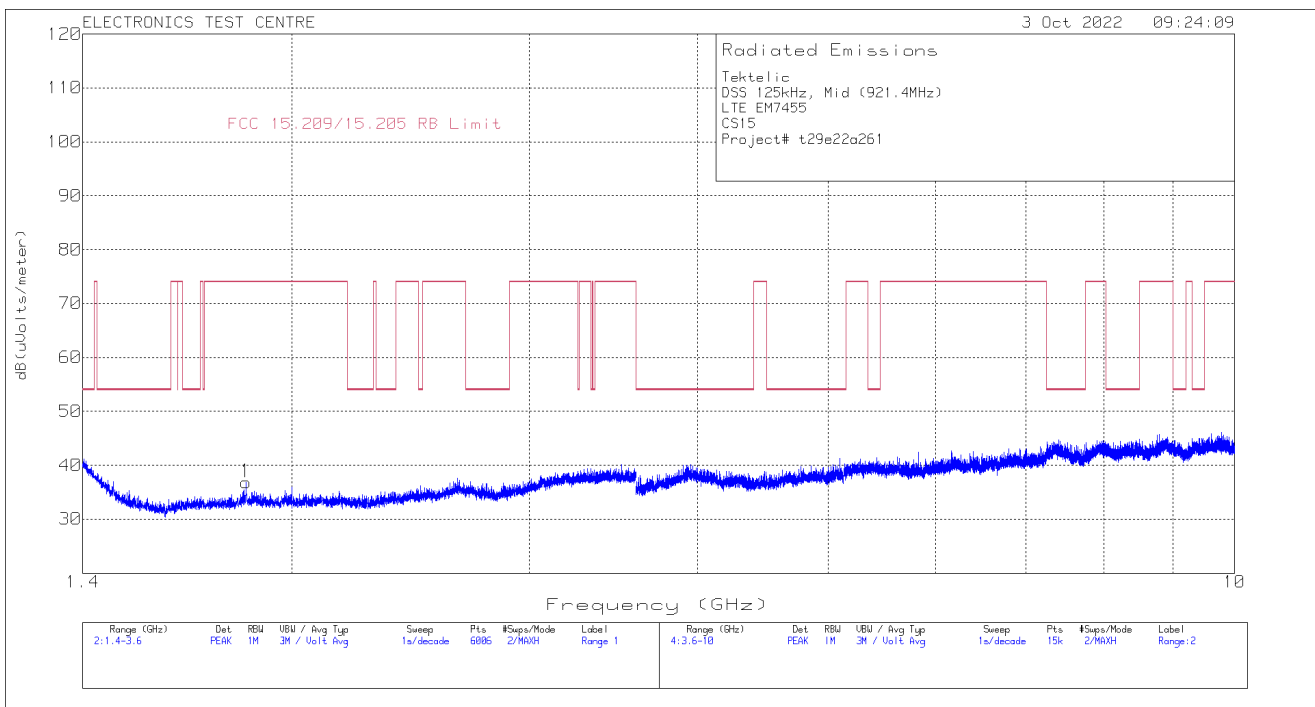

2.11 Radiated Emissions Receive Mode

Test Lab: Electronics Test Centre, Airdrie	EUT: Kona Mega Gateway
Test Personnel: Janet Mijares	Standard: FCC Part 15.109
Date:2022-10-03/20 (20.5°C, 25.2% RH)	Basic Standard: ANSI C63.4: 2014
	Class: B

EUT status: Compliant

Frequency (MHz)	FCC Part 15.109 Class B Limit (3m)
30 – 88	40 (dBµV/m)
88 – 216	43.52 (dBµV/m)
216 – 960	46.02 (dBµV/m)
Above 960	53.98 (dBµV/m)

Criteria: The radiated emissions produced by a device, measured at a distance of 3 meters, shall not exceed the limits as specified.

2.11.1 Test Guidance:

From 30 MHz to 1000 MHz, measurements are performed with a broadband biconilog antenna and a resolution bandwidth of 120 kHz.

Above 1000 MHz, measurements are performed with a DRG Horn antenna or a Standard Gain horn, and a resolution bandwidth of 1 MHz.

The scan is performed at discreet increments of turntable azimuth and stepped antenna height, with peak detector and Max Hold function which are selected in accordance with the applicable standard in order to assure capture of frequencies of interest. Optimization is performed based on the scan data.

After the pre-scan is completed, the frequencies of interest are optimized. The EUT is rotated in azimuth over 360 degrees and the direction of maximum emission is noted.

Antenna height is varied from 1 – 4 meters at this azimuth to obtain the maximum emission. Then the maximum level is measured with the appropriate detector and recorded. This may produce a different reading than the pre scan trace. Up to 1 GHz, measurements are performed with a Quasi-Peak detector. Above 1 GHz, measurements are recorded with Peak and/or Average detectors, as applicable.

2.11.2 Deviations From The Standard:

There were no deviations from the EUT setup or methodology specified in the standard.

2.11.3 Test Equipment

Testing was performed with the following equipment:

Equipment	Manufacturer	Model #	Asset #	Calibration Date	Calibration Due
EMC Software	UL	Ver. 9.5	ETC-SW-EMC 2.1	N/A	
EMI receiver	Agilent	N9038A (FW A.25.05)	6130	2022-07-12	2023-07-12
Biconilog Antenna	SunAR RF Motion;	JB1	6905	2021-10-29	2023-10-29
DRG Horn	Tensor	4105	9588	2021-05-10	2023-05-10
T/H Logger	EXTECH Ins.	42270	5892	2022-04-07	2023-04-07
Pre- Amp	HP	8447D	9291	Monitored	
Low Noise Amplifier	MITEQ	JS43-01001800-21-5P	4354	Monitored	

2.11.4 Test Sample Verification, Configuration & Modifications

To cover the unintentional radiated emission. The both radios were configured in receive mode. Unit was placed at the center of turntable in semi-anechoic chamber 80cm above the ground plane and at a distance of 3m from the test receive antenna.

The EUT met the requirements without modification.

EUT configuration for Radiated Emissions testing:

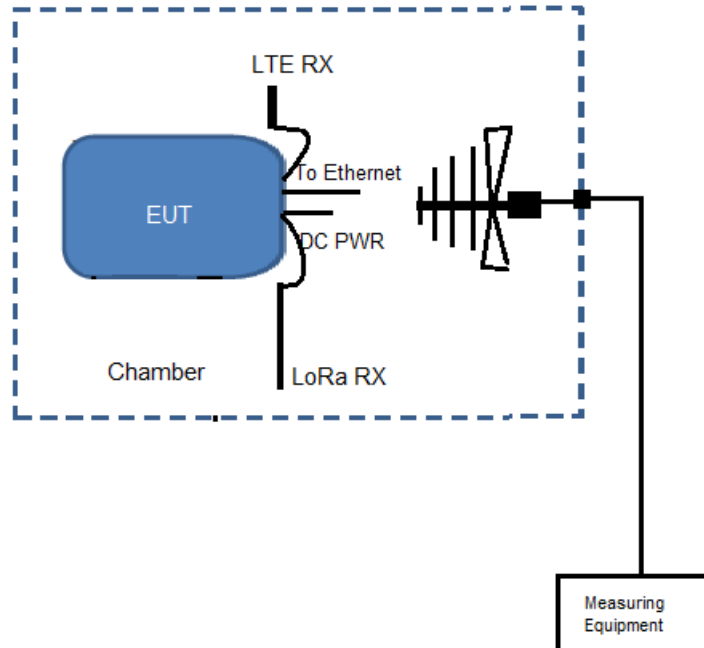

2.11.5 Radiated Emissions Data maximization: with LTE EM7455 Modem

The emissions data are presented in tabular form, showing turntable azimuth, antenna height and polarization, the uncorrected spectrum analyzer reading, the correction factors applied, the net result, the value of the limit at the frequency investigated, and the Delta between the result and the limit.

Meter Reading in dBμV + Antenna Factor in dB/m + Gain/Loss Factor in dB = Corrected Field Strength in dBμV/m.

Delta = Field Strength – Limit

Notes:

- When a preamp is used, the resulting gain is compensated, producing a negative value for the Cable Loss.
- Measurements reported are the result of adjusting the turntable azimuth and antenna height to obtain the maximum EUT emission. This may produce a different reading than the plot trace. The plot is a Peak Hold function obtained at discreet increments of height and azimuth, while the reported measurement is obtained with the appropriate Quasi Peak (QP) or Average detector (AV) after the height and azimuth have been adjusted for maximum emission.
- In receive mode, the EUT was assessed up to 5.0 GHz.

Negative values for Delta indicate compliance.

Spurious Emission

Freq. Marker	Freq. [MHz]	Raw reading [dBμv]	Det	Antenna Factor [dB/m]	Pre amp Gain [dB]	Corrected Reading [dBμv/m]	FCC 15.109 Limit [dBμv/m]	Delta [dB]	Azimuth [Deg]	Height [cm]	Polarization
1	539.9901	32.93	QP	22.4	-20.3	35.03	46.03	-11	230	211	Horizontal
2	30.6822	38.45	QP	24.5	-24.7	38.25	40.01	-1.76	319	101	Vertical
3	32.0772	35.31	QP	23.5	-24.7	34.11	40.01	-5.9	278	106	Vertical
4	234.1495	38.98	QP	15.3	-22.2	32.08	46.03	-13.95	101	116	Vertical
5	540.0108	36.69	QP	22.4	-20.3	38.79	46.03	-7.24	169	213	Vertical
6	674.9997	32.71	QP	23.7	-19.4	37.01	46.03	-9.02	0	179	Vertical
1	1184.1	41.02	AV	24.5	-35.3	30.22	53.98	-23.76	248	109	Vertical
2	1250.0	35.56	AV	24.9	-35.2	25.26	53.98	-28.72	139	260	Vertical

Plot of Radiated Emissions: Horizontal polarization

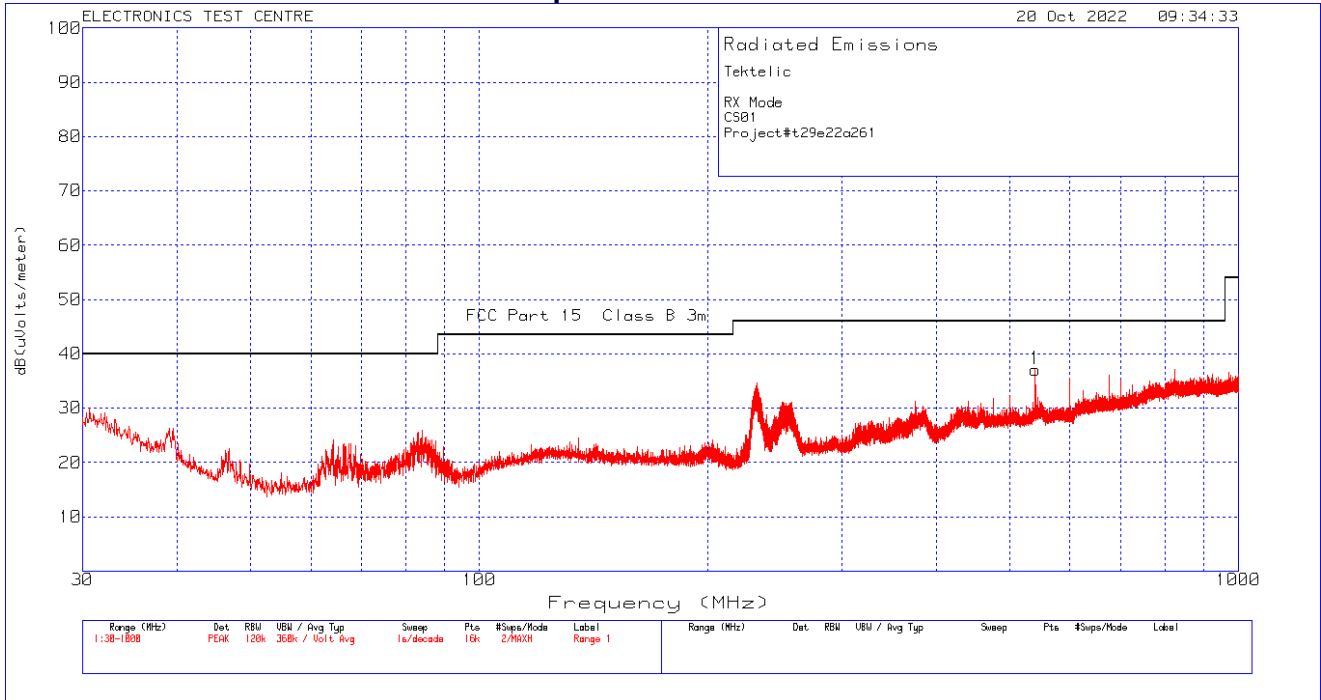

Plot of Radiated Emissions: Vertical polarization

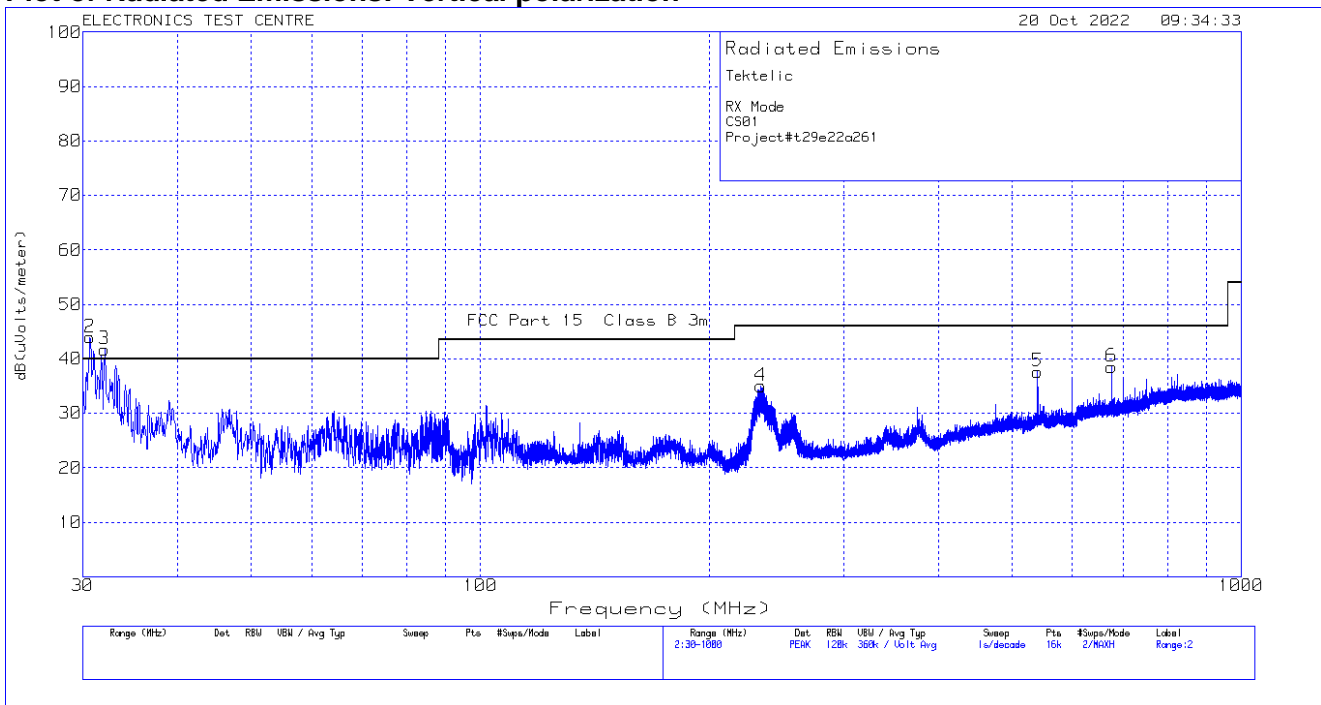

Plot of Radiated Emissions: Horizontal polarization

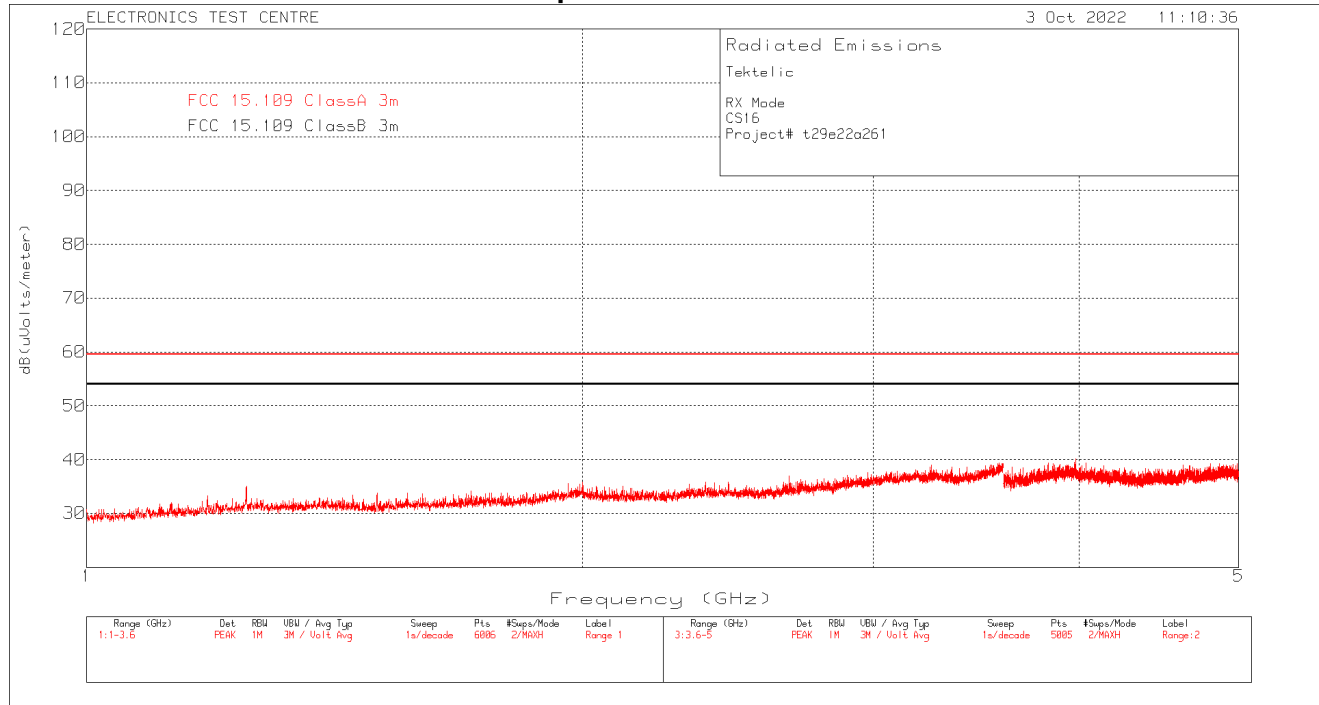

Plot of Radiated Emissions: Vertical polarization

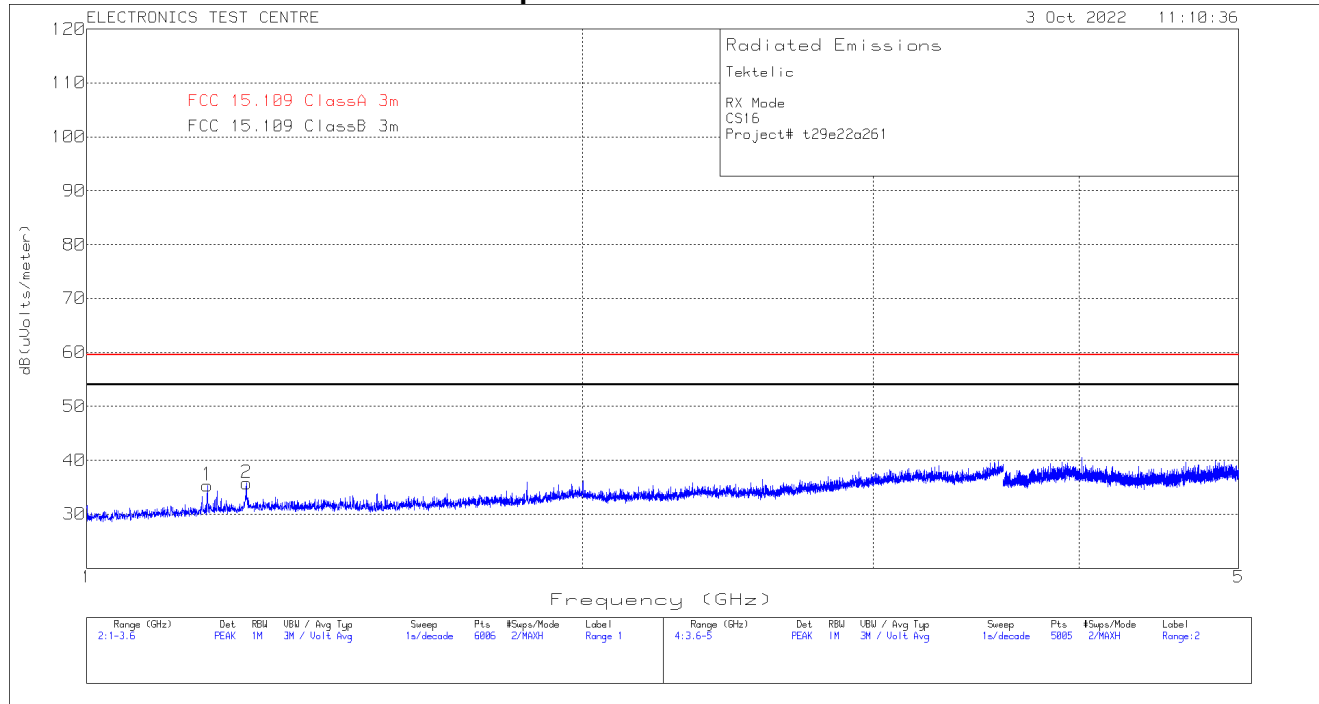

2.12 AC Power Line Conducted Emissions Receive Mode

Test Lab: Electronics Test Centre, Airdrie	EUT: Kona Mega Gateway
Test Personnel: Janet Mijares	Standard: FCC 15.107
Date: 2022-10-04 (20.7°C, 30.1% RH)	Basic Standard: ANSI C63.4: 2014
	Class: B
EUT status: Compliant	

Specification:

Frequency (MHz)	Quasi-Peak Limit (dB μ V)	Average Limit (dB μ V)
0.15 – 0.5	66 to 56 *	56 to 46 *
0.5 – 5	56	46
5 – 30	60	50
<p>Criteria: The conducted emissions produced by a device shall not exceed the limits as specified.</p> <p>*Limits decrease linearly with the logarithm of the frequency*</p>		

2.12.1 Test Guidance

Before any testing is performed, the Ambient (measurement noise floor) is recorded, and a QC check is performed to show that the system is functioning correctly.

The EUT is powered through a 50 μ H Line Impedance Stabilizing Network (LISN) which is placed 80cm away from the EUT. For tabletop equipment, a vertical ground plane is placed 40cm from the edge of the table. Lastly, the spectrum analyzer is connected to the LISN via armored cable run from the control room to the test chamber. Both the LISN and vertical ground plane are grounded to the reference ground plane on the chamber floor.

Testing starts with a scan, performed under software control. After this is complete, the list of frequencies of interest is generated. These frequencies are then investigated for quasi-peak and average amplitude, as applicable. Emissions measured with a QP detector that fall below the Average limit are deemed to meet both requirements.

2.12.2 Deviations From The Standard

There were no deviations from the EUT setup or methodology specified in the standard.

2.12.3 Test Equipment

Testing was performed with the following equipment:

Equipment	Manufacturer	Model #	Asset #	Calibration Date	Calibration Due
EMC Software	UL	Ver. 9.5	ETC-SW-EMC 2.1	N/A	
EMI receiver	Agilent	N9038A FW A.25.05	6130	2022-07-12	2023-07-12
LISN 150kHz to 30MHz	Com-Power	LI-215A	6180	2022-08-09	2024-08-09
Temp/Humidity	Extech	42270	5892	2022-04-07	2023-04-07

2.12.4 Test Sample Verification, Configuration & Modifications

To cover the unintentional conducted emission. The both radios were configured in receive mode. EUT has option of POE. EUT tested for conducted emission on AC side of POE adaptor mode#PD-9501GO-ET/AC and serial#C19026674000302. Customer is not providing POE adaptor with EUT.

The EUT met the requirements without modification.

Diagram of setup for Conducted Emissions testing:

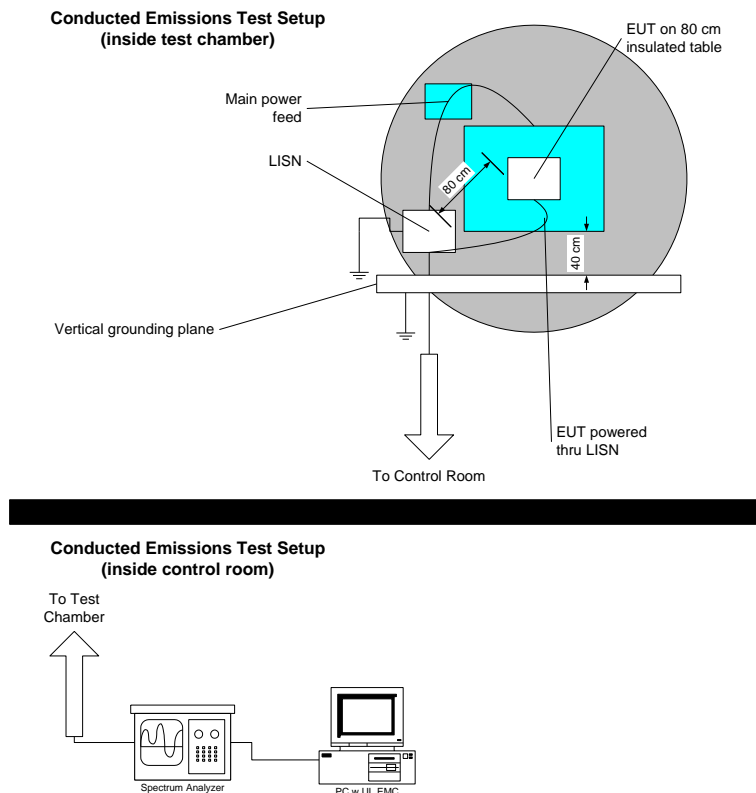

2.12.5 Conducted Emissions Data

The emissions data is presented in tabular form, showing the uncorrected spectrum analyzer reading, the correction factors applied, the net result, the value(s) of limit at the frequency measured, and the Delta between the result and the limit.

EUT with LTE EM7455

Freq. Marker	Freq. (MHz)	Raw reading (dBμV)	Det.	LISN Factor (dB/m)	Cable Loss (dB)	Corrected Reading (dBμV)	FCC 107 Limit (dBμV)	Delta (dB)	L / N
1	.16118	36.73	LnAv	.1	9.8	46.63	55.4	-8.77	Line
2	.51162	27.86	LnAv	0	9.8	37.66	46	-8.34	Line
3	4.85472	18.46	LnAv	0	10	28.46	46	-17.54	Line
4	13.47756	18.03	LnAv	0	10.4	28.43	50	-21.57	Line
1	.16491	35.51	LnAv	.1	9.8	45.41	55.21	-9.8	Neutral
2	.50043	28.87	LnAv	0	9.8	38.67	46	-7.33	Neutral
3	4.8249	23.7	LnAv	0	10	33.7	46	-12.3	Neutral
4	13.41418	18.76	LnAv	0	10.4	29.16	50	-20.84	Neutral

Meter Reading in dBμV + LISN Factor in dB + Gain/Loss Factor in dB = Corrected Emission Strength in dBμV.

Notes:

- When a preamp is used, the resulting gain is compensated, producing a negative value for the Cable Loss.
- LnAv = Linear Average detector

Negative values for Delta indicate compliance.

EUT with LTE EM7455
Plot of Conducted Emissions: LINE

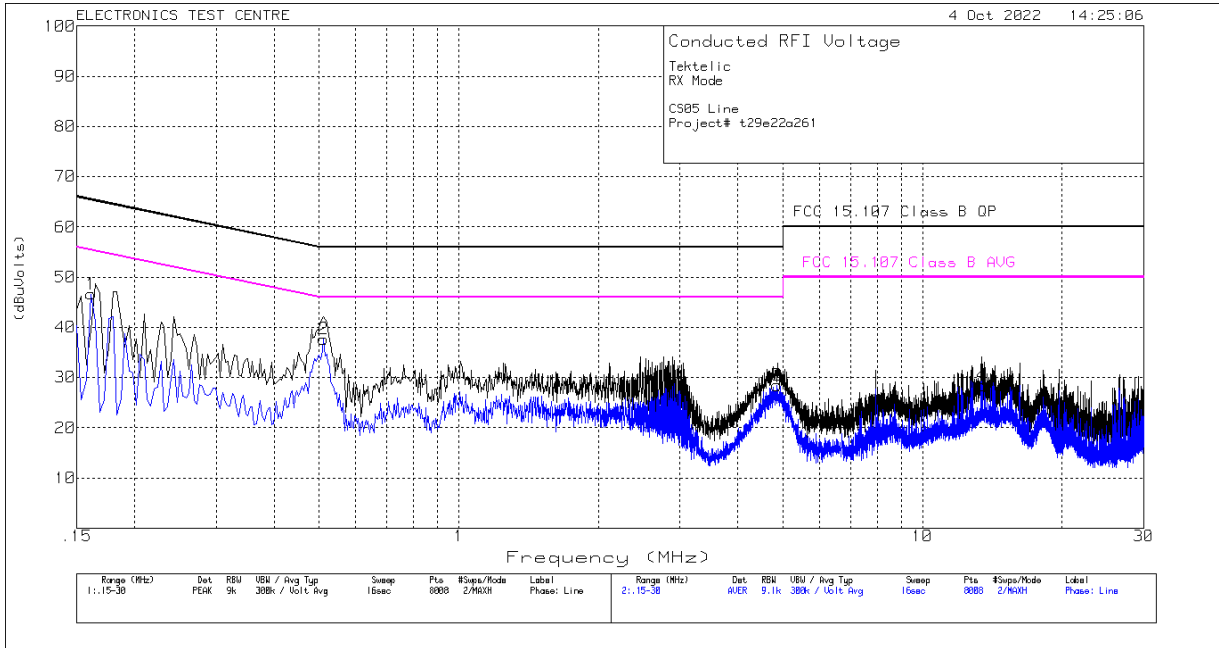

Plot of Conducted Emissions: Neutral

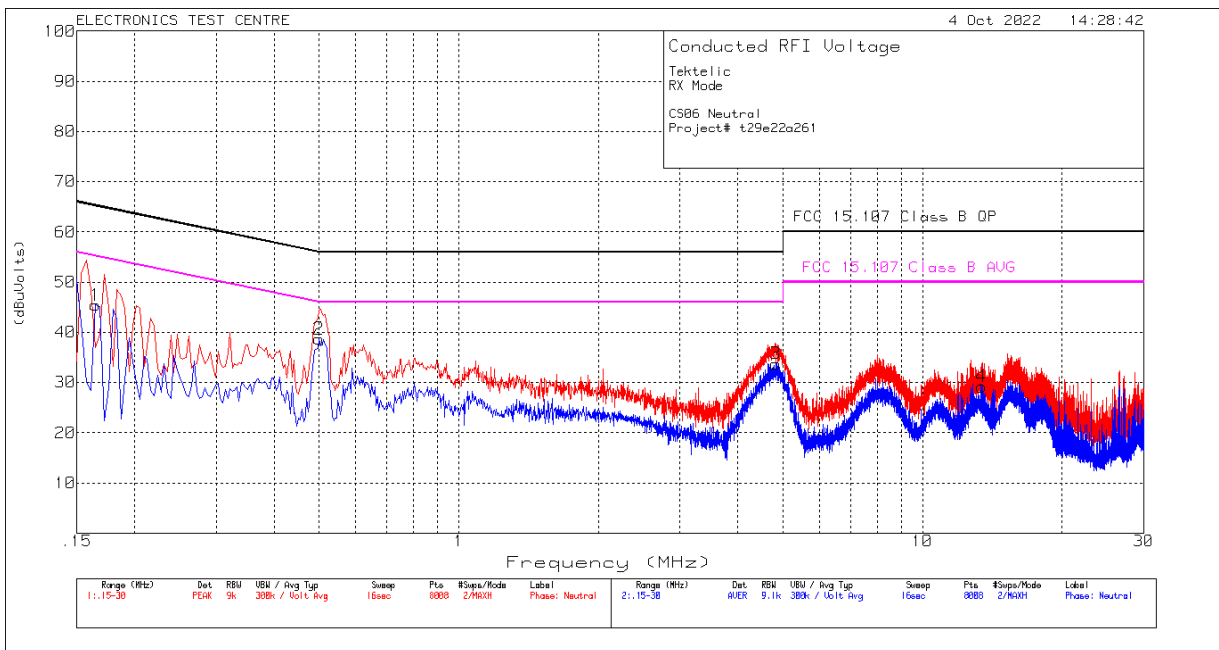

2.13 RF Exposure

Test Lab: Electronics Test Centre, Airdrie	EUT: Kona Mega Gateway
Test Personnel:	Standard: FCC PART 15.247
Date:	
EUT status: Compliant	

Compliant: RF exposure assessment to be provided in a separate Exhibit.

3.0 TEST FACILITY

3.1 Location

The Kona Mega Gateway was tested at the Electronics Test Centre laboratory located in Airdrie, Alberta, Canada. The Radio Frequency Anechoic Chamber (RFAC), identified as Chamber 1, has a usable working space measuring 10.6 m long x 7.3 m wide x 6.5 m high.

Measurements taken at this site are accepted by Industry Canada as evidence of conformity per registration file # 2046A. This site is also listed with the FCC under Registration Number CA2046.

The floor, walls and ceiling consist of annealed steel panels. The walls and ceiling are covered with ferrite tile, augmented by RF absorbant foam material on the end wall nearest the turntable, and on the adjacent walls and the ceiling. The chamber floor supports a 15 cm high internal floor, constructed of annealed steel panels, that forms the ground plane, and is bonded to the chamber walls.

The 3-m diameter turntable is flush-mounted with the floor. A sub-floor cable-way is provided to route cables between the turntable pit and EUT support equipment located in the Control Room. Cables reach the EUT through an opening in the centre of the turntable.

Test instrumentation and EUT support equipment is located in the Control Room, consisting of two shielded vestibules joined together at the side of the main room. Cables are routed through bulkhead panels between the rooms and the test chamber as required. Power feeds are routed into the main room and vestibules through line filters providing at least 100 dB of attenuation between 10 kHz and 10 GHz.

Either floor mounted or table-top equipment can be tested at this facility.

3.2 Grounding Plan

The Kona Mega Gateway was placed at the center of the test chamber turntable on top of a polystyrene foam table. The EUT was grounded according to Tektelic Communication Inc. specifications.

3.3 Power Supply

All EUT power was supplied by an external DC power supply and POE.

Appendix A – EUT Family Information

Product Number	1X LoRa ANT	2X LoRa ANT	LTE Modem
T0004978	X		
T0004982		X	
T0004988	X		
T0004992		X	
T0004996	X		
T0005000		X	
T0005004	X		
T0005006	X		X
T0005008		X	
T0005010		X	X

Appendix B – Test Setup Block Diagram

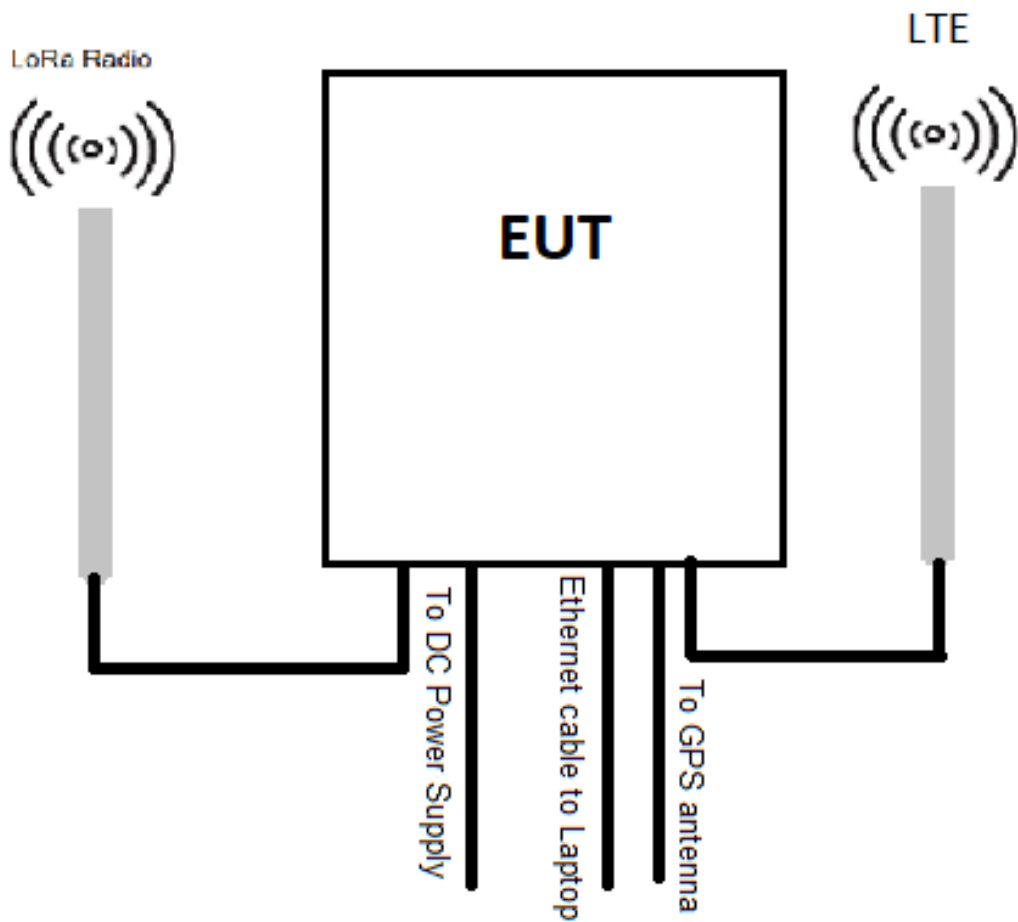

End of Document