

Test Report Prepared By:

Electronics Test Centre
27 East Lake Hill
Airdrie, Alberta
Canada
T4A 2K3

sales@etc-mpbtech.com
<http://www.etc-mpb.com>

Telephone: 1-403-912-0037

ETC Report #: t29e22a153-DSS Release2

Report date: August 11, 2022

Test Date: July 25 & 26, 2022
August 11, 2022

**EMC testing of the Tektelic Communication Inc. COMFORT in accordance with
FCC Part 15.247, and ANSI C63.10: 2013 as referenced by FCC OET KDB
558074 D01 15.247 Measurement Guidance v05r02.**

FCC ID: 2ALEPT0006338

Test Personnel: Imran Akram, Janet Mijares, Brendan Van Hee

Prepared for: Tektelic Communication Inc.

7657 10th Street NE
Calgary, Alberta
Canada
T2E 8X2

Telephone: 1-403-338-6910



Imran Akram
iakram@etc-mpbtech.com
EMC Technologist
Electronics Test Centre (Airdrie)



Marc Rousseau
marc.rousseau@mpbc.ca
QA Manager
Electronics Test Centre (Airdrie)

REVISION RECORD

ISSUE	DATE	AUTHOR	REVISIONS
DRAFT 1	2022-07-28	Branden	Initial draft submitted for review.
Release1	2022-08-05	I. Akram	Sign Off
Release2	2022-08-11	I. Akram	Updated the OBW / Average power data table and corresponding SA screen plots in section 2.2.5 / 2.3.5
			Sign Off

TABLE OF CONTENTS

1.0	INTRODUCTION	4
1.1	Scope	4
1.2	Applicant	4
1.3	Test Sample Description	4
1.4	General Test Conditions	4
1.5	Reference Standards	5
1.6	Test Methodology.....	5
1.6.1	Variations in Test Methodology.....	5
1.6.2	Test Sample Verification, Configuration & Modifications	5
1.6.3	Uncertainty of Measurement:.....	5
2.0	TEST CONCLUSION	6
2.1	AC Power Line Conducted Emissions: N/A	7
2.2	Channel Occupied Bandwidth.....	8
2.2.1	Test Guidance: ANSI C63.10-2013, Clause 6.9.2 & 6.9.3/ FCC OET KDB 558074 8	
2.2.2	Deviations From The Standard:.....	8
2.2.3	Test Equipment.....	8
2.2.4	Test Sample Verification, Configuration & Modifications	9
2.2.5	Channel Occupied Bandwidth Data:	9
2.3	Max Average Output Power	11
2.3.1	Test Guidance: ANSI C63.10-2013, Clause 11.9.2.2.2 Clause 7.8.5 / FCC OET KDB 558074	11
2.3.2	Deviations From The Standard:.....	11
2.3.3	Test Equipment.....	11
2.3.4	Test Sample Verification, Configuration & Modifications	12
2.3.5	Max Average Output Power Data	12
2.4	EUT Positioning Assessment.....	15
2.5	Radiated Spurious Emissions (Restricted Band)	16
2.5.1	Test Guidance: ANSI C63.10-2013, Clause 13.4.2	17
2.5.2	Deviations From The Standard:.....	17
2.5.3	Test Equipment.....	17
2.5.4	Test Sample Verification, Configuration & Modifications	18
2.5.5	Radiated Emissions Data:.....	19
2.6	Radiated Emissions (RX Mode).....	23
2.6.1	Test Guidance:.....	23
2.6.2	Deviations From The Standard:.....	23
2.6.3	Test Equipment.....	24
2.6.4	Test Sample Verification, Configuration & Modifications	24
2.6.5	Radiated Emissions Data maximization:	25
2.7	RF Exposure	28
3.0	TEST FACILITY	29
3.1	Location.....	29
3.2	Grounding Plan	29
3.3	Power Supply	29
	Appendix A – Test Setup Block Diagram	30

1.0 INTRODUCTION

1.1 Scope

The purpose of this report is to present the results of compliance testing performed in accordance with FCC Part 15.247 and ANSI C63.10-2013 to gain FCC Class II permissive change Authorization for Low-Power License-Exempt transmitters. All test procedures, limits, criteria, and results described in this report apply only to the Tektelic Communication Inc. COMFORT test sample, referred to herein as the EUT (Equipment Under Test).

This report does not imply product endorsement by the Electronics Test Centre, A2LA, nor any Canadian Government agency.

1.2 Applicant

This test report has been prepared for Tektelic Communication Inc., located in Calgary, Alberta, Canada.

1.3 Test Sample Description

As provided to ETC (Airdrie) by Tektelic Communication Inc.:

Product Name:		COMFORT	
Lora Radio	Frequency Range	902.3 – 914.9 MHz	
	Type of Modulation	LoRa 125KHz DSS	
	Associated Antennas	LoRa	RUN mXTENDTM (NN02-224) linearly polarized, Peak Gain = 2.2 dBi , Efficiency > 85%
Model# / Serial#		T0006115 / 2229K0002	
Variant Name / Model#		COMFORT / T0006115, VIVID / T0006116	
Power supply:		Battery Powered	

Out of two variant COMFORT model was selected to perform radiated spurious emission analysis as it contain the option of external sensor connected via cable.

Detail differences between the models are given in family exhibit.

1.4 General Test Conditions

The EUT was set up and exercised using the configurations, modes of operation and arrangements defined in this report only. All inputs and outputs to and from other equipment associated with the EUT were adequately simulated.

Where relevant, the EUT was only tested using the monitoring methods and test criteria defined in this report.

The environmental conditions are recorded during each test, and are reported in the relevant sections of this document.

1.5 Reference Standards

Standards	Description
FCC, title 47 CFR § 15.247	Operation within the bands 902-928 MHz, 2400-2483.5 MHz, and 5725-5850 MHz.
FCC, title 47 CFR § 15.207	Conducted limits for an intentional radiator that is designed to be connected to the public utility (AC) power line.
FCC, title 47 CFR § 15.107	Conducted limits for equipment that is designed to be connected to the public utility (AC) power line.
FCC, title 47 CFR § 15.209	Radiated emission limits; general requirements
FCC, title 47 CFR § 15.109	Radiated emission limits; from unintentional radiators digital devices.
ANSI C63.10-2013	American National Standard of Procedures for Compliance Testing of Unlicensed Wireless Devices
ANSI C63.10-2014	American National Standard for Methods of Measurement of Radio – Noise Emissions from Low-Voltage Electrical and Electronic Equipment in the range of 9 KHz to 40 GHz
558074 D01 15.247 Meas Guidance v05r02	Guidance For Compliance Measurements On Digital Transmission System, Frequency Hopping Spread Spectrum System, And Hybrid System Devices Operating Under Section 15.247 Of The FCC Rules

1.6 Test Methodology

Test methods are specified in the Basic Standard as referenced and/or modified by the Product Standard in the part of Section 2 of this report associated with each particular test case. Separate test report is provided to customer for RX mode under SDOC.

1.6.1 Variations in Test Methodology

Any variance in methodology or deviation from the reference Standard is documented in the part of Section 2 of this report associated with each particular Test Case.

1.6.2 Test Sample Verification, Configuration & Modifications

EUT setup, configuration, protocols for operation and monitoring of EUT functions, and any modifications performed in order to meet the requirements, are detailed in each Test Case of Section 2 of this report.

1.6.3 Uncertainty of Measurement:

The factors contributing to measurement uncertainty are identified and calculated in accordance with CISPR 16-4-2: 2011.

This uncertainty estimate represents an expanded uncertainty expressed at approximately 95% confidence using a coverage factor of $k = 2$.

Test Method	Uncertainty
Radiated Emissions Level (9 KHz – 1 GHz)	±5.8 dB
Radiated Emissions Level (1 GHz – 18 GHz)	±4.9 dB
Radiated Emissions Level (18 GHz – 26.5 GHz)	±5.0 dB
Conducted Emissions Level (150 KHz – 30 MHz)	±3.0 dB
Uncertainty Conducted Power level	±0.5 dB
Uncertainty Conducted Spurious emission level	±0.6 dB
Uncertainty for Bandwidth test	±1.5 %

2.0 TEST CONCLUSION

STATEMENT OF COMPLIANCE

The customer equipment referred to in this report was found to comply with the requirements, as summarized below.

The EUT was subjected to the following tests. Compliance status is reported as **Compliant** or **Non-compliant**. **N/A** indicates the test was Not Applicable to the EUT.

The measurement uncertainty is not accounted for determination of the statement of compliance. The statement of compliance is based only on the measurement value recorded.

Note: Maintenance of compliance is the responsibility of the Manufacturer. Any modifications to the product should be assessed to determine their potential impact on the compliance status of the EUT with respect to the standards detailed in this test report.

The following table summarizes the tests performed in terms of the specification, class or performance criterion applied, and the EUT modification state.

Test Case	Test Type	Specification	Test Sample	Mod.	Config.	Result
2.1	AC Conducted Emissions	15.207, 15.109	COMFORT	none	see § 2.1	n/a
2.2	Occupied Bandwidth	15.247(a)(1) 15.247(2)(2)	COMFORT	none	see § 2.2	Compliant
2.3	Max Output average Power Conducted	15.247(b)	COMFORT	none	see § 2.3	Compliant
2.4	EUT Position	ANSI C63.4	COMFORT	none	see § 2.4	assed
2.5	Radiated Spurious Emission (Restricted Band Operation)	15.205, 15.209 15.247(d)	COMFORT	none	see § 2.5	Compliant
2.6	Radiated Emission	15.109	COMFORT	none	see § 2.6	Compliant
2.7	RF Exposure	15.247(i)	COMFORT	none	see § 2.7	Exempt

Refer to the test data for applicable test conditions.

2.1 AC Power Line Conducted Emissions: N/A

Test Lab: Electronics Test Centre, Airdrie	EUT: COMFORT
Test Personnel:	Standard: FCC Part 15.207 / 15.109
Date:	Basic Standard: ANSI C63.10: 2013 ANSI C63.4: 2014
EUT status: N/A	
Comments: EUT is internal Battery Powered. No Direct or indirect Connection to AC main.	

2.2 Channel Occupied Bandwidth

Test Lab: Electronics Test Centre, Airdrie	EUT: COMFORT
Test Personnel: Imran Akram	Standard: FCC PART 15.247
Date: 2022-08-11 (21.4°C,40.5% RH)	Basic Standard: ANSI C63.10-2013 FCC OET KDB 558074
EUT status: Compliant	

Specification: FCC Part 15.247 (a, 2), FCC 15.215 (c)

Criteria: There is no requirement for this type of hybrid system to comply with the 500 kHz minimum bandwidth normally associated with a DTS transmission.

2.2.1 Test Guidance: ANSI C63.10-2013, Clause 6.9.2 & 6.9.3/ FCC OET KDB 558074

This measurement is performed at low, mid and high frequencies, with modulation.

The RF output of EUT with an antenna connector is fed to the input of the spectrum analyzer through appropriate attenuation. The loss from the cable and the attenuator were added on the analyzer as gain offset setting there by allowing direct measurements, without the need for any further corrections.

Use the following spectrum analyzer setting:

Span	Between two time and five times the channel center frequency OBW
RBW	1% to 5% of the OBW
VBW	Approximately three times of RBW
Sweep	Auto Couple
Detector Function	Peak
Trace	Max Hold
Allow the trace to stabilize. The automated 99% BW function of the spectrum analyzer is engaged, 20dB bandwidth is measured with the X dB function.	

2.2.2 Deviations From The Standard:

There were no deviations from the EUT setup or methodology specified in the standard.

2.2.3 Test Equipment

Testing was performed with the following equipment:

Equipment	Manufacturer	Model #	Asset #	Cal. Date	Cal. Due
EXA Signal Analyzer	Agilent	N9010A FW A.25.05	6678	2022-03-11	2023-03-11
Temp/Humidity	Extech	42270	5892	2022-04-07	2023-04-07
Attenuator	Mini-Circuits®	BWS102W263	6932	Cal. before each use	

2.2.4 Test Sample Verification, Configuration & Modifications

The EUT was set to transmit continuously on a selected channel with test-specific software. The output was modulated as in normal operation. The EUT met the requirements without modification.

Test setup diagrams for Occupied Bandwidth testing:

Conducted:



2.2.5 Channel Occupied Bandwidth Data:

Mode of operation	Channel	Freq. [MHz]	20 dB OBW [kHz]	99% OBW [KHz]
LoRa 125KHz	Low	902.3	139.3	128.18
	Mid	908.7	138.9	128.03
	High	914.9	138.8	128.14

Screen Captures from the spectrum analyzer: Low Channel

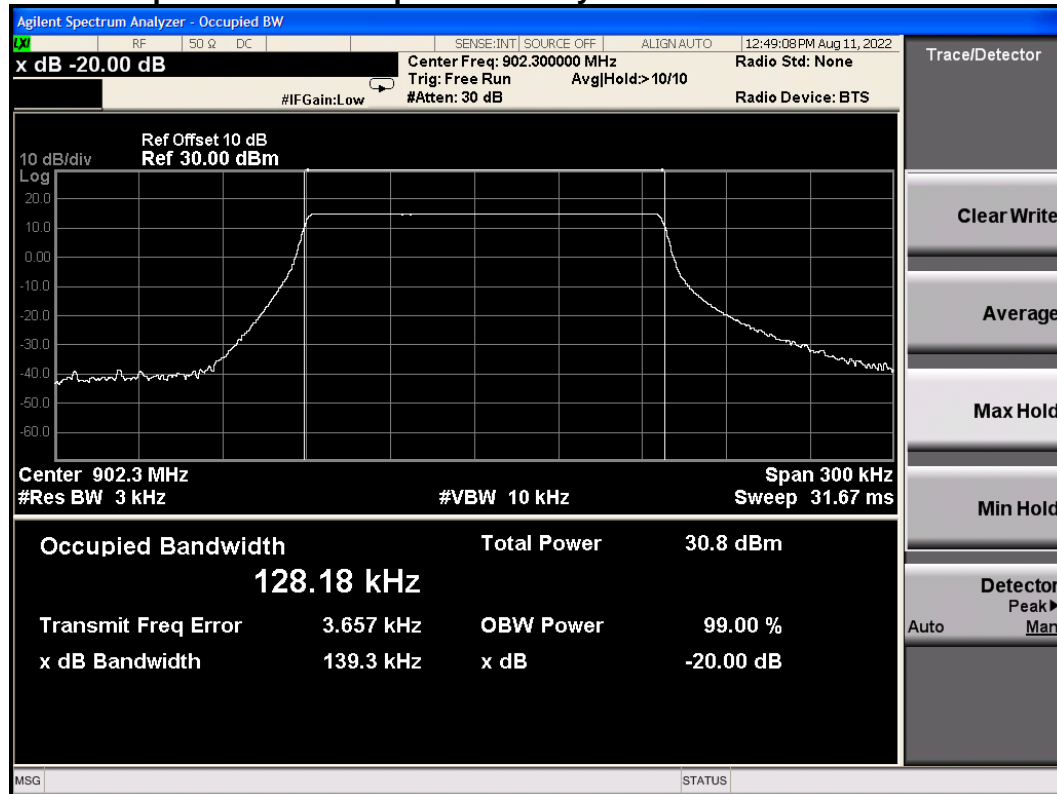

Screen Captures from the spectrum analyzer: MID Channel

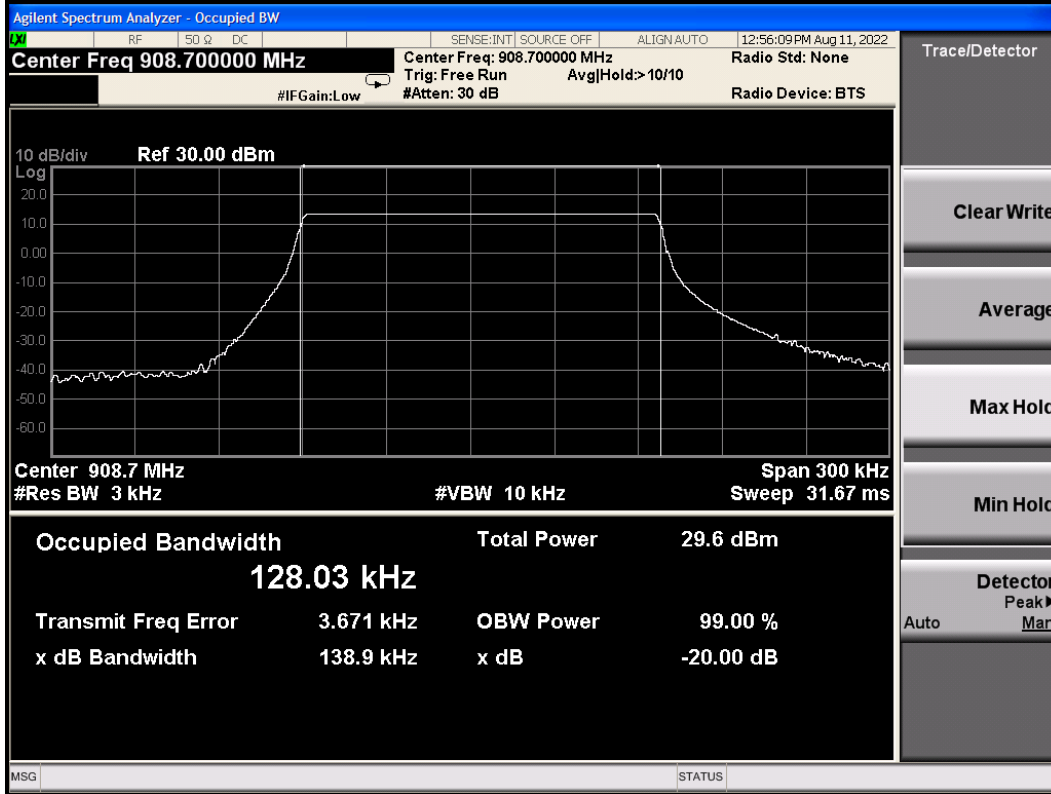

Screen Captures from the spectrum analyzer: High Channel

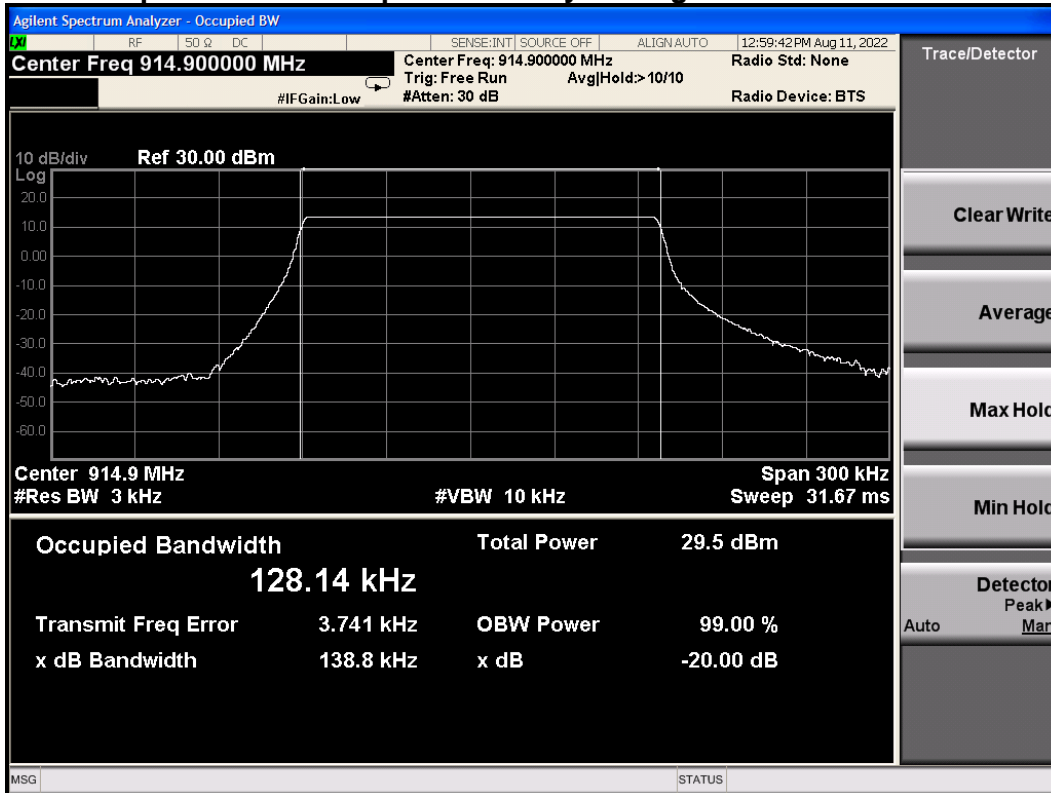

2.3 Max Average Output Power

Test Lab: Electronics Test Centre, Airdrie	EUT: COMFORT
Test Personnel: : Imran Akram	Standard: FCC PART 15.247
Date: 2022-08-11 (21.4°C,40.58% RH)	Basic Standard: ANSI C63.10: 2013 FCC OET KDB 558074

EUT status: Compliant

Specification: FCC Part 15.247

Criteria For systems using digital modulation / hybrid in the 902-928 MHz bands: 1 Watt.

2.3.1 Test Guidance: ANSI C63.10-2013, Clause 11.9.2.2 Clause 7.8.5 / FCC OET KDB 558074

This measurement is performed at low, mid and high frequencies, with modulation.

The RF output of EUT with an antenna connector is fed to the input of the spectrum analyzer through appropriate attenuation. The loss from the cable and the attenuator were added on the analyzer as gain offset setting there by allowing direct measurements, without the need for any further corrections.

2.3.2 Deviations From The Standard:

There were no deviations from the EUT setup or methodology specified in the standard.

2.3.3 Test Equipment

Testing was performed with the following equipment:

Equipment	Manufacturer	Model #	Asset #	Cal. Date	Cal. Due
EXA Signal Analyzer	Agilent	N9010A FW A.25.05	6678	2022-03-11	2023-03-11
Temp/Humidity	Extech	42270	5892	2022-04-07	2023-04-07
Attenuator	Mini-Circuits®	BWS102W263	6932	Cal. before each use	

2.3.4 Test Sample Verification, Configuration & Modifications

The EUT was set to a selected channel with test-specific software. The output was modulated as in normal operation.

The EUT met the requirements without modification.

Test setup diagrams for Peak Power testing:

Conducted:



2.3.5 Max Average Output Power Data

Mode of Operation	Channel	Freq. [MHz]	Out Put Power (dBm)	Out Put Power Limit (dBm)
LoRa 500 KHz	Low	902.3	13.46	30
	Mid	908.7	13.35	30
	High	914.9	13.21	30

Output Power Method AVGSA-1 For DTS	
Span	≥ 1.5 times the OBW
RBW	1 – 5 % of the OBW, ≤ 1 MHz
VBW	≥ 3 x RBW
Number of Points in sweep	≥ 2 x Span / RBW
Sweep time	Auto Couple
Detector	RMS (Power Averaging)
Sweep trigger	Free Run (Duty Cycle ≥98%)
Trace Average	Minimum 100 traces in power Averaging (RMS)
Power measured	Integrated the spectrum across the OBW of the signal using the S/A band power measurement function, with band limit set equal to the OBW band edge.

Screen Captures from the spectrum analyzer Low Channel

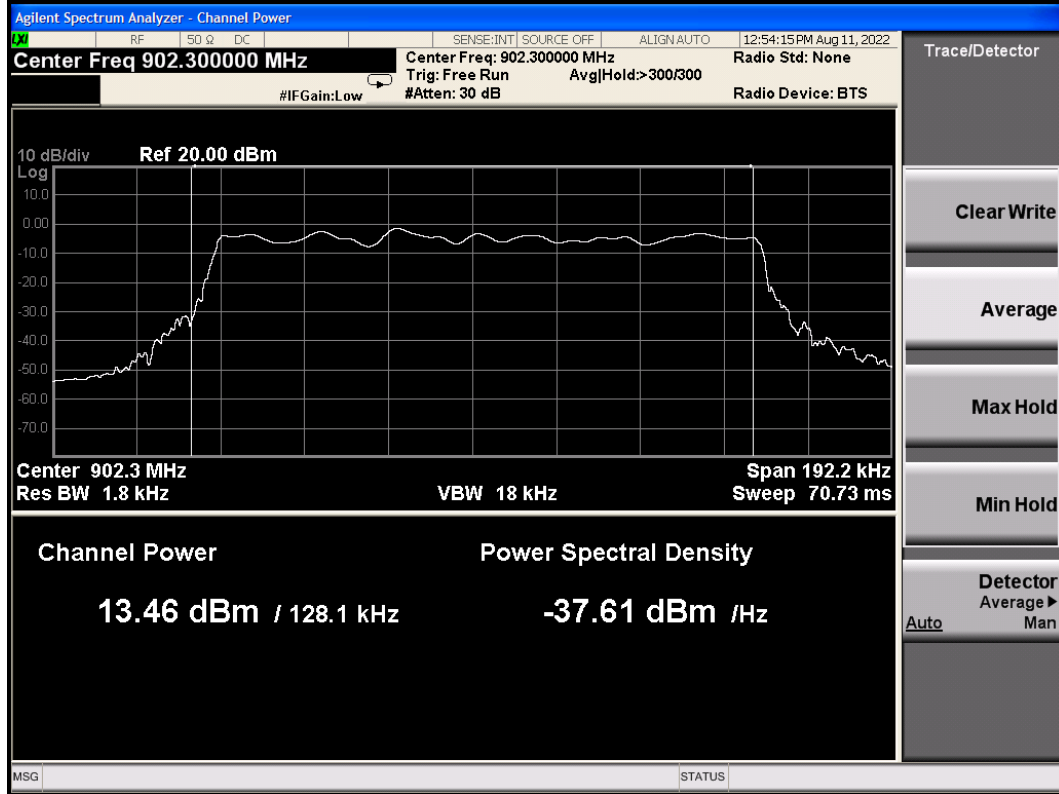

Screen Captures from the spectrum analyzer: MID Channel

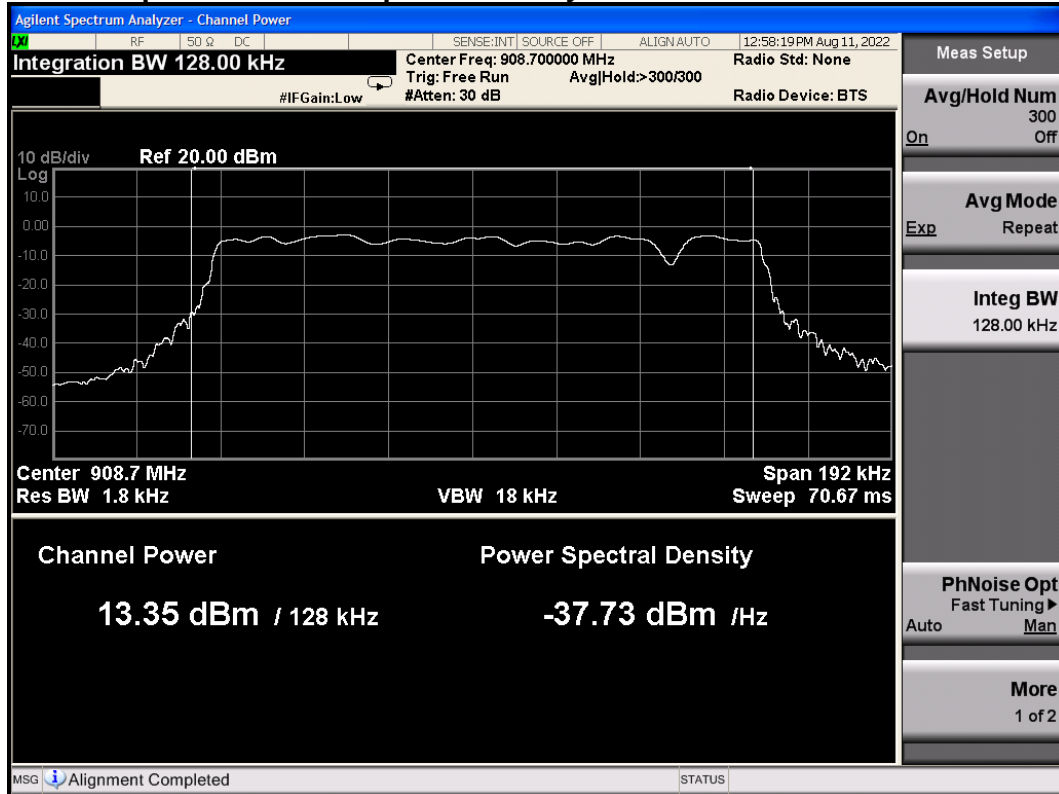

Screen Captures from the spectrum analyzer: High Channel

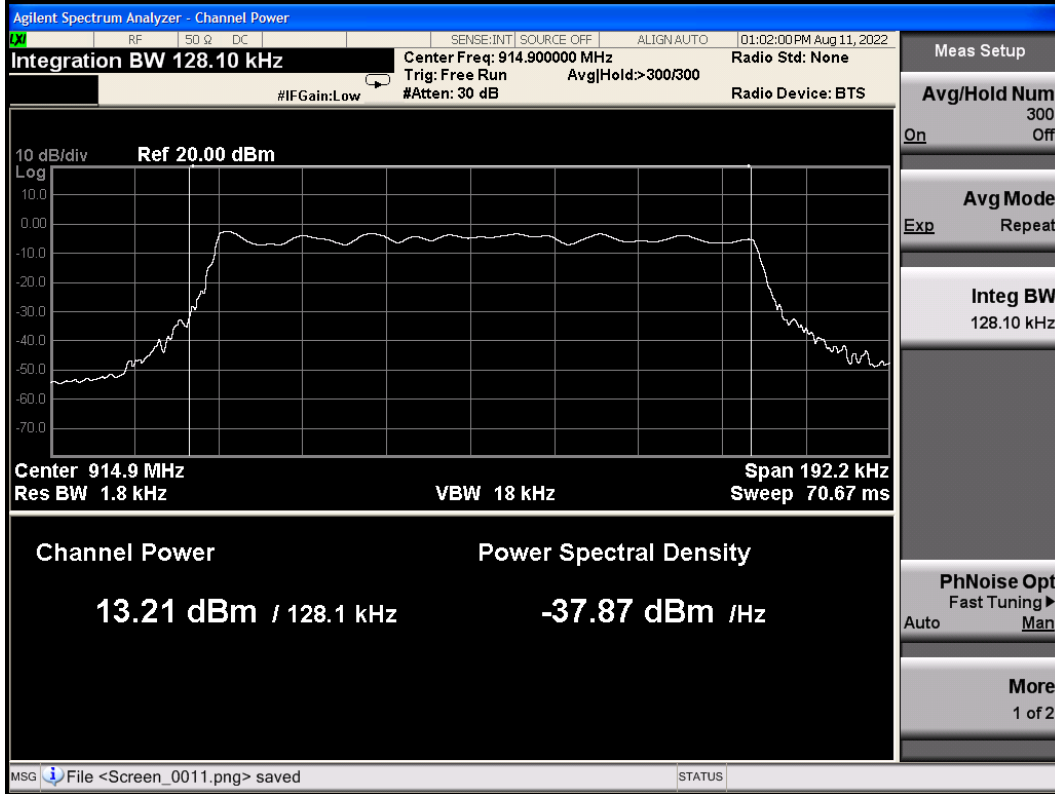

2.4 EUT Positioning Assessment

Test Lab: Electronics Test Centre, Airdrie	EUT: COMFORT
Test Personnel: Janet / Brendan	Standard: FCC PART 15.247
Date: 2022-07-25 (28.8°C,47.2% RH)	Basic Standard: ANSI C63.4-2014
Comments: Y-Axis position found worse	

Specification: ANSI C63.4-2014, Clause 6.3.2.1

Portable, small, lightweight, or modular devices that may be handheld, worn on the body, or placed on a table during operation shall be positioned on a non-conducting platform, the top of which is 80 cm above the reference ground plane. The preferred area occupied by the EUT arrangement is 1 m by 1.5 m, but it may be larger or smaller to accommodate various sized EUTs (see Figure 6, Figure 7, and Figure 9). For testing purposes, ceiling- and wall-mounted devices also shall be positioned on a tabletop (see also 6.3.4 and 6.3.5). In making any tests involving handheld, body-worn, or ceiling-mounted equipment, it is essential to recognize that the measured levels may be dependent on the orientation (attitude) of the three orthogonal axes of the EUT. Thus, exploratory tests as specified in 8.3.1 shall be carried out for various axes orientations to determine the attitude having maximum or near-maximum emission level.

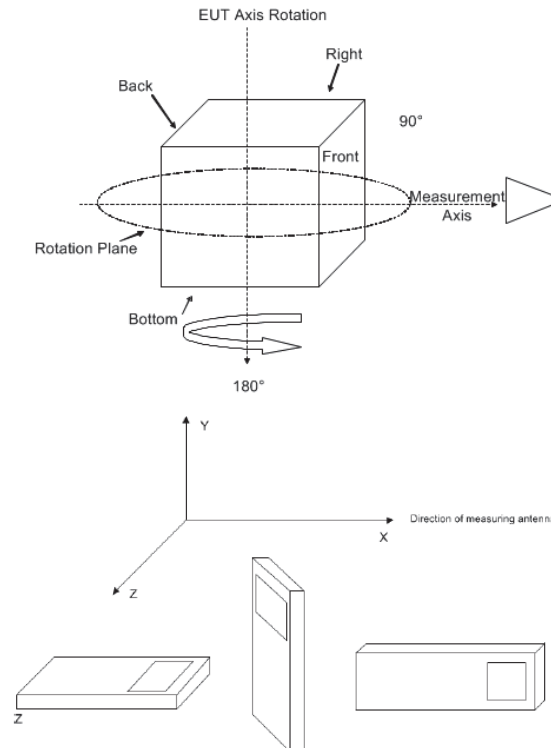

Refer to Test Setup photo exhibit.

2.5 Radiated Spurious Emissions (Restricted Band)

Test Lab: Electronics Test Centre, Airdrie	EUT: COMFORT
Test Personnel: Janet / Brendan	Standard: FCC PART 15.247/15.209
Date: 2022-07-25 / 26 (28.8° C, 47.2 % RH)	Basic Standard: ANSI C63.10-2013
EUT status: Compliant	

Specification: FCC PART 15.247(d)

In any 100 kHz bandwidth outside the frequency band in which the spread spectrum or digitally modulated intentional radiator is operating, the radio frequency power that is produced by the intentional radiator shall be at least 20 dB below that in the 100 kHz bandwidth within the band that contains the highest level of the desired power, based on either an RF conducted or a radiated measurement, provided the transmitter demonstrates compliance with the peak conducted power limits. If the transmitter complies with the conducted power limits based on the use of RMS averaging over a time interval, as permitted under paragraph (b)(3) of this section, the attenuation required under this paragraph shall be 30 dB instead of 20 dB. Attenuation below the general limits specified in §15.209(a) is not required. In addition, radiated emissions which fall in the restricted bands, as defined in §15.205(a), must also comply with the radiated emission limits specified in §15.209(a) (see §15.205(c)).

Restricted Bands of Operation:

MHz	MHz	MHz	MHz	MHz	GHz	GHz
0.0900000 - 0.1100000	8.2910000 - 8.2940000	16.804250 - 16.804750	162.01250 - 167.17000	1660.0000 - 1710.0000	3.6000000 - 4.4000000	14.470000 - 14.500000
0.4950000 - 0.5050000	8.3620000 - 8.3660000	25.500000 - 25.670000	167.72000 - 173.20000	1718.8000 - 1722.2000	4.5000000 - 5.1500000	15.350000 - 16.200000
2.1735000 - 2.1905000	8.3762500 - 8.3867500	37.500000 - 38.250000	240.00000 - 285.00000	2200.0000 - 2300.0000	5.3500000 - 5.4600000	17.700000 - 21.400000
4.1250000 - 4.1280000	8.4142500 - 8.4147500	73.000000 - 74.600000	322.00000 - 335.40000	2310.0000 - 2390.0000	7.2500000 - 7.7500000	22.010000 - 23.120000
4.1772500 - 4.1777500	12.2900000 - 12.2930000	74.800000 - 75.200000	399.90000 - 410.00000	2483.5000 - 2500.0000	8.0250000 - 8.5000000	23.600000 - 24.000000
4.2072500 - 4.2077500	12.519750 - 12.520250	108.00000 - 121.94000	608.00000 - 614.00000	2655.0000 - 2900.0000	9.0000000 - 9.2000000	31.200000 - 31.800000
5.6770000 - 5.6830000	12.576750 - 12.577250	123.00000 - 138.00000	960.00000 - 1240.0000	3260.0000 - 3267.0000	9.3000000 - 9.5000000	36.430000 - 36.500000
6.2150000 - 6.2180000	13.360000 - 13.410000	149.90000 - 150.05000	1300.0000 - 1427.0000	3332.0000 - 3339.0000	10.600000 - 12.700000	Above 38.600000
6.2677500 - 6.2682500	16.420000 - 16.423000	156.52475 - 156.52525	1435.0000 - 1626.5000	3345.8000 - 3358.0000	13.250000 - 13.400000	
6.3117500 - 6.3122500	16.694750 - 16.695250	156.70000 - 156.90000	1645.5000 - 1646.5000	3500.0000 - 3600.0000		

■ US only
 ■ Canada 108 – 138 MHz
 ■ Canada 960 – 1427 MHz
 ■ Canada only

2.5.1 Test Guidance: ANSI C63.10-2013, Clause 13.4.2

From 9 kHz to 150 kHz (resolution bandwidth of 200 Hz) and from 150 kHz to 30 MHz (resolution bandwidth 9 kHz) measurements are performed with a loop antenna (as per KDB 460108).

From 30 MHz to 1000 MHz, measurements are performed with a broadband biconilog antenna and a resolution bandwidth of 120 kHz.

Above 1000 MHz, measurements are performed with a DRG Horn antenna or a Standard Gain horn, and a resolution bandwidth of 1 MHz. The EUT is raised to 150 cm above the ground plane, and the area between the EUT and the antenna mast is covered with RF absorbent material.

The scan is performed at discreet increments of turntable azimuth and antenna height, which are selected in accordance with the applicable standard in order to assure capture of frequencies of interest. Optimization is performed based on the scan data.

Frequencies having peak emissions within 10dB of the limits are optimized. The EUT is rotated in azimuth over 360 degrees and the direction of maximum emission is noted.

Antenna height is varied from 1 – 4 meters at this azimuth to obtain the maximum emission. Then the maximum level is measured with the appropriate detector and recorded. Up to 1 GHz, measurements are performed with a Quasi-Peak detector. Above 1 GHz, measurements are recorded with Peak and/or Average detectors, as applicable.

2.5.2 Deviations From The Standard:

There were no deviations from the EUT setup or methodology specified in the standard.

2.5.3 Test Equipment

Testing was performed with the following equipment:

Equipment	Manufacturer	Model #	Asset #	Cal. Date (yyyy-mm-dd)	Cal. Due (yyyy-mm-dd)
EMC Software	UL	Ver. 9.5	ETC-SW-EMC 2.1	N/A	
EMI receiver	Agilent	N9038A (FW A.25.05)	6130	2022-07-12	2023-07-12
Loop Antenna	EMCO	6502	10868	2021-05-11	2023-05-11
Biconilog Antenna	AR	JB1	6905	2021-10-29	2023-10-21
DRG Horn	EMCO	3115	19357	2020-09-29	2022-09-29
Humidity/Temp Logger	Extech Ins. Corp.	42270	5892	2022-04-07	2023-04-07
Low Noise Amplifier (1 – 18 GHz)	MITEQ	JS43-01001800- 21-5P	4354	2022-06-28	2023-06-28
Pre-Amplifier (30 – 1400 MHz)	HP	8447D	9291	2022-06-28	2023-06-28
RE Cable below 1GHz	Insulated Wire Inc.	KPS-1501A-3600- KPA-01102006	4419	2022-06-28	2023-06-28
Re Cable Above 1 GHz	A.H. System Inc.	SAC-26G-8.23	6187	2022-06-28	2023-06-28
0.9GHz Notch Filter	Microtronics	BRM20784	6947	2022-06-28	2023-06-28

2.5.4 Test Sample Verification, Configuration & Modifications

The EUT was set to a selected channel with test-specific software. The output was modulated as in normal operation. LoRa radio is transmitting at Low Channel 902.3 MHz.

The EUT met the requirements without modification.

Test setup diagram for Radiated Spurious Emissions testing (below 1GHz):

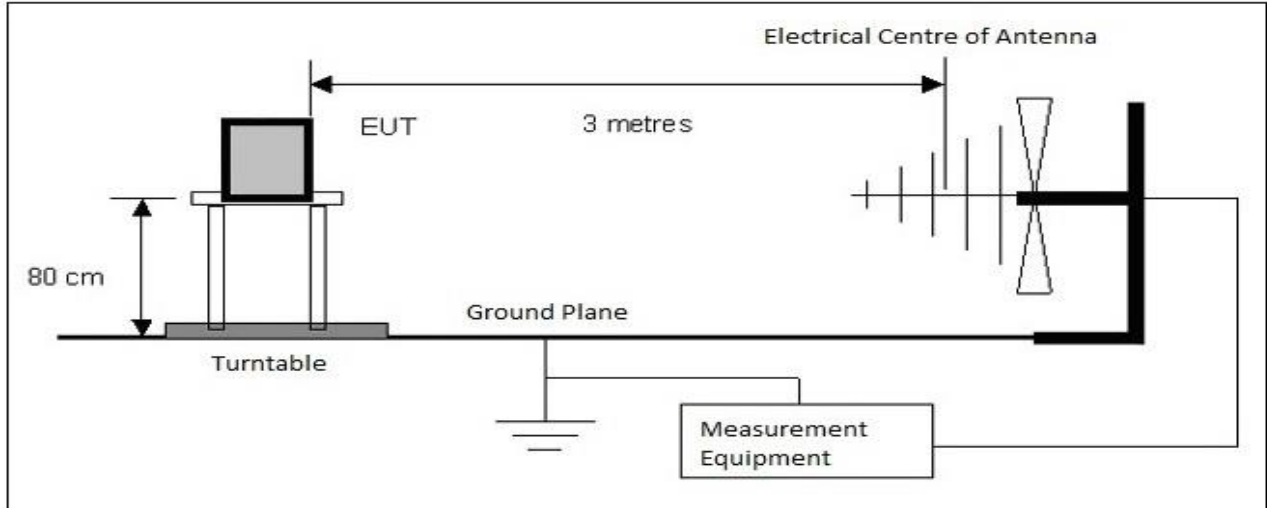

Test setup diagram for Radiated Spurious Emissions testing (above 1GHz):

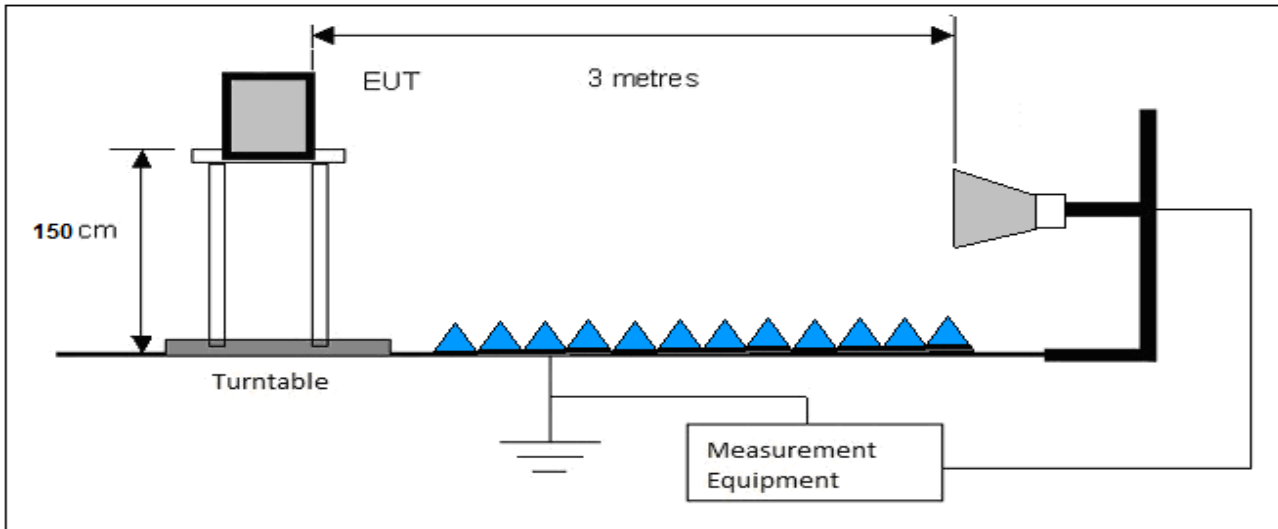

2.5.5 Radiated Emissions Data:

The emissions data are presented in tabular form, showing turntable azimuth, antenna height and polarization, the uncorrected spectrum analyzer reading, the correction factors applied, the net result, the value of the limit at the frequency investigated, and the Delta between the result and the limit.

Meter Reading in dBμV + Antenna Factor in dB/m + Gain/Loss Factor in dB = Corrected Field Strength in dBμV/m.

Delta = Field Strength – Limit

Notes:

- When a preamp is used, the resulting gain is compensated, producing a negative value for the Cable Loss.
- Measurements reported are the result of adjusting the turntable azimuth and antenna height to obtain the maximum EUT emission. This may produce a different reading than the plot trace. The plot is a Peak Hold function obtained at discreet increments of height and azimuth, while the reported measurement is obtained with the appropriate Quasi Peak or Average detector after the height and azimuth have been adjusted for maximum emission.
- Preliminary scans were performed for all channels in Transmit modes. The LOW band channel 902.3 MHz was selected as the worst-case condition for detailed examination.
- In Transmit mode, the EUT was assessed up to 10.0 GHz.

Negative values for Delta indicate compliance.

Freq. Marker	Freq. [GHz]	Raw reading [dBμv]	Det	Antenna Factor [dB/m]	Pre amp Gain/Cable Loss [dB]	Corrected Reading [dBμv/m]	FCC 15.247 Limit [dBμv/m]	Delta [dB]	Azimuth [Deg]	Height [cm]	Polarization
1	2.7070	39.93	AV	29.1	-34.0	35.03	54	-18.97	221	165	H
1	2.7070	45.89	PK	29.1	-34.0	40.99	74	-33.01	221	165	H
2	2.7067	42.70	AV	29.1	-34.0	37.80	54	-16.20	179	162	V
2	2.7067	47.50	PK	29.1	-34.0	42.60	74	-31.40	179	162	V
3	5.4136	39.79	AV	33.9	-30.7	42.99	54	-11.01	63	159	H
3	5.4136	44.88	PK	33.9	-30.7	48.08	74	-25.92	63	159	H
4	5.4137	38.51	AV	33.9	-30.7	41.71	54	-12.29	39	253	V
4	5.4137	43.27	PK	33.9	-30.7	46.47	74	-27.53	39	253	V

PK: Peak Detector, AV: Average Detector

Spurious Emission in Restricted Band

Plot of Radiated Emissions: Measuring Antenna Parallel

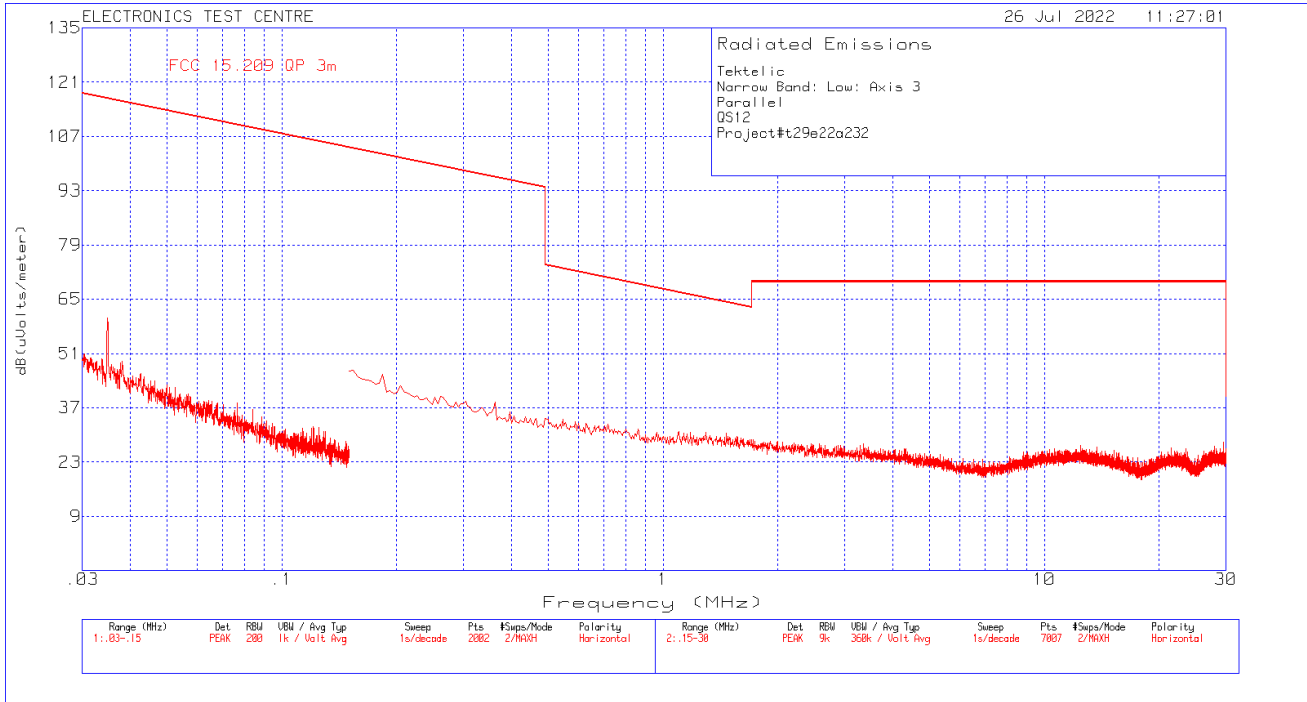

Plot of Radiated Emissions: Measuring Antenna Perpendicular

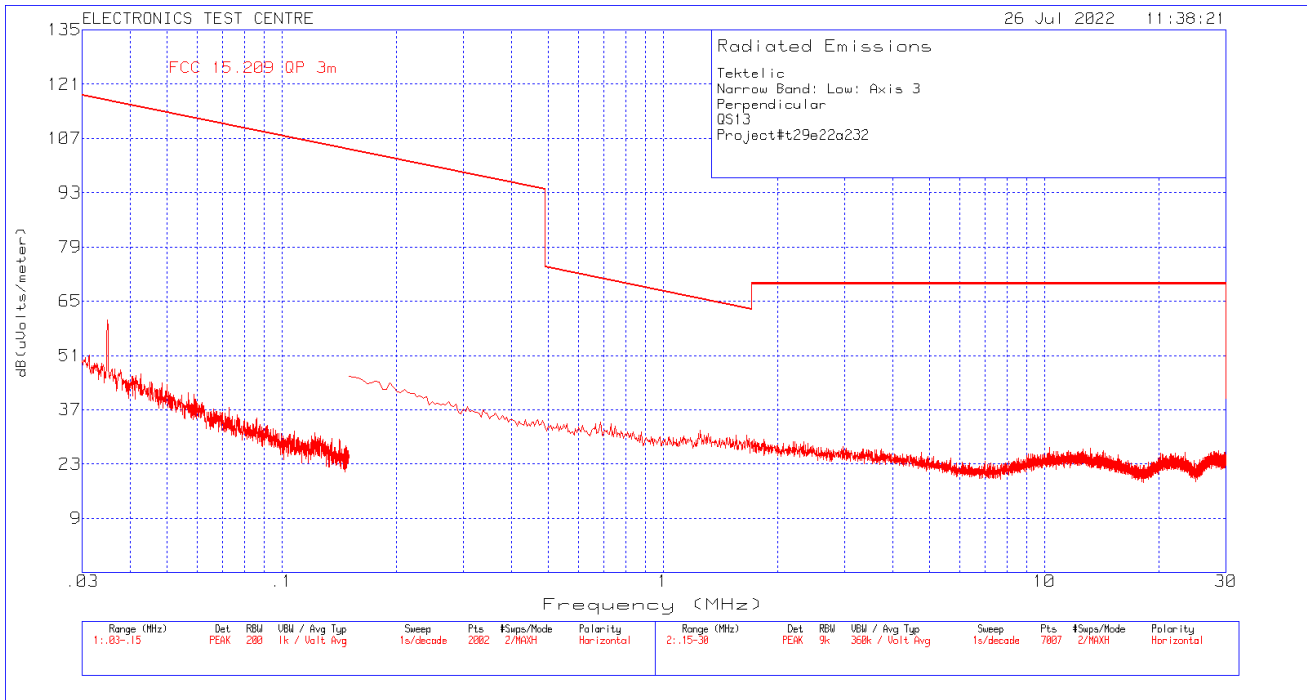

Plot of Radiated Emissions: Horizontal polarization

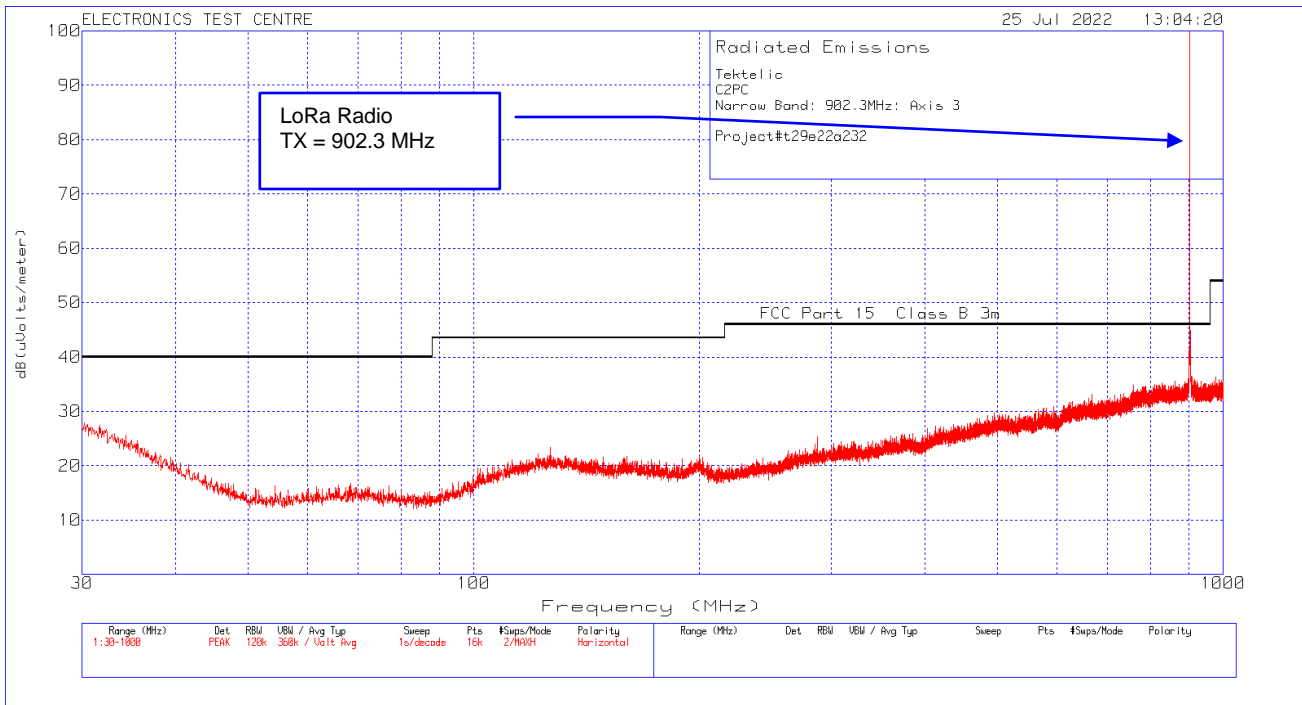

Plot of Radiated Emissions: Vertical polarization

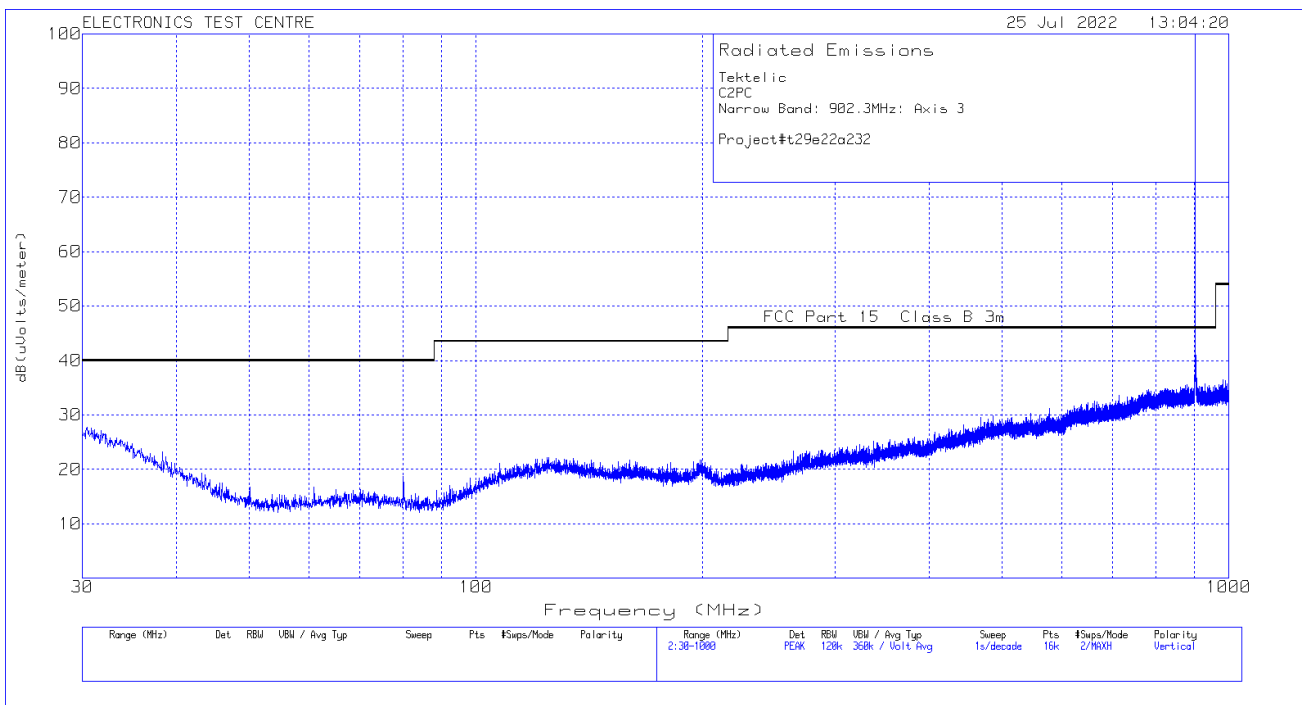

Plot of Radiated Emissions: Horizontal polarization

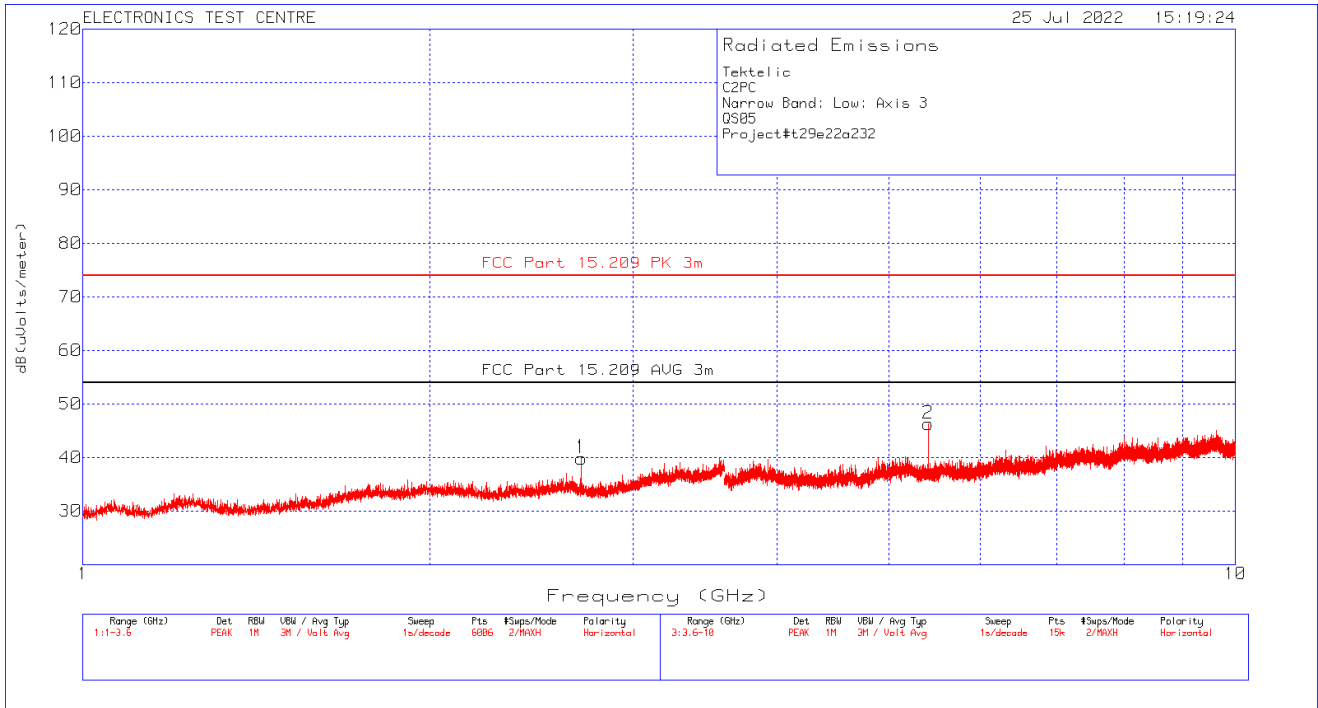

Plot of Radiated Emissions: Vertical polarization

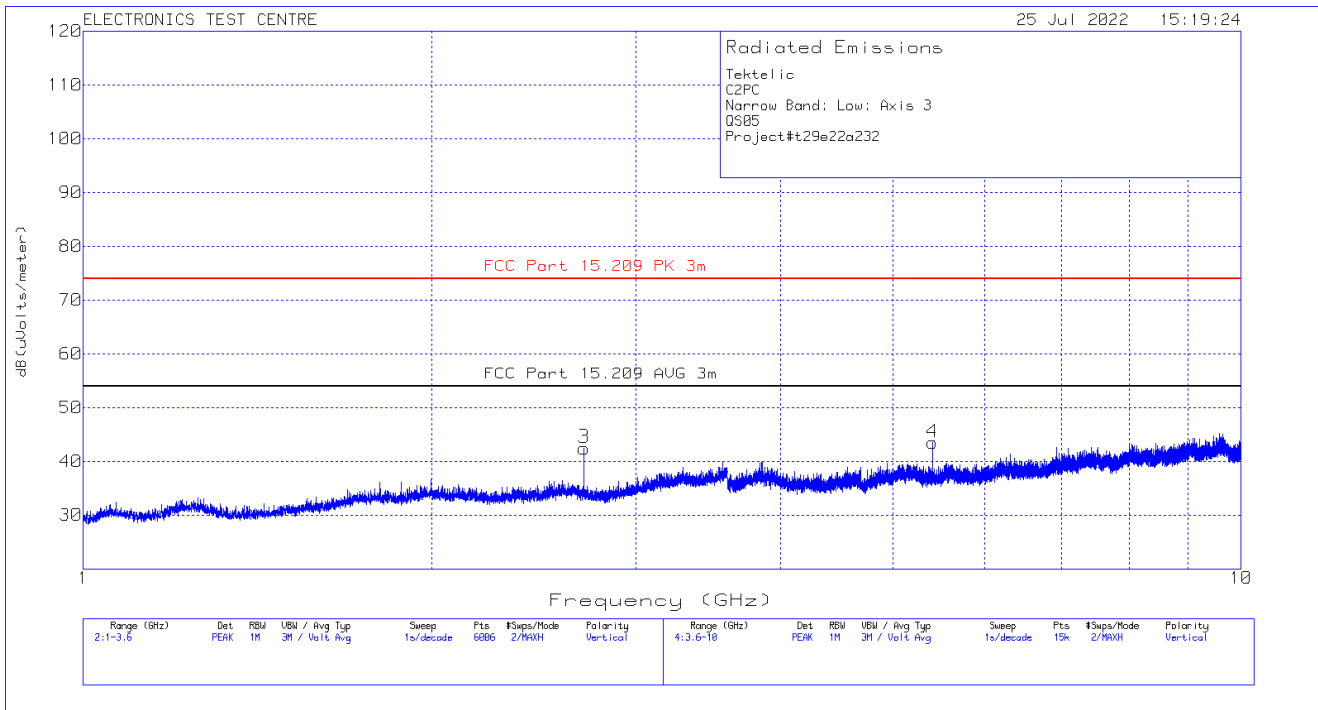

2.6 Radiated Emissions (RX Mode)

Test Lab: Electronics Test Centre, Airdrie	EUT: COMFORT
Test Personnel: Brendan Van Hee, Janet Mijares	Standard: FCC Part 15.109
Date: 2022/07/25 (22.8°C, 47.2% RH)	Basic Standard: ANSI C63.4: 2014
	Class: B
EUT status: Compliant	

Frequency (MHz)	FCC Part 15.109 Class B Limit (3m)
30 – 88	40 (dB μ V/m)
88 – 216	43.52 (dB μ V/m)
216 – 960	46.02 (dB μ V/m)
Above 960	53.98 (dB μ V/m)

Criteria: The radiated emissions produced by a device, measured at a distance of 3 meters, shall not exceed the limits as specified.

2.6.1 Test Guidance:

From 30 MHz to 1000 MHz, measurements are performed with a broadband biconilog antenna and a resolution bandwidth of 120 kHz.

Above 1000 MHz, measurements are performed with a DRG Horn antenna or a Standard Gain horn, and a resolution bandwidth of 1 MHz.

The scan is performed at discreet increments of turntable azimuth and stepped antenna height, with peak detector and Max Hold function which are selected in accordance with the applicable standard in order to assure capture of frequencies of interest. Optimization is performed based on the scan data.

After the pre-scan is completed, the frequencies of interest are optimized. The EUT is rotated in azimuth over 360 degrees and the direction of maximum emission is noted.

Antenna height is varied from 1 – 4 meters at this azimuth to obtain the maximum emission. Then the maximum level is measured with the appropriate detector and recorded. This may produce a different reading than the pre scan trace. Up to 1 GHz, measurements are performed with a Quasi-Peak detector. Above 1 GHz, measurements are recorded with Peak and/or Average detectors, as applicable.

2.6.2 Deviations From The Standard:

There were no deviations from the EUT setup or methodology specified in the standard.

2.6.3 Test Equipment

Testing was performed with the following equipment:

Equipment	Manufacturer	Model #	Asset #	Calibration Date	Calibration Due
EMC Software	UL	Ver. 9.5	ETC-SW-EMC 2.1	N/A	
EMI receiver	Agilent	N9038A (FW A.25.05)	6130	2022-07-12	2023-07-12
Biconilog Antenna	SunAR RF Motion;	JB1	6905	2021-10-29	2023-10-29
DRG Horn	EMCO	3115	19357	2020-09-29	2022-09-29
T/H Logger	EXTECH Ins.	42270	5892	2022-04-07	2023-04-07
Pre- Amp	HP	8447D	9291	Monitored	
Low Noise Amplifier	MITEQ	JS43-01001800-21-5P	4354	Monitored	

2.6.4 Test Sample Verification, Configuration & Modifications

To cover the unintentional radiated emission. The EUT was configured in receive mode. Unit was placed at the center of turntable in semi-anechoic chamber 80cm above the ground plane and at a distance of 3m from the test receive antenna.

The EUT met the requirements without modification.

EUT RX configuration Block Diagram for Radiated Emissions testing:

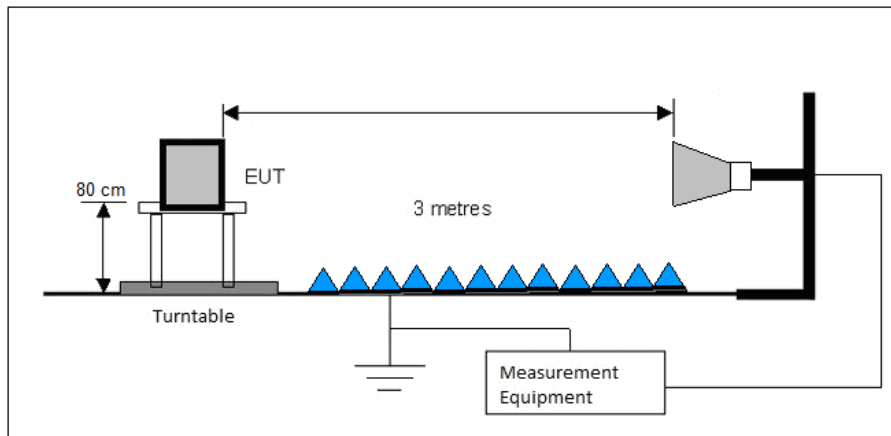
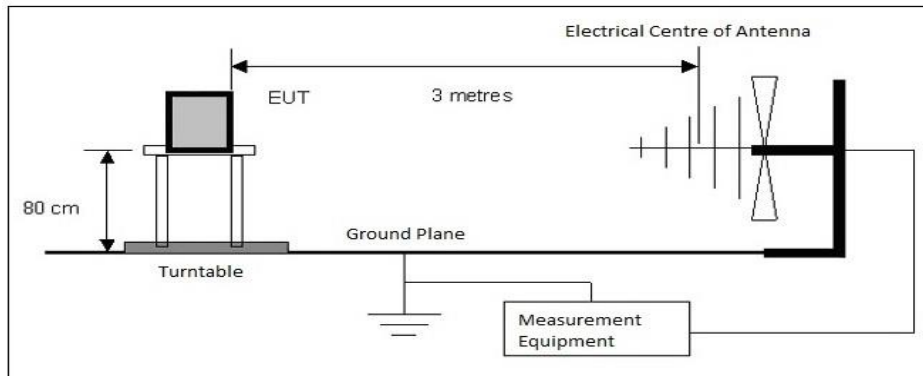

2.6.5 Radiated Emissions Data maximization:

No Emission is found for analysis

Meter Reading in dB μ V + Antenna Factor in dB/m + Gain/Loss Factor in dB = Corrected Field Strength in dB μ V/m.

Plot of Radiated Emissions: Horizontal polarization

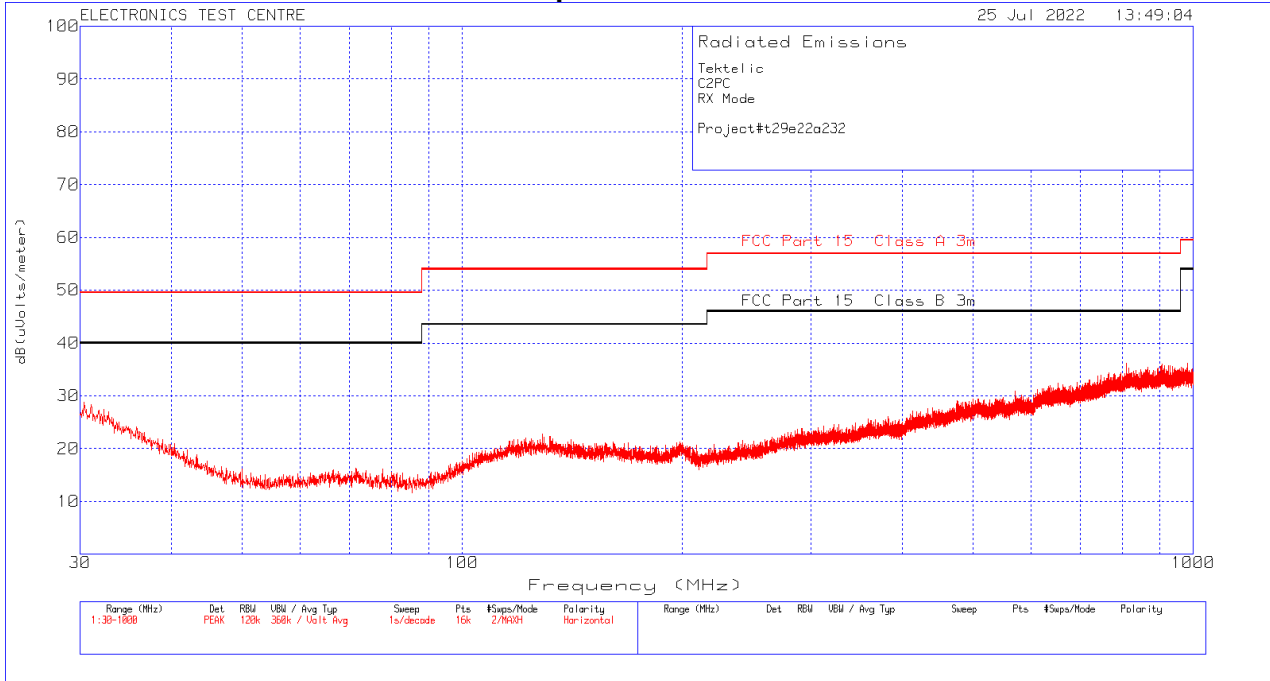

Plot of Radiated Emissions: Vertical polarization

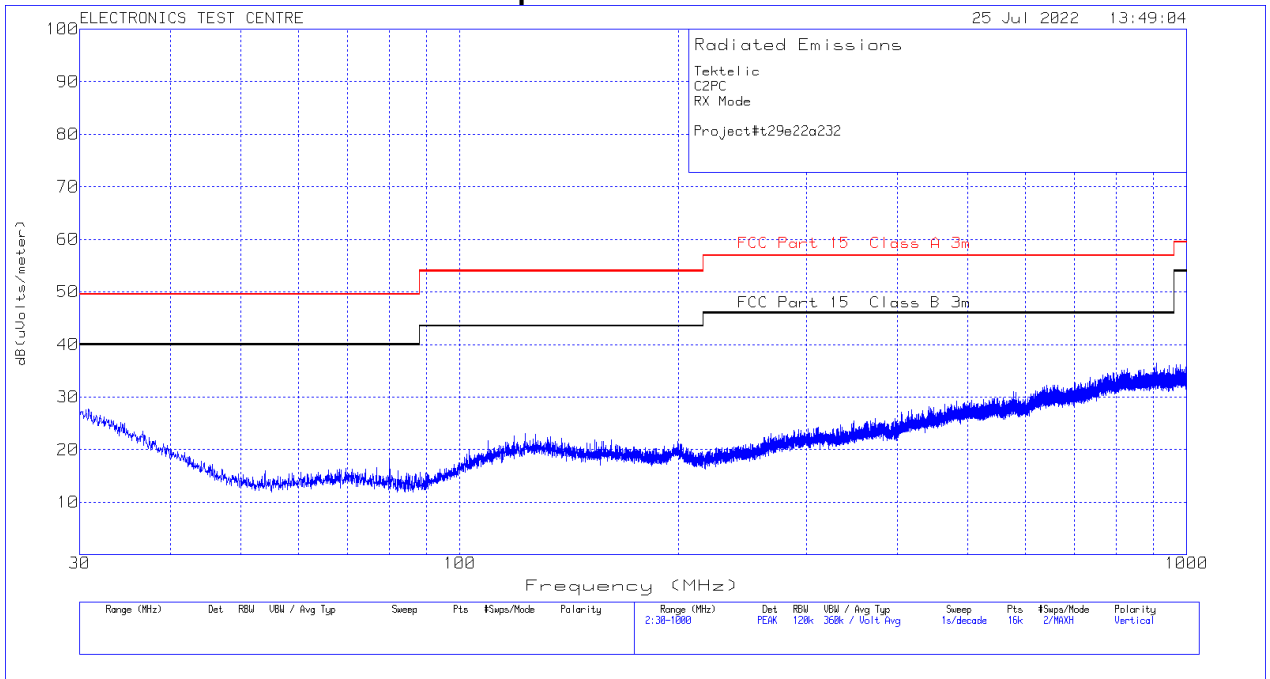

Plot of Radiated Emissions: Horizontal polarization

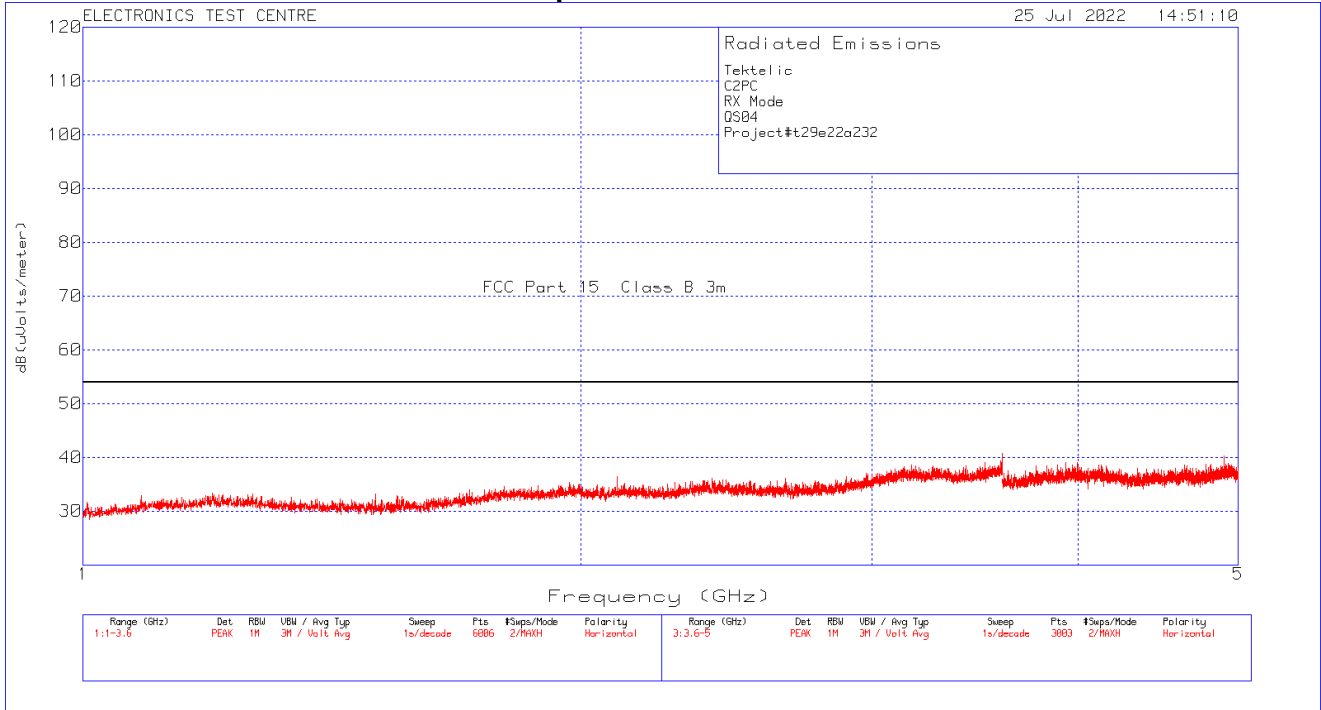

Plot of Radiated Emissions: Vertical polarization

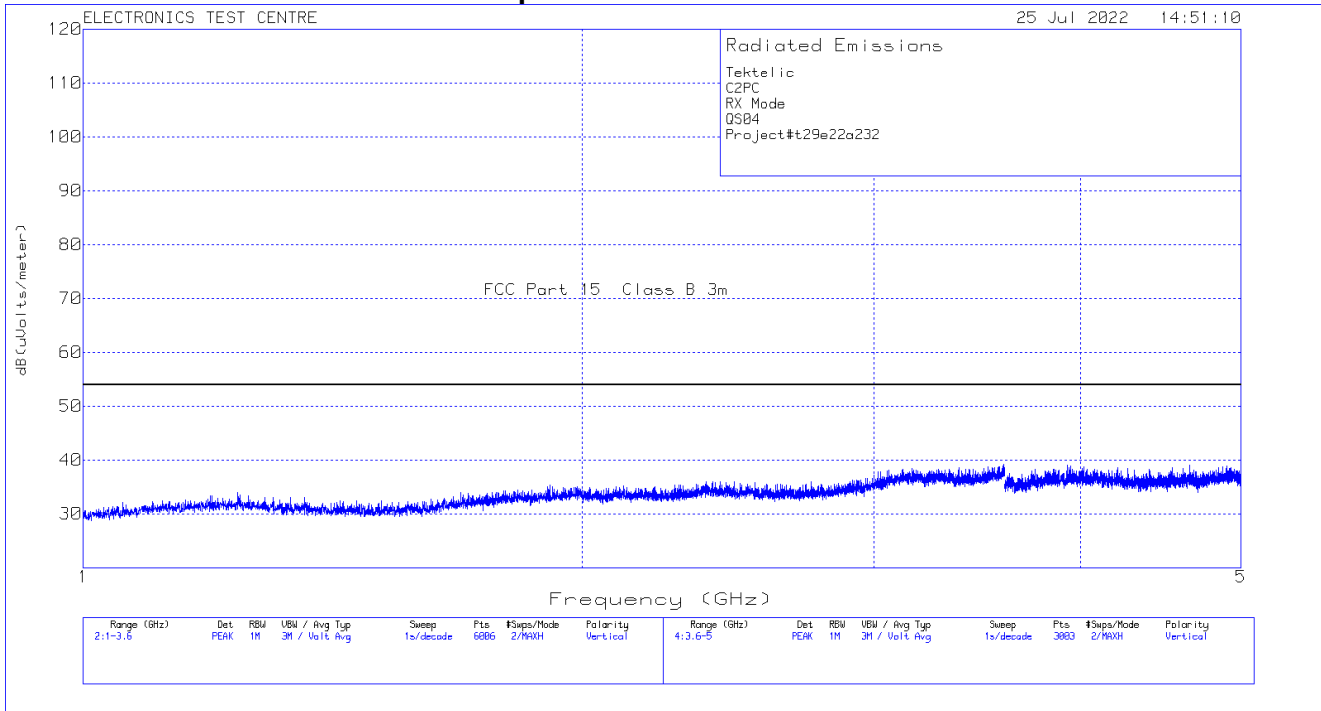

2.7 RF Exposure

Test Lab: Electronics Test Centre, Airdrie	EUT: COMFORT
Test Personnel:	Standard: FCC PART 15.247
Date:	
EUT status: Compliant	

Compliant: RF exposure assessment to be provided in a separate Exhibit.

3.0 TEST FACILITY

3.1 Location

The COMFORT was tested at the Electronics Test Centre laboratory located in Airdrie, Alberta, Canada. The Radio Frequency Anechoic Chamber (RFAC), identified as Chamber 1, has a usable working space measuring 10.6 m long x 7.3 m wide x 6.5 m high.

Measurements taken at this site are accepted by Industry Canada as evidence of conformity per registration file # 2046A. This site is also listed with the FCC under Registration Number CA2046.

The floor, walls and ceiling consist of annealed steel panels. The walls and ceiling are covered with ferrite tile, augmented by RF absorbant foam material on the end wall nearest the turntable, and on the adjacent walls and the ceiling. The chamber floor supports a 15 cm high internal floor, constructed of annealed steel panels, that forms the ground plane, and is bonded to the chamber walls.

The 3-m diameter turntable is flush-mounted with the floor. A sub-floor cable-way is provided to route cables between the turntable pit and EUT support equipment located in the Control Room. Cables reach the EUT through an opening in the centre of the turntable.

Test instrumentation and EUT support equipment is located in the Control Room, consisting of two shielded vestibules joined together at the side of the main room. Cables are routed through bulkhead panels between the rooms and the test chamber as required. Power feeds are routed into the main room and vestibules through line filters providing at least 100 dB of attenuation between 10 kHz and 10 GHz.

Either floor mounted or table-top equipment can be tested at this facility.

3.2 Grounding Plan

The COMFORT was placed at the center of the test chamber turntable on top of a polystyrene foam table. No provision is made within the COMFORT for an earth ground connection.

3.3 Power Supply

All EUT power was supplied by DC Power Supply (EUT modified for testing to provide DC power supply connection for EUT during testing for constant transmitting mode).

Appendix A – Test Setup Block Diagram

TX MODE

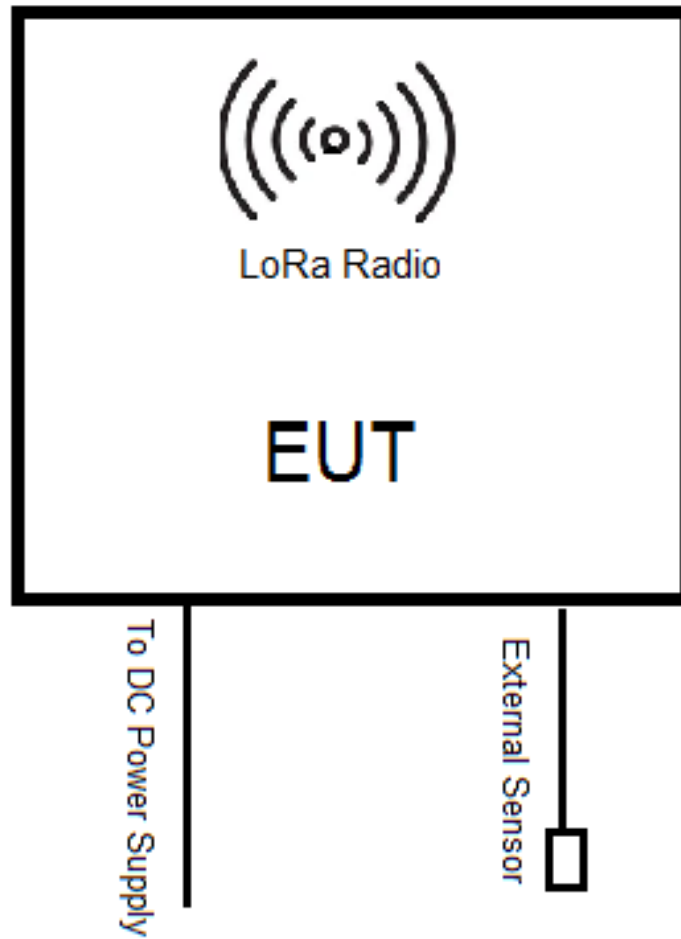

RX Mode

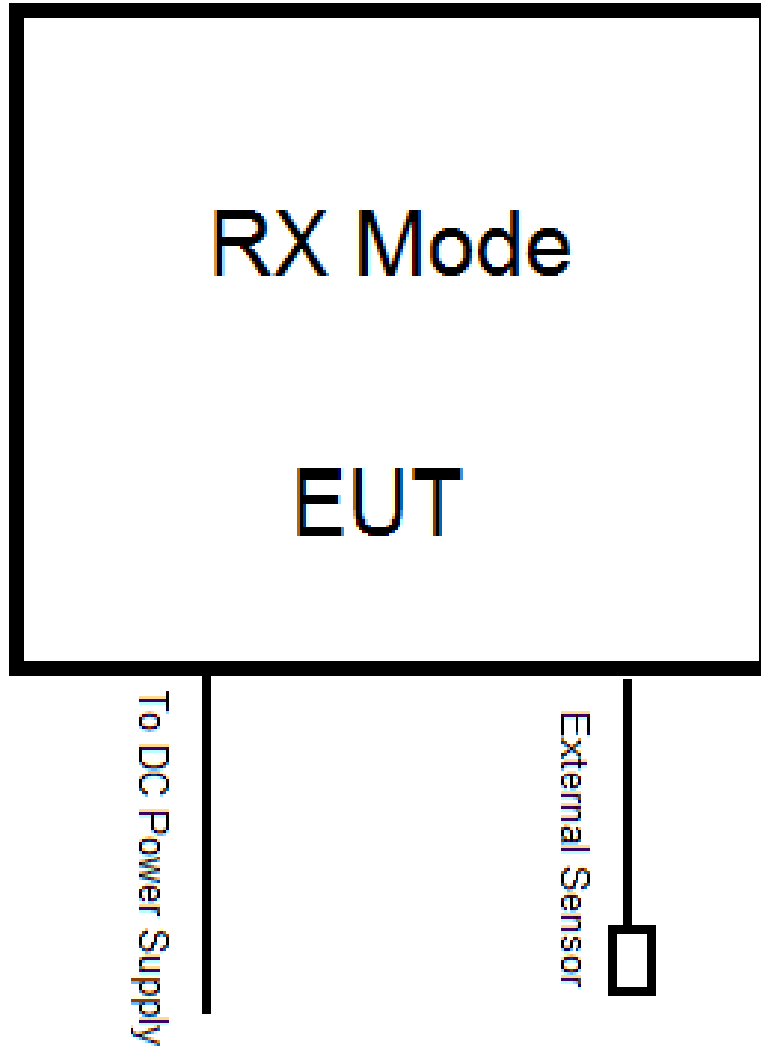

End of Document