



# **FCC RADIO TEST REPORT**

## **FCC ID: 2ALE7S3**

**Product :** Smart body fat scale

**Trade Name :** PICOOC

**Model Name :** S3

**Serial Model :** N/A

**Report No. :** POCE-20170628141F2

### **Prepared for**

PICOOC Technology Co.,Ltd.  
Room 507, Wanwei Building, No.5 Industrial 5th Road,  
NanShan District, Shenzhen.

### **Prepared by**

Shenzhen POCE Technology Co.,Ltd.  
Room 502, Bldg. 1, Xinghua Garden, Baoan Road Xixiang,  
Baoan District,Shenzhen, China

## TEST RESULT CERTIFICATION

**Applicant's name** ..... : PICOOC Technology Co.,Ltd.  
**Address** ..... : Room 507, Wanwei Building, No.5 Industrial 5th Road,  
NanShan District, Shenzhen.  
**Manufacture's Name**..... : PICOOC Technology Co.,Ltd.  
**Address** ..... : Room 507, Wanwei Building, No.5 Industrial 5th Road,  
NanShan District, Shenzhen.

### Product description

**Product name** ..... : Smart body fat scale  
**Model and/or type reference** : S3

**Standards** ..... : FCC 15.247

**Test procedure**..... ANSI C63.10-2013

This device described above has been tested by POCE, and the test results show that the equipment under test (EUT) is in compliance with the FCC requirements. And it is applicable only to the tested sample identified in the report.

This report shall not be reproduced except in full, without the written approval of POCE, this document may be altered or revised by POCE, personal only, and shall be noted in the revision of the document.

**Date of Test** ..... :  
**Date (s) of performance of tests** ..... : 7 Jun. 2017 ~28 Jun. 2017  
**Date of Issue**..... : 28 Jun. 2017  
**Test Result**..... : **Pass**

Testing Engineer :

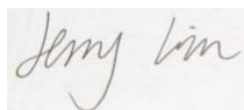

(Jerry Lin)

Technical Manager :



(Jimmy Yao)

Authorized Signatory :



(Terry Yang)

**Table of Contents**

	<b>Page</b>
<b>1 . SUMMARY OF TEST RESULTS</b>	<b>5</b>
1.1 TEST FACILITY	6
1.2 MEASUREMENT UNCERTAINTY	6
<b>2 . GENERAL INFORMATION</b>	<b>7</b>
2.1 GENERAL DESCRIPTION OF EUT	7
2.2 DESCRIPTION OF TEST MODES	9
2.3 BLOCK DIGRAM SHOWING THE CONFIGURATION OF SYSTEM TESTED	10
2.4 DESCRIPTION OF SUPPORT UNITS(CONDUCTED MODE)	11
2.5 EQUIPMENTS LIST FOR ALL TEST ITEMS	12
<b>3 . EMC EMISSION TEST</b>	<b>13</b>
3.1 CONDUCTED EMISSION MEASUREMENT	13
3.1.1 POWER LINE CONDUCTED EMISSION LIMITS	13
3.1.2 TEST PROCEDURE	14
3.1.3 DEVIATION FROM TEST STANDARD	14
3.1.4 TEST SETUP	14
3.1.5 EUT OPERATING CONDITIONS	14
3.1.6 TEST RESULTS	15
3.2 RADIATED EMISSION MEASUREMENT	16
3.2.1 RADIATED EMISSION LIMITS	16
3.2.2 TEST PROCEDURE	17
3.2.3 DEVIATION FROM TEST STANDARD	17
3.2.4 TEST SETUP	18
3.2.5 EUT OPERATING CONDITIONS	19
3.2.6 TEST RESULTS (BETWEEN 9KHZ – 30 MHZ)	20
3.2.7 TEST RESULTS (BETWEEN 30MHZ – 1GHZ)	21
3.2.8 TEST RESULTS (ABOVE 1000 MHZ)	23
<b>4 . POWER SPECTRAL DENSITY TEST</b>	<b>53</b>
4.1 APPLIED PROCEDURES / LIMIT	53
4.1.1 TEST PROCEDURE	53
4.1.2 DEVIATION FROM STANDARD	53
4.1.3 TEST SETUP	53
4.1.4 EUT OPERATION CONDITIONS	53
4.1.5 TEST RESULTS	54
<b>5 . BANDWIDTH TEST</b>	<b>60</b>
5.1 APPLIED PROCEDURES / LIMIT	60
5.1.1 TEST PROCEDURE	60
5.1.2 DEVIATION FROM STANDARD	60

**Table of Contents**

	<b>Page</b>
5.1.3 TEST SETUP	60
5.1.4 EUT OPERATION CONDITIONS	60
5.1.5 TEST RESULTS	61
<b>6 . PEAK OUTPUT POWER TEST</b>	<b>67</b>
6.1 APPLIED PROCEDURES / LIMIT	67
6.1.1 TEST PROCEDURE	67
6.1.2 DEVIATION FROM STANDARD	67
6.1.3 TEST SETUP	67
6.1.4 EUT OPERATION CONDITIONS	67
6.1.5 TEST RESULTS	68
<b>7 . ANTENNA REQUIREMENT</b>	<b>69</b>
7.1 STANDARD REQUIREMENT	69
7.2 EUT ANTENNA	69
<b>8 . EUT TEST PHOTO</b>	<b>70</b>
<b>APPENDIX-PHOTOGRAPHS OF EUT CONSTRUCTIONAL DETAILS</b>	

## 1. SUMMARY OF TEST RESULTS

Test procedures according to the technical standards:

<b>FCC Part15 (15.247) , Subpart C</b>			
<b>Standard Section</b>	<b>Test Item</b>	<b>Judgment</b>	<b>Remark</b>
15.207	Conducted Emission	N/A	
15.247 (a)(2)	6dB Bandwidth	PASS	
15.247 (b)	Peak Output Power	PASS	
15.247 (c)	Radiated Spurious Emission	PASS	
15.247 (d)	Power Spectral Density	PASS	
15.205	Band Edge Emission	PASS	
15.203	Antenna Requirement	PASS	

**NOTE:**

(1) "N/A" denotes test is not applicable in this Test Report

## 1.1 TEST FACILITY

Shenzhen POCE Technology Co.,Ltd.

Add.: Room 502, Bldg. 1, Xinghua Garden, Baoan Road Xixiang, Baoan District, Shenzhen, China

FCC Registration No.: 222278

## 1.2 MEASUREMENT UNCERTAINTY

The reported uncertainty of measurement  $y \pm U$ , where expanded uncertainty  $U$  is based on a standard uncertainty multiplied by a coverage factor of  $k=2$ , providing a level of confidence of approximately **95 %**.

No.	Item	Uncertainty
1	Conducted Emission Test	$\pm 1.38\text{dB}$
2	RF power,conducted	$\pm 0.16\text{dB}$
3	Spurious emissions,conducted	$\pm 0.21\text{dB}$
4	All emissions,radiated(<1G)	$\pm 4.68\text{dB}$
5	All emissions,radiated(>1G)	$\pm 4.89\text{dB}$
6	Temperature	$\pm 0.5^{\circ}\text{C}$
7	Humidity	$\pm 2\%$

## 2. GENERAL INFORMATION

### 2.1 GENERAL DESCRIPTION OF EUT

Equipment	Smart body fat scale	
Trademark	N/A	
Model Name	S3	
Serial Model	N/A	
Model Difference	All the same, Only model name is different	
Product Description	The EUT is a Smart body fat scale	
	Operation Frequency:	2412~2462 MHz
	Modulation Type:	CCK/OFDM/DBPSK/DAPSK
	Bit Rate of Transmitter	802.11b:11/5.5/2/1 Mbps 802.11g:54/48/36/24/18/12/9/6Mbps 802.11n:65/52/6.5 Mbps
	Number Of Channel	11 CH, Please see Note 2.
	Antenna Designation:	Please see Note 3.
	Output Power(Conducted):	802.11b: 8.24 dBm (Max.) 802.11g: 6.46 dBm (Max.) 802.11n: 6.56 dBm (Max.)
	Based on the application, features, or specification exhibited in User's Manual, the EUT is considered as an ITE/Computing Device. More details of EUT technical specification, please refer to the User's Manual.	
Channel List	Please refer to the Note 2.	
Adapter	N/A	
Battery	Rated Voltage:6.0V(4*1.5 AAA battery)	
Connecting I/O Port(s)	Please refer to the User's Manual	

Note  
:

1. For a more detailed features description, please refer to the manufacturer's specifications or the User's Manual.

2.

Channel List for 802.11b/g/n							
Channel	Frequency (MHz)	Channel	Frequency (MHz)	Channel	Frequency (MHz)	Channel	Frequency (MHz)
01	2412	04	2427	07	2442	10	2457
02	2417	05	2432	08	2447	11	2462
03	2422	06	2437	09	2452		

3.

Table for Filed Antenna

Ant	Brand	Model Name	Antenna Type	Connector	Gain (dBi)	NOTE
A	N/A	N/A	PCB antenna	N/A	1.2	Wifi Antenna



## 2.2 DESCRIPTION OF TEST MODES

To investigate the maximum EMI emission characteristics generates from EUT, the test system was pre-scanning tested base on the consideration of following EUT operation mode or test configuration mode which possible have effect on EMI emission level. Each of these EUT operation mode(s) or test configuration mode(s) mentioned above was evaluated respectively.

Pretest Mode	Description
Mode 1	802.11b CH1/ CH6/ CH11
Mode 2	802.11g CH1/ CH6/ CH11
Mode 3	802.11n CH1/ CH6/ CH11
Mode 4	WIFI Link Mode

For Conducted Emission	
Final Test Mode	Description
Mode 4	WIFI Link Mode

For Radiated Emission	
Final Test Mode	Description
Mode 1	802.11b CH1/ CH6/ CH11
Mode 2	802.11g CH1/ CH6/ CH11
Mode 3	802.11n CH1/ CH6/ CH11

Note:

- (1) The measurements are performed at the highest, middle, lowest available channels.
- (2) The measurements are performed at all Bit Rate of Transmitter, the worst data was reported

### 2.3 BLOCK DIGRAM SHOWING THE CONFIGURATION OF SYSTEM TESTED

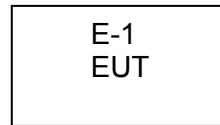

**2.4 DESCRIPTION OF SUPPORT UNITS(CONDUCTED MODE)**

The EUT has been tested as an independent unit together with other necessary accessories or support units. The following support units or accessories were used to form a representative test configuration during the tests.

Item	Equipment	Mfr/Brand	Model/Type No.	Series No.	Note
E-1	Smart body fat scale	PICOOC	S3	N/A	EUT

Item	Shielded Type	Ferrite Core	Length	Note

Note:

- (1) The support equipment was authorized by Declaration of Confirmation.
- (2) For detachable type I/O cable should be specified the length in cm in 『Length』 column.

## 2.5 EQUIPMENTS LIST FOR ALL TEST ITEMS

### Radiation Test equipment

Item	Kind of Equipment	Manufacturer	Type No.	Serial No.	Last calibration	Calibrated until	Calibration period
1	Spectrum Analyzer	Agilent	E4407B	MY45108040	2016.07.06	2017.07.05	1 year
2	Test Receiver	R&S	ESPI	101318	2017.06.07	2018.06.06	1 year
3	Bilog Antenna	TESEQ	CBL6111D	31216	2016.07.06	2017.07.05	1 year
4	50Ω Coaxial Switch	Anritsu	MP59B	6200264416	2017.06.07	2018.06.06	1 year
5	Spectrum Analyzer	ADVANTEST	R3132	150900201	2016.06.07	2017.06.06	1 year
6	Horn Antenna	EM	EM-AH-10180	2011071402	2016.07.06	2017.07.05	1 year
7	Horn Ant	Schwarzbeck	BBHA 9170	9170-181	2016.07.06	2017.07.05	1 year
8	Amplifier	EM	EM-30180	060538	2016.12.22	2017.12.21	1 year
9	Loop Antenna	ARA	PLA-1030/B	1029	2017.06.08	2018.06.07	1 year
10	Power Meter	R&S	NRVS	100696	2016.07.06	2017.07.05	1 year
11	Power Sensor	R&S	URV5-Z4	0395.1619.05	2016.07.06	2017.07.05	1 year

### Conduction Test equipment

Item	Kind of Equipment	Manufacturer	Type No.	Serial No.	Last calibration	Calibrated until	Calibration period
1	Test Receiver	R&S	ESCI	101160	2017.06.06	2018.06.05	1 year
2	LISN	R&S	ENV216	101313	2016.08.24	2017.08.23	1 year
3	LISN	EMCO	3816/2	00042990	2016.08.24	2017.08.23	1 year
4	50Ω Coaxial Switch	Anritsu	MP59B	6200264417	2017.06.07	2018.06.06	1 year
5	Passive Voltage Probe	R&S	ESH2-Z3	100196	2017.06.07	2018.06.06	1 year
6	Absorbing clamp	R&S	MOS-21	100423	2017.06.08	2018.06.07	1 year

### 3. EMC EMISSION TEST

#### 3.1 CONDUCTED EMISSION MEASUREMENT

##### 3.1.1 POWER LINE CONDUCTED EMISSION Limits (Frequency Range 150KHz-30MHz)

FREQUENCY (MHz)	Class B (dBuV)		Standard
	Quasi-peak	Average	
0.15 -0.5	66 - 56 *	56 - 46 *	CISPR
0.50 -5.0	56.00	46.00	CISPR
5.0 -30.0	60.00	50.00	CISPR

0.15 -0.5	66 - 56 *	56 - 46 *	FCC
0.50 -5.0	56.00	46.00	FCC
5.0 -30.0	60.00	50.00	FCC

Note:

- (1) The tighter limit applies at the band edges.
- (2) The limit of " \* " marked band means the limitation decreases linearly with the logarithm of the frequency in the range.

The following table is the setting of the receiver

Receiver Parameters	Setting
Attenuation	10 dB
Start Frequency	0.15 MHz
Stop Frequency	30 MHz
IF Bandwidth	9 kHz

**3.1.2 TEST PROCEDURE**

- a. The EUT was placed 0.4 meters from the horizontal ground plane with EUT being connected to the power mains through a line impedance stabilization network (LISN). All other support equipments powered from additional LISN(s). The LISN provide 50 Ohm/ 50uH of coupling impedance for the measuring instrument.
- b. Interconnecting cables that hang closer than 40 cm to the ground plane shall be folded back and forth in the center forming a bundle 30 to 40 cm long.
- c. I/O cables that are not connected to a peripheral shall be bundled in the center. The end of the cable may be terminated, if required, using the correct terminating impedance. The overall length shall not exceed 1 m.
- d. LISN at least 80 cm from nearest part of EUT chassis.
- e. For the actual test configuration, please refer to the related Item –EUT Test Photos.

**3.1.3 DEVIATION FROM TEST STANDARD**

No deviation

**3.1.4 TEST SETUP**

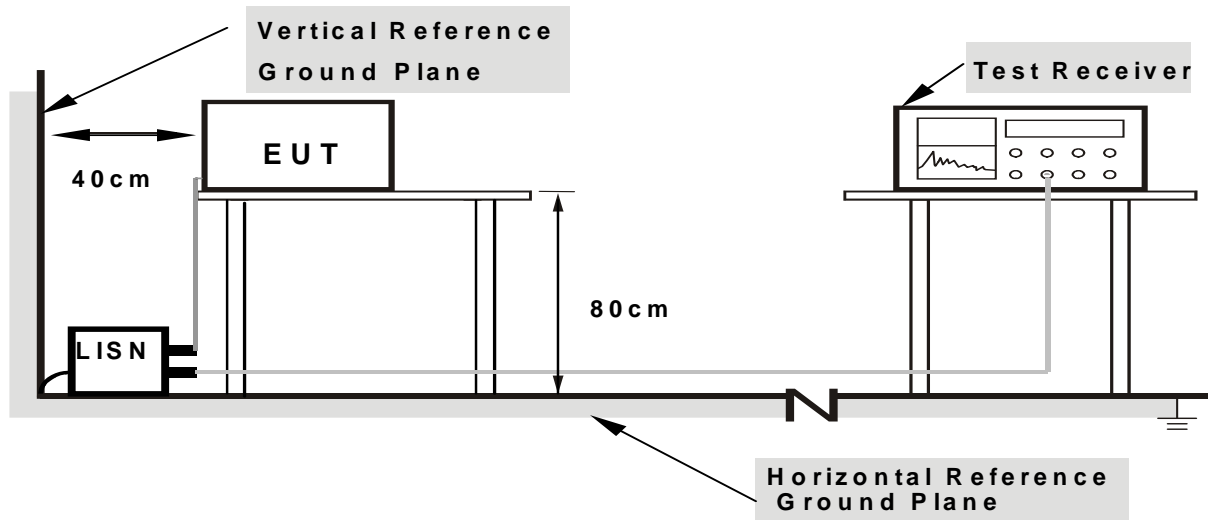

- Note:**
- 1. Support units were connected to second LISN.
  - 2. Both of LISNs (AMN) are 80 cm from EUT and at least 80 from other units and other metal planes

**3.1.5 EUT OPERATING CONDITIONS**

The EUT was configured for testing in a typical fashion (as a customer would normally use it). The EUT has been programmed to continuously transmit during test. This operating condition was tested and used to collect the included data.

### **3.1.6 TEST RESULTS**

This device was powered by AAA battery, No test need for AC conducted emission.

### 3.2 RADIATED EMISSION MEASUREMENT

#### 3.2.1 RADIATED EMISSION LIMITS (Frequency Range 9kHz-1000MHz)

20dBc in any 100 kHz bandwidth outside the operating frequency band. In case the emission fall within the restricted band specified on 15.205(a), then the 15.209(a) limit in the table below has to be followed.

Frequencies (MHz)	Field Strength (micorvolts/meter)	Measurement Distance (meters)
0.009~0.490	2400/F(KHz)	300
0.490~1.705	24000/F(KHz)	30
1.705~30.0	30	30
30~88	100	3
88~216	150	3
216~960	200	3
Above 960	500	3

#### LIMITS OF RADIATED EMISSION MEASUREMENT (Above 1000MHz)

Spectrum Parameter	Setting
Attenuation	Auto
Start Frequency	1000 MHz
Stop Frequency	10th carrier harmonic
RB / VB (emission in restricted band)	1 MHz / 1 MHz for Peak, 1 MHz / 10Hz for Average

Receiver Parameter	Setting
Attenuation	Auto
Start ~ Stop Frequency	9kHz~150kHz / RB 200Hz for QP
Start ~ Stop Frequency	150kHz~30MHz / RB 9kHz for QP
Start ~ Stop Frequency	30MHz~1000MHz / RB 120kHz for QP



### 3.2.2 TEST PROCEDURE

- a. The measuring distance of at 3 m shall be used for measurements at frequency up to 1GHz. For frequencies above 1GHz, any suitable measuring distance may be used.
- b. The EUT was placed on the top of a rotating table 0.8 meters above the ground at a 3 meter open area test site. The table was rotated 360 degrees to determine the position of the highest radiation.
- c. The height of the equipment or of the substitution antenna shall be 0.8 m; the height of the test antenna shall vary between 1 m to 4 m. Both horizontal and vertical polarizations of the antenna are set to make the measurement.
- d. The initial step in collecting conducted emission data is a spectrum analyzer peak detector mode pre-scanning the measurement frequency range. Significant peaks are then marked and then Quasi Peak detector mode re-measured.
- e. If the Peak Mode measured value compliance with and lower than Quasi Peak Mode Limit, the EUT shall be deemed to meet QP Limits and then no additional QP Mode measurement performed.
- f. For the actual test configuration, please refer to the related Item –EUT Test Photos.

Note:

Both horizontal and vertical antenna polarities were tested and performed pretest to three orthogonal axis. The worst case emissions were reported

### 3.2.3 DEVIATION FROM TEST STANDARD

No deviation

### 3.2.4 TEST SETUP

#### (A) Radiated Emission Test-Up Frequency Below 30MHz

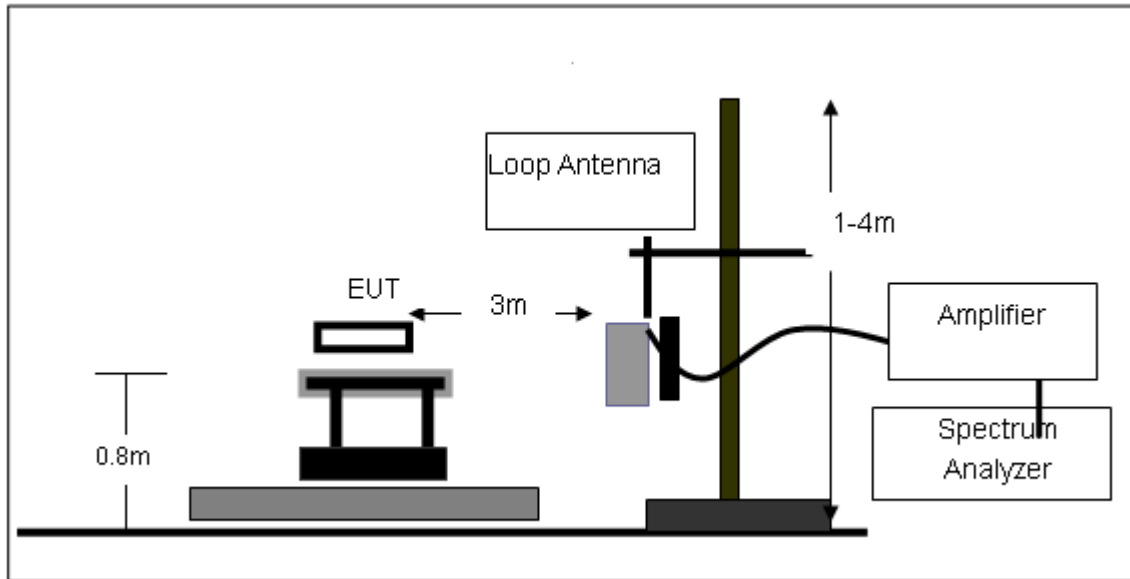

#### (B) Radiated Emission Test-Up Frequency 30MHz~1GHz

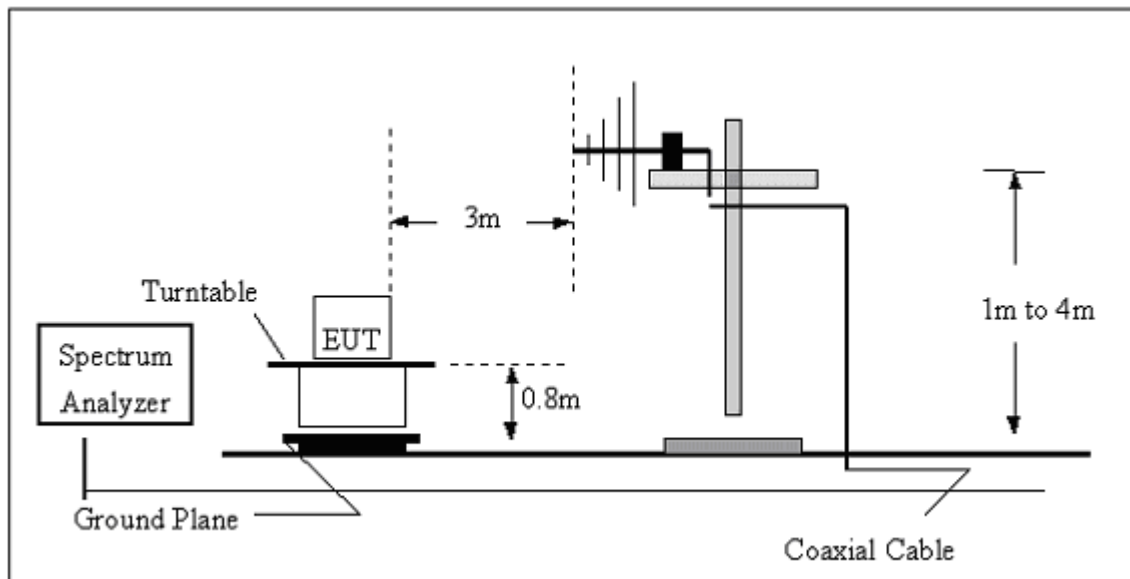

(C) Radiated Emission Test-Up Frequency Above 1GHz

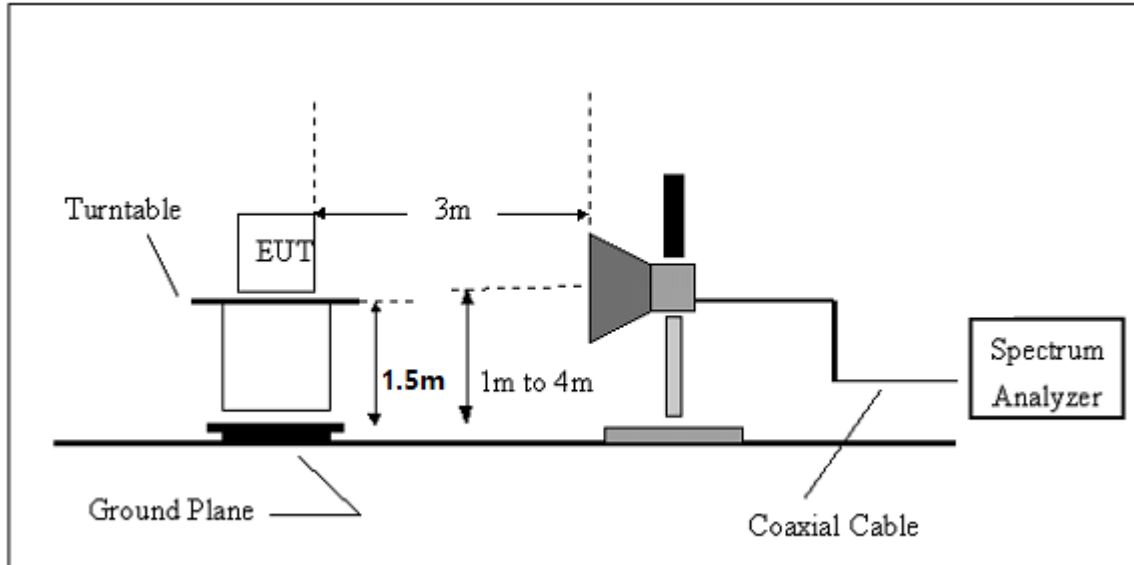

**3.2.5 EUT OPERATING CONDITIONS**

The EUT tested system was configured as the statements of 2.4 Unless otherwise a special operating condition is specified in the follows during the testing.

**3.2.6 TEST RESULTS (BETWEEN 9KHZ – 30 MHZ)**

EUT:	Smart body fat scale	Model Name. :	S3
Temperature:	26 °C	Relative Humidity:	54%
Pressure:	1010 hPa	Test Voltage :	DC 6.0V
Test Mode :	TX	Polarization :	--

Freq.	Reading	Limit	Margin	State
(MHz)	(dBuV/m)	(dBuV/m)	(dB)	P/F
--	--	--	--	PASS
--	--	--	--	PASS

**NOTE:**

The amplitude of spurious emissions which are attenuated by more than 20dB below the permissible value has no need to be reported.

Distance extrapolation factor =  $40 \log(\text{specific distance}/\text{test distance})$ (dB);

Limit line = specific limits(dBuv) + distance extrapolation factor.

### 3.2.7 TEST RESULTS (BETWEEN 30MHZ – 1GHZ)

EUT :	Smart body fat scale	Model Name :	S3
Temperature :	26 °C	Relative Humidity :	54%
Pressure :	1010 hPa	Test Voltage :	DC 6.0V
Test Mode :	TX	Polarization :	Horizontal

Frequency (MHz)	Meter Reading (dBµV)	Factor (dB)	Emission Level (dBµV/m)	Limits (dBµV/m)	Margin (dB)	Detector Type
53.8818	32.03	-10.93	21.10	40.00	-18.90	QP
90.8554	37.23	-17.41	19.82	43.50	-23.68	QP
126.7723	43.90	-14.31	29.59	43.50	-13.91	QP
138.8735	39.16	-13.46	25.70	43.50	-17.80	QP
167.8243	40.57	-13.32	27.25	43.50	-16.25	QP
181.2834	34.80	-14.50	20.30	43.50	-23.20	QP

Remark:  
Factor = Antenna Factor + Cable Loss – Pre-amplifier.

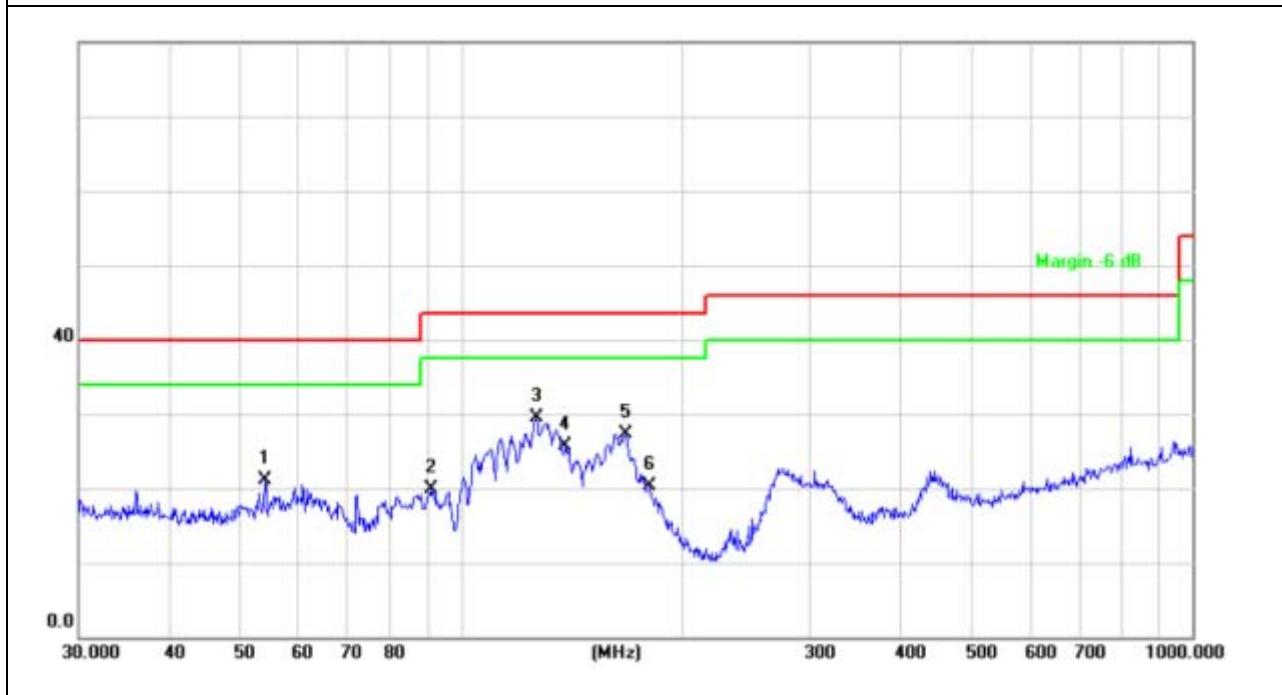

EUT :	Smart body fat scale	Model Name :	S3
Temperature :	26 °C	Relative Humidity :	54%
Pressure :	1010 hPa	Test Voltage :	DC 6.0V
Test Mode :	TX	Polarization :	Vertical

Frequency (MHz)	Meter Reading (dBµV)	Factor (dB)	Emission Level (dBµV/m)	Limits (dBµV/m)	Margin (dB)	Detector Type
30.2111	26.44	-8.05	18.39	40.00	-21.61	QP
51.3005	31.34	-10.50	20.84	40.00	-19.16	QP
126.3286	34.80	-14.33	20.47	43.50	-23.03	QP
162.6106	32.02	-13.02	19.00	43.50	-24.50	QP
945.4399	26.60	-0.56	26.04	46.00	-19.96	QP
989.5355	26.16	-0.32	25.84	54.00	-28.16	QP

Remark:

Factor = Antenna Factor + Cable Loss – Pre-amplifier.

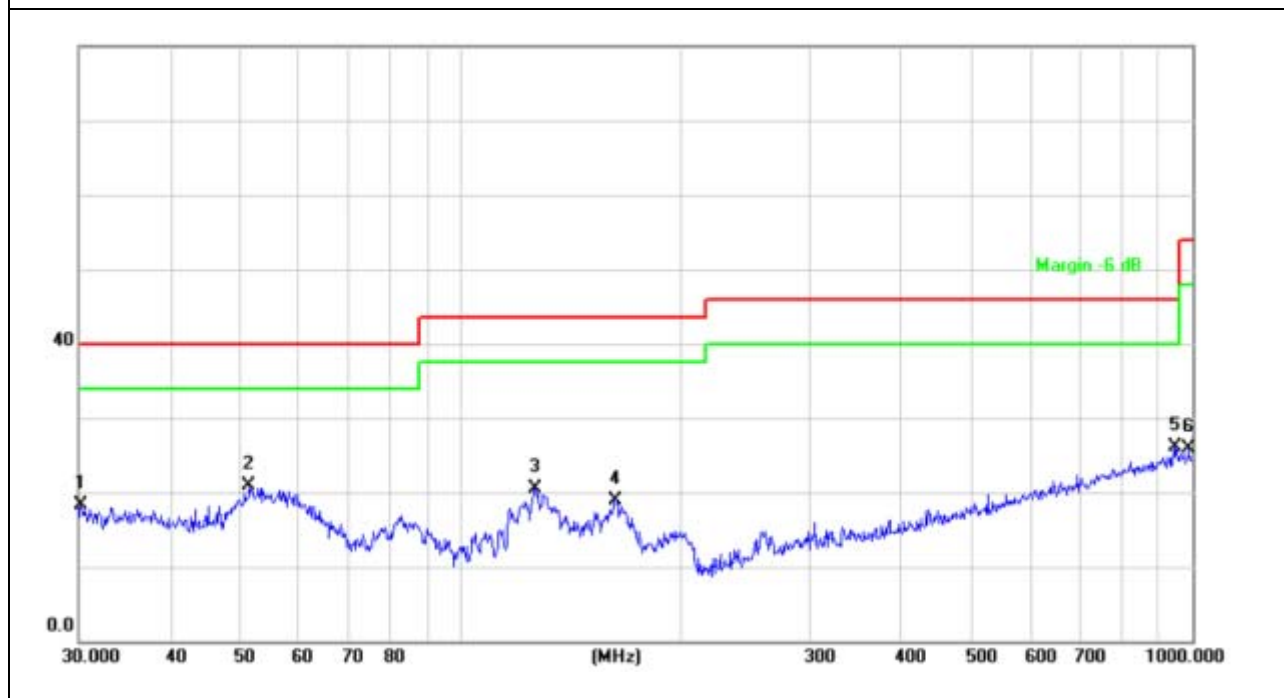

**3.2.8 TEST RESULTS (ABOVE 1000 MHZ)**

EUT :	Smart body fat scale	Model Name :	S3
Temperature :	26 °C	Relative Humidity :	54%
Pressure :	1010 hPa	Test Voltage :	DC 6.0V
Test Mode :	CH1 (802.11b Mode)	Polarization :	Horizontal

Frequency (MHz)	Meter Reading (dBµV)	Factor (dB)	Emission Level (dBµV/m)	Limits (dBµV/m)	Margin (dB)	Detector Type
4824	58.18	2.6	60.78	74	-13.22	peak
4824	38.03	2.6	40.63	54	-13.37	AVG
7236	52.58	4.59	57.17	74	-16.83	peak
7236	36.33	4.59	40.92	54	-13.08	AVG

EUT :	Smart body fat scale	Model Name :	S3
Temperature :	26 °C	Relative Humidity :	54%
Pressure :	1010 hPa	Test Voltage :	DC 6.0V
Test Mode :	CH1 (802.11b Mode)	Polarization :	Vertical

Frequency (MHz)	Meter Reading (dBµV)	Factor (dB)	Emission Level (dBµV/m)	Limits (dBµV/m)	Margin (dB)	Detector Type
4824	55.59	2.6	58.19	74	-15.81	peak
4824	38.48	2.6	41.08	54	-12.92	AVG
7236	49.44	4.59	54.03	74	-19.97	peak
7236	29.88	4.59	34.47	54	-19.53	AVG



EUT :	Smart body fat scale	Model Name :	S3
Temperature :	26 °C	Relative Humidity :	54%
Pressure :	1010 hPa	Test Voltage :	DC 6.0V
Test Mode :	CH6 (802.11b Mode)	Polarization :	Horizontal

Frequency (MHz)	Meter Reading (dBµV)	Factor (dB)	Emission Level (dBµV/m)	Limits (dBµV/m)	Margin (dB)	Detector Type
4874	57.95	2.6	60.55	74	-13.45	peak
4874	40.08	2.6	42.68	54	-11.32	AVG
7311	50.45	4.93	55.38	74	-18.62	peak
7311	36.88	4.93	41.81	54	-12.19	AVG

EUT :	Smart body fat scale	Model Name :	S3
Temperature :	26 °C	Relative Humidity :	54%
Pressure :	1010 hPa	Test Voltage :	DC 6.0V
Test Mode :	CH6 (802.11b Mode)	Polarization :	Vertical

Frequency (MHz)	Meter Reading (dBµV)	Factor (dB)	Emission Level (dBµV/m)	Limits (dBµV/m)	Margin (dB)	Detector Type
4874	56.64	2.6	59.24	74	-14.76	peak
4874	40.19	2.6	42.79	54	-11.21	AVG
7311	50.44	4.93	55.37	74	-18.63	peak
7311	39	4.93	43.93	54	-10.07	AVG

EUT :	Smart body fat scale	Model Name :	S3
Temperature :	26 °C	Relative Humidity :	54%
Pressure :	1010 hPa	Test Voltage :	DC 6.0V
Test Mode :	CH11 (802.11b Mode)	Polarization :	Horizontal

Frequency (MHz)	Meter Reading (dBμV)	Factor (dB)	Emission Level (dBμV/m)	Limits (dBμV/m)	Margin (dB)	Detector Type
4924	56.85	2.6	59.45	74	-14.55	peak
4924	39.06	2.6	41.66	54	-12.34	AVG
7386	48.45	4.93	53.38	74	-20.62	peak
7386	30.88	4.93	35.81	54	-18.19	AVG

EUT :	Smart body fat scale	Model Name :	S3
Temperature :	26 °C	Relative Humidity :	54%
Pressure :	1010 hPa	Test Voltage :	DC 6.0V
Test Mode :	CH11 (802.11b Mode)	Polarization :	Vertical

Frequency (MHz)	Meter Reading (dB $\mu$ V)	Factor (dB)	Emission Level (dB $\mu$ V/m)	Limits (dB $\mu$ V/m)	Margin (dB)	Detector Type
4924	57.79	2.6	60.39	74	-13.61	peak
4924	40.02	2.6	42.62	54	-11.38	AVG
7386	51.22	4.83	56.05	74	-17.95	peak
7386	31.76	4.83	36.59	54	-17.41	AVG

EUT :	Smart body fat scale	Model Name :	S3
Temperature :	26 °C	Relative Humidity :	54%
Pressure :	1010 hPa	Test Voltage :	DC 6.0V
Test Mode :	CH1 (802.11g Mode)	Polarization :	Horizontal

Frequency (MHz)	Meter Reading (dBμV)	Factor (dB)	Emission Level (dBμV/m)	Limits (dBμV/m)	Margin (dB)	Detector Type
4824	53.61	2.6	56.21	74	-17.79	peak
4824	35.6	2.6	38.2	54	-15.8	AVG
7236	47.36	4.59	51.95	74	-22.05	peak
7236	28.99	4.59	33.58	54	-20.42	AVG

EUT :	Smart body fat scale	Model Name :	S3
Temperature :	26 °C	Relative Humidity :	54%
Pressure :	1010 hPa	Test Voltage :	DC 6.0V
Test Mode :	CH1 (802.11g Mode)	Polarization :	Vertical

Frequency (MHz)	Meter Reading (dBµV)	Factor (dB)	Emission Level (dBµV/m)	Limits (dBµV/m)	Margin (dB)	Detector Type
4824	53.7	2.6	56.3	74	-17.7	peak
4824	34.92	2.6	37.52	54	-16.48	AVG
7236	46.79	4.59	51.38	74	-22.62	peak
7236	29.02	4.59	33.61	54	-20.39	AVG

EUT :	Smart body fat scale	Model Name :	S3
Temperature :	26 °C	Relative Humidity :	54%
Pressure :	1010 hPa	Test Voltage :	DC 6.0V
Test Mode :	CH6 (802.11g Mode)	Polarization :	Horizontal

Frequency (MHz)	Meter Reading (dBµV)	Factor (dB)	Emission Level (dBµV/m)	Limits (dBµV/m)	Margin (dB)	Detector Type
4874	54.97	2.57	57.54	74	-16.46	peak
4874	37.99	2.57	40.56	54	-13.44	AVG
7311	51.1	4.93	56.03	74	-17.97	peak
7311	34.88	4.93	39.81	54	-14.19	AVG

EUT :	Smart body fat scale	Model Name :	S3
Temperature :	26 °C	Relative Humidity :	54%
Pressure :	1010 hPa	Test Voltage :	DC 6.0V
Test Mode :	CH6 (802.11g Mode)	Polarization :	Vertical

Frequency (MHz)	Meter Reading (dBµV)	Factor (dB)	Emission Level (dBµV/m)	Limits (dBµV/m)	Margin (dB)	Detector Type
4874	56.01	2.6	58.61	74	-15.39	peak
4874	40.02	2.6	42.62	54	-11.38	AVG
7311	51.22	4.93	56.15	74	-17.85	peak
7311	31.32	4.93	36.25	54	-17.75	AVG



EUT :	Smart body fat scale	Model Name :	S3
Temperature :	26 °C	Relative Humidity :	54%
Pressure :	1010 hPa	Test Voltage :	DC 6.0V
Test Mode :	CH11 (802.11g Mode)	Polarization :	Horizontal

Frequency (MHz)	Meter Reading (dBµV)	Factor (dB)	Emission Level (dBµV/m)	Limits (dBµV/m)	Margin (dB)	Detector Type
4924	54.23	2.6	56.83	74	-17.17	peak
4924	36.22	2.6	38.82	54	-15.18	AVG
7386	49.33	4.93	54.26	74	-19.74	peak
7386	31.43	4.93	36.36	54	-17.64	AVG

EUT :	Smart body fat scale	Model Name :	S3
Temperature :	26 °C	Relative Humidity :	54%
Pressure :	1010 hPa	Test Voltage :	DC 6.0V
Test Mode :	CH11(802.11g Mode)	Polarization :	Vertical

Frequency (MHz)	Meter Reading (dBµV)	Factor (dB)	Emission Level (dBµV/m)	Limits (dBµV/m)	Margin (dB)	Detector Type
4924	65.21	-8.22	56.99	74	-17.01	peak
4924	54.11	-8.22	45.89	54	-8.11	AVG
7386	61.89	-7.39	54.5	74	-19.5	peak
7386	50.09	-7.39	42.7	54	-11.3	AVG

EUT :	Smart body fat scale	Model Name :	S3
Temperature :	26 °C	Relative Humidity :	54%
Pressure :	1010 hPa	Test Voltage :	DC 6.0V
Test Mode :	CH1 (802.11n Mode)	Polarization :	Horizontal

Frequency (MHz)	Meter Reading (dBμV)	Factor (dB)	Emission Level (dBμV/m)	Limits (dBμV/m)	Margin (dB)	Detector Type
4824	58.18	2.6	60.78	74	-13.22	peak
4824	38.03	2.6	40.63	54	-13.37	AVG
7236	52.58	4.59	57.17	74	-16.83	peak
7236	36.33	4.59	40.92	54	-13.08	AVG

EUT :	Smart body fat scale	Model Name :	S3
Temperature :	26 °C	Relative Humidity :	54%
Pressure :	1010 hPa	Test Voltage :	DC 6.0V
Test Mode :	CH1 (802.11n Mode)	Polarization :	Vertical

Frequency (MHz)	Meter Reading (dBµV)	Factor (dB)	Emission Level (dBµV/m)	Limits (dBµV/m)	Margin (dB)	Detector Type
4824	55.59	2.6	58.19	74	-15.81	peak
4824	38.48	2.6	41.08	54	-12.92	AVG
7236	49.44	4.59	54.03	74	-19.97	peak
7236	29.88	4.59	34.47	54	-19.53	AVG

EUT :	Smart body fat scale	Model Name :	S3
Temperature :	26 °C	Relative Humidity :	54%
Pressure :	1010 hPa	Test Voltage :	DC 6.0V
Test Mode :	CH6 (802.11n Mode)	Polarization :	Horizontal

Frequency (MHz)	Meter Reading (dBμV)	Factor (dB)	Emission Level (dBμV/m)	Limits (dBμV/m)	Margin (dB)	Detector Type
4874	57.95	2.6	60.55	74	-13.45	peak
4874	40.08	2.6	42.68	54	-11.32	AVG
7311	50.45	4.93	55.38	74	-18.62	peak
7311	36.88	4.93	41.81	54	-12.19	AVG

EUT :	Smart body fat scale	Model Name :	S3
Temperature :	26 °C	Relative Humidity :	54%
Pressure :	1010 hPa	Test Voltage :	DC 6.0V
Test Mode :	CH6 (802.11n Mode)	Polarization :	Vertical

Frequency (MHz)	Meter Reading (dBµV)	Factor (dB)	Emission Level (dBµV/m)	Limits (dBµV/m)	Margin (dB)	Detector Type
4874	56.64	2.6	59.24	74	-14.76	peak
4874	40.19	2.6	42.79	54	-11.21	AVG
7311	50.44	4.93	55.37	74	-18.63	peak
7311	39	4.93	43.93	54	-10.07	AVG

EUT :	Smart body fat scale	Model Name :	S3
Temperature :	26 °C	Relative Humidity :	54%
Pressure :	1010 hPa	Test Voltage :	DC 6.0V
Test Mode :	CH11 (802.11n Mode)	Polarization :	Horizontal

Frequency (MHz)	Meter Reading (dBμV)	Factor (dB)	Emission Level (dBμV/m)	Limits (dBμV/m)	Margin (dB)	Detector Type
4924	56.85	2.6	59.45	74	-14.55	peak
4924	39.06	2.6	41.66	54	-12.34	AVG
7386	48.45	4.93	53.38	74	-20.62	peak
7386	30.88	4.93	35.81	54	-18.19	AVG

EUT :	Smart body fat scale	Model Name :	S3
Temperature :	26 °C	Relative Humidity :	54%
Pressure :	1010 hPa	Test Voltage :	DC 6.0V
Test Mode :	CH11 (802.11n Mode)	Polarization :	Vertical

Frequency (MHz)	Meter Reading (dB $\mu$ V)	Factor (dB)	Emission Level (dB $\mu$ V/m)	Limits (dB $\mu$ V/m)	Margin (dB)	Detector Type
4924	57.79	2.6	60.39	74	-13.61	peak
4924	40.02	2.6	42.62	54	-11.38	AVG
7386	51.22	4.83	56.05	74	-17.95	peak
7386	31.76	4.83	36.59	54	-17.41	AVG



**Band Edge Emission:**

EUT :	Smart body fat scale	Model Name :	S3
Temperature :	26 °C	Relative Humidity :	54%
Pressure :	1010 hPa	Test Voltage :	DC 6.0V
Test Mode :	CH1(802.11b Mode)	Polarization :	Horizontal

Frequency (MHz)	Meter Reading (dBμV)	Factor (dB)	Emission Level (dBμV/m)	Limits (dBμV/m)	Margin (dB)	Detector Type
2397.8	63.66	-13	50.66	74	-23.34	peak
2400	60.2	-12.99	47.21	74	-26.79	peak
2400	55.48	-12.99	42.49	54	-11.51	AVG

Remark:  
 Factor = Antenna Factor + Cable Loss – Pre-amplifier.

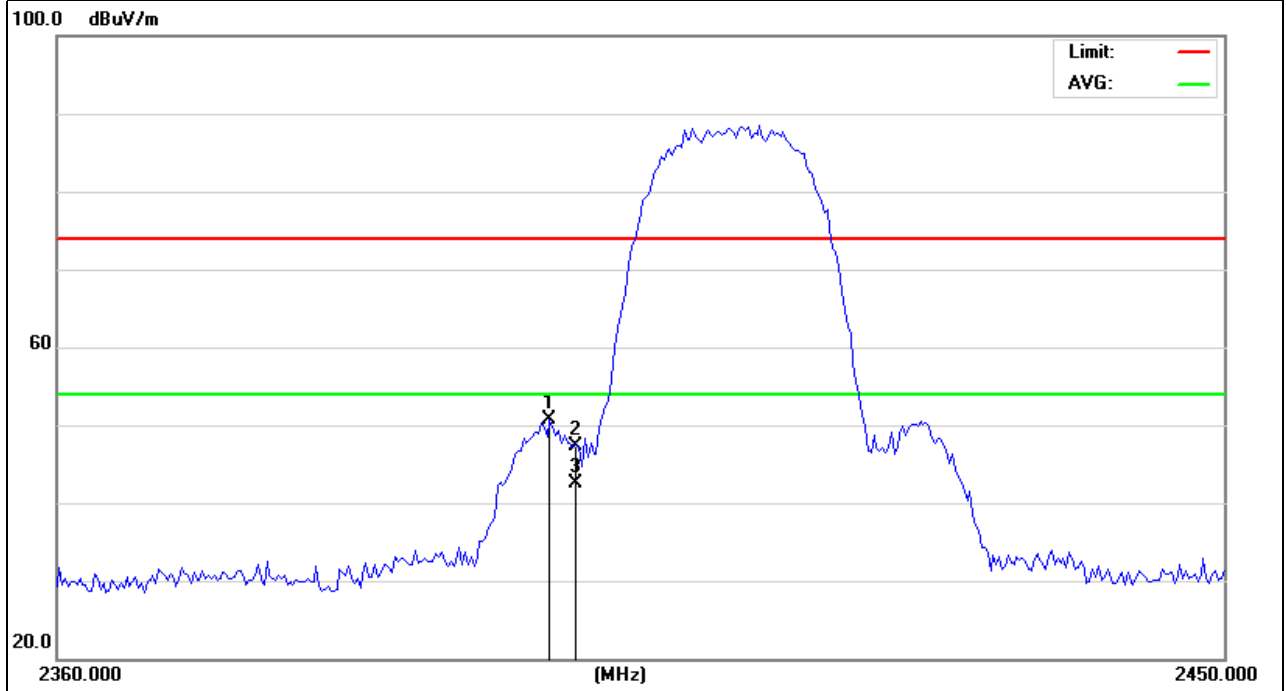

EUT :	Smart body fat scale	Model Name :	S3
Temperature :	26 °C	Relative Humidity :	54%
Pressure :	1010 hPa	Test Voltage :	DC 6.0V
Test Mode :	CH1(802.11b Mode)	Polarization :	Vertical

Frequency (MHz)	Meter Reading (dBµV)	Factor (dB)	Emission Level (dBµV/m)	Limits (dBµV/m)	Margin (dB)	Detector Type
2397.8	69.77	-13	56.77	74	-17.23	peak
2400	67.01	-12.99	54.02	74	-19.98	peak
2400	59.65	-12.99	46.66	54	-7.34	AVG

Remark:  
 Factor = Antenna Factor + Cable Loss – Pre-amplifier.

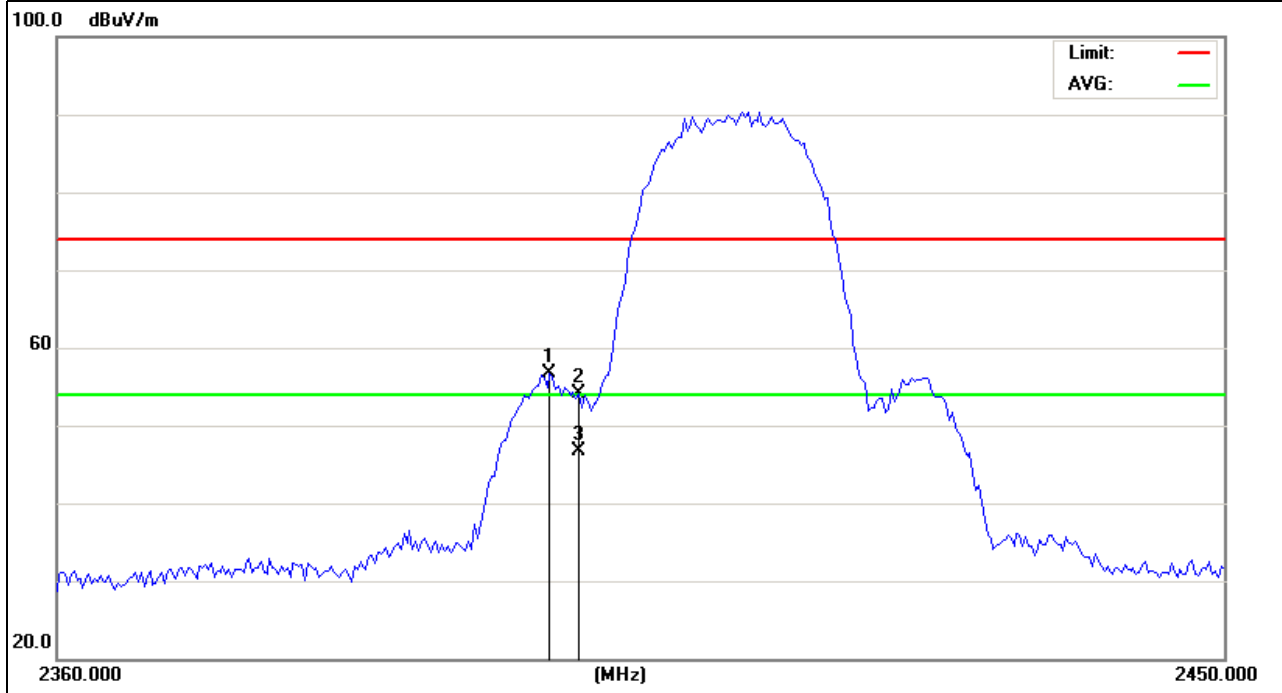

EUT :	Smart body fat scale	Model Name :	S3
Temperature :	26 °C	Relative Humidity :	54%
Pressure :	1010 hPa	Test Voltage :	DC 6.0V
Test Mode :	CH11(802.11b Mode)	Polarization :	Horizontal

Frequency (MHz)	Meter Reading (dBµV)	Factor (dB)	Emission Level (dBµV/m)	Limits (dBµV/m)	Margin (dB)	Detector Type
2483.5	73.25	-12.78	60.47	74	-13.53	peak
2483.5	58.33	-12.78	45.55	54	-8.45	AVG
2486.5	76.26	-12.77	63.49	74	-10.51	peak
2486.5	59.25	-12.77	46.48	54	-7.52	AVG

Remark:  
Factor = Antenna Factor + Cable Loss – Pre-amplifier.

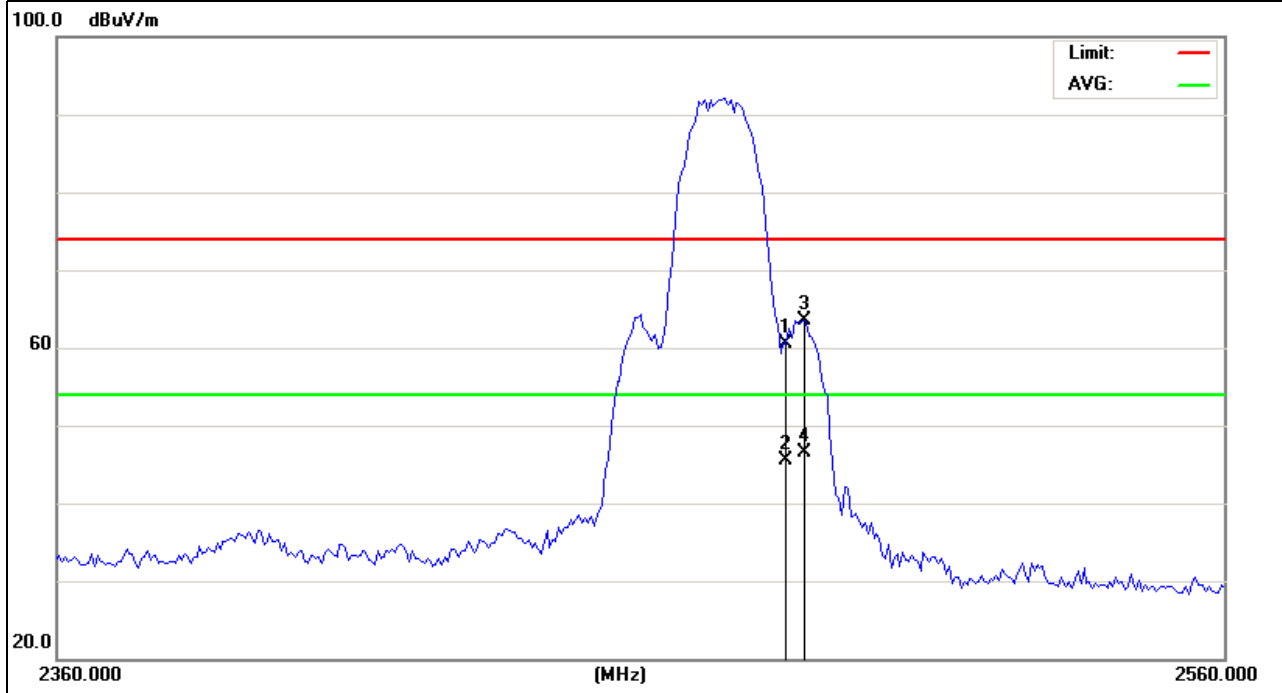

EUT :	Smart body fat scale	Model Name :	S3
Temperature :	26 °C	Relative Humidity :	54%
Pressure :	1010 hPa	Test Voltage :	DC 6.0V
Test Mode :	CH11(802.11b Mode)	Polarization :	Vertical

Frequency (MHz)	Meter Reading (dBµV)	Factor (dB)	Emission Level (dBµV/m)	Limits (dBµV/m)	Margin (dB)	Detector Type
2483.5	73.25	-12.78	60.47	74	-13.53	peak
2483.5	58.84	-12.78	46.06	54	-7.94	AVG
2487	76.31	-12.77	63.54	74	-10.46	peak
2487	57.94	-12.77	45.17	54	-8.83	AVG

Remark:  
Factor = Antenna Factor + Cable Loss – Pre-amplifier.

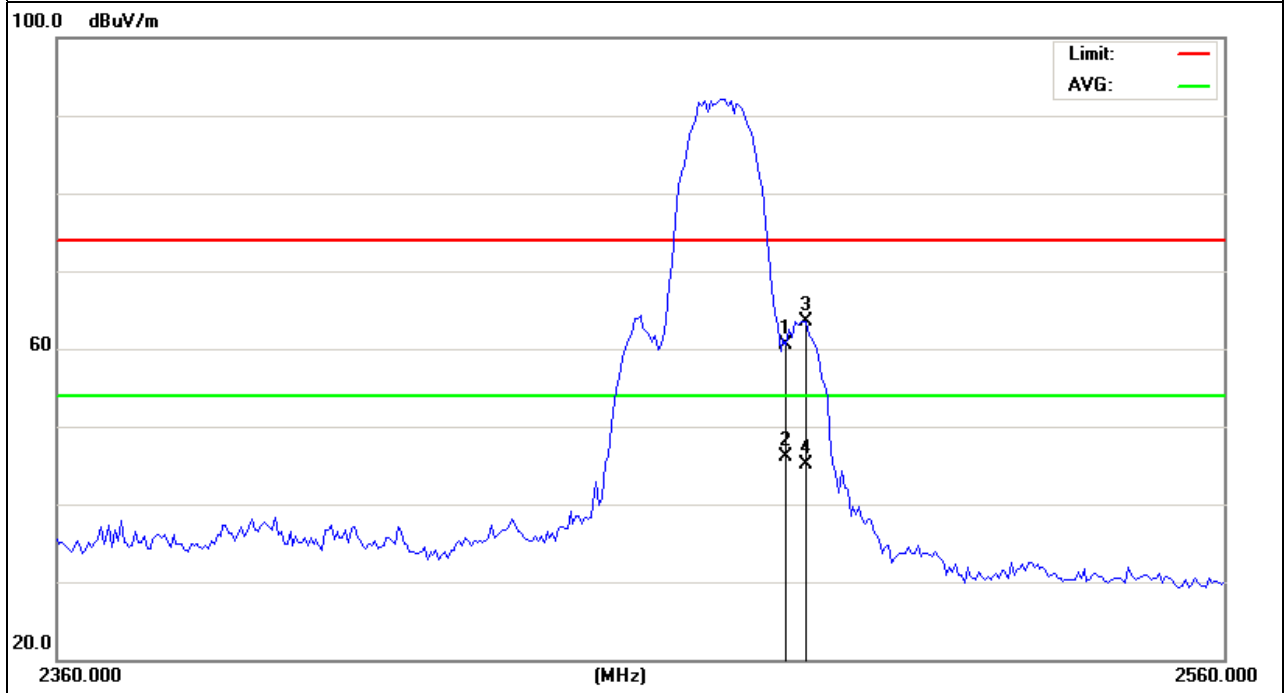

EUT :	Smart body fat scale	Model Name :	S3
Temperature :	26 °C	Relative Humidity :	54%
Pressure :	1010 hPa	Test Voltage :	DC 6.0V
Test Mode :	CH1(802.11g Mode)	Polarization :	Horizontal

Frequency (MHz)	Meter Reading (dBµV)	Factor (dB)	Emission Level (dBµV/m)	Limits (dBµV/m)	Margin (dB)	Detector Type
2400	70.17	-12.99	57.18	74	-16.82	peak
2400	59.84	-12.99	46.85	54	-7.15	AVG

Remark:  
Factor = Antenna Factor + Cable Loss – Pre-amplifier.

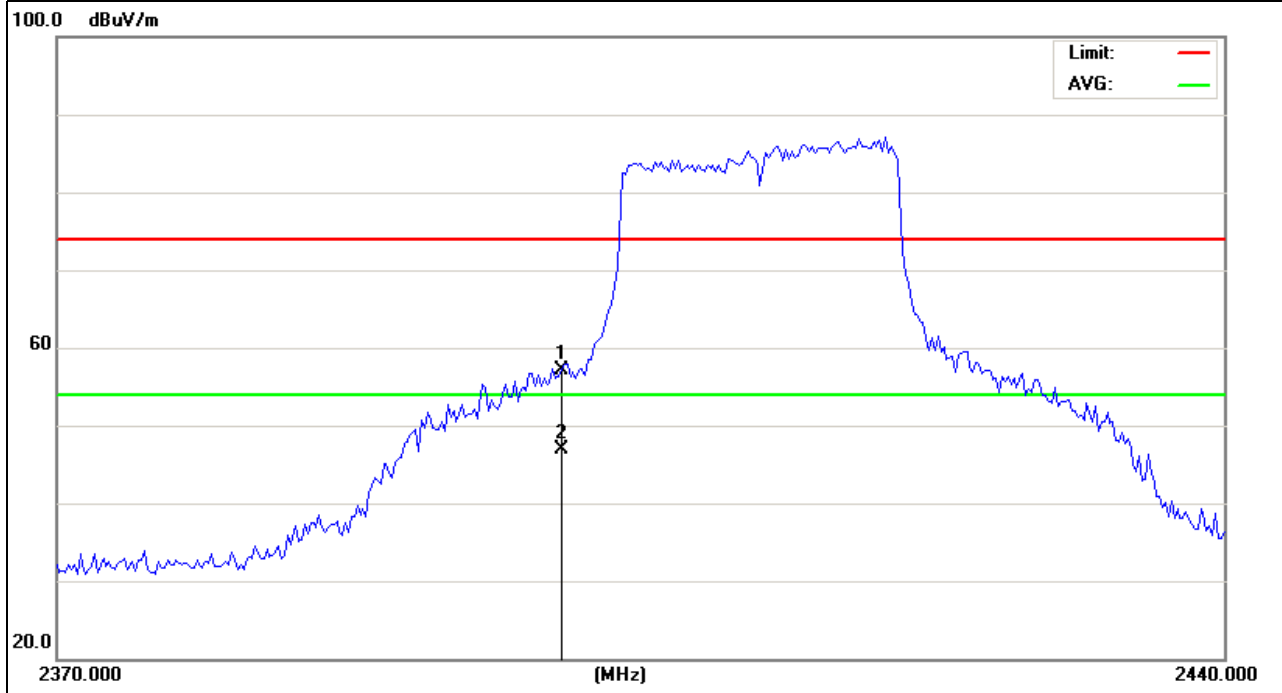

EUT :	Smart body fat scale	Model Name :	S3
Temperature :	26 °C	Relative Humidity :	54%
Pressure :	1010 hPa	Test Voltage :	DC 6.0V
Test Mode :	CH1(802.11gMode)	Polarization :	Vertical

Frequency (MHz)	Meter Reading (dBµV)	Factor (dB)	Emission Level (dBµV/m)	Limits (dBµV/m)	Margin (dB)	Detector Type
2400	70.28	-12.99	57.29	74	-16.71	peak
2400	58.75	-12.99	45.76	54	-8.24	AVG

Remark:  
Factor = Antenna Factor + Cable Loss – Pre-amplifier.

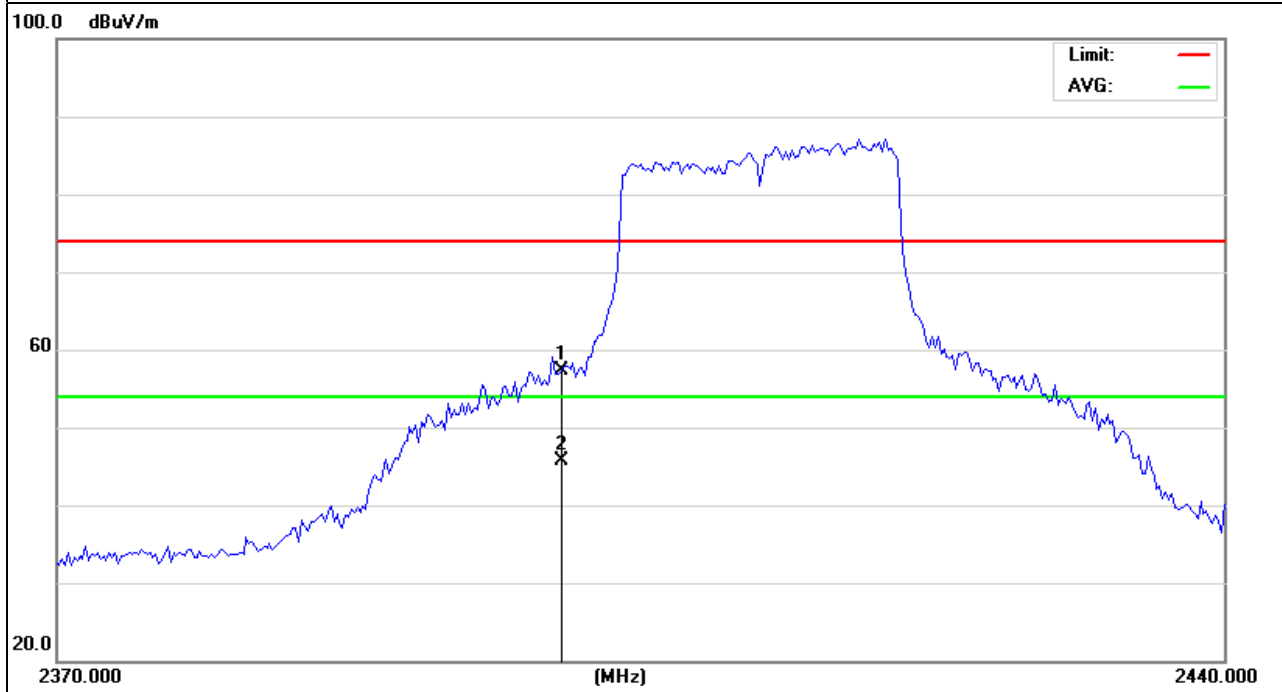

EUT :	Smart body fat scale	Model Name :	S3
Temperature :	26 °C	Relative Humidity :	54%
Pressure :	1010 hPa	Test Voltage :	DC 6.0V
Test Mode :	CH11(802.11g Mode)	Polarization :	Horizontal

Frequency (MHz)	Meter Reading (dBµV)	Factor (dB)	Emission Level (dBµV/m)	Limits (dBµV/m)	Margin (dB)	Detector Type
2483.5	78.02	-12.78	65.24	74	-8.76	peak
2483.5	57.6	-12.78	44.82	54	-9.18	AVG

Remark:  
Factor = Antenna Factor + Cable Loss – Pre-amplifier.

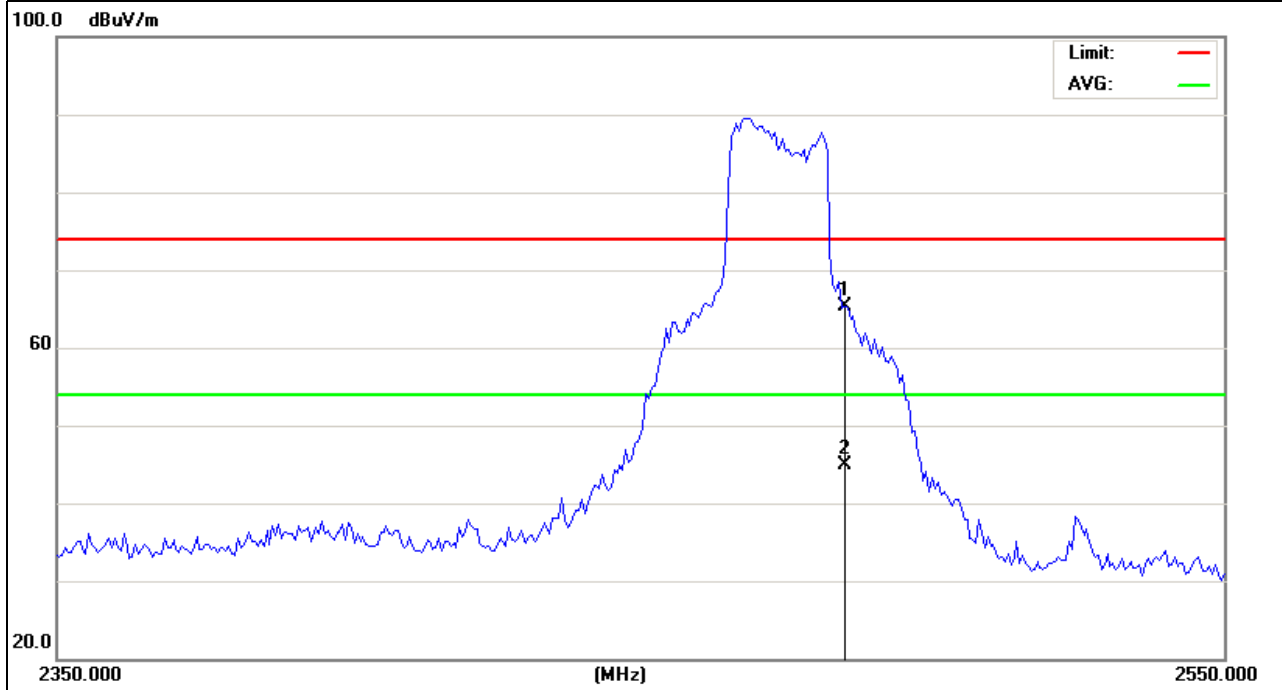

EUT :	Smart body fat scale	Model Name :	S3
Temperature :	26 °C	Relative Humidity :	54%
Pressure :	1010 hPa	Test Voltage :	DC 6.0V
Test Mode :	CH11(802.11g Mode)	Polarization :	Vertical

Frequency (MHz)	Meter Reading (dBµV)	Factor (dB)	Emission Level (dBµV/m)	Limits (dBµV/m)	Margin (dB)	Detector Type
2483.5	78.02	-12.78	65.24	74	-8.76	peak
2483.5	57.52	-12.78	44.74	54	-9.26	AVG

Remark:  
 Factor = Antenna Factor + Cable Loss – Pre-amplifier.

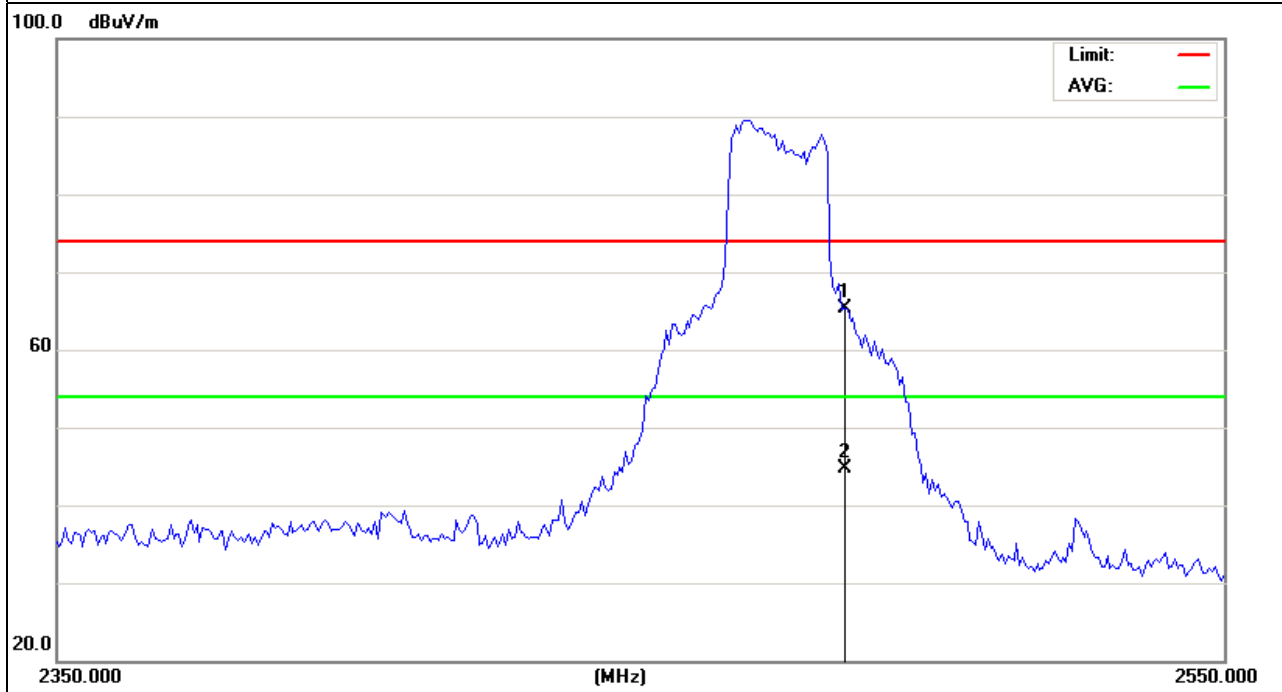



EUT :	Smart body fat scale	Model Name :	S3
Temperature :	26 °C	Relative Humidity :	54%
Pressure :	1010 hPa	Test Voltage :	DC 6.0V
Test Mode :	CH1(802.11n Mode)	Polarization :	Horizontal

Frequency (MHz)	Meter Reading (dBµV)	Factor (dB)	Emission Level (dBµV/m)	Limits (dBµV/m)	Margin (dB)	Detector Type
2400	70.43	-12.99	57.44	74	-16.56	peak
2400	58.18	-12.99	45.19	54	-8.81	AVG

Remark:  
Factor = Antenna Factor + Cable Loss – Pre-amplifier.

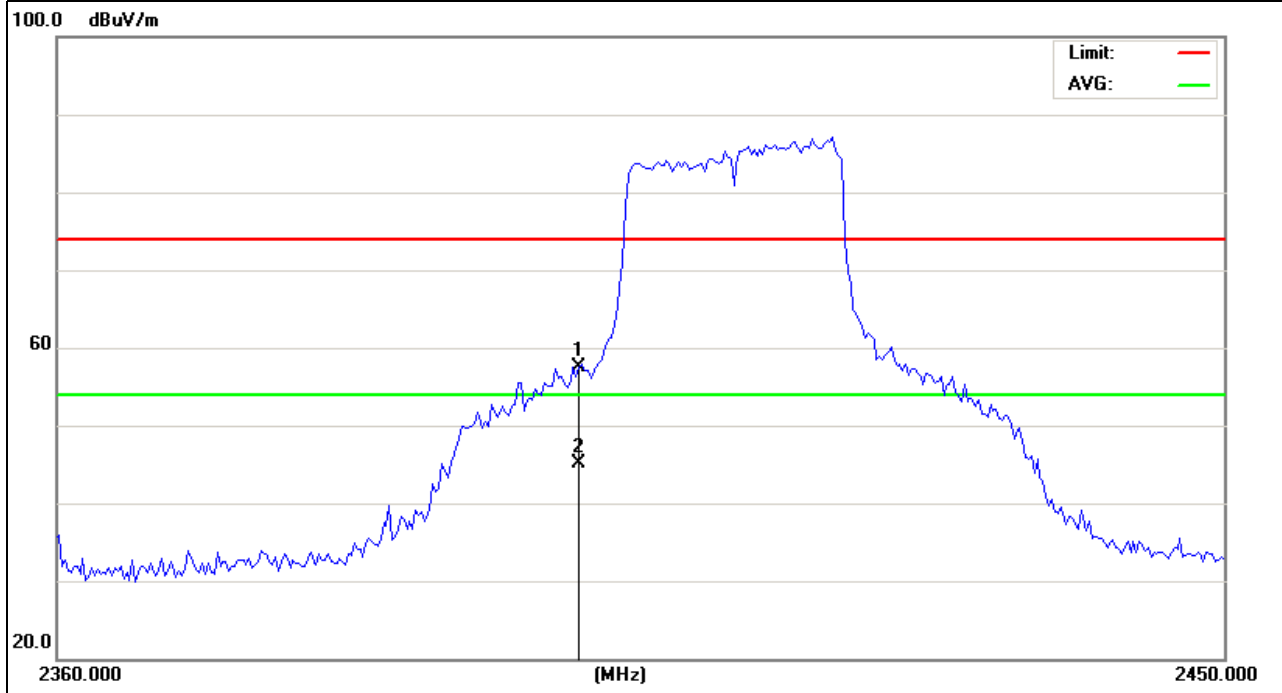

EUT :	Smart body fat scale	Model Name :	S3
Temperature :	26 °C	Relative Humidity :	54%
Pressure :	1010 hPa	Test Voltage :	DC 6.0V
Test Mode :	CH1(802.11n Mode)	Polarization :	Vertical

Frequency (MHz)	Meter Reading (dBμV)	Factor (dB)	Emission Level (dBμV/m)	Limits (dBμV/m)	Margin (dB)	Detector Type
2400	65.62	-12.99	52.63	74	-21.37	peak
2400	57.81	-12.99	44.82	54	-9.18	AVG

Remark:  
Factor = Antenna Factor + Cable Loss – Pre-amplifier.

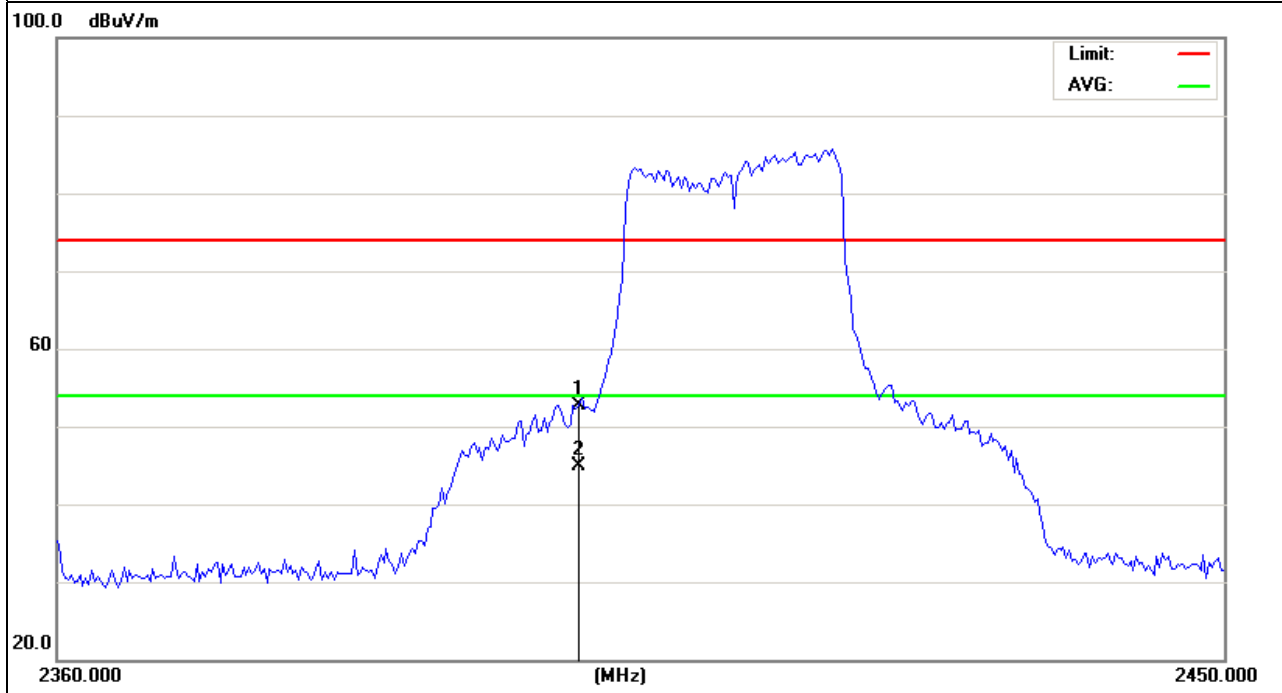

EUT :	Smart body fat scale	Model Name :	S3
Temperature :	26 °C	Relative Humidity :	54%
Pressure :	1010 hPa	Test Voltage :	DC 6.0V
Test Mode :	CH11(802.11n Mode)	Polarization :	Horizontal

Frequency (MHz)	Meter Reading (dBµV)	Factor (dB)	Emission Level (dBµV/m)	Limits (dBµV/m)	Margin (dB)	Detector Type
2483.5	77.74	-12.78	64.96	74	-9.04	peak
2483.5	57.55	-12.78	44.77	54	-9.23	AVG

Remark:  
 Factor = Antenna Factor + Cable Loss – Pre-amplifier.

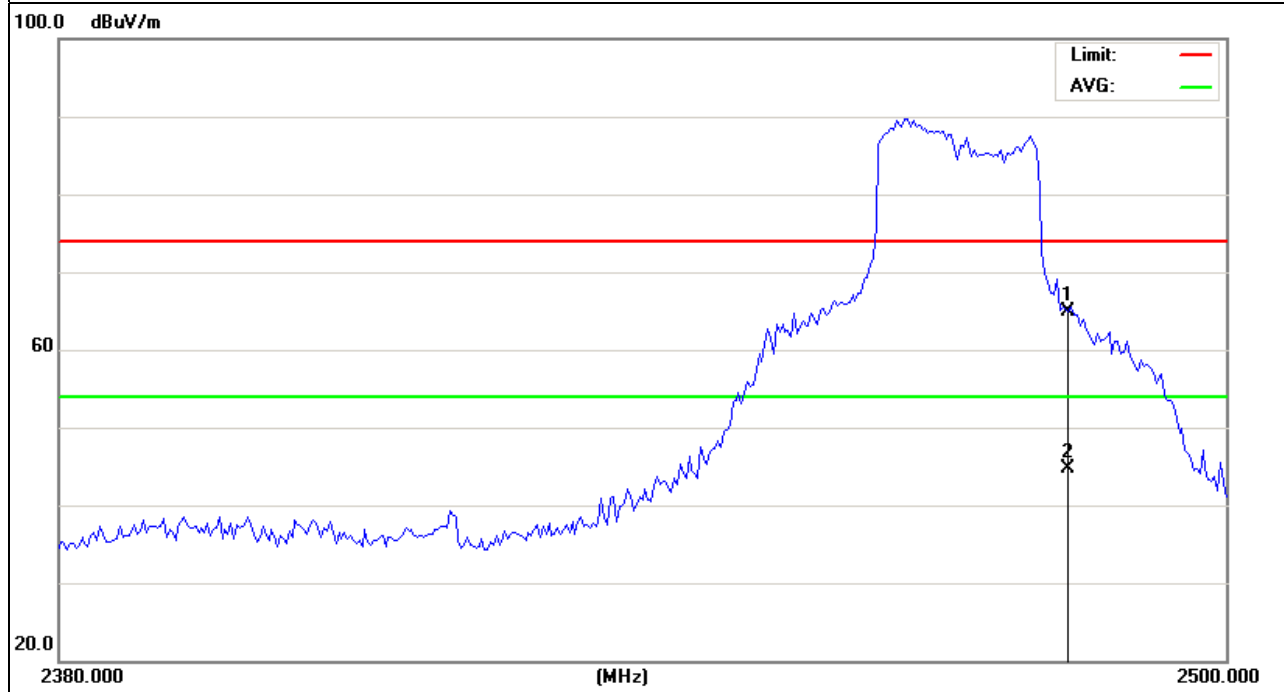

EUT :	Smart body fat scale	Model Name :	S3
Temperature :	26 °C	Relative Humidity :	54%
Pressure :	1010 hPa	Test Voltage :	DC 6.0V
Test Mode :	CH11(802.11n Mode)	Polarization :	Vertical

Frequency (MHz)	Meter Reading (dBµV)	Factor (dB)	Emission Level (dBµV/m)	Limits (dBµV/m)	Margin (dB)	Detector Type
2483.5	70.58	-12.78	57.8	74	-16.2	peak
2483.5	53.92	-12.78	41.14	54	-12.86	AVG

Remark:  
 Factor = Antenna Factor + Cable Loss – Pre-amplifier.

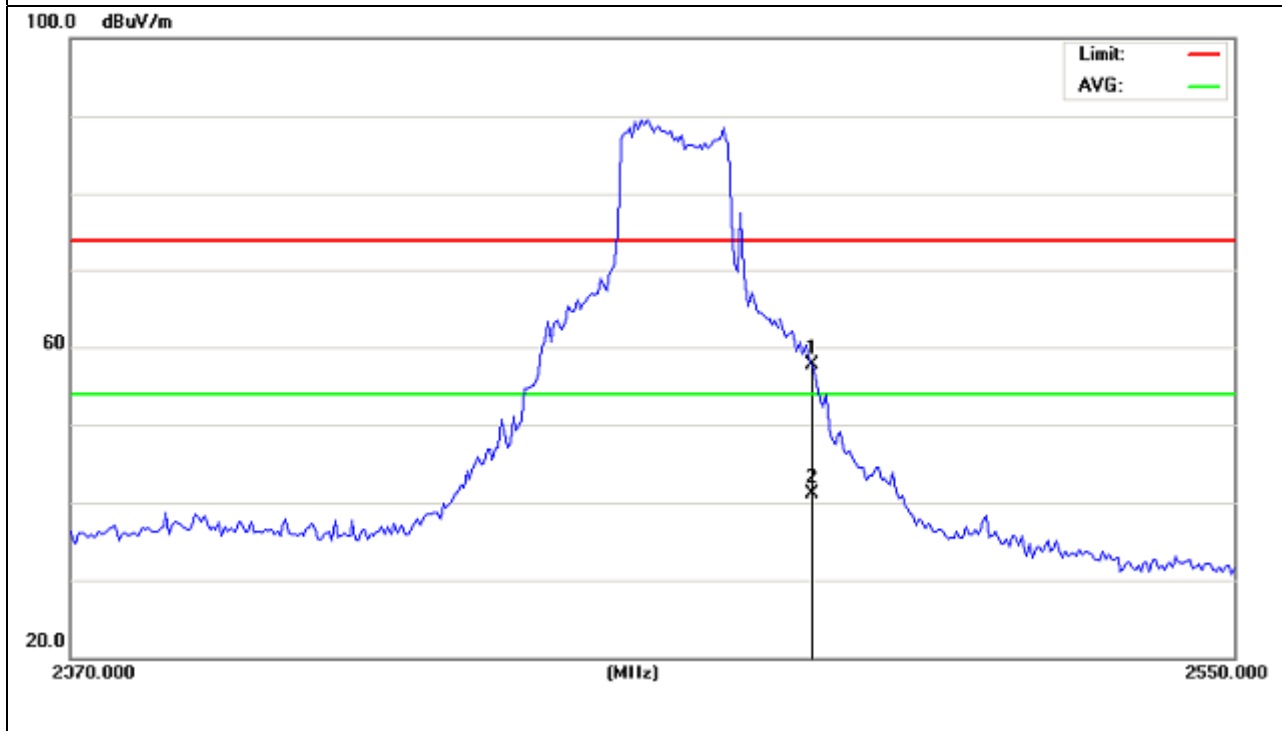

#### 4. POWER SPECTRAL DENSITY TEST

##### 4.1 APPLIED PROCEDURES / LIMIT

FCC Part15 (15.247) , Subpart C				
Section	Test Item	Limit	Frequency Range (MHz)	Result
15.247	Power Spectral Density	8 dBm (in any 3KHz)	2400-2483.5	PASS

##### 4.1.1 TEST PROCEDURE

1. Set analyzer center frequency to DTS channel center frequency.
2. Set the span to 1.5 times the DTS channel bandwidth.
3. Set the RBW  $\geq$  3 kHz.
4. Set the VBW  $\geq$  3 x RBW.
5. Detector = peak.
6. Sweep time = auto couple.
7. Trace mode = max hold.
8. Allow trace to fully stabilize.
9. Use the peak marker function to determine the maximum amplitude level.
10. If measured value exceeds limit, reduce RBW (no less than 3 kHz) and repeat.

##### 4.1.2 DEVIATION FROM STANDARD

No deviation.

##### 4.1.3 TEST SETUP



##### 4.1.4 EUT OPERATION CONDITIONS

The EUT tested system was configured as the statements of 2.1 Unless otherwise a special operating condition is specified in the follows during the testing.

### 4.1.5 TEST RESULTS

EUT :	Smart body fat scale	Model Name :	S3
Temperature :	26 °C	Relative Humidity :	54%
Pressure :	1015 hPa	Test Voltage :	DC 6.0V
Test Mode :	TX b Mode /CH01, CH06, CH11		

Frequency	Power Density (dBm)	Limit (dBm)	Result
2412 MHz	-11.26	8	PASS
2437 MHz	-11.68	8	PASS
2462 MHz	-12.19	8	PASS

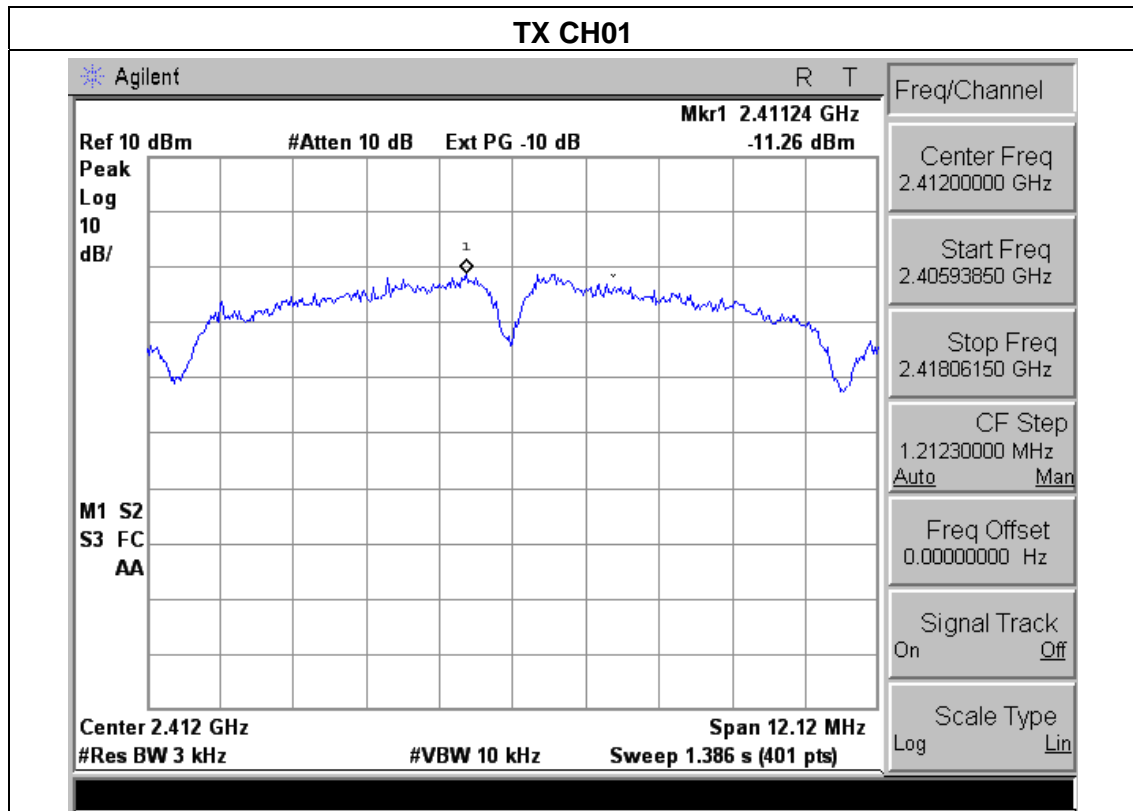

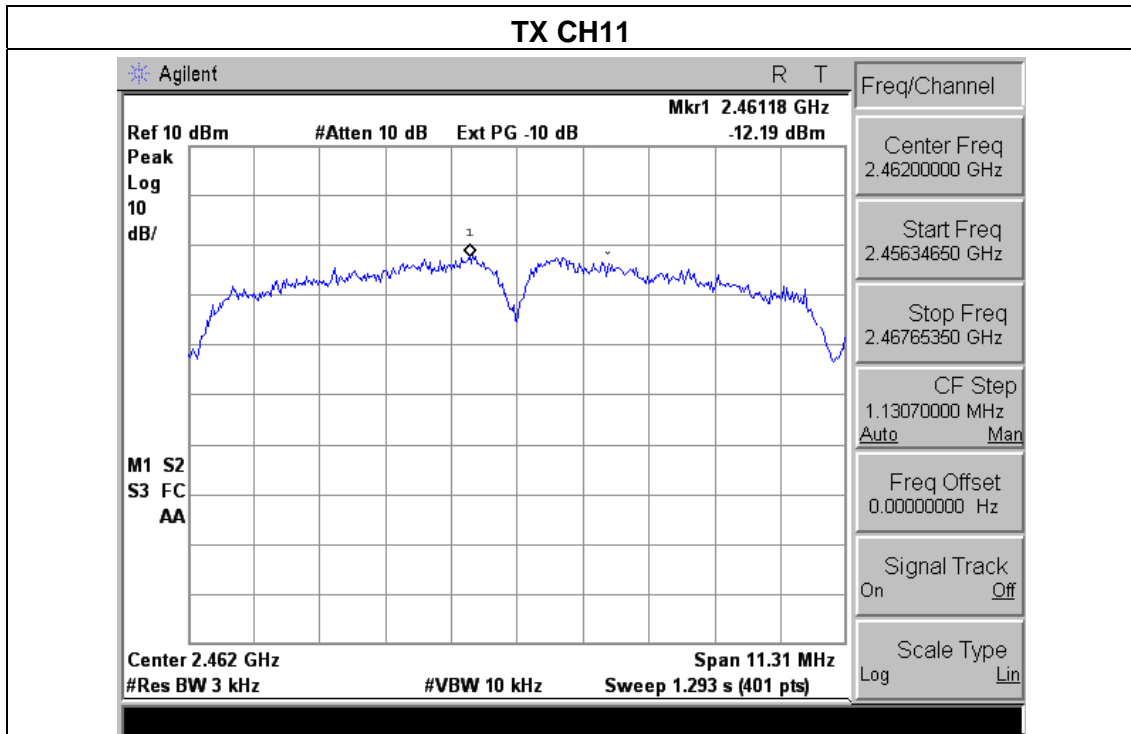
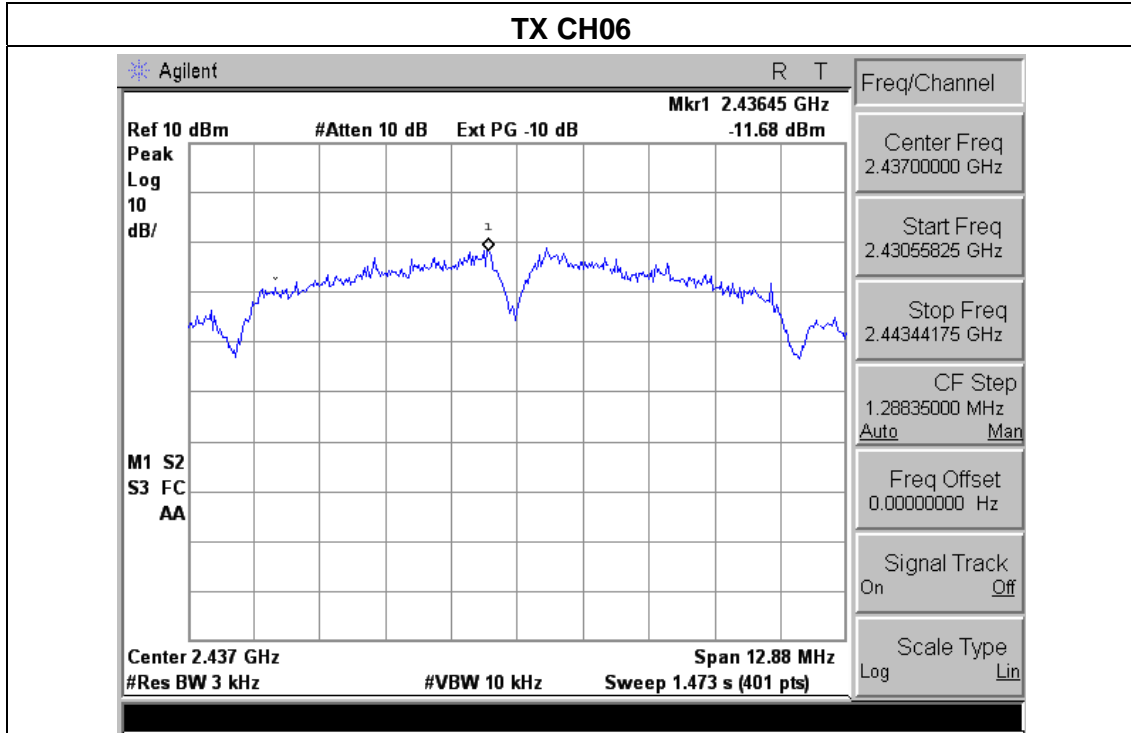

EUT :	Smart body fat scale	Model Name :	S3
Temperature :	26 °C	Relative Humidity :	54%
Pressure :	1015 hPa	Test Voltage :	DC 6.0V
Test Mode :	TX g Mode /CH01, CH06, CH11		

Frequency	Power Density (dBm)	Limit (dBm)	Result
2412 MHz	-13.74	8	PASS
2437 MHz	-13.73	8	PASS
2462 MHz	-13.90	8	PASS

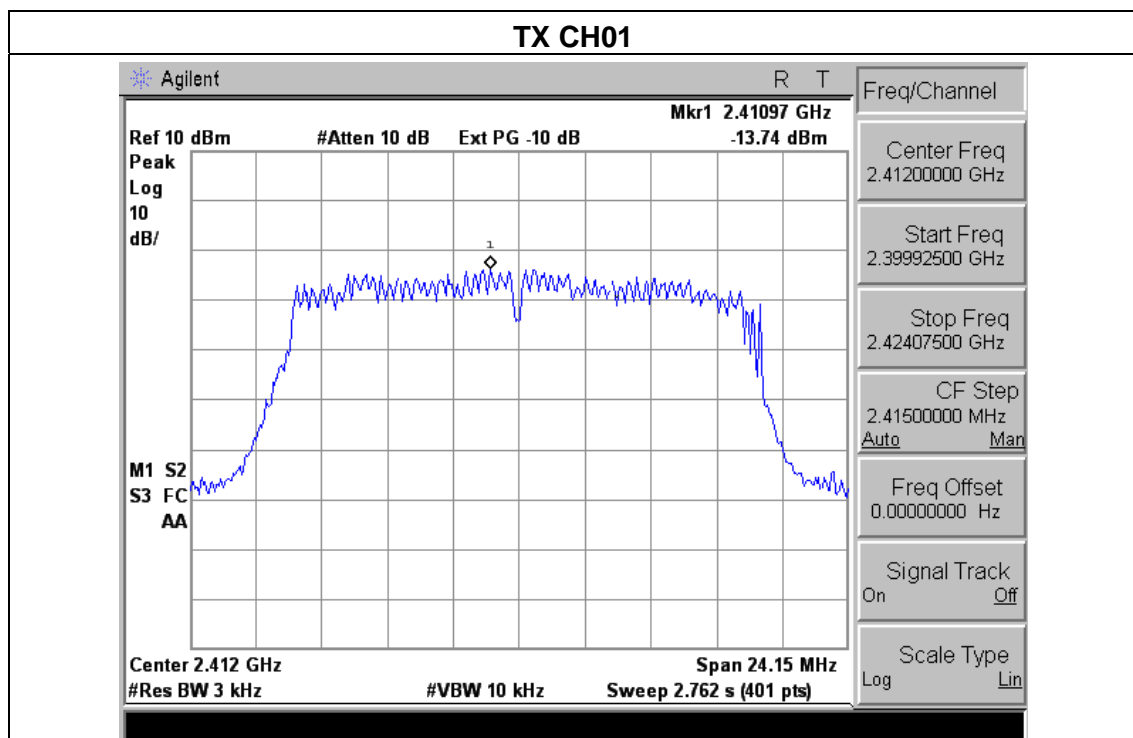



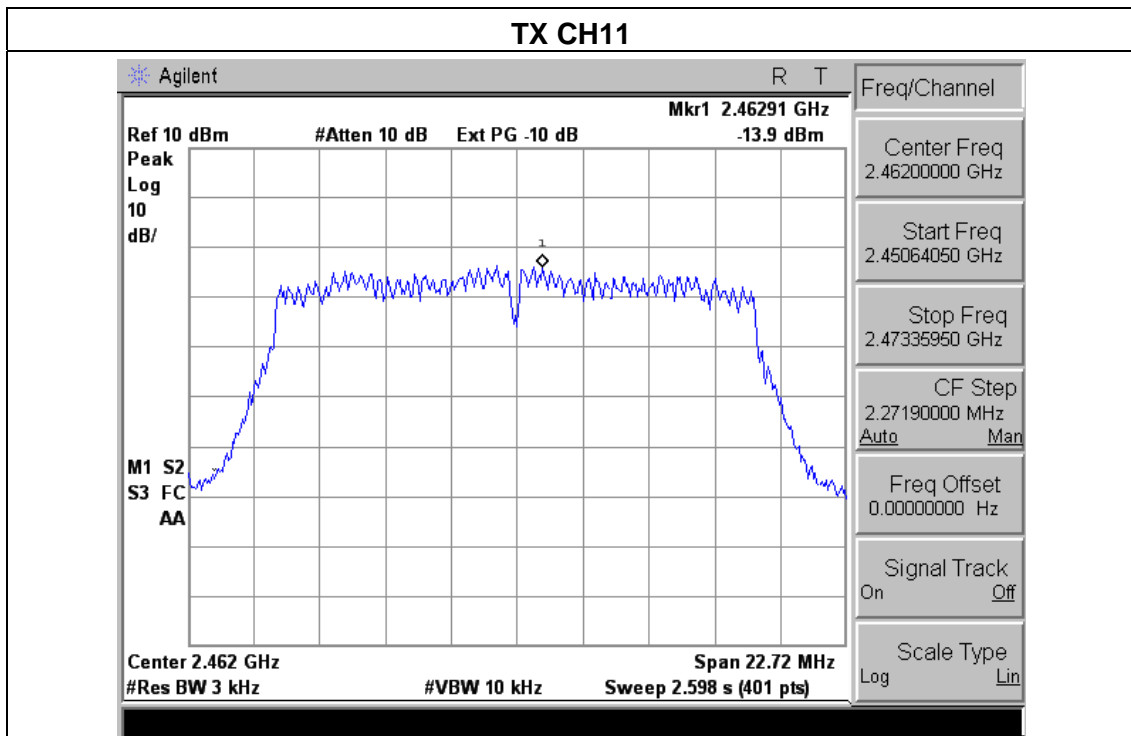
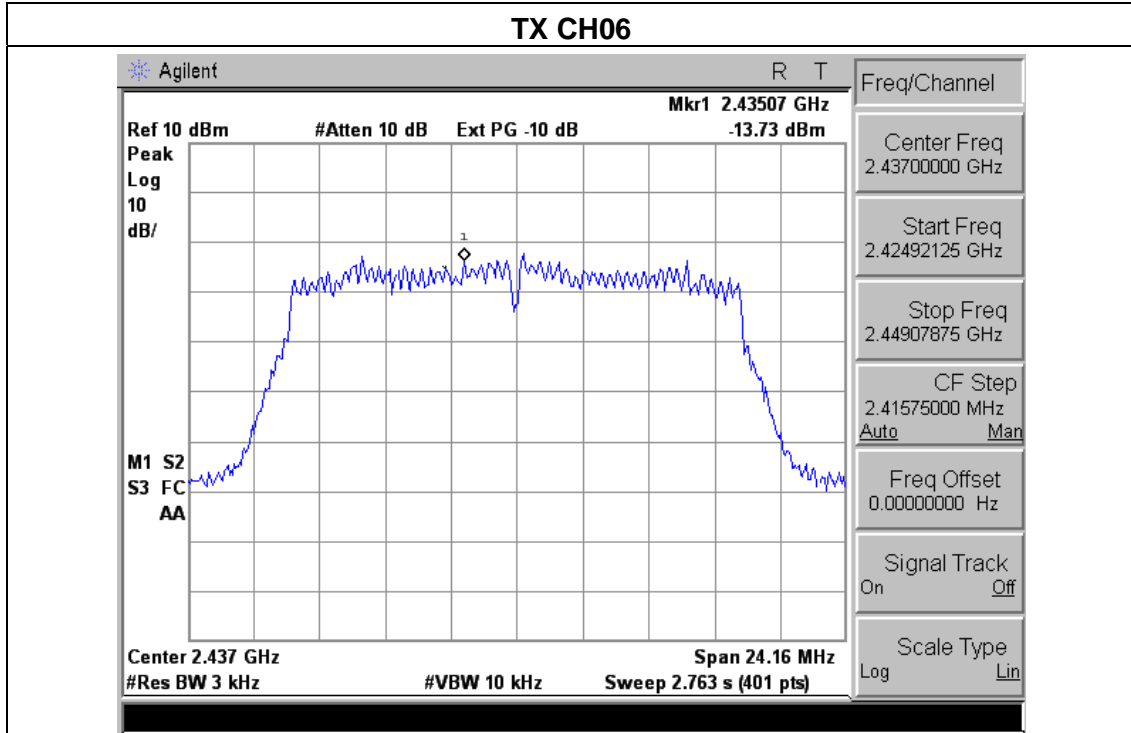

EUT :	Smart body fat scale	Model Name :	S3
Temperature :	26 °C	Relative Humidity :	54%
Pressure :	1015 hPa	Test Voltage :	DC 6.0V
Test Mode :	TX n Mode /CH01, CH06, CH11		

Frequency	Power Density (dBm)	Limit (dBm)	Result
2412 MHz	-13.92	8	PASS
2437 MHz	-13.68	8	PASS
2462 MHz	-13.50	8	PASS

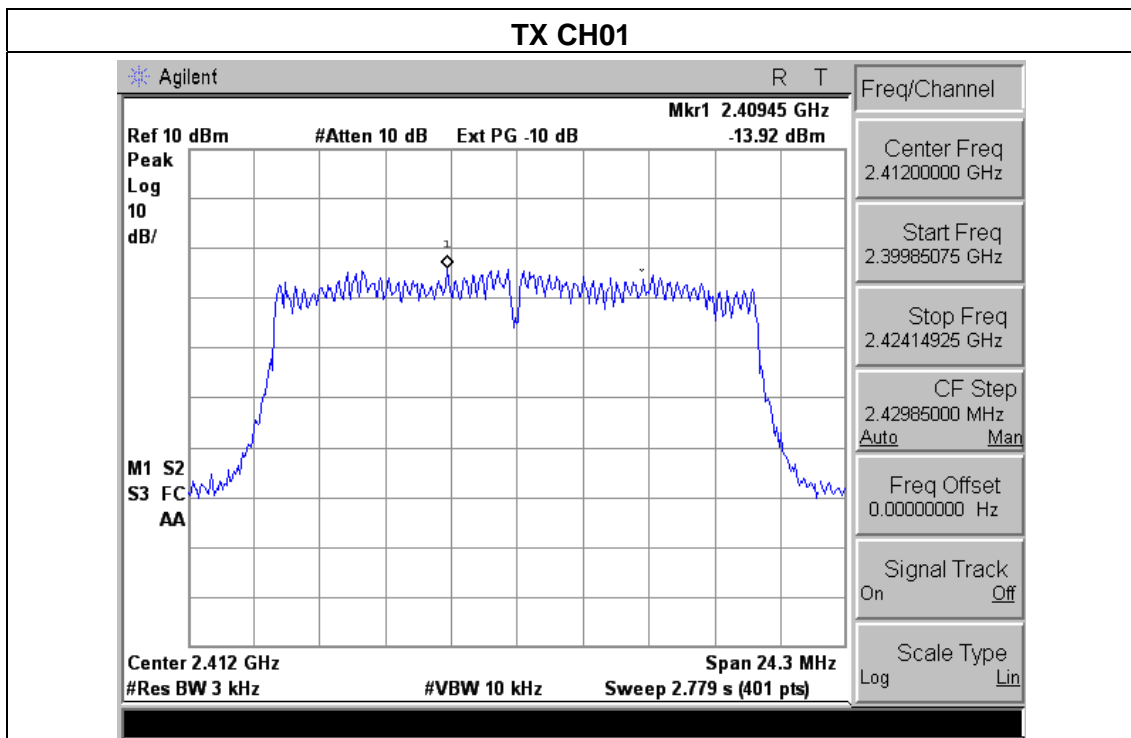

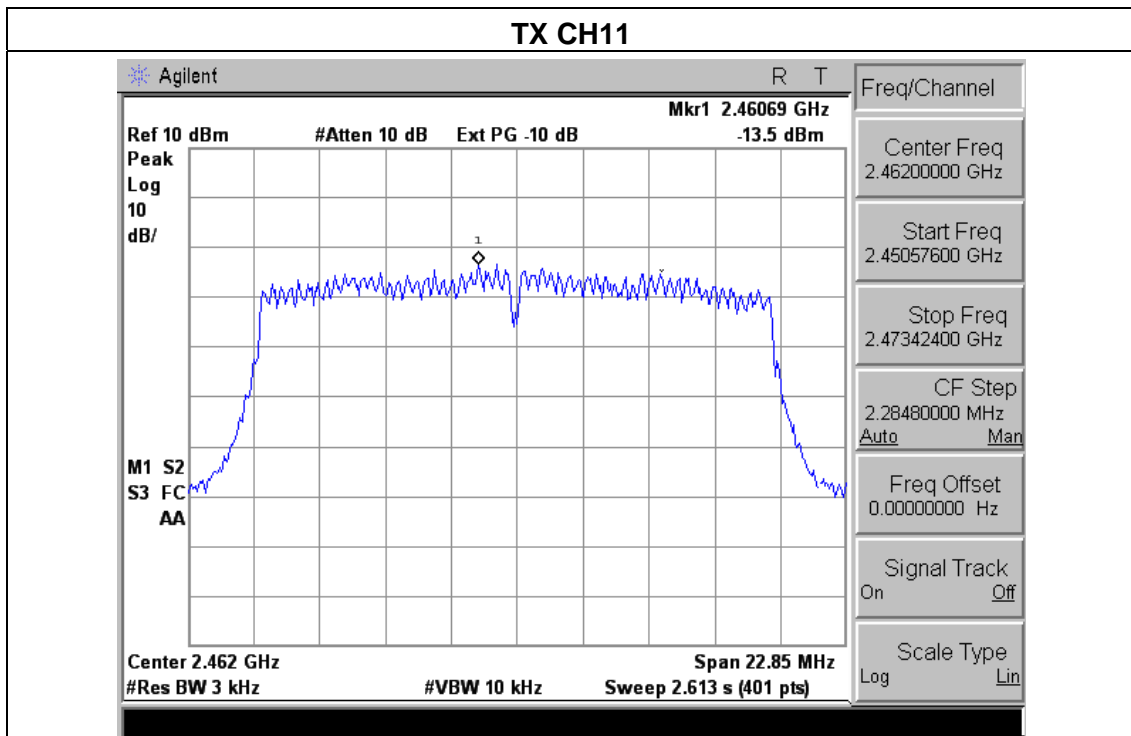
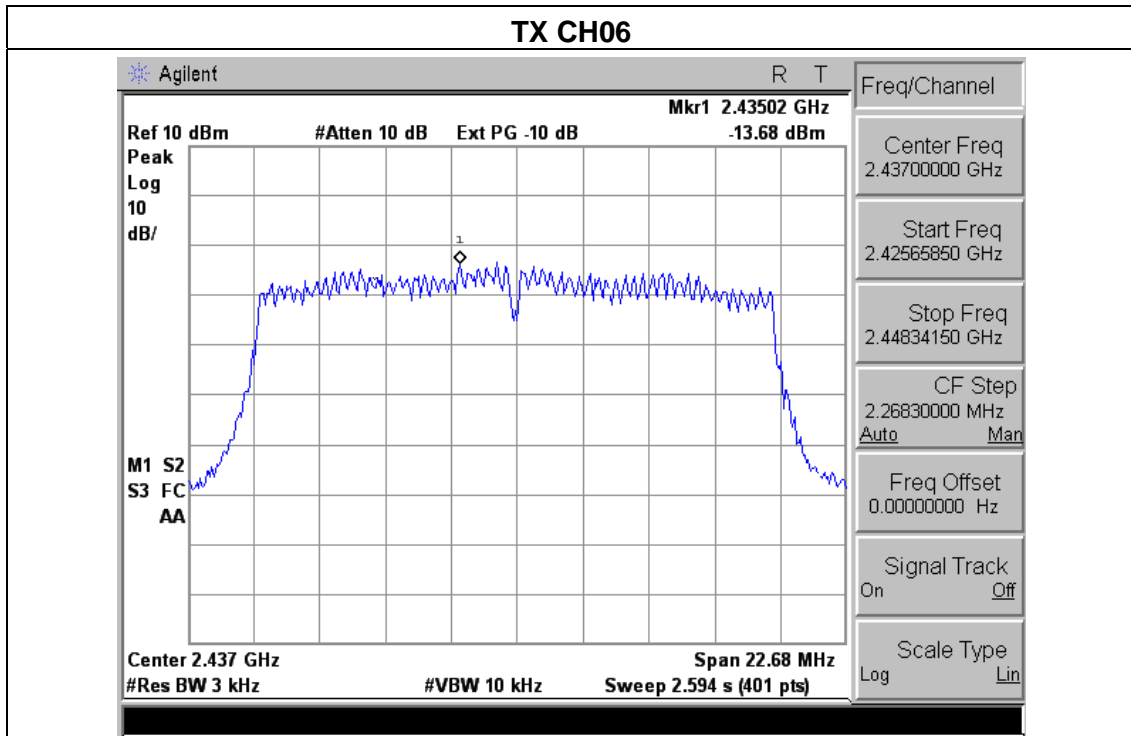

**5. BANDWIDTH TEST**

**5.1 APPLIED PROCEDURES / LIMIT**

FCC Part15 (15.247) , Subpart C				
Section	Test Item	Limit	Frequency Range (MHz)	Result
15.247(a)(2)	Bandwidth	$\geq 500\text{KHz}$ (6dB bandwidth)	2400-2483.5	PASS

**5.1.1 TEST PROCEDURE**

a.

1. Set RBW= 100 kHz.
2. Set the video bandwidth (VBW)  $\geq 3 \times$  RBW.
3. Detector = Peak.
4. Trace mode = max hold.
5. Sweep = auto couple.
6. Allow the trace to stabilize.
7. Measure the maximum width of the emission that is constrained by the frequencies associated with the two outermost amplitude points (upper and lower) that are attenuated by 6 dB relative to the maximum level measured in the fundamental emission.

**5.1.2 DEVIATION FROM STANDARD**

No deviation.

**5.1.3 TEST SETUP**



**5.1.4 EUT OPERATION CONDITIONS**

The EUT tested system was configured as the statements of 2.4 Unless otherwise a special operating condition is specified in the follows during the testing.

### 5.1.5 TEST RESULTS

EUT :	Smart body fat scale	Model Name :	S3
Temperature :	26 °C	Relative Humidity :	54%
Pressure :	1012 hPa	Test Voltage :	DC 6.0V
Test Mode :	TX b Mode /CH01, CH06, CH11		

Channel	Frequency (MHz)	6dB bandwidth (MHz)	Limit (kHz)	Result
Low	2412	8.08	500	Pass
Middle	2437	8.59	500	Pass
High	2462	7.54	500	Pass

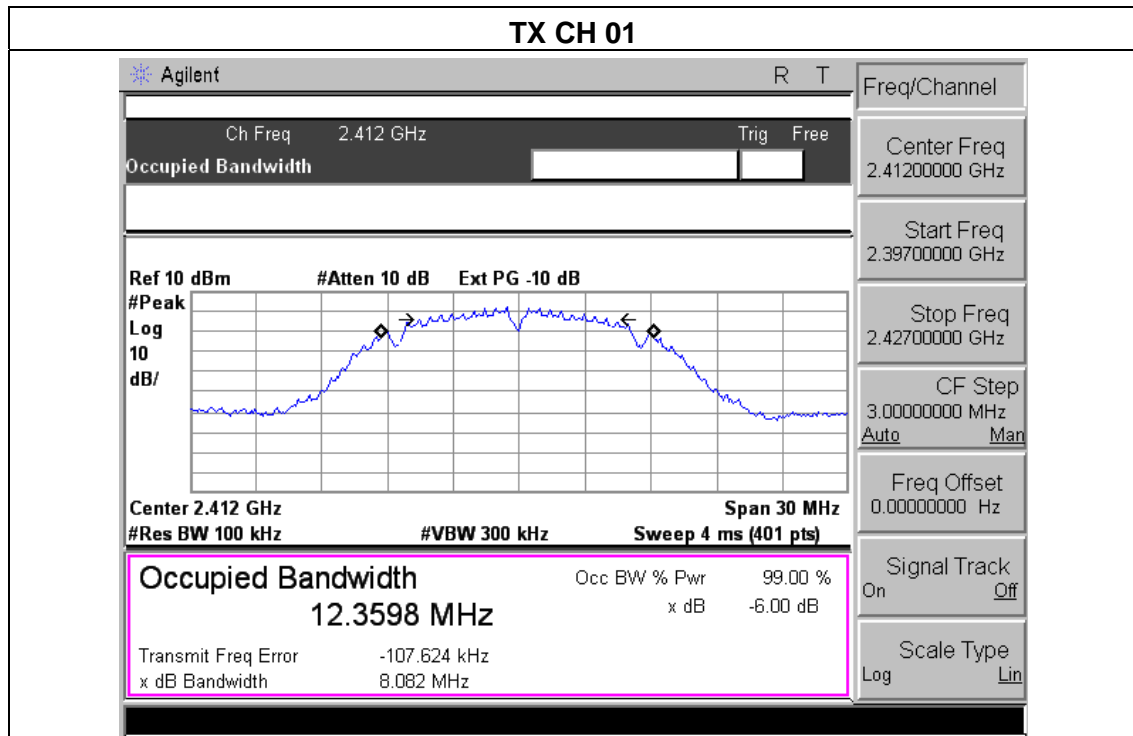

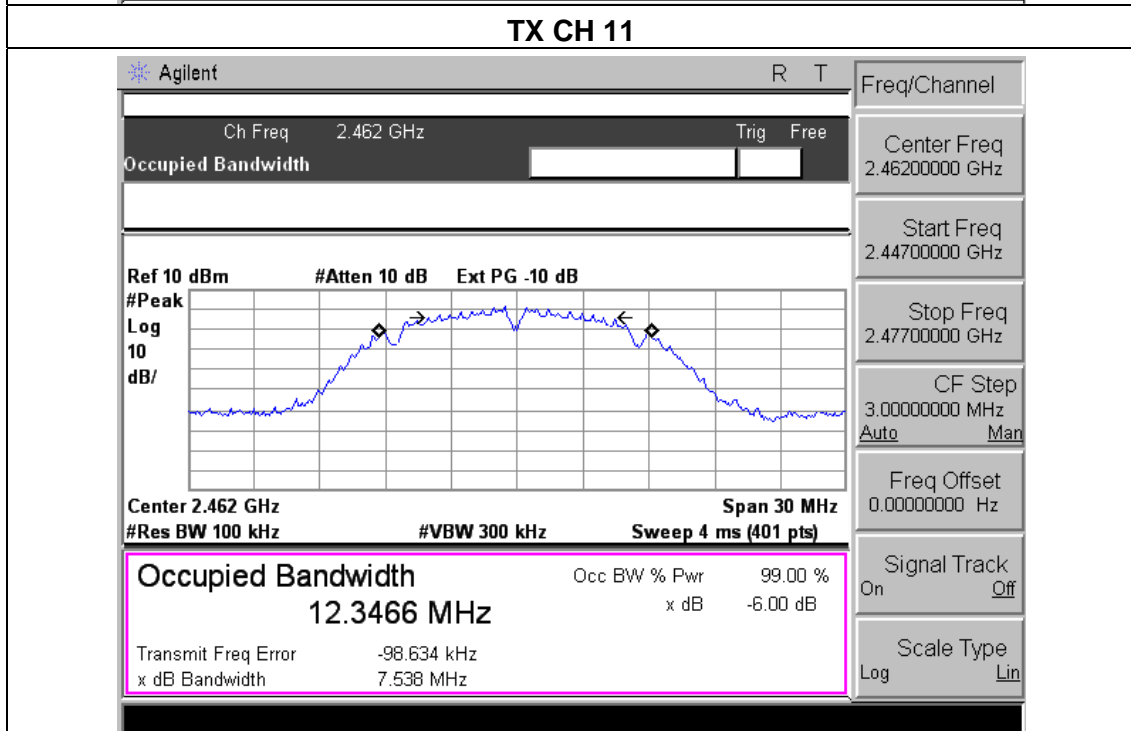
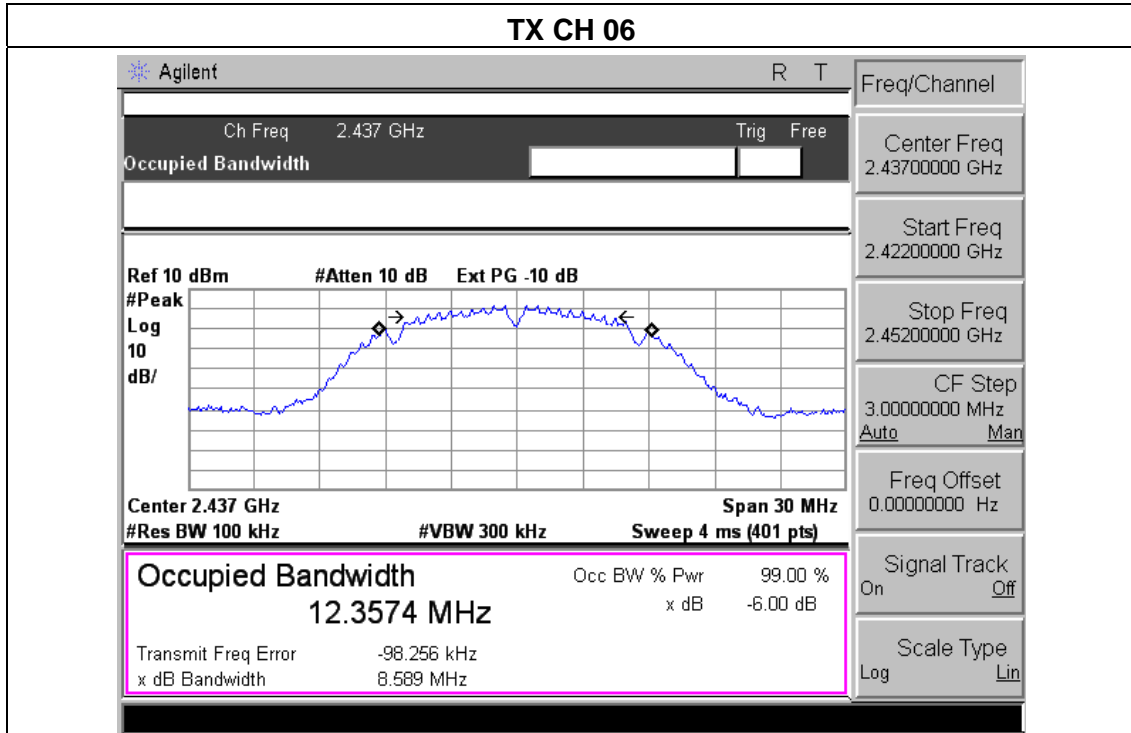

EUT :	Smart body fat scale	Model Name :	S3
Temperature :	26 °C	Relative Humidity :	54%
Pressure :	1012 hPa	Test Voltage :	DC 6.0V
Test Mode :	TX g Mode /CH01, CH06, CH11		

Channel	Frequency (MHz)	6dB bandwidth (MHz)	Limit (kHz)	Result
Low	2412	16.10	500	Pass
Middle	2437	16.11	500	Pass
High	2462	15.15	500	Pass

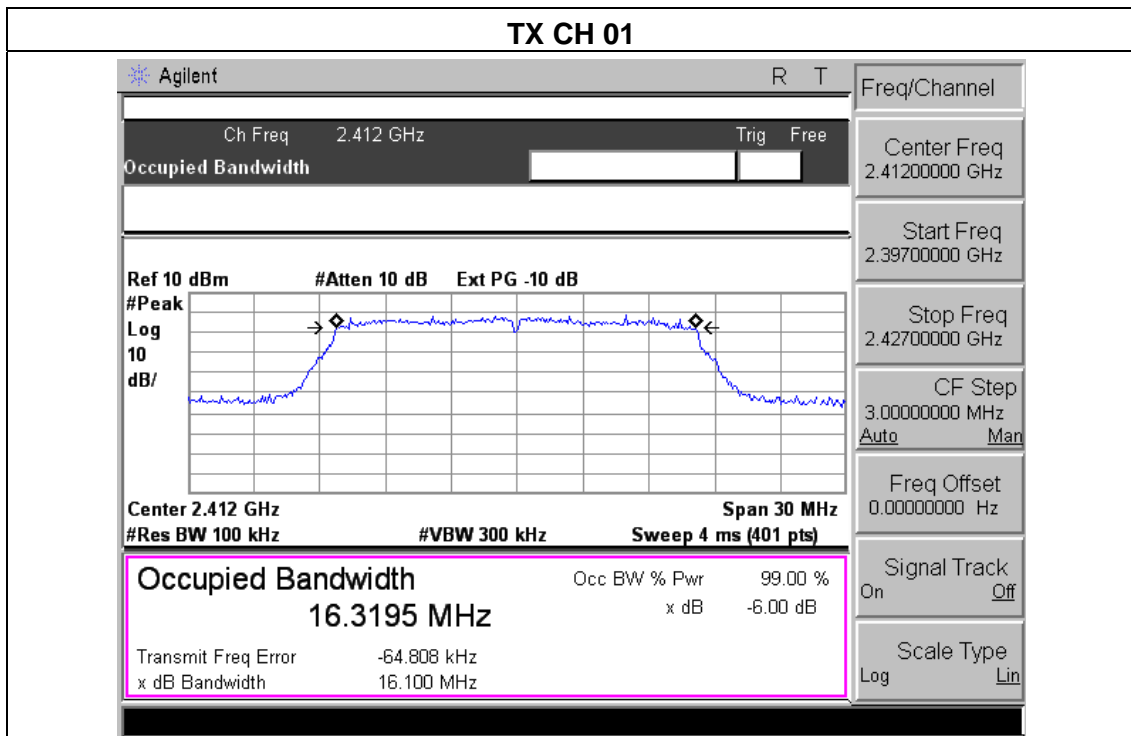

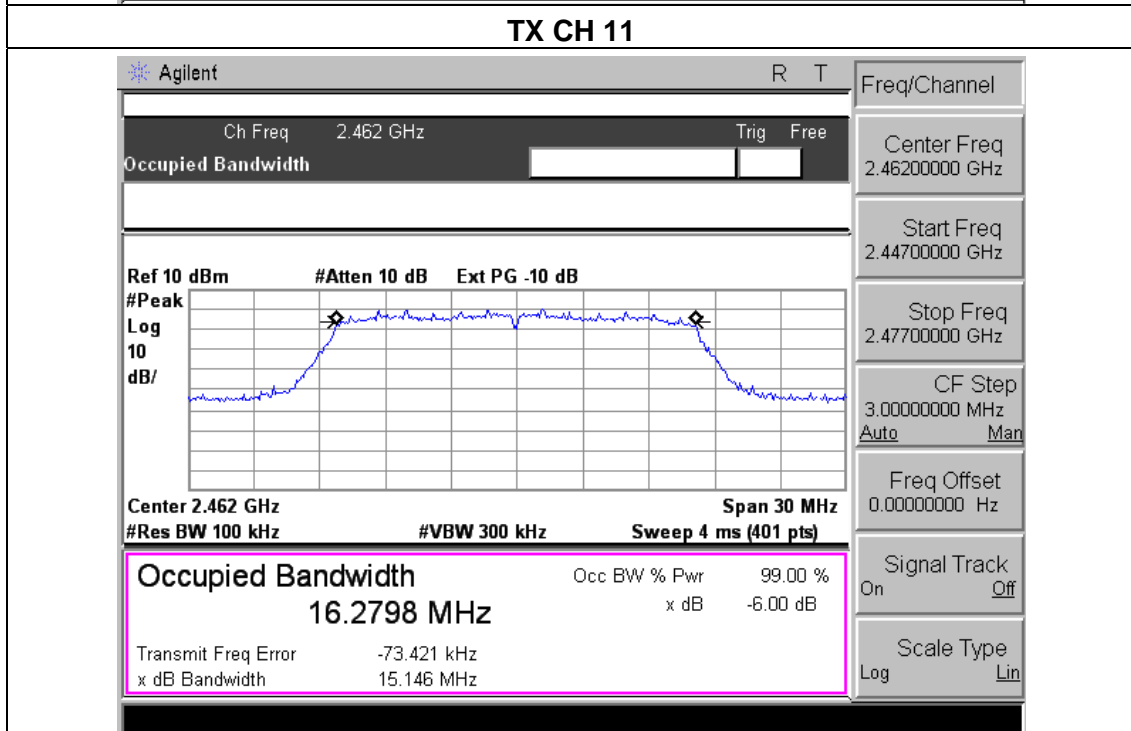
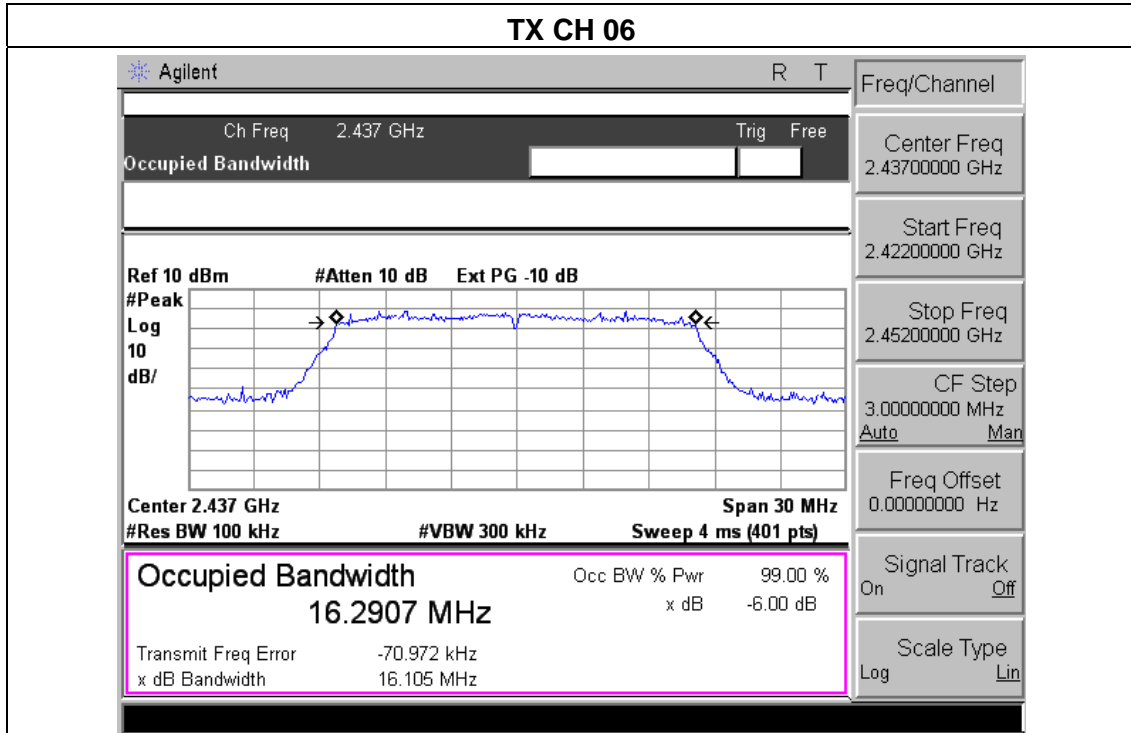



EUT :	Smart body fat scale	Model Name :	S3
Temperature :	26 °C	Relative Humidity :	54%
Pressure :	1012 hPa	Test Voltage :	DC 6.0V
Test Mode :	TX n Mode /CH01, CH06, CH11		

Channel	Frequency (MHz)	6dB bandwidth (MHz)	Limit (kHz)	Result
Low	2412	16.20	500	Pass
Middle	2437	15.12	500	Pass
High	2462	15.23	500	Pass

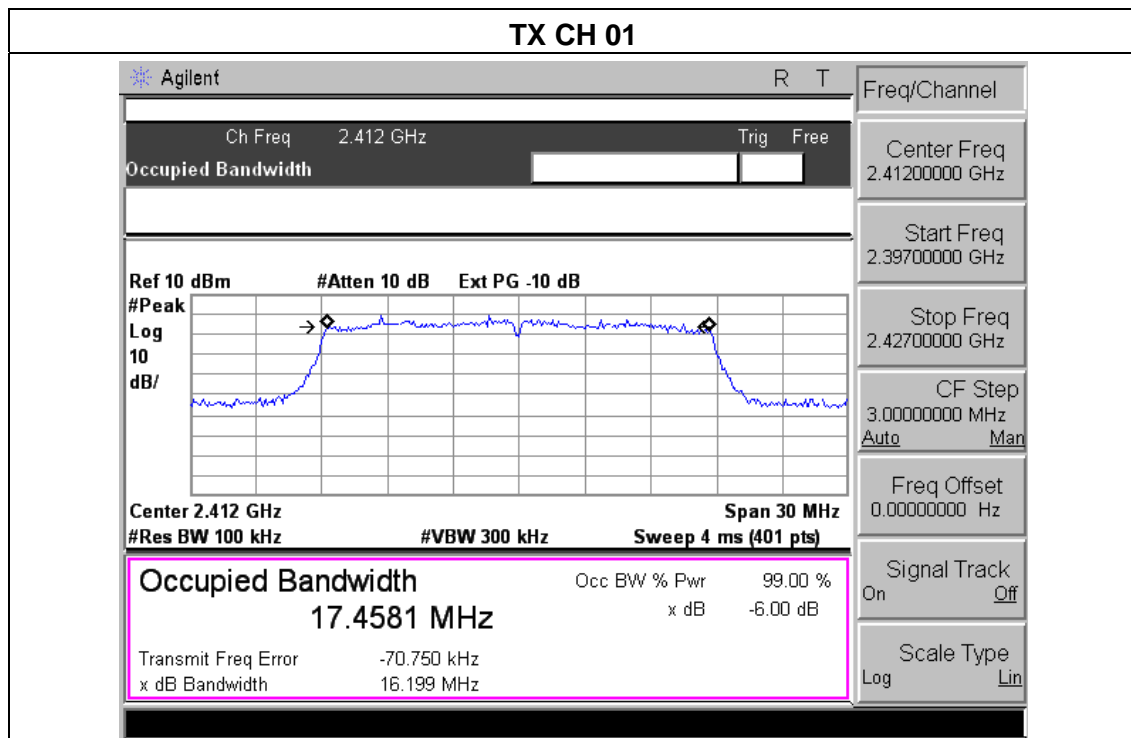

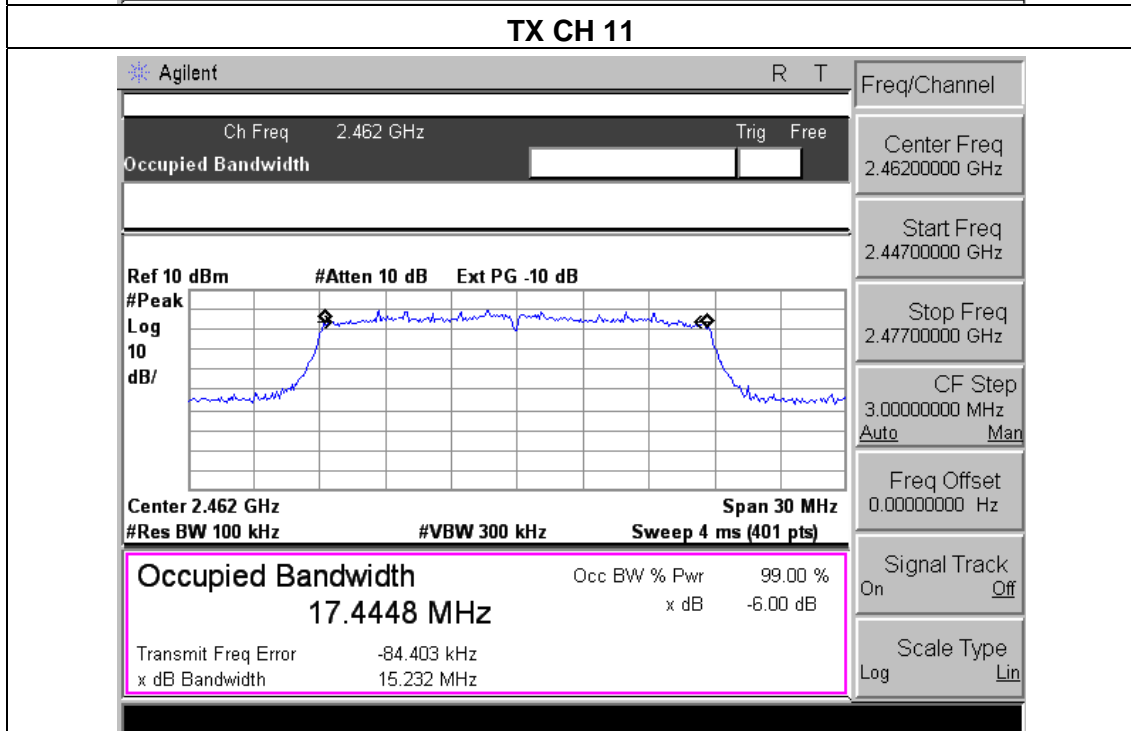
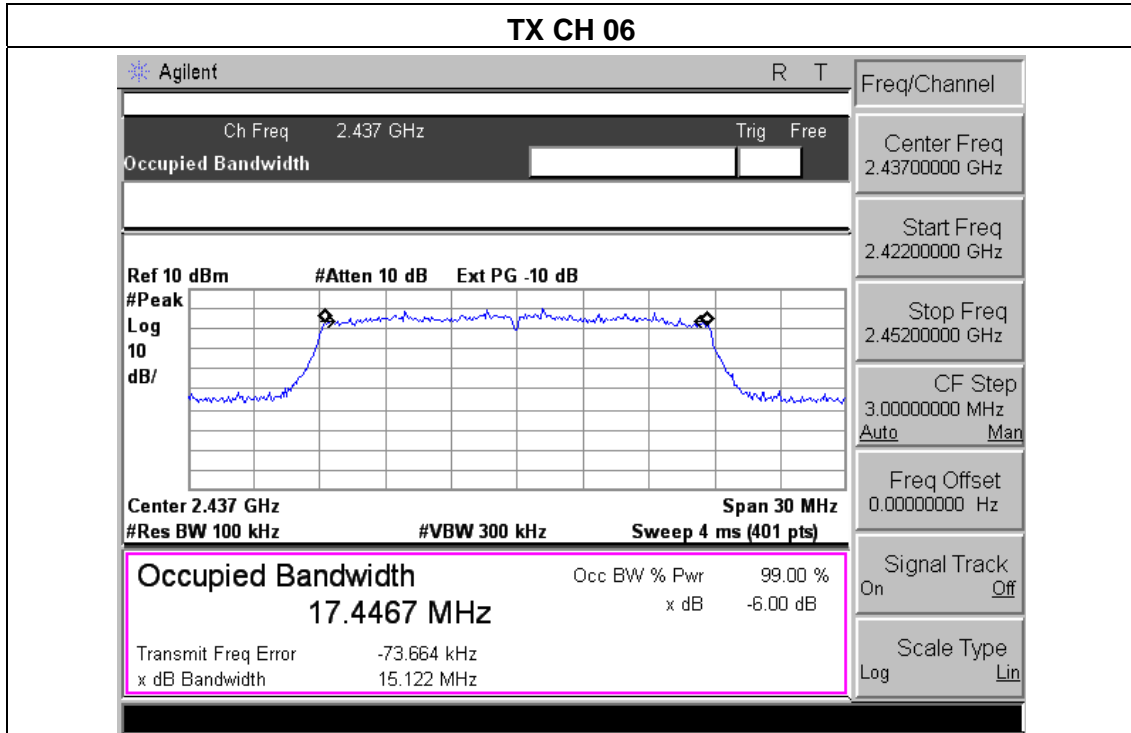

**6. PEAK OUTPUT POWER TEST**

**6.1 APPLIED PROCEDURES / LIMIT**

FCC Part15 (15.247) , Subpart C				
Section	Test Item	Limit	Frequency Range (MHz)	Result
15.247(b)(3)	Peak Output Power	1 watt or 30dBm	2400-2483.5	PASS

**6.1.1 TEST PROCEDURE**

- a. The EUT was directly connected to the Power meter

**6.1.2 DEVIATION FROM STANDARD**

No deviation.

**6.1.3 TEST SETUP**



**6.1.4 EUT OPERATION CONDITIONS**

The EUT tested system was configured as the statements of 2.4 Unless otherwise a special operating condition is specified in the follows during the testing.

**6.1.5 TEST RESULTS**

EUT :	Smart body fat scale	Model Name :	S3
Temperature :	26 °C	Relative Humidity :	54%
Pressure :	1012 hPa	Test Voltage :	DC 6.0V
Test Mode :	TX b/g/n Mode /CH01, CH06, CH11		

<b>TX 802.11b Mode</b>			
Test Channel	Frequency	Maximum Conducted Output Power(PK)	LIMIT
	(MHz)	(dBm)	dBm
CH01	2412	8.24	30
CH06	2437	8.11	30
CH11	2462	8.10	30
<b>TX 802.11g Mode</b>			
CH01	2412	6.46	30
CH06	2437	6.33	30
CH11	2462	6.08	30
<b>TX 802.11n Mode</b>			
CH01	2412	6.56	30
CH06	2437	6.43	30
CH11	2462	6.22	30

## **7. ANTENNA REQUIREMENT**

### **7.1 STANDARD REQUIREMENT**

15.203 requirement: For intentional device, according to 15.203: an intentional radiator shall be designed to ensure that no antenna other than that furnished by the responsible party shall be used with the device.

### **7.2 EUT ANTENNA**

The EUT antenna is PCB antenna(Gain:1.2dBi) . It comply with the standard requirement.

## 8. EUT TEST PHOTO

### Radiated Measurement Photos

