



SmartSet® Clock Radio

With Auto-Time Setting System,

Dual Clock Alarm, PLL FM Radio,

4-Level Dimmer, Wireless Charger

and Temperature Sensor

(U.S. Patent No. 6,567,344)

OWNER'S MANUAL

CKSW0555



Visit our website at www.emersonradio.com

1 WARNING

AVERTISSEMENT: AFIN DE PRÉVENIR TOUT RISQUE D'INCENDIE OU D'ÉLECTROCUTION N'EXPOSEZ PAS CET APPAREIL À LA PLUIE NI À L'HUMIDITÉ.
TO PREVENT FIRE OR SHOCK HAZARD, DO NOT USE THIS PLUG WITH AN EXTENSION CORD, RECEPTACLE OR OTHER OUTLET UNLESS THE BLADES CAN BE FULLY INSERTED TO PREVENT BLADE EXPOSURE. TO PREVENT FIRE OR SHOCK HAZARD, DO NOT EXPOSE THIS APPLIANCE TO RAIN OR MOISTURE.

The lightning flash with arrow-head symbol, within an equilateral triangle is intended to alert the user to the presence of 'uninsulated' dangerous voltage' within the product's enclosure that may be of sufficient magnitude to constitute a risk of electric shock to persons.	The exclamation point within an equilateral triangle is intended to alert the user to the presence of important operating and maintenance (servicing) instructions in the literature accompanying the appliance.

This is CLASS II apparatus with double insulation, and no protective earth provided. The Caution Marking and Rating plate are located at the bottom enclosure of the apparatus.

IMPORTANT SAFETY INSTRUCTIONS

- 1.) Read these instructions.
- 2.) Keep these instructions.
- 3.) Heed all warnings.
- 4.) Follow all instructions.
- 5.) Do not use this apparatus near water.
- 6.) Clean only with dry cloth.
- 7.) Do not block any ventilation openings. Install in accordance with the manufacturer's instructions.
- 8.) Do not install near any heat sources such as radiators, heat registers, stoves, or other apparatus (including amplifiers) that produce heat.
- 9.) Do not defeat the safety purpose of the polarized or grounding-type plug. A polarized plug has two blades with one wider than the other. A grounding type plug has two blades and a third grounding prong. The wide blade or the third prong is provided for your safety. If the provided plug does not fit into your outlet, consult an electrician for replacement of the obsolete outlet.
- 10.) Protect the power cord from being walked on or pinched particularly at plugs, convenience receptacles, and the point where they exit from the apparatus.
- 11.) Only use attachments / accessories specified by the manufacturer.
- 12.) Unplug this apparatus during lightning storms or when unused for long periods of time.
- 13.) Refer all servicing to qualified service personnel. Servicing is required when the apparatus has been damaged in any way, such as power-supply cord or plug is damaged, liquid has been spilled or objects have fallen into the apparatus, the apparatus has been exposed to rain or moisture, does not operate normally, or has been dropped.
- 14.) Use only with the cart, stand, tripod, bracket, or table specified by the manufacturer, or sold with the apparatus. When a cart is used, use caution when moving the cart/apparatus combination to avoid injury from tip-over.
- 15.) The apparatus shall not be exposed to dripping or splashing and that no objects filled with liquids, such as vases, shall be placed on apparatus.
- 16.) Mains plug is used as disconnect device and it should remain readily operable during intended use. In order to disconnect the apparatus from the mains completely, the mains plug should be disconnected from the mains socket outlet completely.
- 17.) Battery shall not be exposed to excessive heat such as sunshine, fire or the like.

CAUTION: Danger of explosion if battery is incorrectly replaced. Replace only with the same or equivalent type.

PRÉCAUTION: Danger d'explosion si les piles sont remplacées de façon incorrect. Remplacer les piles seulement par le même type de pile ou l'équivalent.

* Les marquages sont inscrits en bas de l'appareil. Les précautions d'emploi sont inscrites en bas de l'appareil.
 La prise du secteur ne doit pas être obstruée ou doit être facilement accessible pendant son utilisation. Pour être complètement déconnecté de l'alimentation d'entrée, la prise doit être débranchée du secteur.
 Les piles ne doivent pas être exposées à de forte chaleur, tel qu'à la lumière du soleil, au feu ou autres choses de semblable.
 La prise du secteur est utilisé pour déconnecter le système.
 La prise du secteur ne doit pas être obstruée ou doit être facilement accessible pendant son utilisation.
 Pour être complètement déconnecté de l'alimentation d'entrée, la prise doit être débranchée du secteur.
 L'adaptateur AC/AC de l'appareil est utilisé pour déconnecter le système.
 L'adaptateur AC/AC de l'appareil ne doit pas être obstrué ou doit être facilement accessible pendant son utilisation.
 Pour être complètement déconnecté de l'alimentation d'entrée, l'adaptateur AC/AC de l'appareil doit être déconnecté du secteur.
 -minimum distances 10 cm around the apparatus for sufficient ventilations.
 -10cm de distance minimale autour de l'appareil pour une ventilation suffisante.
 -the ventilation should not be impeded by covering the ventilation openings with items such as newspaper, table-cloths, curtains etc.
 - Ne pas recouvrir les entrées d'aérations avec des objets tel qu'un journal, une nappe, un rideau, etc...
 -no naked flame sources such as lighted candles should be placed on the apparatus.
 - Aucune source de flamme nue, tel qu'une bougie, ne doit être placée sur l'appareil.
 -attention should be drawn to the environmental aspects of battery disposal.
 - Les piles usages doivent être jetées en respectant l'environnement.
 -the use of apparatus in tropical and/or moderate climates.
 -L'utilisation de l'appareil dans un climat tropical et/ou modéré

WARNING

WARNING
 Do not ingest the battery, Chemical Burn Hazard
 This product contains a coin/button cell battery.
 If the coin/button is swallowed, it can cause severe internal burns in just 2 hours and can lead to death.
 Keep new and used batteries away from children.
 If the battery compartment does not close securely, stop using the product and keep it away from children.
 If you think batteries might have been swallowed or placed inside any part of the body, seek immediate medical attention.

AVERTISSEMENT

Ne pas ingérer la pile, Danger de brûlure chimique
 Ce produit contient une pile bouton. Si la pile bouton est avalée, elle peut provoquer de graves brûlures internes en 2 heures seulement et peut entraîner la mort.
 Conserver les piles neuves et usées hors de portée des enfants.
 Si le compartiment pile ne se ferme pas correctement, cesser d'utiliser le produit et tenir hors de portée des enfants.
 En cas de doute concernant le fait que les piles pourraient avoir été avalées ou introduites dans une partie quelconque du corps, consulter immédiatement un médecin.

Thank you for purchasing this Emerson SmartSet® Dual Alarm Clock Radio. This clock radio uses Emerson's patented SmartSet® Automatic Time Setting System. The first time you connect this clock radio to your AC outlet, and after every power interruption, within seconds the clock will automatically set itself to the correct Year, Month, Date, Day, and Time. In addition all changes from Standard Time to Daylight Saving Time, and back to Standard Time, are made automatically. There are dual alarms that can be set and used independently, and both of the alarms can be programmed for everyday operation, weekdays only, or weekends only. There is a long life lithium battery installed in this clock radio when you buy it. This battery can maintain the time and alarm settings for 3 to 5 years, or even longer. We have taken every precaution to make sure this radio was in perfect working order when it left our factory. If you encounter any problems with the set up or operation of this item, please call the Emerson Consumer Products Corp., Customer Service Hotline, toll free, at **1-800-898-9020**.

2 IMPORTANT NOTES

- Avoid installing this unit in places exposed to direct sunlight or close to heat radiating appliances such as electric heaters, on top of other stereo equipment that radiates too much heat, places lacking ventilation or dusty areas, places subject to constant vibration and/or humid or moist areas.
- Operate controls and switches as described in the manual.
- Before turning on the power, make certain that the AC adapter is properly installed.
- When moving the set, be sure to first disconnect the AC adapter.

FCC Information

This equipment has been tested and found to comply with the limits for a Class B digital device, pursuant to Part 15 of the FCC Rules. These limits are designed to provide reasonable protection against harmful interference in a residential installation. This equipment generates, uses, and can radiate radio frequency energy and, if not installed and used in accordance with the instructions, may cause harmful interference to radio communications. However, there is no guarantee that interference will not occur in a particular installation. If this equipment does cause harmful interference to radio or television reception, which can be determined by turning the equipment off and on, the user is encouraged to try to correct the interference by one or more of the following measures:

- Reorient or relocate the receiving antenna.
- Increase the separation between the equipment and receiver.
- Connect the equipment into an outlet on a circuit different from that to which the receiver is connected.
- Consult the dealer or an experienced radio/TV technician for help. This device complies with Part 15 of the FCC Rules. Operation is subject to the following two conditions:
 - (1) This device may not cause harmful interference, and
 - (2) This device must accept any interference received, including interference that may cause undesired operation.

Changes or modifications not expressly approved by the party responsible for compliance could void the user's authority to operate the equipment. The device has been evaluated to meet general RF exposure requirement. This equipment should be installed and operated with a minimum distance of 20cm between the radiator and your body.

3 PREPARATION FOR USE

Unpacking And Set Up

- Remove the radio from the carton and remove all packing material from the

radio. **We suggest that you save the packing material, if possible, in the unlikely event that your radio ever needs to be returned for service. The original carton and packing material is the only safe way to pack your radio to protect it from damage in transit.**

- Remove any descriptive labels, stickers or protective film on the front or top of the cabinet, if any. Do Not remove any labels or stickers from the back or bottom of the cabinet.
- Note the serial number on the bottom of your radio and write this number in the space provided on the Warranty page of this manual.
- Place your radio on a level surface such as a table, desk or shelf, convenient to an AC outlet, out of direct sunlight, and away from sources of excess heat, dirt, dust, moisture, humidity, or vibration.
- Unwind the line cord connecting the AC adapter. Extend the wire antenna fully and orient it for better FM reception.

Protect Your Furniture

This model is equipped with non-skid rubber 'feet' to prevent the product from moving when you operate the controls. These 'feet' are made from non-migrating rubber material specially formulated to avoid leaving any marks or stains on your furniture. However certain types of oil based furniture polishes, wood preservatives, or cleaning sprays may cause the rubber 'feet' to soften, and leave marks or a rubber residue on the furniture. To prevent any damage to your furniture we strongly recommend that you purchase small self-adhesive felt pads, available at hardware stores and home improvement centers everywhere, and apply these pads to the bottom of the rubber 'feet' before you place the product on fine wooden furniture.

Power Source

This radio is designed to operate on normal 120V 60Hz AC power only. Do not attempt to operate the radio on any other power source. You could cause damage to the radio that is not covered by your warranty. This radio should be connected to an AC outlet that is always 'live'. Do not connect it to an outlet that is controlled by a wall switch. When the power to the radio is interrupted, the built in lithium battery takes over to maintain the time and alarm settings. To maximize the life of the lithium battery keep the radio connected to a 'live' AC outlet at all times.

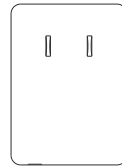

4 LOCATION OF CONTROLS AND INDICATORS

Front Panel



Top Panel

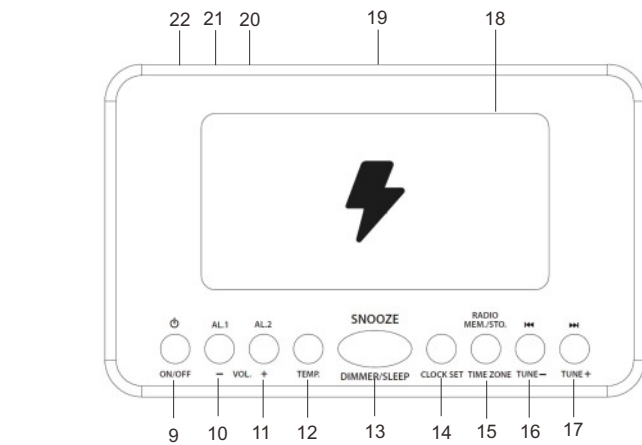

- 1.) Alarm 1 'Radio' Indicator
- 2.) Alarm 1 'Buzzer' Indicator
- 3.) AM Indicator ('On'=AM, 'Off'=PM)
- 4.) Wireless Charging Indicator
- 5.) Battery Compartment (bottom)
- 6.) LOW BATT. Indicator
- 7.) Alarm 2 'Buzzer' Indicator
- 8.) Alarm 2 'Radio' Indicator
- 9.) ON/OFF button
- 10.) VOL-/AL.1 button
- 11.) VOL+/AL.2 button
- 12.) Ambient Temperature button
- 13.) SNOOZE/DIMMER/SLEEP button
- 14.) CLOCK SET button
- 15.) TIME ZONE/MEM./STO. button
- 16.) TUNE- button
- 17.) TUNE+ button
- 18.) Wireless Charging Pad
- 19.) Speaker (back)
- 20.) Temperature Sensor (back)
- 21.) AC Adapter (bottom)
- 22.) FM Wire Antenna (back)

5 OPERATING INSTRUCTIONS

Setting The Time, The First Time

IMPORTANT: The first time you connect your new SmartSet® clock radio to the AC outlet the internal computer will automatically set the time correctly for the **Eastern Time Zone**, which is the initial default setting. The display will scan for a few seconds and then show the correct **Day** and **Time** in the Eastern zone. If you live in the Eastern Time zone, there's nothing else to do. Your clock is set correctly and running.

If you do not live in the Eastern Time zone you must change the default zone display to your own zone. You only do this one time and the **Smart Set®** will remember the new default zone setting and will always return to that setting after a power interruption.

There are 7 time zones programmed into your **Smart Set®** clock radio as follows :

- | | |
|------------------------|---|
| ZONE 1 — Atlantic Time | ZONE 2 — Eastern Time (Default Setting) |
| ZONE 3 — Central Time | ZONE 4 — Mountain Time |
| ZONE 5 — Pacific Time | ZONE 6 — Yukon Time |
| ZONE 7 — Hawaiian Time | |

To change the default time zone display, press and hold the **TIME ZONE** button, until the display 'Flashes' The number "2" will appear on the display indicating that the default zone is ZONE 2, Eastern Time.



Release the **TIME ZONE** button and then press either the **TUNE-** or **TUNE+** button until your own time zone appears on the display, then release the button. The clock display will change to the correct time in the time zone you selected. The clock will always return to the correct time in the zone you selected after every power interruption. If you move to a different time zone, simply change the default zone display to the new zone and the SmartSet® will remember that setting for you.

Checking The Current Year-Date-Day of Week-Time Settings

Press the **CLOCK SET** button repeatedly to see the cycle of year, date, day of week and time. To restore time display mode, leave it idle for few seconds.



Note: From d1, d2 to d7 stand for from Monday, Tuesday to Sunday separately.

Setting The Year

- ① Press and hold the **CLOCK SET** button until the Year 'Flashes', then release the button;
- ② Press the **TUNE-** or **TUNE+** button to adjust the Year ('y22'=year 2022 and so on);



Setting The Date

- ③ Press the **CLOCK SET** button again and release, the Date 'Flashes';
- ④ Press the **TUNE-** or **TUNE+** button to adjust the Month;
- ⑤ Press the **CLOCK SET** button again and release, the Date 'Flashes';
- ⑥ Press the **TUNE-** or **TUNE+** button to adjust the Date;



Setting The Time

- ⑦ Press the **CLOCK SET** button again and release, the Hour 'Flashes';
- ⑧ Press the **TUNE-** or **TUNE+** button to adjust the Hour (where AM indicator 'On' is AM, 'Off' is PM);
- ⑨ Press the **CLOCK SET** button again and release, the Minutes 'Flashes';
- ⑩ Press the **TUNE-** or **TUNE+** button to adjust the Minutes
- ⑪ Press the **CLOCK SET** button again, or leave it idle for few tens of seconds, to save all new settings and restore it to time display mode.



Note: Time zone and clock settings can only be adjusted in Standby mode, where the FM Radio is disabled.

Daylight Saving Time And Leap Year Adjustments

All Daylight Saving and Leap Year adjustments are made automatically by the SmartSet® internal computer as follows:

- **Start of Daylight Saving Time:**
At "2:00 AM" on the **2nd Sunday in March**, the clock will automatically advance to "3:00 AM".
- **End of Daylight Saving Time:**
At "3:00 AM" on the **1st Sunday in November**, the clock will automatically reset to "2:00 AM".
- **Leap Year**
At "12:00 Midnight" on **February 28th**, the calendar display will change to "2.29".

IMPORTANT NOTES

Turn Daylight Saving Function OFF/ON (in Standby Mode Only)
 Daylight Saving Time is NOT observed in Hawaii, American Samoa, Guam, Puerto Rico, the Virgin Islands and in, most of Arizona, with exception of the Navajo Indian Reservation in Arizona. If you do not want the clock to adjust itself automatically according to Daylight Saving Time, you can disable it by pressing and holding the **TUNE+** (DST start date) or **TUNE-** (DST end date) button for 5 secs, the display will show 'dSt On' DST start or end date accordingly, which means the auto Daylight Saving Time has been enabled ('On' by default). Press the **TUNE+** or **TUNE-** button accordingly to toggle between 'OFF' and 'On' both DST start and end dates. Leave it idle for a few seconds to store your new DST settings and resume to clock mode.
NOTE: If you manually adjust the time, your new setting is entered into the SmartSet® memory. If the power is interrupted, the display will return to your new setting, not the original setting, when the power is restored.

Adjusting The Wake Up Time, Alarm Week Mode And Alarm Volume

IMPORTANT: *Alarm settings can only be adjusted in Standby mode.*

Your SmartSet® clock radio has separate alarms that can be set and used independently. You may use the alarms to wake two people at different times, or you may use one alarm for weekdays and the other for weekend wake up times. The procedure for adjusting the wake up times is the same for both Alarm1 and Alarm2.

- Press and hold the **AL.1(AL.2)** button until the display blinks and changes from the current time to the Alarm1(Alarm2) wake up time.
- Release the **AL.1(AL.2)** button, press the **TUNE-** or **TUNE+** button to adjust Hours. Press the **AL.1(AL.2)** button again to confirm, then the Minutes blinks. Press the **TUNE-** or **TUNE+** button to adjust Minutes.
- Press the **AL.1(AL.2)** button again to confirm, then the Alarm Week Mode blinks. Press the **AL.1(AL.2)** button repeatedly to select your desired Alarm Week Mode: **1-7, 1-5 or 6-7.**
- Press the **AL.1(AL.2)** button again to confirm, then the Alarm Volume blinks (only if it is set to wake-to-radio alarm mode). Press the **TUNE-** or **TUNE+** button to select your desired wake-to-radio alarm volume (**V01~V16**).
- Press the **AL.1(AL.2)** button again to store the alarm setting and resume to clock mode.

NOTE: *Be sure that you have set the wake up time correctly by observing the AM Indicator. If the AM Indicator is 'On' the wake up time is "AM". If the AM Indicator is 'Off', the wake up time is "PM".*

Your SmartSet® clock radio allows you to select from three different **Alarm Week Modes** for each alarm. They are:

- **1-7 Everyday** — the alarm will turn on all 7 days.

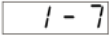

- **1-5 Weekdays only** — the alarm will only turn on Monday through Friday;

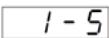

- **6-7 Weekends only** — the alarm will only turn on Saturday and Sunday.

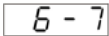

Checking The Wake Up Times (in Standby mode only)

To check the Wake Up Time set for Alarm1(Alarm2), press briefly the **AL.1(AL.2)** button.

Listening To The Radio

- 1.) Press the **ON/OFF** button to turn the radio On. The frequency of the tuning frequency will show for a few seconds on the display.
- 2.) Set the volume level by pressing the **VOL+** or **VOL-** button to a level that is neither too high nor too inaudible.
- 3.) Select your desired radio station/frequency with the TUNING control:
 - a) Press **TUNE+** or **TUNE-** button briefly, the receiving frequency will increment or decrement by one step.
 - b) Press and hold the **TUNE+** or **TUNE-** button for two seconds then release. Auto Station Searching will be engaged, the receiving frequency will increment or decrement automatically until a station with acceptable reception is found.
- 4.) Adjust the volume control to the desired setting.
- 5.) When you finished listening, press the **ON/OFF** button to turn the radio Off.

Storing And Recalling Radio Station Memory

When you have a few favorite radio stations to listen to, you may like to save them, and pick one out of them in a few seconds without needing to search it each time.

Our digital tuning technology PLL (Phase-Lock-Loop) allows you to do this easily

by following steps:

Storing Stations Into Memory

- 1) Make sure the radio is turned ON.
- 2) Tune in the desired station with the TUNING control described above.
- 3) Press and hold the **STO.** button until 'PXX' blinks, where 'XX' (01~20) is the programmable memory location.
- 4) While 'PXX' is blinking, press the **TUNE-** or **TUNE+** button to change it to your desired memory location from 01 to 20. For example, 'P03' means the current listening station is about to be stored on the 3rd location of the memory.
- 5) After deciding the memory location, press the **STO.** button again, the current listening station is then stored accordingly.
- 6) The display will show the frequency of the station just stored for few seconds and then resume to clock mode.

Recalling Stations From Memory

- 1) Make sure the radio is ON.
- 2) Press the **MEM.** button, 'PXX' shows on the display. The station according to the memory location will be tuned in.
- 3) While 'PXX' is showing on the display, press the **TUNE-** or **TUNE+** button can change the memory location from 1 through 20, and the station stored in that location will then be tuned in.
- 4) The display will show the frequency of the station for few seconds and then resume to clock mode.

Wake To RADIO (1↯ or 2↯)

- 1) Press the **AL.1(AL.2)** button repeatedly to turn the **1↯(2↯)** Indicator On.
- 2) Press and hold the **AL.1(AL.2)** button until the display blinks and changes from the current time to the Alarm1 or Alarm2 wake up time.
- 3) Release the **AL.1(AL.2)** button, press the **TUNE-** or **TUNE+** button to adjust Hour. Press the **AL.1(AL.2)** button to confirm, then the Minutes will blink. Press the **TUNE-** or **TUNE+** button to adjust Minutes.
- 4) Press the **AL.1(AL.2)** button to confirm, then press the **TUNE-** or **TUNE+** button to select Alarm Week Mode (1-7 everyday, 1-5 weekdays or 6-7 weekends only), if necessary.

- 5) Press the **AL.1(AL.2)** button to confirm, then press the **VOL-** or **VOL+** button to adjust the alarm volume level (V01~V16) that will come on at wake up time.
- 6) Press the **AL.1(AL.2)** button to confirm and save the alarm settings.
- 7) At the selected wake up time the radio will turn On and has its radio volume gradually reaches its preset level. It will play for one hour and then shut Off automatically.
- 8) To stop the radio sooner, press the **ON/OFF** button. The radio will stop but the alarm remains set and will turn the radio On again at the same time on the following day (depending on the Alarm Week Mode setting).
- 9) If you do not want the alarm to turn the radio On the following day, quickly press and release the appropriate ALARM button until alarm indicator light is Off.

Wake To BUZZER(1↯ or 2↯)

NOTE: *Alarm 1 and Alarm 2 have different buzzer sounds.*

- *Alarm 1 is a "Single beep" sound.*
- *Alarm 2 is a "Double beep" sound.*

You will be able to tell which alarm is going off by the sound that it makes.

- 1.) Reconfirm the wake up time and alarm mode settings for the alarm you are using, Alarm 1, Alarm 2, or both alarms.
- 2.) Press **AL1** or **AL2** button slightly, and repeat doing so if necessary, until **ALARM 1** 1↯ "BUZZER" or **ALARM 2** 2↯ "BUZZER" indicator is lit on the display.
- 3.) At the selected wake up time the buzzer will sound. It will continue for one hour and then shut off automatically.

NOTE: Wake-to-buzzer alarm volume level is fixed and cannot be adjusted.
- 4.) To stop the buzzer sooner, press the **ON/OFF** button. The buzzer will stop but the alarm remains set and will turn the buzzer on again at the same time on the following day (depending on the Alarm Week Mode setting).
- 5.) If you do not want the alarm to turn the radio on the following day, quickly press and release the appropriate ALARM button until the alarm indicator light is off.

Radio And Buzzer Alarm Operation

You may also set one alarm for wake to **RADIO** and the other for wake to **BUZZER**. Just press the **AL1** and **AL 2** buttons to the desired status as shown on the ALARM indicators.

Snooze/Repeat Alarm

After the alarm turns 'On' you can press the **SNOOZE** button on the top cabinet for a few extra minutes sleep. The corresponding ALARM indicator will flash. The alarm will stop for approximately 9 minutes and then comes 'On' again. The Snooze operation may be repeated several times if desired but after one hour the alarm will not come on again.

Sleep To Music Timer

You can program the sleep timer to play the radio for up to 90 minutes and then shut 'Off' automatically.

- 1) Press the **SLEEP** button after the radio is turned On. The display will show '10' (10 minutes default). After 10 minutes countdown the radio will shut off automatically. Each time you press the **SLEEP** button the sleep timer increases in 10 minutes step (10-90, OFF minutes).

NOTE: *When you change the sleep timer from the 10 minutes default setting to a different setting, the new setting becomes the default setting. Whenever you activate the sleep timer it will begin with your new default setting and count down to zero from that point.*
- 2) To cancel the sleep timer before it counts down to '00' and shut the radio Off immediately, press the **ON/OFF** button once.





4-Level DIMMER Control

Press the **DIMMER** button while in Standby mode and select any of the four levels.

Wireless Charging

A 5W Wireless Charging Pad is built on top of this unit for wireless power transfer to any Qi-compatible Smartphones or Qi-enabled Receivers over a vertical distance of NOT more than 0.2 inches (5 mm).

- 1) Place your Qi-compatible smartphone or receiver (only one set at a time) on top of the Wireless Charging Pad. The center of your smartphone or receiver must be positioned properly right at the middle of this charging pad in order to maximize the charging efficiency.
- 2) While wireless charging started or detected, the  indicator will be flashing 'Red' slowly.
- 3) To make sure wireless charging performs properly, check the charging icon and/or charging message displays on your phone.
- 4) While your phone is fully charged, the  indicator will turn solid 'Red'. Please also check the charging icon and/or charging message on your phone to ensure it is fully charged, then remove it from the wireless charging pad.

Note:

- This wireless charging pad works with Qi-compatible device including iPhone 14/13/12/11/XS/XR/X/8/8 Plus, Galaxy S22, S21, S20, S10 Plus/S10E/S10/S9 and 5W-15W all Qi-enabled phones.
- Wireless charging may not work properly if the protective case or accessory placed at the back of your smartphone is thicker than 0.2 inches (5 mm), remove the protective case or accessory before placing your phone (screen facing upward) on the wireless charging pad.
- Do not place any foreign objects, such as coins, keys, metallic objects, magnets, and magnetic stripe cards, between your phone and the wireless charger, to avoid interference or overheating. While wireless charging error occurred, the  indicator will be flashing 'Red' rapidly to alert user to get the erroneous receiver removed.

Sensing Room Temperature

- ① Press the **TEMP.** button to sense indoor temperature.
- ② Temperature can be converted between Fahrenheit and Celsius by pressing and holding the **TEMP.** button while in temperature mode.

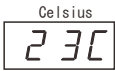

WARNING: DO NOT place the Temperature Sensor in the mouth or any part of the body to avoid it from fracturing into small particles and harming you.

NOTE: *When the sensor exceeds the operating range (32-140°F), it will display as "--F".*

Changing The Lithium Battery

Like all batteries, eventually the built in lithium battery will need to be replaced. A number of factors, such as, the length of time between the date the radio was manufactured and the date you plugged it in for the first time determine the amount of time before replacement. During this initial storage period, the lithium battery is supplying power to the SmartSet® computer memory. Once you plug the radio in, your household outlet supplies the power, and the battery is not being used. A fresh lithium battery can supply power to the SmartSet® computer for at least 3 years even if it is never connected to an AC power supply. If your clock radio was connected to your AC supply within a few months after it was manufactured, and you experience only the normal, nuisance type, short duration power interruptions, your battery may last for up to 5 years or even longer.

When the battery power drops below a certain level, the  **LOW BATT.** indicator will 'Flash'. When you see this indicator, you should change the battery as soon as it is convenient for you to do so. To change the battery proceed as follows:

- 1.) Purchase a replacement 3V lithium battery wherever batteries are sold . The battery type is **CR2032** or equivalent.
 - 2.) Remove the battery from its package so it is ready to install.

IMPORTANT: *Leave the AC adapter connected to your AC outlet. This will provide power to the SmartSet® computer memory while the original lithium battery is removed.*
 - 3.) Turn the radio bottom up and use a small screw driver to remove the screw securing the battery holder to the cabinet.
 - 4.) Remove the original battery from the holder and insert the new battery into the holder the same way, observing the positive (+) direction. Slide the holder with the new battery back into the slot in the cabinet.

BE CAREFUL NOT TO LOSE THIS SMALL SCREW!
 - 5.) Replace the screw that secures the battery holder in the cabinet.
 - 6.) Turn the radio right side up and confirm that the  **LOW BATT** indicator is 'Off'.
 - 7.) Save these instructions for future use as you will have to do this again.
- WARNING: DANGER OF EXPLOSION IF BATTERY IS INCORRECTLY REPLACED. REPLACE ONLY WITH THE SAME OR EQUIVALENT TYPE.**

Resetting The Clock After A Total Memory Loss

If you do not change the built in lithium battery within a reasonable period of time after you see the  warning indicator, the lithium battery may become exhausted and will no longer be able to supply back up power to the SmartSet® internal computer. If the unit is disconnected from the AC outlet after the battery is exhausted or if a power interruption occurs, the SmartSet® memory will be lost and the clock will need to be reset when the power is restored. Be sure to install a fresh lithium battery before you reset the clock, otherwise the clock will need to be reset each time the power is interrupted.

If the lithium battery is exhausted and you experience an interruption in the AC power supply, the clock will reset itself to its initial default setting when the power is restored.

The initial default setting is "**12:00 AM, Saturday, January 1st (1. 1), 2022**".

If you notice that the time on your SmartSet® clock radio is completely incorrect, and the **DAY OF WEEK** indicator is also wrong, press the **CLOCK SET** button to see the date.

If the date display is showing "**1. 1**" (January 1st), you probably experienced a total memory loss. To reset the clock after a total memory loss, proceed as follows:

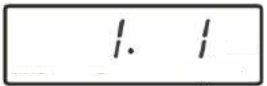

- 1.) Follow the instructions on previous page to install a new **CR2032** lithium battery in the battery compartment.
- 2.) Connect the radio to your AC outlet and let the clock set itself.
- 3.) Follow the instructions on sections Setting the Year/Date/Time to set the clock to the correct year,date and time
- 4.)The **DAY OF WEEK** indicator will change automatically as you adjust the Month/Date settings. Press the **CLOCK SET** button repeatedly to check the year,date and time.
- 5.)Be sure to confirm that you have set the time correctly to 'AM' or 'PM' by observing the **AM** indicator. Make final adjustment if necessary.

The SmartSet® clock memory is now reset and the new lithium battery will maintain it for the next 3 to 5 years, depending on the number and duration of the power outages you experience.

IMPORTANT NOTE

After resetting the clock, don't forget to reset your wake up times and alarm mode settings, and sleep timer settings as well.

6 CARE AND MAINTENANCE

Care Of Cabinets

If the cabinet becomes dusty, wipe it with a soft cloth. If the cabinet becomes smudged or dirty, clean it with a soft, slightly dampened cloth . Never allow water or any liquid to get inside the cabinet. Never use any abrasive cleaners or cleaning pads as these will damage the finish of your radio.

Lithium Battery Precautions

- *Dispose of the old battery properly. Do not leave it lying around where a young child or pet could play with , or swallow it. If the battery is swallowed, contact a physician immediately.*
- *Battery may explode if mistreated. Do not attempt to recharge it or disassemble it. Do not dispose of the old battery in a fire.*

7 LIMITED WARRANTY

Emerson Radio Corp. warrants this product to be free from manufacturing defects in original material, including original parts, and workmanship under normal home use and conditions ("manufacturing defect") for a period of ninety (90) days from date of original purchase in, and if used in the United States. Should service be necessary under this warranty, Emerson will provide the following at our Return Repair Facility provided the manufacturing defect is verified along with the date of purchase:

* **Repair service for ninety (90) days from date of original purchase at no charge for labor and parts.**

To Receive Authorization to Return a Defective Item, please contact Emerson Customer Service at 1-800-898-9020 or at <http://www.emersonradio.com/service/> return-policy. Have your Model number, Serial Number and dated Proof of Purchase with you when you call. In the event the product must be returned to Emerson:

- * Pack the unit in a well-padded heavy corrugated box. Please insure the item is well padded to avoid damage while in transit back to our facility. **If the item incurs damage, it will NOT be replaced and the consumer will be responsible for return freight costs to receive their same unit back.**
- * Enclose your check or money order payable to Emerson Radio in the amount of \$10 to cover return shipping and handling costs.
- * Enclose a note with your name, address, phone number, Return Authorization number and brief reason for returning the unit.
- * Enclose a copy of your proof of purchase (warranty service will not be provided without dated proof of purchase).
- * Ship the unit prepaid via UPS or parcel post (SHIP INSURED and obtain a tracking number).

NOTE: This warranty does not cover:

- (a) Damage to equipment not properly connected to the product.
- (b) Cost incurred in the shipping of the product to and from Emerson's Return Facility.
- (c) Damage or improper operation of unit caused by customer abuse, misuse, negligence or failure to follow operating instructions (including cleaning instructions) provided with the product.
- (d) Ordinary adjustments to the product which can be performed by customer as outlined in the owner's manual.
- (e) Signal reception problems caused by external antenna or cable systems.
- (f) Products not purchased in the United States.
- (g) Damage to product if used outside the United States.
- (h) Refurbished units.

THIS WARRANTY IS NON-TRANSFERABLE AND APPLIES ONLY TO THE ORIGINAL PURCHASER AND DOES NOT EXTEND TO SUBSEQUENT OWNERS OF THE PRODUCT. ANY APPLICABLE IMPLIED WARRANTIES, INCLUDING THE WARRANTY OF MERCHANTABILITY, ARE LIMITED IN DURATION TO A PERIOD OF THE EXPRESSED WARRANTY AS PROVIDED HEREIN BEGINNING WITH THE DATE OF ORIGINAL PURCHASE AT RETAIL AND NO WARRANTIES, WHETHER EXPRESSED OR IMPLIED, SHALL APPLY TO THE PRODUCT THEREAFTER. EMERSON MAKES NO WARRANTY AS TO THE FITNESS OF THE PRODUCT FOR ANY PARTICULAR PURPOSE OR USE. THE EXTENT OF EMERSON RADIO CORP'S LIABILITY UNDER THIS LIMITED WARRANTY IS THE REPAIR OR REPLACEMENT PROVIDED ABOVE AND, IN NO EVENT, SHALL EMERSON RADIO CORP'S LIABILITY EXCEED THE PURCHASE PRICE PAID BY THE PURCHASER OF THE PRODUCT. UNDER NO CIRCUMSTANCES SHALL EMERSON RADIO CORP. BE LIABLE FOR ANY LOSS, DIRECT, INDIRECT, INCIDENTAL, SPECIAL, OR CONSEQUENTIAL DAMAGE ARISING OUT OF OR IN CONNECTION WITH THE USE OF THIS PRODUCT. THIS WARRANTY IS VALID ONLY IN THE UNITED STATES OF AMERICA. THIS WARRANTY GIVES YOU SPECIFIC LEGAL RIGHTS. HOWEVER, YOU MAY HAVE OTHER RIGHTS WHICH MAY VARY FROM STATE TO STATE. SOME STATES DO NOT ALLOW LIMITATIONS ON IMPLIED WARRANTIES OR EXCLUSION OF CONSEQUENTIAL DAMAGE, THEREFORE THESE RESTRICTIONS MAY NOT APPLY TO YOU.

10-90-1402A

The Serial Number can be found on the bottom cabinet. We suggest that you record the Serial Number of your unit in the space below for future reference. Model Number: CKSW0555
Serial Number: _____

To register your product online please visit <http://www.emersonradio.com/service/product-registration/>



 **CALIFORNIA RESIDENTS ONLY – WARNING:** Cancer and Reproductive Harm – www.P65Warnings.ca.gov

Emerson Part No. CKSW0555-20230206-00

Printed in China