

# LF Beauty Limitd

## TEST REPORT

**SCOPE OF WORK**

EMC TESTING-2043972

**REPORT NUMBER**

180731131GZU-001

**ISSUE DATE**

28-August-2018

**[REVISED DATE]**

[-----]

**PAGES**

54

**DOCUMENT CONTROL NUMBER**

FCC BT 4.0-c

© 2017 INTERTEK



## TEST REPORT

Telephone: 86-20-8213 9688

Facsimile: 86-20-3205 7538

[www.intertek.com](http://www.intertek.com)

Applicant Name & Address : LF Beauty Limitd  
2/F, HK Spinners Industrial Building, Phases I & II, 800 Cheung Sha  
Wan Road, Kowloon, Hong Kong, China

Manufacturing Site : Same as applicant

Intertek Report No: 180731131GZU-001

FCC ID: 2ALCP2043972

## Test standards

**47 CFR PART 15 Subpart C: 2017 section 15.247**

## Sample Description

Product : DP BASE FOR CTD LLAB STD ALONE C1

Model No. : 2043972

Electrical Rating : Powered by 3.7Vdc (recharged batteries) or powered by  
5Vdc(adaptor)

Adaptor: Model:TBA0050500100D4  
Input: 100-240Vac, 50/60Hz, 1500mA, Max  
Output:5Vdc, 1000mA

**Serial No.** : Not Labeled

Date Received : 31 July 2018

Date Test : 31 July 2018-27 August 2018

Conducted

Prepared and Checked By

Approved By:



Daniel He

Project Engineer

Intertek Guangzhou



Helen Ma

Team Leader

Intertek Guangzhou

This report is for the exclusive use of Intertek's Client and is provided pursuant to the agreement between Intertek and its Client. Intertek's responsibility and liability are limited to the terms and conditions of the agreement. Intertek assumes no liability to any party, other than to the Client in accordance with the agreement, for any loss, expense or damage occasioned by the use of this report. Only the Client is authorized to permit copying or distribution of this report and then only in its entirety. Any use of the Intertek name or one of its marks for the sale or advertisement of the tested material, product or service must first be approved in writing by Intertek. The observations and test results in this report are relevant only to the sample tested. This report by itself does not imply that the material, product, or service is or has ever been under an Intertek certification program.

**TEST REPORT**

**CONTENT**

**TEST REPORT ..... 1**

**CONTENT ..... 3**

**1.0 TEST RESULT SUMMARY ..... 4**

**2.0 GENERAL DESCRIPTION..... 5**

    2.1 PRODUCT DESCRIPTION .....5

    2.2 RELATED SUBMITTAL(S) GRANTS .....6

    2.3 TEST METHODOLOGY .....6

    2.4 TEST FACILITY.....6

**3.0 SYSTEM TEST CONFIGURATION..... 6**

    3.1 JUSTIFICATION .....6

    3.2 EUT EXERCISING SOFTWARE.....7

    3.3 SPECIAL ACCESSORIES.....7

    3.4 MEASUREMENT UNCERTAINTY.....8

    3.5 EQUIPMENT MODIFICATION .....8

    3.6 SUPPORT EQUIPMENT LIST AND DESCRIPTION .....8

**4.0 MEASUREMENT RESULTS..... 9**

    4.1 ANTENNA REQUIREMENT .....9

    4.2 6 dB BANDWIDTH (DTS BANDWIDTH) .....10

    4.3 MAXIMUM PEAK CONDUCTED OUTPUT POWER .....14

    4.4 PEAK POWER SPECTRAL DENSITY.....18

    4.5 OUT OF BAND CONDUCTED EMISSIONS .....22

    4.6 OUT OF BAND RADIATED EMISSIONS .....27

    4.7 RADIATED EMISSIONS IN RESTRICTED BANDS.....28

    4.8 BAND EDGES REQUIREMENT.....47

    4.9 CONDUCTED EMISSION TEST.....51

**5.0 TEST EQUIPMENT LIST ..... 54**

## TEST REPORT

### 1.0 TEST RESULT SUMMARY

Test Item	Test Requirement	Test Method	Result
Antenna Requirement	FCC PART 15 C section 15.247 (c) and Section 15.203	FCC PART 15 C section 15.247 (c) and Section 15.203	PASS
6 dB Bandwidth (DTS bandwidth)	FCC PART 15 C section 15.247 (a)(2)	ANSI C63.10: Clause 11.8	PASS
Maximum Peak Conducted Output Power	FCC PART 15 C section 15.247(b)(3)	ANSI C63.10: Clause 11.9.1.2	PASS
Peak Power Spectral Density	FCC PART 15 C section 15.247(e)	ANSI C63.10: Clause 11.10.2	PASS
Out of Band Conducted Emissions	FCC PART 15 C section 15.209 & 15.247(d)	ANSI C63.10: Clause 11.11	PASS
Out of Band Radiated Emission	FCC PART 15 C section 15.209 & 15.247(d)	ANSI C63.10: Clause 11.11, 6.4, 6.5 and 6.6	N/A
Radiated Emissions in Restricted Bands	FCC PART 15 C section 15.209 & 15.247(d)	ANSI C63.10: Clause 11.12.1, 6.4, 6.5 and 6.6	PASS
Band Edges Measurement	FCC PART 15 C section 15.247 (d) & 15.205	ANSI C63.10: Clause 11.11 and 11.13	PASS
Conducted Emissions at Mains Terminals	FCC PART 15 C section 15.207	ANSI C63.10: Clause 6.2	PASS

**Remark:**

N/A: not applicable. Refer to the relative section for the details.

EUT: In this whole report EUT means Equipment Under Test.

Tx: In this whole report Tx (or tx) means Transmitter.

Rx: In this whole report Rx (or rx) means Receiver.

RF: In this whole report RF means Radio Frequency.

ANSI C63.10: the detail version is ANSI C63.10:2013 in the whole report.

## TEST REPORT

### 2.0 General Description

#### 2.1 Product Description

Operating Frequency: 2402 MHz – 2480MHz  
 Type of Modulation: GFSK  
 Number of Channels: 40 Channels  
 Channel Separation: 2 MHz  
 Antenna Type: Integral  
 Antenna Gain: 2 dBi  
 Speciality: Bluetooth 4.0 with BLE (Bluetooth Low Energy)  
 Power Supply: Powered by 3.7Vdc (recharged batteries) or powered by 5Vdc(adaptor)

Power cord: 1.2 m x 2 wires unscreened AC supply cable

EUT modulation and data packet during test:

The EUT has been tested on the Modulation of GFSK with 1 Mbps data rate.

EUT channels and frequencies list:

Test frequencies are lowest channel 0: 2402 MHz, middle channel 19: 2440 MHz and highest channel 39: 2480 MHz.

Channel	Frequency (MHz)	Channel	Frequency (MHz)	Channel	Frequency (MHz)
0	2402	14	2430	28	2458
1	2404	15	2432	29	2460
2	2406	16	2434	30	2462
3	2408	17	2436	31	2464
4	2410	18	2438	32	2466
5	2412	19	2440	33	2468
6	2414	20	2442	34	2470
7	2416	21	2444	35	2472
8	2418	22	2446	36	2474
9	2420	23	2448	37	2476
10	2422	24	2450	38	2478
11	2424	25	2452	39	2480
12	2426	26	2454	/	/
13	2428	27	2456	/	/

## TEST REPORT

### 2.2 Related Submittal(s) Grants

This is an application for certification of:  
DTS- Part 15 Digital Transmission Systems

Remaining portions are subject to the following procedures:

1. Receiver portion of BLE: exempt from technical requirement of this Part.
2. The Lighting function: evaluate by FCC SDOC.
3. NFC Part: exempt from FCC requirement (Remark: The NFC on the DUT is PASSIVE Tag, it has not its own power source).

### 2.3 Test Methodology

Both AC mains line-conducted and radiated emission measurements were performed according to the procedures in ANSI C63.10. Radiated emission measurement was performed in semi-anechoic chamber and conducted emission measurement was performed in shield room. For radiated emission measurement, preliminary scans and final tests were performed in the semi-anechoic chamber to determine the worst case modes. All radiated tests were performed at an antenna to EUT distance of 3 meters, unless stated otherwise.

### 2.4 Test Facility

All tests were performed at:

Room102/104, No 203, KeZhu Road, Science City, GETDD Guangzhou, China

Except Conducted Emissions was performed at:

Block E, No.7-2 Guang Dong Software Science Park, Caipin Road, Guangzhou Science City, GETDD Guangzhou, China

A2LA Certificate Number 0078.10

Intertek Testing Services Shenzhen Ltd. Guangzhou Branch is accredited by A2LA and Listed in FCC website. FCC accredited test labs may perform both Certification testing under Parts 15 and 18 and Declaration of Conformity testing.

## 3.0 System Test Configuration

### 3.1 Justification

For emissions testing, the equipment under test (EUT) setup to transmit continuously to simplify the measurement methodology. Care was taken to ensure proper power supply voltages during testing. During testing, AC power line was manipulated to produce worst case emissions. It was powered by 5Vdc (adaptor) supply.

## TEST REPORT

The signal is maximized through rotation and placement in the three orthogonal axes. The antenna height and polarization are varied during the search for maximum signal level. The antenna height is varied from 1 to 4 meters. Radiated emissions are taken at three meters unless the signal level is too low for measurement at that distance. If necessary, a pre-amplifier is used and/or the test is conducted at a closer distance.

All readings are extrapolated back to the equivalent three meter reading using inverse scaling with distance. The spurious emissions more than 20 dB below the permissible value are not reported.

For an intentional radiator, the spectrum shall be investigated from the lowest radio frequency signal generated in the device, without going below 9 kHz, up to at least the frequency shown in the following table:

Frequency range of radiated emission measurements

Lowest frequency generated in the device	Upper frequency range of measurement
9 kHz to below 10 GHz	10th harmonic of highest fundamental frequency or to 40 GHz, whichever is lower
At or above 10 GHz to below 30 GHz	5th harmonic of highest fundamental frequency or to 100 GHz, whichever is lower
At or above 30 GHz	5th harmonic of highest fundamental frequency or to 200 GHz, whichever is lower, unless otherwise specified

Number of fundamental frequencies to be tested in EUT transmit band

Frequency range in which device operates	Number of frequencies	Location in frequency range of operation
1 MHz or less	1	Middle
1 MHz to 10 MHz	2	1 near top and 1 near bottom
More than 10 MHz	3	1 near top, 1 near middle and 1 near bottom

### 3.2 EUT Exercising Software

N/A

### 3.3 Special Accessories

No special accessories used.

## TEST REPORT

### 3.4 Measurement Uncertainty

No.	Item	Measurement Uncertainty
1	20 dB Bandwidth	2.3%
2	Carrier Frequencies Separated	2.3%
3	Maximum Peak Conducted Output Power	1.5
4	Out of Band Conducted Emissions	1.5
5	Radiated Emissions	4.7 dB (25 MHz-1 GHz)
		4.8 dB (1 GHz-18 GHz)
6	Conducted Emissions at Mains Terminals	2.58
7	Temperature	0.5 °C
8	Humidity	0.4 %
9	Time	1.2%

The measurement uncertainty describes the overall uncertainty of the given measured value during the operation of the EUT.

Measurement uncertainty is calculated in accordance with ETSI TR 100 028-2001.

The measurement uncertainty is given with a confidence of 95%, k=2.

When determining of the test conclusion, the Measurement Uncertainty of test has been considered.

Uncertainty and Compliance – Unless the standard specifically states that measured values are to be extended by the measurement uncertainty in determining compliance, all compliance determinations are based on the actual measured value.

### 3.5 Equipment Modification

Any modifications installed previous to testing by LF Beauty Limitd will be incorporated in each production model sold / leased in the United States.

No modifications were installed by Intertek Testing Services Shenzhen Ltd. Guangzhou Branch.

### 3.6 Support Equipment List and Description

The client makes a continuous transmit sample for test.



## TEST REPORT

### 4.0 Measurement Results

#### 4.1 Antenna Requirement

Standard requirement:

15.203 requirement:

For intentional device. According to 15.203 an intentional radiator shall be designed to Ensure that no antenna other than that furnished by the responsible party shall be used with the device.

15.247(c) (1)(i) requirement:

(i) Systems operating in the 2400-2483.5 MHz bands that are used exclusively for fixed. Point-to-point operations may employ transmitting antennas with directional gain greater than 6 dBi provided the maximum conducted output power of the intentional radiator is reduced by 1 dB for every 3 dB that the directional gain of the antenna exceeds 6 dBi.

EUT Antenna

The antenna is a Pin antenna and no consideration of replacement. The best case gain of the antenna is 2 dBi.

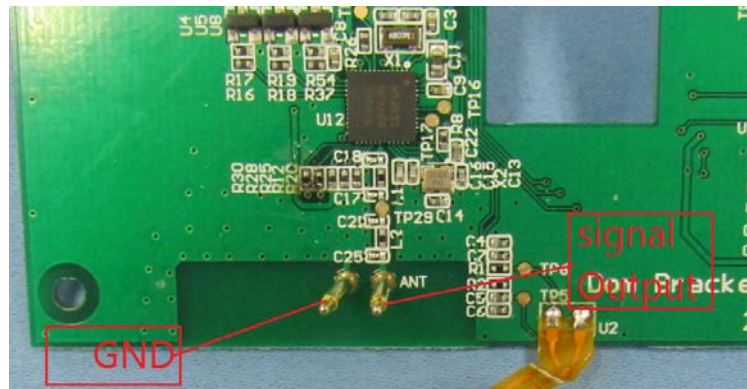

## TEST REPORT

### 4.2 6 dB Bandwidth (DTS bandwidth)

Test Requirement:	FCC Part 15 C section 15.247 (a)(2) Systems using digital modulation techniques may operate in the 902-928 MHz, 2400-2483.5MHz, and 5725-5850 MHz bands. The minimum 6 dB bandwidth shall be at least 500 kHz.
Test Method:	ANSI C63.10: Clause 11.8
Test Status:	Pre-Scan has been conducted to determine the worst-case mode from all possible combinations between available modulations, data rates and antenna ports (if EUT with antenna diversity architecture). Following channel(s) was (were) selected for the final test as listed below. Pre-test the EUT supplied by adaptor mode and recharged batteries mode, find worse case in supplied by adaptor mode.

Test Configuration:

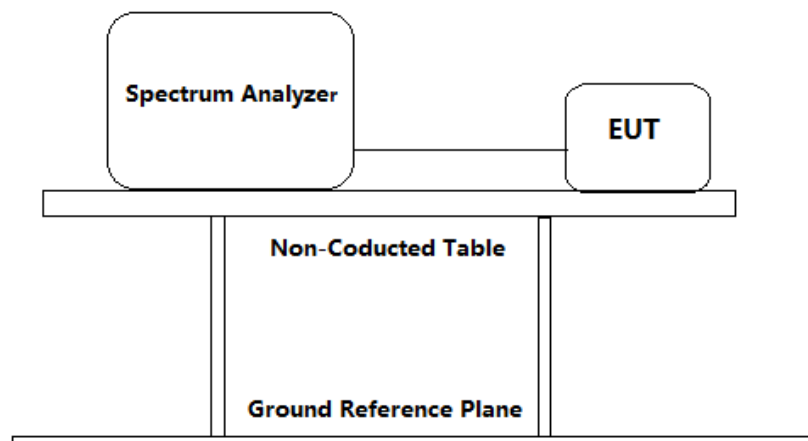

Test Procedure:

1. Remove the antenna from the EUT and then connect a low attention attenuation RF cable (cable loss =0 dB) from the antenna port to the spectrum.
2. Set the spectrum analyzer:
  - a) Set RBW = 100 kHz
  - b) Set the VBW  $\geq [3 \times \text{RBW}]$
  - c) Detector = peak.
  - d) Trace mode = max hold.
  - e) Sweep = auto couple
  - f) Allow the trace to stabilize.
  - g) Measure the maximum width of the emission that is constrained by the frequencies associated with the two outermost amplitude points (upper and lower frequencies) that are attenuated by 6 dB relative to the maximum level measured

**TEST REPORT**

in the fundamental emission.

h)  $\text{Span} = 2 * \text{BW} \sim 5 * \text{BW}$

3. Repeat until all the test status is investigated.
4. Report the worst case.

**Used Test Equipment List**

Spectrum Analyzer. Refer to Clause 5 Test Equipment List for details.

Channel No.	Frequency (MHz)	Measured 6dB bandwidth (kHz)	Limit (kHz)	Result
0	2402	872.6	≥500	Pass
19	2440	833.6		Pass
39	2480	864.0		Pass

Test result: The unit does meet the FCC requirements.

**TEST REPORT**

Result plot as follows:

Lowest Channel(2.402 GHz):

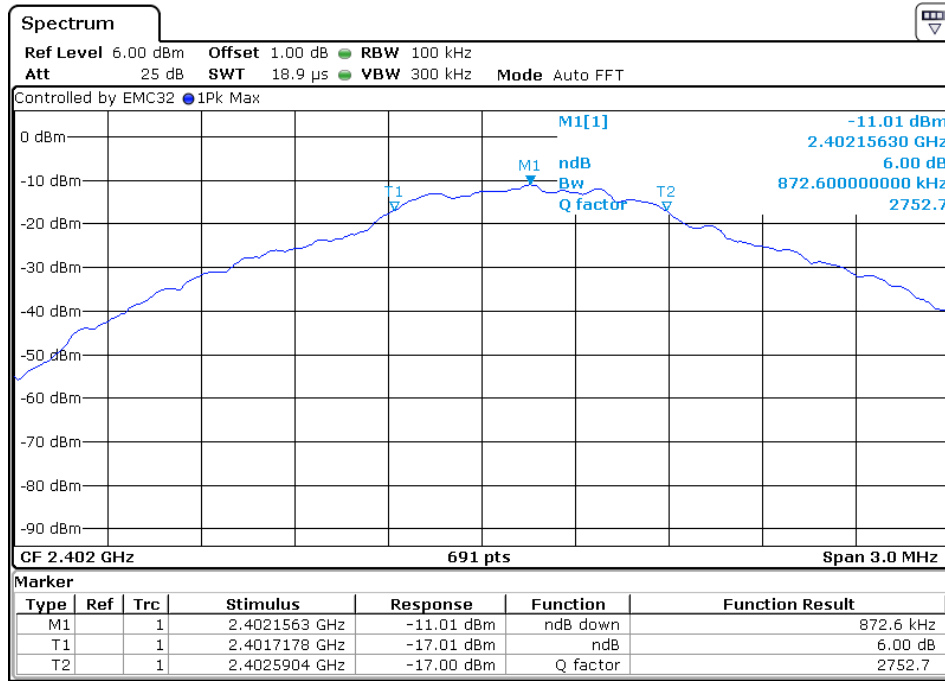

Middle Channel(2.440 GHz):

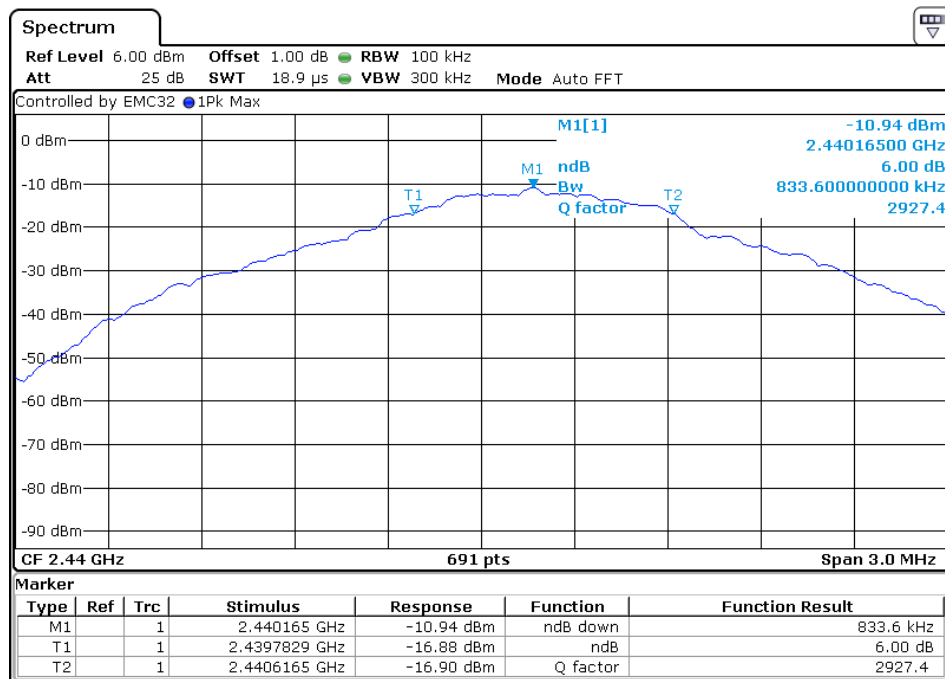

**TEST REPORT**

Highest Channel(2.480 GHz):

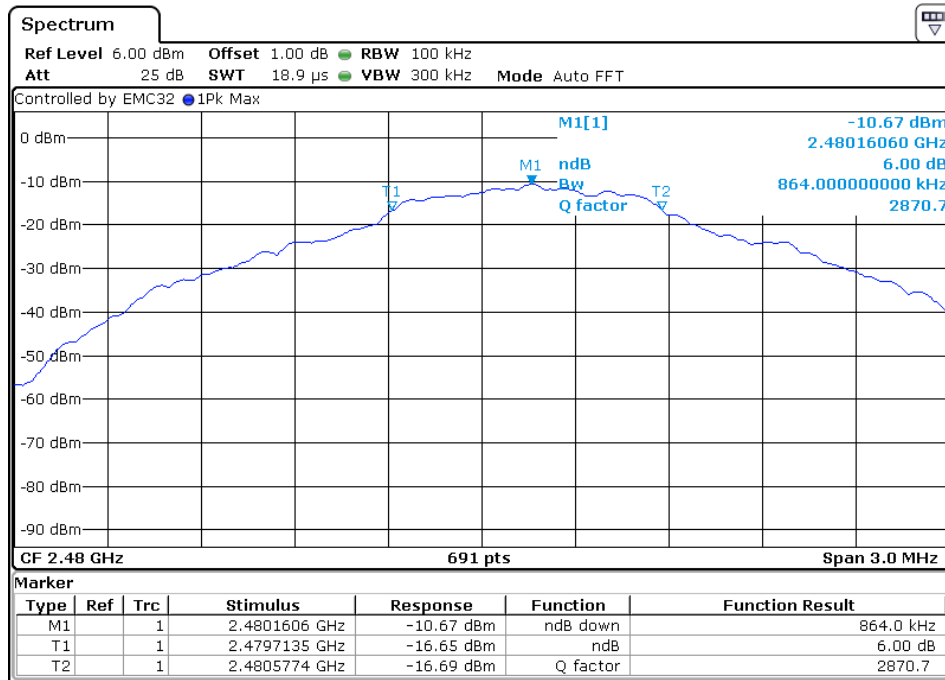

## TEST REPORT

### 4.3 Maximum Peak Conducted Output Power

Test Requirement:	FCC Part 15 C section 15.247 (b)(3) For systems using digital modulation in the 902-928 MHz, 2400-2483.5 MHz, and 5725-5850 MHz bands: 1 Watt. Except as shown in paragraph (c) of this section, if transmitting antennas of directional gain greater than 6 dBi are used, the conducted output power from the intentional radiator shall be reduced below the stated values in paragraphs (b) (1), (b) (2), and (b) (3) of this section, as appropriate, by the amount in dB that the directional gain of the antenna exceeds 6 dBi.
Test Method:	ANSI C63.10: Clause 11.9.1.1(RBW $\geq$ DTS bandwidth)
Test Status:	Pre-Scan has been conducted to determine the worst-case mode from all possible combinations between available modulations, data rates and antenna ports (if EUT with antenna diversity architecture). Following channel(s) was (were) selected for the final test as listed below. Pre-test the EUT supplied by adaptor mode and recharged batteries mode, find worse case in supplied by adaptor mode.

Test Configuration:

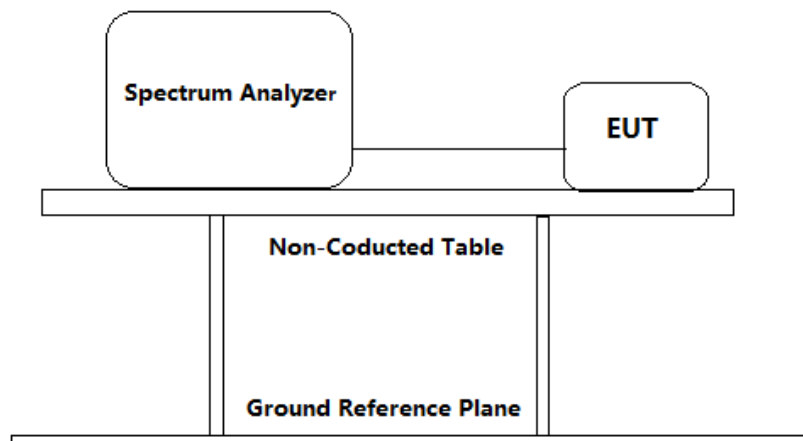

Test Procedure:

1. Remove the antenna from the EUT and then connect a low attention attenuation RF cable (cable loss =2 dB) from the antenna port to the spectrum.
2. Set the spectrum analyzer:
  - a) Set the RBW = 1 MHz ( RBW  $\geq$  DTS bandwidth ) .
  - b) Set the VBW  $\geq$  [3  $\times$  RBW].
  - c) Set the span  $\geq$  10 MHz[3  $\times$  RBW].
  - d) Detector = peak.
  - e) Sweep time = auto couple.
  - f) Trace mode = max hold.
  - g) Allow trace to fully stabilize.

**TEST REPORT**

- h) Use peak marker function to determine the peak amplitude level.
3. Repeat until all the test status is investigated.
  4. Report the worst case.

**Used Test Equipment List**

Spectrum Analyzer. Refer to Clause 5 Test Equipment List for details.

**Test result:**

Channel No.	Frequency (MHz)	Measured channel Power (dBm)	Limit	Result
0	2402	-11.08	1W (30 dBm)	Pass
19	2440	-10.97		Pass
39	2480	-10.71		Pass

Remark: Level = Read Level + Cable Loss

**TEST REPORT**

Result plot as follows:

Lowest channel (2.402 GHz):

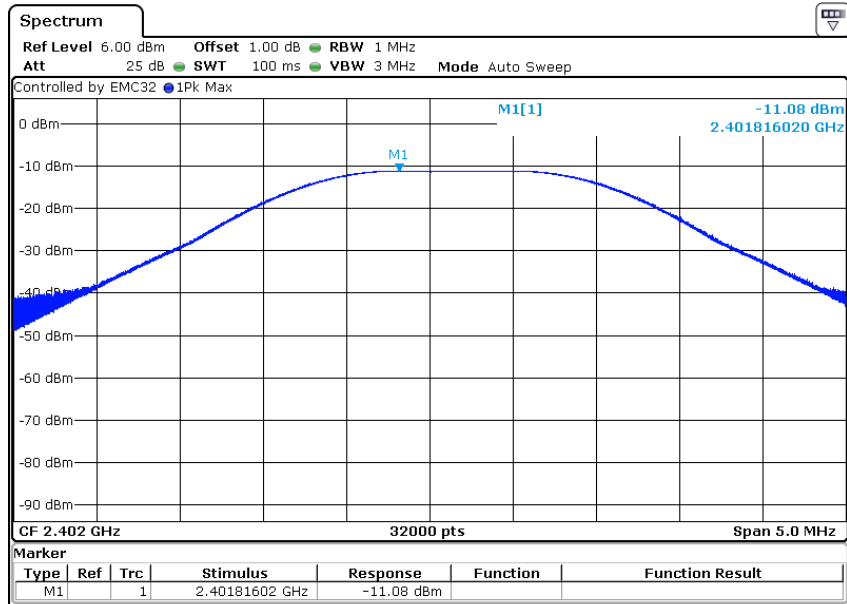

Middle Channel (2.440 GHz):

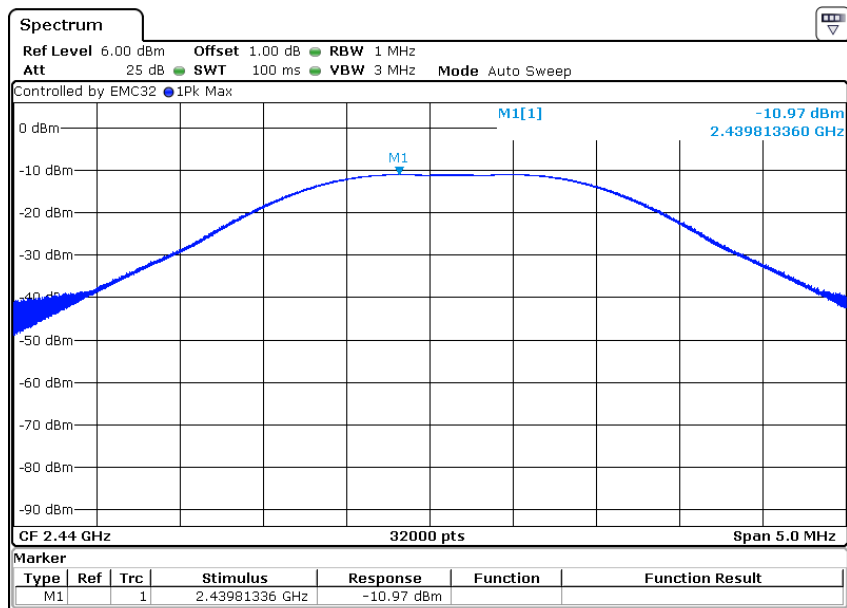



**TEST REPORT**

Highest Channel (2.480 GHz):

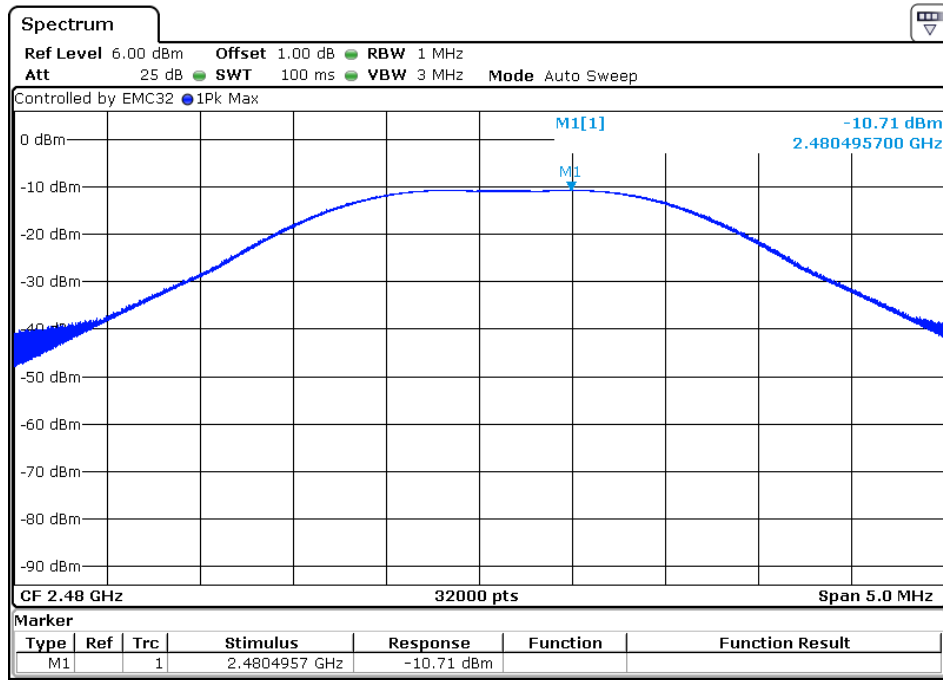

**Test result: The unit does meet the FCC requirements.**

## TEST REPORT

### 4.4 Peak Power Spectral Density

- Test Requirement: FCC Part 15 C section 15.247  
(e) For digitally modulated systems, the power spectral density conducted from the intentional radiator to the antenna shall not be greater than 8 dBm in any 3 kHz band during any time interval of continuous transmission.  
This power spectral density shall be determined in accordance with the provisions of paragraph (b) of this section. The same method of determining the conducted output power shall be used to determine the power spectral density.
- Test Method: ANSI C63.10: Clause 11.10.2
- Test Status: Pre-Scan has been conducted to determine the worst-case mode from all possible combinations between available modulations, data rates and antenna ports (if EUT with antenna diversity architecture). Following channel(s) was (were) selected for the final test as listed below.  
Pre-test the EUT supplied by adaptor mode and recharged batteries mode, find worse case in supplied by adaptor mode.

#### Test Configuration:

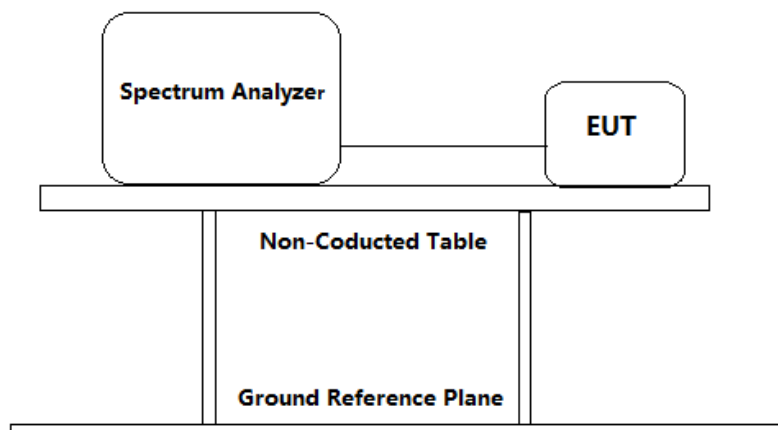

#### Test Procedure:

1. Remove the antenna from the EUT and then connect a low attention attenuation RF cable(cable loss =2 dB) from the antenna port to the spectrum analyzer or power meter.
2. Set the spectrum analyzer:
  - a) Set analyzer center frequency to DTS channel center frequency.
  - b) Set the span= 1.5 × DTS bandwidth.
  - c) Set the RBW to  $3 \text{ kHz} \leq \text{RBW} \leq 100 \text{ kHz}$ .
  - d) Set the VBW  $\geq [3 \times \text{RBW}]$ .
  - e) Detector = peak.

## TEST REPORT

- f) Sweep time = auto couple.
  - g) Trace mode = max hold.
  - h) Allow trace to fully stabilize.
  - i) Use the peak marker function to determine the maximum amplitude level within the RBW.
  - j) If measured value exceeds requirement, then reduce RBW (but no less than 3 kHz) and repeat.
3. Measure the Power Spectral Density of the test frequency with special test status.
  4. Repeat until all the test status is investigated.
  5. Report the worst case.

### Used Test Equipment List

Spectrum Analyzer. Refer to Clause 5 Test Equipment List for details.

Test result:

Channel No.	Frequency (MHz)	Measured Peak Power Spectral Density (dBm/3 kHz)	Limit	Result
0	2402	-25.26	8 dBm/3kHz	Pass
19	2440	-23.51		Pass
39	2480	-24.28		Pass

Test result: Level = Read Level + Cable Loss.

**TEST REPORT**

Result plot as follows:

Lowest channel (2.402 GHz):

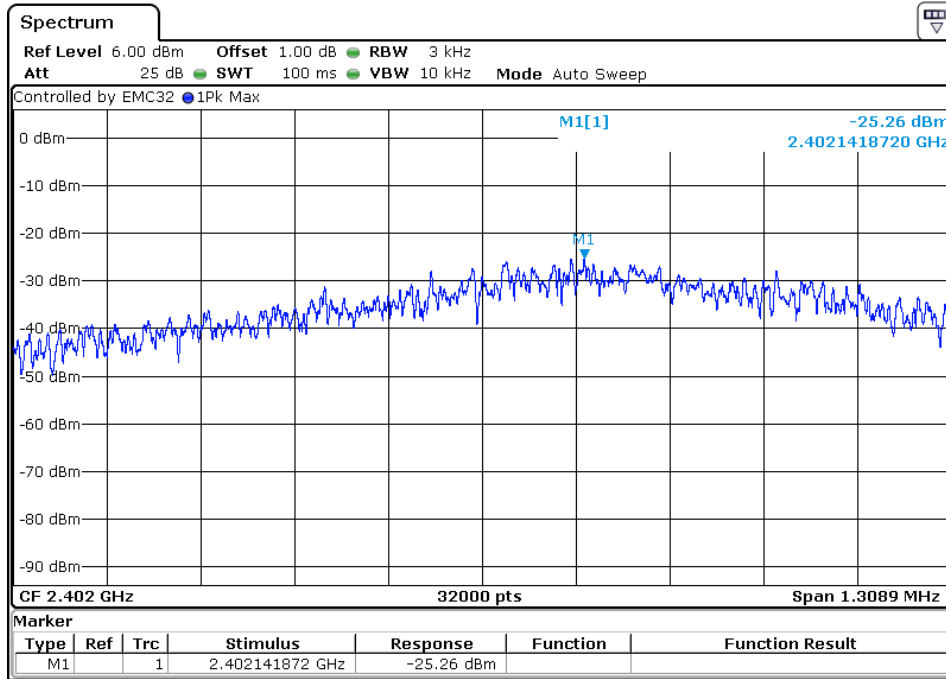

Middle Channel (2.440 GHz):

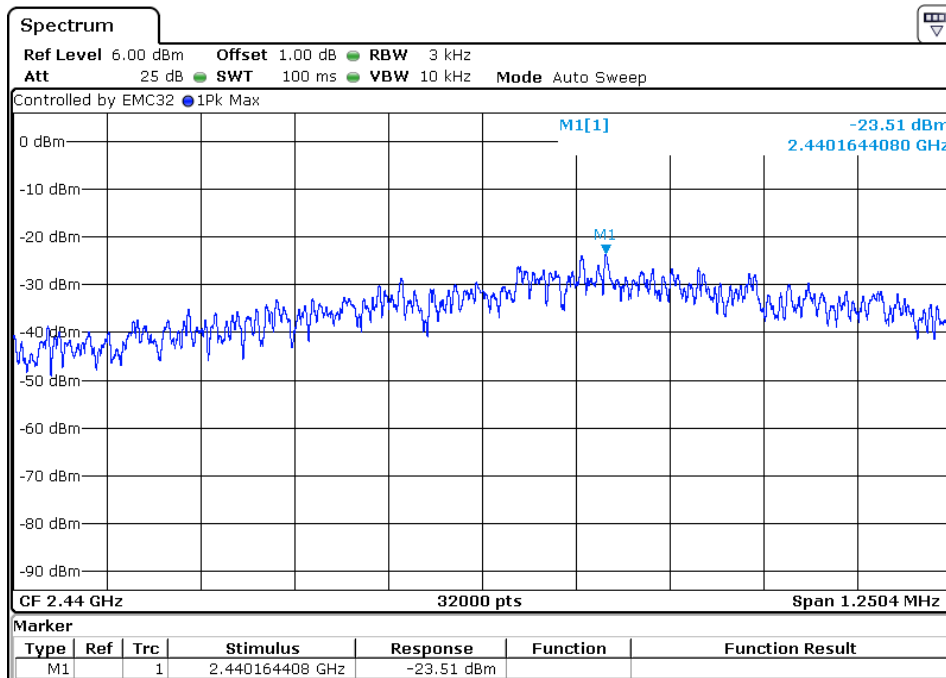

**TEST REPORT**

Highest Channel (2.480 GHz):

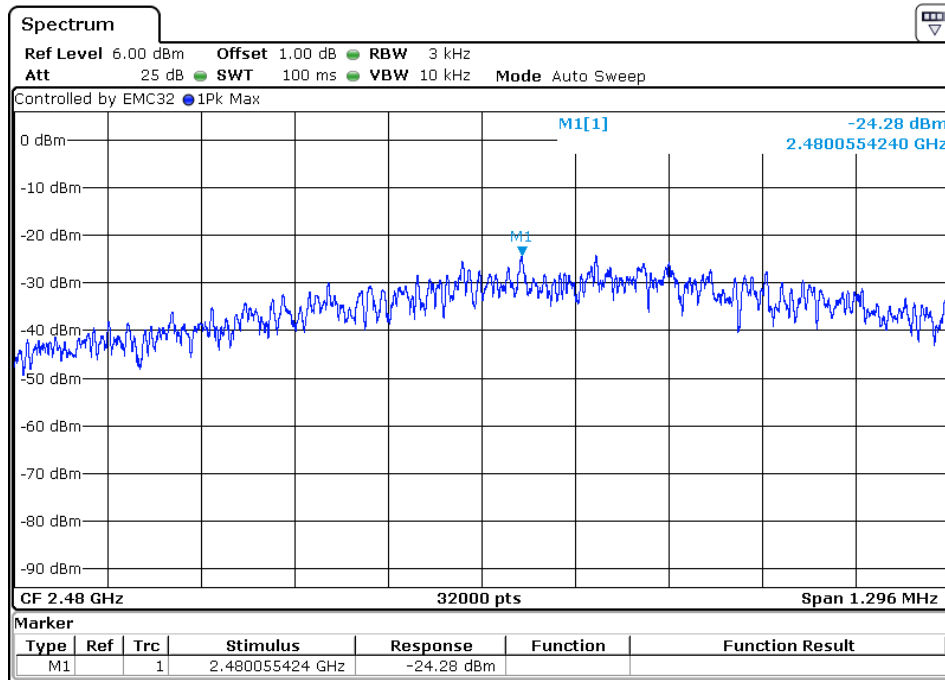

## TEST REPORT

### 4.5 Out of Band Conducted Emissions

Test Requirement: FCC Part 15 C section 15.247

(d) In any 100 kHz bandwidth outside the frequency band in which the spread spectrum or digitally modulated intentional radiator is operating. The radio frequency power that is produced by the intentional radiator shall be at least 20 dB below that in the 100 kHz bandwidth within the band that contains the highest level of the desired power. Based on either an RF conducted or a radiated measurement. Provided the transmitter demonstrates compliance with the peak conducted power limits.

Test Method: ANSI C63.10: Clause 11.11

Test Status: Pre-Scan has been conducted to determine the worst-case mode from all possible combinations between available modulations, data rates and antenna ports (if EUT with antenna diversity architecture). Following channel(s) was (were) selected for the final test as listed below.  
Pre-test the EUT supplied by adaptor mode and recharged batteries mode, find worse case in supplied by adaptor mode.

Test Configuration:

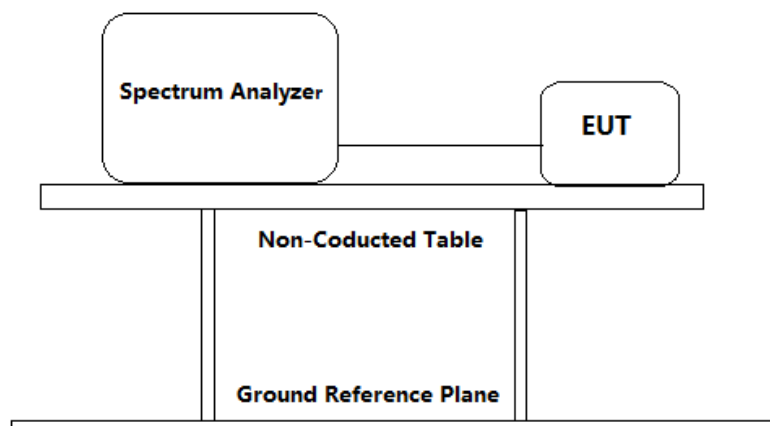

Test Procedure:

1. Remove the antenna from the EUT and then connect a low RF cable (cable loss =2dB) from the antenna port to the spectrum analyzer or power meter.
2. Establish a reference level by using the following procedure:
  - a) Set instrument center frequency to DTS channel center frequency.
  - b) Set the span to  $\geq 1.5 \times$  DTS bandwidth.
  - c) Set the RBW = 100 kHz.
  - d) Set the VBW  $\geq [3 \times$  RBW].
  - e) Detector = peak.
  - f) Sweep time = auto couple.

## TEST REPORT

- g) Trace mode = max hold.
  - h) Allow trace to fully stabilize.
  - i) Use the peak marker function to determine the maximum PSD level.  
Note that the channel found to contain the maximum PSD level can be used to establish the reference level
3. Emission level measurement
- a) Set the center frequency and span to encompass frequency range to be measured.
  - b) Set the RBW = 100 kHz.
  - c) Set the VBW  $\geq [3 \times \text{RBW}]$ .
  - d) Detector = peak.
  - e) Sweep time = auto couple.
  - f) Trace mode = max hold.
  - g) Allow trace to fully stabilize.
  - h) Use the peak marker function to determine the maximum amplitude level.
4. Measure the Conducted unwanted Emissions of the test frequency with special test status.
5. Repeat until all the test status is investigated.
6. Report the worst case.

### Used Test Equipment List

Spectrum Analyzer. Refer to Clause 5 Test Equipment List for details.

## TEST REPORT

Result plot as follows:

Lowest channel (2.402 GHz):

30 MHz to 25 GHz:

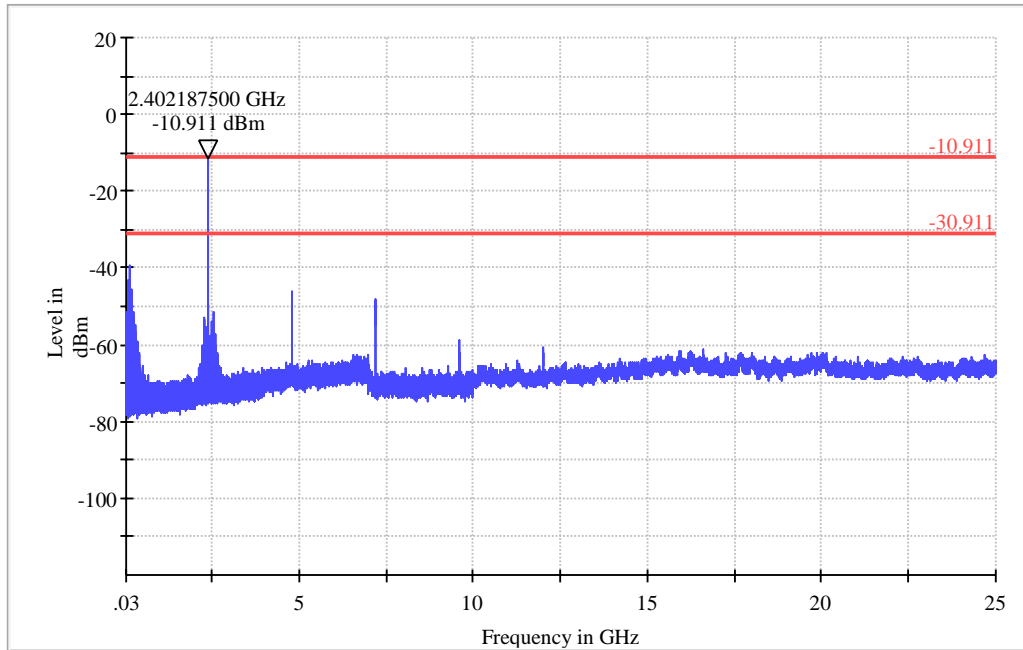

In any 100 kHz bandwidth, the Conducted Spurious Emissions from 30 MHz to 25 GHz were greater than 20dB below the peak emission within the band that contains the highest level of the desired power.



**TEST REPORT**

Middle Channel (2.440 GHz):  
30 MHz to 25 GHz:

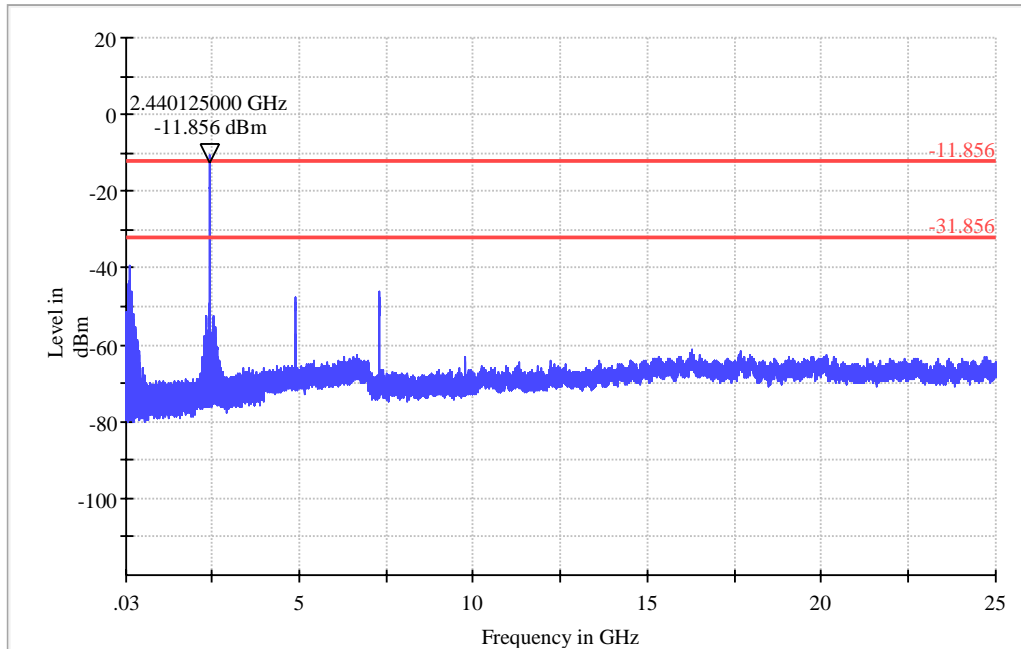

In any 100 kHz bandwidth, the Conducted Spurious Emissions from 30 MHz to 25 GHz were greater than 20dB below the peak emission within the band that contains the highest level of the desired power.

**TEST REPORT**

Highest Channel (2.480 GHz):

30 MHz to 25 GHz:

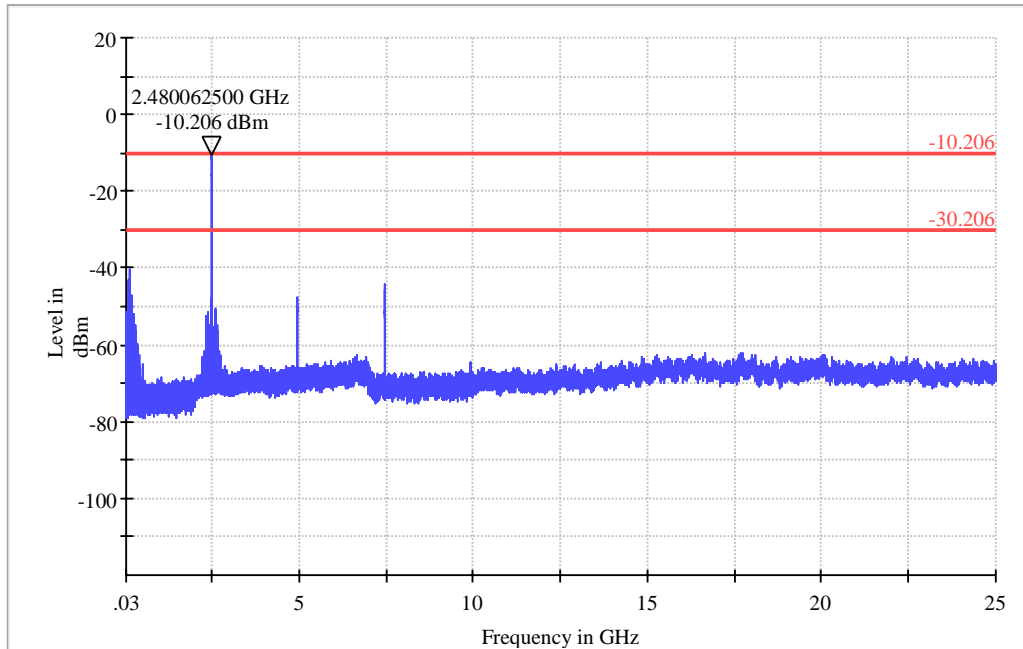

In any 100 kHz bandwidth, the Conducted Spurious Emissions from 30 MHz to 25 GHz were greater than 20dB below the peak emission within the band that contains the highest level of the desired power.

## TEST REPORT

### 4.6 Out of Band Radiated Emissions

For out of band radiated emissions into Non-Restricted Frequency Bands were performed at a 3m separation distance to determine whether these emissions complied with the 20dB attenuation requirement.

Not required, since all emissions are more than 20dB below fundamental

See attached data sheet

## TEST REPORT

### 4.7 Radiated Emissions in Restricted Bands

Test Requirement:	FCC Part 15 C section 15.247  (d) In addition, radiated emissions which fall in the restricted bands, as defined in Section 15.205(a), must also comply with the radiated emission limits specified in Section 15.209(a) (see Section 15.205(c)).
Test Method:	ANSI C63.10: Clause 11.12.1, 6.4, 6.5 and 6.6
Test Status:	Pre-Scan has been conducted to determine the worst-case mode from all possible combinations between available modulations, data rates and antenna ports (if EUT with antenna diversity architecture). Following channel(s) was (were) selected for the final test as listed below. Pre-test the EUT supplied by adaptor mode and recharged batteries mode, find worse case in supplied by adaptor mode.
Test site:	Measurement Distance: 3m (Semi-Anechoic Chamber)
Limit:	40.0 dB $\mu$ V/m between 30MHz & 88MHz; 43.5 dB $\mu$ V/m between 88MHz & 216MHz; 46.0 dB $\mu$ V/m between 216MHz & 960MHz; 54.0 dB $\mu$ V/m above 960MHz.
Detector:	For Peak and Quasi-Peak value: RBW = 1 MHz for $f \geq 1$ GHz, 200 Hz for 9 kHz to 150 kHz 9 kHz for 150 kHz to 30 MHz 120 kHz for 30 MHz to 1GHz VBW $\geq$ RBW Sweep = auto Detector function = peak for $f \geq 1$ GHz, QP for $f < 1$ GHz Trace = max hold  For AV value: RBW = 1 MHz for $f \geq 1$ GHz, 100 kHz for $f < 1$ GHz VBW=10 Hz Sweep = auto Trace = max hold
Field Strength Calculation:	The field strength is calculated by adding the reading on the Spectrum Analyzer to the factors associated with preamplifiers (if any), antennas, cables, pulse desensitization and average factors (when specified limit is in average and measurements are made with peak detectors). A sample calculation is included below: $FS = RA + AF + CF - AG + PD + AV$

## TEST REPORT

Where:

FS = RA + Correct Factor + AV  
FS = Field Strength in dB $\mu$ V/m  
RA = Receiver Amplitude (including preamplifier) in dB $\mu$ V  
AF = Antenna Factor in dB  
CF = Cable Attenuation Factor in dB  
AG = Amplifier Gain in dB  
PD = Pulse Desensitization in dB  
AV = Average Factor in -dB  
Correct Factor = AF + CF - AG + PD

In the radiated emission table which follows, the reading shown on the data table may reflect the preamplifier gain. An example of the calculations, where the reading does not reflect the preamplifier gain, follows:

$$FS = RA + AF + CF - AG + PD + AV$$

Assume a receiver reading of 62.0 dB $\mu$ V is obtained. The antenna factor of 7.4 dB and cable factor of 1.6 dB is added. The amplifier gain of 29 dB is subtracted. The pulse desensitization factor of the spectrum analyzer was 0 dB, and the resultant average factor was -10 dB. The net field strength for comparison to the appropriate emission limit is 32 dB $\mu$ V/m.

$$RA = 62.0 \text{ dB}\mu\text{V}$$

$$AF = 7.4 \text{ dB}$$

$$CF = 1.6 \text{ dB}$$

$$AG = 29.0 \text{ dB}$$

$$PD = 0 \text{ dB}$$

$$AV = -10 \text{ dB}$$

$$\text{Correct Factor} = 7.4 + 1.6 - 29.0 + 0 = -20 \text{ dB}$$

$$FS = 62 + (-20) + (-10) = 32 \text{ dB}\mu\text{V/m}$$

Remark: Above the 1GHz, spectrum used the RBW 1MHz(1/RBW=1us) for test, which is shorter than the width of one pulse, so PD=0dB

Section 15.205 Restricted bands of operation.

(a) Except as shown in paragraph (d) of this section. Only spurious emissions are permitted in any of the frequency bands listed below:

## TEST REPORT

MHz	MHz	MHz	GHz
0.090 - 0.110	16.42 - 16.423	399.9 - 410	4.5 - 5.15
10.495 - 0.505	16.69475 - 16.69525	608 - 614	5.35 - 5.46
2.1735 - 2.1905	16.80425 - 16.80475	960 - 1240	7.25 - 7.75
4.125 - 4.128	25.5 - 25.67	1300 - 1427	8.025 - 8.5
4.17725 - 4.17775	37.5 - 38.25	1435 - 1626.5	9.0 - 9.2
4.20725 - 4.20775	73 - 74.6	1645.5 - 1646.5	9.3 - 9.5
6.215 - 6.218	74.8 - 75.2	1660 - 1710	10.6 - 12.7
6.26775 - 6.26825	108 - 121.94	1718.8 - 1722.2	13.25 - 13.4
6.31175 - 6.31225	123 - 138	2200 - 2300	14.47 - 14.5
8.291 - 8.294	149.9 - 150.05	2310 - 2390	15.35 - 16.2
8.362 - 8.366	156.52475 -	2483.5 - 2500	17.7 - 21.4
8.37625 - 8.38675	156.52525	2655 - 2900	22.01 - 23.12
8.41425 - 8.41475	156.7 - 156.9	3260 - 3267	23.6 - 24.0
12.29 - 12.293	162.0125 - 167.17	3332 - 3339	31.2 - 31.8
12.51975 - 12.52025	167.72 - 173.2	3345.8 - 3358	36.43 - 36.5
12.57675 - 12.57725	240 - 285	3600 - 4400	
13.36 - 13.41	322 - 335.4		

**TEST REPORT**

Test Configuration:

1) 9 kHz to 30 MHz emissions:

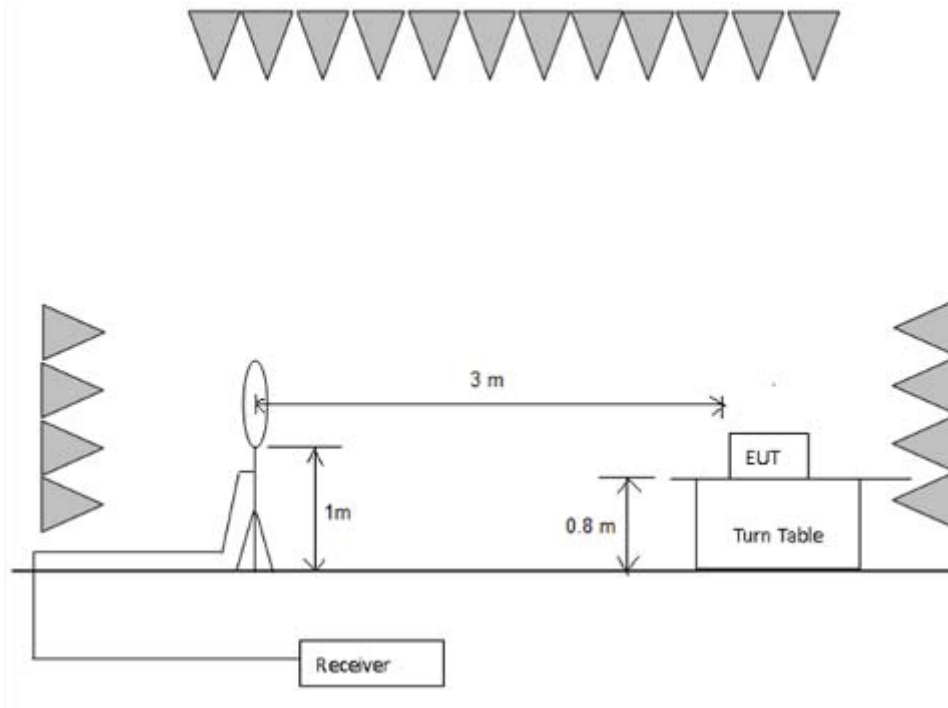

2) 30 MHz to 1 GHz emissions:

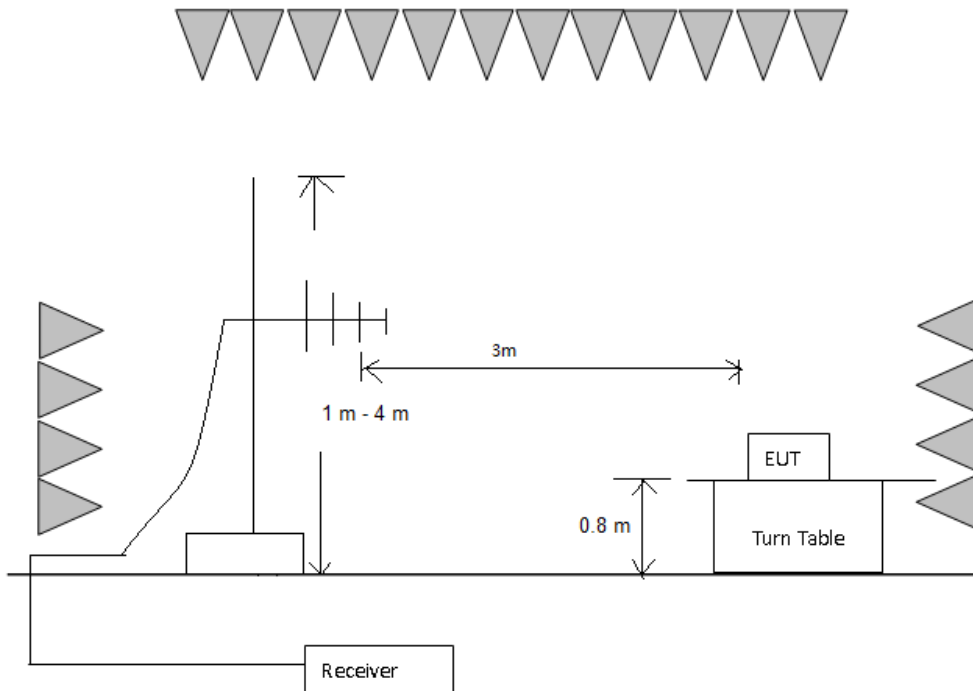

## TEST REPORT

### 3) 1 GHz to 40 GHz emissions:

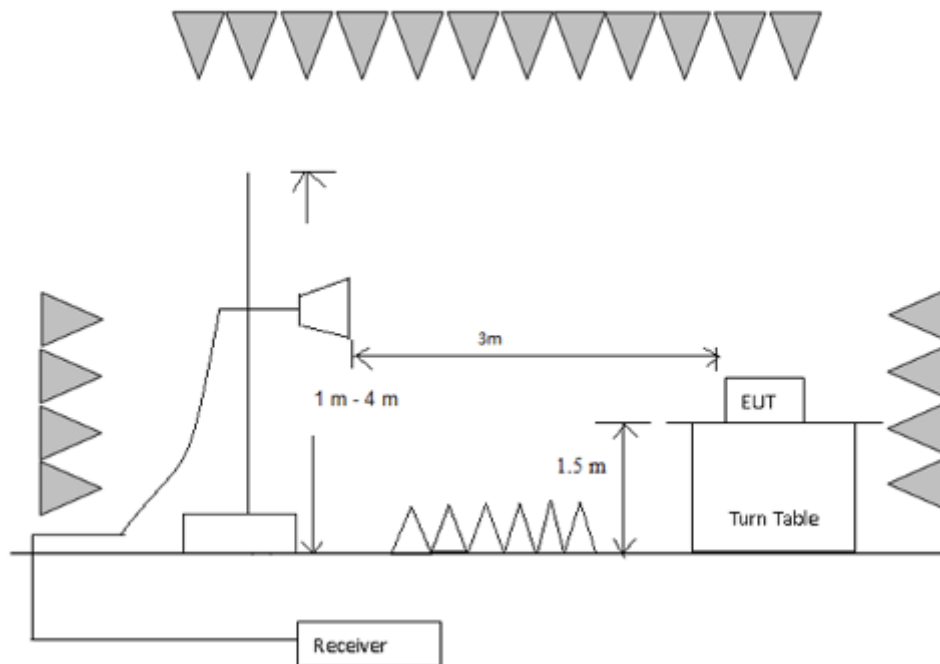

#### Test Procedure:

##### 1) 9 kHz to 30 MHz emissions:

For testing performed with the loop antenna. The centre of the loop was positioned 1 m above the ground and positioned with its plane vertical at the special distance from the EUT. During testing the loop was rotated about its vertical axis for maximum response at each azimuth and also investigated with the loop positioned in the horizontal plane.

##### 2) 30 MHz to 1 GHz emissions:

For testing performed with the bi-log type antenna. The measurement is performed with the EUT rotated 360°, the antenna height scanned between 1m and 4m, and the antenna rotated to repeat the measurement for both the horizontal and vertical antenna polarizations.

##### 3) 1 GHz to 25 GHz emissions:

Test site with RF absorbing material covering the ground plane that met the site validation criterion called out in CISPR 16-1-4:2010 was used to perform radiated emission test above 1 GHz.

For testing performed with the horn antenna. The measurement is performed with the EUT rotated 360°, the antenna height scanned between 1m and 4m, and the antenna rotated to repeat the measurement for both the horizontal and vertical antenna polarizations.

4) The receiver was scanned from 9 kHz to 25 GHz. When an emission was found, the table was rotated to produce the maximum signal strength. An initial pre-scan was performed for in peak detection mode using the receiver. The EUT was measured for both the Horizontal and Vertical polarities and performed a pre-test three orthogonal planes. For intentional radiators, measurements of the variation of the input power or the radiated signal level of the fundamental frequency component of the emission, as appropriate, shall be performed with the supply voltage varied between 85% and 115% of the nominal rated supply voltage. The worst case emissions were reported.



## TEST REPORT

### Used Test Equipment List:

3m Semi-Anechoic Chamber, EMI Test Receiver (9 kHz~7 GHz), Signal and Spectrum Analyzer (10 Hz~40 GHz), Loop antenna (9 kHz-30 MHz). TRILOG Super Broadband test Antenna(30 MHz-3 GHz) (RX), Double-Ridged Waveguide Horn Antenna (800 MHz-18 GHz)(RX) and High Frequency Antenna & preamplifier(18 GHz~26.5 GHz) (RX). Refer to Clause 5 Test Equipment List for details.

9 kHz~30 MHz Field Strength of Unwanted Emissions. Quasi-Peak Measurement

The measurements with active loop antenna were greater than 20dB below the limit, so the test data were not recorded in the test report.

**TEST REPORT**

Test at Channel 0 (2.402 GHz) in transmitting status

30 MHz~1 GHz Spurious Emissions .Quasi-Peak Measurement

Vertical:

Peak scan

Level (dBuV/m)

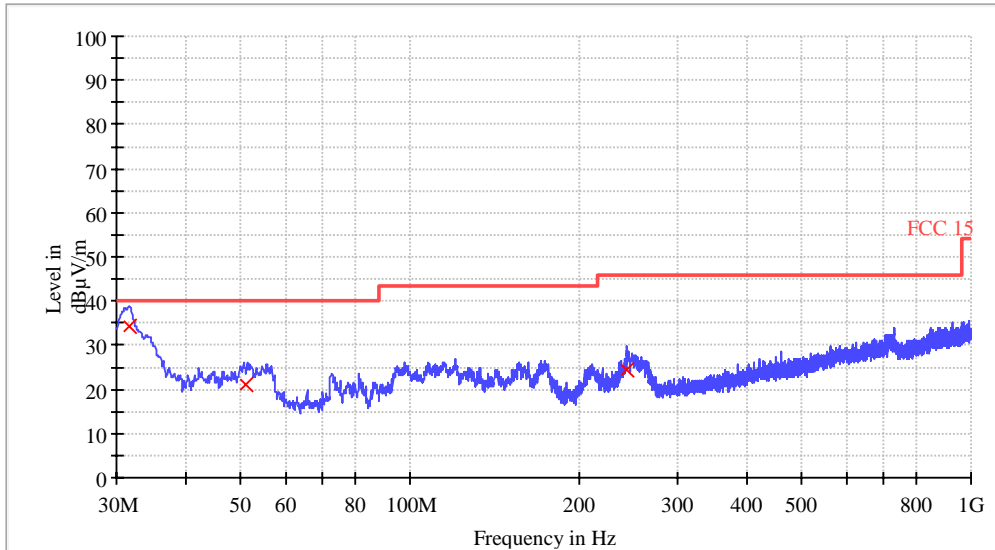

Quasi-peak measurement:

Frequency (MHz)	Receiver Reading Level (dBμV)	Correction factors (dB/m)	Emission Level (dBμV/m)	Limit (dBμV/m)
31.56	22.8	11.6	34.4	40.0
51.20	7.0	14.0	21.0	40.0
244.12	11.1	13.5	24.6	46.0

Remark:

Final Test Level =Receiver Reading + Correction Factor

Correction Factor = Antenna Factor + Cable Loss.

**TEST REPORT**

Horizontal:

Peak scan

Level (dBuV/m)

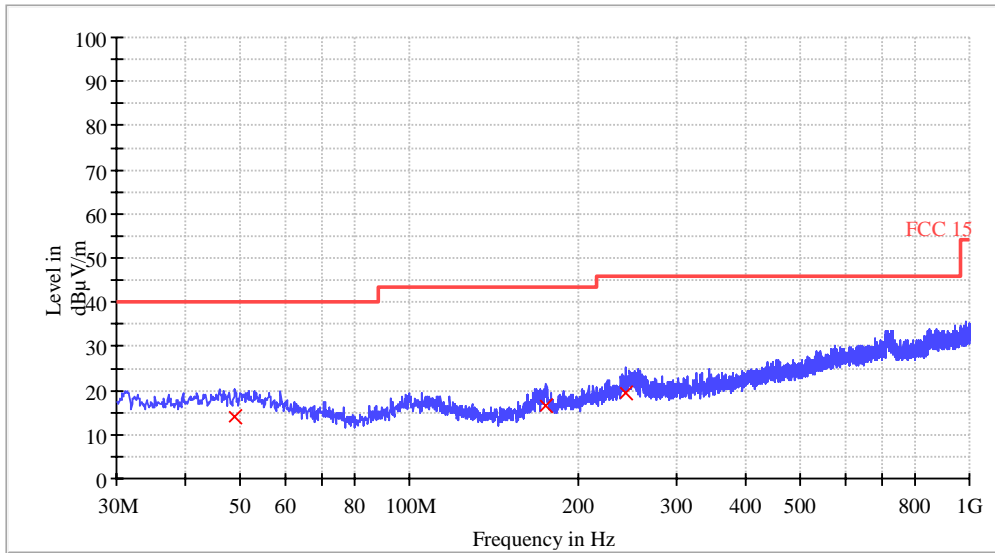

Quasi-peak measurement

Frequency (MHz)	Receiver Reading Level (dBμV)	Correction factors (dB/m)	Emission Level (dBμV/m)	Limit (dBμV/m)
48.80	0.1	14.3	14.4	40.0
175.76	6.4	10.1	16.5	40.0
243.64	6.2	13.4	19.6	46.0

Remark:

Final Test Level = Receiver Reading + Correction Factor

Correction Factor = Antenna Factor + Cable Loss.

**TEST REPORT**

1~25 GHz Radiated Emissions. Peak & Average Measurement

**PK Measurement:**

Frequency (MHz)	PK Reading Level (dBμV)	Correction factors (dB/m)	PK Emission Level (dBμV/m)	PK Limit (dBμV/m)	Antenna polarization
4804.600	49.9	-0.5	49.4	74	Horizontal
7206.700	44.5	3.4	47.9	74	Horizontal
9608.142	41.3	6.3	47.6	74	Horizontal
4804.600	49.6	-0.5	49.1	74	Vertical
7206.700	44.2	3.4	47.6	74	Vertical
9608.142	41.5	6.3	47.8	74	Vertical

**AV Measurement:**

Frequency (MHz)	AV Reading Level (dBμV)	Correction factors (dB/m)	AV Emission Level (dBμV/m)	AV Limit (dBμV/m)	Antenna polarization
4804.600	/	-0.5	/	54	Horizontal
7206.700	/	3.4	/	54	Horizontal
9608.142	/	6.3	/	54	Horizontal
4804.600	/	-0.5	/	54	Vertical
7206.700	/	3.4	/	54	Vertical
9608.142	/	6.3	/	54	Vertical

The field strength is calculated by adding the Antenna Factor, Cable Factor & Preamplifier. The basic equation with a sample calculation is as follows:

Final Test Level = Receiver Reading + Correction Factor

Correction Factor = Antenna Factor + Cable Loss – Preamplifier Factor.

Remark:

When Peak emission level was below AV limit, the AV emission level did not be recorded.

**TEST REPORT**

Band Edge test Restricted Bands  
Horizontal

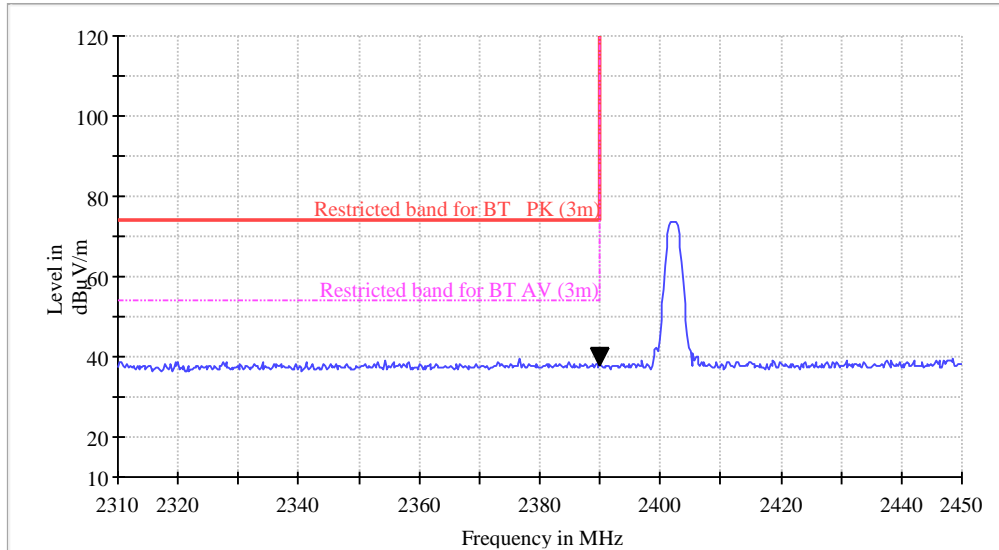

Frequency (MHz)	PK Reading Level (dBµV)	Correction factors (dB/m)	PK Emission Level (dBµV/m)	Limit (dBµV/m)
2390.33	40.5	-2.3	38.2	74.0

**Remark:**

Final Test Level = Receiver Reading + Correction Factor

Correction Factor = Antenna Factor + Cable Loss – Preamplifier Factor.

When Peak emission level was below AV limit, the AV emission level did not be recorded.

## TEST REPORT

Vertical

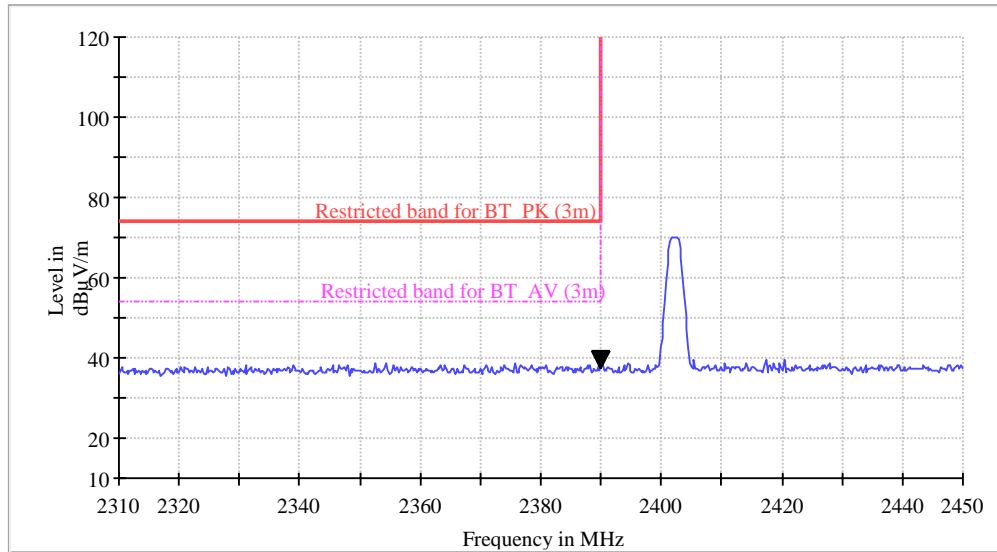

Frequency (MHz)	PK Reading Level (dBµV)	Correction factors (dB/m)	PK Emission Level (dBµV/m)	Limit (dBµV/m)
2373.9	40.2	-2.3	37.9	74.0

Remark:

Final Test Level = Receiver Reading + Correction Factor

Correction Factor = Antenna Factor + Cable Loss – Preamplifier Factor.

When Peak emission level was below AV limit, the AV emission level did not be recorded.

**TEST REPORT**

Test at Channel 19 (2.440 GHz) in transmitting status

30 MHz~1 GHz Radiated Emissions .Quasi-Peak Measurement

Vertical:

Peak scan

Level (dBμV/m)

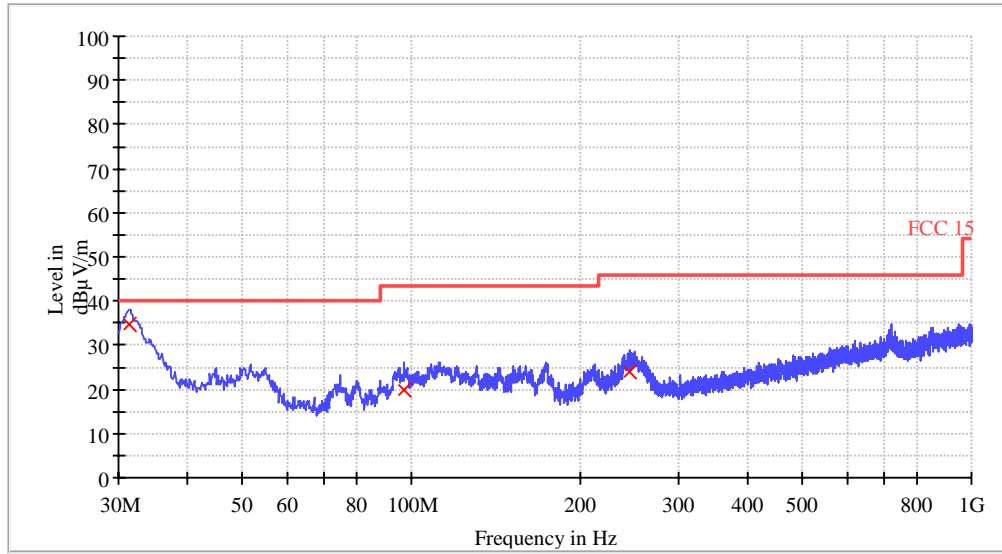

Quasi-peak measurement

Frequency (MHz)	Receiver Reading Level (dBμV)	Correction factors (dB/m)	Emission Level (dBμV/m)	Limit (dBμV/m)
31.32	23.3	11.6	34.9	40.0
97.16	8.0	11.8	19.8	43.5
246.08	10.4	13.5	23.9	46.0

Remark:

Final Test Level =Receiver Reading + Correction Factor

Correction Factor = Antenna Factor + Cable Loss.

**TEST REPORT**

Horizontal:

Peak scan

Level (dBμV/m)

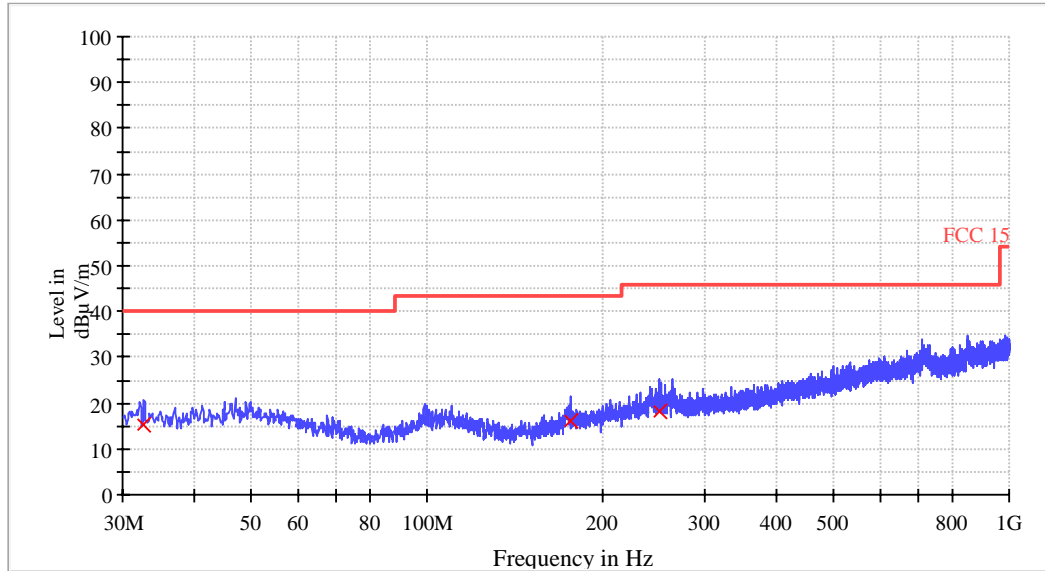

Quasi-peak measurement

Frequency (MHz)	Receiver Reading Level (dBμV)	Correction factors (dB/m)	Emission Level (dBμV/m)	Limit (dBμV/m)
32.68	3.5	11.7	15.2	40.0
176.36	6.0	10.2	16.2	43.5
251.52	4.7	13.6	18.3	46.0

Remark:

Final Test Level = Receiver Reading + Correction Factor

Correction Factor = Antenna Factor + Cable Loss.



**TEST REPORT**

1~25 GHz Radiated Emissions. Peak & Average Measurement

**PK Measurement:**

Frequency (MHz)	PK Reading Level (dBμV)	Correction factors (dB/m)	PK Emission Level (dBμV/m)	PK Limit (dBμV/m)	Antenna polarization
4879.400	50.4	-0.5	49.9	74	Horizontal
7320.600	43.8	3.8	47.6	74	Horizontal
9760.124	40.7	6.8	47.5	74	Horizontal
4879.400	48.9	-0.5	48.4	74	Vertical
7320.600	43.6	3.8	47.4	74	Vertical
9760.124	40.5	6.8	47.3	74	Vertical

**AV Measurement:**

Frequency (MHz)	AV Reading Level (dBμV)	Correction factors (dB/m)	AV Emission Level (dBμV/m)	AV Limit (dBμV/m)	Antenna polarization
4879.400	/	-0.5	/	54	Horizontal
7320.600	/	3.8	/	54	Horizontal
9760.124	/	6.8	/	54	Horizontal
4879.400	/	-0.5	/	54	Vertical
7320.600	/	3.8	/	54	Vertical
9760.124	/	6.8	/	54	Vertical

The field strength is calculated by adding the Antenna Factor, Cable Factor & Preamplifier. The basic equation with a sample calculation is as follows:

Final Test Level = Receiver Reading + Correction Factor

Correction Factor = Antenna Factor + Cable Loss – Preamplifier Factor.

Remark:

When Peak emission level was below AV limit, the AV emission level did not be recorded.

**TEST REPORT**

Test at Channel 39 (2.480 GHz) in transmitting status

30 MHz~1 GHz Radiated Emissions .Quasi-Peak Measurement

Vertical:

Peak scan

Level (dBμV/m)

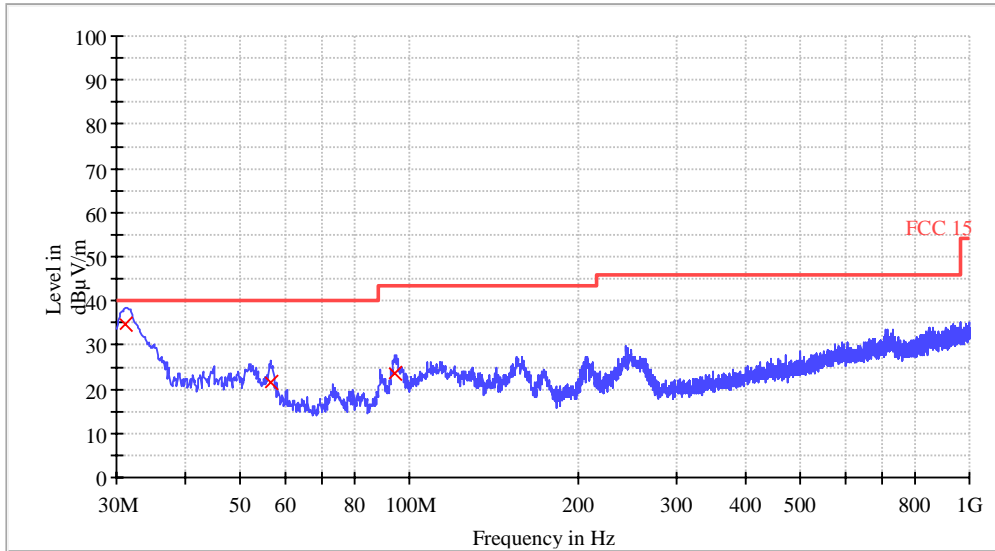

Quasi-peak measurement

Frequency (MHz)	Receiver Reading Level (dBμV)	Correction factors (dB/m)	Emission Level (dBμV/m)	Limit (dBμV/m)
31.08	23.2	11.6	34.8	40.0
56.56	8.2	13.2	21.4	40.0
94.52	12.3	11.2	23.5	43.5

Remark:

Final Test Level = Receiver Reading + Correction Factor

Correction Factor = Antenna Factor + Cable Loss.

**TEST REPORT**

Horizontal:

Peak scan

Level (dBμV/m)

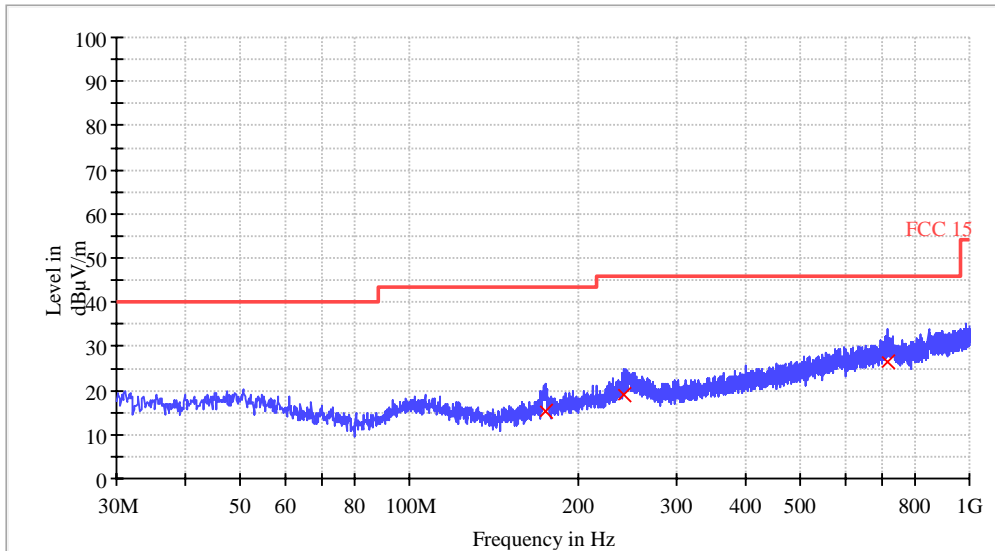

Quasi-peak measurement

Frequency (MHz)	Receiver Reading Level (dBμV)	Correction factors (dB/m)	Emission Level (dBμV/m)	Limit (dBμV/m)
174.88	5.1	10.1	15.2	43.5
241.96	5.5	13.4	18.9	46.0
713.72	3.5	23.1	26.6	46.0

Remark:

Final Test Level = Receiver Reading + Correction Factor

Correction Factor = Antenna Factor + Cable Loss.

**TEST REPORT**

1~25 GHz Radiated Emissions. Peak & Average Measurement

**PK Measurement:**

Frequency (MHz)	PK Reading Level (dBμV)	Correction factors (dB/m)	PK Emission Level (dBμV/m)	PK Limit (dBμV/m)	Antenna polarization
4961.000	49.4	-0.5	48.9	74	Horizontal
7439.600	50.7	4.2	54.9	74	Horizontal
9920.234	42.5	7.3	49.8	74	Horizontal
4961.000	48.2	-0.5	47.7	74	Vertical
7439.600	47.9	4.2	52.1	74	Vertical
9920.234	40.5	7.3	47.8	74	Vertical

**AV Measurement:**

Frequency (MHz)	AV Reading Level (dBμV)	Correction factors (dB/m)	AV Emission Level (dBμV/m)	AV Limit (dBμV/m)	Antenna polarization
4953.000	/	-0.5	/	54	Horizontal
7439.600	41.4	4.2	45.6	54	Horizontal
9921.489	/	7.3	/	54	Horizontal
4953.000	/	-0.5	/	54	Vertical
7439.600	/	4.2	/	54	Vertical
9921.489	/	7.3	/	54	Vertical

The field strength is calculated by adding the Antenna Factor, Cable Factor & Preamplifier. The basic equation with a sample calculation is as follows:

Final Test Level = Receiver Reading + Correction Factor

Correction Factor = Antenna Factor + Cable Loss – Preamplifier Factor.

Remark:

When Peak emission level was below AV limit, the AV emission level did not be recorded.

**TEST REPORT**

Band Edge test Restricted Bands  
Horizontal

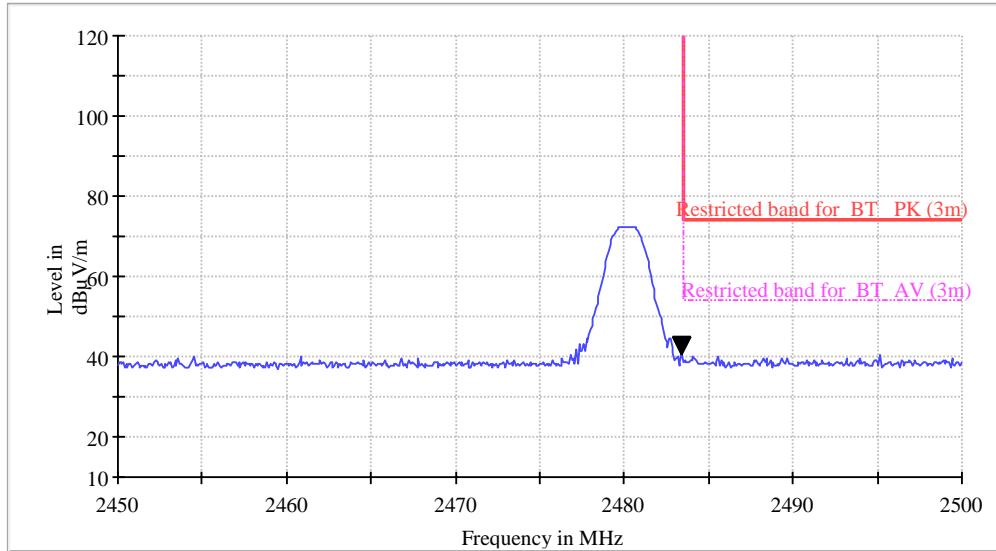

Frequency (MHz)	PK Reading Level (dBµV)	Correction factors (dB/m)	PK Emission Level (dBµV/m)	Limit (dBµV/m)
2483.42	43.2	-2.1	41.1	74.0

Remark:

Final Test Level = Receiver Reading + Correction Factor

Correction Factor = Antenna Factor + Cable Loss - Preamplifier Factor.

When Peak emission level was below AV limit, the AV emission level did not be recorded.

## TEST REPORT

Vertical

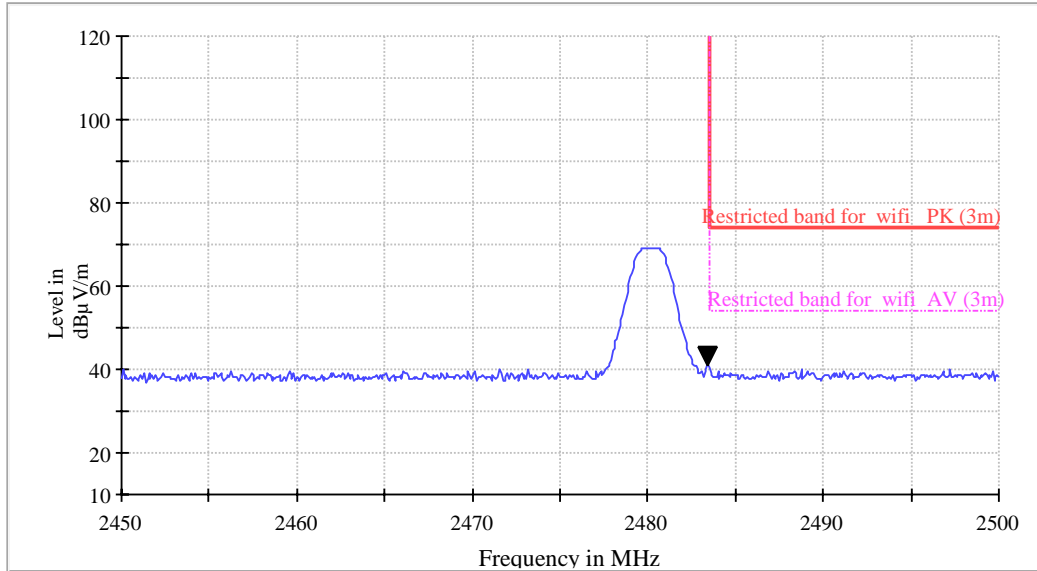

Frequency (MHz)	PK Reading Level (dBµV)	Correction factors (dB/m)	PK Emission Level (dBµV/m)	Limit (dBµV/m)
2483.42	43.6	-2.1	41.5	74.0

Remark:

Final Test Level = Receiver Reading + Correction Factor

Correction Factor = Antenna Factor + Cable Loss - Preamplifier Factor.

When Peak emission level was below AV limit, the AV emission level did not be recorded.

## TEST REPORT

### 4.8 Band Edges Requirement

Test Requirement:	FCC Part 15 C section 15.247  (d) In any 100 kHz bandwidth outside the frequency band in which the spread spectrum or digitally modulated intentional radiator is operating. The radio frequency power that is produced by the intentional radiator shall be at least 20 dB below that in the 100 kHz bandwidth within the band that contains the highest level of the desired power. Based on either an RF conducted or a radiated measurement. Provided the transmitter demonstrates compliance with the peak conducted power limits.
Frequency Band:	2400 MHz to 2483.5 MHz
Test Method:	ANSI C63.10: Clause 11.11 and 11.13
Test Status:	Pre-Scan has been conducted to determine the worst-case mode from all possible combinations between available modulations, data rates and antenna ports (if EUT with antenna diversity architecture). Following channel(s) was (were) selected for the final test as listed below. Pre-test the EUT supplied by adaptor mode and recharged batteries mode, find worse case in supplied by adaptor mode.
Test Configuration:	For Band Edges Emission in Radiated mode, Please refer to clause 4.7

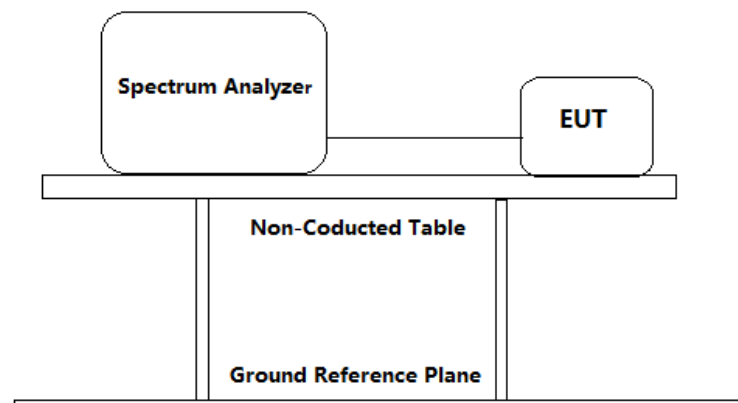

#### Test Procedure:

1. Remove the antenna from the EUT and then connect a low RF cable from the antenna port to the spectrum analyzer.
  - a) Set instrument center frequency to the frequency of the emission to be measured (must be within 2 MHz of the authorized band edge).
  - b) Set the center frequency and span to encompass frequency range to be measured.
  - c) RBW = 100 kHz.
  - d) VBW  $\geq$  [3  $\times$  RBW].

## TEST REPORT

- e) Detector = peak.
  - f) Sweep time = auto.
  - g) Trace mode = max hold.
  - h) Allow sweep to continue until the trace stabilizes (required measurement time may increase for low-duty-cycle applications).
  - i) For radiated Band-edge emissions within a restricted band and within 2 MHz of an authorized band edge, integration method is considered.
2. Repeat until all the test status is investigated.
  3. Report the worst case.

### Used Test Equipment List:

3m Semi-Anechoic Chamber, EMI Test Receiver (9 kHz~7 GHz), Signal and Spectrum Analyzer (10 Hz~40 GHz), Loop antenna (9 kHz-30 MHz). TRILOG Super Broadband test Antenna(30 MHz-3 GHz) (RX), Double-Ridged Waveguide Horn Antenna (800 MHz-18 GHz)(RX) and High Frequency Antenna & preamplifier(18 GHz~26.5 GHz) (RX). Refer to Clause 5 Test Equipment List for details.

Test result with plots as follows:



**TEST REPORT**

For conduct mode:

The band edges was measured and recorded Result:

The Lower Edges attenuated more than 20dB.

The Upper Edges attenuated more than 20dB.

Channel 0: 2.402 GHz

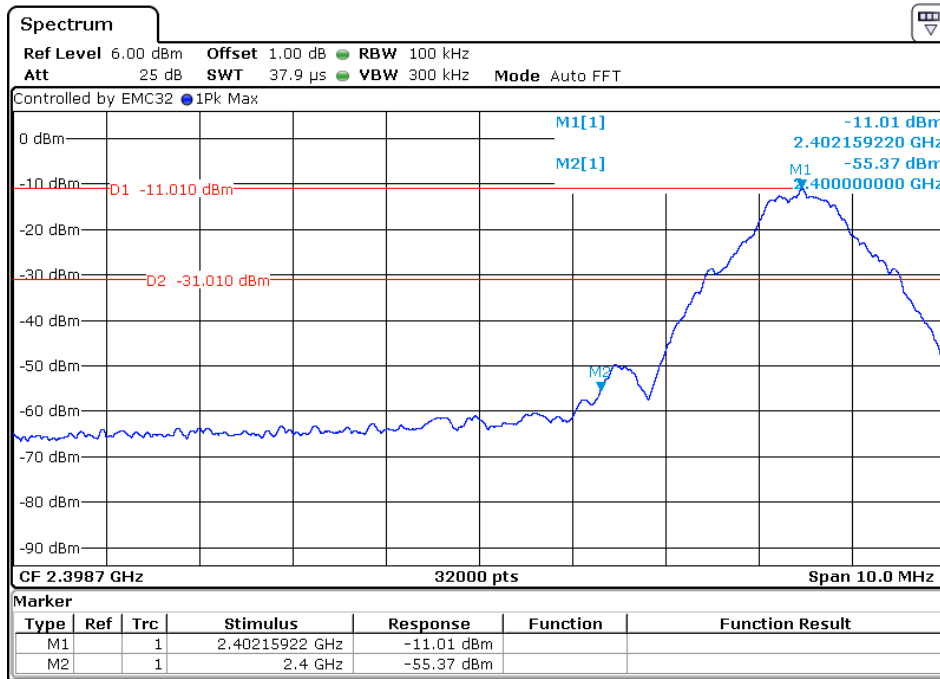

Channel 39: 2.480 GHz

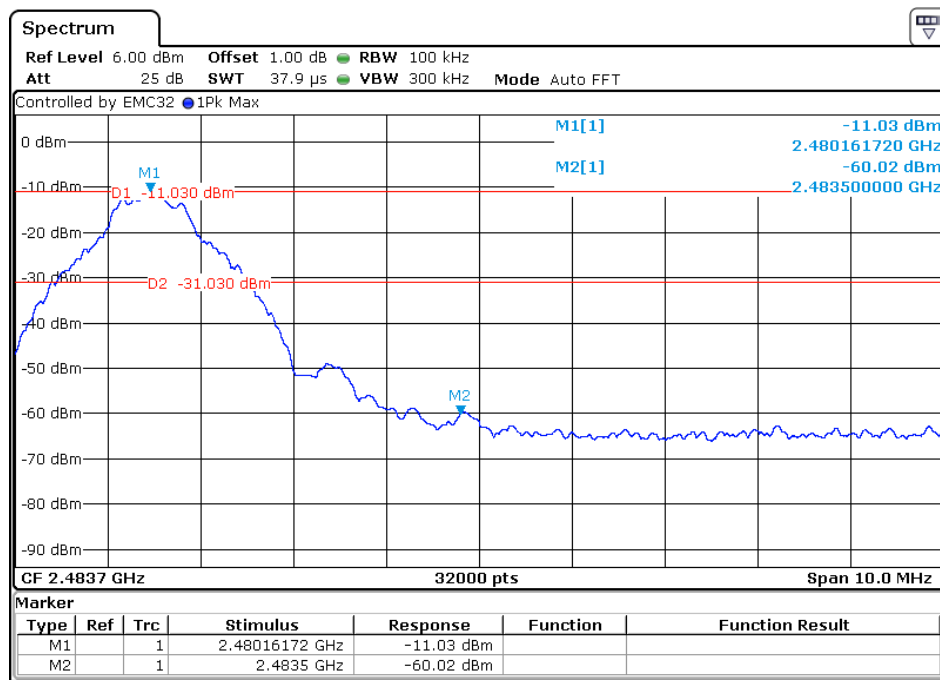

## TEST REPORT

For radiated mode:

Please refer Clause 4.7 Radiated Emissions in Restricted Bands of this test report for more details. The resultant field strength in band edges meet the general radiated emission limit in section 15.209, which does not exceed 74 dB $\mu$ V/m (Peak Limit) and 54 dB $\mu$ V/m (Average Limit).

## TEST REPORT

### 4.9 Conducted Emission Test

Test Configuration:

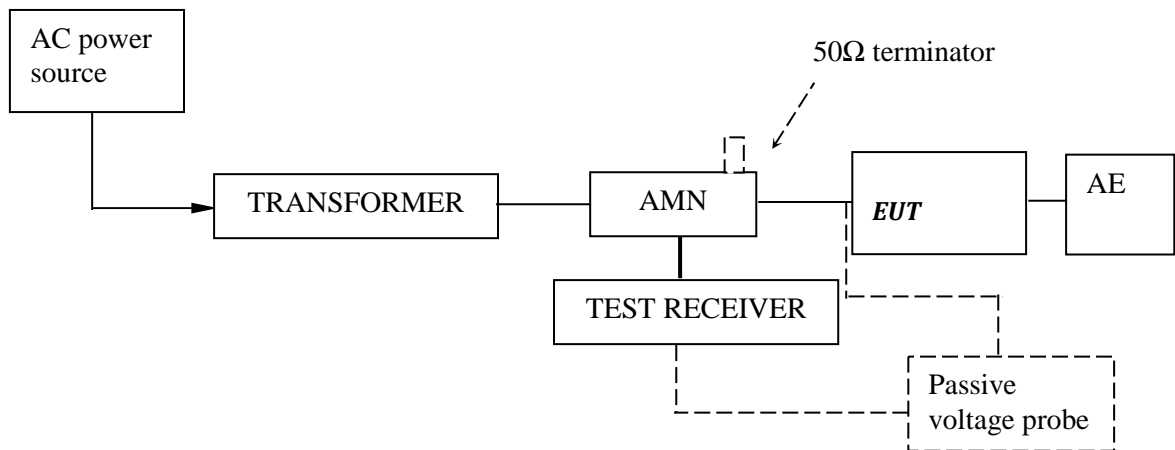

#### Test Setup and Procedure:

Test was performed according to ANSI C63.10 Clause 6.2. The EUT was set to achieve the maximum emission level. The mains terminal disturbance voltage was measured with the EUT in a shielded room. The EUT was connected to AC power source through an Artificial Mains Network which provides a 50Ω linear impedance. An Artificial hand is used if appropriate (for handheld apparatus). The load/control terminal disturbance voltage was measured with a passive voltage probe if appropriate.

The table-top EUT was placed on a 0.8m high non-metallic table above earthed ground plane (Ground Reference Plane). And for floor standing EUT, was placed on a 0.1m high non-metallic supported on GRP. The EUT keeps a distance of at least 0.8m from any other of the metallic surface. The Artificial Mains Network is situated at a distance of 0.8m from the EUT.

During the test, mains lead of EUT excess 0.8m was folded back and forth parallel to the lead so as to form a horizontal bundle with a length between 0.3m and 0.4m.

The bandwidth of test receiver was set at 9 kHz. The frequency range from 150 kHz to 30MHz was checked.

Pre-test in the three channels: 2402MHz, 2441MHz and 2480MHz and found the conducted emission on 2402MHz was the worst case, so below test data was for 2402MHz.

**TEST REPORT**

Test Data and Curve

At main terminal: Pass

Tested Wire: Live

Operation Mode: transmitting mode

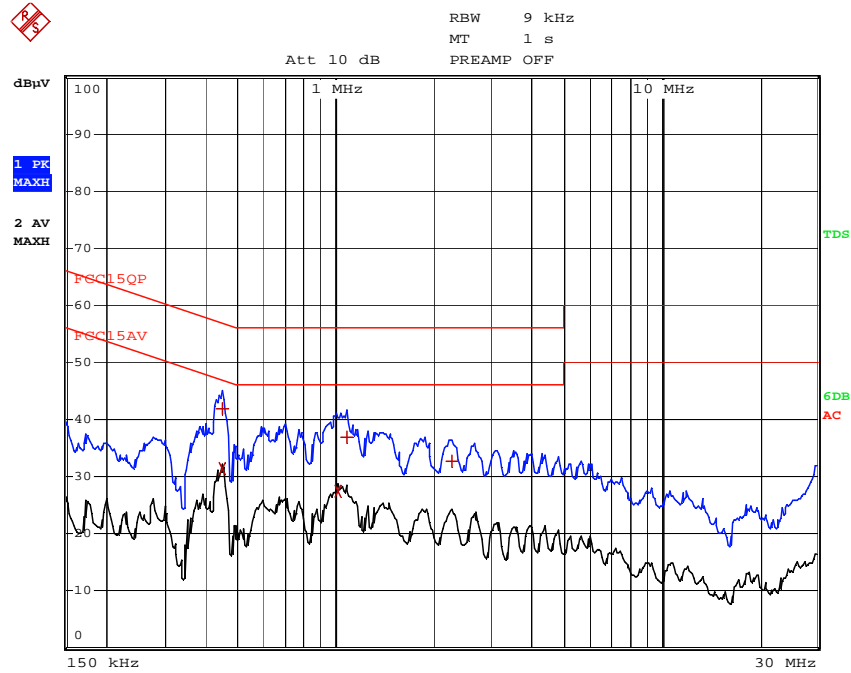

EDIT PEAK LIST (Final Measurement Results)				
Trace1:	FCC15QP			
Trace2:	FCC15AV			
Trace3:	---			
TRACE	FREQUENCY	LEVEL dBµV		DELTA LIMIT dB
1 Quasi Peak	446 kHz	41.83	L1	-15.11
2 Average	446 kHz	31.25	L1	-15.69
2 Average	1.018 MHz	27.46	L1	-18.53
1 Quasi Peak	1.082 MHz	36.83	L1	-19.16
1 Quasi Peak	2.278 MHz	32.72	L1	-23.27

Remark:

1. Corr. (dB) = LISN Factor (dB) + Cable Loss (dB)
2. Level (dBµV) = Corr. (dB) + Read Level (dBµV)
3. Delta Limit (dB) = Level (dBµV)-Limit (dBµV)

**TEST REPORT**

Tested Wire: Neutral

Operation Mode: transmitting mode

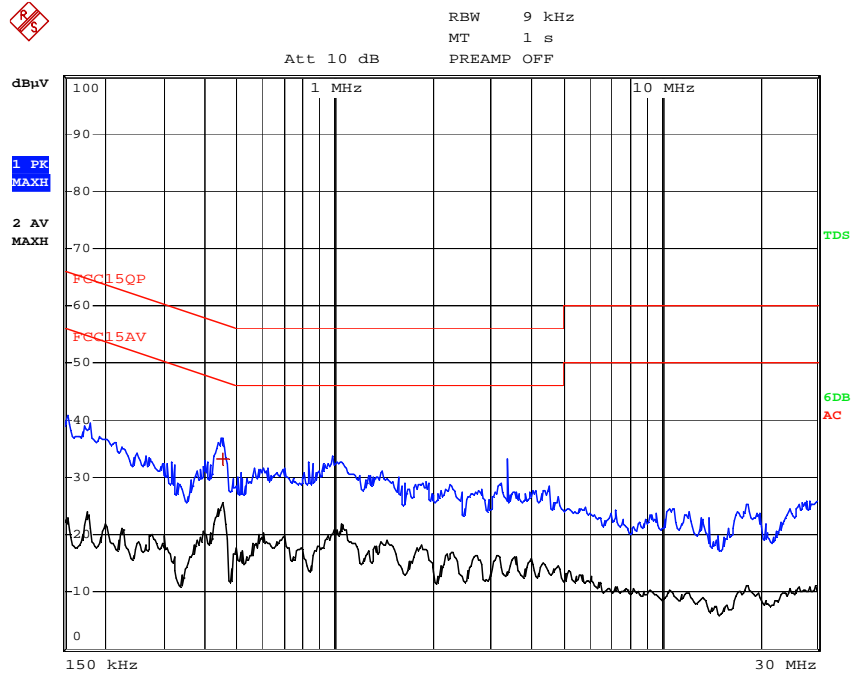

EDIT PEAK LIST (Final Measurement Results)			
Trace1:	FCC15QP		
Trace2:	FCC15AV		
Trace3:	---		
TRACE	FREQUENCY	LEVEL dBµV	DELTA LIMIT dB
1 Quasi Peak	454 kHz	33.17 L1	-23.62

Remark:

1. Corr. (dB) = LISN Factor (dB) + Cable Loss (dB)
2. Level (dBµV) = Corr. (dB) + Read Level (dBµV)
3. Delta Limit (dB) = Level (dBµV)-Limit (dBµV)

**TEST REPORT**

**5.0 Test Equipment List**

**Radiated Emission/Radio**

Equipment No.	Equipment	Model	Manufacturer	Cal. Due date (YYYY-MM-DD)	Calibration Interval
EM030-04	3m Semi-Anechoic Chamber	9×6×6 m <sup>3</sup>	ETS·LINDGRE N	5/6/2019	1Y
EM031-02	EMI Test Receiver (9 kHz~7 GHz)	R&S ESR7	R&S	3/11/2019	1Y
EM031-03	Signal and Spectrum Analyzer (10 Hz~40 GHz)	R&S FSV40	R&S	9/4/2018	1Y
EM011-04	Loop antenna (9 kHz-30 MHz)	HFH2-Z2	R&S	6/14/2019	1Y
EM061-03	TRILOG Super Broadband test Antenna (30 MHz-1.5 GHz) (TX)	VULB 9161	SCHWARZBECK	6/4/2019	1Y
EM033-01	TRILOG Super Broadband test Antenna(30 MHz-3 GHz) (RX)	VULB 9163	SCHWARZBECK	9/19/2018	1Y
EM033-02	Bouble-Ridged Waveguide Horn Antenna (800 MHz-18 GHz)(RX)	R&S HF907	R&S	6/14/2019	1Y
EM033-03	High Frequency Antenna & preamplifier(18 GHz~26.5 GHz) (RX)	R&S SCU-26	R&S	5/4/2019	1Y
EM033-04	High Frequency Antenna & preamplifier (26 GHz-40 GHz)	R&S SCU-40	R&S	5/4/2019	1Y
EM031-02-01	Coaxial cable(9 kHz-1 GHz)	N/A	R&S	5/6/2019	1Y
EM033-02-02	Coaxial cable(1 GHz-18 GHz)	N/A	R&S	5/6/2019	1Y
EM033-04-02	Coaxial cable(18 GHz~40 GHz)	N/A	R&S	5/1/2019	1Y
EM031-01	Signal Generator (9 kHz~6 GHz)	SMB100A	R&S	7/18/2019	1Y
EM085-02	Signal Generator (10MHz-40GHz)	68369B	Wiltron	7/19/2019	1Y
EM040-01	Band Reject/Notch Filter	WRHFV	Wainwright	N/A	1Y
EM040-02	Band Reject/Notch Filter	WRCGV	Wainwright	N/A	1Y
EM040-03	Band Reject/Notch Filter	WRCGV	Wainwright	N/A	1Y
EM022-03	2.45 GHz Filter	BRM50702	Micro-Tronics	5/21/2019	1Y
SA016-16	Programmable Temperature & Humidity Test Chamber	MHU-800LJ	TERCHY	10/15/2018	1Y
SA016-22	Climatic Test Chamber	C7-1500	Vötsch	10/27/2018	1Y
SA012-74	Digital Multimeter	FLUKE175	FLUKE	10/15/2018	1Y
EM010-01	Regulated DC Power supply	PAB-3003A	GUANHUA	N/A	1Y
SA040-22	Regulated DC Power supply	IT6721	ITECH	9/14/2018	1Y
EM084-06	Audio Analyzer	8903B	HP	4/13/2019	1Y
EM045-01-01	EMC32 software (RE/RS)	V10.01.00	R&S	N/A	N/A
EM045-01-09	EMC32 software (328/893)	V9.26.01	R&S	N/A	N/A

**Conducted emission at the mains terminals**

Equipment No.	Equipment	Model	Manufacturer	Cal. Due date (YYYY-MM-DD)	Calibration Interval
EM080-05	EMI receiver	ESCI	R&S	7/18/2019	1Y
EM006-05	LISN	ENV216	R&S	6/6/2019	1Y
EM006-06	LISN	ENV216	R&S	9/14/2018	1Y
EM006-06-01	Coaxial cable	/	R&S	4/7/2019	1Y
EM004-04	EMC shield Room	8m×3m×3m	Zhongyu	1/7/2019	1Y

\*\*\*\*\*End of the test report\*\*\*\*\*