

TEST REPORT

FCC ID: 2ALCFXO-9921

Product: bluetooth headset

Model No.: XO-9921-1

Additional Model No.: N/A

Trade Mark: N/A

Report No.: TCT200324E009

Issued Date: Apr. 01, 2020

Issued for:

Dongguan Xing Yue Electronic co., Ltd
#98 LiWu Swan Industrial District, Qiao Tou Town, Dong Guan City,
Guang Dong, China

Issued By:

Shenzhen Tongce Testing Lab.
1B/F., Building 1, Yibaolai Industrial Park, Qiaotou, Fuyong, Baoan District,
Shenzhen, Guangdong, China
TEL: +86-755-27673339
FAX: +86-755-27673332

Note: This report shall not be reproduced except in full, without the written approval of Shenzhen Tongce Testing Lab.

This document may be altered or revised by Shenzhen Tongce Testing Lab. personnel only, and shall be noted in the revision section of the document. The test results in the report only apply to the tested sample.

TABLE OF CONTENTS

1. Test Certification 3

2. Test Result Summary 4

3. EUT Description..... 5

4. General Information..... 6

 4.1. Test environment and mode..... 6

 4.2. Description of Support Units..... 6

5. Facilities and Accreditations 7

 5.1. Facilities 7

 5.2. Location 7

 5.3. Measurement Uncertainty 7

6. Test Results and Measurement Data 8

 6.1. Antenna requirement 8

 6.2. Conducted Emission 9

 6.3. Conducted Output Power 13

 6.4. 20dB Occupy Bandwidth 17

 6.5. Carrier Frequencies Separation 21

 6.6. Hopping Channel Number 25

 6.7. Dwell Time..... 28

 6.8. Pseudorandom Frequency Hopping Sequence 32

 6.9. Conducted Band Edge Measurement 33

 6.10. Conducted Spurious Emission Measurement..... 36

 6.11. Radiated Spurious Emission Measurement 39

Appendix A: Photographs of Test Setup

Appendix B: Photographs of EUT

1. Test Certification

Product:	bluetooth headset
Model No.:	XO-9921-1
Additional Model:	N/A
Trade Mark:	N/A
Applicant:	Dongguan Xing Yue Electronic co., Ltd
Address:	#98 LiWu Swan Industrial District, Qiao Tou Town, Dong Guan City, Guang Dong, China
Manufacturer:	Dongguan Xing Yue Electronic co., Ltd
Address:	#98 LiWu Swan Industrial District, Qiao Tou Town, Dong Guan City, Guang Dong, China
Date of Test:	Mar. 25, 2020 – Mar. 31, 2020
Applicable Standards:	FCC CFR Title 47 Part 15 Subpart C Section 15.247 FCC KDB 558074 D01 15.247 Meas Guidance v05r02 ANSI C63.10:2013

The above equipment has been tested by Shenzhen Tongce Testing Lab. and found compliance with the requirements set forth in the technical standards mentioned above. The results of testing in this report apply only to the product/system, which was tested. Other similar equipment will not necessarily produce the same results due to production tolerance and measurement uncertainties.

Tested By:**Rleo****Date:****Mar. 31, 2020****Reviewed By:****Beryl Zhao****Date:****Apr. 01, 2020****Approved By:****Tomsin****Date:****Apr. 01, 2020**

2. Test Result Summary

Requirement	CFR 47 Section	Result
Antenna Requirement	§15.203/§15.247 (c)	PASS
AC Power Line Conducted Emission	§15.207	PASS
Conducted Peak Output Power	§15.247 (b)(1)	PASS
20dB Occupied Bandwidth	§15.247 (a)(1)	PASS
Carrier Frequencies Separation	§15.247 (a)(1)	PASS
Hopping Channel Number	§15.247 (a)(1)	PASS
Dwell Time	§15.247 (a)(1)	PASS
Radiated Emission	§15.205/§15.209	PASS
Band Edge	§15.247(d)	PASS

Note:

1. PASS: Test item meets the requirement.
2. Fail: Test item does not meet the requirement.
3. N/A: Test case does not apply to the test object.
4. The test result judgment is decided by the limit of test standard.

3. EUT Description

Product Name:	bluetooth headset
Model :	XO-9921-1
Additional Model:	N/A
Trade Mark:	N/A
Bluetooth version:	V5.0
Operation Frequency:	2402MHz~2480MHz
Transfer Rate:	1/2 Mbits/s
Number of Channel:	79
Modulation Type:	GFSK, $\pi/4$ -DQPSK
Modulation Technology:	FHSS
Antenna Type:	Ceramic Antenna
Antenna Gain:	-0.58dBi
Power Supply:	Rechargeable Li-ion Battery DC 3.7V

Operation Frequency each of channel for GFSK, $\pi/4$ -DQPSK

Channel	Frequency	Channel	Frequency	Channel	Frequency	Channel	Frequency
0	2402MHz	20	2422MHz	40	2442MHz	60	2462MHz
1	2403MHz	21	2423MHz	41	2443MHz	61	2463MHz
...
10	2412MHz	30	2432MHz	50	2452MHz	70	2472MHz
11	2413MHz	31	2433MHz	51	2453MHz	71	2473MHz
...
18	2420MHz	38	2440MHz	58	2460MHz	78	2480MHz
19	2421MHz	39	2441MHz	59	2461MHz		-

Remark: Channel 0, 39 & 78 have been tested for GFSK, $\pi/4$ -DQPSK modulation mode.

4. General Information

4.1. Test environment and mode

Operating Environment:		
Condition	Conducted Emission	Radiated Emission
Temperature:	25.0 °C	25.0 °C
Humidity:	55 % RH	55 % RH
Atmospheric Pressure:	1010 mbar	1010 mbar
Test Mode:		
Engineering mode:	Keep the EUT in continuous transmitting by select channel and modulations with Fully-charged battery	
<p>The sample was placed 0.8m & 1.5m for the measurement below & above 1GHz above the ground plane of 3m chamber. Measurements in both horizontal and vertical polarities were performed. During the test, each emission was maximized by: having the EUT continuously working, investigated all operating modes, rotated about all 3 axis (X, Y & Z) and considered typical configuration to obtain worst position, manipulating interconnecting cables, rotating the turntable, varying antenna height from 1m to 4m in both horizontal and vertical polarizations. The emissions worst-case(Z axis) are shown in Test Results of the following pages.</p>		

4.2. Description of Support Units

The EUT has been tested as an independent unit together with other necessary accessories or support units. The following support units or accessories were used to form a representative test configuration during the tests.

Equipment	Model No.	Serial No.	FCC ID	Trade Name
/	/	/	/	/

Note:

1. All the equipment/cables were placed in the worst-case configuration to maximize the emission during the test.
2. Grounding was established in accordance with the manufacturer's requirements and conditions for the intended use.
3. For conducted measurements (Output Power, 20dB Occupied Bandwidth, Carrier Frequencies Separation, Hopping Channel Number, Dwell Time, Spurious Emissions), the antenna of EUT is connected to the test equipment via temporary antenna connector, the antenna connector is soldered on the antenna port of EUT, and the temporary antenna connector is listed in the Test Instruments.

5. Facilities and Accreditations

5.1. Facilities

The test facility is recognized, certified, or accredited by the following organizations:

- FCC - Registration No.: 645098

Shenzhen Tongce Testing Lab

The 3m Semi-anechoic chamber has been registered and fully described in a report with the (FCC) Federal Communications Commission. The acceptance letter from the FCC is maintained in our files.

- IC - Registration No.: 10668A-1

The 3m Semi-anechoic chamber of Shenzhen TCT Testing Technology Co., Ltd. has been registered by Certification and Engineering Bureau of Industry Canada for radio equipment testing

5.2. Location

Shenzhen Tongce Testing Lab

Address: 1B/F., Building 1, Yibaolai Industrial Park, Qiaotou, Fuyong, Baoan District, Shenzhen, Guangdong, China

Tel: 86-755-27673339

5.3. Measurement Uncertainty

The reported uncertainty of measurement $y \pm U$, where expanded uncertainty U is based on a standard uncertainty multiplied by a coverage factor of $k=2$, providing a level of confidence of approximately 95 %.

No.	Item	MU
1	Conducted Emission	$\pm 2.56\text{dB}$
2	RF power, conducted	$\pm 0.12\text{dB}$
3	Spurious emissions, conducted	$\pm 0.11\text{dB}$
4	All emissions, radiated(<1G)	$\pm 3.92\text{dB}$
5	All emissions, radiated(>1G)	$\pm 4.28\text{dB}$
6	Temperature	$\pm 0.1^\circ\text{C}$
7	Humidity	$\pm 1.0\%$

6. Test Results and Measurement Data

6.1. Antenna requirement

Standard requirement:

FCC Part15 C Section 15.203 /247(c)

15.203 requirement:

An intentional radiator shall be designed to ensure that no antenna other than that furnished by the responsible party shall be used with the device. The use of a permanently attached antenna or of an antenna that uses a unique coupling to the intentional radiator, the manufacturer may design the unit so that a broken antenna can be replaced by the user, but the use of a standard antenna jack or electrical connector is prohibited.

15.247(c) (1)(i) requirement:

(i) Systems operating in the 2400-2483.5 MHz band that is used exclusively for fixed. Point-to-point operations may employ transmitting antennas with directional gain greater than 6dBi provided the maximum conducted output power of the intentional radiator is reduced by 1 dB for every 3 dB that the directional gain of the antenna exceeds 6dBi.

E.U.T Antenna:

The Bluetooth antenna is ceramic antenna which permanently attached, and the best case gain of the antenna is -0.58dBi.

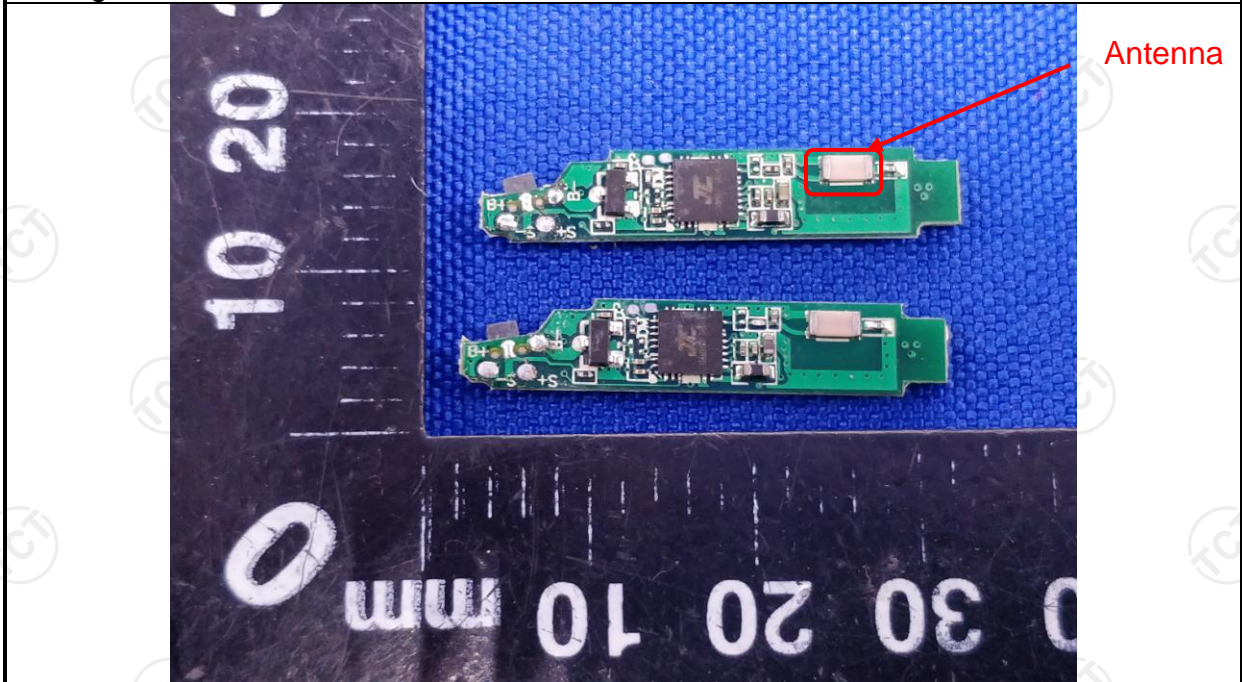

6.2. Conducted Emission

6.2.1. Test Specification

Test Requirement:	FCC Part15 C Section 15.207														
Test Method:	ANSI C63.10:2013														
Frequency Range:	150 kHz to 30 MHz														
Receiver setup:	RBW=9 kHz, VBW=30 kHz, Sweep time=auto														
Limits:	<table border="1"> <thead> <tr> <th rowspan="2">Frequency range (MHz)</th> <th colspan="2">Limit (dBuV)</th> </tr> <tr> <th>Quasi-peak</th> <th>Average</th> </tr> </thead> <tbody> <tr> <td>0.15-0.5</td> <td>66 to 56*</td> <td>56 to 46*</td> </tr> <tr> <td>0.5-5</td> <td>56</td> <td>46</td> </tr> <tr> <td>5-30</td> <td>60</td> <td>50</td> </tr> </tbody> </table>	Frequency range (MHz)	Limit (dBuV)		Quasi-peak	Average	0.15-0.5	66 to 56*	56 to 46*	0.5-5	56	46	5-30	60	50
Frequency range (MHz)	Limit (dBuV)														
	Quasi-peak	Average													
0.15-0.5	66 to 56*	56 to 46*													
0.5-5	56	46													
5-30	60	50													
Test Setup:	<p><i>Remark</i> E.U.T: Equipment Under Test LISN: Line Impedance Stabilization Network Test table height=0.8m</p>														
Test Mode:	Refer to item 4.1														
Test Procedure:	<ol style="list-style-type: none"> 1. The E.U.T is connected to an adapter through a line impedance stabilization network (L.I.S.N.). This provides a 50ohm/50uH coupling impedance for the measuring equipment. 2. The peripheral devices are also connected to the main power through a LISN that provides a 50ohm/50uH coupling impedance with 50ohm termination. (Please refer to the block diagram of the test setup and photographs). 3. Both sides of A.C. line are checked for maximum conducted interference. In order to find the maximum emission, the relative positions of equipment and all of the interface cables must be changed according to ANSI C63.10:2013 on conducted measurement. 														
Test Result:	PASS														

6.2.2. Test Instruments

Conducted Emission Shielding Room Test Site (843)				
Equipment	Manufacturer	Model	Serial Number	Calibration Due
Test Receiver	R&S	ESPI	101402	Jul. 29, 2020
LISN	Schwarzbeck	NSLK 8126	8126453	Sep. 11, 2020
Coax cable (9KHz-30MHz)	TCT	CE-05	N/A	Sep. 08, 2020
EMI Test Software	Shurple Technology	EZ-EMC	N/A	N/A

Note: The calibration interval of the above test instruments is 12 months and the calibrations are traceable to international system unit (SI).

6.2.3. Test data

Please refer to following diagram for individual

Conducted Emission on Line Terminal of the power line (150 kHz to 30MHz)

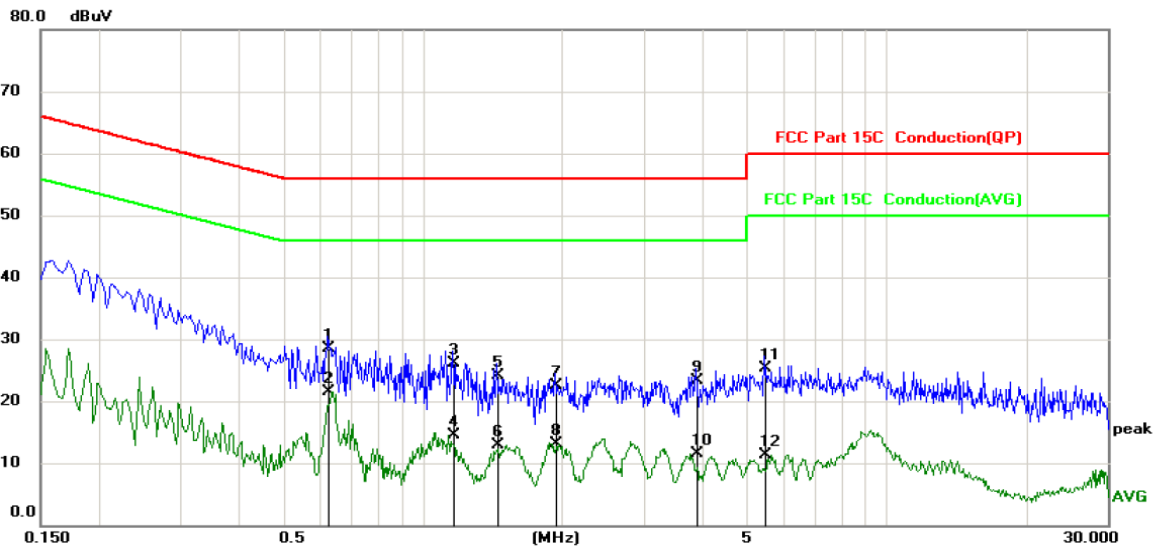

Site: _____ Phase: **L1** Temperature: 25
Limit: FCC Part 15C Conduction(QP) Power: _____ Humidity: 55 %

No.	Mk.	Freq. MHz	Reading Level dBuV	Correct Factor dB	Measure- ment dBuV	Limit dBuV	Over dB	Detector	Comment
1		0.6270	18.24	10.23	28.47	56.00	-27.53	QP	
2	*	0.6270	11.28	10.23	21.51	46.00	-24.49	AVG	
3		1.1625	15.78	10.37	26.15	56.00	-29.85	QP	
4		1.1625	4.04	10.37	14.41	46.00	-31.59	AVG	
5		1.4415	13.75	10.40	24.15	56.00	-31.85	QP	
6		1.4415	2.58	10.40	12.98	46.00	-33.02	AVG	
7		1.9365	12.11	10.44	22.55	56.00	-33.45	QP	
8		1.9365	2.69	10.44	13.13	46.00	-32.87	AVG	
9		3.8850	12.86	10.47	23.33	56.00	-32.67	QP	
10		3.8850	0.94	10.47	11.41	46.00	-34.59	AVG	
11		5.4645	14.88	10.48	25.36	60.00	-34.64	QP	
12		5.4645	0.88	10.48	11.36	50.00	-38.64	AVG	

Note:

- Freq. = Emission frequency in MHz
- Reading level (dBuV) = Receiver reading
- Corr. Factor (dB) = LISN factor + Cable loss
- Measurement (dBuV) = Reading level (dBuV) + Corr. Factor (dB)
- Limit (dBuV) = Limit stated in standard
- Margin (dB) = Measurement (dBuV) – Limits (dBuV)
- Q.P. =Quasi-Peak
- AVG =average
- * is meaning the worst frequency has been tested in the frequency range 150 kHz to 30MHz

Conducted Emission on Neutral Terminal of the power line (150 kHz to 30MHz)

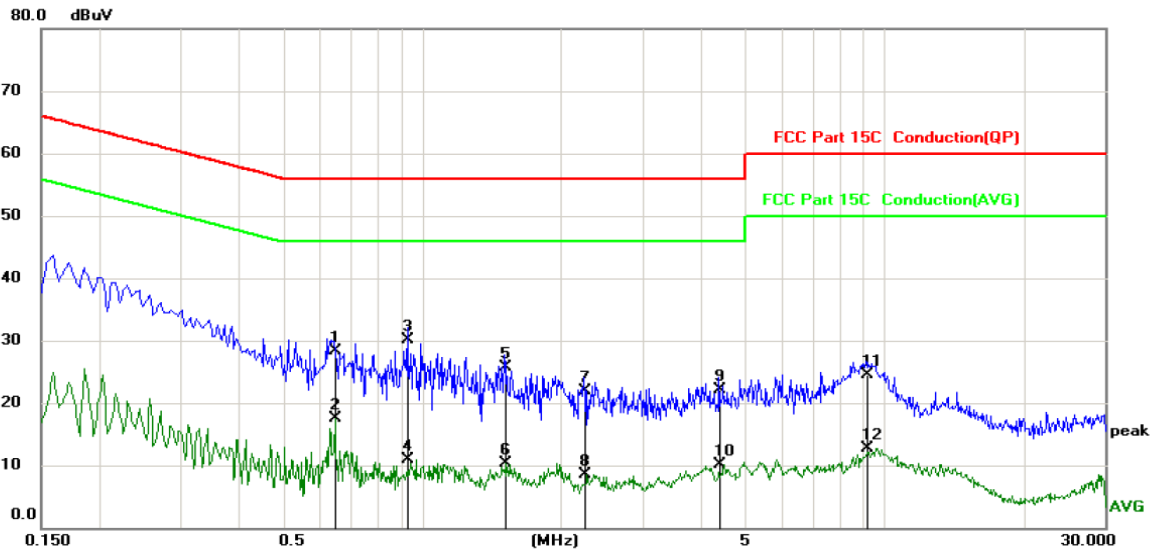

Site: _____ Phase: **N** Temperature: 25
Limit: FCC Part 15C Conduction(QP) Power: _____ Humidity: 55 %

No.	Mk.	Freq.	Reading Level	Correct Factor	Measurement	Limit	Over	Detector	Comment
		MHz	dBuV	dB	dBuV	dBuV	dB		
1		0.6493	18.04	10.22	28.26	56.00	-27.74	QP	
2		0.6493	7.27	10.22	17.49	46.00	-28.51	AVG	
3	*	0.9285	19.71	10.33	30.04	56.00	-25.96	QP	
4		0.9285	0.56	10.33	10.89	46.00	-35.11	AVG	
5		1.5090	15.23	10.41	25.64	56.00	-30.36	QP	
6		1.5090	-0.20	10.41	10.21	46.00	-35.79	AVG	
7		2.2425	11.55	10.45	22.00	56.00	-34.00	QP	
8		2.2425	-2.03	10.45	8.42	46.00	-37.58	AVG	
9		4.4069	11.56	10.48	22.04	56.00	-33.96	QP	
10		4.4069	-0.46	10.48	10.02	46.00	-35.98	AVG	
11		9.1410	14.04	10.56	24.60	60.00	-35.40	QP	
12		9.1410	2.18	10.56	12.74	50.00	-37.26	AVG	

Note1:

Freq. = Emission frequency in MHz
 Reading level (dBuV) = Receiver reading
 Corr. Factor (dB) = LISN factor + Cable loss
 Measurement (dBuV) = Reading level (dBuV) + Corr. Factor (dB)
 Limit (dBuV) = Limit stated in standard
 Margin (dB) = Measurement (dBuV) – Limits (dBuV)
 Q.P. =Quasi-Peak AVG =average
 * is meaning the worst frequency has been tested in the frequency range 150 kHz to 30MHz.

Note2:

Measurements were conducted in all three channels (high, middle, low) and two modulation (GFSK, Pi/4 DQPSK), and the worst case Mode (Middle channel and Pi/4 DQPSK) was submitted only.

6.3. Conducted Output Power

6.3.1. Test Specification

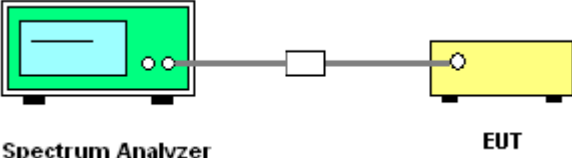
Test Requirement:	FCC Part15 C Section 15.247 (b)(1)
Test Method:	KDB 558074 D01 v05r02
Limit:	Section 15.247 (b) The maximum peak conducted output power of the intentional radiator shall not exceed the following: (1) For frequency hopping systems operating in the 2400-2483.5 MHz band employing at least 75 non-overlapping hopping channels, and all frequency hopping systems in the 5725-5850 MHz band: 1 watt. For all other frequency hopping systems in the 2400-2483.5 MHz band 0.125 watts.
Test Setup:	 <p style="text-align: center;">Spectrum Analyzer EUT</p>
Test Mode:	Transmitting mode with modulation
Test Procedure:	Use the following spectrum analyzer settings: Span = approximately 5 times the 20 dB bandwidth, centered on a hopping channel RBW > the 20 dB bandwidth of the emission being measured VBW ≥ RBW Sweep = auto Detector function = peak Trace = max hold Allow the trace to stabilize. Use the marker-to-peak function to set the marker to the peak of the emission.
Test Result:	PASS

6.3.2. Test Instruments

Equipment	Manufacturer	Model	Serial Number	Calibration Due
Spectrum Analyzer	R&S	FSU	200054	Sep. 11, 2020
RF cable (9kHz-26.5GHz)	TCT	RE-06	N/A	Sep. 11, 2020
Antenna Connector	TCT	RFC-01	N/A	Sep. 11, 2020

Note: The calibration interval of the above test instruments is 12 months and the calibrations are traceable to international system unit (SI).

6.3.3. Test Data

GFSK mode			
Test channel	Peak Output Power (dBm)	Limit (dBm)	Result
Lowest	-1.05	30.00	PASS
Middle	-1.08	30.00	PASS
Highest	-1.41	30.00	PASS

Pi/4DQPSK mode			
Test channel	Peak Output Power (dBm)	Limit (dBm)	Result
Lowest	-0.37	21.00	PASS
Middle	-0.40	21.00	PASS
Highest	-0.74	21.00	PASS

Test plots as follows:

Lowest channel

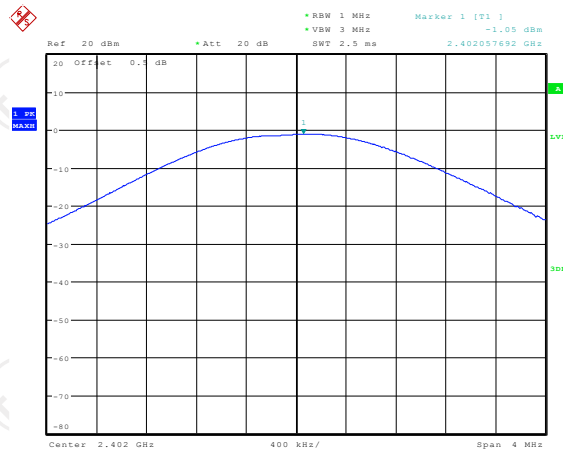

Date: 27.MAR.2020 09:52:15

Middle channel

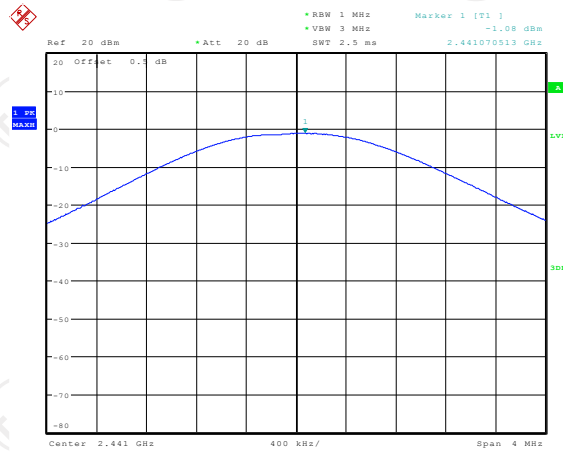

Date: 27.MAR.2020 09:52:29

Highest channel

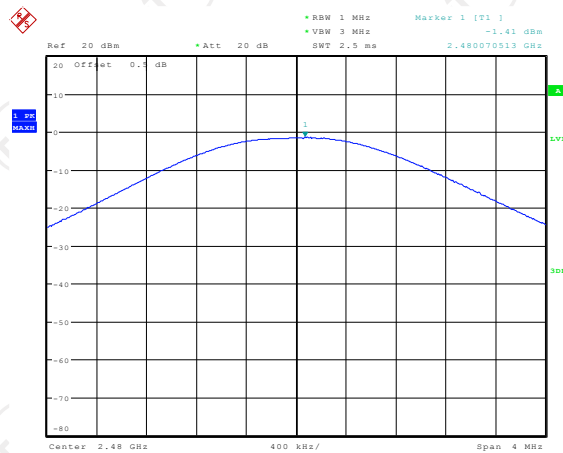

Date: 27.MAR.2020 09:52:42

Lowest channel

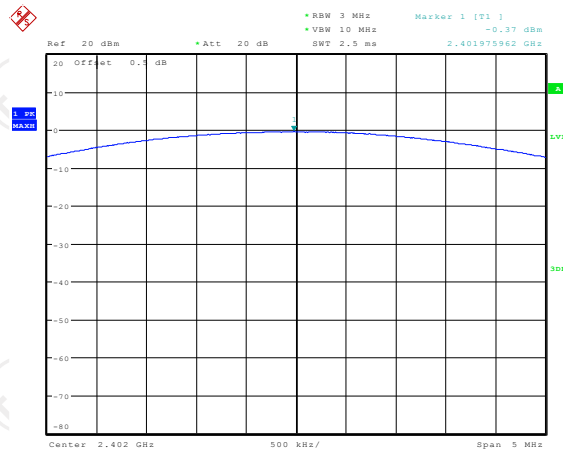

Date: 27.MAR.2020 09:53:33

Middle channel

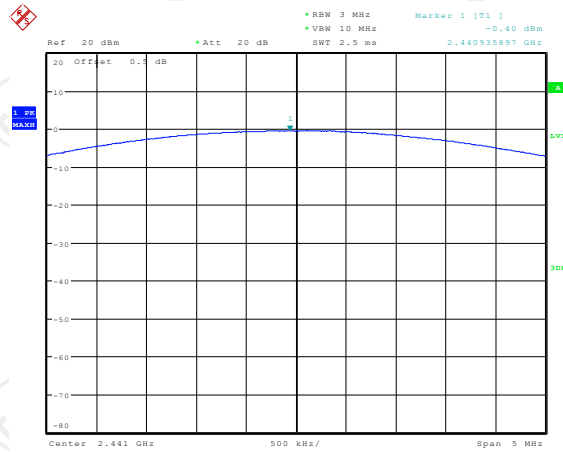

Date: 27.MAR.2020 09:53:19

Highest channel

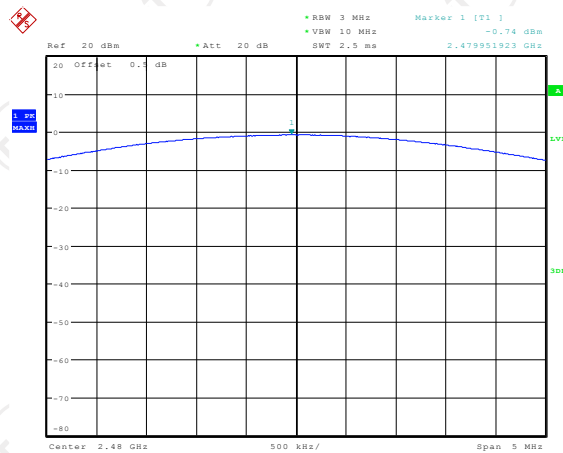

Date: 27.MAR.2020 09:53:07

6.4. 20dB Occupy Bandwidth

6.4.1. Test Specification

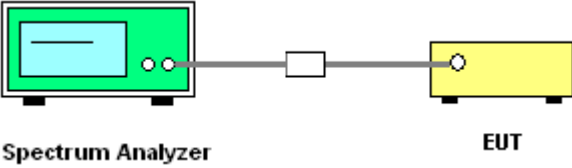
Test Requirement:	FCC Part15 C Section 15.247 (a)(1)
Test Method:	KDB 558074 D01 v05r02
Limit:	N/A
Test Setup:	 <p style="text-align: center;">Spectrum Analyzer EUT</p>
Test Mode:	Transmitting mode with modulation
Test Procedure:	<ol style="list-style-type: none"> 1. The RF output of EUT was connected to the spectrum analyzer by RF cable and attenuator. The path loss was compensated to the results for each measurement. 2. Set to the maximum power setting and enable the EUT transmit continuously. 3. Use the following spectrum analyzer settings for 20dB Bandwidth measurement. Span = approximately 2 to 5 times the 20 dB bandwidth, centered on a hopping channel; $1\% \leq RBW \leq 5\%$ of the 20 dB bandwidth; $VBW \geq 3RBW$; Sweep = auto; Detector function = peak; Trace = max hold. 4. Measure and record the results in the test report.
Test Result:	PASS

6.4.2. Test Instruments

Equipment	Manufacturer	Model	Serial Number	Calibration Due
Spectrum Analyzer	R&S	FSU	200054	Sep. 11, 2020
RF cable (9kHz-26.5GHz)	TCT	RE-06	N/A	Sep. 11, 2020
Antenna Connector	TCT	RFC-01	N/A	Sep. 11, 2020

Note: The calibration interval of the above test instruments is 12 months and the calibrations are traceable to international system unit (SI).

6.4.3. Test data

Test channel	20dB Occupy Bandwidth (kHz)		
	GFSK	$\pi/4$ -DQPSK	Conclusion
Lowest	775.95	1197.12	PASS
Middle	776.92	1197.12	PASS
Highest	778.85	1197.12	PASS

Test plots as follows:

Lowest channel

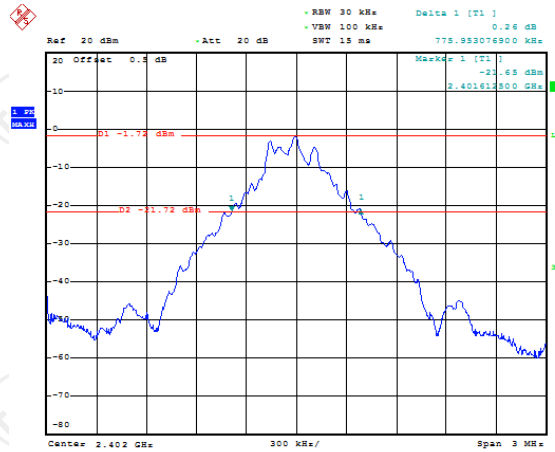

Date: 27.MAR.2020 09:56:09

Middle channel

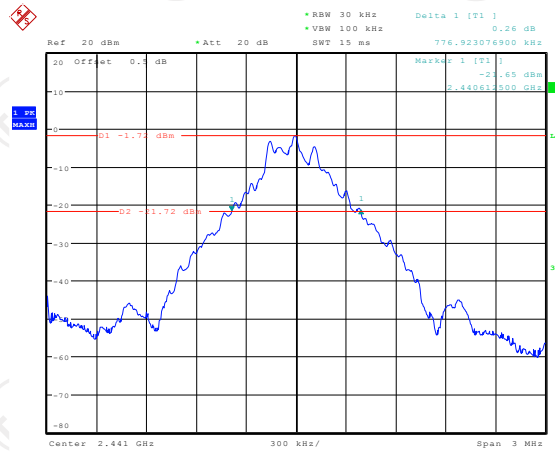

Date: 27.MAR.2020 09:57:09

Highest channel

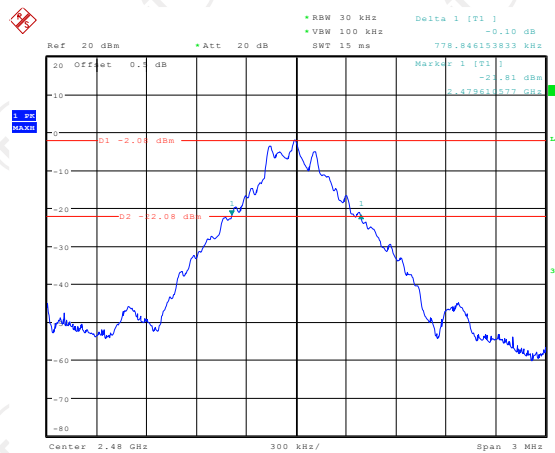

Date: 27.MAR.2020 09:56:36

Lowest channel

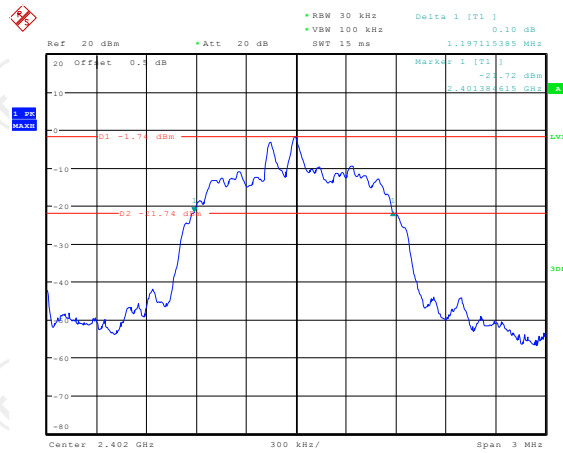

Date: 27.MAR.2020 09:54:46

Middle channel

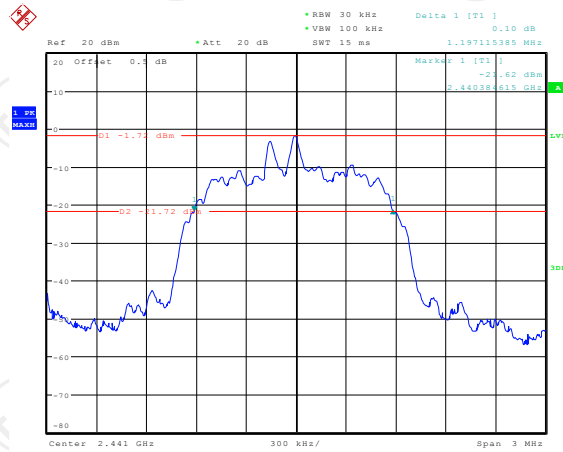

Date: 27.MAR.2020 09:55:28

Highest channel

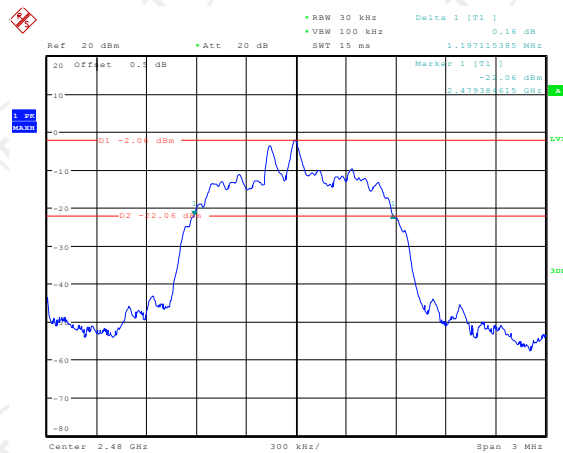

Date: 27.MAR.2020 09:56:01

6.5. Carrier Frequencies Separation

6.5.1. Test Specification

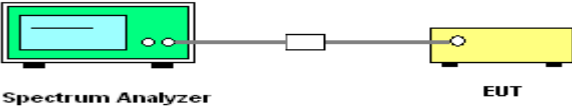
Test Requirement:	FCC Part15 C Section 15.247 (a)(1)
Test Method:	KDB 558074 D01 v05r02
Limit:	Frequency hopping systems shall have hopping channel carrier frequencies separated by a minimum of 25 kHz or the 20 dB bandwidth of the hopping channel, whichever is greater. Alternatively, frequency hopping systems operating in the 2400-2483.5 MHz band may have hopping channel carrier frequencies that are separated by 25 kHz or two-thirds of the 20 dB bandwidth of the hopping channel, whichever is greater, provided the systems operate with an output power no greater than 125 mW.
Test Setup:	 <p style="text-align: center;">Spectrum Analyzer EUT</p>
Test Mode:	Hopping mode
Test Procedure:	<ol style="list-style-type: none"> 1. The RF output of EUT was connected to the spectrum analyzer by RF cable and attenuator. The path loss was compensated to the results for each measurement. 2. Set to the maximum power setting and enable the EUT transmit continuously. 3. Enable the EUT hopping function. 4. Use the following spectrum analyzer settings: Span = wide enough to capture the peaks of two adjacent channels; RBW is set to approximately 30% of the channel spacing, adjust as necessary to best identify the center of each individual channel; VBW ≥ RBW; Sweep = auto; Detector function = peak; Trace = max hold. 5. Use the marker-delta function to determine the separation between the peaks of the adjacent channels. Record the value in report.
Test Result:	PASS

6.5.2. Test Instruments

Equipment	Manufacturer	Model	Serial Number	Calibration Due
Spectrum Analyzer	R&S	FSU	200054	Sep. 11, 2020
RF cable (9kHz-26.5GHz)	TCT	RE-06	N/A	Sep. 11, 2020
Antenna Connector	TCT	RFC-01	N/A	Sep. 11, 2020

Note: The calibration interval of the above test instruments is 12 months and the calibrations are traceable to international system unit (SI).

6.5.3. Test data

GFSK mode			
Test channel	Carrier Frequencies Separation (kHz)	Limit (kHz)	Result
Lowest	1000.00	778.85	PASS
Middle	1000.00	778.85	PASS
Highest	1004.00	778.85	PASS

Pi/4 DQPSK mode			
Test channel	Carrier Frequencies Separation (kHz)	Limit (kHz)	Result
Lowest	998.00	798.08	PASS
Middle	1002.00	798.08	PASS
Highest	1000.00	798.08	PASS

Note: According to section 6.4

Mode	20dB bandwidth (kHz) (worse case)	Limit (kHz) (Carrier Frequencies Separation)
GFSK	778.85	778.85
$\pi/4$ -DQPSK	1197.12	798.08

Test plots as follows:

Lowest channel

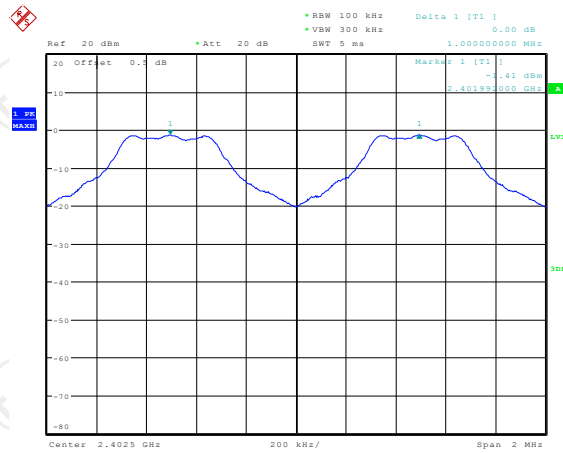

Date: 26.MAR.2020 16:32:01

Middle channel

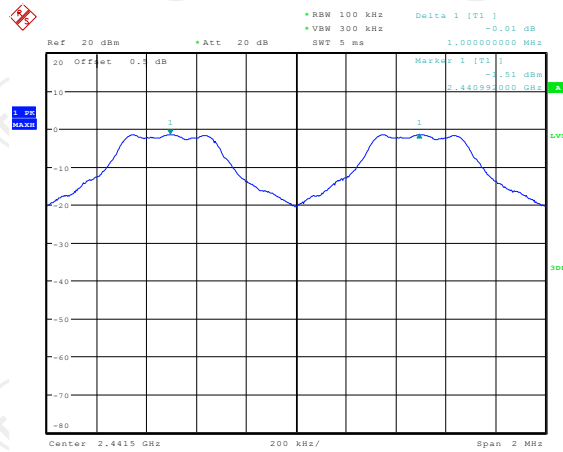

Date: 26.MAR.2020 16:33:16

Highest channel

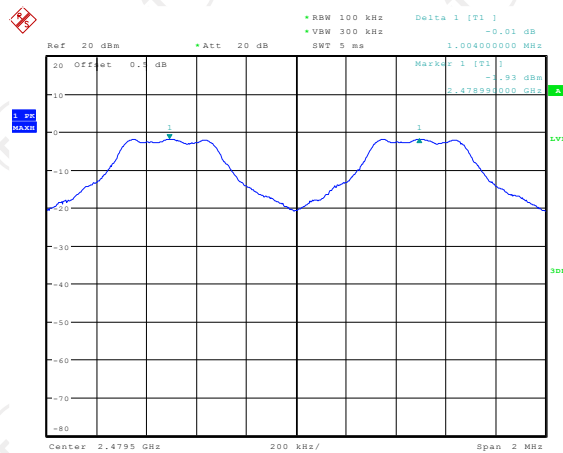

Date: 26.MAR.2020 16:34:07

Lowest channel

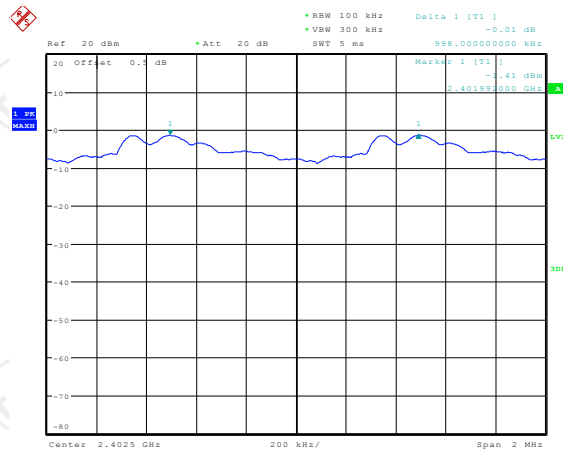

Date: 26.MAR.2020 16:39:07

Middle channel

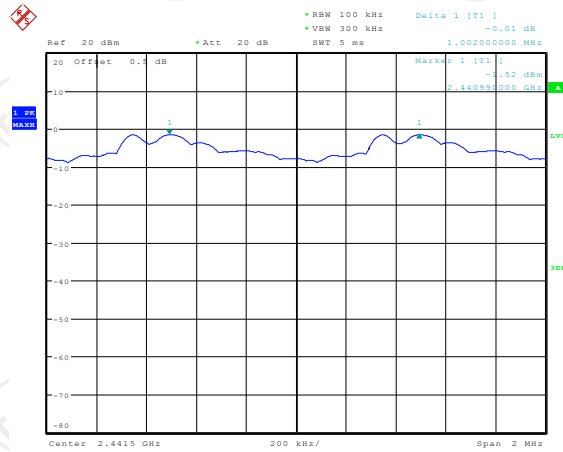

Date: 26.MAR.2020 16:37:42

Highest channel

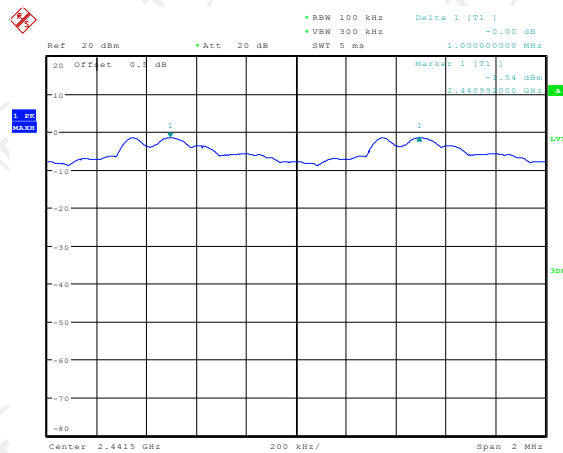

Date: 26.MAR.2020 16:44:08

6.6. Hopping Channel Number

6.6.1. Test Specification

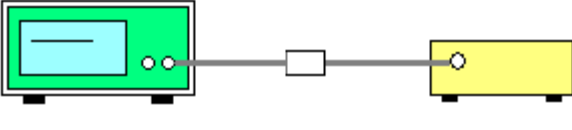
Test Requirement:	FCC Part15 C Section 15.247 (a)(1)
Test Method:	KDB 558074 D01 v05r02
Limit:	Frequency hopping systems in the 2400-2483.5 MHz band shall use at least 15 channels.
Test Setup:	 <p style="text-align: center;">Spectrum Analyzer EUT</p>
Test Mode:	Hopping mode
Test Procedure:	<ol style="list-style-type: none"> 1. The RF output of EUT was connected to the spectrum analyzer by RF cable and attenuator. The path loss was compensated to the results for each measurement. 2. Set to the maximum power setting and enable the EUT transmit continuously. 3. Enable the EUT hopping function. 4. Use the following spectrum analyzer settings: Span = the frequency band of operation; set the RBW to less than 30% of the channel spacing or the 20 dB bandwidth, whichever is smaller; VBW\geqRBW; Sweep = auto; Detector function = peak; Trace = max hold. 5. The number of hopping frequency used is defined as the number of total channel. 6. Record the measurement data in report.
Test Result:	PASS

6.6.2. Test Instruments

Equipment	Manufacturer	Model	Serial Number	Calibration Due
Spectrum Analyzer	R&S	FSU	200054	Sep. 11, 2020
RF cable (9kHz-26.5GHz)	TCT	RE-06	N/A	Sep. 11, 2020
Antenna Connector	TCT	RFC-01	N/A	Sep. 11, 2020

Note: The calibration interval of the above test instruments is 12 months and the calibrations are traceable to international system unit (SI).

6.6.3. Test data

Mode	Hopping channel numbers	Limit	Result
GFSK, Pi/4DQPSK	79	15	PASS

Test plots as follows:



GFSK

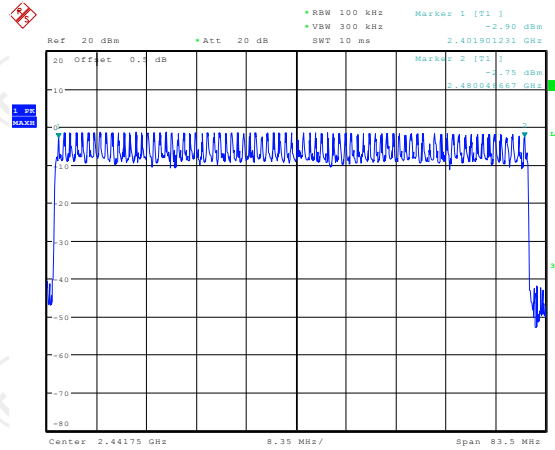

Date: 26.MAR.2020 16:50:23

Pi/4DQPSK

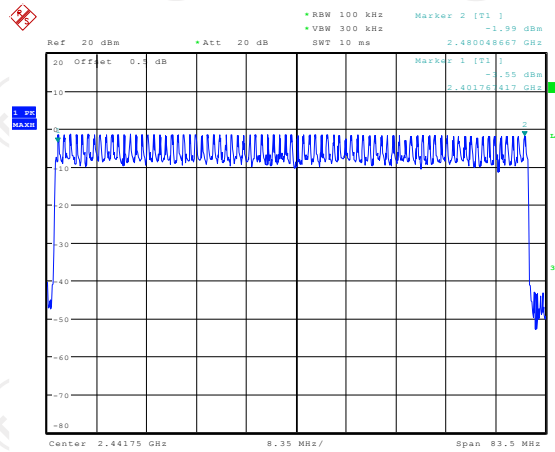

Date: 26.MAR.2020 16:48:10

6.7.3. Test Data

Mode	Packet	Hops Over Occupancy Time (hops)	Package Transfer Time (ms)	Dwell time (second)	Limit (second)	Result
GFSK	DH1	320	0.434	0.139	0.4	PASS
GFSK	DH3	160	1.707	0.273	0.4	PASS
GFSK	DH5	106.67	2.962	0.316	0.4	PASS
Pi/4 DQPSK	2-DH1	320	0.447	0.143	0.4	PASS
Pi/4 DQPSK	2-DH3	160	1.726	0.276	0.4	PASS
Pi/4 DQPSK	2-DH5	106.67	2.955	0.315	0.4	PASS

Note: 1. In normal mode, hopping rate is 1600 hops/s with 6 slots in 79 hopping channels.

For DH1, With channel hopping rate (1600 / 2 / 79) in Occupancy Time Limit (0.4 x 79) (s), Hops Over Occupancy Time comes to (1600 / 2 / 79) x (0.4 x 79) = 320 hops

For DH3, With channel hopping rate (1600 / 4 / 79) in Occupancy Time Limit (0.4 x 79) (s), Hops Over Occupancy Time comes to (1600 / 4 / 79) x (0.4 x 79) = 160 hops

For DH5, With channel hopping rate (1600 / 6 / 79) in Occupancy Time Limit (0.4 x 79) (s), Hops Over Occupancy Time comes to (1600 / 6 / 79) x (0.4 x 79) = 106.67 hops

2. Dwell Time(s) = Hops Over Occupancy Time (hops) x Package Transfer Time

Test plots as follows:

**GFSK
DH1**

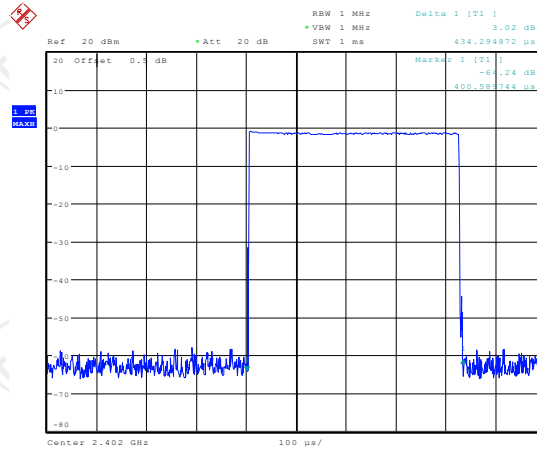

Date: 26.MAR.2020 16:53:01

DH3

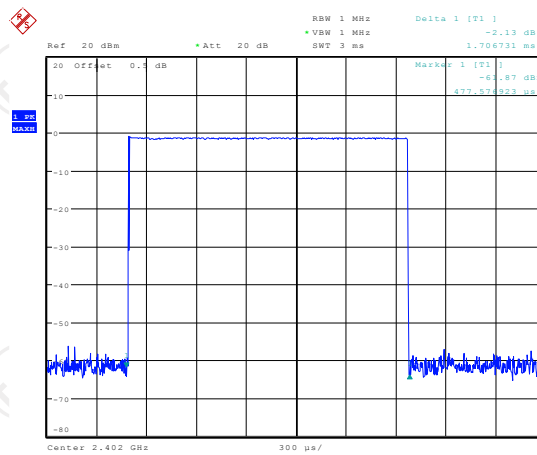

Date: 26.MAR.2020 16:55:00

DH5

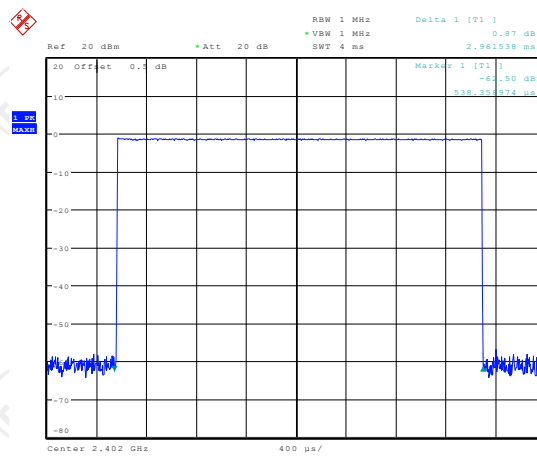

Date: 26.MAR.2020 16:55:40

Pi/4DQPSK
2-DH1

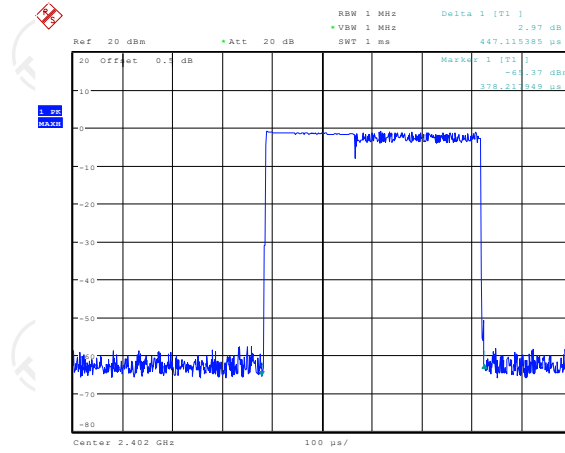

Date: 26.MAR.2020 16:53:36

2-DH3

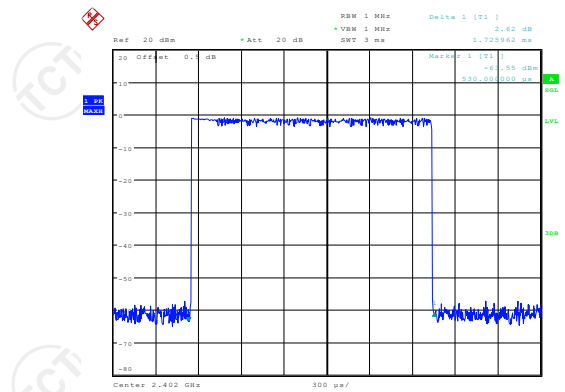

Date: 26.MAR.2020 16:54:41

2-DH5

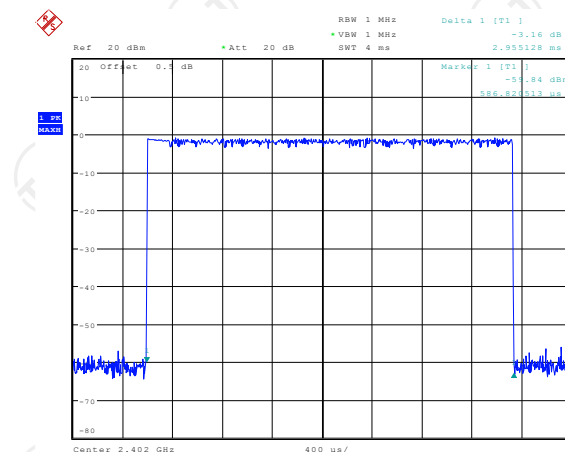

Date: 26.MAR.2020 16:56:12

6.8. Pseudorandom Frequency Hopping Sequence

Test Requirement: FCC Part15 C Section 15.247 (a)(1) requirement:

Frequency hopping systems shall have hopping channel carrier frequencies separated by a minimum of 25 kHz or the 20 dB bandwidth of the hopping channel, whichever is greater.

Alternatively. Frequency hopping systems operating in the 2400-2483.5 MHz band may have hopping channel carrier frequencies that are separated by 25 kHz or two-thirds of the 20 dB bandwidth of the hopping channel, whichever is greater, provided the systems operate with an output power no greater than 125 mW. The system shall hop to channel frequencies that are selected at the system hopping rate from a Pseudorandom ordered list of hopping frequencies. Each frequency must be used equally on the average by each transmitter. The system receivers shall have input bandwidths that match the hopping channel bandwidths of their corresponding transmitters and shall shift frequencies in synchronization with the transmitted signals.

EUT Pseudorandom Frequency Hopping Sequence

The pseudorandom sequence may be generated in a nine-stage shift register whose 5th and 9th stage outputs are added in a modulo-two addition stage. And the result is fed back to the input of the first stage. The sequence begins with the first one of 9 consecutive ones; i.e. the shift register is initialized with nine ones.

- Number of shift register stages: 9
- Length of pseudo-random sequence: $2^9 - 1 = 511$ bits
- Longest sequence of zeros: 8 (non-inverted signal)

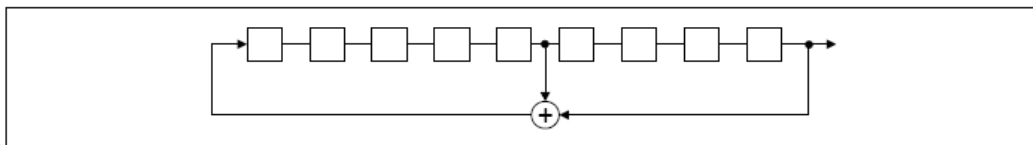

Linear Feedback Shift Register for Generation of the PRBS sequence

An example of Pseudorandom Frequency Hopping Sequence as follow:

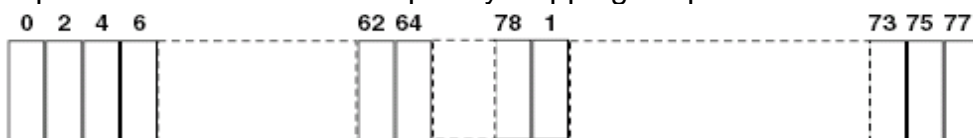

Each frequency used equally on the average by each transmitter. The system receivers have input bandwidths that match the hopping channel bandwidths of their corresponding transmitters and shift frequencies in synchronization with the transmitted signals.

6.9. Conducted Band Edge Measurement

6.9.1. Test Specification

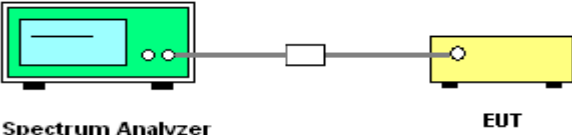
Test Requirement:	FCC Part15 C Section 15.247 (d)
Test Method:	KDB 558074 D01 v05r02
Limit:	In any 100 kHz bandwidth outside the intentional radiation frequency band, the radio frequency power shall be at least 20 dB below the highest level of the radiated power. In addition, radiated emissions which fall in the restricted bands must also comply with the radiated emission limits.
Test Setup:	 <p style="text-align: center;">Spectrum Analyzer EUT</p>
Test Mode:	Transmitting mode with modulation
Test Procedure:	<ol style="list-style-type: none"> 1. Set to the maximum power setting and enable the EUT transmit continuously. 2. Set RBW = 100 kHz ($\geq 1\%$ span=10MHz), VBW = 300 kHz (\geqRBW). Band edge emissions must be at least 20 dB down from the highest emission level within the authorized band as measured with a 100kHz RBW. The attenuation shall be 30 dB instead of 20 dB when RMS conducted output power procedure is used. 3. Enable hopping function of the EUT and then repeat step 2 and 3. 4. Measure and record the results in the test report.
Test Result:	PASS

6.9.2. Test Instruments

Equipment	Manufacturer	Model	Serial Number	Calibration Due
Spectrum Analyzer	R&S	FSU	200054	Sep. 11, 2020
RF cable (9kHz-26.5GHz)	TCT	RE-06	N/A	Sep. 11, 2020
Antenna Connector	TCT	RFC-01	N/A	Sep. 11, 2020

Note: The calibration interval of the above test instruments is 12 months and the calibrations are traceable to international system unit (SI).

6.9.3. Test Data

GFSK Modulation

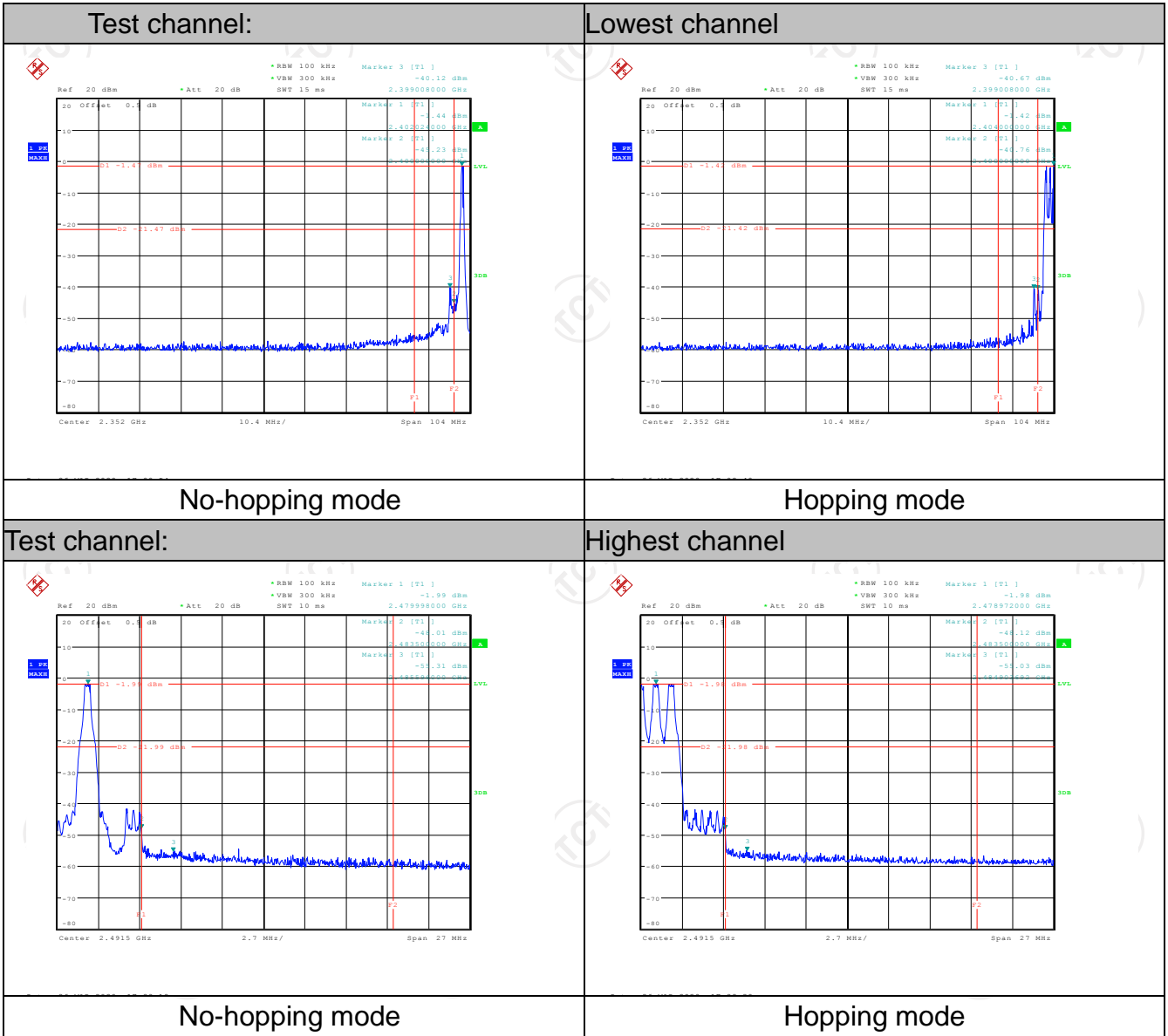

Pi/4DQPSK Modulation

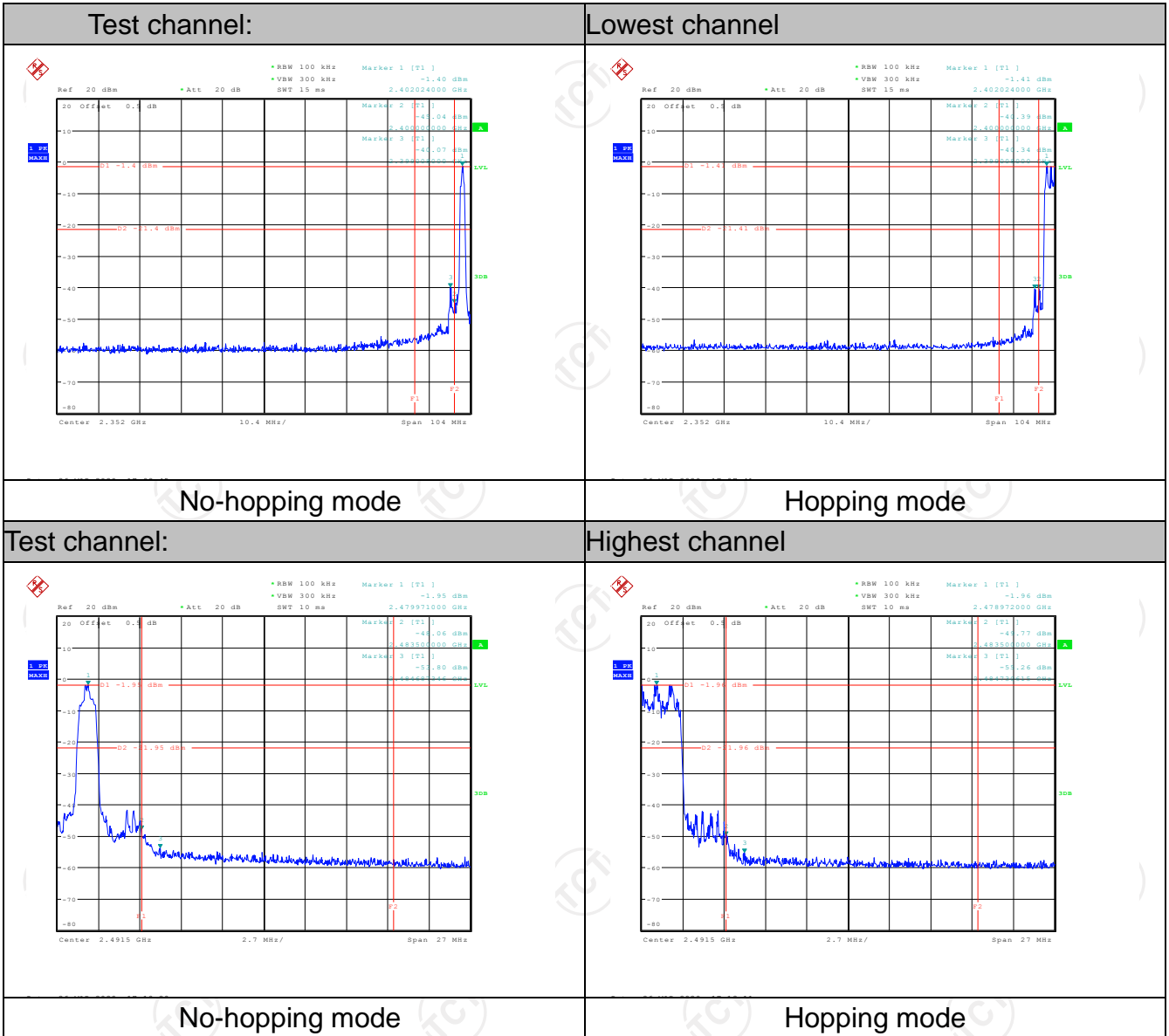

6.10. Conducted Spurious Emission Measurement

6.10.1. Test Specification

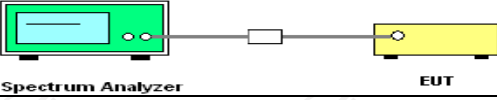
Test Requirement:	FCC Part15 C Section 15.247 (d)
Test Method:	KDB 558074 D01 v05r02
Limit:	In any 100 kHz bandwidth outside the intentional radiation frequency band, the radio frequency power shall be at least 20 dB below the highest level of the radiated power. In addition, radiated emissions which fall in the restricted bands must also comply with the radiated emission limits.
Test Setup:	 <p style="text-align: center;">Spectrum Analyzer EUT</p>
Test Mode:	Transmitting mode with modulation
Test Procedure:	<ol style="list-style-type: none"> 1. The RF output of EUT was connected to the spectrum analyzer by RF cable and attenuator. The path loss was compensated to the results for each measurement. 2. Set to the maximum power setting and enable the EUT transmit continuously. 3. Set RBW = 100 kHz, VBW = 300kHz, scan up through 10th harmonic. All harmonics / spurs must be at least 20 dB down from the highest emission level within the authorized band as measured with a 100 kHz RBW. 4. Measure and record the results in the test report. 5. The RF fundamental frequency should be excluded against the limit line in the operating frequency band.
Test Result:	PASS

6.10.2. Test Instruments

Equipment	Manufacturer	Model	Serial Number	Calibration Due
Spectrum Analyzer	R&S	FSU	200054	Sep. 11, 2020
Spectrum Analyzer	ROHDE&SCHWARZ	FSQ40	200061	Sep. 11, 2020
RF Cable (9KHz-26.5GHz)	TCT	RE-06	N/A	Sep. 11, 2020
Antenna Connector	TCT	RFC-01	N/A	Sep. 11, 2020

Note: The calibration interval of the above test instruments is 12 months and the calibrations are traceable to international system unit (SI).

6.10.3. Test Data

GFSK mode

Lowest Channel

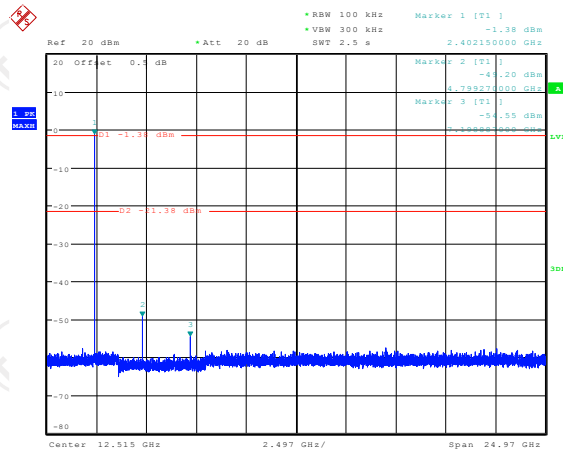

Date: 26 MAR 2020 17:35:17

Middle Channel

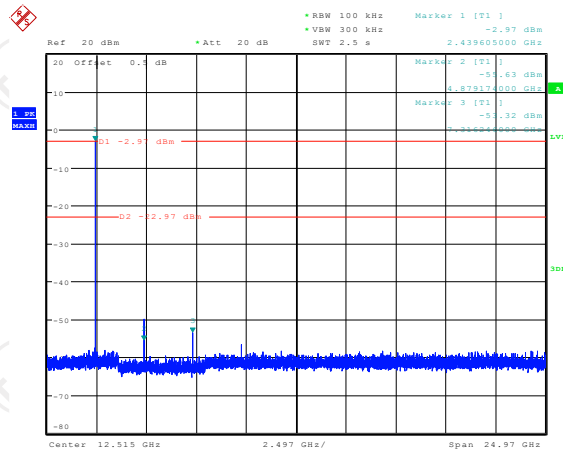

Date: 26 MAR 2020 17:34:17

Highest Channel

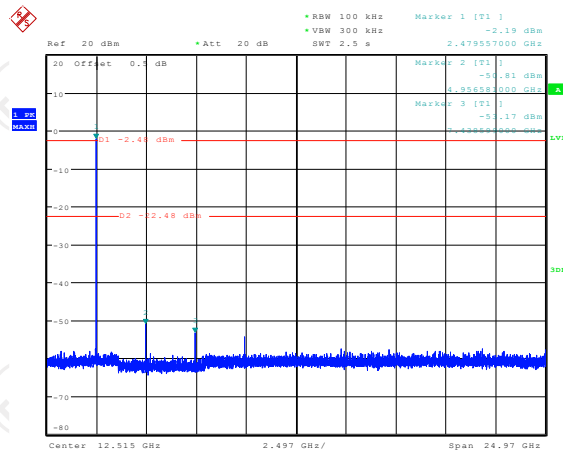

Date: 26 MAR 2020 17:31:07

Pi/4DQPSK mode

Lowest Channel

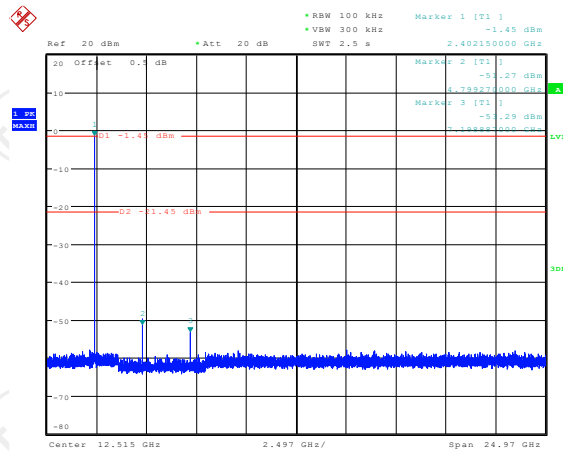

Date: 26.MAR.2020 17:38:39

Middle Channel

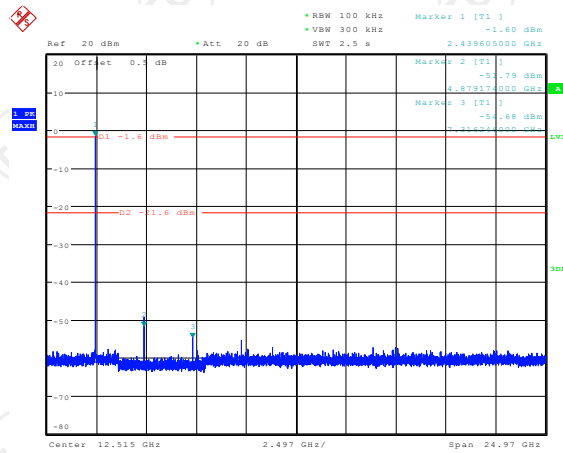

Date: 26.MAR.2020 17:33:42

Highest Channel

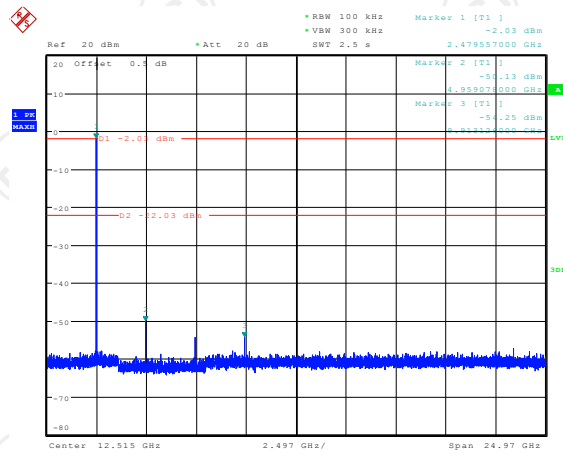

Date: 26.MAR.2020 17:32:11

6.11. Radiated Spurious Emission Measurement

6.11.1. Test Specification

Test Requirement:	FCC Part15 C Section 15.209					
Test Method:	ANSI C63.10:2013					
Frequency Range:	9 kHz to 25 GHz					
Measurement Distance:	3 m					
Antenna Polarization:	Horizontal & Vertical					
Receiver Setup:	Frequency	Detector	RBW	VBW	Remark	
	9kHz- 150kHz	Quasi-peak	200Hz	1kHz	Quasi-peak Value	
	150kHz- 30MHz	Quasi-peak	9kHz	30kHz	Quasi-peak Value	
	30MHz-1GHz	Quasi-peak	120KHz	300KHz	Quasi-peak Value	
	Above 1GHz	Peak	1MHz	3MHz	Peak Value	
		Peak	1MHz	10Hz	Average Value	
Limit:	Frequency	Field Strength (microvolts/meter)	Measurement Distance (meters)			
	0.009-0.490	2400/F(KHz)	300			
	0.490-1.705	24000/F(KHz)	30			
	1.705-30	30	30			
	30-88	100	3			
	88-216	150	3			
	216-960	200	3			
	Above 960	500	3			
	Frequency	Field Strength (microvolts/meter)	Measurement Distance (meters)	Detector		
	Above 1GHz	500	3	Average		
	5000	3	Peak			
Test setup:	For radiated emissions below 30MHz					
	<p>Distance = 3m</p> <p>0.8m</p> <p>Turn table</p> <p>1m</p> <p>Ground Plane</p> <p>Computer</p> <p>Pre-Amplifier</p> <p>Receiver</p>					
	30MHz to 1GHz					

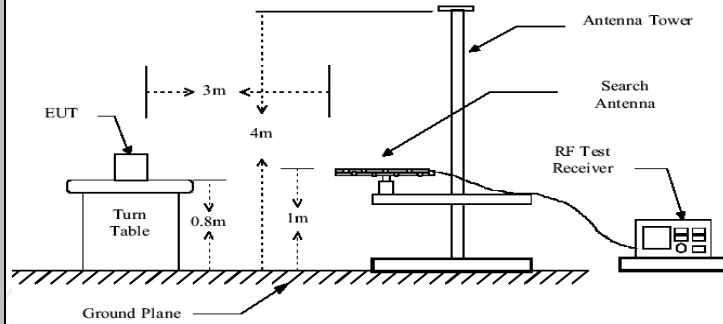

Above 1GHz

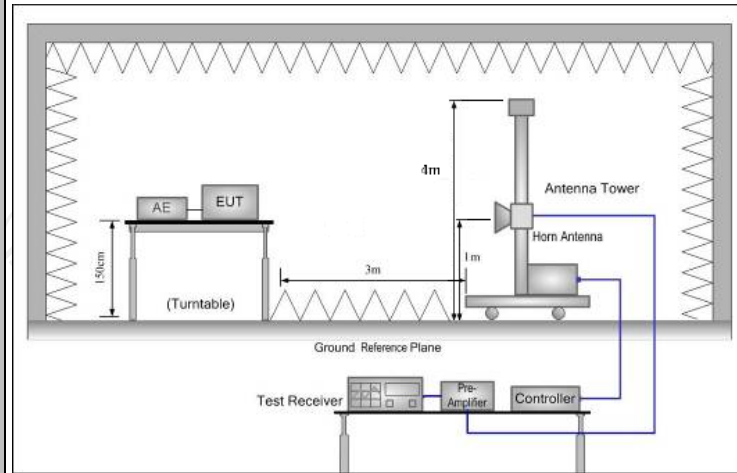

Test Mode:

Transmitting mode with modulation

Test Procedure:

1. The testing follows the guidelines in Spurious Radiated Emissions of ANSI C63.10:2013 Measurement Guidelines.
2. For the radiated emission test below 1GHz:
The EUT was placed on a turntable with 0.8 meter above ground. The EUT was set 3 meters from the interference receiving antenna, which was mounted on the top of a variable height antenna tower. The EUT was arranged to its worst case and then tune the antenna tower (from 1 m to 4 m) and turntable (from 0 degree to 360 degrees) to find the maximum reading. A pre-amp and a high PASS filter are used for the test in order to get better signal level.
- For the radiated emission test above 1GHz:
Place the measurement antenna on a turntable with 1.5 meter above ground, which is away from each area of the EUT determined to be a source of emissions at the specified measurement distance, while keeping the measurement antenna aimed at the source of emissions at each frequency of significant emissions, with polarization oriented for maximum response. The measurement antenna may have to be higher or lower than the EUT, depending on the radiation pattern of the emission

	<p>and staying aimed at the emission source for receiving the maximum signal. The final measurement antenna elevation shall be that which maximizes the emissions. The measurement antenna elevation for maximum emissions shall be restricted to a range of heights of from 1 m to 4 m above the ground or reference ground plane.</p> <p>3. Set to the maximum power setting and enable the EUT transmit continuously.</p> <p>4. Use the following spectrum analyzer settings:</p> <p>(1) Span shall wide enough to fully capture the emission being measured;</p> <p>(2) Set RBW=120 kHz for $f < 1$ GHz, RBW=1MHz for $f > 1$GHz ; VBW\geqRBW; Sweep = auto; Detector function = peak; Trace = max hold for peak</p> <p>(3) For average measurement: use duty cycle correction factor method per 15.35(c). Duty cycle = On time/100 milliseconds On time = $N_1 * L_1 + N_2 * L_2 + \dots + N_{n-1} * L_{n-1} + N_n * L_n$ Where N_1 is number of type 1 pulses, L_1 is length of type 1 pulses, etc. Average Emission Level = Peak Emission Level + $20 * \log(\text{Duty cycle})$ Corrected Reading: Antenna Factor + Cable Loss + Read Level - Preamp Factor = Level</p>
Test results:	PASS

6.11.2. Test Instruments

Radiated Emission Test Site (966)				
Name of Equipment	Manufacturer	Model	Serial Number	Calibration Due
Test Receiver	ROHDE&SCHW ARZ	ESIB7	100197	Jul. 29, 2020
Spectrum Analyzer	ROHDE&SCHW ARZ	FSQ40	200061	Sep. 11, 2020
Pre-amplifier	EM Electronics Corporation CO.,LTD	EM30265	07032613	Sep. 08, 2020
Pre-amplifier	HP	8447D	2727A05017	Sep. 08, 2020
Loop antenna	ZHINAN	ZN30900A	12024	Sep. 11, 2020
Broadband Antenna	Schwarzbeck	VULB9163	340	Sep. 06, 2020
Horn Antenna	Schwarzbeck	BBHA 9120D	631	Sep. 06, 2020
Horn Antenna	A-INFO	LB-180400-KF	J211020657	Sep. 06, 2020
Antenna Mast	Keleto	RE-AM	N/A	N/A
Coax cable (9KHz-40GHz)	TCT	RE-high-02	N/A	Sep. 08, 2020
Coax cable (9KHz-40GHz)	TCT	RE-high-04	N/A	Sep. 08, 2020
EMI Test Software	Shurple Technology	EZ-EMC	N/A	N/A

Note: The calibration interval of the above test instruments is 12 months and the calibrations are traceable to international system unit (SI).

6.11.3. Test Data

Duty cycle correction factor for average measurement

DH5 on time (One Pulse) Plot on Channel 00

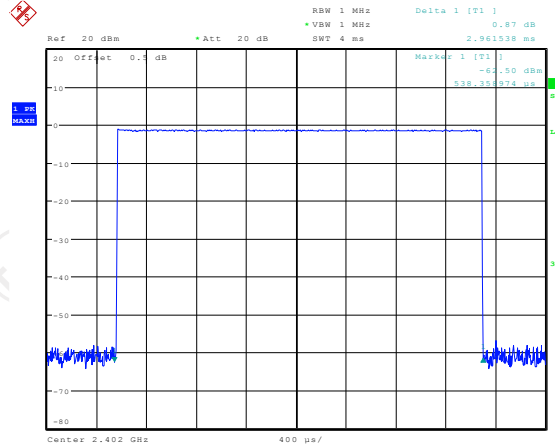

Date: 26.MAR.2020 16:55:40

DH5 on time (Count Pulses) Plot on Channel 00

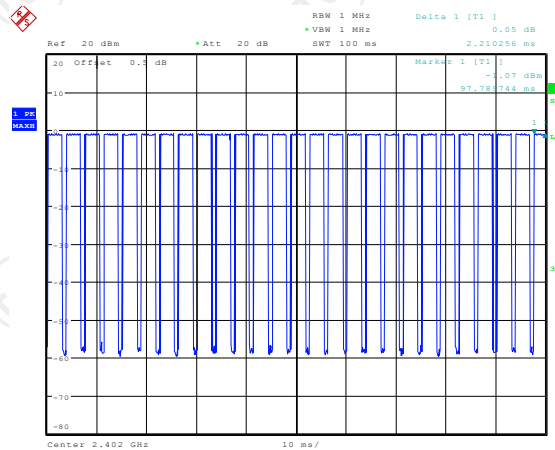

Date: 26.MAR.2020 16:57:19

Note:

1. Worst case Duty cycle = on time/100 milliseconds = $(2.962 \times 26 + 2.210) / 100 = 0.7922$
2. Worst case Duty cycle correction factor = $20 \times \log(\text{Duty cycle}) = -2.02 \text{ dB}$
3. 2DH5 has the highest duty cycle worst case and is reported.
4. The average levels were calculated from the peak level corrected with duty cycle correction factor (-2.02dB) derived from $20 \log(\text{dwell time}/100\text{ms})$. This correction is only for signals that hop with the fundamental signal, such as band-edge and harmonic. Other spurious signals that are independent of the hopping signal would not use this correction.

Please refer to following diagram for individual

Below 1GHz

Horizontal:

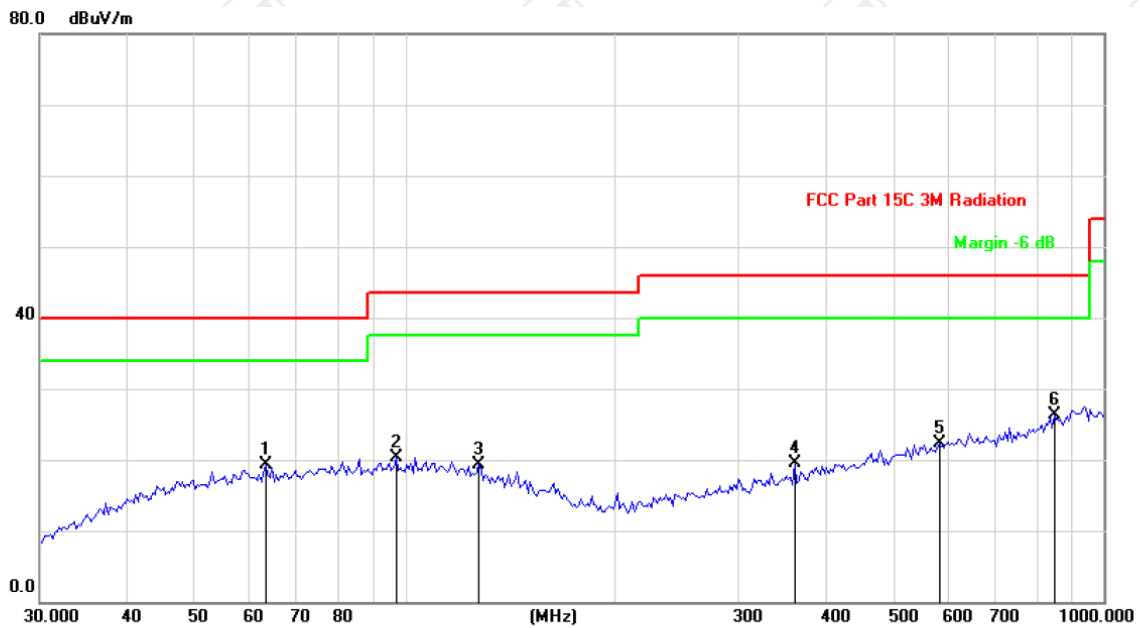

Site: Polarization: **Horizontal** Temperature: 25
Limit: FCC Part 15C 3M Radiation Power: DC 3.7V Humidity: 55 %

No.	Mk.	Freq. MHz	Reading Level dBuV	Correct Factor dB	Measure- ment dBuV/m	Limit dB/m	Over dB	Detector
1		63.1857	32.75	-13.42	19.33	40.00	-20.67	peak
2		97.0023	29.05	-8.72	20.33	43.50	-23.17	peak
3		127.5865	33.88	-14.48	19.40	43.50	-24.10	peak
4		360.9775	29.06	-9.53	19.53	46.00	-26.47	peak
5		582.1122	28.53	-6.22	22.31	46.00	-23.69	peak
6	*	850.7603	30.05	-3.80	26.25	46.00	-19.75	peak

Vertical:

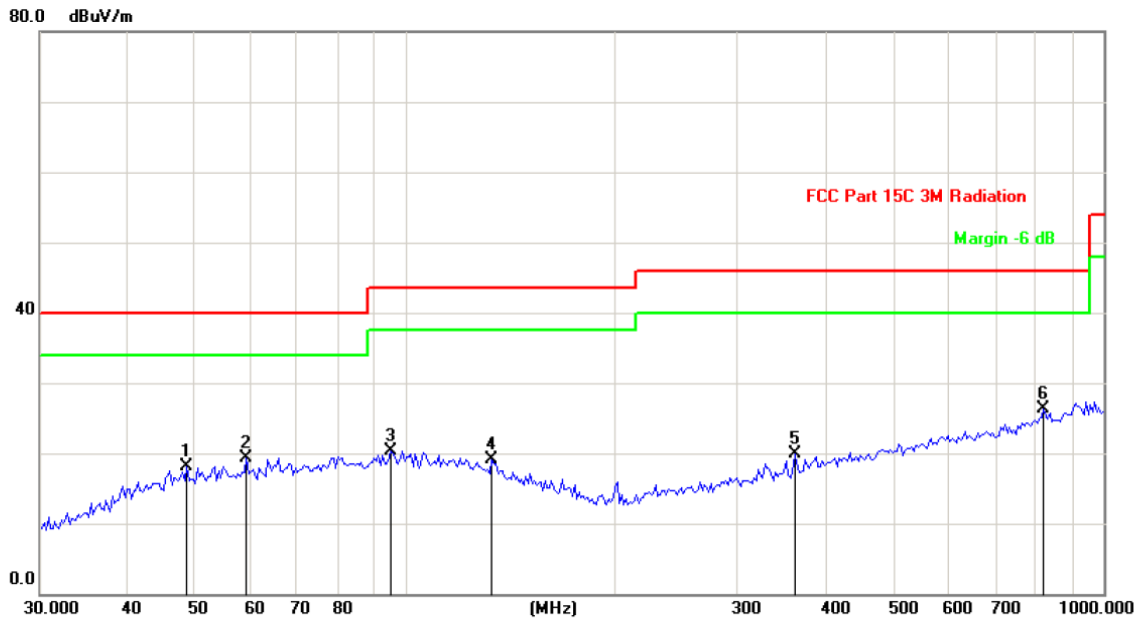

Site: Polarization: **Vertical** Temperature: 25
 Limit: FCC Part 15C 3M Radiation Power: DC 3.7V Humidity: 55 %

No.	Mk.	Freq. MHz	Reading Level dBuV	Correct Factor dB	Measure- ment dBuV/m	Limit dB/m	Over dB	Detector
1		48.7191	28.29	-10.15	18.14	40.00	-21.86	peak
2		59.3133	31.62	-12.22	19.40	40.00	-20.60	peak
3		95.6485	29.32	-9.04	20.28	43.50	-23.22	peak
4		133.0809	34.66	-15.62	19.04	43.50	-24.46	peak
5		360.9775	29.44	-9.53	19.91	46.00	-26.09	peak
6	*	821.3871	30.57	-4.31	26.26	46.00	-19.74	peak

Note: 1. The low frequency, which started from 9KHz~30MHz, was pre-scanned and the result which was 20dB lower than the limit line per 15.31(o) was not reported

2. Measurements were conducted in all three channels (high, middle, low) and two modulation (GFSK, Pi/4 DQPSK) and the worst case Mode (Middle channel and Pi/4 DQPSK) was submitted only.

3. Freq. = Emission frequency in MHz

Measurement (dBuV/m) = Reading level (dBuV) + Corr. Factor (dB)

Correction Factor = Antenna Factor + Cable loss - Pre-amplifier

Limit (dBuV/m) = Limit stated in standard

Margin (dB) = Measurement (dBuV/m) - Limits (dBuV/m)

Any value more than 10dB below limit have not been specifically reported.

* is meaning the worst frequency has been tested in the test frequency range

Test Result of Radiated Spurious at Band edges

Lowest channel 2402:

Horizontal:

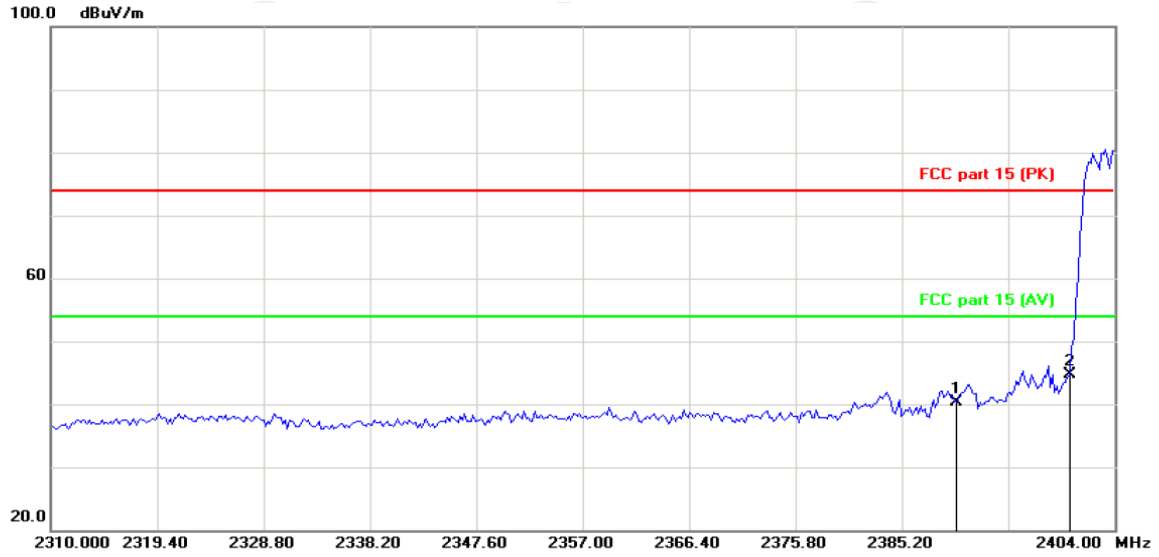

Site: Polarization: **Horizontal** Temperature: 25
Limit: FCC part 15 (PK) Power: DC 3.7V Humidity: 55 %

Vertical:

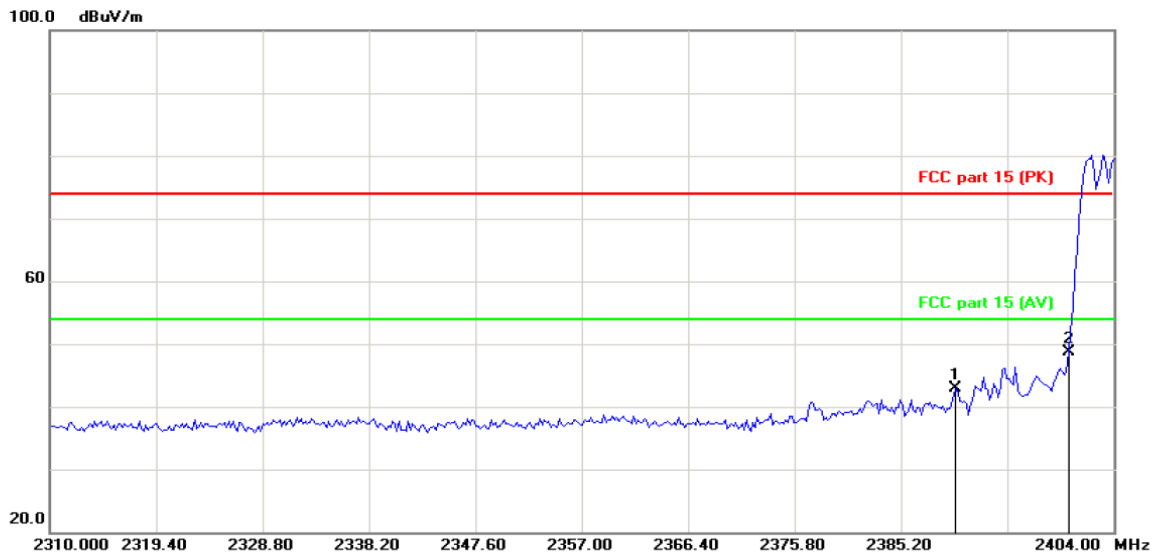

Site: Polarization: **Vertical** Temperature: 25
Limit: FCC part 15 (PK) Power: DC 3.7V Humidity: 55 %

Frequency (MHz)	Ant. Pol. H/V	Peak (dBuV/m)	Duty cycle factor (dB/m)	AV (dBuV/m)	Peak limit (dBuV/m)	AV limit (dBuV/m)	PK Margin (dB)	AVG Margin (dB)
2390	H	40.27	-2.02	38.25	74	54	-33.73	-15.75
2390	V	42.89	-2.02	40.87	74	54	-31.11	-13.13
2400	H	44.80	-2.02	42.78	74	54	-29.20	-11.22
2400	V	48.69	-2.02	46.67	74	54	-25.31	-7.33

Highest channel 2480:

Horizontal:

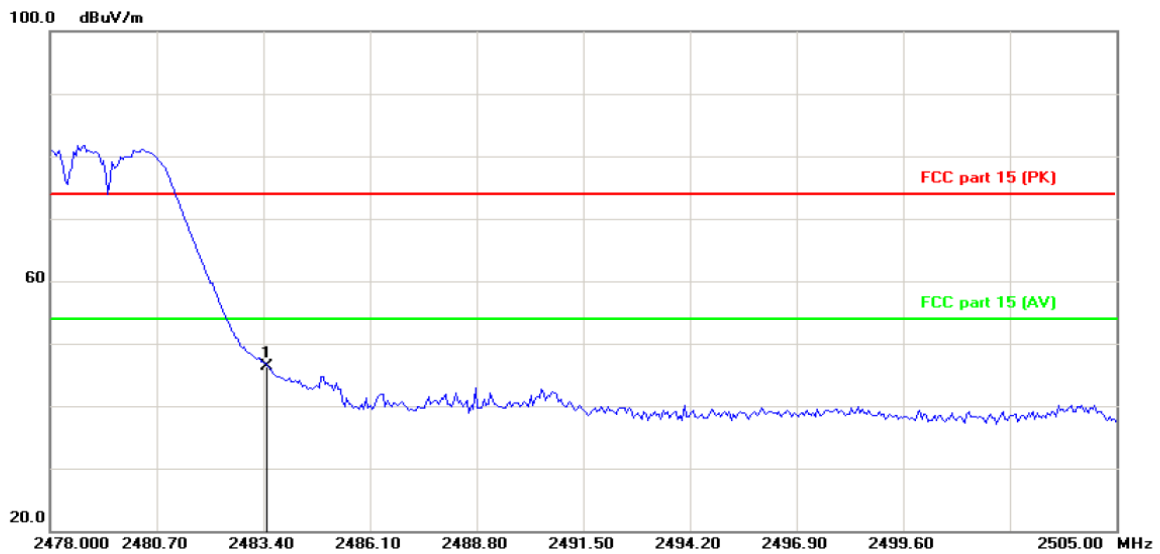

Site: _____ Polarization: **Horizontal** Temperature: 25
 Limit: FCC part 15 (PK) Power: DC 3.7V Humidity: 55 %

Vertical:

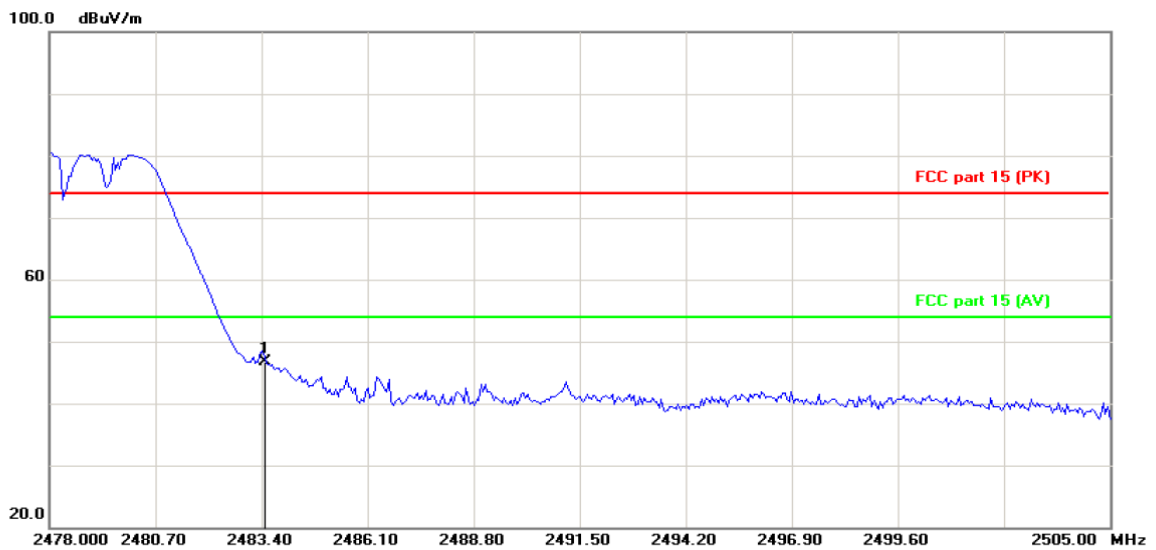

Site: _____ Polarization: **Vertical** Temperature: 25
 Limit: FCC part 15 (PK) Power: DC 3.7V Humidity: 55 %

Frequency (MHz)	Ant. Pol. H/V	Peak (dB μ V/m)	Duty cycle factor (dB/m)	AV (dB μ V/m)	Peak limit (dB μ V/m)	AV limit (dB μ V/m)	PK Margin (dB)	AVG Margin (dB)
2483.5	H	46.35	-2.02	44.33	74	54	-27.65	-9.67
2483.5	V	46.69	-2.02	44.67	74	54	-27.31	-9.33

Note: Measurements were conducted in all two modulation (GFSK, Pi/4DQPSK), and the worst case Mode (Pi/4DQPSK) was submitted only.

Above 1GHz

Modulation Type: Pi/4DQPSK									
Low channel: 2402 MHz									
Frequency (MHz)	Ant. Pol. H/V	Peak reading (dB μ V)	AV reading (dB μ V)	Correction Factor (dB/m)	Emission Level		Peak limit (dB μ V/m)	AV limit (dB μ V/m)	Margin (dB)
					Peak (dB μ V/m)	AV (dB μ V/m)			
4804	H	45.75	---	0.66	46.41	---	74	54	-7.59
7206	H	37.71	---	9.5	47.21	---	74	54	-6.79
---	H	---	---	---	---	---	---	---	---
4804	V	44.36	---	0.66	45.02	---	74	54	-8.98
7206	V	37.82	---	9.5	47.32	---	74	54	-6.68
---	V	---	---	---	---	---	---	---	---

Middle channel: 2441 MHz									
Frequency (MHz)	Ant. Pol. H/V	Peak reading (dB μ V)	AV reading (dB μ V)	Correction Factor (dB/m)	Emission Level		Peak limit (dB μ V/m)	AV limit (dB μ V/m)	Margin (dB)
					Peak (dB μ V/m)	AV (dB μ V/m)			
4882	H	47.33	---	0.99	48.32	---	74	54	-5.68
7323	H	38.49	---	9.87	48.36	---	74	54	-5.64
---	H	---	---	---	---	---	---	---	---
4882	V	44.69	---	0.99	45.68	---	74	54	-8.32
7323	V	38.54	---	9.87	48.41	---	74	54	-5.59
---	V	---	---	---	---	---	---	---	---

High channel: 2480 MHz									
Frequency (MHz)	Ant. Pol. H/V	Peak reading (dB μ V)	AV reading (dB μ V)	Correction Factor (dB/m)	Emission Level		Peak limit (dB μ V/m)	AV limit (dB μ V/m)	Margin (dB)
					Peak (dB μ V/m)	AV (dB μ V/m)			
4960	H	45.73	---	1.33	47.06	---	74	54	-6.94
7440	H	37.67	---	10.22	47.89	---	74	54	-6.11
---	H	---	---	---	---	---	---	---	---
4960	V	48.88	---	1.33	50.21	---	74	54	-3.79
7440	V	36.42	---	10.22	46.64	---	74	54	-7.36
---	V	---	---	---	---	---	---	---	---

Note:

1. Emission Level=Peak Reading + Correction Factor; Correction Factor= Antenna Factor + Cable loss – Pre-amplifier
2. Margin (dB) = Emission Level (Peak) (dB μ V/m)-Average limit (dB μ V/m)
3. The emission levels of other frequencies are very lower than the limit and not show in test report.
4. Measurements were conducted from 1 GHz to the 10th harmonic of highest fundamental frequency.
5. Data of measurement shown “---“in the above table mean that the reading of emissions is attenuated more than 20 dB below the limits or the field strength is too small to be measured.
6. Measurements were conducted in all two modulation (GFSK, Pi/4 DQPSK), and the worst case Mode (Pi/4 DQPSK) was submitted only.
7. All the restriction bands are compliance with the limit of 15.209.

Appendix A: Photographs of Test Setup

Product: bluetooth headset

Model: XO-9921-1

Radiated Emission

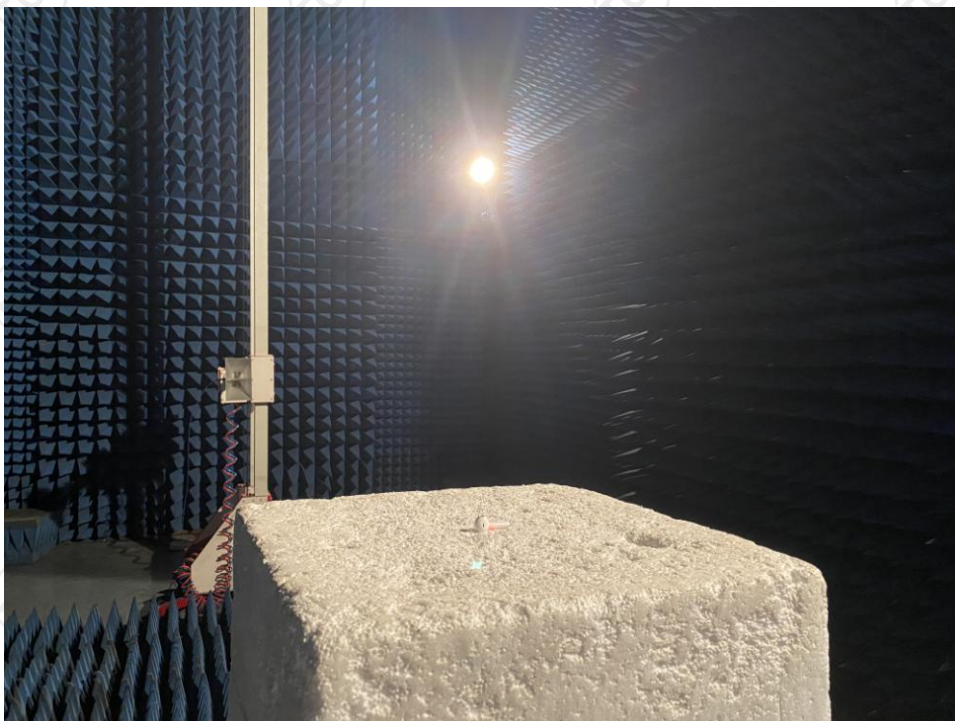
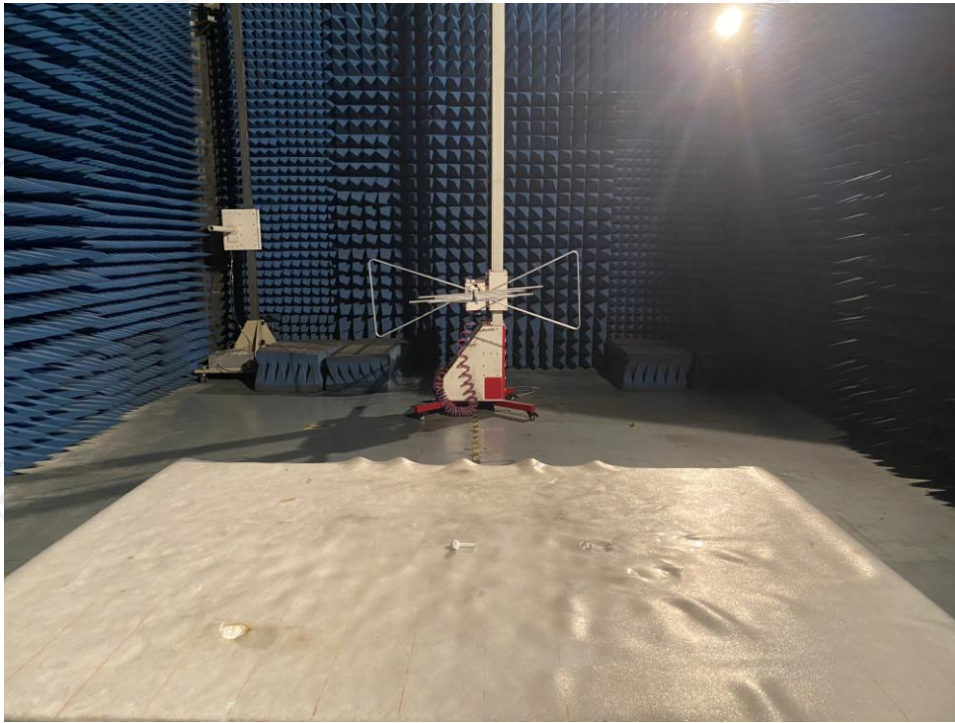

Conducted Emission

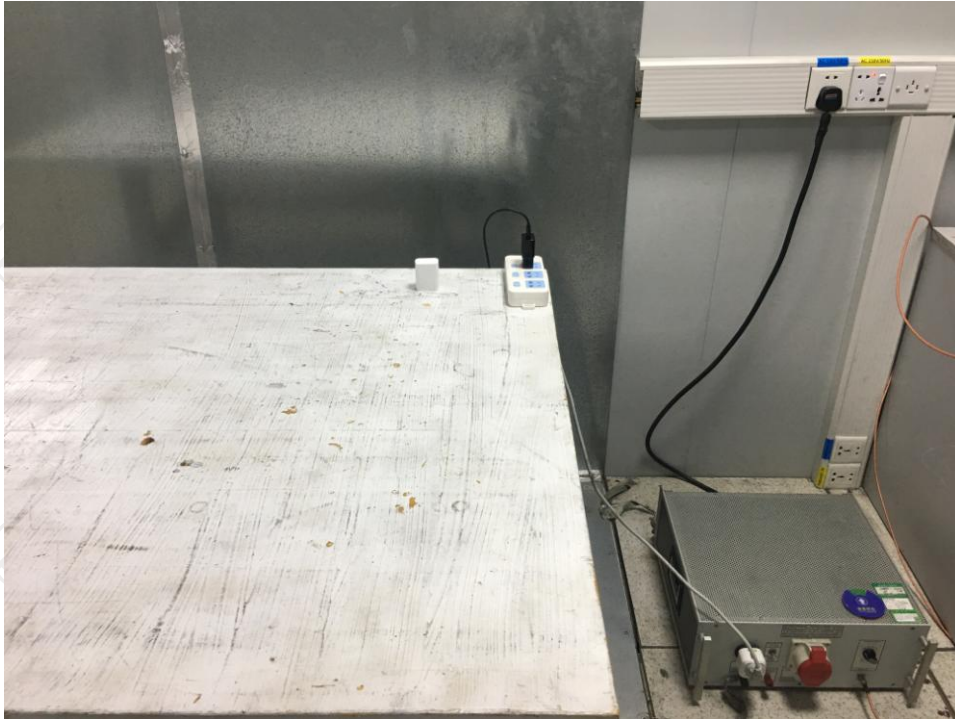

Appendix B: Photographs of EUT

Product: bluetooth headset

Model: XO-9921-1

External Photos







Product: bluetooth headset
Model: XO-9921-1
Internal Photos

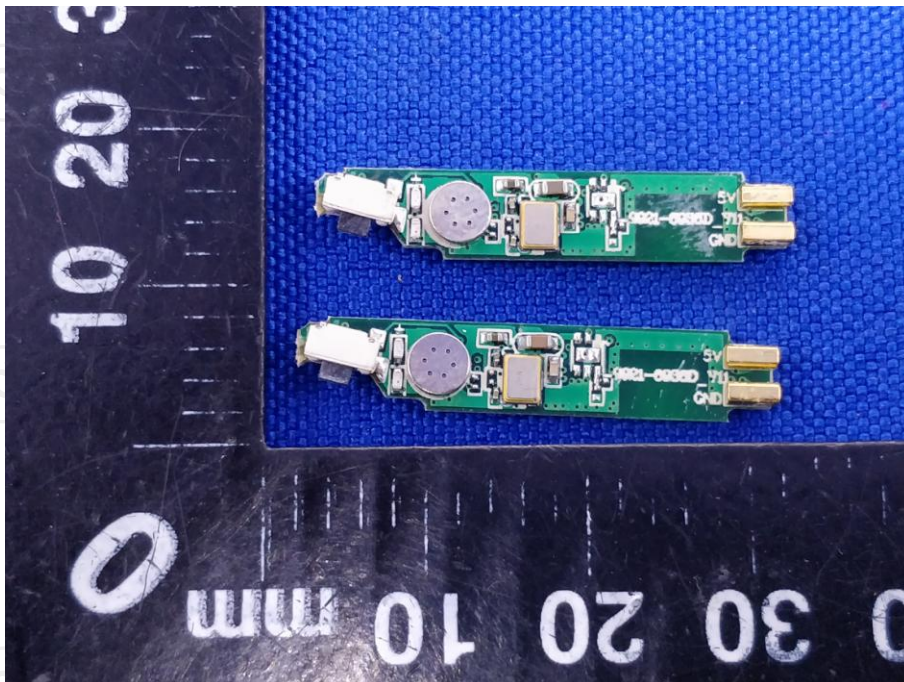

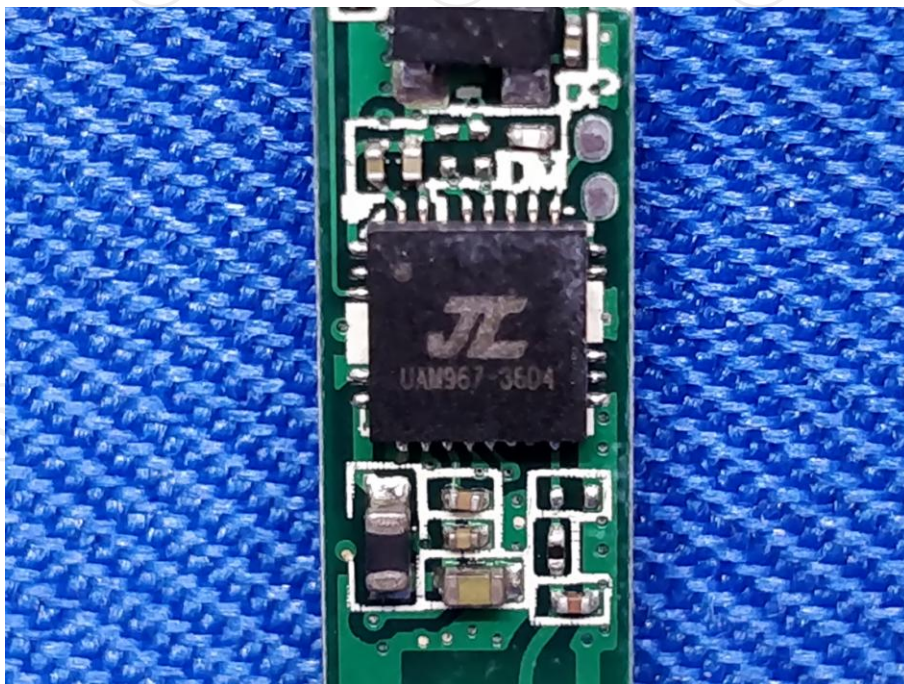
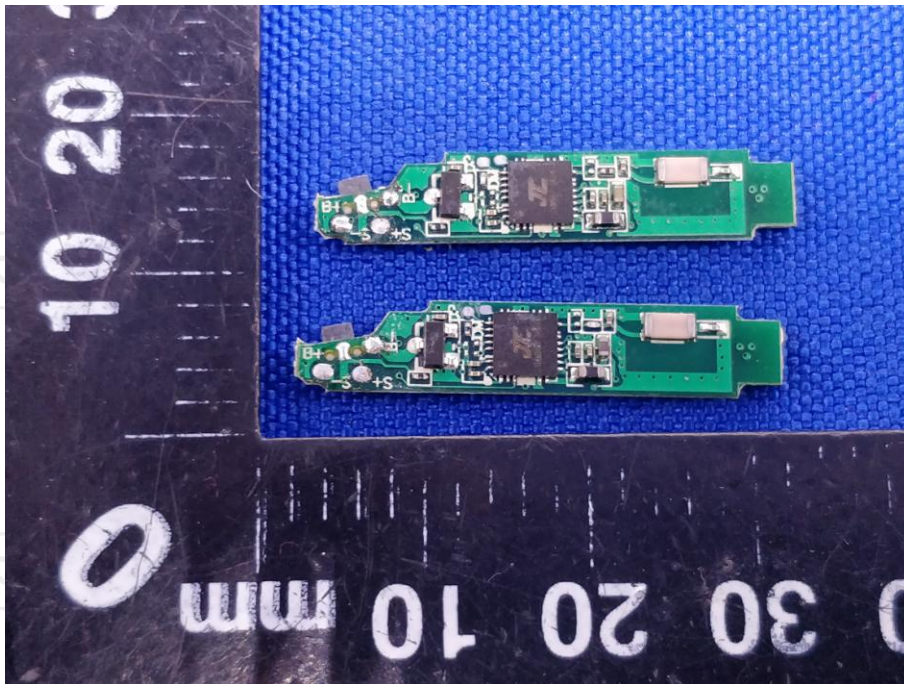

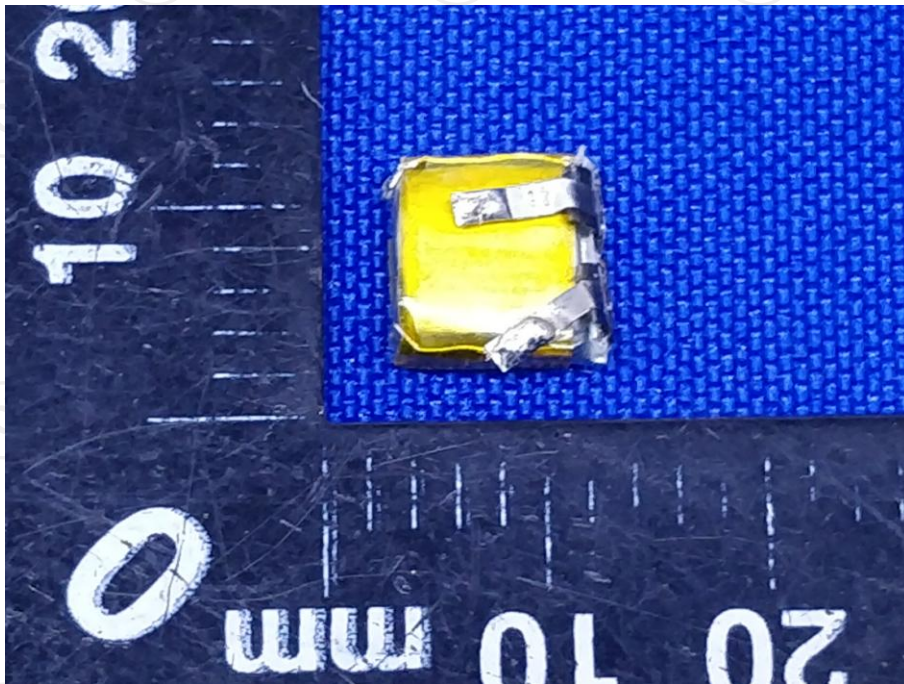
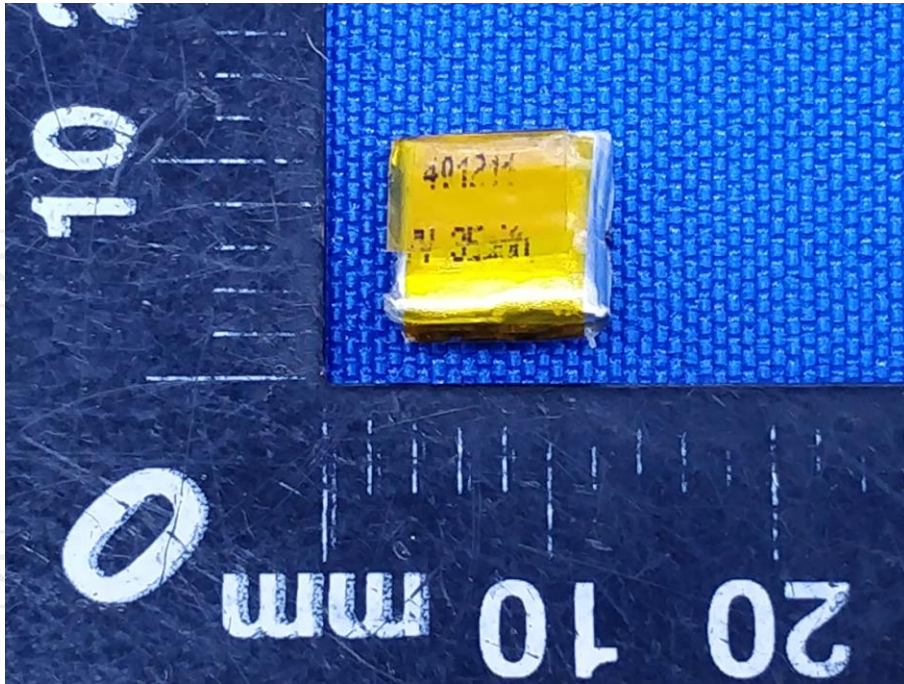

*****END OF REPORT*****