



# TEST REPORT

<b>FCC ID</b> .....	2ALCFXO-9533-3	
<b>Test Report No</b> .....	TCT220517E004	
<b>Date of issue</b> .....	May 19, 2022	
<b>Testing laboratory</b> .....	SHENZHEN TONGCE TESTING LAB	
<b>Testing location/ address:</b>	TCT Testing Industrial Park Fuqiao 5th Industrial Zone, Fuhai Street, Bao'an District Shenzhen, Guangdong, 518103, People's Republic of China	
<b>Applicant's name</b> .....	Dongguan Xing Yue Electronic co., Ltd	
<b>Address</b> .....	#98 LiWu Swan Industrial District, Qiao Tou Town, Dong Guan City, Guang Dong, China	
<b>Manufacturer's name</b> ...	Dongguan Xing Yue Electronic co., Ltd	
<b>Address</b> .....	#98 LiWu Swan Industrial District, Qiao Tou Town, Dong Guan City, Guang Dong, China	
<b>Standard(s)</b> .....	FCC CFR Title 47 Part 15 Subpart C Section 15.247 FCC KDB 558074 D01 15.247 Meas Guidance v05r02 ANSI C63.10:2013	
<b>Product Name</b> .....	IPX6 Flame Lamp Wireless Speaker	
<b>Trade Mark</b> .....	N/A	
<b>Model/Type reference</b> .....	XO-9533-3, MA-HY009-D, MA112-MGV, MA112PK2-MGV	
<b>Rating(s)</b> .....	Rechargeable Li-ion Battery DC 3.7V	
<b>Date of receipt of test item</b> .....	May 17, 2022	
<b>Date (s) of performance of test</b> .....	May 17, 2022 - May 19, 2022	
<b>Tested by (+signature)</b> ...	Rleo LIU	
<b>Check by (+signature)</b> ....	Beryl ZHAO	
<b>Approved by (+signature)</b> :	Tomsin	



**General disclaimer:**

This report shall not be reproduced except in full, without the written approval of SHENZHEN TONGCE TESTING LAB. This document may be altered or revised by SHENZHEN TONGCE TESTING LAB personnel only, and shall be noted in the revision section of the document. The test results in the report only apply to the tested sample.

## Table of Contents

<b>1. General Product Information .....</b>	<b>3</b>
1.1. EUT description .....	3
1.2. Model(s) list.....	3
1.3. Operation Frequency .....	3
<b>2. Test Result Summary .....</b>	<b>4</b>
<b>3. General Information.....</b>	<b>5</b>
3.1. Test environment and mode.....	5
3.2. Description of Support Units.....	5
<b>4. Facilities and Accreditations .....</b>	<b>6</b>
4.1. Facilities .....	6
4.2. Location .....	6
4.3. Measurement Uncertainty.....	6
<b>5. Test Results and Measurement Data .....</b>	<b>7</b>
5.1. Antenna requirement .....	7
5.2. Conducted Emission.....	8
5.3. Conducted Output Power .....	12
5.4. Emission Bandwidth .....	13
5.5. Power Spectral Density.....	14
5.6. Conducted Band Edge and Spurious Emission Measurement .....	15
5.7. Radiated Spurious Emission Measurement.....	17
<b>Appendix A: Test Result of Conducted Test</b>	
<b>Appendix B: Photographs of Test Setup</b>	
<b>Appendix C: Photographs of EUT</b>	

## 1. General Product Information

### 1.1. EUT description

Product Name.....:	IPX6 Flame Lamp Wireless Speaker
Model/Type reference.....:	XO-9533-3
Sample Number.....:	TCT220517E003-0101
Bluetooth Version .....	V5.1 (This report is for BLE)
Operation Frequency .....	2402MHz~2480MHz
Channel Separation.....:	2MHz
Data Rate.....:	LE 1M PHY, LE 2M PHY
Number of Channel .....	40
Modulation Type .....	GFSK
Antenna Type.....:	PCB Antenna
Antenna Gain.....:	-0.58dBi
Rating(s).....:	Rechargeable Li-ion Battery DC 3.7V

Note: The antenna gain listed in this report is provided by applicant, and the test laboratory is not responsible for this parameter.

### 1.2. Model(s) list

No.	Model No.	Tested with
1	XO-9533-3	<input checked="" type="checkbox"/>
Other models	MA-HY009-D, MA112-MGV, MA112PK2-MGV	<input type="checkbox"/>

Note: XO-9533-3 is tested model, other models are derivative models. The models are identical in circuit and PCB layout, only different on the model names. So the test data of XO-9533-3 can represent the remaining models.

### 1.3. Operation Frequency

Channel	Frequency	Channel	Frequency	Channel	Frequency	Channel	Frequency
0	2402MHz	10	2422MHz	20	2442MHz	30	2462MHz
1	2404MHz	11	2424MHz	21	2444MHz	31	2464MHz
...	...	...	...	...	...	...	...
8	2418MHz	18	2438MHz	28	2458MHz	38	2478MHz
9	2420MHz	19	2440MHz	29	2460MHz	39	2480MHz

Remark: Channel 0, 19 & 39 have been tested.

## 2. Test Result Summary

Requirement	CFR 47 Section	Result
Antenna requirement	§15.203/§15.247 (c)	PASS
AC Power Line Conducted Emission	§15.207	PASS
Conducted Peak Output Power	§15.247 (b)(3)	PASS
6dB Emission Bandwidth	§15.247 (a)(2)	PASS
Power Spectral Density	§15.247 (e)	PASS
Band Edge	§15.247(d)	PASS
Spurious Emission	§15.205/§15.209	PASS

**Note:**

1. PASS: Test item meets the requirement.
2. Fail: Test item does not meet the requirement.
3. N/A: Test case does not apply to the test object.
4. The test result judgment is decided by the limit of test standard.
5. After pre-testing the two earphones, the two earphones are left and right ears respectively; we found that the left earphone is the worst case, so the results are recorded in this report.

### 3. General Information

#### 3.1. Test environment and mode

Operating Environment:		
Condition	Conducted Emission	Radiated Emission
Temperature:	25.3 °C	24.5 °C
Humidity:	56 % RH	56 % RH
Atmospheric Pressure:	1010 mbar	1010 mbar
Test Software:		
Software Information:	FCC Assist 1.0.2.2	
Power Level:	Defaulted	
Test Mode:		
Engineering mode:	Keep the EUT in continuous transmitting by select channel and modulations with Fully-charged battery	
<p>The sample was placed 0.8m &amp; 1.5m for the measurement below &amp; above 1GHz above the ground plane of 3m chamber. Measurements in both horizontal and vertical polarities were performed. During the test, each emission was maximized by: having the EUT continuously working, investigated all operating modes, rotated about all 3 axis (X, Y &amp; Z) and considered typical configuration to obtain worst position, manipulating interconnecting cables, rotating the turntable, varying antenna height from 1m to 4m in both horizontal and vertical polarizations. The emissions worst-case( Z axis) are shown in Test Results of the following pages.</p>		

#### 3.2. Description of Support Units

The EUT has been tested as an independent unit together with other necessary accessories or support units. The following support units or accessories were used to form a representative test configuration during the tests.

Equipment	Model No.	Serial No.	FCC ID	Trade Name
Adapter	JD-050200	2012010907576735	/	JD

**Note:**

1. All the equipment/cables were placed in the worst-case configuration to maximize the emission during the test.
2. Grounding was established in accordance with the manufacturer's requirements and conditions for the intended use.
3. For conducted measurements (Output Power, 6dB Emission Bandwidth, Power Spectral Density, Spurious Emissions), the antenna of EUT is connected to the test equipment via temporary antenna connector, the antenna connector is soldered on the antenna port of EUT, and the temporary antenna connector is listed in the Test Instruments.

## 4. Facilities and Accreditations

### 4.1. Facilities

The test facility is recognized, certified, or accredited by the following organizations:

- FCC - Registration No.: 645098  
SHENZHEN TONGCE TESTING LAB  
Designation Number: CN1205

The testing lab has been registered and fully described in a report with the (FCC) Federal Communications Commission. The acceptance letter from the FCC is maintained in our files.

- IC - Registration No.: 10668A-1  
SHENZHEN TONGCE TESTING LAB  
CAB identifier: CN0031

The testing lab has been registered by Certification and Engineering Bureau of Industry Canada for radio equipment testing.

### 4.2. Location

SHENZHEN TONGCE TESTING LAB

Address: TCT Testing Industrial Park Fuqiao 5th Industrial Zone, Fuhai Street, Bao'an District Shenzhen, Guangdong, 518103, People's Republic of China

TEL: +86-755-27673339

### 4.3. Measurement Uncertainty

The reported uncertainty of measurement  $y \pm U$ , where expanded uncertainty  $U$  is based on a standard uncertainty multiplied by a coverage factor of  $k=2$ , providing a level of confidence of approximately 95 %.

No.	Item	MU
1	Conducted Emission	$\pm 3.10$ dB
2	RF power, conducted	$\pm 0.12$ dB
3	Spurious emissions, conducted	$\pm 0.11$ dB
4	All emissions, radiated(<1 GHz)	$\pm 4.56$ dB
5	All emissions, radiated(1 GHz - 18 GHz)	$\pm 4.22$ dB
6	All emissions, radiated(18 GHz- 40 GHz)	$\pm 4.36$ dB

## 5. Test Results and Measurement Data

### 5.1. Antenna requirement

<b>Standard requirement:</b>	FCC Part15 C Section 15.203 /247(c)
<p>15.203 requirement: An intentional radiator shall be designed to ensure that no antenna other than that furnished by the responsible party shall be used with the device. The use of a permanently attached antenna or of an antenna that uses a unique coupling to the intentional radiator, the manufacturer may design the unit so that a broken antenna can be replaced by the user, but the use of a standard antenna jack or electrical connector is prohibited.</p> <p>15.247(c) (1)(i) requirement: (i) Systems operating in the 2400-2483.5 MHz band that is used exclusively for fixed. Point-to-point operations may employ transmitting antennas with directional gain greater than 6dBi provided the maximum conducted output power of the intentional radiator is reduced by 1 dB for every 3 dB that the directional gain of the antenna exceeds 6dBi.</p>	
<b>E.U.T Antenna:</b>	
<p>The Bluetooth antenna is PCB antenna which permanently attached, and the best case gain of the antenna is -0.58dBi.</p>	

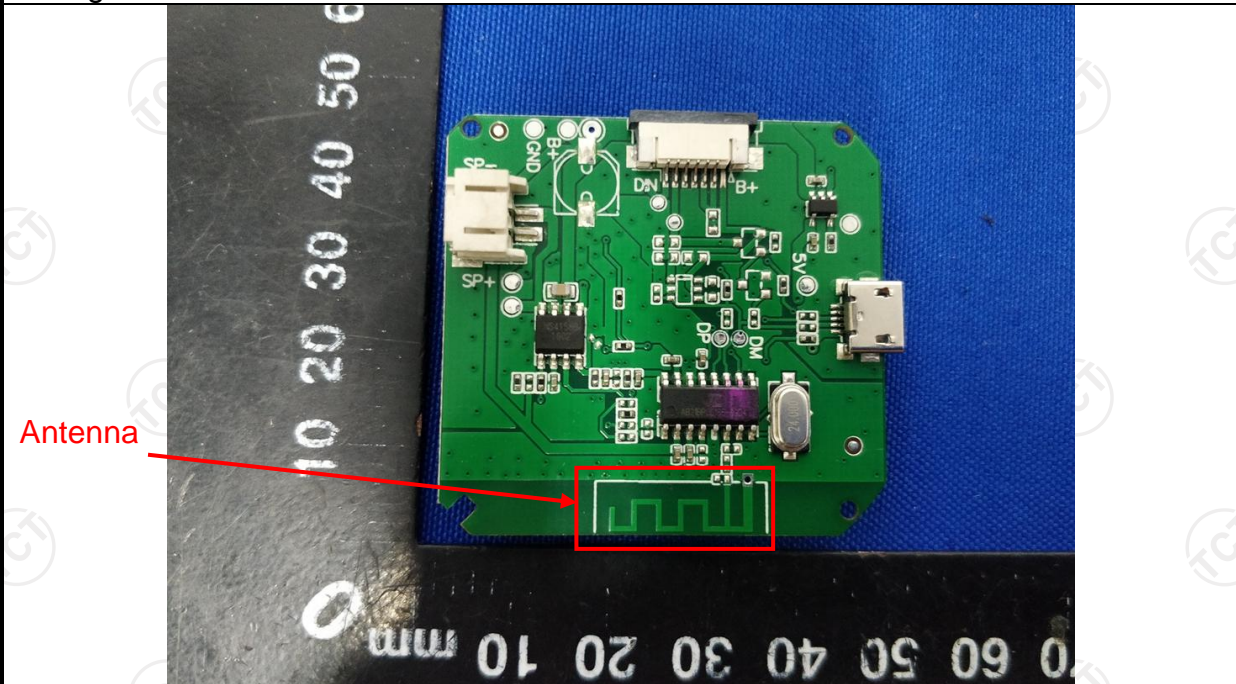

## 5.2. Conducted Emission

### 5.2.1. Test Specification

<b>Test Requirement:</b>	FCC Part15 C Section 15.207														
<b>Test Method:</b>	ANSI C63.10:2013														
<b>Frequency Range:</b>	150 kHz to 30 MHz														
<b>Receiver setup:</b>	RBW=9 kHz, VBW=30 kHz, Sweep time=auto														
<b>Limits:</b>	<table border="1"> <thead> <tr> <th rowspan="2">Frequency range (MHz)</th> <th colspan="2">Limit (dBuV)</th> </tr> <tr> <th>Quasi-peak</th> <th>Average</th> </tr> </thead> <tbody> <tr> <td>0.15-0.5</td> <td>66 to 56*</td> <td>56 to 46*</td> </tr> <tr> <td>0.5-5</td> <td>56</td> <td>46</td> </tr> <tr> <td>5-30</td> <td>60</td> <td>50</td> </tr> </tbody> </table>	Frequency range (MHz)	Limit (dBuV)		Quasi-peak	Average	0.15-0.5	66 to 56*	56 to 46*	0.5-5	56	46	5-30	60	50
Frequency range (MHz)	Limit (dBuV)														
	Quasi-peak	Average													
0.15-0.5	66 to 56*	56 to 46*													
0.5-5	56	46													
5-30	60	50													
<b>Test Setup:</b>	<p>Remark: E.U.T: Equipment Under Test LISN: Line Impedance Stabilization Network Test table height=0.8m</p>														
<b>Test Mode:</b>	Charging + Transmitting Mode														
<b>Test Procedure:</b>	<ol style="list-style-type: none"> <li>1. The E.U.T is connected to an adapter through a line impedance stabilization network (L.I.S.N.). This provides a 50ohm/50uH coupling impedance for the measuring equipment.</li> <li>2. The peripheral devices are also connected to the main power through a LISN that provides a 50ohm/50uH coupling impedance with 50ohm termination. (Please refer to the block diagram of the test setup and photographs).</li> <li>3. Both sides of A.C. line are checked for maximum conducted interference. In order to find the maximum emission, the relative positions of equipment and all of the interface cables must be changed according to ANSI C63.10:2013 on conducted measurement.</li> </ol>														
<b>Test Result:</b>	PASS														



**5.2.2. Test Instruments**

Conducted Emission Shielding Room Test Site (843)				
Equipment	Manufacturer	Model	Serial Number	Calibration Due
EMI Test Receiver	R&S	ESCI3	100898	Jul. 07, 2022
Line Impedance Stabilisation Newtork(LISN)	Schwarzbeck	NSLK 8126	8126453	Feb. 24, 2023
Line-5	TCT	CE-05	N/A	Jul. 07, 2022
EMI Test Software	Shurple Technology	EZ-EMC	N/A	N/A

5.2.3. Test data

Please refer to following diagram for individual

Conducted Emission on Line Terminal of the power line (150 kHz to 30MHz)

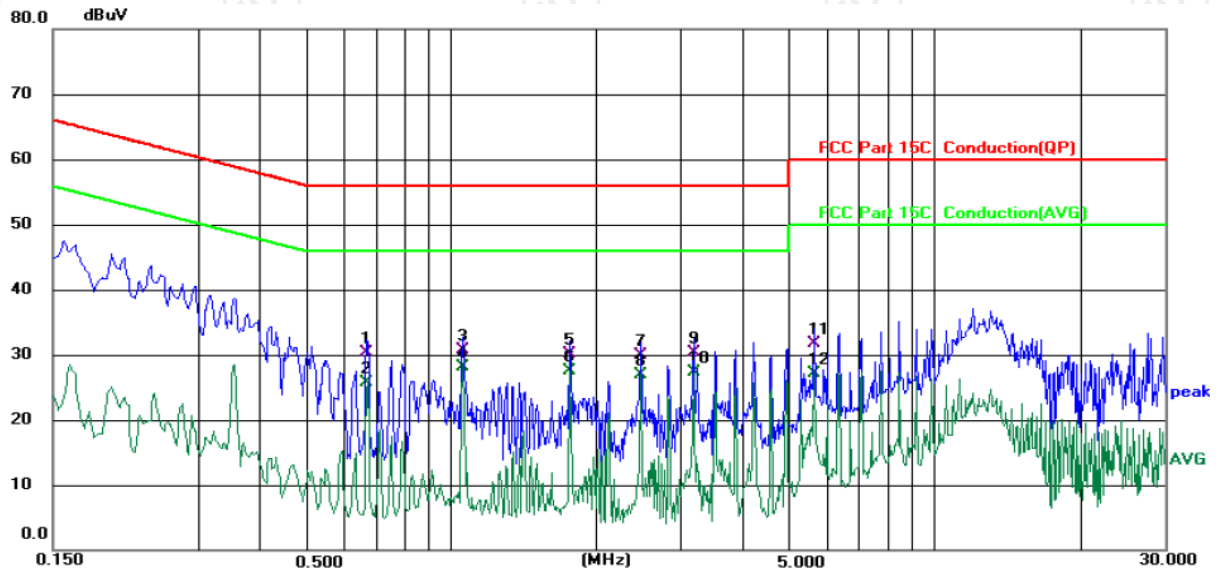

Site 844 Shielding Room Phase: L1 Temperature: 25.3 (°C) Humidity: 56 %

Limit: FCC Part 15C Conduction(QP)

Power: DC 5 V(Adapter Input AC 120 V/60 Hz)

No.	Mk.	Freq. MHz	Reading Level dBuV	Correct Factor dB	Measure- ment dBuV	Limit dBuV	Over dB	Detector	Comment
1		0.6700	20.19	10.14	30.33	56.00	-25.67	QP	
2		0.6700	15.51	10.14	25.65	46.00	-20.35	AVG	
3		1.0580	20.63	10.14	30.77	56.00	-25.23	QP	
4	*	1.0580	17.97	10.14	28.11	46.00	-17.89	AVG	
5		1.7660	20.02	10.16	30.18	56.00	-25.82	QP	
6		1.7660	17.31	10.16	27.47	46.00	-18.53	AVG	
7		2.4780	19.70	10.17	29.87	56.00	-26.13	QP	
8		2.4780	16.79	10.17	26.96	46.00	-19.04	AVG	
9		3.1860	20.22	10.18	30.40	56.00	-25.60	QP	
10		3.1860	17.21	10.18	27.39	46.00	-18.61	AVG	
11		5.6460	21.53	10.23	31.76	60.00	-28.24	QP	
12		5.6460	16.79	10.23	27.02	50.00	-22.98	AVG	

**Note:**

Freq. = Emission frequency in MHz

Reading level (dBuV) = Receiver reading

Corr. Factor (dB) = LISN factor + Cable loss

Measurement (dBuV) = Reading level (dBuV) + Corr. Factor (dB)

Limit (dBuV) = Limit stated in standard

Margin (dB) = Measurement (dBuV) – Limits (dBuV)

Q.P. =Quasi-Peak

AVG =average

\* is meaning the worst frequency has been tested in the frequency range 150 kHz to 30MHz

**Conducted Emission on Neutral Terminal of the power line (150 kHz to 30MHz)**

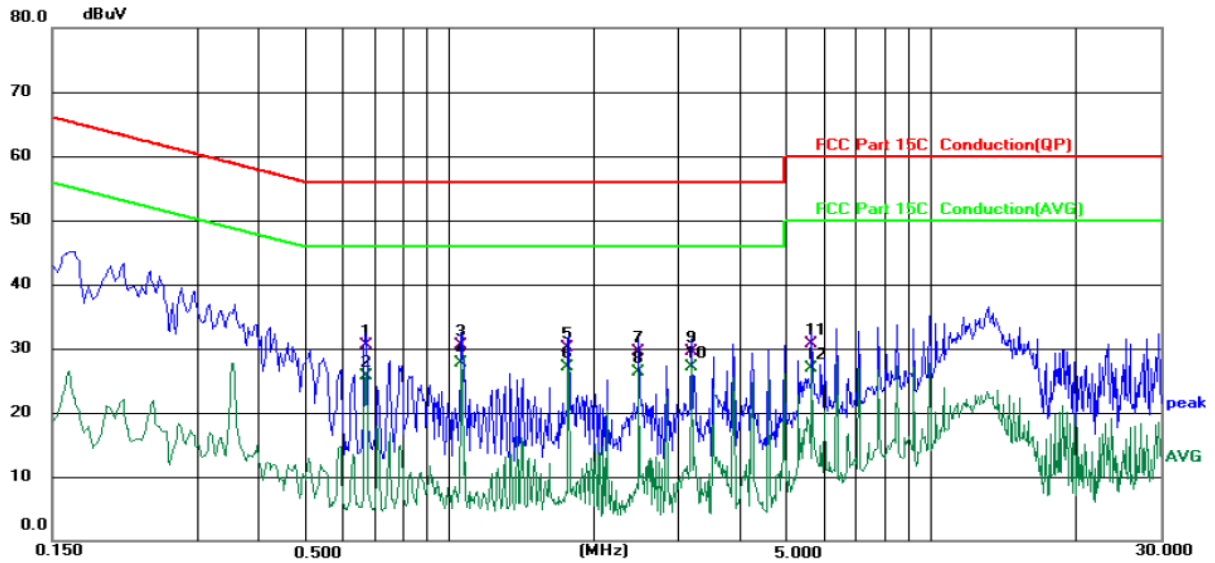

Site 844 Shielding Room Phase: *N* Temperature: 25.3 (°C) Humidity: 56 %

Limit: FCC Part 15C Conduction(QP) Power: DC 5 V(Adapter Input AC 120 V/60 Hz)

No.	Mk.	Freq.	Reading Level	Correct Factor	Measurement	Limit	Over	Detector	Comment
		MHz	dBuV	dB	dBuV	dBuV	dB		
1		0.6740	20.28	10.14	30.42	56.00	-25.58	QP	
2		0.6740	15.54	10.14	25.68	46.00	-20.32	AVG	
3		1.0620	20.30	10.14	30.44	56.00	-25.56	QP	
4	*	1.0620	17.57	10.14	27.71	46.00	-18.29	AVG	
5		1.7700	19.89	10.16	30.05	56.00	-25.95	QP	
6		1.7700	16.85	10.16	27.01	46.00	-18.99	AVG	
7		2.4820	19.40	10.17	29.57	56.00	-26.43	QP	
8		2.4820	16.20	10.17	26.37	46.00	-19.63	AVG	
9		3.1900	19.36	10.18	29.54	56.00	-26.46	QP	
10		3.1900	17.01	10.18	27.19	46.00	-18.81	AVG	
11		5.6700	20.55	10.23	30.78	60.00	-29.22	QP	
12		5.6700	16.62	10.23	26.85	50.00	-23.15	AVG	

**Note1:**

Freq. = Emission frequency in MHz

Reading level (dBuV) = Receiver reading

Corr. Factor (dB) = LISN factor + Cable loss

Measurement (dBuV) = Reading level (dBuV) + Corr. Factor (dB)

Limit (dBuV) = Limit stated in standard

Margin (dB) = Measurement (dBuV) – Limits (dBuV)

Q.P. =Quasi-Peak

AVG =average

\* is meaning the worst frequency has been tested in the frequency range 150 kHz to 30MHz.

**Note2:** Speed for 1M and 2M modulations of EUT have been tested, but the test data only show the worst case in this report, and we found the worst case is 2M speed modulation. Measurements were conducted in all three channels (high, middle, low), and the worst case Mode (Highest channel) was submitted only.

### 5.3. Conducted Output Power

#### 5.3.1. Test Specification

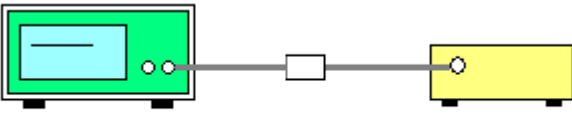
<b>Test Requirement:</b>	FCC Part15 C Section 15.247 (b)(3)
<b>Test Method:</b>	KDB 558074 D01 v05r02
<b>Limit:</b>	30dBm
<b>Test Setup:</b>	 <p style="text-align: center;">Spectrum Analyzer                      EUT</p>
<b>Test Mode:</b>	Refer to item 3.1
<b>Test Procedure:</b>	<p>Set spectrum analyzer as following:</p> <ul style="list-style-type: none"> <li>a) Set the RBW <math>\geq</math> DTS bandwidth.</li> <li>b) Set VBW <math>\geq 3 \times</math> RBW.</li> <li>c) Set span <math>\geq 3 \times</math> RBW</li> <li>d) Sweep time = auto couple.</li> <li>e) Detector = peak.</li> <li>f) Trace mode = max hold.</li> <li>g) Allow trace to fully stabilize.</li> <li>h) Use peak marker function to determine the peak amplitude level.</li> </ul>
<b>Test Result:</b>	PASS

#### 5.3.2. Test Instruments

Name	Manufacturer	Model No.	Serial Number	Calibration Due
Spectrum Analyzer	Agilent	N9020A	MY49100619	Jul. 18, 2022
Combiner Box	Ascentest	AT890-RFB	N/A	Jul. 07, 2022

## 5.4. Emission Bandwidth

### 5.4.1. Test Specification

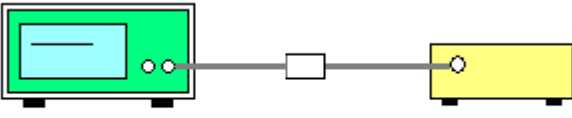
<b>Test Requirement:</b>	FCC Part15 C Section 15.247 (a)(2)
<b>Test Method:</b>	KDB 558074 D01 v05r02
<b>Limit:</b>	>500kHz
<b>Test Setup:</b>	 <p style="text-align: center;">Spectrum Analyzer                      EUT</p>
<b>Test Mode:</b>	Refer to item 3.1
<b>Test Procedure:</b>	<ol style="list-style-type: none"> <li>1. Set to the maximum power setting and enable the EUT transmit continuously.</li> <li>2. Make the measurement with the spectrum analyzer's resolution bandwidth (RBW) = 100 kHz. Set the Video bandwidth (VBW) = 300 kHz. In order to make an accurate measurement. The 6dB bandwidth must be greater than 500 kHz.</li> <li>3. Measure and record the results in the test report.</li> </ol>
<b>Test Result:</b>	PASS

### 5.4.2. Test Instruments

Name	Manufacturer	Model No.	Serial Number	Calibration Due
Spectrum Analyzer	Agilent	N9020A	MY49100619	Jul. 18, 2022
Combiner Box	Ascentest	AT890-RFB	N/A	Jul. 07, 2022

## 5.5. Power Spectral Density

### 5.5.1. Test Specification

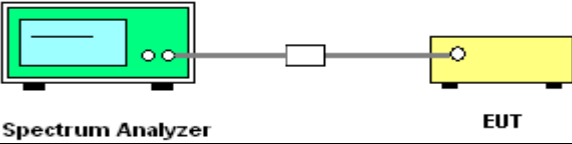
<b>Test Requirement:</b>	FCC Part15 C Section 15.247 (e)
<b>Test Method:</b>	KDB 558074 D01 v05r02
<b>Limit:</b>	The peak power spectral density shall not be greater than 8dBm in any 3kHz band at any time interval of continuous transmission.
<b>Test Setup:</b>	 <p style="text-align: center;">Spectrum Analyzer                      EUT</p>
<b>Test Mode:</b>	Refer to item 3.1
<b>Test Procedure:</b>	<ol style="list-style-type: none"> <li>1. The RF output of EUT was connected to the spectrum analyzer by RF cable and attenuator. The path loss was compensated to the results for each measurement.</li> <li>2. Set to the maximum power setting and enable the EUT transmit continuously.</li> <li>3. Make the measurement with the spectrum analyzer's resolution bandwidth (RBW): <math>3 \text{ kHz} \leq \text{RBW} \leq 100 \text{ kHz}</math>. Video bandwidth <math>\text{VBW} \geq 3 \times \text{RBW}</math>. In order to make an accurate measurement, set the span to 1.5 times DTS Channel Bandwidth. (6dB BW)</li> <li>4. Detector = peak, Sweep time = auto couple, Trace mode = max hold, Allow trace to fully stabilize. Use the peak marker function to determine the maximum power level.</li> <li>5. Measure and record the results in the test report.</li> </ol>
<b>Test Result:</b>	PASS

### 5.5.2. Test Instruments

Name	Manufacturer	Model No.	Serial Number	Calibration Due
Spectrum Analyzer	Agilent	N9020A	MY49100619	Jul. 18, 2022
Combiner Box	Ascentest	AT890-RFB	N/A	Jul. 07, 2022

## 5.6. Conducted Band Edge and Spurious Emission Measurement

### 5.6.1. Test Specification

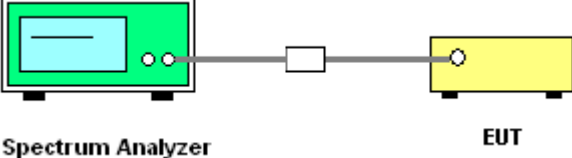
<b>Test Requirement:</b>	FCC Part15 C Section 15.247 (d)
<b>Test Method:</b>	KDB 558074 D01 v05r02
<b>Limit:</b>	In any 100 kHz bandwidth outside of the authorized frequency band, the emissions which fall in the non-restricted bands shall be attenuated at least 20 dB / 30dB relative to the maximum PSD level in 100 kHz by RF conducted measurement and radiated emissions which fall in the restricted bands, as defined in Section 15.205(a), must also comply with the radiated emission limits specified in Section 15.209(a).
<b>Test Setup:</b>	 <p style="text-align: center;">Spectrum Analyzer                      EUT</p>
<b>Test Mode:</b>	Refer to item 3.1
<b>Test Procedure:</b>	<ol style="list-style-type: none"> <li>1. The RF output of EUT was connected to the spectrum analyzer by RF cable and attenuator. The path loss was compensated to the results for each measurement.</li> <li>2. Set to the maximum power setting and enable the EUT transmit continuously.</li> <li>3. Set RBW = 100 kHz, VBW=300 kHz, Peak Detector. Unwanted Emissions measured in any 100 kHz bandwidth outside of the authorized frequency band shall be attenuated by at least 20 dB relative to the maximum in-band peak PSD level in 100 kHz when maximum peak conducted output power procedure is used. If the transmitter complies with the conducted power limits based on the use of RMS averaging over a time interval, the attenuation required under this paragraph shall be 30 dB instead of 20 dB per 15.247(d).</li> <li>4. Measure and record the results in the test report.</li> <li>5. The RF fundamental frequency should be excluded against the limit line in the operating frequency band.</li> </ol>
<b>Test Result:</b>	PASS

**5.6.2. Test Instruments**

Name	Manufacturer	Model No.	Serial Number	Calibration Due
Spectrum Analyzer	Agilent	N9020A	MY49100619	Jul. 18, 2022
Combiner Box	Ascentest	AT890-RFB	N/A	Jul. 07, 2022



## 5.7. Radiated Spurious Emission Measurement

### 5.7.1. Test Specification

<b>Test Requirement:</b>	FCC Part15 C Section 15.209					
<b>Test Method:</b>	ANSI C63.10:2013					
<b>Frequency Range:</b>	9 kHz to 25 GHz					
<b>Measurement Distance:</b>	3 m					
<b>Antenna Polarization:</b>	Horizontal & Vertical					
<b>Operation mode:</b>	Refer to item 3.1					
<b>Receiver Setup:</b>	Frequency	Detector	RBW	VBW	Remark	
	9kHz- 150kHz	Quasi-peak	200Hz	1kHz	Quasi-peak Value	
	150kHz- 30MHz	Quasi-peak	9kHz	30kHz	Quasi-peak Value	
	30MHz-1GHz	Quasi-peak	120KHz	300KHz	Quasi-peak Value	
	Above 1GHz	Peak	1MHz	3MHz	Peak Value	
		Peak	1MHz	10Hz	Average Value	
<b>Limit:</b>	Frequency	Field Strength (microvolts/meter)	Measurement Distance (meters)			
	0.009-0.490	2400/F(KHz)	300			
	0.490-1.705	24000/F(KHz)	30			
	1.705-30	30	30			
	30-88	100	3			
	88-216	150	3			
	216-960	200	3			
	Above 960	500	3			
	Frequency	Field Strength (microvolts/meter)	Measurement Distance (meters)	Detector		
	Above 1GHz	500	3	Average		
	5000	3	Peak			
<b>Test setup:</b>	For radiated emissions below 30MHz					
	<p>Distance = 3m</p> <p>0.8m</p> <p>Turn table</p> <p>1m</p> <p>Ground Plane</p> <p>Computer</p> <p>Pre -Amplifier</p> <p>Receiver</p>					
	30MHz to 1GHz					

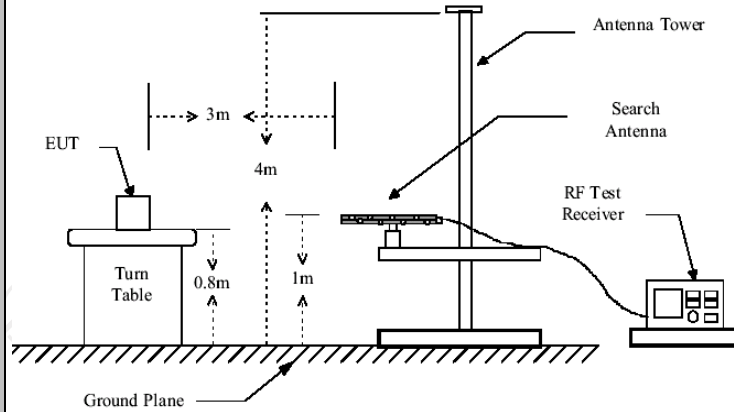

Above 1GHz

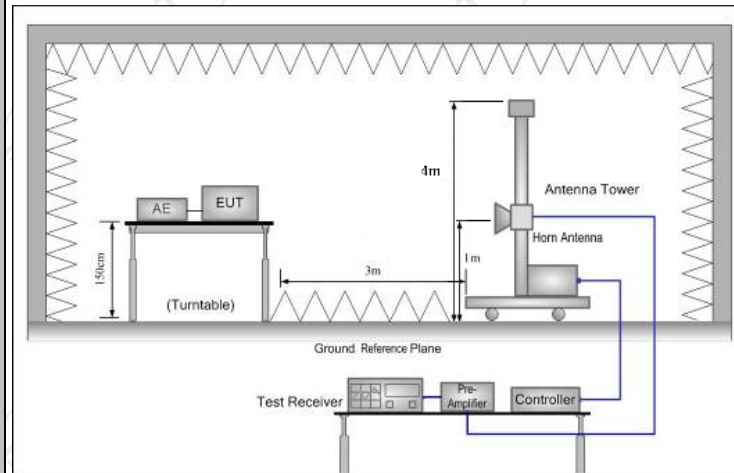

**Test Procedure:**

1. For the radiated emission test below 1GHz:  
The EUT was placed on a turntable with 0.8 meter above ground. The EUT was set 3 meters from the interference receiving antenna, which was mounted on the top of a variable height antenna tower. The EUT was arranged to its worst case and then tune the antenna tower (from 1 m to 4 m) and turntable (from 0 degree to 360 degrees) to find the maximum reading. A pre-amp and a high PASS filter are used for the test in order to get better signal level.
- For the radiated emission test above 1GHz:  
Place the measurement antenna on a turntable with 1.5 meter above ground, which is away from each area of the EUT determined to be a source of emissions at the specified measurement distance, while keeping the measurement antenna aimed at the source of emissions at each frequency of significant emissions, with polarization oriented for maximum response. The measurement antenna may have to be higher or lower than the EUT, depending on the radiation pattern of the emission and staying aimed at the emission source for receiving the maximum signal. The final

	<p>measurement antenna elevation shall be that which maximizes the emissions. The measurement antenna elevation for maximum emissions shall be restricted to a range of heights of from 1 m to 4 m above the ground or reference ground plane.</p> <p>2. Corrected Reading: Antenna Factor + Cable Loss + Read Level - Preamp Factor = Level</p> <p>3. For measurement below 1GHz, If the emission level of the EUT measured by the peak detector is 3 dB lower than the applicable limit, the peak emission level will be reported. Otherwise, the emission measurement will be repeated using the quasi-peak detector and reported.</p> <p>4. Use the following spectrum analyzer settings:</p> <p>(1) Span shall wide enough to fully capture the emission being measured;</p> <p>(2) Set RBW=120 kHz for <math>f &lt; 1</math> GHz; VBW <math>\geq</math> RBW; Sweep = auto; Detector function = peak; Trace = max hold;</p> <p>(3) Set RBW = 1 MHz, VBW= 3MHz for <math>f &gt; 1</math> GHz for peak measurement.</p> <p>For average measurement: VBW = 10 Hz, when duty cycle is no less than 98 percent. VBW <math>\geq 1/T</math>, when duty cycle is less than 98 percent where T is the minimum transmission duration over which the transmitter is on and is transmitting at its maximum power control level for the tested mode of operation.</p>
<b>Test mode:</b>	Refer to section 3.1 for details
<b>Test results:</b>	PASS

5.7.2. Test Instruments

Radiated Emission Test Site (966)				
Name of Equipment	Manufacturer	Model	Serial Number	Calibration Due
EMI Test Receiver	R&S	ESIB7	100197	Jul. 07, 2022
Spectrum Analyzer	R&S	FSQ40	200061	Jul. 07, 2022
Pre-amplifier	SKET	LNPA_0118G-45	SK2021012102	Feb. 24, 2023
Pre-amplifier	SKET	LNPA_1840G-50	SK202109203500	Feb. 24, 2023
Pre-amplifier	HP	8447D	2727A05017	Jul. 07, 2022
Loop antenna	ZHINAN	ZN30900A	12024	Sep. 05, 2022
Broadband Antenna	Schwarzbeck	VULB9163	340	Sep. 04, 2022
Horn Antenna	Schwarzbeck	BBHA 9120D	631	Sep. 04, 2022
Horn Antenna	Schwarzbeck	BBHA 9170	00956	Apr. 10, 2023
Antenna Mast	Keleto	RE-AM	N/A	N/A
Coaxial cable	SKET	RC_DC18G-N	N/A	Feb. 24, 2023
Coaxial cable	SKET	RC-DC18G-N	N/A	Feb. 24, 2023
Coaxial cable	SKET	RC-DC40G-N	N/A	Jul. 07, 2022
EMI Test Software	Shurple Technology	EZ-EMC	N/A	N/A

5.7.3. Test Data

Please refer to following diagram for individual  
Below 1GHz

Horizontal:

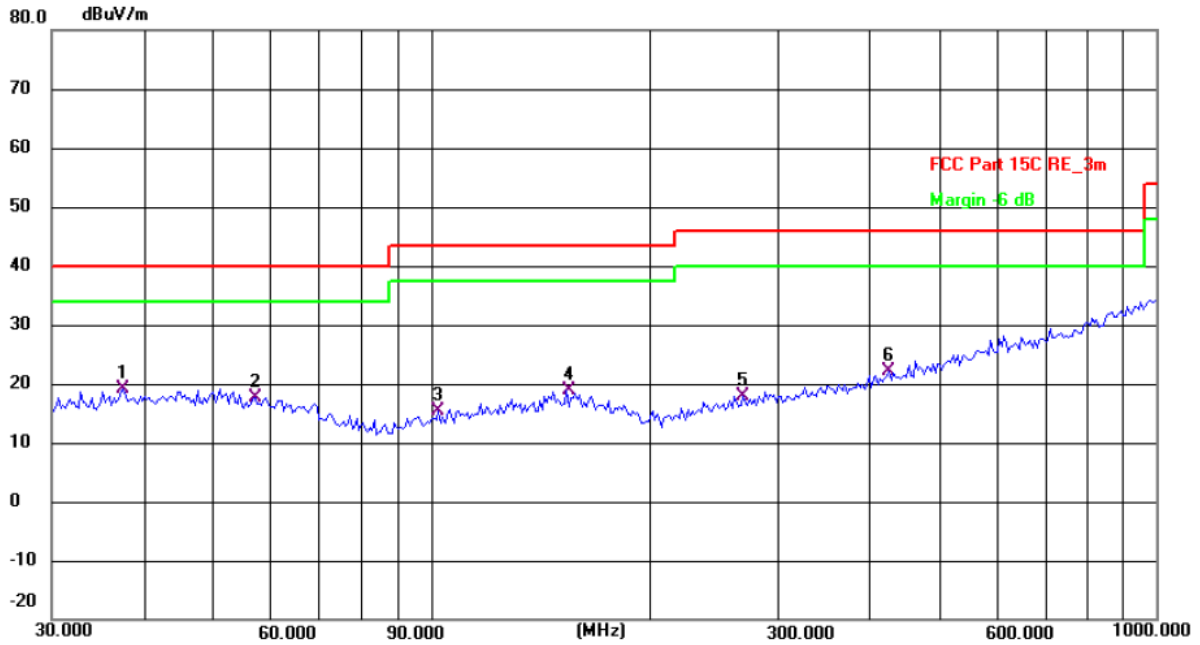

Site #1 3m Anechoic Chamber

Polarization: *Horizontal*

Temperature: 24.5(C) Humidity: 56 %

Limit: FCC Part 15C RE\_3m

Power: DC 3.7 V

No.	Frequency (MHz)	Reading (dBuV)	Factor (dB/m)	Level (dBuV/m)	Limit (dBuV/m)	Margin (dB)	Detector	P/F	Remark
1 *	37.5478	5.65	13.47	19.12	40.00	-20.88	QP	P	
2	57.1914	5.20	12.55	17.75	40.00	-22.25	QP	P	
3	102.3596	5.35	10.07	15.42	43.50	-28.08	QP	P	
4	153.7385	5.69	13.15	18.84	43.50	-24.66	QP	P	
5	269.4282	5.15	12.69	17.84	46.00	-28.16	QP	P	
6	428.0192	5.30	16.73	22.03	46.00	-23.97	QP	P	

Vertical:

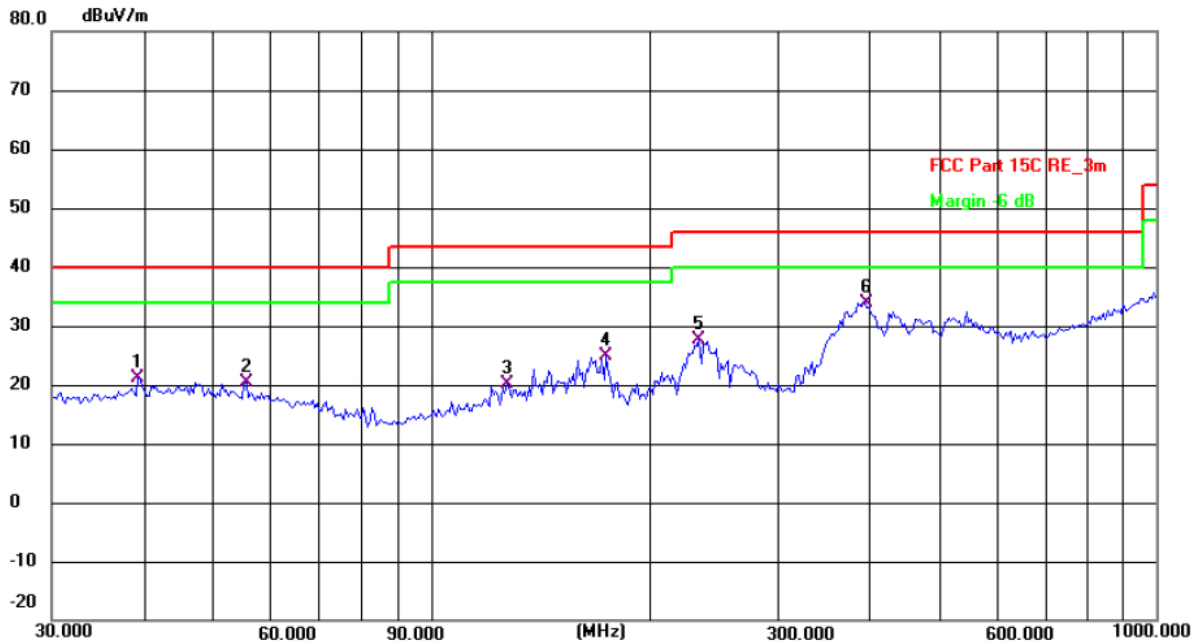

Site #1 3m Anechoic Chamber

Polarization: **Vertical**

Temperature: 24.5(C) Humidity: 56 %

Limit: FCC Part 15C RE\_3m

Power: DC 3.7 V

No.	Frequency (MHz)	Reading (dBuV)	Factor (dB/m)	Level (dBuV/m)	Limit (dBuV/m)	Margin (dB)	Detector	P/F	Remark
1	39.4371	7.38	13.67	21.05	40.00	-18.95	QP	P	
2	55.6092	7.73	12.74	20.47	40.00	-19.53	QP	P	
3	127.2176	8.25	11.98	20.23	43.50	-23.27	QP	P	
4	174.4240	12.97	11.97	24.94	43.50	-18.56	QP	P	
5	234.1682	15.84	11.83	27.67	46.00	-18.33	QP	P	
6 *	396.2414	17.98	15.96	33.94	46.00	-12.06	QP	P	

**Note:** 1. The low frequency, which started from 9KHz~30MHz, was pre-scanned and the result which was 20dB lower than the limit line per 15.31(o) was not reported

2. Speed for 1M and 2M modulations of EUT have been tested, but the test data only show the worst case in this report, and we found the worst case is 2M speed modulation. Measurements were conducted in all three channels (high, middle, low), and the worst case Mode (Highest channel) was submitted only.

3. Freq. = Emission frequency in MHz

Measurement (dBuV/m) = Reading level (dBuV) + Corr. Factor (dB)

Correction Factor = Antenna Factor + Cable loss – Pre-amplifier

Limit (dBuV/m) = Limit stated in standard

Margin (dB) = Measurement (dBuV/m) – Limits (dBuV/m)

\* is meaning the worst frequency has been tested in the test frequency range

Test Result of Radiated Spurious at Band edges

Lowest channel 2402:

Horizontal:

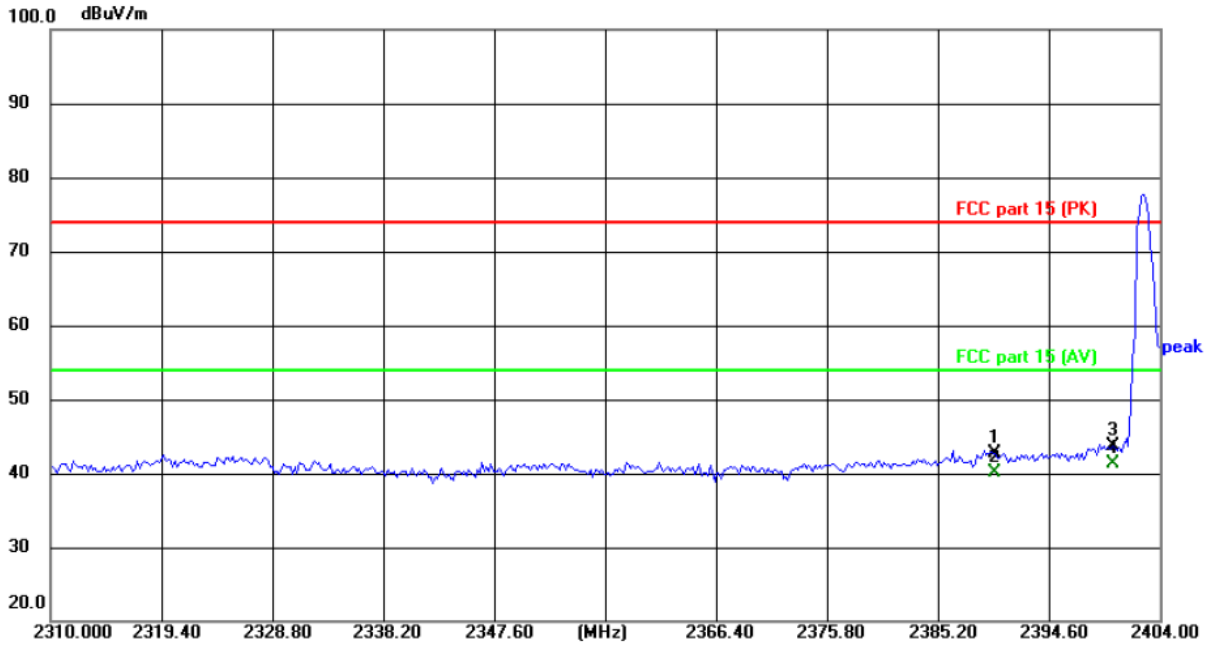

Site: Polarization: **Horizontal** Temperature: 25(°C)  
Limit: FCC part 15 (PK) Power: DC 3.7V Humidity: 55 %

No.	Frequency (MHz)	Reading (dBuV)	Factor (dB/m)	Level (dBuV/m)	Limit (dBuV/m)	Margin (dB)	Detector	P/F	Remark
1	2390.000	55.92	-13.15	42.77	74.00	-31.23	peak	P	
2	2390.000	53.18	-13.15	40.03	54.00	-13.97	AVG	P	
3	2400.000	56.92	-13.12	43.80	74.00	-30.20	peak	P	
4 *	2400.000	54.48	-13.12	41.36	54.00	-12.64	AVG	P	

Vertical:

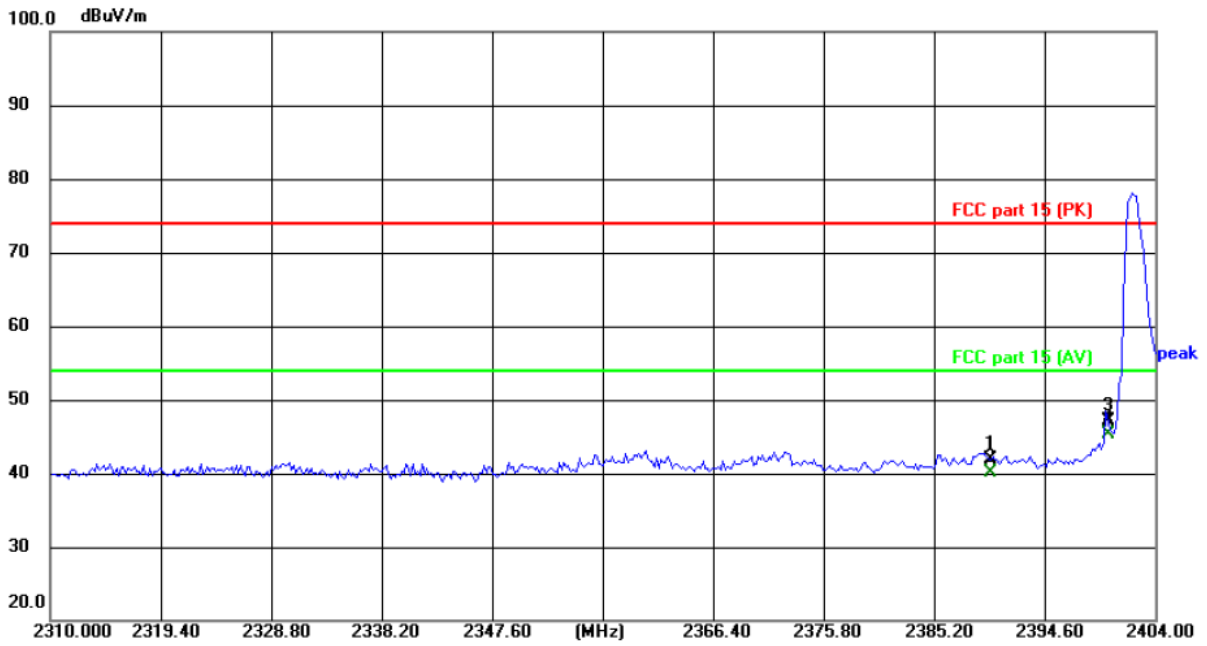

Site: Polarization: **Vertical** Temperature: 25(°C)  
 Limit: FCC part 15 (PK) Power: DC 3.7V Humidity: 55 %

No.	Frequency (MHz)	Reading (dBuV)	Factor (dB/m)	Level (dBuV/m)	Limit (dBuV/m)	Margin (dB)	Detector	P/F	Remark
1	2390.000	55.04	-13.15	41.89	74.00	-32.11	peak	P	
2	2390.000	53.31	-13.15	40.16	54.00	-13.84	AVG	P	
3	2400.000	60.31	-13.12	47.19	74.00	-26.81	peak	P	
4 *	2400.000	58.38	-13.12	45.26	54.00	-8.74	AVG	P	





Highest channel 2480:

Horizontal:

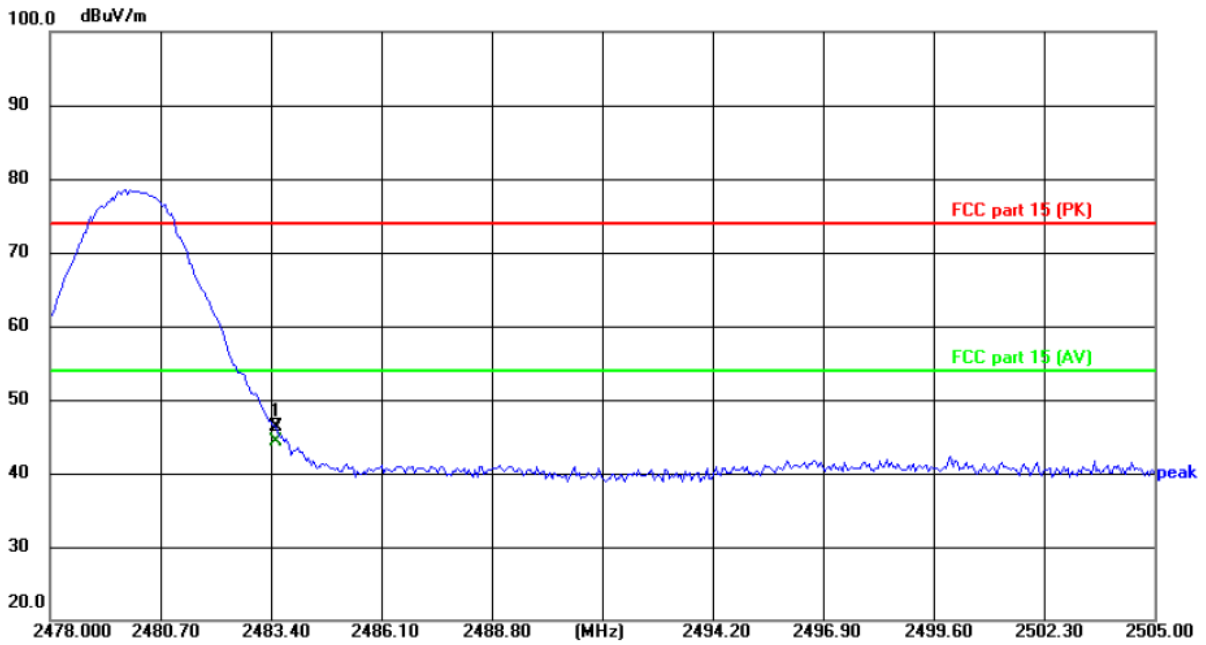

Site: Polarization: **Horizontal** Temperature: 25(°C)  
Limit: FCC part 15 (PK) Power: DC 3.7V Humidity: 55 %

No.	Frequency (MHz)	Reading (dBuV)	Factor (dB/m)	Level (dBuV/m)	Limit (dBuV/m)	Margin (dB)	Detector	P/F	Remark
1	2483.500	59.19	-12.84	46.35	74.00	-27.65	peak	P	
2 *	2483.500	57.20	-12.84	44.36	54.00	-9.64	AVG	P	

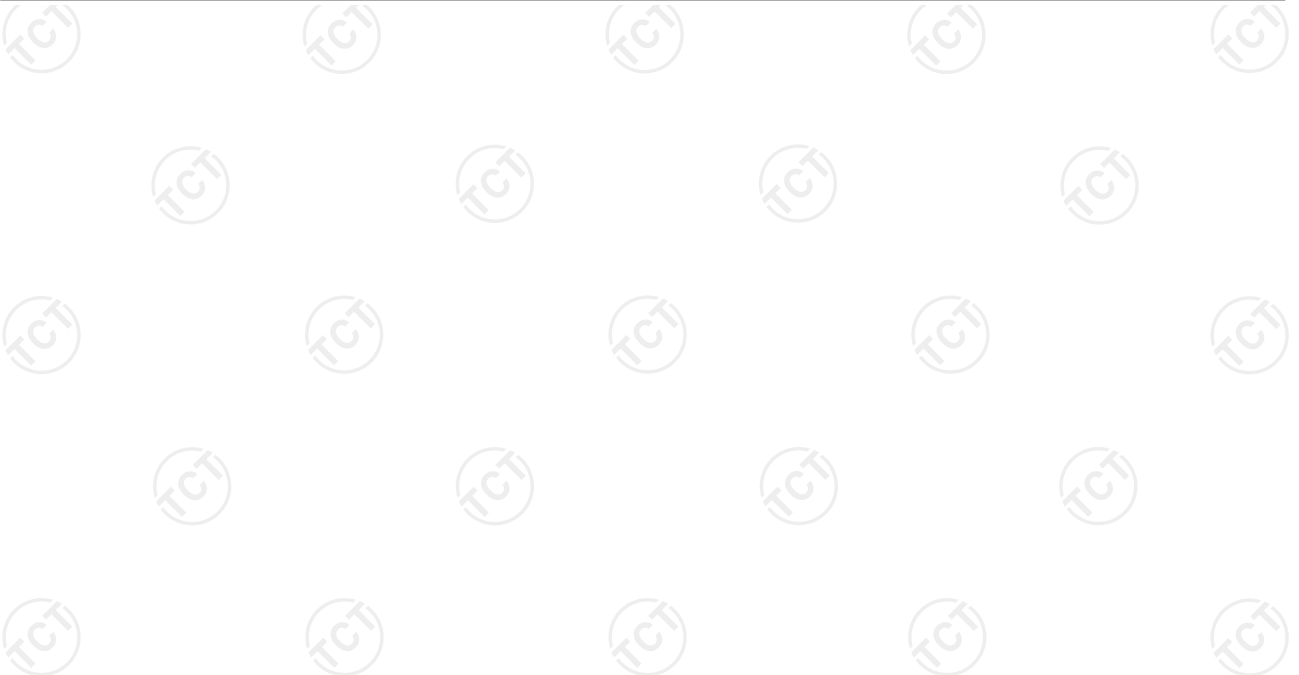

Vertical:

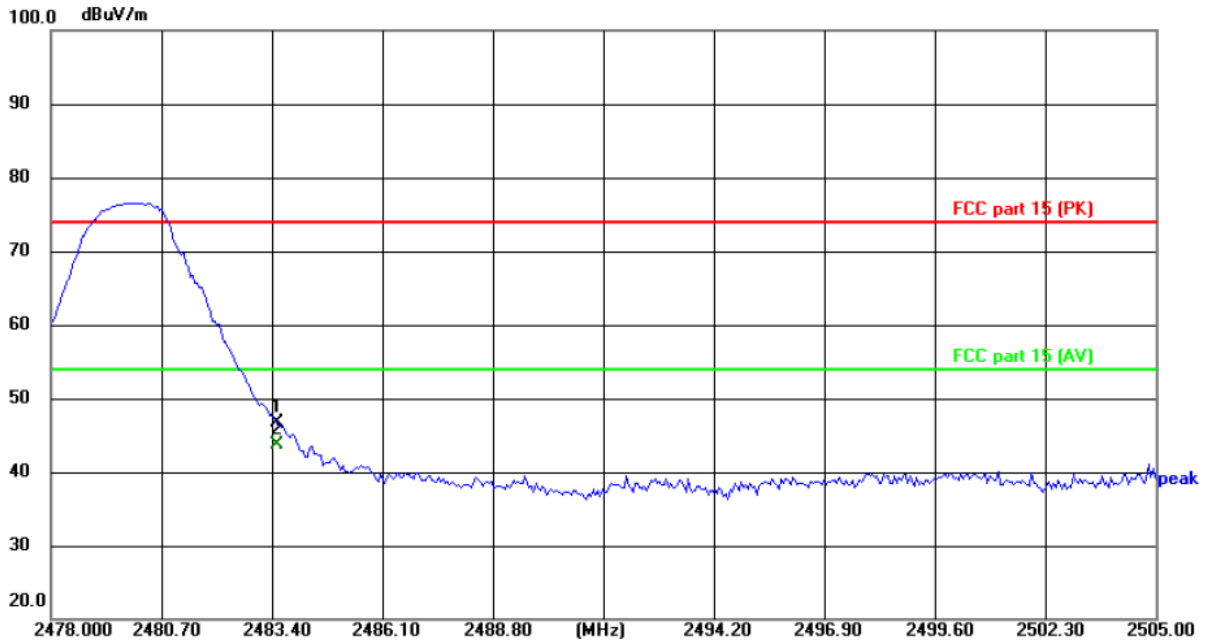

Site: Polarization: **Vertical** Temperature: 25(°C)  
 Limit: FCC part 15 (PK) Power: DC 3.7V Humidity: 55 %

No.	Frequency (MHz)	Reading (dBuV)	Factor (dB/m)	Level (dBuV/m)	Limit (dBuV/m)	Margin (dB)	Detector	P/F	Remark
1	2483.500	59.53	-12.84	46.69	74.00	-27.31	peak	P	
2 *	2483.500	56.46	-12.84	43.62	54.00	-10.38	AVG	P	

**Note:** Speed for 1M and 2M modulations of EUT have been tested, but the test data only show the worst case in this report, and we found the worst case is 2M speed modulation.

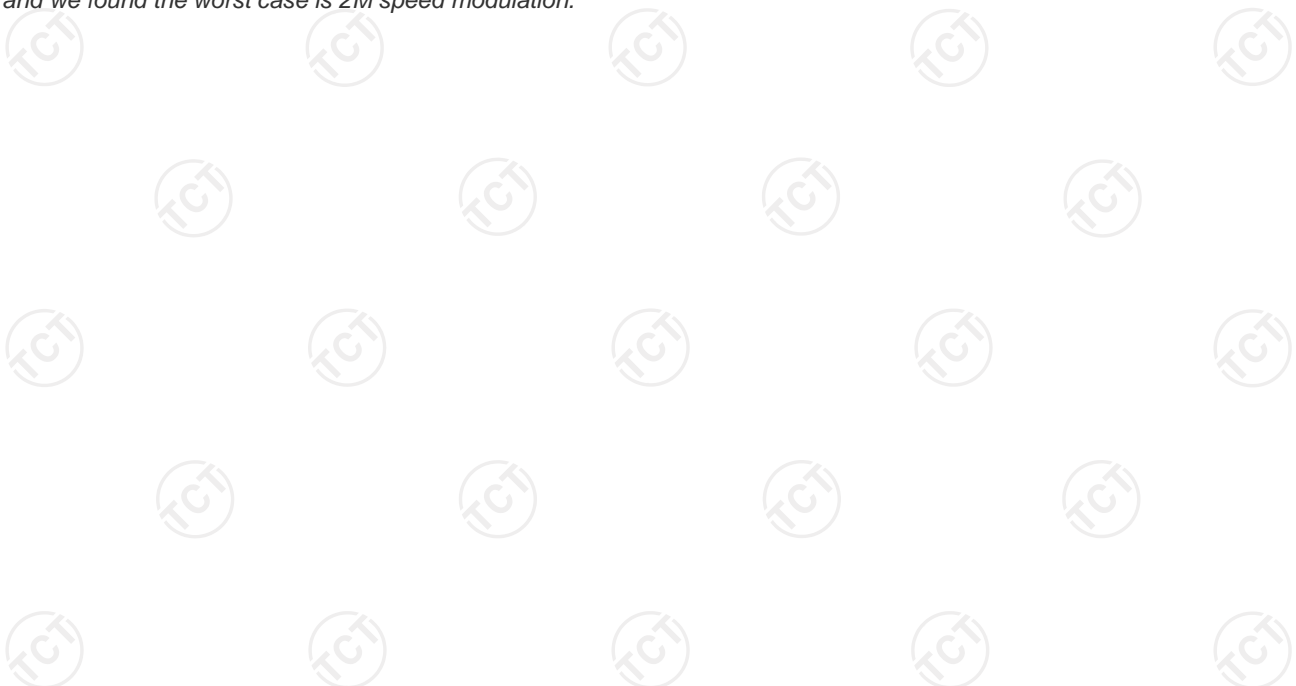

**Above 1GHz**

Low channel: 2402 MHz									
Frequency (MHz)	Ant. Pol. H/V	Peak reading (dB $\mu$ V)	AV reading (dB $\mu$ V)	Correction Factor (dB/m)	Emission Level		Peak limit (dB $\mu$ V/m)	AV limit (dB $\mu$ V/m)	Margin (dB)
					Peak (dB $\mu$ V/m)	AV (dB $\mu$ V/m)			
4804	H	45.95	---	0.66	46.61	---	74	54	-7.39
7206	H	36.43	---	9.50	45.93	---	74	54	-8.07
---	H	---	---	---	---	---	---	---	---
4804	V	45.83	---	0.66	46.49	---	74	54	-7.51
7206	V	35.02	---	9.50	44.52	---	74	54	-9.48
---	V	---	---	---	---	---	---	---	---

Middle channel: 2440 MHz									
Frequency (MHz)	Ant. Pol. H/V	Peak reading (dB $\mu$ V)	AV reading (dB $\mu$ V)	Correction Factor (dB/m)	Emission Level		Peak limit (dB $\mu$ V/m)	AV limit (dB $\mu$ V/m)	Margin (dB)
					Peak (dB $\mu$ V/m)	AV (dB $\mu$ V/m)			
4880	H	46.36	---	0.99	47.35	---	74	54	-6.65
7320	H	37.27	---	9.87	47.14	---	74	54	-6.86
---	H	---	---	---	---	---	---	---	---
4880	V	45.83	---	0.99	46.82	---	74	54	-7.18
7320	V	35.95	---	9.87	45.82	---	74	54	-8.18
---	V	---	---	---	---	---	---	---	---

High channel: 2480 MHz									
Frequency (MHz)	Ant. Pol. H/V	Peak reading (dB $\mu$ V)	AV reading (dB $\mu$ V)	Correction Factor (dB/m)	Emission Level		Peak limit (dB $\mu$ V/m)	AV limit (dB $\mu$ V/m)	Margin (dB)
					Peak (dB $\mu$ V/m)	AV (dB $\mu$ V/m)			
4960	H	44.16	---	1.33	45.49	---	74	54	-8.51
7440	H	34.83	---	10.22	45.05	---	74	54	-8.95
---	H	---	---	---	---	---	---	---	---
4960	V	44.25	---	1.33	45.58	---	74	54	-8.42
7440	V	34.41	---	10.22	44.63	---	74	54	-9.37
---	V	---	---	---	---	---	---	---	---

**Note:**

1. Emission Level=Peak Reading + Correction Factor; Correction Factor= Antenna Factor + Cable loss – Pre-amplifier
2. Margin (dB) = Emission Level (Peak) (dB $\mu$ V/m)-Average limit (dB $\mu$ V/m)
3. The emission levels of other frequencies are very lower than the limit and not show in test report.
4. Measurements were conducted from 1 GHz to the 10th harmonic of highest fundamental frequency.
5. Data of measurement shown “---“in the above table mean that the reading of emissions is attenuated more than 20 dB below the limits or the field strength is too small to be measured.
6. Speed for 1M and 2M modulations of EUT have been tested, but the test data only show the worst case in this report, and we found the worst case is 2M speed modulation.
7. All the restriction bands are compliance with the limit of 15.209.

**Appendix A: Test Result of Conducted Test**  
**Maximum Conducted Output Power**

Condition	Mode	Frequency (MHz)	Conducted Power (dBm)	Limit (dBm)	Verdict
NVNT	BLE 1M	2402	-2.03	30	Pass
NVNT	BLE 1M	2440	-1.88	30	Pass
NVNT	BLE 1M	2480	-1.74	30	Pass
NVNT	BLE 2M	2402	-1.95	30	Pass
NVNT	BLE 2M	2440	-1.79	30	Pass
NVNT	BLE 2M	2480	-1.67	30	Pass

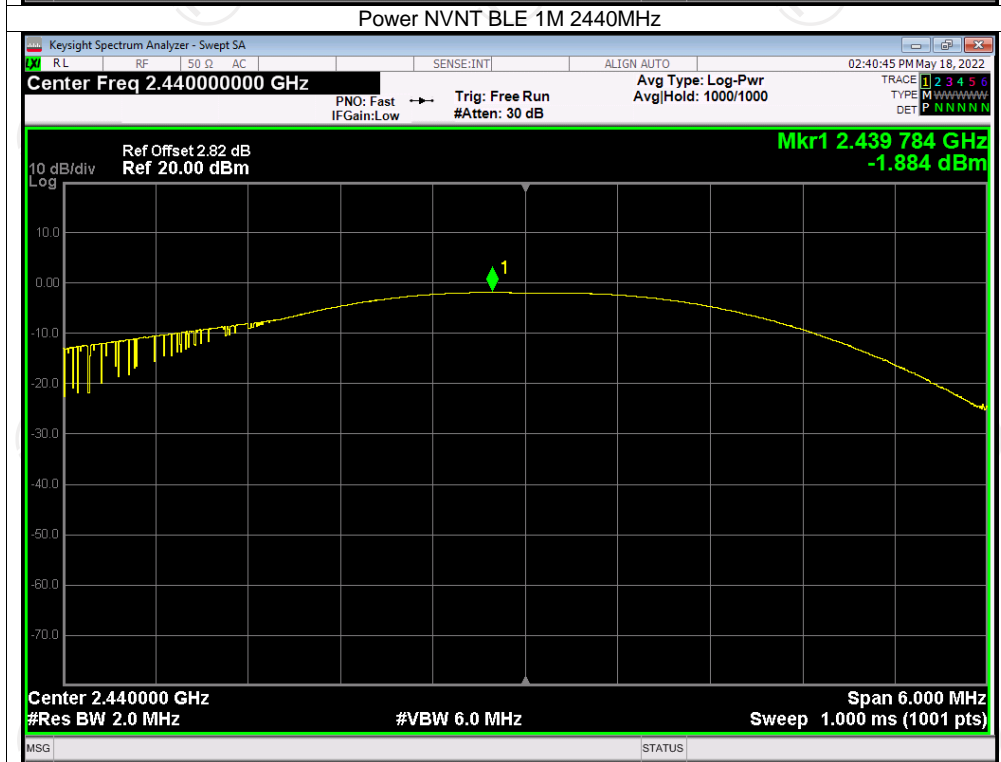



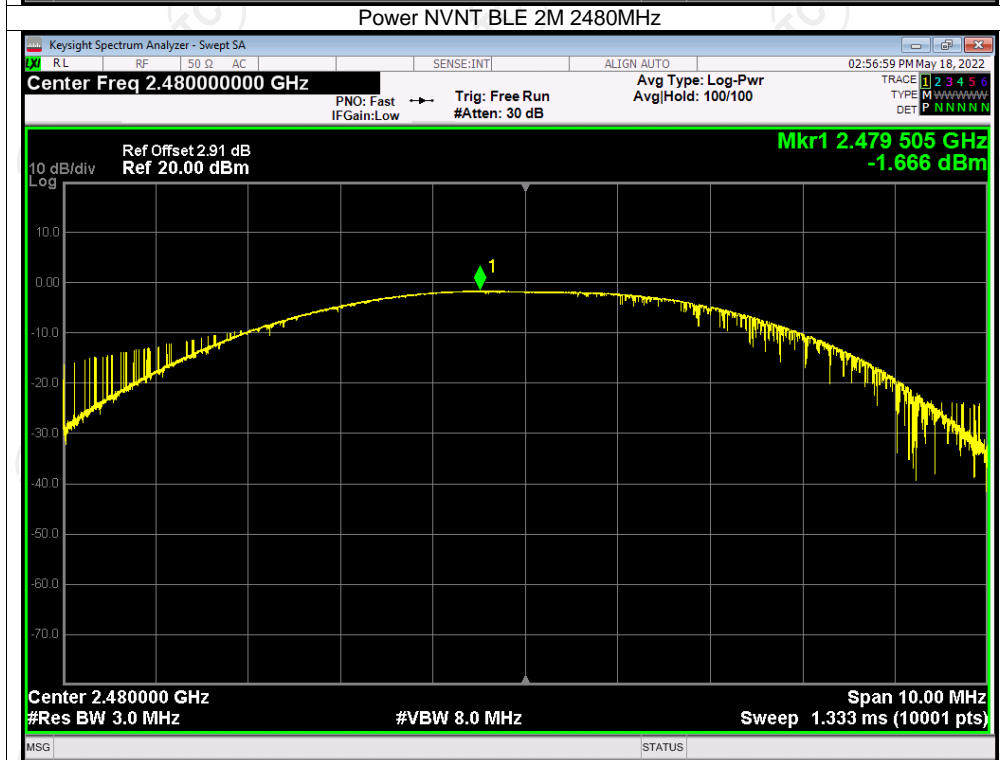
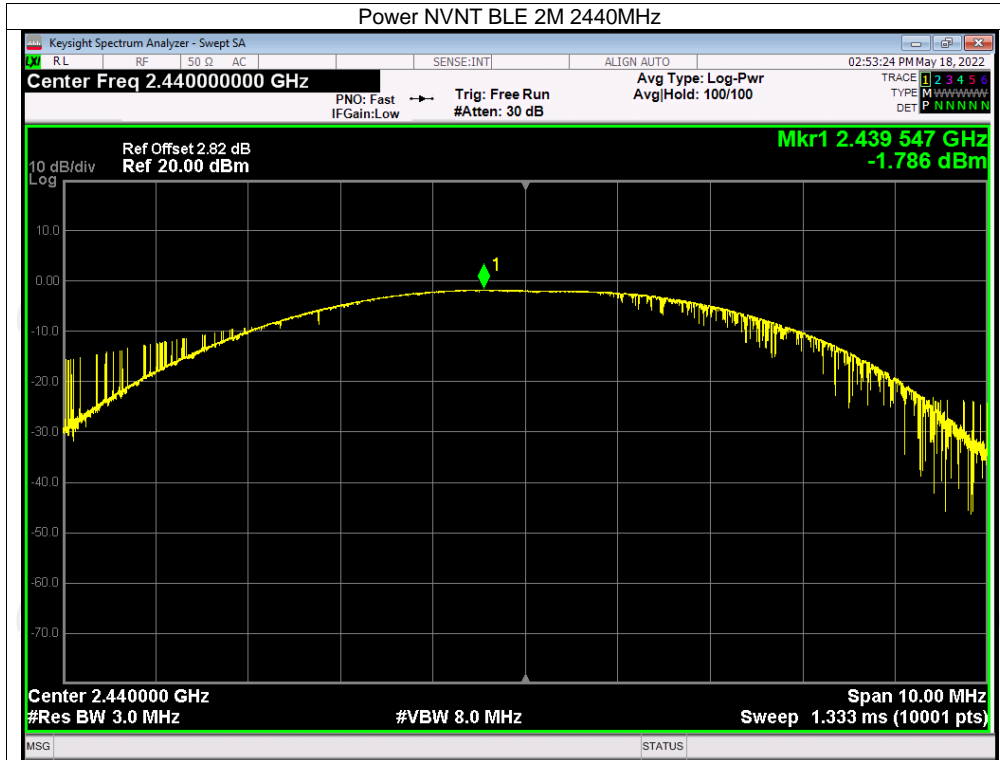

**-6dB Bandwidth**

Condition	Mode	Frequency (MHz)	-6 dB Bandwidth (MHz)	Limit -6 dB Bandwidth (MHz)	Verdict
NVNT	BLE 1M	2402	0.502	0.5	Pass
NVNT	BLE 1M	2440	0.504	0.5	Pass
NVNT	BLE 1M	2480	0.504	0.5	Pass
NVNT	BLE 2M	2402	0.865	0.5	Pass
NVNT	BLE 2M	2440	0.865	0.5	Pass
NVNT	BLE 2M	2480	0.865	0.5	Pass





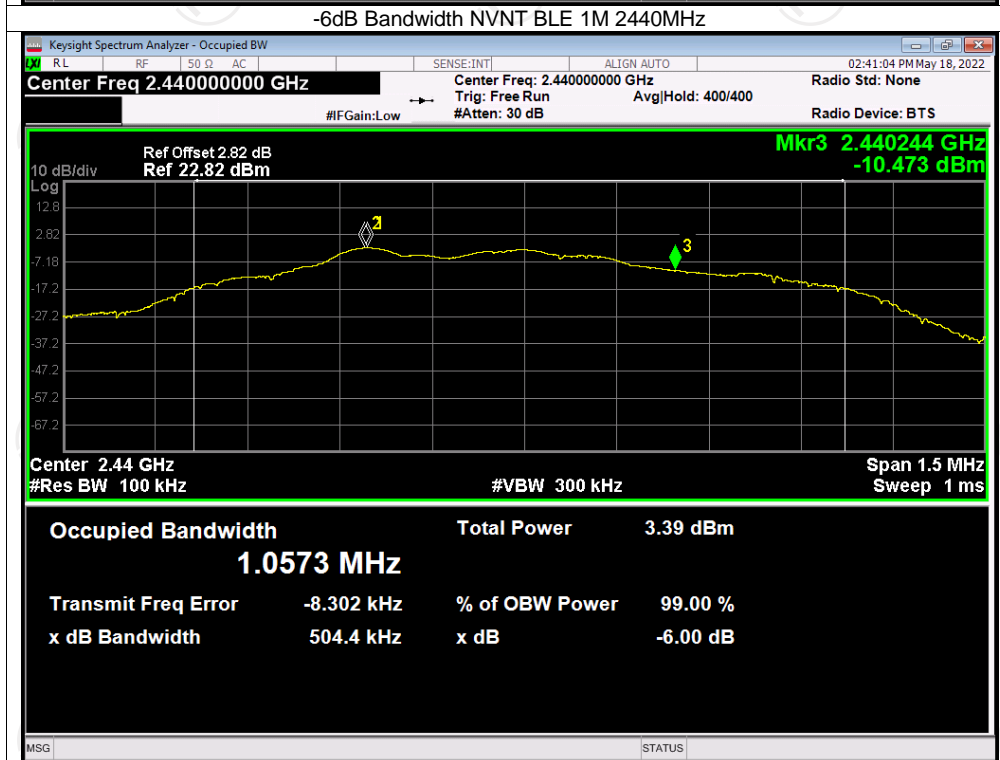
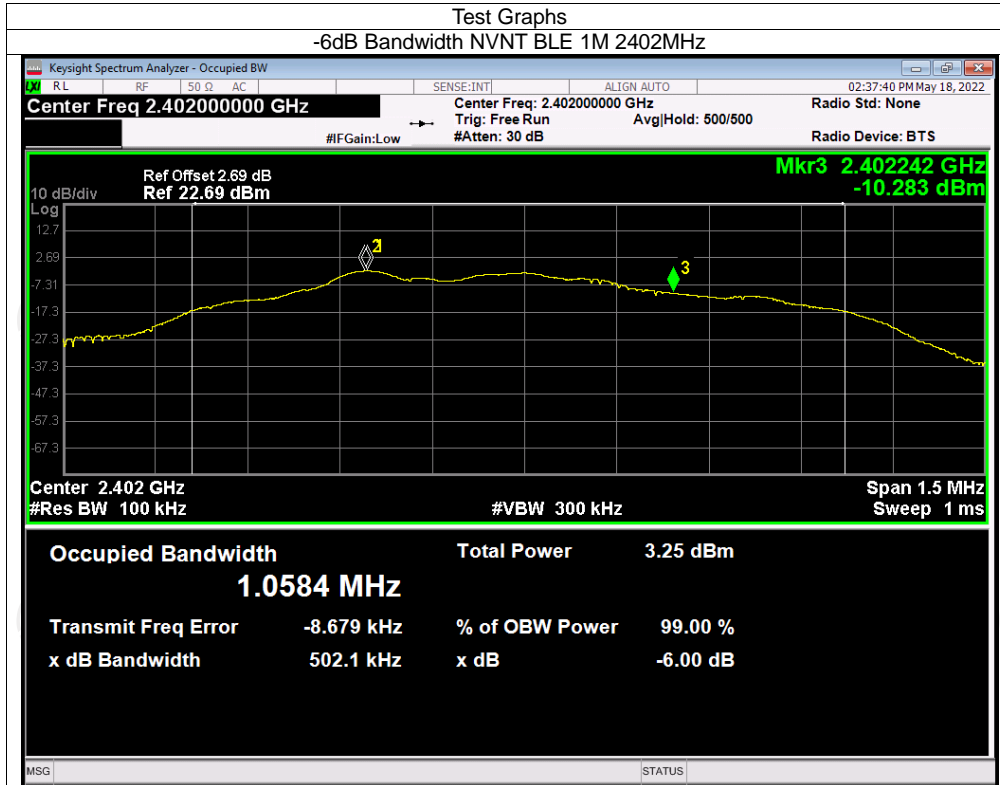

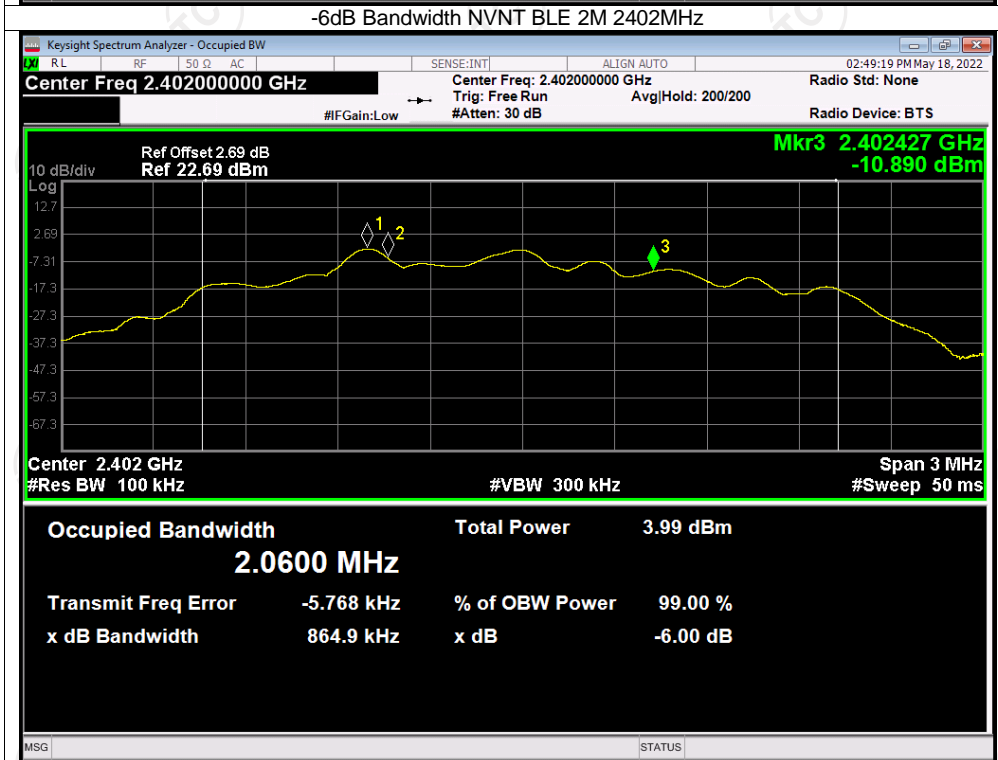
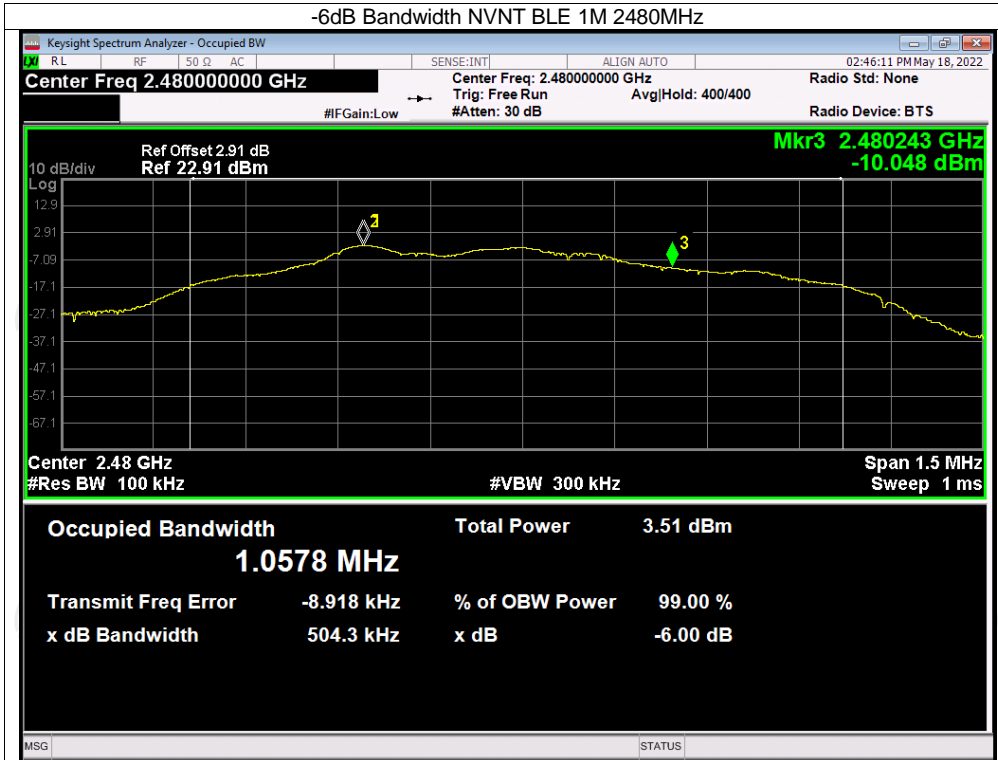

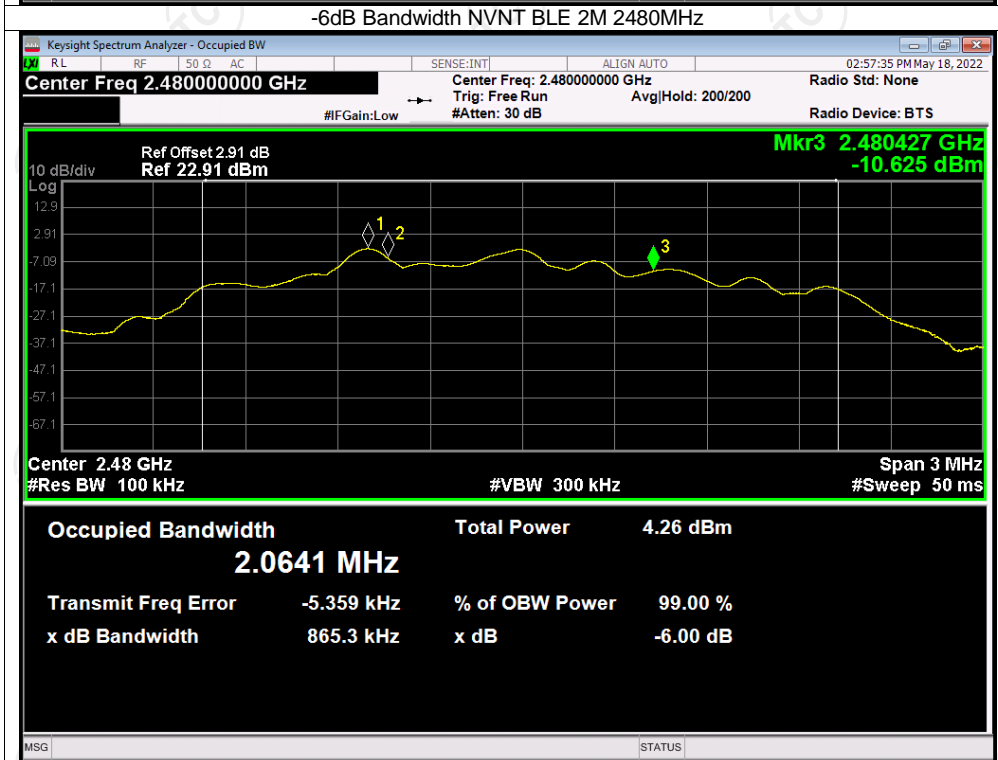
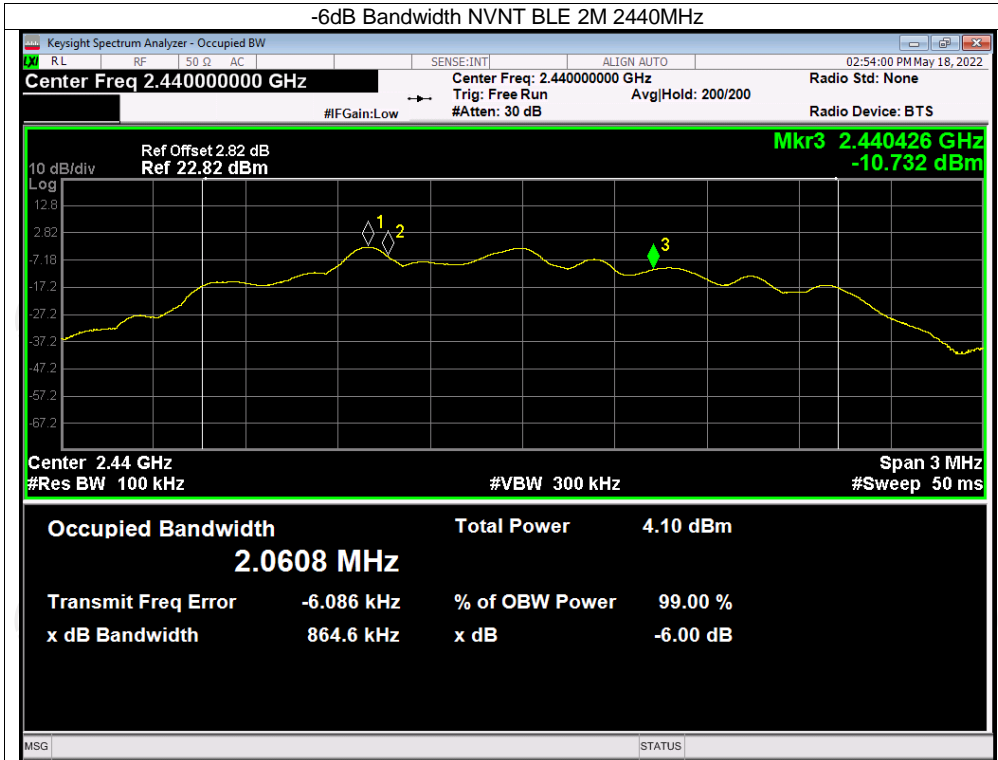

**Maximum Power Spectral Density Level**

Condition	Mode	Frequency (MHz)	Conducted PSD (dBm/3kHz)	Limit (dBm/3kHz)	Verdict
NVNT	BLE 1M	2402	-21.64	8	Pass
NVNT	BLE 1M	2440	-21.43	8	Pass
NVNT	BLE 1M	2480	-21.22	8	Pass
NVNT	BLE 2M	2402	-24.22	8	Pass
NVNT	BLE 2M	2440	-24.04	8	Pass
NVNT	BLE 2M	2480	-24.01	8	Pass

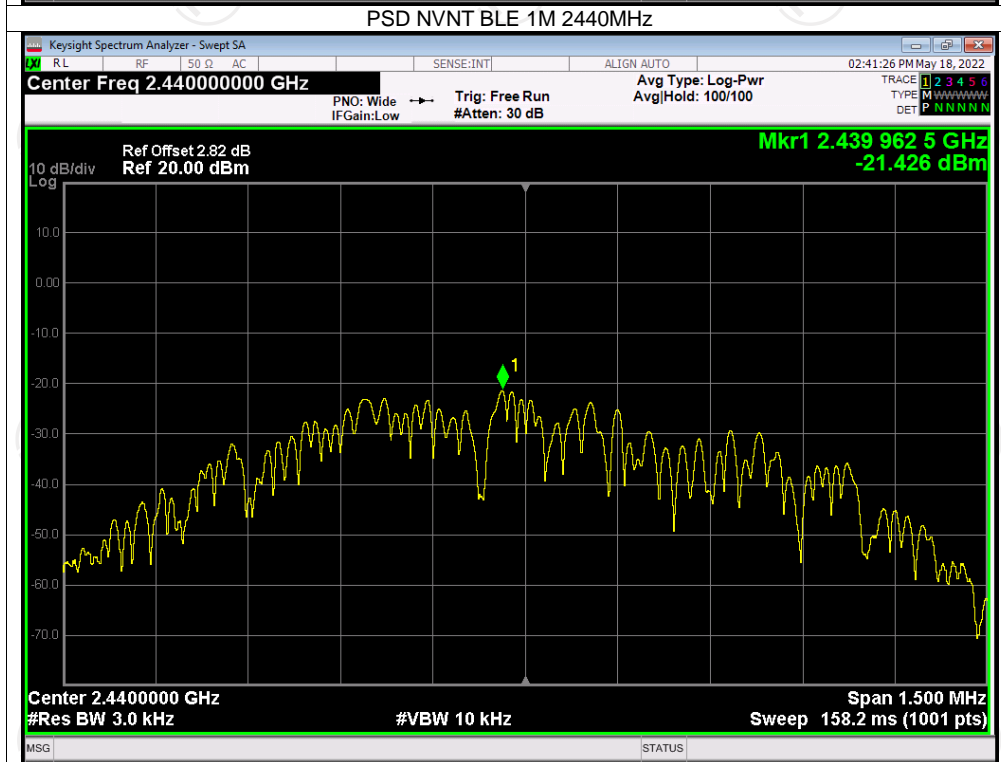
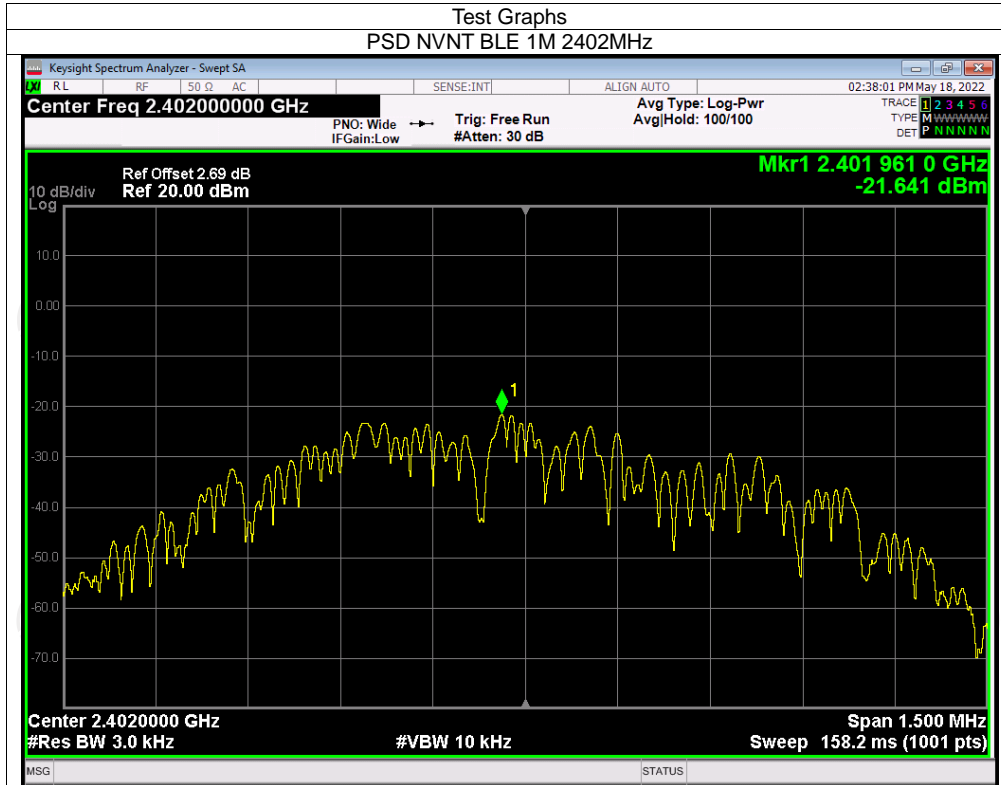

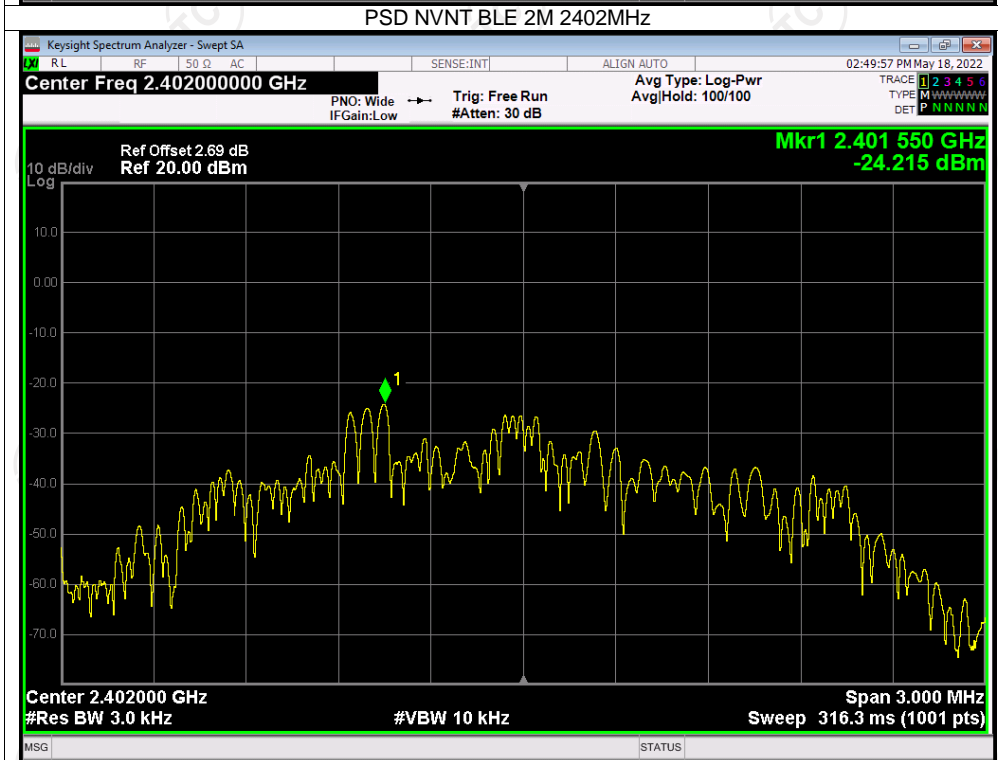
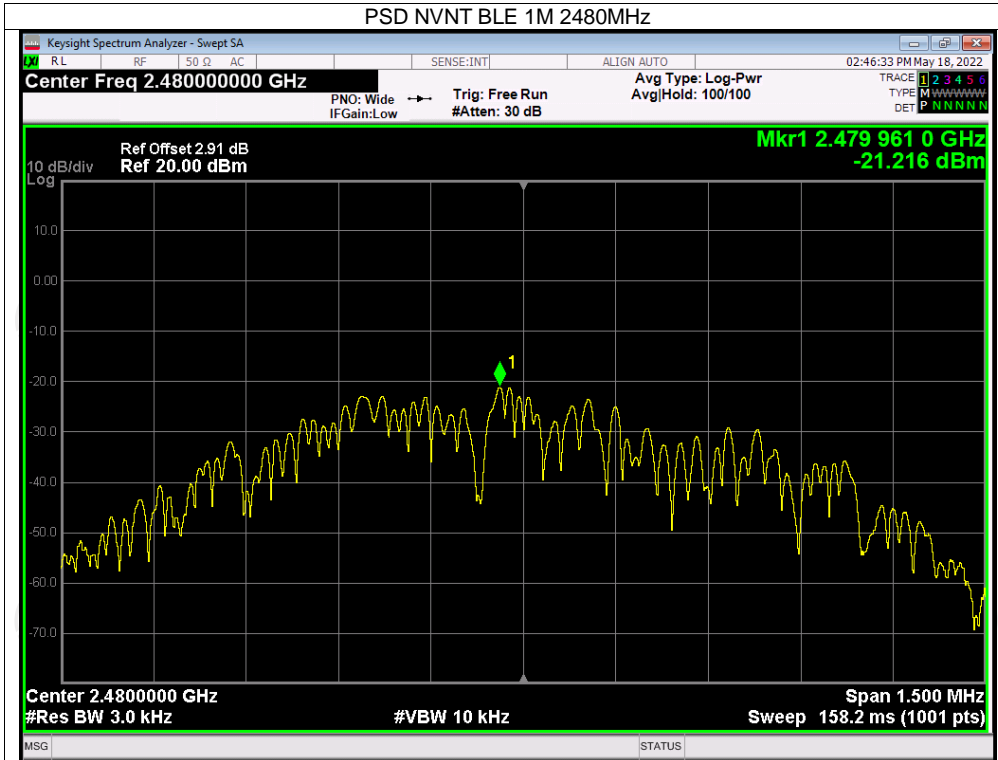

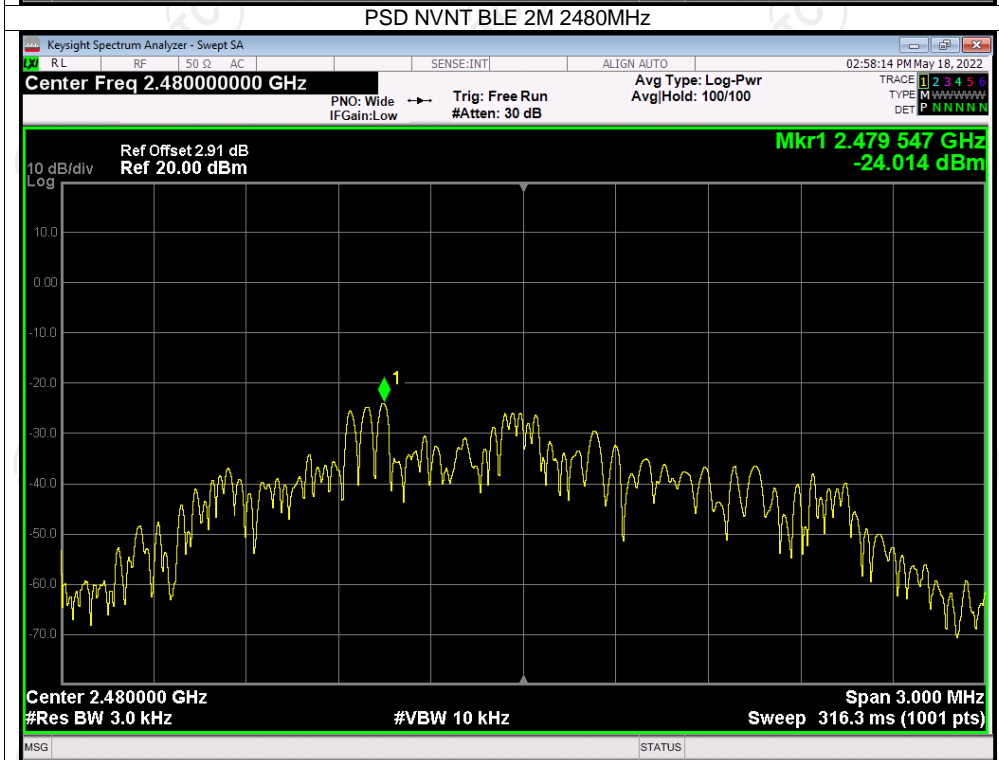
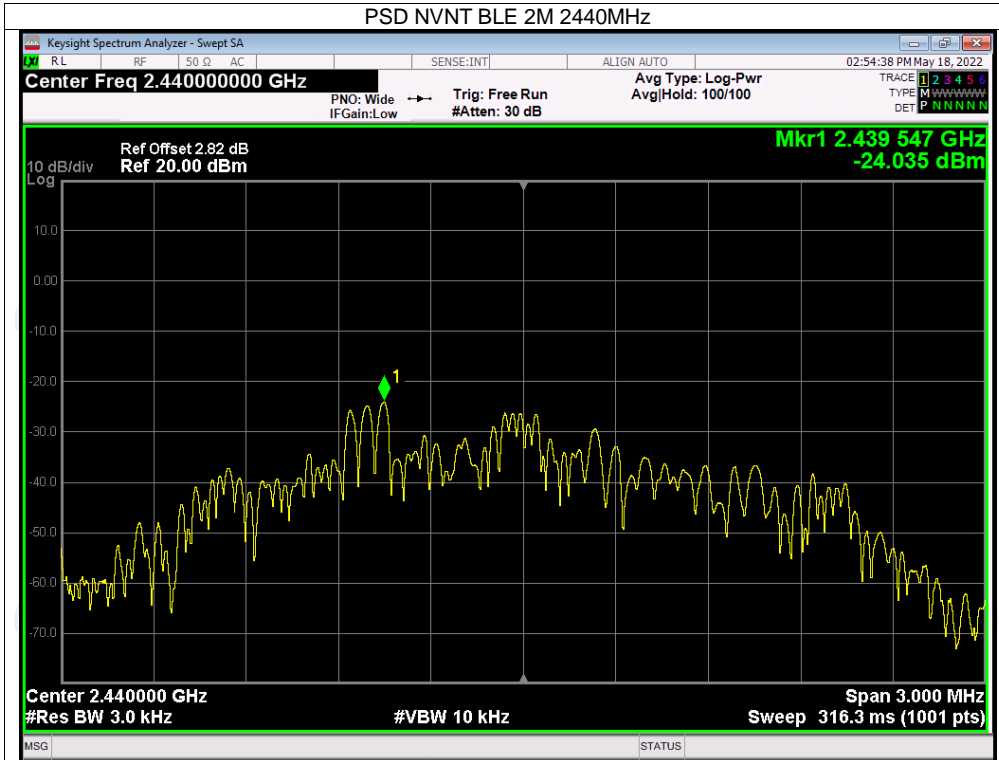

**Band Edge**

Condition	Mode	Frequency (MHz)	Max Value (dBc)	Limit (dBc)	Verdict
NVNT	BLE 1M	2402	-46.14	-20	Pass
NVNT	BLE 1M	2480	-46.15	-20	Pass
NVNT	BLE 2M	2402	-47.28	-20	Pass
NVNT	BLE 2M	2480	-47.96	-20	Pass





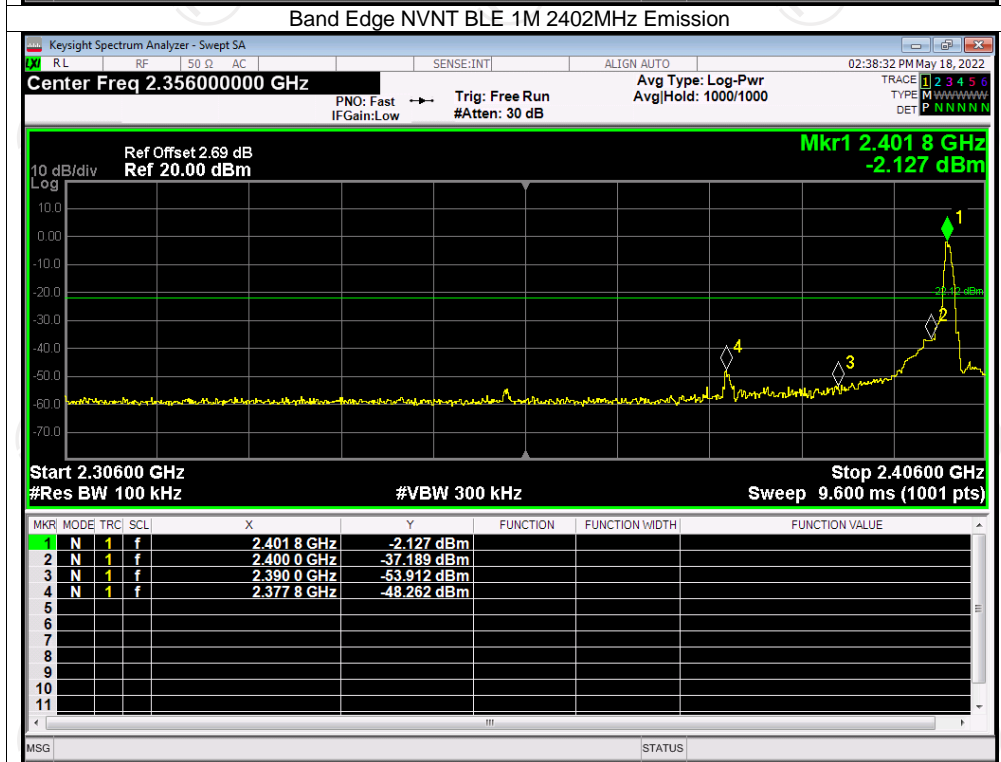

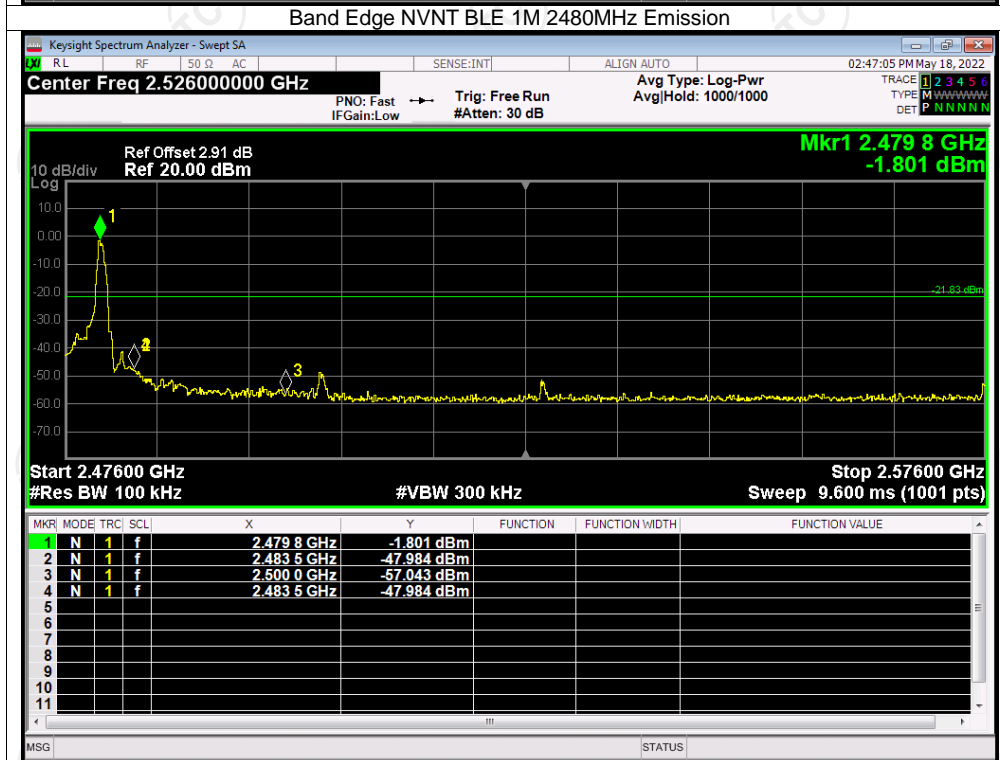
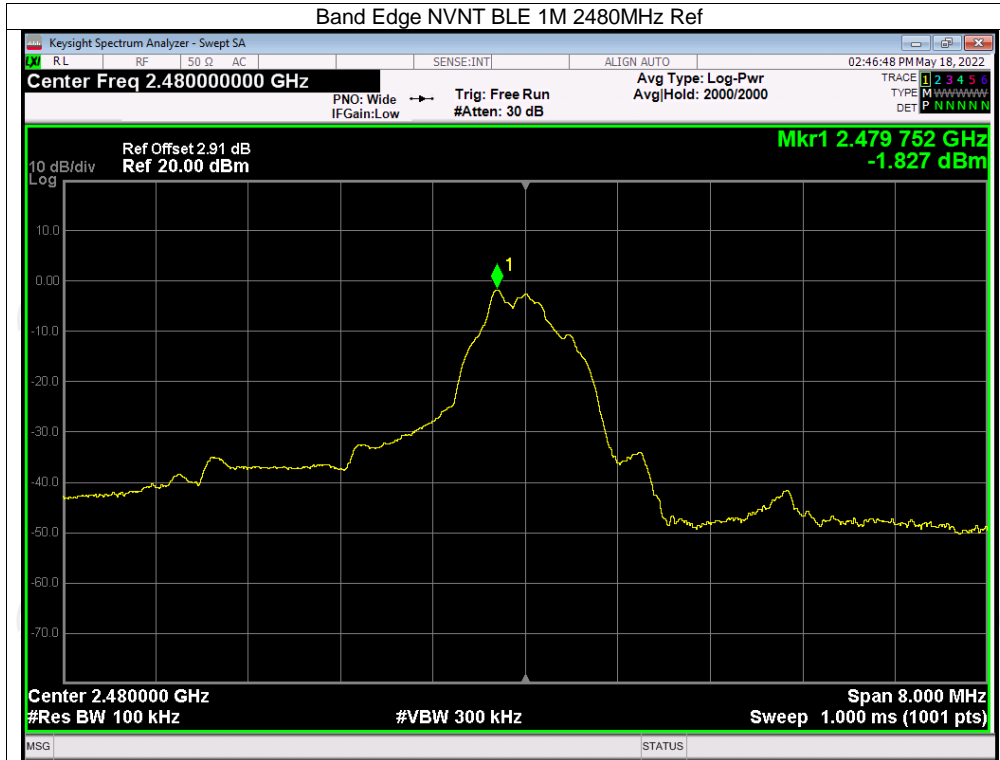

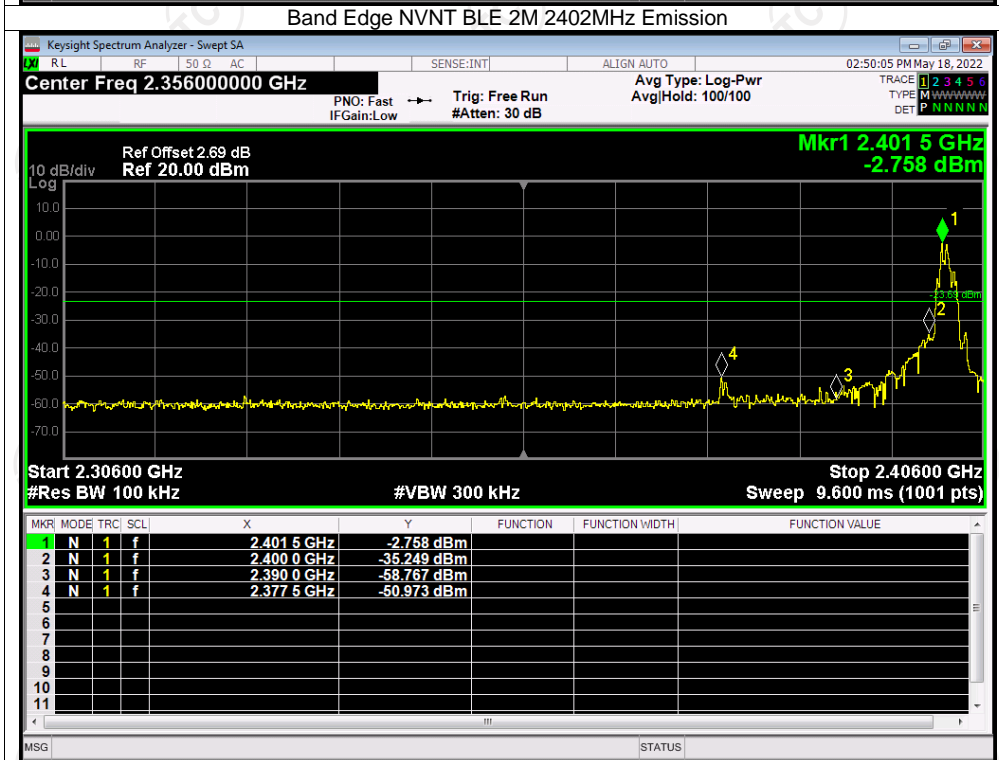
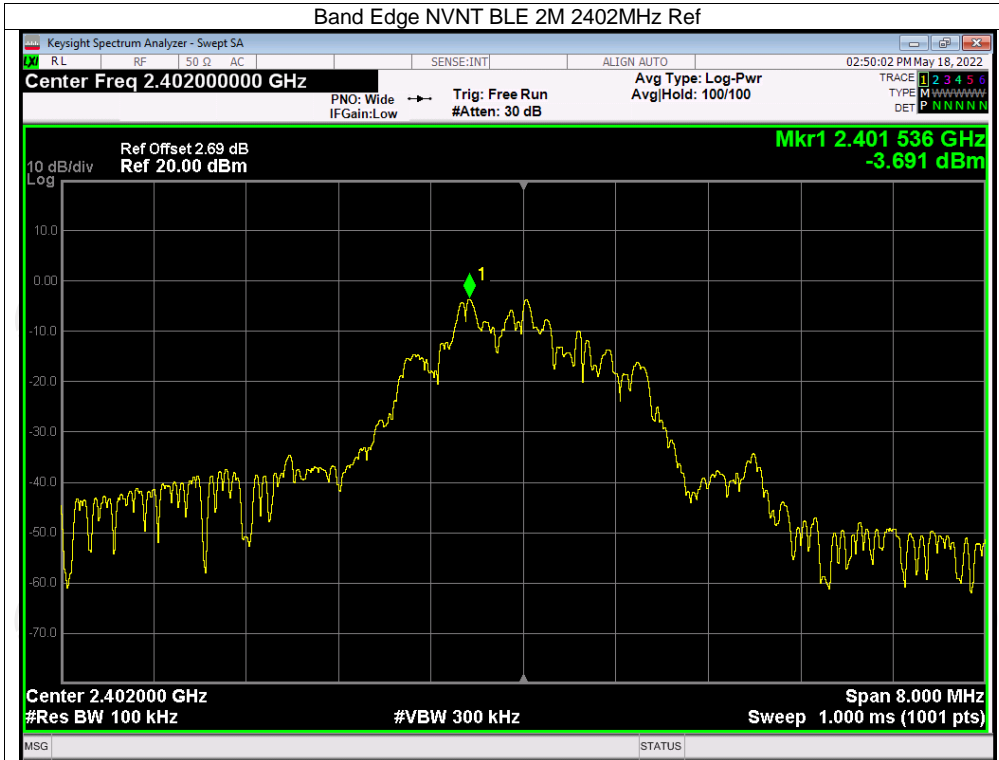

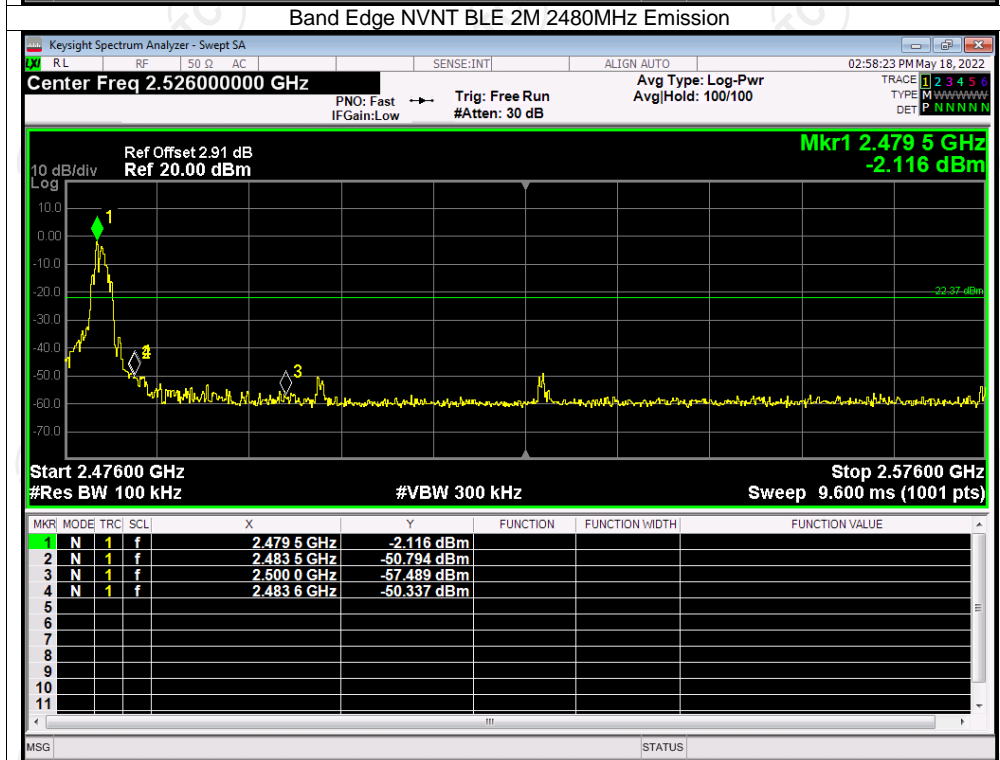
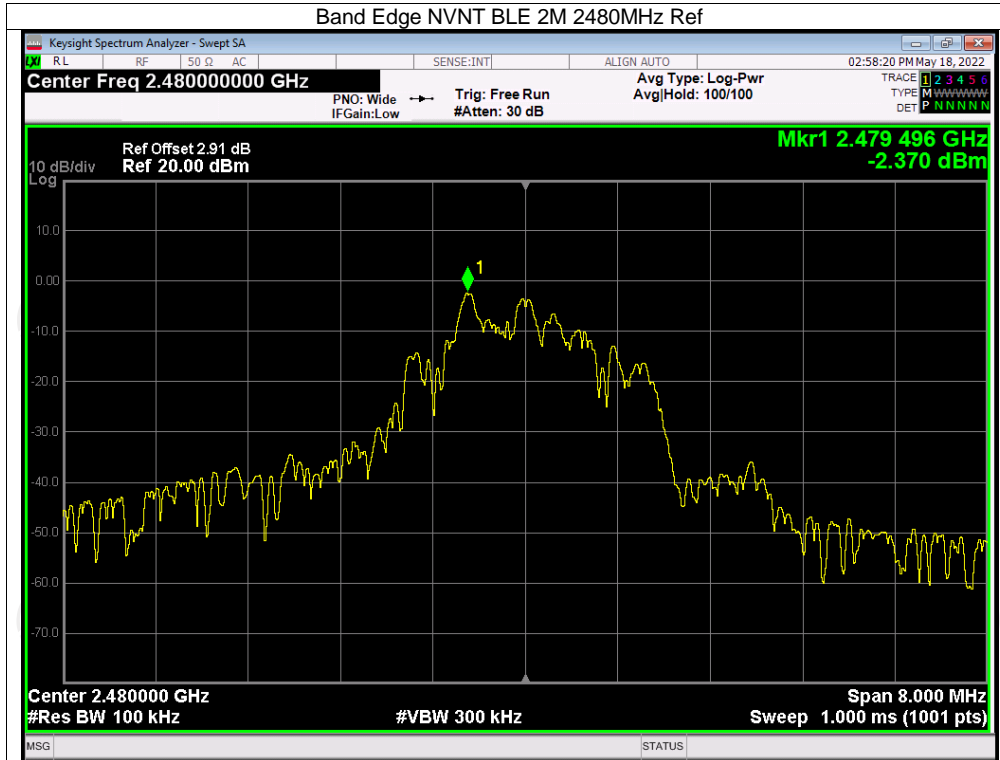

### Conducted RF Spurious Emission

Condition	Mode	Frequency (MHz)	Max Value (dBc)	Limit (dBc)	Verdict
NVNT	BLE 1M	2402	-42.23	-20	Pass
NVNT	BLE 1M	2440	-43.07	-20	Pass
NVNT	BLE 1M	2480	-42.90	-20	Pass
NVNT	BLE 2M	2402	-42.76	-20	Pass
NVNT	BLE 2M	2440	-42.25	-20	Pass
NVNT	BLE 2M	2480	-41.05	-20	Pass

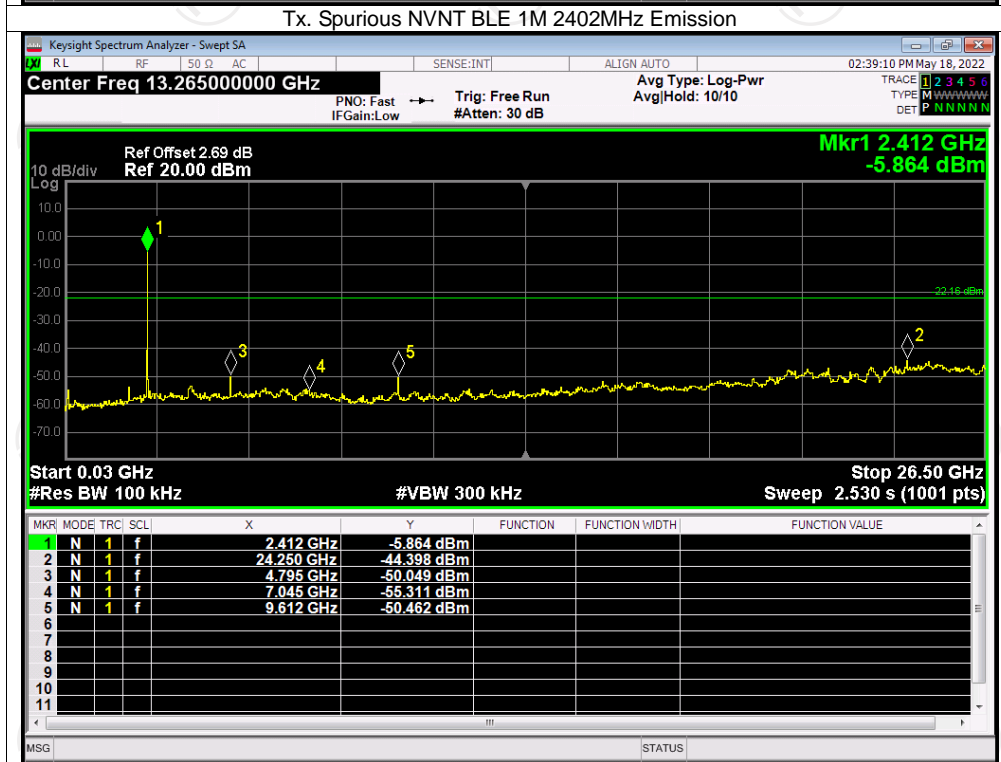

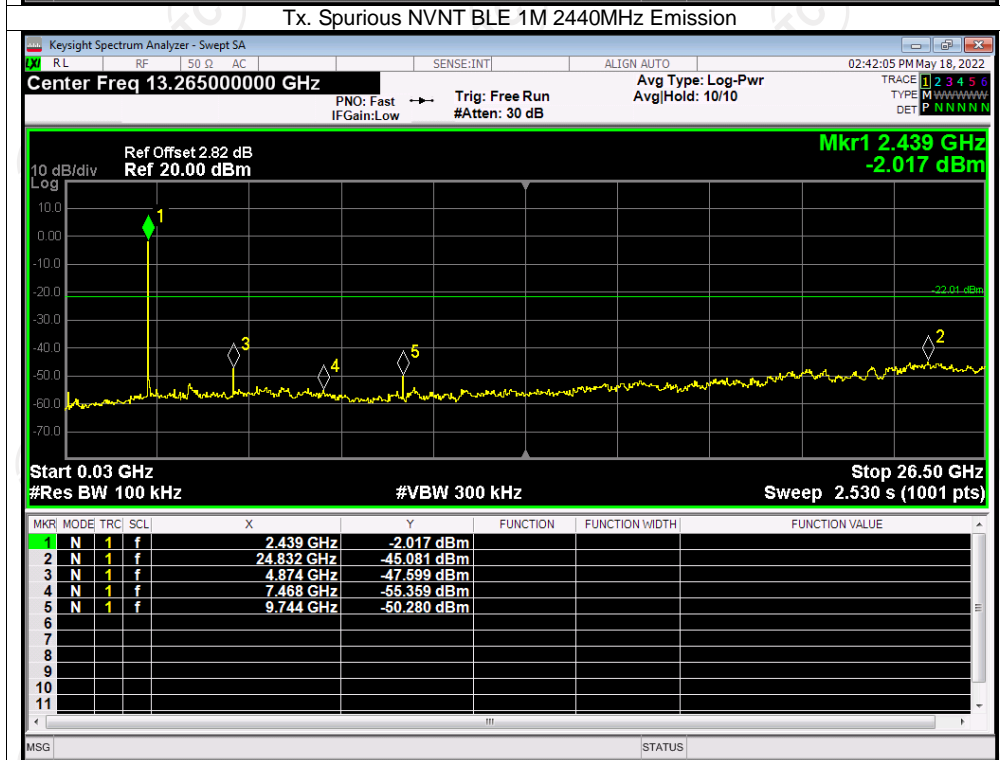
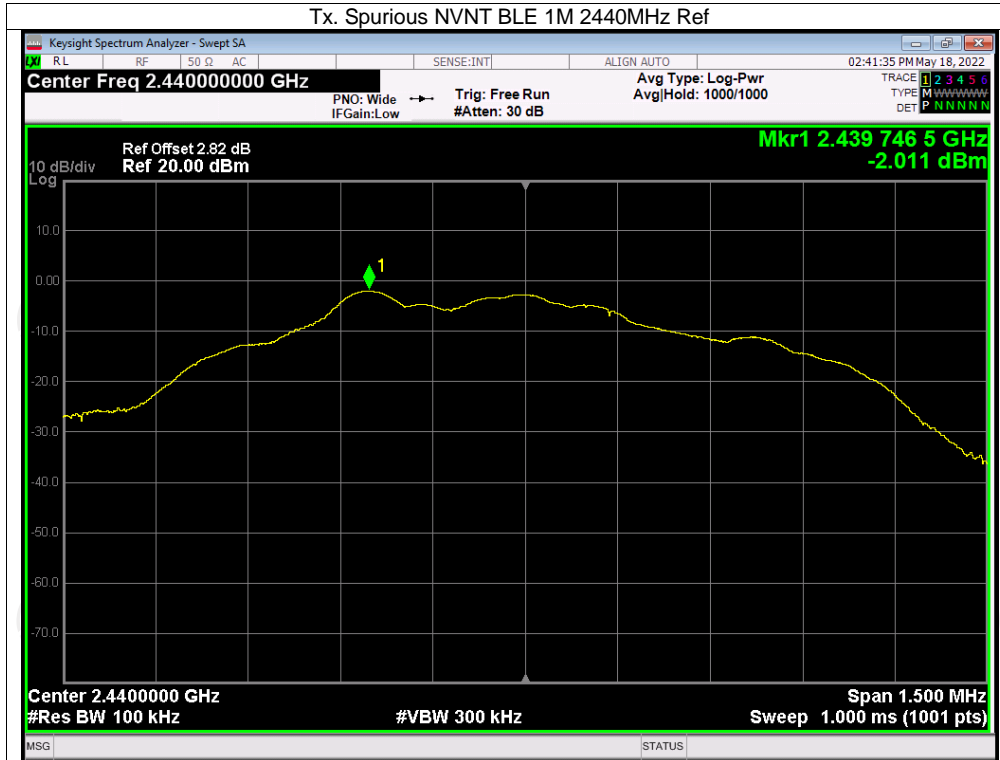

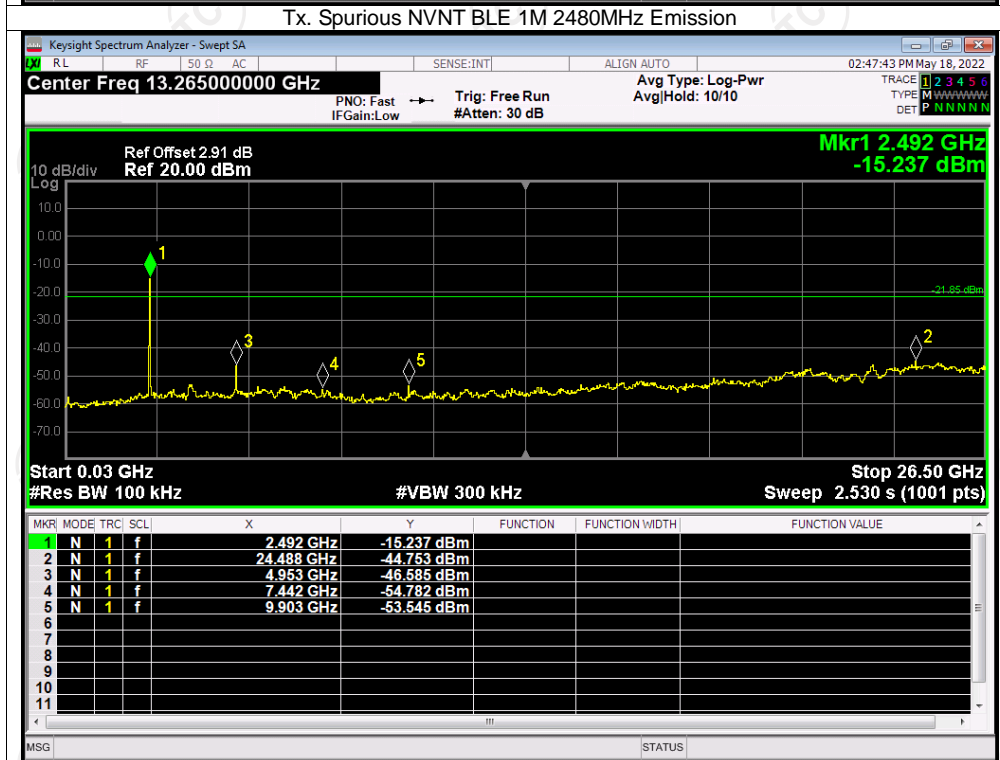



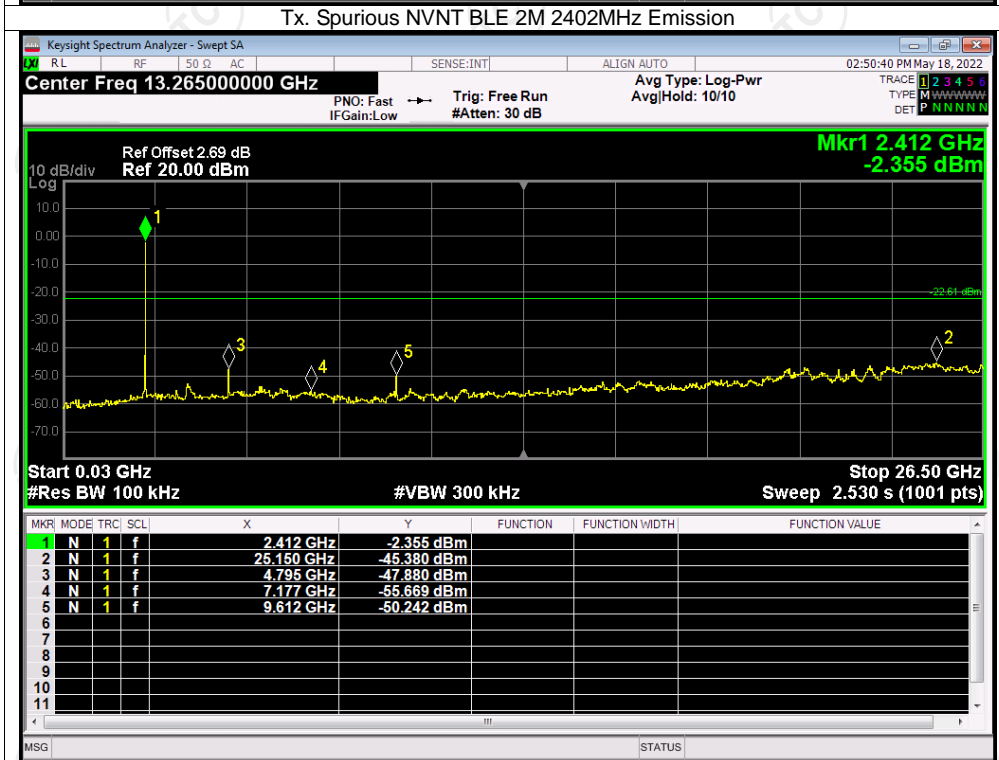
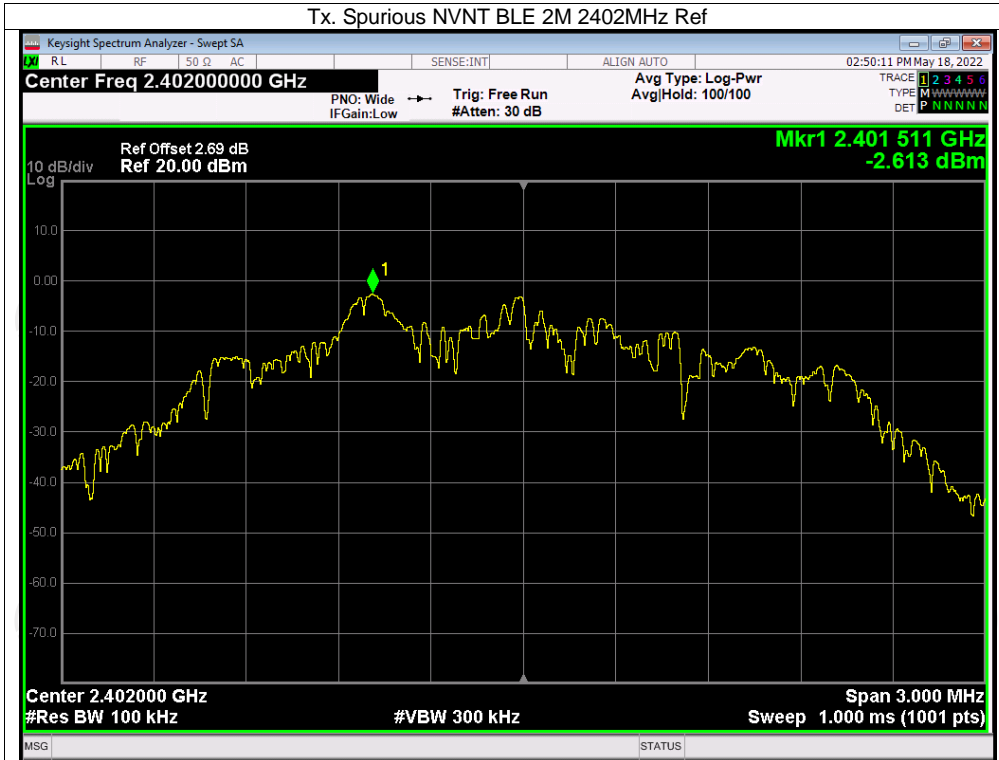

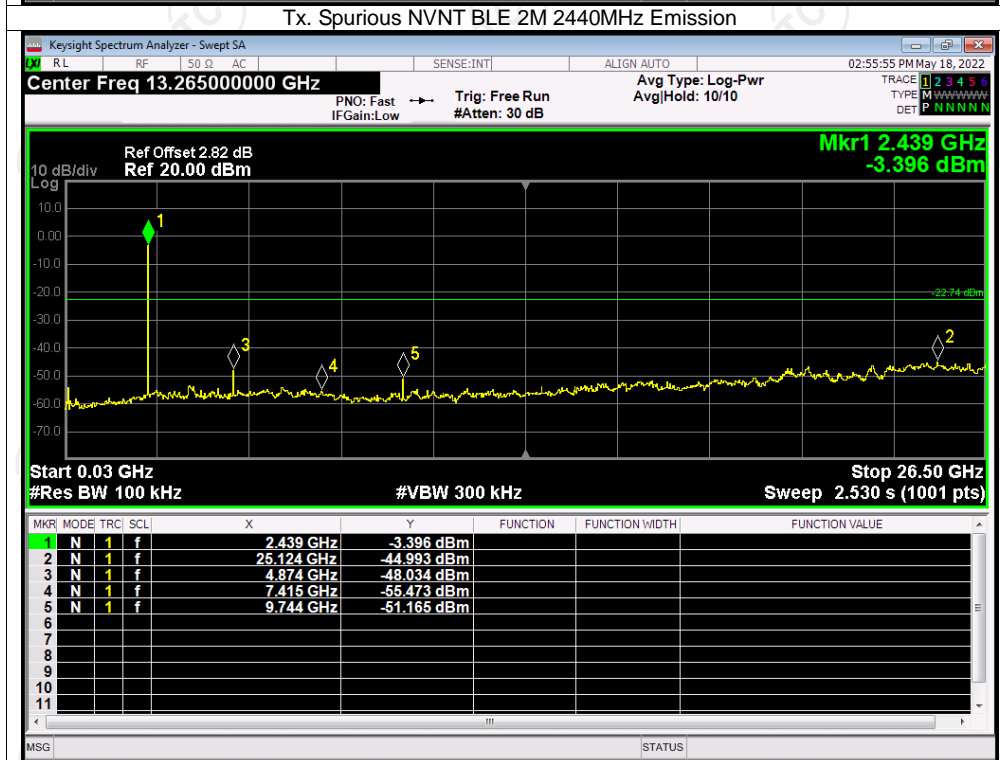
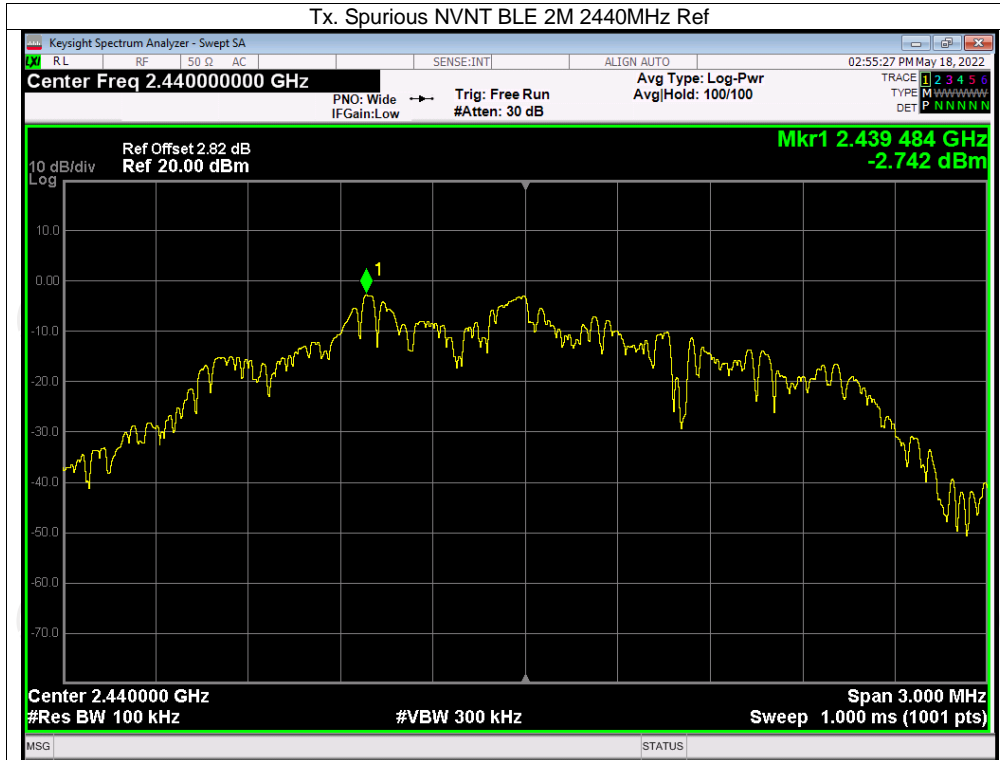

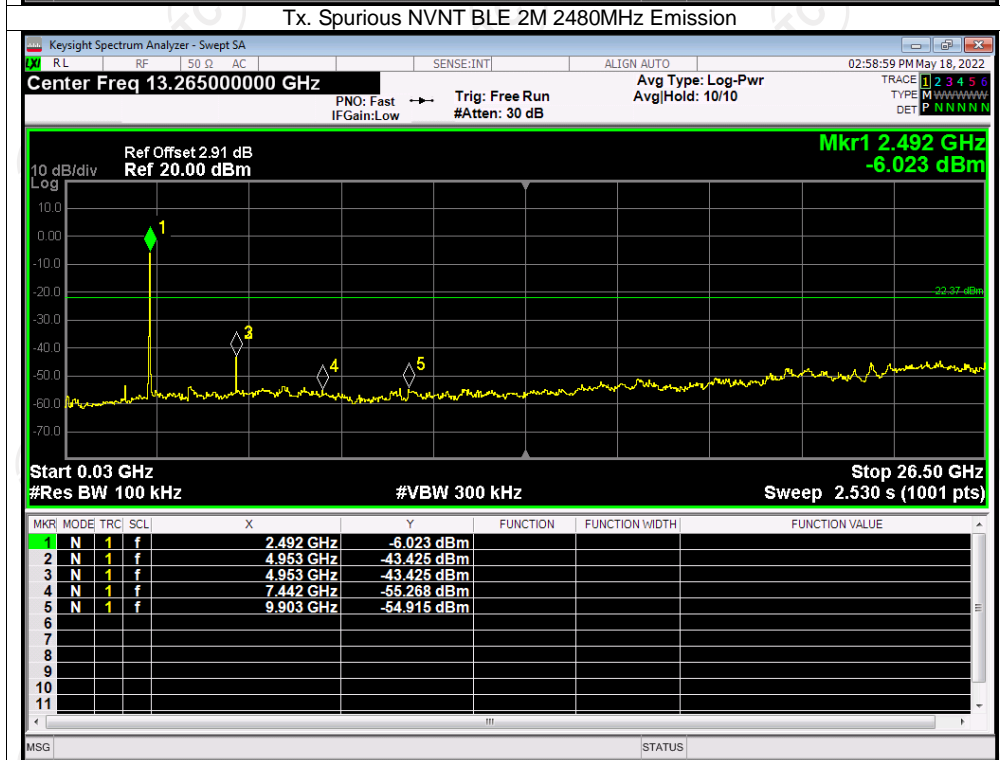
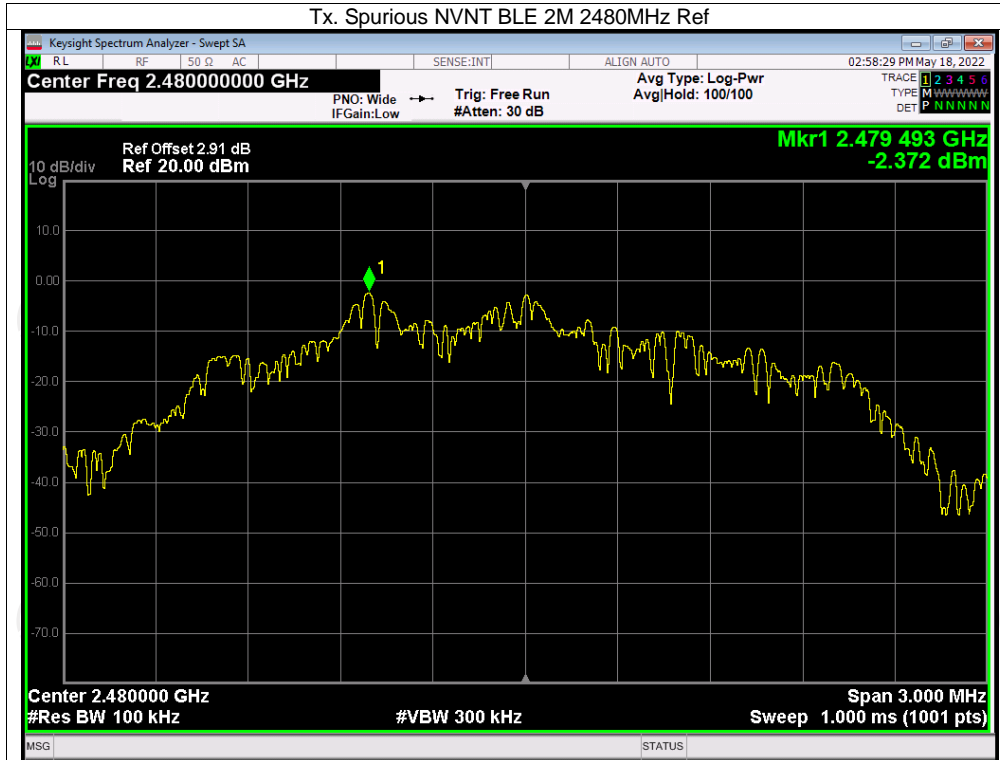

## Appendix B: Photographs of Test Setup

Refer to the test report No. TCT220517E003

## Appendix C: Photographs of EUT

Refer to the test report No. TCT220517E003

**\*\*\*\*\*END OF REPORT\*\*\*\*\***