



# FCC RF Test Report

**APPLICANT** : Gillon UK LLC  
**EQUIPMENT** : HDMI Digital Media Receiver  
**MODEL NAME** : LDC9WZ  
**FCC ID** : 2ALBL-1731  
**STANDARD** : FCC Part 15 Subpart E §15.407  
**CLASSIFICATION** : (NII) Unlicensed National Information Infrastructure

The testing was completed on Jul. 04, 2017. We, SPORTON INTERNATIONAL INC., would like to declare that the tested sample has been evaluated in accordance with the test procedures and has been in compliance with the applicable technical standards.

The test results in this report apply exclusively to the tested model / sample. Without written approval of SPORTON INTERNATIONAL INC., the test report shall not be reproduced except in full.

Reviewed by: Joseph Lin / Supervisor

Approved by: Jones Tsai / Manager



## **SPORTON INTERNATIONAL INC.**

**No. 52, Hwa Ya 1<sup>st</sup> Rd., Hwa Ya Technology Park, Kwei-Shan District, Tao Yuan City, Taiwan, R.O.C.**

SPORTON INTERNATIONAL INC.

TEL : 886-3-327-3456

FAX : 886-3-328-4978

FCC ID : 2ALBL-1731

Page Number : 1 of 32

Report Issued Date : Aug. 21, 2017

Report Version : Rev. 01

Report Template No.: BU5-FR15EWLAC MA Version 2.0



# TABLE OF CONTENTS

**REVISION HISTORY..... 3**

**SUMMARY OF TEST RESULT ..... 4**

**1 GENERAL DESCRIPTION ..... 5**

    1.1 Applicant ..... 5

    1.2 Product Feature of Equipment Under Test..... 5

    1.3 Product Specification of Equipment Under Test..... 6

    1.4 Modification of EUT ..... 7

    1.5 Testing Location ..... 8

    1.6 Applicable Standards..... 8

**2 TEST CONFIGURATION OF EQUIPMENT UNDER TEST ..... 9**

    2.1 Carrier Frequency and Channel ..... 9

    2.2 Test Mode ..... 10

    2.3 Connection Diagram of Test System ..... 12

    2.4 Support Unit used in test configuration and system ..... 13

    2.5 EUT Operation Test Setup ..... 13

    2.6 Measurement Results Explanation Example..... 13

**3 TEST RESULT ..... 14**

    3.1 26dB & 99% Occupied Bandwidth Measurement ..... 14

    3.2 Maximum Conducted Output Power Measurement ..... 16

    3.3 Power Spectral Density Measurement ..... 17

    3.4 Unwanted Emissions Measurement ..... 20

    3.5 AC Conducted Emission Measurement..... 25

    3.6 Frequency Stability Measurement ..... 27

    3.7 Automatically Discontinue Transmission ..... 28

    3.8 Antenna Requirements ..... 30

**4 LIST OF MEASURING EQUIPMENT ..... 31**

**5 UNCERTAINTY OF EVALUATION ..... 32**

**APPENDIX A. CONDUCTED TEST RESULTS**

**APPENDIX B. AC CONDUCTED EMISSION TEST RESULT**

**APPENDIX C. RADIATED SPURIOUS EMISSION**

**APPENDIX D. RADIATED SPURIOUS EMISSION PLOTS**

**APPENDIX E. DUTY CYCLE PLOTS**



### REVISION HISTORY

REPORT NO.	VERSION	DESCRIPTION	ISSUED DATE
FR730732-01D	Rev. 01	Initial issue of report	Aug. 21, 2017



### SUMMARY OF TEST RESULT

Report Section	FCC Rule	Description	Limit	Result
3.1	2.1049 15.403(i)	26dB & 99% Bandwidth	-	Pass
3.2	15.407(a)	Maximum Conducted Output Power	≤ 24 dBm (depend on band)	Pass
3.3	15.407(a)	Power Spectral Density	≤ 11 dBm (depend on band)	Pass
3.4	15.407(b)	Unwanted Emissions	≤ -17, -27 dBm (depend on band)&15.209(a)	Pass
3.5	15.207	AC Conducted Emission	15.207(a)	Pass
3.6	15.407(g)	Frequency Stability	Within Operation Band	Pass
3.7	15.407(c)	Automatically Discontinue Transmission	Discontinue Transmission	Pass
3.8	15.203 & 15.407(a)	Antenna Requirement	N/A	Pass



# 1 General Description

## 1.1 Applicant

Gillon UK LLC

106 E. Sixth Street, Suite 900, Austin, Texas 78701

## 1.2 Product Feature of Equipment Under Test

Product Feature	
Equipment	HDMI Digital Media Receiver
Model Name	LDC9WZ
FCC ID	2ALBL-1731
EUT supports Radios application	WLAN 11b/g/n HT20 WLAN 11a/n HT20/HT40 WLAN 11ac VHT20/VHT40/VHT80 Bluetooth BR/EDR/LE



### 1.3 Product Specification of Equipment Under Test

Standards-related Product Specification	
<b>Tx/Rx Frequency Range</b>	5180 MHz ~ 5240 MHz
<b>Maximum Output Power to Antenna</b>	<p><b>&lt;5180 MHz ~ 5240 MHz&gt;</b></p> <p><b>&lt;Ant. 1&gt;</b>            802.11a : 16.31 dBm / 0.0428 W            802.11n HT20 : 16.27 dBm / 0.0424 W            802.11n HT40 : 15.06 dBm / 0.0321 W            802.11ac VHT20: 16.26 dBm / 0.0423 W            802.11ac VHT40: 15.04 dBm / 0.0319 W            802.11ac VHT80: 6.88 dBm / 0.0049 W</p> <p><b>&lt;Ant. 2&gt;</b>            802.11a : 16.43 dBm / 0.0440 W            802.11n HT20 : 16.23 dBm / 0.0420 W            802.11n HT40 : 16.01 dBm / 0.0399 W            802.11ac VHT20: 16.22 dBm / 0.0419 W            802.11ac VHT40: 16.00 dBm / 0.0398 W            802.11ac VHT80: 11.73 dBm / 0.0149 W</p> <p><b>MIMO &lt;Ant. 1+2&gt;</b>            802.11a : 18.48 dBm / 0.0705 W            802.11n HT20 : 18.40 dBm / 0.0692 W            802.11n HT40 : 18.22 dBm / 0.0664 W            802.11ac VHT20: 18.38 dBm / 0.0689 W            802.11ac VHT40: 18.15 dBm / 0.0653 W            802.11ac VHT80: 10.66 dBm / 0.0116 W</p>
<b>99% Occupied Bandwidth</b>	<p><b>&lt;Ant. 1&gt;</b>            802.11a : 18.50 MHz            802.11n HT20 : 19.05 MHz            802.11n HT40 : 36.90 MHz            802.11ac VHT80 : 75.96 MHz</p> <p><b>&lt;Ant. 1&gt;</b>            802.11a : 18.48 MHz            802.11n HT20 : 19.00 MHz            802.11n HT40 : 36.60 MHz            802.11ac VHT80 : 75.96 MHz</p> <p><b>MIMO &lt;Ant. 1&gt;</b>            802.11a : 18.25 MHz            802.11n HT20 : 18.90 MHz            802.11n HT40 : 36.80 MHz            802.11ac VHT80 : 75.96 MHz</p> <p><b>MIMO &lt;Ant. 2&gt;</b>            802.11a : 18.20 MHz            802.11n HT20 : 18.95 MHz            802.11n HT40 : 36.70 MHz            802.11ac VHT80 : 75.96 MHz</p>



Standards-related Product Specification		
<b>Antenna Type / Gain</b>	<5180 MHz ~ 5240 MHz> <b>Ant. 1</b> : Fixed internal Antenna with gain 4.41 dBi <b>Ant. 2</b> : Fixed internal Antenna with gain 5.80 dBi	
<b>Type of Modulation</b>	802.11a/n : OFDM (BPSK / QPSK / 16QAM / 64QAM) 802.11ac : OFDM (BPSK / QPSK / 16QAM / 64QAM / 256QAM)	
<b>Antenna Function Description</b>		
		Ant. 1      Ant. 2
	802.11 a/n/ac	V      V
802.11 a/n/ac MIMO	V      V	

**Note:** MIMO Ant. 1+2 is a calculated result from sum of the power MIMO Ant. 1 and MIMO Ant. 2.

### 1.4 Modification of EUT

No modifications are made to the EUT during all test items.



### 1.5 Testing Location

Sporton Lab is accredited to ISO 17025 by Taiwan Accreditation Foundation (TAF code : 1190) and the FCC designation No. TW0007 under the FCC 2.948(e) by Mutual Recognition Agreement (MRA) in FCC Test.

<b>Test Site</b>	SPORTON INTERNATIONAL INC.	
<b>Test Site Location</b>	No. 52, Hwa Ya 1 <sup>st</sup> Rd., Hwa Ya Technology Park, Kwei-Shan District, Tao Yuan City, Taiwan, R.O.C. TEL: +886-3-327-3456 FAX: +886-3-328-4978	
<b>Test Site No.</b>	<b>Sporton Site No.</b>	
	TH05-HY	CO05-HY

**Note:** The test site complies with ANSI C63.4 2014 requirement.

<b>Test Site</b>	SPORTON INTERNATIONAL INC.	
<b>Test Site Location</b>	No.58, Aly. 75, Ln. 564, Wenhua 3rd Rd. Guishan Dist, Taoyuan City, Taiwan (R.O.C.) TEL: +886-3-327-0868 FAX: +886-3-327-0855	
<b>Test Site No.</b>	<b>Sporton Site No.</b>	
	03CH12-HY	

**Note:** The test site complies with ANSI C63.4 2014 requirement.

### 1.6 Applicable Standards

According to the specifications of the manufacturer, the EUT must comply with the requirements of the following standards:

- ♦ FCC Part 15 Subpart E
- ♦ FCC KDB 789033 D02 General UNII Test Procedures New Rules v01r04.
- ♦ FCC KDB 662911 D01 Multiple Transmitter Output v02r01.
- ♦ FCC KDB 644545 D03 Guidance for IEEE 802 11ac New Rules v01
- ♦ ANSI C63.10-2013

**Remark:** All test items were verified and recorded according to the standards and without any deviation during the test.





## 2 Test Configuration of Equipment Under Test

- a. The EUT has been associated with peripherals and configuration operated in a manner tended to maximize its emission characteristics in a typical application. Frequency range investigated: conduction emission (150 kHz to 30 MHz), radiation emission (9 kHz to the 10th harmonic of the highest fundamental frequency or to 40 GHz, whichever is lower). For radiated measurement, the pretesting was done for radiated with and without the TV and the worst case was reported, and then pre-scanned in three orthogonal panels, X, Y, Z, and the worst cases (X plane) were recorded in this report.
- b. AC power line Conducted Emission was tested under maximum output power.

### 2.1 Carrier Frequency and Channel

Frequency Band	Channel	Freq. (MHz)	Channel	Freq. (MHz)
5150-5250 MHz Band 1 (U-NII-1)	36	5180	44	5220
	38*	5190	46*	5230
	40	5200	48	5240
	42 <sup>#</sup>	5210		

**Note:**

1. The above Frequency and Channel in "\*" were 802.11n HT40 and 802.11ac VHT40.
2. The above Frequency and Channel in "<sup>#</sup>" were 802.11ac VHT80.



## 2.2 Test Mode

Final test mode of conducted test items and radiated spurious emissions are considering the modulation and worse data rates as below table.

### Single Antenna

Modulation	Data Rate
802.11a	6 Mbps
802.11n HT20	MCS0
802.11n HT40	MCS0
802.11ac VHT20	MCS0
802.11ac VHT40	MCS0
802.11ac VHT80	MCS0

### MIMO Antenna

Modulation	Data Rate
802.11a	6 Mbps
802.11n HT20	MCS0
802.11n HT40	MCS0
802.11ac VHT20	MCS0
802.11ac VHT40	MCS0
802.11ac VHT80	MCS0

Test Cases	
AC Conducted Emission	Mode 1 : WLAN (5GHz) Link + Bluetooth Link + MPEG4 (4K HDR) + USB Cable 1 (Charging from Adapter)



Ch. #		Band I : 5150-5250 MHz	Band I : 5150-5250 MHz	Band I : 5150-5250 MHz
		802.11a	802.11n HT20	802.11n HT40
L	Low	36	36	38
M	Middle	44	44	-
H	High	48	48	46

Ch. #		Band I : 5150-5250 MHz	Band I : 5150-5250 MHz	Band I : 5150-5250 MHz
		802.11ac VHT20	802.11ac VHT40	802.11ac VHT80
L	Low	36	38	-
M	Middle	44	-	42
H	High	48	46	-

## 2.3 Connection Diagram of Test System

<WLAN Tx Mode>

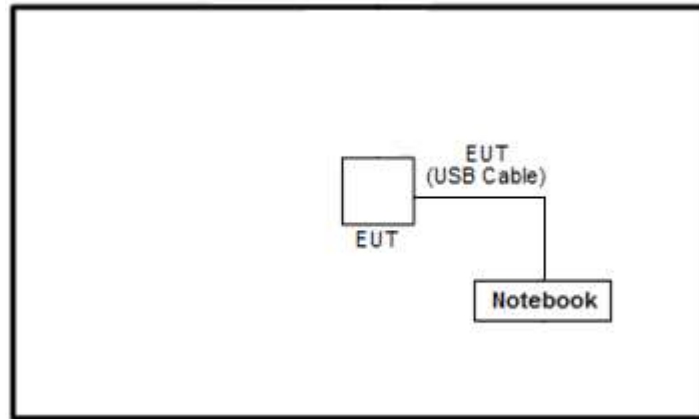

<AC Conducted Emission Mode>

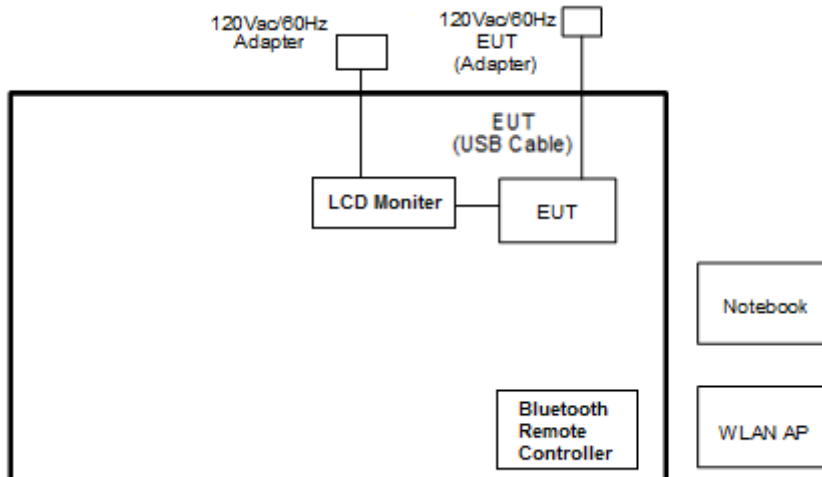



### 2.4 Support Unit used in test configuration and system

Item	Equipment	Trade Name	Model Name	FCC ID	Data Cable	Power Cord
1.	WLAN AP	ASUS	RT-AC66U	MSQ-RTAC66U	N/A	Unshielded, 1.8 m
2.	Notebook-40	Lenovo	E335	N/A	N/A	N/A
3.	Notebook	DELL	Latitude E6320	FCC DoC/ Contains FCC ID: QDS-BRCM1054	N/A	AC I/P: Unshielded, 1.2 m DC O/P: Shielded, 1.8 m
4.	LCD Monitor	Sony	KD-55X8500D	FCC DoC	Shielded, 1.6 m	Unshielded, 1.8 m

### 2.5 EUT Operation Test Setup

The RF test items, programmed RF utility, "CMD" installed in the notebook make the EUT provide functions like channel selection and power level for continuous transmitting and receiving signals.

### 2.6 Measurement Results Explanation Example

For all conducted test items:

The offset level is set in the spectrum analyzer to compensate the RF cable loss and attenuator factor between EUT conducted output port and spectrum analyzer. With the offset compensation, the spectrum analyzer reading level is exactly the EUT RF output level.

Example :

The spectrum analyzer offset is derived from RF cable loss and attenuator factor.

$$\text{Offset} = \text{RF cable loss} + \text{attenuator factor}.$$

Following shows an offset computation example with cable loss 4.2 dB and 10dB attenuator.

$$\begin{aligned} \text{Offset(dB)} &= \text{RF cable loss(dB)} + \text{attenuator factor(dB)}. \\ &= 4.2 + 10 = 14.2 \text{ (dB)} \end{aligned}$$

### 3 Test Result

#### 3.1 26dB & 99% Occupied Bandwidth Measurement

##### 3.1.1 Description of 26dB & 99% Occupied Bandwidth

This section is for reporting purpose only.

There is no restriction limits for bandwidth.

##### 3.1.2 Measuring Instruments

The measuring equipment is listed in the section 4 of this test report.

##### 3.1.3 Test Procedures

1. The testing follows FCC KDB 789033 D02 General UNII Test Procedures New Rules v01r04.  
Section C) Emission bandwidth
2. Set RBW = approximately 1% of the emission bandwidth.
3. Set the VBW > RBW.
4. Detector = Peak.
5. Trace mode = max hold
6. Measure the maximum width of the emission that is 26 dB down from the peak of the emission.  
Compare this with the RBW setting of the analyzer. Readjust RBW and repeat measurement as needed until the RBW/EBW ratio is approximately 1%.
7. For 99% Bandwidth Measurement, the spectrum analyzer's resolution bandwidth (RBW) is set 1MHz and set the Video bandwidth (VBW)  $\geq 3 * RBW$ .
8. Measure and record the results in the test report.

##### 3.1.4 Test Setup

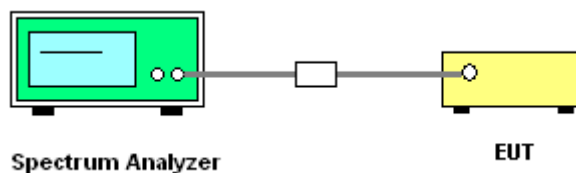



### 3.1.5 Test Result of 26dB & 99% Occupied Bandwidth

Please refer to Appendix A.

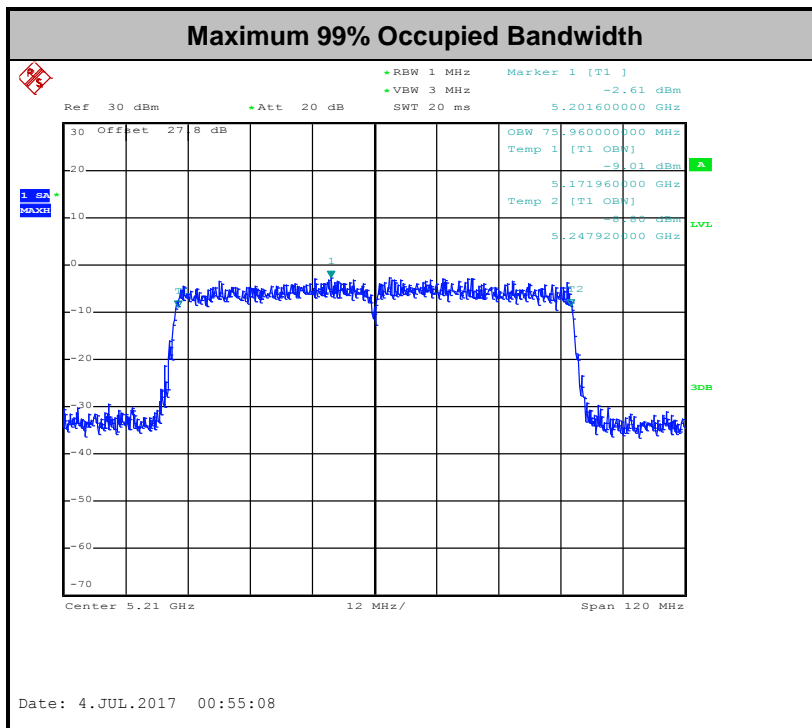
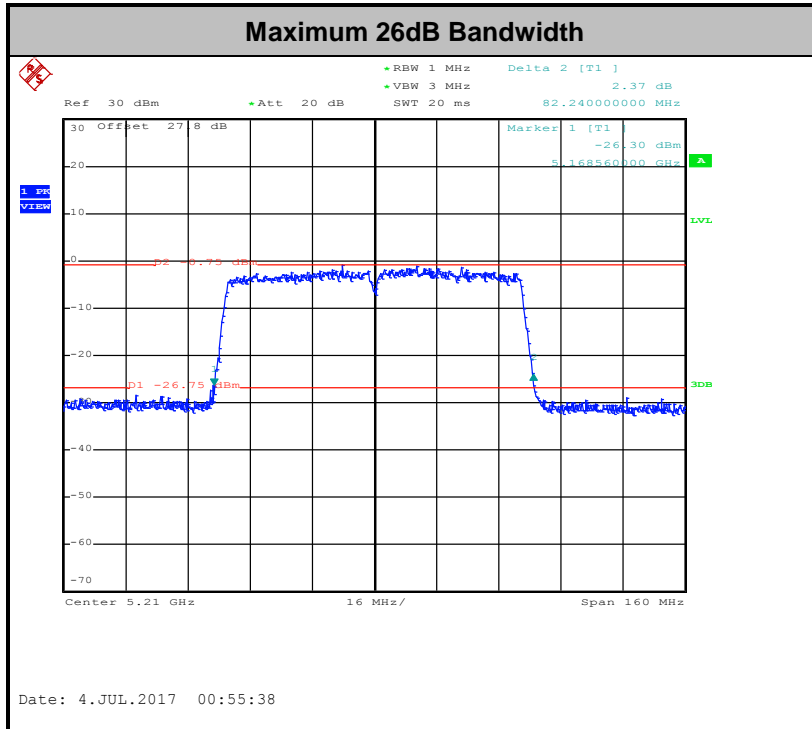

**Note:** The occupied channel bandwidth is maintained within the band of operation for all of the modulations.

## 3.2 Maximum Conducted Output Power Measurement

### 3.2.1 Limit of Maximum Conducted Output Power

For mobile and portable client devices in the 5.15–5.25 GHz band, the maximum conducted output power over the frequency band of operation shall not exceed 250 mW.

If transmitting antennas of directional gain greater than 6 dBi are used, the peak output power shall be reduced by the amount in dB that the directional gain of the antenna exceeds 6 dBi.

### 3.2.2 Measuring Instruments

The measuring equipment is listed in the section 4 of this test report.

### 3.2.3 Test Procedures

#### CDD modes

The testing follows Method PM of FCC KDB 789033 D02 General UNII Test Procedures New Rules v01r04 for CDD modes.

Method PM (Measurement using an RF average power meter):

1. Measurement is performed using a wideband RF power meter.
2. The EUT is configured to transmit continuously with a consistent duty cycle at its maximum power control level.
3. Measure the average power of the transmitter, and the average power is corrected with duty factor,  $10 \log(1/x)$ , where  $x$  is the duty cycle.

### 3.2.4 Test Setup

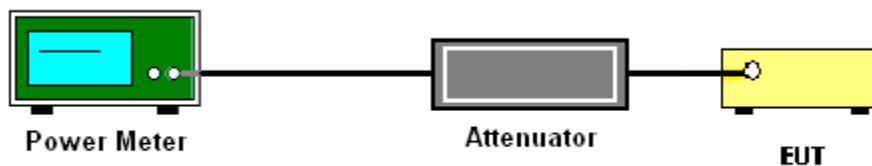

### 3.2.5 Test Result of Maximum Conducted Output Power

Please refer to Appendix A.





### 3.3 Power Spectral Density Measurement

#### 3.3.1 Limit of Power Spectral Density

For mobile and portable client devices in the 5.15–5.25 GHz band, the maximum power spectral density shall not exceed 11dBm in any 1 megahertz band.

If transmitting antennas of directional gain greater than 6 dBi are used, the peak output power shall be reduced by the amount in dB that the directional gain of the antenna exceeds 6 dBi.

#### 3.3.2 Measuring Instruments

The measuring equipment is listed in the section 4 of this test report.

#### 3.3.3 Test Procedures

The testing follows FCC KDB 789033 D02 General UNII Test Procedures New Rules v01r04. Section F) Maximum power spectral density.

##### CDD modes

##### **# Method SA-2 #**

(trace averaging across on and off times of the EUT transmissions, followed by duty cycle correction).

- Measure the duty cycle.
- Set span to encompass the entire emission bandwidth (EBW) of the signal.
- Set RBW = 1 MHz.
- Set VBW  $\geq$  3 MHz.
- Number of points in sweep  $\geq$  2 Span / RBW.
- Sweep time = auto.
- Detector = RMS
- Trace average at least 100 traces in power averaging mode.
- Add  $10 \log(1/x)$ , where x is the duty cycle, to the measured power in order to compute the average power during the actual transmission times. For example, add  $10 \log(1/0.25) = 6$  dB if the duty cycle is 25 percent.

1. The RF output of EUT was connected to the spectrum analyzer by a low loss cable.
2. Each plot has already offset with cable loss, and attenuator loss. Measure the PPSD and record it.
3. For MIMO mode, calculation method follows FCC KDB 662911 D01 Multiple Transmitter Output v02r01.

Method (a): Measure and sum the spectra across the outputs.

The total final Power Spectral Density is from a device with 2 transmitter outputs. The spectrum measurements of the individual outputs are all performed with the same span and number of points, the spectrum value in the first spectral bin of output 1 is summed with that in the first spectral bin of output 2 to obtain the value for the first frequency bin of the summed spectrum.

### 3.3.4 Test Setup

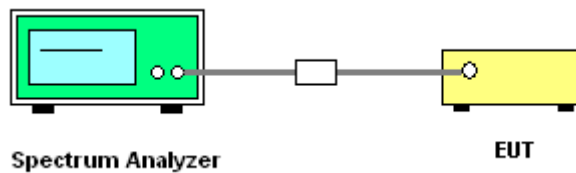



### 3.3.5 Test Result of Power Spectral Density

Please refer to Appendix A.

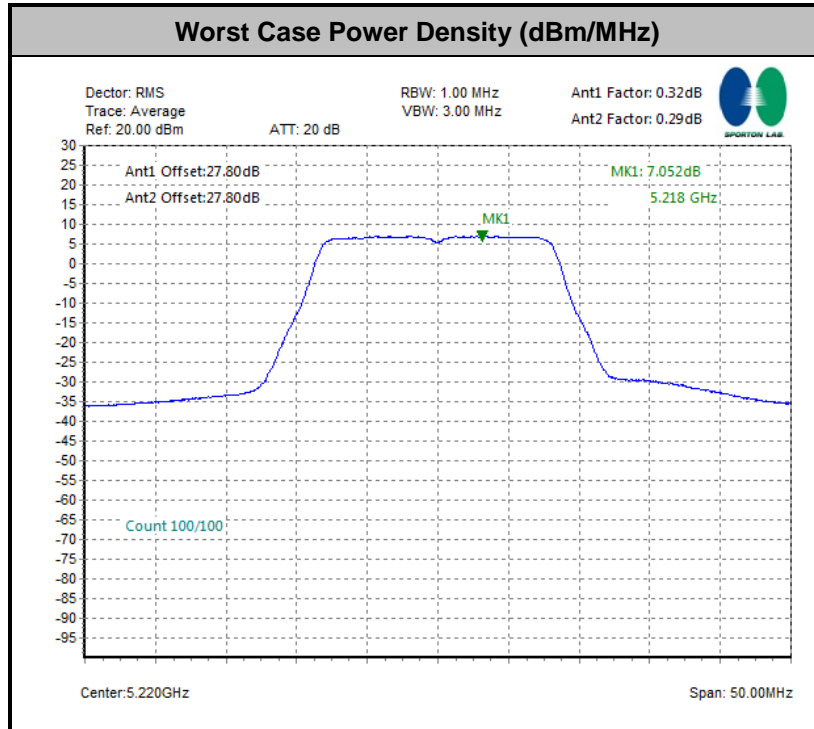

**Note:** Average Power Density (dB) = Measured value + Duty Factor



### 3.4 Unwanted Emissions Measurement

This section is to measure unwanted emissions through radiated measurement for band edge spurious emissions and out of band emissions measurement.

#### 3.4.1 Limit of Unwanted Emissions

- (1) For transmitters operating in the 5150-5250 MHz band: all emissions outside of the 5150-5350 MHz band shall not exceed an EIRP of -27dBm/MHz.
- (2) Unwanted spurious emissions fallen in restricted bands per FCC Part15.205 shall comply with the general field strength limits set forth in § 15.209 as below table,

Frequency (MHz)	Field Strength (microvolts/meter)	Measurement Distance (meters)
0.009 – 0.490	2400/F(kHz)	300
0.490 – 1.705	24000/F(kHz)	30
1.705 – 30.0	30	30
30 – 88	100	3
88 – 216	150	3
216 - 960	200	3
Above 960	500	3

**Note:** The following formula is used to convert the EIRP to field strength.

$$E = \frac{1000000\sqrt{30P}}{3} \text{ } \mu\text{V/m, where P is the eirp (Watts)}$$



EIRP (dBm)	Field Strength at 3m (dBµV/m)
- 27	68.3

(3) KDB789033 D02 v01r04 G)2)c)

- (i) Section 15.407(b)(1-3) specifies the unwanted emissions limit for the U-NII-1 and 2 bands. As specified, emissions above 1000 MHz that are outside of the restricted bands are subject to a peak emission limit of -27 dBm/MHz. However, an out-of-band emission that complies with both the average and peak limits of Section 15.209 is not required to satisfy the -27 dBm/MHz dBm/MHz peak emission limit.
- (ii) Section 15.407(b)(4) specifies the unwanted emissions limit for the U-NII-3 band. A band emissions mask is specified in Section 15.407(b)(4)(i). An alternative to the band emissions mask is specified in Section 15.407(b)(4)(ii). The alternative limits are based on the highest antenna gain specified in the filing. There are also marketing and importation restrictions for the alternative limit.

**Note 3:** An out-of-band emission that complies with both the average and peak limits of Section 15.209 is not required to satisfy the -27 dBm/MHz peak emission limit.

**Note 4:** Only devices with antenna gains of 10 dBi or less may be approved using the emission limits specified in Section 15.247(d) till March 2, 2018; all other devices operating in this band must use the mask specified in Section 15.407(b)(4)(i).

### 3.4.2 Measuring Instruments

The measuring equipment is listed in the section 4 of this test report.



### 3.4.3 Test Procedures

1. The testing follows FCC KDB 789033 D02 General UNII Test Procedures New Rules v01r04. Section G) Unwanted emissions measurement.
  - (1) Procedure for Unwanted Emissions Measurements Below 1000MHz
    - RBW = 120 kHz
    - VBW = 300 kHz
    - Detector = Peak
    - Trace mode = max hold
  - (2) Procedure for Peak Unwanted Emissions Measurements Above 1000 MHz
    - RBW = 1 MHz
    - VBW  $\geq$  3 MHz
    - Detector = Peak
    - Sweep time = auto
    - Trace mode = max hold
  - (3) Procedures for Average Unwanted Emissions Measurements Above 1000MHz
    - RBW = 1 MHz
    - VBW = 10 Hz, when duty cycle is no less than 98 percent.
    - VBW  $\geq$  1/T, when duty cycle is less than 98 percent where T is the minimum transmission duration over which the transmitter is on and is transmitting at its maximum power control level for the tested mode of operation.
2. The EUT was placed on a turntable with 0.8 meter for frequency below 1GHz and 1.5 meter for frequency above 1GHz respectively above ground.
3. The EUT was set 3 meters from the interference receiving antenna which was mounted on the top of a variable height antenna tower.
4. The antenna is a broadband antenna and its height is adjusted between one meter and four meters above ground to find the maximum value of the field strength for both horizontal polarization and vertical polarization of the antenna.
5. For each suspected emission, the EUT was arranged to its worst case and then adjust the antenna tower (from 1 m to 4 m) and turntable (from 0 degree to 360 degrees) to find the maximum reading.
6. For testing below 1GHz, if the emission level of the EUT in peak mode was 3 dB lower than the limit specified, then peak values of EUT will be reported, otherwise, the emissions will be repeated one by one using the CISPR quasi-peak method and reported.
7. For testing above 1GHz, the emission level of the EUT in peak mode was 20dB lower than average limit (that means the emission level in average mode also complies with the limit in average mode), then peak values of EUT will be reported, otherwise, the emissions will be measured in average mode again and reported.

### 3.4.4 Test Setup

For radiated emissions below 30MHz

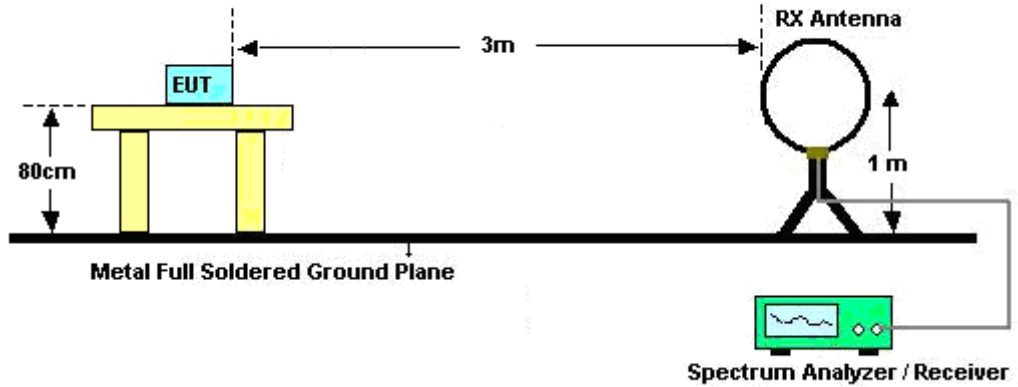

For radiated emissions from 30MHz to 1GHz

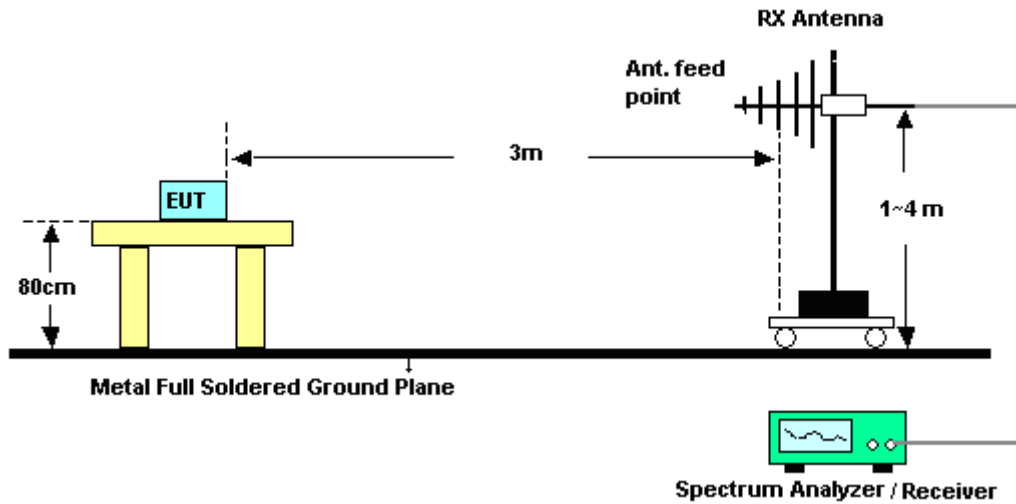

For radiated emissions above 1GHz

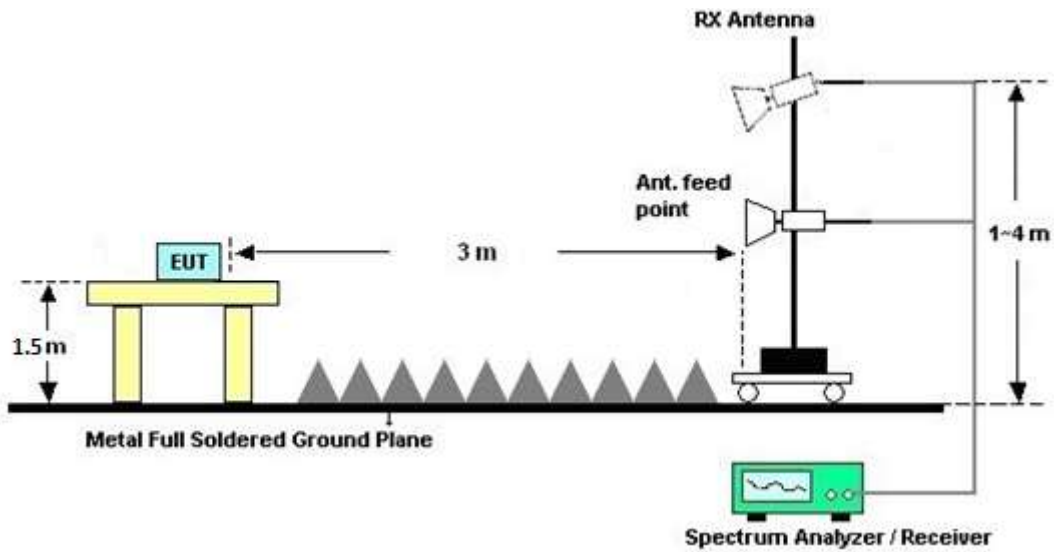

### 3.4.5 Test Results of Radiated Spurious Emissions (9 kHz ~ 30 MHz)

The low frequency, which started from 9 kHz to 30MHz, was pre-scanned and the result which was 20dB lower than the limit line was not reported.

There is a comparison data of both open-field test site and semi-Anechoic chamber, and the result came out very similar.

### 3.4.6 Test Result of Radiated Spurious at Band Edges

Please refer to Appendix C and D.

### 3.4.7 Duty Cycle

Please refer to Appendix E.

### 3.4.8 Test Result of Radiated Spurious Emissions (30MHz ~ 10th Harmonic)

Please refer to Appendix C and D.





### 3.5 AC Conducted Emission Measurement

#### 3.5.1 Limit of AC Conducted Emission

For equipment that is designed to be connected to the public utility (AC) power line, the radio frequency voltage that is conducted back onto the AC power line on any frequency or frequencies within the band 150 kHz to 30 MHz shall not exceed the limits in the following table.

Frequency of emission (MHz)	Conducted limit (dBµV)	
	Quasi-peak	Average
0.15-0.5	66 to 56*	56 to 46*
0.5-5	56	46
5-30	60	50

\*Decreases with the logarithm of the frequency.

#### 3.5.2 Measuring Instruments

The measuring equipment is listed in the section 4 of this test report.

#### 3.5.3 Test Procedures

1. The EUT was placed 0.4 meter from the conducting wall of the shielding room was kept at least 80 centimeters from any other grounded conducting surface.
2. Connect EUT to the power mains through a line impedance stabilization network (LISN).
3. All the support units are connecting to the other LISN.
4. The LISN provides 50 ohm coupling impedance for the measuring instrument.
5. The FCC states that a 50 ohm, 50 microhenry LISN should be used.
6. Both sides of AC line were checked for maximum conducted interference.
7. The frequency range from 150 kHz to 30 MHz was searched.
8. Set the test-receiver system to Peak Detect Function and specified bandwidth with Maximum Hold Mode.

### 3.5.4 Test Setup

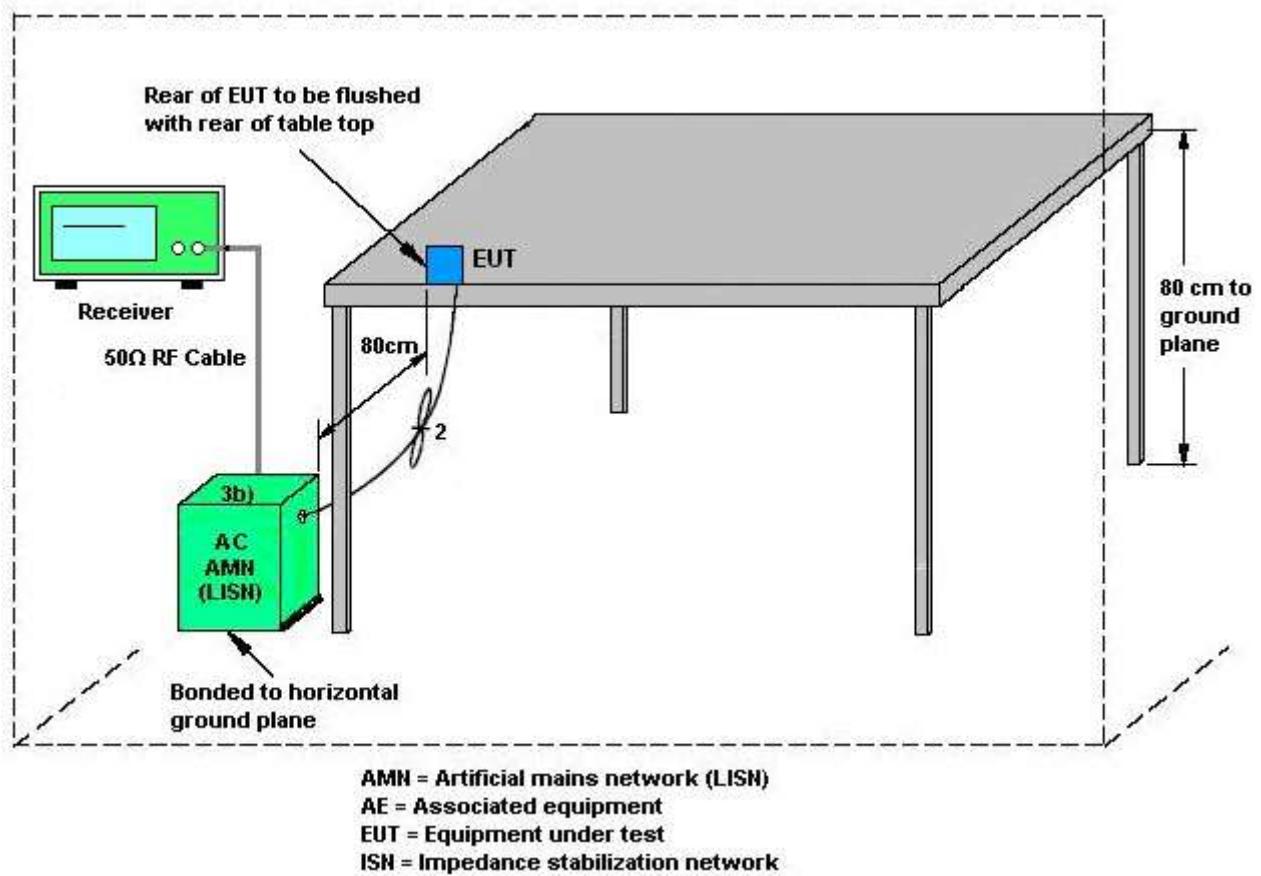

### 3.5.5 Test Result of AC Conducted Emission

Please refer to Appendix B.

## 3.6 Frequency Stability Measurement

### 3.6.1 Limit of Frequency Stability

Manufacturers of U-NII devices are responsible for ensuring frequency stability such that an emission is maintained within the band of operation under all conditions of normal operation as specified in the user's manual.

### 3.6.2 Measuring Instruments

The measuring equipment is listed in the section 4 of this test report.

### 3.6.3 Test Procedures

1. To ensure emission at the band edge is maintained within the authorized band, those values shall be measured by radiation emissions at upper and lower frequency points, and finally compensated by frequency deviation as procedures below.
2. The EUT was operated at the maximum output power, and connected to the spectrum analyzer, which is set to maximum hold function and peak detector. The peak value of the power envelope was measured and noted. The upper and lower frequency points were respectively measured relatively 10dB lower than the measured peak value.
3. The frequency deviation was calculated by adding the upper frequency point and the lower frequency point divided by two. Those detailed values of frequency deviation are provided in table below.

### 3.6.4 Test Setup

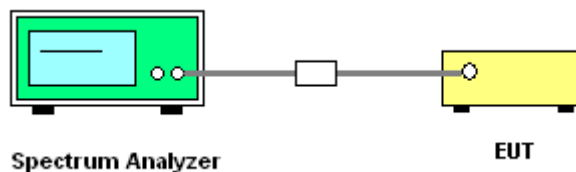

### 3.6.5 Test Result of Frequency Stability

Please refer to Appendix A.

The frequency band 5180-5240MHz which was verified by testing against other standard is less than 20 ppm which is sufficient to maintain the signal within the 5150-5250MHz band.



### **3.7 Automatically Discontinue Transmission**

#### **3.7.1 Limit of Automatically Discontinue Transmission**

The device shall automatically discontinue transmission in case of either absence of information to transmit or operational failure. These provisions are not intended to preclude the transmission of control or signaling information or the use of repetitive codes used by certain digital technologies to complete frame or burst intervals. Applicants shall include in their application for equipment authorization to describe how this requirement is met.

#### **3.7.2 Measuring Instruments**

The measuring equipment is listed in the section 4 of this test report.

#### **3.7.3 Test Result of Automatically Discontinue Transmission**

EUT is verified this characteristic during the function check of normal sample associated with an access point:

- A. Information start: make EUT supply information to the access point.
- B. Information stop: stop supplying information to the access point.

While the EUT is not transmitting any information, the EUT can automatically discontinue transmission and become standby mode for power saving.

- C. Information start: make EUT supply information to the access point again.

The EUT can detect the controlling signal of ACK message transmitting from remote device and verify whether it shall resend or discontinue transmission.



5180MHz

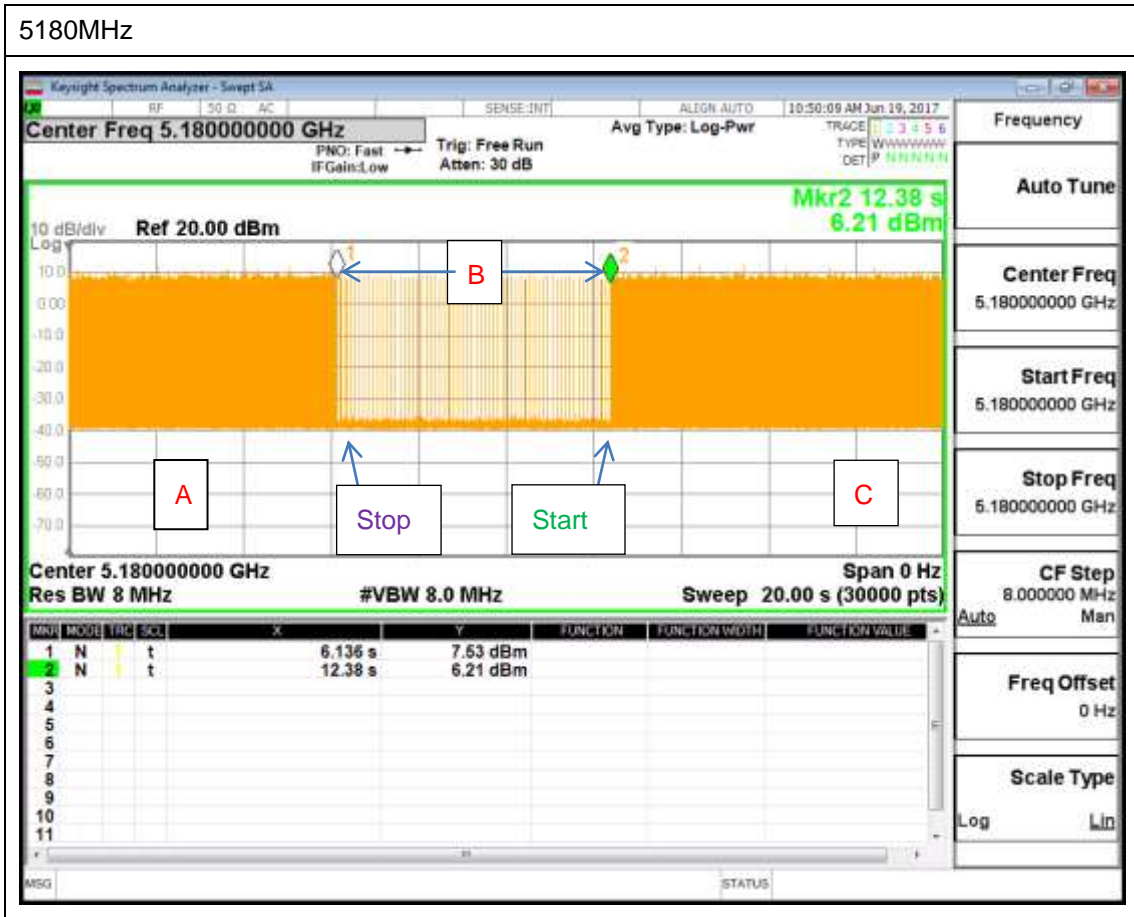

Note : The control / signalling information during the period B is precluded.



### 3.8 Antenna Requirements

#### 3.8.1 Standard Applicable

If transmitting antenna directional gain is greater than 6 dBi, both the peak transmit power and the peak power spectral density shall be reduced by the amount in dB that the directional gain of the antenna exceeds 6 dBi.

#### 3.8.2 Antenna Anti-Replacement Construction

An embedded-in antenna design is used.

#### 3.8.3 Antenna Gain

##### CDD modes

FCC KDB 662911 D01 Multiple Transmitter Output v02r01

For CDD transmissions, directional gain is calculated as

Directional gain =  $G_{ANT} + \text{Array Gain}$ , where Array Gain is as follows.

For power spectral density (PSD) measurements on all devices,

Array Gain =  $10 \log(N_{ANT}/N_{SS}=1)$  dB.

For power measurements on IEEE 802.11 devices,

Array Gain = 0 dB (i.e., no array gain) for  $N_{ANT} \leq 4$ .

Directional gain may be calculated by using the formulas applicable to equal gain antennas with  $G_{ANT}$  set equal to the gain of the antenna having the highest gain;

The EUT supports CDD mode.

For power, the directional gain  $G_{ANT}$  is set equal to the antenna having the highest gain, i.e., F)2)f)i).

For PSD, the directional gain calculation is following F)2)f)ii) of KDB 662911 D01 v02r01.

The power and PSD limit should be modified if the directional gain of EUT is over 6 dBi,

The directional gain "DG" is calculated as following table.

			DG	DG	Power	PSD
			for	for	Limit	Limit
	Ant 1	Ant 2	Power	PSD	Reduction	Reduction
	(dBi)	(dBi)	(dBi)	(dBi)	(dB)	(dB)
Band I	4.41	5.80	5.80	8.14	0.00	2.14

Power limit reduction = Composite gain – 6dBi, ( min = 0 )

PSD limit reduction = Composite gain + PSD Array gain – 6dBi, ( min = 0 )



## 4 List of Measuring Equipment

Instrument	Manufacturer	Model No.	Serial No.	Characteristics	Calibration Date	Test Date	Due Date	Remark
Power Meter	Anritsu	ML2495A	0932001	300MHz~40GHz	Sep. 29, 2016	Jun. 13, 2017 ~ Jul. 04, 2017	Sep. 28, 2017	Conducted (TH05-HY)
Power Sensor	Anritsu	MA2411B	0846202	300MHz~40GHz	Sep. 29, 2016	Jun. 13, 2017 ~ Jul. 04, 2017	Sep. 28, 2017	Conducted (TH05-HY)
Spectrum Analyzer	Rohde & Schwarz	FSP40	100057	9kHz-40GHz	Nov. 25, 2016	Jun. 13, 2017 ~ Jul. 04, 2017	Nov. 24, 2017	Conducted (TH05-HY)
Temperature Chamber	ESPEC	SH-641	92013720	-40°C ~90°C	Sep. 01, 2016	Jun. 13, 2017 ~ Jul. 04, 2017	Aug. 31, 2017	Conducted (TH05-HY)
Programmable Power Supply	GW Instek	PSS-2005	EL890094	1V~20V 0.5A~5A	Oct. 11, 2016	Jun. 13, 2017 ~ Jul. 04, 2017	Oct. 10, 2017	Conducted (TH05-HY)
AC Power Source	AC POWER	AFC-500W	F104070011	50Hz~60Hz	Dec. 01, 2016	Jun. 13, 2017 ~ Jul. 04, 2017	Nov. 30, 2017	Conducted (TH05-HY)
AC Power Source	ChainTek	APC-1000W	N/A	N/A	N/A	Jun. 07, 2017	N/A	Conduction (CO05-HY)
EMI Test Receiver	Rohde & Schwarz	ESCI 7	100724	9kHz~7GHz	Aug. 30, 2016	Jun. 07, 2017	Aug. 29, 2017	Conduction (CO05-HY)
LISN	Rohde & Schwarz	ENV216	100080	9kHz~30MHz	Nov. 29, 2016	Jun. 07, 2017	Nov. 28, 2017	Conduction (CO05-HY)
LISN	Rohde & Schwarz	ENV216	100081	9kHz~30MHz	Dec. 06, 2016	Jun. 07, 2017	Dec. 05, 2017	Conduction (CO05-HY)
EMI Test Receiver	Rohde & Schwarz	ESU26	100390	20Hz~26.5GHz	Dec. 23, 2016	Jun. 14, 2017 ~ Jul. 02, 2017	Dec. 22, 2017	Radiation (03CH12-HY)
Spectrum Analyzer	Agilent	N9030A	MY52350276	3Hz~44GHz	Mar. 23, 2017	Jun. 14, 2017 ~ Jul. 02, 2017	Mar. 22, 2018	Radiation (03CH12-HY)
Loop Antenna	Rohde & Schwarz	HFH2-Z2	100488	9 kHz~30 MHz	Oct. 20, 2016	Jun. 14, 2017 ~ Jul. 02, 2017	Oct. 19, 2018	Radiation (03CH12-HY)
Bilog Antenna	TESEQ	CBL 6111D&00800 N1D01N-06	37059&01	30MHz~1GHz	Oct. 15, 2016	Jun. 14, 2017 ~ Jul. 02, 2017	Oct. 14, 2017	Radiation (03CH12-HY)
Horn Antenna	SCHWARZBECK	BBHA 9120D	9120D-1328	1GHz ~ 18GHz	Oct. 25, 2016	Jun. 14, 2017 ~ Jul. 02, 2017	Oct. 24, 2017	Radiation (03CH12-HY)
SHF-EHF Horn Antenna	SCHWARZBECK	BBHA 9170	BBHA917057 6	18GHz ~ 40GHz	Apr. 27, 2017	Jun. 14, 2017 ~ Jul. 02, 2017	Apr. 26, 2018	Radiation (03CH12-HY)
Preamplifier	COM-POWER	PA-103	161075	10MHz~1GHz	Mar. 23, 2017	Jun. 14, 2017 ~ Jul. 02, 2017	Mar. 22, 2018	Radiation (03CH12-HY)
Preamplifier	Keysight	83017A	MY53270148	1GHz~26.5GHz	Jan. 12, 2017	Jun. 14, 2017 ~ Jul. 02, 2017	Jan. 11, 2018	Radiation (03CH12-HY)
Preamplifier	MITEQ	AMF-7D-0010 1800-30-10P	1815698	1GHz~18GHz	Dec. 01, 2016	Jun. 14, 2017 ~ Jul. 02, 2017	Nov. 30, 2017	Radiation (03CH12-HY)
Amplifier	MITEQ	TTA1840-35-H G	1871923	18GHz~40GHz	Jul. 16, 2016	Jun. 14, 2017 ~ Jul. 02, 2017	Jul. 15, 2017	Radiation (03CH12-HY)
Antenna Mast	EMEC	AM-BS-4500-B	N/A	1m~4m	N/A	Jun. 14, 2017 ~ Jul. 02, 2017	N/A	Radiation (03CH12-HY)
Turn Table	EMEC	TT2000	N/A	0~360 Degree	N/A	Jun. 14, 2017 ~ Jul. 02, 2017	N/A	Radiation (03CH12-HY)



## 5 Uncertainty of Evaluation

### Uncertainty of Conducted Emission Measurement (150kHz ~ 30MHz)

Measuring Uncertainty for a Level of Confidence of 95% ( $U = 2Uc(y)$ )	2.70
---	------

### Uncertainty of Radiated Emission Measurement (30 MHz ~ 1000 MHz)

Measuring Uncertainty for a Level of Confidence of 95% ( $U = 2Uc(y)$ )	5.10
---	------

### Uncertainty of Radiated Emission Measurement (1000 MHz ~ 18000 MHz)

Measuring Uncertainty for a Level of Confidence of 95% ( $U = 2Uc(y)$ )	5.20
---	------

### Uncertainty of Radiated Emission Measurement (18000 MHz ~ 40000 MHz)

Measuring Uncertainty for a Level of Confidence of 95% ( $U = 2Uc(y)$ )	4.70
---	------



**Appendix A. Test Result of Conducted Test Items**

Test Engineer:	Aking Chang / Tommy Lee	Temperature:	21~25	°C
Test Date:	2017/06/13~2017/07/04	Relative Humidity:	51~54	%

**TEST RESULTS DATA**  
**26dB and 99% OBW**

Band I													
Mod.	Data Rate	NTX	CH.	Freq. (MHz)	99% Bandwidth (MHz)		26 dB Bandwidth (MHz)		IC 99% Bandwidth Power Limit (dBm)		IC 99% Bandwidth EIRP Limit (dBm)		Note
					Ant 1	Ant 2	Ant 1	Ant 2	Ant 1	Ant 2	Ant 1	Ant 2	
11a	6Mbps	1	36	5180	18.50	18.45	22.90	22.90	-	-	22.67	22.66	
11a	6Mbps	1	44	5220	18.35	18.20	22.80	23.00	-	-	22.64	22.60	
11a	6Mbps	1	48	5240	18.35	18.30	22.90	22.90	-	-	22.64	22.62	
HT20	MCS0	1	36	5180	19.05	18.85	23.50	23.30	-	-	22.80	22.75	
HT20	MCS0	1	44	5220	19.00	18.90	23.20	23.00	-	-	22.79	22.76	
HT20	MCS0	1	48	5240	18.85	19.00	23.10	23.40	-	-	22.75	22.79	
HT40	MCS0	1	38	5190	36.90	36.60	41.40	41.04	-	-	23.01	23.01	
HT40	MCS0	1	46	5230	36.70	36.60	41.40	41.76	-	-	23.01	23.01	
VHT80	MCS0	1	42	5210	75.96	75.96	81.92	81.60	-	-	23.01	23.01	
11a	6Mbps	2	36	5180	18.20	18.20	22.90	22.90	-	-	22.60		
11a	6Mbps	2	44	5220	18.25	18.15	23.00	22.90	-	-	22.59		
11a	6Mbps	2	48	5240	18.20	18.00	22.90	22.90	-	-	22.55		
HT20	MCS0	2	36	5180	18.85	18.75	23.30	23.20	-	-	22.73		
HT20	MCS0	2	44	5220	18.90	18.80	23.10	23.10	-	-	22.74		
HT20	MCS0	2	48	5240	18.85	18.95	23.20	23.20	-	-	22.75		
HT40	MCS0	2	38	5190	36.80	36.60	41.58	41.22	-	-	23.01		
HT40	MCS0	2	46	5230	36.70	36.70	41.58	41.22	-	-	23.01		
VHT80	MCS0	2	42	5210	75.96	75.96	82.24	81.92	-	-	23.01		

**TEST RESULTS DATA**  
**Average Power Table**

FCC Band I														
Mod.	Data Rate	NTX	CH.	Freq. (MHz)	Duty Factor (dB)		Average Conducted Power (dBm)			FCC Conducted Power Limit (dBm)		DG (dBi)		Pass/Fail
					Ant 1	Ant 2	Ant 1	Ant 2	SUM	Ant 1	Ant 2	Ant 1	Ant 2	
11a	6Mbps	1	36	5180	0.29	0.29	15.00	16.38		24.00	24.00	4.41	5.80	Pass
11a	6Mbps	1	44	5220	0.29	0.29	16.29	16.43		24.00	24.00	4.41	5.80	Pass
11a	6Mbps	1	48	5240	0.29	0.29	16.31	16.24		24.00	24.00	4.41	5.80	Pass
HT20	MCS0	1	36	5180	0.35	0.31	14.54	15.61		24.00	24.00	4.41	5.80	Pass
HT20	MCS0	1	44	5220	0.35	0.31	16.27	16.23		24.00	24.00	4.41	5.80	Pass
HT20	MCS0	1	48	5240	0.35	0.31	16.23	16.21		24.00	24.00	4.41	5.80	Pass
HT40	MCS0	1	38	5190	0.62	0.62	7.25	11.97		24.00	24.00	4.41	5.80	Pass
HT40	MCS0	1	46	5230	0.62	0.62	15.06	16.01		24.00	24.00	4.41	5.80	Pass
VHT20	MCS0	1	36	5180	0.34	0.34	14.53	15.54		24.00	24.00	4.41	5.80	Pass
VHT20	MCS0	1	44	5220	0.34	0.34	16.26	16.22		24.00	24.00	4.41	5.80	Pass
VHT20	MCS0	1	48	5240	0.34	0.34	16.22	16.19		24.00	24.00	4.41	5.80	Pass
VHT40	MCS0	1	38	5190	0.60	0.66	7.23	11.94		24.00	24.00	4.41	5.80	Pass
VHT40	MCS0	1	46	5230	0.60	0.66	15.04	16.00		24.00	24.00	4.41	5.80	Pass
VHT80	MCS0	1	42	5210	1.18	1.20	6.88	11.73		24.00	24.00	4.41	5.80	Pass
11a	6Mbps	2	36	5180	0.32	0.29	13.55	15.09	17.40	24.00		5.80		Pass
11a	6Mbps	2	44	5220	0.32	0.29	14.42	16.31	18.48	24.00		5.80		Pass
11a	6Mbps	2	48	5240	0.32	0.29	14.32	16.16	18.35	24.00		5.80		Pass
HT20	MCS0	2	36	5180	0.34	0.34	13.60	15.13	17.44	24.00		5.80		Pass
HT20	MCS0	2	44	5220	0.34	0.34	14.27	16.27	18.40	24.00		5.80		Pass
HT20	MCS0	2	48	5240	0.34	0.34	14.13	16.10	18.24	24.00		5.80		Pass
HT40	MCS0	2	38	5190	0.67	0.67	7.25	8.92	11.17	24.00		5.80		Pass
HT40	MCS0	2	46	5230	0.67	0.67	14.30	15.96	18.22	24.00		5.80		Pass
VHT20	MCS0	2	36	5180	0.34	0.34	13.57	15.09	17.41	24.00		5.80		Pass
VHT20	MCS0	2	44	5220	0.34	0.34	14.24	16.26	18.38	24.00		5.80		Pass
VHT20	MCS0	2	48	5240	0.34	0.34	14.09	16.09	18.22	24.00		5.80		Pass
VHT40	MCS0	2	38	5190	0.60	0.60	7.18	8.85	11.11	24.00		5.80		Pass
VHT40	MCS0	2	46	5230	0.60	0.60	14.23	15.89	18.15	24.00		5.80		Pass
VHT80	MCS0	2	42	5210	1.20	1.20	6.90	8.30	10.66	24.00		5.80		Pass

**TEST RESULTS DATA**  
**Power Spectral Density**

FCC Band I														
Mod.	Data Rate	NTX	CH.	Freq. (MHz)	Duty Factor (dB)		Average Power Density (dBm/MHz)			Average PSD Limit (dBm/MHz)		DG (dBi)		Pass /Fail
					Ant 1	Ant 2	Ant 1	Ant 2	SUM	Ant 1	Ant 2	Ant 1	Ant 2	
11a	6Mbps	1	36	5180	0.29	0.29	3.39	4.40		11.00	11.00	4.41	5.80	Pass
11a	6Mbps	1	44	5220	0.29	0.29	4.58	4.20		11.00	11.00	4.41	5.80	Pass
11a	6Mbps	1	48	5240	0.29	0.29	4.36	4.13		11.00	11.00	4.41	5.80	Pass
HT20	MCS0	1	36	5180	0.35	0.31	3.50	4.61		11.00	11.00	4.41	5.80	Pass
HT20	MCS0	1	44	5220	0.35	0.31	5.09	4.76		11.00	11.00	4.41	5.80	Pass
HT20	MCS0	1	48	5240	0.35	0.31	4.98	4.46		11.00	11.00	4.41	5.80	Pass
HT40	MCS0	1	38	5190	0.62	0.62	-6.70	-2.10		11.00	11.00	4.41	5.80	Pass
HT40	MCS0	1	46	5230	0.62	0.62	1.02	1.68		11.00	11.00	4.41	5.80	Pass
VHT80	MCS0	1	42	5210	1.18	1.20	-9.88	-5.02		11.00	11.00	4.41	5.80	Pass
11a	6Mbps	2	36	5180	0.32	0.29			5.78	8.86	8.14			Pass
11a	6Mbps	2	44	5220	0.32	0.29			7.05	8.86	8.14			Pass
11a	6Mbps	2	48	5240	0.32	0.29			6.31	8.86	8.14			Pass
HT20	MCS0	2	36	5180	0.34	0.34			6.27	8.86	8.14			Pass
HT20	MCS0	2	44	5220	0.34	0.34			6.89	8.86	8.14			Pass
HT20	MCS0	2	48	5240	0.34	0.34			6.71	8.86	8.14			Pass
HT40	MCS0	2	38	5190	0.67	0.67			-3.07	8.86	8.14			Pass
HT40	MCS0	2	46	5230	0.67	0.67			3.72	8.86	8.14			Pass
VHT80	MCS0	2	42	5210	1.20	1.20			-6.40	8.86	8.14			Pass

**TEST RESULTS DATA**  
**Frequency Stability**

Band I										
Mod.	Data Rate	NTX	CH.	Freq. (MHz)	Center Frequency (MHz)	Frequency Deviation (MHz)	Frequency Stability (ppm)	Temperature (°C)	Voltage (V)	Note
11a	6Mbps	1	36	5180	5180.000	0.000	0.00	35	5	
11a	6Mbps	1	36	5180	5180.050	0.050	9.65	0	5	
11a	6Mbps	1	36	5180	5179.950	-0.050	-9.65	20	5.2	
11a	6Mbps	1	36	5180	5179.950	-0.050	-9.65	20	4.5	
11a	6Mbps	1	36	5180	5180.000	0.000	0.00	20	5	



## Appendix B. AC Conducted Emission Test Results

Test Engineer :	Marlowe Ho	Temperature :	23~25°C
		Relative Humidity :	50~53%

## EUT Information

Report NO : 730732-01  
 Test Mode : Mode 1  
 Test Voltage : 120Vac/60Hz  
 Phase : Line

ENV216 Auto Test FCC Power Bar - L

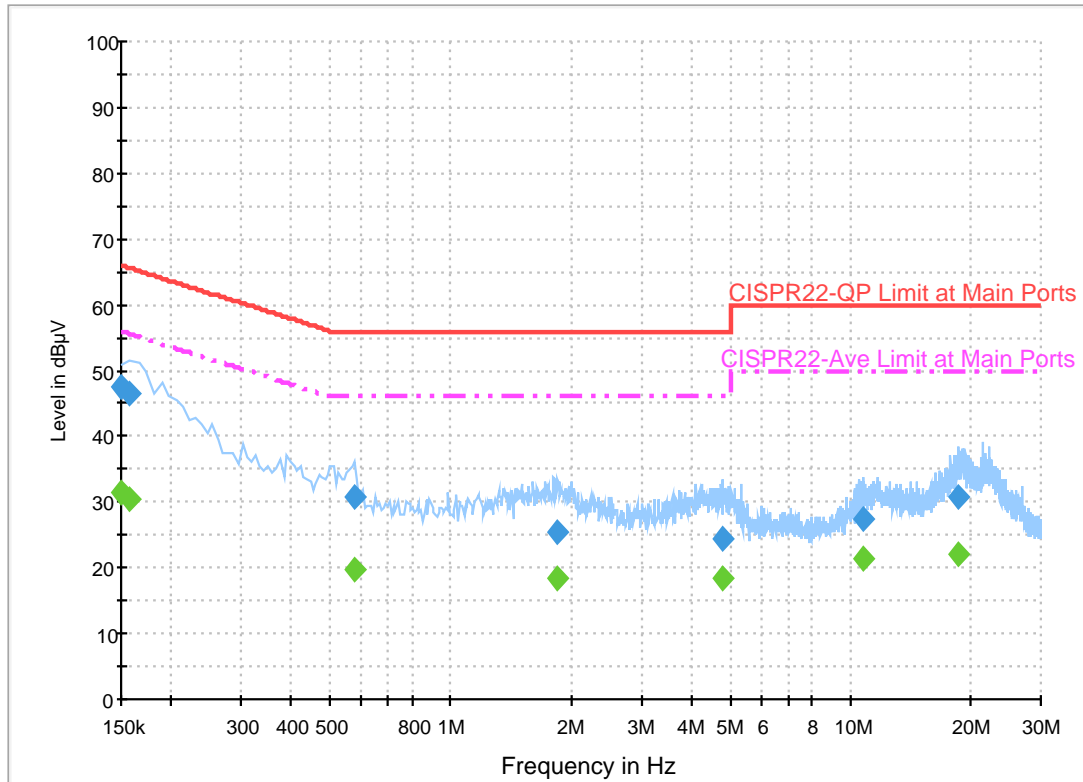

### Final Result 1

Frequency (MHz)	QuasiPeak (dBµV)	Filter	Line	Corr. (dB)	Margin (dB)	Limit (dBµV)
0.150000	47.5	Off	L1	19.6	18.5	66.0
0.158000	46.6	Off	L1	19.6	19.0	65.6
0.574000	30.6	Off	L1	19.6	25.4	56.0
1.854000	25.3	Off	L1	19.6	30.7	56.0
4.790000	24.6	Off	L1	19.8	31.4	56.0
10.750000	27.4	Off	L1	20.1	32.6	60.0
18.702000	30.6	Off	L1	20.5	29.4	60.0

### Final Result 2

Frequency (MHz)	Average (dBµV)	Filter	Line	Corr. (dB)	Margin (dB)	Limit (dBµV)
0.150000	31.3	Off	L1	19.6	24.7	56.0
0.158000	30.3	Off	L1	19.6	25.3	55.6
0.574000	19.6	Off	L1	19.6	26.4	46.0
1.854000	18.5	Off	L1	19.6	27.5	46.0
4.790000	18.4	Off	L1	19.8	27.6	46.0
10.750000	21.3	Off	L1	20.1	28.7	50.0
18.702000	22.2	Off	L1	20.5	27.8	50.0

# EUT Information

Report NO : 730732-01  
 Test Mode : Mode 1  
 Test Voltage : 120Vac/60Hz  
 Phase : Neutral

ENV216 Auto Test FCC Power Bar - N

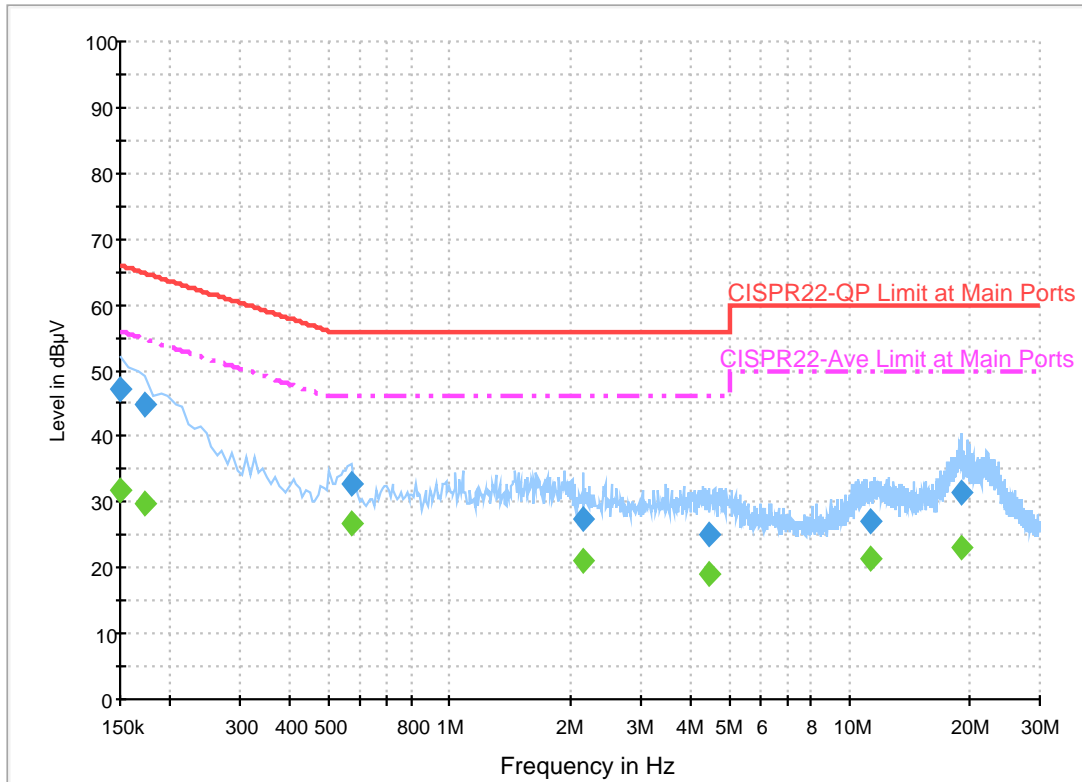

## Final Result 1

Frequency (MHz)	QuasiPeak (dBµV)	Filter	Line	Corr. (dB)	Margin (dB)	Limit (dBµV)
0.150000	47.1	Off	N	19.5	18.9	66.0
0.174000	44.8	Off	N	19.5	20.0	64.8
0.566000	32.7	Off	N	19.5	23.3	56.0
2.158000	27.4	Off	N	18.4	28.6	56.0
4.470000	24.9	Off	N	19.7	31.1	56.0
11.310000	26.9	Off	N	20.1	33.1	60.0
18.982000	31.3	Off	N	20.6	28.7	60.0

## Final Result 2

Frequency (MHz)	Average (dBµV)	Filter	Line	Corr. (dB)	Margin (dB)	Limit (dBµV)
0.150000	31.7	Off	N	19.5	24.3	56.0
0.174000	29.9	Off	N	19.5	24.9	54.8
0.566000	26.8	Off	N	19.5	19.2	46.0
2.158000	21.0	Off	N	18.4	25.0	46.0
4.470000	19.1	Off	N	19.7	26.9	46.0
11.310000	21.5	Off	N	20.1	28.5	50.0
18.982000	23.1	Off	N	20.6	26.9	50.0





## Appendix C. Radiated Spurious Emission

Test Engineer :	Peter Liao and Nick Yu	Temperature :	22~26°C
		Relative Humidity :	56~62%

**Band 1 - 5150~5250MHz**  
**WIFI 802.11a (Band Edge @ 3m)**

WIFI	Note	Frequency	Level	Over	Limit	Read	Antenna	Cable	Preamp	Ant	Table	Peak	Pol.
Ant.				Limit	Line	Level	Factor	Loss	Factor	Pos	Pos	Avg.	
1		( MHz )	( dBμV/m )	( dB )	( dBμV/m )	(dBμV)	( dB/m )	( dB )	( dB )	( cm )	( deg )	(P/A)	(H/V)
802.11a CH 36 5180MHz		5148.2	61.27	-12.73	74	53.76	32.47	5.99	30.95	111	360	P	H
		5150	50.76	-3.24	54	43.25	32.47	5.99	30.95	111	360	A	H
	*	5180	114.18	-	-	106.65	32.46	6.02	30.95	111	360	P	H
	*	5180	103.35	-	-	95.82	32.46	6.02	30.95	111	360	A	H
		5148.72	56.58	-17.42	74	49.07	32.47	5.99	30.95	391	256	P	V
		5149.76	45.98	-8.02	54	38.47	32.47	5.99	30.95	391	256	A	V
	*	5180	110.63	-	-	103.1	32.46	6.02	30.95	391	256	P	V
	*	5180	99.77	-	-	92.24	32.46	6.02	30.95	391	256	A	V
802.11a CH 44 5220MHz		5150	55.52	-18.48	74	48.01	32.47	5.99	30.95	100	360	P	H
		5150	43.97	-10.03	54	36.46	32.47	5.99	30.95	100	360	A	H
	*	5220	115.48	-	-	107.93	32.46	6.04	30.95	100	360	P	H
	*	5220	104.62	-	-	97.07	32.46	6.04	30.95	100	360	A	H
		5438.72	57.49	-16.51	74	49.84	32.41	6.19	30.95	100	360	P	H
		5444.32	48.44	-5.56	54	40.79	32.41	6.19	30.95	100	360	A	H
		5146.64	50.39	-23.61	74	42.88	32.47	5.99	30.95	363	253	P	V
		5150	39.75	-14.25	54	32.24	32.47	5.99	30.95	363	253	A	V
	*	5220	111.78	-	-	104.23	32.46	6.04	30.95	363	253	P	V
	*	5220	100.91	-	-	93.36	32.46	6.04	30.95	363	253	A	V
		5445.16	51.75	-22.25	74	44.1	32.41	6.19	30.95	363	253	P	V
		5443.48	42.28	-11.72	54	34.63	32.41	6.19	30.95	363	253	A	V



<b>802.11a</b> <b>CH 48</b> <b>5240MHz</b>		5137.02	52.52	-21.48	74	45.02	32.47	5.98	30.95	101	0	P	H
		5149.24	41.15	-12.85	54	33.64	32.47	5.99	30.95	101	0	A	H
	*	5240	115.38	-	-	107.83	32.45	6.05	30.95	101	0	P	H
	*	5240	104.45	-	-	96.9	32.45	6.05	30.95	101	0	A	H
		5455.8	56.36	-17.64	74	48.69	32.41	6.21	30.95	101	0	P	H
		5457.76	47.35	-6.65	54	39.68	32.41	6.21	30.95	101	0	A	H
		5138.32	50	-24	74	42.5	32.47	5.98	30.95	400	256	P	V
		5138.06	39.4	-14.6	54	31.9	32.47	5.98	30.95	400	256	A	V
	*	5240	110.92	-	-	103.37	32.45	6.05	30.95	400	256	P	V
	*	5240	99.96	-	-	92.41	32.45	6.05	30.95	400	256	A	V
		5450.48	51.8	-22.2	74	44.13	32.41	6.21	30.95	400	256	P	V
		5451.32	41.68	-12.32	54	34.01	32.41	6.21	30.95	400	256	A	V
Remark	1. No other spurious found. 2. All results are PASS against Peak and Average limit line.												



**Band 1 5150~5250MHz**  
**WIFI 802.11a (Harmonic @ 3m)**

WIFI Ant. 1	Note	Frequency ( MHz )	Level ( dBμV/m )	Over Limit ( dB )	Limit Line ( dBμV/m )	Read Level (dBμV)	Antenna Factor ( dB/m )	Cable Loss ( dB )	Preamp Factor ( dB )	Ant Pos ( cm )	Table Pos ( deg )	Peak Avg. (P/A)	Pol. (H/V)
802.11a CH 36 5180MHz		4750	53.03	-20.97	74	46.22	32.05	5.75	30.99	111	360	P	H
		4750	41.18	-12.82	54	34.37	32.05	5.75	30.99	111	360	A	H
		5395	61.08	-12.92	74	53.45	32.42	6.16	30.95	111	360	P	H
		5395	49.04	-4.96	54	41.41	32.42	6.16	30.95	111	360	A	H
		5608	59.49	-8.71	68.2	51.44	32.7	6.34	30.99	111	360	P	H
		10360	49.43	-18.77	68.2	57.03	39.75	9.25	57.14	100	0	P	H
		15540	60.15	-13.85	74	66.76	39.38	11.47	58.22	121	33	P	H
		15540	44.34	-9.66	54	50.95	39.38	11.47	58.22	121	33	A	H
		4744	50.87	-23.13	74	44.08	32.04	5.74	30.99	391	256	P	V
		4744	38.92	-15.08	54	32.13	32.04	5.74	30.99	391	256	A	V
		5395	54.93	-19.07	74	47.3	32.42	6.16	30.95	391	256	P	V
		5395	42.11	-11.89	54	34.48	32.42	6.16	30.95	391	256	A	V
		5614	55.11	-13.09	68.2	47.04	32.72	6.34	30.99	391	256	P	V
		10360	49.09	-19.11	68.2	56.69	39.75	9.25	57.14	100	0	P	V
		15540	54.4	-19.6	74	61.01	39.38	11.47	58.22	114	346	P	V
		15540	39.49	-14.51	54	46.1	39.38	11.47	58.22	114	346	A	V
802.11a CH 44 5220MHz		4785	54.75	-19.25	74	47.85	32.11	5.77	30.98	100	360	P	H
		4785	43.46	-10.54	54	36.56	32.11	5.77	30.98	100	360	A	H
		5656	59.22	-8.98	68.2	51.04	32.84	6.35	31.01	100	360	P	H
		10440	55.4	-12.8	68.2	62.71	39.89	9.28	57.02	100	0	P	H
		15660	60.8	-13.2	74	67.46	39.02	11.53	57.96	117	30	P	H
		15660	45.33	-8.67	54	51.99	39.02	11.53	57.96	117	30	A	H
		4785	53.92	-20.08	74	47.02	32.11	5.77	30.98	363	253	P	V
		4785	40.89	-13.11	54	33.99	32.11	5.77	30.98	363	253	A	V
		5668	54.53	-13.67	68.2	46.32	32.87	6.35	31.01	363	253	P	V
		10440	51.04	-17.16	68.2	58.35	39.89	9.28	57.02	100	0	P	V
		15660	55.67	-18.33	74	62.33	39.02	11.53	57.96	118	348	P	V
		15660	40.56	-13.44	54	47.22	39.02	11.53	57.96	118	348	A	V



<b>802.11a CH 48 5240MHz</b>		4803	56.22	-17.78	74	49.27	32.15	5.78	30.98	101	0	P	H
		4803	42.57	-11.43	54	35.62	32.15	5.78	30.98	101	0	A	H
		5464	58.3	-9.9	68.2	50.63	32.41	6.21	30.95	101	0	P	H
		5680	58.93	-9.27	68.2	50.69	32.9	6.35	31.01	101	0	P	H
		10480	52.64	-15.56	68.2	59.76	39.96	9.31	56.93	100	0	P	H
		15720	60.13	-13.87	74	66.8	38.84	11.56	57.81	115	37	P	H
		15720	44.1	-9.9	54	50.77	38.84	11.56	57.81	115	37	A	H
		4803	52.74	-21.26	74	45.79	32.15	5.78	30.98	400	256	P	V
		4803	39.24	-14.76	54	32.29	32.15	5.78	30.98	400	256	A	V
		5460	52.42	-15.78	68.2	44.75	32.41	6.21	30.95	400	256	P	V
		5674	53.87	-14.33	68.2	45.64	32.89	6.35	31.01	400	256	P	V
		10480	50.1	-18.1	68.2	57.22	39.96	9.31	56.93	100	0	P	V
		15720	54.92	-19.08	74	61.59	38.84	11.56	57.81	117	348	P	V
		15720	39.38	-14.62	54	46.05	38.84	11.56	57.81	117	348	A	V
<b>Remark</b>	<ol style="list-style-type: none"> <li>1. No other spurious found.</li> <li>2. All results are PASS against Peak and Average limit line.</li> </ol>												



**Band 1 5150~5250MHz**  
**WIFI 802.11n HT20 (Band Edge @ 3m)**

WIFI Ant. 1	Note	Frequency ( MHz )	Level ( dBμV/m )	Over Limit ( dB )	Limit Line ( dBμV/m )	Read Level ( dBμV )	Antenna Factor ( dB/m )	Cable Loss ( dB )	Preamp Factor ( dB )	Ant Pos ( cm )	Table Pos ( deg )	Peak Avg. ( P/A )	Pol. ( H/V )
802.11n HT20 CH 36 5180MHz		5148.98	61.03	-12.97	74	53.52	32.47	5.99	30.95	111	0	P	H
		5149.5	50.54	-3.46	54	43.03	32.47	5.99	30.95	111	0	A	H
	*	5180	114.07	-	-	106.54	32.46	6.02	30.95	111	0	P	H
	*	5180	102.7	-	-	95.17	32.46	6.02	30.95	111	0	A	H
		5150	56.56	-17.44	74	49.05	32.47	5.99	30.95	391	257	P	V
		5150	46.02	-7.98	54	38.51	32.47	5.99	30.95	391	257	A	V
	*	5180	110.57	-	-	103.04	32.46	6.02	30.95	391	257	P	V
	*	5180	99.02	-	-	91.49	32.46	6.02	30.95	391	257	A	V
802.11n HT20 CH 44 5220MHz		5148.46	55.92	-18.08	74	48.41	32.47	5.99	30.95	100	0	P	H
		5149.24	45.16	-8.84	54	37.65	32.47	5.99	30.95	100	0	A	H
	*	5220	117.71	-	-	110.16	32.46	6.04	30.95	100	0	P	H
	*	5220	105.73	-	-	98.18	32.46	6.04	30.95	100	0	A	H
		5444.88	59.24	-14.76	74	51.59	32.41	6.19	30.95	100	0	P	H
		5445.72	49.37	-4.63	54	41.72	32.41	6.19	30.95	100	0	A	H
		5148.2	51.9	-22.1	74	44.39	32.47	5.99	30.95	366	253	P	V
		5149.24	40.42	-13.58	54	32.91	32.47	5.99	30.95	366	253	A	V
	*	5220	112.3	-	-	104.75	32.46	6.04	30.95	366	253	P	V
	*	5220	100.48	-	-	92.93	32.46	6.04	30.95	366	253	A	V
		5441.8	51.49	-22.51	74	43.84	32.41	6.19	30.95	366	253	P	V
	5444.88	41.71	-12.29	54	34.06	32.41	6.19	30.95	366	253	A	V	



<b>802.11n</b>  <b>HT20</b>  <b>CH 48</b>  <b>5240MHz</b>		5138.58	51.71	-22.29	74	44.21	32.47	5.98	30.95	110	0	P	H
		5150	41.63	-12.37	54	34.12	32.47	5.99	30.95	110	0	A	H
	*	5240	116.37	-	-	108.82	32.45	6.05	30.95	110	0	P	H
	*	5240	105.34	-	-	97.79	32.45	6.05	30.95	110	0	A	H
		5450.2	57.86	-16.14	74	50.19	32.41	6.21	30.95	110	0	P	H
		5460	48.03	-5.97	54	40.36	32.41	6.21	30.95	110	0	A	H
		5134.16	49.9	-24.1	74	42.4	32.47	5.98	30.95	400	253	P	V
		5148.72	39.52	-14.48	54	32.01	32.47	5.99	30.95	400	253	A	V
	*	5240	110.79	-	-	103.24	32.45	6.05	30.95	400	253	P	V
	*	5240	99.43	-	-	91.88	32.45	6.05	30.95	400	253	A	V
		5451.88	51.7	-22.3	74	44.03	32.41	6.21	30.95	400	253	P	V
		5451.6	41.98	-12.02	54	34.31	32.41	6.21	30.95	400	253	A	V
<b>Remark</b>	1. No other spurious found. 2. All results are PASS against Peak and Average limit line.												



**Band 1 5150~5250MHz**  
**WIFI 802.11n HT20 (Harmonic @ 3m)**

WIFI Ant. 1	Note	Frequency ( MHz )	Level ( dBμV/m )	Over Limit ( dB )	Limit Line ( dBμV/m )	Read Level ( dBμV )	Antenna Factor ( dB/m )	Cable Loss ( dB )	Preamp Factor ( dB )	Ant Pos ( cm )	Table Pos ( deg )	Peak Avg. ( P/A )	Pol. ( H/V )
802.11n HT20 CH 36 5180MHz		4756	54.32	-19.68	74	47.5	32.06	5.75	30.99	111	0	P	H
		4756	42.24	-11.76	54	35.42	32.06	5.75	30.99	111	0	A	H
		5395	60.77	-13.23	74	53.14	32.42	6.16	30.95	111	0	P	H
		5395	48.54	-5.46	54	40.91	32.42	6.16	30.95	111	0	A	H
		5608	58.93	-9.27	68.2	50.88	32.7	6.34	30.99	111	0	P	H
		10360	48.93	-19.27	68.2	56.53	39.75	9.25	57.14	100	0	P	H
		15540	58.4	-15.6	74	65.01	39.38	11.47	58.22	122	31	P	H
		15540	43.51	-10.49	54	50.12	39.38	11.47	58.22	122	31	A	H
		4744	52.41	-21.59	74	45.62	32.04	5.74	30.99	391	257	P	V
		4744	40.37	-13.63	54	33.58	32.04	5.74	30.99	391	257	A	V
		5395	51.98	-22.02	74	44.35	32.42	6.16	30.95	391	257	P	V
		5395	42.02	-11.98	54	34.39	32.42	6.16	30.95	391	257	A	V
		5608	54.95	-13.25	68.2	46.9	32.7	6.34	30.99	391	257	P	V
		10360	49.23	-18.97	68.2	56.83	39.75	9.25	57.14	100	0	P	V
		15540	53.32	-20.68	74	59.93	39.38	11.47	58.22	117	350	P	V
		15540	38.69	-15.31	54	45.3	39.38	11.47	58.22	117	350	A	V
i802.11n HT20 CH 44 5220MHz		4785	57.43	-16.57	74	50.53	32.11	5.77	30.98	100	0	P	H
		4785	43.85	-10.15	54	36.95	32.11	5.77	30.98	100	0	A	H
		5656	59.05	-9.15	68.2	50.87	32.84	6.35	31.01	100	0	P	H
		10440	52.77	-15.43	68.2	60.08	39.89	9.28	57.02	100	0	P	H
		15660	60.66	-13.34	74	67.32	39.02	11.53	57.96	123	35	P	H
		15660	45.14	-8.86	54	51.8	39.02	11.53	57.96	123	35	A	H
		4785	54.16	-19.84	74	47.26	32.11	5.77	30.98	366	253	P	V
		4785	40.95	-13.05	54	34.05	32.11	5.77	30.98	366	253	A	V
		4972	52.15	-21.85	74	44.78	32.45	5.87	30.95	372	249	P	V
		4972	39.3	-14.7	54	31.93	32.45	5.87	30.95	372	249	A	V
		5662	53.14	-15.06	68.2	44.95	32.85	6.35	31.01	366	253	P	V
		10440	51.21	-16.99	68.2	58.52	39.89	9.28	57.02	100	0	P	V
		15660	54.45	-19.55	74	61.11	39.02	11.53	57.96	118	350	P	V
		15660	39.86	-14.14	54	46.52	39.02	11.53	57.96	118	350	A	V



<b>802.11n</b>  <b>HT20</b>  <b>CH 48</b>  <b>5240MHz</b>		4810	56.04	-17.96	74	49.08	32.16	5.78	30.98	110	0	P	H
		4810	43.29	-10.71	54	36.33	32.16	5.78	30.98	110	0	A	H
		5464	59.61	-8.59	68.2	51.94	32.41	6.21	30.95	110	0	P	H
		5674	59.12	-9.08	68.2	50.89	32.89	6.35	31.01	110	0	P	H
		10480	51.76	-16.44	68.2	58.88	39.96	9.31	56.93	100	0	P	H
		15720	59.71	-14.29	74	66.38	38.84	11.56	57.81	123	34	P	H
		15720	44.58	-9.42	54	51.25	38.84	11.56	57.81	123	34	A	H
		4810	53.18	-20.82	74	46.22	32.16	5.78	30.98	400	253	P	V
		4810	39.42	-14.58	54	32.46	32.16	5.78	30.98	400	253	A	V
		5460	52.09	-16.11	68.2	44.42	32.41	6.21	30.95	400	253	P	V
		5680	53.89	-14.31	68.2	45.65	32.9	6.35	31.01	400	253	P	V
		10480	50.04	-18.16	68.2	57.16	39.96	9.31	56.93	100	0	P	V
		15720	54.28	-19.72	74	60.95	38.84	11.56	57.81	119	347	P	V
		15720	39.41	-14.59	54	46.08	38.84	11.56	57.81	119	347	A	V
<b>Remark</b>	1. No other spurious found. 2. All results are PASS against Peak and Average limit line.												





**Band 1 5150~5250MHz**  
**WIFI 802.11n HT40 (Band Edge @ 3m)**

WIFI Ant. 1	Note	Frequency ( MHz )	Level ( dBμV/m )	Over Limit ( dB )	Limit Line ( dBμV/m )	Read Level ( dBμV )	Antenna Factor ( dB/m )	Cable Loss ( dB )	Preamp Factor ( dB )	Ant Pos ( cm )	Table Pos ( deg )	Peak Avg. ( P/A )	Pol. ( H/V )
802.11n HT40 CH 38 5190MHz		5145.08	61.07	-12.93	74	53.56	32.47	5.99	30.95	113	0	P	H
		5149.76	50.44	-3.56	54	42.93	32.47	5.99	30.95	113	0	A	H
	*	5190	105.23	-	-	97.7	32.46	6.02	30.95	113	0	P	H
	*	5190	93.98	-	-	86.45	32.46	6.02	30.95	113	0	A	H
		5419.68	50.47	-23.53	74	42.82	32.42	6.18	30.95	113	0	P	H
		5400.08	40.2	-13.8	54	32.57	32.42	6.16	30.95	113	0	A	H
		5144.82	54.12	-19.88	74	46.61	32.47	5.99	30.95	389	256	P	V
		5149.76	44.16	-9.84	54	36.65	32.47	5.99	30.95	389	256	A	V
	*	5190	100.2	-	-	92.67	32.46	6.02	30.95	389	256	P	V
	*	5190	89.09	-	-	81.56	32.46	6.02	30.95	389	256	A	V
		5450.2	49.52	-24.48	74	41.85	32.41	6.21	30.95	389	256	P	V
		5417.16	38.92	-15.08	54	31.27	32.42	6.18	30.95	389	256	A	V
802.11n HT40 CH 46 5230MHz		5149.24	62.04	-11.96	74	54.53	32.47	5.99	30.95	124	0	P	H
		5148.98	50.8	-3.2	54	43.29	32.47	5.99	30.95	124	0	A	H
	*	5230	114.01	-	-	106.47	32.45	6.04	30.95	124	0	P	H
	*	5230	101.7	-	-	94.16	32.45	6.04	30.95	124	0	A	H
		5353.32	55.73	-18.27	74	48.13	32.43	6.12	30.95	124	0	P	H
		5351.08	44.52	-9.48	54	36.92	32.43	6.12	30.95	124	0	A	H
		5147.42	55.14	-18.86	74	47.63	32.47	5.99	30.95	366	251	P	V
		5149.24	44.83	-9.17	54	37.32	32.47	5.99	30.95	366	251	A	V
	*	5230	107.62	-	-	100.08	32.45	6.04	30.95	366	251	P	V
	*	5230	96.42	-	-	88.88	32.45	6.04	30.95	366	251	A	V
	5359.48	52.48	-21.52	74	44.86	32.43	6.14	30.95	366	251	P	V	
	5351.08	40.79	-13.21	54	33.19	32.43	6.12	30.95	366	251	A	V	
Remark	1. No other spurious found. 2. All results are PASS against Peak and Average limit line.												



**Band 1 5150~5250MHz**  
**WIFI 802.11n HT40 (Harmonic @ 3m)**

WIFI Ant. 1	Note	Frequency ( MHz )	Level ( dBμV/m )	Over Limit ( dB )	Limit Line ( dBμV/m )	Read Level (dBμV)	Antenna Factor ( dB/m )	Cable Loss ( dB )	Preamp Factor ( dB )	Ant Pos ( cm )	Table Pos ( deg )	Peak Avg. (P/A)	Pol. (H/V)
802.11n HT40 CH 38 5190MHz		10380	48.54	-19.66	68.2	56.07	39.78	9.26	57.11	100	0	P	H
		15570	46.97	-27.03	74	53.59	39.29	11.49	58.15	100	0	P	H
		10380	48.14	-20.06	68.2	55.67	39.78	9.26	57.11	100	0	P	V
		15570	46.71	-27.29	74	53.33	39.29	11.49	58.15	100	0	P	V
802.11n HT40 CH 46 5230MHz		10460	48.81	-19.39	68.2	56.04	39.93	9.29	56.99	100	0	P	H
		15690	55.52	-18.48	74	62.19	38.93	11.54	57.88	122	36	P	H
		15690	41.85	-12.15	54	48.52	38.93	11.54	57.88	122	36	A	H
		10460	48.37	-19.83	68.2	55.6	39.93	9.29	56.99	100	0	P	V
		15690	49.21	-24.79	74	55.88	38.93	11.54	57.88	100	0	P	V
Remark	1. No other spurious found. 2. All results are PASS against Peak and Average limit line.												



Band 1 5150~5250MHz
WIFI 802.11ac VHT80 (Band Edge @ 3m)

Table with 14 columns: WIFI Ant. 1, Note, Frequency (MHz), Level (dBµV/m), Over Limit (dB), Limit Line (dBµV/m), Read Level (dBµV), Antenna Factor (dB/m), Cable Loss (dB), Preamp Factor (dB), Ant Pos (cm), Table Pos (deg), Peak Avg. (P/A), Pol. (H/V). Rows include test results for 802.11ac VHT80 CH 42 5210MHz and a Remark section.



Band 1 5150~5250MHz

WIFI 802.11ac VHT80 (Harmonic @ 3m)

WIFI Ant. 1	Note	Frequency ( MHz )	Level ( dBμV/m )	Over Limit ( dB )	Limit Line ( dBμV/m )	Read Level (dBμV)	Antenna Factor ( dB/m )	Cable Loss ( dB )	Preamp Factor ( dB )	Ant Pos ( cm )	Table Pos ( deg )	Peak Avg. (P/A)	Pol. (H/V)
802.11ac		10420	48.69	-19.51	68.2	56.07	39.86	9.27	57.05	100	0	P	H
VHT80		15630	47.64	-26.36	74	54.27	39.11	11.51	58	100	0	P	H
CH 42		10420	49.48	-18.72	68.2	56.86	39.86	9.27	57.05	100	0	P	V
5210MHz		15630	47.78	-26.22	74	54.41	39.11	11.51	58	100	0	P	V
Remark	1. No other spurious found. 2. All results are PASS against Peak and Average limit line.												



Emission below 1GHz
WIFI 802.11n HT40 (LF @ 3m)

Table with 14 columns: WIFI, Note, Frequency, Level, Over, Limit, Read, Antenna, Cable, Preamp, Ant, Table, Peak, Pol. It contains 12 rows of test data for 802.11n HT40 LF and a Remark section at the bottom.



**Band 1 - 5150~5250MHz**  
**WIFI 802.11a (Band Edge @ 3m)**

WIFI	Note	Frequency	Level	Over	Limit	Read	Antenna	Cable	Preamp	Ant	Table	Peak	Pol.
Ant.				Limit	Line	Level	Factor	Loss	Factor	Pos	Pos	Avg.	
2		( MHz )	( dBμV/m )	( dB )	( dBμV/m )	( dBμV )	( dB/m )	( dB )	( dB )	( cm )	( deg )	( P/A )	( H/V )
802.11a CH 36 5180MHz		5149.76	62.24	-11.76	74	54.73	32.47	5.99	30.95	114	148	P	H
		5149.76	50.97	-3.03	54	43.46	32.47	5.99	30.95	114	148	A	H
	*	5180	113.25	-	-	105.72	32.46	6.02	30.95	114	148	P	H
	*	5180	102.43	-	-	94.9	32.46	6.02	30.95	114	148	A	H
		5146.9	57.97	-16.03	74	50.46	32.47	5.99	30.95	393	26	P	V
		5149.76	46.42	-7.58	54	38.91	32.47	5.99	30.95	393	26	A	V
	*	5180	108.94	-	-	101.41	32.46	6.02	30.95	393	26	P	V
	*	5180	97.93	-	-	90.4	32.46	6.02	30.95	393	26	A	V
802.11a CH 44 5220MHz		5066.56	54.62	-19.38	74	47.15	32.49	5.93	30.95	100	145	P	H
		5057.46	45.1	-8.9	54	37.63	32.49	5.93	30.95	100	145	A	H
	*	5220	113.76	-	-	106.21	32.46	6.04	30.95	100	145	P	H
	*	5220	102.79	-	-	95.24	32.46	6.04	30.95	100	145	A	H
		5387.2	56.63	-17.37	74	49.01	32.42	6.15	30.95	100	145	P	H
		5384.96	47.44	-6.56	54	39.82	32.42	6.15	30.95	100	145	A	H
		5063.18	51.31	-22.69	74	43.84	32.49	5.93	30.95	366	25	P	V
		5065.52	41.13	-12.87	54	33.66	32.49	5.93	30.95	366	25	A	V
	*	5220	109.04	-	-	101.49	32.46	6.04	30.95	366	25	P	V
	*	5220	98.19	-	-	90.64	32.46	6.04	30.95	366	25	A	V
		5379.08	52.85	-21.15	74	45.23	32.42	6.15	30.95	366	25	P	V
		5377.12	43.58	-10.42	54	35.96	32.42	6.15	30.95	366	25	A	V



<b>802.11a CH 48 5240MHz</b>		5073.32	54.67	-19.33	74	47.19	32.49	5.94	30.95	123	146	P	H
		5074.1	44.94	-9.06	54	37.46	32.49	5.94	30.95	123	146	A	H
	*	5240	114.12	-	-	106.57	32.45	6.05	30.95	123	146	P	H
	*	5240	103.03	-	-	95.48	32.45	6.05	30.95	123	146	A	H
		5393.36	56.73	-17.27	74	49.11	32.42	6.15	30.95	123	146	P	H
		5393.92	47.2	-6.8	54	39.58	32.42	6.15	30.95	123	146	A	H
		5142.22	50.62	-23.38	74	43.12	32.47	5.98	30.95	400	63	P	V
		5087.36	40.13	-13.87	54	32.66	32.48	5.94	30.95	400	63	A	V
	*	5240	108.68	-	-	101.13	32.45	6.05	30.95	400	63	P	V
	*	5240	97.84	-	-	90.29	32.45	6.05	30.95	400	63	A	V
		5404.56	53.47	-20.53	74	45.84	32.42	6.16	30.95	400	63	P	V
		5402.6	43.29	-10.71	54	35.66	32.42	6.16	30.95	400	63	A	V
Remark	1. No other spurious found. 2. All results are PASS against Peak and Average limit line.												



**Band 1 5150~5250MHz**  
**WIFI 802.11a (Harmonic @ 3m)**

WIFI Ant. 2	Note	Frequency ( MHz )	Level ( dBμV/m )	Over Limit ( dB )	Limit Line ( dBμV/m )	Read Level ( dBμV )	Antenna Factor ( dB/m )	Cable Loss ( dB )	Preamp Factor ( dB )	Ant Pos ( cm )	Table Pos ( deg )	Peak Avg. ( P/A )	Pol. ( H/V )
<b>802.11a CH 36 5180MHz</b>		4750	53.08	-20.92	74	46.27	32.05	5.75	30.99	114	148	P	H
		4750	40.1	-13.9	54	33.29	32.05	5.75	30.99	114	148	A	H
		5344	57.42	-10.78	68.2	49.82	32.43	6.12	30.95	114	148	P	H
		5392	58.35	-15.65	74	50.73	32.42	6.15	30.95	114	148	P	H
		5392	45.99	-8.01	54	38.37	32.42	6.15	30.95	114	148	A	H
		5620	54.1	-14.1	68.2	46.01	32.74	6.34	30.99	114	148	P	H
		10360	51.8	-16.4	68.2	59.4	39.75	9.25	57.14	100	0	P	H
		15540	49.03	-24.97	74	55.64	39.38	11.47	58.22	100	0	P	H
		5338	53.87	-14.33	68.2	46.28	32.43	6.11	30.95	393	26	P	V
		5392	54.04	-19.96	74	46.42	32.42	6.15	30.95	393	26	P	V
		5392	40.89	-13.11	54	33.27	32.42	6.15	30.95	393	26	A	V
		5614	50.77	-17.43	68.2	42.7	32.72	6.34	30.99	393	26	P	V
		10360	51.7	-16.5	68.2	59.3	39.75	9.25	57.14	100	0	P	V
		15540	47.28	-26.72	74	53.89	39.38	11.47	58.22	100	0	P	V
<b>802.11a CH 44 5220MHz</b>		5002	53.59	-20.41	74	46.15	32.5	5.89	30.95	100	145	P	H
		5002	40.45	-13.55	54	33.01	32.5	5.89	30.95	100	145	A	H
		5662	52.63	-15.57	68.2	44.44	32.85	6.35	31.01	100	145	P	H
		10440	51.92	-16.28	68.2	59.23	39.89	9.28	57.02	100	0	P	H
		15660	50.59	-23.41	74	57.25	39.02	11.53	57.96	100	0	P	H
		10440	52.51	-15.69	68.2	59.82	39.89	9.28	57.02	100	0	P	V
		15660	50.17	-23.83	74	56.83	39.02	11.53	57.96	100	0	P	V





<b>802.11a</b> <b>CH 48</b> <b>5240MHz</b>		5675	51.26	-16.94	68.2	43.03	32.89	6.35	31.01	123	146	P	H
		10480	54.38	-13.82	68.2	61.5	39.96	9.31	56.93	100	0	P	H
		15720	54.55	-19.45	74	61.22	38.84	11.56	57.81	109	188	P	H
		15720	39.28	-14.72	54	45.95	38.84	11.56	57.81	109	188	A	H
		10480	53.37	-14.83	68.2	60.49	39.96	9.31	56.93	100	0	P	V
		15720	55.09	-18.91	74	61.76	38.84	11.56	57.81	112	183	P	V
		15720	39.4	-14.6	54	46.07	38.84	11.56	57.81	112	183	A	V
<b>Remark</b>	1. No other spurious found. 2. All results are PASS against Peak and Average limit line.												



**Band 1 5150~5250MHz**  
**WIFI 802.11n HT20 (Band Edge @ 3m)**

WIFI Ant. 2	Note	Frequency ( MHz )	Level ( dBμV/m )	Over Limit ( dB )	Limit Line ( dBμV/m )	Read Level ( dBμV )	Antenna Factor ( dB/m )	Cable Loss ( dB )	Preamp Factor ( dB )	Ant Pos ( cm )	Table Pos ( deg )	Peak Avg. ( P/A )	Pol. ( H/V )
802.11n HT20 CH 36 5180MHz		5150	61.16	-12.84	74	53.65	32.47	5.99	30.95	111	147	P	H
		5150	48.99	-5.01	54	41.48	32.47	5.99	30.95	111	147	A	H
	*	5180	112.92	-	-	105.39	32.46	6.02	30.95	111	147	P	H
	*	5180	101.37	-	-	93.84	32.46	6.02	30.95	111	147	A	H
		5404.28	55.59	-18.41	74	47.96	32.42	6.16	30.95	100	235	P	H
		5395.88	45.21	-8.79	54	37.58	32.42	6.16	30.95	100	235	A	H
		5148.72	57.7	-16.3	74	50.19	32.47	5.99	30.95	394	39	P	V
		5150	44.73	-9.27	54	37.22	32.47	5.99	30.95	394	39	A	V
	*	5180	107.64	-	-	100.11	32.46	6.02	30.95	394	39	P	V
	*	5180	96.31	-	-	88.78	32.46	6.02	30.95	394	39	A	V
		5405.96	55.12	-18.88	74	47.49	32.42	6.16	30.95	306	265	P	V
		5393.64	44.91	-9.09	54	37.29	32.42	6.15	30.95	306	265	A	V
802.11n HT20 CH 44 5220MHz		5062.14	54.55	-19.45	74	47.08	32.49	5.93	30.95	100	146	P	H
		5056.94	44.85	-9.15	54	37.38	32.49	5.93	30.95	100	146	A	H
	*	5220	114	-	-	106.45	32.46	6.04	30.95	100	146	P	H
	*	5220	102.51	-	-	94.96	32.46	6.04	30.95	100	146	A	H
		5378.24	56.41	-17.59	74	48.79	32.42	6.15	30.95	100	146	P	H
		5385.52	47.19	-6.81	54	39.57	32.42	6.15	30.95	100	146	A	H
		5067.34	50.71	-23.29	74	43.24	32.49	5.93	30.95	365	25	P	V
		5062.66	41.11	-12.89	54	33.64	32.49	5.93	30.95	365	25	A	V
	*	5220	109.22	-	-	101.67	32.46	6.04	30.95	365	25	P	V
	*	5220	97.72	-	-	90.17	32.46	6.04	30.95	365	25	A	V
	5387.2	52.52	-21.48	74	44.9	32.42	6.15	30.95	365	25	P	V	
	5384.12	42.94	-11.06	54	35.32	32.42	6.15	30.95	365	25	A	V	



<b>802.11n</b>  <b>HT20</b>  <b>CH 48</b>  <b>5240MHz</b>		5071.5	54.25	-19.75	74	46.77	32.49	5.94	30.95	123	146	P	H
		5074.36	44.78	-9.22	54	37.3	32.49	5.94	30.95	123	146	A	H
	*	5240	114.47	-	-	106.92	32.45	6.05	30.95	123	146	P	H
	*	5240	103.09	-	-	95.54	32.45	6.05	30.95	123	146	A	H
		5392.8	56.76	-17.24	74	49.14	32.42	6.15	30.95	123	146	P	H
		5397.84	47.11	-6.89	54	39.48	32.42	6.16	30.95	123	146	A	H
		5077.48	51	-23	74	43.53	32.48	5.94	30.95	365	40	P	V
		5075.14	41.35	-12.65	54	33.88	32.48	5.94	30.95	365	40	A	V
	*	5240	109.49	-	-	101.94	32.45	6.05	30.95	365	40	P	V
	*	5240	98.24	-	-	90.69	32.45	6.05	30.95	365	40	A	V
		5403.16	53.7	-20.3	74	46.07	32.42	6.16	30.95	365	40	P	V
		5404.84	43.73	-10.27	54	36.1	32.42	6.16	30.95	365	40	A	V
<b>Remark</b>	1. No other spurious found. 2. All results are PASS against Peak and Average limit line.												



**Band 1 5150~5250MHz**  
**WIFI 802.11n HT20 (Harmonic @ 3m)**

WIFI Ant. 2	Note	Frequency ( MHz )	Level ( dBμV/m )	Over Limit ( dB )	Limit Line ( dBμV/m )	Read Level (dBμV)	Antenna Factor ( dB/m )	Cable Loss ( dB )	Preamp Factor ( dB )	Ant Pos ( cm )	Table Pos ( deg )	Peak Avg. (P/A)	Pol. (H/V)
802.11n HT20 CH 36 5180MHz		5344	57.17	-11.03	68.2	49.57	32.43	6.12	30.95	111	147	P	H
		5388	58.05	-15.95	74	50.43	32.42	6.15	30.95	111	147	P	H
		5388	45.02	-8.98	54	37.4	32.42	6.15	30.95	111	147	A	H
		5608	52.38	-15.82	68.2	44.33	32.7	6.34	30.99	111	147	P	H
		10360	50.01	-18.19	68.2	57.61	39.75	9.25	57.14	100	0	P	H
		15540	48.13	-25.87	74	54.74	39.38	11.47	58.22	100	0	P	H
		5338	52.7	-15.5	68.2	45.11	32.43	6.11	30.95	394	39	P	V
		5404	52.31	-21.69	74	44.68	32.42	6.16	30.95	394	39	P	V
		5404	39.53	-14.47	54	31.9	32.42	6.16	30.95	394	39	A	V
		10360	49.44	-18.76	68.2	57.04	39.75	9.25	57.14	100	0	P	V
	15540	47.26	-26.74	74	53.87	39.38	11.47	58.22	100	0	P	V	
802.11n HT20 CH 44 5220MHz		10440	53.53	-14.67	68.2	60.84	39.89	9.28	57.02	100	0	P	H
		15660	49.56	-24.44	74	56.22	39.02	11.53	57.96	100	0	P	H
		10440	52.06	-16.14	68.2	59.37	39.89	9.28	57.02	100	0	P	V
		15660	49.74	-24.26	74	56.4	39.02	11.53	57.96	100	0	P	V
802.11n HT20 CH 48 5240MHz		4804	51.79	-22.21	74	44.84	32.15	5.78	30.98	123	146	P	H
		4804	38.86	-15.14	54	31.91	32.15	5.78	30.98	123	146	A	H
		10480	54.9	-13.3	68.2	62.02	39.96	9.31	56.93	100	0	P	H
		15720	48.99	-25.01	74	55.66	38.84	11.56	57.81	100	0	P	H
		10480	52.49	-15.71	68.2	59.61	39.96	9.31	56.93	100	0	P	V
		15720	49.14	-24.86	74	55.81	38.84	11.56	57.81	100	0	P	V
Remark	1. No other spurious found. 2. All results are PASS against Peak and Average limit line.												



**Band 1 5150~5250MHz**  
**WIFI 802.11n HT40 (Band Edge @ 3m)**

WIFI Ant. 2	Note	Frequency ( MHz )	Level ( dBμV/m )	Over Limit ( dB )	Limit Line ( dBμV/m )	Read Level ( dBμV )	Antenna Factor ( dB/m )	Cable Loss ( dB )	Preamp Factor ( dB )	Ant Pos ( cm )	Table Pos ( deg )	Peak Avg. ( P/A )	Pol. ( H/V )	
802.11n HT40 CH 38 5190MHz		5143.78	61.7	-12.3	74	54.19	32.47	5.99	30.95	112	148	P	H	
		5149.24	50.97	-3.03	54	43.46	32.47	5.99	30.95	112	148	A	H	
	*	5190	106.69	-	-	99.16	32.46	6.02	30.95	112	148	P	H	
	*	5190	95.64	-	-	88.11	32.46	6.02	30.95	112	148	A	H	
		5358.36	51.62	-22.38	74	44	32.43	6.14	30.95	112	148	P	H	
		5351.92	42.56	-11.44	54	34.96	32.43	6.12	30.95	112	148	A	H	
		5149.24	56.15	-17.85	74	48.64	32.47	5.99	30.95	391	24	P	V	
		5148.98	45.06	-8.94	54	37.55	32.47	5.99	30.95	391	24	A	V	
	*	5190	102.53	-	-	95	32.46	6.02	30.95	391	24	P	V	
	*	5190	91.09	-	-	83.56	32.46	6.02	30.95	391	24	A	V	
		5364.52	50.12	-23.88	74	42.5	32.43	6.14	30.95	391	24	P	V	
		5353.6	40.26	-13.74	54	32.66	32.43	6.12	30.95	391	24	A	V	
	802.11n HT40 CH 46 5230MHz		5150	57.25	-16.75	74	49.74	32.47	5.99	30.95	112	145	P	H
			5148.98	46.51	-7.49	54	39	32.47	5.99	30.95	112	145	A	H
*		5230	111.3	-	-	103.76	32.45	6.04	30.95	112	145	P	H	
*		5230	99.97	-	-	92.43	32.45	6.04	30.95	112	145	A	H	
		5403.72	54.54	-19.46	74	46.91	32.42	6.16	30.95	112	145	P	H	
		5396.44	45.47	-8.53	54	37.84	32.42	6.16	30.95	112	145	A	H	
		5143	53.21	-20.79	74	45.7	32.47	5.99	30.95	400	63	P	V	
		5148.98	42.25	-11.75	54	34.74	32.47	5.99	30.95	400	63	A	V	
*		5230	105.8	-	-	98.26	32.45	6.04	30.95	400	63	P	V	
*		5230	94.78	-	-	87.24	32.45	6.04	30.95	400	63	A	V	
	5377.4	51.71	-22.29	74	44.09	32.42	6.15	30.95	400	63	P	V		
	5397.84	42.16	-11.84	54	34.53	32.42	6.16	30.95	400	63	A	V		
Remark	1. No other spurious found. 2. All results are PASS against Peak and Average limit line.													



Band 1 5150~5250MHz
WIFI 802.11n HT40 (Harmonic @ 3m)

Table with 14 columns: WIFI Ant. 2, Note, Frequency (MHz), Level (dBµV/m), Over Limit (dB), Limit Line (dBµV/m), Read Level (dBµV), Antenna Factor (dB/m), Cable Loss (dB), Preamp Factor (dB), Ant Pos (cm), Table Pos (deg), Peak Avg. (P/A), Pol. (H/V). Rows include data for 802.11n HT40 CH 38 (5190MHz) and 802.11n HT40 CH 46 (5230MHz).

Remark
1. No other spurious found.
2. All results are PASS against Peak and Average limit line.



**Band 1 5150~5250MHz**  
**WIFI 802.11ac VHT80 (Band Edge @ 3m)**

WIFI Ant. 2	Note	Frequency ( MHz )	Level ( dBμV/m )	Over Limit ( dB )	Limit Line ( dBμV/m )	Read Level (dBμV)	Antenna Factor ( dB/m )	Cable Loss ( dB )	Preamp Factor ( dB )	Ant Pos ( cm )	Table Pos ( deg )	Peak Avg. (P/A)	Pol. (H/V)
<b>802.11ac VHT80 CH 42 5210MHz</b>		5113.62	59.95	-14.05	74	52.45	32.48	5.97	30.95	100	148	P	H
		5112.58	50.96	-3.04	54	43.46	32.48	5.97	30.95	100	148	A	H
	*	5210	103.88	-	-	96.34	32.46	6.03	30.95	100	148	P	H
	*	5210	93.45	-	-	85.91	32.46	6.03	30.95	100	148	A	H
		5382.44	52.24	-21.76	74	44.62	32.42	6.15	30.95	100	148	P	H
		5358.08	42.93	-11.07	54	35.33	32.43	6.12	30.95	100	148	A	H
		5113.1	55.97	-18.03	74	48.47	32.48	5.97	30.95	400	62	P	V
		5114.66	46.7	-7.3	54	39.2	32.48	5.97	30.95	400	62	A	V
	*	5210	98.56	-	-	91.02	32.46	6.03	30.95	400	62	P	V
	*	5210	88.18	-	-	80.64	32.46	6.03	30.95	400	62	A	V
		5379.36	50.74	-23.26	74	43.12	32.42	6.15	30.95	400	62	P	V
	5399.24	41.36	-12.64	54	33.73	32.42	6.16	30.95	400	62	A	V	
<b>Remark</b>	1. No other spurious found. 2. All results are PASS against Peak and Average limit line.												



Band 1 5150~5250MHz

WIFI 802.11ac VHT80 (Harmonic @ 3m)

WIFI Ant. 2	Note	Frequency ( MHz )	Level ( dBμV/m )	Over Limit ( dB )	Limit Line ( dBμV/m )	Read Level (dBμV)	Antenna Factor ( dB/m )	Cable Loss ( dB )	Preamp Factor ( dB )	Ant Pos ( cm )	Table Pos ( deg )	Peak Avg. (P/A)	Pol. (H/V)
802.11ac VHT80 CH 42 5210MHz		10420	48.29	-19.91	68.2	55.67	39.86	9.27	57.05	100	0	P	H
		15630	47.31	-26.69	74	53.94	39.11	11.51	58	100	0	P	H
		10420	48.61	-19.59	68.2	55.99	39.86	9.27	57.05	100	0	P	V
		15630	47.73	-26.27	74	54.36	39.11	11.51	58	100	0	P	V
Remark	1. No other spurious found. 2. All results are PASS against Peak and Average limit line.												





Emission below 1GHz
WIFI 802.11n HT40 (LF @ 3m)

Table with 14 columns: WIFI, Note, Frequency, Level, Over, Limit, Read, Antenna, Cable, Preamp, Ant, Table, Peak, Pol. It contains 12 rows of test data for 802.11n HT40 LF and a Remark section at the bottom.



**Band 1 - 5150~5250MHz**  
**WIFI 802.11a (Band Edge @ 3m)**

WIFI	Note	Frequency	Level	Over	Limit	Read	Antenna	Cable	Preamp	Ant	Table	Peak	Pol.
Ant.				Limit	Line	Level	Factor	Loss	Factor	Pos	Pos	Avg.	
1+2		( MHz )	( dBμV/m )	( dB )	( dBμV/m )	( dBμV )	( dB/m )	( dB )	( dB )	( cm )	( deg )	(P/A)	(H/V)
802.11a CH 36 5180MHz		5149.5	60.78	-13.22	74	53.27	32.47	5.99	30.95	104	232	P	H
		5148.98	49.64	-4.36	54	42.13	32.47	5.99	30.95	104	232	A	H
	*	5180	114.77	-	-	107.24	32.46	6.02	30.95	104	232	P	H
	*	5180	104.05	-	-	96.52	32.46	6.02	30.95	104	232	A	H
		5145.86	56.08	-17.92	74	48.57	32.47	5.99	30.95	313	299	P	V
		5150	45.34	-8.66	54	37.83	32.47	5.99	30.95	313	299	A	V
	*	5180	110.12	-	-	102.59	32.46	6.02	30.95	313	299	P	V
	*	5180	99.73	-	-	92.2	32.46	6.02	30.95	313	299	A	V
802.11a CH 44 5220MHz		5143.52	54.59	-19.41	74	47.08	32.47	5.99	30.95	100	232	P	H
		5056.16	43.75	-10.25	54	36.28	32.49	5.93	30.95	100	232	A	H
	*	5220	115.76	-	-	108.21	32.46	6.04	30.95	100	232	P	H
	*	5220	104.91	-	-	97.36	32.46	6.04	30.95	100	232	A	H
		5430.88	59.18	-14.82	74	51.53	32.41	6.19	30.95	100	232	P	H
		5431.72	49.75	-4.25	54	42.1	32.41	6.19	30.95	100	232	A	H
		5066.3	50.85	-23.15	74	43.38	32.49	5.93	30.95	383	253	P	V
		5065.52	40.15	-13.85	54	32.68	32.49	5.93	30.95	383	253	A	V
	*	5220	112.41	-	-	104.86	32.46	6.04	30.95	383	253	P	V
	*	5220	101.8	-	-	94.25	32.46	6.04	30.95	383	253	A	V
		5431.16	52.08	-21.92	74	44.43	32.41	6.19	30.95	383	253	P	V
		5441.24	43.1	-10.9	54	35.45	32.41	6.19	30.95	383	253	A	V



<b>802.11a CH 48 5240MHz</b>		5085.02	53.75	-20.25	74	46.28	32.48	5.94	30.95	114	229	P	H
		5076.44	44.55	-9.45	54	37.08	32.48	5.94	30.95	114	229	A	H
	*	5240	115.88	-	-	108.33	32.45	6.05	30.95	114	229	P	H
	*	5240	105.21	-	-	97.66	32.45	6.05	30.95	114	229	A	H
		5457.48	58.07	-15.93	74	50.4	32.41	6.21	30.95	114	229	P	H
		5451.88	49.45	-4.55	54	41.78	32.41	6.21	30.95	114	229	A	H
		5122.2	50.57	-23.43	74	43.07	32.48	5.97	30.95	400	257	P	V
		5135.46	39.7	-14.3	54	32.2	32.47	5.98	30.95	400	257	A	V
	*	5240	112.57	-	-	105.02	32.45	6.05	30.95	400	257	P	V
	*	5240	101.81	-	-	94.26	32.45	6.05	30.95	400	257	A	V
		5394.76	52.24	-21.76	74	44.61	32.42	6.16	30.95	400	257	P	V
		5451.88	43.18	-10.82	54	35.51	32.41	6.21	30.95	400	257	A	V
Remark	1. No other spurious found. 2. All results are PASS against Peak and Average limit line.												



**Band 1 5150~5250MHz**  
**WIFI 802.11a (Harmonic @ 3m)**

WIFI Ant. 1+2	Note	Frequency ( MHz )	Level ( dBμV/m )	Over Limit ( dB )	Limit Line ( dBμV/m )	Read Level (dBμV)	Antenna Factor ( dB/m )	Cable Loss ( dB )	Preamp Factor ( dB )	Ant Pos ( cm )	Table Pos ( deg )	Peak Avg. (P/A)	Pol. (H/V)
802.11a CH 36 5180MHz		5338	57.03	-11.17	68.2	49.44	32.43	6.11	30.95	104	232	P	H
		5396	62.07	-11.93	74	54.44	32.42	6.16	30.95	104	232	P	H
		5396	50.29	-3.71	54	42.66	32.42	6.16	30.95	104	232	A	H
		5608	55.68	-12.52	68.2	47.63	32.7	6.34	30.99	104	232	P	H
		10360	50.4	-17.8	68.2	58	39.75	9.25	57.14	100	0	P	H
		15540	58.15	-15.85	74	64.76	39.38	11.47	58.22	126	35	P	H
		15540	42.59	-11.41	54	49.2	39.38	11.47	58.22	126	35	A	H
		5398	54.38	-19.62	74	46.75	32.42	6.16	30.95	313	299	P	V
		5398	41.89	-12.11	54	34.26	32.42	6.16	30.95	313	299	A	V
		5614	53.68	-14.52	68.2	45.61	32.72	6.34	30.99	313	299	P	V
		10360	50.02	-18.18	68.2	57.62	39.75	9.25	57.14	100	0	P	V
		15540	55.4	-18.6	74	62.01	39.38	11.47	58.22	400	40	P	V
		15540	39.82	-14.18	54	46.43	39.38	11.47	58.22	400	40	A	V
	802.11a CH 44 5220MHz		5655	53.38	-14.82	68.2	45.21	32.83	6.35	31.01	100	232	P
		10440	53.81	-14.39	68.2	61.12	39.89	9.28	57.02	100	0	P	H
		15660	58.47	-15.53	74	65.13	39.02	11.53	57.96	127	36	P	H
		15660	42.41	-11.59	54	49.07	39.02	11.53	57.96	127	36	A	H
		5655	52.17	-16.03	68.2	44	32.83	6.35	31.01	383	253	P	V
		10440	52.82	-15.38	68.2	60.13	39.89	9.28	57.02	100	0	P	V
		15660	56.01	-17.99	74	62.67	39.02	11.53	57.96	100	59	P	V
		15660	40.37	-13.63	54	47.03	39.02	11.53	57.96	100	59	A	V



<b>802.11a</b> <b>CH 48</b> <b>5240MHz</b>		4803	53.21	-20.79	74	46.26	32.15	5.78	30.98	114	229	P	H
		4803	40.06	-13.94	54	33.11	32.15	5.78	30.98	114	229	A	H
		5677	56.56	-11.64	68.2	48.32	32.9	6.35	31.01	114	229	P	H
		10480	54.6	-13.6	68.2	61.72	39.96	9.31	56.93	100	0	P	H
		15720	60.85	-13.15	74	67.52	38.84	11.56	57.81	125	112	P	H
		15720	44.51	-9.49	54	51.18	38.84	11.56	57.81	125	112	A	H
		4803	54.13	-19.87	74	47.18	32.15	5.78	30.98	362	251	P	V
		4803	39.93	-14.07	54	32.98	32.15	5.78	30.98	362	251	A	V
		5674	52.55	-15.65	68.2	44.32	32.89	6.35	31.01	400	257	P	V
		10480	53.13	-15.07	68.2	60.25	39.96	9.31	56.93	100	0	P	V
		15720	56.43	-17.57	74	63.1	38.84	11.56	57.81	100	60	P	V
		15720	41.06	-12.94	54	47.73	38.84	11.56	57.81	100	60	A	V
<b>Remark</b>	1. No other spurious found. 2. All results are PASS against Peak and Average limit line.												



**Band 1 5150~5250MHz**  
**WIFI 802.11n HT20 (Band Edge @ 3m)**

WIFI Ant. 1+2	Note	Frequency ( MHz )	Level ( dBμV/m )	Over Limit ( dB )	Limit Line ( dBμV/m )	Read Level ( dBμV )	Antenna Factor ( dB/m )	Cable Loss ( dB )	Preamp Factor ( dB )	Ant Pos ( cm )	Table Pos ( deg )	Peak Avg. ( P/A )	Pol. ( H/V )
802.11n HT20 CH 36 5180MHz		5148.98	60.83	-13.17	74	53.32	32.47	5.99	30.95	119	324	P	H
		5148.98	50.68	-3.32	54	43.17	32.47	5.99	30.95	119	324	A	H
	*	5180	114.43	-	-	106.9	32.46	6.02	30.95	119	324	P	H
	*	5180	103.22	-	-	95.69	32.46	6.02	30.95	119	324	A	H
		5149.76	54.72	-19.28	74	47.21	32.47	5.99	30.95	390	248	P	V
		5149.24	44.78	-9.22	54	37.27	32.47	5.99	30.95	390	248	A	V
	*	5180	110.8	-	-	103.27	32.46	6.02	30.95	390	248	P	V
	5180	100.08	-	-	92.55	32.46	6.02	30.95	390	248	A	V	
802.11n HT20 CH 44 5220MHz		5150	53.5	-20.5	74	45.99	32.47	5.99	30.95	101	324	P	H
		5148.2	43.25	-10.75	54	35.74	32.47	5.99	30.95	101	324	A	H
	*	5220	115.4	-	-	107.85	32.46	6.04	30.95	101	324	P	H
	*	5220	104.56	-	-	97.01	32.46	6.04	30.95	101	324	A	H
		5439.56	57.58	-16.42	74	49.93	32.41	6.19	30.95	101	324	P	H
		5429.48	48.42	-5.58	54	40.78	32.41	6.18	30.95	101	324	A	H
		5146.9	50.23	-23.77	74	42.72	32.47	5.99	30.95	363	254	P	V
		5065.26	40	-14	54	32.53	32.49	5.93	30.95	363	254	A	V
	*	5220	111.56	-	-	104.01	32.46	6.04	30.95	363	254	P	V
	*	5220	100.91	-	-	93.36	32.46	6.04	30.95	363	254	A	V
		5442.08	52.7	-21.3	74	45.05	32.41	6.19	30.95	363	254	P	V
	5444.6	43.22	-10.78	54	35.57	32.41	6.19	30.95	363	254	A	V	



<b>802.11n</b>  <b>HT20</b>  <b>CH 48</b>  <b>5240MHz</b>		5141.44	51.99	-22.01	74	44.49	32.47	5.98	30.95	126	325	P	H
		5075.14	41.18	-12.82	54	33.71	32.48	5.94	30.95	126	325	A	H
	*	5240	115.08	-	-	107.53	32.45	6.05	30.95	126	325	P	H
	*	5240	104.21	-	-	96.66	32.45	6.05	30.95	126	325	A	H
		5457.76	56.87	-17.13	74	49.2	32.41	6.21	30.95	126	325	P	H
		5450.2	48.01	-5.99	54	40.34	32.41	6.21	30.95	126	325	A	H
		5145.6	50.14	-23.86	74	42.63	32.47	5.99	30.95	400	256	P	V
		5136.5	39.68	-14.32	54	32.18	32.47	5.98	30.95	400	256	A	V
	*	5240	111.84	-	-	104.29	32.45	6.05	30.95	400	256	P	V
	*	5240	100.98	-	-	93.43	32.45	6.05	30.95	400	256	A	V
		5391.96	52.81	-21.19	74	45.19	32.42	6.15	30.95	400	256	P	V
		5453	42.57	-11.43	54	34.9	32.41	6.21	30.95	400	256	A	V
<b>Remark</b>	1. No other spurious found. 2. All results are PASS against Peak and Average limit line.												



**Band 1 5150~5250MHz**  
**WIFI 802.11n HT20 (Harmonic @ 3m)**

WIFI Ant. 1+2	Note	Frequency ( MHz )	Level ( dBμV/m )	Over Limit ( dB )	Limit Line ( dBμV/m )	Read Level (dBμV)	Antenna Factor ( dB/m )	Cable Loss ( dB )	Preamp Factor ( dB )	Ant Pos ( cm )	Table Pos ( deg )	Peak Avg. (P/A)	Pol. (H/V)
802.11n HT20 CH 36 5180MHz		4748	56.06	-17.94	74	49.25	32.05	5.75	30.99	119	327	P	H
		4748	43.74	-10.26	54	36.93	32.05	5.75	30.99	119	327	A	H
		5395	61.75	-12.25	74	54.12	32.42	6.16	30.95	100	325	P	H
		5395	49.68	-4.32	54	42.05	32.42	6.16	30.95	100	320	A	H
		5611	58.31	-9.89	68.2	50.25	32.71	6.34	30.99	119	324	P	H
		10360	49.61	-18.59	68.2	57.21	39.75	9.25	57.14	100	0	P	H
		15540	56.99	-17.01	74	63.6	39.38	11.47	58.22	100	0	P	H
		15540	42.36	-11.64	54	48.97	39.38	11.47	58.22	122	34	A	H
		4748	53.85	-20.15	74	47.04	32.05	5.75	30.99	394	251	P	V
		4748	40.75	-13.25	54	33.94	32.05	5.75	30.99	394	251	A	V
		5395	58.48	-15.52	74	50.85	32.42	6.16	30.95	400	248	P	V
		5395	46.12	-7.88	54	38.49	32.42	6.16	30.95	400	248	A	V
		5611	52.12	-16.08	68.2	44.06	32.71	6.34	30.99	390	248	P	V
		10360	49.98	-18.22	68.2	57.58	39.75	9.25	57.14	100	0	P	V
		15540	48.88	-25.12	74	55.49	39.38	11.47	58.22	100	0	P	V
802.11n HT20 CH 44 5220MHz		4785	55.62	-18.38	74	48.72	32.11	5.77	30.98	105	319	P	H
		4785	42.92	-11.08	54	36.02	32.11	5.77	30.98	105	319	A	H
		5655	58.13	-10.07	68.2	49.96	32.83	6.35	31.01	101	324	P	H
		10440	54.81	-13.39	68.2	62.12	39.89	9.28	57.02	100	0	P	H
		15660	57.15	-16.85	74	63.81	39.02	11.53	57.96	120	35	P	H
		15660	42.64	-11.36	54	49.3	39.02	11.53	57.96	120	35	A	H
		4785	52.61	-21.39	74	45.71	32.11	5.77	30.98	386	252	P	V
		4785	39.68	-14.32	54	32.78	32.11	5.77	30.98	386	252	A	V
		5655	52.45	-15.75	68.2	44.28	32.83	6.35	31.01	363	254	P	V
		10440	54.42	-13.78	68.2	61.73	39.89	9.28	57.02	100	0	P	V
	15660	54.99	-19.01	74	61.65	39.02	11.53	57.96	100	58	P	V	
	15660	40.28	-13.72	54	46.94	39.02	11.53	57.96	100	58	A	V	





<b>802.11n</b> <b>HT20</b> <b>CH 48</b> <b>5240MHz</b>		4803	54.51	-19.49	74	47.56	32.15	5.78	30.98	114	321	P	H
		4803	42.16	-11.84	54	35.21	32.15	5.78	30.98	114	321	A	H
		5676	56.67	-11.53	68.2	48.44	32.89	6.35	31.01	126	325	P	H
		10480	53.46	-14.74	68.2	60.58	39.96	9.31	56.93	100	0	P	H
		15720	58.02	-15.98	74	64.69	38.84	11.56	57.81	128	112	P	H
		15720	43.16	-10.84	54	49.83	38.84	11.56	57.81	128	112	A	H
		5676	52.84	-15.36	68.2	44.61	32.89	6.35	31.01	400	256	P	V
		10480	52.93	-15.27	68.2	60.05	39.96	9.31	56.93	100	0	P	V
		15720	49.49	-24.51	74	56.16	38.84	11.56	57.81	100	0	P	V
<b>Remark</b>	1. No other spurious found. 2. All results are PASS against Peak and Average limit line.												



**Band 1 5150~5250MHz**  
**WIFI 802.11n HT40 (Band Edge @ 3m)**

WIFI Ant. 1+2	Note	Frequency ( MHz )	Level ( dBμV/m )	Over Limit ( dB )	Limit Line ( dBμV/m )	Read Level ( dBμV )	Antenna Factor ( dB/m )	Cable Loss ( dB )	Preamp Factor ( dB )	Ant Pos ( cm )	Table Pos ( deg )	Peak Avg. ( P/A )	Pol. ( H/V )
802.11n HT40 CH 38 5190MHz		5150	60.03	-13.97	74	52.52	32.47	5.99	30.95	116	324	P	H
		5149.24	50.13	-3.87	54	42.62	32.47	5.99	30.95	116	324	A	H
	*	5190	105.15	-	-	97.62	32.46	6.02	30.95	116	324	P	H
	*	5190	94.94	-	-	87.41	32.46	6.02	30.95	116	324	A	H
		5362.28	50.62	-23.38	74	43	32.43	6.14	30.95	116	324	P	H
		5351.36	40.01	-13.99	54	32.41	32.43	6.12	30.95	116	324	A	H
		5149.24	54.21	-19.79	74	46.7	32.47	5.99	30.95	389	249	P	V
		5149.5	44.32	-9.68	54	36.81	32.47	5.99	30.95	389	249	A	V
	*	5190	101.71	-	-	94.18	32.46	6.02	30.95	389	249	P	V
	*	5190	91.56	-	-	84.03	32.46	6.02	30.95	389	249	A	V
		5383	49.15	-24.85	74	41.53	32.42	6.15	30.95	389	249	P	V
		5385.8	39.28	-14.72	54	31.66	32.42	6.15	30.95	389	249	A	V
802.11n HT40 CH 46 5230MHz		5147.42	60.27	-13.73	74	52.76	32.47	5.99	30.95	100	325	P	H
		5149.24	48.99	-5.01	54	41.48	32.47	5.99	30.95	100	325	A	H
	*	5230	112.24	-	-	104.7	32.45	6.04	30.95	100	325	P	H
	*	5230	101.69	-	-	94.15	32.45	6.04	30.95	100	325	A	H
		5350	52.39	-21.61	74	44.79	32.43	6.12	30.95	100	325	P	H
		5383.84	42.69	-11.31	54	35.07	32.42	6.15	30.95	100	325	A	H
		5142.48	55.07	-18.93	74	47.56	32.47	5.99	30.95	400	257	P	V
		5150	45.49	-8.51	54	37.98	32.47	5.99	30.95	400	257	A	V
	*	5230	108.18	-	-	100.64	32.45	6.04	30.95	400	257	P	V
	*	5230	98.01	-	-	90.47	32.45	6.04	30.95	400	257	A	V
	5395.6	51.58	-22.42	74	43.95	32.42	6.16	30.95	400	257	P	V	
	5384.12	41.88	-12.12	54	34.26	32.42	6.15	30.95	400	257	A	V	
Remark	1. No other spurious found. 2. All results are PASS against Peak and Average limit line.												



Band 1 5150~5250MHz
WIFI 802.11n HT40 (Harmonic @ 3m)

Table with 14 columns: WIFI Ant. 1+2, Note, Frequency (MHz), Level (dBµV/m), Over Limit (dB), Limit Line (dBµV/m), Read Level (dBµV), Antenna Factor (dB/m), Cable Loss (dB), Preamp Factor (dB), Ant Pos (cm), Table Pos (deg), Peak Avg. (P/A), Pol. (H/V). Rows include data for 802.11n HT40 CH 38 (5190MHz) and 802.11n HT40 CH 46 (5230MHz).

- 1. No other spurious found.
2. All results are PASS against Peak and Average limit line.



**Band 1 5150~5250MHz**  
**WIFI 802.11ac VHT80 (Band Edge @ 3m)**

WIFI Ant. 1+2	Note	Frequency ( MHz )	Level ( dBμV/m )	Over Limit ( dB )	Limit Line ( dBμV/m )	Read Level (dBμV)	Antenna Factor ( dB/m )	Cable Loss ( dB )	Preamp Factor ( dB )	Ant Pos ( cm )	Table Pos ( deg )	Peak Avg. (P/A)	Pol. (H/V)
<b>802.11ac VHT80 CH 42 5210MHz</b>		5141.96	59.41	-14.59	74	51.91	32.47	5.98	30.95	100	325	P	H
		5145.86	50.27	-3.73	54	42.76	32.47	5.99	30.95	100	325	A	H
	*	5210	101.52	-	-	93.98	32.46	6.03	30.95	100	325	P	H
	*	5210	92.06	-	-	84.52	32.46	6.03	30.95	100	325	A	H
		5430.32	50.22	-23.78	74	42.57	32.41	6.19	30.95	100	325	P	H
		5351.08	41.57	-12.43	54	33.97	32.43	6.12	30.95	100	325	A	H
		5149.5	53.47	-20.53	74	45.96	32.47	5.99	30.95	365	254	P	V
		5148.98	44.6	-9.4	54	37.09	32.47	5.99	30.95	365	254	A	V
	*	5210	98.03	-	-	90.49	32.46	6.03	30.95	365	254	P	V
	*	5210	88.57	-	-	81.03	32.46	6.03	30.95	365	254	A	V
		5450.76	49.4	-24.6	74	41.73	32.41	6.21	30.95	365	254	P	V
		5356.68	40.47	-13.53	54	32.87	32.43	6.12	30.95	365	254	A	V
<b>Remark</b>	1. No other spurious found. 2. All results are PASS against Peak and Average limit line.												



Band 1 5150~5250MHz

WIFI 802.11ac VHT80 (Harmonic @ 3m)

WIFI Ant. 1+2	Note	Frequency ( MHz )	Level ( dBμV/m )	Over Limit ( dB )	Limit Line ( dBμV/m )	Read Level (dBμV)	Antenna Factor ( dB/m )	Cable Loss ( dB )	Preamp Factor ( dB )	Ant Pos ( cm )	Table Pos ( deg )	Peak Avg. (P/A)	Pol. (H/V)
802.11ac VHT80 CH 42 5210MHz		10420	49.17	-19.03	68.2	56.55	39.86	9.27	57.05	100	0	P	H
		15630	48.85	-25.15	74	55.48	39.11	11.51	58	100	0	P	H
		10420	49.02	-19.18	68.2	56.4	39.86	9.27	57.05	100	0	P	V
		15630	48.15	-25.85	74	54.78	39.11	11.51	58	100	0	P	V
Remark	1. No other spurious found. 2. All results are PASS against Peak and Average limit line.												



**Emission below 1GHz**  
**WIFI 802.11n HT20 (LF @ 3m)**

WIFI	Note	Frequency	Level	Over	Limit	Read	Antenna	Cable	Preamp	Ant	Table	Peak	Pol.
Ant.				Limit	Line	Level	Factor	Loss	Factor	Pos	Pos	Avg.	
1+2		( MHz )	( dBμV/m )	( dB )	( dBμV/m )	( dBμV )	( dB/m )	( dB )	( dB )	( cm )	( deg )	( P/A )	( H/V )
802.11n HT20 LF		173.91	30.84	-12.66	43.5	46.51	15.48	1.09	32.41			P	H
		210.63	32.72	-10.78	43.5	48.56	15.22	1.19	32.39			P	H
		242.22	29.97	-16.03	46	43.19	17.72	1.28	32.38			P	H
		729.1	33.97	-12.03	46	36.43	27.65	2.18	32.39			P	H
		746.6	35.35	-10.65	46	37.22	28.16	2.21	32.34	100	0	P	H
		947.5	32.14	-13.86	46	29.86	30.77	2.49	31.22			P	H
		36.75	30.51	-9.49	40	41.49	21.05	0.48	32.49			P	V
		119.91	25.35	-18.15	43.5	39.34	17.55	0.89	32.46			P	V
		216.03	26.18	-19.82	46	41.97	15.27	1.19	32.39			P	V
		729.8	34.98	-11.02	46	37.43	27.65	2.18	32.38			P	V
		746.6	38.48	-7.52	46	40.35	28.16	2.21	32.34	100	0	P	V
	972.7	32.08	-21.92	54	29.25	31.09	2.51	31			P	V	
Remark	1. No other spurious found. 2. All results are PASS against limit line.												



**Note symbol**

*	<b>Fundamental Frequency</b> which can be ignored. However, the level of any unwanted emissions shall not exceed the level of the fundamental frequency.
!	Test result is <b>over limit</b> line.
P/A	<b>Peak</b> or <b>Average</b>
H/V	<b>Horizontal</b> or <b>Vertical</b>



A calculation example for radiated spurious emission is shown as below:

WIFI	Note	Frequency	Level	Over	Limit	Read	Antenna	Cable	Preamp	Ant	Table	Peak	Pol.
Ant.				Limit	Line	Level	Factor	Loss	Factor	Pos	Pos	Avg.	
1+2		( MHz )	( dBμV/m )	( dB )	( dBμV/m )	( dBμV )	( dB/m )	( dB )	( dB )	( cm )	( deg )	( P/A )	( H/V )
802.11b		2390	55.45	-18.55	74	54.51	32.22	4.58	35.86	103	308	P	H
CH 01													
2412MHz		2390	43.54	-10.46	54	42.6	32.22	4.58	35.86	103	308	A	H

- Level(dBμV/m) =  
Antenna Factor(dB/m) + Cable Loss(dB) + Read Level(dBμV) - Preamp Factor(dB)
- Over Limit(dB) = Level(dBμV/m) – Limit Line(dBμV/m)

**For Peak Limit @ 2390MHz:**

- Level(dBμV/m)  
= Antenna Factor(dB/m) + Cable Loss(dB) + Read Level(dBμV) - Preamp Factor(dB)  
= 32.22(dB/m) + 4.58(dB) + 54.51(dBμV) – 35.86 (dB)  
= 55.45 (dBμV/m)
- Over Limit(dB)  
= Level(dBμV/m) – Limit Line(dBμV/m)  
= 55.45(dBμV/m) – 74(dBμV/m)  
= -18.55(dB)

**For Average Limit @ 2390MHz:**

- Level(dBμV/m)  
= Antenna Factor(dB/m) + Cable Loss(dB) + Read Level(dBμV) - Preamp Factor(dB)  
= 32.22(dB/m) + 4.58(dB) + 42.6(dBμV) – 35.86 (dB)  
= 43.54 (dBμV/m)
- Over Limit(dB)  
= Level(dBμV/m) – Limit Line(dBμV/m)  
= 43.54(dBμV/m) – 54(dBμV/m)  
= -10.46(dB)

Both peak and average measured complies with the limit line, so test result is “PASS”.





## Appendix D. Radiated Spurious Emission

Test Engineer :	Peter Liao and Nick Yu	Temperature :	22~26°C
		Relative Humidity :	56~62%

### Note symbol

-L	Low channel location
-R	High channel location



Band 1 - 5150~5250MHz
WIFI 802.11a (Band Edge @ 3m)

Table with 2 columns (WIFI, ANT) and 2 rows (Peak, Avg.). It contains spectral plots for 'Horizontal' and 'Fundamental' views. The 'Peak' row shows a sharp peak at 5180MHz in the 'Fundamental' view. The 'Avg.' row shows a broader peak in the 'Horizontal' view. The 'Fundamental' view in the 'Avg.' row is labeled 'Left blank'.



WIFI	Band 1 5150~5250MHz Band Edge @ 3m	
ANT	802.11a CH36 5180MHz	
1	Vertical	Fundamental
Peak	<p>Site Condition : 03CH12-HY : PEAK_BE_74 3m HORN_9120D_1328 VERTICAL</p>	<p>Site Condition : 03CH12-HY : PEAK(U) 3m HORN_9120D_1328 VERTICAL</p>
Avg.	<p>Site Condition : 03CH12-HY : AVG_BE_54 3m HORN_9120D_1328 VERTICAL</p>	Left blank

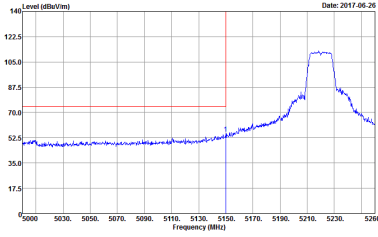
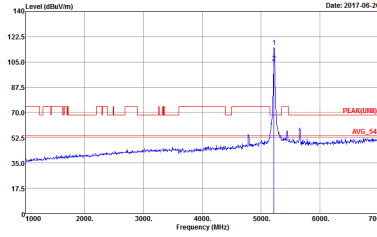
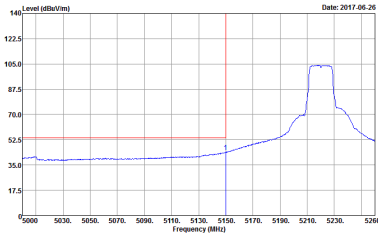

WIFI	Band 1 5150~5250MHz Band Edge @ 3m	
ANT	802.11a CH44 5220MHz - L	
1	Horizontal	Fundamental
<p><b>Peak</b></p>	 <p>Site Condition : 03CH12-HY : PEAK_BE_74 3m HORN_9120D_1328 HORIZONTAL</p>	 <p>Site Condition : 03CH12-HY : PEAK(UNI) 3m HORN_9120D_1328 HORIZONTAL</p>
<p><b>Avg.</b></p>	 <p>Site Condition : 03CH12-HY : AVG_BE_54 3m HORN_9120D_1328 HORIZONTAL</p>	<p>Left blank</p>



WIFI	Band 1 5150~5250MHz Band Edge @ 3m	
ANT	802.11a CH44 5220MHz - R	
1	Horizontal	Fundamental
Peak	<p>Site Condition : 03CH12-HY : PEAK_BE_74 3m HORN_9120D_1328 HORIZONTAL</p>	Left blank
Avg.	<p>Site Condition : 03CH12-HY : AVG_BE_54 3m HORN_9120D_1328 HORIZONTAL</p>	Left blank

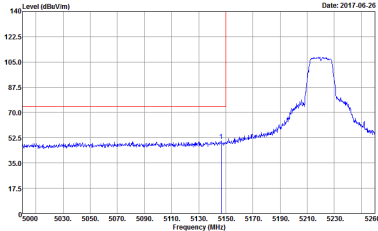
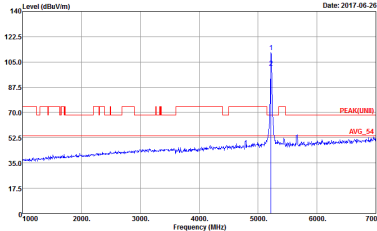
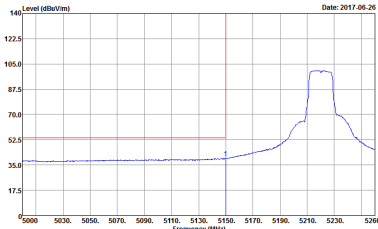

WIFI	Band 1 5150~5250MHz Band Edge @ 3m	
ANT	802.11a CH44 5220MHz - L	
1	Vertical	Fundamental
Peak	 <p>Site Condition : 03CH12-HY : PEAK_BE_74 3m HORN_9120D_1328 VERTICAL</p>	 <p>Site Condition : 03CH12-HY : PEAK(UNI) 3m HORN_9120D_1328 VERTICAL</p>
Avg.	 <p>Site Condition : 03CH12-HY : AVG_BE_54 3m HORN_9120D_1328 VERTICAL</p>	Left blank



WIFI	Band 1 5150~5250MHz Band Edge @ 3m	
ANT	802.11a CH44 5220MHz - R	
1	Vertical	Fundamental
Peak	<p>Site Condition : 03CH12-HY : PEAK_BE_74 3m HORN_9120D_1328 VERTICAL</p>	Left blank
Avg.	<p>Site Condition : 03CH12-HY : AVG_BE_54 3m HORN_9120D_1328 VERTICAL</p>	Left blank



WIFI	Band 1 5150~5250MHz Band Edge @ 3m	
ANT	802.11a CH48 5240MHz - L	
1	Horizontal	Fundamental
<p><b>Peak</b></p>		
<p><b>Avg.</b></p>		<p><b>Left blank</b></p>



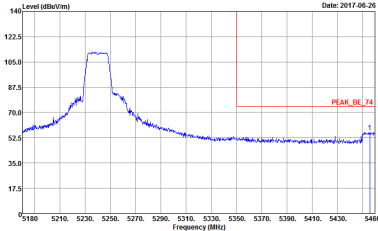
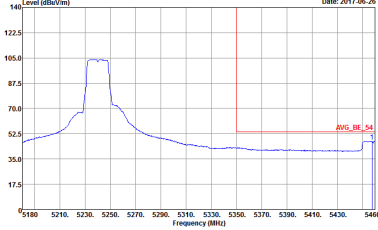

WIFI	Band 1 5150~5250MHz Band Edge @ 3m	
ANT	802.11a CH48 5240MHz - R	
1	Horizontal	Fundamental
<p><b>Peak</b></p>	 <p>Site Condition : 03CH12-HY : PEAK_BE_74 3m HORN_9120D_1328 HORIZONTAL</p>	<p>Left blank</p>
<p><b>Avg.</b></p>	 <p>Site Condition : 03CH12-HY : AVG_BE_54 3m HORN_9120D_1328 HORIZONTAL</p>	<p>Left blank</p>



WIFI	Band 1 5150~5250MHz Band Edge @ 3m	
ANT	802.11a CH48 5240MHz - L	
1	Vertical	Fundamental
Peak	<p>Site Condition : 03CH12-HY : PEAK_BE_74 3m HORN_9120D_1328 VERTICAL</p>	<p>Site Condition : 03CH12-HY : PEAK(UNIB) 3m HORN_9120D_1328 VERTICAL</p>
Avg.	<p>Site Condition : 03CH12-HY : AVG_BE_54 3m HORN_9120D_1328 VERTICAL</p>	Left blank

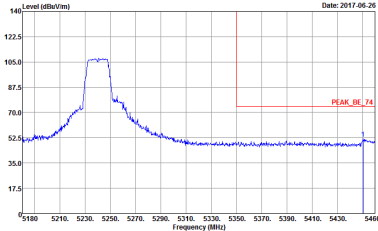
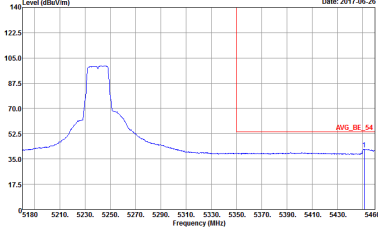

WIFI	Band 1 5150~5250MHz Band Edge @ 3m	
ANT	802.11a CH48 5240MHz - R	
1	Vertical	Fundamental
<p><b>Peak</b></p>	 <p>Site Condition : 03CH12-HY : PEAK_BE_74 3m HORN_9120D_1328 VERTICAL</p>	<p>Left blank</p>
<p><b>Avg.</b></p>	 <p>Site Condition : 03CH12-HY : AVG_BE_54 3m HORN_9120D_1328 VERTICAL</p>	<p>Left blank</p>



**Band 1 5150~5250MHz  
WIFI 802.11n HT20 (Band Edge @ 3m)**

WIFI	Band 1 5150~5250MHz Band Edge @ 3m	
ANT	802.11n HT20 CH36 5180MHz	
1	Horizontal	Fundamental
<b>Peak</b>	<p>Site Condition : 03CH12-HY : PEAK_BE_74 3m HORN_9120D_1328 HORIZONTAL</p>	<p>Site Condition : 03CH12-HY : PEAK(UM) 3m HORN_9120D_1328 HORIZONTAL</p>
<b>Avg.</b>	<p>Site Condition : 03CH12-HY : AVG_BE_54 3m HORN_9120D_1328 HORIZONTAL</p>	<b>Left blank</b>

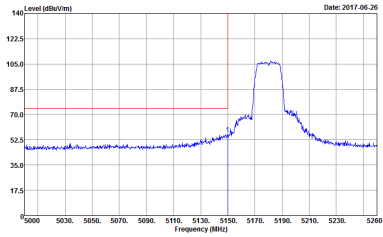
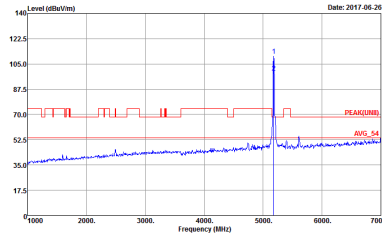
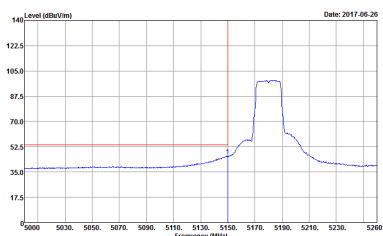

WIFI	Band 1 5150~5250MHz Band Edge @ 3m	
ANT	802.11n HT20 CH36 5180MHz	
1	Vertical	Fundamental
Peak	 <p>Site Condition : 03CH12-HY : PEAK_BE_74 3m HORN_9120D_1328 VERTICAL</p>	 <p>Site Condition : 03CH12-HY : PEAK(UNI) 3m HORN_9120D_1328 VERTICAL</p>
Avg.	 <p>Site Condition : 03CH12-HY : AVG_BE_54 3m HORN_9120D_1328 VERTICAL</p>	Left blank



WIFI	Band 1 5150~5250MHz Band Edge @ 3m	
ANT	802.11n HT20 CH44 5220MHz - L	
1	Horizontal	Fundamental
Peak	<p>Site Condition : 03CH12-HY : PEAK_BE_74 3m HORN_9120D_132B HORIZONTAL</p>	<p>Site Condition : 03CH12-HY : PEAK(UNI) 3m HORN_9120D_132B HORIZONTAL</p>
Avg.	<p>Site Condition : 03CH12-HY : AVG_BE_54 3m HORN_9120D_132B HORIZONTAL</p>	Left blank

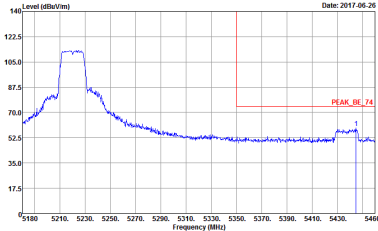
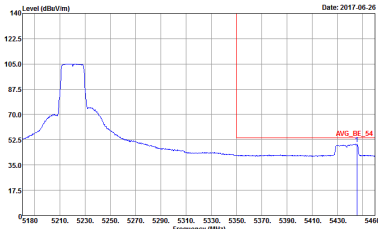

WIFI	Band 1 5150~5250MHz Band Edge @ 3m	
ANT	802.11n HT20 CH44 5220MHz - R	
1	Horizontal	Fundamental
<p><b>Peak</b></p>	 <p>Site Condition : 03CH12-HY : PEAK_BE_74 3m HORN_9120D_1328 HORIZONTAL</p>	<p>Left blank</p>
<p><b>Avg.</b></p>	 <p>Site Condition : 03CH12-HY : AVG_BE_54 3m HORN_9120D_1328 HORIZONTAL</p>	<p>Left blank</p>

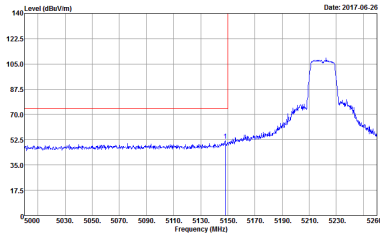
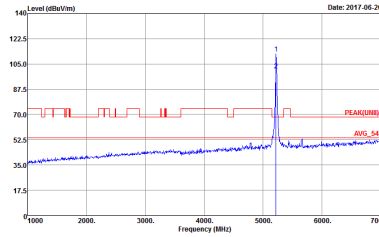
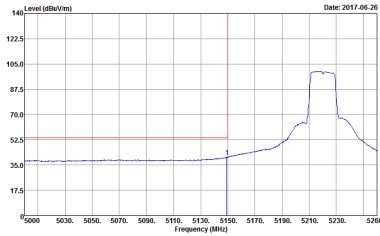

WIFI	Band 1 5150~5250MHz Band Edge @ 3m	
ANT	802.11n HT20 CH44 5220MHz - L	
1	Vertical	Fundamental
<p><b>Peak</b></p>	 <p>Site Condition : 03CH12-HY : PEAK_BE_74 3m HORN_9120D_1328 VERTICAL</p>	 <p>Site Condition : 03CH12-HY : PEAK(UN) 3m HORN_9120D_1328 VERTICAL</p>
<p><b>Avg.</b></p>	 <p>Site Condition : 03CH12-HY : AVG_BE_54 3m HORN_9120D_1328 VERTICAL</p>	<p>Left blank</p>





WIFI	Band 1 5150~5250MHz Band Edge @ 3m	
ANT	802.11n HT20 CH44 5220MHz - R	
1	Vertical	Fundamental
Peak	<p>Site Condition : 03CH12-HY : PEAK_BE_74 3m HORN_9120D_1328 VERTICAL</p>	Left blank
Avg.	<p>Site Condition : 03CH12-HY : AVG_BE_54 3m HORN_9120D_1328 VERTICAL</p>	Left blank

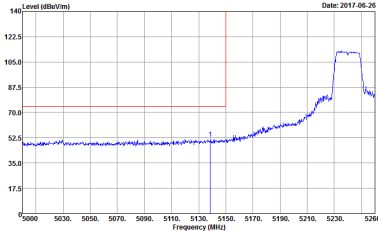
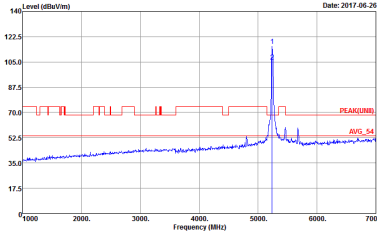
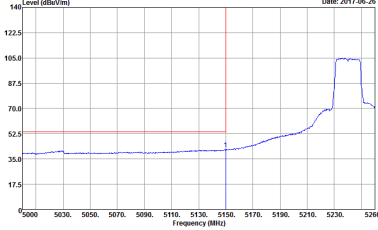

WIFI	Band 1 5150~5250MHz Band Edge @ 3m	
ANT	802.11n HT20 CH48 5240MHz - L	
1	Horizontal	Fundamental
<p><b>Peak</b></p>	 <p>Site Condition : 03CH12-HY : PEAK_BE_74 3m HORN_9120D_132B HORIZONTAL</p>	 <p>Site Condition : 03CH12-HY : PEAK(UNI) 3m HORN_9120D_132B HORIZONTAL</p>
<p><b>Avg.</b></p>	 <p>Site Condition : 03CH12-HY : AVG_BE_54 3m HORN_9120D_132B HORIZONTAL</p>	<p><b>Left blank</b></p>



WIFI	Band 1 5150~5250MHz Band Edge @ 3m	
ANT	802.11n HT20 CH48 5240MHz - R	
1	Horizontal	Fundamental
Peak	<p>Site Condition : 03CH12-HY : PEAK_BE_74 3m HORN_9120D_1328 HORIZONTAL</p>	Left blank
Avg.	<p>Site Condition : 03CH12-HY : AVG_BE_54 3m HORN_9120D_1328 HORIZONTAL</p>	Left blank



WIFI	Band 1 5150~5250MHz Band Edge @ 3m	
ANT	802.11n HT20 CH48 5240MHz - L	
1	Vertical	Fundamental
Peak	<p>Site Condition : 03CH12-HY : PEAK_BE_74 3m HORN_9120D_1328 VERTICAL</p>	<p>Site Condition : 03CH12-HY : PEAK(UNI) 3m HORN_9120D_1328 VERTICAL</p>
Avg.	<p>Site Condition : 03CH12-HY : AVG_BE_54 3m HORN_9120D_1328 VERTICAL</p>	Left blank



WIFI	Band 1 5150~5250MHz Band Edge @ 3m	
ANT	802.11n HT20 CH48 5240MHz - R	
1	Vertical	Fundamental
Peak	<p>Site Condition : 03CH12-HY : PEAK_BE_74 3m HORN_9120D_1328 VERTICAL</p>	Left blank
Avg.	<p>Site Condition : 03CH12-HY : AVG_BE_54 3m HORN_9120D_1328 VERTICAL</p>	Left blank



**Band 1 5150~5250MHz  
WIFI 802.11n HT40 (Band Edge @ 3m)**

WIFI	Band 1 5150~5250MHz Band Edge @ 3m	
ANT	802.11n HT40 CH38 5190MHz - L	
1	Horizontal	Fundamental
<b>Peak</b>	<p>Site Condition : 03CH12-HY : PEAK_BE_74 3m HORN_9120D_1328 HORIZONTAL</p>	<p>Site Condition : 03CH12-HY : PEAK(UNI) 3m HORN_9120D_1328 HORIZONTAL</p>
<b>Avg.</b>	<p>Site Condition : 03CH12-HY : AVG_BE_54 3m HORN_9120D_1328 HORIZONTAL</p>	<b>Left blank</b>



WIFI	Band 1 5150~5250MHz Band Edge @ 3m	
ANT	802.11n HT40 CH38 5190MHz - R	
1	Horizontal	Fundamental
<p><b>Peak</b></p>		<p>Left blank</p>
<p><b>Avg.</b></p>		<p>Left blank</p>



WIFI	Band 1 5150~5250MHz Band Edge @ 3m	
ANT	802.11n HT40 CH38 5190MHz - L	
1	Vertical	Fundamental
Peak	<p>Site Condition : 03CH12-HY : PEAK_BE_74 3m HORN_91200_1328 VERTICAL</p>	<p>Site Condition : 03CH12-HY : PEAK(UNI) 3m HORN_91200_1328 VERTICAL</p>
Avg.	<p>Site Condition : 03CH12-HY : AVG_BE_54 3m HORN_91200_1328 VERTICAL</p>	Left blank





WIFI	Band 1 5150~5250MHz Band Edge @ 3m	
ANT	802.11n HT40 CH38 5190MHz - R	
1	Vertical	Fundamental
<p><b>Peak</b></p>	<p>Site Condition : 03CH12-HY : PEAK_BE_74 3m HORN_9120D_1328 VERTICAL</p>	<p>Left blank</p>
<p><b>Avg.</b></p>	<p>Site Condition : 03CH12-HY : AVG_BE_54 3m HORN_9120D_1328 VERTICAL</p>	<p>Left blank</p>



WIFI	Band 1 5150~5250MHz Band Edge @ 3m	
ANT	802.11n HT40 CH46 5230MHz - L	
1	Horizontal	Fundamental
<p><b>Peak</b></p>	<p>Site Condition : 03CH12-HY : PEAK_BE_74 3m HORN_9120D_1328 HORIZONTAL</p>	<p>Site Condition : 03CH12-HY : PEAK(UNI) 3m HORN_9120D_1328 HORIZONTAL</p>
<p><b>Avg.</b></p>	<p>Site Condition : 03CH12-HY : AVG_BE_54 3m HORN_9120D_1328 HORIZONTAL</p>	<p>Left blank</p>



WIFI	Band 1 5150~5250MHz Band Edge @ 3m	
ANT	802.11n HT40 CH46 5230MHz - R	
1	Horizontal	Fundamental
<p><b>Peak</b></p>		<p>Left blank</p>
<p><b>Avg.</b></p>		<p>Left blank</p>



WIFI	Band 1 5150~5250MHz Band Edge @ 3m	
ANT	802.11n HT40 CH46 5230MHz - L	
1	Vertical	Fundamental
Peak	<p>Site Condition : 03CH12-HY : PEAK_BE_74 3m HORN_9120D_1328 VERTICAL</p>	<p>Site Condition : 03CH12-HY : PEAK(UNI) 3m HORN_9120D_1328 VERTICAL</p>
Avg.	<p>Site Condition : 03CH12-HY : AVG_BE_54 3m HORN_9120D_1328 VERTICAL</p>	Left blank



WIFI	Band 1 5150~5250MHz Band Edge @ 3m	
ANT	802.11n HT40 CH46 5230MHz - R	
1	Vertical	Fundamental
<p><b>Peak</b></p>		<p>Left blank</p>
<p><b>Avg.</b></p>		<p>Left blank</p>



**Band 1 5150~5250MHz  
WIFI 802.11ac VHT80 (Band Edge @ 3m)**

WIFI	Band 1 5150~5250MHz Band Edge @ 3m	
ANT	802.11ac VHT80 CH42 5210MHz - L	
1	Horizontal	Fundamental
<b>Peak</b>	<p>Site Condition : 03CH12-HY : PEAK_BE_74 3m HORN_91200_1328 HORIZONTAL</p>	<p>Site Condition : 03CH12-HY : PEAK(UNI) 3m HORN_91200_1328 HORIZONTAL</p>
<b>Avg.</b>	<p>Site Condition : 03CH12-HY : AVG_BE_54 3m HORN_91200_1328 HORIZONTAL</p>	<b>Left blank</b>



WIFI	Band 1 5150~5250MHz Band Edge @ 3m	
ANT	802.11ac VHT80 CH42 5210MHz - R	
1	Horizontal	Fundamental
<p><b>Peak</b></p>	<p>Site Condition : 03CH12-HY : PEAK_BE_74 3m HORN_9120D_1328 HORIZONTAL</p>	<p>Left blank</p>
<p><b>Avg.</b></p>	<p>Site Condition : 03CH12-HY : AVG_BE_54 3m HORN_9120D_1328 HORIZONTAL</p>	<p>Left blank</p>

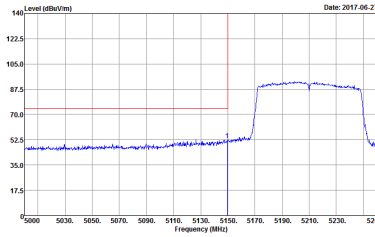
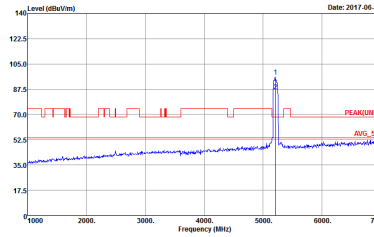
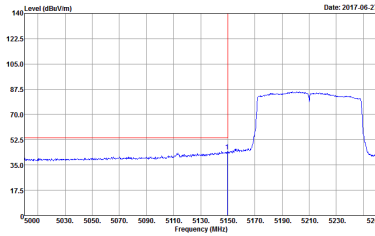

WIFI	Band 1 5150~5250MHz Band Edge @ 3m	
ANT	802.11ac VHT80 CH42 5210MHz - L	
1	Vertical	Fundamental
<p><b>Peak</b></p>	 <p>Site Condition : 03CH12-HY : PEAK_BE_74 3m HORN_9120D_1328 VERTICAL</p>	 <p>Site Condition : 03CH12-HY : PEAK(UNI) 3m HORN_9120D_1328 VERTICAL</p>
<p><b>Avg.</b></p>	 <p>Site Condition : 03CH12-HY : AVG_BE_54 3m HORN_9120D_1328 VERTICAL</p>	<p><b>Left blank</b></p>





WIFI	Band 1 5150~5250MHz Band Edge @ 3m	
ANT	802.11ac VHT80 CH42 5210MHz - R	
1	Vertical	Fundamental
Peak	<p>Site Condition : 03CH12-HY : PEAK_BE_74 3m HORN_9120D_1328 VERTICAL</p>	Left blank
Avg.	<p>Site Condition : 03CH12-HY : AVG_BE_54 3m HORN_9120D_1328 VERTICAL</p>	Left blank



Band 1 - 5150~5250MHz

WIFI 802.11a (Harmonic @ 3m)

WIFI	Band 1 5150~5250MHz Harmonic @ 3m	
ANT	802.11a CH36 5180MHz	
1	Horizontal	Vertical
Peak Avg.	<p>Site Condition : 03CH12-RY : PEAK(UNIT) 3m HORN_9120D_1328 HORIZONTAL</p>	<p>Site Condition : 03CH12-RY : PEAK(UNIT) 3m HORN_9120D_1328 VERTICAL</p>



WIFI	Band 1 5150~5250MHz Harmonic @ 3m	
ANT	802.11a CH44 5220MHz	
1	Horizontal	Vertical
Peak Avg.		

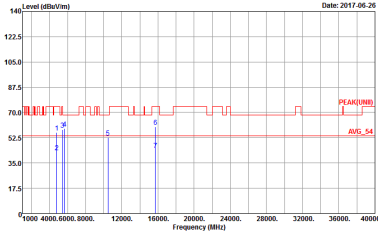
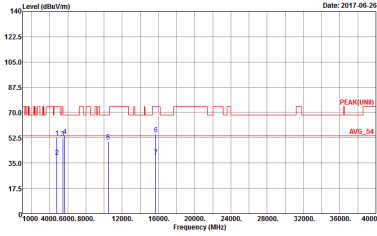

WIFI	Band 1 5150~5250MHz Harmonic @ 3m	
ANT	802.11a CH48 5240MHz	
1	Horizontal	Vertical
Peak Avg.	 <p>Site Condition : 03CH12-HY : PEAK(UNIT) 3m HORN_9120D_1328 HORIZONTAL</p>	 <p>Site Condition : 03CH12-HY : PEAK(UNIT) 3m HORN_9120D_1328 VERTICAL</p>



**Band 1 5150~5250MHz  
WIFI 802.11n HT20 (Harmonic @ 3m)**

WIFI	Band 1 5150~5250MHz Harmonic @ 3m	
ANT	802.11n HT20 CH36 5180MHz	
1	Horizontal	Vertical
<p><b>Peak</b></p> <p><b>Avg.</b></p>	<p>Site Condition : 03CH12-HY : PEAK(UNIT) 3m HORN_9120D_132B HORIZONTAL</p>	<p>Site Condition : 03CH12-HY : PEAK(UNIT) 3m HORN_9120D_132B VERTICAL</p>

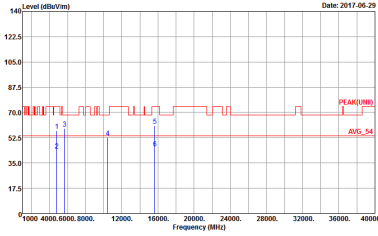
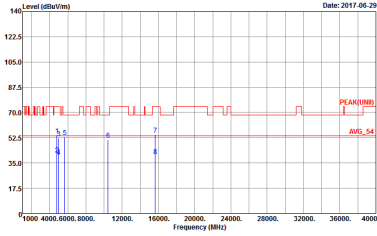

WIFI	Band 1 5150~5250MHz Harmonic @ 3m	
ANT	802.11n HT20 CH44 5220MHz	
1	Horizontal	Vertical
Peak Avg.	 <p>Site Condition : 03CH12-HY : PEAK(UNI) 3m HORN_9120D_1328 HORIZONTAL</p>	 <p>Site Condition : 03CH12-HY : PEAK(UNI) 3m HORN_9120D_1328 VERTICAL</p>



WIFI	Band 1 5150~5250MHz Harmonic @ 3m	
ANT	802.11n HT20 CH48 5240MHz	
1	Horizontal	Vertical
Peak Avg.	<p>Horizontal spectrum plot showing Level (dBuV/m) vs Frequency (MHz). The plot displays a series of peaks between 5150 MHz and 5250 MHz. The y-axis ranges from 0 to 140 dBuV/m, and the x-axis ranges from 0 to 40000 MHz. A red line indicates the average level at 54 dBuV/m. The plot is dated 2017.06.29. The site condition is 03CH12-HY : PEAK(UNI) 3m HORN_9120D_1328 HORIZONTAL.</p>	<p>Vertical spectrum plot showing Level (dBuV/m) vs Frequency (MHz). The plot displays a series of peaks between 5150 MHz and 5250 MHz. The y-axis ranges from 0 to 140 dBuV/m, and the x-axis ranges from 0 to 40000 MHz. A red line indicates the average level at 54 dBuV/m. The plot is dated 2017.06.29. The site condition is 03CH12-HY : PEAK(UNI) 3m HORN_9120D_1328 VERTICAL.</p>



Band 1 5150~5250MHz  
WIFI 802.11n HT40 (Harmonic @ 3m)

WIFI	Band 1 5150~5250MHz Harmonic @ 3m	
ANT	802.11n HT40 CH38 5190MHz	
1	Horizontal	Vertical
Peak Avg.	<p>Site Condition : 03CH12-HY : PEAK(UNIT) 3m HORN_9120D_132B HORIZONTAL</p>	<p>Site Condition : 03CH12-HY : PEAK(UNIT) 3m HORN_9120D_132B VERTICAL</p>





WIFI	Band 1 5150~5250MHz Harmonic @ 3m	
ANT	802.11n HT40 CH46 5230MHz	
1	Horizontal	Vertical
Peak Avg.		



Band 1 5150~5250MHz
WIFI 802.11ac VHT80 (Harmonic @ 3m)

Table with 3 columns: WIFI, ANT, and 1. It contains two graphs: Horizontal and Vertical, showing Level (dBuV/m) vs Frequency (MHz) for Peak and Avg. values. Includes site condition details like '03CH12-HY' and 'PEAK(UNIT) 3m HORN\_9120D\_132B HORIZONTAL'.



Emission below 1GHz  
5GHz WIFI 802.11n HT40 (LF)

WIFI	5GHz WIFI	
ANT	802.11n HT40 LF	
1	Horizontal	Vertical
QP / Peak	<p>Site Condition : 03CH12-RT : QP 3m BILOG_6111D_37059 HORIZONTAL</p>	<p>Site Condition : 03CH12-RT : QP 3m BILOG_6111D_37059 VERTICAL</p>



**Band 1 - 5150~5250MHz**  
**WIFI 802.11a (Band Edge @ 3m)**

WIFI	Band 1 5150~5250MHz Band Edge @ 3m	
ANT	802.11a CH36 5180MHz	
2	Horizontal	Fundamental
<b>Peak</b>	<p>Site Condition : 03CH12-HY : PEAK_BE_74 3m HORN_91200_1328 HORIZONTAL</p>	<p>Site Condition : 03CH12-HY : PEAK(UNIT) 3m HORN_91200_1328 HORIZONTAL</p>
<b>Avg.</b>	<p>Site Condition : 03CH12-HY : AVG_BE_54 3m HORN_91200_1328 HORIZONTAL</p>	<b>Left blank</b>



WIFI	Band 1 5150~5250MHz Band Edge @ 3m	
ANT	802.11a CH36 5180MHz	
2	Vertical	Fundamental
Peak	<p>Site Condition : 03CH12-HY : PEAK_BE_74 3m HORN_9120D_1328 VERTICAL</p>	<p>Site Condition : 03CH12-HY : PEAK(UNI) 3m HORN_9120D_1328 VERTICAL</p>
Avg.	<p>Site Condition : 03CH12-HY : AVG_BE_54 3m HORN_9120D_1328 VERTICAL</p>	Left blank



WIFI	Band 1 5150~5250MHz Band Edge @ 3m	
ANT	802.11a CH44 5220MHz - L	
2	Horizontal	Fundamental
<p><b>Peak</b></p>		
<p><b>Avg.</b></p>		<p><b>Left blank</b></p>

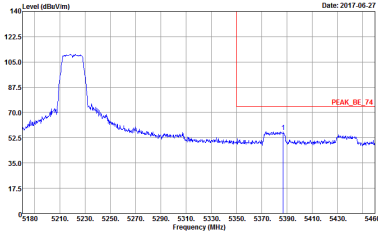
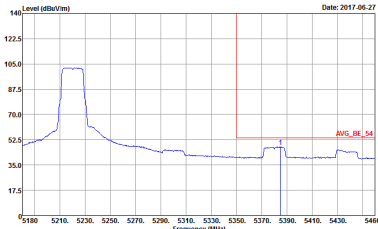

WIFI	Band 1 5150~5250MHz Band Edge @ 3m	
ANT	802.11a CH44 5220MHz - R	
2	Horizontal	Fundamental
<p><b>Peak</b></p>	 <p>Site Condition : 03CH12-HY : PEAK_BE_74 3m HORN_9120D_1328 HORIZONTAL</p>	<p>Left blank</p>
<p><b>Avg.</b></p>	 <p>Site Condition : 03CH12-HY : AVG_BE_54 3m HORN_9120D_1328 HORIZONTAL</p>	<p>Left blank</p>



WIFI	Band 1 5150~5250MHz Band Edge @ 3m	
ANT	802.11a CH44 5220MHz - L	
2	Vertical	Fundamental
<p><b>Peak</b></p>	<p>Site Condition : 03CH12-HY : PEAK_BE_74 3m HORN_9120D_1328 VERTICAL</p>	<p>Site Condition : 03CH12-HY : PEAK(UNI) 3m HORN_9120D_1328 VERTICAL</p>
<p><b>Avg.</b></p>	<p>Site Condition : 03CH12-HY : AVG_BE_54 3m HORN_9120D_1328 VERTICAL</p>	<p>Left blank</p>



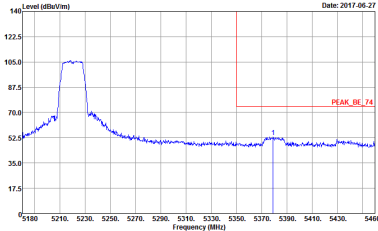
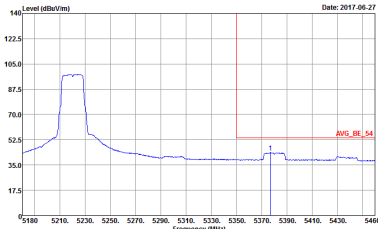

WIFI	Band 1 5150~5250MHz Band Edge @ 3m	
ANT	802.11a CH44 5220MHz - R	
2	Vertical	Fundamental
<p><b>Peak</b></p>	 <p>Site Condition : 03CH12-HY : PEAK_BE_74 3m HORN_9120D_1328 VERTICAL</p>	<p>Left blank</p>
<p><b>Avg.</b></p>	 <p>Site Condition : 03CH12-HY : AVG_BE_54 3m HORN_9120D_1328 VERTICAL</p>	<p>Left blank</p>



WIFI	Band 1 5150~5250MHz Band Edge @ 3m	
ANT	802.11a CH48 5240MHz - L	
2	Horizontal	Fundamental
<p><b>Peak</b></p>		
<p><b>Avg.</b></p>		<p><b>Left blank</b></p>

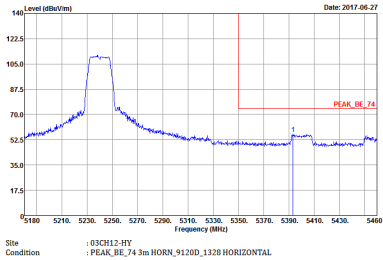
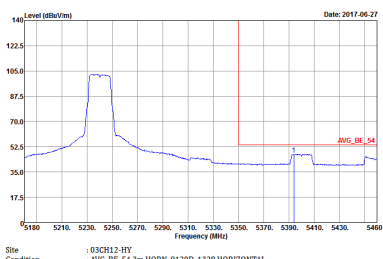

WIFI	Band 1 5150~5250MHz Band Edge @ 3m	
ANT	802.11a CH48 5240MHz - R	
2	Horizontal	Fundamental
Peak		Left blank
Avg.		Left blank



WIFI	Band 1 5150~5250MHz Band Edge @ 3m	
ANT	802.11a CH48 5240MHz - L	
2	Vertical	Fundamental
Peak	<p>Site Condition : 03CH12-HY : PEAK_BE_74 3m HORN_9120D_1328 VERTICAL</p>	<p>Site Condition : 03CH12-HY : PEAK(UNI) 3m HORN_9120D_1328 VERTICAL</p>
Avg.	<p>Site Condition : 03CH12-HY : AVG_BE_54 3m HORN_9120D_1328 VERTICAL</p>	Left blank



WIFI	Band 1 5150~5250MHz Band Edge @ 3m	
ANT	802.11a CH48 5240MHz - R	
2	Vertical	Fundamental
Peak		Left blank
Avg.		Left blank



**Band 1 5150~5250MHz  
WIFI 802.11n HT20 (Band Edge @ 3m)**

WIFI	Band 1 5150~5250MHz Band Edge @ 3m	
ANT	802.11n HT20 CH36 5180MHz	
2	Horizontal	Fundamental
<b>Peak</b>	<p>Site Condition : 03CH12-HY : PEAK_BE_74 3m HORN_9120D_1328 HORIZONTAL</p>	<p>Site Condition : 03CH12-HY : PEAK(UM) 3m HORN_9120D_1328 HORIZONTAL</p>
<b>Avg.</b>	<p>Site Condition : 03CH12-HY : AVG_BE_54 3m HORN_9120D_1328 HORIZONTAL</p>	Left blank



WIFI	Band 1 5150~5250MHz Band Edge @ 3m	
ANT	802.11n HT20 CH36 5180MHz	
2	Vertical	Fundamental
Peak	<p>Site Condition : 03CH12-HY : PEAK_BE_74 3m HORN_9120D_1328 VERTICAL</p>	<p>Site Condition : 03CH12-HY : PEAK(UN) 3m HORN_9120D_1328 VERTICAL</p>
Avg.	<p>Site Condition : 03CH12-HY : AVG_BE_54 3m HORN_9120D_1328 VERTICAL</p>	Left blank



WIFI	Band 1 5150~5250MHz Band Edge @ 3m	
ANT	802.11n HT20 CH44 5220MHz - L	
2	Horizontal	Fundamental
<p><b>Peak</b></p>		
<p><b>Avg.</b></p>		<p><b>Left blank</b></p>



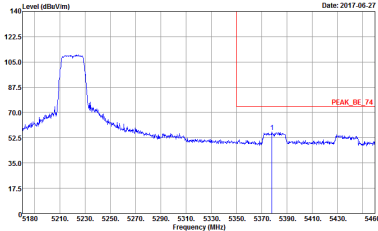
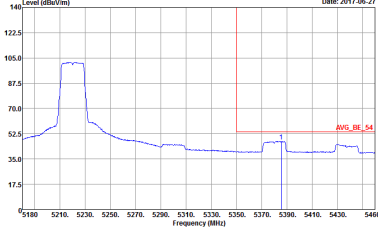

WIFI	Band 1 5150~5250MHz Band Edge @ 3m	
ANT	802.11n HT20 CH44 5220MHz - R	
2	Horizontal	Fundamental
<p><b>Peak</b></p>	 <p>Site Condition : 03CH12-HY : PEAK_BE_74 3m HORN_9120D_1328 HORIZONTAL</p>	<p>Left blank</p>
<p><b>Avg.</b></p>	 <p>Site Condition : 03CH12-HY : AVG_BE_54 3m HORN_9120D_1328 HORIZONTAL</p>	<p>Left blank</p>



WIFI	Band 1 5150~5250MHz Band Edge @ 3m	
ANT	802.11n HT20 CH44 5220MHz - L	
2	Vertical	Fundamental
<p><b>Peak</b></p>		
<p><b>Avg.</b></p>		<p><b>Left blank</b></p>

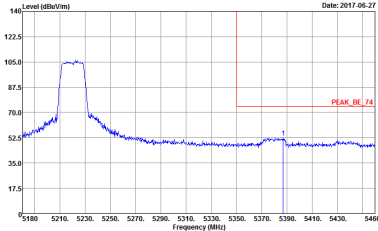
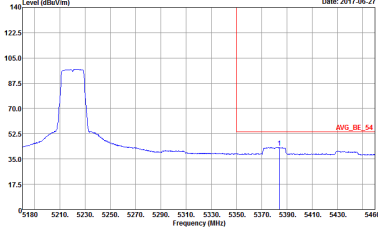

WIFI	Band 1 5150~5250MHz Band Edge @ 3m	
ANT	802.11n HT20 CH44 5220MHz - R	
2	Vertical	Fundamental
<p><b>Peak</b></p>	 <p>Site Condition : 03CH12-HY : PEAK_BE_74 3m HORN_9120D_1328 VERTICAL</p>	<p>Left blank</p>
<p><b>Avg.</b></p>	 <p>Site Condition : 03CH12-HY : AVG_BE_54 3m HORN_9120D_1328 VERTICAL</p>	<p>Left blank</p>



WIFI	Band 1 5150~5250MHz Band Edge @ 3m	
ANT	802.11n HT20 CH48 5240MHz - L	
2	Horizontal	Fundamental
<p><b>Peak</b></p>		
<p><b>Avg.</b></p>		<p><b>Left blank</b></p>



WIFI	Band 1 5150~5250MHz Band Edge @ 3m	
ANT	802.11n HT20 CH48 5240MHz - R	
2	Horizontal	Fundamental
<p><b>Peak</b></p>		<p>Left blank</p>
<p><b>Avg.</b></p>		<p>Left blank</p>



WIFI	Band 1 5150~5250MHz Band Edge @ 3m	
ANT	802.11n HT20 CH48 5240MHz - L	
2	Vertical	Fundamental
Peak		
Avg.		Left blank



WIFI	Band 1 5150~5250MHz Band Edge @ 3m	
ANT	802.11n HT20 CH48 5240MHz - R	
2	Vertical	Fundamental
Peak	<p>Site Condition : 03CH12-HY : PEAK_BE_74 3m HORN_9120D_1328 VERTICAL</p>	Left blank
Avg.	<p>Site Condition : 03CH12-HY : AVG_BE_54 3m HORN_9120D_1328 VERTICAL</p>	Left blank



**Band 1 5150~5250MHz  
WIFI 802.11n HT40 (Band Edge @ 3m)**

WIFI	Band 1 5150~5250MHz Band Edge @ 3m	
ANT	802.11n HT40 CH38 5190MHz - L	
2	Horizontal	Fundamental
<b>Peak</b>	<p>Site Condition : 03CH12-HY : PEAK_BE_74 3m HORN_9120D_1328 HORIZONTAL</p>	<p>Site Condition : 03CH12-HY : PEAK(UM) 3m HORN_9120D_1328 HORIZONTAL</p>
<b>Avg.</b>	<p>Site Condition : 03CH12-HY : AVG_BE_54 3m HORN_9120D_1328 HORIZONTAL</p>	Left blank





WIFI	Band 1 5150~5250MHz Band Edge @ 3m	
ANT	802.11n HT40 CH38 5190MHz - R	
2	Horizontal	Fundamental
<p><b>Peak</b></p>		<p>Left blank</p>
<p><b>Avg.</b></p>		<p>Left blank</p>



WIFI	Band 1 5150~5250MHz Band Edge @ 3m	
ANT	802.11n HT40 CH38 5190MHz - L	
2	Vertical	Fundamental
Peak		
Avg.		Left blank



WIFI	Band 1 5150~5250MHz Band Edge @ 3m	
ANT	802.11n HT40 CH38 5190MHz - R	
2	Vertical	Fundamental
Peak	<p>Peak</p>	Left blank
Avg.	<p>Avg.</p>	Left blank



WIFI	Band 1 5150~5250MHz Band Edge @ 3m	
ANT	802.11n HT40 CH46 5230MHz - L	
2	Horizontal	Fundamental
Peak		
Avg.		Left blank

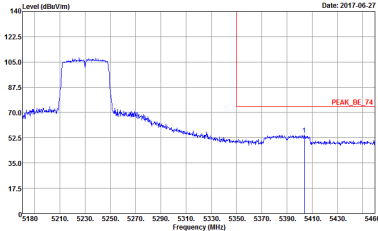
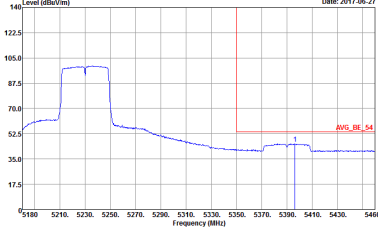

WIFI	Band 1 5150~5250MHz Band Edge @ 3m	
ANT	802.11n HT40 CH46 5230MHz - R	
2	Horizontal	Fundamental
<p><b>Peak</b></p>	 <p>Site Condition : 03CH12-HY : PEAK_BE_74 3m HORN_9120D_1328 HORIZONTAL</p>	<p>Left blank</p>
<p><b>Avg.</b></p>	 <p>Site Condition : 03CH12-HY : AVG_BE_54 3m HORN_9120D_1328 HORIZONTAL</p>	<p>Left blank</p>



WIFI	Band 1 5150~5250MHz Band Edge @ 3m	
ANT	802.11n HT40 CH46 5230MHz - L	
2	Vertical	Fundamental
<p><b>Peak</b></p>	<p>Site Condition : 03CH12-HY : PEAK_BE_74 3m HORN_9120D_1328 VERTICAL</p>	<p>Site Condition : 03CH12-HY : PEAK(UNI) 3m HORN_9120D_1328 VERTICAL</p>
<p><b>Avg.</b></p>	<p>Site Condition : 03CH12-HY : AVG_BE_54 3m HORN_9120D_1328 VERTICAL</p>	<p><b>Left blank</b></p>

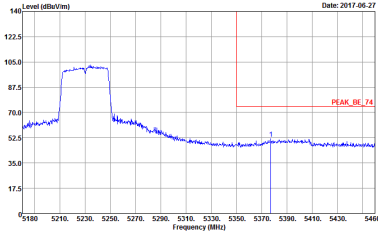
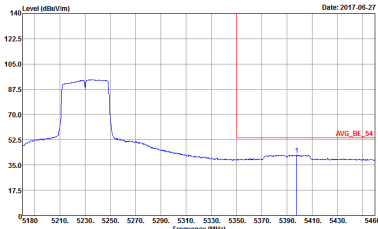

WIFI	Band 1 5150~5250MHz Band Edge @ 3m	
ANT	802.11n HT40 CH46 5230MHz - R	
2	Vertical	Fundamental
<p><b>Peak</b></p>	 <p>Site Condition : 03CH12-HY : PEAK_BE_74 3m HORN_9120D_1328 VERTICAL</p>	<p>Left blank</p>
<p><b>Avg.</b></p>	 <p>Site Condition : 03CH12-HY : AVG_BE_54 3m HORN_9120D_1328 VERTICAL</p>	<p>Left blank</p>



**Band 1 5150~5250MHz  
WIFI 802.11ac VHT80 (Band Edge @ 3m)**

WIFI	Band 1 5150~5250MHz Band Edge @ 3m	
ANT	802.11ac VHT80 CH42 5210MHz - L	
2	Horizontal	Fundamental
<b>Peak</b>	<p>Site Condition : 03CH12-HY : PEAK_BE_74 3m HORN_91200_1320 HORIZONTAL</p>	<p>Site Condition : 03CH12-HY : PEAK(UNI) 3m HORN_91200_1320 HORIZONTAL</p>
<b>Avg.</b>	<p>Site Condition : 03CH12-HY : AVG_BE_54 3m HORN_91200_1320 HORIZONTAL</p>	Left blank





WIFI	Band 1 5150~5250MHz Band Edge @ 3m	
ANT	802.11ac VHT80 CH42 5210MHz - R	
2	Horizontal	Fundamental
<p><b>Peak</b></p>		<p>Left blank</p>
<p><b>Avg.</b></p>		<p>Left blank</p>

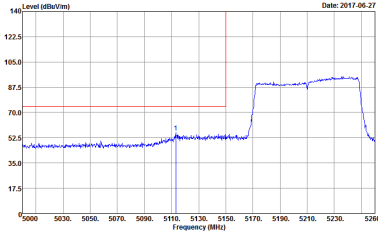
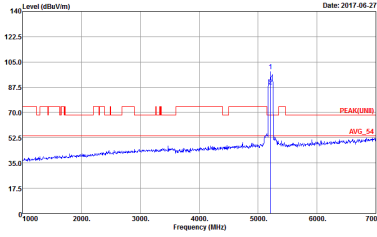
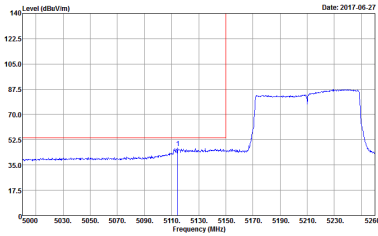

WIFI	Band 1 5150~5250MHz Band Edge @ 3m	
ANT	802.11ac VHT80 CH42 5210MHz - L	
2	Vertical	Fundamental
Peak	 <p>Site Condition : 03CH12-HY : PEAK_BE_74 3m HORN_9120D_1328 VERTICAL</p>	 <p>Site Condition : 03CH12-HY : PEAK(UNI) 3m HORN_9120D_1328 VERTICAL</p>
Avg.	 <p>Site Condition : 03CH12-HY : AVG_BE_54 3m HORN_9120D_1328 VERTICAL</p>	Left blank



WIFI	Band 1 5150~5250MHz Band Edge @ 3m	
ANT	802.11ac VHT80 CH42 5210MHz - R	
2	Vertical	Fundamental
<p><b>Peak</b></p>	<p>Site Condition : 03CH12-HY : PEAK_BE_74 3m HORN_9120D_1328 VERTICAL</p>	<p>Left blank</p>
<p><b>Avg.</b></p>	<p>Site Condition : 03CH12-HY : AVG_BE_54 3m HORN_9120D_1328 VERTICAL</p>	<p>Left blank</p>



**Band 1 - 5150~5250MHz**  
**WIFI 802.11a (Harmonic @ 3m)**

<b>WIFI</b>	<b>Band 1 5150~5250MHz Harmonic @ 3m</b>	
<b>ANT</b>	<b>802.11a CH36 5180MHz</b>	
<b>2</b>	<b>Horizontal</b>	<b>Vertical</b>
<b>Peak Avg.</b>	<p>Site Condition : (03)CH12-RY : PEAK(UWB) 3m HORN_9120D_1328 HORIZONTAL</p>	<p>Site Condition : (03)CH12-RY : PEAK(UWB) 3m HORN_9120D_1328 VERTICAL</p>



WIFI	Band 1 5150~5250MHz Harmonic @ 3m	
ANT	802.11a CH44 5220MHz	
2	Horizontal	Vertical
Peak Avg.		



WIFI	Band 1 5150~5250MHz Harmonic @ 3m	
ANT	802.11a CH48 5240MHz	
2	Horizontal	Vertical
Peak Avg.		



**Band 1 5150~5250MHz  
WIFI 802.11n HT20 (Harmonic @ 3m)**

<b>WIFI</b>	<b>Band 1 5150~5250MHz Harmonic @ 3m</b>	
<b>ANT</b>	<b>802.11n HT20 CH36 5180MHz</b>	
<b>2</b>	<b>Horizontal</b>	<b>Vertical</b>
<b>Peak Avg.</b>		

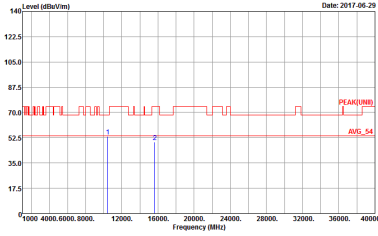
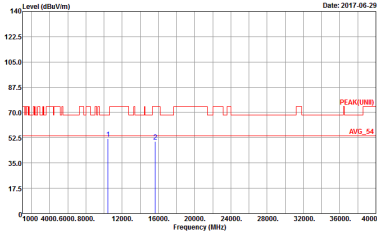

<b>WIFI</b>	<b>Band 1 5150~5250MHz Harmonic @ 3m</b>	
<b>ANT</b>	<b>802.11n HT20 CH44 5220MHz</b>	
<b>2</b>	<b>Horizontal</b>	<b>Vertical</b>
<b>Peak Avg.</b>	 <p>Site Condition : 03CH12-HY : PEAK(UNI) 3m HORN_9120D_1328 HORIZONTAL</p>	 <p>Site Condition : 03CH12-HY : PEAK(UNI) 3m HORN_9120D_1328 VERTICAL</p>





WIFI	Band 1 5150~5250MHz Harmonic @ 3m	
ANT	802.11n HT20 CH48 5240MHz	
2	Horizontal	Vertical
Peak Avg.		



**Band 1 5150~5250MHz  
WIFI 802.11n HT40 (Harmonic @ 3m)**

<b>WIFI</b>	<b>Band 1 5150~5250MHz Harmonic @ 3m</b>	
<b>ANT</b>	<b>802.11n HT40 CH38 5190MHz</b>	
<b>2</b>	<b>Horizontal</b>	<b>Vertical</b>
<b>Peak Avg.</b>	<p>Site Condition : 03CH12-HY : PEAK(UNIT) 3m HORN_9120D_132B HORIZONTAL</p>	<p>Site Condition : 03CH12-HY : PEAK(UNIT) 3m HORN_9120D_132B VERTICAL</p>



WIFI	Band 1 5150~5250MHz Harmonic @ 3m	
ANT	802.11n HT40 CH46 5230MHz	
2	Horizontal	Vertical
Peak Avg.		

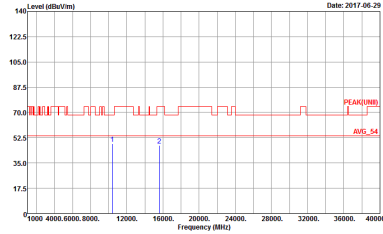
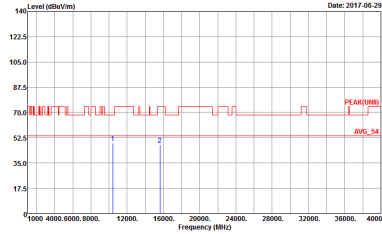

**Band 1 5150~5250MHz  
WIFI 802.11ac VHT80 (Harmonic @ 3m)**

WIFI	Band 1 5150~5250MHz Harmonic @ 3m	
ANT	802.11ac VHT80 CH42 5210MHz	
2	Horizontal	Vertical
<p><b>Peak</b> <b>Avg.</b></p>	 <p>Site Condition : 03CH12-HY : PEAK(UNIT) 3m HORN_9120D_132B HORIZONTAL</p>	 <p>Site Condition : 03CH12-HY : PEAK(UNIT) 3m HORN_9120D_132B VERTICAL</p>



Emission below 1GHz  
5GHz WIFI 802.11n HT40 (LF)

WIFI	5GHz WIFI	
ANT	802.11n HT40 LF	
2	Horizontal	Vertical
QP / Peak		



**Band 1 - 5150~5250MHz**  
**WIFI 802.11a (Band Edge @ 3m)**

WIFI	Band 1 5150~5250MHz Band Edge @ 3m	
ANT	802.11a CH36 5180MHz	
1+2	Horizontal	Fundamental
<b>Peak</b>		
<b>Avg.</b>		<b>Left blank</b>



WIFI	Band 1 5150~5250MHz Band Edge @ 3m	
ANT	802.11a CH36 5180MHz	
1+2	Vertical	Fundamental
<p><b>Peak</b></p>	<p>Site Condition : 03CH12-HY : PEAK_BE_74 3m HORN_9120D_1328 VERTICAL</p>	<p>Site Condition : 03CH12-HY : PEAK(UNII) 3m HORN_9120D_1328 VERTICAL</p>
<p><b>Avg.</b></p>	<p>Site Condition : 03CH12-HY : AVG_BE_54 3m HORN_9120D_1328 VERTICAL</p>	<p>Left blank</p>

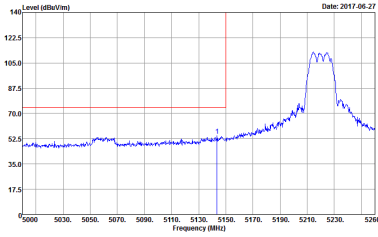
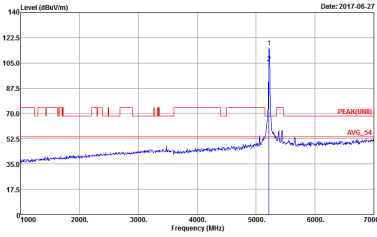
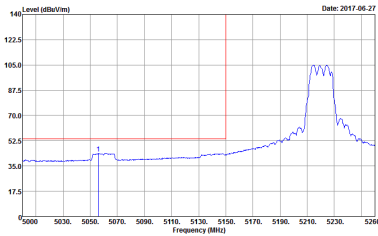

WIFI	Band 1 5150~5250MHz Band Edge @ 3m	
ANT	802.11a CH44 5220MHz - L	
1+2	Horizontal	Fundamental
<p><b>Peak</b></p>	 <p>Site Condition : 03CH12-HY : PEAK_BE_74 3m HORN_9120D_1328 HORIZONTAL</p>	 <p>Site Condition : 03CH12-HY : PEAK(UNI) 3m HORN_9120D_1328 HORIZONTAL</p>
<p><b>Avg.</b></p>	 <p>Site Condition : 03CH12-HY : AVG_BE_54 3m HORN_9120D_1328 HORIZONTAL</p>	<p>Left blank</p>





WIFI	Band 1 5150~5250MHz Band Edge @ 3m	
ANT	802.11a CH44 5220MHz - R	
1+2	Horizontal	Fundamental
Peak	<p>Site Condition : 03CH12-HY : PEAK_BE_74 3m HORN_9120D_1328 HORIZONTAL</p>	Left blank
Avg.	<p>Site Condition : 03CH12-HY : AVG_BE_54 3m HORN_9120D_1328 HORIZONTAL</p>	Left blank

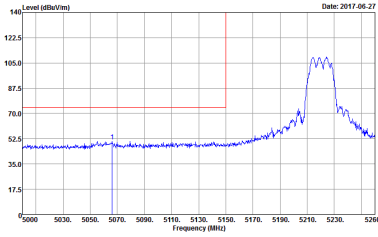
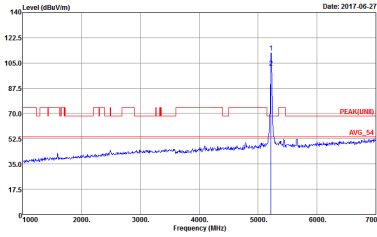
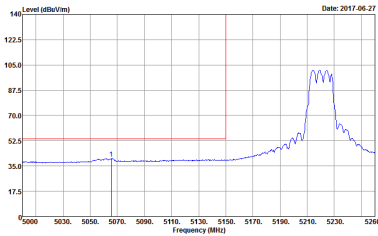

WIFI	Band 1 5150~5250MHz Band Edge @ 3m	
ANT	802.11a CH44 5220MHz - L	
1+2	Vertical	Fundamental
<p><b>Peak</b></p>	 <p>Site Condition : 03CH12-HY : PEAK_BE_74 3m HORN_9120D_1328 VERTICAL</p>	 <p>Site Condition : 03CH12-HY : PEAK(LNB) 3m HORN_9120D_1328 VERTICAL</p>
<p><b>Avg.</b></p>	 <p>Site Condition : 03CH12-HY : AVG_BE_54 3m HORN_9120D_1328 VERTICAL</p>	<p><b>Left blank</b></p>



WIFI	Band 1 5150~5250MHz Band Edge @ 3m	
ANT	802.11a CH44 5220MHz - R	
1+2	Vertical	Fundamental
<p><b>Peak</b></p>	<p>Site Condition : 03CH12-HY : PEAK_BE_74 3m HORN_9120D_1328 VERTICAL</p>	<p>Left blank</p>
<p><b>Avg.</b></p>	<p>Site Condition : 03CH12-HY : AVG_BE_54 3m HORN_9120D_1328 VERTICAL</p>	<p>Left blank</p>



WIFI	Band 1 5150~5250MHz Band Edge @ 3m	
ANT	802.11a CH48 5240MHz - L	
1+2	Horizontal	Fundamental
<p><b>Peak</b></p>		
<p><b>Avg.</b></p>		<p><b>Left blank</b></p>



WIFI	Band 1 5150~5250MHz Band Edge @ 3m	
ANT	802.11a CH48 5240MHz - R	
1+2	Horizontal	Fundamental
Peak	<p>Site Condition : 03CH12-HY : PEAK_BE_74 3m HORN_9120D_1328 HORIZONTAL</p>	Left blank
Avg.	<p>Site Condition : 03CH12-HY : AVG_BE_54 3m HORN_9120D_1328 HORIZONTAL</p>	Left blank

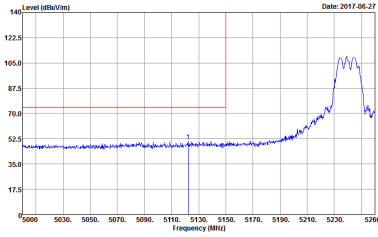
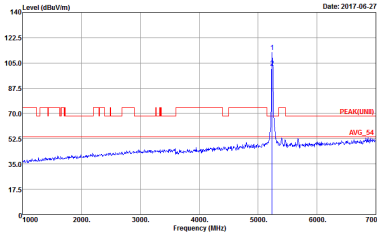
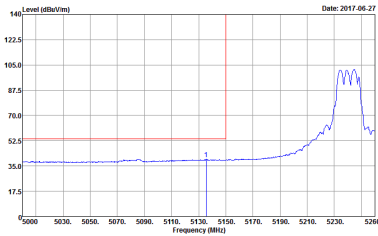

WIFI	Band 1 5150~5250MHz Band Edge @ 3m	
ANT	802.11a CH48 5240MHz - L	
1+2	Vertical	Fundamental
Peak	 <p>Site : 03CH12-HY Condition : PEAK_BE_74 3m HORN_9120D_1328 VERTICAL</p>	 <p>Site : 03CH12-HY Condition : PEAK(LNB) 3m HORN_9120D_1328 VERTICAL</p>
Avg.	 <p>Site : 03CH12-HY Condition : AVG_BE_54 3m HORN_9120D_1328 VERTICAL</p>	Left blank



WIFI	Band 1 5150~5250MHz Band Edge @ 3m	
ANT	802.11a CH48 5240MHz - R	
1+2	Vertical	Fundamental
<p><b>Peak</b></p>		<p>Left blank</p>
<p><b>Avg.</b></p>		<p>Left blank</p>

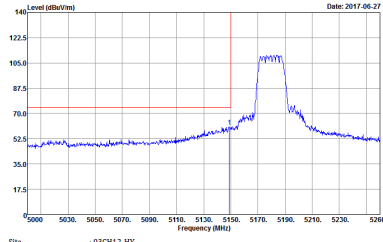
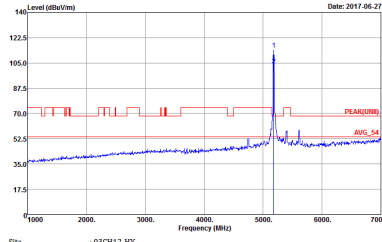
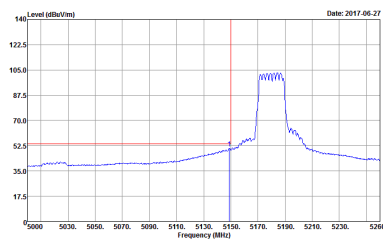

**Band 1 5150~5250MHz  
WIFI 802.11n HT20 (Band Edge @ 3m)**

WIFI	Band 1 5150~5250MHz Band Edge @ 3m	
ANT	802.11n HT20 CH36 5180MHz	
1+2	Horizontal	Fundamental
<p><b>Peak</b></p>	 <p>Site Condition : 03CH12-HY : PEAK_BE_74 3m HORN_9120D_1328 HORIZONTAL</p>	 <p>Site Condition : 03CH12-HY : PEAK(UNI) 3m HORN_9120D_1328 HORIZONTAL</p>
<p><b>Avg.</b></p>	 <p>Site Condition : 03CH12-HY : AVG_BE_54 3m HORN_9120D_1328 HORIZONTAL</p>	<p align="center"><b>Left blank</b></p>





WIFI	Band 1 5150~5250MHz Band Edge @ 3m	
ANT	802.11n HT20 CH36 5180MHz	
1+2	Vertical	Fundamental
<p><b>Peak</b></p>	<p>Site Condition : 03CH12-HY : PEAK_BE_74 3m HORN_9120D_1328 VERTICAL</p>	<p>Site Condition : 03CH12-HY : PEAK(LNB) 3m HORN_9120D_1328 VERTICAL</p>
<p><b>Avg.</b></p>	<p>Site Condition : 03CH12-HY : AVG_BE_54 3m HORN_9120D_1328 VERTICAL</p>	<p>Left blank</p>

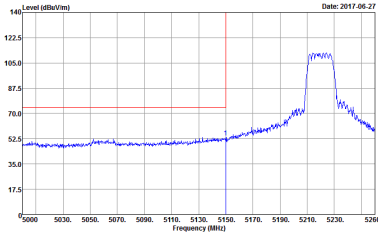
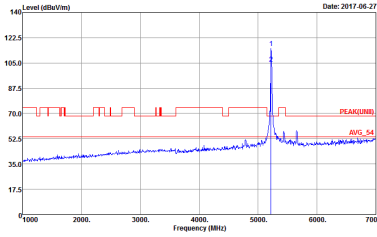
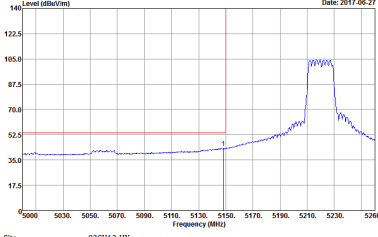

WIFI	Band 1 5150~5250MHz Band Edge @ 3m	
ANT	802.11n HT20 CH44 5220MHz - L	
1+2	Horizontal	Fundamental
<p><b>Peak</b></p>	 <p>Site Condition : 03CH12-HY : PEAK_BE_74 3m HORN_9120D_1328 HORIZONTAL</p>	 <p>Site Condition : 03CH12-HY : PEAK(UNI) 3m HORN_9120D_1328 HORIZONTAL</p>
<p><b>Avg.</b></p>	 <p>Site Condition : 03CH12-HY : AVG_BE_54 3m HORN_9120D_1328 HORIZONTAL</p>	<p>Left blank</p>



WIFI	Band 1 5150~5250MHz Band Edge @ 3m	
ANT	802.11n HT20 CH44 5220MHz - R	
1+2	Horizontal	Fundamental
Peak	<p>Site Condition : 03CH12-HY : PEAK_BE_74 3m HORN_9120D_1328 HORIZONTAL</p>	Left blank
Avg.	<p>Site Condition : 03CH12-HY : AVG_BE_54 3m HORN_9120D_1328 HORIZONTAL</p>	Left blank

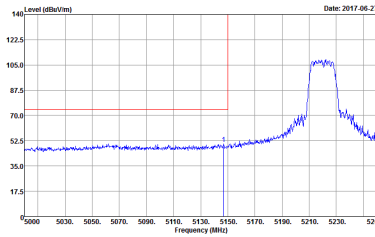
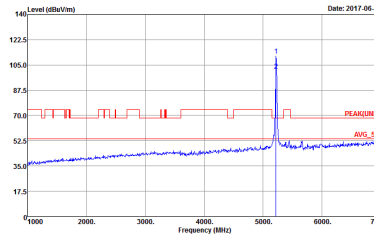
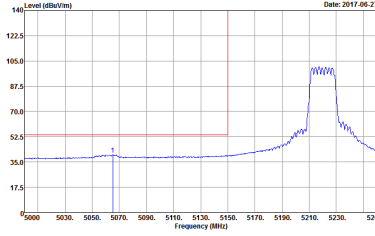

WIFI	Band 1 5150~5250MHz Band Edge @ 3m	
ANT	802.11n HT20 CH44 5220MHz - L	
1+2	Vertical	Fundamental
<p><b>Peak</b></p>	 <p>Site Condition : 03CH12-HY : PEAK_BE_74 3m HORN_9120D_1328 VERTICAL</p>	 <p>Site Condition : 03CH12-HY : PEAK(LNB) 3m HORN_9120D_1328 VERTICAL</p>
<p><b>Avg.</b></p>	 <p>Site Condition : 03CH12-HY : AVG_BE_54 3m HORN_9120D_1328 VERTICAL</p>	<p>Left blank</p>

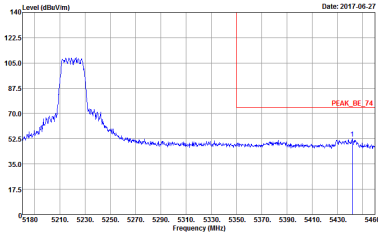
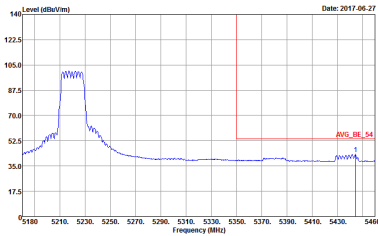

WIFI	Band 1 5150~5250MHz Band Edge @ 3m	
ANT	802.11n HT20 CH44 5220MHz - R	
1+2	Vertical	Fundamental
<p><b>Peak</b></p>	 <p>Site Condition : 03CH12-HY : PEAK_BE_74 3m HORN_9120D_1328 VERTICAL</p>	<p>Left blank</p>
<p><b>Avg.</b></p>	 <p>Site Condition : 03CH12-HY : AVG_BE_54 3m HORN_9120D_1328 VERTICAL</p>	<p>Left blank</p>



WIFI	Band 1 5150~5250MHz Band Edge @ 3m	
ANT	802.11n HT20 CH48 5240MHz - L	
1+2	Horizontal	Fundamental
<p><b>Peak</b></p>		
<p><b>Avg.</b></p>		<p><b>Left blank</b></p>

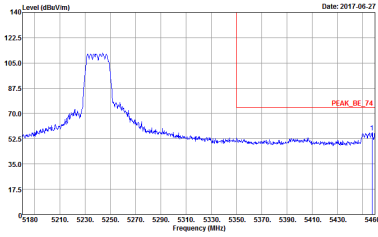
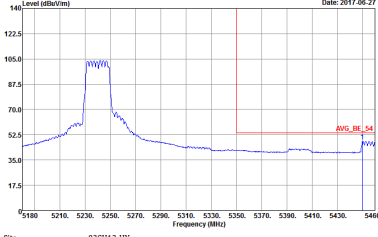

WIFI	Band 1 5150~5250MHz Band Edge @ 3m	
ANT	802.11n HT20 CH48 5240MHz - R	
1+2	Horizontal	Fundamental
<p><b>Peak</b></p>	 <p>Site Condition : 03CH12-HY : PEAK_BE_74 3m HORN_9120D_1328 HORIZONTAL</p>	<p>Left blank</p>
<p><b>Avg.</b></p>	 <p>Site Condition : 03CH12-HY : AVG_BE_54 3m HORN_9120D_1328 HORIZONTAL</p>	<p>Left blank</p>



WIFI	Band 1 5150~5250MHz Band Edge @ 3m	
ANT	802.11n HT20 CH48 5240MHz - L	
1+2	Vertical	Fundamental
<p><b>Peak</b></p>	<p>Site : 03CH12-HY Condition : PEAK_BE_74 3m HORN_9120D_1328 VERTICAL</p>	<p>Site : 03CH12-HY Condition : PEAK(FUN1) 3m HORN_9120D_1328 VERTICAL</p>
<p><b>Avg.</b></p>	<p>Site : 03CH12-HY Condition : AVG_BE_54 3m HORN_9120D_1328 VERTICAL</p>	<p><b>Left blank</b></p>



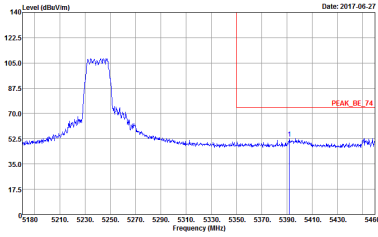
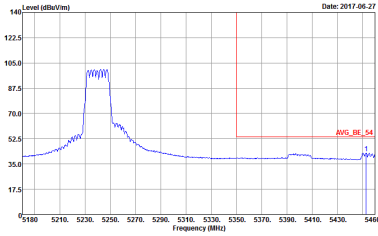

WIFI	Band 1 5150~5250MHz Band Edge @ 3m	
ANT	802.11n HT20 CH48 5240MHz - R	
1+2	Vertical	Fundamental
Peak	 <p>Site Condition :03CH12-HY :PEAK_BE_74 3m HORN_9120D_1328 VERTICAL</p>	Left blank
Avg.	 <p>Site Condition :03CH12-HY :AVG_BE_54 3m HORN_9120D_1328 VERTICAL</p>	Left blank

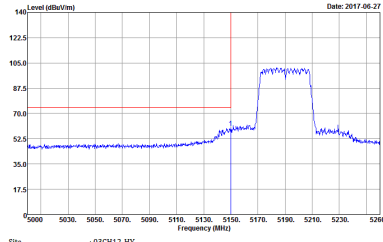
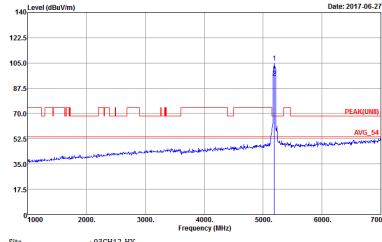
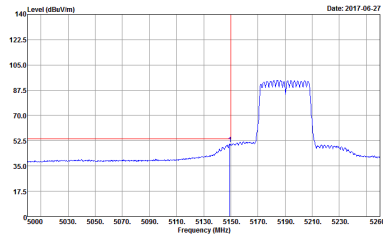

**Band 1 5150~5250MHz  
WIFI 802.11n HT40 (Band Edge @ 3m)**

WIFI	Band 1 5150~5250MHz Band Edge @ 3m	
ANT	802.11n HT40 CH38 5190MHz - L	
1+2	Horizontal	Fundamental
<p><b>Peak</b></p>	 <p>Site Condition : 03CH12-HY : PEAK_BE_74 3m HORN_9120D_1328 HORIZONTAL</p>	 <p>Site Condition : 03CH12-HY : PEAK(UNI) 3m HORN_9120D_1328 HORIZONTAL</p>
<p><b>Avg.</b></p>	 <p>Site Condition : 03CH12-HY : AVG_BE_54 3m HORN_9120D_1328 HORIZONTAL</p>	<p><b>Left blank</b></p>



WIFI	Band 1 5150~5250MHz Band Edge @ 3m	
ANT	802.11n HT40 CH38 5190MHz - R	
1+2	Horizontal	Fundamental
<p><b>Peak</b></p>	<p>Site Condition : 03CH12-HY : PEAK_BE_74 3m HORN_9120D_1328 HORIZONTAL</p>	<p>Left blank</p>
<p><b>Avg.</b></p>	<p>Site Condition : 03CH12-HY : AVG_BE_54 3m HORN_9120D_1328 HORIZONTAL</p>	<p>Left blank</p>

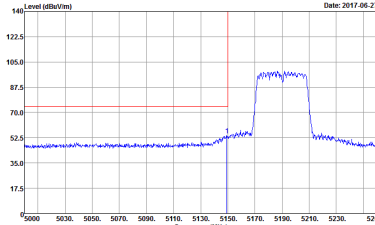
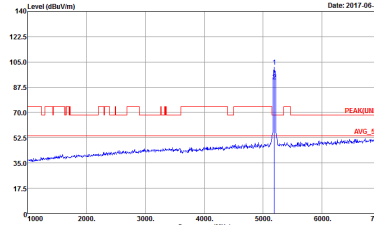
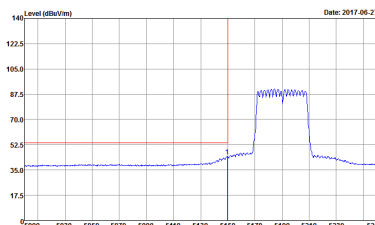

WIFI	Band 1 5150~5250MHz Band Edge @ 3m	
ANT	802.11n HT40 CH38 5190MHz - L	
1+2	Vertical	Fundamental
<p><b>Peak</b></p>	 <p>Site Condition : 03CH12-HY : PEAK_BE_74 3m HORN_9120D_1328 VERTICAL</p>	 <p>Site Condition : 03CH12-HY : PEAK(UNI) 3m HORN_9120D_1328 VERTICAL</p>
<p><b>Avg.</b></p>	 <p>Site Condition : 03CH12-HY : AVG_BE_54 3m HORN_9120D_1328 VERTICAL</p>	<p><b>Left blank</b></p>



WIFI	Band 1 5150~5250MHz Band Edge @ 3m	
ANT	802.11n HT40 CH38 5190MHz - R	
1+2	Vertical	Fundamental
<p><b>Peak</b></p>	<p>Site Condition : 03CH12-HY : PEAK_BE_74 3m HORN_9120D_1328 VERTICAL</p>	<p>Left blank</p>
<p><b>Avg.</b></p>	<p>Site Condition : 03CH12-HY : AVG_BE_54 3m HORN_9120D_1328 VERTICAL</p>	<p>Left blank</p>

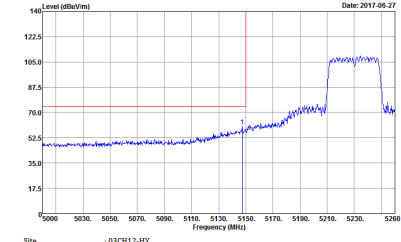
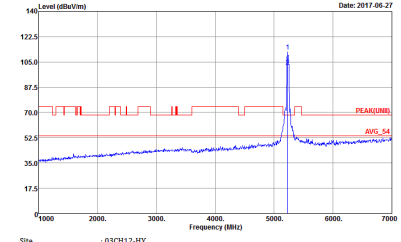
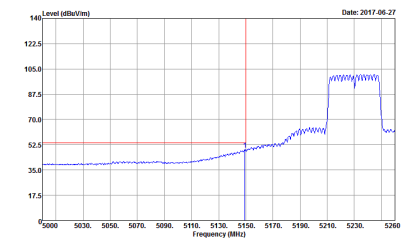

WIFI	Band 1 5150~5250MHz Band Edge @ 3m	
ANT	802.11n HT40 CH46 5230MHz - L	
1+2	Horizontal	Fundamental
Peak	 <p>Site Condition : 03CH12-HY : PEAK_BE_74 3m HORN_9120D_1328 HORIZONTAL</p>	 <p>Site Condition : 03CH12-HY : PEAK(UNI) 3m HORN_9120D_1328 HORIZONTAL</p>
Avg.	 <p>Site Condition : 03CH12-HY : AVG_BE_54 3m HORN_9120D_1328 HORIZONTAL</p>	Left blank

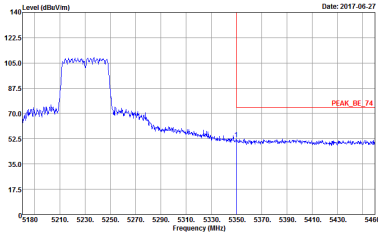
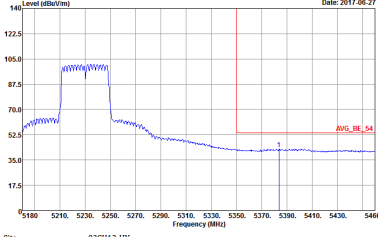

WIFI	Band 1 5150~5250MHz Band Edge @ 3m	
ANT	802.11n HT40 CH46 5230MHz - R	
1+2	Horizontal	Fundamental
<p><b>Peak</b></p>	 <p>Site Condition : 03CH12-HY : PEAK_BE_74 3m HORN_9120D_1328 HORIZONTAL</p>	<p>Left blank</p>
<p><b>Avg.</b></p>	 <p>Site Condition : 03CH12-HY : AVG_BE_54 3m HORN_9120D_1328 HORIZONTAL</p>	<p>Left blank</p>

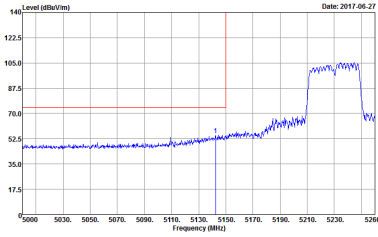
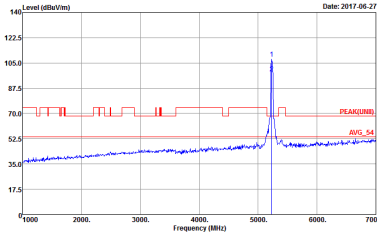
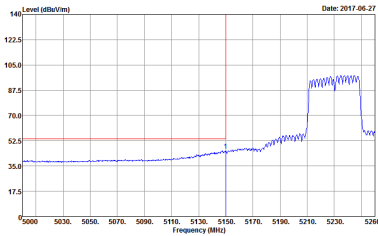

WIFI	Band 1 5150~5250MHz Band Edge @ 3m	
ANT	802.11n HT40 CH46 5230MHz - L	
1+2	Vertical	Fundamental
Peak	 <p>Site Condition : 03CH12-HY : PEAK_BE_74 3m HORN_9120D_1328 VERTICAL</p>	 <p>Site Condition : 03CH12-HY : PEAK(UNI) 3m HORN_9120D_1328 VERTICAL</p>
Avg.	 <p>Site Condition : 03CH12-HY : AVG_BE_54 3m HORN_9120D_1328 VERTICAL</p>	Left blank





WIFI	Band 1 5150~5250MHz Band Edge @ 3m	
ANT	802.11n HT40 CH46 5230MHz - R	
1+2	Vertical	Fundamental
Peak	<p>Site Condition : 03CH12-HY : PEAK_BE_74 3m HORN_9120D_1328 VERTICAL</p>	Left blank
Avg.	<p>Site Condition : 03CH12-HY : AVG_BE_54 3m HORN_9120D_1328 VERTICAL</p>	Left blank



**Band 1 5150~5250MHz  
WIFI 802.11ac VHT80 (Band Edge @ 3m)**

WIFI	Band 1 5150~5250MHz Band Edge @ 3m	
ANT	802.11ac VHT80 CH42 5210MHz - L	
1+2	Horizontal	Fundamental
<b>Peak</b>	<p>Site Condition : 03CH12-HY : PEAK_BE_74 3m HORN_9120D_1328 HORIZONTAL</p>	<p>Site Condition : 03CH12-HY : PEAK(UM) 3m HORN_9120D_1328 HORIZONTAL</p>
<b>Avg.</b>	<p>Site Condition : 03CH12-HY : AVG_BE_54 3m HORN_9120D_1328 HORIZONTAL</p>	<b>Left blank</b>

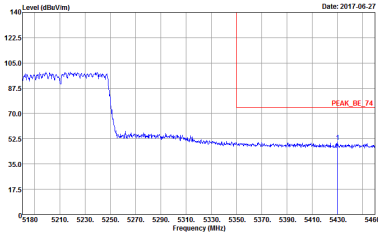
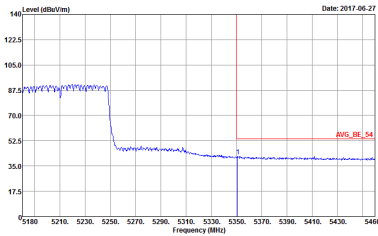

WIFI	Band 1 5150~5250MHz Band Edge @ 3m	
ANT	802.11ac VHT80 CH42 5210MHz - R	
1+2	Horizontal	Fundamental
<p><b>Peak</b></p>	 <p>Site Condition : 03CH12-HY : PEAK_BE_74 3m HORN_9120D_1328 HORIZONTAL</p>	<p>Left blank</p>
<p><b>Avg.</b></p>	 <p>Site Condition : 03CH12-HY : AVG_BE_54 3m HORN_9120D_1328 HORIZONTAL</p>	<p>Left blank</p>



WIFI	Band 1 5150~5250MHz Band Edge @ 3m	
ANT	802.11ac VHT80 CH42 5210MHz - L	
1+2	Vertical	Fundamental
<p><b>Peak</b></p>	<p>Site Condition : 03CH12-HY : PEAK_BE_74 3m HORN_9120D_1328 VERTICAL</p>	<p>Site Condition : 03CH12-HY : PEAK(UNI) 3m HORN_9120D_1328 VERTICAL</p>
<p><b>Avg.</b></p>	<p>Site Condition : 03CH12-HY : AVG_BE_54 3m HORN_9120D_1328 VERTICAL</p>	<p><b>Left blank</b></p>



WIFI	Band 1 5150~5250MHz Band Edge @ 3m	
ANT	802.11ac VHT80 CH42 5210MHz - R	
1+2	Vertical	Fundamental
<p><b>Peak</b></p>	<p>Site Condition : 03CH12-HY : PEAK_BE_74 3m HORN_9120D_1328 VERTICAL</p>	<p>Left blank</p>
<p><b>Avg.</b></p>	<p>Site Condition : 03CH12-HY : AVG_BE_54 3m HORN_9120D_1328 VERTICAL</p>	<p>Left blank</p>



Band 1 - 5150~5250MHz
WIFI 802.11a (Harmonic @ 3m)

Table with 3 columns: WIFI (Band 1 5150~5250MHz Harmonic @ 3m), ANT (802.11a CH36 5180MHz), and 1+2 (Horizontal/Vertical). The table contains two graphs showing Level (dBuV/m) vs Frequency (MHz) for Peak and Avg. measurements.



WIFI	Band 1 5150~5250MHz Harmonic @ 3m	
ANT	802.11a CH44 5220MHz	
1+2	Horizontal	Vertical
Peak Avg.	<p>Site Condition : 03CH12-RY : PEAK(UNIT) 3m HORN_9120D_1328 HORIZONTAL</p>	<p>Site Condition : 03CH12-RY : PEAK(UNIT) 3m HORN_9120D_1328 VERTICAL</p>

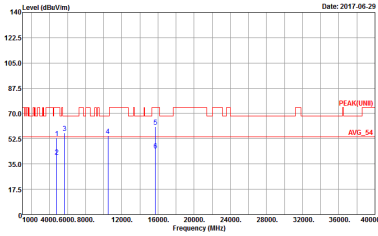
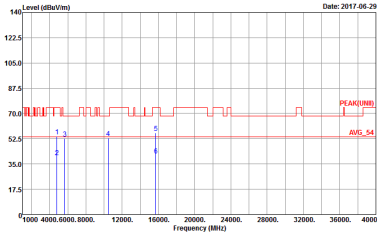

WIFI	Band 1 5150~5250MHz Harmonic @ 3m	
ANT	802.11a CH48 5240MHz	
1+2	Horizontal	Vertical
Peak Avg.	 <p>Site Condition : 03CH12-RY : PEAK(UNIT) 3m HORN_9120D_1328 HORIZONTAL</p>	 <p>Site Condition : 03CH12-RY : PEAK(UNIT) 3m HORN_9120D_1328 VERTICAL</p>





**Band 1 5150~5250MHz  
WIFI 802.11n HT20 (Harmonic @ 3m)**

<b>WIFI</b>	<b>Band 1 5150~5250MHz Harmonic @ 3m</b>	
<b>ANT</b>	<b>802.11n HT20 CH36 5180MHz</b>	
<b>1+2</b>	<b>Horizontal</b>	<b>Vertical</b>
<b>Peak Avg.</b>	<p>Site Condition : 03CH12-HY : PEAK(UNIT) 3m HORN_9120D_1328 HORIZONTAL</p>	<p>Site Condition : 03CH12-HY : PEAK(UNIT) 3m HORN_9120D_1328 VERTICAL</p>

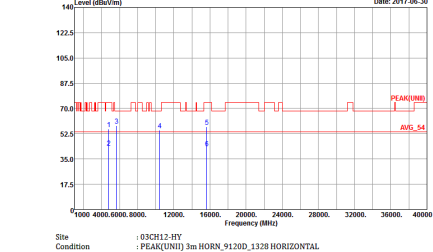
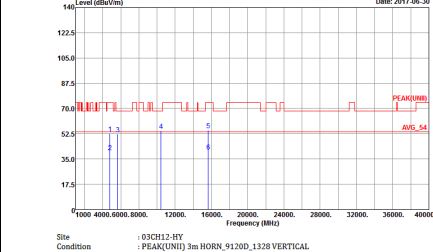

WIFI	Band 1 5150~5250MHz Harmonic @ 3m	
ANT	802.11n HT20 CH44 5220MHz	
1+2	Horizontal	Vertical
Peak Avg.		



WIFI	Band 1 5150~5250MHz Harmonic @ 3m	
ANT	802.11n HT20 CH48 5240MHz	
1+2	Horizontal	Vertical
Peak Avg.	<p>Site Condition : 03CH12-RY : PEAK(UNIT) 3m HORN_9120D_1328 HORIZONTAL</p>	<p>Site Condition : 03CH12-RY : PEAK(UNIT) 3m HORN_9120D_1328 VERTICAL</p>



Band 1 5150~5250MHz
WIFI 802.11n HT40 (Harmonic @ 3m)

Table with 3 columns: WIFI, ANT, 1+2. It contains two graphs: Horizontal and Vertical, showing Level (dBm/1m) vs Frequency (MHz) for Peak and Avg. measurements. Includes site condition details like '03CH12-HY' and 'PEAK(UNI) 3m HORN\_9120D\_1328 HORIZONTAL'.



WIFI	Band 1 5150~5250MHz Harmonic @ 3m	
ANT	802.11n HT40 CH46 5230MHz	
1+2	Horizontal	Vertical
Peak Avg.	<p>Site Condition : 03CH12-RY : PEAQ(UNI) 3m HORN_9120D_1328 HORIZONTAL</p>	<p>Site Condition : 03CH12-RY : PEAQ(UNI) 3m HORN_9120D_1328 VERTICAL</p>



Band 1 5150~5250MHz  
WIFI 802.11ac VHT80 (Harmonic @ 3m)

WIFI	Band 1 5150~5250MHz Harmonic @ 3m	
ANT	802.11ac VHT80 CH42 5210MHz	
1+2	Horizontal	Vertical
Peak Avg.	<p>Site Condition : 03CH12-HY : PEAK(UNIT) 3m HORN_9120D_1328 HORIZONTAL</p>	<p>Site Condition : 03CH12-HY : PEAK(UNIT) 3m HORN_9120D_1328 VERTICAL</p>



Emission below 1GHz  
5GHz WIFI 802.11n HT20 (LF)

WIFI	5GHz WIFI	
ANT	802.11n HT20 LF	
1+2	Horizontal	Vertical
QP / Peak	<p>Site : 03CH12-HY Condition : QP 3m BLDG_6111D_37059 HORIZONTAL</p>	<p>Site : 03CH12-HY Condition : QP 3m BLDG_6111D_37059 VERTICAL</p>



### Appendix E. Duty Cycle Plots

Antenna	Band	Duty Cycle(%)	T(us)	1/T(kHz)	VBW Setting
1	802.11a	93.51	1440	0.69	1kHz
1	5GHz 802.11n HT20	92.36	1330	0.75	1kHz
1	5GHz 802.11n HT40	86.61	660	1.52	3kHz
1	5GHz 802.11ac VHT80	76.15	332	3.01	10kHz
2	802.11a	93.46	1430	0.70	1kHz
2	5GHz 802.11n HT20	93.06	1340	0.75	1kHz
2	5GHz 802.11n HT40	86.61	660	1.52	3kHz
2	5GHz 802.11ac VHT80	75.93	328	3.05	10kHz
1+2	5GHz 802.11a for Ant 1	92.86	1430	0.70	1kHz
1+2	5GHz 802.11a for Ant 2	93.51	1440	0.69	1kHz
1+2	5GHz 802.11n HT20 for Ant 1	92.41	1340	0.75	1kHz
1+2	5GHz 802.11n HT20 for Ant 2	92.41	1340	0.75	1kHz
1+2	5GHz 802.11n HT40 for Ant 1	85.71	660	1.52	3kHz
1+2	5GHz 802.11n HT40 for Ant 2	85.71	660	1.52	3kHz
1+2	5GHz 802.11ac VHT80 for Ant 1	75.93	328	3.05	10kHz
1+2	5GHz 802.11ac VHT80 for Ant 2	75.93	328	3.05	10kHz





<Ant. 1>

802.11a

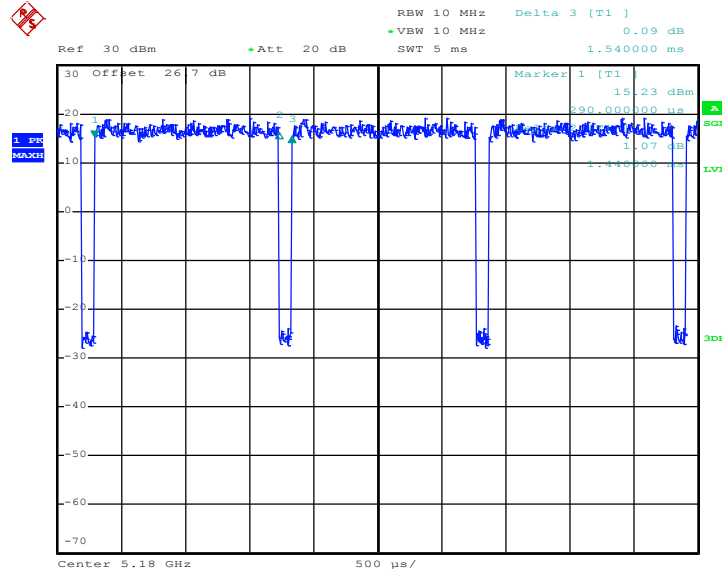

Date: 13.JUN.2017 23:08:18

802.11n HT20

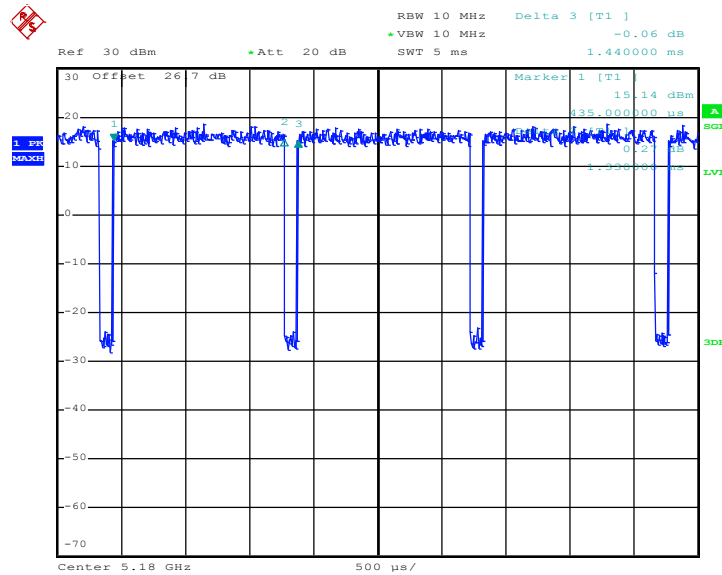

Date: 13.JUN.2017 23:11:35



802.11n HT40

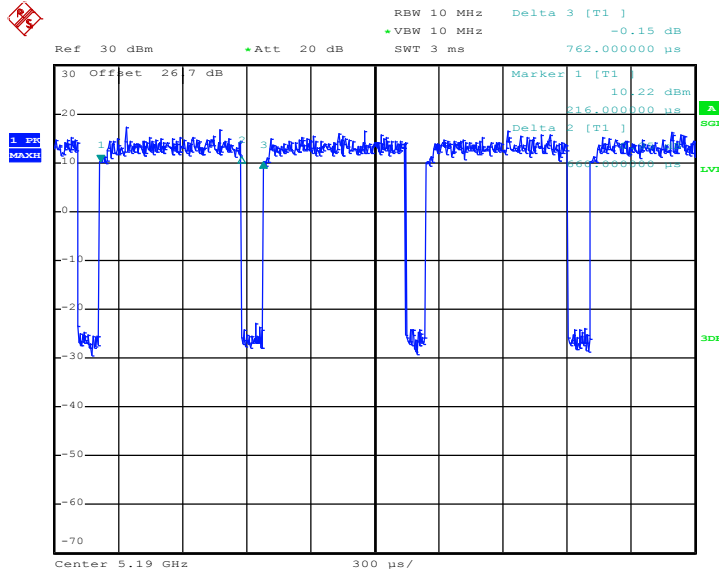

Date: 13.JUN.2017 23:15:15

802.11ac VHT80

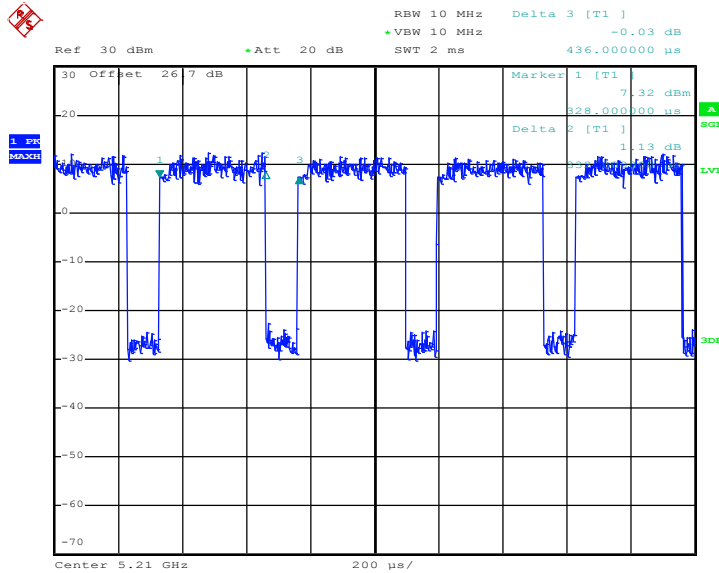

Date: 13.JUN.2017 23:32:23



<Ant. 2>

802.11a

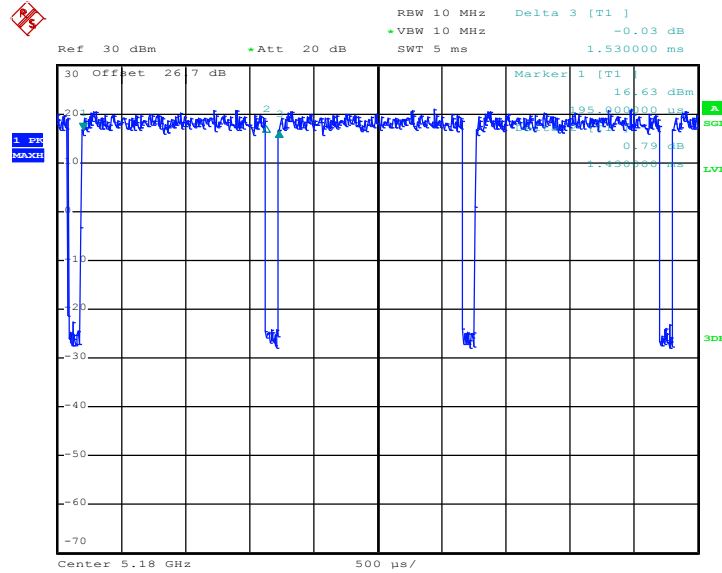

Date: 13.JUN.2017 23:09:13

802.11n HT20

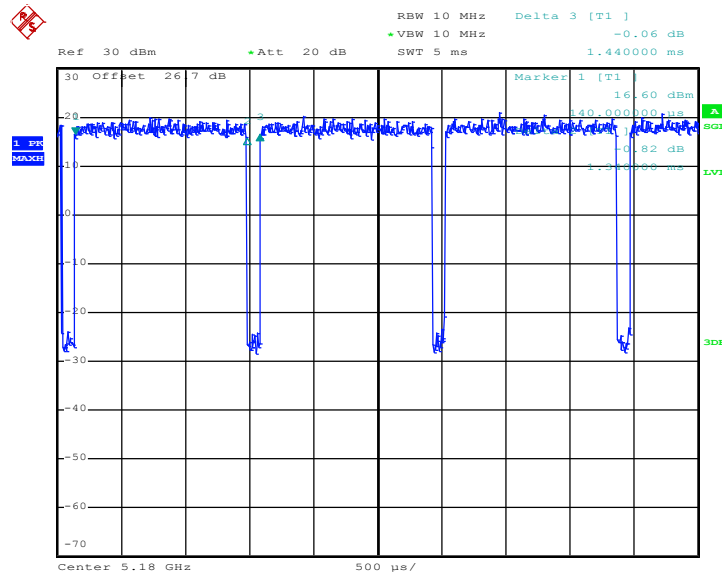

Date: 13.JUN.2017 23:12:30



802.11n HT40

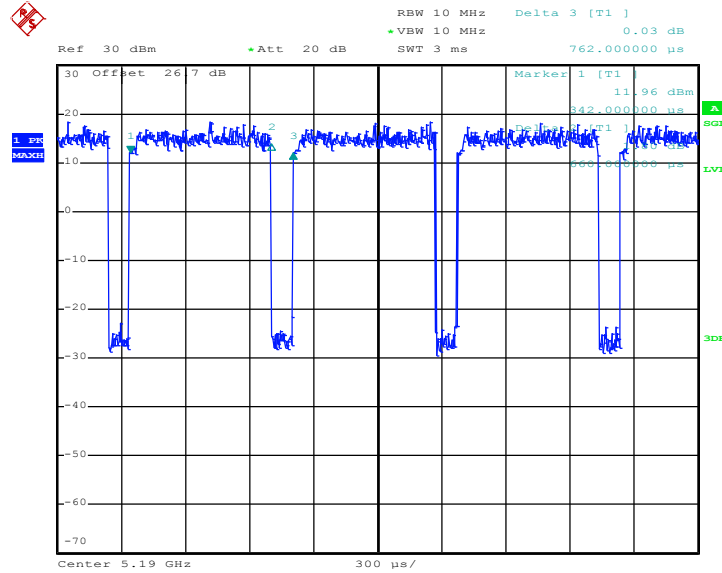

Date: 13.JUN.2017 23:15:59

802.11ac VHT80

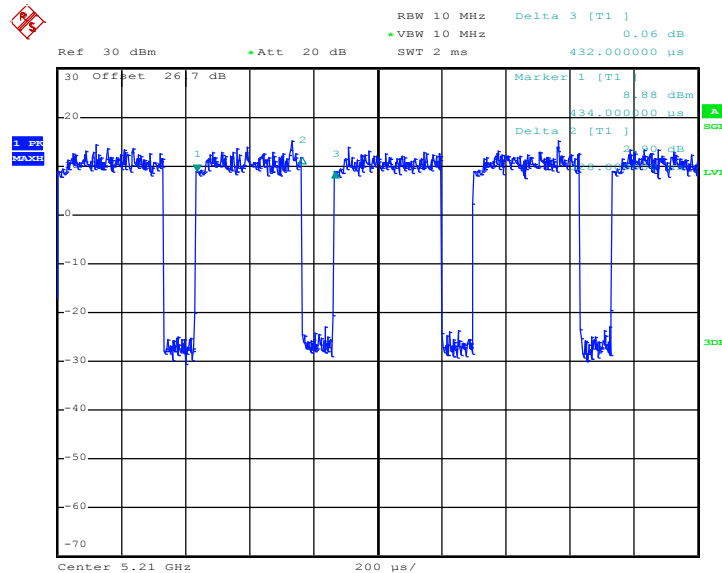

Date: 13.JUN.2017 23:33:03



MIMO <Ant. 1+2(1)>

802.11a

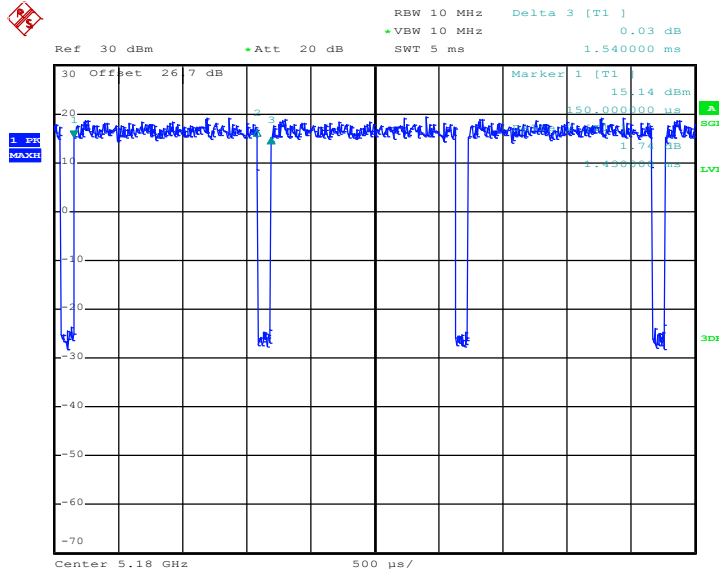

Date: 13.JUN.2017 23:10:07

802.11n HT20

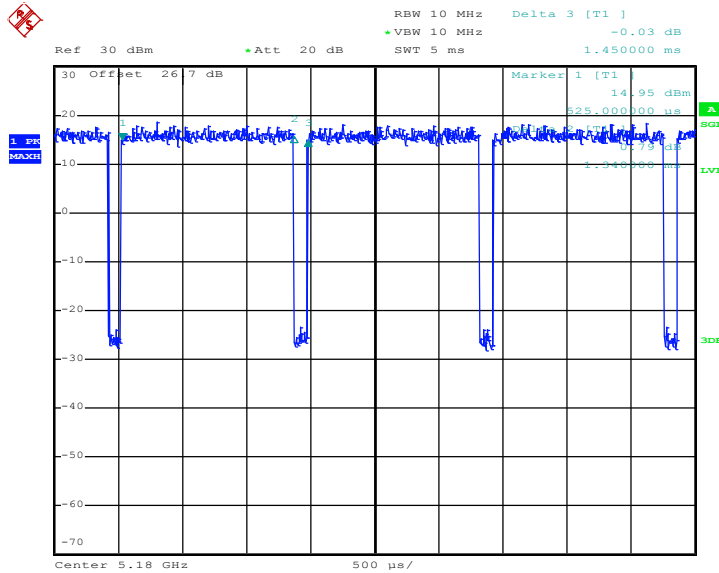

Date: 13.JUN.2017 23:13:10



802.11n HT40

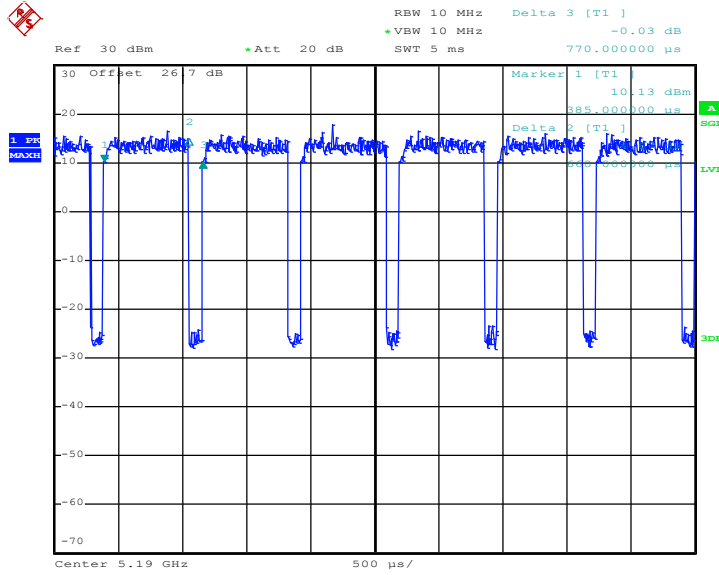

Date: 13.JUN.2017 23:16:52

802.11ac VHT80

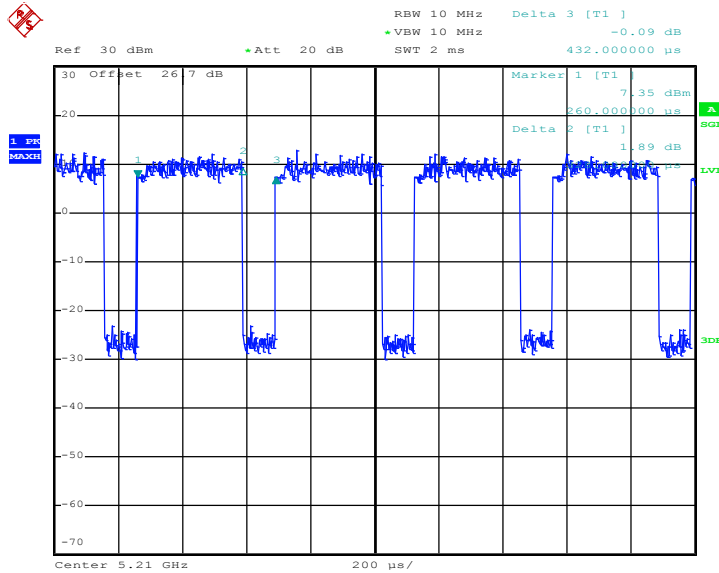

Date: 13.JUN.2017 23:33:39



MIMO <Ant. 1+2(2)>

802.11a

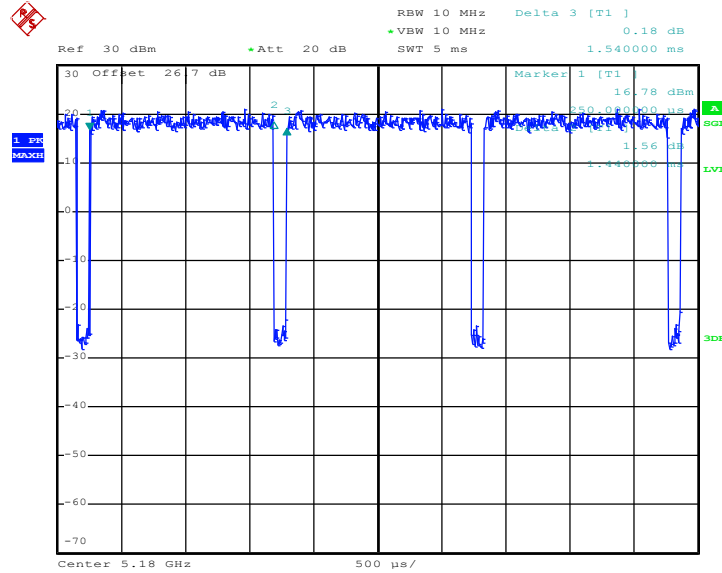

Date: 13.JUN.2017 23:10:40

802.11n HT20

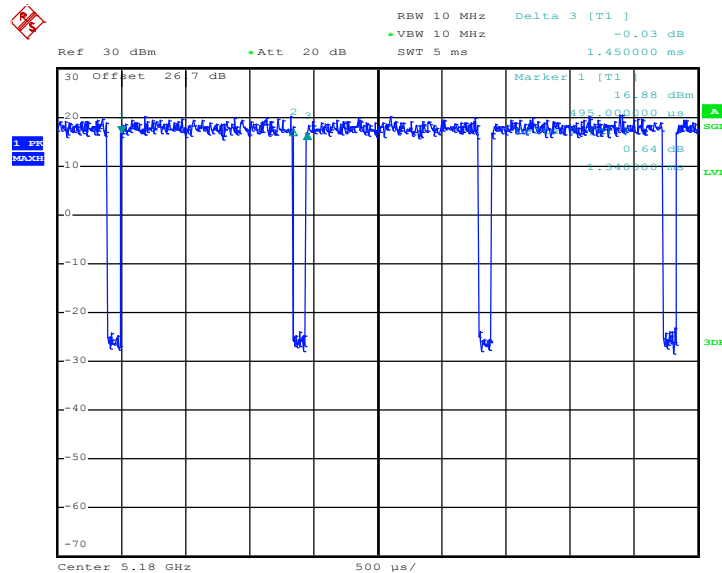

Date: 13.JUN.2017 23:13:44



802.11n HT40

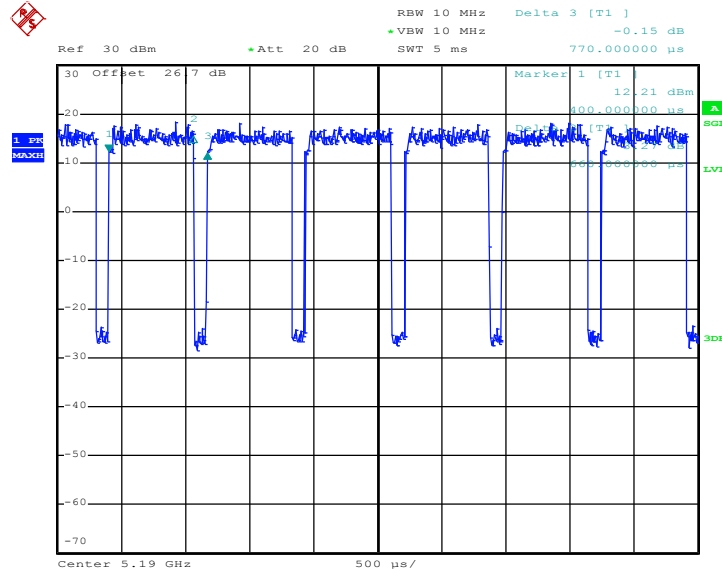

Date: 13.JUN.2017 23:18:52

802.11ac VHT80

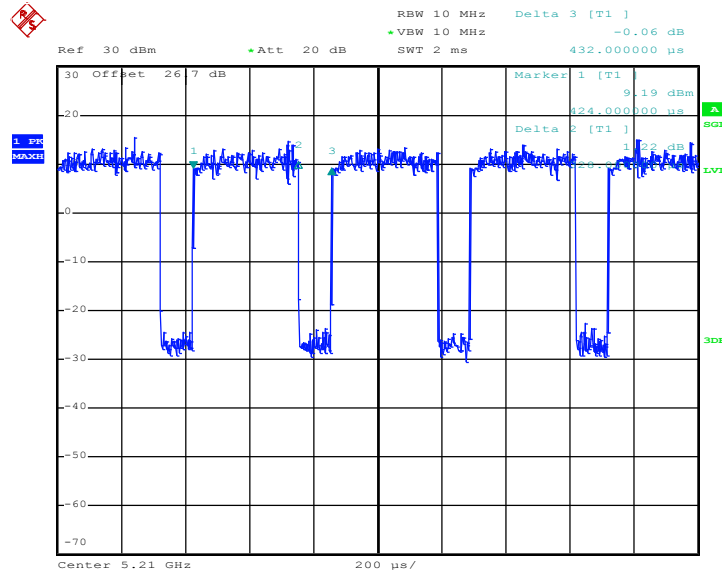

Date: 13.JUN.2017 23:34:24