

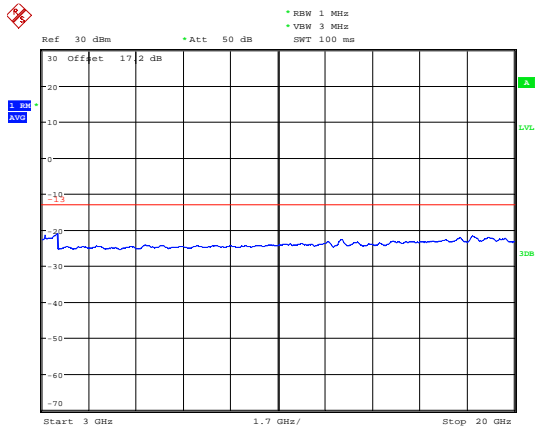

LTE Band 66 1.4MHz CH-Low 3GHz~20GHz



Date: 20.AUG.2019 20:26:55

LTE Band 66 1.4MHz CH-Middle 3GHz~20GHz

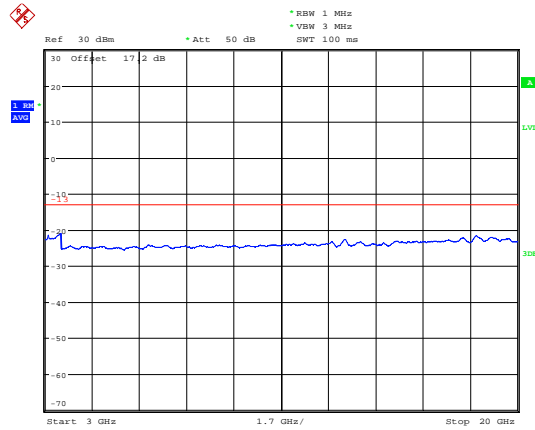

Date: 20.AUG.2019 20:27:06

LTE Band 66 1.4MHz CH-High 30MHz~1GHz

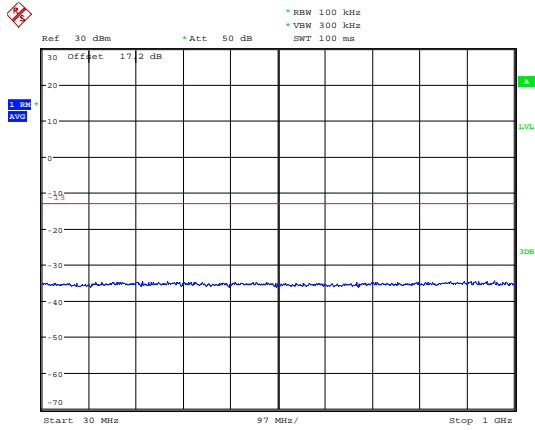

Date: 20.AUG.2019 20:14:23

LTE Band 66 3MHz CH-Low 30MHz~1GHz

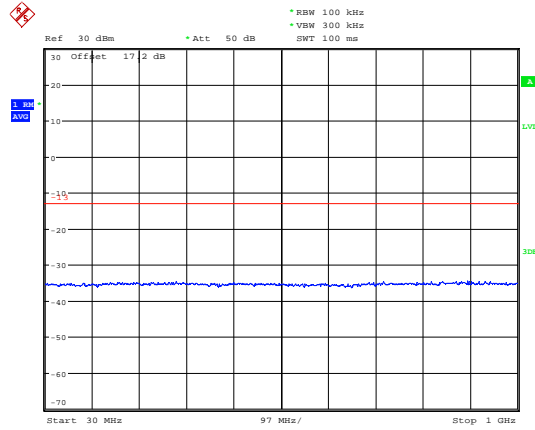

Date: 20.AUG.2019 20:14:37

LTE Band 66 1.4MHz CH-High 1GHz~3GHz

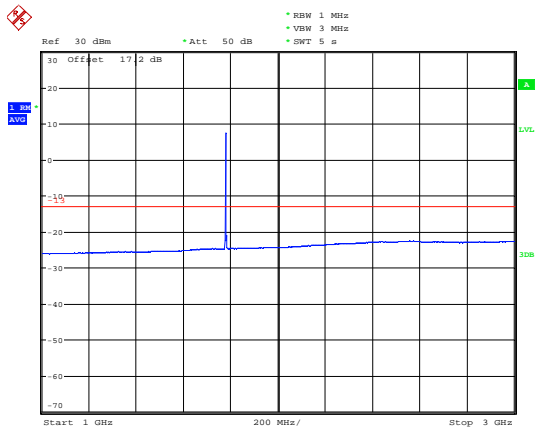

Date: 21.AUG.2019 20:11:39

LTE Band 66 3MHz CH-Low 1GHz~3GHz

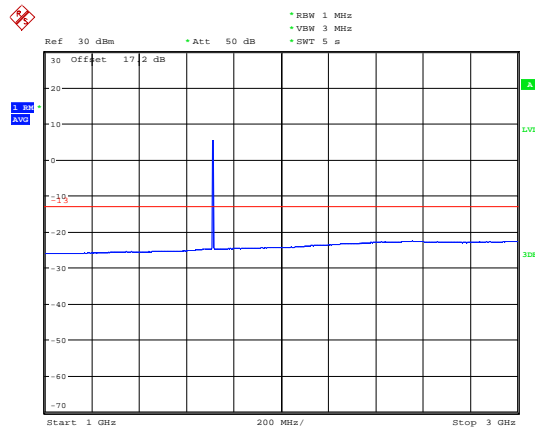

Date: 21.AUG.2019 20:12:57



LTE Band 66 1.4MHz CH-High 3GHz~20GHz

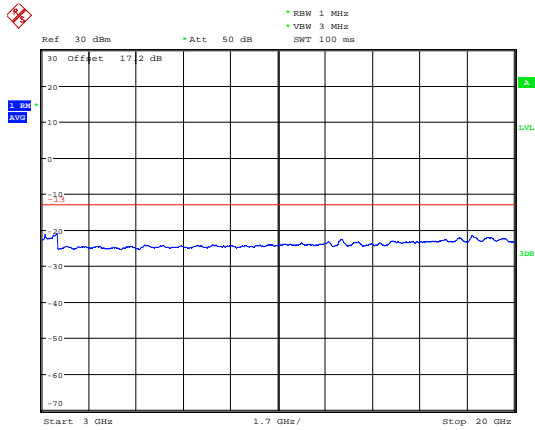

Date: 20.AUG.2019 20:27:18

LTE Band 66 3MHz CH-Low 3GHz~20GHz

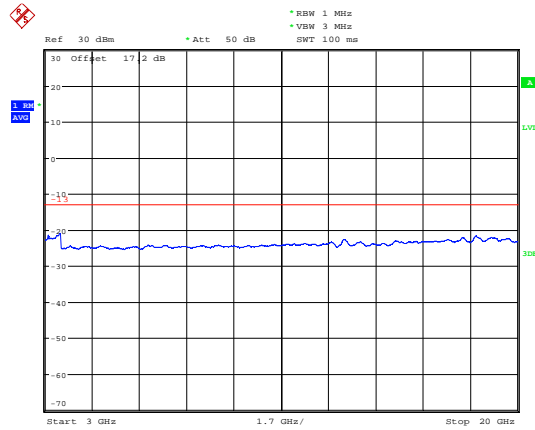

Date: 20.AUG.2019 20:27:39

LTE Band 66 3MHz CH-Middle 30MHz~1GHz

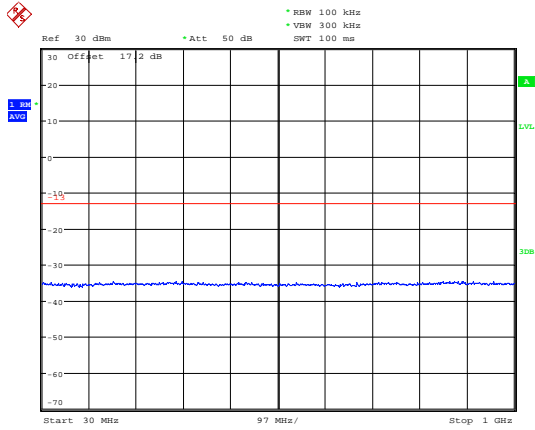

Date: 20.AUG.2019 20:14:52

LTE Band 66 3MHz CH-High 30MHz~1GHz

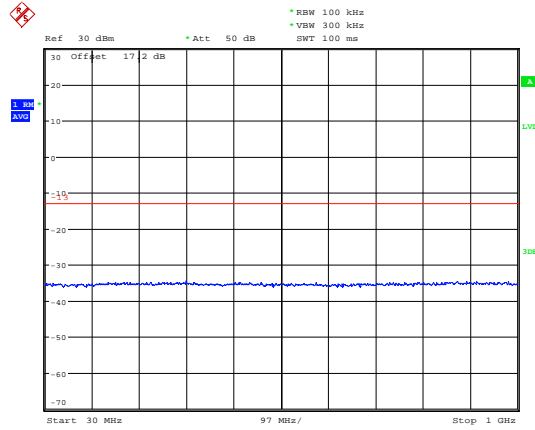

Date: 20.AUG.2019 20:15:11

LTE Band 66 3MHz CH-Middle 1GHz~3GHz

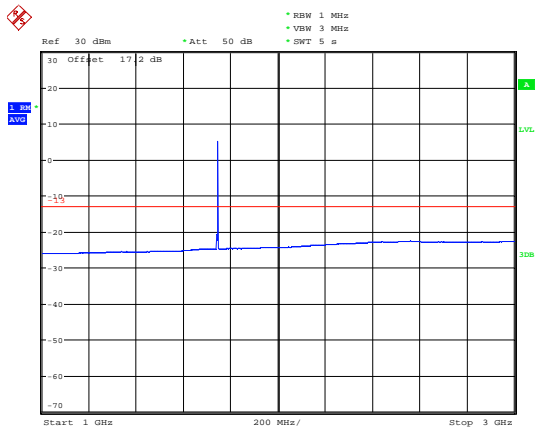

Date: 21.AUG.2019 20:15:03

LTE Band 66 3MHz CH-High 1GHz~3GHz

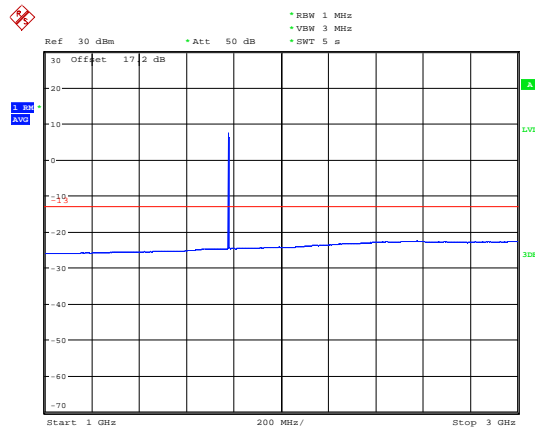

Date: 21.AUG.2019 20:16:32



LTE Band 66 3MHz CH-Middle 3GHz~20GHz

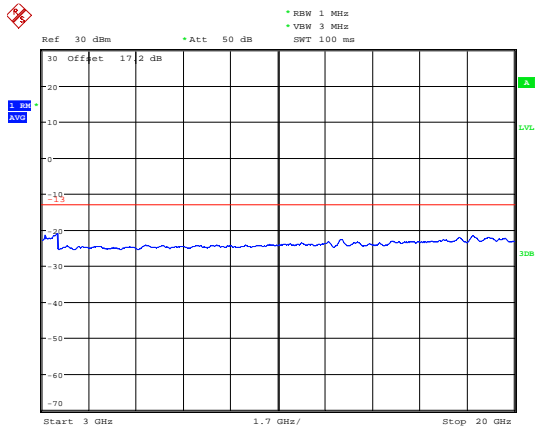

Date: 20.AUG.2019 20:28:10

LTE Band 66 3MHz CH-High 3GHz~20GHz

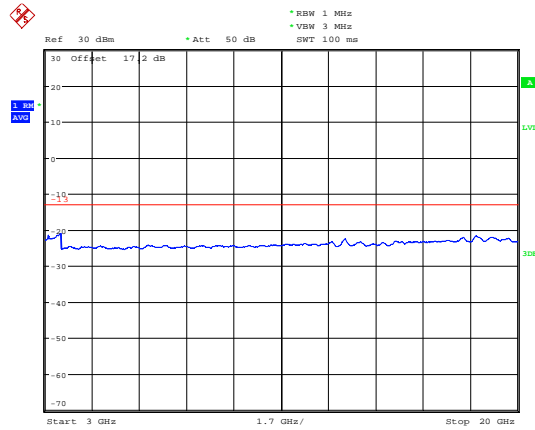

Date: 20.AUG.2019 20:28:28

LTE Band 66 5MHz CH-Low 30MHz~1GHz

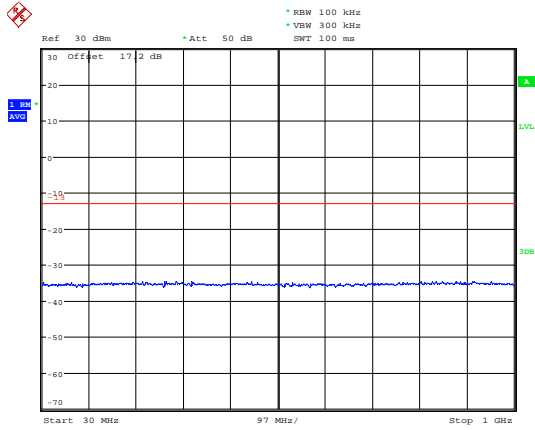

Date: 20.AUG.2019 20:15:33

LTE Band 66 5MHz CH-Middle 30MHz~1GHz

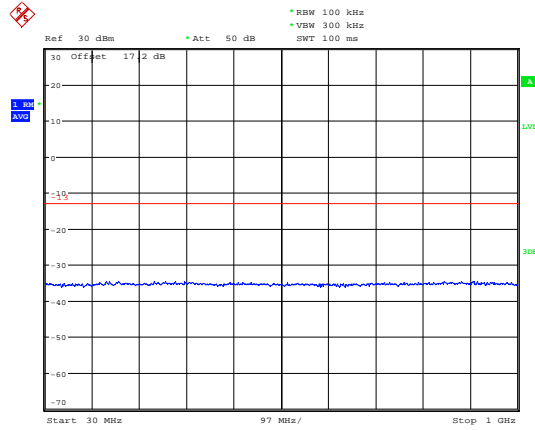

Date: 20.AUG.2019 20:15:59

LTE Band 66 5MHz CH-Low 1GHz~3GHz

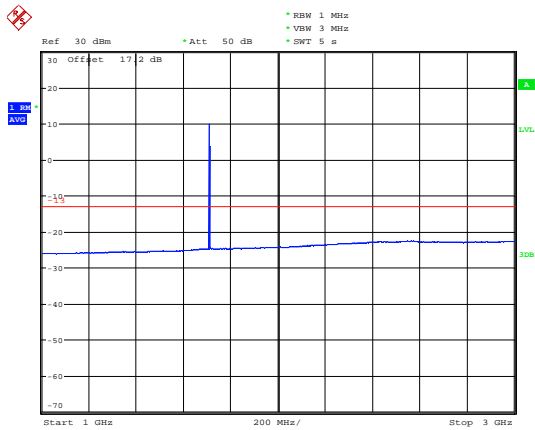

Date: 21.AUG.2019 20:18:11

LTE Band 66 5MHz CH-Middle 1GHz~3GHz

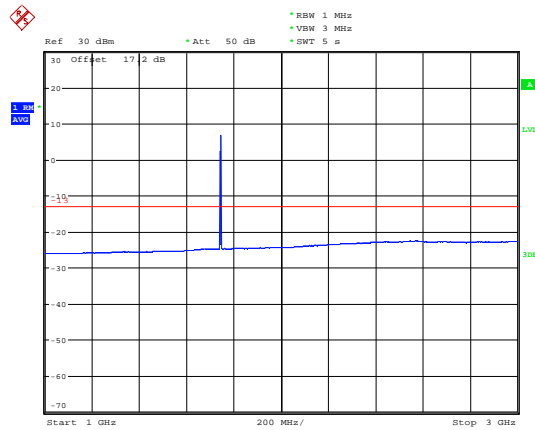

Date: 21.AUG.2019 20:19:52



LTE Band 66 5MHz CH-Low 3GHz~20GHz

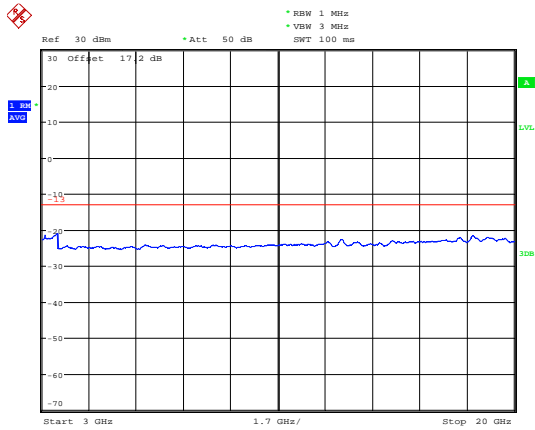

Date: 20.AUG.2019 20:28:44

LTE Band 66 5MHz CH-Middle 3GHz~20GHz

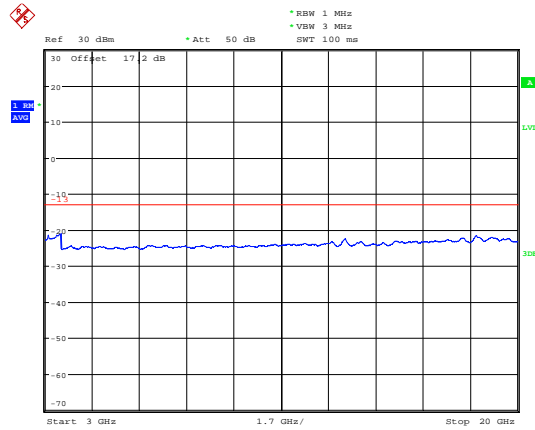

Date: 20.AUG.2019 20:28:56

LTE Band 66 5MHz CH-High 30MHz~1GHz

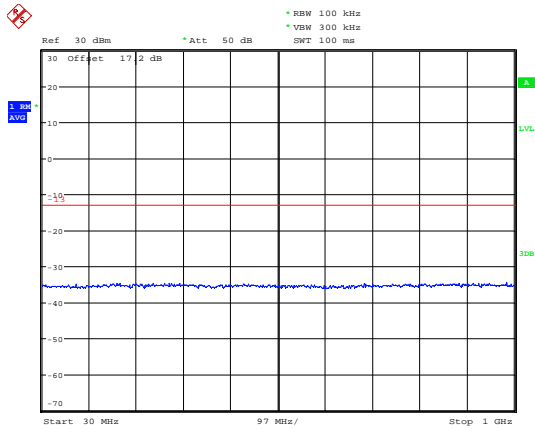

Date: 20.AUG.2019 20:16:41

LTE Band 66 10MHz CH-Low 30MHz~1GHz

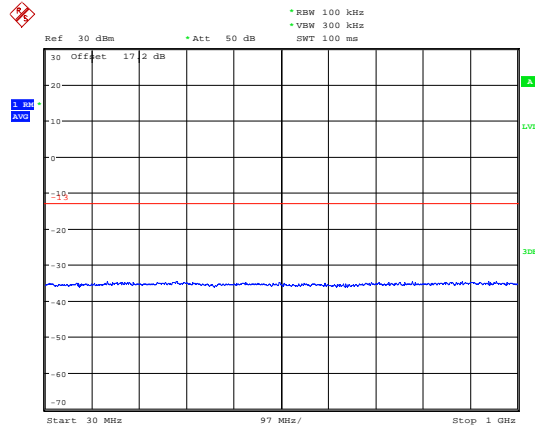

Date: 20.AUG.2019 20:17:02

LTE Band 66 5MHz CH-High 1GHz~3GHz

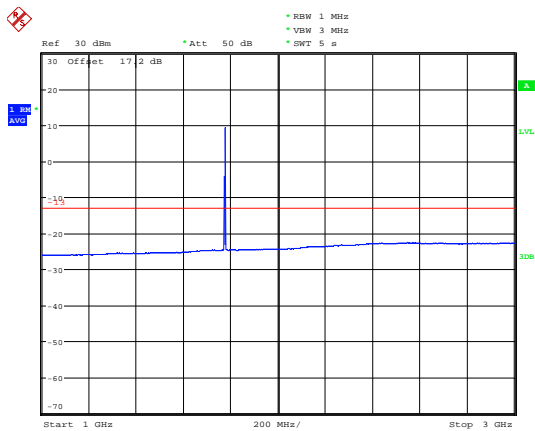

Date: 21.AUG.2019 20:21:30

LTE Band 66 10MHz CH-Low 1GHz~3GHz

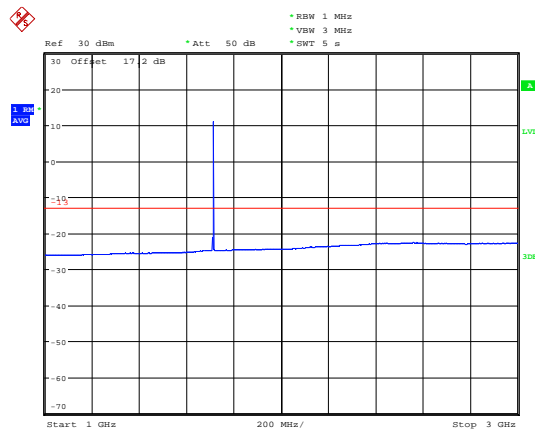

Date: 21.AUG.2019 20:23:02



LTE Band 66 5MHz CH-High 3GHz~20GHz

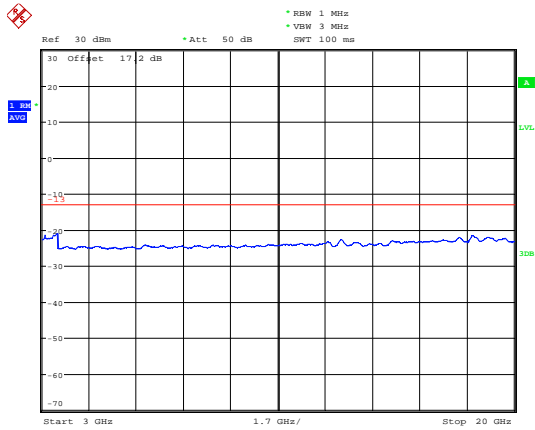

Date: 20.AUG.2019 20:29:10

LTE Band 66 10MHz CH-Low 3GHz~20GHz

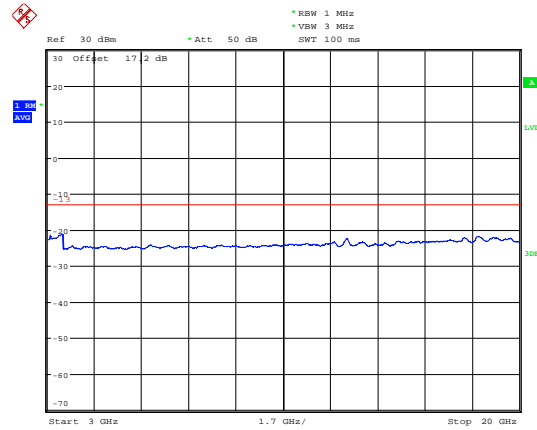

Date: 20.AUG.2019 20:29:37

LTE Band 66 10MHz CH-Middle 30MHz~1GHz

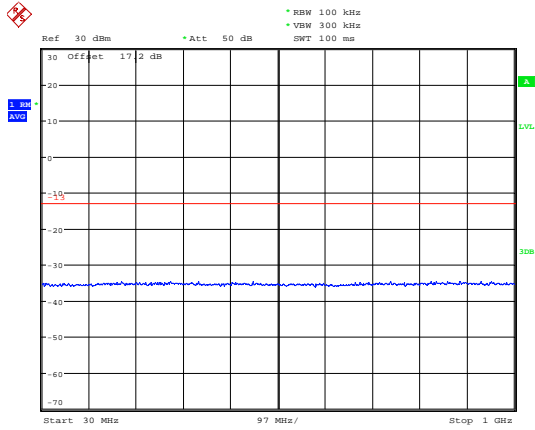

Date: 20.AUG.2019 20:17:32

LTE Band 66 10MHz CH-High 30MHz~1GHz

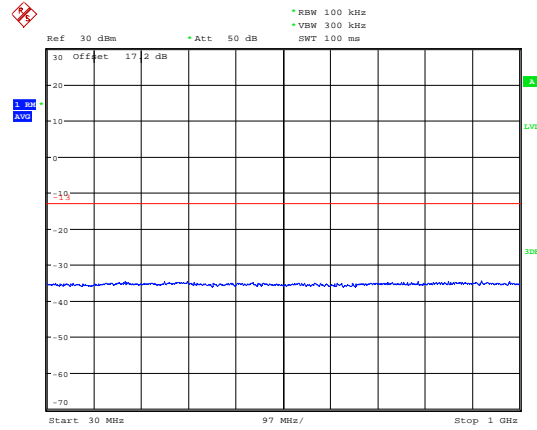

Date: 20.AUG.2019 20:18:41

LTE Band 66 10MHz CH-Middle 1GHz~3GHz

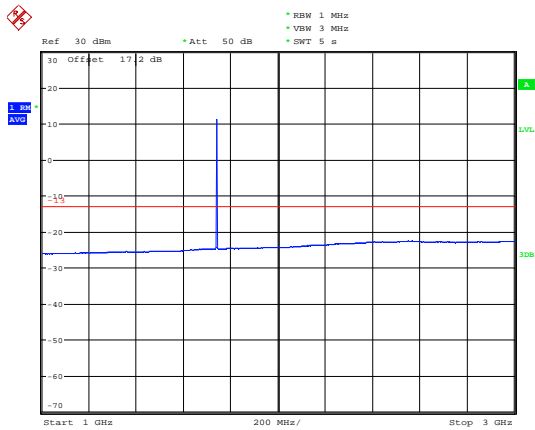

Date: 21.AUG.2019 20:24:30

LTE Band 66 10MHz CH-High 1GHz~3GHz

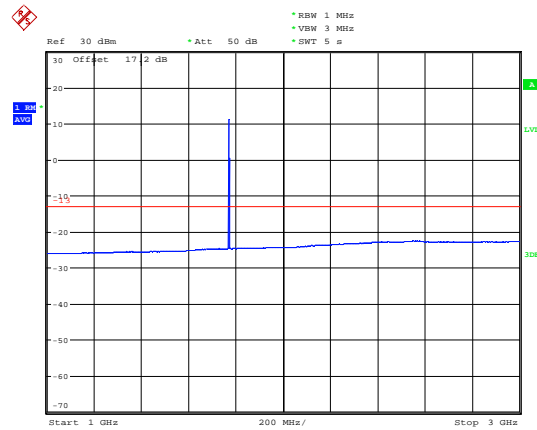

Date: 21.AUG.2019 20:25:11



LTE Band 66 10MHz CH-Middle 3GHz~20GHz

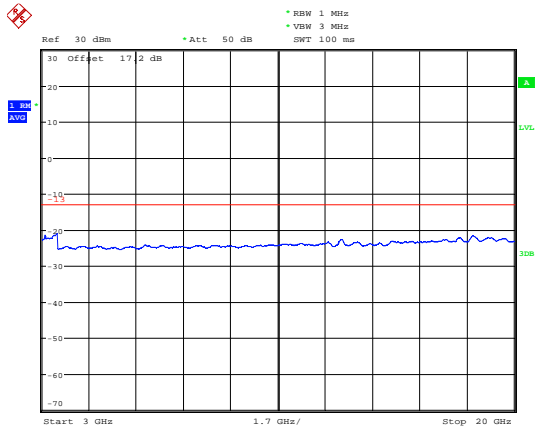

Date: 20.AUG.2019 20:29:58

LTE Band 66 10MHz CH-High 3GHz~20GHz

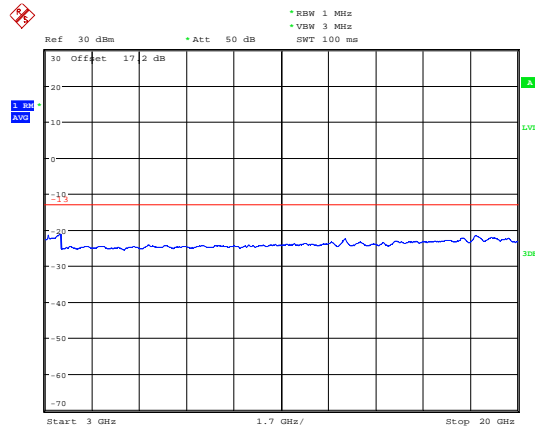

Date: 20.AUG.2019 20:30:16

LTE Band 66 15MHz CH-Low 30MHz~1GHz

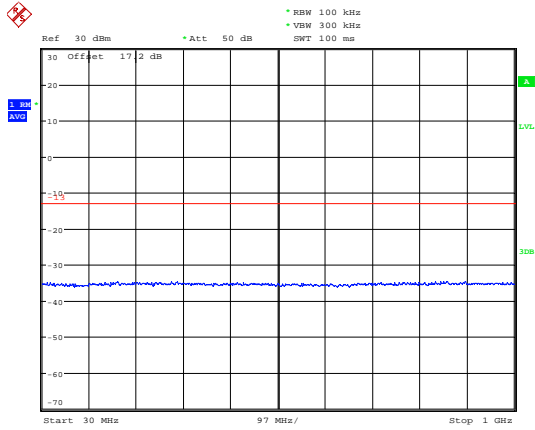

Date: 20.AUG.2019 20:20:19

LTE Band 66 15MHz CH-Middle 30MHz~1GHz

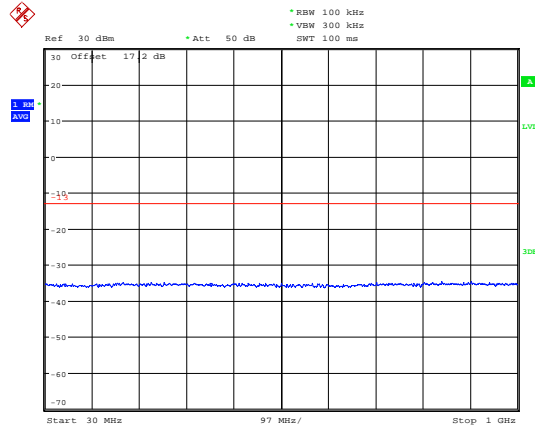

Date: 26.AUG.2019 11:02:56

LTE Band 66 15MHz CH-Low 1GHz~3GHz

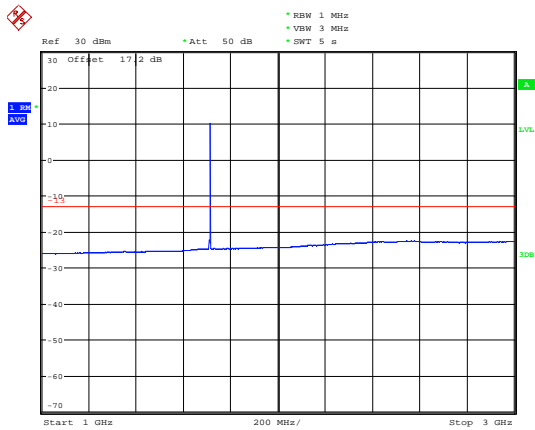

Date: 21.AUG.2019 20:25:54

LTE Band 66 15MHz CH-Middle 1GHz~3GHz

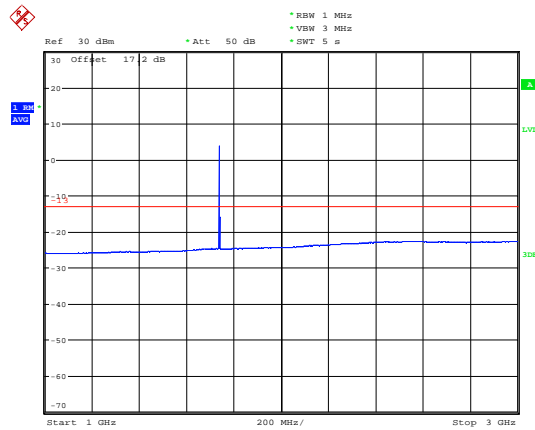

Date: 21.AUG.2019 20:26:48



LTE Band 66 15MHz CH-Low 3GHz~20GHz

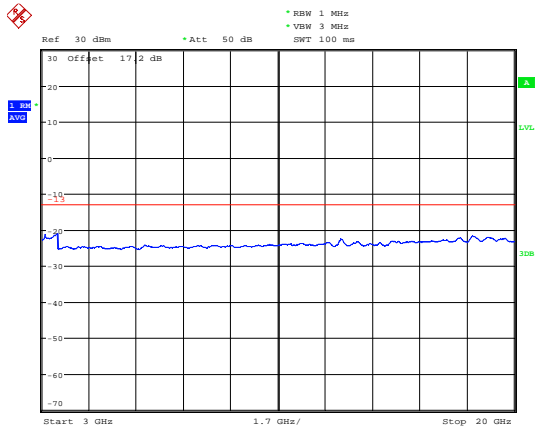

Date: 20.AUG.2019 20:30:36

LTE Band 66 15MHz CH-Middle 3GHz~20GHz

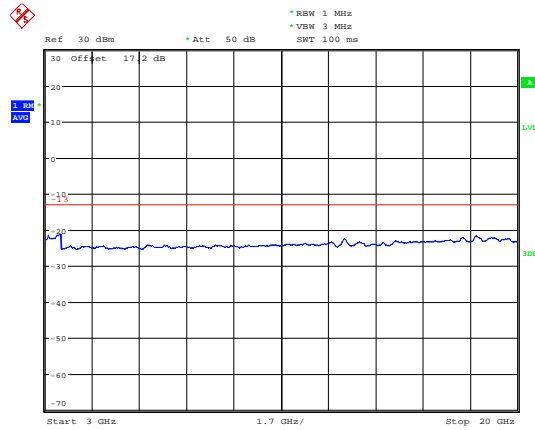

Date: 20.AUG.2019 20:30:57

LTE Band 66 15MHz CH-High 30MHz~1GHz

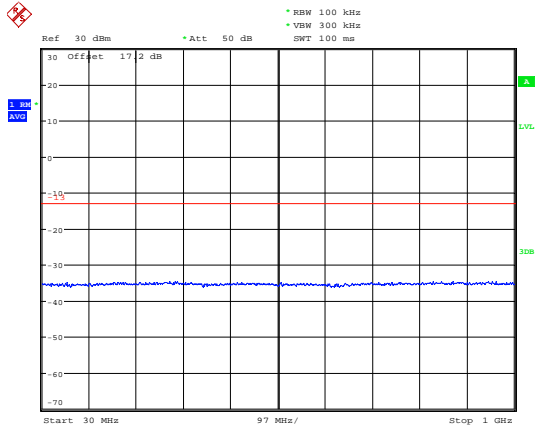

Date: 20.AUG.2019 20:22:29

LTE Band 66 20MHz CH-Low 30MHz~1GHz

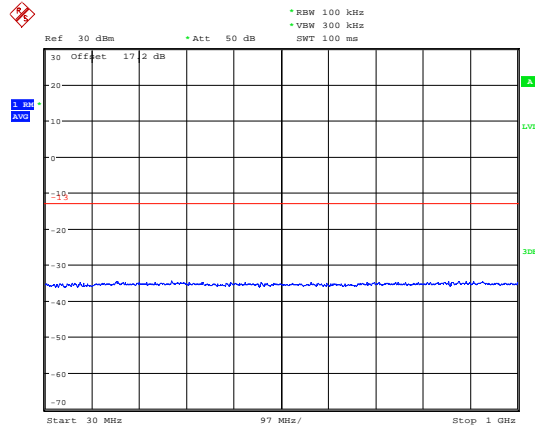

Date: 20.AUG.2019 20:22:57

LTE Band 66 15MHz CH-High 1GHz~3GHz

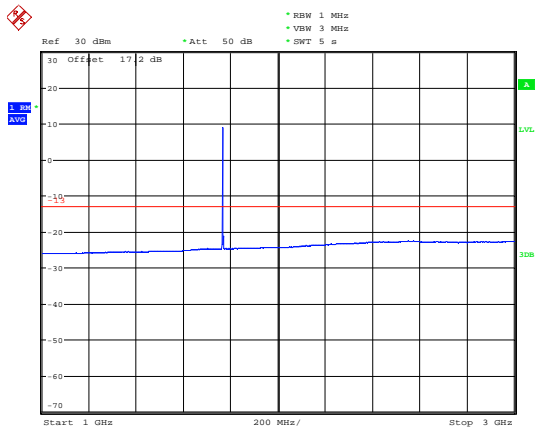

Date: 21.AUG.2019 20:27:21

LTE Band 66 20MHz CH-Low 1GHz~3GHz

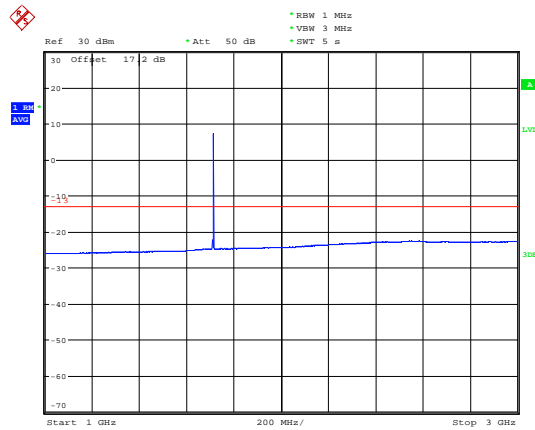

Date: 21.AUG.2019 20:28:00



LTE Band 66 15MHz CH-High 3GHz~20GHz

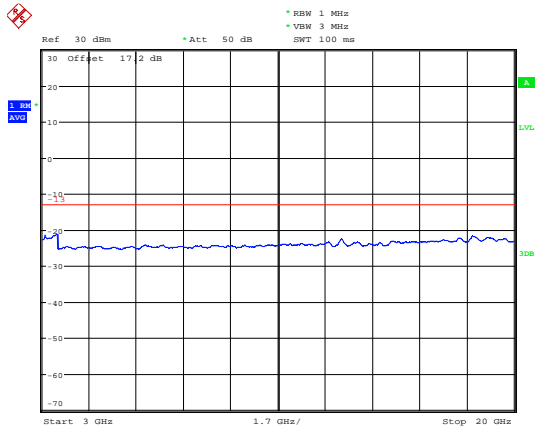

Date: 20.AUG.2019 20:31:12

LTE Band 66 20MHz CH-Low 3GHz~20GHz

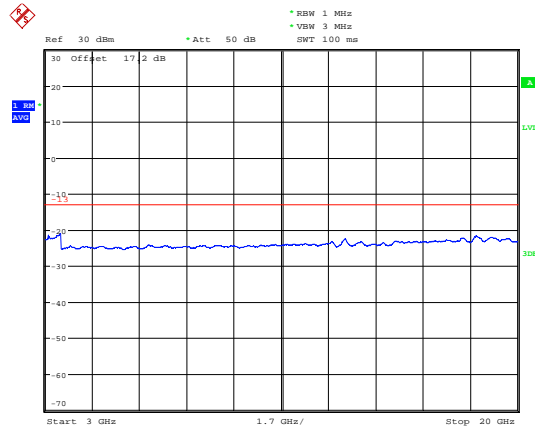

Date: 20.AUG.2019 20:31:32

LTE Band 66 20MHz CH-Middle 30MHz~1GHz

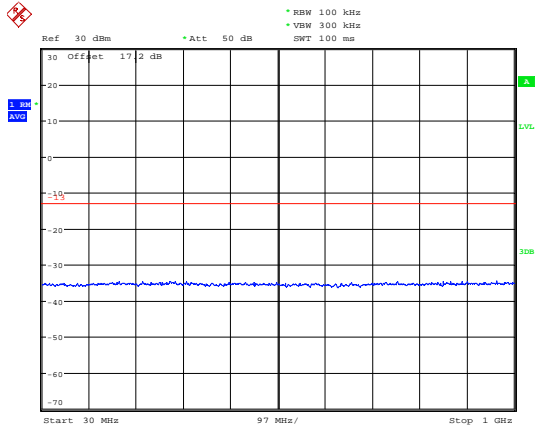

Date: 20.AUG.2019 20:23:32

LTE Band 66 20MHz CH-High 30MHz~1GHz

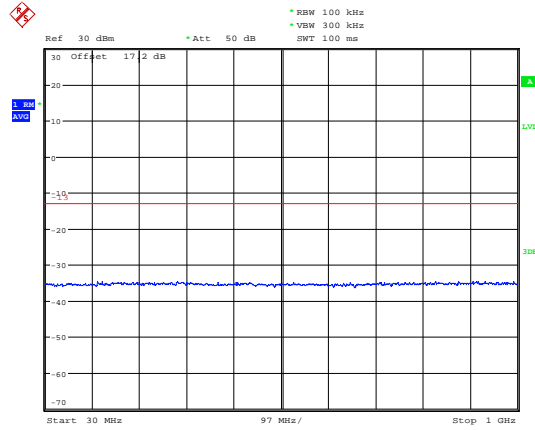

Date: 20.AUG.2019 20:24:17

LTE Band 66 20MHz CH-Middle 1GHz~3GHz

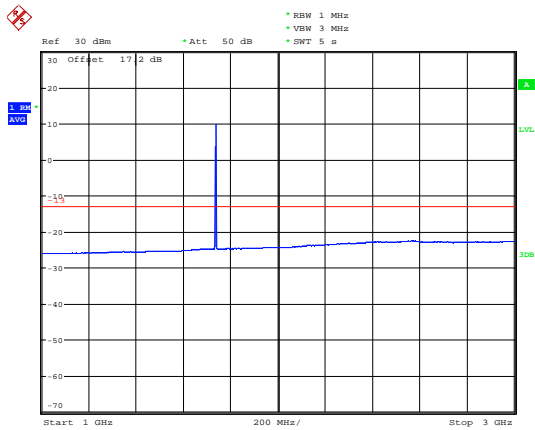

Date: 21.AUG.2019 20:28:30

LTE Band 66 20MHz CH-High 1GHz~3GHz

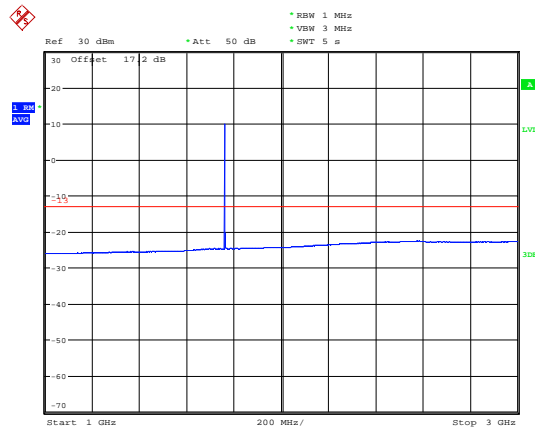

Date: 21.AUG.2019 20:29:01



LTE Band 66 20MHz CH-Middle 3GHz~20GHz

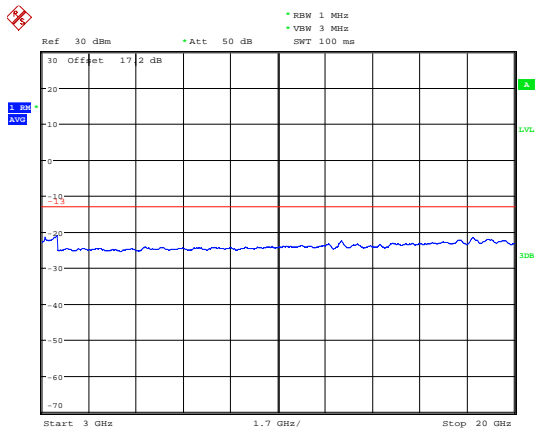

Date: 20.AUG.2019 20:31:54

LTE Band 66 20MHz CH-High 3GHz~20GHz

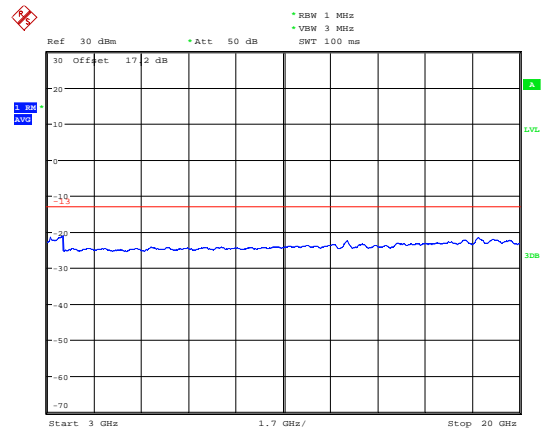

Date: 20.AUG.2019 20:32:04



LTE Band 85 5MHz CH-Low 30MHz~1GHz

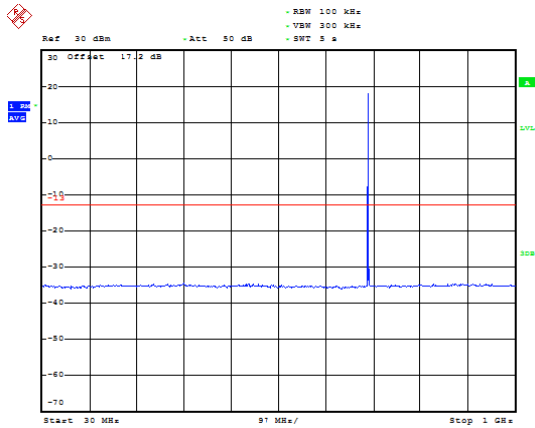

Date: 26.AUG.2019 20:27:58

LTE Band 85 5MHz CH-Low 1GHz~9GHz

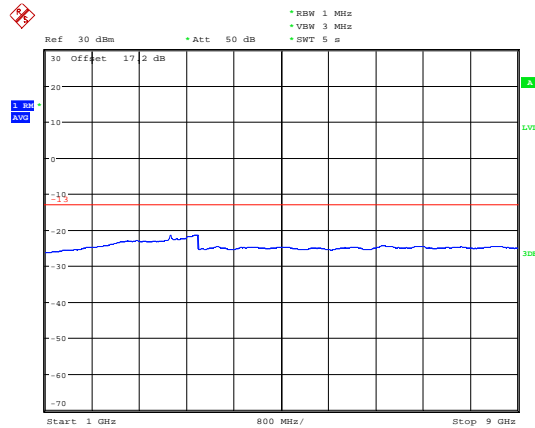

Date: 26.AUG.2019 20:35:15

LTE Band 85 5MHz CH-Middle 30MHz~1GHz

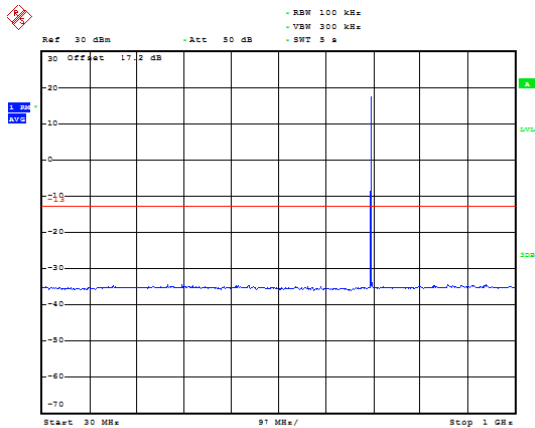

Date: 26.AUG.2019 20:29:10

LTE Band 85 5MHz CH-Middle 1GHz~9GHz

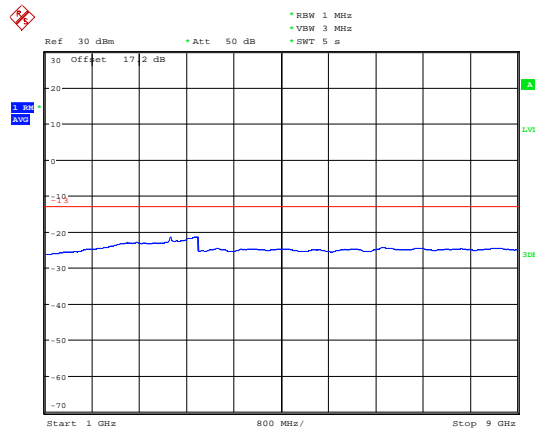

Date: 26.AUG.2019 20:35:30

LTE Band 85 5MHz CH-High 30MHz~1GHz

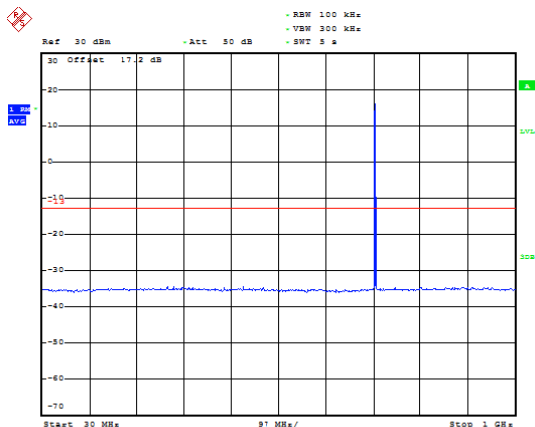

Date: 26.AUG.2019 20:29:51

LTE Band 85 5MHz CH-High 1GHz~9GHz

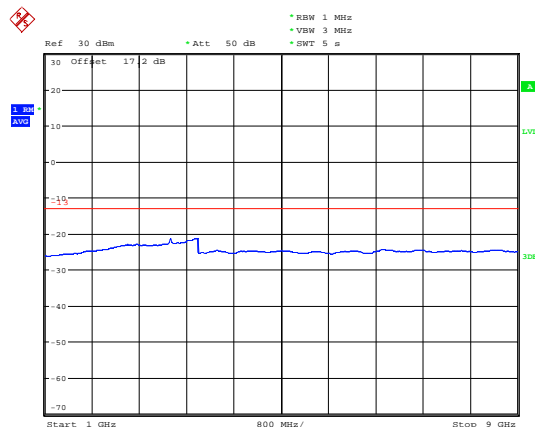

Date: 26.AUG.2019 20:35:58



LTE Band 85 10MHz CH- Low 30MHz~1GHz

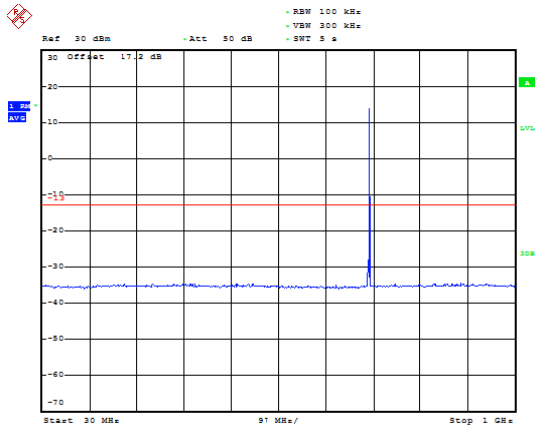

Date: 26.AUG.2019 20:31:55

LTE Band 85 10MHz CH- Low 1GHz~9GHz

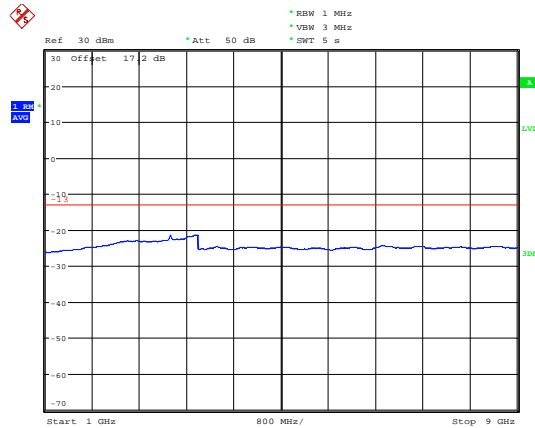

Date: 26.AUG.2019 20:36:21

LTE Band 85 10MHz CH-Middle 30MHz~1GHz

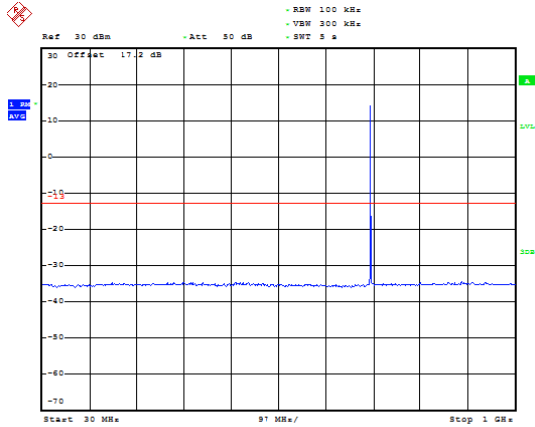

Date: 26.AUG.2019 20:32:40

LTE Band 85 10MHz CH-Middle 1GHz~9GHz

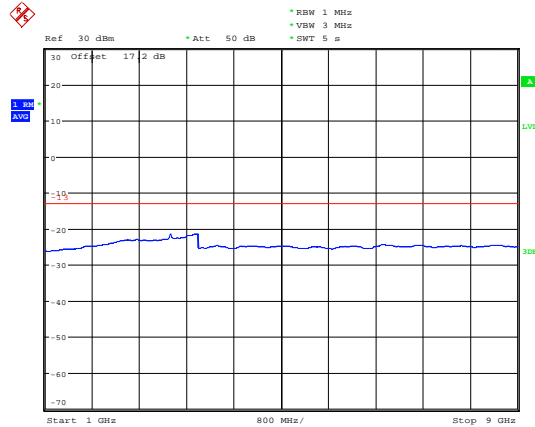

Date: 26.AUG.2019 20:36:43

LTE Band 85 10MHz CH- High 30MHz~1GHz

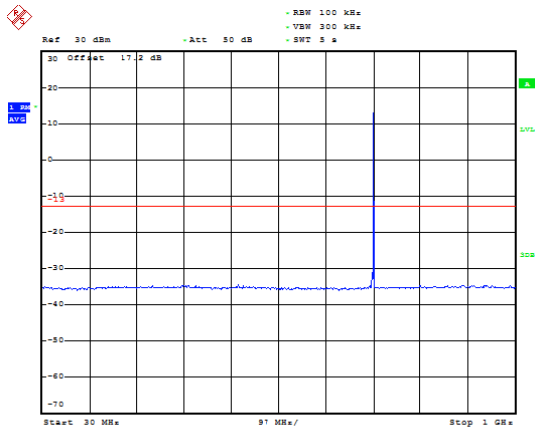

Date: 26.AUG.2019 20:33:29

LTE Band 85 10MHz CH- High 1GHz~9GHz

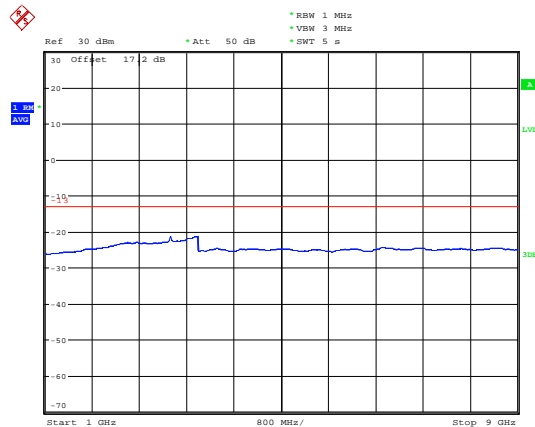

Date: 26.AUG.2019 20:37:07

5.7 Radiates Spurious Emission

Ambient condition

Temperature	Relative humidity	Pressure
23°C ~25°C	45%~50%	101.5kPa

Method of Measurement

- The testing follows FCC KDB 971168 D01 v03r01 Section 5.8 and ANSI C63.26 (2015).
- Below 1GHz: The EUT is placed on a turntable 0.8 meters above the ground in the chamber, 3 meter away from the antenna. The maximal emission value is acquired by adjusting the antenna height, polarisation and turntable azimuth. Normally, the height range of antenna is 1 m to 4 m, the azimuth range of turntable is 0° to 360°, and the receive antenna has two polarizations Vertical (V) and Horizontal (H). Above 1GHz: (Note: the FCC's permission to use 1.5m as an alternative per TCBC Conf call of Dec. 2, 2014.) The EUT is placed on a turntable 1.5 meters above the ground in the chamber, 3 meter away from the antenna. The maximal emission value is acquired by adjusting the antenna height, polarisation and turntable azimuth. Normally, the height range of antenna is 1 m to 4 m, the azimuth range of turntable is 0° to 360°, and the receive antenna has two polarizations Vertical (V) and Horizontal (H).
- A loop antenna, A log-periodic antenna or horn antenna shall be substituted in place of the EUT. The log-periodic antenna will be driven by a signal generator and the level will be adjusted till the same power value on the spectrum analyzer or receiver. The level of the spurious emissions can be calculated through the level of the signal generator, cable loss, the gain of the substitution antenna and the reading of the spectrum analyzer or receiver.
- The EUT is then put into continuously transmitting mode at its maximum power level during the test. Set Test Receiver or Spectrum RBW=200Hz,VBW=600Hz for 9kHz150kHz , RBW=10kHz, VBW=30kHz 150kHz-30MHz ,RBW=100kHz,VBW=300kHz for 30MHz to 1GHz and RBW=1MHz, VBW=3MHz for above 1GHz And the maximum value of the receiver should be recorded as (Pr).
- The EUT shall be replaced by a substitution antenna. In the chamber, an substitution antenna for the frequency band of interest is placed at the reference point of the chamber. An RF Signal source for the frequency band of interest is connected to the substitution antenna with a cable that has been constructed to not interfere with the radiation pattern of the antenna. A power (PMea) is applied to the input of the substitution antenna, and adjust the level of the signal generator output until the value of the receiver reach the previously recorded (Pr). The power of signal source (PMea) is recorded. The test should be performed by rotating the test item and adjusting the receiving antenna polarization.
- A amplifier should be connected to the Signal Source output port. And the cable should be connect between the Amplifier and the Substitution Antenna. The cable loss (Pcl) ,the Substitution Antenna Gain (Ga) and the Amplifier Gain (PAg) should be recorded after test.
- The measurement results are obtained as described below:
 $Power(EIRP)=PMea- PAg - Pcl + Ga$
 The measurement results are amend as described below:
 $Power(EIRP)=PMea- Pcl + Ga$
- This value is EIRP since the measurement is calibrated using an antenna of known gain (2.15 dBi) and known input power. ERP can be calculated from EIRP by subtracting the gain of the dipole, ERP

= EIRP-2.15dBi.

The modulation mode and RB allocation refer to section 5.1, using the maximum output power configuration.

Test setup

9KHz ~ 30MHz

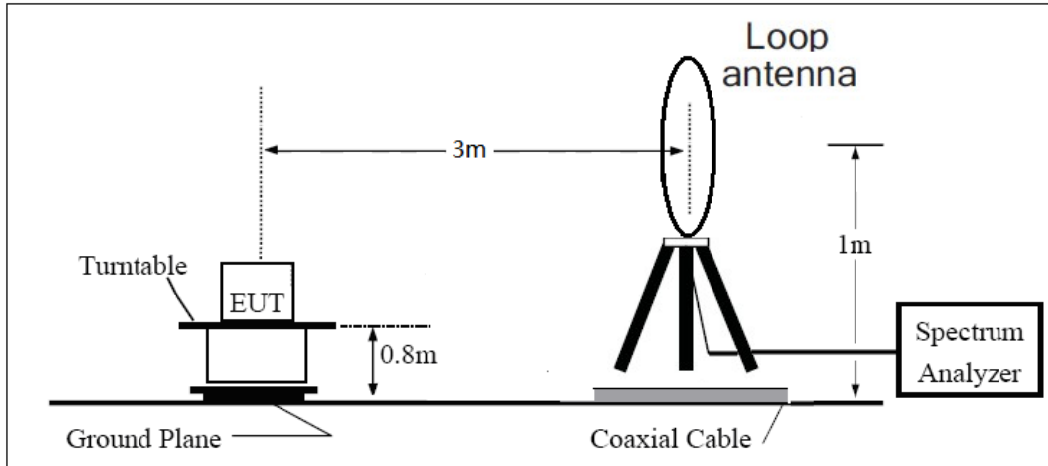

30MHz ~ 1GHz

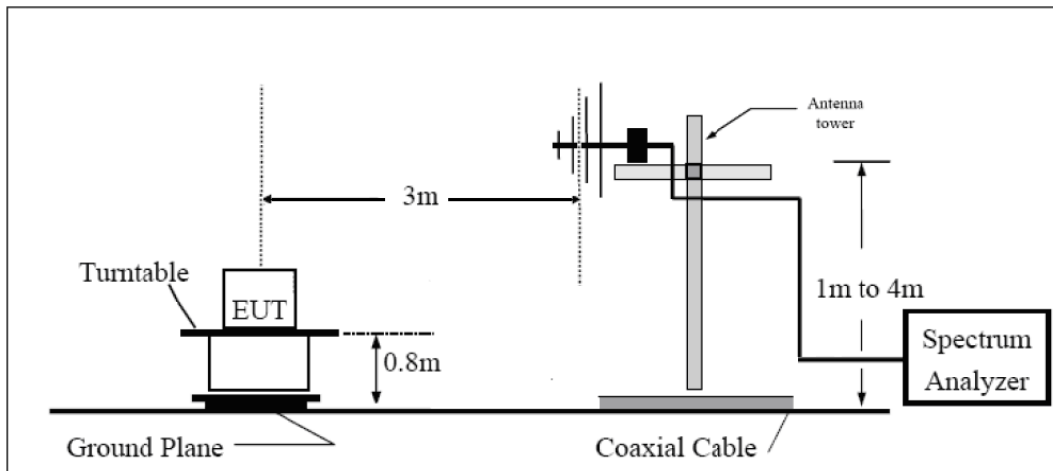

Above 1GHz

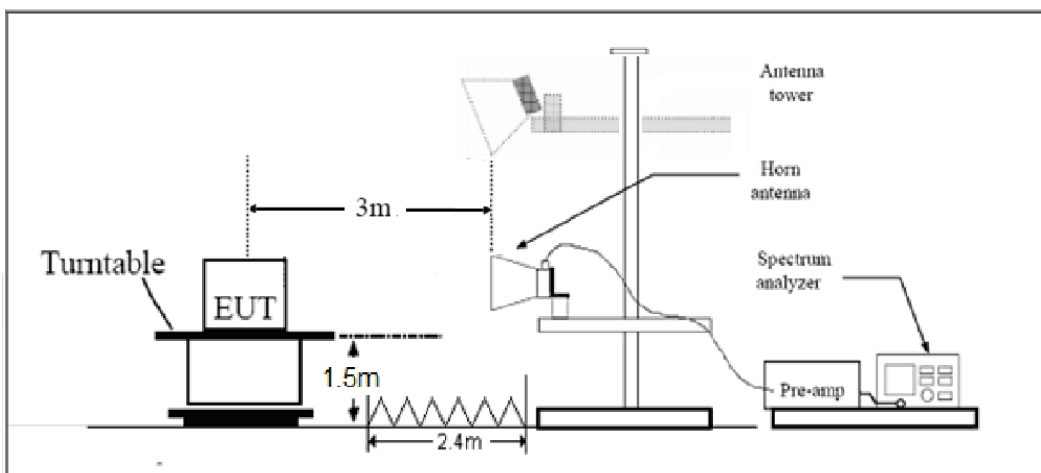

Note: Area side:2.4mX3.6m

**Limits**

Rule Part 27.53(h) specifies that “for operations in the 1695-1710 MHz, 1710-1755 MHz, 1755-1780 MHz, 1915-1920 MHz, 1995-2000 MHz, 2000-2020 MHz, 2110-2155 MHz, 2155-2180 MHz, and 2180-2200 bands, the power of any emission outside a licensee's frequency block shall be attenuated below the transmitter power (P) in watts by at least $43 + 10 \log_{10}(P)$ dB.”

Rule Part 27.53 (g) For operations in the 600 MHz band and the 698-746 MHz band, the power of any emission outside a licensee's frequency band(s) of operation shall be attenuated below the transmitter power (P) within the licensed band(s) of operation, measured in watts, by at least $43 + 10 \log(P)$ dB. Compliance with this provision is based on the use of measurement instrumentation employing a resolution bandwidth of 100 kilohertz or greater. However, in the 100 kilohertz bands immediately outside and adjacent to a licensee's frequency block, a resolution bandwidth of at least 30 kHz may be employed.

Rule Part 27.53(f) For operations in the 746-758 MHz, 775-788 MHz, and 805-806 MHz bands, emissions in the band 1559-1610 MHz shall be limited to -70 dBW/MHz equivalent isotropically radiated power (EIRP) for wideband signals, and -80 dBW EIRP for discrete emissions of less than 700 Hz bandwidth. For the purpose of equipment authorization, a transmitter shall be tested with an antenna that is representative of the type that will be used with the equipment in normal operation.

Part 27.53 (c) For operations in the 746-758 MHz band and the 776-788 MHz band, the power of any emission outside the licensee's frequency band(s) of operation shall be attenuated below the transmitter power (P) within the licensed band(s) of operation, measured in watts, in accordance with the following:

- (1) On any frequency outside the 746-758 MHz band, the power of any emission shall be attenuated outside the band below the transmitter power (P) by at least $43 + 10 \log(P)$ dB;
- (2) On any frequency outside the 776-788 MHz band, the power of any emission shall be attenuated outside the band below the transmitter power (P) by at least $43 + 10 \log(P)$ dB;
- (3) On all frequencies between 763-775 MHz and 793-805 MHz, by a factor not less than $76 + 10 \log(P)$ dB in a 6.25 kHz band segment, for base and fixed stations;
- (4) On all frequencies between 763-775 MHz and 793-805 MHz, by a factor not less than $65 + 10 \log(P)$ dB in a 6.25 kHz band segment, for mobile and portable stations;
- (5) Compliance with the provisions of paragraphs (c)(1) and (c)(2) of this section is based on the use of measurement instrumentation employing a resolution bandwidth of 100 kHz or greater. However, in the 100 kHz bands immediately outside and adjacent to the frequency block, a resolution bandwidth of at least 30 kHz may be employed;

Part 27.53(a)/(h)/(g) Limit		-13 dBm
Part 27.53(f) Limit	Limit out of the band 1559-1610 MHz	-13 dBm
	Limit in the band 1559-1610 MHz	-40 dBm

Measurement Uncertainty

The assessed measurement uncertainty to ensure 95% confidence level for the normal distribution is with the coverage factor $k = \pm 1.96$, $U = \pm 3.55$ dB.

**Test Result**

Sweep the whole frequency band through the range from 9kHz to the 10th harmonic of the carrier, the emissions below the noise floor will not be recorded in the report.

Variant:

LTE Band 4 QPSK 1.4MHz CH-Middle, RB 1

Harmonic	Frequency (MHz)	SG (dBm)	Cable Loss (dB)	Gain (dBi)	Antenna Polarization	EIRP Level (dBm)	Limit (dBm)	Margin (dB)	Azimuth (deg)
2	3465.0	-53.01	2.6	10.75	Horizontal	-44.86	-13.00	31.86	45
3	5197.5	-59.36	2.4	11.05	Horizontal	-50.71	-13.00	37.71	0
4	6930.0	-60.39	4.5	11.15	Horizontal	-53.74	-13.00	40.74	135
5	8662.5	-56.17	5.1	11.35	Horizontal	-49.92	-13.00	36.92	225
6	10395.0	-51.80	5.3	11.95	Horizontal	-45.15	-13.00	32.15	135
7	12127.5	-53.44	5.5	13.55	Horizontal	-45.39	-13.00	32.39	90
8	13860.0	-51.48	6.3	13.75	Horizontal	-44.03	-13.00	31.03	45
9	15592.5	-50.05	6.7	13.85	Horizontal	-42.90	-13.00	29.90	90
10	17325.0	-47.18	6.8	14.25	Horizontal	-39.73	-13.00	26.73	180

Note: 1.The other Spurious RF Radiated emissions level is no more than noise floor.
2. The worst emission was found in the antenna is Horizontal position.

LTE Band 4 QPSK 5MHz CH-Middle, RB 1

Harmonic	Frequency (MHz)	SG (dBm)	Cable Loss (dB)	Gain (dBi)	Antenna Polarization	EIRP Level (dBm)	Limit (dBm)	Margin (dB)	Azimuth (deg)
2	3460.5	-56.26	2.6	10.75	Horizontal	-48.11	-13.00	35.11	180
3	5191.5	-58.73	2.4	11.05	Horizontal	-50.08	-13.00	37.08	45
4	6930.0	-59.76	4.5	11.15	Horizontal	-53.11	-13.00	40.11	90
5	8662.5	-55.51	5.1	11.35	Horizontal	-49.26	-13.00	36.26	135
6	10395.0	-51.63	5.3	11.95	Horizontal	-44.98	-13.00	31.98	315
7	12127.5	-53.62	5.5	13.55	Horizontal	-45.57	-13.00	32.57	225
8	13860.0	-51.10	6.3	13.75	Horizontal	-43.65	-13.00	30.65	180
9	15592.5	-49.29	6.7	13.85	Horizontal	-42.14	-13.00	29.14	45
10	17325.0	-48.52	6.8	14.25	Horizontal	-41.07	-13.00	28.07	90

Note: 1.The other Spurious RF Radiated emissions level is no more than noise floor.
2. The worst emission was found in the antenna is Horizontal position.



LTE Band 4 QPSK 20MHz CH-Middle, RB 1

Harmonic	Frequency (MHz)	SG (dBm)	Cable Loss (dB)	Gain (dBi)	Antenna Polarization	EIRP Level (dBm)	Limit (dBm)	Margin (dB)	Azimuth (deg)
2	3480.8	-56.72	2.6	10.75	Horizontal	-48.57	-13.00	35.57	45
3	5221.1	-58.77	2.4	11.05	Horizontal	-50.12	-13.00	37.12	90
4	6961.5	-59.89	4.5	11.15	Horizontal	-53.24	-13.00	40.24	180
5	8701.9	-56.47	5.1	11.35	Horizontal	-50.22	-13.00	37.22	0
6	10442.3	-51.57	5.3	11.95	Horizontal	-44.92	-13.00	31.92	0
7	12182.6	-52.42	5.5	13.55	Horizontal	-44.37	-13.00	31.37	135
8	13923.0	-51.11	6.3	13.75	Horizontal	-43.66	-13.00	30.66	45
9	15663.4	-49.64	6.7	13.85	Horizontal	-42.49	-13.00	29.49	90
10	17403.8	-48.64	6.8	14.25	Horizontal	-41.19	-13.00	28.19	180

Note: 1.The other Spurious RF Radiated emissions level is no more than noise floor.

2. The worst emission was found in the antenna is Horizontal position.

LTE Band 12 QPSK 1.4MHz CH-Middle, RB 1

Harmonic	Frequency (MHz)	SG (dBm)	Cable Loss (dB)	Gain (dBi)	Antenna Polarization	ERP Level (dBm)	Limit (dBm)	Margin (dB)	Azimuth (deg)
2	1415.0	-47.67	2.00	10.75	Horizontal	-41.07	-13.00	28.07	45
3	2122.5	-56.94	2.51	11.05	Horizontal	-50.55	-13.00	37.55	90
4	2830.0	-57.86	4.20	11.15	Horizontal	-53.06	-13.00	40.06	45
5	3537.5	-54.55	5.20	11.15	Horizontal	-50.75	-13.00	37.75	90
6	4245.0	-56.02	5.50	11.95	Horizontal	-51.72	-13.00	38.72	180
7	4952.5	-55.57	5.70	13.55	Horizontal	-49.87	-13.00	36.87	0
8	5660.0	-56.19	6.30	13.75	Horizontal	-50.89	-13.00	37.89	45
9	6367.5	-56.97	6.80	13.85	Horizontal	-52.07	-13.00	39.07	90
10	7075.0	-57.36	6.90	14.25	Horizontal	-52.16	-13.00	39.16	0

Note: 1.The other Spurious RF Radiated emissions level is no more than noise floor.

2. The worst emission was found in the antenna is Horizontal position.



LTE Band 12 QPSK 5MHz CH-Middle, RB 1

Harmonic	Frequency (MHz)	SG (dBm)	Cable Loss (dB)	Gain (dBi)	Antenna Polarization	ERP Level (dBm)	Limit (dBm)	Margin (dB)	Azimuth (deg)
2	1414.6	-49.30	2.00	10.75	Horizontal	-42.70	-13.00	29.70	90
3	2121.8	-57.20	2.51	11.05	Horizontal	-50.81	-13.00	37.81	135
4	2829.1	-53.66	4.20	11.15	Horizontal	-48.86	-13.00	35.86	90
5	3537.5	-56.87	5.20	11.15	Horizontal	-53.07	-13.00	40.07	135
6	4243.7	-55.48	5.50	11.95	Horizontal	-51.18	-13.00	38.18	45
7	4949.9	-55.92	5.70	13.55	Horizontal	-50.22	-13.00	37.22	225
8	5656.0	-56.04	6.30	13.75	Horizontal	-50.74	-13.00	37.74	135
9	6362.2	-56.43	6.80	13.85	Horizontal	-51.53	-13.00	38.53	90
10	7068.4	-57.33	6.90	14.25	Horizontal	-52.13	-13.00	39.13	180

Note: 1. The other Spurious RF Radiated emissions level is no more than noise floor.
2. The worst emission was found in the antenna is Horizontal position.

LTE Band 12 QPSK 10MHz CH-Middle, RB 1

Harmonic	Frequency (MHz)	SG (dBm)	Cable Loss (dB)	Gain (dBi)	Antenna Polarization	ERP Level (dBm)	Limit (dBm)	Margin (dB)	Azimuth (deg)
2	1411.3	-50.54	2.00	10.75	Horizontal	-43.94	-13.00	30.94	315
3	2117.0	-57.65	2.51	11.05	Horizontal	-51.26	-13.00	38.26	45
4	2822.7	-52.61	4.20	11.15	Horizontal	-47.81	-13.00	34.81	135
5	3528.3	-57.14	5.20	11.15	Horizontal	-53.34	-13.00	40.34	315
6	4233.9	-56.47	5.50	11.95	Horizontal	-52.17	-13.00	39.17	225
7	4939.6	-56.38	5.70	13.55	Horizontal	-50.68	-13.00	37.68	90
8	5645.2	-56.20	6.30	13.75	Horizontal	-50.90	-13.00	37.90	45
9	6350.9	-56.30	6.80	13.85	Horizontal	-51.40	-13.00	38.40	315
10	7056.5	-57.25	6.90	14.25	Horizontal	-52.05	-13.00	39.05	225

Note: 1. The other Spurious RF Radiated emissions level is no more than noise floor.
2. The worst emission was found in the antenna is Horizontal position.



LTE Band 13 QPSK 5MHz CH-Middle, RB 1

Harmonic	Frequency (MHz)	SG (dBm)	Cable Loss (dB)	Gain (dBi)	Antenna Polarization	ERP Level (dBm)	Limit (dBm)	Margin (dB)	Azimuth (deg)
2	1560.2	-54.90	2.00	10.75	Horizontal	-48.30	-40.00	8.30	135
3	2340.3	-53.49	2.51	11.05	Horizontal	-47.10	-13.00	34.10	270
4	3120.4	-50.89	4.20	11.15	Horizontal	-46.09	-13.00	33.09	180
5	3900.5	-55.59	5.20	11.15	Horizontal	-51.79	-13.00	38.79	90
6	4680.6	-54.56	5.50	11.95	Horizontal	-50.26	-13.00	37.26	45
7	5460.7	-56.56	5.70	13.55	Horizontal	-50.86	-13.00	37.86	225
8	6240.8	-57.17	6.30	13.75	Horizontal	-51.87	-13.00	38.87	91
9	7020.9	-57.27	6.80	13.85	Horizontal	-52.37	-13.00	39.37	135
10	7801.0	-54.69	6.90	14.25	Horizontal	-49.49	-13.00	36.49	180

Note: 1.The other Spurious RF Radiated emissions level is no more than noise floor.
2. The worst emission was found in the antenna is Horizontal position.

LTE Band 13 QPSK 10MHz CH-Middle, RB 1

Harmonic	Frequency (MHz)	SG (dBm)	Cable Loss (dB)	Gain (dBi)	Antenna Polarization	ERP Level (dBm)	Limit (dBm)	Margin (dB)	Azimuth (deg)
2	1555.3	-54.54	2.00	10.75	Horizontal	-47.94	-40.00	7.94	135
3	2346.0	-52.54	2.51	11.05	Horizontal	-46.15	-13.00	33.15	315
4	3128.0	-52.45	4.20	11.15	Horizontal	-47.65	-13.00	34.65	45
5	3910.0	-55.65	5.20	11.15	Horizontal	-51.85	-13.00	38.85	90
6	4692.0	-55.21	5.50	11.95	Horizontal	-50.91	-13.00	37.91	0
7	5474.0	-56.35	5.70	13.55	Horizontal	-50.65	-13.00	37.65	0
8	6256.0	-57.14	6.30	13.75	Horizontal	-51.84	-13.00	38.84	45
9	7038.0	-57.62	6.80	13.85	Horizontal	-52.72	-13.00	39.72	90
10	7820.0	-55.51	6.90	14.25	Horizontal	-50.31	-13.00	37.31	315

Note: 1.The other Spurious RF Radiated emissions level is no more than noise floor.
2. The worst emission was found in the antenna is Horizontal position.



LTE Band 66 QPSK 1.4MHz CH-Middle, RB 1

Harmonic	Frequency (MHz)	SG (dBm)	Cable Loss (dB)	Gain (dBi)	Antenna Polarization	EIRP Level (dBm)	Limit (dBm)	Margin (dB)	Azimuth (deg)
2	3510	-53.64	2.6	10.75	Horizontal	-45.49	-13.00	32.49	45
3	5265	-59.65	2.4	11.05	Horizontal	-51.00	-13.00	38.00	135
4	7020	-58.20	4.5	11.15	Horizontal	-51.55	-13.00	38.55	180
5	8775	-55.19	5.1	11.35	Horizontal	-48.94	-13.00	35.94	270
6	10530	-52.26	5.3	11.95	Horizontal	-45.61	-13.00	32.61	315
7	12285	-53.06	5.5	13.55	Horizontal	-45.01	-13.00	32.01	45
8	14040	-51.10	6.3	13.75	Horizontal	-43.65	-13.00	30.65	315
9	15795	-49.68	6.7	13.85	Horizontal	-42.53	-13.00	29.53	225
10	17550	-49.11	6.8	14.25	Horizontal	-41.66	-13.00	28.66	90

Note: 1. The other Spurious RF Radiated emissions level is no more than noise floor.
2. The worst emission was found in the antenna is Horizontal position.

LTE Band 66 QPSK 5MHz CH-Middle, RB 1

Harmonic	Frequency (MHz)	SG (dBm)	Cable Loss (dB)	Gain (dBi)	Antenna Polarization	EIRP Level (dBm)	Limit (dBm)	Margin (dB)	Azimuth (deg)
2	3505.5	-52.75	2.6	10.75	Horizontal	-44.60	-13.00	31.60	0
3	5258.25	-60.14	2.4	11.05	Horizontal	-51.49	-13.00	38.49	315
4	7011	-59.26	4.5	11.15	Horizontal	-52.61	-13.00	39.61	135
5	8763.75	-56.16	5.1	11.35	Horizontal	-49.91	-13.00	36.91	90
6	10516.5	-51.72	5.3	11.95	Horizontal	-45.07	-13.00	32.07	315
7	12269.25	-53.42	5.5	13.55	Horizontal	-45.37	-13.00	32.37	135
8	14022	-51.19	6.3	13.75	Horizontal	-43.74	-13.00	30.74	270
9	15774.75	-50.36	6.7	13.85	Horizontal	-43.21	-13.00	30.21	0
10	17527.5	-49.58	6.8	14.25	Horizontal	-42.13	-13.00	29.13	90

Note: 1. The other Spurious RF Radiated emissions level is no more than noise floor.
2. The worst emission was found in the antenna is Horizontal position.



LTE Band 66 QPSK 20MHz CH-Middle, RB 1

Harmonic	Frequency (MHz)	SG (dBm)	Cable Loss (dB)	Gain (dBi)	Antenna Polarization	EIRP Level (dBm)	Limit (dBm)	Margin (dB)	Azimuth (deg)
2	3492.75	-54.06	2.6	10.75	Horizontal	-45.91	-13.00	32.91	90
3	5238.75	-59.28	2.4	11.05	Horizontal	-50.63	-13.00	37.63	180
4	6984.75	-59.02	4.5	11.15	Horizontal	-52.37	-13.00	39.37	315
5	8730.75	-55.46	5.1	11.35	Horizontal	-49.21	-13.00	36.21	225
6	10476.75	-52.43	5.3	11.95	Horizontal	-45.78	-13.00	32.78	45
7	12222.75	-53.13	5.5	13.55	Horizontal	-45.08	-13.00	32.08	315
8	13968.75	-51.14	6.3	13.75	Horizontal	-43.69	-13.00	30.69	0
9	15714.75	-49.89	6.7	13.85	Horizontal	-42.74	-13.00	29.74	225
10	17460.75	-49.75	6.8	14.25	Horizontal	-42.30	-13.00	29.30	315

Note: 1.The other Spurious RF Radiated emissions level is no more than noise floor.
2. The worst emission was found in the antenna is Horizontal position.

LTE Band 85 QPSK 5MHz CH-Middle, RB 1

Harmonic	Frequency (MHz)	SG (dBm)	Cable Loss (dB)	Gain (dBi)	Antenna Polarization	ERP Level (dBm)	Limit (dBm)	Margin (dB)	Azimuth (deg)
2	1414.0	-66.64	2.00	10.75	Horizontal	-60.04	-13.00	47.04	90
3	2121.0	-64.38	2.51	11.05	Horizontal	-57.99	-13.00	44.99	135
4	2828.0	-62.01	4.20	11.15	Horizontal	-57.21	-13.00	44.21	0
5	3535.0	-56.77	5.20	11.15	Horizontal	-52.97	-13.00	39.97	315
6	4242.0	-53.81	5.50	11.95	Horizontal	-49.51	-13.00	36.51	180
7	4949.0	-54.62	5.70	13.55	Horizontal	-48.92	-13.00	35.92	270
8	5656.0	-54.75	6.30	13.75	Horizontal	-49.45	-13.00	36.45	90
9	6363.0	-54.18	6.80	13.85	Horizontal	-49.28	-13.00	36.28	0
10	7070.0	-55.50	6.90	14.25	Horizontal	-50.30	-13.00	37.30	45

Note: 1.The other Spurious RF Radiated emissions level is no more than noise floor.
2. The worst emission was found in the antenna is Horizontal position.



LTE Band 85 QPSK 10MHz CH-Middle, RB 1

Harmonic	Frequency (MHz)	SG (dBm)	Cable Loss (dB)	Gain (dBi)	Antenna Polarization	ERP Level (dBm)	Limit (dBm)	Margin (dB)	Azimuth (deg)
2	1414.0	-66.58	2.00	10.75	Horizontal	-59.98	-13.00	46.98	180
3	2121.0	-64.87	2.51	11.05	Horizontal	-58.48	-13.00	45.48	225
4	2828.0	-61.13	4.20	11.15	Horizontal	-56.33	-13.00	43.33	90
5	3535.0	-56.10	5.20	11.15	Horizontal	-52.30	-13.00	39.30	315
6	4242.0	-53.42	5.50	11.95	Horizontal	-49.12	-13.00	36.12	180
7	4949.0	-54.26	5.70	13.55	Horizontal	-48.56	-13.00	35.56	270
8	5656.0	-54.82	6.30	13.75	Horizontal	-49.52	-13.00	36.52	225
9	6363.0	-55.48	6.80	13.85	Horizontal	-50.58	-13.00	37.58	135
10	7070.0	-55.03	6.90	14.25	Horizontal	-49.83	-13.00	36.83	90

Note: 1. The other Spurious RF Radiated emissions level is no more than noise floor.

2. The worst emission was found in the antenna is Horizontal position.



6 Main Test Instruments

Name	Manufacturer	Type	Serial Number	Calibration Date	Expiration Date
Base Station Simulator	R&S	CMW500	113824	2019-05-19	2020-05-18
Power Splitter	Hua Xiang	SHX-GF2-2-13	10120101	/	/
Spectrum Analyzer	Key sight	N9010A	MY50210259	2019-05-19	2020-05-18
Signal Analyzer	R&S	FSV40	101298	2019-05-19	2020-05-18
Loop Antenna	SCHWARZBECK	FMZB1519	1519-047	2017-09-26	2020-09-25
Trilog Antenna	SCHWARZBECK	VUBL 9163	9163-201	2017-11-18	2020-11-17
Horn Antenna	R&S	HF907	100126	2018-07-07	2020-07-06
Horn Antenna	ETS-Lindgren	3160-09	00102643	2018-06-20	2020-06-19
Signal generator	R&S	SMB 100A	102594	2019-05-19	2020-05-18
Climatic Chamber	ESPEC	SU-242	93000506	2017-12-17	2020-12-16
Preamplifier	R&S	SCU18	102327	2019-05-19	2020-05-18
MOB COMMS DC SUPPLY	Keysight	66319D	MY43004105	2019-05-19	2020-05-18
RF Cable	Agilent	SMA 15cm	0001	2019-12-13	2020-6-12
Software	R&S	EMC32	9.26.0	/	/



ANNEX A: Product Change Description

Quetcetel Wireless Solutions Co., Ltd

Statement

We **Quetcetel Wireless Solutions Co., Ltd** declare the following models.

Product Name: Cat M1 Module

Model Number: BG95-M3, BG95-M1

Hardware Version: R2.1

Module	Category	Supported Band
BG95-M3	CatM1/NB-IoT/ GSM/GPRS/EGPRS	Cat M1: LTE-FDD: B1/B2/B3/B4/B5/B8/B12/B13/ B14/B18/B19/B20/B25/B26/B27/ B28/B66/B85 Cat NB2: LTE-FDD:B1/B2/B3/B4/B5/B8/B12/B13/ B18/B19/B20/B25/B26/ B28/B66/B71/B85 GSM/GPRS/ EGPRS: 850/900/1800/1900MHz
BG95-M1	CatM1	Cat M1: LTE-FDD:B1/B2/B3/B4/B5/B8/B12/B13/ B14/B18/B19/B20/B25/B26/ B27/B28/B66/B85

BG95-M1 and BG95-M3 share the same HW design, BG95-M1 only do removal of the component for GSM/GPRS/EGPRS on the hardware network according to the model requirement of the product definition, and BG95-M1 disable NB by SW on the basis of BG95-M3.

Quectel Wireless Solutions Co., Ltd

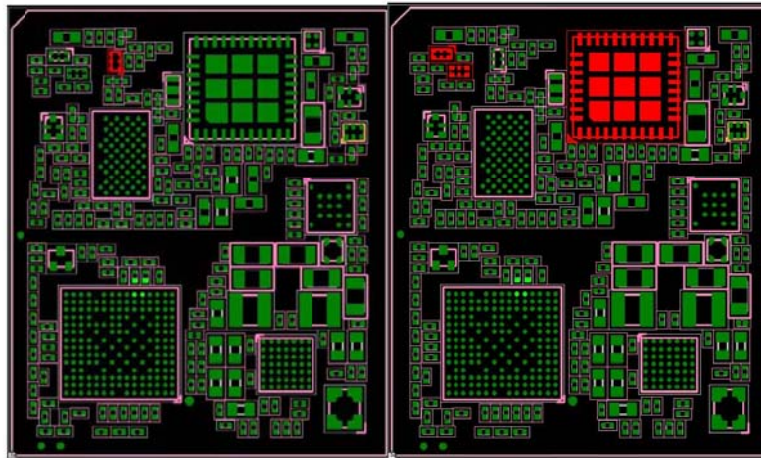

BG95-M3

BG95-M1

Designator	BG95-M3 (Part Description)	BG95-M1 (Part Description)
U602	NA	IC RF THIN-FILM Directional Coupler 450MHz-3800MHz 1.0x0.5mm H0.3mm RO
U603	IC RF SWITCH SP10T + GSM Qualband 5.3x5.5mm H0.905mm RO	NA
U502	IC RF LOW PASS FILTER 698-960MHz 1.0x0.5mm H0.4mm RO	NA
U504	IC RF TX LPF 1695-2180MHz 1.0x0.5mm H0.5mm RO	NA

The change will not impact RF performance of Cat M1 .

Your assistance on this matter is highly appreciated.

Sincerely,

Name: Jean Hu 

Title: Certification Section

ANNEX B: Product Change Description 2

Statement

We **Quectel Wireless Solutions Co., Ltd** declare the following models.

Product Name: LTE Cat M1 & Cat NB2 & EGPRS Module

Model Number: BG95-M3, BG95-M1

Hardware Version: R2.1

Module	Category	Supported Band
BG95-M3	CatM1/NB-IoT/EGPRS	Cat M1: LTE-FDD: B1/B2/B3/B4/B5/B8/B12/B13/B14/B18/B19/ B20/B25/B26/B27/ B28/B66/B85 Cat NB2: LTE-FDD:B1/B2/B3/B4/B5/B8/B12/B13/ B18/B19/B20/B25/B26 B28/B66/B71/B85 EGPRS: 850/900/1800/1900MHz
BG95-M1	CatM1	Cat M1: LTE-FDD:B1/B2/B3/B4/B5/B8/B12/B13/B1 8/B19/B20/B25/B26/ B27/B28/B66/B85

BG95-M1 and BG95-M3 share the same HW design, only dodeletion on the hardware network according to the model requirementof the product definition,BG95-M1 deletes the 2G part on the basis of BG95-M3, and disableall NB-IoT bands and LTE CatM1 Band14 by SW.

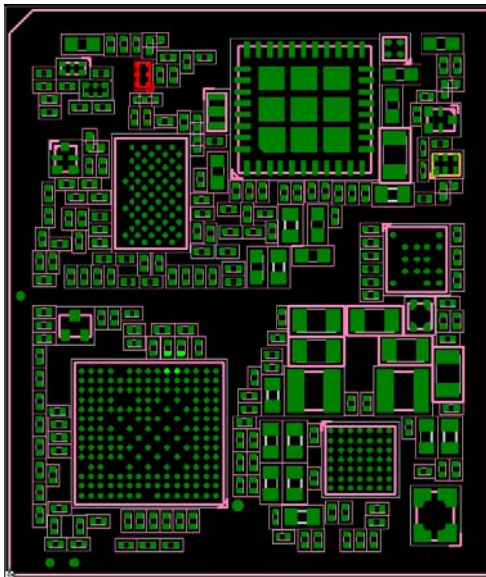

BG95-M3

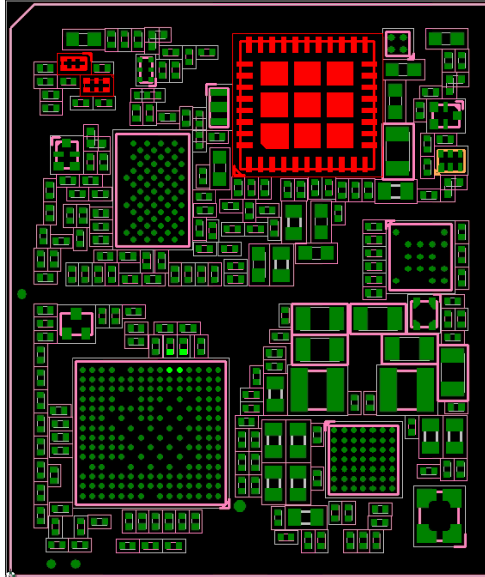

BG95-M1

Designator	BG95-M3 (Part Description)	BG95-M1 (Part Description)
U602	NA	IC RF THIN-FILM Directional Coupler 450MHz-3800MHz 1.0x0.5mm H0.3mm RO
U603	IC RF SWITCH SP10T + GSM Qualband 5.3x5.5mm H0.905mm RO	NA
U502	IC RF LOW PASS FILTER 698-960MHz 1.0x0.5mm H0.4mm RO	NA
U504	IC RF TX LPF 1695-2180MHz 1.0x0.5mm H0.5mm RO	NA

The change will not impact RF performance of Cat M1.

Your assistance on this matter is highly appreciated.

Sincerely,



Name: Jean Hu

Title: Certification Section

*****END OF REPORT *****