

TEST REPORT

Reference No...... : WTS17S0169868E V1
FCC ID : 2ALAYMYKIPET
Applicant..... : Allterco Robotics
Address..... : 1404 Sofia, Bulgaria,109 Bulgaria Blvd. Iv.8, Bulgaria
Manufacturer : Shenzhen Broadwell Technology Co., LTD
Address..... : 719, Mintai Mansion, Minzhi Road, Longhua New District,
Shenzhen, Guangdong, China
Product Name..... : Smart Pet Tracker
Model No...... : MyKi PET
Brand..... : MyKi
Standards..... : FCC CFR47 Part 22 Subpart H: 2016
: FCC CFR47 Part 24 Subpart E: 2016
Date of Receipt sample : Jan. 18, 2017
Date of Test : Jan. 19 – Feb. 20, 2017
Date of Issue..... : Mar. 16, 2017
Test Result..... : **Pass**

Remarks:

The results shown in this test report refer only to the sample(s) tested, this test report cannot be reproduced, except in full, without prior written permission of the company. The report would be invalid without specific stamp of test institute and the signatures of compiler and approver.

Prepared By:

Waltek Services (Shenzhen) Co., Ltd.

Address: 1/F., Fukangtai Building, West Baima Road, Songgang Street, Baoan District, Shenzhen,
Guangdong, China

Tel :+86-755-83551033

Fax:+86-755-83552400

Compiled by:



Zero Zhou / Test Engineer

Approved by:

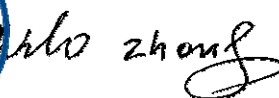

Philo Zhong / Manager

2 Laboratories Introduction

Waltek Services Test Group Ltd is a professional third-party testing and certification organization with multi-year product testing and certification experience, established strictly in accordance with ISO/IEC 17025 requirements, and accredited by CNAS (China National Accreditation Service for Conformity Assessment) AQS1Q, CMA and IECEE for CBTL. Meanwhile, Waltek has got recognition as registration and accreditation laboratory from EMSD (Electrical and Mechanical Services Department), and American Energy star, FCC(The Federal Communications Commission), CPSC(Consumer Product Safety Commission), CEC(California energy efficiency), IC(Industry Canada) and ELI(Efficient Lighting Initiative). It's the strategic partner and data recognition laboratory of international authoritative organizations, such as UL, Intertek(ETL-SEMKO), CSA, TÜV Rheinland, TÜV SÜD, etc.



Waltek Services Test Group Ltd. is one of the largest and the most comprehensive third party testing organizations in China, our headquarter located in Shenzhen and have branches in Foshan, Dongguan, Zhongshan, Suzhou, Ningbo and Hong Kong, Our test capability covered four large fields: safety test. ElectroMagnetic Compatibility(EMC), reliability and energy performance, Chemical test. As a professional, comprehensive, justice international test organization, we still keep the scientific and rigorous work attitude to help each client satisfy the international standards and assist their product enter into globe market smoothly.

3 Contents

	Page
1 COVER PAGE.....	1
2 LABORATORIES INTRODUCTION.....	2
3 CONTENTS.....	3
4 REVISION HISTORY.....	5
5 GENERAL INFORMATION.....	6
5.1 GENERAL DESCRIPTION OF E.U.T.	6
5.2 DETAILS OF E.U.T.	6
5.3 TEST MODE.....	7
5.4 TEST FACILITY.....	7
6 TEST SUMMARY.....	8
7 EQUIPMENT USED DURING TEST.....	9
7.1 EQUIPMENTS LIST.....	9
7.2 MEASUREMENT UNCERTAINTY.....	10
7.3 TEST EQUIPMENT CALIBRATION.....	10
8 RF OUTPUT POWER.....	11
8.1 EUT OPERATION.....	11
8.2 TEST PROCEDURE.....	11
8.3 TEST RESULT.....	12
9 PEAK-TO-AVERAGE RATIO.....	15
9.1 EUT OPERATION.....	15
9.2 TEST PROCEDURE.....	15
9.3 TEST RESULT.....	16
10 BANDWIDTH.....	17
10.1 EUT OPERATION.....	17
10.2 TEST PROCEDURE.....	17
10.3 TEST RESULT.....	18
11 SPURIOUS EMISSIONS AT ANTENNA TERMINALS.....	21
11.1 EUT OPERATION.....	21
11.2 TEST PROCEDURE.....	21
11.3 TEST RESULT.....	22
12 SPURIOUS RADIATED EMISSIONS.....	26
12.1 EUT OPERATION.....	26
12.2 TEST SETUP.....	26
12.3 SPECTRUM ANALYZER SETUP.....	27
12.4 TEST PROCEDURE.....	28
12.5 SUMMARY OF TEST RESULTS.....	29
13 BAND EDGE MEASUREMENT.....	30
13.1 EUT OPERATION.....	30
13.2 TEST PROCEDURE.....	30
13.3 TEST RESULT.....	31
14 FREQUENCY STABILITY.....	35
14.1 EUT OPERATION.....	35
14.2 TEST PROCEDURE.....	35

14.3	TEST RESULT	36
15	RF EXPOSURE.....	38
	REQUIREMENTS	38
	THE PROCEDURES / LIMIT	38
	MPE CALCULATION METHOD.....	39
16	PHOTOGRAPHS OF TEST SETUP AND EUT.....	40

4 Revision History

Test report No.	Date of Receipt sample	Date of Test	Date of Issue	Purpose	Comment	Approved
WTS17S0169868E	Jan. 18, 2017	Jan. 19 – Feb. 20, 2017	Feb. 21, 2017	original	-	Replaced
WTS17S0169868E V1	Jan. 18, 2017	Jan. 19 – Feb. 20, 2017	Mar. 16, 2017	Version 1	Updated	Valid

5 General Information

5.1 General Description of E.U.T.

Product Name:	Smart Pet Tracker
Model No.:	MyKi PET
Model Description:	N/A
GSM Band(s):	GSM 850/900/1800/1900MHz
GPRS Class:	12
WCDMA Band(s):	N/A
LTE Band(s):	N/A
Wi-Fi Specification:	N/A
Bluetooth Version:	N/A
GPS:	Support
NFC:	N/A
Hardware Version:	G72S-MB-V2.0
Software Version:	G72S-SW-V1.0
Storage Location:	Internal Storage
Note:	N/A

5.2 Details of E.U.T.

Operation Frequency:	GSM/GPRS 850: 824~849MHz PCS/GPRS 1900: 1850~1910MHz
Max. RF output power:	GSM 850: 32.96dBm PCS1900: 30.03dBm
Type of Modulation:	GSM,GPRS: GMSK
Antenna installation:	GSM: internal permanent antenna
Antenna Gain:	GSM900: 0.5dBi GSM1800: 1.0dBi
Technical Data:	Battery DC 3.7V 480mAh
Adapter:	Sale without adapter
Type of Emission:	GSM850: 247KGXW, GPRS850: 249KGXW, PCS1900: 246KGXW, GPRS1900: 243KGXW,

5.3 Test Mode

All test mode(s) and condition(s) mentioned were considered and evaluated respectively by performing full tests, the worst data were recorded and reported.

Support Band	Test Mode	Channel Frequency	Channel Number
GSM 850	GSM/GPRS	824.2 MHz	128
		836.6 MHz	190
		848.8 MHz	251
PCS 1900	GSM/GPRS	1850.2 MHz	512
		1880.0 MHz	661
		1909.8 MHz	810
Remark: All mode(s) were tested and the worst data was recorded.			

5.4 Test Facility

The test facility has a test site registered with the following organizations:

- **IC – Registration No.: 7760A**

Waltek Services(Shenzhen) Co., Ltd. Has been registered and fully described in a report filed with the Industry Canada. The acceptance letter from the Industry Canada is maintained in our files. Registration number 7760A, October 15, 2015.

- **FCC Test Site 1#– Registration No.: 880581**

Waltek Services(Shenzhen) Co., Ltd. EMC Laboratory `has been registered and fully described in a report filed with the (FCC) Federal Communications Commission. The acceptance letter from the FCC is maintained in our files. Registration 880581, April 29, 2014.

- **FCC Test Site 2#– Registration No.: 328995**

Waltek Services(Shenzhen) Co., Ltd. EMC Laboratory `has been registered and fully described in a report filed with the (FCC) Federal Communications Commission. The acceptance letter from the FCC is maintained in our files. Registration 328995, December 3, 2014.

6 Test Summary

Test Items	Test Requirement	Result
RF Output Power	2.1046 22.913 (a) 24.232 (c)	PASS
Peak-to-Average Ratio	24.232 (d)	PASS
Bandwidth	2.1049 22.905 22.917 24.238	PASS
Spurious Emissions at Antenna Terminal	2.1051 22.917 (a) 24.238 (a)	PASS
Field Strength of Spurious Radiation	2.1053 22.917 (a) 24.238 (a)	PASS
Out of band emission, Band Edge	22.917 (a) 24.238 (a)	PASS
Frequency Stability	2.1055 22.355 24.235	PASS
Maximum Permissible Exposure (SAR)	1.1307 2.1093	PASS

7 Equipment Used during Test

7.1 Equipments List

Conducted Emissions Test Site 1#						
Item	Equipment	Manufacturer	Model No.	Serial No.	Last Calibration Date	Calibration Due Date
1.	EMI Test Receiver	R&S	ESCI	100947	Sep.12,2016	Sep.11,2017
2.	LISN	R&S	ENV216	101215	Sep.12,2016	Sep.11,2017
3.	Cable	Top	TYPE16(3.5M)	-	Sep.12,2016	Sep.11,2017
Conducted Emissions Test Site 2#						
Item	Equipment	Manufacturer	Model No.	Serial No.	Last Calibration Date	Calibration Due Date
1.	EMI Test Receiver	R&S	ESCI	101155	Sep.12,2016	Sep.11,2017
2.	LISN	SCHWARZBECK	NSLK 8128	8128-289	Sep.12,2016	Sep.11,2017
3.	Limiter	York	MTS-IMP-136	261115-001-0024	Sep.12,2016	Sep.11,2017
4.	Cable	LARGE	RF300	-	Sep.12,2016	Sep.11,2017
3m Semi-anechoic Chamber for Radiation Emissions Test site 1#						
Item	Equipment	Manufacturer	Model No.	Serial No.	Last Calibration Date	Calibration Due Date
1	Spectrum Analyzer	R&S	FSP	100091	Apr.29, 2016	Apr.28, 2017
2	Active Loop Antenna	Beijing Dazhi	ZN30900A	-	Apr.09,2016	Apr.08,2017
3	Trilog Broadband Antenna	SCHWARZBECK	VULB9163	336	Apr.09,2016	Apr.08,2017
4	Coaxial Cable (below 1GHz)	Top	TYPE16(13M)	-	Sep.12,2016	Sep.11,2017
5	Broad-band Horn Antenna	SCHWARZBECK	BBHA 9120 D	667	Apr.09,2016	Apr.08,2017
6	Broad-band Horn Antenna	SCHWARZBECK	BBHA 9170	335	Apr.09,2016	Apr.08,2017
7	Broadband Pre-amplifier	COMPLIANCE DIRECTION	PAP-1G18	2004	Apr.13,2016	Apr.12,2017
8	Coaxial Cable (above 1GHz)	Top	1GHz-25GHz	EW02014-7	Apr.13,2016	Apr.12,2017
9	Universal Radio Communication Tester	R&S	CMU 200	112461	Apr.13,2016	Apr.12,2017
10	Signal Generator	R&S	SMR20	100046	Sep.12,2016	Sep.11,2017
11	Smart Antenna	SCHWARZBECK	HA08	-	Apr.09,2016	Apr.08,2017
3m Semi-anechoic Chamber for Radiation Emissions Test site 2#						
Item	Equipment	Manufacturer	Model No.	Serial No	Last Calibration Date	Calibration Due Date

1	Test Receiver	R&S	ESCI	101296	Apr.13,2016	Apr.12,2017
2	Trilog Broadband Antenna	SCHWARZBECK	VULB9160	9160-3325	Apr.09,2016	Apr.08,2017
3	Amplifier	Compliance pirection systems inc	PAP-0203	22024	Apr.13,2016	Apr.12,2017
4	Cable	HUBER+SUHNER	CBL2	525178	Apr.13,2016	Apr.12,2017
RF Conducted Testing						
Item	Equipment	Manufacturer	Model No.	Serial No.	Last Calibration Date	Calibration Due Date
1.	EMC Analyzer (9k~26.5GHz)	Agilent	E7405A	MY45114943	Sep.12,2016	Sep.11,2017
2.	Spectrum Analyzer (9k-6GHz)	R&S	FSL6	100959	Sep.12,2016	Sep.11,2017
3.	Universal Radio Communication Tester	R&S	CMU 200	112461	Apr.13,2016	Apr.12,2017
4	Signal Analyzer (9k~26.5GHz)	Agilent	N9010A	MY50520207	Sep.12,2016	Sep.11,2017

7.2 Measurement Uncertainty

Parameter	Uncertainty
Radio Frequency	$\pm 1 \times 10^{-6}$
RF Power	± 1.0 dB
RF Power Density	± 2.2 dB
Radiated Spurious Emissions test	± 5.03 dB (Bilog antenna 30M~1000MHz)
	± 5.47 dB (Horn antenna 1000M~25000MHz)
Conducted Spurious Emissions test	± 3.64 dB (AC mains 150KHz~30MHz)
Confidence interval: 95%. Confidence factor:k=2	

7.3 Test Equipment Calibration

All the test equipments used are valid and calibrated by CEPREI Certification Body that address is No.110 Dongguan Zhuang RD. Guangzhou, P.R.China.

8 RF OUTPUT POWER

Test Requirement:	FCC Part 2.1046, 22.913 (a), 24.232 (c)
Test Method:	TIA/EIA-603-D:2010 KDB971168 D01 v02r02
Test Mode:	TX transmitting

8.1 EUT Operation

Operating Environment :

Temperature:	22.5 °C
Humidity:	52.1 % RH
Atmospheric Pressure:	101.2kPa

8.2 Test Procedure

Conducted method:

The RF output of the transmitter was connected to the wireless test set and the spectrum analyzer through sufficient attenuation.

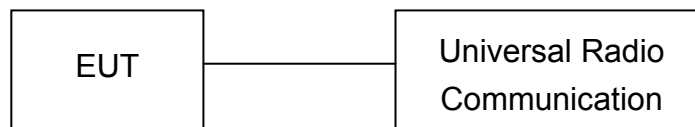

Radiated method:

1. The setup of EUT is according with per TIA/EIA Standard 603D.
2. The measurement antenna was placed at a distance of 3 meters from the EUT. During the tests, the antenna height and polarization as well as EUT azimuth were varied in order to identify the maximum level of emissions from the EUT. The test was performed by placing the EUT on 3-orthogonal axis.
3. The frequency range up to tenth harmonic of the fundamental frequency was investigated.
4. Remove the EUT and replace it with substitution antenna. A signal generator was connected to the substitution antenna by a non-radiating cable. The absolute levels of the spurious emissions were measured by the substitution.

8.3 Test Result

Conducted Power						
GSM - Burst Average Power (dBm)						
Band	GSM850			PCS1900		
Channel	128	190	251	512	661	810
Frequency (MHz)	824.2	836.6	848.8	1850.2	1880	1909.8
GSM	32.72	32.77	32.96	30.03	29.90	29.33
GPRS (1 slot)	32.75	32.84	32.94	30.01	29.75	29.29
GPRS (2 slots)	32.45	32.34	32.23	28.99	28.96	28.63
GPRS (3 slots)	31.37	31.22	31.12	27.10	27.04	26.79
GPRS (4 slots)	28.43	28.29	28.20	25.98	25.88	25.64

Radiated Power

ERP and EIRP

Cellular Band 850 (Part 22H)

Frequency	Receiver Reading	Turn table Angle	RX Antenna		Substituted			Absolute Level	Part 22H	
			Height	Polar	SG Level	Cable	Antenna Gain		Limit	Margin
(MHz)	(dBμV)	Degree	(m)	(H/V)	(dBm)	(dB)	(dB)	(dBm)	(dBm)	(dB)
GSM 850 Channel 128										
824.20	91.07	107	1.4	H	24.04	0.20	0.00	23.84	38.45	-14.61
824.20	97.98	282	2.2	V	30.88	0.20	0.00	30.68	38.45	-7.77
GSM 850 Channel 190										
836.60	91.11	48	2.5	H	24.08	0.20	0.00	23.88	38.45	-14.57
836.60	97.99	140	1.7	V	30.89	0.20	0.00	30.69	38.45	-7.76
GSM 850 Channel 251										
848.80	90.03	246	1.3	H	23.00	0.20	0.00	22.80	38.45	-15.65
848.80	97.32	140	1.6	V	30.22	0.20	0.00	30.02	38.45	-8.43
GPRS 850 Channel 128										
824.20	93.95	252	1.1	H	26.92	0.20	0.00	26.72	38.45	-11.73
824.20	97.92	277	1.4	V	30.82	0.20	0.00	30.62	38.45	-7.83
GPRS 850 Channel 190										
836.60	90.17	258	2.2	H	23.14	0.20	0.00	22.94	38.45	-15.51
836.60	97.16	243	2.3	V	30.06	0.20	0.00	29.86	38.45	-8.59
GPRS 850 Channel 251										
848.80	90.79	184	2.4	H	23.76	0.20	0.00	23.56	38.45	-14.89
848.80	97.89	22	1.3	V	30.79	0.20	0.00	30.59	38.45	-7.86

Cellular Band 1900 (Part 24E)

Frequency	Receiver Reading	Turn table Angle	RX Antenna		Substituted			Absolute Level	Part 24E	
			Height	Polar	SG Level	Cable	Antenna Gain		Limit	Margin
(MHz)	(dB μ V)	Degree	(m)	(H/V)	(dBm)	(dB)	(dB)	(dBm)	(dBm)	(dB)
PCS 1900 Channel 512										
1850.20	84.74	211	1.4	H	10.77	0.31	10.40	20.86	33	-12.14
1850.20	92.46	295	2.1	V	19.18	0.31	10.40	29.27	33	-3.73
PCS 1900 Channel 661										
1880.00	86.43	19	1.9	H	12.58	0.31	10.40	22.67	33	-10.33
1880.00	92.97	191	1.7	V	19.85	0.31	10.40	29.94	33	-3.06
PCS 1900 Channel 810										
1909.80	86.49	67	2.4	H	12.76	0.32	10.40	22.84	33	-10.16
1909.80	92.01	197	2.3	V	19.05	0.32	10.40	29.13	33	-3.87
GPRS 1900 Channel 512										
1850.20	87.55	207	1.8	H	13.58	0.31	10.40	23.67	33	-9.33
1850.20	92.87	103	1.1	V	19.59	0.31	10.40	29.68	33	-3.32
GPRS 1900 Channel 661										
1880.00	86.42	246	1.2	H	12.57	0.31	10.40	22.66	33	-10.34
1880.00	92.84	204	1.4	V	19.72	0.31	10.40	29.81	33	-3.19
GPRS 1900 Channel 810										
1909.80	85.95	57	2.5	H	12.22	0.32	10.40	22.30	33	-10.70
1909.80	92.17	207	1.2	V	19.21	0.32	10.40	29.29	33	-3.71

9 Peak-to-Average Ratio

Test Requirement:	24.232 (d)
Test Method:	N/A
Test Mode:	TX transmitting

9.1 EUT Operation

Operating Environment :

Temperature:	22.5 °C
Humidity:	52.3% RH
Atmospheric Pressure:	101.2kPa

9.2 Test Procedure

1. The EUT was connected to spectrum analyzer and system simulator via a power divider.
2. Set EUT to transmit at maximum output power.
3. When the duty cycle is less than 98%, then signal gating will be implemented on the spectrum analyzer by triggering from the system simulator.
4. Set the CCDF (Complementary Cumulative Distribution Function) option of the spectrum analyzer. Record the maximum PAPR level associated with a probability of 0.1%.

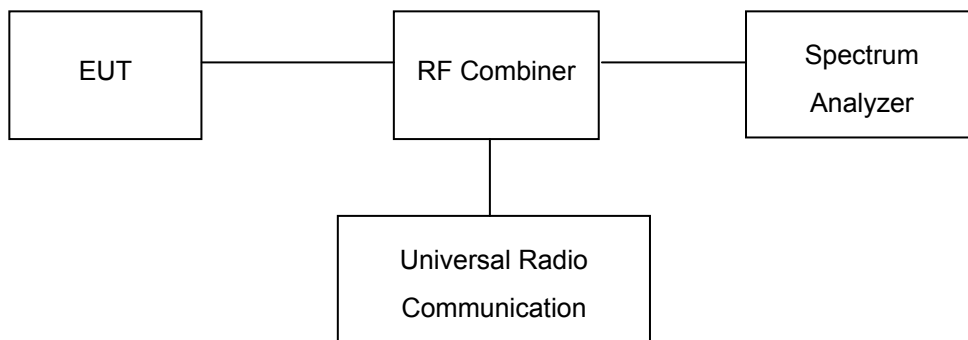

9.3 Test Result

Cellular Band (Part 24E)

Remark: Only the worst case (middle channel mode) were reported.

Mode	PCS 1900			GPRS 1900			Limit (dB)
	Channel	512	661	810	512	661	
Frequency (MHz)	1850.2	1880.0	1909.8	1850.2	1880.0	1909.8	
Peak-to-Average Ratio (dB)	9.39	9.41	9.36	9.18	9.27	9.24	13

Test Plots (Part 24E)

PCS1900 Middle Channel

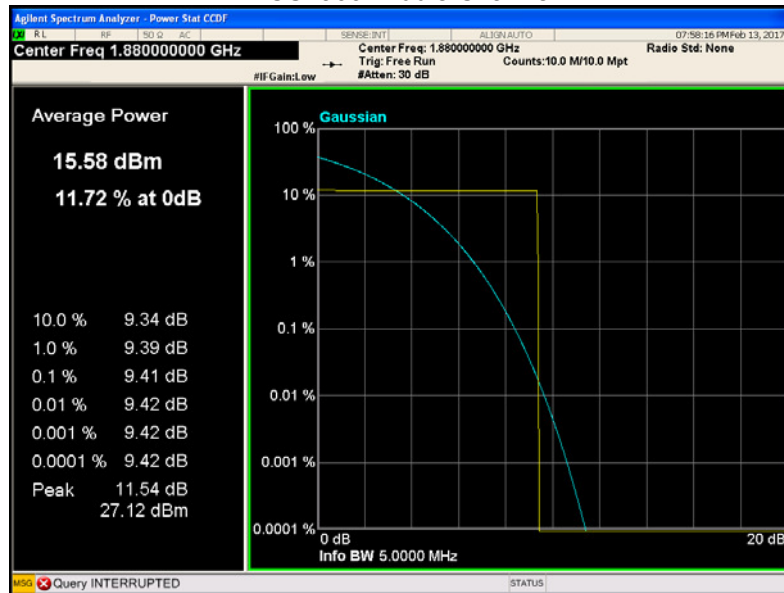

GPRS 1900 Middle Channel

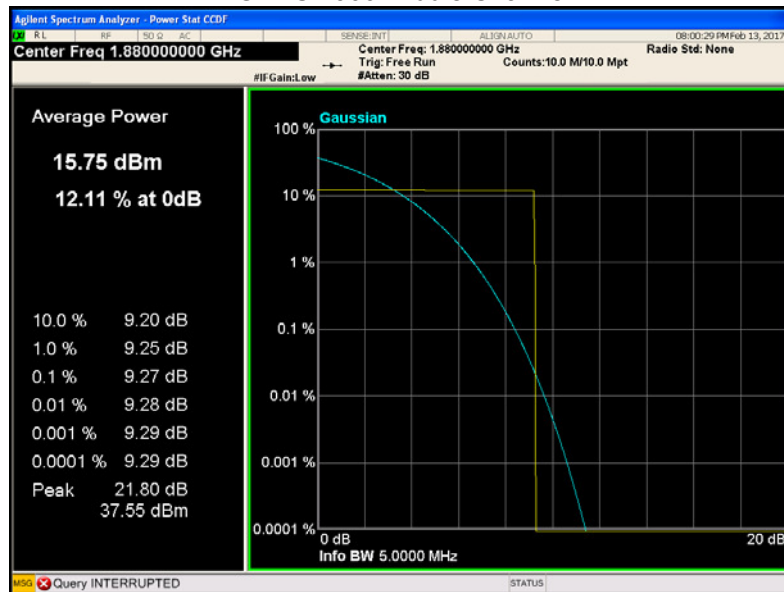

10 BANDWIDTH

Test Requirement:	FCC Part 2.1049, 22.917, 22.905, 24.238
Test Method:	TIA/EIA-603-D:2010 KDB971168 D01 v02r02
Test Mode:	TX transmitting

10.1 EUT Operation

Operating Environment :

Temperature:	22.5 °C
Humidity:	52.3% RH
Atmospheric Pressure:	101.2kPa

10.2 Test Procedure

The RF output of the transmitter was connected to the wireless test set and the spectrum analyzer through sufficient attenuation.

The resolution bandwidth of the spectrum analyzer was set at 3 kHz (Cellular /PCS) and the 26 dB & 99% bandwidth was recorded.

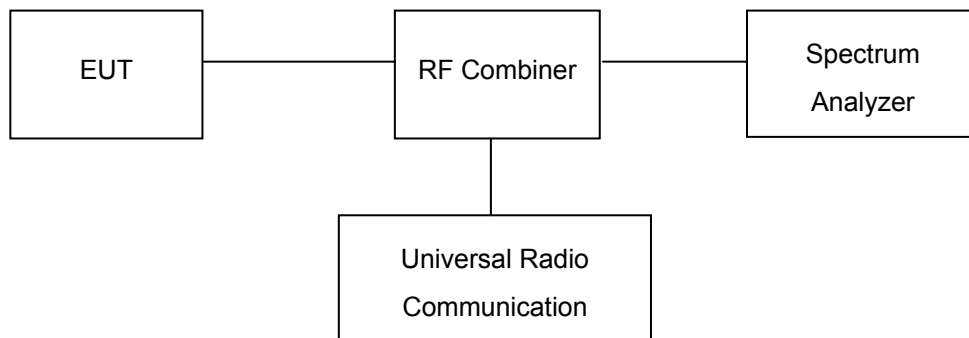

10.3 Test Result

Remark: Only the worst case (middle channel mode) were reported.

Cellular Band (Part 22H)

Test Mode	Channel	Frequency (MHz)	99% Occupied Bandwidth(kHz)	26 dB Emission Bandwidth(kHz)
GSM 850	128	824.2	246.43	310.48
	190	836.6	246.52	310.60
	251	848.8	246.51	310.52
GPRS 850	128	824.2	248.92	319.05
	190	836.6	249.00	319.10
	251	848.8	248.85	318.99

Cellular Band (Part 24E)

Test Mode	Channel	Frequency (MHz)	99% Occupied Bandwidth(kHz)	26 dB Emission Bandwidth(kHz)
PCS 1900	512	1850.2	246.07	316.32
	661	1880.0	246.19	316.40
	810	1909.8	246.08	316.29
GPRS 1900	512	1850.2	243.32	311.99
	661	1880.0	243.44	312.10
	810	1909.8	243.33	312.01

Test Plots (worst case)
 Cellular Band (Part 22H)
 GSM 850

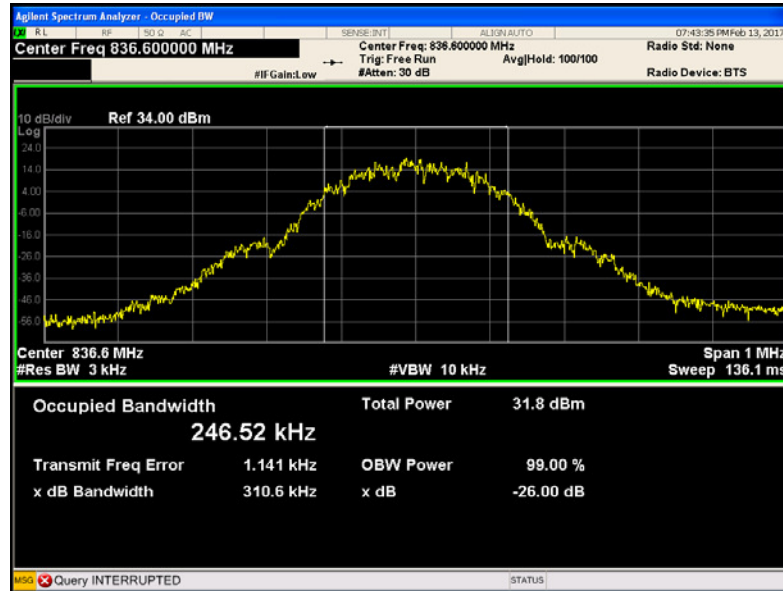

GPRS 850

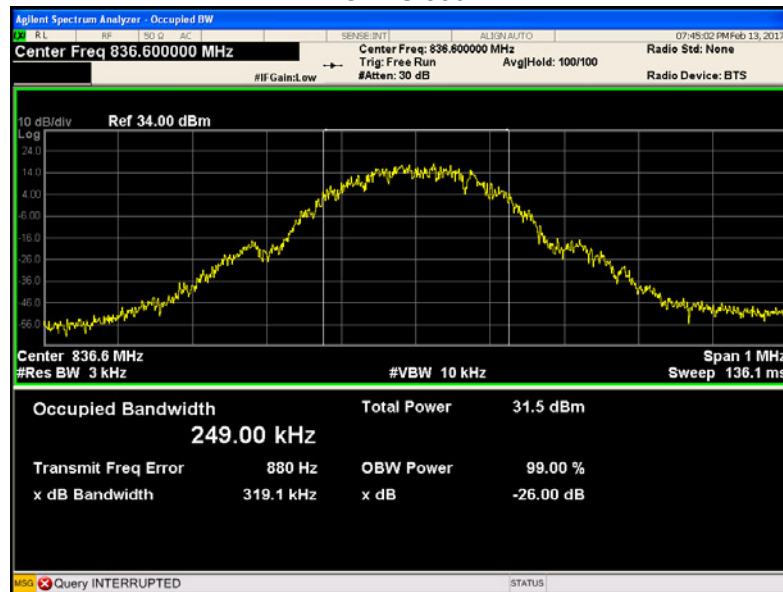

Cellular Band (Part 24E)

PCS 1900

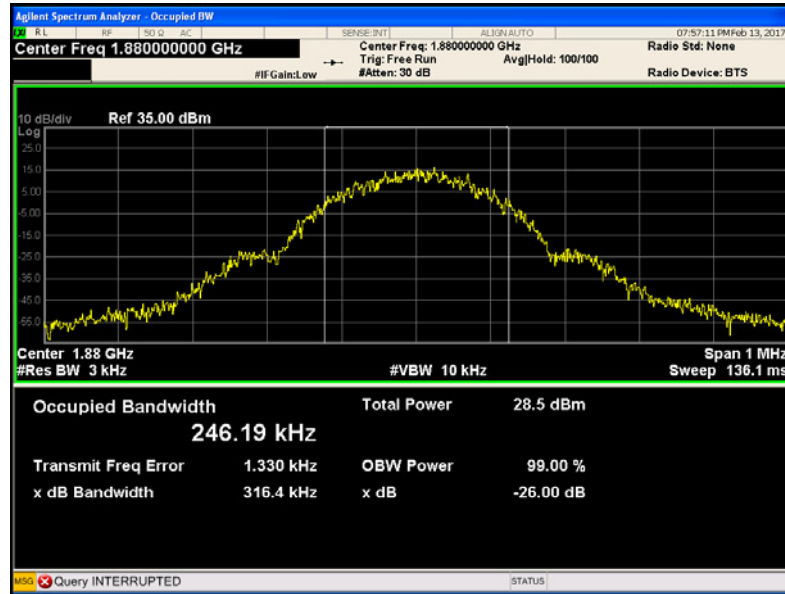

GPRS 1900

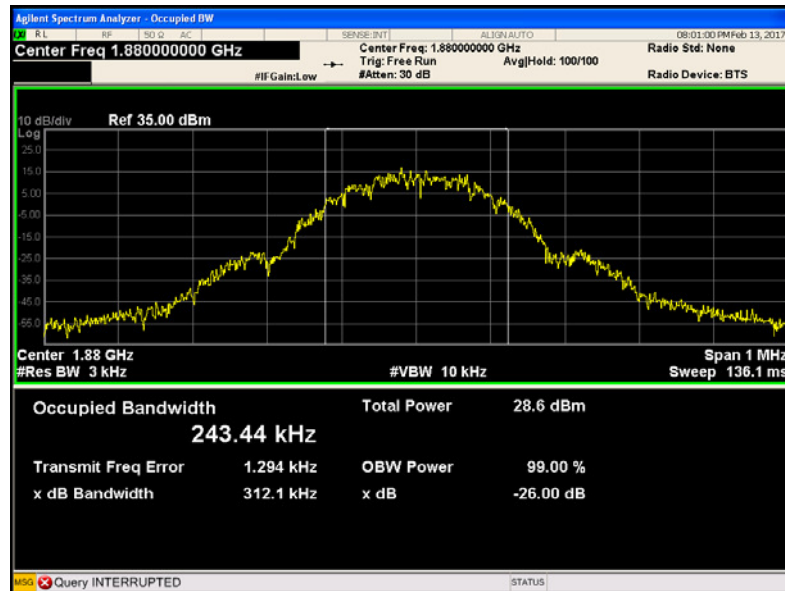

11 SPURIOUS EMISSIONS AT ANTENNA TERMINALS

Test Requirement:	FCC Part 2.1051, 22.917(a), 24.238(a)
Test Method:	TIA/EIA-603-D:2010 KDB971168 D01 v02r02
Test Mode:	TX transmitting

11.1 EUT Operation

Operating Environment :

Temperature:	23.5 °C
Humidity:	52.1 % RH
Atmospheric Pressure:	101.3kPa

11.2 Test Procedure

The RF output of the transceiver was connected to a spectrum analyzer and simulator through appropriate attenuation. The resolution bandwidth of the spectrum analyzer was set at 1MHz. Sufficient scans were taken to show any out of band emissions up to 10th harmonics.

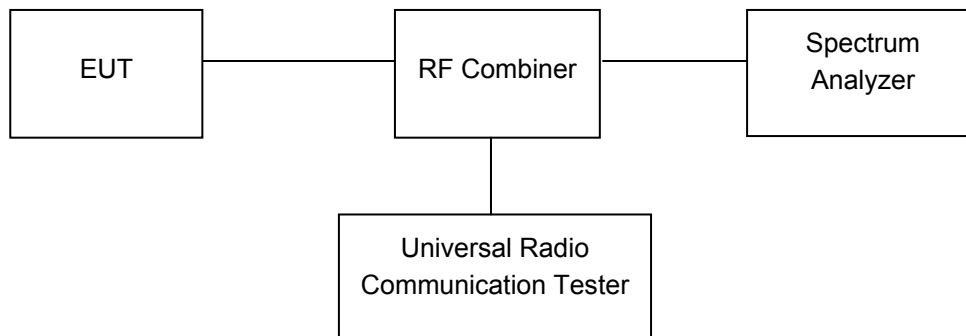

11.3 Test Result

Remark: only the worst data were recorded.

Cellular Band (Part 22H)

GSM 850 - channel 128

30MHz-1GHz

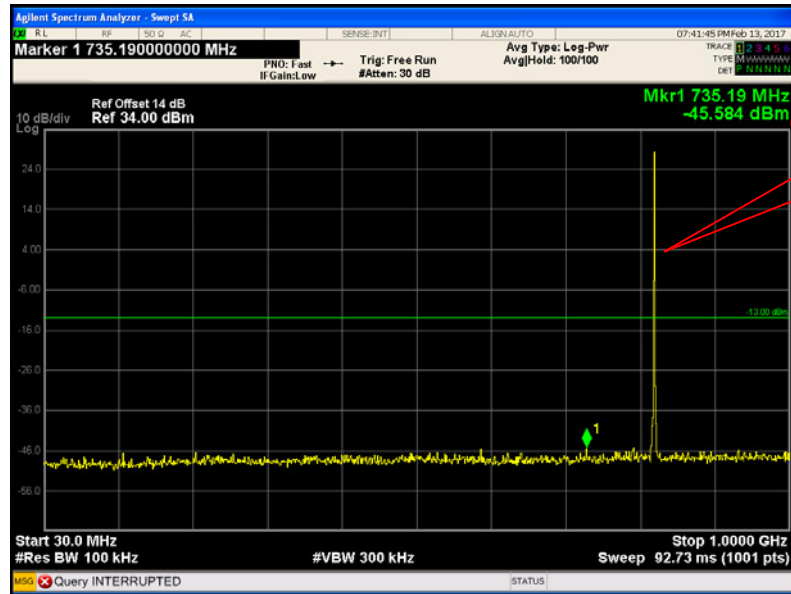

Above 1GHz

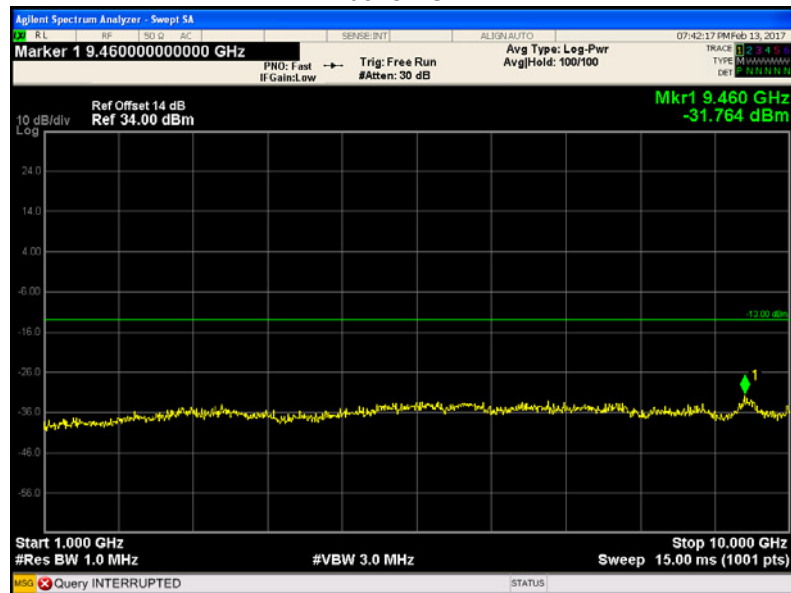

Cellular Band (Part 22H)
GPRS 850 - channel 128
30MHz-1GHz

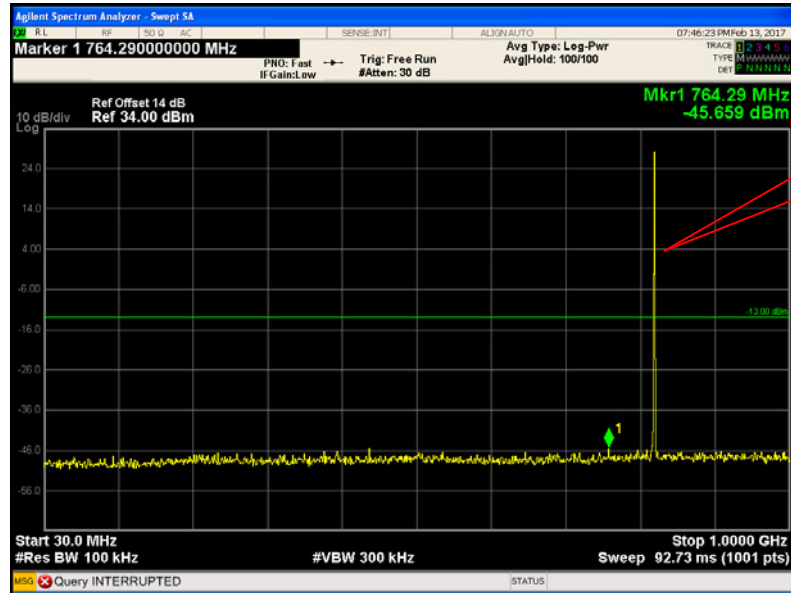

Above 1GHz

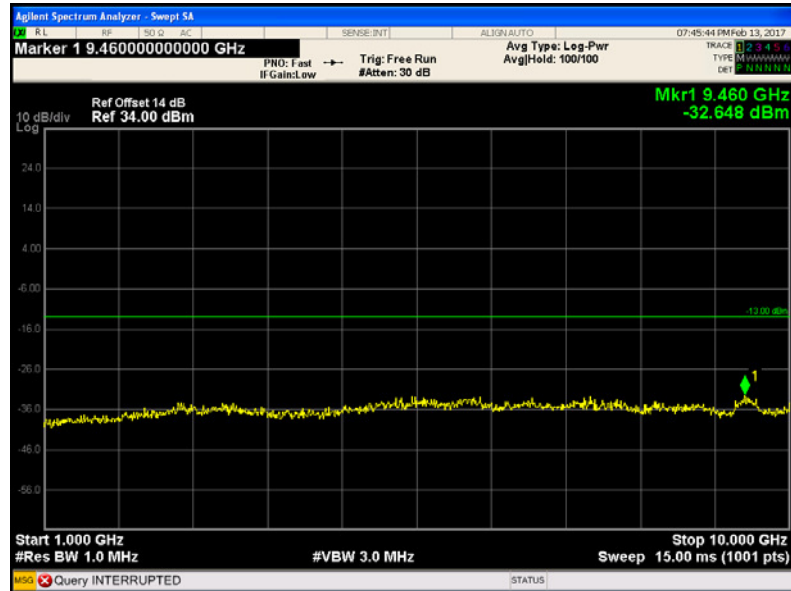

Cellular Band (Part 24E)
PCS 1900 - channel 512
30MHz-1GHz

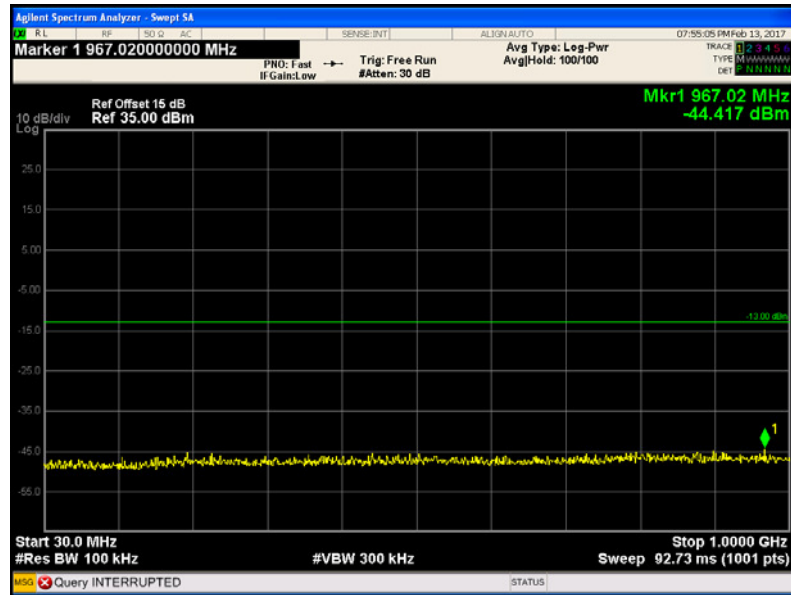

Above 1GHz

Fundamental

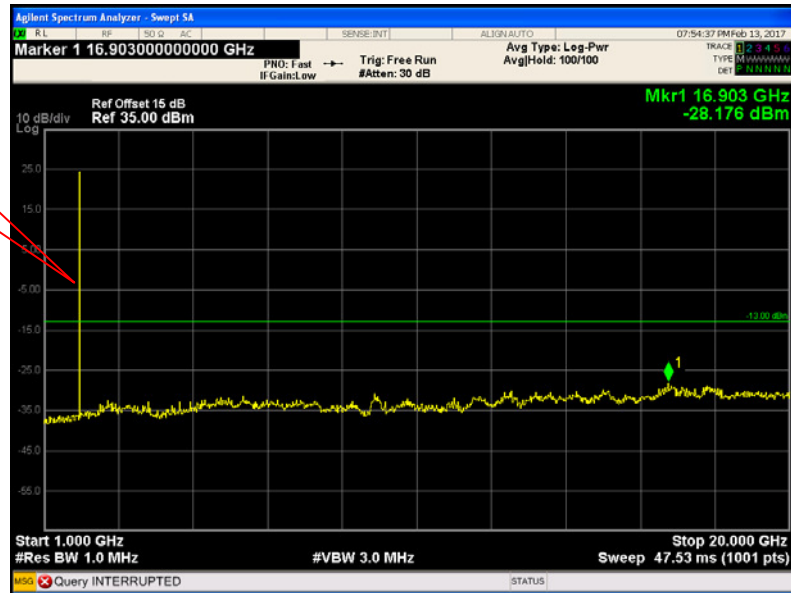

Cellular Band (Part 24E)

GPRS 1900 - channel 512

30MHz-1GHz

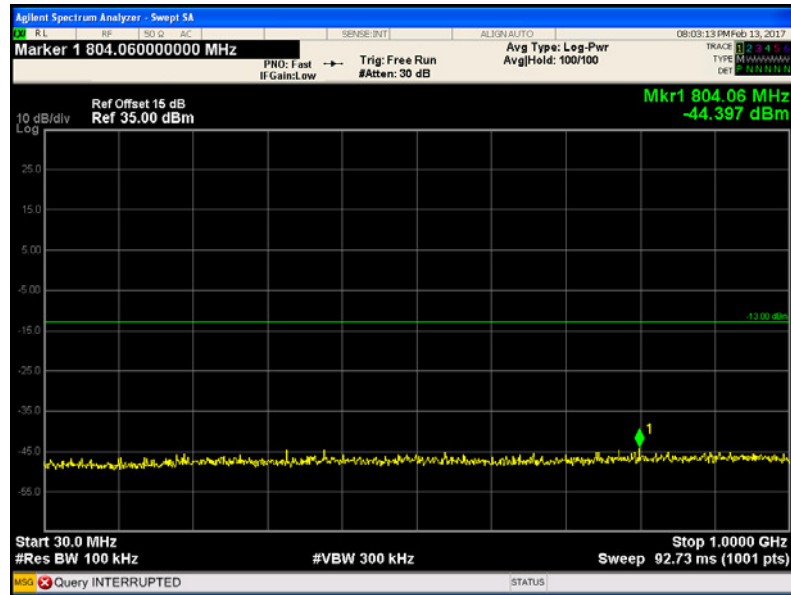

Above 1GHz

Fundamental

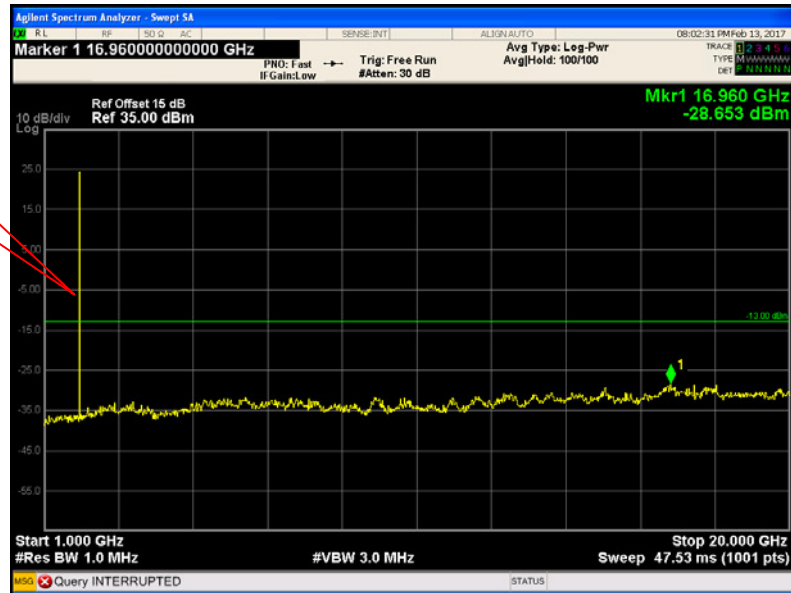

12 SPURIOUS RADIATED EMISSIONS

Test Requirement:	FCC Part 2.1053, 22.917, 24.238
Test Method:	TIA/EIA-603-D:2010 KDB971168 D01 v02r02
Test Mode:	TX transmitting

12.1 EUT Operation

Operating Environment :	
Temperature:	23.5 °C
Humidity:	52.1 % RH
Atmospheric Pressure:	101.2kPa

12.2 Test Setup

The radiated emission tests were performed in the 3m Semi- Anechoic Chamber test site. The test setup for emission measurement from 30 MHz to 1 GHz.

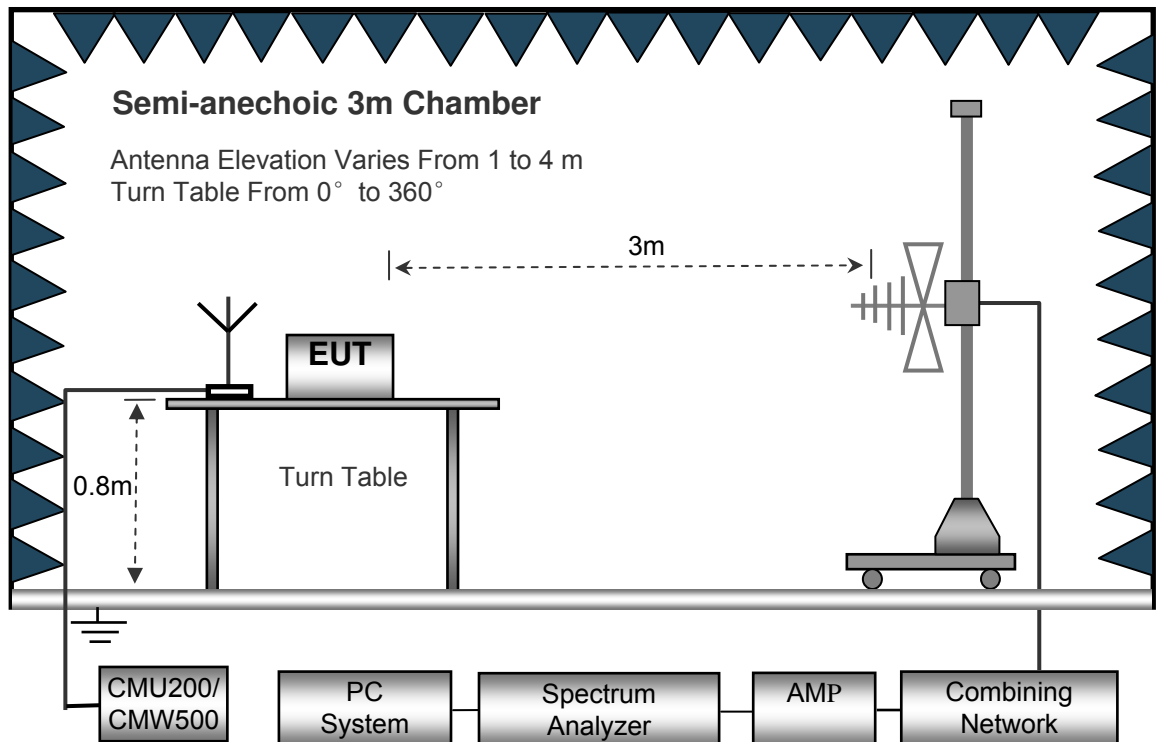

The test setup for emission measurement above 1 GHz.

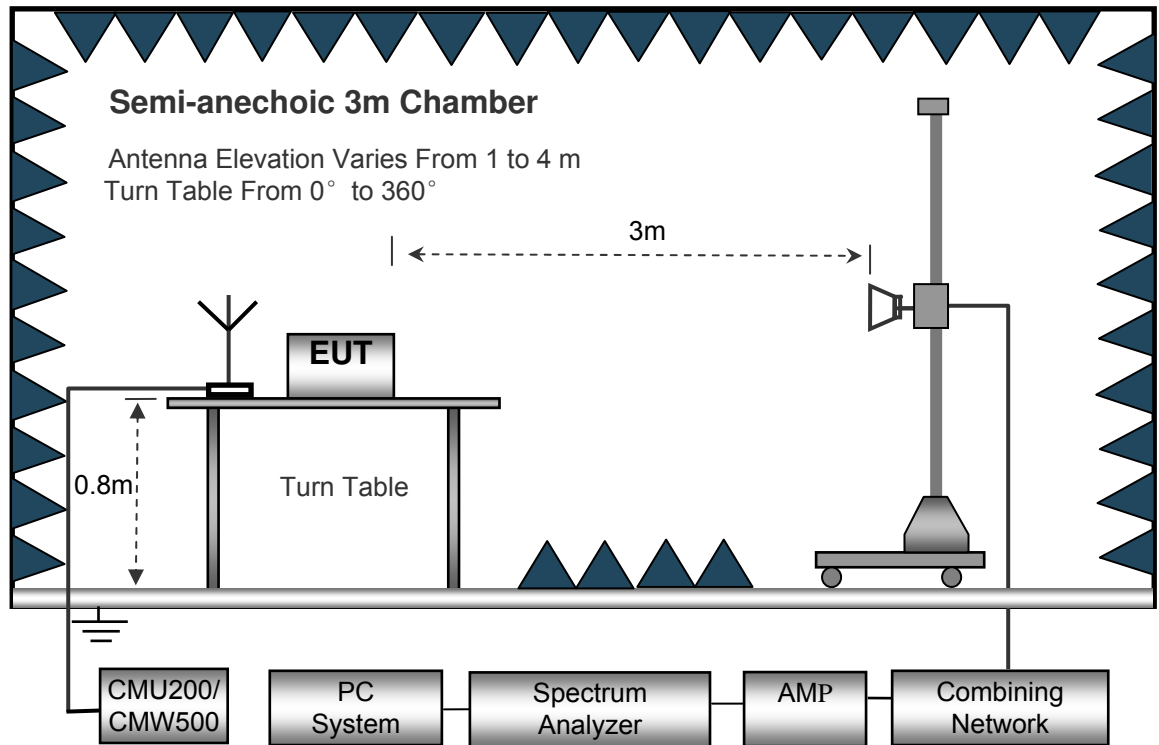

12.3 Spectrum Analyzer Setup

30MHz ~ 1GHz

Sweep Speed Auto
 Detector PK
 Resolution Bandwidth..... 100kHz
 Video Bandwidth..... 300kHz

Above 1GHz

Sweep Speed Auto
 Detector PK
 Resolution Bandwidth..... 1MHz
 Video Bandwidth..... 3MHz
 Detector Ave.
 Resolution Bandwidth..... 1MHz
 Video Bandwidth..... 10Hz

12.4 Test Procedure

1. The EUT is placed on a turntable, which is 0.8m above ground plane.
2. The turntable shall be rotated for 360 degrees to determine the position of maximum emission level.
3. EUT is set 3m away from the receiving antenna, which is moved from 1m to 4m to find out the maximum emissions. The spectrum was investigated from 30MHz up to the tenth harmonic of the highest fundamental frequency.
4. Maximum procedure was performed on the six highest emissions to ensure EUT compliance.
5. And also, each emission was to be maximized by changing the polarization of receiving antenna both horizontal and vertical.
6. The radiation measurements are tested under 3-axes(X,Y,Z) position(X denotes lying on the table, Y denotes side stand and Z denotes vertical stand), After pre-test, It was found that the worse radiation emission was get at the Z position. So the data shown was the Z position only.
7. Remove the EUT and replace it with substitution antenna. A signal generator was connected to the substitution antenna by a non-radiating cable. The absolute levels of the spurious emissions were measured by the substitution.
Spurious emissions in dB = $10 \lg (\text{TXpwr in Watts}/0.001)$ – the absolute level
Spurious attenuation limit in dB = $43 + 10 \text{Log}10 (\text{power out in Watts})$
8. Repeat above procedures until the measurements for all frequencies are completed.

12.5 Summary of Test Results

For 26MHz~30MHz,

The measurements were more than 20 dB below the limit and not reported.

Remark: Test performed from 30MHz to 10th harmonics with low/middle/high channels, only the worst data were recorded.

Cellular Band (Part 22H)

Frequency (MHz)	Receiver Reading (dBμV)	Turn table Angle Degree	RX Antenna		Substituted			Absolute Level (dBm)	Result	
			Height (m)	Polar (H/V)	SG Level (dBm)	Cable (dB)	Antenna Gain (dB)		Limit (dBm)	Margin (dB)
GSM 850 Channel 128										
199.38	41.43	211	1.1	H	-69.08	0.15	0.00	-69.23	-13.00	-56.23
199.38	45.65	165	2.1	V	-61.94	0.15	0.00	-62.09	-13.00	-49.09
1648.40	67.84	322	1.7	H	-46.13	0.30	9.40	-37.03	-13.00	-24.03
1648.40	58.32	65	1.3	V	-55.21	0.30	9.40	-46.11	-13.00	-33.11
2472.60	57.83	80	1.6	H	-56.17	0.43	10.60	-46.00	-13.00	-33.00
2472.60	48.14	279	2.0	V	-62.14	0.43	10.60	-51.97	-13.00	-38.97

Cellular Band (Part 24E)

Frequency (MHz)	Receiver Reading (dBμV)	Turn table Angle Degree	RX Antenna		Substituted			Absolute Level (dBm)	Result	
			Height (m)	Polar (H/V)	SG Level (dBm)	Cable (dB)	Antenna Gain (dB)		Limit (dBm)	Margin (dB)
PCS 1900 Channel 512										
199.38	48.42	247	2.0	H	-62.09	0.15	0.00	-62.24	-13.00	-49.24
199.38	39.43	130	2.2	V	-68.16	0.15	0.00	-68.31	-13.00	-55.31
3700.40	65.95	69	1.0	H	-45.59	2.37	12.50	-35.46	-13.00	-22.46
3700.40	59.98	114	1.2	V	-49.83	2.37	12.50	-39.70	-13.00	-26.70
5550.60	53.58	313	1.8	H	-56.03	2.86	12.90	-45.99	-13.00	-32.99
5550.60	44.73	142	1.0	V	-64.15	2.86	12.90	-54.11	-13.00	-41.11

Note: 1) Absolute Level = SG Level - Cable loss + Antenna Gain

2) Margin = Limit- Absolute Level

13 Band Edge Measurement

Test Requirement:	FCC Part 2.1051, 22.917(a), 24.238(a)
Test Method:	TIA/EIA-603-D:2010 KDB971168 D01 v02r02
Test Mode:	TX transmitting

13.1 EUT Operation

Operating Environment :

Temperature:	23.5 °C
Humidity:	52.3 % RH
Atmospheric Pressure:	101.3kPa

13.2 Test Procedure

The RF output of the transmitter was connected to the input of the spectrum analyzer through sufficient attenuation.

According to FCC Part 22.917(a), the power of any emissions outside of the authorized operating frequency ranges must be attenuated below the TX transmitting power (P) by a factor of at least $43 + 10 \log(P)$ dB.

According to FCC Part 24.238(a), the power of any emissions outside of the authorized operating frequency ranges must be attenuated below the TX transmitting power (P) by a factor of at least $43 + 10 \log(P)$ dB.

The center of the spectrum analyzer was set to block edge frequency

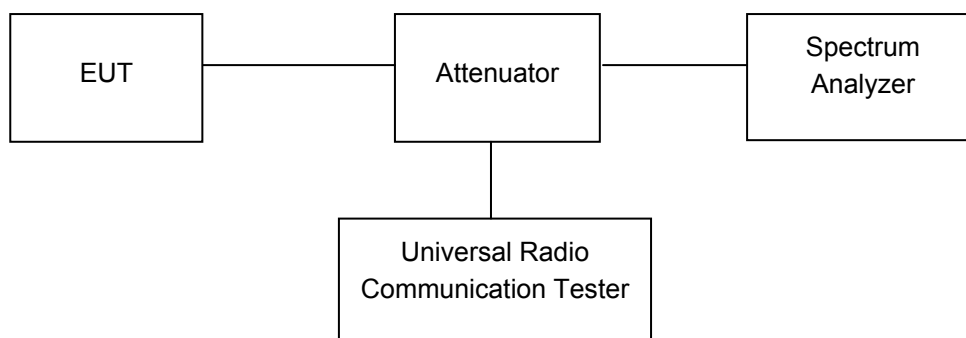

13.3 Test Result

Test plots
Cellular Band (Part 22H)
GSM 850 band edge-left side

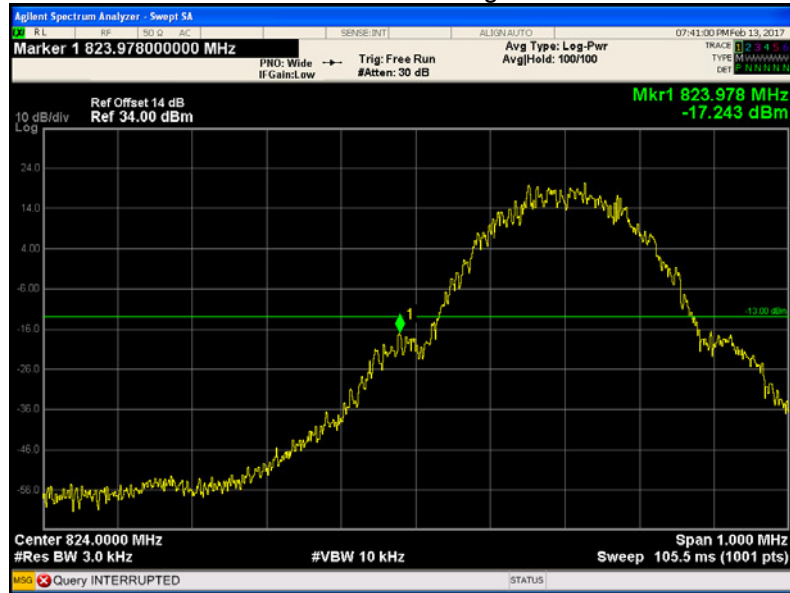

GSM 850 band edge-right side

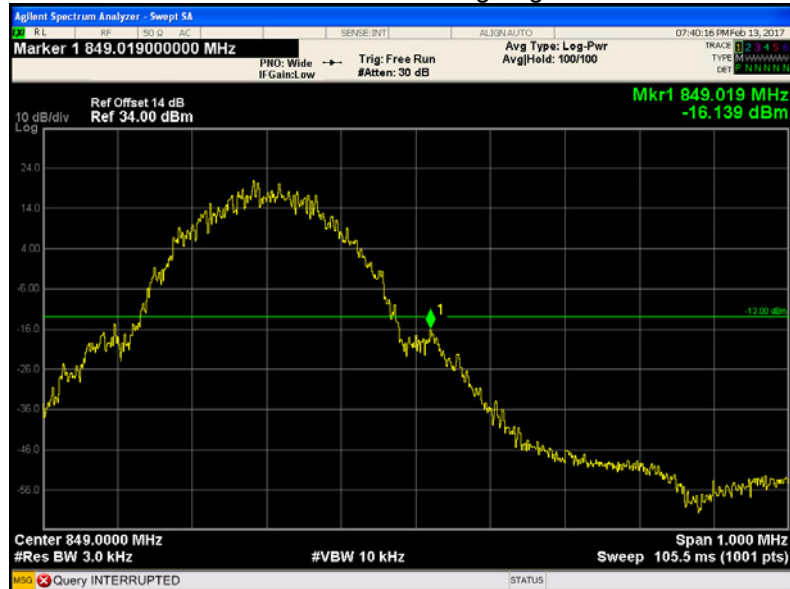

GPRS 850 band edge-left side

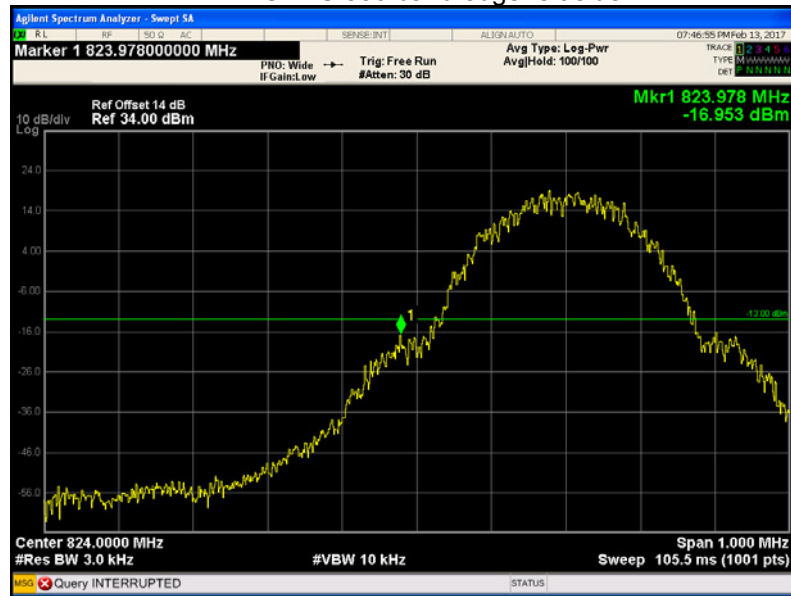

GPRS 850 band edge-right side

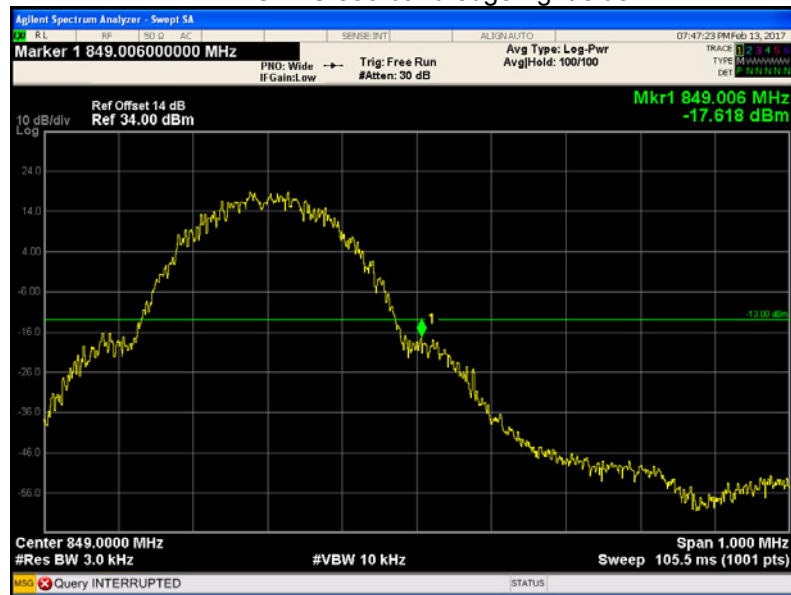

Cellular Band (Part 24E)

PCS 1900 band edge-left side

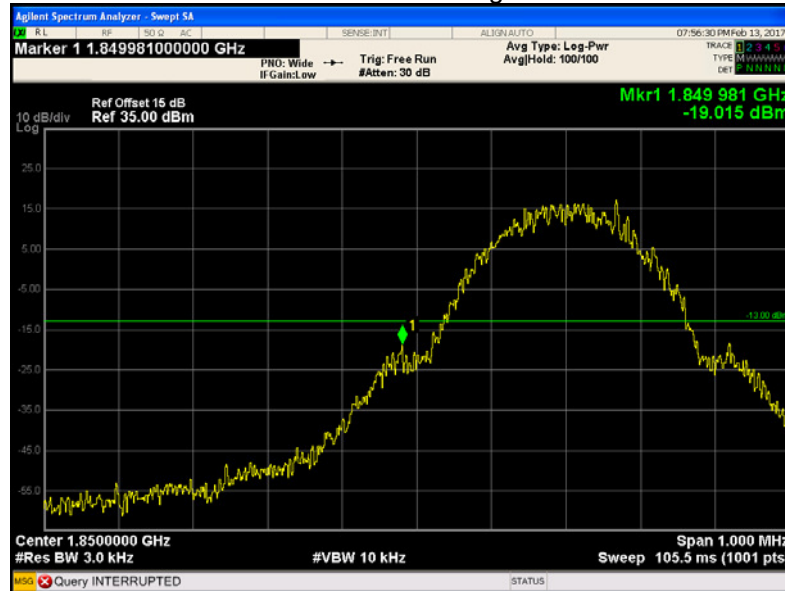

PCS 1900 band edge-right side



GPRS 1900 band edge-left side

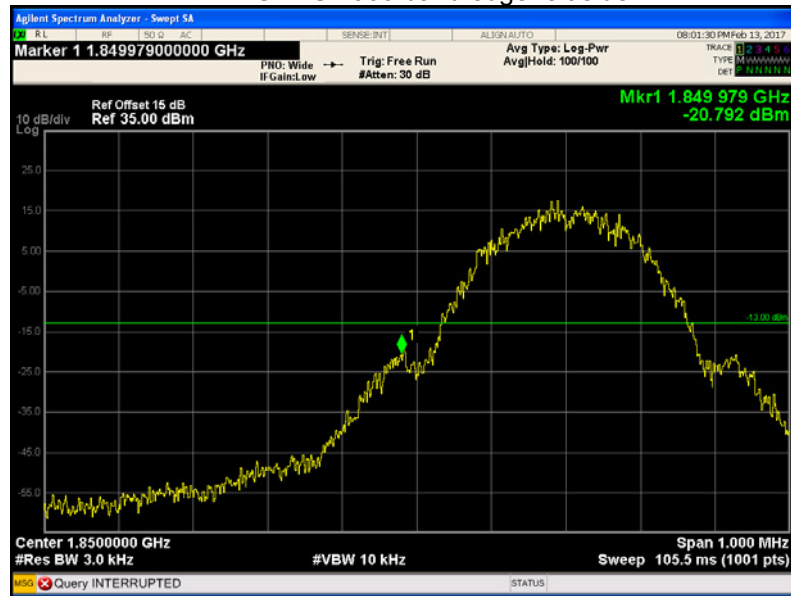

GPRS 1900 band edge-right side

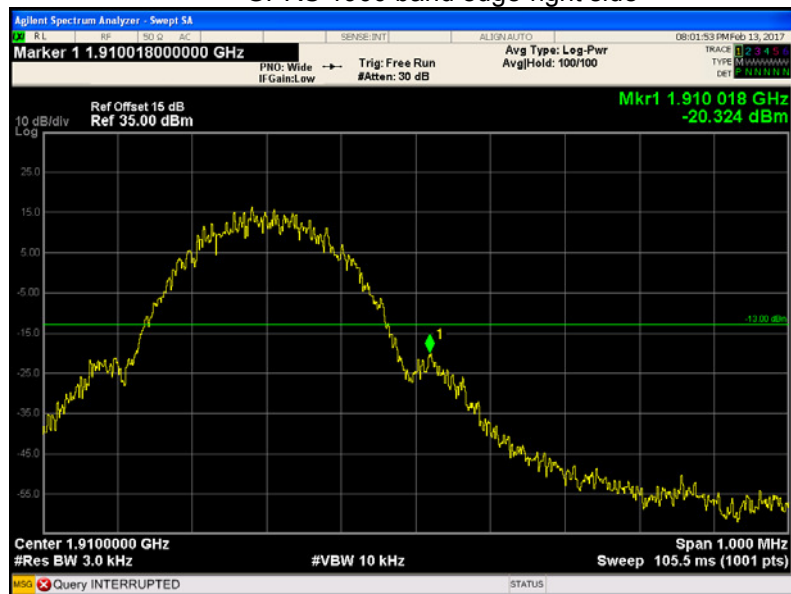

14 FREQUENCY STABILITY

Test Requirement:	FCC Part 2.1055, 22.355, 24.235
Test Method:	TIA/EIA-603-D:2010 KDB971168 D01 v02r02
Test Mode:	TX transmitting

14.1 EUT Operation

Operating Environment :

Temperature:	22.9 °C
Humidity:	52.0 % RH
Atmospheric Pressure:	101.3kPa

14.2 Test Procedure

Frequency Stability vs. Temperature: The equipment under test was connected to an external DC power supply and the RF output was connected to communication test set via feed-through attenuators. The EUT was placed inside the temperature chamber. The DC leads and RF output cable exited the chamber through an opening made for the purpose.

After the temperature stabilized for approximately 20 minutes, the frequency output was recorded from the communication test set.

Frequency Stability vs. Voltage: For hand carried, battery powered equipment; reduce primary supply voltage to the battery operating end point which shall be specified by the manufacturer.

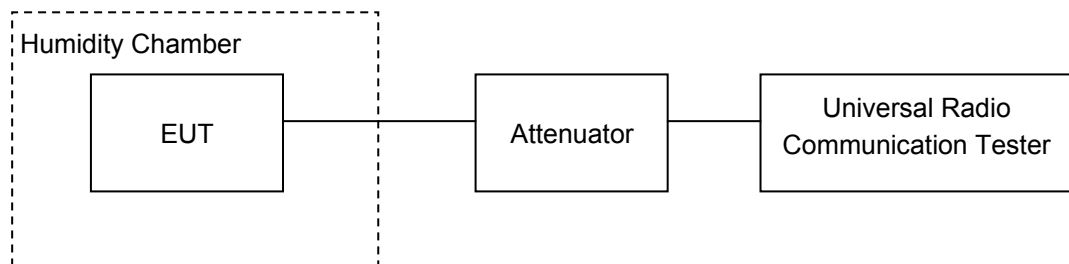

14.3 Test Result

Cellular Band (Part 22H)

GSM 850 Test Frequency:836.6MHz				
Temperature (°C)	Power Supply (VDC)	Frequency Error (Hz)	Frequency Error (ppm)	Limit (ppm)
50	3.7	-2	-0.0024	2.5
40		4	0.0048	2.5
30		3	0.0036	2.5
20		-4	-0.0048	2.5
10		-9	-0.0108	2.5
0		1	0.0012	2.5
-10		-13	-0.0155	2.5
-20		-5	-0.0060	2.5
-30		-11	-0.0131	2.5
20		3.3	0	0.0000
20	4.2	-6	-0.0072	2.5

GPRS 850 Test Frequency:836.6MHz				
Temperature (°C)	Power Supply (VDC)	Frequency Error (Hz)	Frequency Error (ppm)	Limit (ppm)
50	3.7	9	0.0108	2.5
40		8	0.0096	2.5
30		0	0.0000	2.5
20		5	0.0060	2.5
10		5	0.0060	2.5
0		-3	-0.0036	2.5
-10		11	0.0131	2.5
-20		2	0.0024	2.5
-30		10	0.0120	2.5
20		3.3	13	0.0155
20	4.2	-3	-0.0036	2.5

PCS Band (Part 24E)

PCS 1900 Test Frequency:1880.0MHz				
Temperature (°C)	Power Supply (VDC)	Frequency Error (Hz)	Frequency Error (ppm)	Limit (ppm)
50	3.7	18	0.0096	2.5
40		15	0.0080	2.5
30		14	0.0074	2.5
20		15	0.0080	2.5
10		24	0.0128	2.5
0		15	0.0080	2.5
-10		11	0.0059	2.5
-20		8	0.0043	2.5
-30		11	0.0059	2.5
20	3.3	6	0.0032	2.5
20	4.2	12	0.0064	2.5

GPRS 1900 Test Frequency:1880.0MHz				
Temperature (°C)	Power Supply (VDC)	Frequency Error (Hz)	Frequency Error (ppm)	Limit (ppm)
50	3.7	10	0.0053	2.5
40		17	0.0090	2.5
30		10	0.0053	2.5
20		11	0.0059	2.5
10		19	0.0101	2.5
0		9	0.0048	2.5
-10		6	0.0032	2.5
-20		13	0.0069	2.5
-30		9	0.0048	2.5
20	3.3	5	0.0027	2.5
20	4.2	13	0.0069	2.5

15 RF Exposure

Test Requirement: FCC Part 1.1307

Evaluation Method: FCC Part 2.1091

Requirements

Systems operating under the provisions of this section shall be operated in a manner that ensures that the public is not exposed to radio frequency energy levels in excess limit for maximum permissible exposure. In accordance with 47 CFR FCC Part 2 Subpart J, section 2.1091 this device has been defined as a mobile device whereby a distance of 0.2 m normally can be maintained between the user and the device.

The procedures / limit

(A) Limits for Occupational / Controlled Exposure

Frequency Range (MHz)	Electric Field Strength (E) (V/m)	Magnetic Field Strength (H) (A/m)	Power Density (S) (mW/ cm ²)	Averaging Time E ² , H ² or S (minutes)
0.3-3.0	614	1.63	(100)*	6
3.0-30	1842 / f	4.89 / f	(900 / f)*	6
30-300	61.4	0.163	1.0	6
300-1500			F/300	6
1500-100,000			5	6

(B) Limits for General Population / Uncontrolled Exposure

Frequency Range (MHz)	Electric Field Strength (E) (V/m)	Magnetic Field Strength (H) (A/m)	Power Density (S) (mW/ cm ²)	Averaging Time E ² , H ² or S (minutes)
0.3-1.34	614	1.63	(100)*	30
1.34-30	824/f	2.19/f	(180/f)*	30
30-300	27.5	0.073	0.2	30
300-1500			F/1500	30
1500-100,000			1.0	30

Note: f = frequency in MHz ; *Plane-wave equivalent power density

MPE Calculation Method

$$S = \frac{P \times G}{4 \times \pi \times R^2}$$

S = power density (in appropriate units, e.g. mW/cm²)

P = output power to the antenna (in appropriate units, e.g., mW).

G = power gain of the antenna in the direction of interest relative to an isotropic radiator,
the power gain factor, is normally numeric gain.

R = distance to the center of radiation of the antenna (appropriate units, e.g., cm)

From the peak EUT RF output power, the minimum mobile separation distance, R=20cm, as well as the gain of the used antenna, the RF power density can be obtained

Test Mode	Antenna Gain (dBi)	Antenna Gain (numeric)	Max. Peak Output Power (dBm)	Peak Output Power (mW)	Power Density (mW/cm ²)	Limit of Power Density (mW/cm ²)
GSM 850	0.50	1.122	32.96	1976.97	0.441286	1
GSM 1900	1.00	1.259	30.03	1006.93	0.252185	1

