



TEST REPORT

Test Report No. : UL-RPT-RP-12266880-116-FCC

Applicant : Casambi Technologies Oy
Model No. : CBU-DCS
FCC ID : 2ALA3-CBUDCS
Technology : Bluetooth – Low Energy
Test Standard(s) : FCC Parts 15.207, 15.209 & 15.247

For details of applied tests refer to test result summary

1. This test report shall not be reproduced in full or partial, without the written approval of UL International Germany GmbH.
2. The results in this report apply only to the sample tested.
3. The test results in this report are traceable to the national or international standards.
4. Test Report Version 1.0
5. Result of the tested sample: **PASS**

Prepared by: Segun I. Adeniji
Title: Engineer
Date: 26.June. 2018

Approved by: Ajit, Phadtare
Title: Lead Test Engineer
Date: 26.June. 2018



Deutsche
Akkreditierungsstelle
D-PL-19381-02-00

This laboratory is accredited by DAkkS.
The tests reported herein have been performed in
accordance with its' terms of accreditation.

UL INTERNATIONAL GERMANY GMBH

Hedelfinger Str. 61
70327 Stuttgart, Germany
STU.CTECHLab@ul.com

This page has been left intentionally blank.

Table of Contents

1. Customer Information.....	4
1.1.Applicant Information	4
1.2.Manufacturer Information	4
2. Summary of Testing.....	5
2.1. General Information	5
Applied Standards	5
Location	5
Date information	5
2.2. Summary of Test Results	6
2.3. Methods and Procedures	6
2.4. Deviations from the Test Specification	6
3. Equipment Under Test (EUT)	7
3.1. Identification of Equipment Under Test (EUT)	7
3.2. Description of EUT	7
3.3. Modifications Incorporated in the EUT	7
3.4. Additional Information Related to Testing	7
3.5. Support Equipment	8
A. Support Equipment (In-house)	8
B. Support Equipment (Manufacturer supplied)	8
4. Operation and Monitoring of the EUT during Testing	9
4.1. Operating Modes	9
4.2. Configuration and Peripherals	9
5. Measurements, Examinations and Derived Results	10
5.1. General Comments	10
5.2. Test Results	11
5.2.1. Transmitter AC Conducted Spurious Emissions	11
5.2.2. Transmitter Minimum 6 dB Bandwidth	15
5.2.3. Transmitter Duty Cycle	17
Transmitter Duty Cycle continued	18
5.2.4. Transmitter Maximum Peak Output Power	19
5.2.5. Transmitter Radiated Emissions	21
5.2.6. Transmitter Band Edge Radiated Emissions	28
6. Measurement Uncertainty	32
7. Used equipment	33
8. Report Revision History	34

1. Customer Information

1.1.Applicant Information

Company Name:	Casambi Technologies Oy
Company Address:	Bertel Jungin aukio 1 E, Espoo, 02600 Finland
Company Phone No.:	--
Company E-Mail:	--
Contact Person:	Mr. Kai Toetterman
Contact E-Mail Address:	kai.totterman@casambi.com
Contact Phone No.:	+358 45 137 9988

1.2.Manufacturer Information

Company Name:	Casambi Technologies Oy
Company Address:	Bertel Jungin aukio 1 E, Espoo, 02600 Finland
Company Phone No.:	--
Company E-Mail:	--
Contact Person:	Mr. Kai Toetterman
Contact E-Mail Address:	kai.totterman@casambi.com
Contact Phone No.:	+358 45 137 9988

2. Summary of Testing

2.1. General Information

Applied Standards

Specification Reference:	47CFR15.247
Specification Title:	Code of Federal Regulations Volume 47 (Telecommunications): Part 15 Subpart C (Intentional Radiators) - Section 15.247
Specification Reference:	47CFR15.207 and 47CFR15.209
Specification Title:	Code of Federal Regulations Volume 47 (Telecommunications): Part 15 Subpart C (Intentional Radiators) - Sections 15.207 and 15.209
Test Firm Registration:	399704

Location

Location of Testing:	UL International Germany GmbH Hedelfinger Str. 61 70327 Stuttgart Germany
-----------------------------	--

Date information

Order Date:	16 April 2017
EUT arrived:	30 May 2018
Test Dates:	30 May 2018
EUT returned:	-/-

2.2. Summary of Test Results

Clause	Measurement	Complied	Did not comply	Not performed	Not applicable
Part 15.207	Transmitter AC Conducted Emissions	<input checked="" type="checkbox"/>	<input type="checkbox"/>	<input type="checkbox"/>	<input type="checkbox"/>
Part 15.247(a)(2)	Transmitter Minimum 6 dB Bandwidth	<input checked="" type="checkbox"/>	<input type="checkbox"/>	<input type="checkbox"/>	<input type="checkbox"/>
Part 15.247(e)	Transmitter Power Spectral Density ^(Note1)	<input checked="" type="checkbox"/>	<input type="checkbox"/>	<input type="checkbox"/>	<input type="checkbox"/>
Part 15.247(b)(3)	Transmitter Maximum Peak Output Power	<input checked="" type="checkbox"/>	<input type="checkbox"/>	<input type="checkbox"/>	<input type="checkbox"/>
Part 15.247(d)/15.209(a)	Transmitter Radiated Emissions	<input checked="" type="checkbox"/>	<input type="checkbox"/>	<input type="checkbox"/>	<input type="checkbox"/>
Part 15.247(d)/15.209(a)& 209(b)	Transmitter Band Edge Radiated Emissions	<input checked="" type="checkbox"/>	<input type="checkbox"/>	<input type="checkbox"/>	<input type="checkbox"/>

Note(s):

- For the purpose of this report, In accordance with FCC KDB 558074 Section 10.1, PSD is not required if th maximum conducted output power is less than the PSD limit of 8 dBm / 3 kHz. The PSD level is therefore deemed to be equal to the measured total output power. Nevertheless, a measurement was performed for PSD and the result is stored in our internal database.

2.3. Methods and Procedures

Reference:	ANSI C63.10-2013
Title:	American National Standard of Procedures for Compliance Testing of Unlicensed Wireless Devices
Reference:	KDB 558074 D01 DTS Meas Guidance v04 April 5, 2017
Title:	Guidance for Performing Compliance Measurements on Digital Transmission Systems (DTS) Operating Under §15.247
Reference:	Line Conducted FAQ v01r01 June 3, 2015
Title:	AC Power-Line Conducted Emissions Frequently Asked Questions

2.4. Deviations from the Test Specification

For the measurements contained within this test report, there were no deviations from, additions to, or exclusions from the test specification identified above.

3. Equipment Under Test (EUT)

3.1. Identification of Equipment Under Test (EUT)

EUT Description:	Bluetooth controllable DALI controller
Brand Name:	Casambi
Model Name or Number:	CBU-DCS
Test Sample Serial Number:	D27C7C5448C9
Hardware Version Number:	CBU-DCS v1.0
Software/ Firmware Version Number:	23.1
FCC ID:	2ALA3-CBUDCS

3.2. Description of EUT

The equipment under test was a Bluetooth controllable DALI controller with a Bluetooth low energy module.

3.3. Modifications Incorporated in the EUT

No modifications were applied to the EUT during testing.

3.4. Additional Information Related to Testing

Technology Tested:	Bluetooth Low Energy (Digital Transmission System)		
Type of Unit:	Transceiver		
Channel Spacing:	2 MHz		
Modulation:	GFSK		
Data Rate:	1 Mbps		
Power Supply Requirement(s):	Nominal	16 VDC	
Antenna Gain:	2 dBi		
Transmit Frequency Range:	2402 MHz to 2480 MHz		
Transmit Channels Tested:	Channel ID	RF Channel Number	Channel Frequency (MHz)
	Bottom	0	2402
	Middle	19	2440
	Top	39	2480

3.5. Support Equipment

The following support equipment was used to exercise the EUT during testing:

A. Support Equipment (In-house)

Item	Description	Brand Name	Model Name or Number	Serial Number
1				
2				
3				

B. Support Equipment (Manufacturer supplied)

Item	Description	Brand Name	Model Name or Number	Serial Number
1	Power Cable (Length: 2 metres)	Not marked or stated	Not marked or stated	Not marked or stated
2	Laboratory Power Supply	Conrad Electronic Germany	PS -2403D	Not marked or stated
3	MP3 player	Apple	iPod Touch	CCQSCOZMGGK6
4	DALI bus power supply	Tridonic	DALI-PS1	N/A

4. Operation and Monitoring of the EUT during Testing

4.1. Operating Modes

The EUT was tested in the following operating mode(s):

Transmitting at maximum power in *Bluetooth* LE mode with modulation, maximum possible data length available.

4.2. Configuration and Peripherals

The EUT was tested in the following configuration(s):

- The EUT was powered using a 16 V DC power supply.
- Controlled in test mode using a software application Utility installed on the MP3 player supplied by the customer. The application was used to enable a continuous transmission and to select the test channels as required.
- For the conducted measurement, the EUT was made to transmit with a transmitter delay between packets of 100 us. The duty cycle for this mode is presented in section 5.2.3 and for the radiated measurements the EUT was made to transmit continuously with a duty cycle of more than 98 %.
- EMC32 V10.1.0 Software was used for the Radiated spurious emission measurement.

5. Measurements, Examinations and Derived Results

5.1. General Comments

Measurement uncertainties are evaluated in accordance with current best practice. Our reported expanded uncertainties are based on standard uncertainties, which are multiplied by an appropriate coverage factor to provide a statistical confidence level of approximately 95%. Please refer to Section 6 *Measurement Uncertainty* for details.

In accordance with DAkkS requirements all the measurement equipment is on a calibration schedule. All equipment was within the calibration period on the date of testing.

5.2. Test Results

5.2.1. Transmitter AC Conducted Spurious Emissions

Test Summary:

Test Engineer:	M. Asim Shahzad	Test Date:	30 May 2018
Test Sample Serial Number:	D27C7C5448C9		
Test Site Identification	SR 7/8		

Clause:	Part 15.207
Test Method:	ANSI C63.10 Section 6.2 / FCC KDB 174176 and notes below

Environmental Conditions:

Temperature (°C):	22
Relative Humidity (%):	38

Settings of the Instrument

Detector	Quasi Peak/ Average Peak
-----------------	--------------------------

Note(s):

1. The EUT was connected to an AC/DC Power Supply.
2. The AC/DC Power Supply was connected to a 120 VAC 60 Hz single phase supply via a LISN.
3. The final measured value, for the given emission, in the table below incorporates the cable loss.
4. All other emissions shown on the pre-scan plot were investigated and found to be ambient or >20 dB below the applicable limit or below the measurement system noise floor.
5. Measurements were performed in shielded room (SR7/ 8 Asset Number 1603671). The EUT was placed at a height of 80 cm above the reference ground plane and in a distance of 40 cm from the vertical ground plane at the edge of the table.
6. The device was configured to the test mode with a test program installed on the iPod.

Transmitter AC Conducted Spurious Emissions (continued)

Test setup:

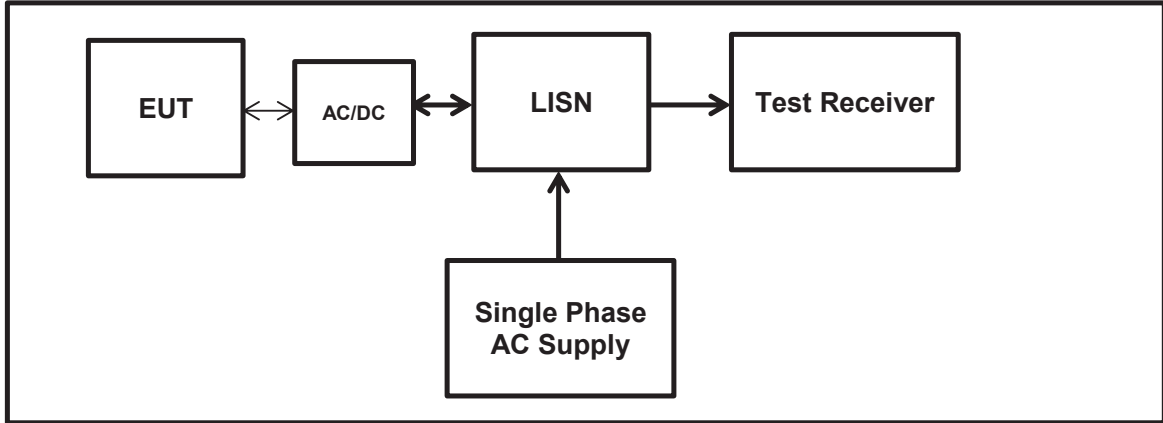

Results: Live / Quasi Peak

Frequency (MHz)	Line	Level (dB μ V)	Limit (dB μ V)	Margin (dB)	Result
0.20288	Live	25.5	63.5	38	Complied
0.57222	Live	28.6	56	27.4	Complied
1.13079	Live	9.4	56	46.6	Complied
2.17858	Live	11.2	56	44.8	Complied
4.11899	Live	13.3	56	42.7	Complied

Results: Live / Average

Frequency (MHz)	Line	Level (dB μ V)	Limit (dB μ V)	Margin (dB)	Result
0.20288	Live	15	53.5	38.5	Complied
0.57222	Live	23.5	46	22.5	Complied
1.13079	Live	5.2	46	40.8	Complied
2.17858	Live	7.3	46	38.7	Complied
4.11899	Live	9.9	46	36.1	Complied
7.61006	Live	9.5	50	40.5	Complied

Results: Neutral / Quasi Peak

Frequency (MHz)	Line	Level (dB μ V)	Limit (dB μ V)	Margin (dB)	Result
0.20765	Neutral	25.5	63.3	37.8	Complied
0.57593	Neutral	29.8	56	26.2	Complied
1.06151	Neutral	10.5	56	45.5	Complied
4.16318	Neutral	14.2	56	41.8	Complied
7.15494	Neutral	14	60	46	Complied
7.85373	Neutral	14.3	60	45.7	Complied

Results: Neutral / Average

Frequency (MHz)	Line	Level (dB μ V)	Limit (dB μ V)	Margin (dB)	Result
0.20765	Neutral	15	53.3	38.3	Complied
0.57593	Neutral	23.1	46	22.9	Complied
1.06151	Neutral	7.4	46	38.6	Complied
4.16318	Neutral	9.4	46	36.6	Complied
7.15494	Neutral	9.5	50	40.5	Complied
7.85373	Neutral	9.5	50	40.5	Complied

Result: Pass

Plot: Live and Neutral Line

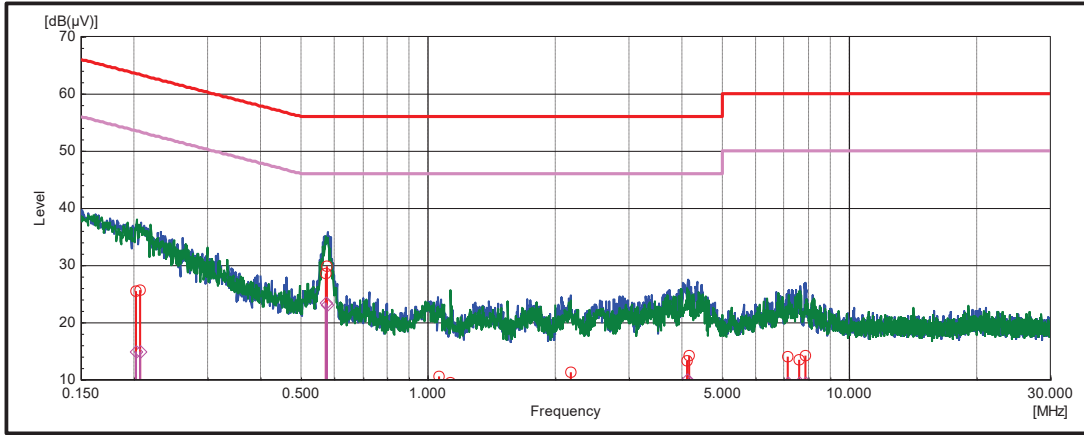

Note: These plots are pre-scans and for indication purposes only. For final measurements, see accompanying tables.

5.2.2. Transmitter Minimum 6 dB Bandwidth

Test Summary:

Test Engineer:	Segun I. Adeniji	Test Date:	30 May 2018
Test Sample Serial Number:	D27C7C5448C9		
Test Site Identification	SR 9		

FCC Reference:	Part 15.247(a)(2)
Test Method Used:	FCC KDB 558074 Section 8.1 Option 1

Environmental Conditions:

Temperature (°C):	24
Relative Humidity (%):	33

Note(s):

- 6 dB DTS bandwidth tests were performed using a spectrum analyser in accordance with FCC KDB 558074 Section 8.1 Option 1 measurement procedure. The spectrum analyser resolution bandwidth was set to 100 kHz and video bandwidth 300 kHz. A peak detector was used, sweep time was set to auto and the trace mode was Max Hold. The DTS bandwidth was measured at 6 dB down from the peak of the signal.
- The spectrum analyser was connected to the RF port on the EUT using suitable attenuation and RF cable.

Test Setup:

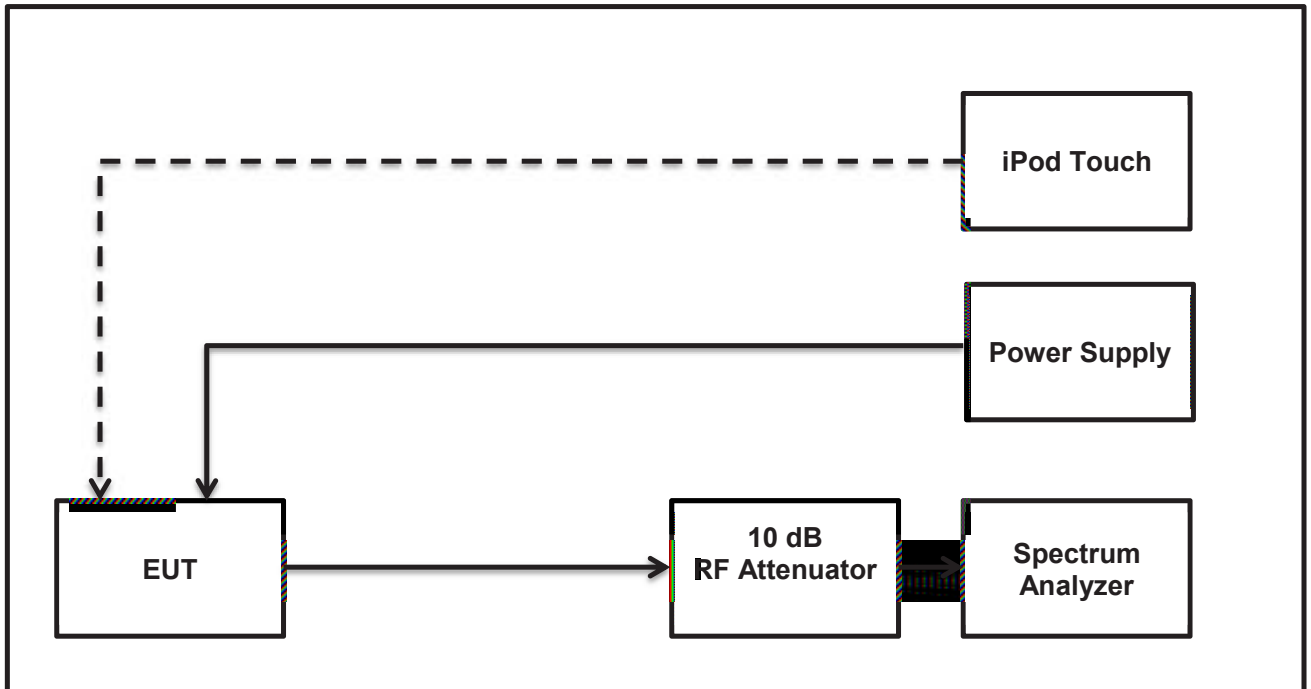

Results:

Channel	6 dB Bandwidth (kHz)	Limit (kHz)	Margin (kHz)	Result
Bottom	792.080	≥500	292.080	Complied
Middle	792.080	≥500	292.080	Complied
Top	792.080	≥500	292.080	Complied

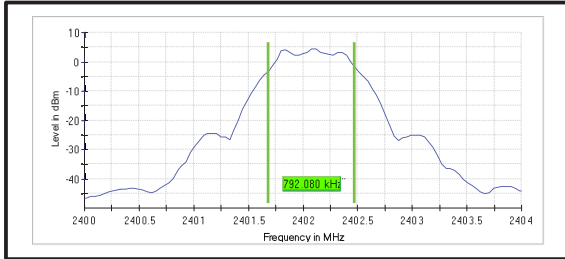

Bottom Channel

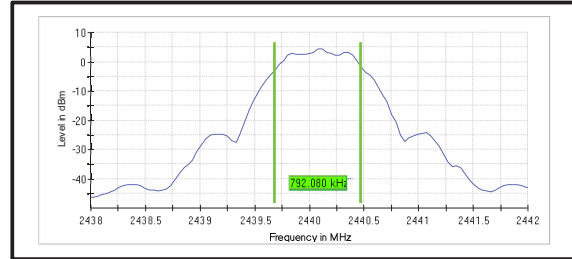

Middle Channel

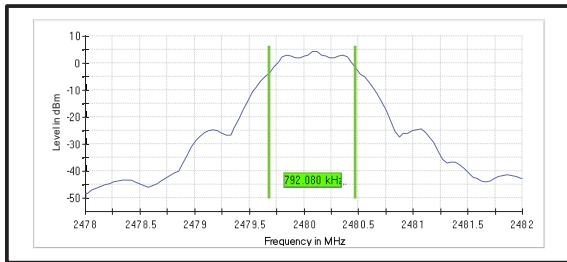

Top Channel

Result: Pass

System Measurement Settings:

Setting	Instrument Value	Target Value
Span	4.000 MHz	4.000 MHz
RBW	100.000 kHz	~ 100.000 kHz
VBW	300.000 kHz	~ 300.000 kHz
SweepPoints	101	~ 40
SweepTime	18.938 μs	AUTO
Reference Level	0.000 dBm	0.000 dBm
Attenuation	20.000 dB	AUTO
Detector	MaxPeak	MaxPeak
SweepCount	100	100
Filter	3 dB	3 dB
Trace Mode	Max Hold	Max Hold
SweepType	FFT	AUTO
Preamp	off	off
Stablemode	Trace	Trace
Stablevalue	0.50 dB	0.50 dB
Run	12 / max. 150	max. 150
Stable	5 / 5	5
Max Stable Difference	0.13 dB	0.50 dB

5.2.3. Transmitter Duty Cycle

Test Summary:

Test Engineer:	Segun I. Adeniji	Test Date:	30 May 2018
Test Sample Serial Number:	D27C7C5448C9		
Test Site Identification	SR 9		

FCC Reference:	Part 15.35(c)
Test Method Used:	FCC KDB 558074 Section 6.0

Environmental Conditions:

Temperature (°C):	24
Relative Humidity (%):	44

Note(s):

The transmitter duty cycle was measured using a spectrum analyser in the time domain and calculated by using the following calculation:

$$10 \log (1 / (\text{On Time} / [\text{Period or } 100 \text{ ms whichever is the lesser}])).$$

$$\text{BLE duty cycle: } 10 \log (1 / (774.78 \mu\text{s} / 1.00435 \text{ ms})) = 1.13 \text{ dB}$$

Test setup:

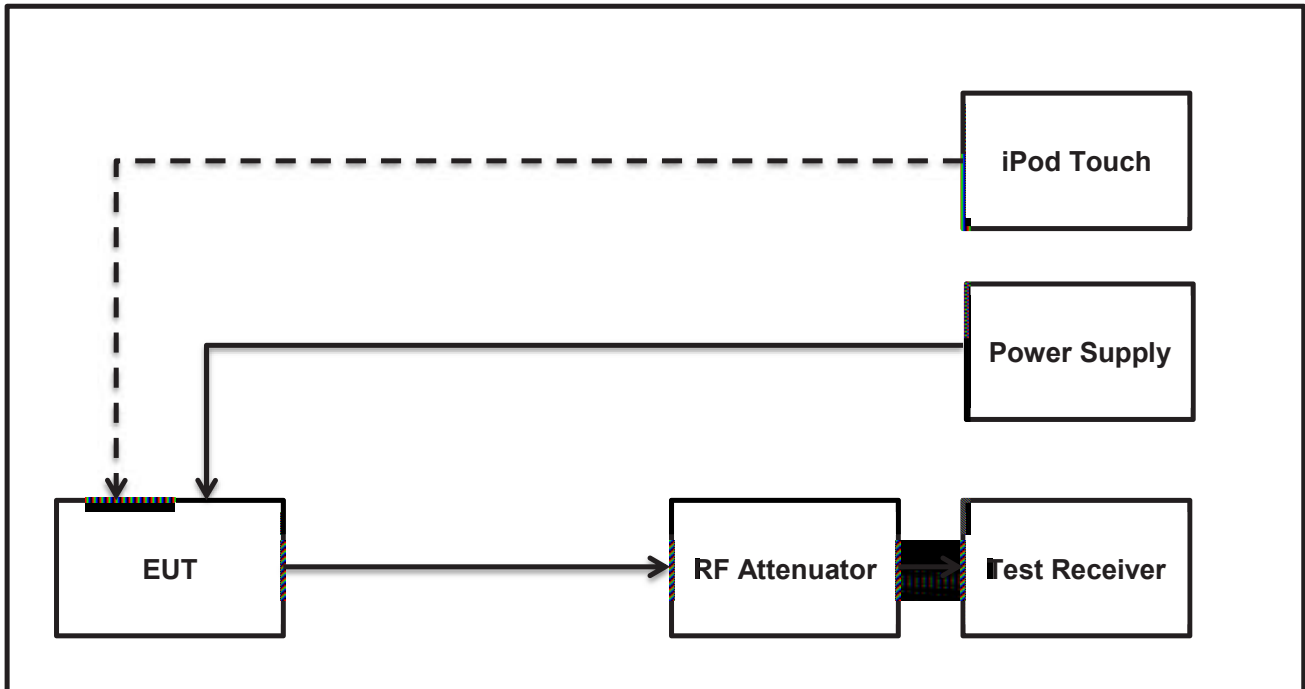

Transmitter Duty Cycle continued

Results:

Pulse Duration (µs)	Period (µs)	Duty Cycle Correction (dB)
774.78	1004.35	1.13

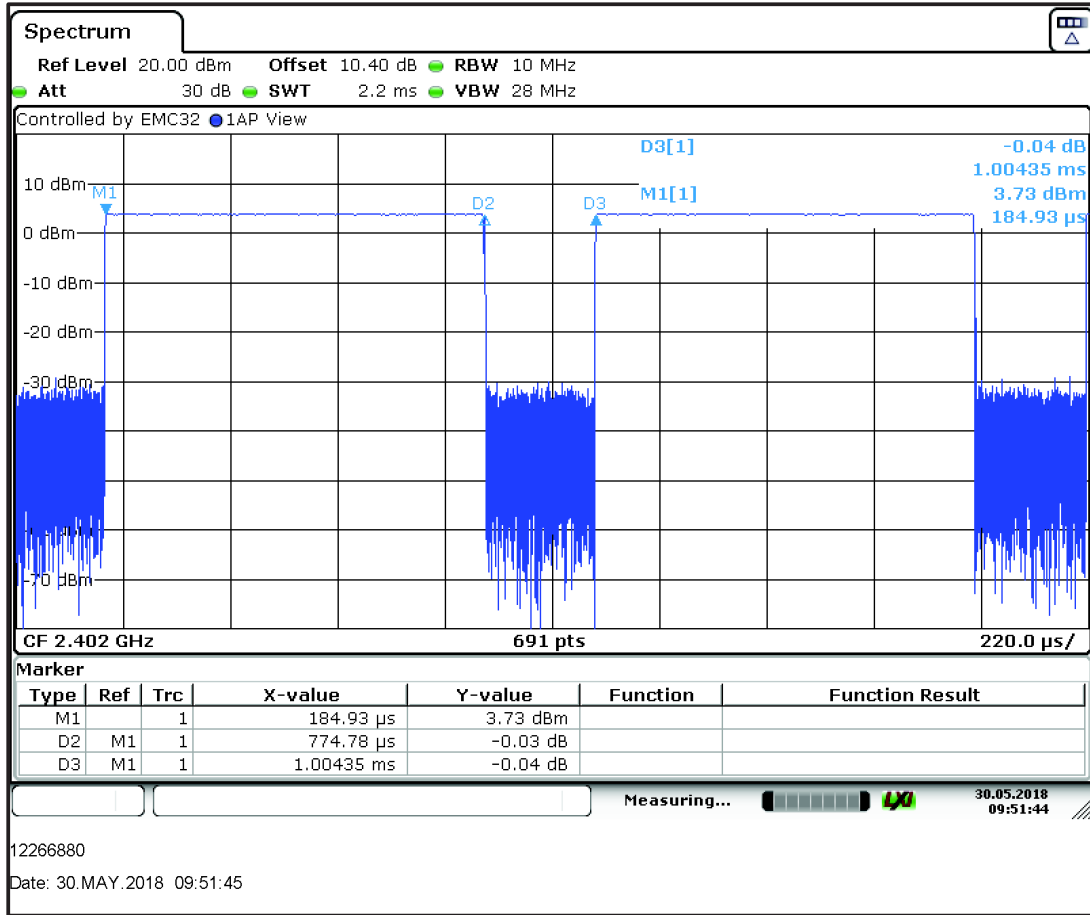

5.2.4. Transmitter Maximum Peak Output Power

Test Summary:

Test Engineer:	Segun I. Adeniji	Test Date:	30 May 2018
Test Sample Serial Number:	D27C7C5448C9		
Test Site Identification	SR 9		

FCC Reference:	Part 15.247(b)(3)
Test Method Used:	FCC KDB 558074 Section 9.1.1 and Notes below

Environmental Conditions:

Temperature (°C):	25
Relative Humidity (%):	42

Note(s):

Conducted power tests were performed using a spectrum analyser in accordance with FCC KDB 558074 Section 9.1.1 with the RBW > *DTS bandwidth* procedure.

The signal analyser resolution bandwidth was set to 3 MHz and video bandwidth of 10 MHz. A peak detector was used, sweep time was set to auto and trace mode was Max Hold. The span was set to 9 MHz. A marker was placed at the peak of the signal and the results recorded in the table below.

The spectrum analyser was connected to the RF port on the EUT using suitable attenuation and RF cable. An RF level offset was entered on the spectrum analyser to compensate for the loss of the attenuator and RF cable.

The measurement was made with highest possible duty cycle

The conducted power was added to the declared antenna gain to obtain the EIRP.

Test setup:

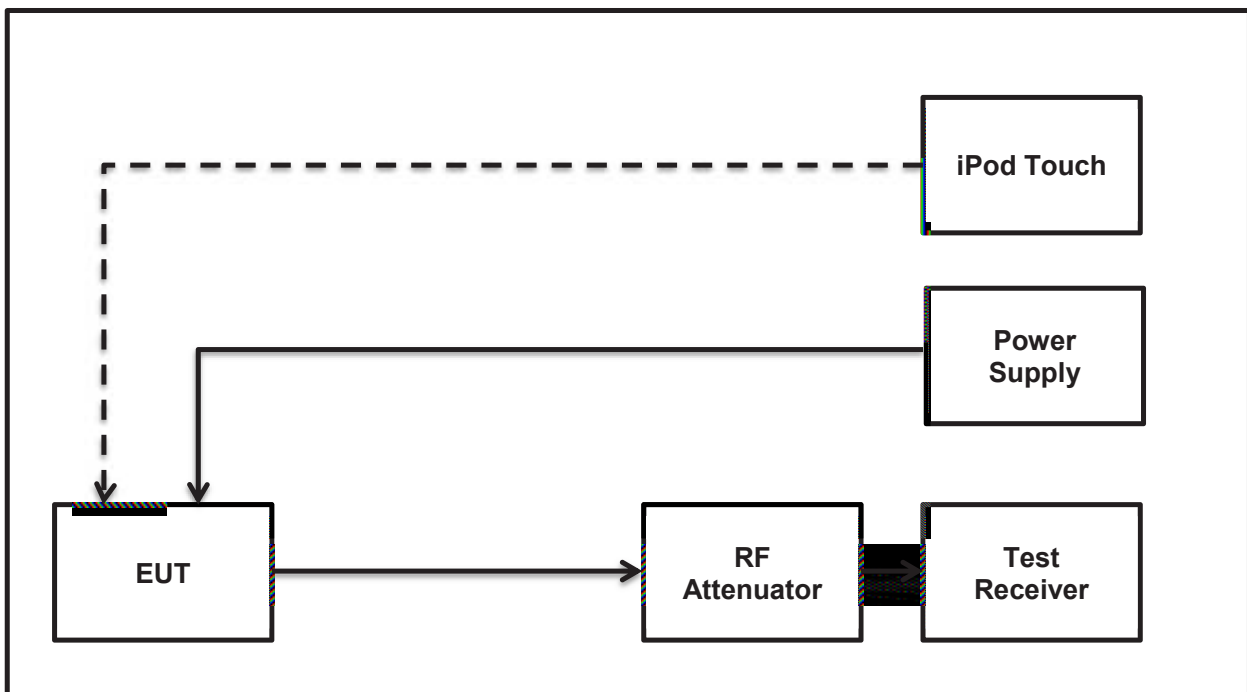

Results:

Channel	Conducted Peak Power (dBm)	Conducted Peak Power Limit (dBm)	Margin (dB)	Result
Bottom	4.8	30.0	25.2	Complied
Middle	4.7	30.0	25.3	Complied
Top	4.4	30.0	25.6	Complied

Channel	Conducted Peak Power (dBm)	Declared Antenna Gain (dBi)	EIRP (dBm)	De Facto EIRP Limit (dBm)	Margin (dB)	Result
Bottom	4.8	2.0	6.8	36.0	29.2	Complied
Middle	4.7	2.0	6.7	36.0	29.3	Complied
Top	4.4	2.0	6.4	36.0	29.6	Complied

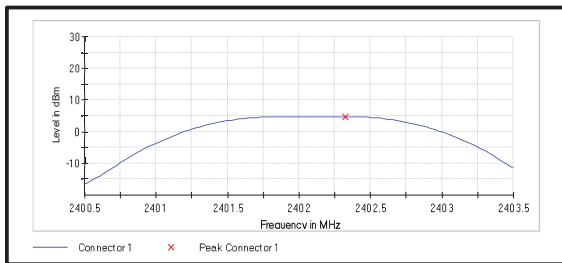

Bottom Channel

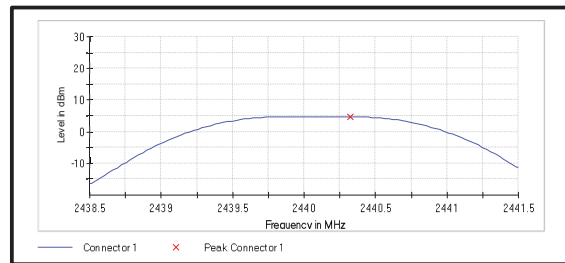

Middle Channel

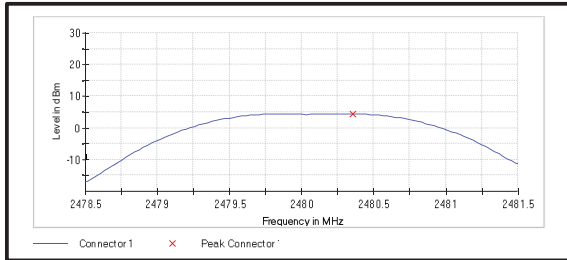

Top Channel

Result: Pass

System Measurement Settings:

Setting	Instrument Value	Target Value
Span	9.000 MHz	9.000 MHz
RBW	3.000 MHz	>= 3.000 MHz
VBW	10.000 MHz	>= 9.000 MHz
SweepPoints	101	~ 101
SweepTime	1.271 μ s	AUTO
Reference Level	10.000 dBm	10.000 dBm
Attenuation	30.000 dB	AUTO
Detector	MaxPeak	MaxPeak
SweepCount	100	100
Filter	3 dB	3 dB
Trace Mode	Max Hold	Max Hold
SweepType	FFT	AUTO
Preamp	off	off
Stablemode	Trace	Trace
Stablevalue	0.50 dB	0.50 dB
Run	-1 / max. 150	max. 150
Stable	-1 / 3	3
Max Stable Difference	-1.00 dB	0.50 dB

5.2.5. Transmitter Radiated Emissions

Test Summary:

Test Engineer:	Segun I. Adeniji	Test Date:	30 May 2018
Test Sample Serial Number:	D27C7C5448C9		
Test Site Identification	SR 9		

FCC Reference:	Parts 15.247(d) & 15.209
Test Method Used:	ANSI C63.10 Sections 6.3 and 6.5
Frequency Range	30 MHz to 1000 MHz

Environmental Conditions:

Temperature (°C):	22
Relative Humidity (%):	45

Note(s):

1. The final measured value, for the given emission, in the table below incorporates the calibrated antenna factor and cable loss.
2. The preliminary scans showed similar emission levels below 1 GHz, for each channel of operation. Therefore final radiated emissions measurements were performed with the EUT set to the Middle channel only.
3. Measurements below 1 GHz were performed in a semi-anechoic chamber at a distance of 3 metres. The EUT was placed at a height of 80 cm above the reference ground plane in the centre of the chamber turntable. Maximum emission levels were determined by height searching the measurement antenna over the range 1 metre to 4 metres.
4. Pre-scans were performed and markers placed on the highest measured levels. The test receiver resolution bandwidth was set to 100 kHz and video bandwidth 300 kHz. A peak detector was used, sweep time was set to auto and trace mode was Max Hold.
5. Final measurements were performed on the marker frequencies and the results entered into the table below. The test receiver resolution bandwidth was set to 120 kHz, using a CISPR quasi-peak detector and span big enough to see the whole emission.

Test Setup:

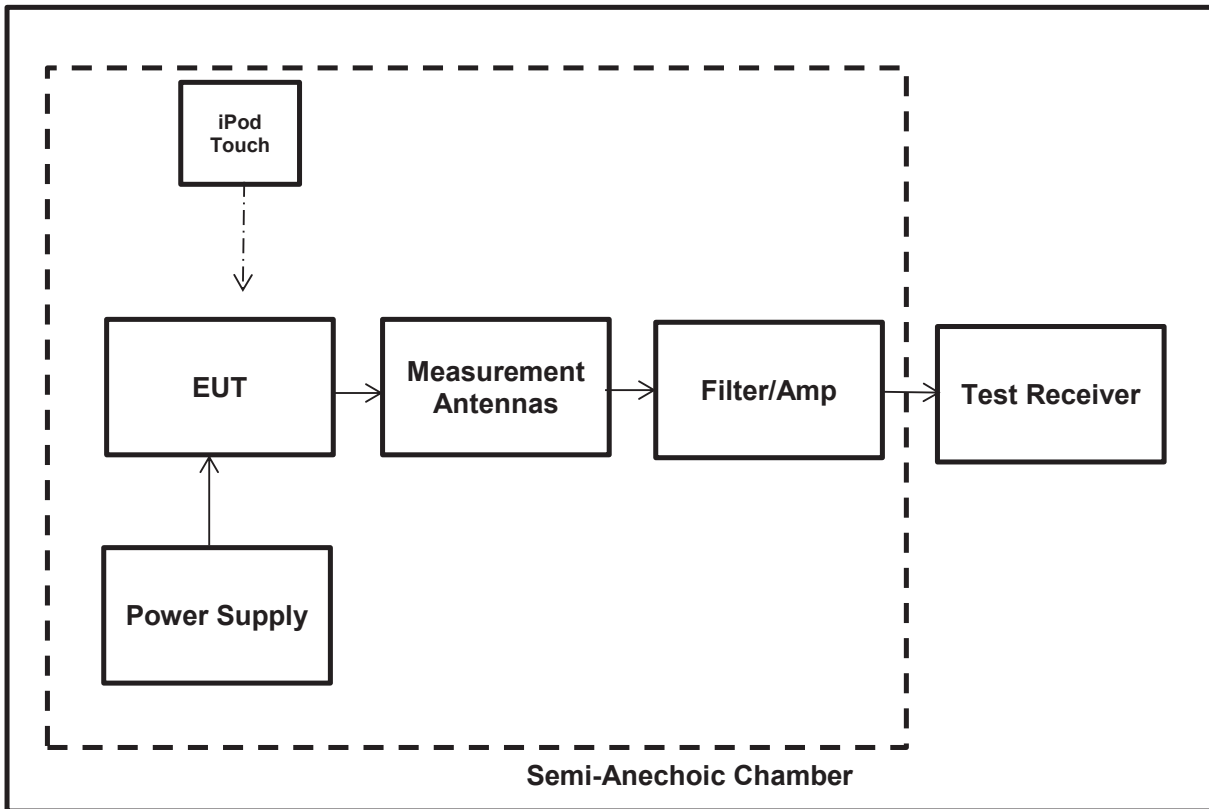

Results: Middle Channel

Frequency (MHz)	Antenna Polarization	MaxPeak Level (dB μ V/m)	Limit (dB μ V/m)	Margin (dB)	Result
39.765000	H	13.78	40.00	26.22	Complied
59.925000	H	15.31	40.00	24.69	Complied
65.325000	H	14.62	40.00	25.38	Complied
480.200000	V	22.50	46.00	23.50	Complied
667.125000	V	25.93	46.00	20.07	Complied
927.083333	H	31.42	46.00	14.58	Complied

Plot: 30 MHz – 1GHz

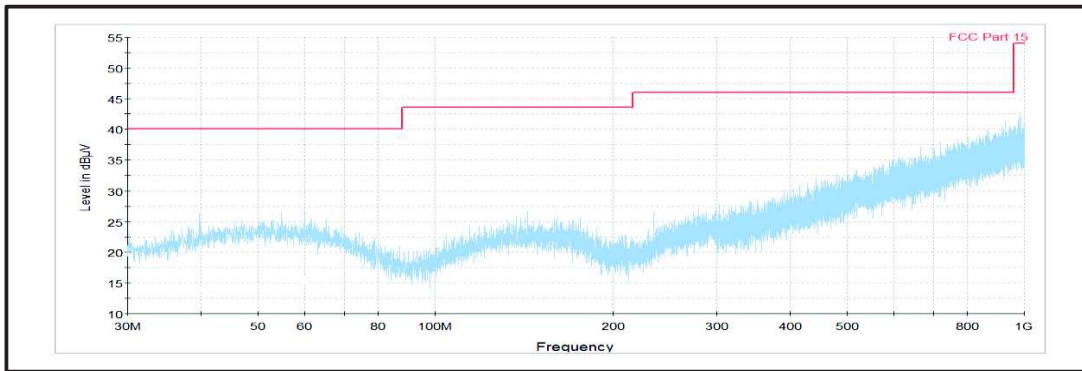

Note: This plot is a pre-scan and for indication purposes only. For final measurements, see accompanying table.

Result: Pass

Test Summary:

Test Engineer:	Segun I. Adeniji	Test Date:	30 May 2018
Test Sample Serial Number:	D27C7C5448C9		
Test Site Identification	SR 1/2		

FCC Reference:	Parts 15.247(d) & 15.209(a)
Test Method Used:	FCC KDB 558074 Sections 11 & 12 referencing ANSI C63.10 Sections 6.3 and 6.6
Frequency Range	1 GHz to 25 GHz

Environmental Conditions:

Temperature (°C):	22
Relative Humidity (%):	42

Note(s):

1. The final measured value, for the given emission, in the table below incorporates the calibrated antenna factor and cable loss.
2. All the spurious emissions detected were re-investigated and re-measured with an average detector and in this case the emission was compared to the peak limit. For frequency range between 18 GHz and 25 GHz, no critical emission was found so only the measurement receiver noise floor level has been measured and recorded in the table The peak level was compared to the average limit as opposed to being compared to the peak limit because this is the more onerous limit. Only the middle channel plot was included in the report as similar result was obtained on both bottom and top channels.
3. The emission shown around the 2.4 GHz is the EUT fundamental.
4. Measurements above 1 GHz were performed in a semi-anechoic chamber at a distance of 3 metres. The EUT was placed at a height of 1.5 m above the reference ground plane in the centre of the chamber turntable. Maximum emission levels were determined by height searching the measurement antenna over the range 1 metre to 4 metres.
5. Pre-scans were performed and a marker placed on the highest measured level of the appropriate plot. The test receiver resolution bandwidth was set to 1 MHz and video bandwidth 3 MHz. The sweep time was set to auto.
6. *In accordance with ANSI C63.10 Section 6.6.4.3, Note 1, if the peak measured value complies with the average limit, it is unnecessary to perform an average measurement.
7. The reference level for the emission in the non-restricted band was established by following KDB 558074 Section 11.2 procedure.

Results:

Results: Peak / Bottom Channel

Frequency (MHz)	Antenna Polarization	Level (dB μ V/m)	Limit (dB μ V/m)	Margin (dB)	Result
4802	Horizontal	52.15	74.0	21.85	Complied
7204	Horizontal	53.87	74.0	20.13	Complied

Results: Average / Bottom Channel

Frequency (MHz)	Antenna Polarization	Level (dB μ V/m)	Limit (dB μ V/m)	Margin (dB)	Result
4802	Horizontal	50.01	54.0	3.99	Complied
7204	Horizontal	43.12	54.0	10.88	Complied

Results: Peak / Middle Channel

Frequency (MHz)	Antenna Polarization	Level (dB μ V/m)	Limit (dB μ V/m)	Margin (dB)	Result
4880	Horizontal	53.97	74.0	20.03	Complied
7320	Horizontal	53.13	74.0	20.87	Complied

Results: Average / Middle Channel

Frequency (MHz)	Antenna Polarization	Level (dB μ V/m)	Limit (dB μ V/m)	Margin (dB)	Result
4880	Horizontal	50.02	54.0	3.98	Complied
7320	Horizontal	38.17	54.0	15.83	Complied

Results: Peak / Top Channel

Frequency (MHz)	Antenna Polarization	Level (dB μ V/m)	Limit (dB μ V/m)	Margin (dB)	Result
2479.92	Vertical	51.27	74.0	22.73	Complied
4960.33	Horizontal	60.01	74.0	13.99	Complied

Results: Average / Top Channel

Frequency (MHz)	Antenna Polarization	Level (dB μ V/m)	Limit (dB μ V/m)	Margin (dB)	Result
2479.92	Vertical	48.53	54.0	5.47	Complied
4960.33	Horizontal	36.12	54.0	17.88	Complied

Result: Pass

Plot: 1 GHz – 18GHz (Bottom channel) with Peak detector

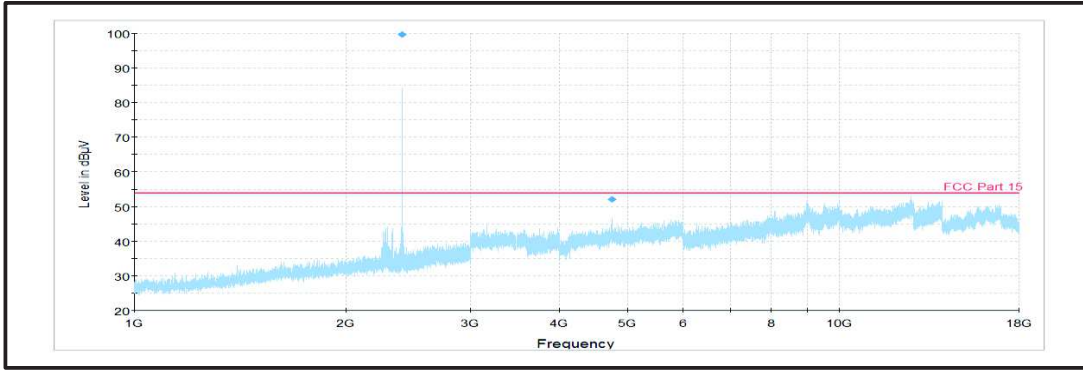

Plot: 1 GHz – 18GHz (Middle channel) with Peak detector

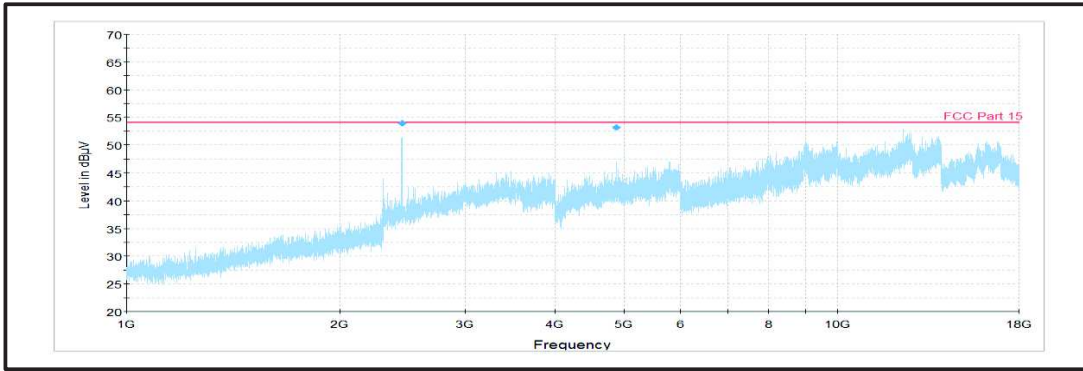

Plot: 1 GHz – 18GHz (Top channel) with Peak detector

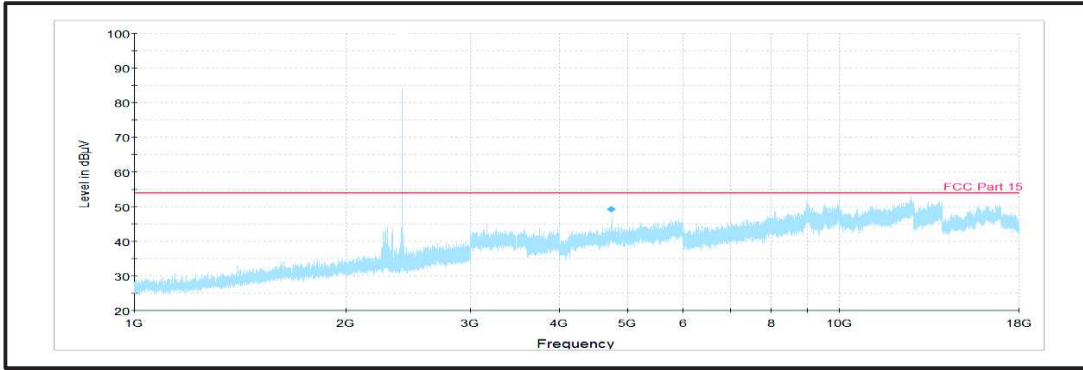

Plot: 18 GHz – 25GHz (Middle channel) with Peak detector

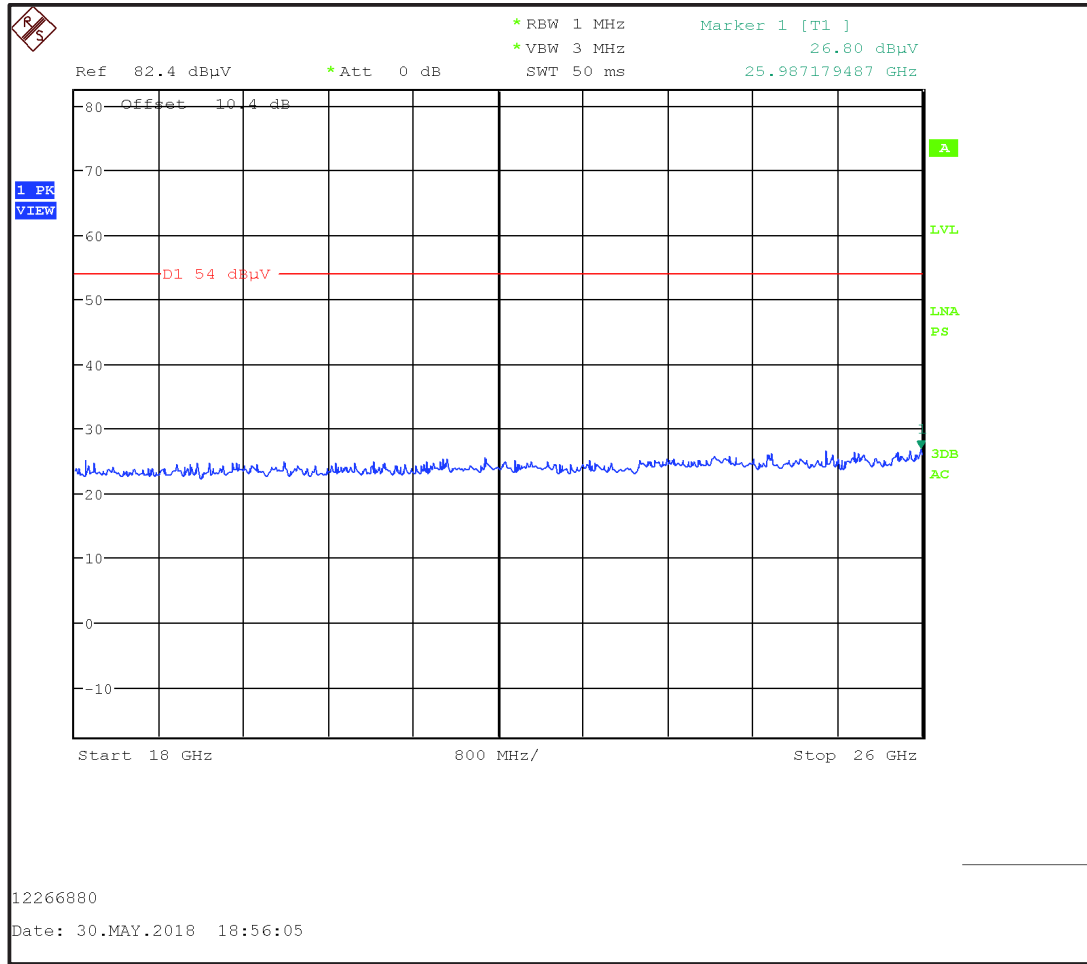

Note: The above plots are pre-scans with peak detector and for indication purposes only. For final measurements, see accompanying tables.

5.2.6. Transmitter Band Edge Radiated Emissions

Test Summary:

Test Engineer:	Segun I. Adeniji	Test Date:	30 May 2018
Test Sample Serial Number:	D27C7C5448C9		
Test Site Identification	SR 9		

FCC Reference:	Parts 15.247(d) & 15.209(a) & 15.209(b)
Test Method Used:	ANSI C63.10 Section 6.10.4, 6.10.5 & KDB 558074 Section 11

Environmental Conditions:

Temperature (°C):	22
Relative Humidity (%):	41

Note(s):

1. As the lower band edges fall within non-restricted bands, only peak measurements are required. In accordance with FCC KDB 558074 Section 11.1, the test method in Section 11.3 was followed: the test receiver resolution bandwidth was set to 100 kHz and video bandwidth 300 kHz. A peak detector was used, sweep time was set to auto and trace mode was Max Hold. The test receiver was left to sweep for a sufficient length of time in order to maximise the carrier level and out-of-band emissions. A marker and corresponding reference level line were placed on the peak of the carrier. As the maximum peak conducted output power was measured using a peak detector in accordance with FCC KDB 558074 Section 9.1.1 an out-of-band limit line was placed 20 dB below the peak level (FCC KDB 558074 Section 11.1(a)). A marker was placed on the band edge spot frequencies and a second marker placed on the highest emission level in the adjacent non-restricted band of operation (where a higher level emission was present). Marker frequencies and levels were recorded.
2. As the upper band edge falls within a restricted band both peak and average measurements were recorded by placing a marker at the edge of the band. For peak measurements the test receiver resolution bandwidth was set to 1 MHz and the video bandwidth 3 MHz. A peak detector was used, sweep time was set to auto and trace mode was Max Hold. For average measurements the test receiver resolution bandwidth was set to 1 MHz and the video bandwidth 3 MHz. An average detector was used, sweep time was set to auto and trace mode was Max Hold. The test receiver was left to sweep for a sufficient length of time in order to maximise the carrier level and out-of-band emissions. A marker was placed on the band edge spot frequencies and a second marker placed on the highest emission level in the adjacent restricted band of operation (where a higher level emission was present). Marker frequencies and levels were recorded.
3. There is a restricted band 10 MHz below the lower band edge. The test receiver was set up as follows: the RBW set to 1 MHz, the VBW set to 3 MHz, with the sweep time set to auto couple. Peak and average measurements were performed with their respective detectors. Markers were placed on the highest point on each trace.
4. *Emissions in restricted bands: In accordance with C63.10 Section 6.6.4.3, Note 1, where the peak detected amplitude was shown to comply with the average limit, an average measurement was not performed.

Test Setup:

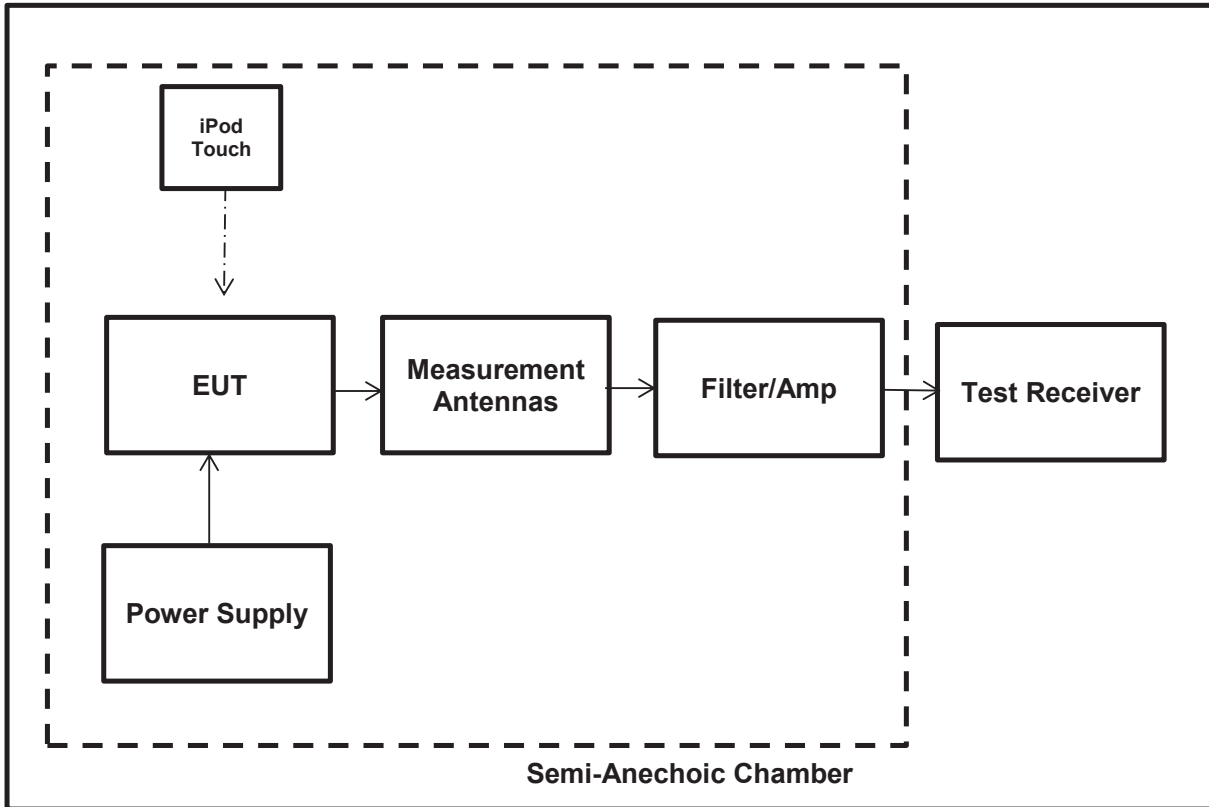

Results: Lower Band Edge/Peak

Frequency (MHz)	Level (dB μ V/m)	-20 dBc Limit (dB μ V/m)	Margin (dB)	Result
2400.000	52.89	79.26	26.37	Complied

Results: Upper Band Edge / Restricted Band / Peak

Frequency (MHz)	Level (dB μ V/m)	Limit (dB μ V/m)	Margin (dB)	Result
2483.500	57.89	74.0	16.11	Complied

Results: Upper Band Edge / Restricted Band / Average

Frequency (MHz)	Average Level (dB μ V/m)	Limit (dB μ V/m)	Margin (dB)	Result
2483.500	53.38	54.0	0.62	Complied

Results: 2310 to 2390 MHz Restricted Band / Peak

Frequency (MHz)	Peak Level (dB μ V/m)	Limit (dB μ V/m)	Margin (dB)	Result
2330.25	59.10	74.0	14.90	Complied

Results: 2310 to 2390 MHz Restricted Band / Average

Frequency (MHz)	Average Level (dB μ V/m)	Limit (dB μ V/m)	Margin (dB)	Result
2390.00	47.73	54.0	6.27	Complied

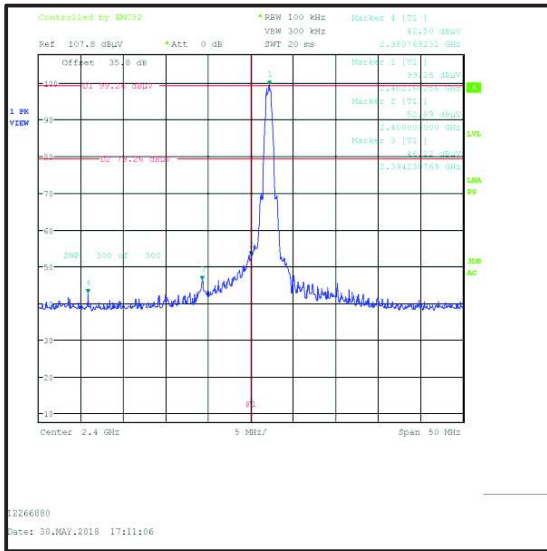

Lower Band Edge Peak Measurement

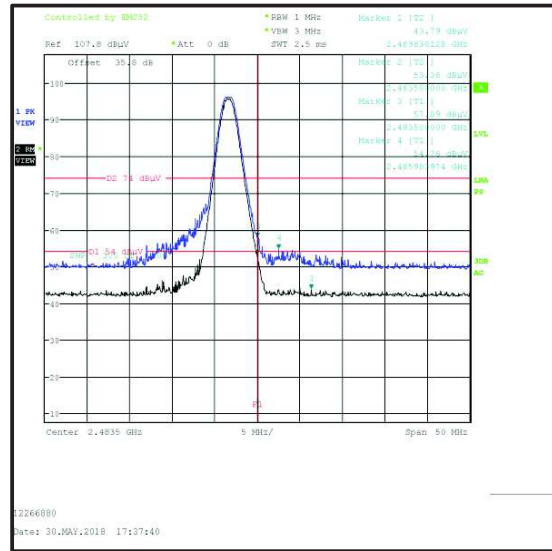

Upper Band Edge Peak & Average Measurement

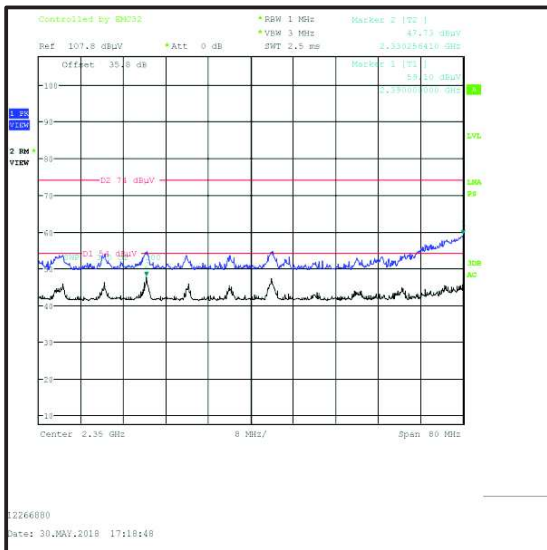

2310 MHz to 2390 MHz Restricted Band Plot

6. Measurement Uncertainty

The expression of uncertainty of a measurement result allows realistic comparison of results with reference values and limits given in specifications and standards.

The uncertainty of the result may need to be taken into account when interpreting the measurement results.

The reported expanded uncertainties below are based on a standard uncertainty multiplied by an appropriate coverage factor such that a confidence level of approximately 95% is maintained. For the purposes of this document “approximately” is interpreted as meaning “effectively” or “for most practical purposes”.

Measurement Type	Confidence Level (%)	Calculated Uncertainty
AC Conducted Spurious Emissions	95%	±2.49 dB
Conducted Maximum Peak Output Power	95%	±0.59 dB
Radiated Spurious Emissions	95%	±3.10 dB
Band Edge Radiated Emissions	95%	±3.10 dB
Minimum 6 dB Bandwidth	95%	±0.87 %
Spectral Power Density	95%	±0.59 dB

The methods used to calculate the above uncertainties are in line with those recommended within the various measurement specifications. Where measurement specifications do not include guidelines for the evaluation of measurement uncertainty the published guidance of the appropriate accreditation body is followed.

7. Used equipment

Test site: SR 1/2

ID	Manufacturer	Type	Model	Serial No.	Calibration Date	Cal. Cycle
350	Rohde & Schwarz	Receiver, EMI Test	ESIB7	836697/014	7/13/2017	12
377	Bonn Elektronik	Amplifier, Low Noise Pre	BLMA 0118-1A	025294B	7/11/2017	12
423	Bonn Elektronik	Amplifier, Low Noise Pre	BLMA 1840-1A	055929	7/12/2017	12
460	Deisl	Turntable	DT 4250 S		n/a	n/a
465	Schwarzbeck	Antenna, Trilog Broadband	VULB 9168	9168-240	8/8/2016	36
496	Rohde & Schwarz	Antenna, log. - periodical	HL050	100297	7/20/2016	24
587	Maturo	antenna mast, tilting	TAM 4.0-E	011/7180311	n/a	n/a
588	Maturo	Controller	NCD	029/7180311	n/a	n/a
591	Rohde & Schwarz	Receiver	ESU 40	100244/040	7/12/2017	12
608	Rohde & Schwarz	Switch Matrix	OSP 120	101227	4/8/2014	60
614	Wainwright Instruments	Highpass Filter 3GHz	WHKX10-	1	Lab verification	n/a
615	Wainwright Instruments	Highpass Filter 1GHz	WHKX12-	3	Lab verification	n/a
620	Bonn Elektronik	pre-amplifier	BLNA 0110-01N	1510111	7/12/2017	24
628	Maturo	Antenna mast	CAM 4.0-P	224/19590716	n/a	n/a
629	Maturo	Kippeinrichtung	KE 2.5-R-M	MAT002	n/a	n/a

Test site: SR 9

ID	Manufacturer	Type	Model	Serial No.	Calibration Date	Cal. Cycle
424	EMCO	Antenna, Horn	EMCO 3116	00046537	7/28/2016	24
634	Rohde & Schwarz	Wireless Devices Test System	TS8997		7/11/2017	12
636	Rohde & Schwarz	switching unit	OSP120	101698	7/14/2017	12
637	Rohde & Schwarz	Spectrum Analyzer	FSV40	101587	7/11/2017	12
195	SPS	Power Supply	TOE8842-24	51455	Verified by Multimeter	12
216	Agilent	Multimeter	34401A	US36017458	7/11/2017	24

Test site: SR 7/8

ID	Manufacturer	Type	Model	Serial No.	Calibration Date	Cal. Cycle
22	Rohde & Schwarz	Artificial Mains	50 Ohm// 50uH	831767/014	7/12/2017	12
215	Rohde & Schwarz	Artificial Mains Network	9 kHz - 30 MHz; 3 phase	879675/002	7/12/2017	12
350	Rohde & Schwarz	Receiver, EMI Test	20 Hz - 7 GHz	836697/014	7/13/2017	12
616	Rohde & Schwarz	ISN	8 wire ISN for CAT6	101656	7/13/2017	12

8. Report Revision History

Version Number	Revision Details		
	Page No(s)	Clause	Details
1.0	-	-	Initial Version