



TEST REPORT

Test Report No. : UL-RPT-RP-12761134-216-FCC

Applicant : Casambi Technologies Oy
Model No. : CBU-A2D
FCC ID : 2ALA3-CBUA2D
Technology : Bluetooth – Low Energy
Test Standard(s) : FCC Parts 15.207, 15.209(a) & 15.247

For details of applied tests refer to test result summary

1. This test report shall not be reproduced in full or partial, without the written approval of UL International Germany GmbH.
2. The results in this report apply only to the sample tested.
3. The test results in this report are traceable to the national or international standards.
4. Test Report Version 1.1 supersedes Test Report Version 1.0
5. Result of the tested sample: **PASS**

Krume Ivanov

Prepared by: Krume, Ivanov
Title: Laboratory Engineer
Date: 13 June 2019

A. Phadtare

Approved by: Ajit, Phadtare
Title: Lead Test Engineer
Date: 13 June 2019



Deutsche
Akkreditierungsstelle
D-PL-19381-02-00

This laboratory is accredited by DAkkS.
The tests reported herein have been performed in
accordance with its' terms of accreditation.

UL INTERNATIONAL GERMANY GMBH

Hedelfinger Str. 61
70327 Stuttgart, Germany
STU.CTECHLab@ul.com

This page has been left intentionally blank.

Table of Contents

1. Customer Information.....	4
1.1.Applicant Information	4
1.2.Manufacturer Information	4
2. Summary of Testing.....	5
2.1. General Information	5
Applied Standards	5
Location	5
Date information	5
2.2. Summary of Test Results	6
2.3. Methods and Procedures	6
2.4. Deviations from the Test Specification	6
3. Equipment Under Test (EUT)	7
3.1. Identification of Equipment Under Test (EUT)	7
3.2. Description of EUT	7
3.3. Modifications Incorporated in the EUT	7
3.4. Additional Information Related to Testing	8
3.5. Support Equipment	8
A. Support Equipment (Manufacturer supplied)	8
4. Operation and Monitoring of the EUT during Testing	9
4.1. Operating Modes	9
4.2. Configuration and Peripherals	9
5. Measurements, Examinations and Derived Results	10
5.1. General Comments	10
5.2. Test Results	11
5.2.1. Transmitter AC Conducted Spurious Emissions	11
5.2.2. Transmitter Duty Cycle	17
5.2.3. Transmitter Minimum 6 dB Bandwidth	19
5.2.4. Transmitter Maximum Peak Output Power	21
5.2.5. Transmitter Radiated Emissions	25
5.2.6. Transmitter Band Edge Radiated Emissions	34
6. Measurement Uncertainty	38
7. Used equipment	39
8. Report Revision History	40

1. Customer Information

1.1.Applicant Information

Company Name:	Casambi Technologies Oy
Company Address:	Bertel Jungin aukio 1 E, Espoo, 02600 Finland
Contact Person:	Mr. Kai Toetterman
Contact E-Mail Address:	kai.totterman@casambi.com
Contact Phone No.:	+358 45 137 9988

1.2.Manufacturer Information

Company Name:	Casambi Technologies Oy
Company Address:	Bertel Jungin aukio 1 E, Espoo, 02600 Finland
Contact Person:	Mr. Kai Toetterman
Contact E-Mail Address:	kai.totterman@casambi.com
Contact Phone No.:	+358 45 137 9988

2. Summary of Testing

2.1. General Information

Applied Standards

Specification Reference:	47CFR15.247
Specification Title:	Code of Federal Regulations Volume 47 (Telecommunications): Part 15 Subpart C (Intentional Radiators) - Section 15.247
Specification Reference:	47CFR15.207 and 47CFR15.209
Specification Title:	Code of Federal Regulations Volume 47 (Telecommunications): Part 15 Subpart C (Intentional Radiators) - Sections 15.207 and 15.209
Test Firm Registration:	399704

Location

Location of Testing:	UL International Germany GmbH Hedelfinger Str. 61 70327 Stuttgart Germany
-----------------------------	--

Date information

Order Date:	07 March 2019
EUT arrived:	15 May 2019
Test Dates:	15 May 2019 to 28 May 2019
EUT returned:	-/-

2.2. Summary of Test Results

Clause	Measurement	Complied	Did not comply	Not performed	Not applicable
Part 15.207	Transmitter AC Conducted Emissions	<input checked="" type="checkbox"/>	<input type="checkbox"/>	<input type="checkbox"/>	<input type="checkbox"/>
Part 15.247(a)(2)	Transmitter Minimum 6 dB Bandwidth	<input checked="" type="checkbox"/>	<input type="checkbox"/>	<input type="checkbox"/>	<input type="checkbox"/>
Part 15.247(e)	Transmitter Power Spectral Density ⁽¹⁾	<input type="checkbox"/>	<input type="checkbox"/>	<input checked="" type="checkbox"/>	<input type="checkbox"/>
Part 15.247(b)(3)	Transmitter Maximum Peak Output Power	<input checked="" type="checkbox"/>	<input type="checkbox"/>	<input type="checkbox"/>	<input type="checkbox"/>
Part 15.247(d)	Transmitter Conducted Emissions	<input type="checkbox"/>	<input type="checkbox"/>	<input checked="" type="checkbox"/>	<input type="checkbox"/>
Part 15.247(d)/15.209(a)	Transmitter Radiated Emissions	<input checked="" type="checkbox"/>	<input type="checkbox"/>	<input type="checkbox"/>	<input type="checkbox"/>
Part 15.247(d)/15.209(a)	Transmitter Band Edge Radiated Emissions	<input checked="" type="checkbox"/>	<input type="checkbox"/>	<input type="checkbox"/>	<input type="checkbox"/>

Note(s):

- In accordance with KDB 558074 D01 section 8.4 referencing ANSI C63.10:2013, subclause 11.10.1, PSD is not required if the maximum conducted output power is less than the PSD limit of 8 dBm / 3 kHz. The PSD level is therefore deemed to be equal to the measured total output power.

2.3. Methods and Procedures

Reference:	ANSI C63.10-2013
Title:	American National Standard of Procedures for Compliance Testing of Unlicensed Wireless Devices
Reference:	KDB 558074 D01 DTS Meas Guidance v05r01 February 11, 2019
Title:	Guidance for Compliance Measurements on Digital Transmission System, Frequency Hopping Spread Spectrum System, and Hybrid System Devices Operating Under Section 15.247 of the FCC Rules
Reference:	KDB 174176 D01 Line Conducted FAQ v01r01 June 3, 2015
Title:	AC Power-Line Conducted Emissions Frequently Asked Questions

2.4. Deviations from the Test Specification

For the measurements contained within this test report, there were no deviations from, additions to, or exclusions from the test specification identified above.

3. Equipment Under Test (EUT)

3.1. Identification of Equipment Under Test (EUT)

Brand Name:	Casambi
Model Name or Number:	CBU-A2D
Test Sample Serial Number:	E7C2ABC2C1A3 (EUT for Radiated & AC Conducted Line Emissions)
Hardware Version Number:	V1.2
Software / Firmware Version Number:	26.1
FCC ID:	2ALA3-CBUA2D

Brand Name:	Casambi
Model Name or Number:	CBU-A2D
Test Sample Serial Number:	C1A124EED0DD (EUT for Duty Cycle test)
Hardware Version Number:	V1.2
Software/ Firmware Version Number:	26.1
FCC ID:	2ALA3-CBUA2D

3.2. Description of EUT

The equipment under test was a Bluetooth controllable 2ch 0-10V controller supporting Bluetooth Low Energy.

3.3. Modifications Incorporated in the EUT

No modifications were applied to the EUT during testing.

3.4. Additional Information Related to Testing

Technology Tested:	Bluetooth Low Energy (Digital Transmission System)		
Type of Unit:	Transceiver		
Channel Spacing:	2 MHz		
Modulation:	GFSK		
Data Rate:	1 Mbps		
Power Supply Requirement(s):	Nominal	85-277 VAC 25 mA	
Maximum measured Conducted Output Power:	-4.79 dBm		
Maximum Antenna Gain:	2.0 dBi		
Antenna Type:	Monopole antenna (PCB trace antenna)		
Antenna Details:	Antenna length 26.5 mm		
Transmit Frequency Range:	2402 MHz to 2480 MHz		
Transmit Channels Tested:	Channel ID	RF Channel	Channel Frequency (MHz)
	Bottom	0	2402
	Middle	19	2440
	Top	39	2480

3.5. Support Equipment**A. Support Equipment (Manufacturer supplied)**

Item	Description	Brand Name	Model Name or Number	Serial Number
1	2 x Power resistors	TE Connectivity	THS10 Metal clad resistor	Not stated
2	MP3 player	Apple	iPod Touch	CCQSCOZMGGK6

4. Operation and Monitoring of the EUT during Testing

4.1. Operating Modes

The EUT was tested in the following operating mode(s):

Transmitting at maximum power in Bluetooth LE mode with modulation, maximum possible data length available and Pseudorandom Bit Sequence 9.

4.2. Configuration and Peripherals

The EUT was tested in the following configuration(s):

- The EUT was powered using a 120 VAC power supply.
- Controlled in test mode using a software application "Casambi Utility" installed on the MP3 player supplied by the customer. The application was used to enable a continuous transmission and to select the test channels as required.
- For Transmit tests: A MP3 player with the above mentioned software application was used to place the EUT into *Bluetooth* mode.
- The EUT conducted sample was used for transmitter duty cycle measurements.
- The EUT radiated sample was used for AC conducted line emissions, radiated emissions, radiated band edge measurements, 6 dB bandwidth and maximum peak output power measurements.
- The EUT radiated sample was made to transmit continuously with a duty cycle of more than 98 % delay between packets of 5 μ s. Therefore no duty cycle corrections are required for radiated emissions measured with Average detector.
- EMC32 V10.1.0 Software was used for the Radiated spurious emission measurement.
- For AC Conducted line emissions tests were performed with the EUT was powered by 120 VAC & 240 V AC mains & two loads were connected to EUT to draw Max Current.

5. Measurements, Examinations and Derived Results

5.1. General Comments

Measurement uncertainties are evaluated in accordance with current best practice. Our reported expanded uncertainties are based on standard uncertainties, which are multiplied by an appropriate coverage factor to provide a statistical confidence level of approximately 95%. Please refer to Section 6 *Measurement Uncertainty* for details.

In accordance with DAkkS requirements all the measurement equipment is on a calibration schedule. All equipment was within the calibration period on the date of testing.

5.2. Test Results

5.2.1. Transmitter AC Conducted Spurious Emissions

Test Summary:

Test Engineer:	M. Asim Shahzad	Test Date:	16 May 2019
Test Sample Serial Number:	E7C2ABC2C1A3		
Test Site Identification	SR 7/8		

Clause:	Part 15.207
Test Method:	ANSI C63.10 Section 6.2 / FCC KDB 174176 and notes below

Environmental Conditions:

Temperature (°C):	20
Relative Humidity (%):	33

Settings of the Instrument

Detector	Quasi Peak/ Average Peak
----------	--------------------------

Note(s):

Transmitter AC Conducted Spurious Emissions (120 VAC 60 Hz)

- In accordance with FCC KDB 174176 Q4, tests were performed with a 120 VAC 60 Hz single phase supply .
- The EUT was connected to a 120 VAC 60 Hz single phase supply via a LISN & two loads were connected to EUT to draw Max Current.
- The final measured value, for the given emission, in the table below incorporates the cable loss.
- All other emissions shown on the pre-scan plot were investigated and found to be ambient or >20 dB below the applicable limit or below the measurement system noise floor.
- Measurements were performed in shielded room (SR7/ 8 Asset Number 1603671). The EUT was placed at a height of 80 cm above the reference ground plane and in a distance of 40 cm from the vertical ground plane at the edge of the table.
- The device was configured to the test mode with a test program installed on the iPod provided by the customer.

Transmitter AC Conducted Spurious Emissions (240 VAC 60 Hz)

- In accordance with FCC KDB 174176 Q4, tests were performed with a 240 VAC 60 Hz single phase supply .
- The EUT was connected to a 240 VAC 60 Hz single phase supply via a LISN & two loads were connected to EUT to draw Max Current.
- The final measured value, for the given emission, in the table below incorporates the cable loss.
- All other emissions shown on the pre-scan plot were investigated and found to be ambient or >20 dB below the applicable limit or below the measurement system noise floor.
- Measurements were performed in shielded room (SR7/ 8 Asset Number 1603671). The EUT was placed at a height of 80 cm above the reference ground plane and in a distance of 40 cm from the vertical ground plane at the edge of the table.
- The device was configured to the test mode with a test program installed on the iPod provided by the customer.

Transmitter AC Conducted Spurious Emissions (continued)

Test setup:

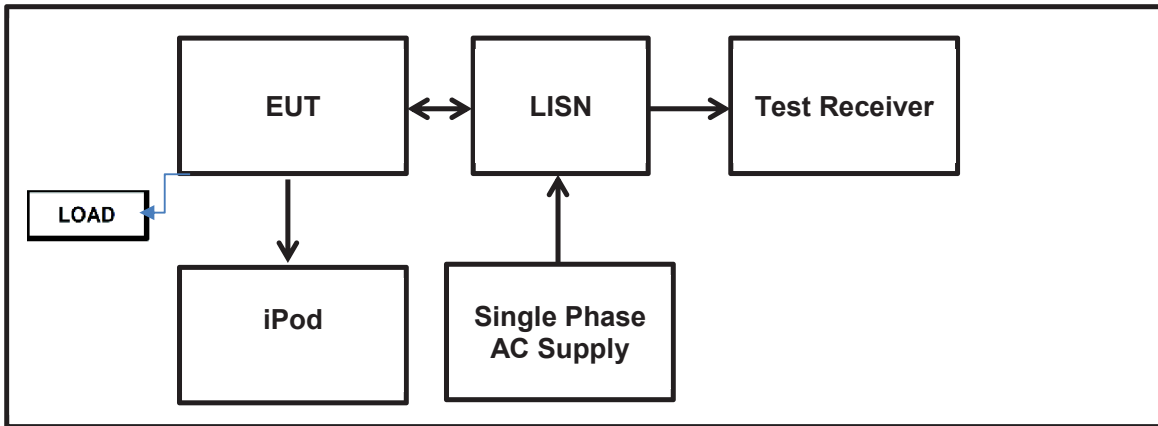

Results: 120 VAC 60 Hz / Live / Quasi Peak

Frequency (MHz)	Line	Level (dB μ V)	Limit (dB μ V)	Margin (dB)	Result
0.15200	Live	45.7	65.9	20.2	Complied
0.26673	Live	42.4	61.2	18.8	Complied
0.40100	Live	30.7	57.8	27.1	Complied
0.68557	Live	36.9	56	19.1	Complied
0.95731	Live	34.3	56	21.7	Complied
1.50621	Live	31.9	56	24.1	Complied

Results: 120 VAC 60 Hz / Live / Average

Frequency (MHz)	Line	Level (dB μ V)	Limit (dB μ V)	Margin (dB)	Result
0.15200	Live	31.1	55.9	24.8	Complied
0.26673	Live	31.9	51.2	19.3	Complied
0.40100	Live	27.2	47.8	20.6	Complied
0.68557	Live	30.5	46	15.5	Complied
0.95731	Live	26.1	46	19.9	Complied
1.50621	Live	22.7	46	23.3	Complied

Results: 120 VAC 60 Hz / Neutral / Quasi Peak

Frequency (MHz)	Line	Level (dB μ V)	Limit (dB μ V)	Margin (dB)	Result
0.15351	Neutral	43.1	65.8	22.7	Complied
0.26723	Neutral	42.3	61.2	18.9	Complied
0.40301	Neutral	28.5	57.8	29.3	Complied
0.68657	Neutral	35.3	56	20.7	Complied
0.93747	Neutral	32.3	56	23.7	Complied
1.36513	Neutral	29.9	56	26.1	Complied

Results: 120 VAC 60 Hz / Neutral / Average

Frequency (MHz)	Line	Level (dB μ V)	Limit (dB μ V)	Margin (dB)	Result
0.15351	Neutral	28.9	55.8	26.9	Complied
0.26723	Neutral	31.2	51.2	20	Complied
0.40301	Neutral	26.3	47.8	21.5	Complied
0.68657	Neutral	28.8	46	17.2	Complied
0.93747	Neutral	25.6	46	20.4	Complied
1.36513	Neutral	21.7	46	24.3	Complied

Result: Pass

Plot: 120 VAC 60 Hz / Live and Neutral Line

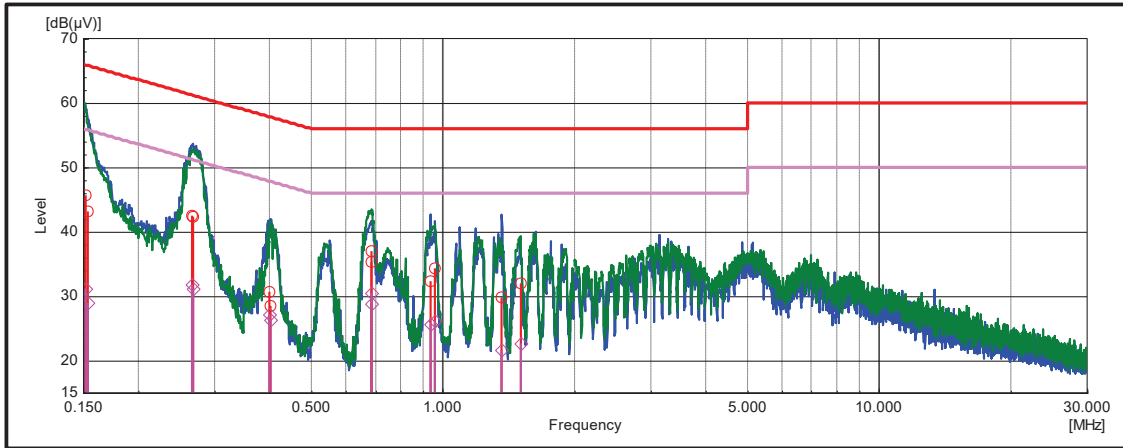

Note: These plots are pre-scans and for indication purposes only. For final measurements, see accompanying tables.

Results: 240 VAC 60 Hz / Live / Quasi Peak

Frequency (MHz)	Line	Level (dB μ V)	Limit (dB μ V)	Margin (dB)	Result
0.15752	Live	38.1	65.6	27.5	Complied
0.27475	Live	40.7	61	20.3	Complied
0.40501	Live	37.1	57.8	20.7	Complied
0.65852	Live	37.3	56	18.7	Complied
0.80681	Live	37.9	56	18.1	Complied
1.33206	Live	38.8	56	17.2	Complied

Results: 240 VAC 60 Hz / Live / Average

Frequency (MHz)	Line	Level (dB μ V)	Limit (dB μ V)	Margin (dB)	Result
0.15752	Live	22.8	55.6	32.8	Complied
0.27475	Live	30.4	51	20.6	Complied
0.40501	Live	33.5	47.8	14.3	Complied
0.65852	Live	28.5	46	17.5	Complied
0.80681	Live	32.5	46	13.5	Complied
1.33206	Live	29.4	46	16.6	Complied

Results: 240 VAC 60 Hz / Neutral / Quasi Peak

Frequency (MHz)	Line	Level (dB μ V)	Limit (dB μ V)	Margin (dB)	Result
0.15200	Neutral	45.7	65.9	20.2	Complied
0.27375	Neutral	41.3	61	19.7	Complied
0.39649	Neutral	35.0	57.9	22.9	Complied
0.68657	Neutral	34.6	56	21.4	Complied
0.81283	Neutral	35.8	56	20.2	Complied
1.36513	Neutral	37.4	56	18.6	Complied

Results: 240 VAC 60 Hz / Neutral / Average

Frequency (MHz)	Line	Level (dB μ V)	Limit (dB μ V)	Margin (dB)	Result
0.15200	Neutral	27.6	55.9	28.3	Complied
0.27375	Neutral	29.3	51	21.7	Complied
0.39649	Neutral	30.0	47.9	17.9	Complied
0.68657	Neutral	27.8	46	18.2	Complied
0.81283	Neutral	30.6	46	15.4	Complied
1.36513	Neutral	29.2	46	16.8	Complied

Result: Pass

Plot: 240 VAC 60 Hz / Live and Neutral Line

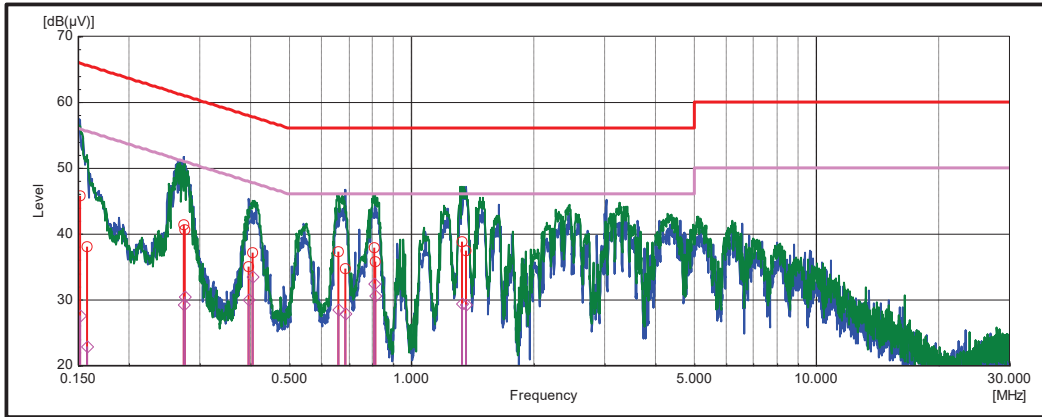

Note: These plots are pre-scans and for indication purposes only. For final measurements, see accompanying tables.

5.2.2. Transmitter Duty Cycle

Test Summary:

Test Engineer:	Krume Ivanov	Test Date:	15 May 2019
Test Sample Serial Number:	C1A124EED0DD		
Test Site Identification	SR 9		

FCC Reference:	Part 15.35(c)
Test Method Used:	FCC KDB 558074 Section 6.0

Environmental Conditions:

Temperature (°C):	24
Relative Humidity (%):	44

Note(s):

The transmitter duty cycle was measured using a spectrum analyser in the time domain and calculated by using the following calculation:

$$10 \log (1 / (\text{On Time} / [\text{Period or } 100 \text{ ms whichever is the lesser}])).$$

$$\text{BLE duty cycle: } 10 \log (1 / (774.93 \mu\text{s} / 908.26 \text{ ms})) = 0.69 \text{ dB}$$

Test setup:

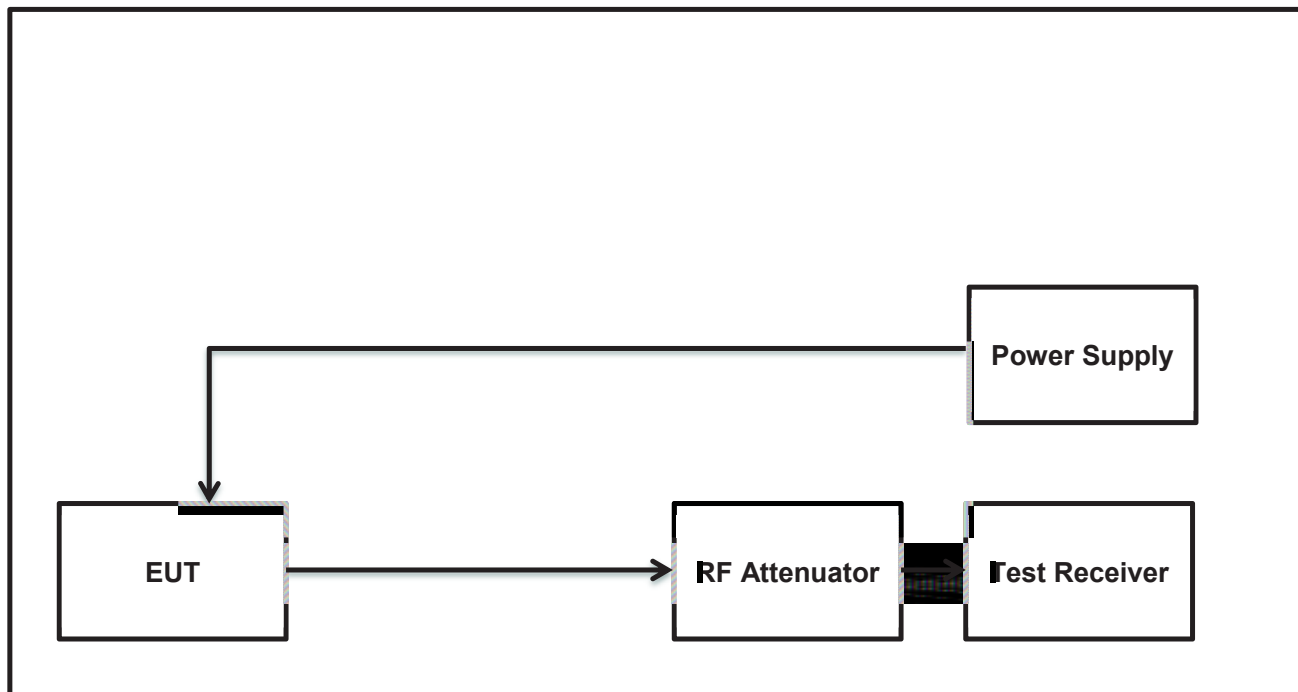

Transmitter Duty Cycle continued

Results:

Pulse Duration (µs)	Period (µs)	Duty Cycle Correction (dB)
774.93	908.26	0.69

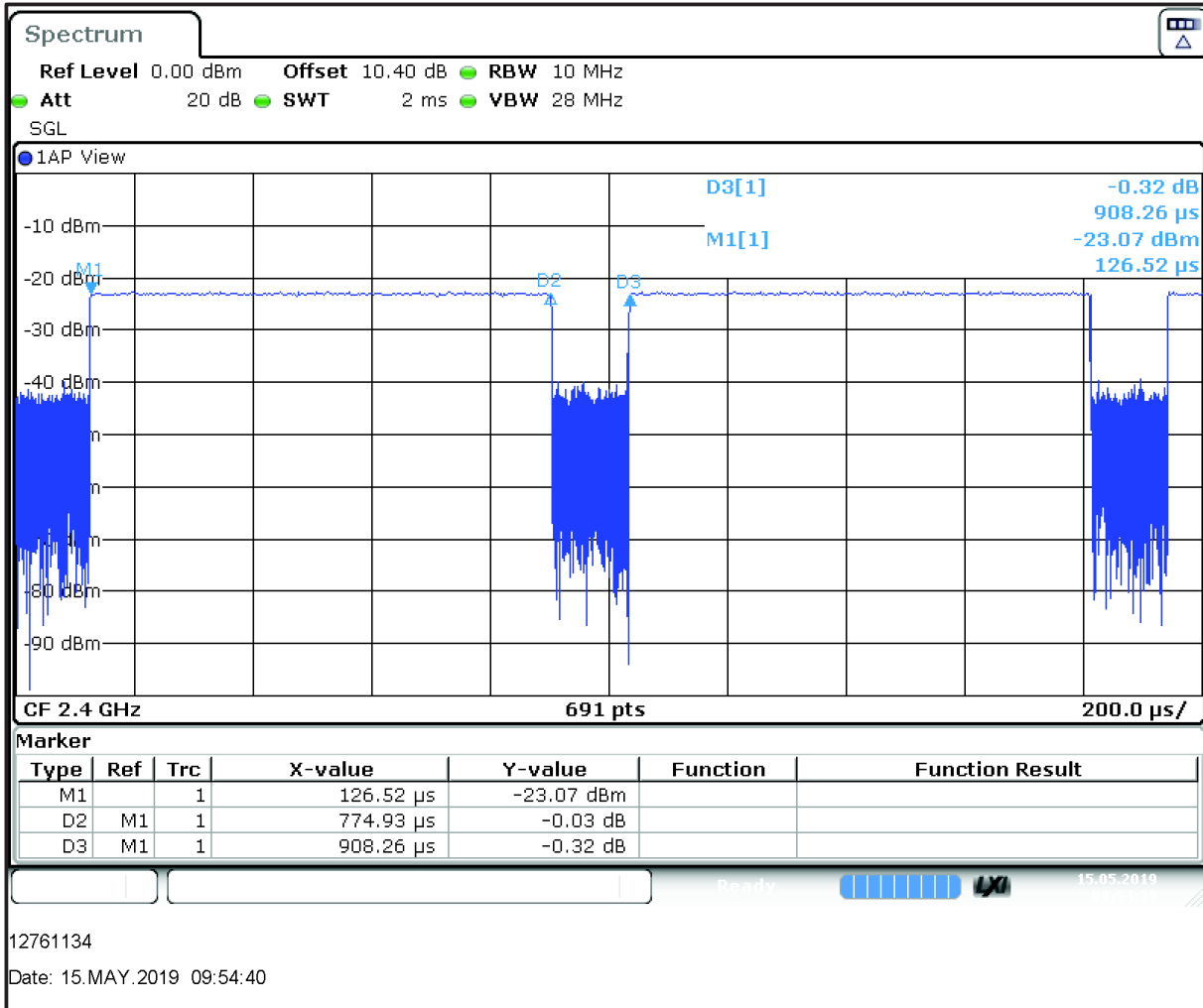

5.2.3. Transmitter Minimum 6 dB Bandwidth

Test Summary:

Test Engineer:	Krume Ivanov	Test Date:	20 May 2019
Test Sample Serial Number:	E7C2ABC2C1A3		
Test Site Identification	SR 1/2		

FCC Reference:	Part 15.247(a)(2)
Test Method Used:	FCC KDB 558074 Section 8.2 referring ANSI C63.10:2013 Section 11.8.1 Option 1

Environmental Conditions:

Temperature (°C):	23
Relative Humidity (%):	40

Note(s):

1. 6 dB DTS bandwidth tests were performed using a spectrum analyser in accordance with FCC KDB 558074 Section 8.2 referring ANSI C63.10:2013 Section 11.8.1 Option 1 measurement procedure. The spectrum analyser resolution bandwidth was set to 100 kHz and video bandwidth 300 kHz. A peak detector was used, sweep time was set to auto and the trace mode was Max Hold. The DTS bandwidth was measured at 6 dB down from the peak of the signal.
2. 6 dB DTS bandwidth tests were performed radiated. The measured values takes into consideration the external attenuation correction factors.

Test Setup:

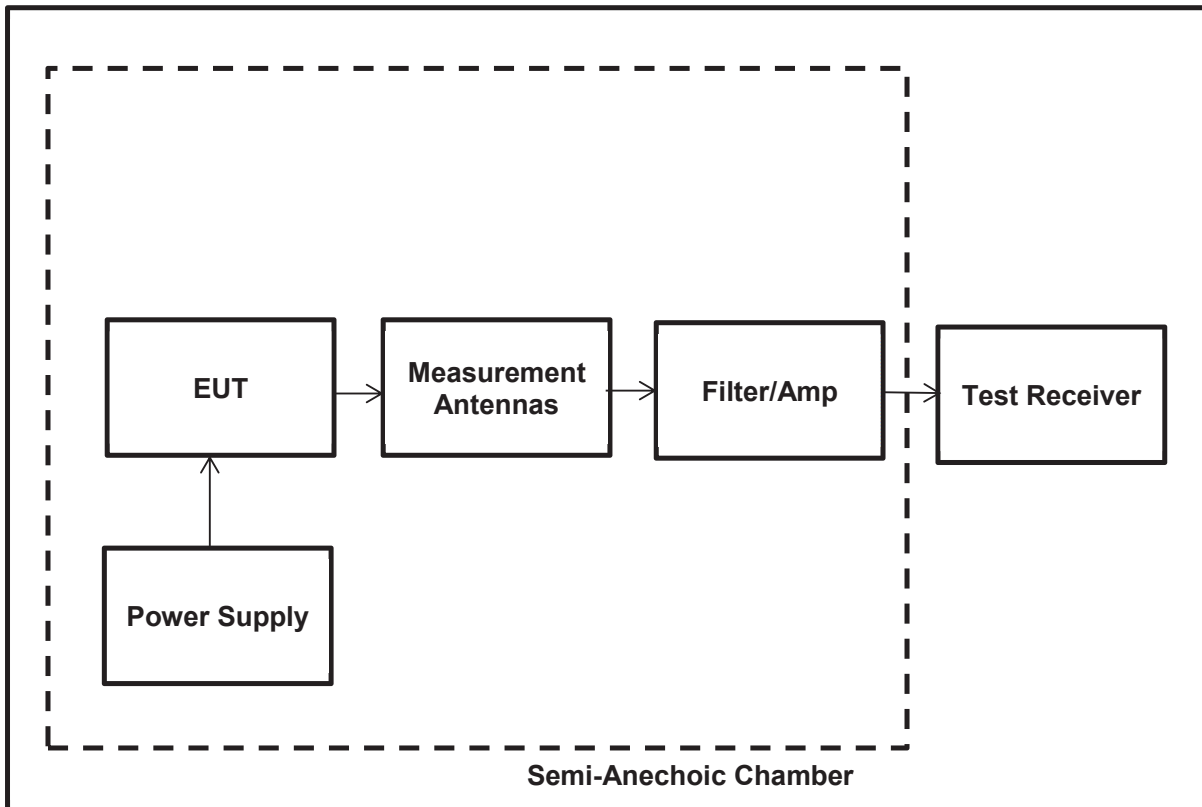

Results:

Channel	6 dB Bandwidth (kHz)	Limit (kHz)	Margin (kHz)	Result
Bottom	735.576	≥500	235.576	Complied
Middle	759.615	≥500	259.615	Complied
Top	769.230	≥500	269.230	Complied



Bottom Channel

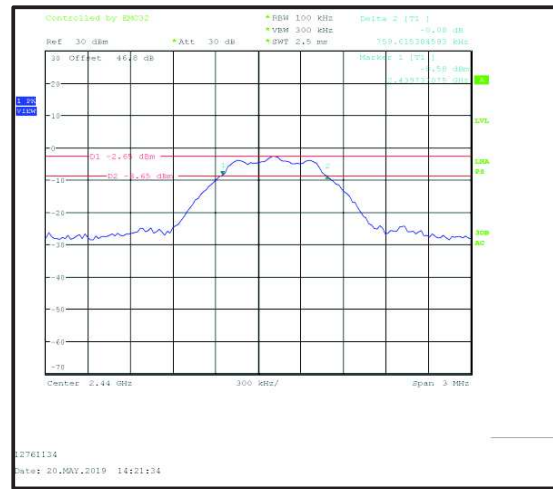

Middle Channel

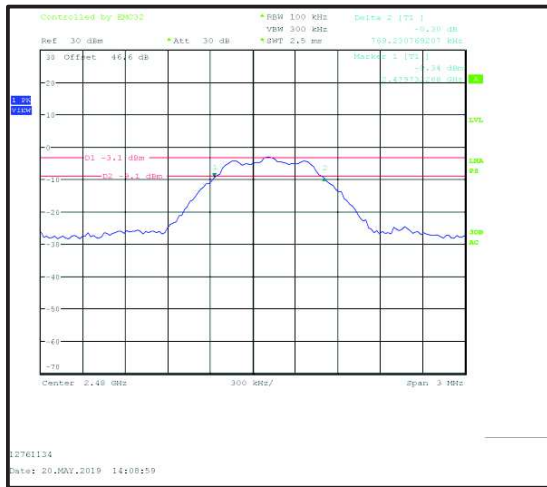

Top Channel

Result: **Pass**

5.2.4. Transmitter Maximum Peak Output Power**Test Summary:**

Test Engineer:	Krume Ivanov	Test Date:	28 May 2019
Test Sample Serial Number:	E7C2ABC2C1A3		
Test Site Identification	SR 1/2		

FCC Reference:	Part 15.247(b)(3)
Test Method Used:	FCC KDB 558074 Section 8.3.1.1 referring ANSI C63.10 Section 11.9.1.1 FCC KDB 558074 Section 3

Environmental Conditions:

Temperature (°C):	23
Relative Humidity (%):	33

Note(s):

- Radiated power tests were performed using a spectrum analyser in accordance with FCC KDB 558074 Section 8.3.1.1 referring ANSI C63.10 Section 11.9.1.1 with the $RBW \geq DTS \text{ bandwidth}$ procedure. A resolution bandwidth of 1 MHz was used and the video bandwidth was set to 3 MHz.
- The signal analyser resolution bandwidth was set to 3 MHz and video bandwidth of 10 MHz. A peak detector was used, sweep time was set to auto and trace mode was Max Hold. The span was set to 10 MHz. A marker was placed at the peak of the signal and the results recorded in the table below.
- The measured values takes into consideration the external attenuation correction factors.
- The measurement was made with highest possible duty cycle.
- The measured field strength values in $\text{dB}\mu\text{V}/\text{m}$ @ 3m were converted to equivalent EIRP power values in dBm by subtracting 95.2; in accordance with FCC KDB 558074 Section 3 & ANSI C63.10:2013, Annex G.2.
- Following formula (Working in dB units,) was used

$$\text{EIRP}[\text{dBm}] = \text{E}[\text{dB}\mu\text{V}/\text{m}] + 20\log(d [\text{m}]) - 104.77$$
 at $d=3 \text{ m}$

$$\text{EIRP}[\text{dBm}] = \text{E}[\text{dB}\mu\text{V}/\text{m}] - 95.2$$
 Where, E: field strength | d: measurement distance | EIRP: equivalent isotropically radiated power
- The declared antenna gain in dBi was then subtracted from EIRP power values in dBm to obtain the equivalent conducted power values in dBm.

Test Setup:

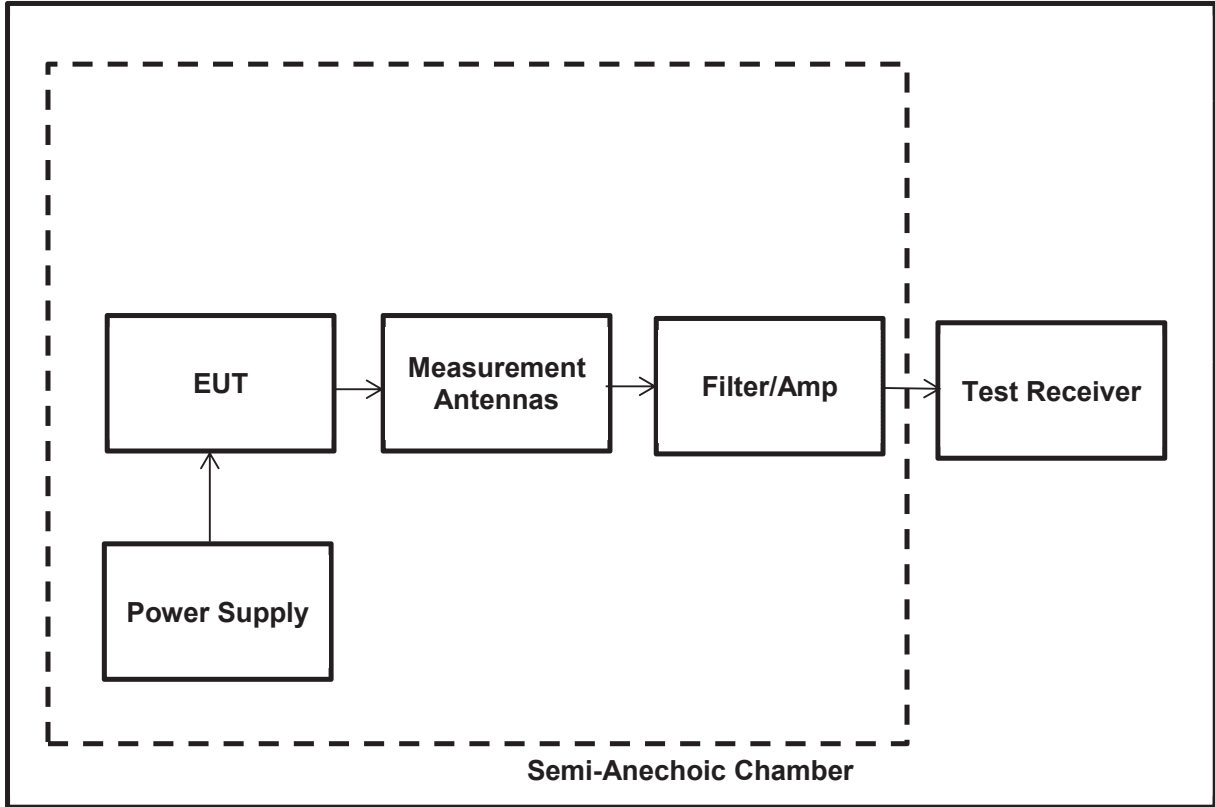

Transmitter Maximum Peak Output Power (continued)**Results:**

Channel	Radiated Field Strength @3m (dB μ V/m)	dB μ V/m to dBm Conversion factor@3m	EIRP (dBm)	De Facto EIRP Limit (dBm)	Margin (dB)	Result
Bottom	92.41	-95.2	-2.79	36.0	38.79	Complied
Middle	88.57	-95.2	-6.93	36.0	42.93	Complied
Top	83.37	-95.2	-11.83	36.0	47.83	Complied

Channel	EIRP (dBm)	Declared Antenna Gain (dBi)	Conducted Power (dBm)	Conducted Peak Power Limit (dBm)	Margin (dB)	Result
Bottom	-2.79	2.0	-4.79	30.0	34.79	Complied
Middle	-6.93	2.0	-8.93	30.0	38.93	Complied
Top	-11.83	2.0	-13.83	30.0	43.83	Complied

Result: Pass

Transmitter Maximum Peak Output Power (continued)

Results:



Bottom Channel

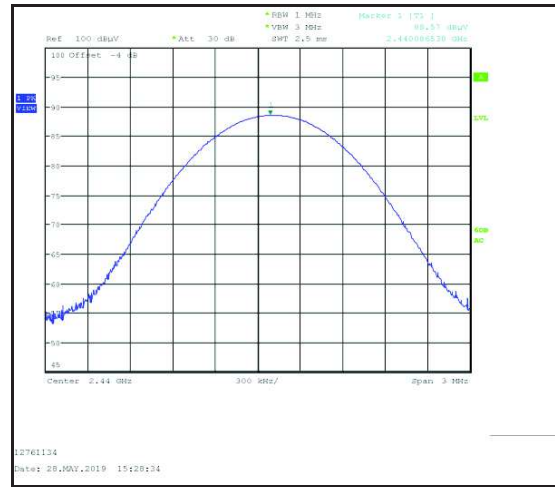

Middle Channel

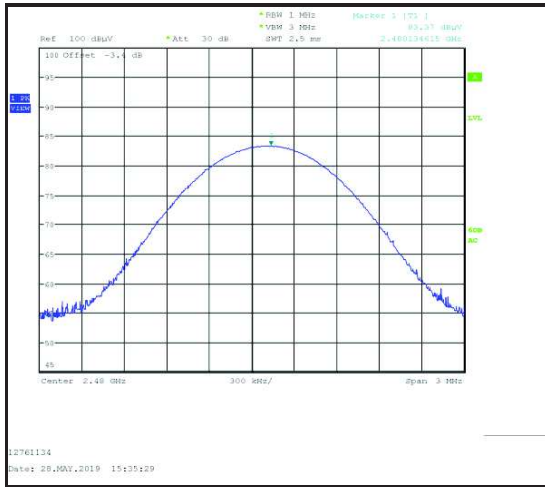

Top Channel

Result: **Pass**

5.2.5. Transmitter Radiated Emissions**Test Summary:**

Test Engineer:	Krume Ivanov	Test Date:	16 May 2019
Test Sample Serial Number:	E7C2ABC2C1A3		
Test Site Identification	SR 1/2		

FCC Reference:	Parts 15.247(d) & 15.209(a)
Test Method Used:	FCC KDB 558074 Sections 8.5 & 8.6 referring ANSI C63.10 Sections 11.10 and 11.12 ANSI C63.10:2013 Sections 6.3 and 6.5
Frequency Range	30 MHz to 1000 MHz

Environmental Conditions:

Temperature (°C):	23
Relative Humidity (%):	32

Notes:

1. The final measured value, for the given emission, in the table below incorporates the calibrated antenna factor and cable loss.
2. The preliminary scans showed similar emission levels below 1 GHz, for each channel of operation. Therefore final radiated emissions measurements were performed with the EUT set to the top channel only.
3. All emissions shown on the pre-scans were investigated and found to be ambient, or > 20 dB below the appropriate limit or below the noise floor of the measurement system. Therefore the highest peak noise floor reading of the measuring receiver was recorded in the table below.
4. All other emissions shown on the pre-scan plots were investigated and found to be ambient, or >20 dB below the applicable limit or below the measurement system noise floor and therefore not recorded.
5. No spurious emissions were detected above the noise floor of the measuring receiver therefore the highest peak noise floor reading of the measuring receiver was recorded as shown in the table below.
6. Measurements below 1 GHz were performed in a semi-anechoic chamber (Asset Number K0001) at a distance of 3 metres. The EUT was placed at a height of 80 cm above the reference ground plane in the centre of the chamber turntable. Maximum emission levels were determined by height searching the measurement antenna over the range 1 metre to 4 metres.
7. Pre-scans were performed and markers placed on the highest measured levels. The test receiver resolution bandwidth was set to 100 kHz and video bandwidth 300 kHz. A peak detector was used, sweep time was set to auto and trace mode was Max Hold.
8. Final measurements were performed on the marker frequencies and the results entered into the table below. The test receiver resolution bandwidth was set to 120 kHz, using a CISPR quasi-peak detector and span big enough to see the whole emission.
9. The EUT was transmitting with 100% duty cycle therefore no duty cycle correction was required.

Test Setup:

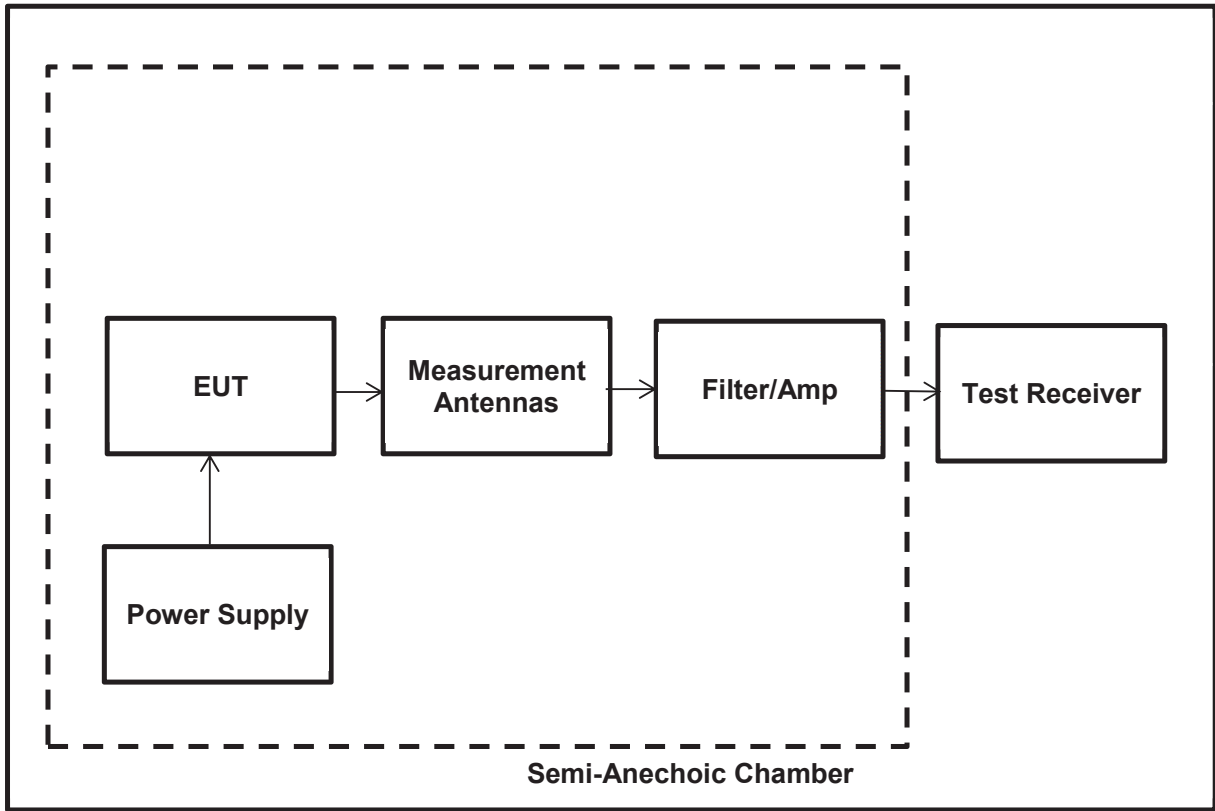

Results: Top Channel

Frequency (MHz)	Antenna Polarization	Level (dB μ V/m)	Limit (dB μ V/m)	Margin (dB)	Result
47.865	Vertical	14.96	40.00	25.04	Complied
147.765	Vertical	20.40	43.50	23.10	Complied
959.750	Horizontal	31.37	46.00	14.63	Complied

Plot: 30 MHz – 1GHz (Top Channel)

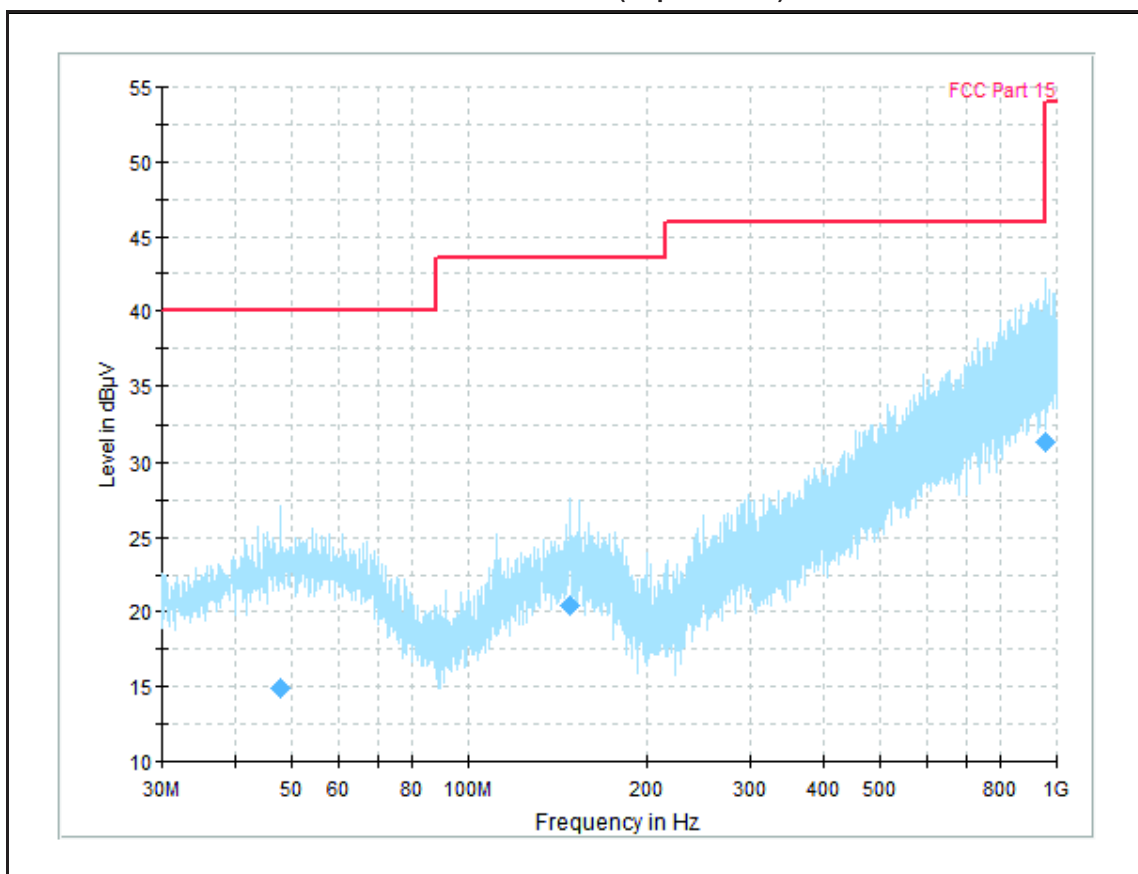

Note: This plot is a pre-scan and for indication purposes only. For final measurements, see accompanying table.

Result: Pass

Test Summary:

Test Engineer:	Krume Ivanov	Test Date:	15 May 2019 20 May 2019
Test Sample Serial Number:	E7C2ABC2C1A3		
Test Site Identification	SR 1/2		

FCC Reference:	Parts 15.247(d) & 15.209(a)
Test Method Used:	FCC KDB 558074 Sections 8.5 & 8.6 referring ANSI C63.10 Sections 11.10 and 11.12 ANSI C63.10:2013 Sections 6.3 and 6.6
Frequency Range	1 GHz to 25 GHz

Environmental Conditions:

Temperature (°C):	23 & 23
Relative Humidity (%):	31 & 40

Note(s):

- The final measured value, for the given emission, in the table below incorporates the calibrated antenna factor and cable loss.
- All other emissions shown on the pre-scan plot were investigated and found to be ambient or below the measurement system noise floor.
- No spurious emissions were detected above the noise floor of the measuring receiver therefore the highest peak noise floor reading of the measuring receiver was recorded as shown in the table above. The peak level was compared to the average limit as opposed to being compared to the peak limit because this is the more onerous limit.
- The emission shown on the 1 GHz to 4 GHz plot is the EUT fundamental.
- Pre-scans above 1 GHz were performed in a fully anechoic chamber (Asset Number K0002) at a distance of 3 metres. The EUT was placed at a height of 1.5 metres above the test chamber floor in the centre of the chamber turntable. All measurement antennas were placed at a fixed height of 1.5 metres above the test chamber floor, in line with the EUT. Final measurements above 1 GHz were performed in a semi-anechoic chamber (Asset Number K0001) at a distance of 3 metres. The EUT was placed at a height of 1.5 m above the reference ground plane in the centre of the chamber turntable. Maximum emission levels were determined by height searching the measurement antenna over the range 1 metre to 4 metres.
- Pre-scans were performed and a marker placed on the highest measured level of the appropriate plot. The test receiver resolution bandwidth was set to 1 MHz and video bandwidth 3 MHz. The sweep time was set to auto.
- *In accordance with ANSI C63.10 Section 6.6.4.3, Note 1, if the peak measured value complies with the average limit, it is unnecessary to perform an average measurement.
- The reference level for the emission in the non-restricted band was established by following KDB 558074 Section 8.5 referring Section 11.11 of ANSI C63.10 procedure 11.2 procedure.
- ** -20 dBc limit applies in non-restricted band as the conducted output power measurements were performed using a peak detector.
- The preliminary scans showed similar emission levels above 18 GHz, for each channel of operation. Therefore final radiated emissions measurements were performed with the EUT set to the top channel only.
- The EUT was transmitting with 100% duty cycle therefore no duty cycle correction was required.

Transmitter Radiated Emissions (continued)**Results: Peak / Bottom Channel**

Frequency (MHz)	Antenna Polarization	Level (dB μ V/m)	Average Limit (dB μ V/m)	Margin (dB)	Result
No spurious was found					

Results: Peak / Middle Channel

Frequency (MHz)	Antenna Polarization	Level (dB μ V/m)	Average Limit (dB μ V/m)	Margin (dB)	Result
No spurious was found					

Results: Peak / Top Channel

Frequency (MHz)	Antenna Polarization	Level (dB μ V/m)	Average Limit (dB μ V/m)	Margin (dB)	Result
No spurious was found					

Result: Pass

Transmitter Radiated Emissions (continued)

Plot: 1 GHz – 18GHz (Bottom Channel) with Peak detector

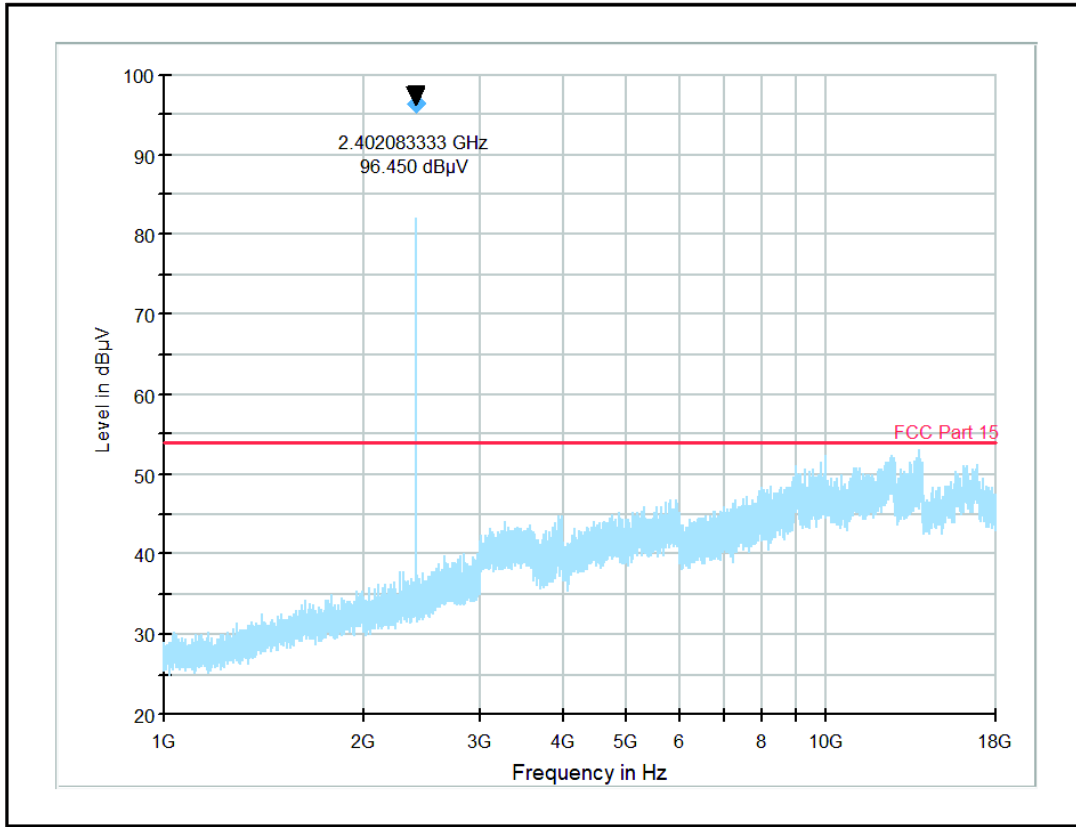

Note: The above plot is a pre-scan and for indication purposes only. For final measurements, see accompanying tables.

Plot: 1 GHz – 18GHz (Middle Channel) with Peak detector

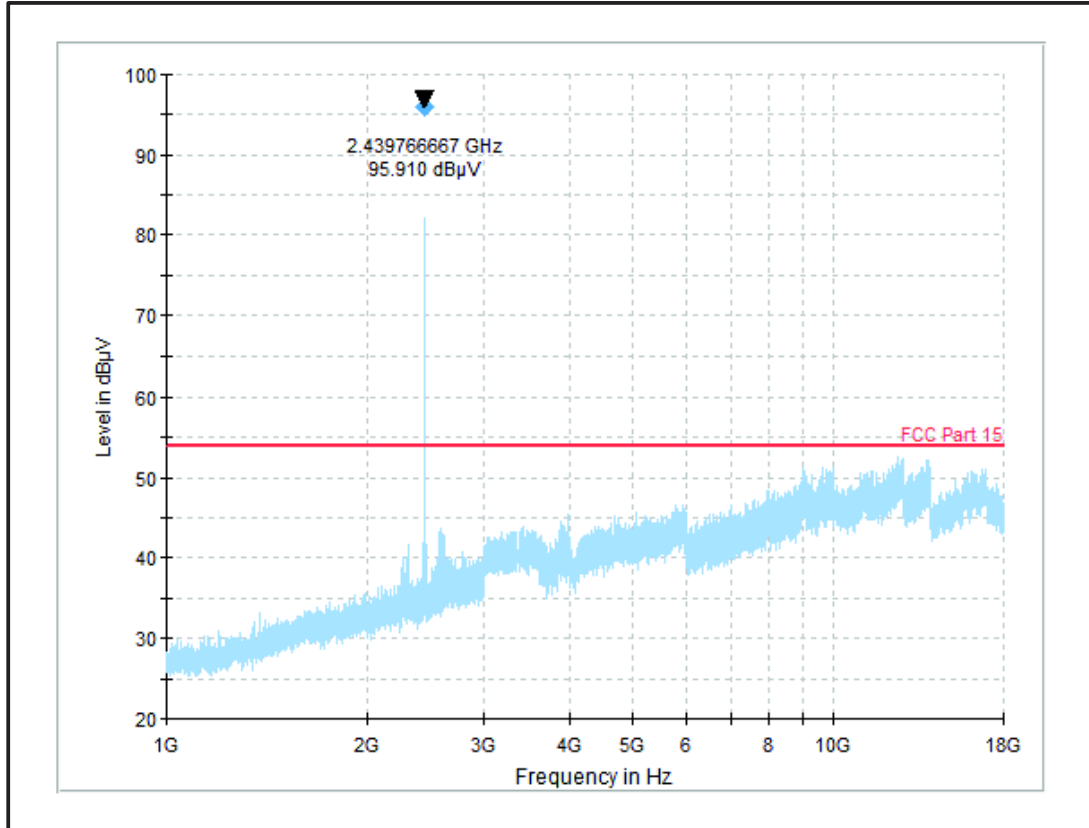

Note: The above plot is a pre-scan and for indication purposes only. For final measurements, see accompanying tables.

Transmitter Radiated Emissions (continued)

Plot: 1 GHz – 18GHz (Top Channel) with Peak detector

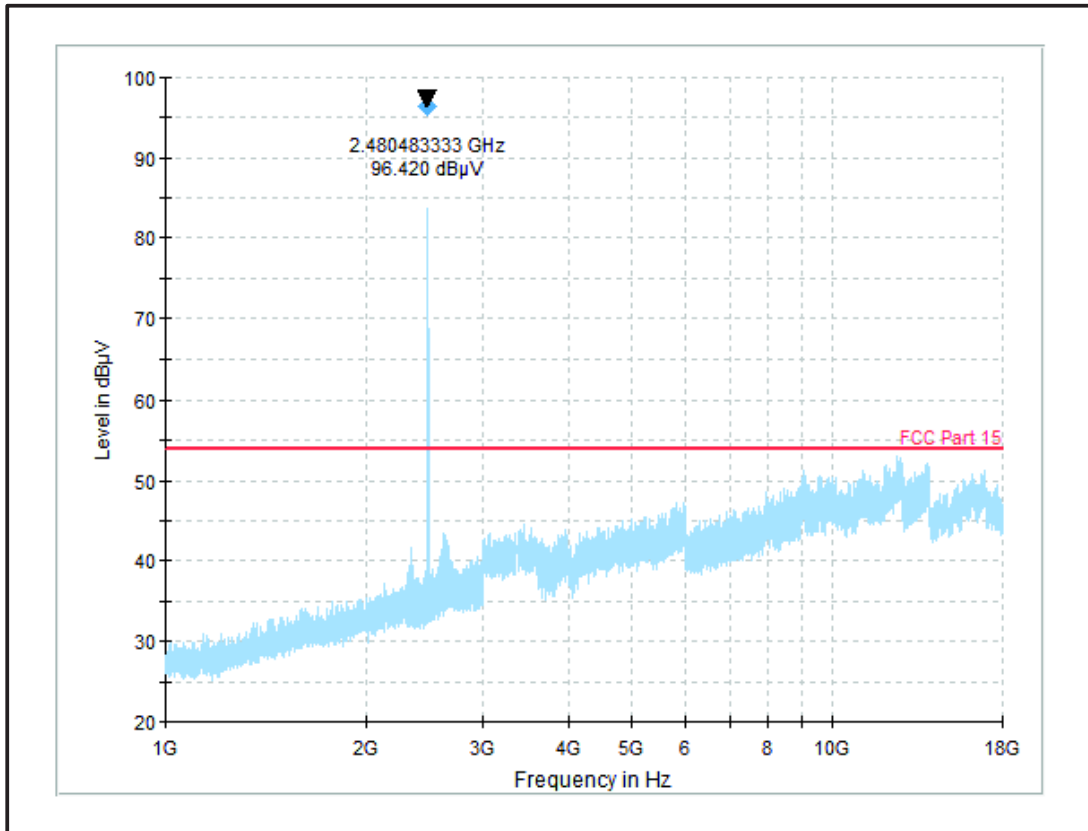

Note: The above plot is a pre-scan and for indication purposes only. For final measurements, see accompanying tables.

Transmitter Radiated Emissions (continued)

Results: Peak / Top Channel

Frequency (MHz)	Antenna Polarization	Peak Level (dBµV/m)	Average Limit (dBµV/m)	Margin (dB)	Result
No critical spurious was found					

Plot: 18 GHz – 25GHz (Top Channel) with Peak detector

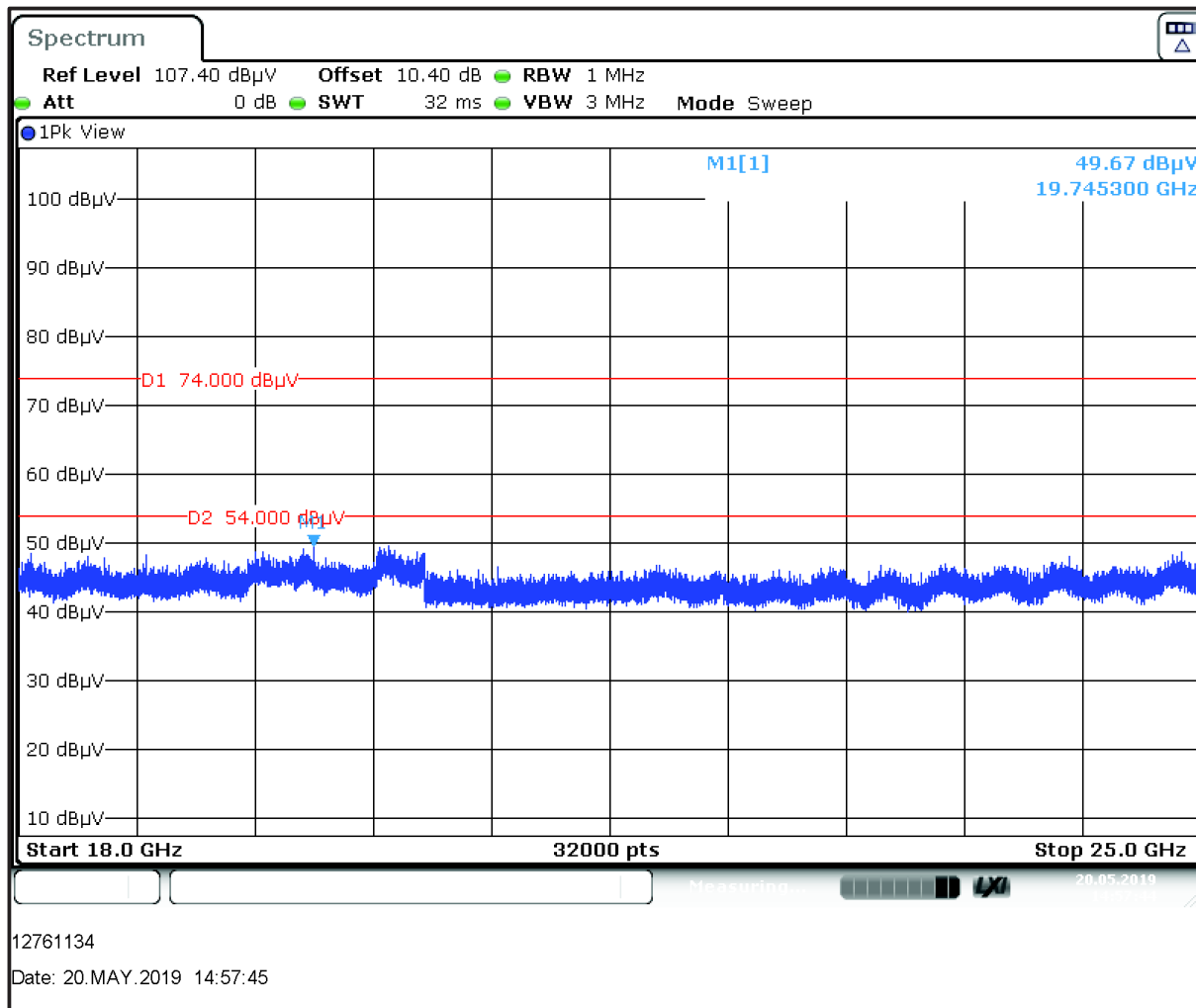

12761134
Date: 20.MAY.2019 14:57:45

Note: The above plots are pre-scans and for indication purposes only. For final measurements, see accompanying tables.

5.2.6. Transmitter Band Edge Radiated Emissions**Test Summary:**

Test Engineer:	Krume Ivanov	Test Date:	15 May 2019
Test Sample Serial Number:	E7C2ABC2C1A3		
Test Site Identification	SR 1/2		

FCC Reference:	Parts 15.247(d) & 15.209(a)
Test Method Used:	FCC KDB 558074 Sections 8.7 referring ANSI C63.10:2013 Section 6.10.4, 6.10.5 & Section 11.11

Environmental Conditions:

Temperature (°C):	23
Relative Humidity (%):	31

Notes:

1. The final measured value, for the given emission, in the table below incorporates the calibrated antenna factor and cable loss.
2. The maximum peak conducted output power was previously measured. In accordance with FCC KDB 558074 Section 8.7 lower band edge measurement was performed with a peak detector and the -20 dBc limit applied.
3. As the lower band edge falls within a non-restricted band, only peak measurements are required. The test receiver resolution bandwidth was set to 100 kHz and video bandwidth 300 kHz. A peak detector was used, sweep time was set to auto and trace mode was Max Hold. The test receiver was left to sweep for a sufficient length of time in order to maximise the carrier level and out-of-band emissions. A marker and corresponding reference level line were placed on the peak of the carrier. Marker frequencies and levels were recorded.
4. As the upper band edge falls within a restricted band both peak and average measurements were recorded by placing a marker at the edge of the band. For peak measurements the test receiver resolution bandwidth was set to 1 MHz and the video bandwidth 3 MHz. A peak detector was used, sweep time was set to auto and trace mode was Max Hold. For average measurements the test receiver resolution bandwidth was set to 1 MHz and the video bandwidth 10 Hz. A peak detector was used, sweep time was set to auto and trace mode was Max Hold. The test receiver was left to sweep for a sufficient length of time in order to maximise the carrier level and out-of-band emissions. A marker was placed on the band edge spot frequencies and a second marker placed on the highest emission level in the adjacent restricted band of operation (where a higher level emission was present). Marker frequencies and levels were recorded.
5. There is a restricted band 10 MHz below the lower band edge. The test receiver was set up as follows: the RBW set to 1 MHz, the VBW set to 3 MHz, with the sweep time set to auto couple. Peak and average measurements were performed with their respective detectors. Markers were placed on the highest point on each trace.
6. The EUT was transmitting with 100% duty cycle therefore no duty cycle correction was required.

Test Setup:

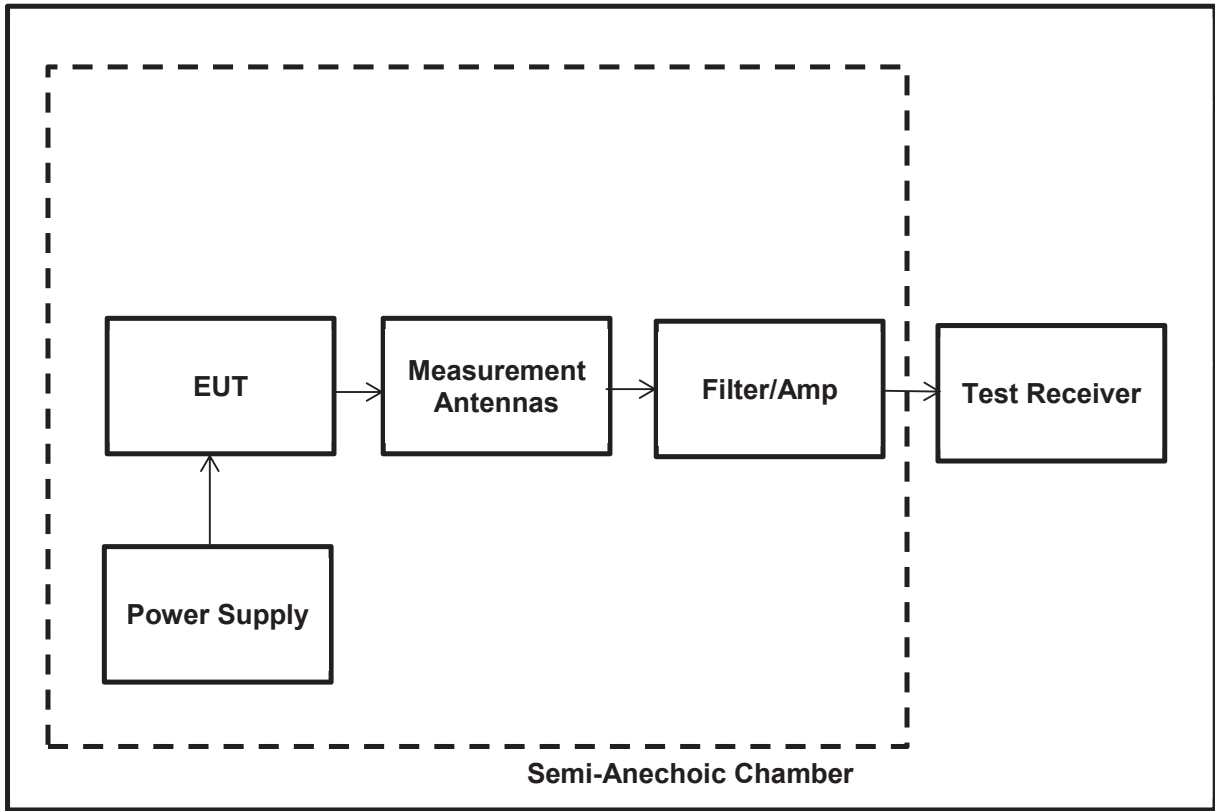

Transmitter Band Edge Radiated Emissions (Continued)**Results: Lower Band Edge/Peak**

Frequency (MHz)	Peak Level (dB μ V/m)	-20 dBc Limit (dB μ V/m)	Margin (dB)	Result
2400.000	38.58	74.56	35.98	Complied

Results: Upper Band Edge / Restricted Band / Peak

Frequency (MHz)	Peak Level (dB μ V/m)	Peak Limit (dB μ V/m)	Margin (dB)	Result
2483.500	48.76	74.0	25.24	Complied

Results: Upper Band Edge / Restricted Band / Average

Frequency (MHz)	Average Level (dB μ V/m)	Average Limit (dB μ V/m)	Margin (dB)	Result
2483.500	35.91	54.0	18.09	Complied

Results: 2310 to 2390 MHz Restricted Band / Peak

Frequency (MHz)	Peak Level (dB μ V/m)	Peak Limit (dB μ V/m)	Margin (dB)	Result
2387.30	45.79	74.0	28.21	Complied

Results: 2310 to 2390 MHz Restricted Band / Average

Frequency (MHz)	Average Level (dB μ V/m)	Average Limit (dB μ V/m)	Margin (dB)	Result
2362.17	35.02	54.0	18.98	Complied

Transmitter Band Edge Radiated Emissions (Continued)

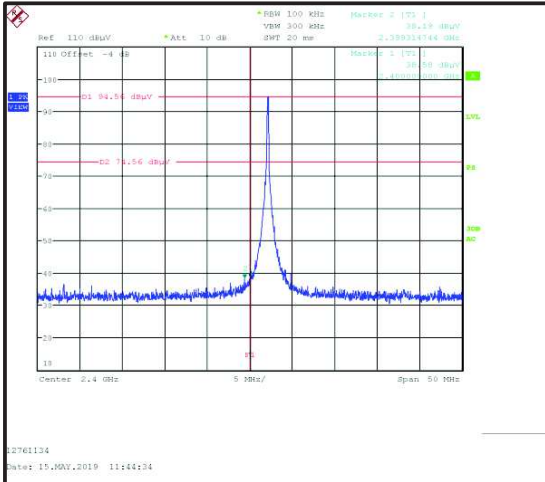

Lower Band Edge Peak Measurement

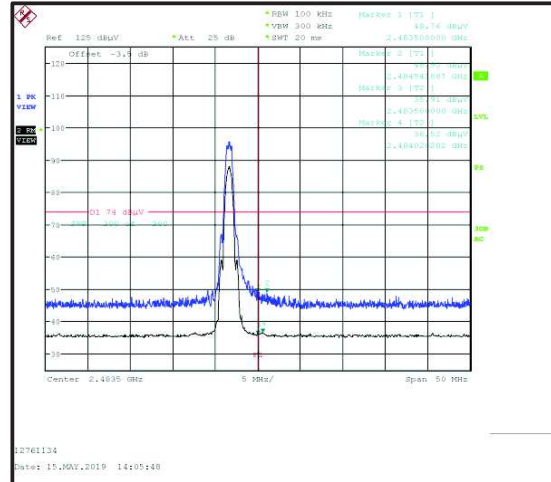

Upper Band Edge Peak Measurement

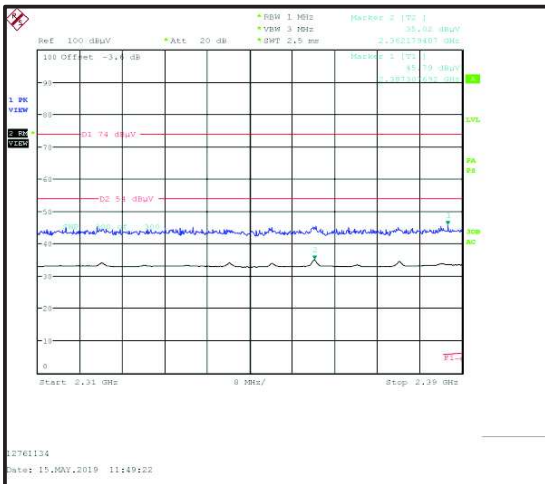

2310 MHz to 2390 MHz Restricted Band Plot

6. Measurement Uncertainty

The expression of uncertainty of a measurement result allows realistic comparison of results with reference values and limits given in specifications and standards.

The uncertainty of the result may need to be taken into account when interpreting the measurement results.

The reported expanded uncertainties below are based on a standard uncertainty multiplied by an appropriate coverage factor such that a confidence level of approximately 95% is maintained. For the purposes of this document "approximately" is interpreted as meaning "effectively" or "for most practical purposes".

Measurement Type	Confidence Level (%)	Calculated Uncertainty
AC Conducted Spurious Emissions	95%	±2.49 dB
Radiated Maximum Peak Output Power	95%	±3.10 dB
Radiated Spurious Emissions	95%	±3.10 dB
Band Edge Radiated Emissions	95%	±3.10 dB
Minimum 6 dB Bandwidth	95%	±0.87 %

The methods used to calculate the above uncertainties are in line with those recommended within the various measurement specifications. Where measurement specifications do not include guidelines for the evaluation of measurement uncertainty the published guidance of the appropriate accreditation body is followed.

7. Used equipment

Test site: SR 1/2

ID	Manufacturer	Type	Model	Serial No.	Calibration Date	Cal. Cycle
377	BONN Elektronik	Amplifier, Low Noise Pre	BLMA 0118-1A	025294B	7/12/2018	12
383	Rohde & Schwarz	Antenna, Rod	HFH2-Z1	890151/11	7/14/2017	24
423	Bonn Elektronik	Amplifier, Low Noise Pre	BLMA 1840-1A	055929	7/12/2018	12
424	EMCO	Antenna, Horn	EMCO 3116	00046537	7/28/2016	24
460	Deisl	Turntable	DT 4250 S		n/a	n/a
465	Schwarzbeck	Antenna, Trilog Broadband	VULB 9168	9168-240	8/8/2016	36
495	Rohde & Schwarz	Antenna, Log.- Periodical	HL050	100296	7/20/2016	36
587	Maturo	antenna mast, tilting	TAM 4.0-E	011/7180311	n/a	n/a
588	Maturo	Controller	NCD	029/7180311	n/a	n/a
591	Rohde & Schwarz	Receiver	ESU 40	100244/040	7/12/2018	12
608	Rohde & Schwarz	Switch Matrix	OSP 120	101227	4/8/2014	60
615	Wainwright Instruments	Highpass Filter 1GHz	WHKX12-	3	Lab verification	n/a
620	Bonn Elektronik	pre-amplifier	BLNA 0110-01N	1510111	7/12/2017	24
628	Maturo	Antenna mast	CAM 4.0-P	224/19590716	n/a	n/a
629	Maturo	Kippeinrichtung	KE 2.5-R-M	MAT002	n/a	n/a

Test site: SR 9

ID	Manufacturer	Type	Model	Serial No.	Calibration Date	Cal. Cycle
636	Rohde & Schwarz	switching unit	OSP120	101698	7/12/2018	12
637	Rohde & Schwarz	Spectrum Analyzer	FSV40	101587	7/11/2018	12
423	Bonn Elektronik	Amplifier, Low Noise Pre	BLMA 1840-1A	55929	7/12/2018	24
195	SPS	Power Supply	TOE8842-24	51455	Verified by Multimeter	12
216	Agilent	Multimeter	34401A	US36017458	7/11/2017	24

Test site: SR 7/8

ID	Manufacturer	Type	Model	Serial No.	Calibration Date	Cal. Cycle
22	Rohde & Schwarz	Artificial Mains	50 Ohm// 50uH	831767/014	7/11/2018	12
215	Rohde & Schwarz	Artificial Mains Network	9 kHz - 30 MHz; 3 phase	879675/002	7/11/2018	12
349	Rohde & Schwarz	Receiver, EMI Test	20 Hz - 7 GHz	836697/009	7/10/2018	12
616	Rohde & Schwarz	ISN	8 wire ISN for CAT6	101656	7/12/2018	12

8. Report Revision History

Version Number	Revision Details		
	Page No(s)	Clause	Details
1.0	-	-	Initial Version
1.1	11,15,16	5.2.1	Transmitter AC Conducted Spurious Emissions with 240 VAC 60 Hz added in test report.