

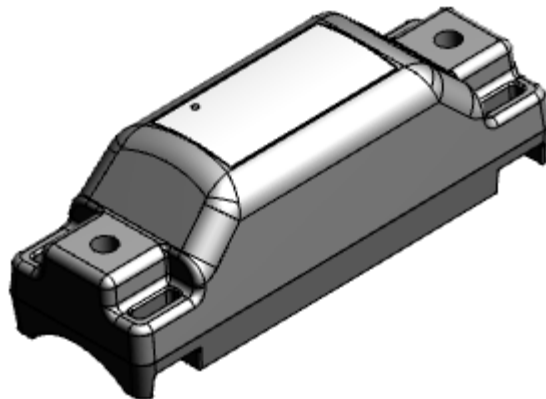

# **T25 Installation Guide**



**Please call  
ZTR Connected Asset Technical Support  
With any questions:  
1-888-320-8332**



# T25 Installation Guide



This page was left blank intentionally.



## T25 Installation Guide



### ZTR Control Systems – T25 Device Regulatory and Compliance Statements – FCC/ISED

This device complies with Part 15 of the FCC Rules. Operation is subject to the following two conditions: (1) this device may not cause harmful interference, and (2) this device must accept any interference received, including interference that may cause undesired operation.

#### Note:

This equipment has been tested and found to comply with the limits for a [Class B digital device](#), pursuant to part 15 of the FCC Rules. These limits are designed to provide reasonable protection against [harmful interference](#) in a residential installation. This equipment generates, uses and can radiate [radio frequency energy](#) and, if not installed and used in accordance with the instructions, may cause [harmful interference](#) to radio communications. However, there is no guarantee that interference will not occur in a particular installation. If this equipment does cause [harmful interference](#) to radio or television reception, which can be determined by turning the equipment off and on, the user is encouraged to try to correct the interference by one or more of the following measures:

- Reorient or relocate the receiving antenna.
- Increase the separation between the equipment and receiver.
- Connect the equipment into an outlet on a circuit different from that to which the receiver is connected.
- Consult the dealer or an experienced radio/TV technician for help.

This device complies with Industry Canada's licence-exempt RSSs. Operation is subject to the following two conditions: (1) This device may not cause interference; and (2) This device must accept any interference, including interference that may cause undesired operation of the device.

Le présent appareil est conforme aux CNR d'Industrie Canada applicables aux appareils radio exempts de licence. L'exploitation est autorisée aux deux conditions suivantes : (1) l'appareil ne doit pas produire de brouillage, et (2) l'utilisateur de l'appareil doit accepter tout brouillage radioélectrique subi, même si le brouillage est susceptible d'en compromettre le fonctionnement.

CAN ICES-3 (B)/NMB-3(B) – This Class B Digital Apparatus Complies with Canadian ICES-003.

Cet Appareil numérique de la classe (B) est conforme à la norme NMB-003 du Canada.

Changes or modifications not expressly approved by the party responsible for compliance could void the user's authority to operate the equipment.



## OWNERSHIP AND CONFIDENTIALITY

The Software, Software Materials and Printed Documents constitute proprietary property of ZTR Control Systems (ZTR) and include trade secrets and confidential information of ZTR. Customer acknowledges that it acquires only the right to use the Software and Software Materials as permitted hereunder and does not acquire any ownership, right or title in or to the Software, the Software Materials or any Third Party Software.

The customer acknowledges that the information contained on the Software, Software Materials and Printed Documents could be used to the detriment of ZTR and that the disclosure could cause irreparable harm to ZTR. Accordingly, the customer undertakes to treat confidentially all information and not to disclose it to any third party.

No part of this document may be reproduced in any form or by any means, electronic or mechanical, including photocopying or printing, without the express written permission of ZTR Control Systems.

The data and illustrations found in this book are not binding. ZTR Control Systems reserves the right to modify its products in line with its policy of continuous product development. A notice of changes may be released for any modifications that may significantly affect the user.

All ZTR Control Systems products, images and marketing materials are protected by various patents, copyrights, and/or trademarks.

©2017 ZTR Control Systems, LLC All Rights Reserved. (07/05)

## **Introduction**

**\*\* PLEASE READ THESE INSTALLATION INSTRUCTIONS THROUGH FIRST TO BECOME FAMILIAR WITH THE INSTALLATION, WIRING AND TESTING PROCEDURES. THIS WILL SAVE INSTALLATION TIME AND BETTER PREPARE YOU FOR TESTING \*\***

This manual includes instructions for permanent installation of the T25 monitoring system.

**The general flow of the instructions are as follows:**

1.	Installation Requirements	Page 6
2.	Supplies - (Included vs. Not Included)	Page 6
3.	Considerations Before Installation	Page 7
4.	T25 Installation	Page 8
5.	ONE <i>i3</i> – Mobile Application	Page 9
6.	T25 Provisioning	Page 14
7.	T25 Provisioning Confirmation	Page 17
	Appendix A: Label Revision History	Page 18
	Appendix B: Installation Guide Revision History	Page 19



The following instructions and any accompanying documentation, drawings and specifications are the property of ZTR CONTROL SYSTEMS. They are issued in strict confidence and shall not be reproduced, copied or used as the basis for sale or manufacture of any apparatus without prior written permission from ZTR CONTROL SYSTEMS.

## 1. Installation Requirements

For reference during the installation of the T25, please be sure to bring along the following documents for your reference as needed:

- Schematics of the equipment you are working on, if applicable

## 2. Supplies

### a. What Comes in the Kit:

- T25
- 3M Double Sided Tape
- T25 Installation Manual

### b. What is Not Included in the Kit:

The following are optional supplies that are **not** provided in this kit which you may need to use during the installation of the M6:

- Tie Wraps.
- Self-tapping screws for Mounting.
- Screws, Nuts & Washers.

**\*\*Please be sure to meet your company's Standard Safety Protocols for Installations\*\***

### 3. Considerations before Installation

The ideal way to ensure a trouble-free installation is to consider your options and make some decisions before starting the install. Take a good look at the asset (equipment or tool) to determine how to best install the T25.

Some factors to consider when planning the installation of the T25 are:

- T25 Mounting Considerations.
  - T25 shouldn't be mounted close to radiating heat
  - T25 should be mounted in an area where it cannot be damaged by falling and moving objects
  - T25 should be mounted in an area where it does not interfere with regular operations of the equipment/tool or the operator
  - T25 should be mounted in a way that the label is easily readable as NFC is beneath the label. It will be easier to read the barcode via camera/scanner and tap the NFC module as needed
  
- Copy and Record the ESN # from the label in case you need to change any details later after activation.



**Figure 2: T25 Serial Number Label (This label is an example only! Please use the ESN from the T25 that is being installed. Do not use the above ESN!!)**

#### 4. T25 Installation

Installation will be dependent on the type of equipment or tool it is being installed on. Always use the provided 3M VHB tape so the T25 can remain stable where it is mounted, even on cylindrical surfaces.

The screw holes can be used to screw the T25 onto the equipment as shown in the picture below.



The T25 can also be strapped down using Zip Ties strung through the holes provided at both ends. See the example pictured below.





## 5. ONE i3 - Mobile Application

The mobile application is used to provision the T25 tags. In order to run the ONE i3 mobile application, the minimum Android version that must be running on your Android compatible smart phone is:



### **Version 5.0 (Lollipop)**

The following steps illustrate the installation of the ONE i3 mobile application:

- a. Download the ONE i3 mobile application from the Google Play store and install it on your Android device.
- b. Once the mobile application is installed, launch it. You will see the screen below.

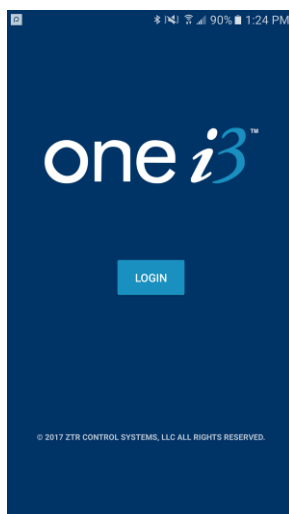

- c. Press the 'Login' button and enter your ONE i3 credentials. If you do not have ONE i3 login credentials, please contact your local administrator.

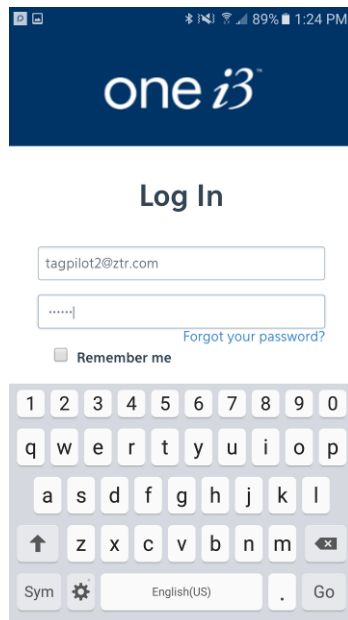

- d. Once you are logged in, the phone will ask you to acknowledge a series of permissions. Please say **Yes** or **Allow** to all of them per below:

- 1) Client Permissions = Yes, Allow

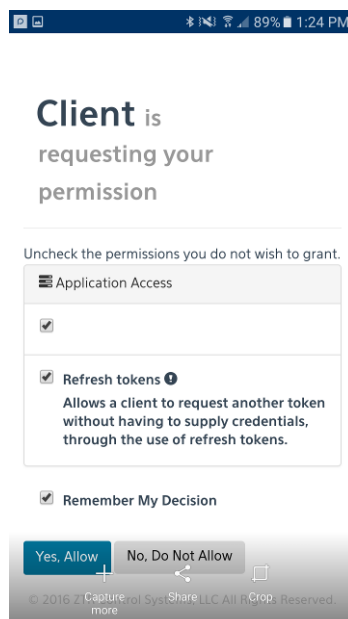

## 2) Telecommunications Access = ALLOW

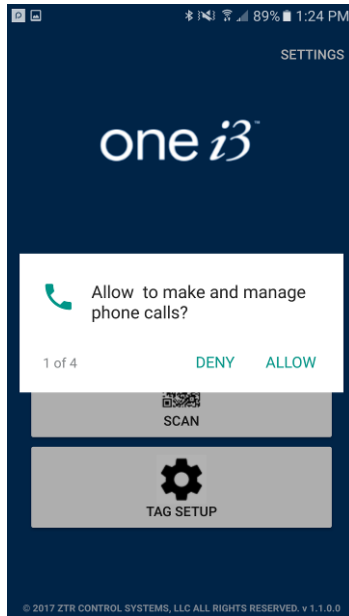

## 3) Photo, Media and File Access = ALLOW

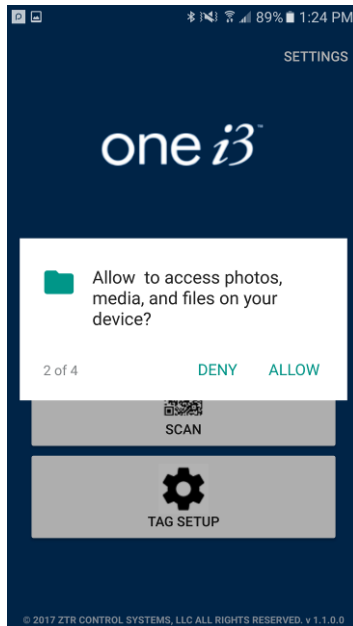

## 4) Camera Access = ALLOW

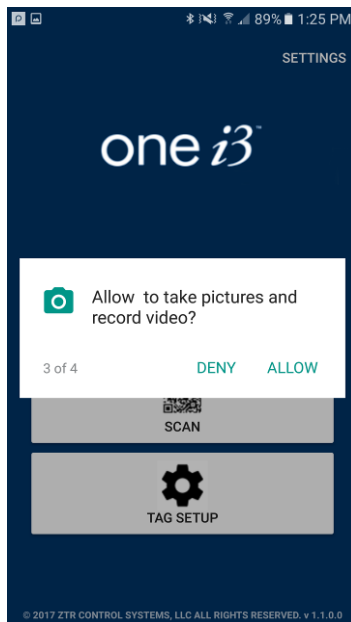

5) Location Access = ALLOW

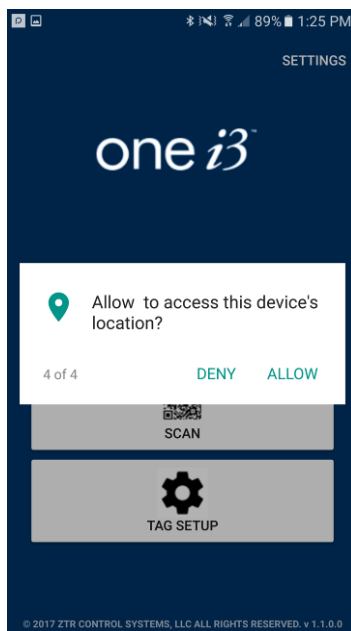

After all the permissions have been attended to, you will be at the 'Home' screen of the mobile application per the screen shot below.



Once at the 'Home' screen, make sure the Phones NFC and Bluetooth functions are turned ON. You should see the following icons at the top of your phone's screen if they are:



## 6. T25 Provisioning

Provisioning T25 tags will make them active within the ONE *i3* platform, allowing you to monitor them through the ONE *i3* web application and mobile application.

Each T25 needs to be provisioned, one at a time. Select 'Tag Setup' from the home screen to access the provisioning features directly or perform one of the following methods for provisioning:

- a. **Tap with Phone** – From the home screen, tap the label on the T25 with the back of phone to start the 'Tag Setup' via the NFC method
  - i. You can also click the 'TAG Setup' button on the ONE *i3* app home screen and then tap the label on the T25 with the back of the phone
  - ii. This should take you to the Installation screen and display the tag serial number in the 'Beacon ID' field per the example below.

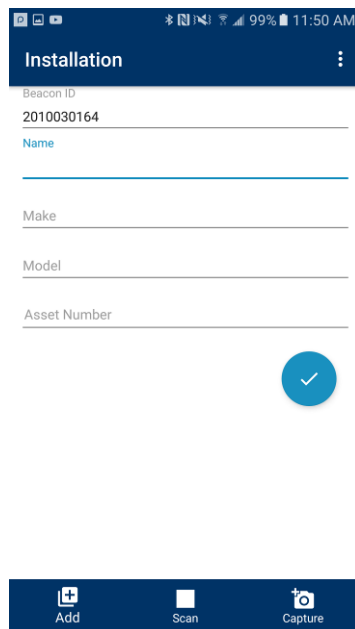

**TIP:** While on the ONE *i3* app home screen, turn the notification volume up on your phone and you will hear a tone when the phone has successfully read the information from the T25. Be sure to leave the back of the phone in contact with the T25 after the tap as the read that is done can take a few seconds.

- b. **Scan QR Code** - Tap the 'Scan' button on the ONE /3 mobile applications home. This method uses the camera view to scan the barcode label on the T25. Putting the barcode in view of the camera will capture the 'Beacon ID' value. See the example below.

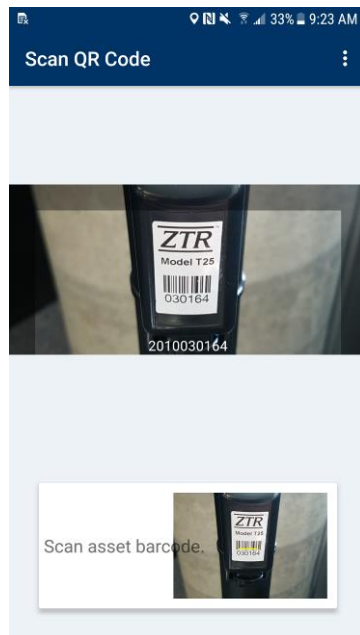

- c. Once the 'Beacon ID' value is populated on the Installation screen, enter all relevant equipment information in the remaining fields for the 'Tag Setup' per the example below.

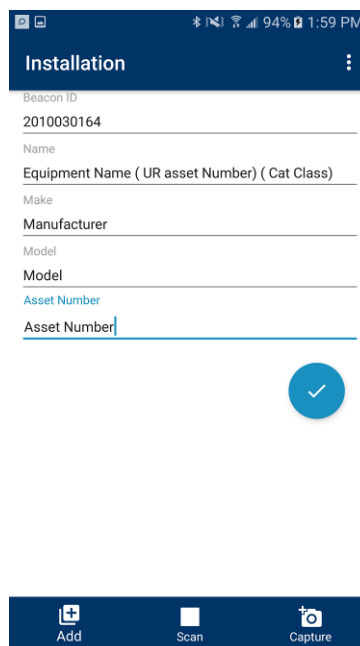

- d. Once you have added all the asset information. Tap the 'Capture' button to take a picture of the asset the T25 has been installed on.
  - i. The picture will be stored in the ONE ß platform associated with the asset and is accessible from the ONE ß web or mobile applications.
- e. After the picture has been taken, tap the blue Check Mark circle to finish the set-up.
  - i. You will see a screen with a progress bar indicating the information is being uploaded to the ONE ß platform.

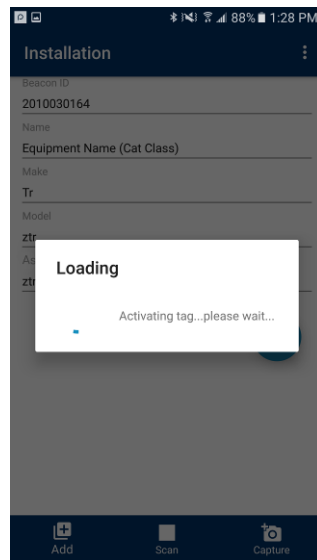

- ii. Once the information has been uploaded successfully, you will see a message that says "Tag has been successfully installed". The T25 is now activate within the ONE ß platform.



## 7. T25 Provisioning Confirmation

To confirm provisioning is complete, perform the following.

- a. There are two ways to confirm the T25 is functioning properly:
  - i. Tap 'Find' on the mobile applications' home screen to have the application detect the T25 and then tap the listing for the newly provisioned T25 when it appears

OR

  - ii. Tap 'Scan' on the mobile applications' home screen you can scan the barcode of the T25.
- b. This will then display a screen with the T25's information per below

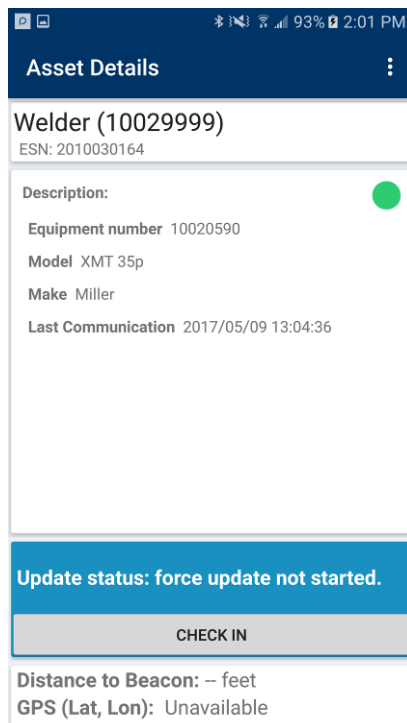

To test the provisioning of the T25, end-to-end, you can push current T25 data to the ONE i3 platform by pressing the 'CHECK IN' button on the current assets' details view. This will force the T25 to push its current data to the ONE i3 platform. Once this forced update is finished, the blue status bar above the 'CHECK IN' button will say "Check in Successful".

**NOTE:** The T25 sends data automatically to the ONE i3 platform after a scheduled interval. The 'CHECK IN' option is useful if you require an immediate update to the



## T25 Installation Guide



asset information on the website for manual updates, testing and/or troubleshooting needs.

## Appendix A: Label Revision History

This section will illustrate any changes to the product label as a result of a revision/update.

Revision:	Date: (MM/DD/YYYY)	Author:	Reason:
1	07/05/2017	C. Moulton	Initial release
			



# T25 Installation Guide





## Appendix B: Installation Guide Revision History

This section will detail any changes to the content of this document as a result of a revision/update.

Revision:	Date: (MM/DD/YYYY)	Author:	Reason:
1.0	07/05/2017	C. Boltë	Initial release