

Test report

330173-1TRFWL

Date of issue: August 25, 2017

Applicant:

T R Controls Inc.

Product:

T25

Model:

T25

FCC ID:

2AL9H-110671

IC Registration number:

22769-110671

Specifications:

◆ **FCC 47 CFR Part 15 Subpart C, §15.247**

Operation in the 902–928 MHz, 2400–2483.5 MHz, and 5725–5850 MHz

◆ **RSS-247, Issue 2, Feb 2017, Section 5**

Digital Transmission Systems (DTSs), Frequency Hopping Systems (FHSs)
and Licence-Exempt Local Area Network (LE-LAN) Devices

5) Standard specifications for frequency hopping systems and digital transmission systems operating in the
bands 902–928 MHz, 2400–2483.5 MHz and 5725–5850 MHz

Test location

Company name	Nemko Canada Inc.
Address	303 River Road
City	Ottawa
Province	Ontario
Postal code	K1V 1H2
Country	Canada
Telephone	+1 613 737 9680
Facsimile	+1 613 737 9691
Toll free	+1 800 563 6336
Website	www.nemko.com
Site number	FCC: CA2040; IC: 2040A-4 (3 m semi anechoic chamber)

Tested by	Andrey Adelberg, Senior Wireless/EMC Specialist
Reviewed by	Kevin Rose, Wireless/EMC Specialist
Review date	August 25, 2017
Reviewer signature	

Limits of responsibility

Note that the results contained in this report relate only to the items tested and were obtained in the period between the date of initial receipt of samples and the date of issue of the report.

This test report has been completed in accordance with the requirements of ISO/IEC 17025. All results contain in this report are within Nemko Canada's ISO/IEC 17025 accreditation.

Copyright notification

Nemko Canada Inc. authorizes the applicant to reproduce this report provided it is reproduced in its entirety and for use by the company's employees only. Any use which a third party makes of this report, or any reliance on or decisions to be made based on it, are the responsibility of such third parties. Nemko Canada Inc. accepts no responsibility for damages, if any, suffered by any third party as a result of decisions made or actions based on this report.
© Nemko Canada Inc.

Table of contents

Table of contents	3
Section 1. Report summary	4
1.1 Applicant and manufacturer	4
1.2 Test specifications	4
1.3 Test methods	4
1.4 Statement of compliance	4
1.5 Exclusions	4
1.6 Test report revision history	4
Section 2. Summary of test results	5
2.1 FCC Part 15 Subpart C, general requirements test results	5
2.2 FCC Part 15 Subpart C, intentional radiators test results	5
2.3 ISED RSS-GEN, Issue 4, test results	5
2.4 ISED RSS-247, Issue 2, test results	6
Section 3. Equipment under test (EUT) details	7
3.1 Sample information	7
3.2 EUT information	7
3.3 Technical information	7
3.4 Product description and theory of operation	7
3.5 EUT exercise details	7
3.6 EUT setup diagram	8
3.7 EUT sub assemblies	8
Section 4. Engineering considerations	9
4.1 Modifications incorporated in the EUT	9
4.2 Technical judgment	9
4.3 Deviations from laboratory tests procedures	9
Section 5. Test conditions	10
5.1 Atmospheric conditions	10
5.2 Power supply range	10
Section 6. Measurement uncertainty	11
6.1 Uncertainty of measurement	11
Section 7. Test equipment	12
7.1 Test equipment list	12
Section 8. Testing data	13
8.1 FCC 15.247(a)(2) and RSS-247 5.2(a) Minimum 6 dB bandwidth for systems using digital modulation techniques	13
8.2 FCC 15.247(b) and RSS-247 5.4 (d) Transmitter output power and e.i.r.p. requirements	15
8.3 FCC 15.247(d) and RSS-247 5.5 Spurious (out-of-band) unwanted emissions	18
8.4 FCC 15.247(e) and RSS-247 5.2(b) Power spectral density for digitally modulated devices	23
Section 9. Block diagrams of test set-ups	25
9.1 Radiated emissions set-up for frequencies below 1 GHz	25
9.2 Radiated emissions set-up for frequencies above 1 GHz	26
9.3 Conducted emissions set-up at antenna port	26

Section 1. Report summary

1.1 Applicant and manufacturer

Company name	T R Controls Inc.
Address	955 Green Valley Rd
City	London
Province/State	ON
Postal/Zip code	N6N 1E4
Country	Canada

1.2 Test specifications

FCC 47 CFR Part 15, Subpart C, Clause 15.247	Operation in the 902–928 MHz, 2400–2483.5 MHz, and 5725–585 MHz
RSS-247, Issue 2, Feb 2017, Section 5	Digital Transmission Systems (DTSs), Frequency Hopping Systems (FHSs) and Licence-Exempt Local Area Network (LE-LAN) Devices

1.3 Test methods

558074 D01 DTS Meas Guidance v04 (April 5, 2017)	Guidance for Performing Compliance Measurements on Digital Transmission Systems (DTS) Operating Under §15.247
ANSI C63.10 v2013	American National Standard of Procedures for Compliance Testing of Unlicensed Wireless Devices

1.4 Statement of compliance

In the configuration tested, the EUT was found compliant.

Testing was completed against all relevant requirements of the test standard or as per detailed in the section 1.5 Exclusions below. Results obtained indicate that the product under test complies in full with the requirements tested. The test results relate only to the items tested.

See “Summary of test results” for full details.

1.5 Exclusions

None

1.6 Test report revision history

Revision #	Details of changes made to test report
TRF	Original report issued

Section 2. Summary of test results

2.1 FCC Part 15 Subpart C, general requirements test results

Part	Test description	Verdict
§15.207(a)	Conducted limits	Not applicable ³
§15.31(e)	Variation of power source	Pass ¹
§15.203	Antenna requirement	Pass ²

Notes: ¹ Testing was performed with charged battery

² The Antennas are located within the enclosure of EUT and not user accessible.

³ EUT is a battery-operated device.

2.2 FCC Part 15 Subpart C, intentional radiators test results

Part	Test description	Verdict
§15.247(a)(1)(i)	Frequency hopping systems operating in the 902–928 MHz band	Not applicable
§15.247(a)(1)(ii)	Frequency hopping systems operating in the 5725–5850 MHz band	Not applicable
§15.247(a)(1)(iii)	Frequency hopping systems operating in the 2400–2483.5 MHz band	Not applicable
§15.247(a)(2)	Minimum 6 dB bandwidth for systems using digital modulation techniques	Pass
§15.247(b)(1)	Maximum peak output power of frequency hopping systems operating in the 2400–2483.5 MHz band and 5725–5850 MHz band	Not applicable
§15.247(b)(2)	Maximum peak output power of Frequency hopping systems operating in the 902–928 MHz band	Not applicable
§15.247(b)(3)	Maximum peak output power of systems using digital modulation in the 902–928 MHz, 2400–2483.5 MHz, and 5725–5850 MHz bands	Pass
§15.247(c)(1)	Fixed point-to-point operation with directional antenna gains greater than 6 dBi	Not applicable
§15.247(c)(2)	Transmitters operating in the 2400–2483.5 MHz band that emit multiple directional beams	Not applicable
§15.247(d)	Spurious emissions	Pass
§15.247(e)	Power spectral density for digitally modulated devices	Pass
§15.247(f)	Time of occupancy for hybrid systems	Not applicable

2.3 ISSED RSS-GEN, Issue 4, test results

Part	Test description	Verdict
7.1.2 ¹	Receiver radiated emission limits	Not applicable
7.1.3 ¹	Receiver conducted emission limits	Not applicable
8.8	Power Line Conducted Emissions Limits for Licence-Exempt Radio Apparatus	Not applicable

Notes: ¹ According to sections 5.2 and 5.3 of RSS-Gen, Issue 4 the EUT does not have a stand-alone receiver neither scanner receiver, therefore exempt from receiver requirements.

² EUT is a battery-operated device.

2.4 ISED RSS-247, Issue 2, test results

Part	Test description	Verdict
5.1	Frequency Hopping Systems (FHSs)	
5.1 (a)	Bandwidth of a frequency hopping channel	Not applicable
5.1 (b)	Minimum channel spacing for frequency hopping systems	Not applicable
5.1 (c)	Frequency hopping systems operating in the 902–928 MHz band	Not applicable
5.1 (d)	Frequency hopping systems operating in the 2400–2483.5 MHz band	Not applicable
5.1 (e)	Frequency hopping systems operating in the 5725–5850 MHz band	Not applicable
5.2	Digital Transmission Systems (DTSSs)	
5.2 (a)	Minimum 6 dB bandwidth	Pass
5.2 (b)	Maximum power spectral density	Pass
5.3	Hybrid Systems	
5.3 (a)	Digital modulation turned off	Not applicable
5.3 (b)	Frequency hopping turned off	Not applicable
5.4	Transmitter output power and e.i.r.p. requirements	
5.4 (a)	Frequency hopping systems operating in the 902–928 MHz band	Not applicable
5.4 (b)	Frequency hopping systems operating in the 2400–2483.5 MHz band	Not applicable
5.4 (c)	Frequency hopping systems operating in the 5725–5850 MHz	Not applicable
5.4 (d)	Systems employing digital modulation techniques	Pass
5.4 (e)	Point-to-point systems in 2400–2483.5 MHz and 5725–5850 MHz band	Not applicable
5.4 (f)	Transmitters which operate in the 2400–2483.5 MHz band with multiple directional beams	Not applicable
5.5	Unwanted emissions	Pass

Notes: None

Section 3. Equipment under test (EUT) details

3.1 Sample information

Receipt date	June 26, 2017
Nemko sample ID number	1

3.2 EUT information

Product name	T25
Model	T25
Serial number	TBD

3.3 Technical information

Applicant IC company number	22769
IC UPN number	110671
All used IC test site(s) Reg. number	2040A-4
RSS number and issue number	RSS-247 Issue 2, Feb 2017
Frequency band	2400–2483.5 MHz
Frequency Min (MHz)	2402
Frequency Max (MHz)	2480
RF power Min (W)	N/A
RF power Max (W), Conducted	0.000696627 (–1.57 dBm)
Field strength, Units @ distance	N/A
Measured BW (kHz) (6 dB)	725
Calculated BW (kHz), as per TRC-43	N/A
Type of modulation	GFSK
Emission classification (F1D, G1D, D1D)	F1D
Transmitter spurious, Units @ distance	41.35 dB μ V/m at 2483.5 MHz @ 3 m distance
Power requirements	Internal battery 3.6 V _{DC}
Antenna information	PCB trace antenna, maximum gain +2.3 dBi The EUT uses a unique antenna coupling/ non-detachable antenna to the intentional radiator.

3.4 Product description and theory of operation

Rugged, intrinsically safe asset tracker, operated at 2.4 GHz ISM band.

3.5 EUT exercise details

EUT was powered using NFC board connected to Laptop, then paired with Smartphone and channel selection and transmission was made wirelessly via this Smartphone.

3.6 EUT setup diagram

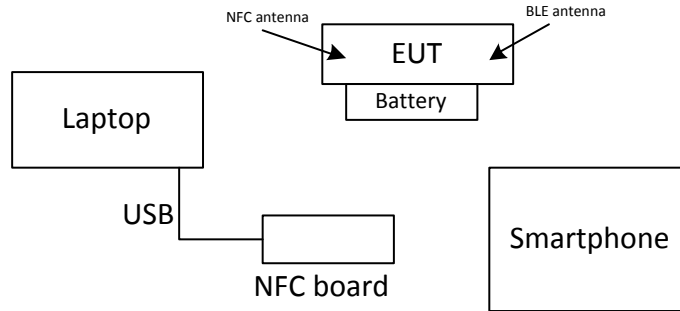

Figure 3.6-1: Setup diagram

3.7 EUT sub assemblies

Table 3.7-1: EUT sub assemblies

Description	Brand name	Model/Part number	Serial number
Laptop	Lenovo	20238	3327394104419
NFC board	STMicroelectronics	MB1054B	2164900435
Smartphone	Motorola	Moto X Play	ZY2223XGZB

Section 4. Engineering considerations

4.1 Modifications incorporated in the EUT

There were no modifications performed to the EUT during this assessment.

4.2 Technical judgment

None

4.3 Deviations from laboratory tests procedures

No deviations were made from laboratory procedures.

Section 5. Test conditions

5.1 Atmospheric conditions

Temperature	15–30 °C
Relative humidity	20–75 %
Air pressure	860–1060 mbar

When it is impracticable to carry out tests under these conditions, a note to this effect stating the ambient temperature and relative humidity during the tests shall be recorded and stated.

5.2 Power supply range

The normal test voltage for equipment to be connected to the mains shall be the nominal mains voltage. For the purpose of the present document, the nominal voltage shall be the declared voltage, or any of the declared voltages $\pm 5\%$, for which the equipment was designed.

Section 6. Measurement uncertainty

6.1 Uncertainty of measurement

UKAS Lab 34 and TIA-603-B have been used as guidance for measurement uncertainty reasonable estimations with regards to previous experience and validation of data. Nemko Canada, Inc. follows these test methods in order to satisfy ISO/IEC 17025 requirements for estimation of uncertainty of measurement for wireless products.

Measurement uncertainty budgets for the tests are detailed below. Measurement uncertainty calculations assume a coverage factor of $K = 2$ with 95% certainty.

Test name	Measurement uncertainty, dB
All antenna port measurements	0.55
Conducted spurious emissions	1.13
Radiated spurious emissions	3.78
AC power line conducted emissions	3.55

Section 7. Test equipment

7.1 Test equipment list

Table 7.1-1: Equipment list

Equipment	Manufacturer	Model no.	Asset no.	Cal cycle	Next cal.
3 m EMI test chamber	TDK	SAC-3	FA002047	1 year	Dec. 1/17
Flush mount turntable	Sunol	FM2022	FA002082	—	NCR
Controller	Sunol	SC104V	FA002060	—	NCR
Antenna mast	Sunol	TLT2	FA002061	—	NCR
Receiver/spectrum analyzer	Rohde & Schwarz	ESU 26	FA002043	1 year	Jan. 31/18
Spectrum analyzer	Rohde & Schwarz	FSU	FA001877	1 year	Jul. 15/17
Horn with Preamp	ETS-Lindgren	3117-PA	FA002840	1 year	Nov. 11/17
Biconical antenna (30–300 MHz)	Sunol	BC2	FA002078	1 year	May. 8/18
Log periodic antenna (200–5000 MHz)	Sunol	LP5	FA002077	1 year	May. 8/18

Note: NCR - no calibration required

Section 8. Testing data

8.1 FCC 15.247(a)(2) and RSS-247 5.2(a) Minimum 6 dB bandwidth for systems using digital modulation techniques

8.1.1 Definitions and limits

FCC and IC:

- (a) Operation under the provisions of this Section is limited to frequency hopping and digitally modulated intentional radiators that comply with the following provisions:
- (2) Systems using digital modulation techniques may operate in the 902–928 MHz, 2400–2483.5 MHz and 5725–5850 MHz bands. The minimum 6 dB bandwidth shall be at least 500 kHz.

8.1.2 Test summary

Test date	June 27, 2017	Temperature	23 °C
Test engineer	Andrey Adelberg	Air pressure	1009 mbar
Verdict	Pass	Relative humidity	33 %

8.1.3 Observations, settings and special notes

Spectrum analyser settings:

Resolution bandwidth	100 kHz
Video bandwidth	$\geq 3 \times \text{RBW}$
Frequency span	5 MHz
Detector mode	Peak
Trace mode	Max Hold

8.1.4 Test data

Table 8.1-1: 6 dB bandwidth results

Frequency, MHz	6 dB bandwidth, MHz	Minimum limit, MHz	Margin, MHz
2402	0.700	0.500	0.200
2442	0.692	0.500	0.192
2480	0.725	0.500	0.225

Section 8

Test name

Specification

Testing data

FCC 15.247(a)(2) and RSS-247 5.2(a) Minimum 6 dB bandwidth for systems using digital modulation techniques

FCC Part 15 Subpart C and RSS-247, Issue 2

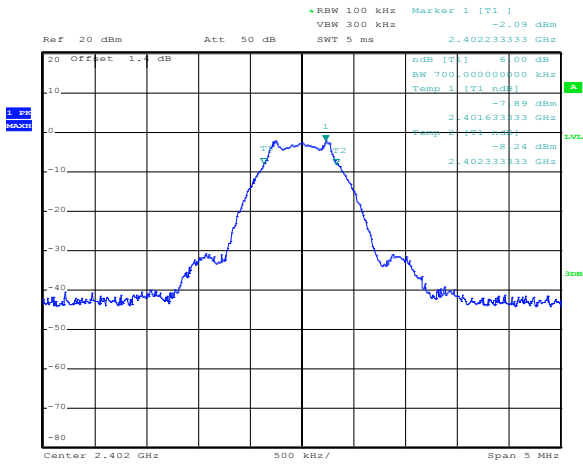

Date: 27.JUN.2017 14:51:46

Figure 8.1-1: 6 dB bandwidth on low channel

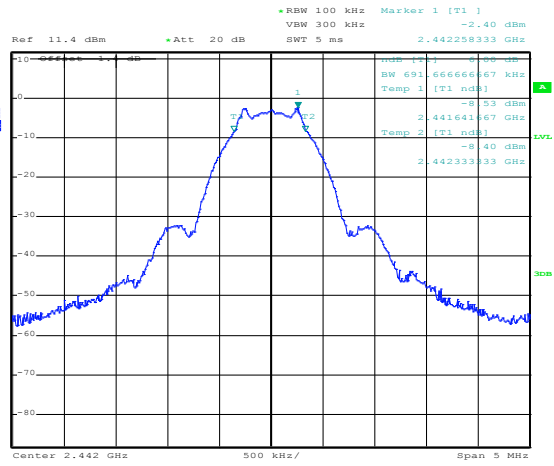

Date: 28.JUN.2017 14:21:23

Figure 8.1-2: 6 dB bandwidth on mid channel

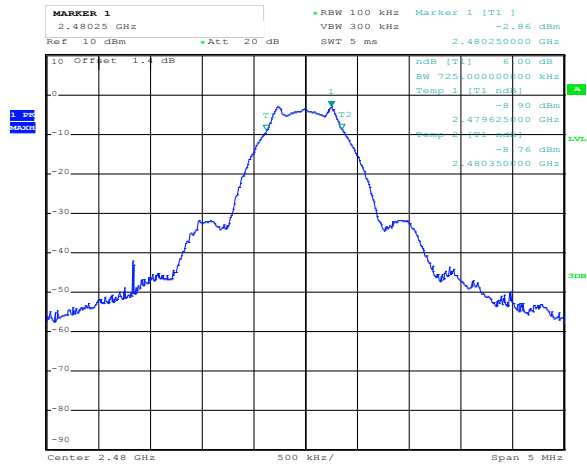

Date: 28.JUN.2017 13:32:51

Figure 8.1-3: 6 dB bandwidth on high channel

8.2 FCC 15.247(b) and RSS-247 5.4 (d) Transmitter output power and e.i.r.p. requirements

8.2.1 Definitions and limits

FCC:

- (b) The maximum peak conducted output power of the intentional radiator shall not exceed the following:
- (3) For systems using digital modulation in the 902–928 MHz, 2400–2483.5 MHz, and 5725–5850 MHz bands: 1 W (30 dBm). As an alternative to a peak power measurement, compliance with the one Watt limit can be based on a measurement of the maximum conducted output power. Maximum Conducted Output Power is defined as the total transmit power delivered to all antennas and antenna elements averaged across all symbols in the signaling alphabet when the transmitter is operating at its maximum power control level. Power must be summed across all antennas and antenna elements. The average must not include any time intervals during which the transmitter is off or is transmitting at a reduced power level. If multiple modes of operation are possible (e.g., alternative modulation methods), the maximum conducted output power is the highest total transmit power occurring in any mode.
 - (4) The conducted output power limit specified in paragraph (b) of this section is based on the use of antennas with directional gains that do not exceed 6 dBi. Except as shown in paragraph (c) of this section, if transmitting antennas of directional gain greater than 6 dBi are used, the conducted output power from the intentional radiator shall be reduced below the stated values in paragraphs (b)(1), (b)(2), and (b)(3) of this section, as appropriate, by the amount in dB that the directional gain of the antenna exceeds 6 dBi.
 - (i) Systems operating in the 2400–2483.5 MHz band that are used exclusively for fixed, point-to-point operations may employ transmitting antennas with directional gain greater than 6 dBi provided the maximum peak output power of the intentional radiator is reduced by 1 dB for every 3 dB that the directional gain of the antenna exceeds 6 dBi.

Fixed, point-to-point operation, as used in paragraphs (b)(3)(i) and (b)(3)(ii) of this section, excludes the use of point-to-multipoint systems, omnidirectional applications, and multiple co-located intentional radiators transmitting the same information. The operator of the spread spectrum intentional radiator or, if the equipment is professionally installed, the installer is responsible for ensuring that the system is used exclusively for fixed, point-to-point operations. The instruction manual furnished with the intentional radiator shall contain language in the installation instructions informing the operator and the installer of this responsibility.

- (c) Operation with directional antenna gains greater than 6 dBi.
- (2) In addition to the provisions in paragraphs (b)(1), (b)(3), (b)(4) and (c)(1)(i) of this section, transmitters operating in the 2400–2483.5 MHz band that emit multiple directional beams, simultaneously or sequentially, for the purpose of directing signals to individual receivers or to groups of receivers provided the emissions comply with the following:
 - (i) Different information must be transmitted to each receiver.
 - (ii) If the transmitter employs an antenna system that emits multiple directional beams but does not do emit multiple directional beams simultaneously, the total output power conducted to the array or arrays that comprise the device, i.e., the sum of the power supplied to all antennas, antenna elements, staves, etc. and summed across all carriers or frequency channels, shall not exceed the limit specified in paragraph (b)(1) or (b)(3) of this section, as applicable. However, the total conducted output power shall be reduced by 1 dB below the specified limits for each 3 dB that the directional gain of the antenna/antenna array exceeds 6 dBi. The directional antenna gain shall be computed as follows:
 - (A) The directional gain shall be calculated as the sum of 10 log (number of array elements or staves) plus the directional gain of the element or stove having the highest gain.

ISED:

- d. For DTSs employing digital modulation techniques operating in the bands 902–928 MHz and 2400–2483.5 MHz, the maximum peak conducted output power shall not exceed 1 W. The e.i.r.p. shall not exceed 4 W, except as provided in section 5.4(e).
As an alternative to a peak power measurement, compliance can be based on a measurement of the maximum conducted output power. The maximum conducted output power is the total transmit power delivered to all antennas and antenna elements, averaged across all symbols in the signalling alphabet when the transmitter is operating at its maximum power control level. Power must be summed across all antennas and antenna elements. The average must not include any time intervals during which the transmitter is off or transmitting at a reduced power level. If multiple modes of operation are implemented, the maximum conducted output power is the highest total transmit power occurring in any mode.
- e. Fixed point-to-point systems in the bands 2400–2483.5 MHz and 5725–5850 MHz are permitted to have an e.i.r.p. higher than 4 W provided that the higher e.i.r.p. is achieved by employing higher gain directional antennas and not higher transmitter output powers. Point-to-multipoint systems, omnidirectional applications and multiple co-located transmitters transmitting the same information are prohibited from exceeding an e.i.r.p. of 4 W.

ISED:

f. Transmitters operating in the band 2400–2483.5 MHz, may employ antenna systems that emit multiple directional beams simultaneously or sequentially, for the purpose of directing signals to individual receivers or to groups of receivers, provided that the emissions comply with the following:

Different information must be transmitted to each receiver.

If the transmitter employs an antenna system that emits multiple directional beams, but does not emit multiple directional beams simultaneously, the total output power conducted to the array or arrays that comprise the device (i.e. the sum of the power supplied to all antennas, antenna elements, staves, etc., and summed across all carriers or frequency channels) shall not exceed the applicable output power limit specified in sections 5.4(b) and 5.4(d). However, the total conducted output power shall be reduced by 1 dB below the specified limits for each 3 dB that the directional gain of the antenna/antenna array exceeds 6 dBi. The directional antenna gain shall be computed as the sum of 10 log (number of array elements or staves) plus the directional gain of the element or staff having the highest gain.

If a transmitter employs an antenna that operates simultaneously on multiple directional beams using the same or different frequency channels, the power supplied to each emission beam is subject to the applicable power limit specified in sections 5.4(b) and 5.4(d). If transmitted beams overlap, the power shall be reduced to ensure that their aggregate power does not exceed the applicable limit specified in sections 5.4(b) and 5.4(d). In addition, the aggregate power transmitted simultaneously on all beams shall not exceed the applicable limit specified in sections 5.4(b) and 5.4(d) by more than 8 dB.

Transmitters that transmit a single directional beam shall operate under the provisions of sections 5.4(b), 5.4(d) and 5.4(e).

8.2.2 Test summary

Test date	June 27, 2017	Temperature	23 °C
Test engineer	Andrey Adelberg	Air pressure	1009 mbar
Verdict	Pass	Relative humidity	33 %

8.2.3 Observations, settings and special notes

The test was performed according to DTS guidelines section 9.1.1 Peak power measurement.
 Spectrum analyser settings:

Resolution bandwidth	3 MHz
Video bandwidth	≥3 × RBW
Frequency span	20 MHz
Detector mode	Peak
Trace mode	Max Hold

8.2.4 Test data

Table 8.2-1: Output power measurements results

Frequency, MHz	Conducted output power, dBm		Margin, dB	Antenna gain, dBi	EIRP, dBm	EIRP limit, dBm	EIRP margin, dB
	Measured	Limit					
2402	-1.57	30.00	31.57	2.30	0.73	36.00	35.27
2442	-1.88	30.00	31.88	2.30	0.42	36.00	35.58
2480	-2.38	30.00	32.38	2.30	-0.08	36.00	36.08

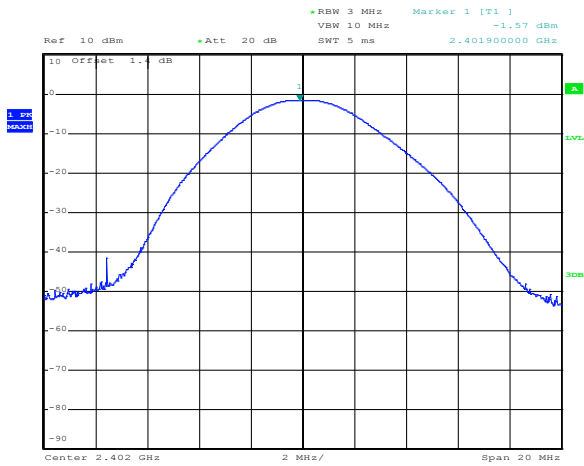

Date: 28.JUN.2017 14:30:12

Figure 8.2-1: Output power on low channel

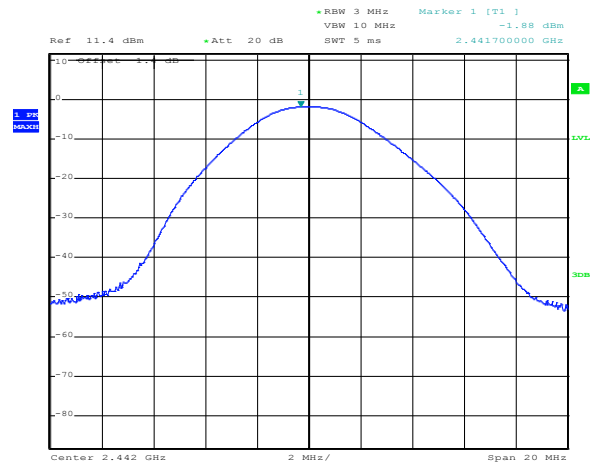

Date: 28.JUN.2017 14:21:58

Figure 8.2-2: Output power on mid channel

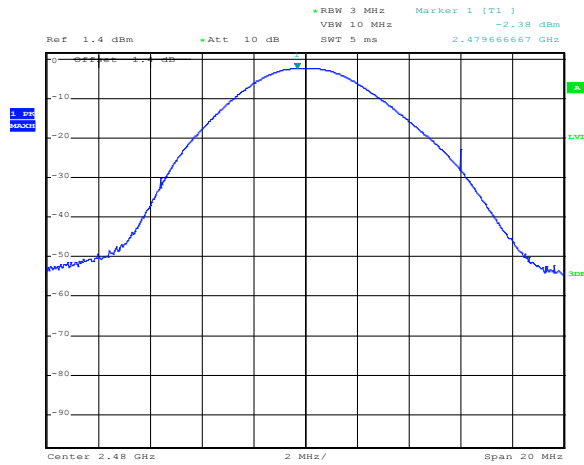

Date: 28.JUN.2017 13:26:49

Figure 8.2-3: Output power on high channel

8.3 FCC 15.247(d) and RSS-247 5.5 Spurious (out-of-band) unwanted emissions

8.3.1 Definitions and limits

FCC:

In any 100 kHz bandwidth outside the frequency band in which the spread spectrum or digitally modulated intentional radiator is operating, the radio frequency power that is produced by the intentional radiator shall be at least 20 dB below that in the 100 kHz bandwidth within the band that contains the highest level of the desired power, based on either an RF conducted or a radiated measurement, provided the transmitter demonstrates compliance with the peak conducted power limits. If the transmitter complies with the conducted power limits based on the use of RMS averaging over a time interval, as permitted under paragraph (b)(3) of this section, the attenuation required under this paragraph shall be 30 dB instead of 20 dB. Attenuation below the general limits specified in §15.209(a) is not required. In addition, radiated emissions which fall in the restricted bands, as defined in §15.205(a), must also comply with the radiated emission limits specified in §15.209(a) (see §15.205(c)).

ISED:

In any 100 kHz bandwidth outside the frequency band in which the spread spectrum or digitally modulated device is operating, the RF power that is produced shall be at least 20 dB below that in the 100 kHz bandwidth within the band that contains the highest level of the desired power, based on either an RF conducted or a radiated measurement, provided that the transmitter demonstrates compliance with the peak conducted power limits. If the transmitter complies with the conducted power limits based on the use of root-mean-square averaging over a time interval, as permitted under section 5.4(d), the attenuation required shall be 30 dB instead of 20 dB. Attenuation below the general field strength limits specified in RSS-Gen is not required.

Table 8.3-1: FCC §15.209 and RSS-Gen – Radiated emission limits

Frequency, MHz	Field strength of emissions		Measurement distance, m
	µV/m	dBµV/m	
0.009–0.490	2400/F	67.6 – 20 × log ₁₀ (F)	300
0.490–1.705	24000/F	87.6 – 20 × log ₁₀ (F)	30
1.705–30.0	30	29.5	30
30–88	100	40.0	3
88–216	150	43.5	3
216–960	200	46.0	3
above 960	500	54.0	3

Notes: In the emission table above, the tighter limit applies at the band edges.

For frequencies above 1 GHz the limit on peak RF emissions is 20 dB above the maximum permitted average emission limit applicable to the equipment under test

Table 8.3-2: ISED restricted frequency bands

MHz	MHz	MHz	GHz
0.090–0.110	12.51975–12.52025	399.9–410	5.35–5.46
2.1735–2.1905	12.57675–12.57725	608–614	7.25–7.75
3.020–3.026	13.36–13.41	960–1427	8.025–8.5
4.125–4.128	16.42–16.423	1435–1626.5	9.0–9.2
4.17725–4.17775	16.69475–16.69525	1645.5–1646.5	9.3–9.5
4.20725–4.20775	16.80425–16.80475	1660–1710	10.6–12.7
5.677–5.683	25.5–25.67	1718.8–1722.2	13.25–13.4
6.215–6.218	37.5–38.25	2200–2300	14.47–14.5
6.26775–6.26825	73–74.6	2310–2390	15.35–16.2
6.31175–6.31225	74.8–75.2	2655–2900	17.7–21.4
8.291–8.294	108–138	3260–3267	22.01–23.12
8.362–8.366	156.52475–156.52525	3332–3339	23.6–24.0
8.37625–8.38675	156.7–156.9	3345.8–3358	31.2–31.8
8.41425–8.41475	240–285	3500–4400	36.43–36.5
12.29–12.293	322–335.4	4500–5150	Above 38.6

Note: Certain frequency bands listed in Table 8.3-2 and above 38.6 GHz are designated for low-power licence-exempt applications. These frequency bands and the requirements that apply to the devices are set out in this Standard

Table 8.3-3: FCC restricted frequency bands

MHz	MHz	MHz	GHz
0.090–0.110	16.42–16.423	399.9–410	4.5–5.15
0.495–0.505	16.69475–16.69525	608–614	5.35–5.46
2.1735–2.1905	16.80425–16.80475	960–1240	7.25–7.75
4.125–4.128	25.5–25.67	1300–1427	8.025–8.5
4.17725–4.17775	37.5–38.25	1435–1626.5	9.0–9.2
4.20725–4.20775	73–74.6	1645.5–1646.5	9.3–9.5
6.215–6.218	74.8–75.2	1660–1710	10.6–12.7
6.26775–6.26825	108–121.94	1718.8–1722.2	13.25–13.4
6.31175–6.31225	123–138	2200–2300	14.47–14.5
8.291–8.294	149.9–150.05	2310–2390	15.35–16.2
8.362–8.366	156.52475–156.52525	2483.5–2500	17.7–21.4
8.37625–8.38675	156.7–156.9	2690–2900	22.01–23.12
8.41425–8.41475	162.0125–167.17	3260–3267	23.6–24.0
12.29–12.293	167.72–173.2	3332–3339	31.2–31.8
12.51975–12.52025	240–285	3345.8–3358	36.43–36.5
12.57675–12.57725	322–335.4	3600–4400	Above 38.6
13.36–13.41			

8.3.2 Test summary

Test date	June 27, 2017	Temperature	23 °C
Test engineer	Andrey Adelberg	Air pressure	1009 mbar
Verdict	Pass	Relative humidity	33 %

8.3.3 Observations, settings and special notes

The spectrum was searched from 30 MHz to the 10th harmonic.
 EUT was set to transmit with 100 % duty cycle.
 Radiated measurements were performed at a distance of 3 m.
 Since fundamental power was tested using peak method, the spurious emissions limit is -20 dBc/100 kHz

Spectrum analyser settings for radiated measurements within restricted bands below 1 GHz:

Resolution bandwidth:	100 kHz
Video bandwidth:	300 kHz
Detector mode:	Peak
Trace mode:	Max Hold

Spectrum analyser settings for peak radiated measurements within restricted bands above 1 GHz:

Resolution bandwidth:	1 MHz
Video bandwidth:	3 MHz
Detector mode:	Peak
Trace mode:	Max Hold

Spectrum analyser settings for average radiated measurements within restricted bands above 1 GHz:

Resolution bandwidth:	1 MHz
Video bandwidth:	10 Hz
Detector mode:	Peak
Trace mode:	Max Hold

Spectrum analyser settings for conducted spurious emissions measurements:

Resolution bandwidth:	100 kHz
Video bandwidth:	300 kHz
Detector mode:	Peak
Trace mode:	Max Hold

8.3.4 Test data

Table 8.3-4: Radiated field strength measurement results

Channel	Frequency, MHz	Peak Field strength, dB μ V/m		Margin, dB	Average Field strength, dB μ V/m		Margin, dB
		Measured	Limit		Measured	Limit	
Low	2390.0	41.97	74.00	32.03	35.54	54.00	18.46
High	2483.5	46.82	74.00	27.18	41.35	54.00	12.65

Notes: Field strength includes correction factor of antenna, cable loss, amplifier, and attenuators where applicable.

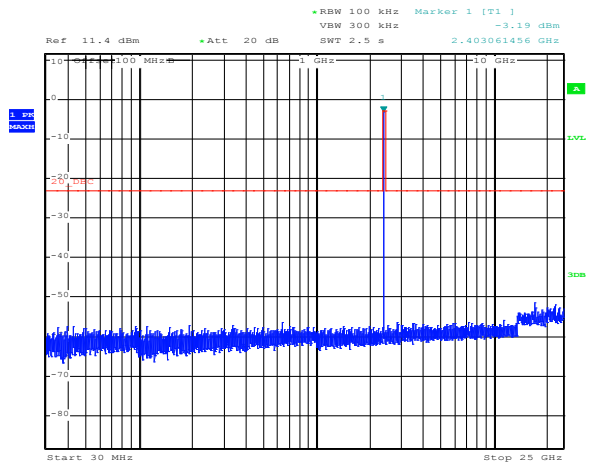

Date: 27.JUN.2017 14:54:03

Figure 8.3-1: Conducted spurious emissions on low channel

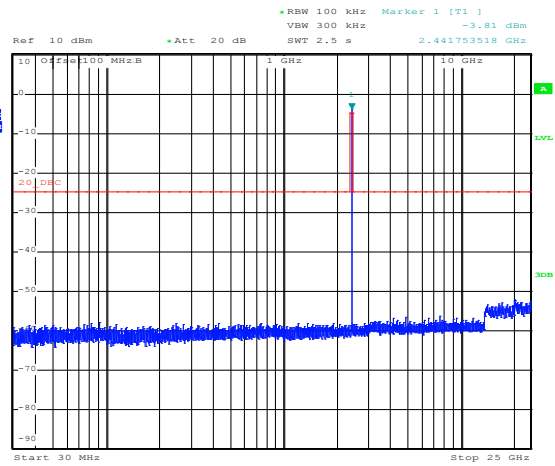

Date: 28.JUN.2017 14:25:41

Figure 8.3-2: Conducted spurious emissions on mid channel

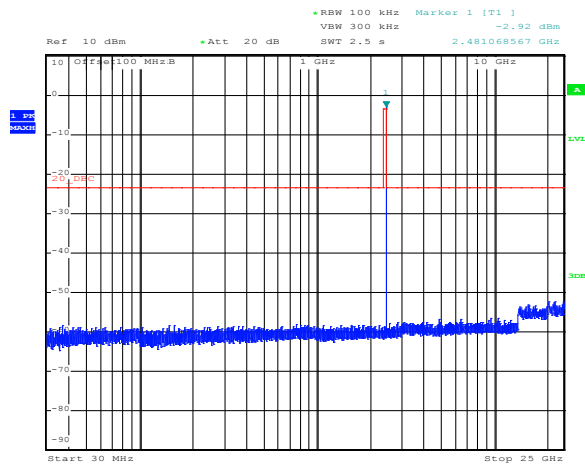

Date: 28.JUN.2017 13:32:05

Figure 8.3-3: Conducted spurious emissions on high channel

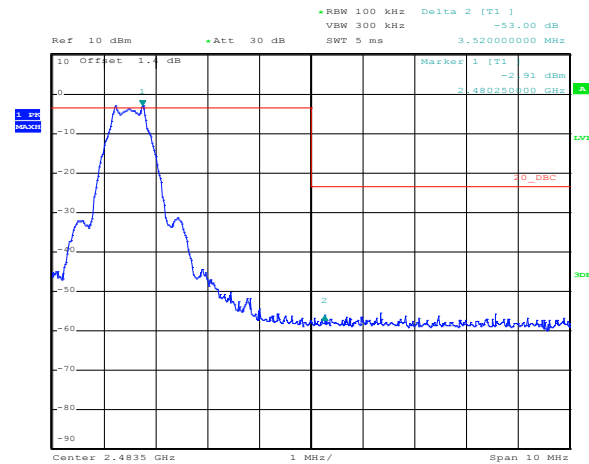
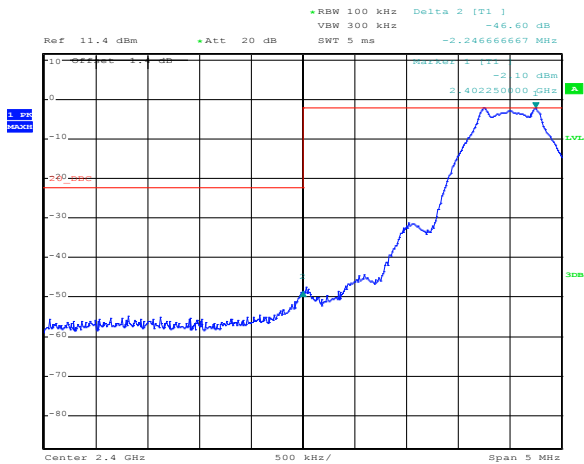

Date: 27.JUN.2017 14:53:15

Date: 28.JUN.2017 13:29:01

Figure 8.3-4: Lower band edge emission outside restricted bands at 2.4 GHz

Figure 8.3-5: Upper band edge emission outside restricted bands at 2.4835 GHz

EUT was scanned for radiated spurious emissions falling into restricted bands within 30 MHz to 25 GHz frequency range. No emissions originating from the RF transmission were detected within 20 dB below the limits.

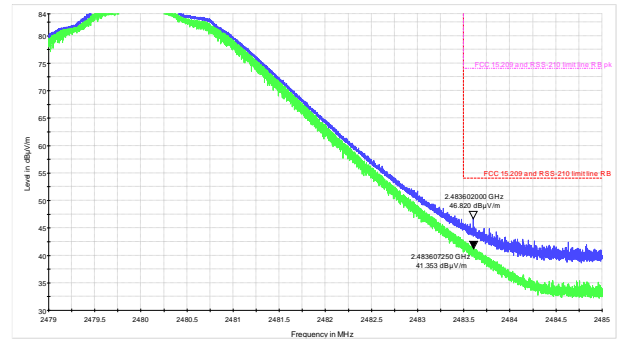
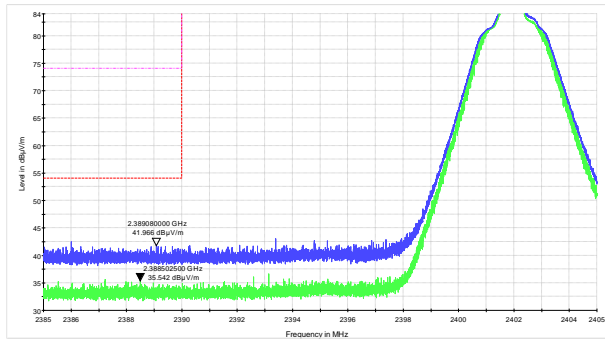

Figure 8.3-6: Lower band edge emission within restricted bands at 2.4 GHz

Figure 8.3-7: Upper band edge emission within restricted bands at 2.4835 GHz

8.4 FCC 15.247(e) and RSS-247 5.2(b) Power spectral density for digitally modulated devices

8.4.1 Definitions and limits

FCC:
 For digitally modulated systems, the power spectral density conducted from the intentional radiator to the antenna shall not be greater than 8 dBm in any 3 kHz band during any time interval of continuous transmission. This power spectral density shall be determined in accordance with the provisions of paragraph (b) of this section. The same method of determining the conducted output power shall be used to determine the power spectral density.

ISED:
 The transmitter power spectral density conducted from the transmitter to the antenna shall not be greater than 8 dBm in any 3 kHz band during any time interval of continuous transmission. This power spectral density shall be determined in accordance with the provisions of section 5.4(d), (i.e. the power spectral density shall be determined using the same method as is used to determine the conducted output power).

8.4.2 Test summary

Test date	June 27, 2017	Temperature	23 °C
Test engineer	Andrey Adelberg	Air pressure	1009 mbar
Verdict	Pass	Relative humidity	33 %

8.4.3 Observations, settings and special notes

The test was performed using method described in section 10.2 Method PKPSD (peak PSD)

Resolution bandwidth:	3 kHz
Video bandwidth:	≥3 × RBW
Frequency span:	1.5 times the OBW
Detector mode:	Peak
Trace mode:	Max hold

8.4.4 Test data

Table 8.4-1: PSD measurements results

Frequency, MHz	PSD, dBm/3 kHz	PSD limit, dBm/3 kHz	Margin, dB
2402	-15.00	8.00	23.00
2442	-13.81	8.00	21.81
2480	-14.28	8.00	22.28

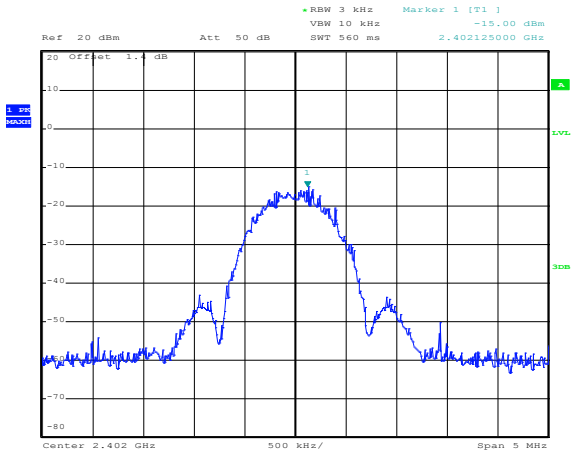

Date: 27.JUN.2017 14:51:24

Figure 8.4-1: PSD sample plot on low channel

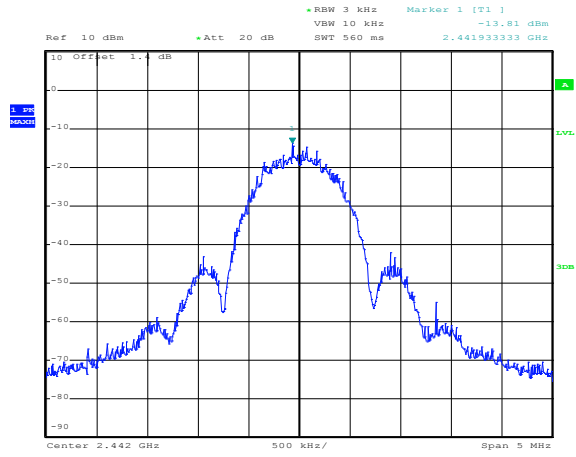

Date: 28.JUN.2017 14:20:37

Figure 8.4-2: PSD sample plot on mid channel

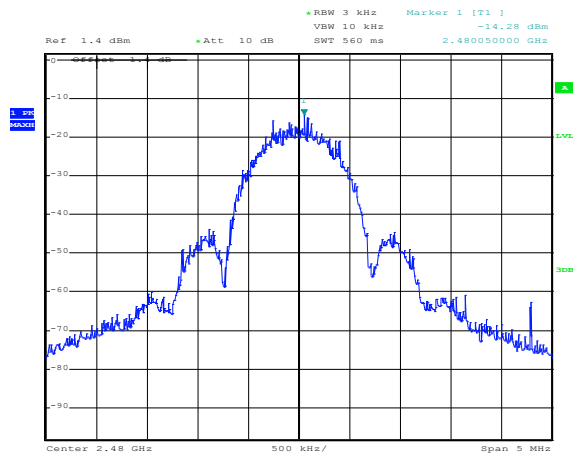

Date: 28.JUN.2017 13:27:52

Figure 8.4-3: PSD sample plot on high channel

Section 9. Block diagrams of test set-ups

9.1 Radiated emissions set-up for frequencies below 1 GHz

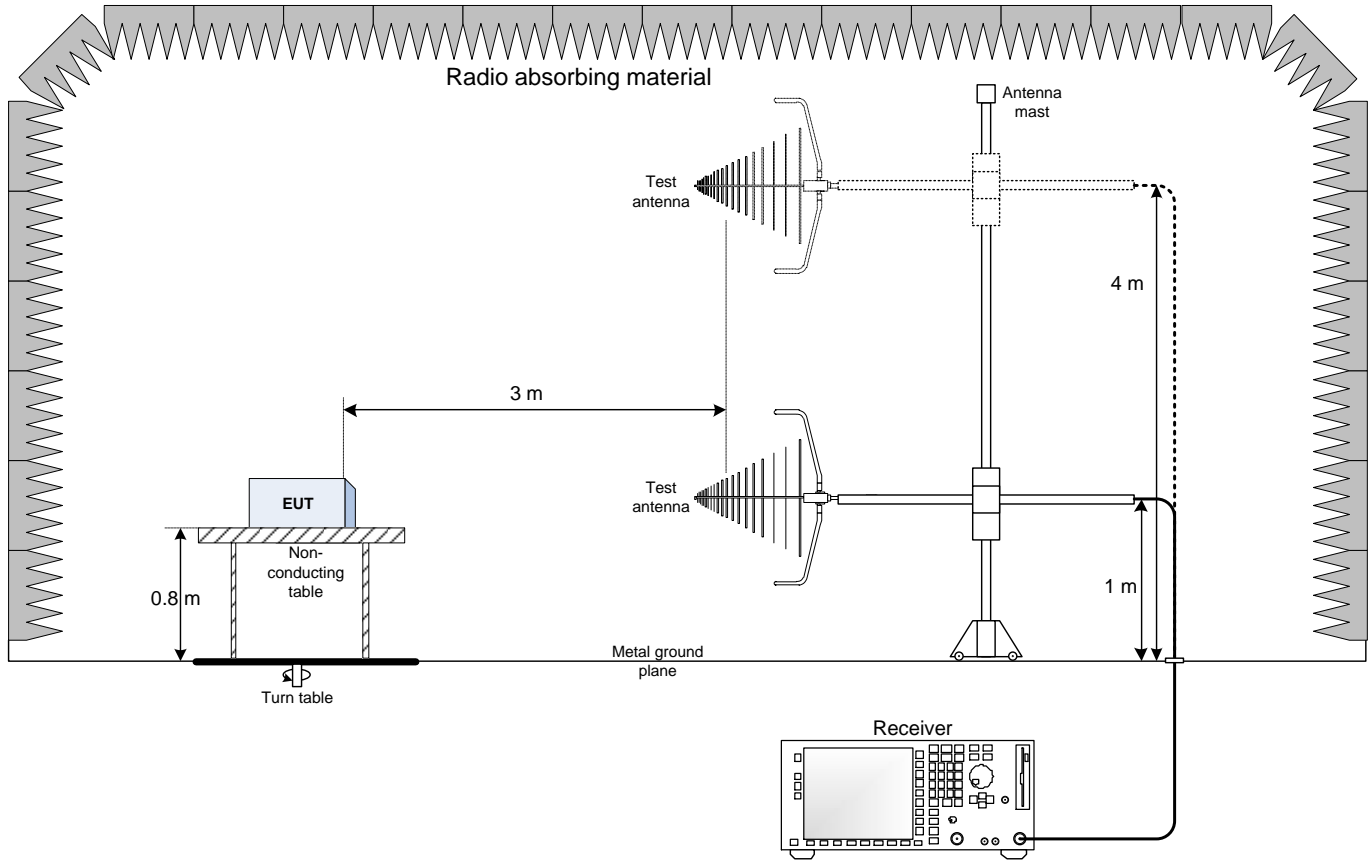

9.2 Radiated emissions set-up for frequencies above 1 GHz

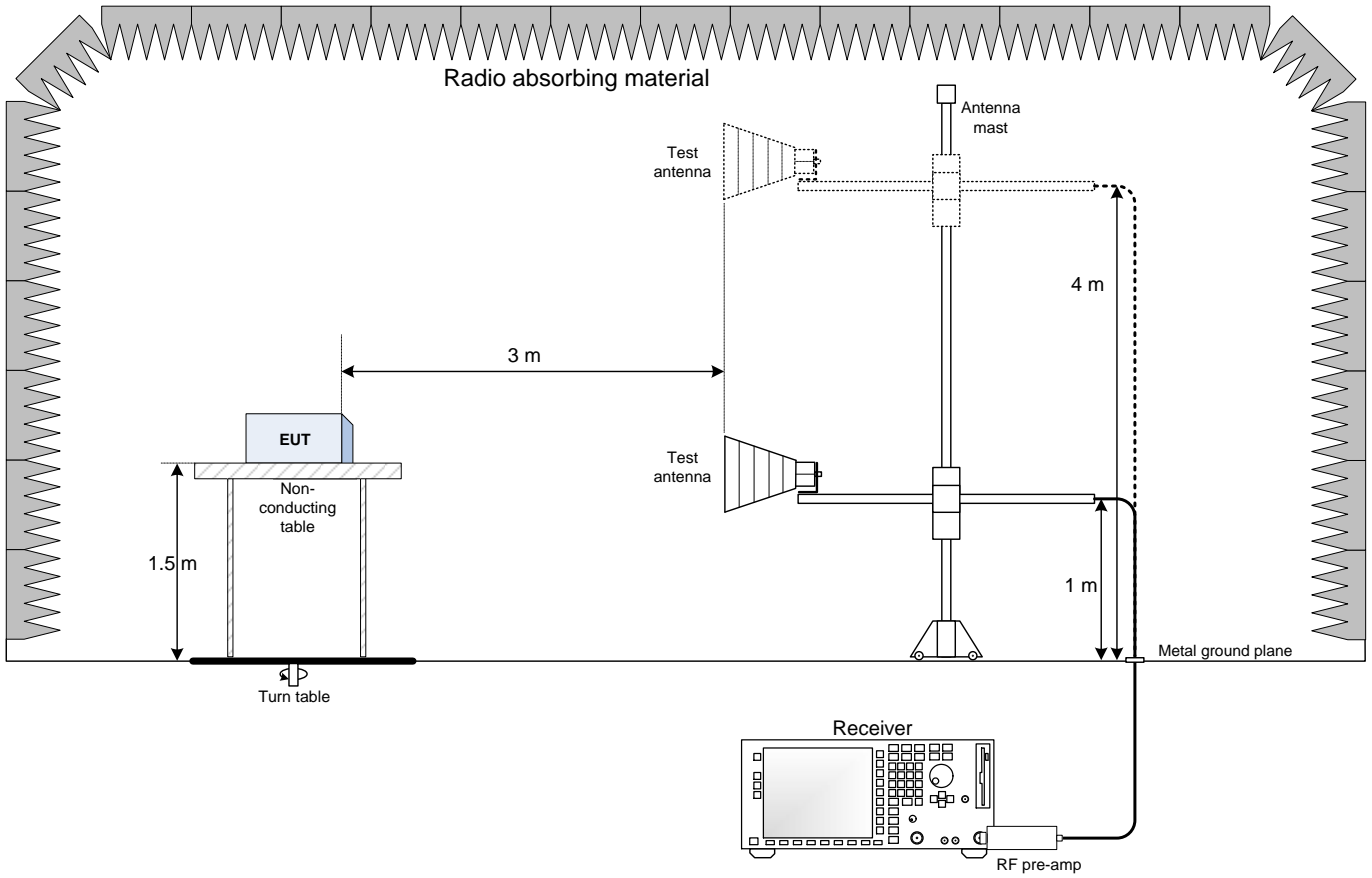

9.3 Conducted emissions set-up at antenna port

