

TEST REPORT

Product Name : **Wireless Router**
Model Number : **SR3000, SR3000-lite, SR3000-5G, SR3000-5G-lite**
FCC ID : **2AL9D-SR3000**

Prepared for : Flyingvoice Network Technology Co., Ltd
Address : Room 01-02, Floor 18, Building 1, Nanshan Zhiyuan,
Chongwen Park, Taoyuan Street, Nanshan
District, Shenzhen, China

Prepared by : EMTEK (SHENZHEN) CO., LTD.
Address : Building 69, Majialong Industry Zone, Nanshan District,
Shenzhen, Guangdong, China

Tel: (0755) 26954280
Fax: (0755) 26954282

Report Number : ENS2403220173W00101R
Date(s) of Tests : April 17, 2024 to May 31, 2024
Date of issue : June 4, 2024

TABLE OF CONTENTS

1 TEST RESULT CERTIFICATION	3
2 EUT TECHNICAL DESCRIPTION	5
3 SUMMARY OF TEST RESULT	6
4 TEST METHODOLOGY	7
4.1 GENERAL DESCRIPTION OF APPLIED STANDARDS	7
4.2 MEASUREMENT EQUIPMENT USED	7
4.3 DESCRIPTION OF TEST MODES	8
5 FACILITIES AND ACCREDITATIONS	9
5.1 FACILITIES	9
5.2 EQUIPMENT	9
5.3 LABORATORY ACCREDITATIONS AND LISTINGS	10
6 TEST SYSTEM UNCERTAINTY	11
7 SETUP OF EQUIPMENT UNDER TEST	12
7.1 RADIO FREQUENCY TEST SETUP 1	12
7.2 RADIO FREQUENCY TEST SETUP 2	12
7.3 CONDUCTED EMISSION TEST SETUP	15
7.4 BLOCK DIAGRAM CONFIGURATION OF TEST SYSTEM	16
7.5 SUPPORT EQUIPMENT	16
8 TEST REQUIREMENTS	17
8.1 ON TIME AND DUTY CYCLE	17
8.2 DTS 6DB BANDWIDTH	19
8.3 DTS 99% BANDWIDTH	45
8.4 MAXIMUM PEAK CONDUCTED OUTPUT POWER	47
8.5 MAXIMUM POWER SPECTRAL DENSITY	61
8.6 UNWANTED EMISSIONS IN NON-RESTRICTED FREQUENCY BANDS	75
8.7 RADIATED SPURIOUS EMISSION	135
8.8 CONDUCTED EMISSION TEST	148
8.9 ANTENNA APPLICATION	151

1 TEST RESULT CERTIFICATION

Applicant : Flyingvoice Network Technology Co., Ltd
Address : Room 01-02, Floor 18, Building 1, Nanshan Zhiyuan, Chongwen Park, Taoyuan Street, Nanshan District, Shenzhen, China
Manufacturer : Flyingvoice Network Technology Co., Ltd
Address : Room 01-02, Floor 18, Building 1, Nanshan Zhiyuan, Chongwen Park, Taoyuan Street, Nanshan District, Shenzhen, China
EUT : Wireless Router
Model Name : SR3000, SR3000-lite, SR3000-5G, SR3000-5G-lite
Trademark : FLYINGVOICE

Measurement Procedure Used:

APPLICABLE STANDARDS	
STANDARD	TEST RESULT
FCC 47 CFR Part 2 , Subpart J FCC 47 CFR Part 15, Subpart C	PASS
IC RSS-GEN, Issue 5(04-2018)+A1(03-2019)+A2(02-2021) IC RSS-247 Issue 2(02-2017)	PASS

The above equipment was tested by EMTEK(SHENZHEN) CO., LTD. The test data, data evaluation, test procedures, and equipment configurations shown in this report were made in accordance with the procedures given in ANSI C63.10 (2013) and the energy emitted by the sample EUT tested as described in this report is in compliance with the requirements of FCC Rules Part 2, Part 15.247, IC RSS-247 Issue 2 and IC RSS-GEN, Issue 5.

The test results of this report relate only to the tested sample identified in this report.

Date of Test : April 17, 2024 to May 31, 2024

Prepared by : 
Una Yu /Editor

Reviewer : 
Joe Xia /Supervisor

Approve & Authorized Signer : 
Lisa Wang/Manager



Modified History

Version	Report No.	Revision Date	Summary
Ver.1.0	ENS2403220173W00101R	/	Original Report



2 EUT TECHNICAL DESCRIPTION

Characteristics	Description
Product:	Wireless Router
Model Number:	SR3000, SR3000-lite, SR3000-5G, SR3000-5G-lite (Note: All models are identical in circuitry and electrical, mechanical and physical construction; the difference are appearance and model for trading purpose. Mode SR3000 was Chosen final test.)
Sample Number:	2#
IEEE 802.11 WLAN Mode Supported:	802.11b 802.11g 802.11n/ax(20MHz channel bandwidth) 802.11n/ax(40MHz channel bandwidth)
Modulation:	DSSS with DBPSK/DQPSK/CCK for 802.11b; OFDM with BPSK/QPSK/16QAM/64QAM for 802.11g/n; OFDM with BPSK/QPSK/16QAM/64QAM/256QAM/1024QAM for 802.11ax;
Operating Frequency Range:	2412-2462MHz for 802.11b/g/n(HT20)/ax(HE20); 2422-2452MHz for 802.11n(HT40)/ax(HE40);
Number of Channels:	11 channels for 802.11b/g/n(HT20)/ax(HE20); 7 Channels for 802.11n(HT40)/ax(HE40);
Transmit Power Max:	16.84 dBm
Antenna Type:	PCB Antenna
Antenna Gain:	Antenna 1: 4.9 dBi Antenna 2: 2.8 dBi
Power Supply:	DC 12V from Adapter
Adapter:	Model:GQ24-120200-AX Input: AC100-240V, 50Hz/60Hz 1.0A Max. Output:12.0V, 2.0A, 24.0W
Power Supply:	AC 120V/60Hz
Date of Received	April 17, 2024
Temperature Range	0°C ~ +50°C
FVIN:	SR3000-MAIN-V1_4

Note: for more details, please refer to the User's manual of the EUT.

3 SUMMARY OF TEST RESULT

FCC Part Clause	IC Part Clause	Test Parameter	Verdict	Remark
15.247(a)(2)	RSS-247 5.2(a) RSS-Gen 6.7	Emission Bandwidth	PASS	
15.247(b)(3)	RSS-247 5.4(d) RSS-Gen 6.12	Maximum Peak Conducted Output Power	PASS	
15.247(e)	RSS-247 5.2(b) RSS-Gen 6.12	Maximum Power Spectral Density Level	PASS	
15.247(d)	RSS-247 5.5	Unwanted Emission Into Non-Restricted Frequency Bands	PASS	
15.247(d)	RSS-247 5.5	Unwanted Emission Into Restricted Frequency Bands (conducted)	PASS	
15.247(d) 15.209 15.205	RSS-Gen 8.9 RSS-Gen 8.10 RSS-Gen 6.13 RSS-247 3.3 RSS-247 5.5	Radiated Spurious Emission	PASS	
15.207	RSS-Gen 8.8	Conducted Emission Test	PASS	
15.203 15.247(b)	RSS-Gen 6.8 RSS-247 5.4	Antenna Application	PASS	
NOTE1: N/A (Not Applicable)				
NOTE2: According to FCC OET KDB 558074, the report use radiated measurements in the restricted frequency bands. In addition, the radiated test is also performed to ensure the emissions emanating from the device cabinet also comply with the applicable limits.				

RELATED SUBMITTAL(S) / GRANT(S):

This submittal(s) (test report) is intended for **FCC ID:2AL9D-SR3000** filing to comply with Section 15.247 of the FCC Part 15, Subpart C Rules.

4 TEST METHODOLOGY

4.1 GENERAL DESCRIPTION OF APPLIED STANDARDS

According to its specifications, the EUT must comply with the requirements of the following standards:

FCC 47 CFR Part 2, Subpart J
 FCC 47 CFR Part 15, Subpart C
 IC RSS-GEN, Issue 5(04-2018)+A1(03-2019)+A2(02-2021)
 IC RSS-247 Issue 2(02-2017)
 FCC KDB 558074 D01 15.247 Meas Guidance v05r02
 FCC KDB 662911 D01 Multiple Transmitter Output v02r01

4.2 MEASUREMENT EQUIPMENT USED

Conducted Emission Test Equipment

Equipment	Manufacturer	Model No.	Serial No.	Last Cal.	Cal. Interval
EMI Test Receiver	Rohde & Schwarz	ESCI	101384	2024/5/11	1Year
AMN	Rohde & Schwarz	ENV216	101161	2024/5/10	1Year

For Spurious Emissions Test

Equipment	Manufacturer	Model No.	Serial No.	Last Cal.	Cal. Interval
EMI Test Receiver	Rohde & Schwarz	ESU 26	100154	2024/5/10	1Year
Pre-Amplifie	Lunar EM	LNA30M3G-25	J10100000070	2024/5/10	1Year
Bilog Antenna	Schwarzbeck	VULB9163	660	2023/5/16	2 Year
Horn antenna	Schwarzbeck	BBHA9120D	9120D-1177	2023/5/12	2 Year
Pre-Amplifie	SKET	LNPA_0118G-45	SK2019051801	2024/5/10	1Year
Loop Antenna	Schwarzbeck	FMZB1519	1519-012	2023/5/12	2 Year
Spectrum Analyzer	Rohde & Schwarz	FSV40	100967	2024/5/10	1Year
Horn antenna	Schwarzbeck	BBHA9170	9170-399	2023/5/12	2 Year
Band reject Filter(50dB)	WI/DE	WRCGV-2400(2400-2485MHz)	2	2024/5/10	1 Year

For other test items:

Equipment	Manufacturer	Model No.	Serial No.	Last Cal.	Cal. Interval
Signal Analyzer	Agilent	N9010A	MY53470879	2024/5/10	1Year
Vector Signal Generater	Agilent	N5182B	MY53050878	2024/5/10	1Year
Analog Signal Generator	Agilent	N5171B	MY53050553	2024/5/10	1Year
RF Control Unit(Power Meter)	Tonscend	JS0806-2	\	2024/5/10	1Year
Temperature&Humidity Chamber	ESPEC	EL-02KA	12107166	2024/5/10	1Year

4.3 DESCRIPTION OF TEST MODES

The EUT has been tested under its typical operating condition.

The EUT configuration for testing is installed on RF field strength measurement to meet the Commissions requirement and operating in a manner which intends to maximize its emission characteristics in a continuous normal application.

The Transmitter was operated in the normal operating mode. The TX frequency was fixed which was for the purpose of the measurements.

Test of channel included the lowest and middle and highest frequency to perform the test, then record on this report.

Those data rates (802.11b: 1 Mbps; 802.11g: 6 Mbps; 802.11n (HT20): MCS0; 802.11n (HT40): MCS0; 802.11ax (HE20): MCS0; 802.11ax (HE40): MCS0;) were used for all test.

Pre-defined engineering program for regulatory testing used to control the EUT for staying in continuous transmitting and receiving mode is programmed.

Frequency and Channel list for 802.11 b/g/n(HT20)/ax(HE20):

Channel	Frequency (MHz)	Channel	Frequency (MHz)	Channel	Frequency (MHz)
1	2412	5	2432	9	2452
2	2417	6	2437	10	2457
3	2422	7	2442	11	2462
4	2427	8	2447		

Frequency and Channel list for 802.11n(HT40)/ax(HE40):

Channel	Frequency (MHz)	Channel	Frequency (MHz)	Channel	Frequency (MHz)
3	2422	6	2437	9	2452
4	2427	7	2442		
5	2432	8	2447		

Test Frequency and Channel for 802.11 b/g/n(HT20)/ax(HE20):

Lowest Frequency		Middle Frequency		Highest Frequency	
Channel	Frequency (MHz)	Channel	Frequency (MHz)	Channel	Frequency (MHz)
1	2412	6	2437	11	2462

Test Frequency and channel for 802.11n(HT40)/ax(HE40):

Lowest Frequency		Middle Frequency		Highest Frequency	
Channel	Frequency (MHz)	Channel	Frequency (MHz)	Channel	Frequency (MHz)
3	2422	6	2437	9	2452

Multi-antenna correlation:

<input checked="" type="checkbox"/>	Transmit Signals are Correlated Directional gain = $10 \log[(10^{G1/20} + 10^{G2/20} + \dots + 10^{GN/20})^2 / N_{ANT}] \text{ dBi}$
<input type="checkbox"/>	All Transmit Signals are Completely Uncorrelated Directional gain = $10 \log[(10^{G1/10} + 10^{G2/10} + \dots + 10^{GN/10}) / N_{ANT}] \text{ dBi}$

Directional gain = $10 \log [(10^{4.9/20} + 10^{2.8/20})^2/2] \text{ dBi}=6.92 \text{ dBi}$

5 FACILITIES AND ACCREDITATIONS

5.1 FACILITIES

All measurement facilities used to collect the measurement data are located at:

EMTEK (Shenzhen) Co., Ltd.

Building 69, Majialong Industry Zone District, Nanshan District, Shenzhen, China

The sites are constructed in conformance with the requirements of ANSI C63.7, ANSI C63.4 and CISPR Publication 22.

5.2 EQUIPMENT

Radiated emissions are measured with one or more of the following types of linearly polarized antennas: tuned dipole, biconical, log periodic, bi-log, and/or ridged waveguide, horn. Spectrum analyzers with preselectors and quasi-peak detectors are used to perform radiated measurements.

Conducted emissions are measured with Line Impedance Stabilization Networks and EMI Test Receivers.

Calibrated wideband preamplifiers, coaxial cables, and coaxial attenuators are also used for making measurements.

All receiving equipment conforms to CISPR Publication 16-1, "Radio Interference Measuring Apparatus and Measurement Methods."

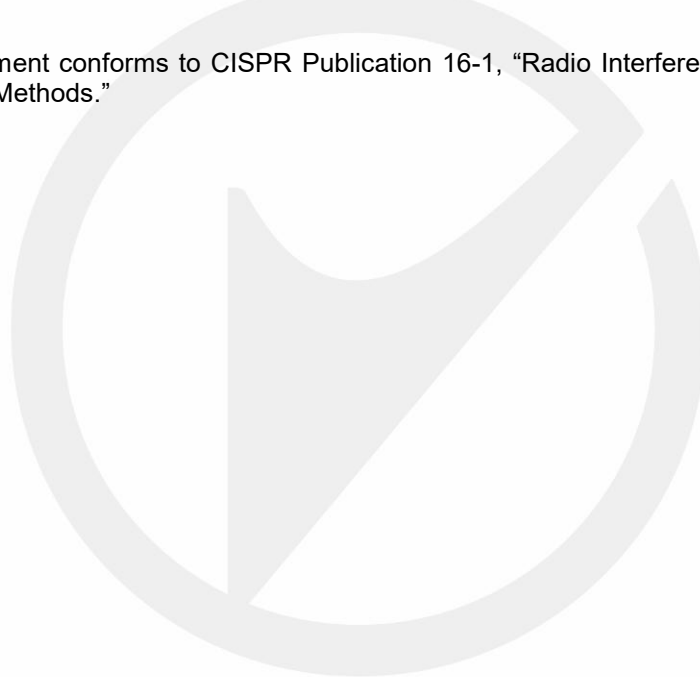

5.3 LABORATORY ACCREDITATIONS AND LISTINGS**Site Description**

EMC Lab. : **Accredited by CNAS**
The Certificate Registration Number is L2291.
The Laboratory has been assessed and proved to be in compliance with CNAS-CL01 (identical to ISO/IEC 17025:2017)

Accredited by FCC
Designation Number: CN1204
Test Firm Registration Number: 882943

Accredited by A2LA
The Certificate Number is 4321.01.

Accredited by Industry Canada
The Conformity Assessment Body Identifier is CN0008

Name of Firm : EMTEK (SHENZHEN) CO., LTD.
Site Location : Building 69, Majialong Industry Zone,
Nanshan District, Shenzhen, Guangdong, China

6 TEST SYSTEM UNCERTAINTY

The following measurement uncertainty levels have been estimated for tests performed on the apparatus:

Test Parameter	Measurement Uncertainty
Radio Frequency	$\pm 1 \times 10^{-5}$
Maximum Peak Output Power Test	$\pm 1.0\text{dB}$
Conducted Emissions Test	$\pm 2.0\text{dB}$
Radiated Emission Test	$\pm 2.0\text{dB}$
Power Density	$\pm 2.0\text{dB}$
Occupied Bandwidth Test	$\pm 1.0\text{dB}$
Band Edge Test	$\pm 3\text{dB}$
All emission, radiated	$\pm 3\text{dB}$
Antenna Port Emission	$\pm 3\text{dB}$
Temperature	$\pm 0.5^\circ\text{C}$
Humidity	$\pm 3\%$

Measurement Uncertainty for a level of Confidence of 95%

7 SETUP OF EQUIPMENT UNDER TEST

7.1 RADIO FREQUENCY TEST SETUP 1

The WLAN component's antenna ports(s) of the EUT are connected to the measurement instrument per an appropriate attenuator. The EUT is controlled by PC/software to emit the specified signals for the purpose of measurements.

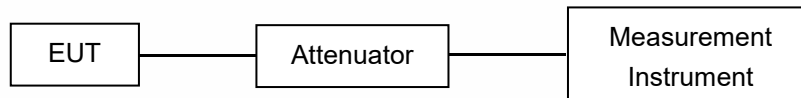

7.2 RADIO FREQUENCY TEST SETUP 2

The test site semi-anechoic chamber has met the requirement of NSA tolerance 4 dB according to the standards: ANSI C63.10. The test distance is 3m. The setup is according to the requirements in Section 13.1.4.1 of ANSI C63.10-2013 and CAN/CSA-CEI/IEC CISPR 22.

The maximal emission value is acquired by adjusting the antenna height, polarisation and turntable azimuth. Normally, the height range of antenna is 1 m to 4 m, the azimuth range of turntable is 0° to 360°, and the receive antenna has two polarizations Vertical (V) and Horizontal (H).

Below 30MHz:

The EUT is placed on a turntable 0.8 meters above the ground in the chamber, 3 meter away from the antenna (loop antenna). The Antenna should be positioned with its plane vertical at the specified distance from the EUT and rotated about its vertical axis for maximum response at each azimuth about the EUT. The center of the loop shall be 1 m above the ground. For certain applications, the loop antenna plane may also need to be positioned horizontally at the specified distance from the EUT.

Above 30MHz:

The EUT is placed on a turntable 0.8 meters above the ground in the chamber, 3 meter away from the antenna. The maximal emission value is acquired by adjusting the antenna height, polarisation and turntable azimuth. Normally, the height range of antenna is 1 m to 4 m, the azimuth range of turntable is 0° to 360°, and the receive antenna has two polarizations Vertical (V) and Horizontal (H).

Above 1GHz:

The EUT is placed on a turntable 1.5 meters above the ground in the chamber, 3 meter away from the antenna. The maximal emission value is acquired by adjusting the antenna height, polarisation and turntable azimuth. Normally, the height range of antenna is 1 m to 4 m, the azimuth range of turntable is 0° to 360°, and the receive antenna has two polarizations Vertical (V) and Horizontal (H).

Measurements shall be taken, using the following steps, at a test site that has been validated using the procedures of ANSI C63.4 or the latest CISPR 16-1-4 for measurements above 1 GHz, so as to simulate a near free-space environment (see RSS-Gen for applicable versions of ANSI and CISPR standards).

(1) Line the ground plane with absorbers between the transmitter and the receive antenna to minimize reflections. The absorbers used should have a minimum-rated attenuation of 20 dB through the measurement frequency range of interest. The absorbers shall be positioned to replicate the layout used when compliance with the applicable acceptability criterion was achieved, as set forth in the aforementioned standards on site validation.

(2) Set the height of the receive antenna to 1.5 m. The receive antenna must be one that was designed and fabricated to operate over the entire frequency range of interest, for example, an appropriate standard gain horn.

(3) The distance between the receive antenna and the radiating source shall be sufficient in order to ensure far-field conditions.

(4) Mount the transmitter at a height of 1.5 m.

(5) Configure the device under test (DUT) to produce the maximum power spectral density as measured while assessing compliance with Section 6.2.2 (i.e. channel frequency, modulation type and data rate). If the DUT is equipped with a detachable antenna and the antenna is intended for remote installation (i.e.

tower-mounted), the DUT may be substituted with a suitable signal generator. The level and frequency settings on the generator shall be set so as to reproduce the maximum power spectral density, measured within a 1 MHz bandwidth, obtained while assessing compliance to Section 6.2.2.

(6) Position the transmitter or the radiating antenna so that elevation pattern measurements can be taken.

(7) Find the 0° reference point in the horizontal plane.

(8) Care should be taken when positioning the receive antenna to avoid cross-polarization. Antennas of known mounting polarization should be assessed with the receive antenna oriented in the same polarity. If the polarization of the transmit antenna is unknown or the transmit antenna can be mounted in either polarization, e.i.r.p. measurements should be performed to find which mounting polarity provides the highest e.i.r.p. value. Testing shall be carried out with the receive antenna and the DUT mounted in each polarity.

(9) The emission shall be centred on the display of the spectrum analyzer with the following settings:

i. If the power spectral density of the DUT was assessed with a peak detector and the antenna cannot be detached from the DUT, the spectrum analyzer shall be set to a peak detector with a resolution bandwidth and video bandwidth of 1 MHz.

ii. If the power spectral density of the DUT was assessed using a sample detector with power averaging and the antenna cannot be detached from the DUT, the spectrum analyzer shall be set to a sample detector, configured to produce 100 power averages and set with a resolution bandwidth, as well as a video bandwidth of 1 MHz.

iii. If the antenna can be detached from the DUT, a continuous wave (CW) signal equal to that of the power spectral density measurement may be used, the spectrum analyzer shall be set to peak detector with a resolution bandwidth and video bandwidth of 1 MHz.

(10) Rotate the turntable 360° recording the field strength at each step. Throughout the main beam of the antenna, the step size shall be kept to a maximum of 1°.

Once outside the main beam of the antenna, the maximum step size shall be as follows, when compared to the requirements of Section 6.2.2:

i. Between 0° and 8°, maximum step size of 2°;

ii. Between 8° and 40°, maximum step size of 4°;

iii. Between 40° and 45°, maximum step size of 1°;

iv. Between 45° and 90°, maximum step size of 5°.

Once the mask reaches 90°, the mask will be inverted and the step size will follow in the same manner as above.

For the purpose of this procedure, the main beam of the antenna is defined as the 3 dB beamwidth.

(11) Convert the measured field strength values in terms of e.i.r.p. density (dBW/1 MHz) using the following equation:

$$\text{e.i.r.p. density (dBW/MHz)} = 10 \log((E \cdot r)^2 / 30)$$

E = field strength in V/m

r = measurement distance in metres

(12) Plot the results against the emission mask with reference to the horizontal plane.

(13) Using the plot, the 0° can be rotated to determine the worst-case installation tilt angle.

(14) Testing shall be performed using the highest gain antenna for every antenna type, if applicable.

(15) Antenna type(s), antenna model number(s), and worst-case tilt angle(s) necessary to remain compliant with the elevation mask requirement set forth in Section 6.2.2(3) of RSS-247 shall be clearly indicated in the user manual.

The following figure is an example of a polar elevation mask measured using the Method 1 reference to dB μ V/m at 3 m.

(a) Radiated Emission Test Set-Up, Frequency Below 30MHz

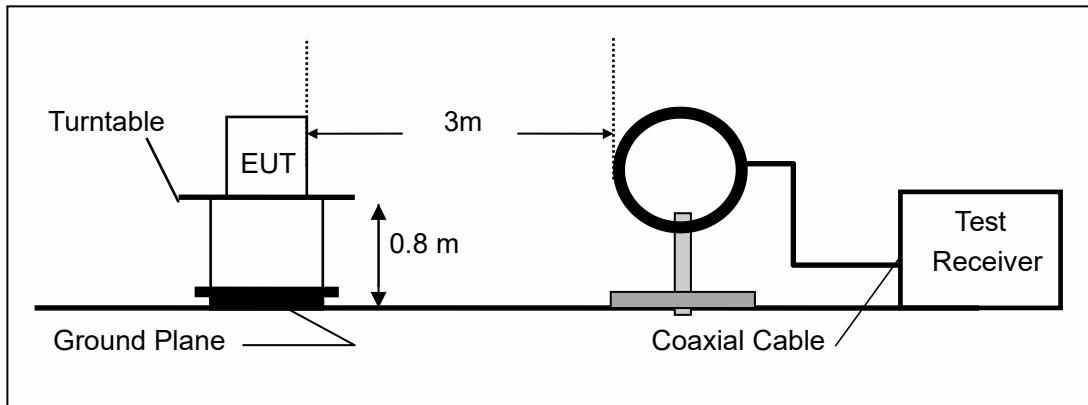

(b) Radiated Emission Test Set-Up, Frequency Below 1000MHz

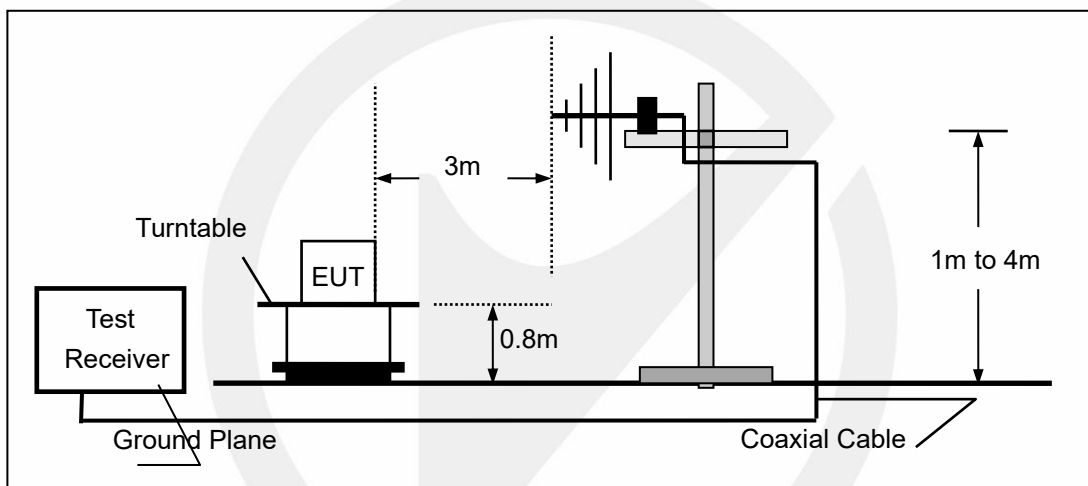

(c) Radiated Emission Test Set-Up, Frequency above 1000MHz

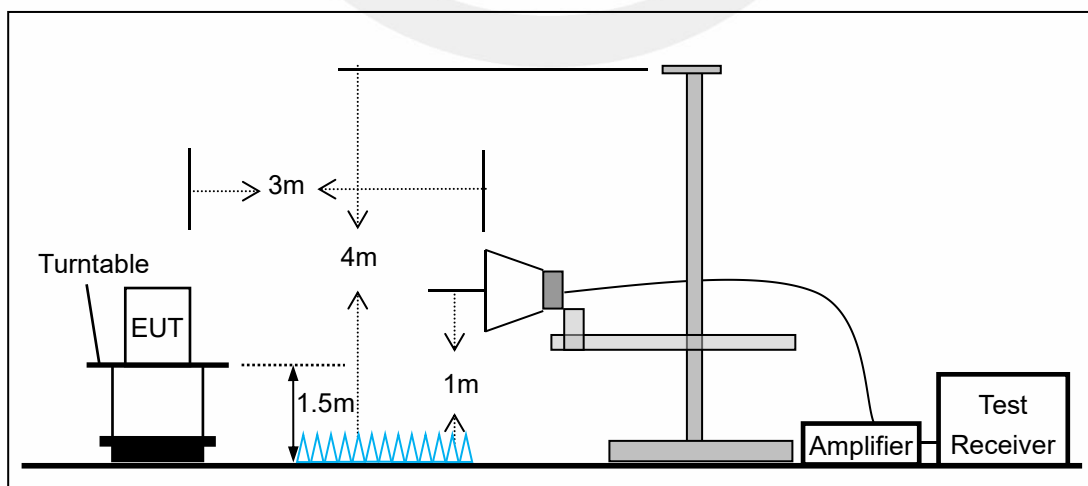

7.3 CONDUCTED EMISSION TEST SETUP

The mains cable of the EUT (maybe per AC/DC Adapter) must be connected to LISN. The LISN shall be placed 0.8 m from the boundary of EUT and bonded to a ground reference plane for LISN mounted on top of the ground reference plane. This distance is between the closest points of the LISN and the EUT. All other units of the EUT and associated equipment shall be at least 0.8m from the LISN.

Ground connections, where required for safety purposes, shall be connected to the reference ground point of the LISN and, where not otherwise provided or specified by the manufacturer, shall be of same length as the mains cable and run parallel to the mains connection at a separation distance of not more than 0.8 m.

According to the requirements in Section 13.1.4.1 of ANSI C63.10-2013 Conducted emissions from the EUT measured in the frequency range between 0.15 MHz and 30 MHz using CISPR Quasi-Peak and average detector mode.

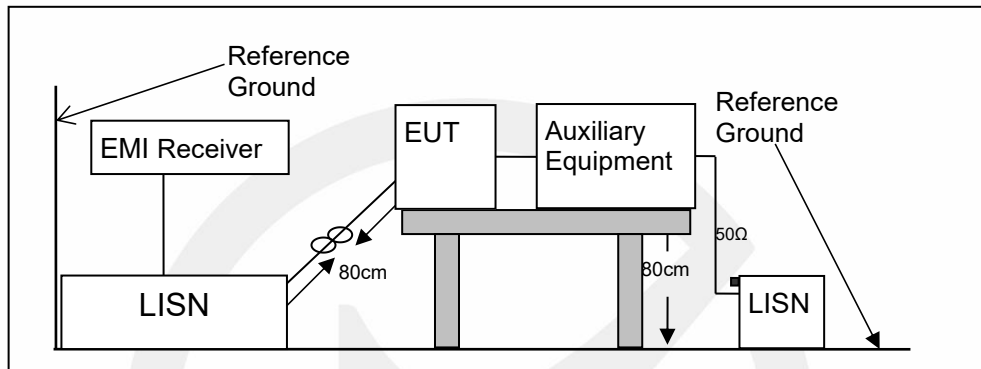

7.4 BLOCK DIAGRAM CONFIGURATION OF TEST SYSTEM

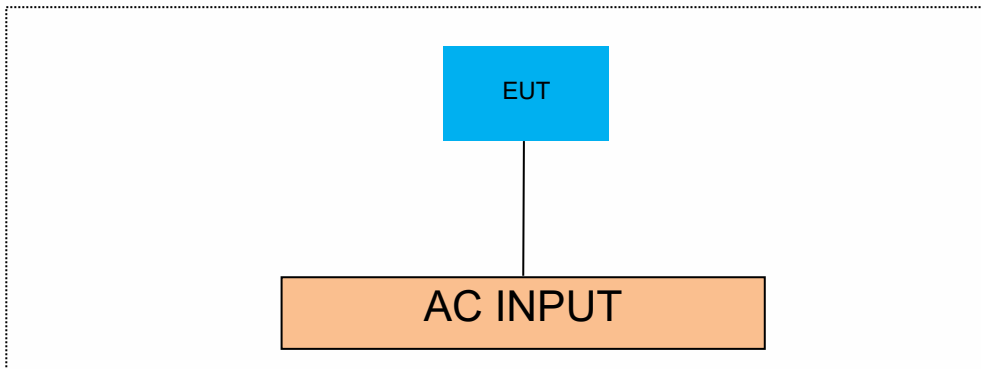

7.5 SUPPORT EQUIPMENT

EUT Cable List and Details			
Cable Description	Length (m)	Shielded/Unshielded	With / Without Ferrite
/	/	/	/

Auxiliary Cable List and Details			
Cable Description	Length (m)	Shielded/Unshielded	With / Without Ferrite
/	/	/	/

Auxiliary Equipment List and Details			
Description	Manufacturer	Model	Serial Number
/	/	/	/

Notes:

1. All the equipment/cables were placed in the worst-case configuration to maximize the emission during the test.
2. Grounding was established in accordance with the manufacturer’s requirements and conditions for the intended use.

8 TEST REQUIREMENTS

8.1 ON TIME AND DUTY CYCLE

8.1.1 Applicable Standard

According to 558074 D01 Section 6

8.1.2 Conformance Limit

N/A; for reporting purposes only.

8.1.3 Test Configuration

Test according to clause 7.1 radio frequency test setup.

8.1.4 Test Procedure

The zero-span mode on a spectrum analyzer or EMI receiver, if the response time and spacing between bins on the sweep are sufficient to permit accurate measurements of the on and off times of the transmitted signal. Set the center frequency of the instrument to the center frequency of the transmission. Set $RBW \geq EBW$ if possible; otherwise, set RBW to the largest available value. Set $VBW \geq RBW$. Set detector = peak or average. The zero-span measurement method shall not be used unless both RBW and VBW are $> 50/T$, where T is the minimum transmission duration over which the transmitter is on and is transmitting at its maximum power control level for the tested mode of operation), and the number of sweep points across duration T exceeds 100. (For example, if VBW and/or RBW are limited to 3 MHz, then the zero-span method of measuring duty cycle shall not be used if $T \leq 16.7$ microseconds.)

8.1.5 Test Results

Temperature:	25°C
Relative Humidity:	45%
ATM Pressure:	1011 mbar

Note: N/A

TestMode	Antenna	Frequency[MHz]	Transmission Duration [ms]	Transmission Period [ms]	Duty Cycle [%]	Factor
11B	Ant1	2412	0.68	1.17	58.12	2.36
	Ant2	2412	0.69	1.10	62.73	2.03
	Ant1	2437	0.69	1.11	62.16	2.06
	Ant2	2437	0.69	1.18	58.47	2.33
	Ant1	2462	0.69	1.19	57.98	2.37
	Ant2	2462	0.68	1.19	57.14	2.43
11G	Ant1	2412	1.97	2.12	92.92	0.32
	Ant2	2412	1.98	2.10	94.29	0.26
	Ant1	2437	1.98	2.11	93.84	0.28
	Ant2	2437	1.97	2.15	91.63	0.38
	Ant1	2462	1.98	2.08	95.19	0.21
	Ant2	2462	1.98	2.09	94.74	0.23
11N20MIMO	Ant1	2412	5.44	5.91	92.05	0.36
	Ant2	2412	5.43	5.92	91.72	0.38
	Ant1	2437	5.42	5.94	91.25	0.40
	Ant2	2437	5.43	5.93	91.57	0.38
	Ant1	2462	5.42	5.88	92.18	0.35
	Ant2	2462	5.44	5.87	92.67	0.33
11N40MIMO	Ant1	2422	5.42	5.92	91.55	0.38
	Ant2	2422	5.43	5.91	91.88	0.37
	Ant1	2437	5.44	5.93	91.74	0.37
	Ant2	2437	5.43	5.91	91.88	0.37
	Ant1	2452	5.43	5.93	91.57	0.38
	Ant2	2452	5.42	5.93	91.40	0.39
11AX20MIMO	Ant1	2412	5.44	5.92	91.89	0.37
	Ant2	2412	5.45	5.89	92.53	0.34
	Ant1	2437	5.45	5.92	92.06	0.36
	Ant2	2437	5.44	5.90	92.20	0.35
	Ant1	2462	5.45	5.91	92.22	0.35
	Ant2	2462	5.45	5.93	91.91	0.37
11AX40MIMO	Ant1	2422	5.44	5.90	92.20	0.35
	Ant2	2422	5.44	5.93	91.74	0.37
	Ant1	2437	5.44	5.91	92.05	0.36
	Ant2	2437	5.44	5.95	91.43	0.39
	Ant1	2452	5.43	6.39	84.98	0.71
	Ant2	2452	5.44	5.89	92.36	0.35

11B_Ant1_2412



11B_Ant2_2412

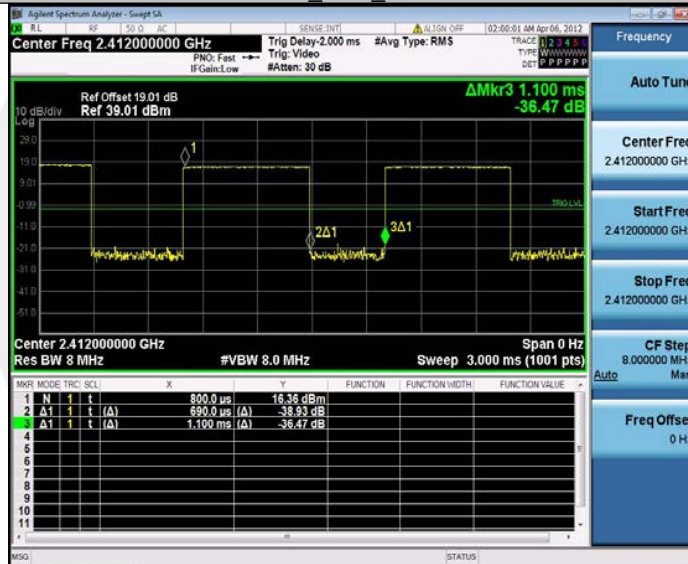

11B_Ant1_2437

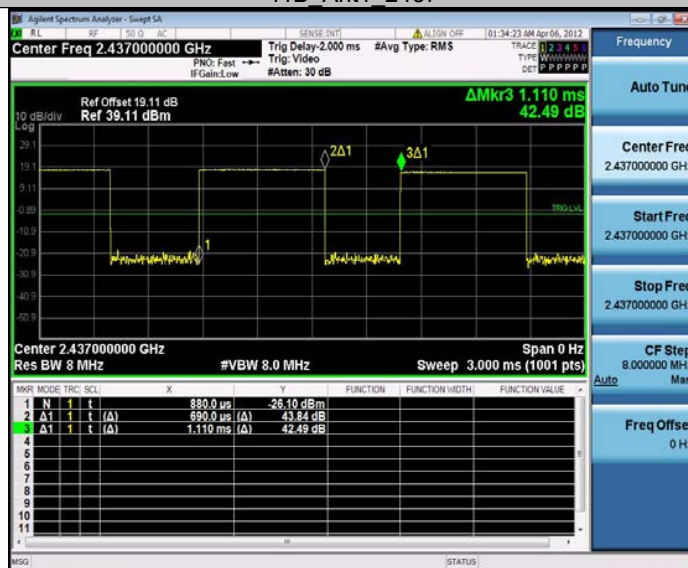

11B_Ant2_2437

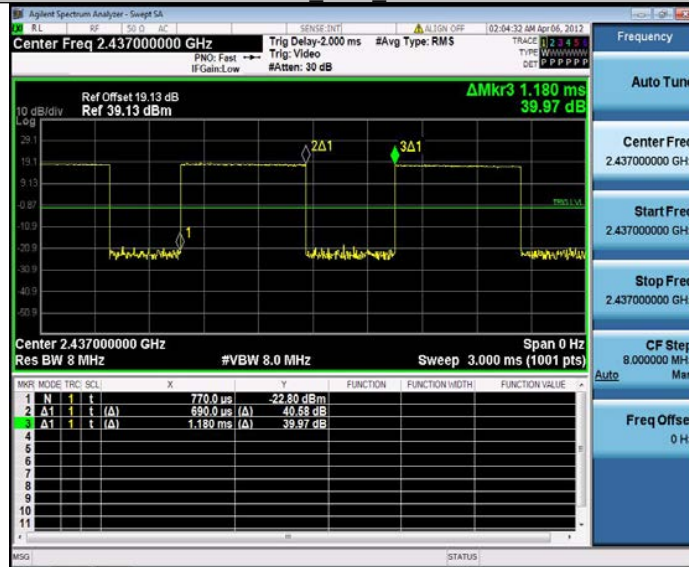

11B_Ant1_2462

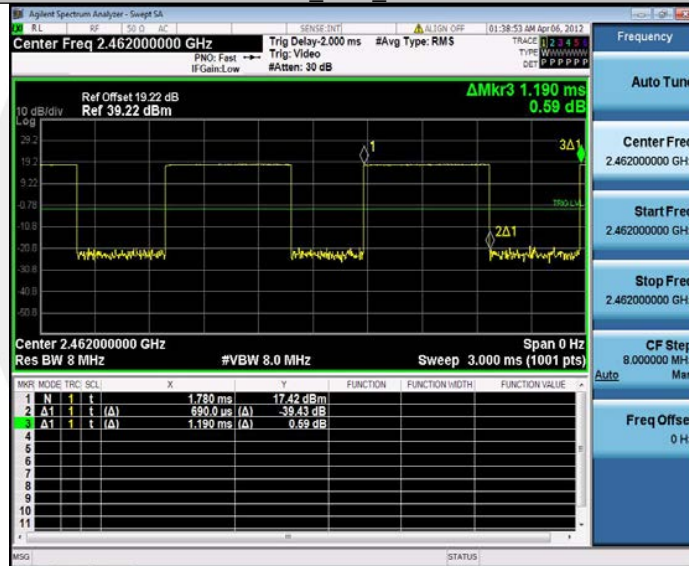

11B_Ant2_2462

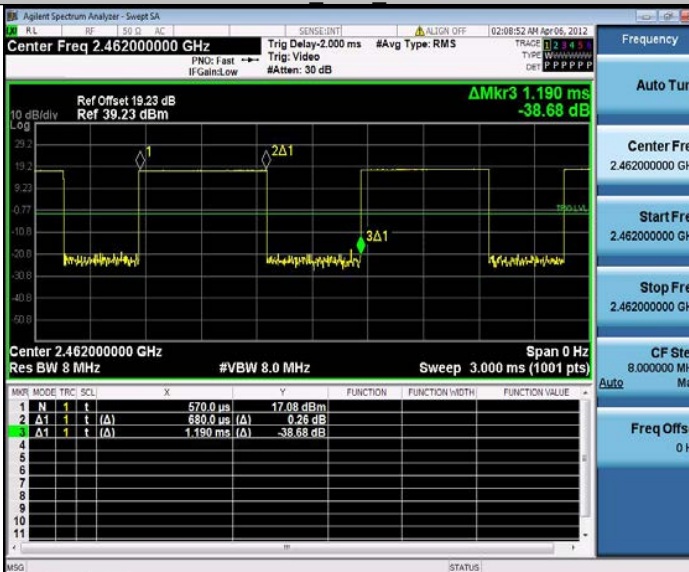

11G Ant1_2412

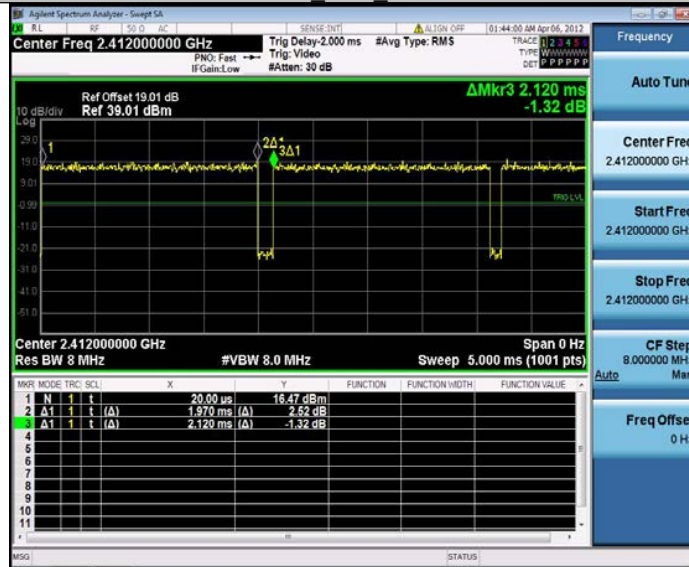

11G Ant2_2412

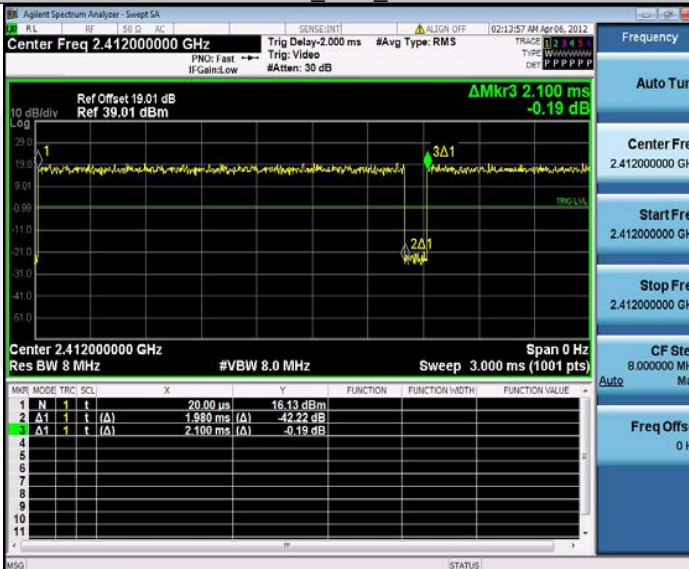

11G Ant1_2437

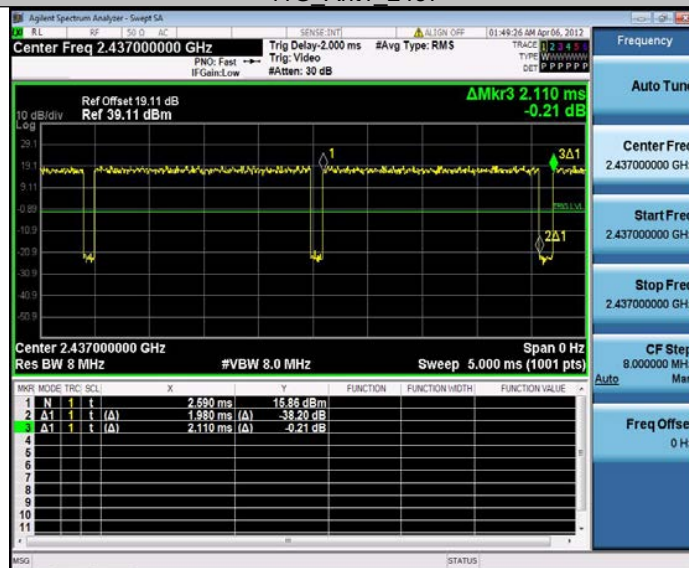

11G Ant2_2437

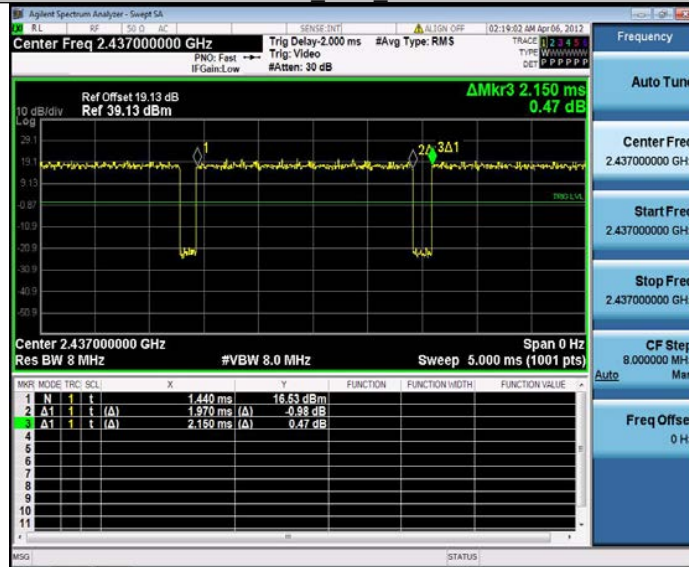

11G Ant1_2462

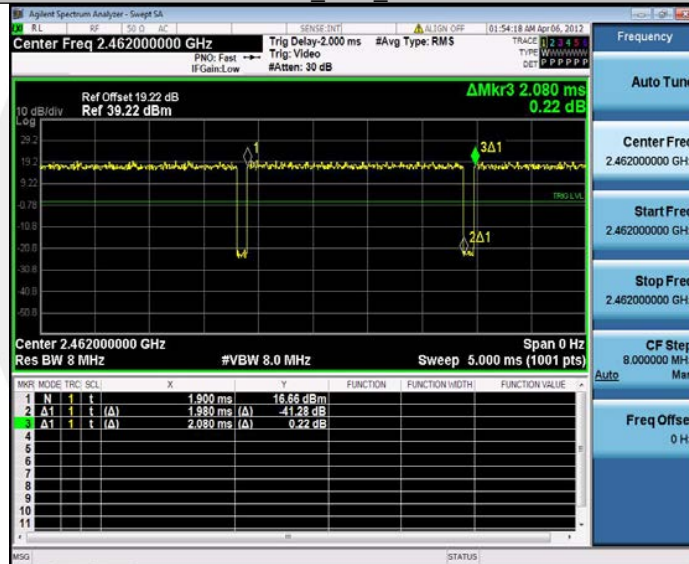

11G Ant2_2462

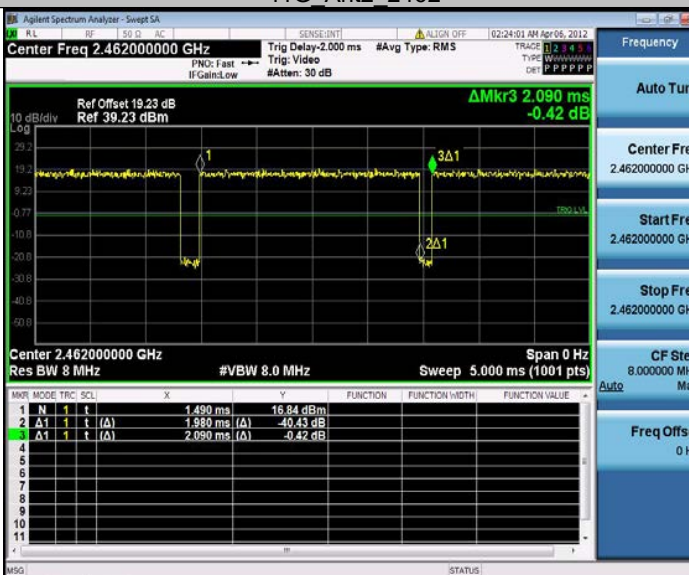

11N20MIMO_Ant1_2412

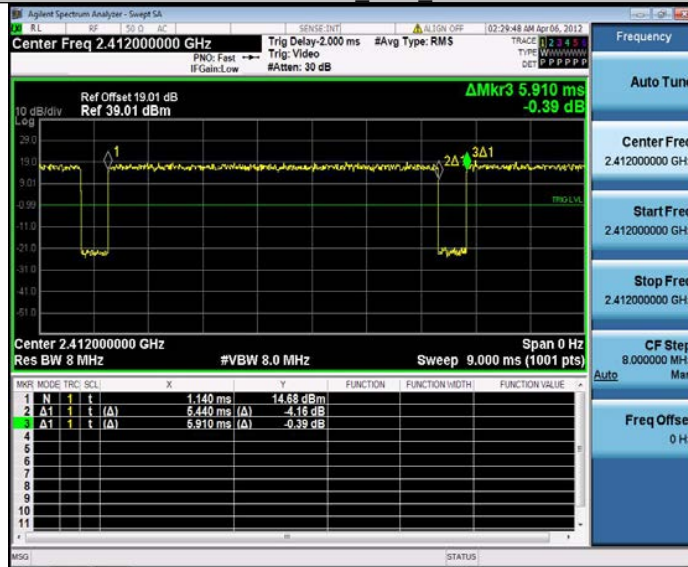

11N20MIMO_Ant2_2412

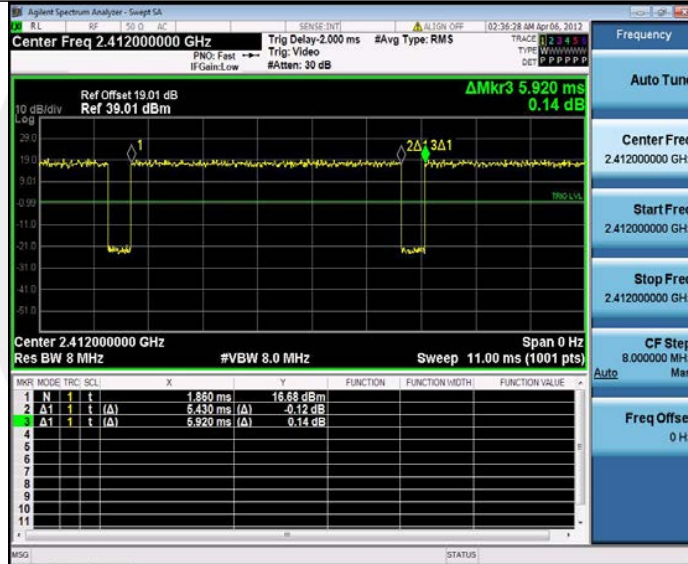

11N20MIMO_Ant1_2437

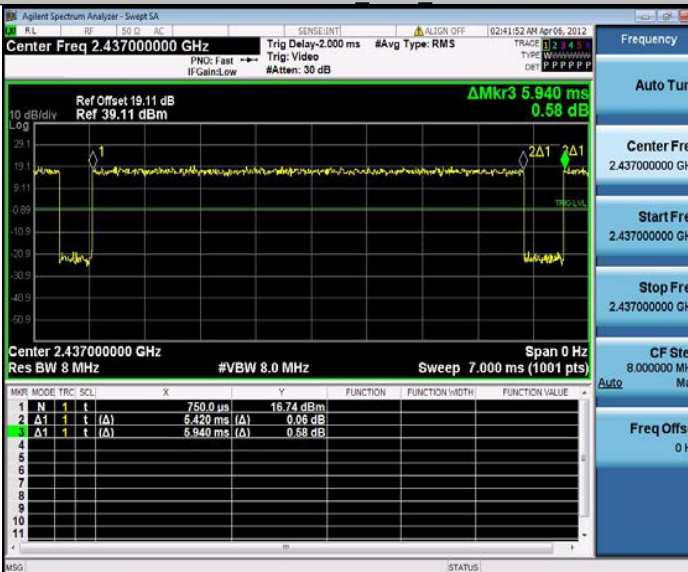

11N20MIMO_Ant2_2437

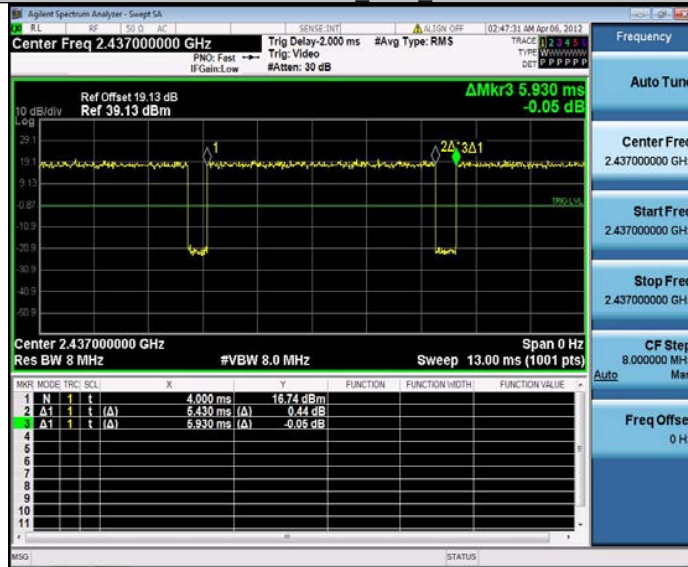

11N20MIMO_Ant1_2462

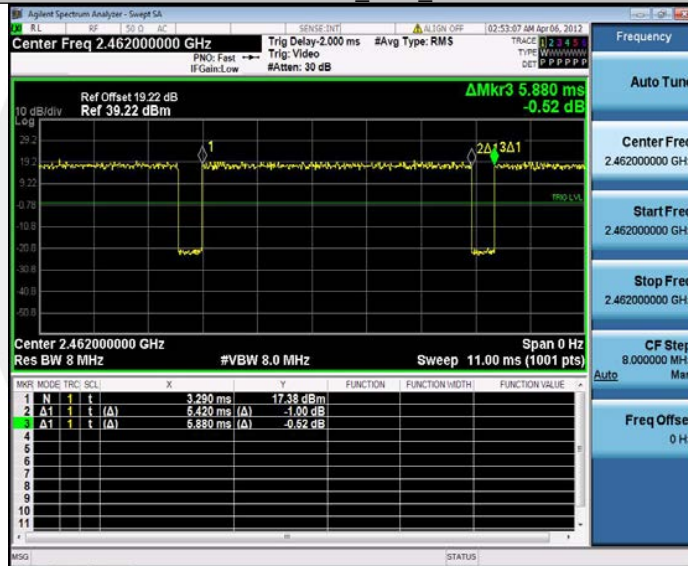

11N20MIMO_Ant2_2462

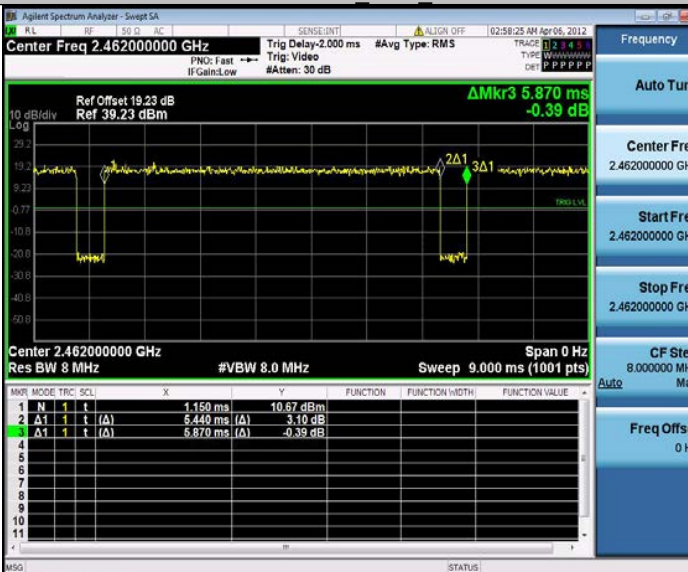

11N40MIMO_Ant1_2422

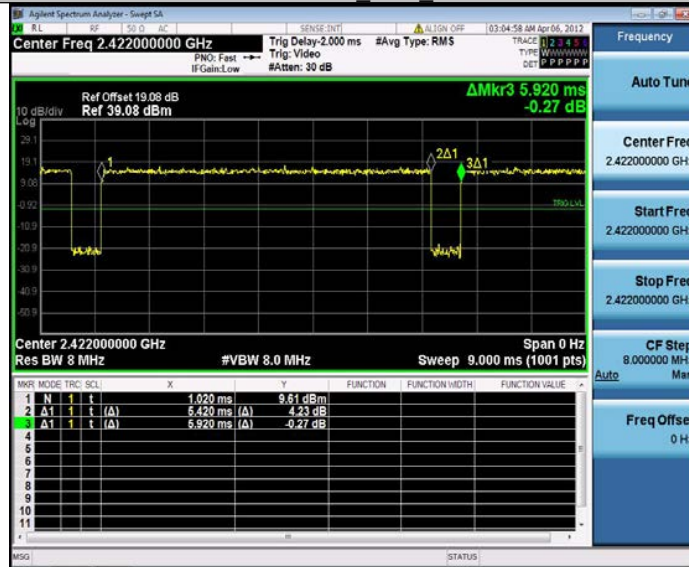

11N40MIMO_Ant2_2422

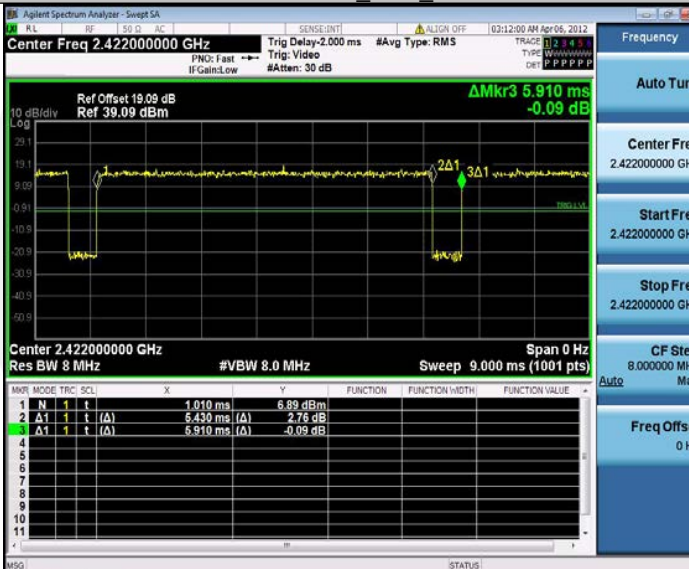

11N40MIMO_Ant1_2437

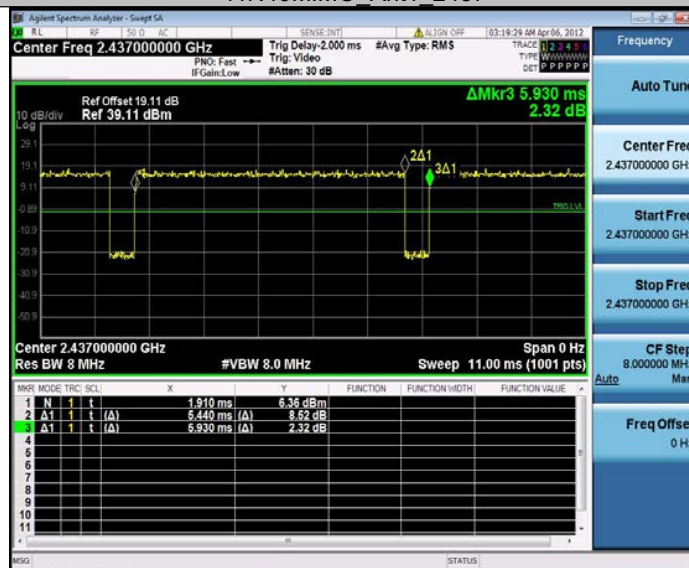

11N40MIMO_Ant2_2437

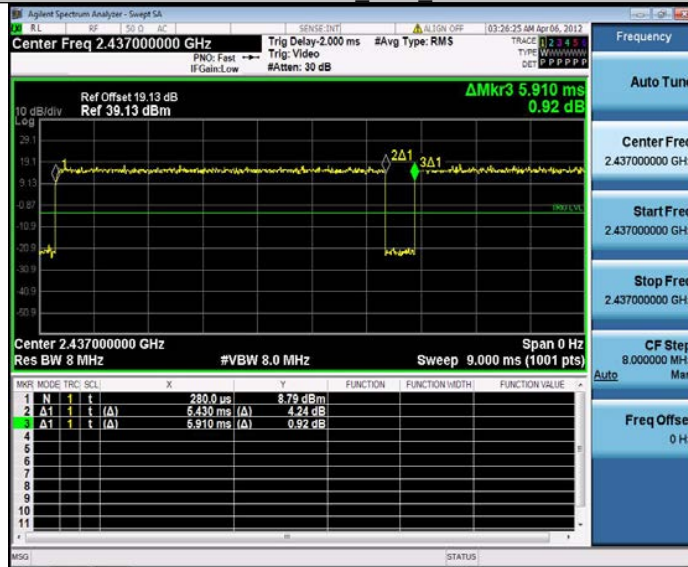

11N40MIMO_Ant1_2452

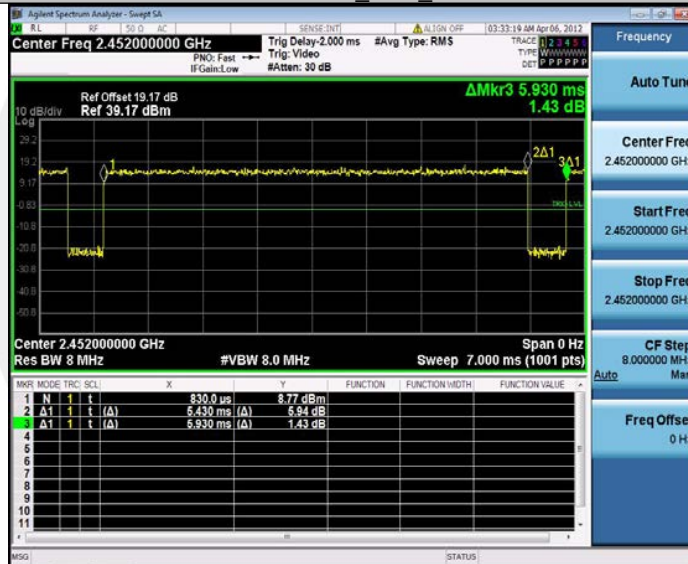

11N40MIMO_Ant2_2452

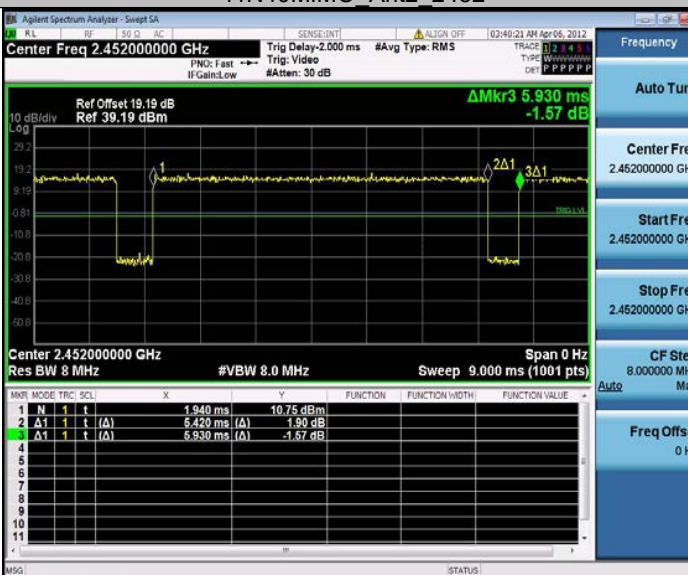

11AX20MIMO_Ant1_2412

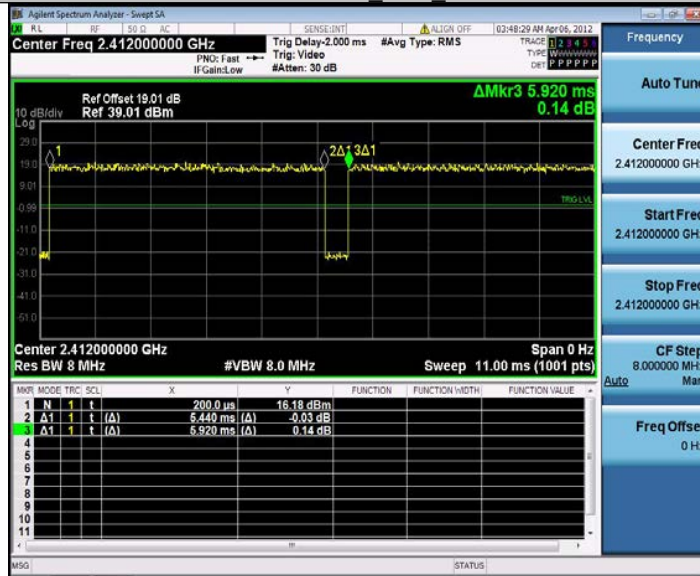

11AX20MIMO_Ant2_2412

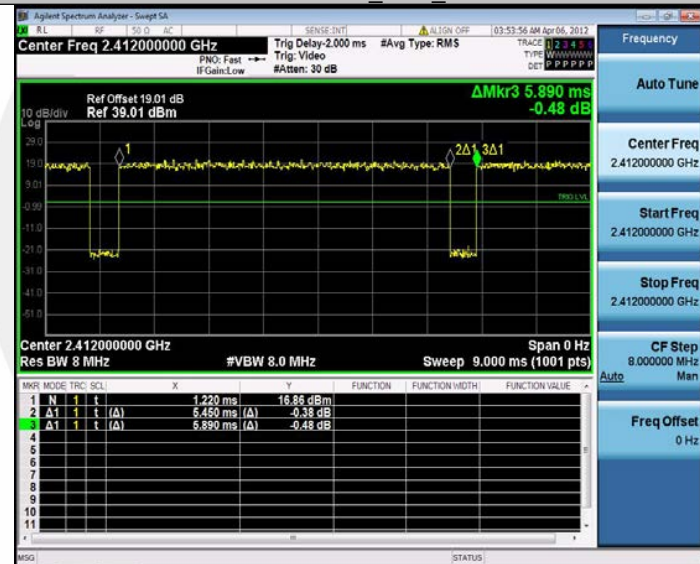

11AX20MIMO_Ant1_2437

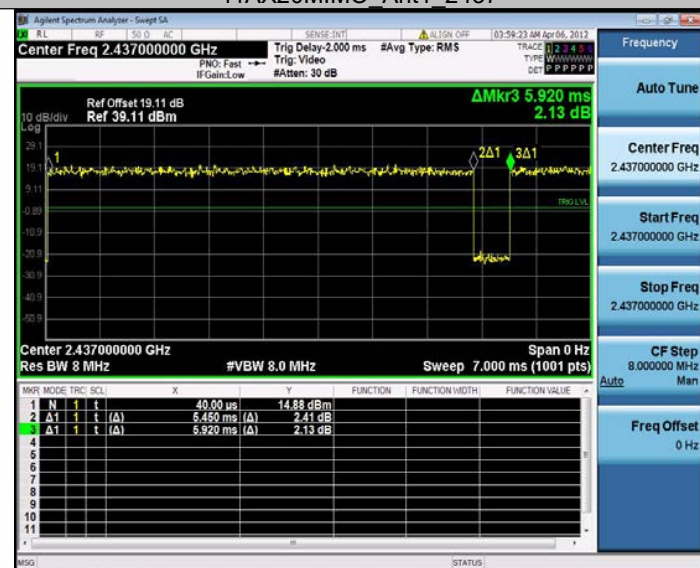

11AX20MIMO Ant2 2437

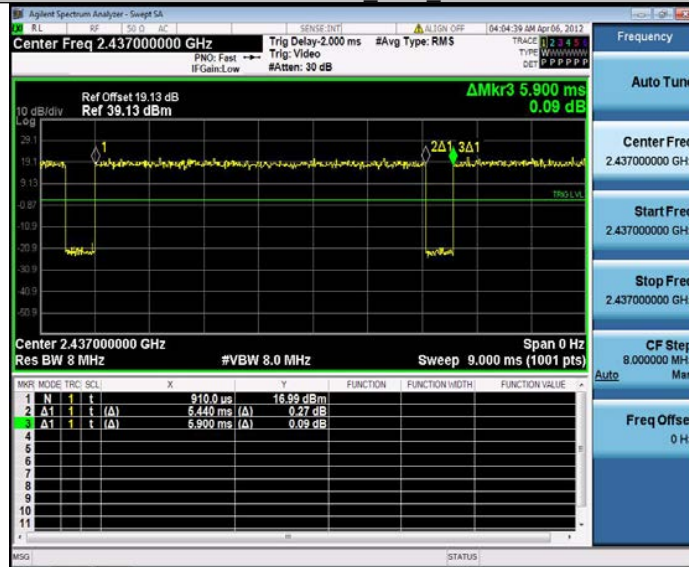

11AX20MIMO Ant1 2462

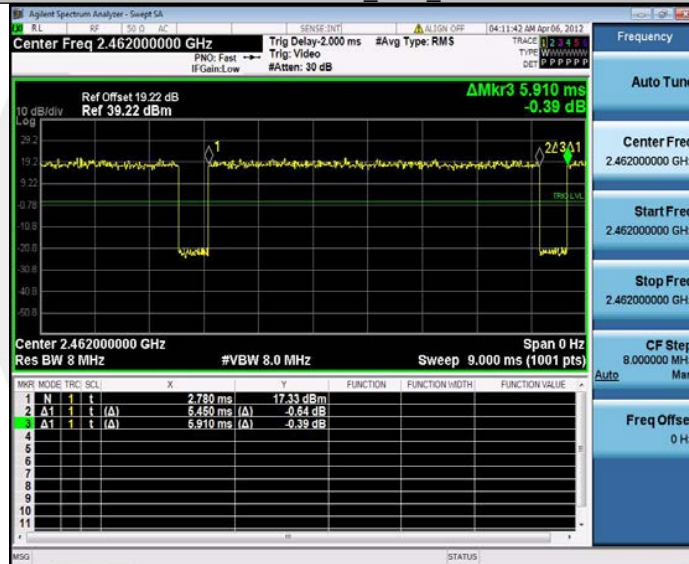

11AX20MIMO Ant2 2462

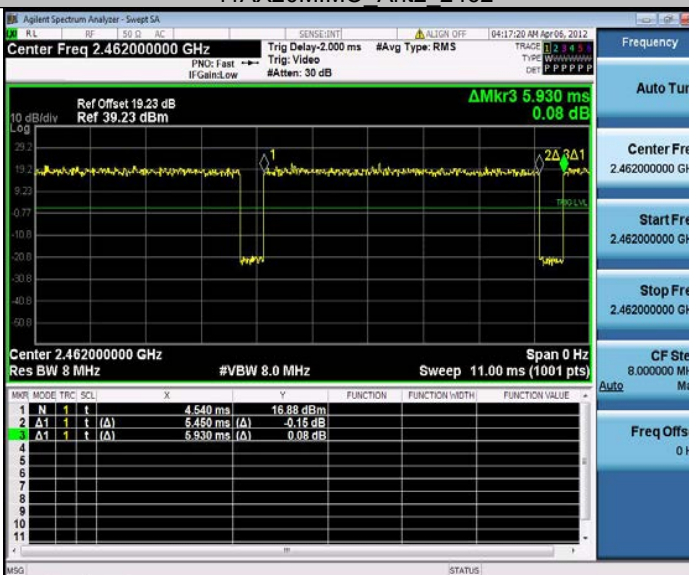

11AX40MIMO Ant1 2422

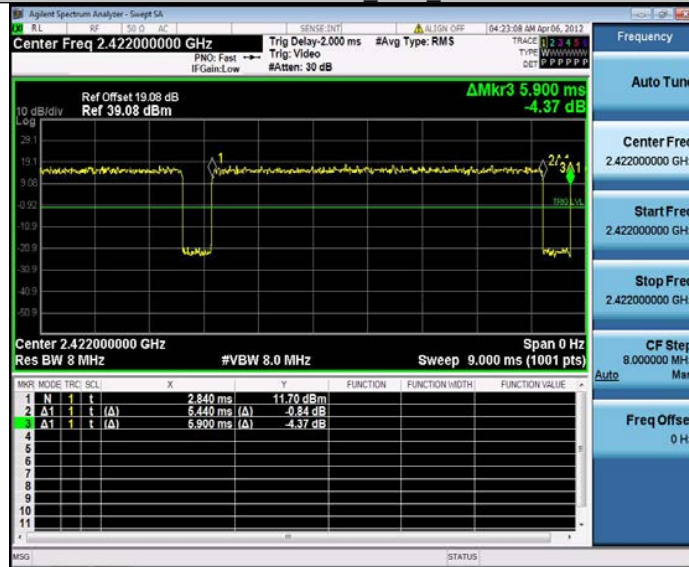

11AX40MIMO Ant2 2422

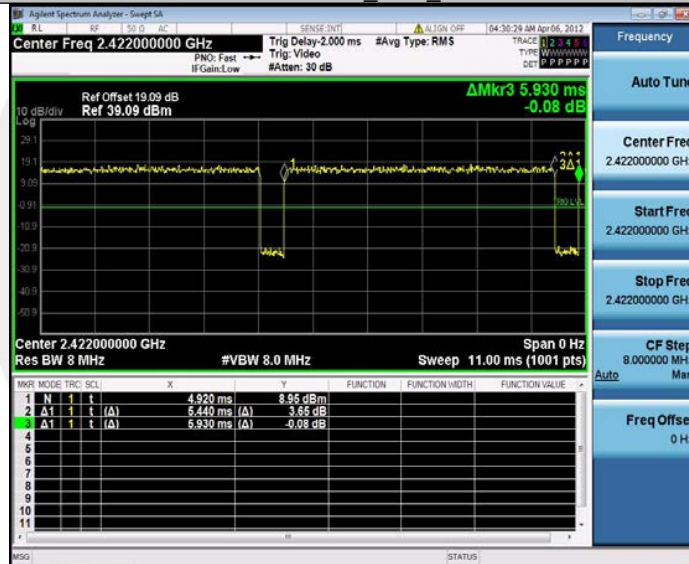

11AX40MIMO Ant1 2437

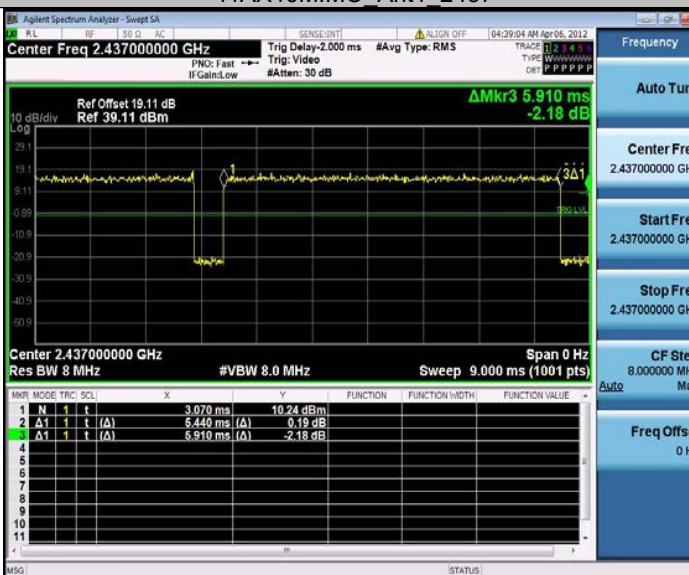

11AX40MIMO Ant2 2437

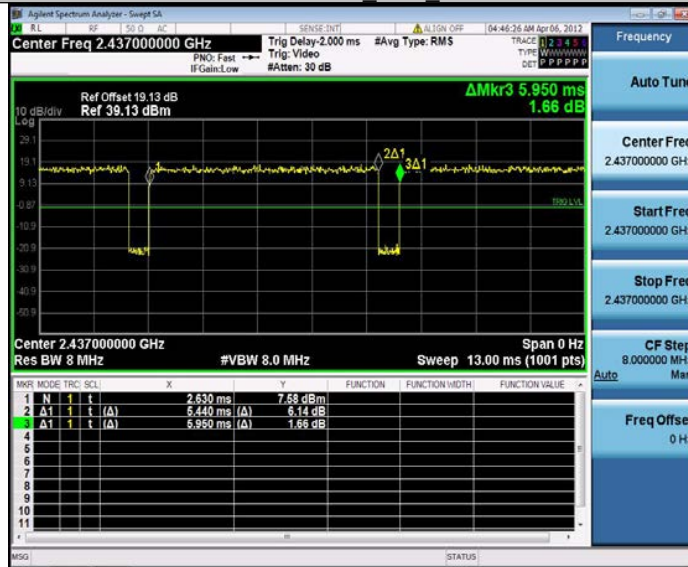

11AX40MIMO Ant1 2452

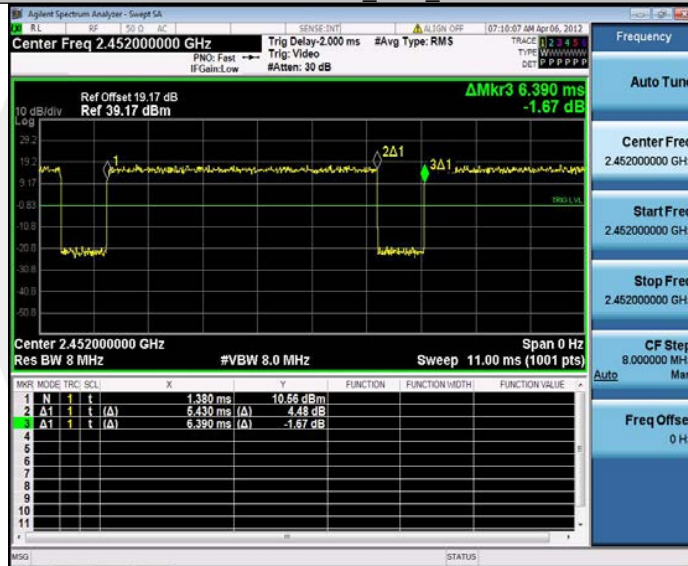

11AX40MIMO Ant2 2452

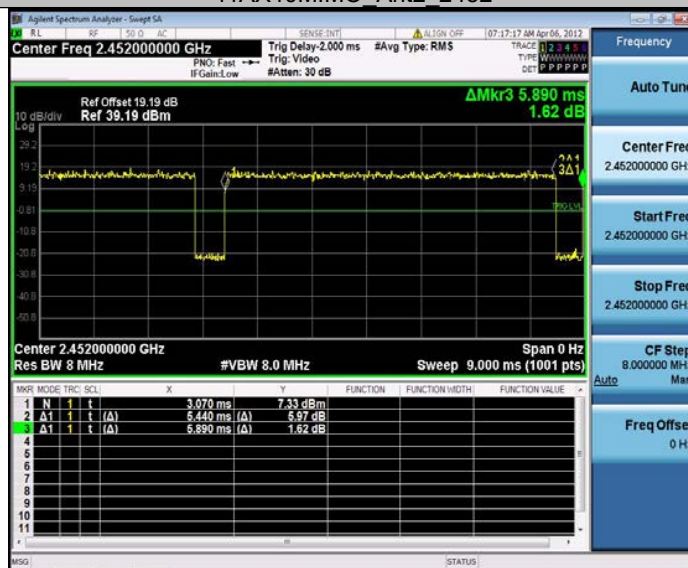

8.2 DTS 6DB BANDWIDTH

8.2.1 Applicable Standard

According to FCC Part15.247 (a)(2)

According to RSS-247 5.2(a)

According to 558074 D01 15.247 Meas Guidance v05r02 Section 8.2

According to ANSI C63.10 Section 11.8

8.2.2 Conformance Limit

The minimum -6 dB bandwidth shall be at least 500 kHz.

8.2.3 Test Configuration

Test according to clause 7.1 radio frequency test setup

8.2.4 Test Procedure

The EUT was operating in WIFI mode and controlled its channel. Printed out the test result from the spectrum by hard copy function.

The RF output of EUT was connected to the spectrum analyzer by RF cable and attenuator. The path loss was compensated to the results for each measurement.

Set to the maximum power setting and enable the EUT transmit continuously

Set RBW = 100 kHz.

Set the video bandwidth (VBW) =300 kHz.

Set Span=2 times OBW

Set Detector = Peak.

Set Trace mode = max hold.

Set Sweep = auto couple.

Allow the trace to stabilize.

Measure the maximum width of the emission that is constrained by the frequencies associated with the two outermost amplitude points (upper and lower frequencies) that are attenuated by 6 dB relative to the maximum level measured in the fundamental emission.

Measure and record the results in the test report.

8.2.5 Test Results

Temperature:	25°C
Relative Humidity:	45%
ATM Pressure:	1011 mbar
Test Engineer:	XXH

Note: N/A

TestMode	Antenna	Frequency[MHz]	DTS BW [MHz]	FL[MHz]	FH[MHz]	Limit[MHz]	Verdict
11B	Ant1	2412	9.000	2407.480	2416.480	0.5	PASS
	Ant2	2412	8.040	2407.960	2416.000	0.5	PASS
	Ant1	2437	8.560	2432.480	2441.040	0.5	PASS
	Ant2	2437	7.400	2433.200	2440.600	0.5	PASS
	Ant1	2462	7.080	2458.480	2465.560	0.5	PASS
	Ant2	2462	8.080	2457.960	2466.040	0.5	PASS
11G	Ant1	2412	13.720	2404.520	2418.240	0.5	PASS
	Ant2	2412	15.360	2404.400	2419.760	0.5	PASS
	Ant1	2437	14.440	2430.120	2444.560	0.5	PASS
	Ant2	2437	10.960	2429.440	2440.400	0.5	PASS
	Ant1	2462	15.480	2454.440	2469.920	0.5	PASS
	Ant2	2462	12.440	2457.040	2469.480	0.5	PASS
11N20MIMO	Ant1	2412	13.000	2405.320	2418.320	0.5	PASS
	Ant2	2412	13.480	2404.840	2418.320	0.5	PASS
	Ant1	2437	11.720	2431.600	2443.320	0.5	PASS
	Ant2	2437	10.480	2431.920	2442.400	0.5	PASS
	Ant1	2462	16.200	2454.200	2470.400	0.5	PASS
	Ant2	2462	13.840	2455.720	2469.560	0.5	PASS
11N40MIMO	Ant1	2422	30.480	2409.040	2439.520	0.5	PASS
	Ant2	2422	26.320	2410.720	2437.040	0.5	PASS
	Ant1	2437	35.200	2419.560	2454.760	0.5	PASS
	Ant2	2437	33.840	2419.480	2453.320	0.5	PASS
	Ant1	2452	35.040	2434.480	2469.520	0.5	PASS
	Ant2	2452	33.840	2435.680	2469.520	0.5	PASS
11AX20MIMO	Ant1	2412	12.200	2404.520	2416.720	0.5	PASS
	Ant2	2412	15.400	2404.480	2419.880	0.5	PASS
	Ant1	2437	15.480	2429.200	2444.680	0.5	PASS
	Ant2	2437	18.720	2427.600	2446.320	0.5	PASS
	Ant1	2462	16.840	2453.520	2470.360	0.5	PASS
	Ant2	2462	15.120	2455.080	2470.200	0.5	PASS
11AX40MIMO	Ant1	2422	31.840	2404.000	2435.840	0.5	PASS
	Ant2	2422	33.680	2404.560	2438.240	0.5	PASS
	Ant1	2437	25.600	2428.520	2454.120	0.5	PASS
	Ant2	2437	32.400	2422.520	2454.920	0.5	PASS
	Ant1	2452	35.680	2434.960	2470.640	0.5	PASS
	Ant2	2452	33.120	2436.160	2469.280	0.5	PASS

11B_Ant1_2412



11B_Ant2_2412



11B_Ant1_2437



11B_Ant2_2437



11B_Ant1_2462



11B_Ant2_2462



11G Ant1_2412



11G Ant2_2412



11G Ant1_2437



11G Ant2_2437



11G Ant1_2462



11G Ant2_2462



11N20MIMO_Ant1_2412



11N20MIMO_Ant2_2412



11N20MIMO_Ant1_2437



11N20MIMO_Ant2_2437



11N20MIMO_Ant1_2462

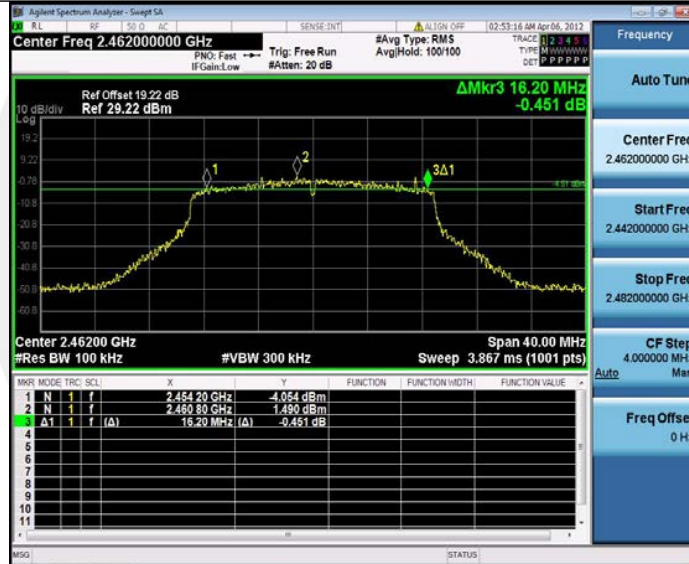

11N20MIMO_Ant2_2462



11N40MIMO_Ant1_2422



11N40MIMO_Ant2_2422



11N40MIMO_Ant1_2437



11N40MIMO_Ant2_2437



11N40MIMO_Ant1_2452

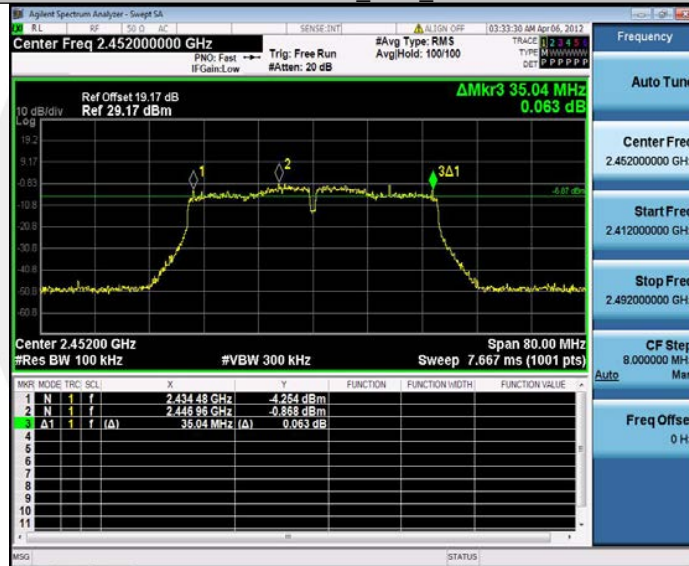

11N40MIMO_Ant2_2452



11AX20MIMO Ant1 2412



11AX20MIMO Ant2 2412



11AX20MIMO Ant1 2437



11AX20MIMO Ant2 2437



11AX20MIMO Ant1 2462



11AX20MIMO Ant2 2462



11AX40MIMO Ant1 2422

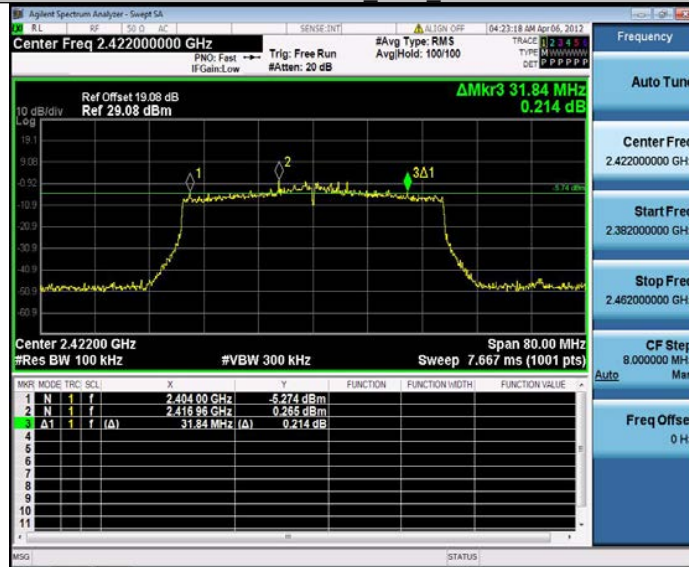

11AX40MIMO Ant2 2422

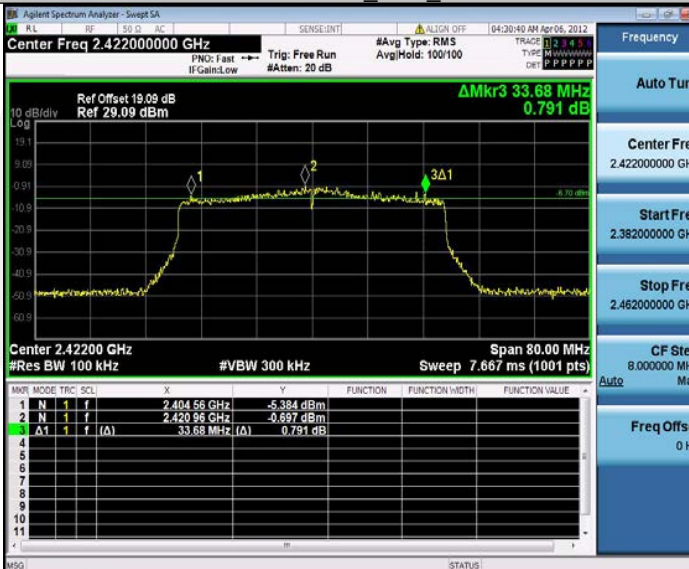

11AX40MIMO Ant1 2437

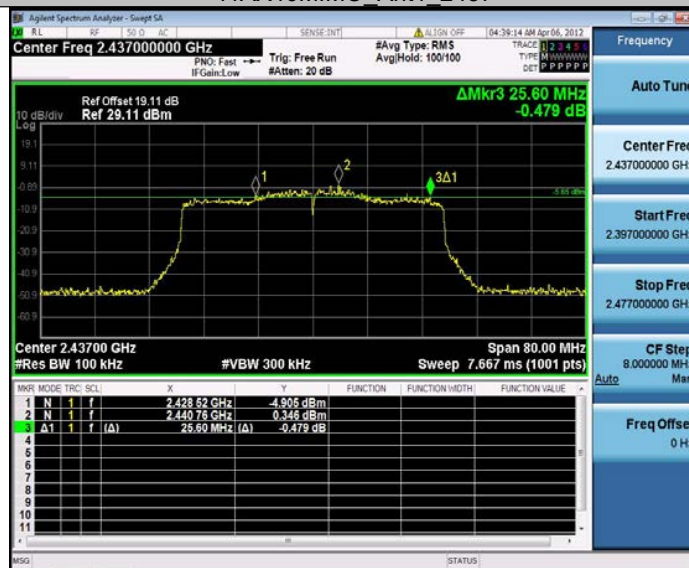

11AX40MIMO Ant2 2437

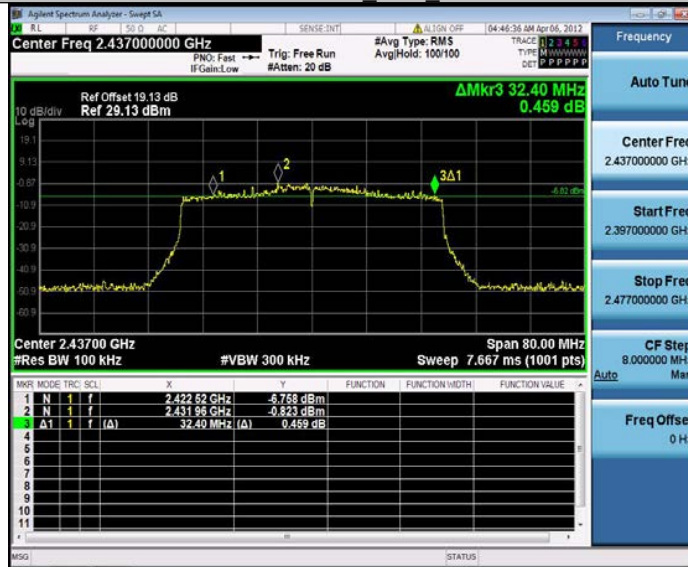

11AX40MIMO Ant1 2452

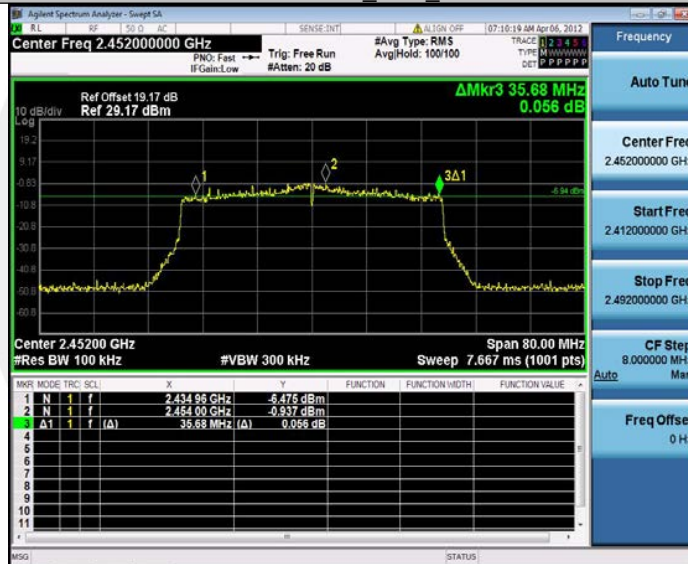

11AX40MIMO Ant2 2452

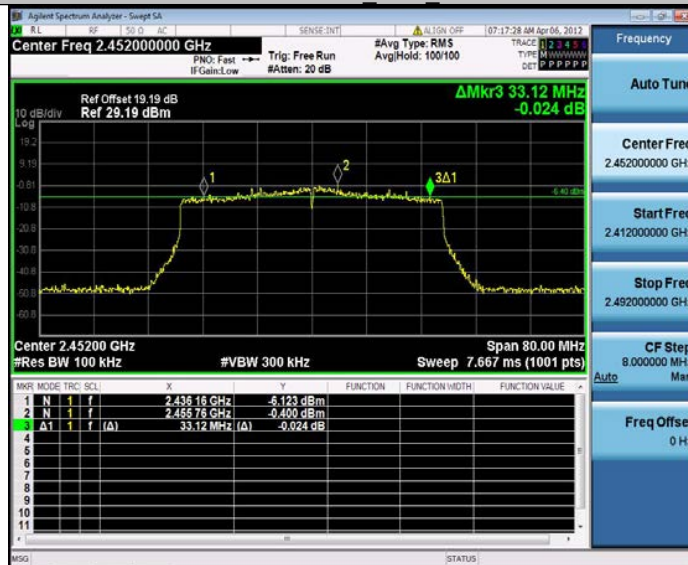

8.3 DTS 99% BANDWIDTH

8.3.1 Applicable Standard

According to RSS-Gen 6.7

8.3.2 Test Configuration

Test according to clause 7.1 radio frequency test setup 1

8.3.3 Test Procedure

The EUT was operating in WIFI mode and controlled its channel. Printed out the test result from the spectrum by hard copy function.

The RF output of EUT was connected to the spectrum analyzer by RF cable and attenuator. The path loss was compensated to the results for each measurement.

Set to the maximum power setting and enable the EUT transmit continuously

Set RBW = 1%-5% OBW.

Set the video bandwidth (VBW) $\geq 3 \times \text{RBW}$.

Set Span=approximately 2 to 3 times the 6 dB bandwidth.

Set Detector = Peak.

Set Trace mode = max hold.

Set Sweep = auto couple.

Allow the trace to stabilize.

Use the 99 % power bandwidth function of the instrument

Measure the maximum width of the emission.

If this value varies with different modes of operation (e.g., data rate, modulation format, etc.), repeat this test for each variation.

Measure and record the results in the test report.

8.3.4 Test Results

Temperature:	25°C
Relative Humidity:	45%
ATM Pressure:	1011 mbar
Test Engineer:	XXH

Note: N/A

TestMode	Antenna	Channel Frequency[MHz]	OCB [MHz]	FL[MHz]	FH[MHz]	Limit[MHz]	Verdict
11B	Ant1	2412	13.131	2405.4507	2418.5817	---	---
	Ant2	2412	13.129	2405.4454	2418.5744	---	---
	Ant1	2437	13.136	2430.4400	2443.5760	---	---
	Ant2	2437	13.112	2430.4417	2443.5537	---	---
	Ant1	2462	13.105	2455.4759	2468.5809	---	---
	Ant2	2462	13.120	2455.4694	2468.5894	---	---
11G	Ant1	2412	16.376	2403.8321	2420.2081	---	---
	Ant2	2412	16.375	2403.8247	2420.1997	---	---
	Ant1	2437	16.338	2428.8300	2445.1680	---	---
	Ant2	2437	16.390	2428.8122	2445.2022	---	---
	Ant1	2462	16.344	2453.8446	2470.1886	---	---
	Ant2	2462	16.358	2453.8260	2470.1840	---	---
11N20MIMO	Ant1	2412	17.549	2403.2299	2420.7789	---	---
	Ant2	2412	17.547	2403.2207	2420.7677	---	---
	Ant1	2437	17.496	2428.2533	2445.7493	---	---
	Ant2	2437	17.505	2428.2570	2445.7620	---	---
	Ant1	2462	17.498	2453.2797	2470.7777	---	---
	Ant2	2462	17.502	2453.2752	2470.7772	---	---
11N40MIMO	Ant1	2422	35.908	2404.1082	2440.0162	---	---
	Ant2	2422	35.888	2404.0729	2439.9609	---	---
	Ant1	2437	35.880	2419.0967	2454.9767	---	---
	Ant2	2437	35.885	2419.0517	2454.9367	---	---
	Ant1	2452	35.899	2434.0896	2469.9886	---	---
	Ant2	2452	35.868	2434.1434	2470.0114	---	---
11AX20MIMO	Ant1	2412	18.777	2402.6393	2421.4163	---	---
	Ant2	2412	18.821	2402.5911	2421.4121	---	---
	Ant1	2437	18.736	2427.6358	2446.3718	---	---
	Ant2	2437	18.799	2427.6223	2446.4213	---	---
	Ant1	2462	18.734	2452.6482	2471.3822	---	---
	Ant2	2462	18.795	2452.6163	2471.4113	---	---
11AX40MIMO	Ant1	2422	37.605	2403.2291	2440.8341	---	---
	Ant2	2422	37.674	2403.1534	2440.8274	---	---
	Ant1	2437	37.448	2418.3107	2455.7587	---	---
	Ant2	2437	37.383	2418.3467	2455.7297	---	---
	Ant1	2452	37.672	2433.1882	2470.8602	---	---
	Ant2	2452	37.547	2433.2503	2470.7973	---	---

11B_Ant1_2412

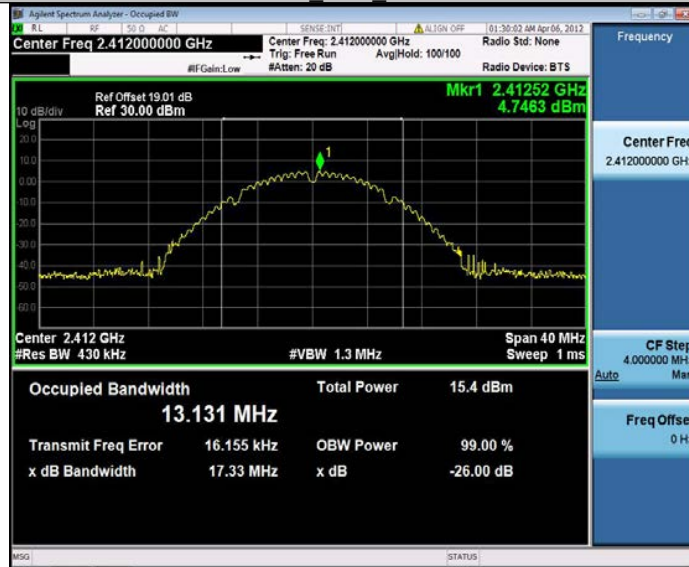

11B_Ant2_2412

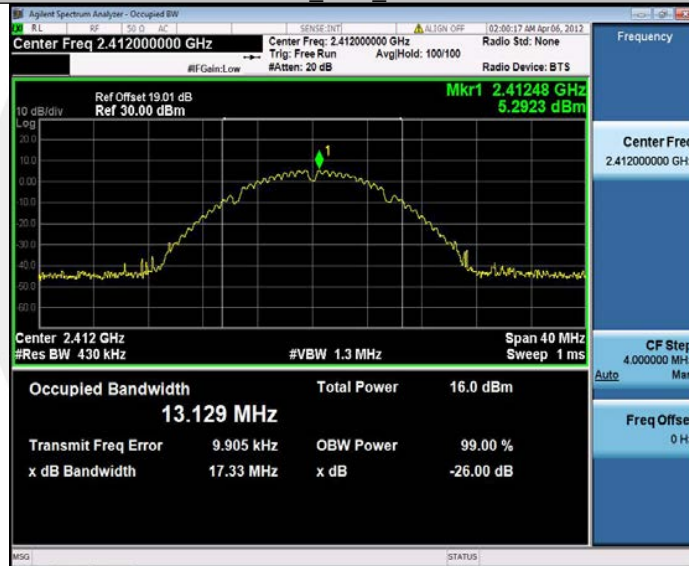

11B_Ant1_2437



11B_Ant2_2437



11B_Ant1_2462

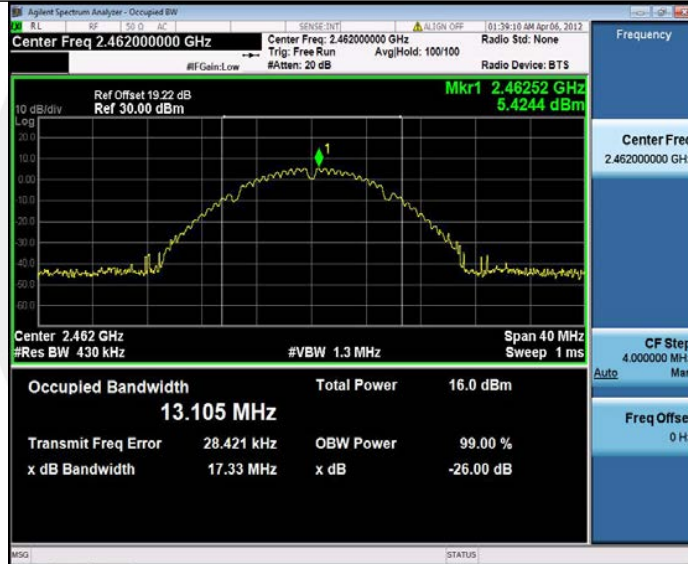

11B_Ant2_2462

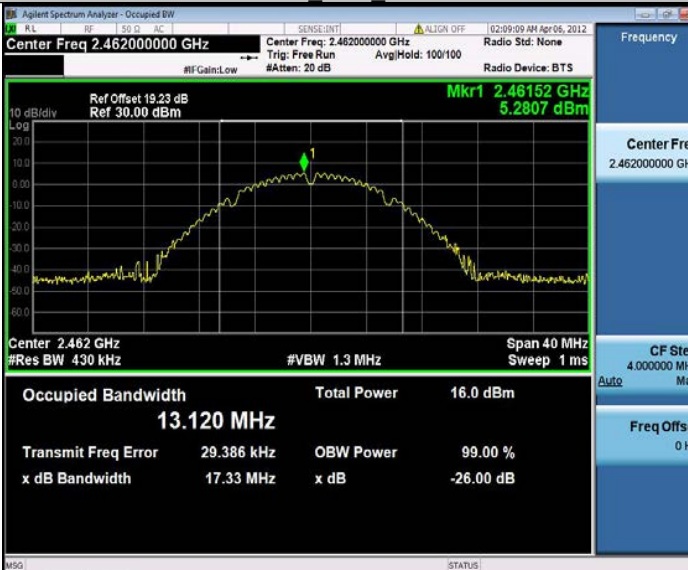

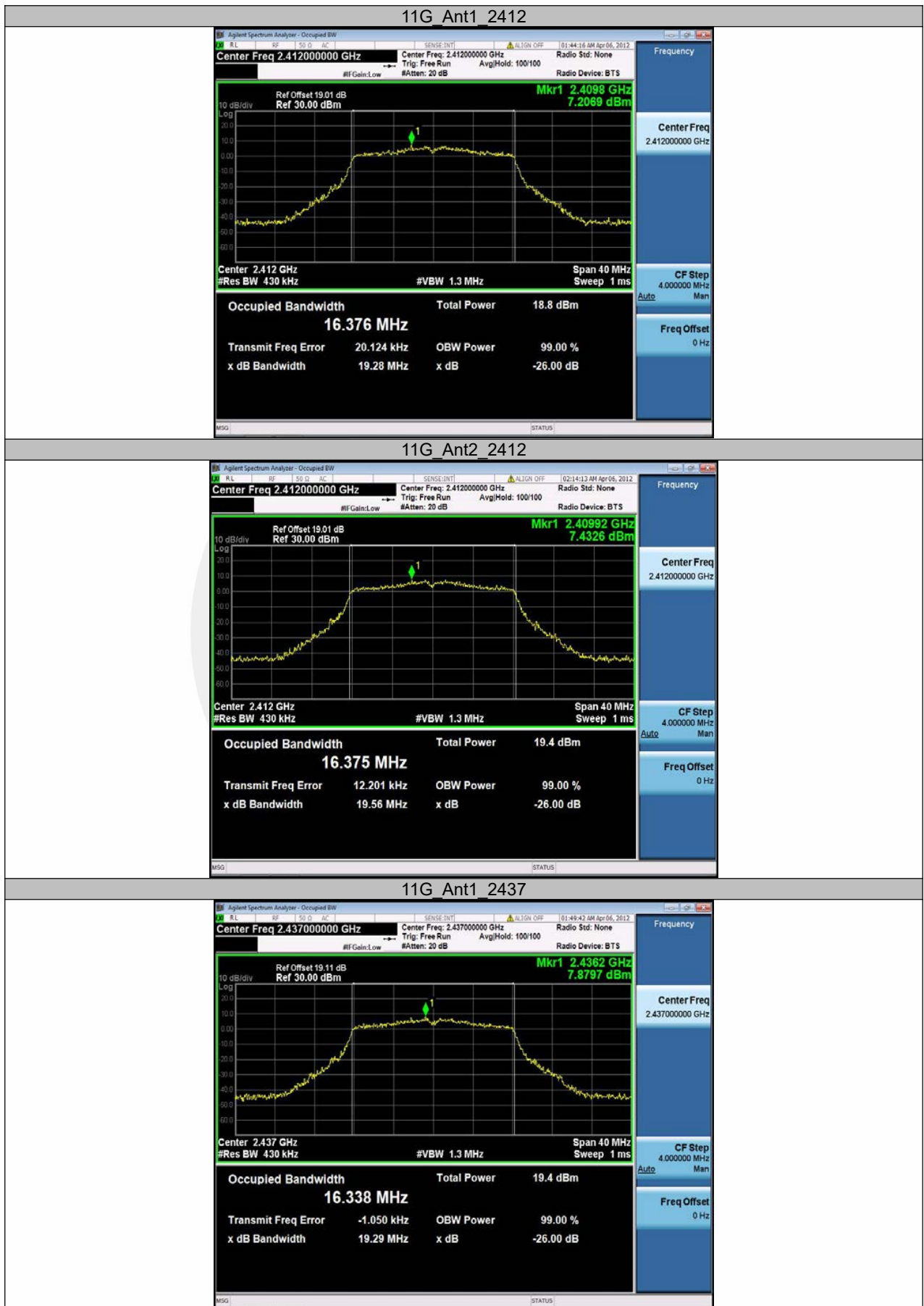

11G Ant2_2437

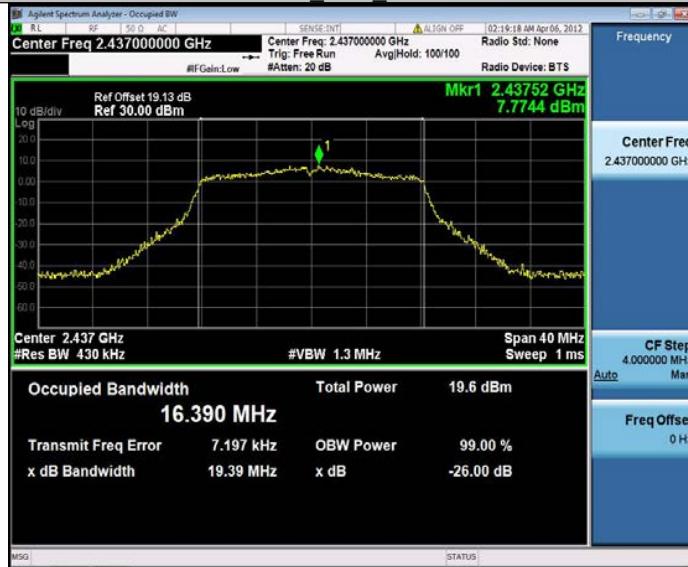

11G Ant1_2462

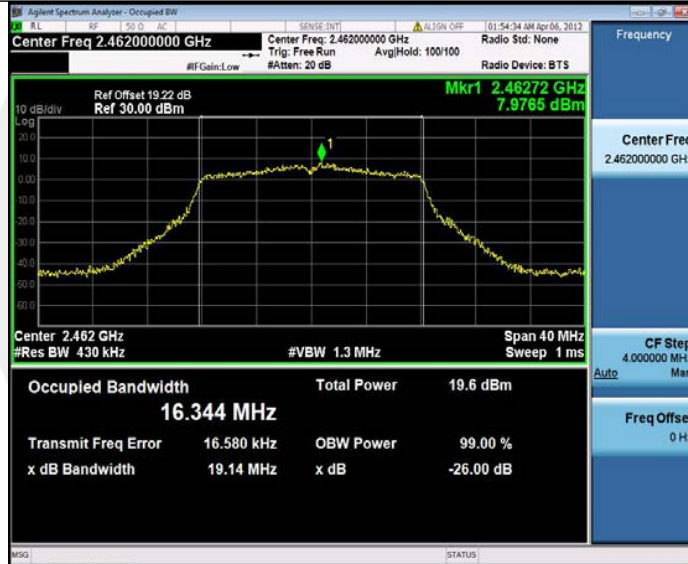

11G Ant2_2462

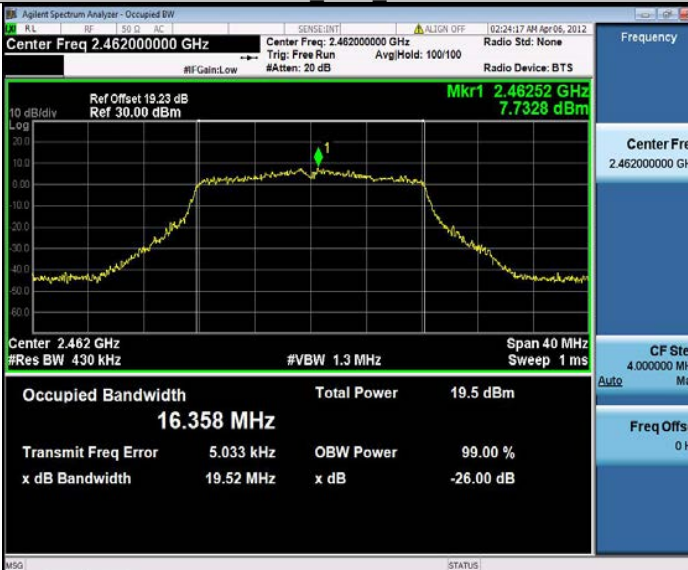

11N20MIMO_Ant1_2412



11N20MIMO_Ant2_2412

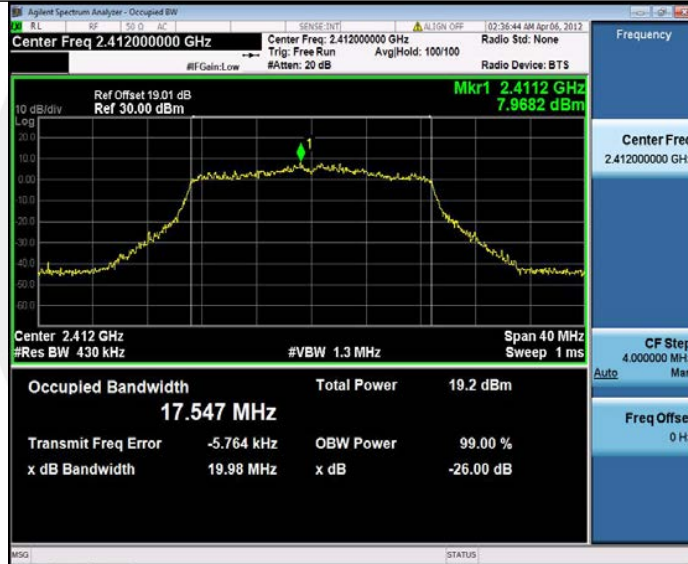

11N20MIMO_Ant1_2437

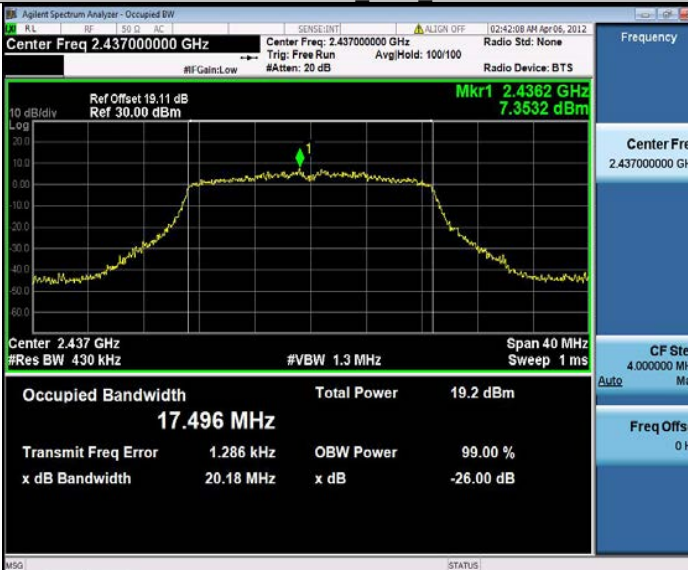

11N20MIMO_Ant2_2437



11N20MIMO_Ant1_2462

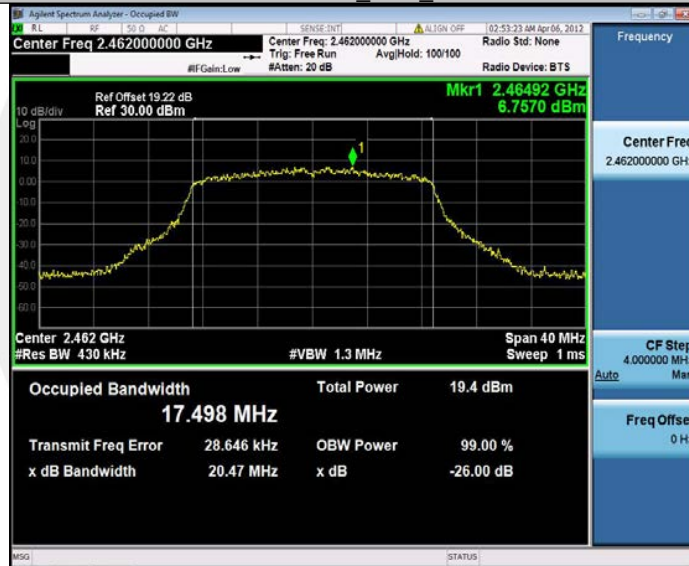

11N20MIMO_Ant2_2462

