



东莞市一佳电子通讯科技有限公司

Dongguan YiJia Electronics Communication Technology Co.,Ltd.

# 规格承认书

## SPECIFICATION FOR APPROVAL

日期  
Date 2023/03/01

编号  
File No 23030101

版本  
Revision 1.0

客户  
CUSTOMER:

飞音时代

客户料号  
CUSTOMER NO:

电话机

品名  
PART NAME:

WiFi Antenna

供方料号  
SUPPLIER NO:

YJT01.057.016.301A

送样日期Date:

送样数量Q “TY:

### 客户确认CUSTOMER APPROVED BY

APPROVAL	CHIEF	SUPERVISOR

### 供方确认 SUPPLIER SIGNATURE

APPROVAL	CHECK	DESIGN
 ChenGuoqiang	XieLi	ChenXingyi

YJ-RD-F04-A

add: 东莞市长安镇沙头社区木鱼路59号元富工业区 Tel:0769-82586086 Fax:0769-82586086



# 承认书项目表

NO	内容 (Contents)	页数 (Number of Page)	页码 (Page Code)
1	承认书封面 (Spec Cover)	1	1
2	承认书项目表 (Spec Item)	1	2
3	工程成品图 (Drawing)	1	3
4	天线规格 (Antenna Specification)	1	4
5	S参数测试 (S Parameter)	1	5
6	无源测试 (Passive Test)	2	6 ~ 7
7	方向图 (Radiation Pattern)	1	8
8	有源测试 (Active Test)	1	9
9	天线装配图 (Antenna Profile)	2	10 ~ 11
10	材质证明 (Material Certificate)	36	12 ~ 47
11	RoHS报告 (RoHS Test Report)	**	**
12	N/A	N/A	N/A
13	-	-	-

**RoHS**  
Compatible

CUSTOMER	
PART NO	

REV.	DESCRIPTION	DATE
△	首次发行	2023-03-01

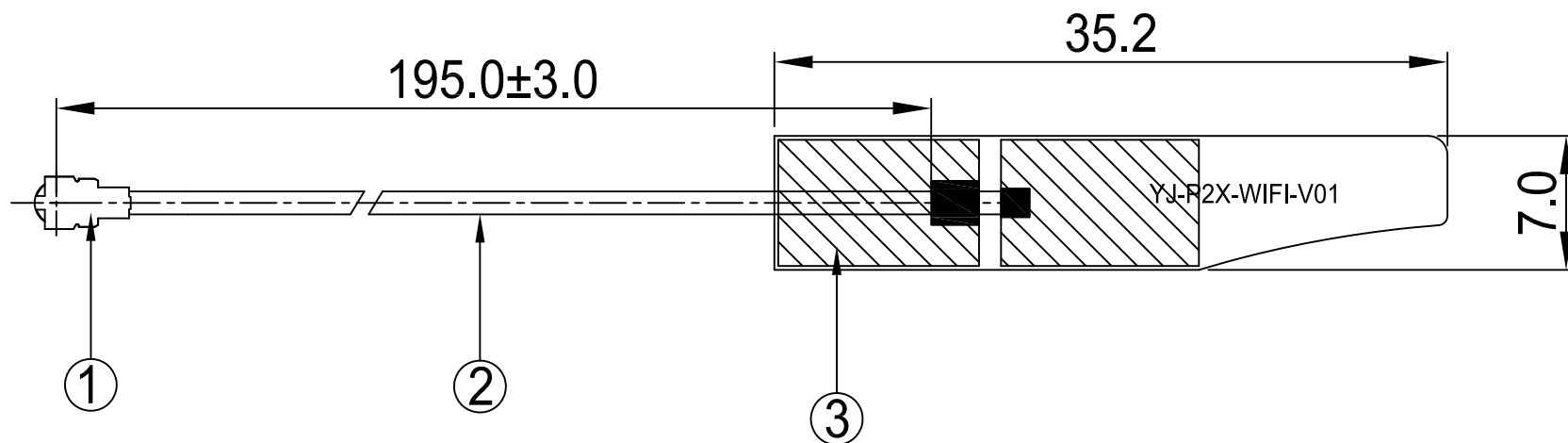

**东莞市一佳电子通讯科技有限公司**  
 Dongguan YiJia Electronics Communication Technology Co.,Ltd. Tel:0769-85535057 Fax:0769-81664308

PART NAME: WiFi Antenna			
PART NO.: YJT01.057.016.301A		DATE: 2023-03-01	
APPROVED BY	CHECKED BY	DESIGNED BY	 Tolerance X.X ±0.50 X.XX±0.15 X° ±3°
殷涛	喻亚峰	陈兴易	
UNITS: mm SCALE: 1/1 REVISION: A			

3	FPCB	35.2*7.0MM	FPCB	FPC1000XA.P01	1
2	Coaxial Cable	O.D.1.13 Black	O.D.1.13	COA1000XA.P01	1
1	Mini Connector	Au Plated 1代	Cu	TER1000XA.P01	1
NO	PART NAME	DESCRIPTION	Material	Part Number	Q.TY



# 天线规格

## Antenna Specification

<b>Electrical Properties</b>	
Frequency	5.15-5.85GHz
Impedance	50 Ohm Nominal
V.S.W.R	2.0 Max
Gain	3.8 dBi
Radiation	Omni-directional
Polarization	Linear
<b>Physical Properties</b>	
Connector	1代IPEX
Cable Type	O.D.1.13mm
Cable Length	195mm
Cable Color	Black
Operating Temp.	-40 ~ +85 °C
Storage Temp / Humidity	25±5°C / <70%



# Antenna Performance Test

**Agilent  
E5071B**

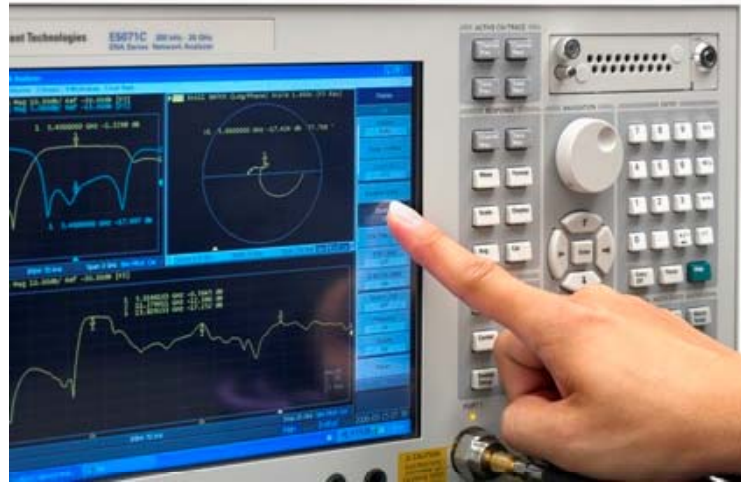

**S  
Parameter  
Test //  
2.4G  
Antenna**

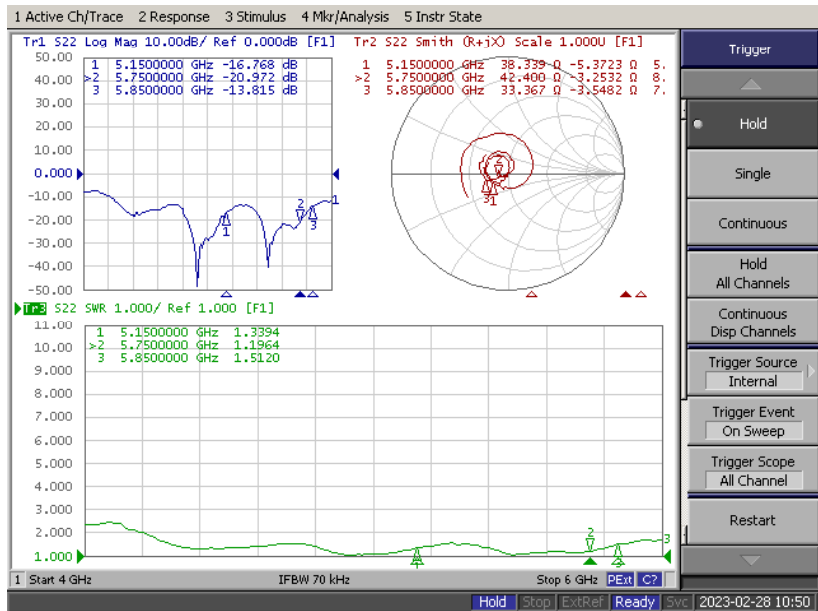



## *Antenna Passive Test*

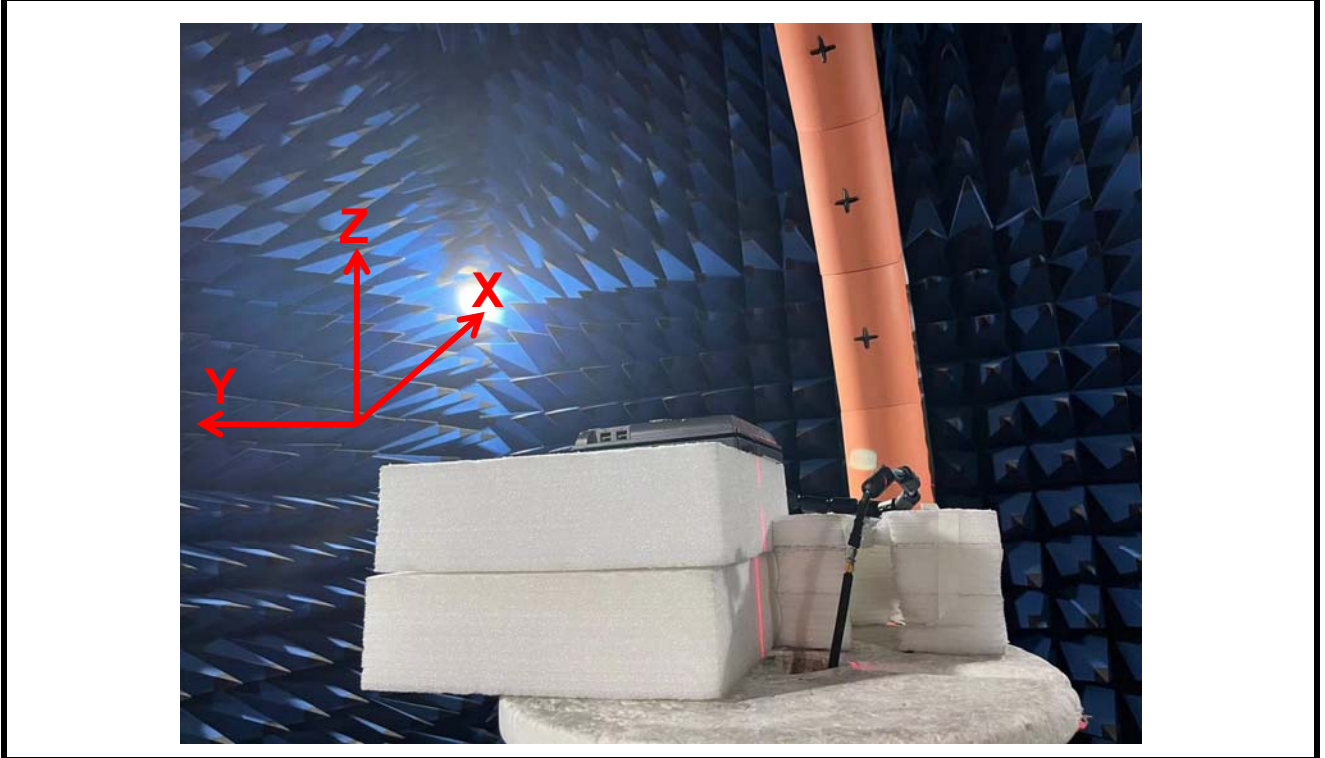
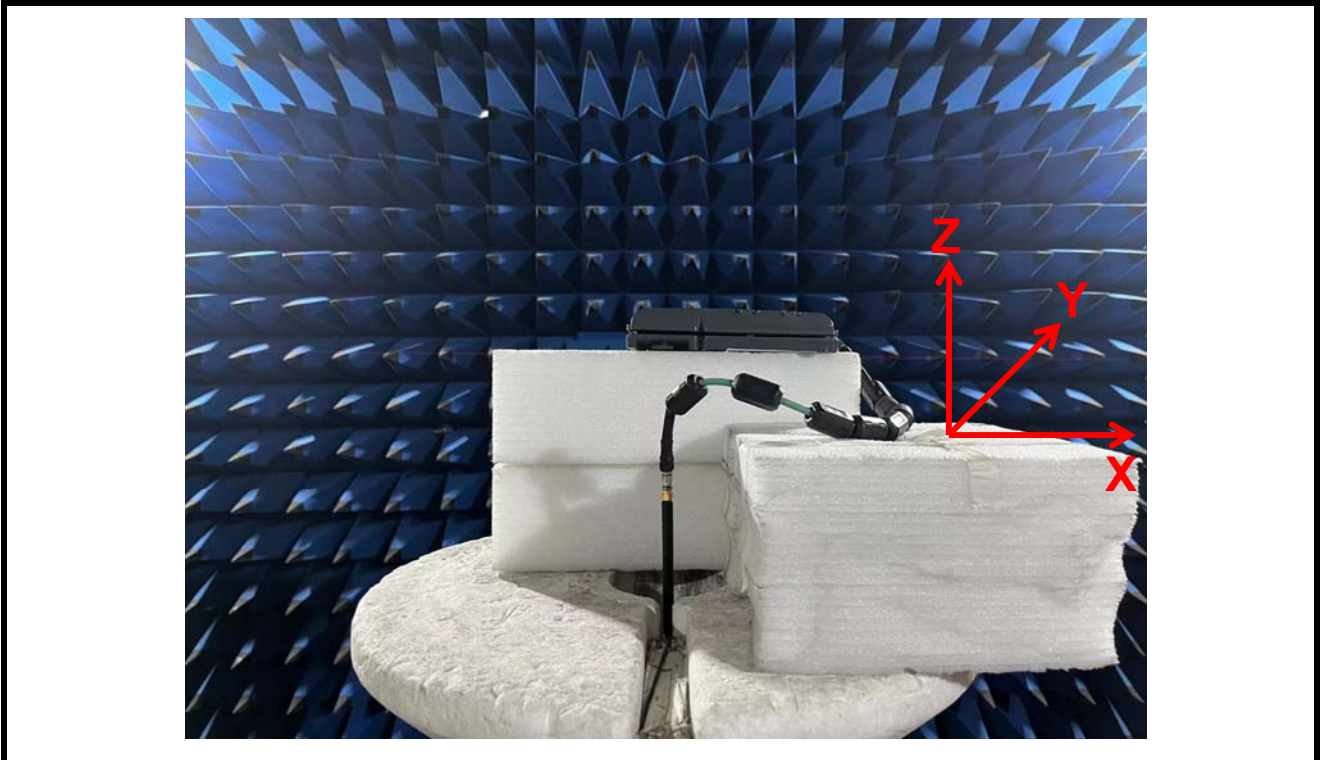



### Passive Test For WiFi Antenna

Freq (MHz)	Effi (%)	Effi (dB)	Gain (dBi)
5150	45.6	-3.4	3.0
5200	45.2	-3.5	2.9
5250	43.7	-3.6	2.7
5300	44.4	-3.5	2.4
5350	42.0	-3.8	1.9
5400	47.1	-3.3	3.4
5450	46.9	-3.3	3.5
5500	43.0	-3.7	3.4
5550	49.1	-3.1	3.8
5600	52.8	-2.8	3.8
5650	48.8	-3.1	3.1
5700	50.0	-3.0	3.0
5750	53.5	-2.7	3.4
5800	52.1	-2.8	3.5
5850	50.4	-3.0	3.4



## Radiation Pattern For 5.8G Antenna(5750MHz)

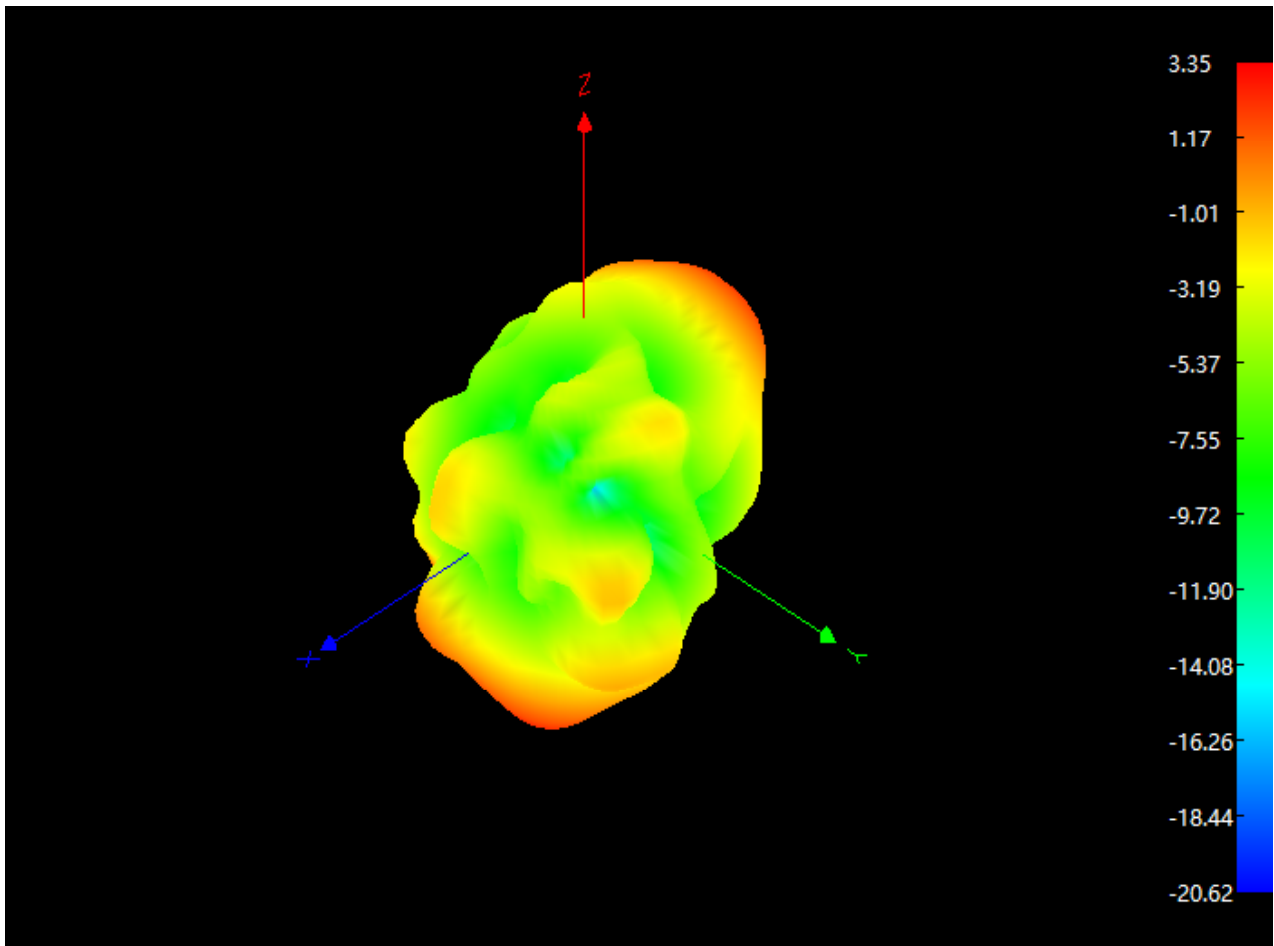





Active Test For WIFI Antenna							
Band	Channel	Data Rate	TRP	EIRP	Data Rate	TIS	EIS
WIFI 5G 802.11a	36	54Mbps	18.5	22.0	54Mbps	-73.8	-77.9
	100		19.4	22.2		-72.8	-76.3
	165		19.1	22.3		-73.5	-76.6
WIFI 5G 802.11n	36	65Mbps	19.5	22.5	65Mbps	-72.3	-76.3
	100		19.8	23.1		-73.5	-77.1
	165		19.2	22.1		-72.1	-76.4

add: 东莞市长安镇沙头社区木鱼路59号元富工业区 Tel:0769-82586086 Fax:0769-82586086



*Device*



*2.4G  
Antenna*

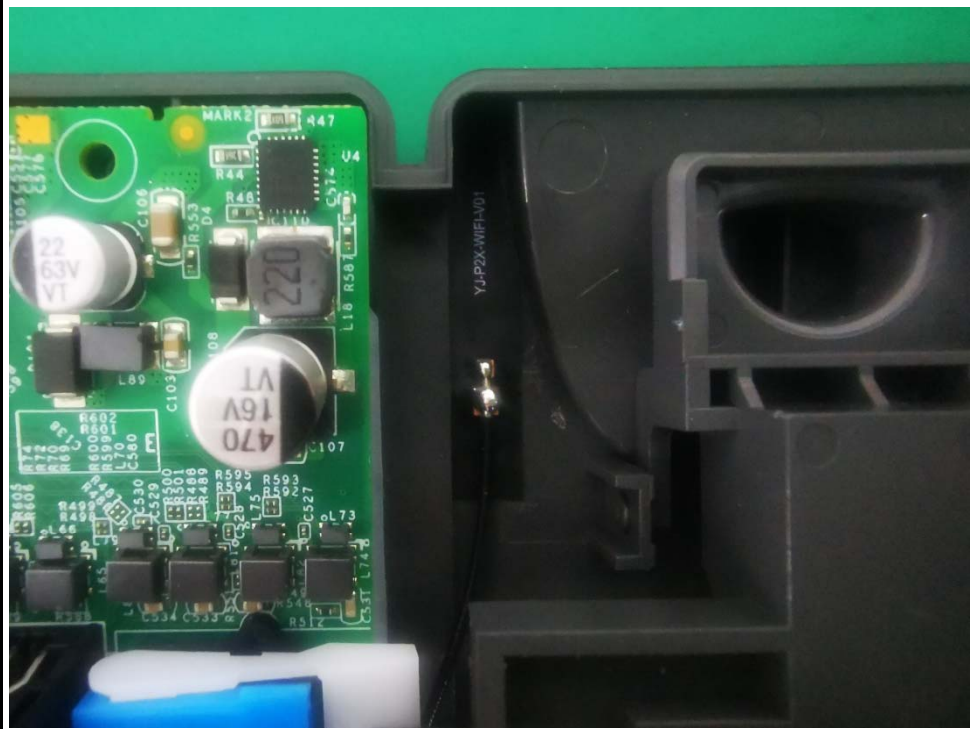



## 5.8G Antenna

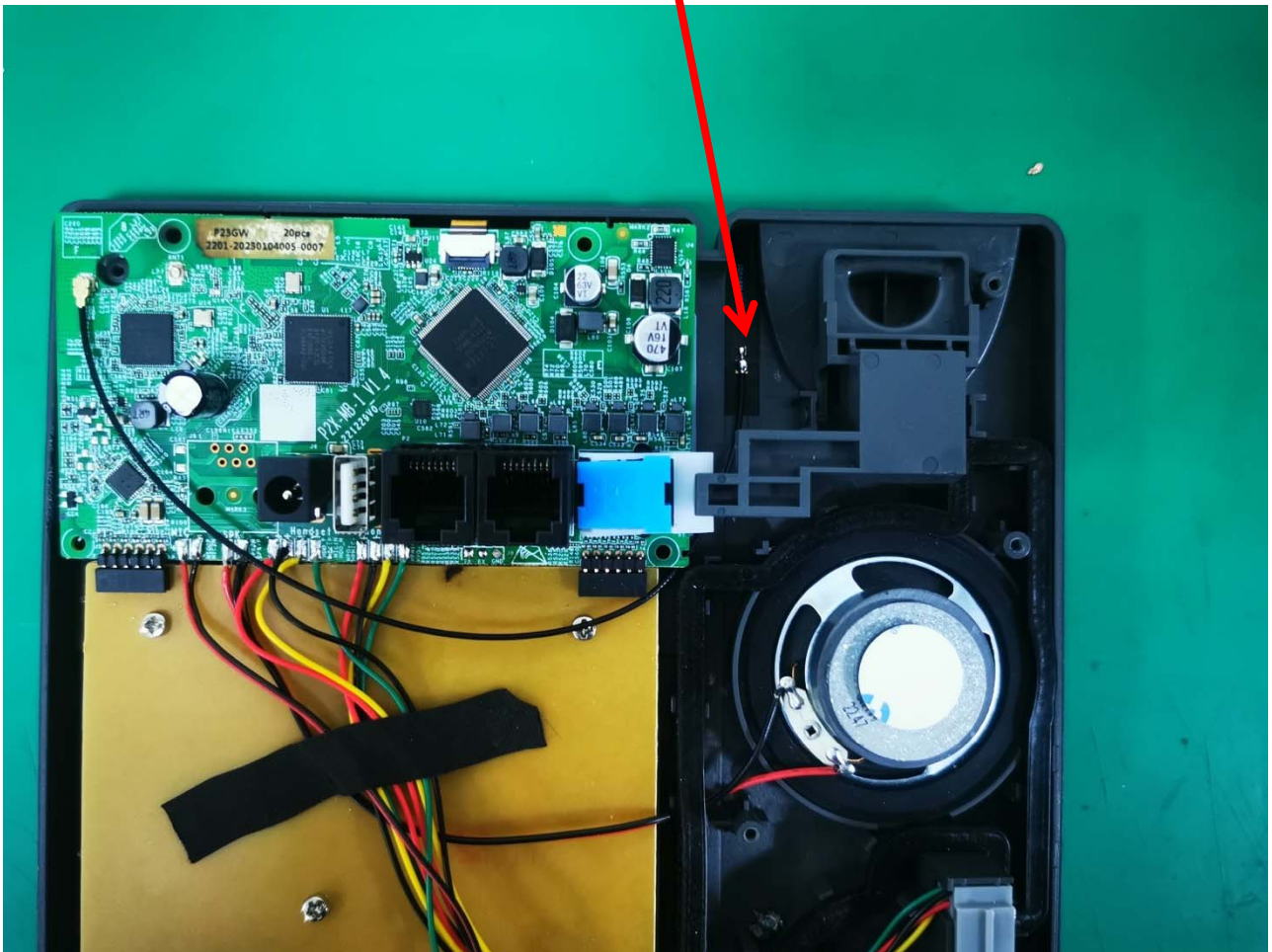

## ， 一、化學品與廠商資料

化學品名稱：液態熱固軟板油墨 PSM-800FSDM-A/SMH-800
其他名稱：
建議用途及限制使用：柔性电路板(PI/Cu), 手機天線板
製造者、輸入者或供應者名稱、地址及電話：製造者：優立實業股份有限公司 住址：桃園市觀音區經建四路 22 號 電話：886-3-4836651
緊急聯絡電話/傳真電話：電話：886-3-4836651、傳真：886-3-4837487

## 二、危害辨識資料

化學品危害分類：
健康及環境危害：急毒性物質（吞食）第 4 級、腐蝕／刺激皮膚物質第 2 級、嚴重損傷／刺激眼睛物質第 2A 級、皮膚過敏物質第 1 級、致癌物質第 2 級、水環境之危害物質（急毒性）第 2 級。
標示內容：
象 徵 符 號：

警 示 語：警告
危害警告訊息：
<ul style="list-style-type: none"> <li>吞食有害</li> <li>造成皮膚刺激</li> <li>造成嚴重眼睛刺激</li> <li>可能造成皮膚過敏</li> <li>懷疑致癌</li> <li>對水生生物有毒</li> </ul>
危害防範措施：
<ul style="list-style-type: none"> <li>置容器於通風良好的地方</li> <li>遠離高溫</li> <li>使用時勿吃、喝</li> <li>衣服一經污染，立即脫掉</li> <li>戴眼罩／護面罩</li> <li>若與眼睛接觸，立刻以大量的水洗滌後洽詢醫療</li> <li>戴上合適的手套</li> <li>勿吸入氣體/煙氣/蒸氣/霧氣</li> <li>使用前取得說明</li> <li>置放於上鎖處</li> <li>在瞭解所有安全防範措施之前切勿處置</li> <li>避免釋放至環境中</li> </ul>
其他危害：—

## 三、成份辨識資料

混合物：			
中英文名稱：液態熱固軟板油墨 PSM-800FSDM-A/SMH-800			
化學性質：			
	危害成分之中英文名稱	化學文摘社登記號碼 (CAS No.)	濃度或濃度範圍(成分百分比)
	環氧丙烯酸酯寡聚物 Epoxy acrylate oligmer	28064-14-4	50 %
	二氧化矽 Fused silica	7631-86-9	13 %
	芳香族溶劑 Aromatic solvent	64742-94-5	4 %



# ，安全資料表

版權 2021-01-10

二丙二醇甲基醚 Methyl dipropylene glycol	34590-94-8	4%
碳黑 Carbon black	1333-86-4	3.5 %
硫酸鋇 BaSO4	13462-86-7	24 %
光敏劑及其它 Photoinitiator and the others	5495-84-1	1.5 %

## 四、急救措施

不同暴露途徑之急救方法：

吸入：1.施救前先做好自身的防護措施。

2.移走污染源或將患者移至新鮮空氣處。

3.若有病人呼吸停止，立即由受過訓的人施以人工呼吸，若心跳停止，施行心肺復甦術，當患者吸入和吞下毒性物質時，別直接使用口對口人工呼吸，應使用單向給氣式之口袋型面罩和其他醫療器材來執行人工呼吸。

4.保持患者安靜及維持正常體溫。6.儘速就醫治療。

皮膚接觸：儘快以緩和流動的水沖洗受污染區域至少20分鐘，沖水前，脫掉污染的衣物、鞋子、皮飾品。

眼睛接觸：立即將眼皮撐開用緩和流動的水沖洗受污眼睛至少20分鐘，並立即就醫。

食入：1.若患者即將喪失意識，或已喪失意識或痙攣，不可餵食任何東西。

2.不可催吐，並給予240-300ml的水。

3.如果自發性嘔吐，讓其漱口，並反覆給水。

最重要症狀及危害效應：—

對急救人員之防護：—

對醫師之提示：—

## 五、滅火措施

適用滅火劑：化學乾粉、酒精泡沫、二氧化碳、噴水，大火：噴水、水霧、泡沫水霧。

滅火時可能遭遇之特殊危害：

1.其蒸氣及熱分解物易燃及有毒。

2.其蒸氣較空氣重，能傳播至遠處之火源處，發生回火。

3.蒸氣與大氣結合可能會發生爆炸。

4.當此物質在室內、室外或下水道有蒸氣爆炸危險。

特殊滅火程序：

1.在安全距離的地方滅火，保持在上風位置。

2.可用水冷卻容器，分散蒸氣沖洗外洩並稀釋外洩物，保護搶救人員。

3.用水噴灑露在火焰中的容器四週，使容器冷卻，直到火勢被撲滅為止。離開容器的本端以維安全。

4.撲滅或移開所有引燃源。

消防人員之特殊防護裝備：消防人員必須配戴空氣呼吸器、消防衣及防護手套。

## 六、洩漏處理方法

個人應注意事項：

1.限制人員進入，直至外溢區完全清理乾淨為止。

2.由受過訓之人員負責清理之工作。

3.穿戴適當的個人防護裝備。

環境注意事項：

1.移去引火源。

2.保持洩漏區通風。

3.處在上風處，避免進入低處。

4.在不危及人員安全情況下，搬移或隔離易燃和可燃物。

5.隔離污染源至少100至200公尺。

清理方法：

1.不可碰觸外洩物。

2. 避免外洩物進入下水道或密閉的空間內。
3. 在安全許可的情形下，設法阻止或減少溢漏。
4. 用不會和外洩物反應的泥土、沙或相似穩定且不可燃的物質圍堵外洩物。
5. 少量溢漏時，用不會和外洩物反應之吸收劑吸收。已污染的吸收劑和外洩物具有同樣的
6. 危害性，須置於加蓋並標示的適當容器裡。用水沖洗溢漏區域。
7. 大量溢漏時：連絡消防、緊急處理單位及供應商以尋求協助。

## 七、安全處置與儲存方法

### 處置：

1. 貯存於陰涼乾燥涼好通風的地方，並避免陽光直射、熱及引火源。
2. 遠離不容物如強氧化物、強酸、水。
3. 使用接地、與無火花之電器儀器、通風系統。
4. 小量時貯存於冰箱，並使用防爆炸冰箱。
5. 設外洩警報系統。
6. 須貯存區與工作區隔離，並限制人員出入貯存區，並貼示警告標語。
7. 避免碰撞，並就近設滅火系統。
8. 不可單獨工作，另一人需隨時待命救援。
9. 在工作區使用許可裝運燃燒性液體的容器，並且所有桶槽、轉裝容器都要接地，且須接觸到裸金屬。
10. 使用最小可能的量，並在指定區內，使用適合的通風系統。
11. 標示容器，當不使用時要緊蓋。

### 儲存：

1. 貯存於陰涼乾燥涼好通風的地方，並避免陽光直射、熱及引火源。
2. 小量時貯存於冰箱，並使用防爆炸冰箱。
3. 須貯存區與工作區隔離，並限制人員出入貯存區，並貼示警告標語。
4. 標示容器，當不使用時要緊蓋。

## 八、暴露預防措施

### 工程控制：

1. 單獨使用步產生火花、接地的通風系統。
2. 排氣口直接通到室外、並採取保護的重要措施。
3. 大量使用此物質時，可能需要局部排氣裝置和製程密閉。
4. 供給充分新鮮空氣以補充排氣系統抽出的空氣。

### 控制參數：—

八小時日時量平均容許濃度/短時間時量平均容許濃度/最高容許濃度：—

### 生物指標：—

### 個人防護設備：

- 呼吸防護：1. 含有機蒸汽過濾毒罐之化學品過濾毒呼吸防護具或自攜式呼吸防護具。  
2. 定流量式供氣式呼吸防護具，動力型含有機蒸氣濾毒罐空氣淨化呼吸防護具，含有機蒸氣濾毒罐的面罩，全面型自攜式呼吸防護具，全面型供氣式呼吸防護具，全面型含有機蒸汽濾毒罐之化學品過濾毒呼吸防護具。  
3. 正壓全面型攜式呼吸防護具或含輔助型正壓自攜式呼吸防護具之正壓全面型供氣式呼吸防護具。  
4. 有機蒸氣濾毒罐的面罩，逃生型自攜式呼吸防護具。
- 手部防護：丁基橡膠最佳，氣聚乙炔，聚乙炔酸，氟化彈性體、丁基橡膠/氣丁橡膠，鐵氟龍，氣丁橡膠/天然橡膠銀罩，氟化彈性體/氣丁基橡膠亦佳的防滲手套。
- 眼睛防護：1. 防濺化學安全眼鏡。  
2. 全面罩。  
3. 勿戴隱形眼鏡。
- 皮膚及身體防護：1. 工作鞋及連身工作服。  
2. 工作區要有淋浴/沖洗設備。

### 衛生措施：

1. 工作後儘速脫掉污染之衣物，洗淨後才可再穿戴。



# ，安全資料表

版權 2021-01-10

2.工作場所嚴禁抽煙或飲食。
3.處理此物後，須徹底洗手。
4.維持作業場所清潔。

## 九、物理及化學性質

外觀(物質狀態、顏色等)：黑色膏狀流體	氣味：臭味
嗅覺閾值：—	熔點：-25℃
pH 值：—	沸點/沸點範圍：218-219℃
易燃性(固體、氣體)：—	閃火點：>75℃
分解溫度：—	測試方法：( ) 開杯 ( V ) 閉杯
自燃溫度：不自燃	爆炸界限：—
蒸氣壓：—	蒸氣密度：6.07
密度：1.24~1.26 (水=1)	溶解度：微溶於水
辛醇/水分配係數(log Kow)：—	揮發速率：—

## 十、安定性及反應性

安定性：密封乾燥容器下安定。
特殊狀況下可能之危害反應：—
應避免之狀況：洩漏、火焰和其他引火源。
應避免之物質：酸、氧化劑
危害分解物：一氧化碳

## 十一、毒性資料

暴露途徑：皮膚、吸入、眼睛、食入
症狀：刺激感、困倦、暈眩、疲倦、頭痛、反胃、呼吸困難及痙攣
急毒性：吸入：1.蒸氣會刺激鼻、咽喉及肺。 皮膚：1.純液體或濃溶液會造成嚴重刺激及灼傷感。 2.蒸氣對皮膚會造成刺激。 3.經由皮膚接觸，液體會被吸收達中毒量。 眼睛：1.蒸氣會刺激眼睛及催淚。 2.液體會造成嚴重眼睛灼傷。 食入：1.會對口及消化道造成明顯的局部刺激。
慢毒性或長期毒性：—

## 十二、生態資料

生態毒性：—
持久性與降解性：避免進入水源入口及水路中，對水中生物具傷害性。
生物蓄積性：—
土壤中之流動性：—
其他不良效應：—

## 十三、廢棄處置方法

廢棄處置方法：
1.參考相關法規處理。
2.依照倉儲條件儲存待處理的廢棄物。
3.可採用特定的焚化或衛生掩埋法處理。

## 十四、運送資料

聯合國編號：—
---------



# ，安全資料表

版權 2021-01-10

聯合國運輸名稱：—
運輸危害分類：依福建商檢報告 0128227 判定為普通貨物
包裝類別：可按普通貨物辦理
海洋污染物(是/否)：否
特殊運送方法及注意事項：—

## 十五、法規資料

適用法規：
1.職業安全衛生設施規則
2.道路交通安全規則
3.事業廢棄物儲存清除處理方法及設施標準
4.危害性化學品標示及通識規則
5.勞工作業場所容許暴露標準

## 十六、其他資料

參考文獻	1.RTECS 資料庫，TOMES PLUS 光碟，Vol.41，1999 2.HSDB 資料庫，TOMES PLUS 光碟，Vol.41，1999
製表單位	名稱：優立實業股份有限公司 住址/電話：桃園市觀音區經建四路 22 號 電話：886-3-4836651
製表人	職稱：總經理 姓名(簽章)：黃志輝
製表日期	2021.01.10
備註	上述資料中"—"代表目前查無相關資料，而符號"/"代表此欄位對該物質並不適用

上述資料由本公司提供，對上述資料已力求正確，但錯誤恐仍難免，各項數據與資料僅供參考，使用者請依應用需求，自行負責判斷其可用性。



# MATERIAL SAFETY DATA SHEET

## 产品安全资料

Section 1 Preparation Identification and Company 样品标公司

Preparation Identification 标记: 防氧化原液DX-808HT

Manufacturers Name 公司名称: 深圳市东方星化工科技有限公司

Manufacturers Address 地址: 东莞市虎门镇大宁村大板地工业区

Emergency Telephone Number 联系电话: 0769-85015502

Emergency Tex Number 传真: 0769-85015500

Postal code 邮政编码: 523900

Section 2 Composition information on Ingredients

成份组成

学名

化学文摘社登记号码

浓度(%)

(Chemical Name)

(CASNO)

(Concentration)

苯并咪唑 Benzimidazole

95-14-7

1%

甲酸 Formic acid

64-18-6

3%

添加剂 Additives

-----

0.05%

DI 水DI water

7732-18-5

95.95%

Section 3 Hazards Identification

危险性概述

Safety and Risk 安全和危险性: DX-808HT contain formic acid which may cause severe burns. 含有甲酸可能导致灼伤

Section 4 First Aid Measures

急救措施

Eyes 眼睛: flush with plenty of clean, cool water for 15 minutes and get immediate medical attention 大量清水冲洗并尽快就医

Skin 皮肤: flush with plenty of clean, cool water for 15 minutes 大量清水冲洗15 分钟

Ingestion 食入: get immediate medical attention 尽快就医

Section 5 Fire Fighting Measures

消防措施

不可燃

Section 6 Accidental Release Measures

泄漏应急措施

Personal Precautions 个人防护: wears protective clothing, chemical safety goggles, respirator, face shield and rubber gloves 穿戴耐酸防护服, 护目镜、面罩和橡胶手套

Clean-up Procedure 清洗: flush with plenty of clean, cool water 用大量清水冲洗

Section 7 Handling and Storage

操作与储存

Ventilation 通风: Store indoors in a cool dry area

阴凉干燥处

Temperature 温度: Store indoors in a cool dry area

阴凉干燥处

Containers 容器: Keep containers tightly closed. Loosen closure cautiously when opening. 保持容器密封, 打开时慎重

Incompatible Materials 不相容物质: alkalis and oxidizers 碱性和氧化物

Pot Life 有效期: six months 6 个月

Section 8 Exposure Controls /Personal Protection 接触控制与个人防护

Ventilation 通风: Exhaust ventilation is recommended 推荐抽出式通风

**Respiration 呼吸:** respirator。 Avoid breathing vapors or mist。 防毒面具  
避免吸入蒸汽或烟雾

**Eyes and Face 眼睛和脸:** chemical safety goggles and face shield 护目镜  
和脸罩

**Hands and Skin 手和皮肤:** rubber gloves 橡胶手套

**Clothing :** protective clothing 耐酸防护服

Section 9 Physical and Chemical Properties 物理和化学特性

**Appearance 外观:** 浅蓝色液体

**Odour 气味:** 淡醋酸味

**PH:** 2.7±0.3

Section 10: Stability and Reactivity 稳定性和反应活性

**Chemical Stability 化学稳定性:** 弱的反应能力

**Incompatible Materials 不相容物质:** alkalis and oxidizers 碱性和氧化物

Section 11 Toxicological Information 毒性资料

NDA 无毒

Section 12 Disposal Consideration 废弃处理

Dispose of material in approved sites 中和后过滤排放, 过滤物交当地合法  
批准单位。

Section 13 生态资料

生态毒性: 无

生物降解性: 无

非生物降解性: 无

其它有害作用: 无

Section 14 法规信息

通用法规:

劳工安全卫生规则

特定化学物预防标准

Section 15 运送资料

国内运输规定: 依道路交通安全规则第84 条

Section 16 其他资料

制表单位: 深圳市东方星化工科技有限公司

制表地址: 东莞市虎门镇大宁村大板地工业区

制表部门: 品质部

制表日期: 2017 年 1 月

# CHUNG YU INDUSTRY CORPORATION

## Material Safety Data Sheet

### Section 1 : Chemical Product and Company Identification

Product name	Thermal curable two-component marking ink
Other means of identification	ZSR-150 ZM-400WF
Recommended use of the chemical and restrictions on use	Use in PCB fabrication.
Manufacturer/Supplier identification	CHUNG YU INDUSTRY COPORATION
Manufacturer/Supplier address	618 Yen-Ping Rd., sec. 3, Ping-Jeng, Tao-Yuan, Taiwan
Emergency telephone No.	(886-3)4641205
FAX No.	(886-3)4644839

### Section 2 : Hazards Identification Information

Hazard classifications of the product	Inflammable liquids(II),Carcinogens, (II), Inhalation of hazardous substances (I)
Label elements	 Hazard symbols: Fire Caution catchwords: Danger Hazard messages: Inflammable liquids and vapor Harmful to swallow Skin irritation Eye irritation
Other hazards	—

### Section 3 : Composition, Information on Ingredients

Mixture :

Chemical name	Concentration(% of contents)	CAS. NO.
Epoxy resin	50	25085-99-8
Barium sulfate	15	7727-43-7
Titanium dioxide	30	13463-67-7
Naphtha	5	8030-30-6

#### Section 4 : First-aid Measures

The first-aid measures for different exposure routes:	
Eyes contact	Immediately flush eyes with plenty of water for at least 15 minutes, occasionally lifting the upper and lower eyelids.
Skin contact	Flush skin with plenty of soap and water for at least 15 minutes while removing contaminated clothing and shoes.
Swallow	Do not induce vomiting. If conscious and alert, rinse mouth and drink 2-4 cupfuls of milk or water.
Inhalation	Remove from exposure to fresh air immediately.
The most important symptoms and hazardous effects	Headache, nausea
Notes to Physicians	Please provide the MSDS for physicians.

#### Section 5 : Fire-fighting Measures

Suitable fire extinguishing media	Chemical dry powders, chemical foam, carbon dioxide
General information	As in any fire, wear a self-contained breathing apparatus in pressure-demand, MSHA/NIOSH (approved or equivalent), and full protective gear. During a fire, irritating and highly toxic gases may be generated by thermal decomposition or combustion.
Specific fire-fighting methods	It's not suitable to use water extinguish.

#### Section 6 : Accidental Release Measures

Person-related precautionary measures	Do not inhale vapors / aerosols. Ensure supply of fresh air in enclosed rooms.
Environmental-protection measures	Do not allow to enter sewerage system.
Procedures for cleaning / absorption	Take up with liquid-absorbent material. Forward for disposal. Clean up affected area

#### Section 7 : Safe Handling and Storage Measures

Handling	Wash thoroughly after handling. Remove contaminated clothing and wash before reuse. Avoid contact with eyes, skin, and clothing. Avoid ingestion and inhalation.
Storage	Store in a cool(15~25°C), dry place. Keep container closed when not in use.

## Section 8 : Exposure Controls Measures

Engineering controls	Use adequate general or local exhaust ventilation to keep airborne concentrations below the permissible exposure limits. Use process enclosure, local exhaust ventilation, or other engineering controls to control airborne levels.				
Control parameters	Term	8 hours time weighted average exposure limits TWA	Short-term exposure limits STEL	Maximum limits CEILING	Biological standards BEIs
	Solvent	100ppm	125ppm	—	—
	Personal protective equipment	<p>Eye protection: Wear safety glasses and chemical goggles if splashing is possible.</p> <p>Skin protection: Wear appropriate protective gloves and clothing to prevent skin exposure.</p> <p>Clothing: Wear appropriate protective clothing to minimize contact with skin.</p> <p>Respirators: Wear a NIOSH/MSHA or European Standard EN 149 approved full-facepiece airline respirator in the positive pressure mode with emergency escape provisions.</p>			

## Section 9 : Physical and Chemical Properties

Physical state : paste	Color : white
Odor threshold : —	Odor : slightly pungent
pH value : —	Melting point : —
Decomposition temperature : —	Boiling point : 110-190°C (solvent)
Flammability(solid, gas) : —	Flash point : 38-43°C (solvent)
Autoignition temperature : —	Test methods : —
Vapor pressure : <5 mmHg @ 25°C (solvent)	Explosion limits : —
Specific gravity/Density : 1.45~1.55 g/cm <sup>3</sup> (water=1)	Solubility in water : insoluble

## Section 10 : Stability and Reactivity

Chemical stability	Stable under normal temperatures and pressures.
Conditions to avoid	Fire.
Incompatibilities with other materials	Strong oxidants.
Hazardous decomposition products	Irritating and toxic fumes and gases.
Hazardous polymerization	Has not been reported.

## Section 11 : Toxicological Information

Information on the likely routes of exposure	Skins, swallow, inhale, eyes
Symptoms	Nausea, vertigo, irritation
Acute toxicity	Skins: Slight irritation Swallow: Nausea, vomit, and the other symptoms same as inhale Inhale: Cause the respiratory tract irritation, nausea, vomit, headache Eyes: The vapor cause eyes irritation  LD50(solvent): >5000mg/kg (mouse, swallow) LC50: —
Further information	Further hazardous properties cannot be excluded. The product should be handled with the usual when dealing with chemicals

## Section 12 : Ecological Information

Ecotoxic effect	Quantitative data on the ecologic effect of this product are not available.
Further ecologic data	No ecological problems are to be expected when the product is handled and due care and attention.

## Section 13 - Disposal Considerations

Dispose of in a manner consistent with federal, state, and local regulations.

## Section 14 - Transport Information

1. United Nation number (UN No.): 1866
2. UN proper shipping name: —
3. Transport hazard classes: 3
4. Packing group: —
5. Marine pollutant (Yes/No): No
6. Specific transport measures and precautionary conditions: —

## Section 15 - Regulatory Information

1. European / International Regulations : European labeling in accordance with EC Directives.
2. Other using condition should follow local regulations.

### Section 16 - Additional Information

Organization that prepared the MSDS	Name: R&D	TEL: (886-3)4641205	
	Address: 618 Yen-Ping Rd., sec. 3, Ping-Jeng, Tao-Yuan, Taiwan		
Person who prepared the MSDS	Job: manager	Name: Wan-Hua Lee	
Date the MSDS was prepared	2018/12/20		

The information above is believed to be accurate and represents the best information currently available to us. However, we make no warranty of merchantability or any other warranty, express or implied, with respect to such information, and we assume no liability resulting from its use. Users should make their own investigations to determine the suitability of the information for their particular purposes. In no way shall the company be liable for any claims, losses, or damages of any third party or for lost profits or any special, indirect, incidental, consequential or exemplary damages, howsoever arising, even if the company has been advised of the possibility of such damages.

# 物质安全资料表

## 一、物品与厂商资料

物品名称：无卤聚酰亚胺铜箔基板(Halogen-free PI -CCL)
物品编号：SHIS or SHID
制造商或供货商名称 / 地址 / 电话/传真： 苏州蔡伦格蒂电子材料有限公司/江苏省太仓市太平北路 168 号辛龙工业园 2#楼 /0512-5337 8333/0512-5337 8355
紧急联络电话/传真电话： 0512-5337 8333/0512-5337 8355

## 二、成分辨识资料

纯物质：

中英文名称： 1. 无卤环氧树脂接着剂 2. 聚酰亚胺膜 3. 铜箔
同义名称： -
化学文摘社登记号码(CAS No.)： 1. (无卤环氧树脂接着剂) 24969-06-0      25% ~ 41.2% 2. (聚亚酰胺膜) 25038-81-7      17.4% ~ 39.6% 3. (铜箔) 7440-50-8      28.7% ~ 48%
有害物质成分(成分百分比)： < 15(无卤环氧树脂接着剂)

## 三、危害辨识数据

最重 要危 害与 效应	健康危害效应：对人体无危害。
	环境影响： -
	物理性及化学性危害： -
	特殊危害： -
主要症状： -	
物品危害分类： -	

## 四、急救措施

不同暴露途径之急救方法： 吸入：胶膜无途径吸入。 皮肤接触：无刺激。 眼睛接触：无挥发物可接触。 食入：胶膜无可能途径。
最重要症状及危害效应： -
对急救人员之防护： -
对医师之提示： -

## 五、灭火措施

适用灭火剂：使用适于隔离火场的灭火剂。
灭火时可能遭遇之特殊危害：高温裂解物质的吸入。
特殊灭火程序： -
消防人员之特殊防护设备：配戴空气呼吸器及防护手套、消防衣。

## 六、泄漏之紧急应变

个人应注意事项：使用个人防护设备。
环境注意事项： -
清理方法： -

## 七、安全处置与储存方法

处置：操作时,与食物、饮料隔离。
储存：储存在阴凉、干燥、通风良好的地方。

## 八、暴露预防措施

工程控制： -
控制参数：



八小时日时量平均容许浓度/短时间时量平均容许浓度/最高容许浓度： - 生物指标： -
个人防护设备： 呼吸防护： 防尘口罩。 手部防护： 手套。 眼睛防护： 安全眼镜。 皮肤及身体防护： -。

九、物理及化学性质

物质状态：	固体	形状：	膜状
颜色：	浅棕 ~ 深棕 (PI 侧)	气味：	无
pH 值：	N/A	沸点/沸点范围：	N/A
分解温度：	N/A	闪火点：	N/A 测试方法：开杯 闭杯
自燃温度：	N/A	爆炸界限：	N/A
蒸气压：	N/A	蒸气密度：	N/A

十、安定性及反应性：

安定性：	正常状况下安定
特殊状况下可能之危害反应：	-
应避免之状况：	-
应避免之物质：	-
危害分解物：	高热分解产生氮，磷氧化气体。

十一、毒性资料

急毒性：	N/A
局部效应：	N/A
致敏感性：	N/A
慢毒性或长期毒性：	N/A
特殊效应：	N/A

十二、生态资料

可能之环境影响/环境流布：	-
---------------	---

十三、废弃处置方法

依当地环保法规处理方式。
--------------

十四、运送资料

国际运送规定：	不适用于 IATA、ICAO。(非危险物品)
联合国编号：	--
国内运送规定：	--
特殊运送方法及 注意事项：	--

十五、法规资料

适用法规：适用于 RoHS、GP、WEEE。
------------------------

十六、其它数据

参考文献：	--	
制表单位：	名称：	苏州蔡伦格蒂电子材料有限公司
	地址/电话：	江苏省太仓市太平北路 168 号幸龙工业园 2#楼/ 0512-5337 8333
制表人：	职称：主管	姓名：黄龙
制表日期：	2020.3.16	
备注：	上述数据中符号“-”代表目前查无相关资料。 对上述数据已力求正确，各项数据与数据仅供参考，使用者请依应用需求，自行判断其可用性。	



## Article Information Sheet

Copyright, 2015, 3M Company.

All rights reserved. Copying and/or downloading of this information for the purpose of properly utilizing 3M products is allowed provided that: (1) the information is copied in full with no changes unless prior written agreement is obtained from 3M, and (2) neither the copy nor the original is resold or otherwise distributed with the intention of earning a profit thereon.

This product is defined as an article based on the definition of an Article under China New Chemical Environmental Management Method MEP Decree No. 7, and does not require a Safety Data Sheet under Dangerous Chemical Safety Management Regulatory China State Council Decree No. 591 and China GB/T16483-2008 Safety Data Sheet for Chemical Products Content and Order of Sections. This article information sheet (AIS) is provided as a courtesy in response to a customer request. When used as recommended or under ordinary conditions, the product should not present a health and safety hazard. However, use or processing of the product not in accordance with the product's recommendations or not under ordinary conditions may affect the performance of the product and may present potential health and safety hazards.

<b>Document Group:</b>	07-7168-3	<b>Version Number:</b>	1.00
<b>Issue Date:</b>	2015/05/19	<b>Supercedes Date:</b>	Initial Issue

### SECTION 1: Identification

#### 1.1. Product identifier

3M™ 300LSE Adhesive Transfer Tapes: 8132LE, 8153LE, 9453FL, 9453LE, 9471FL, 9471LE, 9472FL, 9472LE, 9472LEU, 9653LE, 9671LE, 9672LE and 9698LE

Other means of identification

#### 1.2. Recommended use and restrictions on use

##### Recommended use

Bonding & Attachment, Industrial use

#### 1.3. Supplier's details

**Company:** 3M Company  
**Division:** Industrial Adhesives and Tapes Division  
**ADDRESS:** 3M Center, St. Paul, MN 55144, USA  
**Phone:** 021-22105335  
**FAX:** 021-22105036  
**E Mail:** Tox.cn@mmm.com  
**Website:** www.3m.com.cn

#### 1.4. Emergency telephone number

021-22105335

### SECTION 2: Hazard identification

#### 2.1. Classification of the substance or mixture

This product is considered to be an article and is exempt from GHS classification.

3M™ 300LSE Adhesive Transfer Tapes: 8132LE, 8153LE, 9453FL, 9453LE, 9471FL, 9471LE, 9472FL, 9472LE, 9472LEU, 9653LE, 9671LE, 9672LE and 9698LE

### SECTION 3: Composition/information on ingredients

This material is a mixture.

Ingredient	C.A.S. No.	% by Wt
Paper or Film Liner	Mixture	Not Applicable
Acrylic Polymer Adhesive	Trade Secret	100

### SECTION 4: First aid measures

#### 4.1. Description of first aid measures

**Inhalation:**

No need for first aid is anticipated.

**Skin Contact:**

No need for first aid is anticipated.

**Eye Contact:**

No need for first aid is anticipated.

**If Swallowed:**

No need for first aid is anticipated.

### SECTION 5: Fire-fighting measures

In case of fire: Use a fire fighting agent suitable for ordinary combustible material such as water or foam.

### SECTION 6: Accidental release measures

#### 6.1. Personal precautions, protective equipment and emergency procedures

Not applicable.

#### 6.2. Environmental precautions

Not applicable.

#### 6.3. Methods and material for containment and cleaning up

Not applicable.

### SECTION 7: Handling and storage

#### 7.1. Precautions for safe handling

This product is considered to be an article which does not release or otherwise result in exposure to a hazardous chemical under normal use conditions.

#### 7.2. Conditions for safe storage including any incompatibilities

No special storage requirements.

### SECTION 8: Exposure controls/personal protection

This product is considered to be an article which does not release or otherwise result in exposure to a hazardous chemical

under normal use conditions. No engineering controls or personal protective equipment (PPE) are necessary.

## SECTION 9: Physical and chemical properties

### 9.1. Information on basic physical and chemical properties

Physical state	Solid
Specific Physical Form:	Roll of Tape
Appearance/Odor	Translucent adhesive, slight acrylate odor, paper or fim quick release liner
Odor threshold	<i>Not Applicable</i>
pH	<i>Not Applicable</i>
Melting point/Freezing point	<i>No Data Available</i>
Boiling point/Initial boiling point/Boiling range	<i>Not Applicable</i>
Flash Point	<i>Not Applicable</i>
Evaporation rate	<i>Not Applicable</i>
Flammability (solid, gas)	Not Classified
Flammable Limits(LEL)	<i>Not Applicable</i>
Flammable Limits(UEL)	<i>Not Applicable</i>
Vapor Pressure	<i>Not Applicable</i>
Vapor Density	<i>Not Applicable</i>
Density	<i>Not Applicable</i>
Relative Density	<i>Not Applicable</i>
Water solubility	Nil
Solubility- non-water	<i>Not Applicable</i>
Autoignition temperature	<i>Not Applicable</i>
Decomposition temperature	<i>Not Applicable</i>
Viscosity	<i>Not Applicable</i>
Volatile Organic Compounds	<i>Not Applicable</i>
Percent volatile	<i>Not Applicable</i>
VOC Less H2O & Exempt Solvents	<i>Not Applicable</i>

## SECTION 10: Stability and reactivity

This material is considered to be non reactive under normal use conditions.

## SECTION 11: Toxicological information

### Inhalation:

This product may have a characteristic odor; however, no adverse health effects are anticipated.

### Skin Contact:

No health effects are expected

### Eye Contact:

No health effects are expected

### Ingestion:

No health effects are expected

### Additional Information:

This product, when used under reasonable conditions and in accordance with the directions for use, should not present a health hazard. However, use or processing of the product in a manner not in accordance with the product's directions for use

**3M™ 300LSE Adhesive Transfer Tapes: 8132LE, 8153LE, 9453FL, 9453LE, 9471FL, 9471LE, 9472FL, 9472LE, 9472LEU, 9653LE, 9671LE, 9672LE and 9698LE**

may affect the performance of the product and may present potential health and safety hazards.

## **SECTION 12: Ecological information**

This article is expected to present a low environmental risk either because use and disposal are unlikely to result in a significant release of components to the environment or because those components that may be released are expected to have insignificant environmental impact.

## **SECTION 13: Disposal considerations**

Dispose of contents/container in accordance with the local/regional/national/international regulations.

## **SECTION 14: Transport Information**

Not hazardous for transportation.

## **SECTION 15: Regulatory information**

### **15.1. Safety, health and environmental regulations/legislation specific for the substance or mixture**

This product is an article and is exempted from Measures on Environmental Management of New Chemical Substances and from IECSC inventory listing requirements.

## **SECTION 16: Other information**

### **References**

United Nations 'Recommendations on the Transport of Dangerous Goods - Model Regulations '

United Nations 'Globally Harmonized System of Classification and Labelling of Chemicals (GHS)'.

### **Revision information:**

Conversion to AIS.

**DISCLAIMER:** The information on this Article Information Sheet is based on our experience and is correct to the best of our knowledge at the date of publication, but we do not accept any liability for any loss, damage or injury resulting from its use (except as required by law). The information may not be valid for any use not referred to in this Information Sheet or use of the product in combination with other materials. For these reasons, it is important that customers carry out their own test to satisfy themselves as to the suitability of the product for their own intended applications.

**3M People's Republic of China AISs are available at [www.3m.com.cn](http://www.3m.com.cn)**

MATERIAL SAFETY DATA SHEET

物质安全资料表

1、CHEMICAL PRODUCT AND COMPANY IDENTIFICATION 产品和公司资料

1.1 PRODUCT NAME: Polyimide reinforcement plate

产品名称: Pi 补强片

1.2 PRODUCT USE: Flexible printed circuit Boards.

用途: 用于挠性印制电路板.

1.3 Product Model 产品型号

Model: HS2025、HS3025、HS4025、HS5025、HS6025、HS7025、HS8025、HS9025、HS10025

1.4 公司名称及地址: 深圳市溢海通电子有限公司

NAME of COMPANY and ADDRESS: Shenzhen YiHaiTong Electronics Co.,ltd

广东省深圳市宝安区沙井后亭第二工业区 57 号福新大厦 B 栋 602

Building B, Fuxin Chuangke Building,

No.57 Baoan District, Shenzhen, China

Shajing Houting Second Industrial Zone,

FOR MORE INFORMATION CALL:

IN CASE OF EMERGENCY CALL:

紧急联络电话: (Monday~Saturday,9:00am~6:00pm) (24Hours/Day, 7 Days/Week)

0755-33238080

0755-33238080

2、COMPOSITION INFORMATION ON INGREDIENTS 组成成份资料

2.1 The main ingredient 主要成分

Ingredient name chemical abstract number weight ratio 成分名称 化学文摘号 重量比

Polyimide film 25038-81-7 30-50% 聚酰亚胺薄膜 25038-81-7 30~50%

Remove 10-25% of the release film / paper when it is used 离形膜/纸 使用时撕掉 10~25%

Acrylates 141-32-2 25-40% 丙烯酸酯 141-32-2 25~40%

Acrylic acid 79-10-7 10-20% 丙烯酸 79-10-7 10~20%

2.2 hazardous ingredients 危害物质成分

No. SGS Test Report:No.CANML1412085401, No.CANML1412085402

2.3 Molecular Structure:分子结构

3、HAZARDS IDENTIFICATION 危害性资料

3.1 hazard class filled by GB13690-92 " Classification of hazardous chemicals used and signs " requirement.:

危险性类别 按 GB13690-92 《常用危险化学品的分类及标志》规定填写。

Insoluble in water, no melting point , soluble in acid, alkali .

不溶于水，无熔点，易溶于强酸、强碱。

3.2 Nonflammable sheet material, Fumes if decomposed may irritate eyes、nose and throat..

是一种难燃的片状材料。当分解时产生的气体会刺激眼睛、鼻和咽喉。

POTENTIAL HEALTH HAZARDS:

3.3 A brief description of the extent of environmental harm when hazards caused by certain concentrations of various chemical and biological harm .

环境危害 简要描述化学品在一定浓度时对各种生物造成的危害及其造成危害的程度。

Produces CO<sub>2</sub> and CO decomposition.

分解时会产生 CO<sub>2</sub> 和 CO。

3.4 SKIN: Adhesive may cause moderate skin irritation.

皮肤：胶粘剂可能导致中等程度皮肤过敏。

3.5 EYES: Adhesive may cause eye moderate irritated, Fumes may irritate eyes.

眼睛：胶粘剂可能导致中等程度眼睛过敏。

3.6 INHALATION : Trace of chemical solvents may diffused to air in the processes of varnish preparation and coating production.

吸入物：在涂覆生产过程中，会有少量化学溶剂挥发出来。

3.7 INGESTION: Not determined.

摄食：没有参考值。

4 、 FIRST AID MEASURES 首要援助措施

SKIN: Washing the contaminated clothing in flowing water.

皮肤：脱下已污染衣服，用流动水冲洗。

EYE: Washing with flowing water for 15 minutes, consult the physician If irritation persists.

眼睛：用流动水冲洗 15 分钟，如过敏现象持续发生，请求助于医生。

INHALATION : Such as dust, smoke to much move to fresh air. If can not breathe, give mouth-to-mouth resuscitation and Call physician.

吸入：如粉末烟尘太多请转移到有新鲜空气的地方，如没有呼吸，请进行人工呼吸，并致电医生。

INGESTION: If large amounts are ingested, consult physician.

摄食：如摄入大量，请致电医生。

ADVICE TO PHYSICIAN: Treat symptomatically.

建议医生：处理出现的症状。

5 、 FIRE FIGHTING MEASURES 火灾测试

FLAMMABLE PROPERTIES: N/A

易燃烧性：不适用

FLASH POINT: N/A

闪点：不适用

FLASH POINT METHOD: N/A

闪点方式：不适用

**AUTOIGNITION TEMPERATURE:** Not determined

自燃点温度：无规定

**UPPER FLAME LIMIT (Volume% in air) :** N/A

燃烧上限：不适用

**LOWER FLAME LIMIT (Volume% in air) :** N/A

燃烧下限：不适用

**FLAME PROPAGATION RATE (Solids) :** UL94 V-0

燃烧等级：UL94 V-0

**OSHAFLAMMABILITY CLASS:** N/A

燃烧级别：不适用

**EXTINGUISHING MEDIA:** Water, CO 2 and dry chemical.

灭火介质：水、CO 2 及干化学品

**SPECIAL FIREFIGHTING PRECAUTIONS/INSTRUCTIONS:**

特别火灾指导：

Firemen should wear proper protective equipment and positive pressure self-contained breathing apparatus.

消防员须身穿保护装置及正压呼吸设施。

**6 、 ACCIDENTAL RELEASE MEASURES 意外事故的应变措施**

**IN CASE OF SPILL OR OTHER RELEASE :** ( Always wear recommended personal protection equipment )

如有泄漏或其他释放：( 通常身穿所推荐的保护设施 )

Not applicable for the solid material.

不适用于固体材料。

Spills and releases may have to be reported to local authorities.

有关泄漏应报告当地政府。

**7 、 HANDLING AND STORAGE 仓贮指南**

**7.1 Handling Precautions refers to the process of the operation of the safety of chemicals and personal protection points to note.**

操作注意事项 指对化学品操作过程中的安全注意要点和个体防护。

No.

暂无.

**7.2 Storage Precautions 存储注意事项**

a) disposal: storage spaces non fireworks ,sit housekeeping standards to prevent dust.

处置：存放场所严禁烟火，做好整理、整顿以避免灰尘。

b) Storage: high stability, non-reactive under normal storage conditions.

存储：稳定性高，正常的存储条件下无反应。

**8 、 EXPOSURE CONTROLS / PERSONAL PROTECTION 泄漏控制 / 个人保护**

**ENGINEERING CONTROLS:** Use local exhaust ventilation to control dust..

工程控制：使用当地除尘通风设施。

**PERSONAL PROTECTIVE EQUIPMENT:** 个人保护措施：

**SKIN PROTECTION :** For brief contact to dust,no precautions other than clean bodycovering clothing should

needed.Use gloves and aprons when prolonged or frequently repeated contact occurs.



皮肤保护：对于短暂性的接触粉尘，需要时清洗身体或衣服，无预防措施。对于长期性的接触，要配带手套和围裙。

**EYE PROTECTION:** Use appropriate eye protection when machining material.

眼睛保护：当加工材料时使用眼睛保护装置。

**RESPIRATORY PROTECTION:** When respiratory protection is required for certain operations, use a NIOSH-approved dust respirator.

呼吸保护：当进行产生大量粉尘的操作时使用规范的粉尘防毒面罩。

**ADDITIONAL RECOMMENDATIONS:** N/A

其它建议：不适用。

## 9、PHYSICAL AND CHEMICAL PROPERTIES 物理化学性能

### 9.1 Appearance products 产品外观

Yellow、brown、black and so on, odorless solid flake materials

黄色，棕色和黑色等，无味固体片状材料。

### 9.2 PHYSICAL STATE: Solid

物理形态：固体

### 9.3 ODOR: None, unless heated

气味：无味，除非加热

### 9.4 Heat of combustion

燃烧热 94-V0

### 9.5 SOLUBILITY IN WATER: (Weight%) Negligible in water

水溶性：（重量%）在水中可忽略

### 9.6 The main purpose 主要用途

Mainly used in packing, printing, screen printing, pad printing, nameplates, membrane switches, flexible circuits,

Insulation products, circuit boards, laser security, laminating, electronic, film sealing material, reflective materials,

Waterproof material, medicine(plaster with paper),toilet paper, adhesive, die punching processing and other industries.

主要应用于包装、印刷、丝印、移印、铭板、薄膜开关、柔性线路、绝缘制品、线路板、激光防伪、

贴合、电子、密封材料用膜、反光材料、防水材料、医药（膏药用纸）、卫生用纸、胶粘制品、模切冲型

加工等行业领域。

## 10、STABILITY AND REACTIVITY 稳定性及反应性

### 10.1 NORMALLY STABLE: (conditions to avoid) Stable

通常稳定：稳定

### 10.2 INCOMPATIBILITIES: Not determined

不兼容性：不确定

### 10.3 HAZARDOUS POLYMERIZATION? None

危险聚合物：无

### 10.4 Condition to avoid 避免接触的条件

Not available: 无资料

#### 10.5 Decomposition products 分解产物

Produces Co<sub>2</sub> and Co decomposition.

分解时会产生 Co<sub>2</sub> 和 Co.

#### 11 、 TOXICOLOGICAL INFORMATION 毒物学的资料

##### 11.1 Acute Toxicity 急性毒性

N/A

##### 11.2 Subacute and chronic toxicity 亚急性和慢性毒性

N/A

##### 11.3 Irritating 刺激性

N/A

##### 11.4 Sensitization 致敏性

N/A

##### 11.5 Mutagenicity 致突变性

N/A

##### 11.6 Carcinogenicity 致癌性

N/A

##### 11.7 Other 其他

N/A

#### 12 、 ECOLOGICAL INFORMATION 生态学资料

Not Biodegradable

非生物降解。

#### 13 、 DISPOSAL CONSIDERATIONS 处置问题

Is the unused product a hazardous waste substances list of country hazardous waste if discarded? No.

列入国家危险废物名录的危险废物不能够再利用时是否被丢弃? 不。

OTHER DISPOSAL CONSIDERATIONS : Dispose must be made in accordance with all applicable Local

regulations.

其它处置问题: 处置必须遵循当地的法律法规。

Suggestion method after products will be discarded :

(1)、Separate reuse method: crush products into powder, recycling as a filler.

(2)、Incineration method: incinerate the unused products, this method may cause organic compound gas.

(3)、Bury into deep earth.

产品报废之后有以下几种处置方法:

(1)、分离法: 将产品粉碎, 可作填充料;

(2)、焚烧法: 焚烧过程中可能产生有机化合物气体;

(3)、填埋法。

#### 14 、 TRANSPORT INFORMATION 运输资料

For additional information on shipping regulations affecting this material, contact the information number found

on the first page.

附带资料是当运输规则影响到物料时, 请和第一页所提供的联系方式联系。

#### 15 、 REGULATORY INFORMATION 法规资料

### 15.1 Domestic Chemical Safety regulations 国内化学品安全管理法规

“Material Safety Data Sheet preparation specified range” GB/T 16483-2008

《化学品安全技术说明书编写规定范围》GB/T 16483-2008

“Chemical Dangerous Goods Safety Management Regulations” (February 17, 1987 the State Council issued).

《化学危险物品安全管理条例》（1987年2月17日国务院发布）

“Common Hazardous Chemicals and signs” (GB13690-1992).

《常用危险化学品的分类和标志》（GB13690-1992）

“Air Pollutant Emission Standards” GB16297-1996

《大气污染物综合排放标志》GB16297-1996

“Sour gas transportation safety regulations” SY6506-2000

《含硫气田安全输送规程》SY6506-2000

“Chemical Dangerous Goods Safety Management Regulation implementing rules” (the Labor Fa[1992] No.677)

《化学危险物品安全管理条例实施细则》（化劳发【1992】677号）

“Industrial sites safe use of chemicals” (1996 workers are No.423)

《工业场所安全使用化学品规定》（1996劳都发423号）

“Dangerous Goods Classification and code” GB6944-1986

《危险货物分类和品名编号》GB6944-1986

“Transport of Dangerous Goods Package CATEGORY principle” GB/T15098-1994

《危险货物运输包装类别划分原则》GB/T15098-1994

“Transport of Dangerous Goods Management Regulations” (formerly the Ministry of Railways issued)1995

《危险货物运输管理规则》（原铁道部颁布）1995年

These laws and regulations for the safe use of hazardous chemicals, production, storage, transport, handling, etc.

are made relevant regulations.

以上法规对化学危险品的安全使用，生产，存储，运输，装卸等方面均做了相关规定。

附 加 法 规 资 料 :

Shenzhen YIHAITONG Electronic Co., Ltd. does not use PBBs or PBDEs as flame retardant in the resin system of the products 深圳市溢海通电子有限公司 没有采用多溴联苯或多溴联苯醚作为阻燃剂在产品的树脂体系当中

16 、 OTHER INFORMATION 其它资料 CURRENT ISSUS DATE: 现在版本日期: 2015-11-12

PREVIOUS ISSUE DATE: 2014-6-25 首次版本日期: 2014-6-25

4. MSDS

江阴凯博通信科技有限公司

JIANGYIN KAIBO COMMUNICATION TECHNOLOGY CO., LTD.

Material Safety Data Sheet (物质安全资料表)

一、物品与厂商资料

物品名称：同轴高频线

物品编号：KB113 系列

制造商或供货商名称、地址：江阴市凯博通信科技有限公司/江苏省江阴市澄江镇梅园大街 391 号

紧急联络电话/传真电话：0510-86070001/86070020

二、成分辨识资料

纯物质：

中英文名称：聚全氟乙丙烯 FLUORINATED PROPYLENE ETHYLENE/镀银铜线 Cu-silver plated/镀锡线 TINNED COPPER

同义名称：FEP/SC/TX

危害物质成分(成分百分比)：无

危害物质：

危害物质	浓度或浓度范围 (单位: ppm)	
铅及其化合物 Pb	≤90	
镉及其化合物 Cd	≤75	
汞及其化合物 Hg	≤1000	
六价铬及化合物	≤1000	
卤素	氯 Cl ≤900	氯 Cl+溴 Br ≤1500
	溴 Br ≤900	
SVHC15 种物质	禁止使用	

三、危害辨识数据

最 重 要 危 害 效 应	健康危害效应：在 260℃ 以上，可能会有吸入分解气体的危险。一定要安装排气装置。
	环境影响：要按废弃物处理及清扫法律法规处理，绝对不可燃烧。
	物理性及化学性危害：物理化学性能及其稳定，不易降解，不得擅自填埋。
	特殊危害：无
主要症状：对人的神经系统产生损害	
物品危害分类：大气和水源	

四、急救措施

不同暴露途径之急救方法：
· 吸入：到空气流通处换气。
· 皮肤接触：无
· 眼睛接触：无
· 食入：不消化，排出。

最重要症状及危害效应：无
对急救人员之防护：对流换气
对医师之提示：吸氧

#### 五、灭火措施

适用灭火剂：通用
灭火时可能遭遇之特殊危害：避免分解气体吸入
特殊灭火程序：无
消防人员之特殊防护设备：防毒面罩

#### 六、泄漏处理方法

个人应注意事项：粉状树脂
环境注意事项：不可填埋
清理方法：要按废弃物处理及清扫法律法规处理，绝对不可燃烧。

#### 七、安全处置与储存方法

处置：避免与高温和火源接触。
储存：通风干燥处。

#### 八、暴露预防措施

工程控制：无
控制参数： · 八小时日时量平均容许浓度/短时间时量平均容许浓度/最高容许浓度： · 生物指标：
个人防护设备： · 呼吸防护：安装排气装置 · 手部防护：无 · 眼睛防护：无 · 皮肤及身体防护：无
卫生措施：应将衣服上附着的灰尘抖落，手脸洗净，不要让其附着于香烟上。

#### 九、物理及化学性质

物质状态：固体	形状：透明颗粒
颜色：透明	气味：无
pH 值：7	沸点/沸点范围：/
分解温度：360℃	闪火点：/
自燃温度：/	爆炸界限：/
蒸气压：/	蒸气密度：/
密度：2.2	溶解度：/

#### 十、安定性及反应性

安定性：很稳定
特殊状况下可能之危害反应：高温或燃烧分解气体对人体神经系统的损害。
应避免之状况：绝对不可燃烧。

应避免之物质：金属钠及其强酸的混合物。  
危害分解物： 气体及粉尘。

#### 十一、毒性资料

急毒性： /  
局部效应： /  
致敏感性： /  
慢毒性或长期毒性： /  
特殊效应： /

#### 十二、生态资料

可能之环境影响/环境流布： 不降解, 禁填埋

#### 十三、废弃处置方法

废弃处置方法： 按废弃物处理及清扫法律法规要求送专业资质处理公司处置。

#### 十四、运送资料

国际运送规定： /  
联合国编号： /  
国内运送规定： 无  
特殊运送方法及注意事项： 无

#### 十五、法规资料

适用法规： 遵循欧盟 REACH 法规相关要求。

#### 十六、其它数据

参考文献	杜邦产品说明/SONY 限用物资标准
制窗体位	名称： 江阴凯博通信科技有限公司
	地址/电话： 江阴市澄江街道梅园大街 391 号/0510-86070017
制表人	姓名(签章)： 庄科洁
制表日期	2011/11/3

# MATERIAL SAFETY DATA SHEET (MSDS)

Issued: Dec 20, 2007

Revised: Dec 20, 2007

File No. 2302

## 1. CHEMICAL PRODUCT & COMPANY IDENTIFICATION

CHEMICAL PRODUCT NAME : DURANEX XFR4840  
NAME OF COMPANY : WinTech Polymer Ltd.  
SECTION IN CHARGE : Quality Assurance Dept.  
ADDRESS : 2-18-1 Konan, Minato-ku, Tokyo, 108-8280 Japan  
TELEPHONE NUMBER : 03-6711-8605  
FACSIMILE NUMBER : 03-6711-8616

## 2. COMPOSITION/INFORMATION ON INGREDIENTS

SUBSTANCE/PREPARATION : Preparation RATION  
COMMON CHEMICAL NAME : Polybutyleneterephthalate  
SYNONYMS : Polybutyleneterephthalate(PBT)  
INGREDIENTS AND COMPOSITION : PBT  $\geq$  80%, Phosphorus Flame retardant and others  $\leq$  20%  
CHEMICAL FORMULA :  $\{ \text{C}_6\text{H}_4\text{C}_6\text{H}_4\text{O}_2 \text{ (C}_2\text{H}_4\text{O)}_n$   
SERIAL No IN OFFICIAL GAZETTE : 7-1039 (base resin)  
(Law Concerning Examination and Regulation of Manufacture, etc., of Chemical Substances)  
CAS No : 2 4 9 6 8 - 1 2 - 5 (base resin)

## 3. HAZARDS IDENTIFICATION

PHYSICAL AND CHEMICAL HAZARDS : Not applicable  
HUMAN HEALTH EFFECTS : Not applicable  
ENVIRONMENTAL EFFECTS : Not applicable  
PHYSICAL AND CHEMICAL HAZARDS : It is inflammable substance and combustible if an igniting source is existent. Neither dangerous reaction, fire nor explosion can be caused under normal conditions.  
THE CLASSIFICATION : Not applicable

## 4. FIRST-AID MEASURES

INGESTION : Help to vomit as much as possible. If sick feeling continues, ask a physician for advice.  
INHALATION : When a gas generated from the molten polymer, especially fume generated during combustion or heat, has been inhaled, remove fresh air without delay and wait until the victim is recovered. If sick feeling continues, ask a physician for advice.  
SKIN CONTACT : Cool the contacted skin with clean water without delay, if a contact with the polymer in a molten form. Do not force to remove the solid resin on the skin. If any burns are observed on the skin, ask a physician for advice.

EYE CONTACT : Cool and rinse the eye with clean water for at least 15 minutes when the eyes had contact with molten polymer. In case of wearing contact lenses,remove the lenses as soon as possible,and ask a physician for advice. When the eye had contact with the polymer in an ordinary solid form,rinse the eye with clean water without delay. If the discomfort persists,ask a physician for advice.

---

#### 5. FIRE-FIGHTING MEASURES

EXTINGUISHING MEDIA : Water,form fire-extinguishing agent,powder fire-extinguishing agent,and carbon dioxide gas.

SPECIFIC METHODS : Extinguish the fire with water. A method of extinguishing an ordinary fire may be applied. Do not apply water directly to processing machines.

SPECIFIC HAZARDS : Incomplete combustion leads to generation of toxic gases such as carbon monoxide or tetrahydrofuran,in addition to carbonic acid gas and water.

SPECIAL EQUIPMENT FOR THE PROTECTION OF FIREFIGHTERS : In case the fire gained force,use a gas mask or other protective equipment.

---

#### 6. ACCIDENTAL LEAKAGE MEASURES

PERSONAL PRECAUTIONS : When pellets were spilled on the road or floor,wipe them off with a besom or cleaner not to cause slipping.

ENVIRONMENTAL PRECAUTION : Handle the spillage in accordance with provisions given in the "Resin pellet spillage preventive manual",in order to prevent intakes by marine animals and birds.

---

#### 7. HANDLING AND STORAGE

HANDLING : This resin in a pellet form will neither ignite nor explode at room temperatures.

HANDLING 2 : For molding work,effective means for local exhaust are required to discharge gases generated by melt processing.

HANDLING 3 : Avoid inhaling of gases generated in moulding work. Do not directly touch resin of high temperature.

HANDLING 4 : Avoid retaining hot resin in the processing machines for many hours.

HANDLING 5 : This pellets spilled on the floor are likely to cause slipping. Remove such spillage at any times.

STORAGE : Keep the substance away from any fire or heat sources for the sake of safe storage.

RECOMMENDED PACKAGING MATERIALS : No information.

---

#### 8. EXPOSURE CONTROL / PERSONAL PROTECTION

CONTROL CONCENTRATION : None at present

PERMISSIBLE CONCENTRATION : OSHA PEL/1985  
Max. permissible concentration of inactive powder 15mg/m<sup>3</sup>  
- ditto - (Aspiration ) 5 mg/m<sup>3</sup>  
ACGIH TLV/1992 1993  
Exposure limit of the powder TWA 10 mg/m<sup>3</sup>

ENGINEERING MEASURE : When handling dust: Use totally enclosed containers resisting dust explosion.  
When heat melted in molding: Effective local ventilation must be provided.



PERSONAL PROTECTIVE EQUIPMENT	:	
RESPIRATORY PROTECTION	:	Wear a dust-proof mask.
EYE PROTECTION	:	Wear protective glasses or goggles.
HAND PROTECTION	:	Wear heat-resisting gloves against burns, when handling molten polymer.
SKIN & BODY PROTECTION	:	Wear long sleeve clothes against burns, when handling molten polymer.

---

#### 9. PHYSICAL AND CHEMICAL PROPERTIES

APPEARANCE etc.	:	Pellet
BOILING POINT	:	Not applicable
VAPOUR PRESSURE	:	Not applicable
VOLATILITY	:	Not applicable
SUBLIMATION	:	None
MELTING POINT	:	228°C
DENSITY	:	1.32g/cm <sup>3</sup>
SOLUBILITY	:	Insoluble in water
FLASH POINT	:	300°C or higher
IGNITION POINT	:	300°C or higher
EXPLOSION PROPERTY	:	Not applicable
INFLAMMABILITY	:	None
REACTIVITY WITH WATER	:	None
OXIDIZABILITY	:	None
SELF-REACTIVITY	:	None
DUST EXPLOSIVENESS	:	Upper explosion limit : Not applicable. Lower explosion limit : 35g/m <sup>3</sup>

---

#### 10. STABILITY AND REACTIVITY

STABILITY AND REACTIVITY	:	Stable for normal storage or handling.
--------------------------	---	--

---

#### 11. TOXICOLOGICAL INFORMATION

SKIN CORROSIVE PROPERTIES	:	No finding.
SENSITIZING & IRRITANT EFFECTS	:	Gas generated in drying or melting is irritating eyes and skins.
ACUTE TOXICITY (INCLUDING LD50)	:	No finding.
SUBACUTE TOXICITY	:	No finding.
CHRONIC TOXICITY	:	No finding.

CARCINOGENECITY : No finding.

MUTAGENECITY(Mi : No finding.  
cro  
organisms,chromoso  
mal aberration)

REPRODUCTIVE : No finding.  
TOXICITY

TERATOGENICITY : No finding.

OTHERS(Including : No finding in this report means that there will be no hazard in  
generation of general,but no proving data available at the time of reporting.  
hazardous gases by  
reaction with  
water,for ezample)

OTHER CAUTIONS : With regard to dust,the maximum permissible concentration and limits  
are fixed by OSHA and ACGIH.

---

#### 12. ECOLOGICAL INFORMATION

BIODEGRADABILITY : No finding.

BIOACCUMULATION : No finding.

FISH TOXICITY : No finding.

---

#### 13. DISPOSAL CONSIDERATION

WASTE FROM : This is designated as waste plastics among industrial wastes by the  
RESIDUES Wastes Disposal Law. Disposal waste pellets through licensed wastes  
handlers or local autonomous bodies if they are handling wastes  
disposal.

WASTE FROM : When disposed by incineration,use the well controlled incinerators in  
RESIDUES 2 accordance with the Wastes Disposal Law,Air Pollution Control Law and  
Water Pollution Prevention Law.

---

#### 14. TRANSPORT CONSIDERATION

UN : Not applicable  
CLASSIFICATION  
NUMBER

OTHER CAUSIONS : Handle with care so as not to give damages to containers or not to be  
subjected to wetting.

OTHER CAUSIONS : Secure the containers firmly so as not to cause collapsing.  
2

---

#### 15. REGULATORY INFORMATION

WASTE DISPOSAL : Waste plastics among industrial wastes.  
LAW

---

#### 16. OTHER INFORMATION

HANDLING OF THE : This MSDS is the English version translated from the Japanese MSDS  
DETAILS GIVEN which is prepared for domestic use.  
ABOVE Details given above are based on references, information and data  
available at this moment, but no warranty can be made on exactness of  
these details. They are also prepared on the assumption that the  
product will be handled in a normal way. For special handling, adequate  
safety and environmental measures should be taken in respect to its  
applications. Our products are not specifically intended for implants for  
medical and dental applications, and therefore they are not  
recommended for such applications.  
"No finding" in this report means that there will be no hazard in general,  
but no proving data is available at the time of reporting.

## MATERIAL SAFETY DATA SHEET

MSDS FILE No. (KURAMI WORKS) : 05-1225

(based on Form OSHA-174)

IDENTITY ( AS Used on Label and List )

Product Class : Phosphor Bronze Strip  
 Trade Name : JIS H3130 C5210R (Equivalent to ASTM B103 C52100)  
 CAS No. : Copper: 7440-50-8, Tin: 7440-31-5, Phosphor: 7723-14-0  
 Chemical Composition

	Content(wt-%)	CAS No.
Tin(Sn)	7.0~9.0	7440-31-5
Phosphor(P)	0.03~0.35	7723-14-0
Copper(Cu)	Balance	7440-50-8
Sn+P+Cu	99.7 $\leq$	-

## Section I

Manufacturer's Name NIKKO METAL MANUFACTURING CO., LTD. KURAMI WORKS	Date Prepared May 24th, 2005
Address 3 Kurami Samukawa-cho Kouza-gun Kanagawa prefecture 253-0101 JAPAN	Signature of Person in Charge <i>Chihiro Izumi</i> IZUMI, Chihiro Senior Technical Supervisor, Quality Assurance
Telephone Number for Information (Quality Assurance) +81-467-75-7285	Signature of Person Responsible <i>Hiroaki Watanabe</i>
Facsimile Number for Information (Quality Assurance) +81-467-74-6971	WATANABE, Hiroaki Manager, Quality Assurance Section

## Section II Hazardous Ingredients / Identity Information

Hazardous Components (Specific Chemical Identity : Names OSHA PeI ACGIH TLV)

Nothing for ordinary service condition

## Section III Physical / Chemical Characteristics

Boiling Point 2630 °C for Copper 2275 °C for Tin	Specific Gravity (H2O = 1) 8.80
Vapor Pressure (mmHg) N/A	Melting Point 1025 deg. centi. for C5210 Phosphor Bronze
Vapor Density (Air = 1) N/A	Evaporation Rate (Butyl Acetate = 1) N/A
Solubility in Water N/A	
Appearance and Odor Brown - Red (solid) : Odor - None	

## Section IV Fire and Explosion Hazard Data

Flash Point (Method Used) N/A	Flammable Limits N/A	LEL N/A	UEL N/A
Extinguishing Media N/A ( stable , nonflammable substance )			
Special Fire Fighting Procedures Not specified			
Unusual Fire and Explosion Hazards Metal products do not present fire or explosion hazards under normal conditions.			

**Section V Reactivity Data**

Stability	Unstable		Conditions to Avoid
	Stable	X	

Incompatibility (Materials to Avoid )

Nothing

Hazardous Decomposition or Byproducts

Nothing

Hazardous Polymerization	May Occur		Conditions to Avoid
	Will Not Occur	X	

**Section VI Health Hazard Data**

Route(s) of Entry :	Inhalation ?	Skin ?	Ingestion ?
	N/A	N/A	N/A

Health Hazardous (Acute and Chronic )

N/A

Carcinogenicity :	NTP ?	IARC Monographs ?	OSHA Regulated ?
	N/A	N/A	N/A

Signs and Symptoms of Exposure

N/A

Medical Conditions

Generally Aggravated by Exposure N/A

Emergency and First Aid Procedures

N/A

**Section VII Precautions for State Handling and Use**

Steps to Be Taken in Case Material Is Released or Spilled

N/A

Waste Disposal Method

Collect scrap for remelting.

Precautions to Be Taken in Handling and storing

**For Handling**

- Put safety gloves on to protect your hands from edges of coils which might cut your hands.
- Wear safety glasses when metal powders or chips are expected to be generated in the work.
- Put safety shoes on when handling heavy coils.

**For Storing**

- The environment of stocking area should be free from acid, alkali, chloride, sulfide and other corrosive chemicals to prevent from rusting or corrosion.

Other Precautions

No special requirements

**Section VIII Control Measures**

Respiratory Protection (Specify Type )

Wearing a mask be recommended in the work such as abrasion and buffing which generates metal powders or chips.

Ventilation	Local Exhaust	Special
	None	None
	Mechanical (General )	Other
	None	None

Protective Gloves

Put safety gloves on to protect your hands from edges of coils which might cut your hands.

Eye Protection

Wear safety glasses when metal powder is expected to be generated in the work.

Other Protective Clothing or Equipment

Put safety shoes on when handling heavy coils.

Work / Hygienic Practices

None

Influence to environments

Fish on toxicity : TLm 48 hr. on CuSO4

Salmogairdeneri : 0.038 ~ 0.8 ppm

Oryzias Latipes : 2.1 ~ 24ppm

# Material Safety Data Sheet

## 1. Manufacturer

- Company HARADA Metal Industry Co., Ltd.
- Address 10-18 Sasamekitamati, Toda, Saitama 335-0033, Japan  
TEL 048-422-1588  
FAX 048-449-6303
- Counter The domestic business department business primary and second section  
TEL 048-441-5115  
FAX 048-444-9104  
The domestic business department OSAKA service office  
TEL 06-531-8094  
FAX 06-531-8096  
The domestic business department NAGOYA service office  
TEL 052-821-9778  
FAX 052-822-7500  
The overseas business department export section  
TEL 048-441-5115  
FAX 048-444-9104
- Urgent place to contact  
The quality assurance department  
TEL 048-422-1588  
FAX 048-449-6303

## 2. Products

- Phosphor bronze plates and strips for springs
- Phosphor bronze plates and strips

### 3. Specification of the material

- The division of mixture or single product : Single product
- The chemical name : Copper alloy
- Chemical composition and content rate( wt.%)

Element	Percent					CAS No.
	C5210	C5212	C5191	C5102	C5111	
Copper	rem.	rem.	rem.	rem.	rem.	7440-50-8
Tin	7.0~9.0	7.0~9.0	5.5~7.0	4.5~5.5	3.5~4.5	7440-31-5
Phosphorus	0.03~0.35	0.03~0.35	0.03~0.35	0.03~0.35	0.03~0.35	7723-14-0
Lead	0.05 max	0.05 max	0.05 max	0.05 max	0.05 max	7439-92-1
Iron	0.1 max	0.1 max	0.1 max	0.1 max	0.1 max	7439-89-6
Zinc	0.2 max	0.2 max	0.2 max	0.2 max	0.2 max	7440-66-6

### 4. Classification of harmfulness

- The name of classification : Not classified into the dangerous harmfulness material.
- The danger : No knowledge
- The harmfulness : No knowledge
- The effect for the environment : No knowledge

### 5. First aid

- Eyes : Flush the water. Consult the doctor, when the simulation of the eye continues.
- Skin : Flush the water.
- Inhalation : Consult the doctor, when it was large inhaled.

### 6. The treatment in the fire

- Nonflammable.

### 7. Leakage

- Not applied (because of solid)

### 8. Attention in handling and storage

- Stored at the ordinary—temperature and usual humidity.
- Prohibition of the rapid temperature and humidity change.

9. Treatment on the exposure prevention

- Standard control concentration : Not regulated.
- Allowable temperature : Not regulated.
- Facility countermeasure : The whole ventilation is desirable.
- Protector : For lung ,the wear of protection mask is desirable for the power handling.  
For hand ,the wear of protective glove is desirable.  
For eyes ,the wear of safety goggles is desirable for the power handling.  
For body , the wear of protective clothing is desirable.

10. Physical and chemical characteristic

- Appearance and smell : The solid with the metallic luster. Odoless.
- Boiling point : The indistinctness.
- Solubility : Dissolves in the inorganic acid.

	C5210	C5212	C5191	C5102	C5111
Specific gravity	8.82	8.82	8.85	8.88	8.90
Melting point	1020°C	1020°C	1045°C	1050°C	1060°C

11. Information for danger

- Fire point : The indistinctness.
- Stability : Show the stability at room temperature and in the air.
- The situation to be avoided : —

12. Information for harmfulness

- The powder stimulates eyes , skin and bronchi.
- Produce the ulcer and the hepatic disorder rarely.

13. Information for environment

- No knowledge.

14. Attention for scrapping

- Possible to deal with ,as an industrial waste.

15. Attention for transportation

- No damage transportation is desirable.

16. Applying act

- —