



# TEST REPORT

## FCC PART 15.247

Report Reference No. ....: **CTL1808037031-WF01**

Compiled by:  
( position+printed name+signature)

Happy Guo  
(File administrators)

Happy Guo

Tested by:  
( position+printed name+signature)

Nice Nong  
(Test Engineer)

NICE NONG

Approved by:  
( position+printed name+signature)

Ivan Xie  
(Manager)

Ivan Xie

Product Name.....: VoIP Wireless Router

Model/Type reference .....: FWR9601

List Model(s).....: FWR9600

Brand Name.....: Flyingvoice

FCC ID.....: 2A19D-FWR9601

Applicant's name .....: **Flyingvoice Network Technology Co., Ltd**

Address of applicant .....: Rm 207-209, Unt B52, Zhong Chuang Industrial Park, Nanshan District, Shenzhen, China

Test Firm .....: **Shenzhen CTL Testing Technology Co., Ltd.**

Address of Test Firm .....: Floor 1-A, Baisha Technology Park, No.3011, Shahexi Road, Nanshan District, Shenzhen, China 518055

Test specification.....:

Standard.....: **FCC Part 15.247:** Operation within the bands 902-928 MHz, 2400-2483.5 MHz and 5725-5850 MHz.

TRF Originator .....: Shenzhen CTL Testing Technology Co., Ltd.

Master TRF .....: Dated 2011-01

Date of Receipt.....: Aug. 19, 2018

Date of Test Date.....: Aug. 19, 2018–Dec.18, 2018

Data of Issue.....: Dec.18, 2018

Result.....: **Pass**

**Shenzhen CTL Testing Technology Co., Ltd. All rights reserved.**

This publication may be reproduced in whole or in part for non-commercial purposes as long as the Shenzhen CTL Testing Technology Co., Ltd. is acknowledged as copyright owner and source of the material. Shenzhen CTL Testing Technology Co., Ltd. takes no responsibility for and will not assume liability for damages resulting from the reader's interpretation of the reproduced material due to its placement and context.

# TEST REPORT

<b>Test Report No. :</b>	<b>CTL1808037031-WF01</b>	Dec.18, 2018
		Date of issue

Equipment under Test : VoIP Wireless Router

Model /Type : FWR9601

Listed Models : FWR9600

**Applicant** : **Flyingvoice Network Technology Co., Ltd**

Address : Rm 207-209, Unt B52, Zhong Chuang Industrial Park, Nanshan District, Shenzhen, China

**Manufacturer** : **Flyingvoice Network Technology Co., Ltd**

Address : Rm 207-209, Unt B52, Zhong Chuang Industrial Park, Nanshan District, Shenzhen, China

<b>Test result</b>	<b>Pass *</b>
--------------------	---------------

\* In the configuration tested, the EUT complied with the standards specified page 5.

The test report merely corresponds to the test sample.

It is not permitted to copy extracts of these test result without the written permission of the test laboratory.



## Table of Contents

**Page**

<b>1.</b>	<b>SUMMARY.....</b>	<b>5</b>
1.1.	TEST STANDARDS.....	5
1.2.	TEST DESCRIPTION.....	5
1.3.	TEST FACILITY.....	6
1.4.	STATEMENT OF THE MEASUREMENT UNCERTAINTY.....	6
1.5.	ENVIRONMENTAL CONDITIONS.....	7
1.6.	GENERAL DESCRIPTION OF EUT.....	7
<b>2.</b>	<b>DESCRIPTION OF TEST MODES AND TEST FREQUENCY.....</b>	<b>7</b>
2.1.	EQUIPMENTS USED DURING THE TEST.....	9
2.2.	RELATED SUBMITTAL(S) / GRANT (S).....	9
2.3.	MODIFICATIONS.....	9
<b>3.</b>	<b>TEST CONDITIONS AND RESULTS.....</b>	<b>10</b>
3.1.	CONDUCTED EMISSIONS TEST.....	10
3.2.	RADIATED EMISSIONS AND BAND EDGE.....	13
3.3.	MAXIMUM CONDUCTED OUTPUT POWER.....	20
3.4.	POWER SPECTRAL DENSITY.....	21
3.5.	6dB BANDWIDTH.....	26
3.6.	OUT-OF-BAND EMISSIONS.....	31
3.7.	ANTENNA REQUIREMENT.....	47
<b>4.</b>	<b>TEST SETUP PHOTOS OF THE EUT.....</b>	<b>48</b>
<b>5.</b>	<b>EXTERNAL AND INTERNAL PHOTOS OF THE EUT.....</b>	<b>49</b>

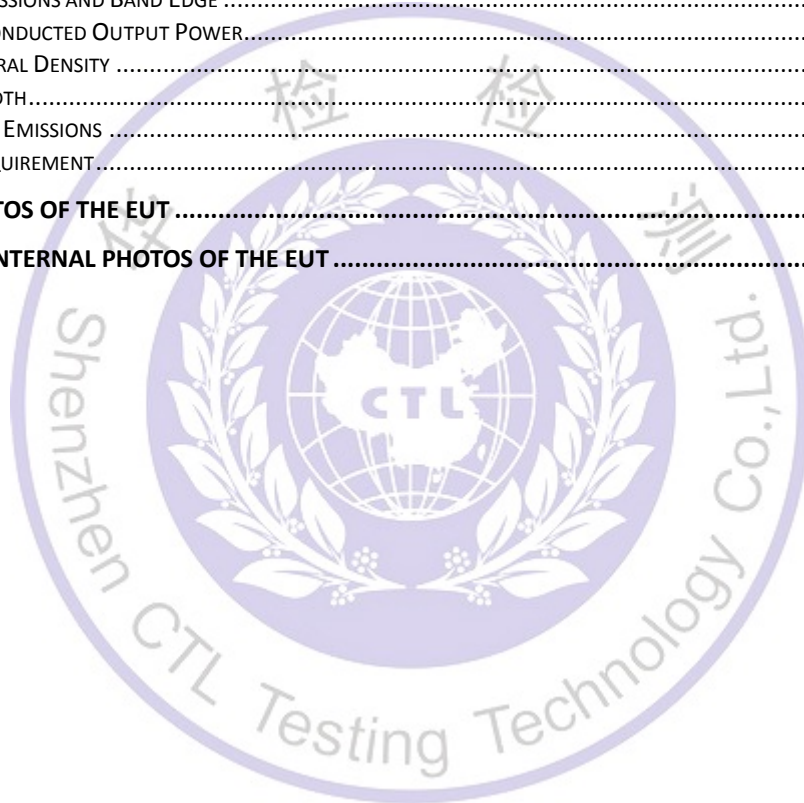

# 1. SUMMARY

## 1.1. TEST STANDARDS

The tests were performed according to following standards:

[FCC Rules Part 15.247](#): Frequency Hopping, Direct Spread Spectrum and Hybrid Systems that are in operation within the bands of 902-928 MHz, 2400-2483.5 MHz, and 5725-5850 MHz

[ANSI C63.10:2013](#) : American National Standard for Testing Unlicensed Wireless Devices

[KDB558074 D01 V03r05](#): Guidance for Performing Compliance Measurements on Digital Transmission Systems (DTS) Operating Under §15.247

[KDB 662911](#): D01Emissions Testing of Transmitters with Multiple Outputs in the Same Band

## 1.2. Test Description

FCC PART 15.247		
FCC Part 15.207	AC Power Conducted Emission	PASS
FCC Part 15.247(a)(2)	6dB Bandwidth	PASS
FCC Part 15.247(d)	Spurious RF Conducted Emission	PASS
FCC Part 15.247(b)	Maximum Conducted Output Power	PASS
FCC Part 15.247(e)	Power Spectral Density	PASS
FCC Part 15.109/ 15.205/ 15.209	Radiated Emissions	PASS
FCC Part 15.247(d)	Band Edge	PASS
FCC Part 15.203/15.247 (b)	Antenna Requirement	PASS

### 1.3. Test Facility

#### 1.3.1 Address of the test laboratory

Shenzhen CTL Testing Technology Co., Ltd.

Floor 1-A, Baisha Technology Park, No. 3011, Shahexi Road, Nanshan, Shenzhen 518055 China

There is one 3m semi-anechoic chamber and two line conducted labs for final test. The Test Sites meet the requirements in documents ANSI C63.4 and CISPR 22/EN 55022 requirements.

#### 1.3.2 Laboratory accreditation

The test facility is recognized, certified, or accredited by the following organizations:

##### IC Registration No.: 9618B

The 3m alternate test site of Shenzhen CTL Testing Technology Co., Ltd. EMC Laboratory has been registered by Certification and Engineer Bureau of Industry Canada for the performance of with Registration No.: 9618B on November 13, 2013.

##### FCC-Registration No.: 399832

Shenzhen CTL Testing Technology Co., Ltd. EMC Laboratory has been registered and fully described in a report filed with the (FCC) Federal Communications Commission. The acceptance letter from the FCC is maintained in our files. Registration 399832, December 08, 2017.

### 1.4. Statement of the measurement uncertainty

The data and results referenced in this document are true and accurate. The reader is cautioned that there may be errors within the calibration limits of the equipment and facilities. The measurement uncertainty was calculated for all measurements listed in this test report acc. to CISPR 16 - 4 "Specification for radio disturbance and immunity measuring apparatus and methods – Part 4: Uncertainty in EMC Measurements" and is documented in the Shenzhen CTL Testing Technology Co., Ltd. quality system acc. to DIN EN ISO/IEC 17025. Furthermore, component and process variability of devices similar to that tested may result in additional deviation. The manufacturer has the sole responsibility of continued compliance of the device.

Hereafter the best measurement capability for CTL laboratory is reported:

Test	Measurement Uncertainty	Notes
Transmitter power conducted	±0.57 dB	(1)
Transmitter power Radiated	±2.20 dB	(1)
Conducted spurious emission 9KHz-40 GHz	±2.20 dB	(1)
Occupied Bandwidth	±0.01ppm	(1)
Radiated Emission 30~1000MHz	±3.53dB	(1)
Radiated Emission Above 1GHz	±4.32dB	(1)
Conducted Disturbance0.15~30MHz	±3.20dB	(1)

- (1) This uncertainty represents an expanded uncertainty expressed at approximately the 95% confidence level using a coverage factor of k=2.

## 1.5.Environmental conditions

During the measurement the environmental conditions were within the listed ranges:

Normal Temperature:	25°C
Relative Humidity:	55 %
Air Pressure:	101 kPa

## 1.6.General Description of EUT

Product Name:	VoIP Wireless Router
Model/Type reference:	FWR9601
Power supply:	DC 12V from AC adapter
Adapter information:	Model:S12B22-120A100-C4 Input: 100-240V, 50/60Hz max 0.5A Output:12V---1.0A
<b>WIFI</b>	
Supported type:	802.11b/802.11g/802.11n(H20)/802.11n(H40)
Modulation:	802.11b: DSSS 802.11g/802.11n(H20)/802.11n(H40): OFDM
Operation frequency:	802.11b/802.11g/802.11n(H20): 2412MHz~2462MHz 802.11n(H40): 2422MHz~2452MHz
Channel number:	802.11b/802.11g/802.11n(H20): 11 802.11n(H40): 7
Channel separation:	5MHz
Antenna type:	Integral Antenna : 2*TX 2*RX
Antenna gain:	2.0dBi

Note:Directional gain=2+10log2=5.01dBi

## 2. Description of Test Modes and Test Frequency

The Applicant provides communication tools software to control the EUT for staying in continuous transmitting (Duty Cycle more than 98%) and receiving mode for testing.

There are 11 channels provided to the EUT and Channel 01/06/11 were selected for WIFI test.

### Operation Frequency WIFI :

Channel	Frequency(MHz)	Channel	Frequency(MHz)
1	2412	8	2447
2	2417	9	2452
3	2422	10	2457
4	2427	11	2462
5	2432		
6	2437		
7	2442		

Note: The line display in grey were the channel selected for testing

**Data Rate Used:**

Preliminary tests were performed in different data rate to find the worst radiated emission. The data rate shown in the table below is the worst-case rate with respect to the specific test item. Investigation has been done on all the possible configurations for searching the worst cases. The following table is a list of the test modes shown in this test report.

Test Items	Mode	Data Rate	Channel
Maximum Conducted Output Power Power Spectral Density 6dB Bandwidth Spurious RF conducted emission Radiated Emission 9kHz~1GHz& Radiated Emission 1GHz~10th Harmonic	11b/DSSS	1 Mbps	1/6/11
	11g/OFDM	6 Mbps	1/6/11
	11n(20MHz)/OFDM	6.5Mbps	1/6/11
	11n(40MHz)/OFDM	13.5 Mbps	3/6/9
Band Edge	11b/DSSS	1 Mbps	1/11
	11g/OFDM	6 Mbps	1/11
	11n(20MHz)/OFDM	6.5Mbps	1/11
	11n(40MHz)/OFDM	13.5 Mbps	3//9

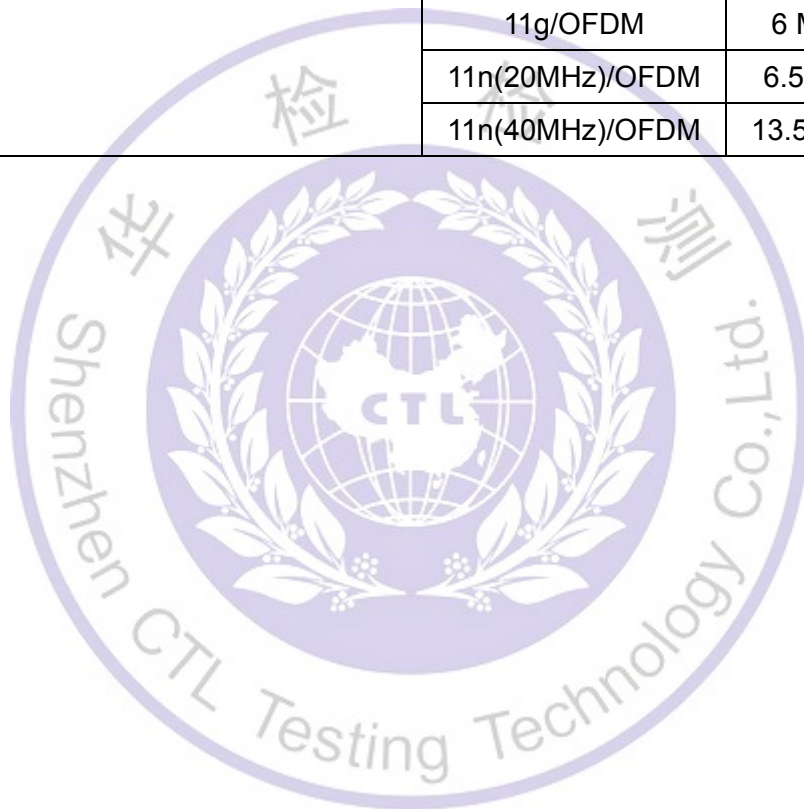



## 2.1. Equipments Used during the Test

Test Equipment	Manufacturer	Model No.	Serial No.	Calibration Date recent	Calibration Due Date
LISN	R&S	ENV216	3560.6550.12	2018/05/20	2019/05/19
LISN	R&S	ESH2-Z5	860014/010	2018/05/20	2019/05/19
Power Meter	Agilent	U2531A	TW53323507	2018/05/20	2019/05/19
Power Sensor	Agilent	U2021XA	MY5365004	2018/05/20	2019/05/19
EMI Test Receiver	R&S	ESCI	103710	2018/05/20	2019/05/19
Spectrum Analyzer	Agilent	E4407B	MY41440676	2018/05/20	2019/05/19
Spectrum Analyzer	Agilent	N9020	US46220290	2018/05/20	2019/05/19
Controller	EM Electronics	Controller EM 1000	N/A	2018/05/20	2019/05/19
Active Loop Antenna	Daze	ZN30900A	N/A	2018/05/20	2019/05/19
Bilog Antenna	Schwarzbeck	VULB 9168	00824	2018/05/20	2019/05/19
Horn Antenna	Sunol Sciences Corp.	DRH-118	A062013	2018/05/20	2019/05/19
Horn Antenna	SCHWARZBACK	BBHA 9170	BBHA9170184	2018/05/20	2019/05/19
Amplifier	Agilent	8349B	3008A02306	2018/05/20	2019/05/19
Amplifier	Agilent	8447D	2944A10176	2018/05/20	2019/05/19
Temperature/Humidity Meter	Gangxing	CTH-608	02	2018/05/20	2019/05/19
High-Pass Filter	K&L	9SH10-2700/X12750-O/O	N/A	2018/05/20	2019/05/19
High-Pass Filter	K&L	41H10-1375/U12750-O/O	N/A	2018/05/20	2019/05/19
Coaxial Cables	HUBER+SUHNER	SUCOFLEX 104PEA-10M	10m	2018/05/20	2019/05/19
Coaxial Cables	HUBER+SUHNER	SUCOFLE 104PEA-3M	3m	2018/05/20	2019/05/19
Coaxial Cables	HUBER+SUHNER	SUCOFLE 104PEA-3M	3m	2018/05/20	2019/05/19
RF Cable	Megalon	RF-A303	N/A	2018/05/20	2019/05/19
EMI Test Software	R&S	ES-K1	V1.7.1	2018/05/20	2019/05/19
EMI Test Software	AUDIX	E3	V6.0	2018/05/20	2019/05/19

The calibration interval was one year

## 2.2. Related Submittal(s) / Grant (s)

This submittal(s) (test report) is intended for FCC ID: 2AL9D-FWR9601 filing to comply with Section 15.247 of the FCC Part 15, Subpart C Rules.

## 2.3. Modifications

No modifications were implemented to meet testing criteria.

### 3. TEST CONDITIONS AND RESULTS

#### 3.1. Conducted Emissions Test

##### LIMIT

FCC CFR Title 47 Part 15 Subpart C Section 15.207

Frequency range (MHz)	Limit (dBuV)	
	Quasi-peak	Average
0.15-0.5	66 to 56*	56 to 46*
0.5-5	56	46
5-30	60	50

\* Decreases with the logarithm of the frequency.

##### TEST CONFIGURATION

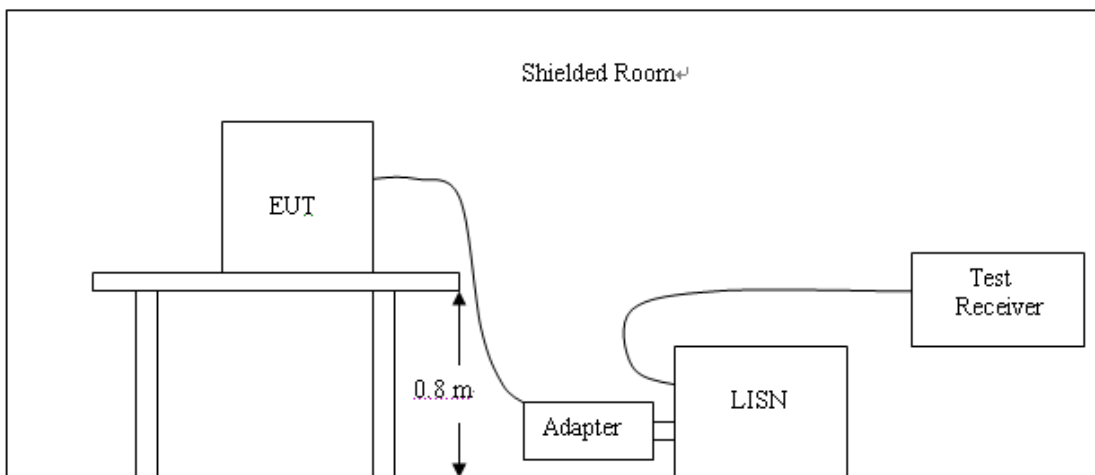

##### TEST PROCEDURE

1. The equipment was set up as per the test configuration to simulate typical actual usage per the user's manual. The EUT is a tabletop system; a wooden table with a height of 0.8 meters is used and is placed on the ground plane as per ANSI C63.10:2013.
2. Support equipment, if needed, was placed as per ANSI C63.10:2013.
3. All I/O cables were positioned to simulate typical actual usage as per ANSI C63.10:2013.
4. The adapter received AC120V/60Hz power through a Line Impedance Stabilization Network (LISN) which supplied power source and was grounded to the ground plane.
5. All support equipments received AC power from a second LISN, if any.
6. The EUT test program was started. Emissions were measured on each current carrying line of the EUT using a spectrum Analyzer / Receiver connected to the LISN powering the EUT. The LISN has two monitoring points: Line 1 (Hot Side) and Line 2 (Neutral Side). Two scans were taken: one with Line 1 connected to Analyzer / Receiver and Line 2 connected to a 50 ohm load; the second scan had Line 1 connected to a 50 ohm load and Line 2 connected to the Analyzer / Receiver.
7. Analyzer / Receiver scanned from 150 KHz to 30MHz for emissions in each of the test modes.
8. During the above scans, the emissions were maximized by cable manipulation.

Remark: We tested three channels (lowest/middle/highest) of each mode and recorded worst case at 802.11b SISO ANT 1 mode low channel.

**TEST RESULTS**

**SCAN TABLE: "Voltage (9K-30M)FIN"**

Short Description: 150K-30M Voltage

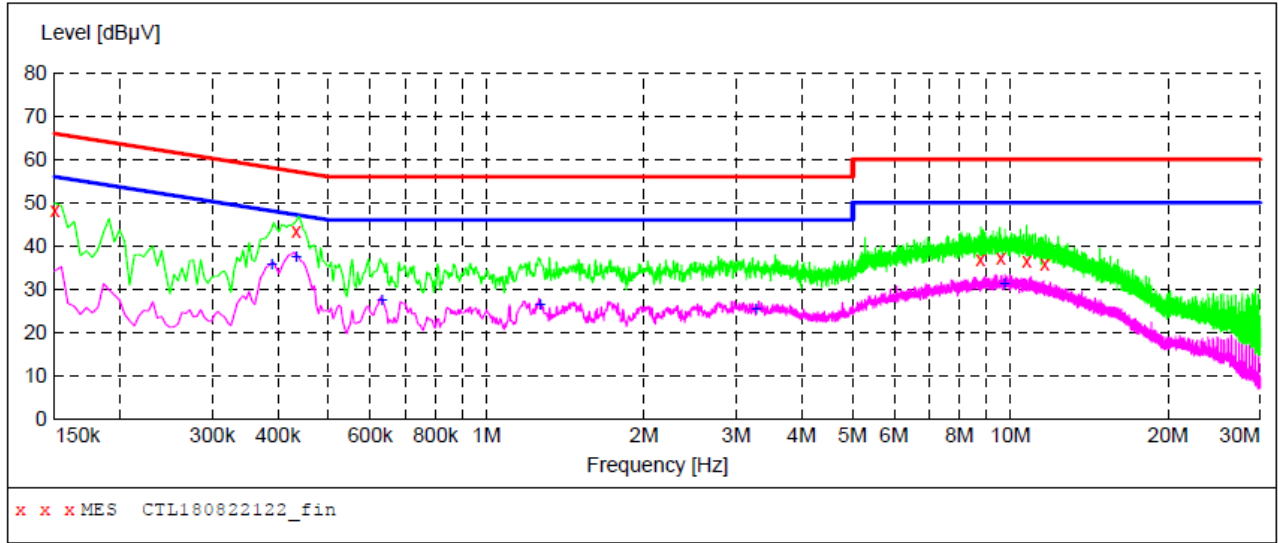

**MEASUREMENT RESULT: "CTL180822122\_fin"**

2018-8-22 07:58??

Frequency MHz	Level dBµV	Transd dB	Limit dBµV	Margin dB	Detector	Line	PE
0.150000	48.20	10.2	66	17.8	QP	L1	GND
0.434000	43.50	10.2	57	13.7	QP	L1	GND
8.762000	36.70	10.6	60	23.3	QP	L1	GND
9.590000	37.10	10.6	60	22.9	QP	L1	GND
10.754000	36.60	10.6	60	23.4	QP	L1	GND
11.636000	35.80	10.6	60	24.2	QP	L1	GND

**MEASUREMENT RESULT: "CTL180822122\_fin2"**

2018-8-22 07:58??

Frequency MHz	Level dBµV	Transd dB	Limit dBµV	Margin dB	Detector	Line	PE
0.390000	35.80	10.2	48	12.3	AV	L1	GND
0.434000	37.60	10.2	47	9.6	AV	L1	GND
0.632000	27.70	10.2	46	18.3	AV	L1	GND
1.268000	26.50	10.3	46	19.5	AV	L1	GND
3.272000	25.50	10.4	46	20.5	AV	L1	GND
9.752000	31.20	10.6	50	18.8	AV	L1	GND

**SCAN TABLE: "Voltage (9K-30M) FIN"**

Short Description: 150K-30M Voltage

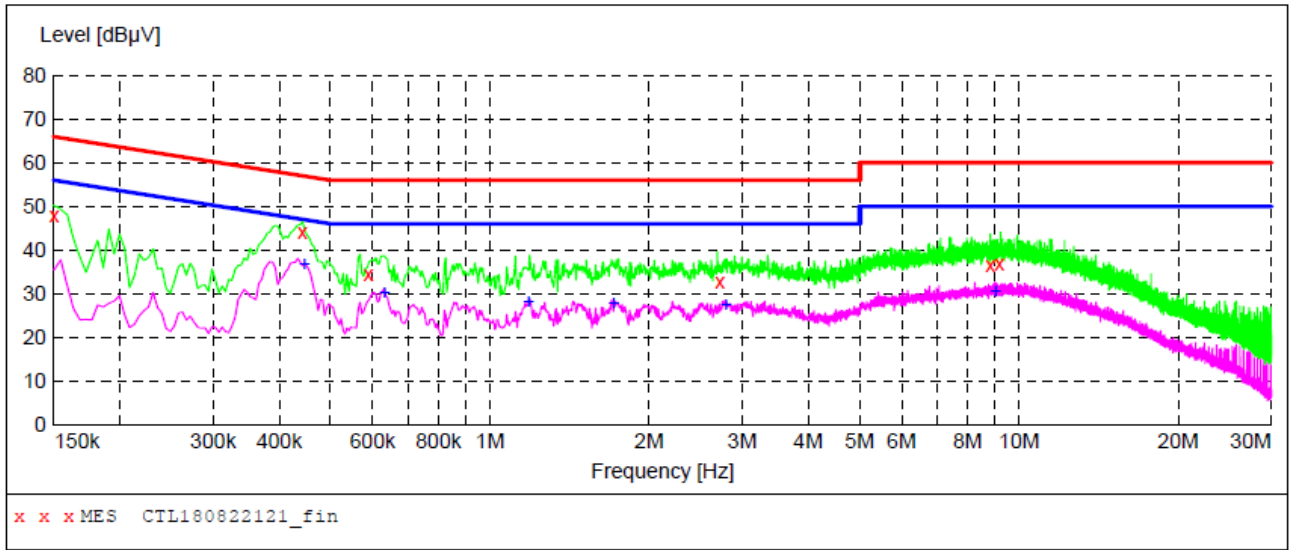

**MEASUREMENT RESULT: "CTL180822121\_fin"**

2018-8-22 07:55??

Frequency MHz	Level dBµV	Transd dB	Limit dBµV	Margin dB	Detector	Line	PE
0.150000	48.10	10.2	66	17.9	QP	N	GND
0.442000	44.10	10.2	57	12.9	QP	N	GND
0.590000	34.40	10.2	56	21.6	QP	N	GND
2.720000	32.60	10.4	56	23.4	QP	N	GND
8.828000	36.50	10.6	60	23.5	QP	N	GND
9.182000	36.90	10.6	60	23.1	QP	N	GND

**MEASUREMENT RESULT: "CTL180822121\_fin2"**

2018-8-22 07:55??

Frequency MHz	Level dBµV	Transd dB	Limit dBµV	Margin dB	Detector	Line	PE
0.446000	37.00	10.2	47	9.9	AV	N	GND
0.632000	30.40	10.2	46	15.6	AV	N	GND
1.184000	28.20	10.3	46	17.8	AV	N	GND
1.712000	27.90	10.3	46	18.1	AV	N	GND
2.792000	27.60	10.4	46	18.4	AV	N	GND
9.032000	30.70	10.6	50	19.3	AV	N	GND

### 3.2. Radiated Emissions and Band Edge

#### Limit

For intentional device, according to § 15.209(a), the general requirement of field strength of radiated emission out of authorized band shall not exceed the following table at a 3 meters measurement distance.

FCC PART 15.249(d) Emissions radiated outside of the specified frequency bands, except for harmonics, shall be attenuated by at least 50 dB below the level of the fundamental or to the general radiated emission limits in §15.209, whichever is the lesser attenuation.

In addition, radiated emissions which fall in the restricted bands, as defined in §15.205(a), must also comply with the radiated emission limits specified in §15.209(a)

Radiated emission limits

Frequency (MHz)	Distance (Meters)	Radiated (dB $\mu$ V/m)	Radiated ( $\mu$ V/m)
0.009-0.49	3	$20\log(2400/F(\text{KHz}))+40\log(300/3)$	$2400/F(\text{KHz})$
0.49-1.705	3	$20\log(24000/F(\text{KHz}))+ 40\log(30/3)$	$24000/F(\text{KHz})$
1.705-30	3	$20\log(30)+ 40\log(30/3)$	30
30-88	3	40.0	100
88-216	3	43.5	150
216-960	3	46.0	200
Above 960	3	54.0	500

#### TEST CONFIGURATION

(A) Radiated Emission Test Set-Up, Frequency Below 30MHz

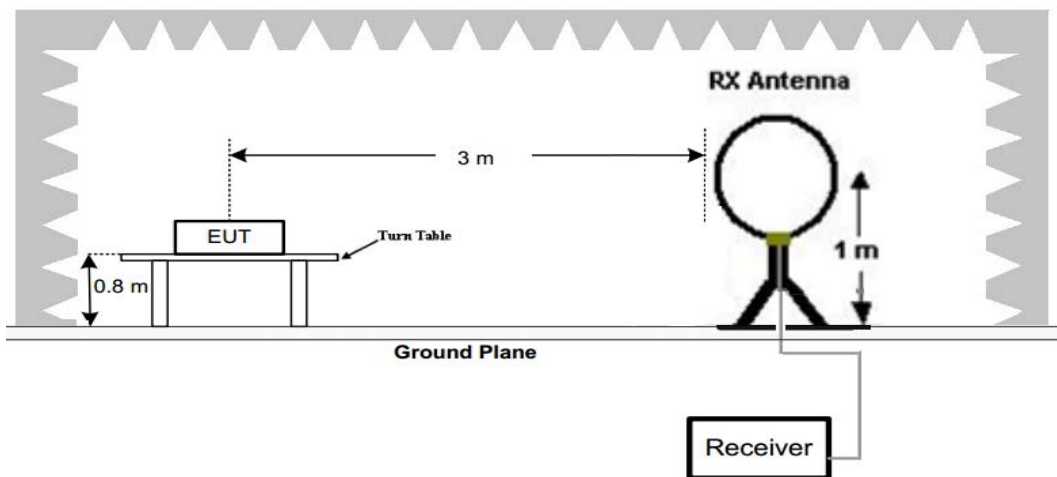

(B) Radiated Emission Test Set-Up, Frequency below 1000MHz

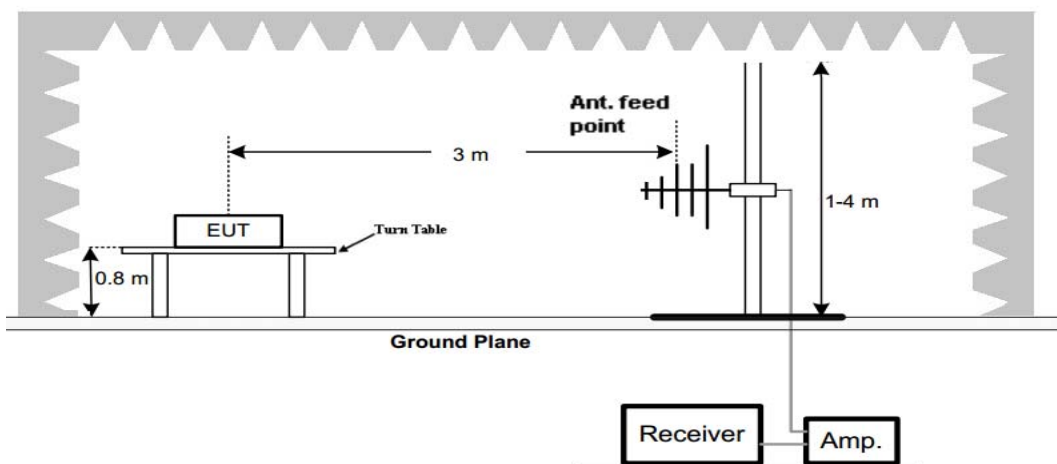

(C) Radiated Emission Test Set-Up, Frequency above 1000MHz

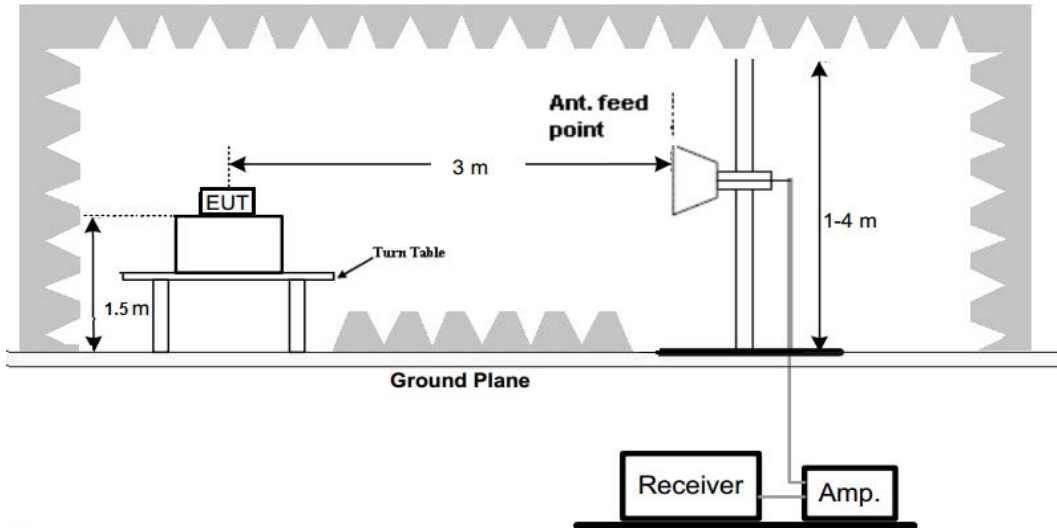

**Test Procedure**

1. Below 1GHz measurement the EUT is placed on a turntable which is 0.8m above ground plane, and above 1GHz measurement EUT was placed on a low permittivity and low loss tangent turn table which is 1.5m above ground plane.
2. Maximum procedure was performed by raising the receiving antenna from 1m to 4m and rotating the turn table from 0° to 360° to acquire the highest emissions from EUT
3. And also, each emission was to be maximized by changing the polarization of receiving antenna both horizontal and vertical.
4. Repeat above procedures until all frequency measurements have been completed.

**TEST RESULTS**

Remark:

1. We tested three channels (lowest/middle/highest) of each mode and recorded worst case at 802.11b SISO ANT 1 mode low channel for measurement below 1GHz.
2. We tested three channels (lowest/middle/highest) of each mode and recorded worst case at 802.11nH20 MIMO mode above 1GHz.

**For 9 KHz-30MHz**

Freq. (MHz)	Level (dBuV)	Over Limit (dB)	Limit Line (dBuV)	Remark
-	-	-	-	See Note

Note: The amplitude of spurious emissions that are attenuated by more than 20dB below the permissible value has no need to be reported.

Distance extrapolation factor=  $40 \log(\text{specific distance}/\text{test distance})$  (dB);  
 Limit line= specific limits (dBuV) + distance extrapolation factor.

For 30MHz-1GHz

Horizontal

**SWEEP TABLE: "test (30M-1G)"**

Short Description:		Field Strength			
Start	Stop	Detector	Meas. Time	IF Bandw.	Transducer
30.0 MHz	1.0 GHz	MaxPeak	200.0 ms	120 kHz	VULB 9168

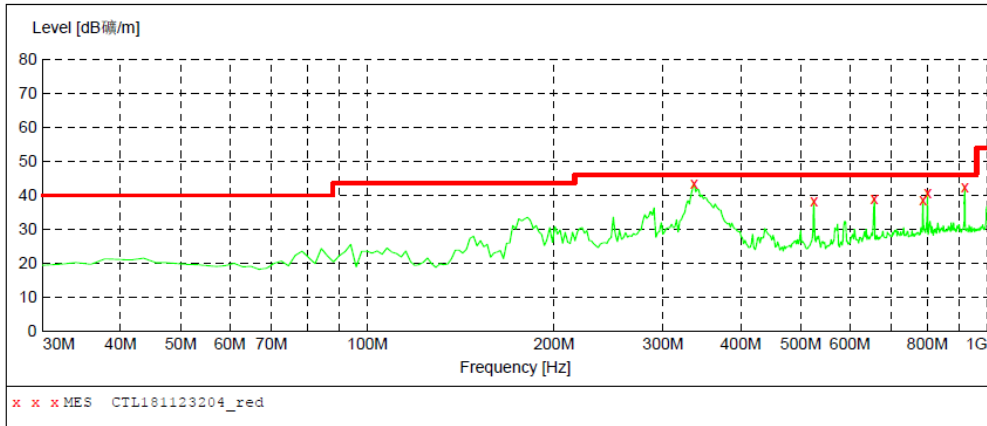

**MEASUREMENT RESULT: "CTL181123204\_red"**

2018-11-23 9:06

Frequency MHz	Level dBμV/m	Transd dB	Limit dBμV/m	Margin dB	Det.	Height cm	Azimuth deg	Polarization
336.520000	43.40	15.0	46.0	2.6	---	0.0	0.00	HORIZONTAL
524.700000	38.40	18.6	46.0	7.6	---	0.0	0.00	HORIZONTAL
656.620000	39.00	21.0	46.0	7.0	---	0.0	0.00	HORIZONTAL
786.600000	38.60	22.6	46.0	7.4	---	0.0	0.00	HORIZONTAL
800.180000	40.80	22.7	46.0	5.2	---	0.0	0.00	HORIZONTAL
918.520000	42.50	24.0	46.0	3.5	---	0.0	0.00	HORIZONTAL

Vertical

**SWEEP TABLE: "test (30M-1G)"**

Short Description:		Field Strength			
Start	Stop	Detector	Meas. Time	IF Bandw.	Transducer
30.0 MHz	1.0 GHz	MaxPeak	200.0 ms	120 kHz	VULB 9168

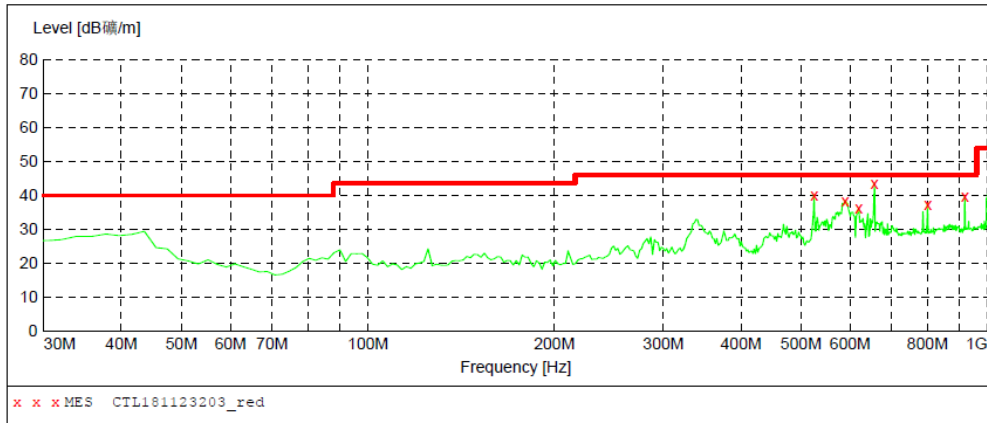

**MEASUREMENT RESULT: "CTL181123203\_red"**

2018-11-23 9:04

Frequency MHz	Level dBμV/m	Transd dB	Limit dBμV/m	Margin dB	Det.	Height cm	Azimuth deg	Polarization
524.700000	40.00	18.6	46.0	6.0	---	0.0	0.00	VERTICAL
588.720000	38.40	19.8	46.0	7.6	---	0.0	0.00	VERTICAL
619.760000	36.10	20.5	46.0	9.9	---	0.0	0.00	VERTICAL
656.620000	43.50	21.0	46.0	2.5	---	0.0	0.00	VERTICAL
800.180000	37.30	22.7	46.0	8.7	---	0.0	0.00	VERTICAL
918.520000	39.50	24.0	46.0	6.5	---	0.0	0.00	VERTICAL

**For 1GHz to 25GHz**

Note: 802.11b/802.11g SISO mode and 802.11n (H20)/ 802.11n (H40) MIMO mode all have been tested, only worse case 802.11nH20 MIMO mode is reported

Frequency(MHz):			2412		Polarity:			HORIZONTAL	
Frequency (MHz)	Emission Level (dBuV/m)		Limit (dBuV/m)	Margin (dB)	Raw Value (dBuV)	Antenna Factor (dB/m)	Cable Factor (dB)	Pre-amplifier (dB)	Correction Factor (dB/m)
4824.00	57.18	PK	74	16.82	52.63	33.52	6.92	35.89	4.55
4824.00	52.31	AV	54	1.69	47.76	33.52	6.92	35.89	4.55
5125.75	43.96	PK	74	30.04	36.76	34.38	7.10	34.28	7.20
5125.75	--	AV	54	--	--	--	--	--	--
7236.00	49.05	PK	74	24.95	37.78	37.1	9.19	35.02	11.27
7236.00	--	AV	54	--	--	--	--	--	--

Frequency(MHz):			2412		Polarity:			VERTICAL	
Frequency (MHz)	Emission Level (dBuV/m)		Limit (dBuV/m)	Margin (dB)	Raw Value (dBuV)	Antenna Factor (dB/m)	Cable Factor (dB)	Pre-amplifier (dB)	Correction Factor (dB/m)
4824.00	58.24	PK	74	15.76	53.69	33.52	6.92	35.89	4.55
4824.00	51.61	AV	54	2.39	47.06	33.52	6.92	35.89	4.55
5125.75	42.88	PK	74	31.12	35.68	34.38	7.10	34.28	7.20
5125.75	--	AV	54	--	--	--	--	--	--
7236.00	50.37	PK	74	23.63	39.10	37.1	9.19	35.02	11.27
7236.00	--	AV	54	--	--	--	--	--	--

Frequency(MHz):			2437		Polarity:			HORIZONTAL	
Frequency (MHz)	Emission Level (dBuV/m)		Limit (dBuV/m)	Margin (dB)	Raw Value (dBuV)	Antenna Factor (dB/m)	Cable Factor (dB)	Pre-amplifier (dB)	Correction Factor (dB/m)
4874.00	57.38	PK	74	16.62	51.14	33.59	6.95	34.3	6.24
4874.00	50.49	AV	54	3.51	44.25	33.59	6.95	34.3	6.24
5215.50	43.72	PK	74	30.28	36.12	34.56	7.15	34.11	7.60
5215.50	--	AV	54	--	--	--	--	--	--
7311.00	49.63	PK	74	24.37	37.97	37.44	9.22	35	11.66
7311.00	--	AV	54	--	--	--	--	--	--

Frequency(MHz):			2437		Polarity:			VERTICAL	
Frequency (MHz)	Emission Level (dBuV/m)		Limit (dBuV/m)	Margin (dB)	Raw Value (dBuV)	Antenna Factor (dB/m)	Cable Factor (dB)	Pre-amplifier (dB)	Correction Factor (dB/m)
4874.00	58.71	PK	74	15.29	52.37	33.59	6.95	34.2	6.34
4874.00	51.04	AV	54	2.96	44.7	33.59	6.95	34.2	6.34
5215.50	44.19	PK	74	29.81	37.29	34.07	7.05	34.22	6.90
5215.50	--	AV	54	--	--	--	--	--	--
7311.00	48.95	PK	74	25.05	37.29	37.44	9.22	35	11.66
7311.00	--	AV	54	--	--	--	--	--	--



Frequency(MHz):			2462		Polarity:			HORIZONTAL	
Frequency (MHz)	Emission Level (dBuV/m)		Limit (dBuV/m)	Margin (dB)	Raw Value (dBuV)	Antenna Factor (dB/m)	Cable Factor (dB)	Pre-amplifier (dB)	Correction Factor (dB/m)
4924.00	57.03	PK	74	16.97	53.55	33.71	6.98	35.91	4.78
4924.00	50.42	AV	54	3.58	43.73	33.71	6.98	35.91	4.78
5105.50	43.77	PK	74	30.23	41.24	34.34	7.09	34.27	7.17
5105.50	--	AV	54	--	--	--	--	--	--
7386.00	48.94	PK	74	25.06	37.4	37.61	9.25	34.98	11.88
7386.00	--	AV	54	--	--	--	--	--	--

Frequency(MHz):			2462		Polarity:			VERTICAL	
Frequency (MHz)	Emission Level (dBuV/m)		Limit (dBuV/m)	Margin (dB)	Raw Value (dBuV)	Antenna Factor (dB/m)	Cable Factor (dB)	Pre-amplifier (dB)	Correction Factor (dB/m)
4924.00	58.18	PK	74	15.82	53.4	33.71	6.98	35.91	4.78
4924.00	51.51	AV	54	2.49	46.73	33.71	6.98	35.91	4.78
5105.50	43.63	PK	74	30.37	36.46	34.34	7.09	34.27	7.17
5105.50	--	AV	54	--	--	--	--	--	--
7386.00	47.98	PK	74	26.02	36.10	37.61	9.25	34.98	11.88
7386.00	--	AV	54	--	--	--	--	--	--

## REMARKS:

1. Emission level (dBuV/m) =Raw Value (dBuV)+Correction Factor (dB/m)
2. Correction Factor (dB/m) = Antenna Factor (dB/m)+Cable Factor (dB)-Pre-amplifier Factor
3. Margin value = Limit value- Emission level.
4. -- Mean the PK detector measured value is below average limit.
5. The other emission levels were very low against the limit.
6. RBW1MHz VBW3MHz Peak detector is for PK value; RMS detector is for AV value.

**Results of Band Edges Test (Radiated)**

Note: 802.11b/802.11g SISO mode and 802.11n (H20)/ 802.11n (H40) MIMO mode all have been tested, only worse case 802.11nH20 MIMO mode is reported

**802.11nH20 MIMO Mode (above 1GHz)**

Frequency(MHz):			2412		Polarity:			HORIZONTAL	
Frequency (MHz)	Emission Level (dBuV/m)		Limit (dBuV/m)	Margin (dB)	Raw Value (dBuV)	Antenna Factor (dB/m)	Cable Factor (dB)	Pre-amplifier (dB)	Correction Factor (dB/m)
2412.00	110.63	PK	--	--	77.24	28.78	4.61	0	33.39
2412.00	102.71	AV	--	--	69.32	28.78	4.61	0	33.39
2357.75	43.92	PK	74	30.08	10.84	28.52	4.56	0	33.08
2357.75	--	AV	54	--	--	--	--	--	--
2390.00	57.01	PK	74	16.99	23.69	28.72	4.60	0	33.32
2390.00	51.48	AV	54	2.52	18.16	28.72	4.60	0	33.32
2400.00	58.02	PK	74	15.98	24.63	28.78	4.61	0	33.39
2400.00	51.76	AV	54	2.24	18.37	28.78	4.61	0	33.39

Frequency(MHz):			2412		Polarity:			VERTICAL	
Frequency (MHz)	Emission Level (dBuV/m)		Limit (dBuV/m)	Margin (dB)	Raw Value (dBuV)	Antenna Factor (dB/m)	Cable Factor (dB)	Pre-amplifier (dB)	Correction Factor (dB/m)
2412.00	109.35	PK	--	--	75.96	28.78	4.61	0	33.39
2412.00	104.76	AV	--	--	71.37	28.78	4.61	0	33.39
2357.75	43.01	PK	74	30.99	9.93	28.52	4.56	0	33.08
2357.75	--	AV	54	--	--	--	--	--	--
2390.00	57.22	PK	74	16.78	23.9	28.72	4.60	0	33.32
2390.00	50.97	AV	54	3.03	17.65	28.72	4.60	0	33.32
2400.00	58.14	PK	74	15.86	24.75	28.78	4.61	0	33.39
2400.00	51.78	AV	54	2.22	18.39	28.78	4.61	0	33.39

Frequency(MHz):			2462		Polarity:			HORIZONTAL	
Frequency (MHz)	Emission Level (dBuV/m)		Limit (dBuV/m)	Margin (dB)	Raw Value (dBuV)	Antenna Factor (dB/m)	Cable Factor (dB)	Pre-amplifier (dB)	Correction Factor (dB/m)
2462.00	108.96	PK	--	--	75.34	28.92	4.7	0	33.62
2462.00	102.61	AV	--	--	68.99	28.92	4.7	0	33.62
2483.50	43.74	PK	74	30.26	10.11	28.93	4.7	0	33.63
2483.50	--	AV	54	--	--	--	--	--	--
2486.75	42.93	PK	74	31.07	9.29	28.94	4.71	0	33.64
2486.75	--	AV	54	--	--	--	--	--	--
2500.00	43.19	PK	74	30.81	9.51	28.96	4.72	0	33.68
2500.00	--	AV	54	--	--	--	--	--	--

Frequency(MHz):			2462		Polarity:			VERTICAL	
Frequency (MHz)	Emission Level (dBuV/m)		Limit (dBuV/m)	Margin (dB)	Raw Value (dBuV)	Antenna Factor (dB/m)	Cable Factor (dB)	Pre-amplifier (dB)	Correction Factor (dB/m)
2462.00	110.83	PK	--	--	77.21	28.92	4.7	0	33.62
2462.00	103.41	AV	--	--	69.79	28.92	4.7	0	33.62
2483.50	44.64	PK	74	29.36	11.01	28.93	4.7	0	33.63
2483.50	--	AV	54	--	--	--	--	--	--
2486.75	43.26	PK	74	30.74	9.62	28.94	4.71	0	33.64
2486.75	--	AV	54	--	--	--	--	--	--
2500.00	43.81	PK	74	30.19	10.13	28.96	4.72	0	33.68
2500.00	--	AV	54	--	--	--	--	--	--

## REMARKS:

1. Emission level (dBuV/m) =Raw Value (dBuV)+Correction Factor (dB/m)
2. Correction Factor (dB/m) = Antenna Factor (dB/m)+Cable Factor (dB)-Pre-amplifier Factor
3. Margin value = Limit value- Emission level.
4. -- Mean the PK detector measured value is below average limit.
5. The other emission levels were very low against the limit.
6. RBW1MHz VBW3MHz Peak detector is for PK value; RMS detector is for AV value.

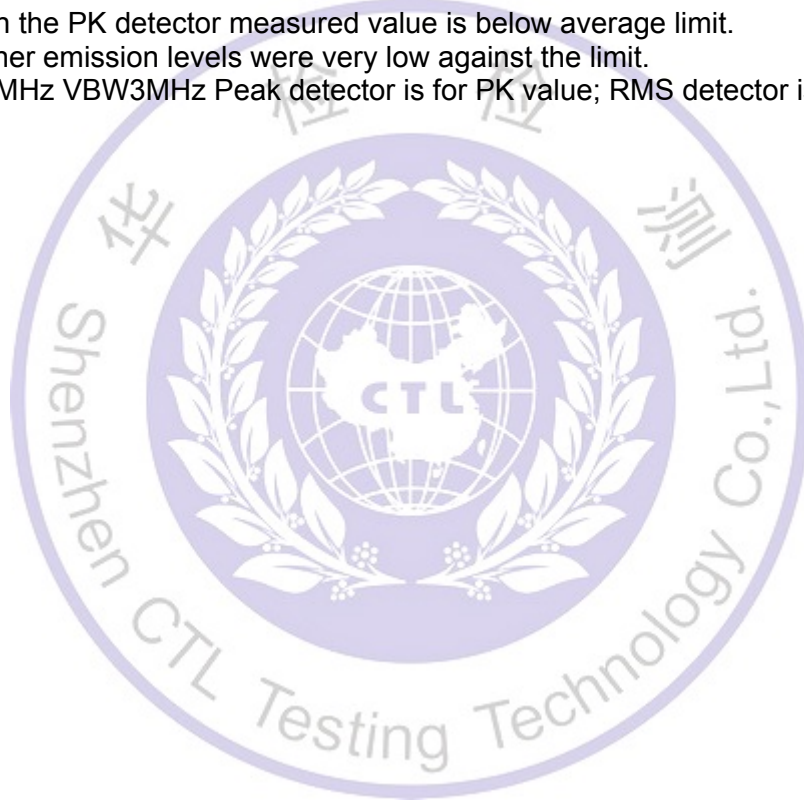

### 3.3. Maximum Conducted Output Power

#### Limit

The Maximum Peak Output Power Measurement is 30dBm.

#### Test Procedure

Remove the antenna from the EUT and then connect a low loss RF cable from the antenna port to the power sensor.

#### Test Configuration

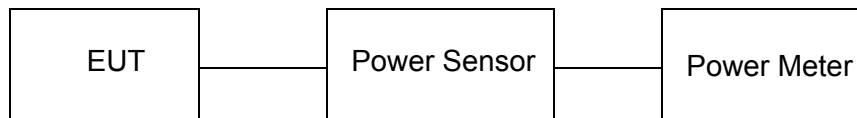

#### Test Results

WIFI						
Type	Channel	Output power Ant1 (dBm)	Output power Ant2 (dBm)	Output power Total (dBm)	Limit (dBm)	Result
802.11b	01	15.57	15.21	/	30.00	Pass
	06	15.14	14.92	/		
	11	14.80	14.61	/		
802.11g	01	13.07	12.89	/	30.00	Pass
	06	12.60	12.53	/		
	11	12.24	12.18	/		
802.11n(HT20) MIMO	01	12.80	12.64	15.73	30.00	Pass
	06	12.41	12.35	15.39		
	11	11.97	11.95	14.97		
802.11n(HT40) MIMO	03	12.19	12.11	15.16	30.00	Pass
	06	11.97	11.87	14.93		
	09	11.73	11.62	14.69		

Note: 1.The test results including the cable lose.

### 3.4. Power Spectral Density

#### Limit

For digitally modulated systems, the power spectral density conducted from the intentional radiator to the antenna shall not be greater than 8 dBm in any 3 kHz band during any time interval of continuous transmission.

#### Test Procedure

1. Use this procedure when the maximum peak conducted output power in the fundamental emission is used to demonstrate compliance.
2. Set the RBW  $\geq$  3 kHz.
3. Set the VBW  $\geq$  3 $\times$  RBW.
4. Set the span to 1.5 times the DTS channel bandwidth.
5. Detector = peak.
6. Sweep time = auto couple.
7. Trace mode = max hold.
8. Allow trace to fully stabilize.
9. Use the peak marker function to determine the maximum power level.
10. If measured value exceeds limit, reduce RBW (no less than 3 kHz) and repeat.
11. The resulting peak PSD level must be 8dBm.

#### Test Configuration



#### Test Results

WIFI						
Type	Channel	Power Spectral Density Ant1 (dBm/3KHz)	Power Spectral Density Ant2 (dBm/3KHz)	Power Spectral Density Total (dBm/3KHz)	Limit (dBm/3KHz)	Result
802.11b	01	-14.106	-14.307	/	8.00	Pass
	06	-14.565	-14.534	/		
	11	-15.158	-14.929	/		
802.11g	01	-22.773	-22.844	/	8.00	Pass
	06	-23.946	-23.259	/		
	11	-24.095	-23.685	/		
802.11n(HT20) MIMO	01	-22.774	-22.778	-19.766	8.00	Pass
	06	-22.048	-23.574	-19.734		
	11	-22.811	-23.615	-20.184		
802.11n(HT40) MIMO	03	-27.463	-28.377	-24.886	8.00	Pass
	06	-27.428	-28.397	-24.875		
	09	-27.362	-27.924	-24.624		

Test plot as follows:

Ant. 1

802.11b

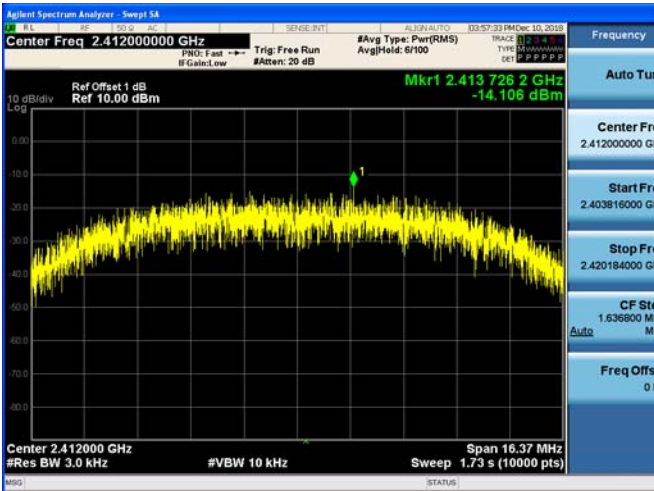

802.11g

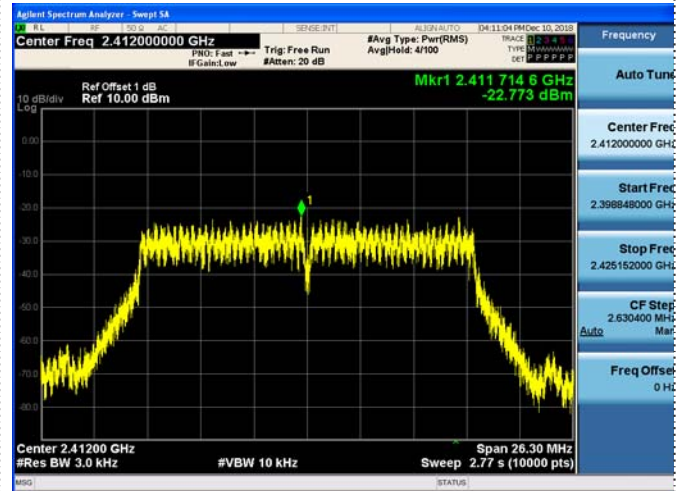

CH01

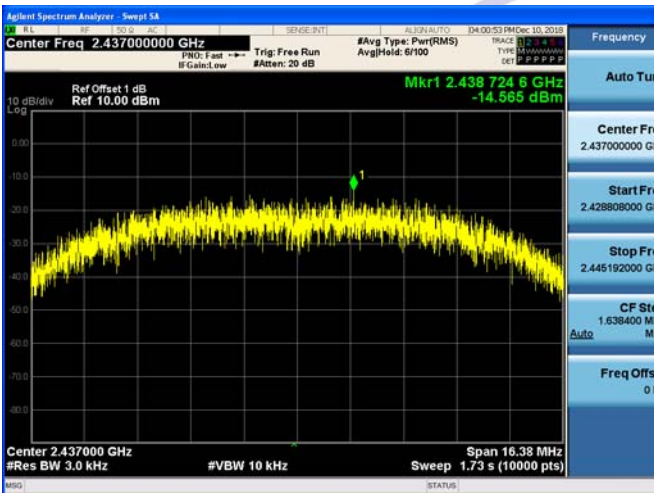

CH01

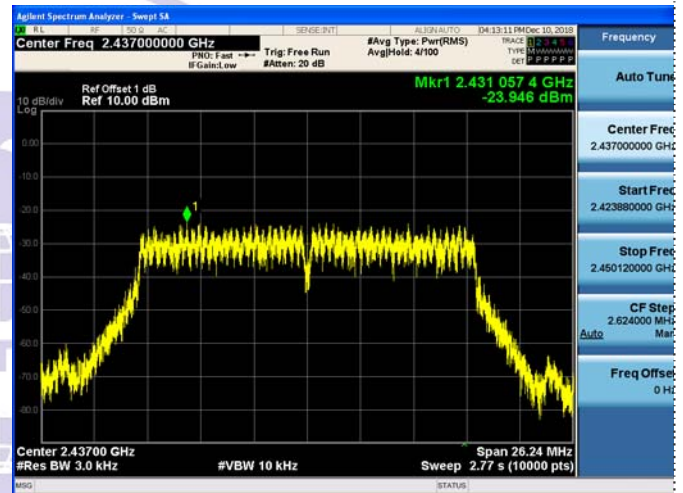

CH06

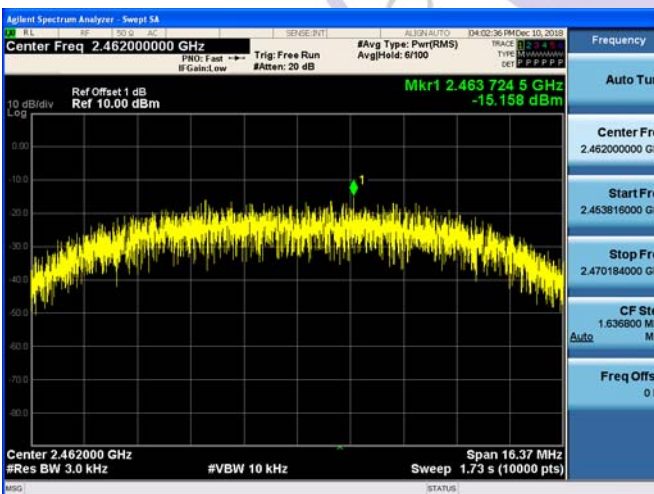

CH06

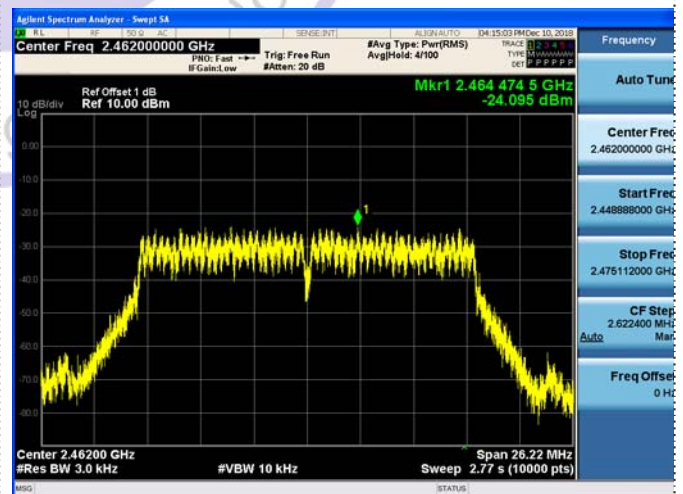

CH11



CH11



802.11n(HT20)

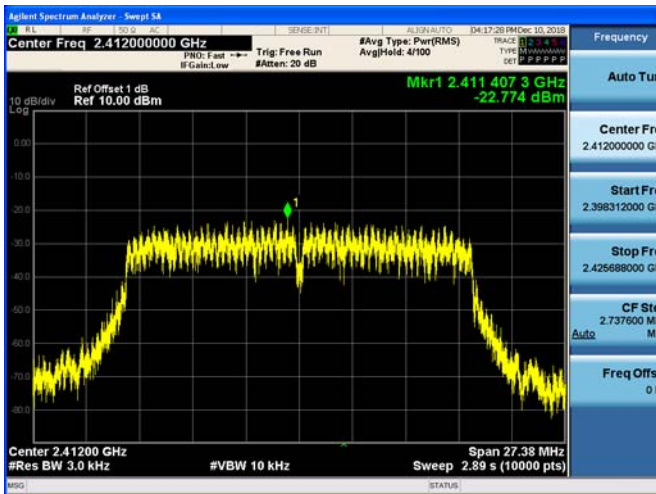

802.11n(HT40)

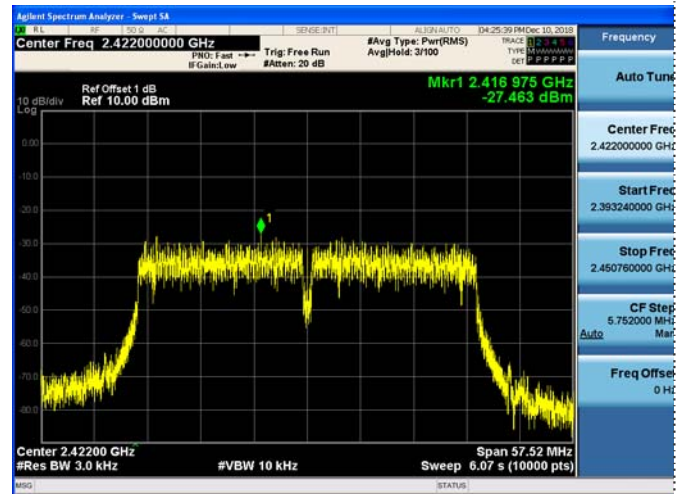

CH01

CH03

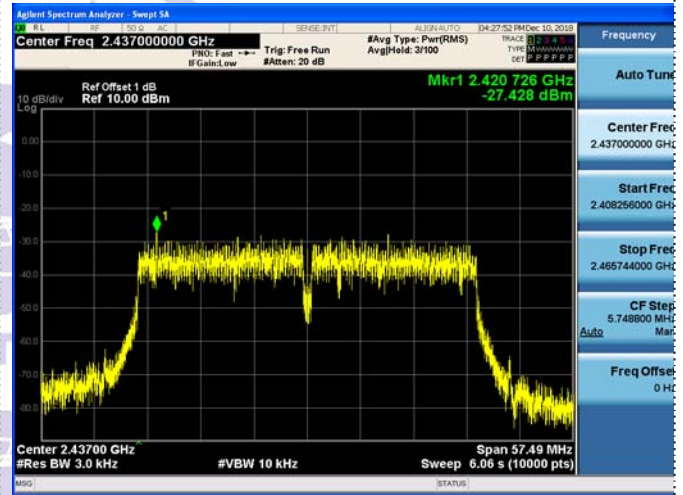
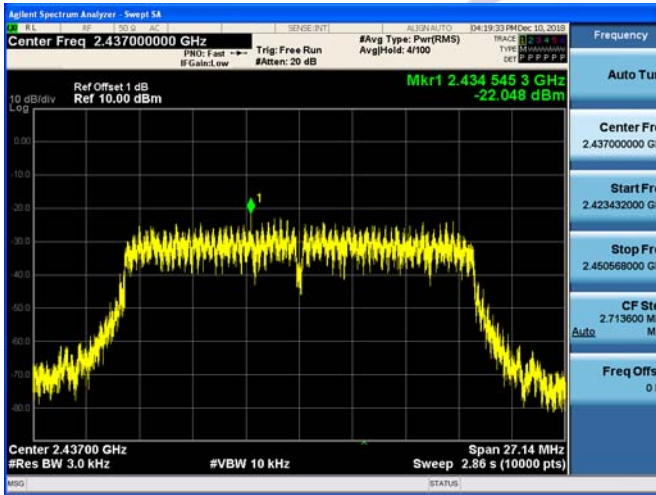

CH06

CH06

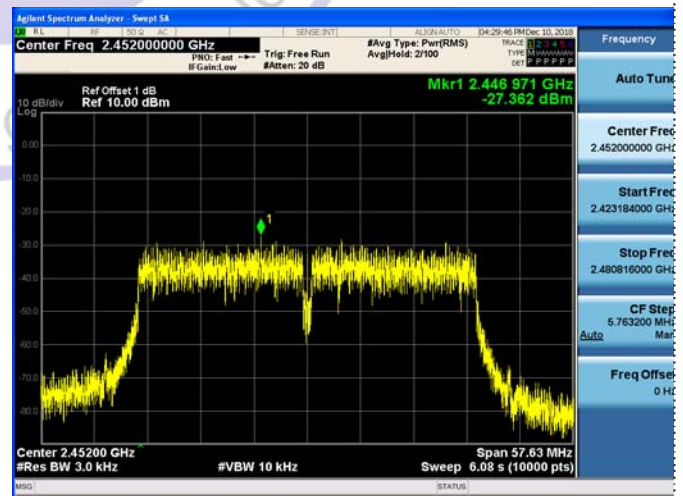
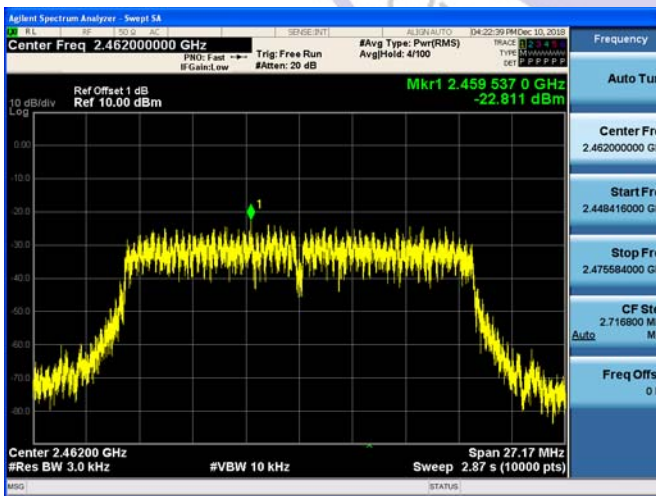

CH11

CH09

Ant. 2

802.11b

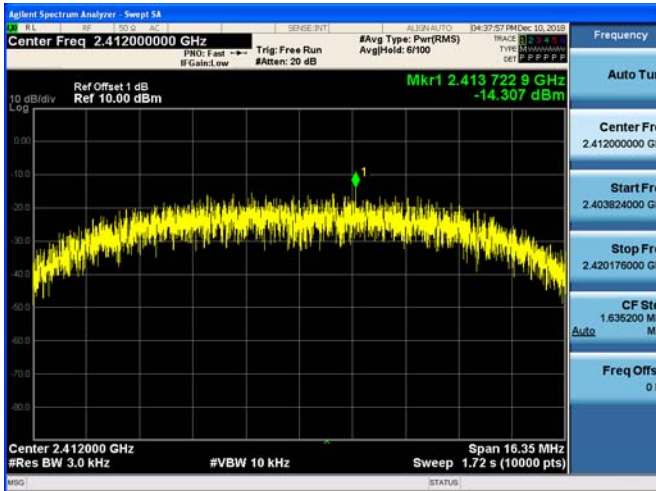

802.11g

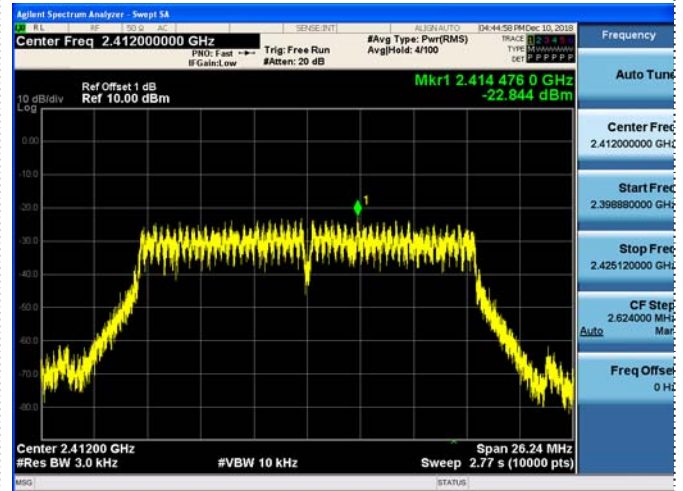

CH01

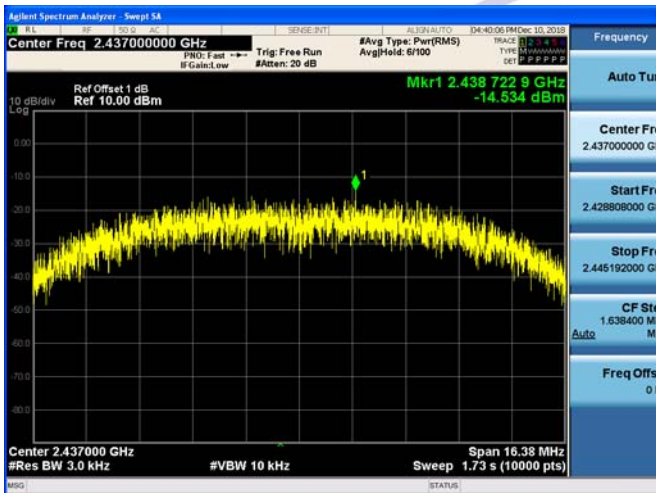

CH01

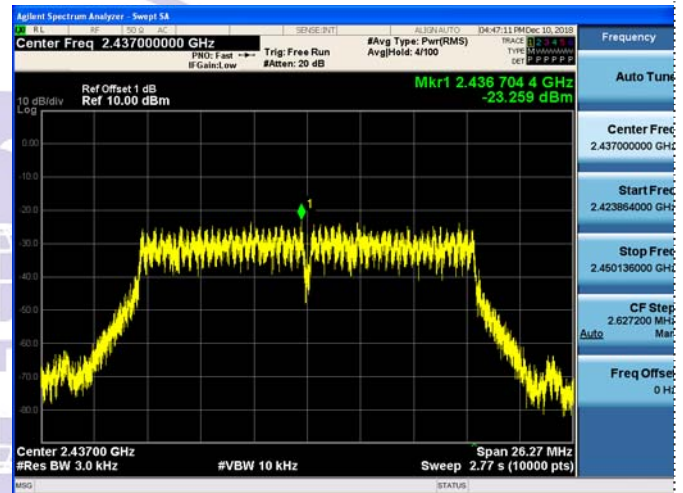

CH06

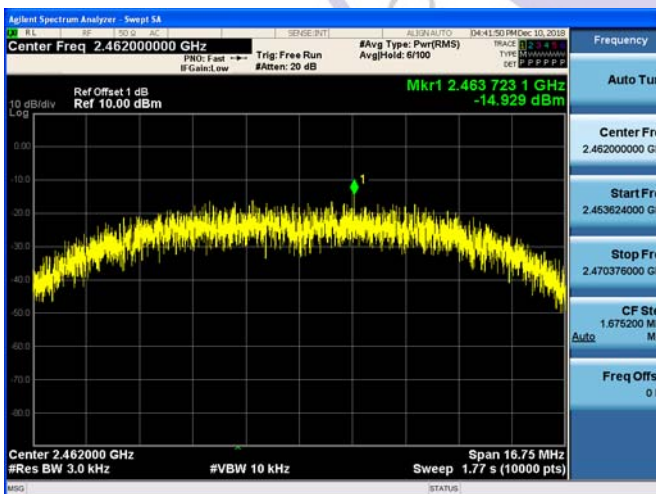

CH06

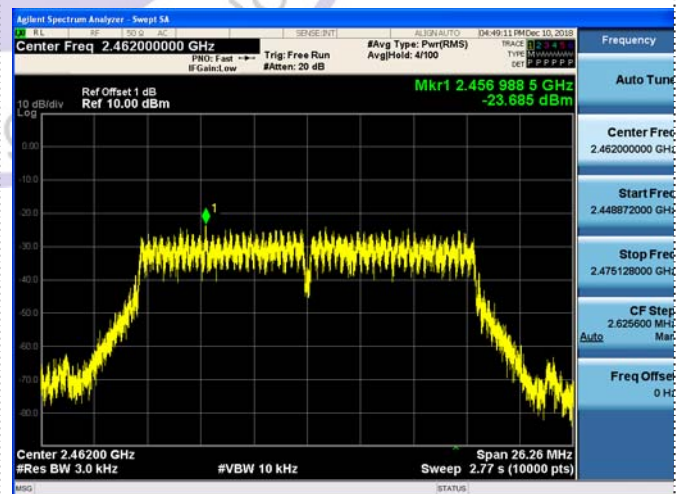

CH11



CH11





802.11n(HT20)

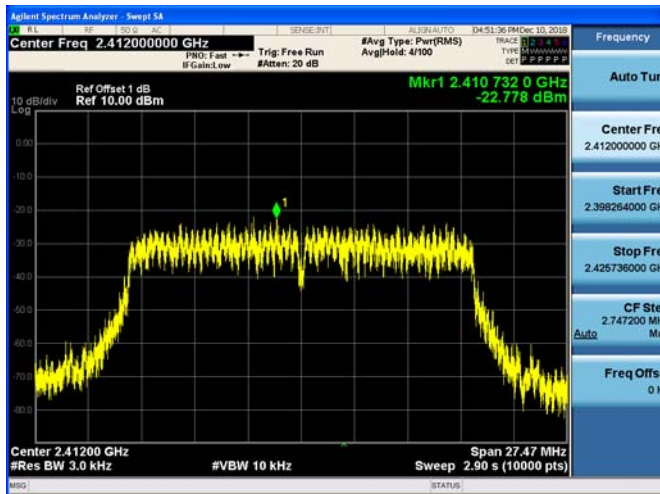

802.11n(HT40)

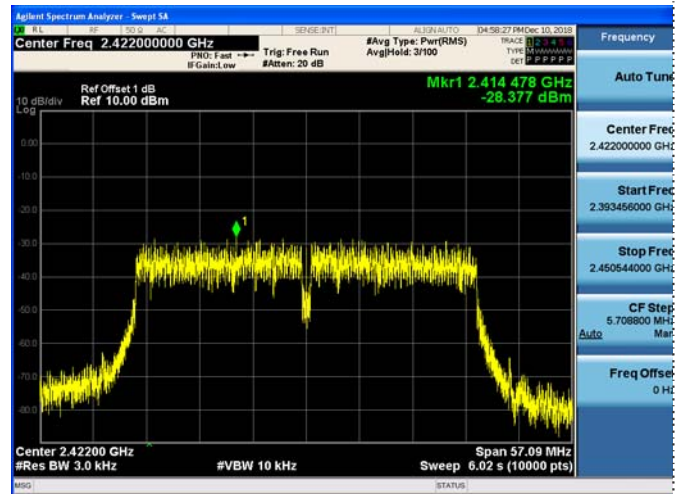

CH01

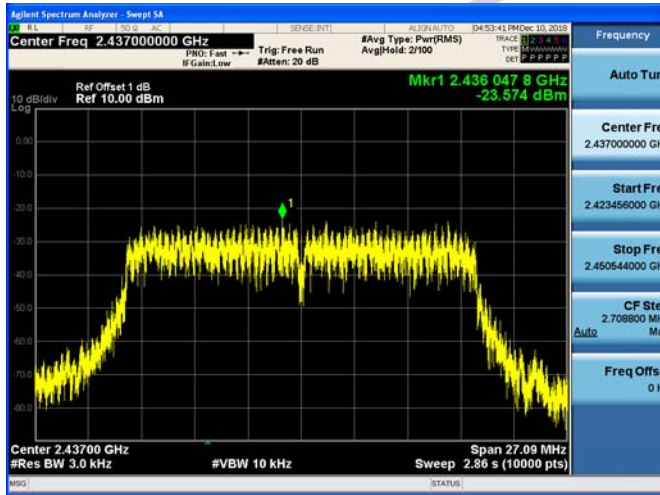

CH03

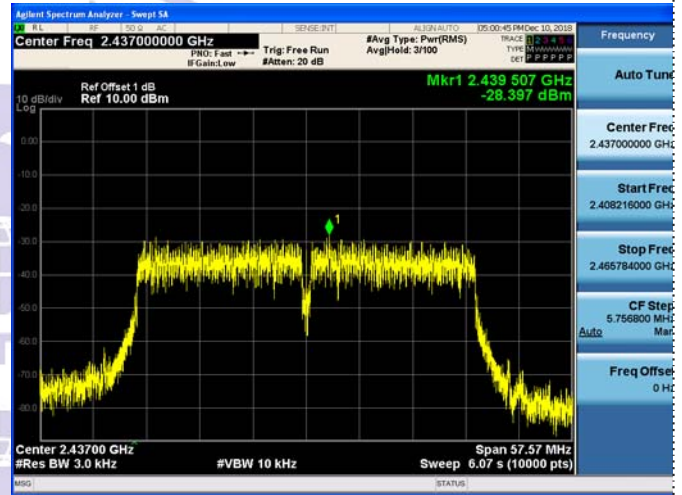

CH06

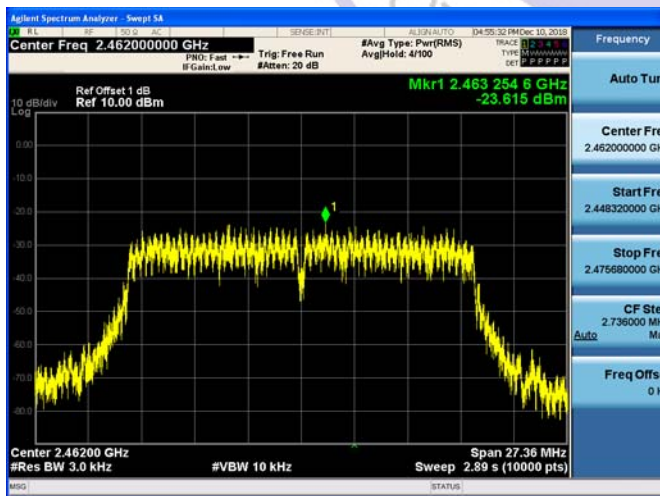

CH06

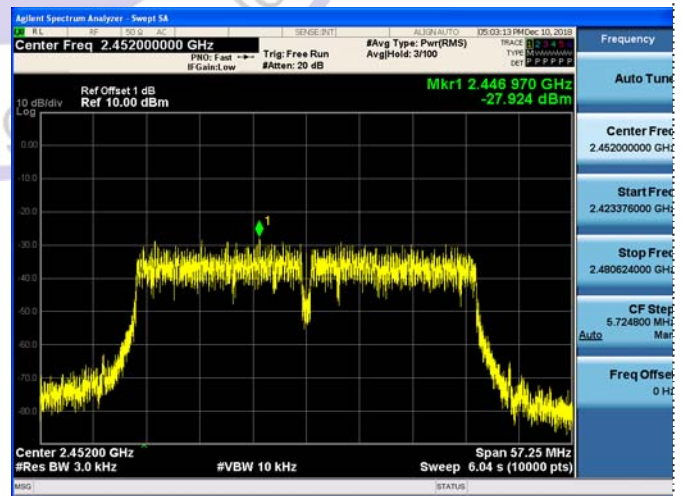

CH11

CH09

### 3.5. 6dB Bandwidth

#### Limit

For digital modulation systems, the minimum 6 dB bandwidth shall be at least 500 kHz

#### Test Procedure

The transmitter output was connected to the spectrum analyzer through an attenuator. The bandwidth of the fundamental frequency was measured by spectrum analyzer with 100 KHz RBW and 300 KHz VBW. The 6dB bandwidth is defined as the total spectrum the power of which is higher than peak power minus 6dB.

#### Test Configuration



#### Test Results

<i>WIFI</i>					
Type	Channel	6dB Bandwidth Ant1 (MHz)	6dB Bandwidth Ant2 (MHz)	Limit (KHz)	Result
802.11b	01	10.23	10.22	≥500	Pass
	06	10.24	10.24		
	11	10.23	10.47		
802.11g	01	16.44	16.40	≥500	Pass
	06	16.40	16.42		
	11	16.39	16.41		
802.11n(HT20)	01	17.11	17.17	≥500	Pass
	06	16.96	16.93		
	11	16.98	17.10		
802.11n(HT40)	03	35.95	35.68	≥500	Pass
	06	35.93	35.98		
	09	36.02	35.78		

Test plot as follows:

Ant.1

802.11b

802.11g

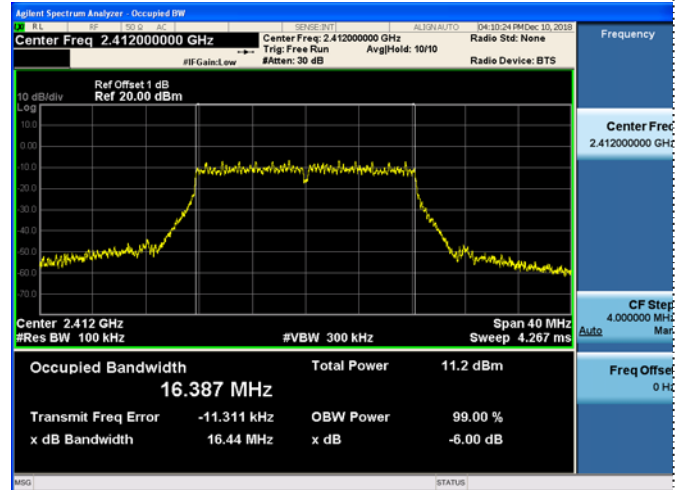
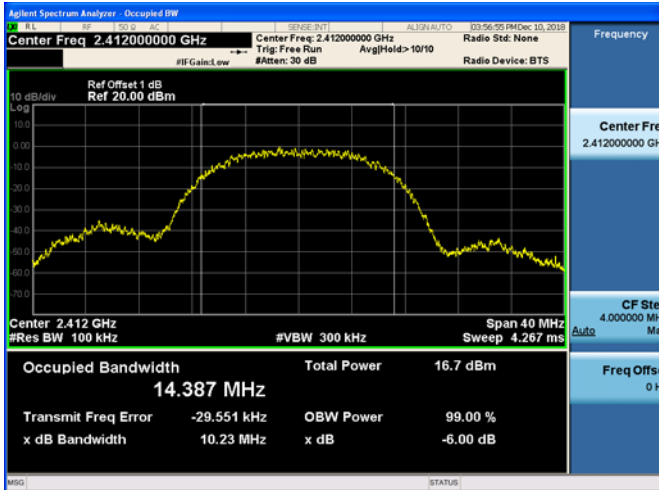

CH01

CH01

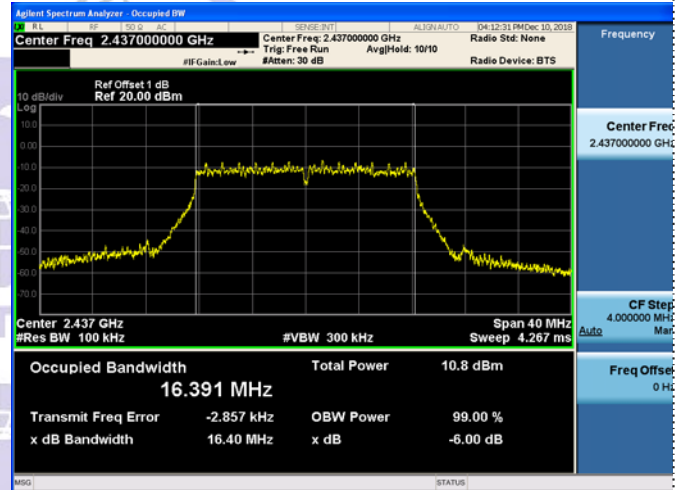
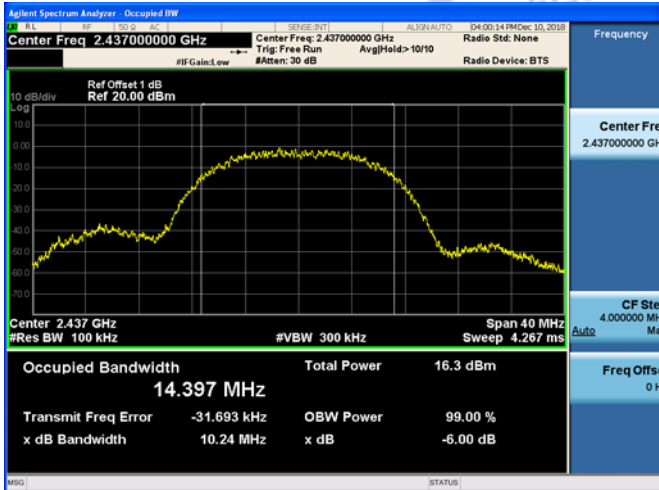

CH06

CH06

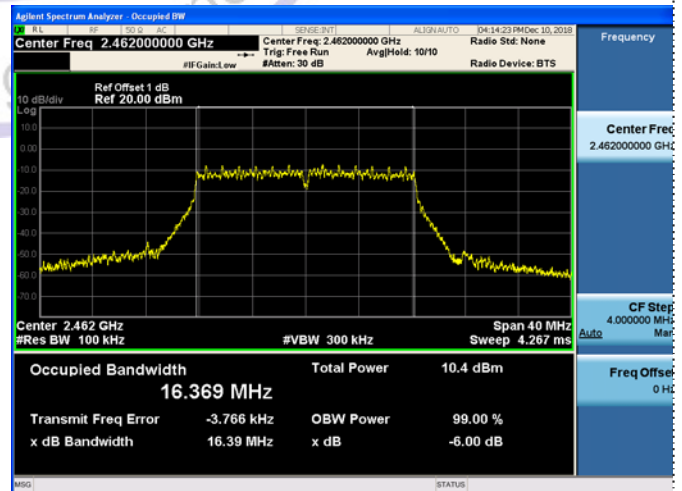
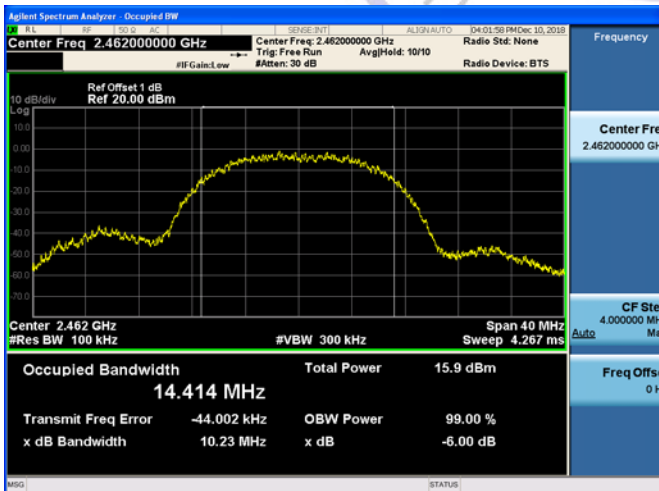

CH11

CH11

802.11n(HT20)

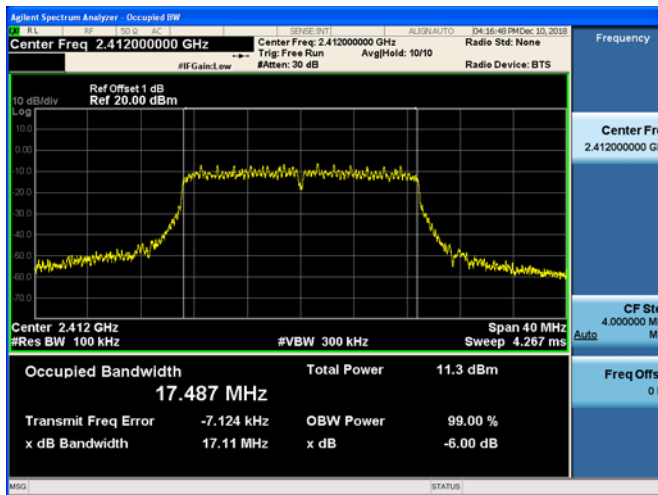

802.11n(HT40)

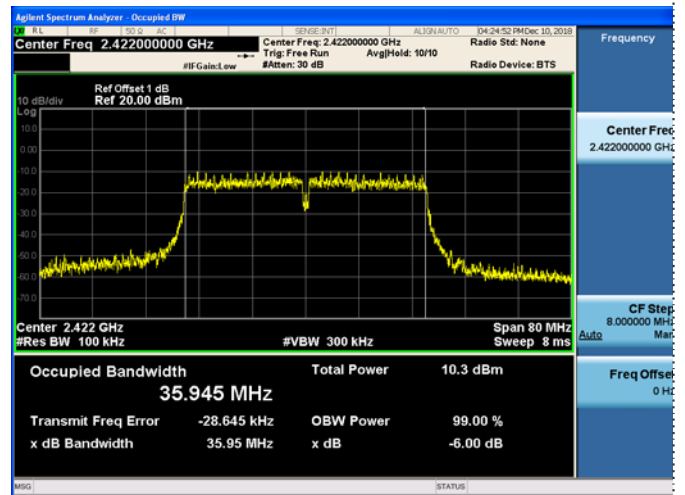

CH01

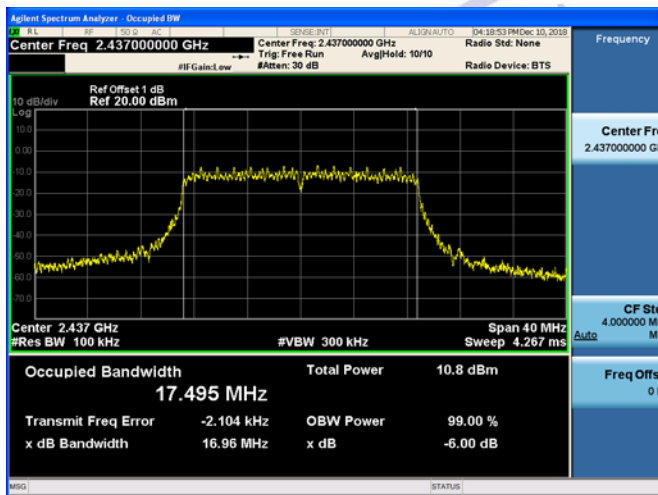

CH03

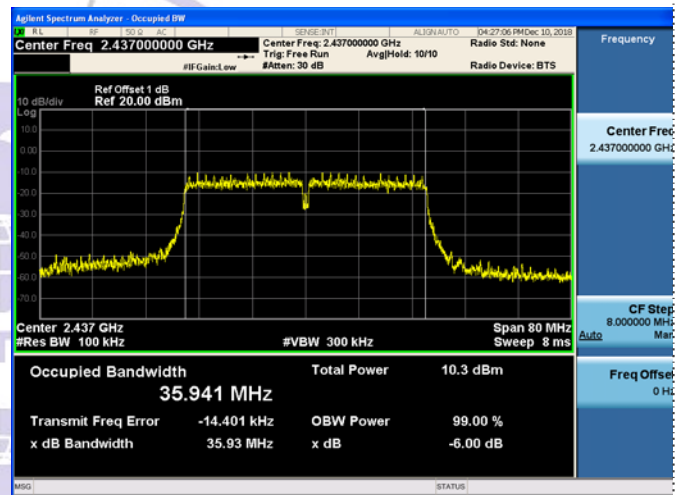

CH06

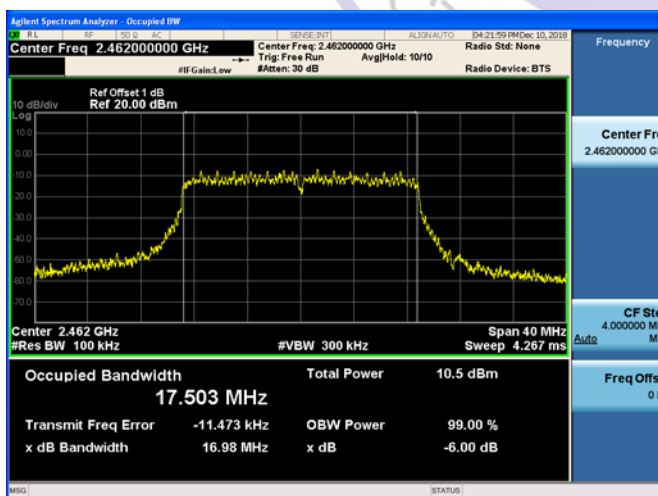

CH06

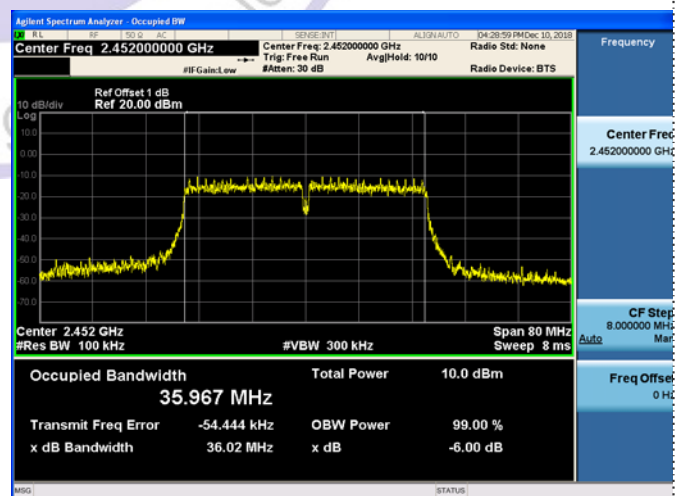

CH11



CH09



Ant.2

802.11b

802.11g

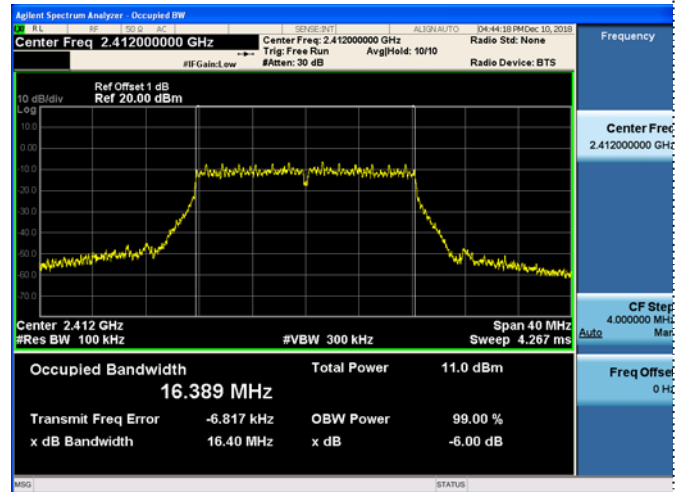
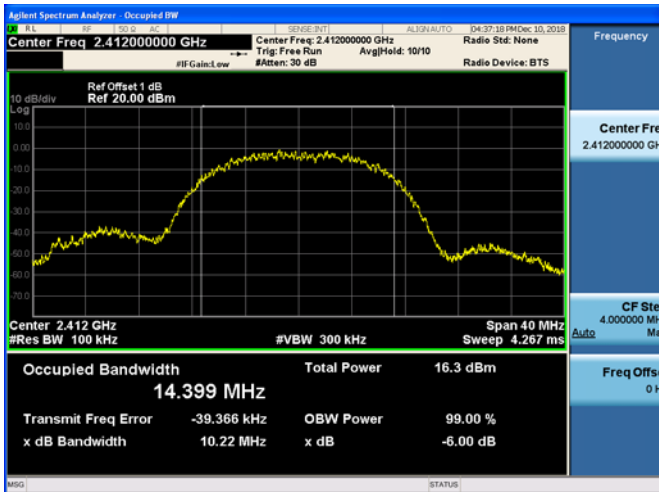

CH01

CH01

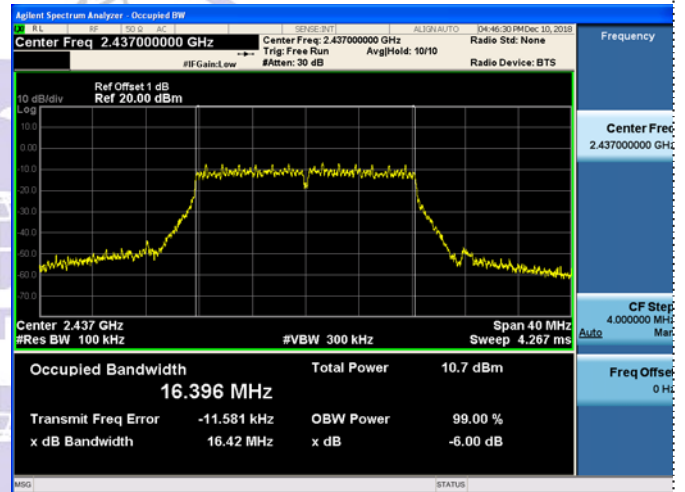
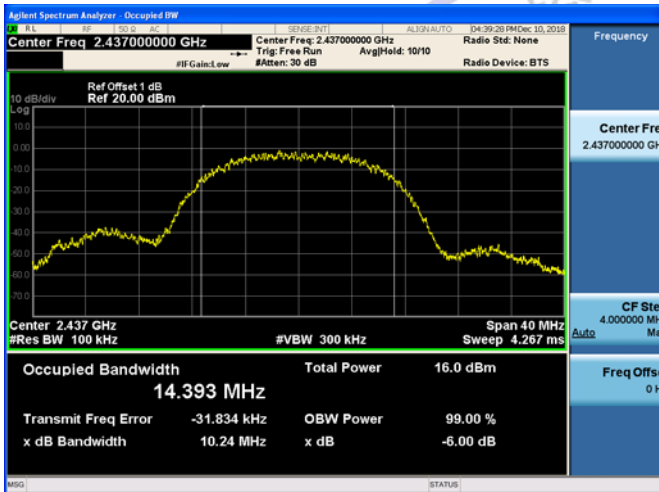

CH06

CH06

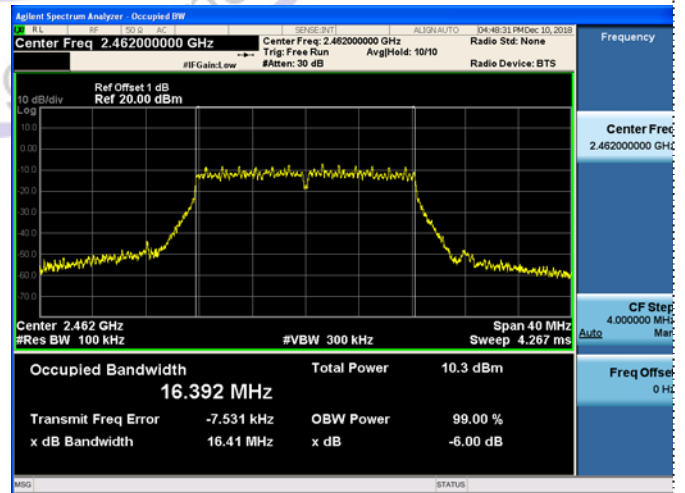
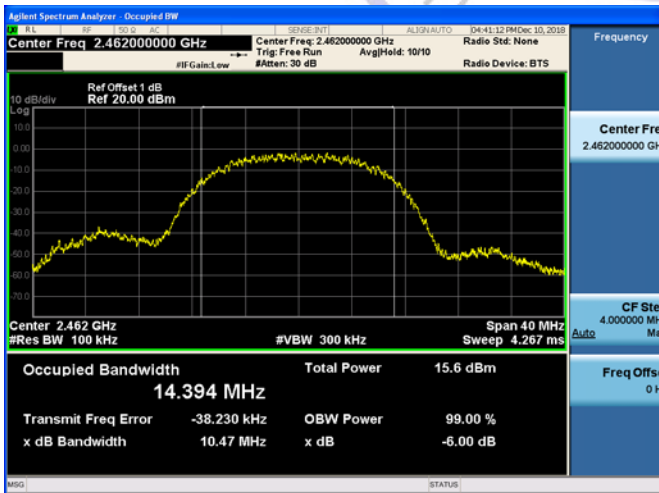

CH11

CH11

802.11n(HT20)

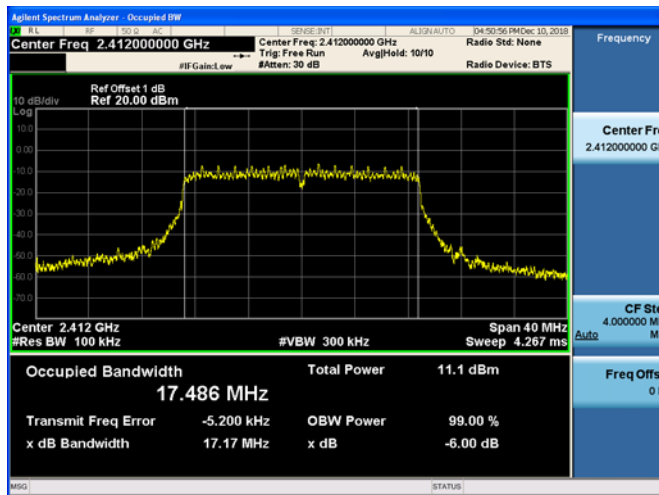

802.11n(HT40)

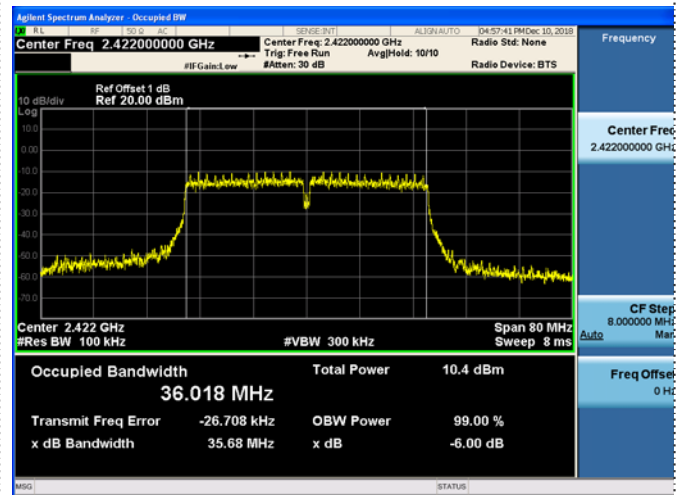

CH01

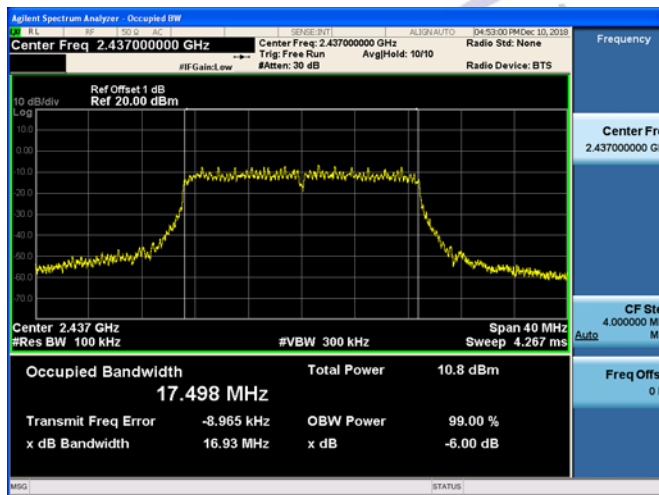

CH03

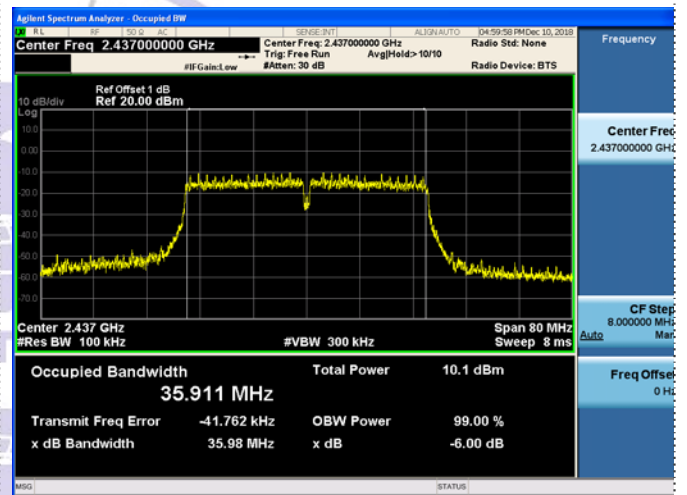

CH06

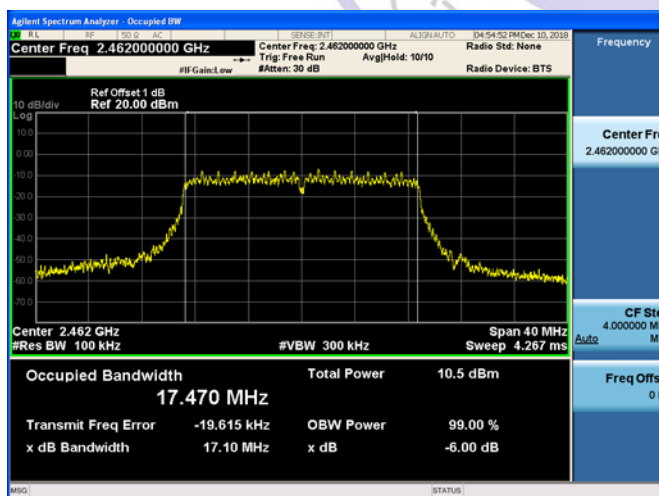

CH06

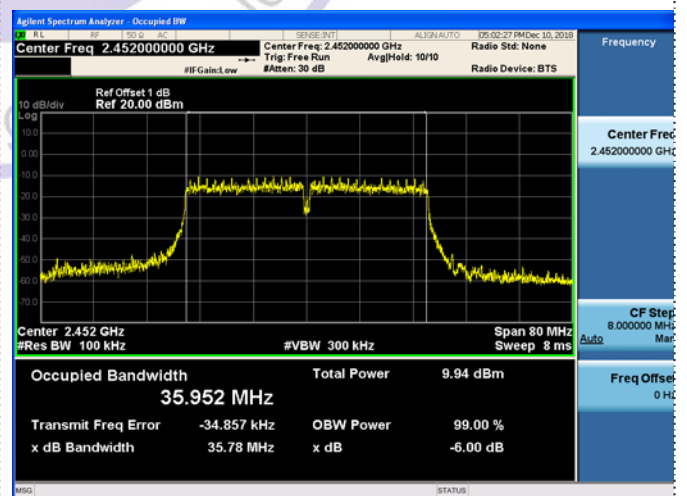

CH11

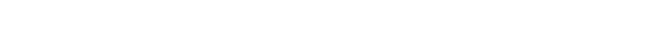

CH09



### 3.6. Out-of-band Emissions

#### Limit

In any 100 kHz bandwidth outside the frequency band in which the spread spectrum or digitally modulated intentional radiator is operating, the radio frequency power that is produced by the intentional radiator shall be at least 20 dB below that in the 100 kHz bandwidth within the band that contains the highest level of the desired power, based on either an RF conducted or a radiated measurement, provided the transmitter demonstrates compliance with the peak conducted power limits. If the transmitter complies with the conducted power limits based on the use of RMS averaging over a time interval, as permitted under paragraph (b)(3) of this section, the attenuation required under this paragraph shall be 30 dB instead of 20 dB. Attenuation below the general limits specified in §15.209(a) is not required.

#### Test Procedure

Connect the transmitter output to spectrum analyzer using a low loss RF cable, and set the spectrum analyzer to RBW=100 kHz, VBW= 300 kHz, peak detector, and max hold. Measurements utilizing these settings are made of the in-band reference level, band-edge and out-of-band emissions.

#### Test Configuration



#### Test Results

Remark: The measurement frequency range is from 30MHz to the 10th harmonic of the fundamental frequency. The lowest, middle and highest channels are tested to verify the spurious emissions and band-edge measurement data.

Test plot as follows:

Ant.1

802.11b CH01

802.11b CH06

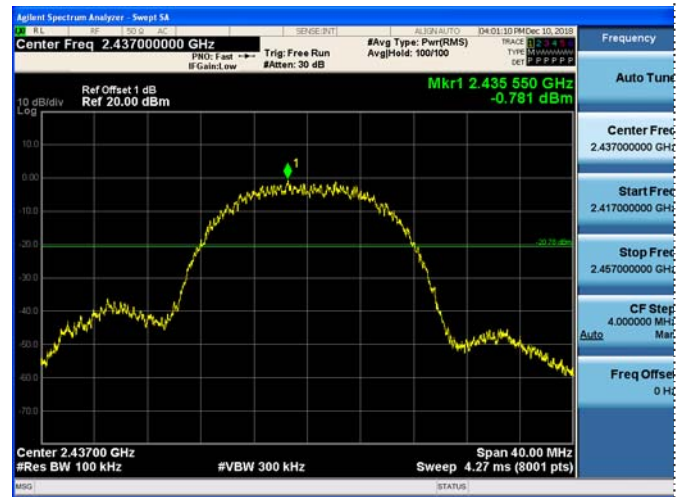

Reference

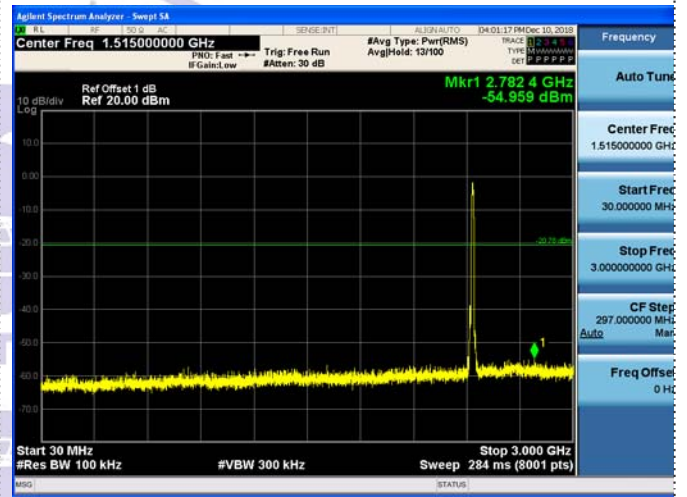
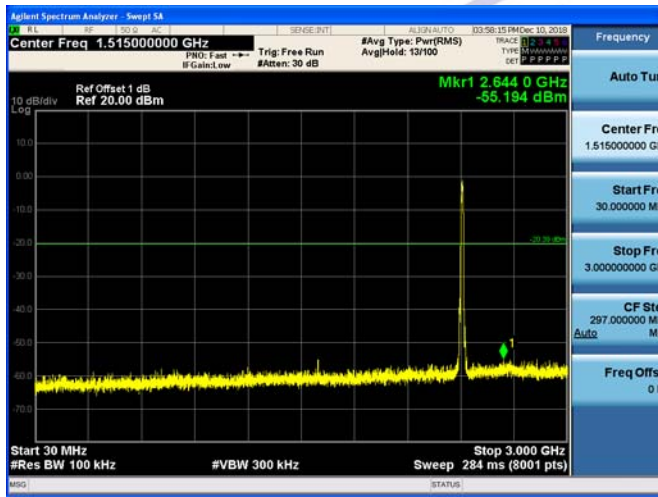

30MHz-3GHz

30MHz-3GHz

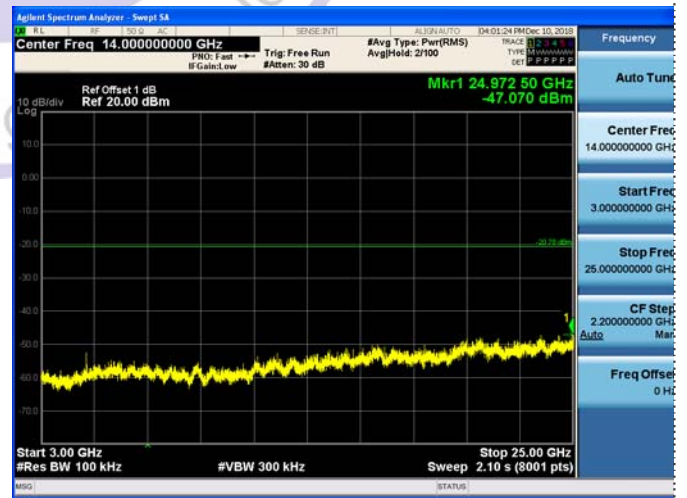
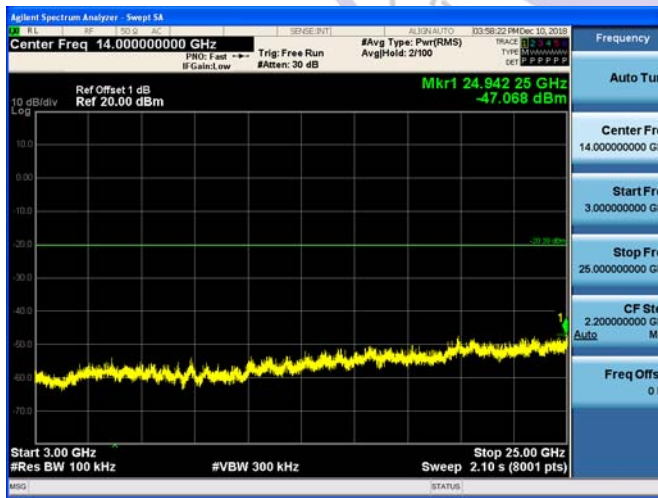

3GHz-25GHz

3GHz-25GHz



802.11b CH11

802.11g CH01

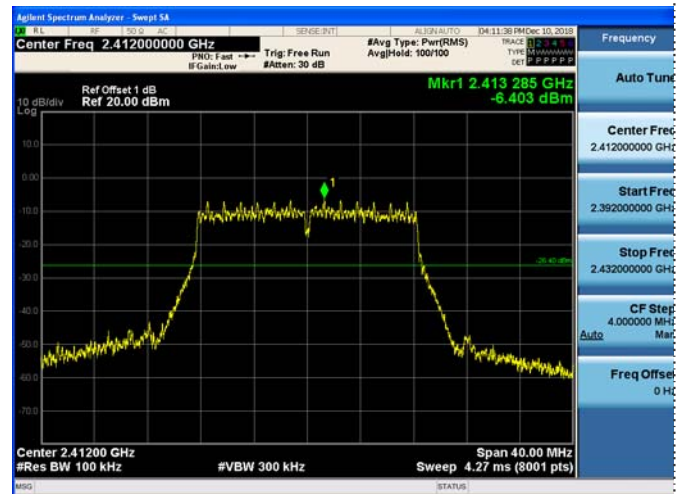

Reference

Reference

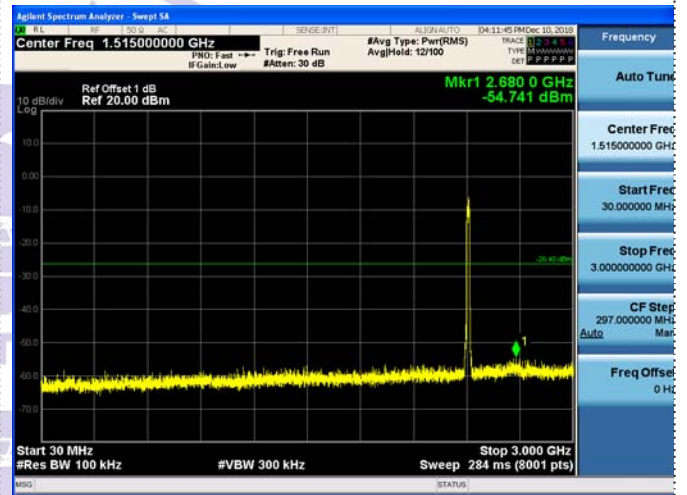
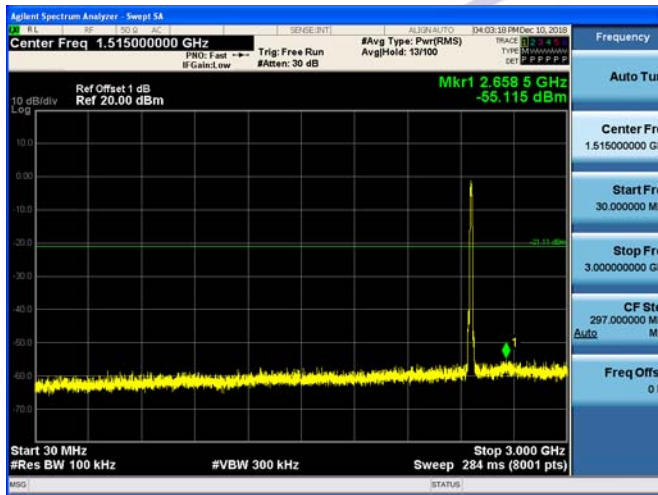

30MHz-3GHz

30MHz-3GHz

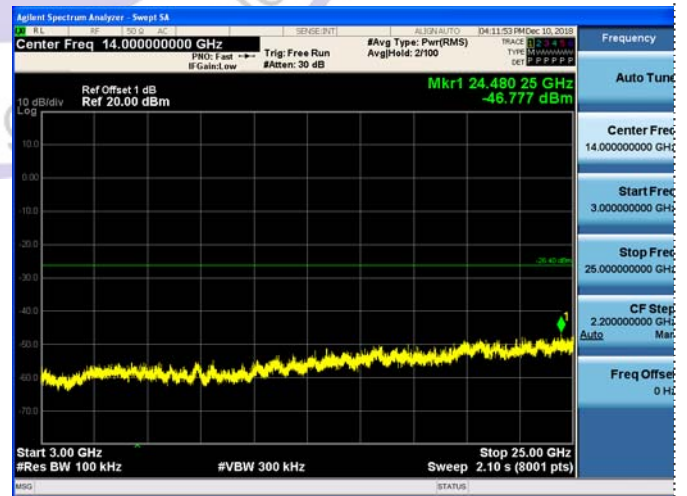
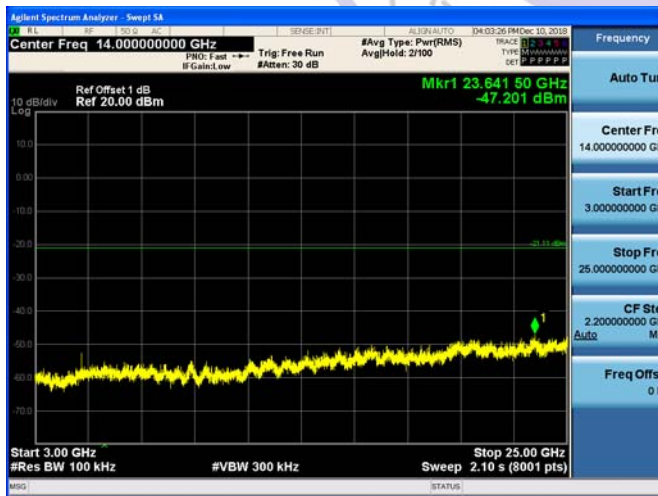

3GHz-25GHz

3GHz-25GHz

802.11g CH06

802.11g CH11

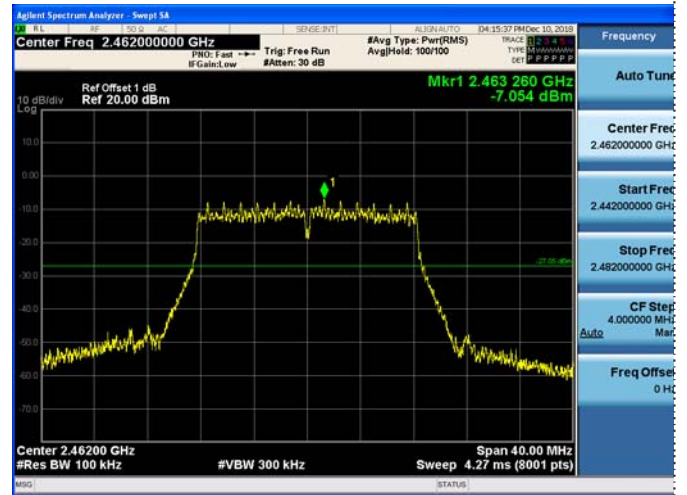
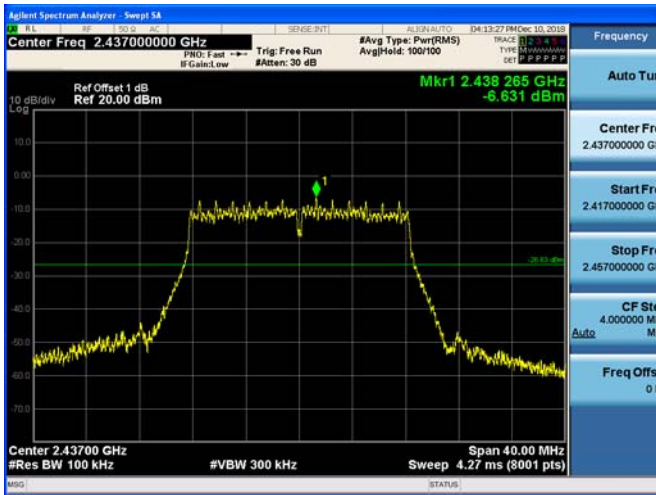

Reference

Reference

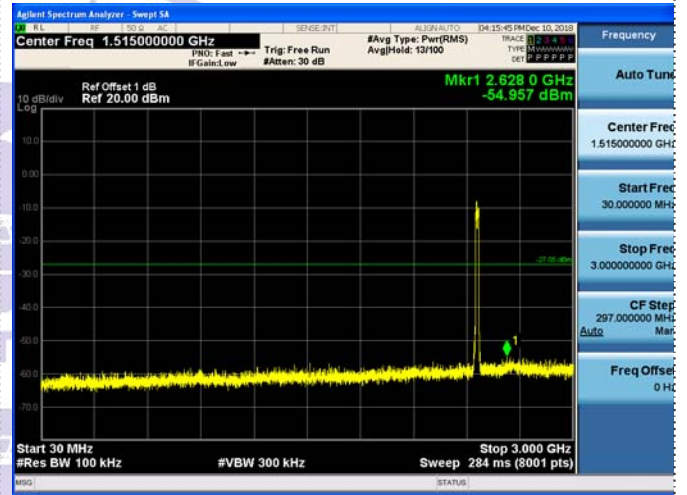
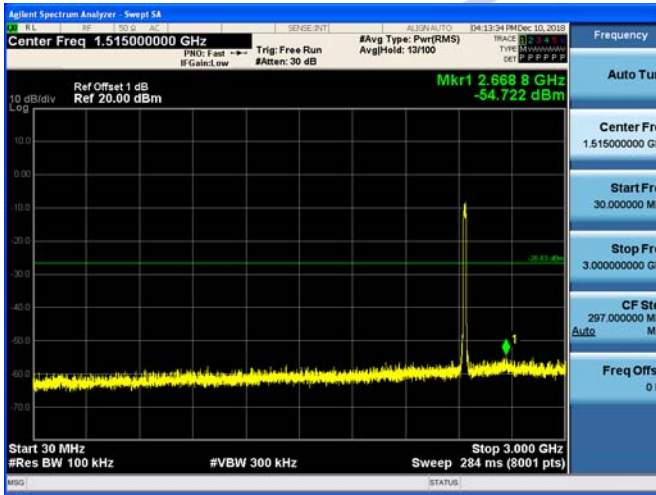

30MHz-3GHz

30MHz-3GHz

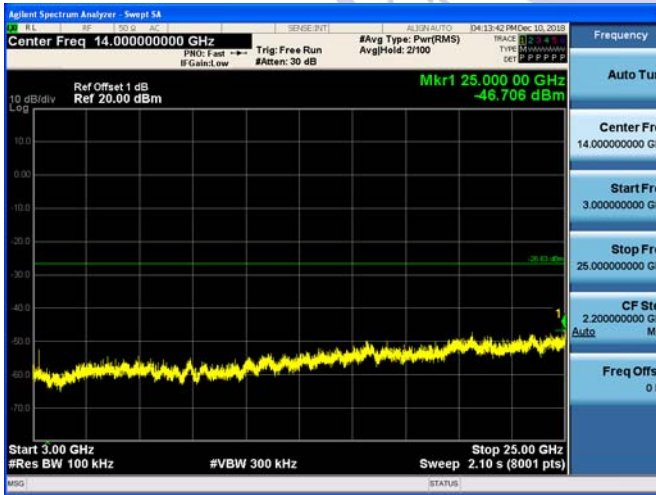

3GHz-25GHz

3GHz-25GHz

802.11n(HT20) CH01

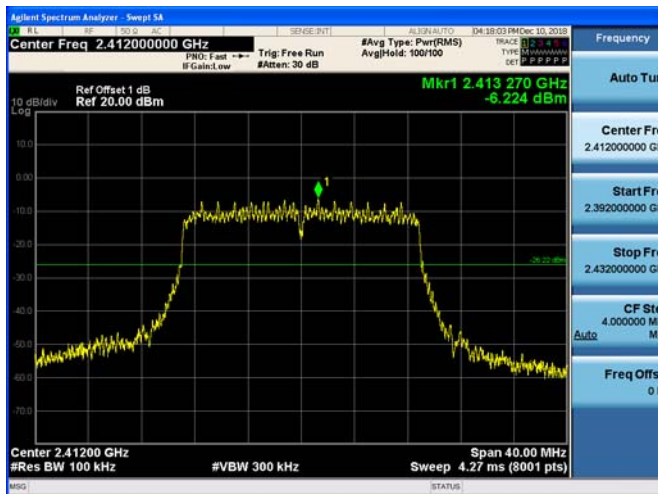

802.11n(HT20) CH06

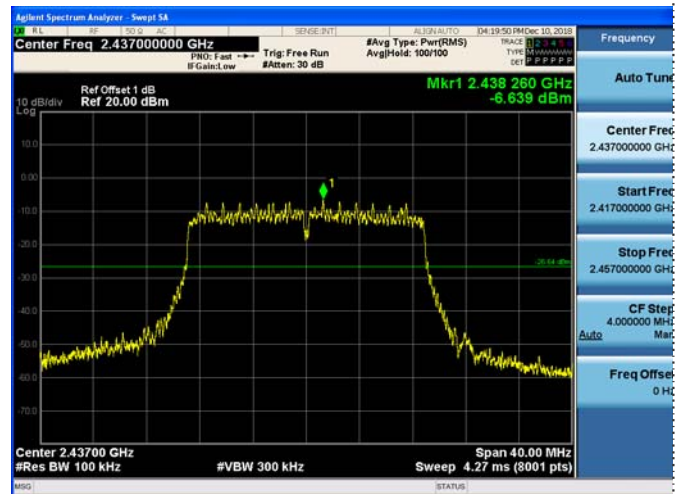

Reference

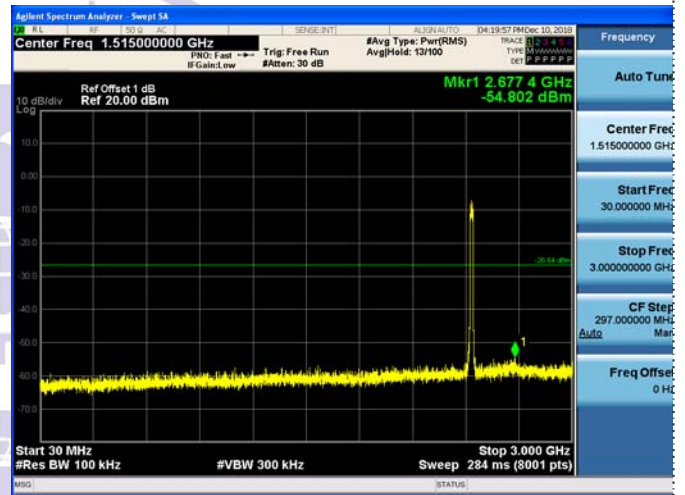
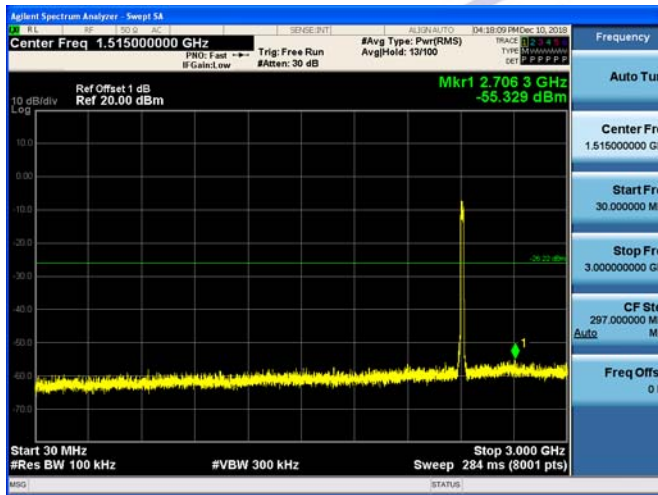

30MHz-3GHz

30MHz-3GHz

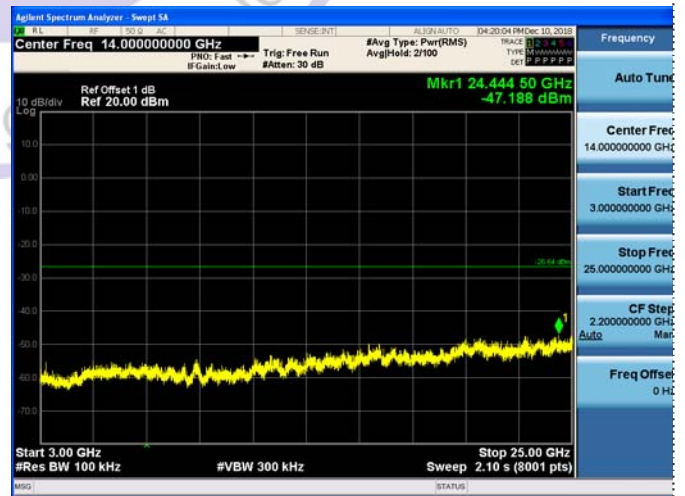
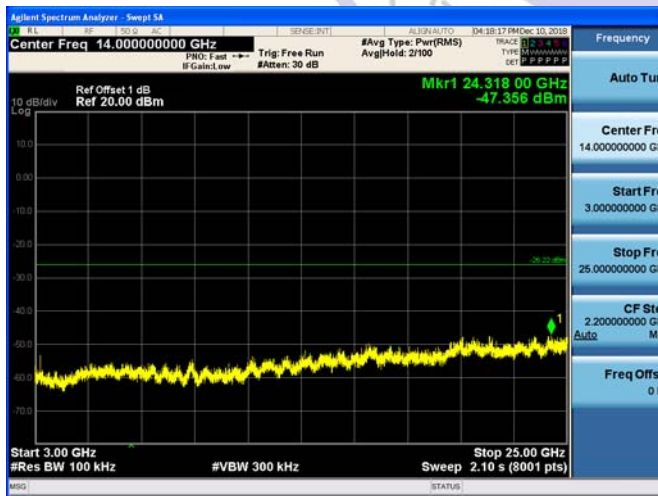

3GHz-25GHz

3GHz-25GHz