

Antenna Describe

1: Antenna Describe

Antenna	PCB
Antenna Gain	0dBi
Frequency Range	2.4Ghz-2.483Ghz
Connector Type	Direct
Location of mearement(company name)	SHENZHEN SHIXINZHONGXIN TECHNOLOGY.CO.,LTD

2: External View Drawing

Picture of antenna

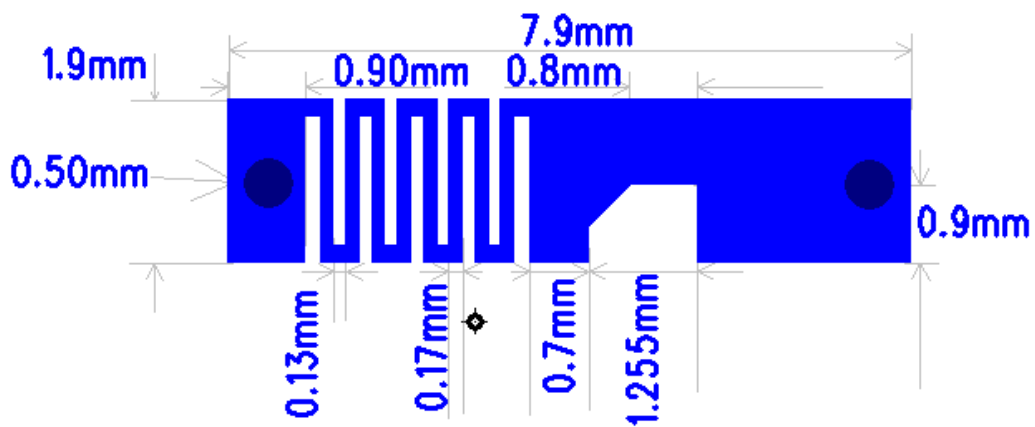

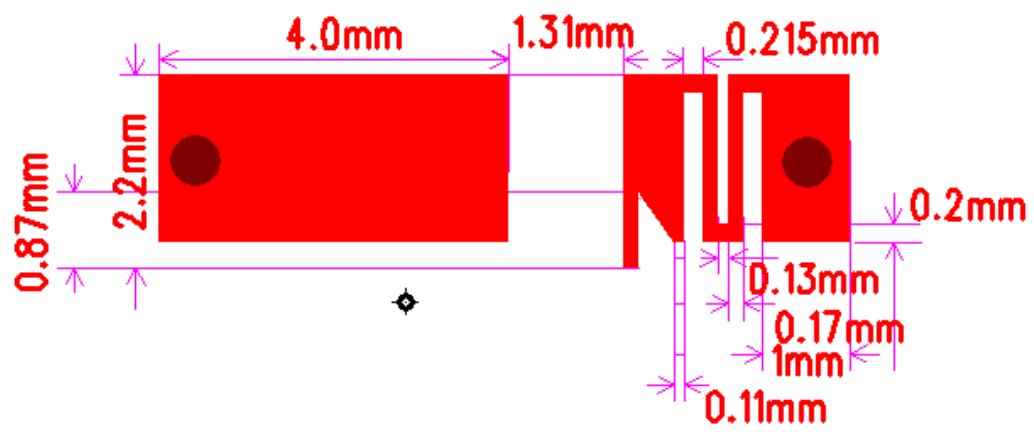

3: Measurement Result

3.1 Return Loss (S11)

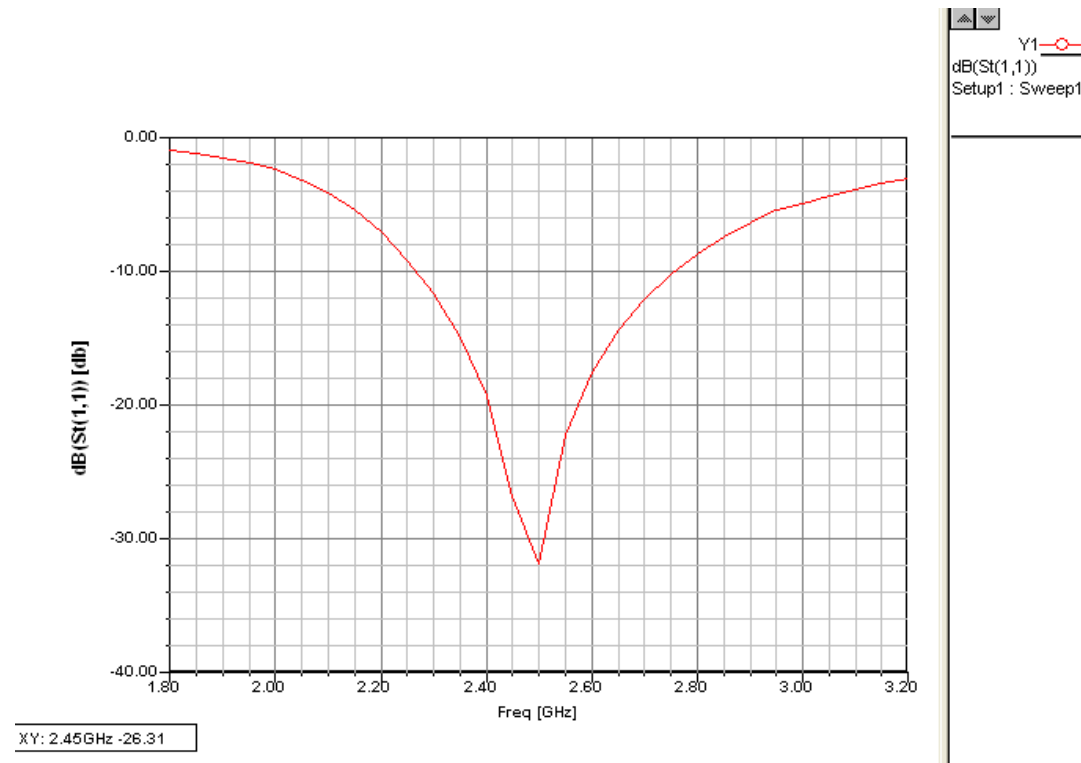

3.2 Smith Chart

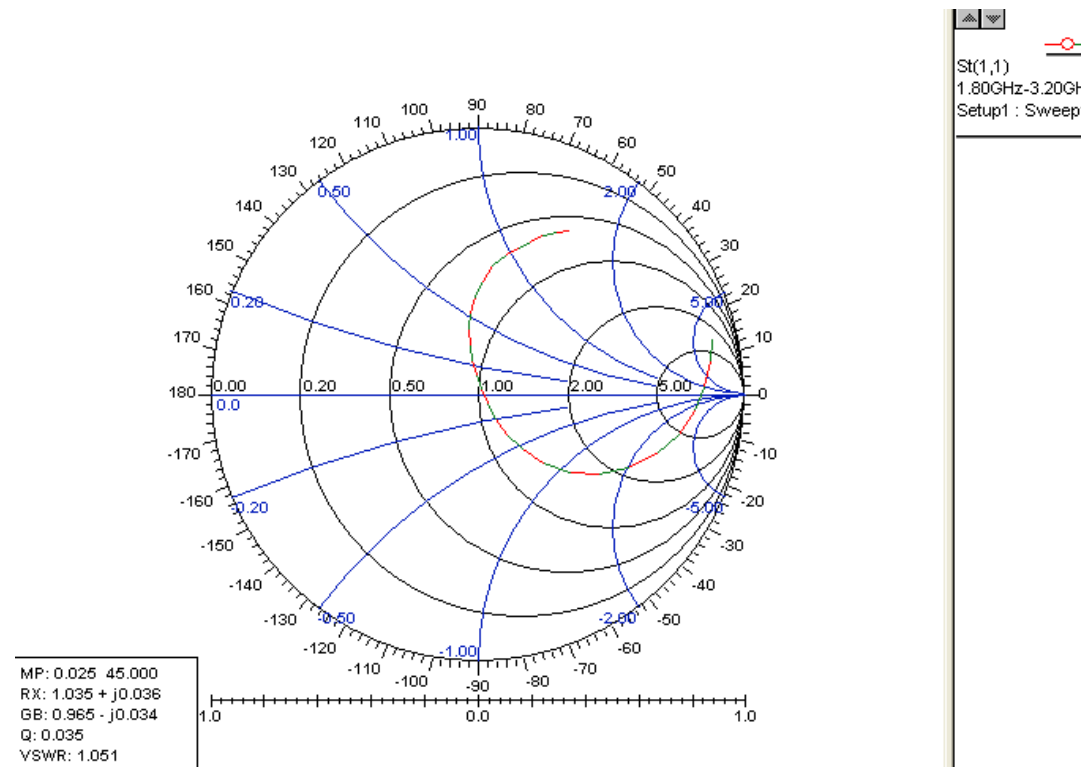

3.3 Gain

2400.000MHz H

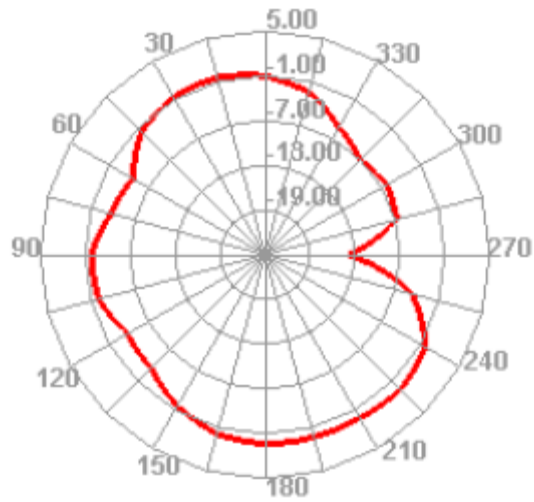

2400.000MHz E1

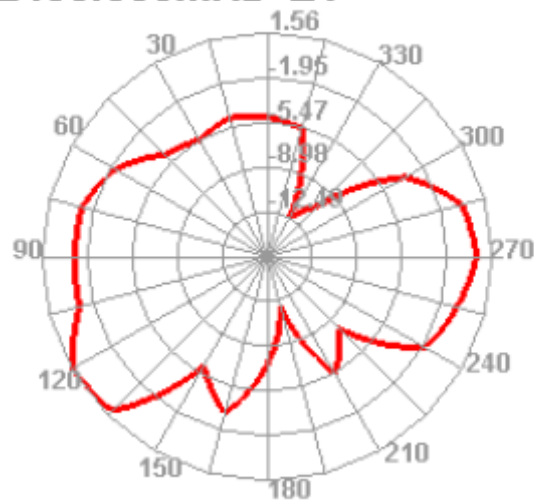

2400.000MHz E2

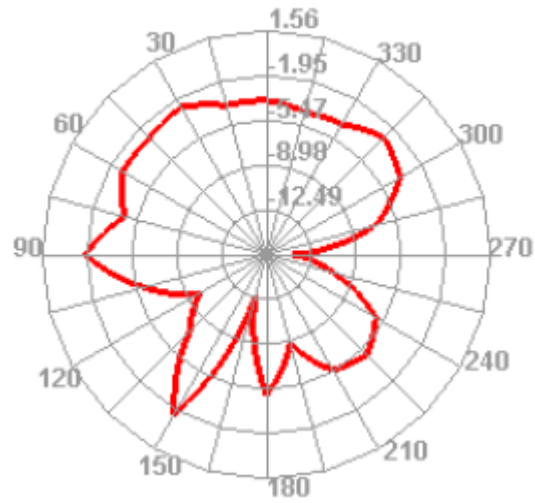

2450.000MHz H

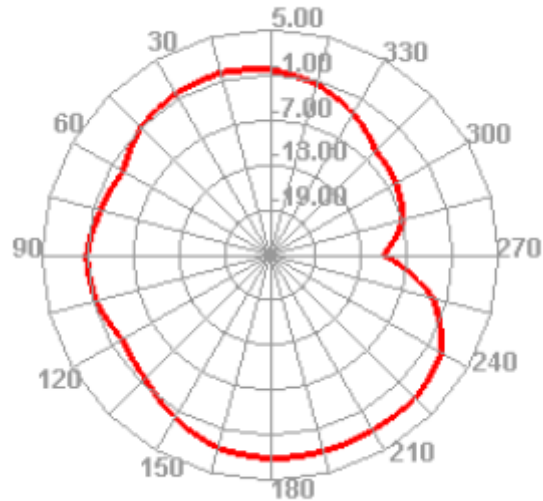

2450.000MHz E1

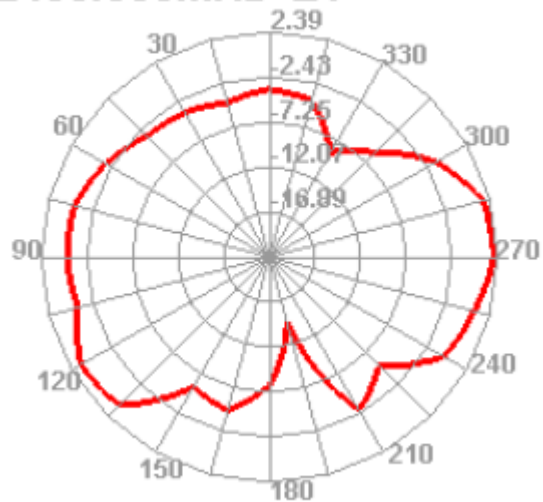

2450.000MHz E2

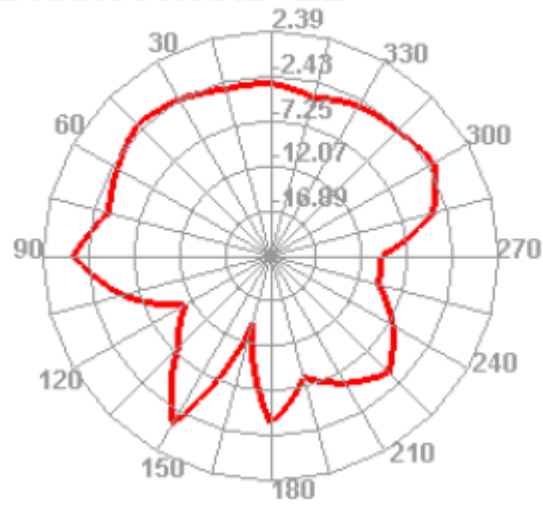

2500.000MHz H

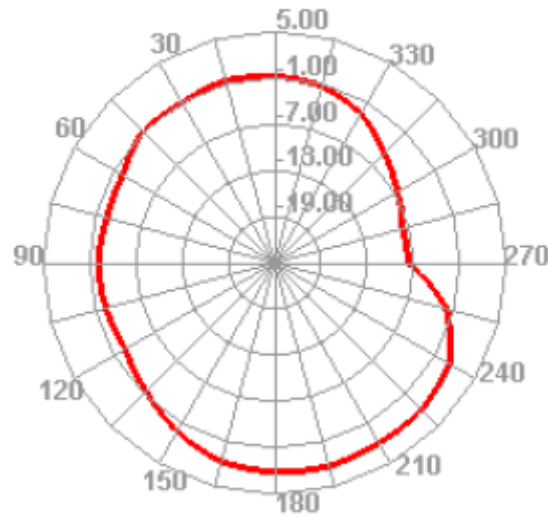

2500.000MHz E1

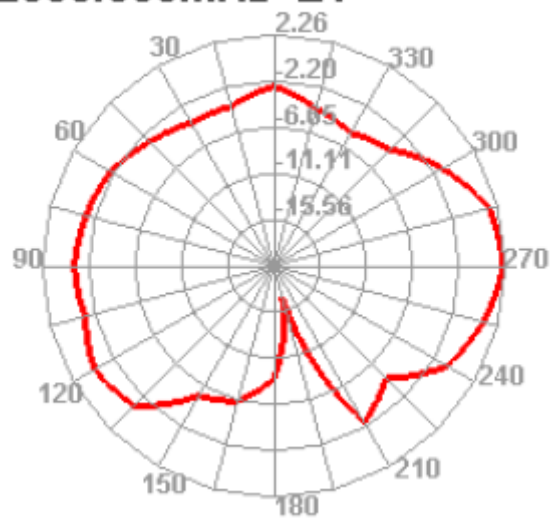

2500.000MHz E2

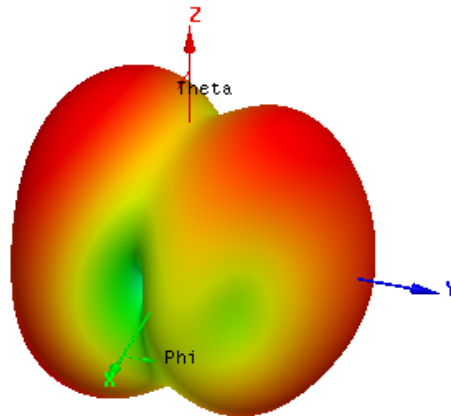
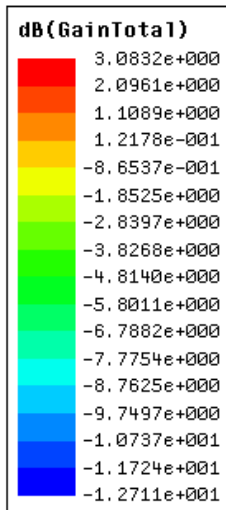
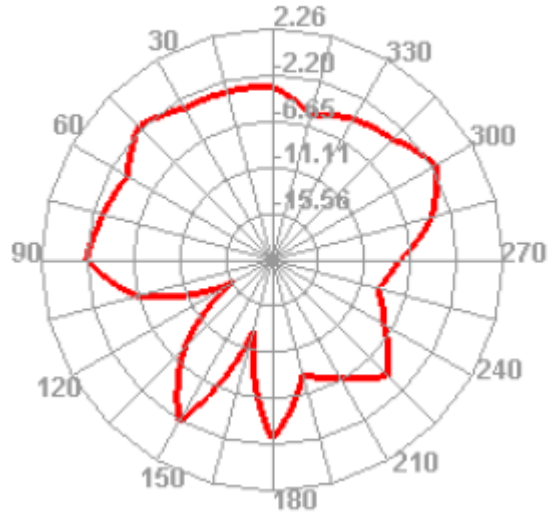

Manufacturer: Shenzhenshi xizhongxi ngi ntechnology.co., Ltd.
Address: No.1004 Huaqiang North Road, Futian District, Shenzhen, Guangdong