

Antenna Describe

1: Antenna Describe

Antenna	PCB
Antenna Gain	2.59dBi
Frequency Range	2.4Ghz-2.483Ghz
Connector Type	Direct
Location of mearement(company name)	SHENZHEN SHIXINZHONGXIN TECHNOLOGY.CO.,LTD

2: External View Drawing

Picture of antenna

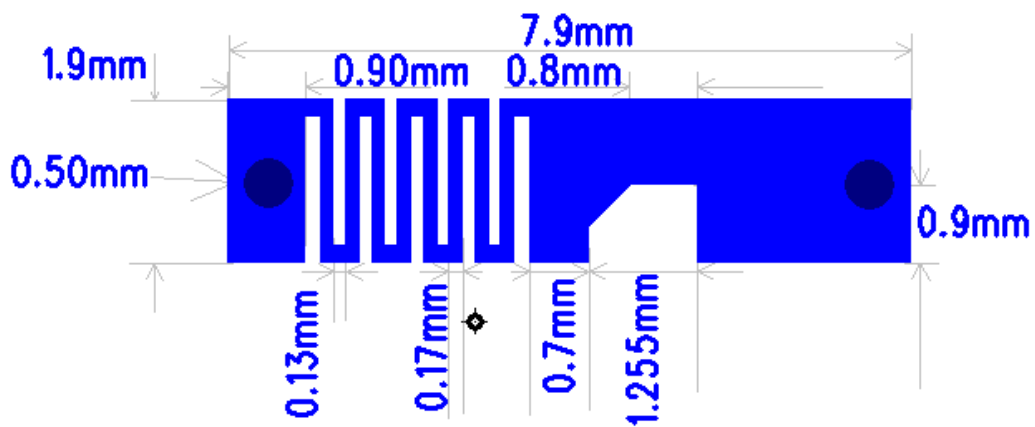

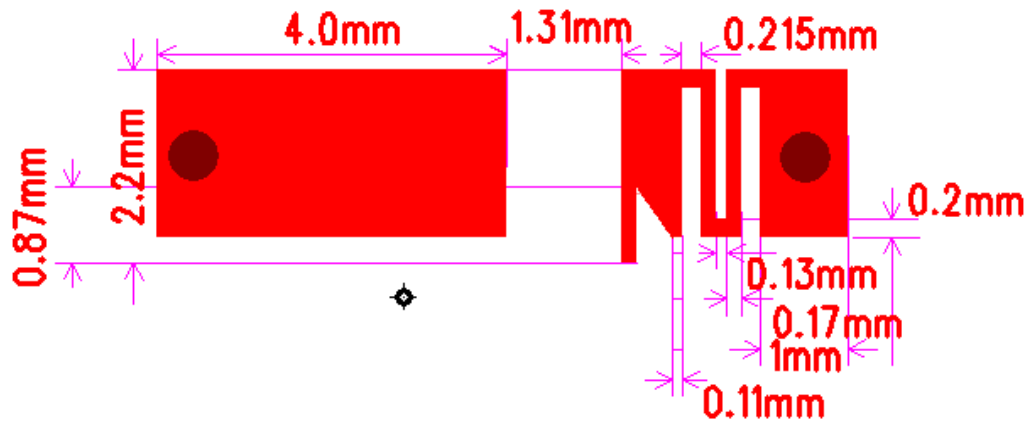

3: Measurement Result

3.1 Return Loss (S11)

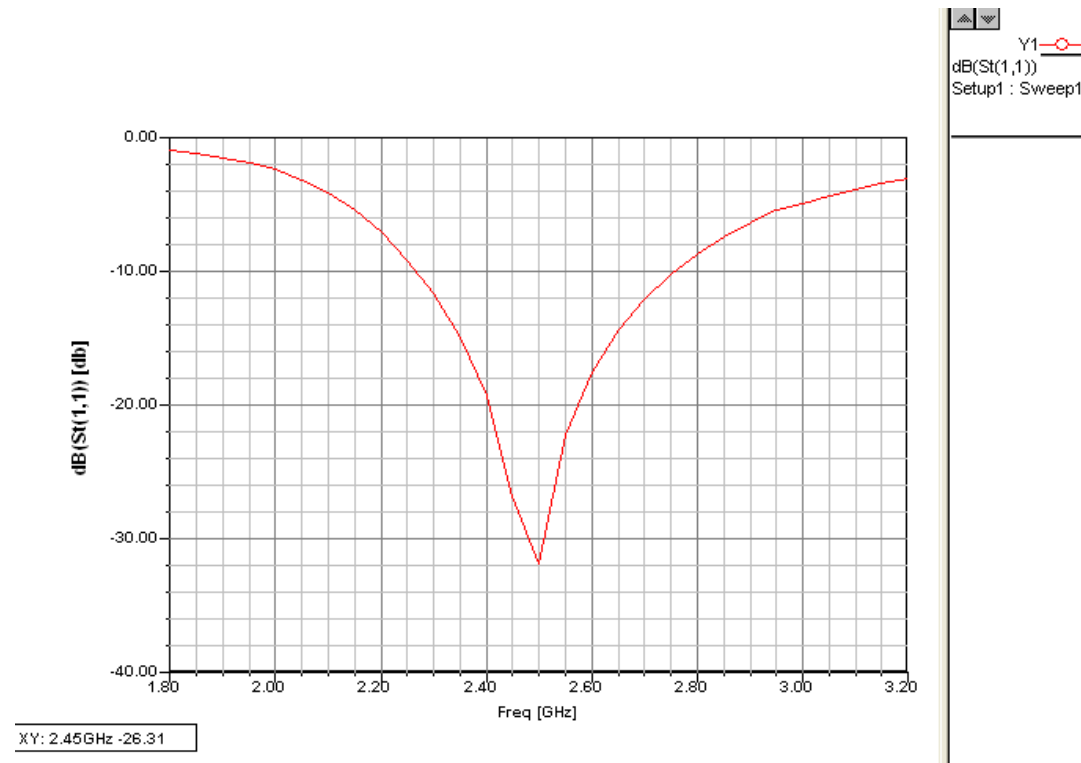

3.2 Smith Chart

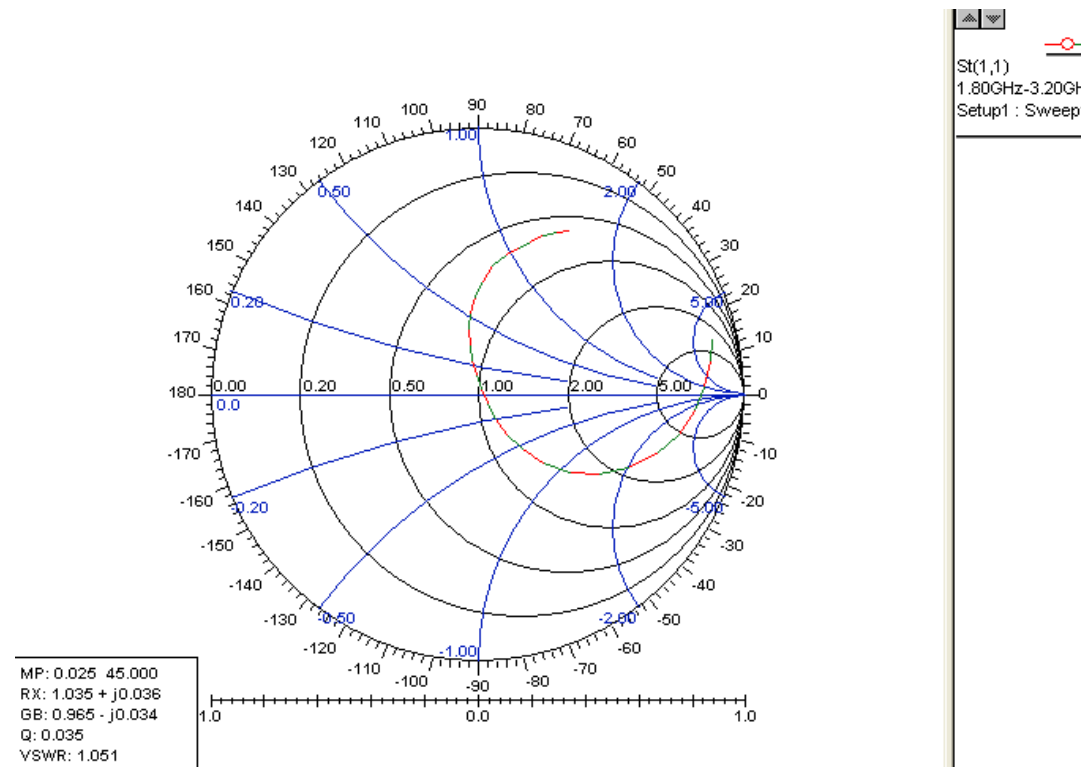

3.3 Gain

2400.000MHz H

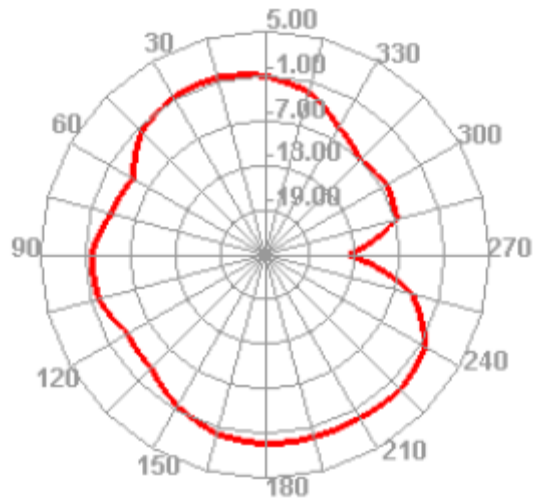

2400.000MHz E1

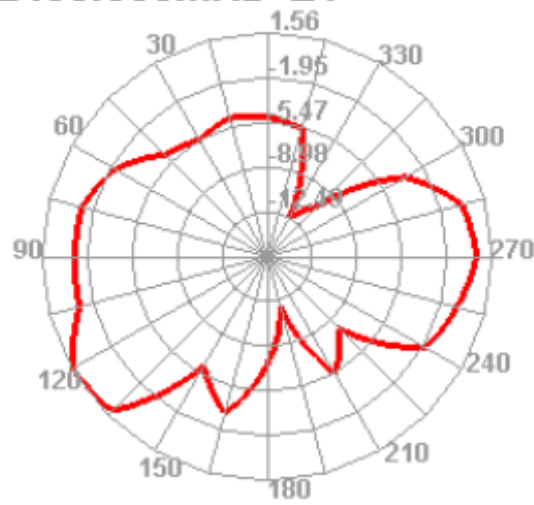

2400.000MHz E2

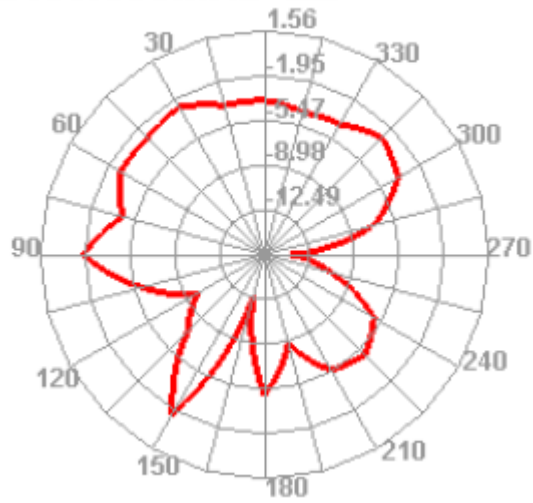

2450.000MHz H

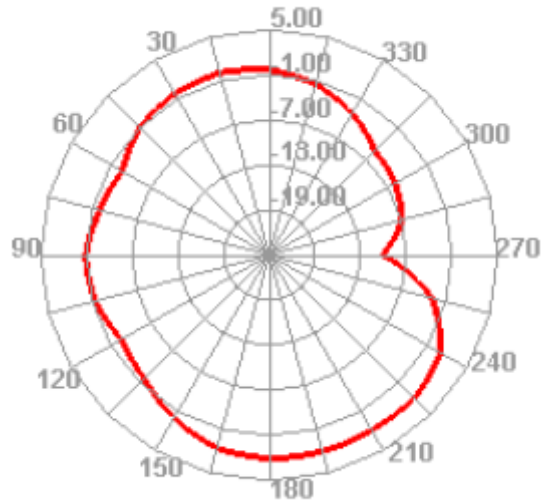

2450.000MHz E1

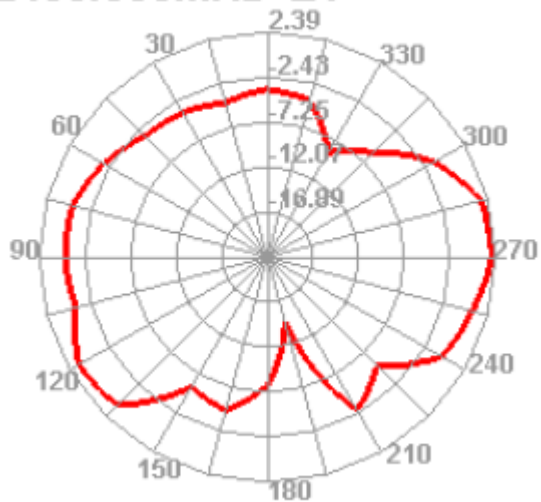

2450.000MHz E2

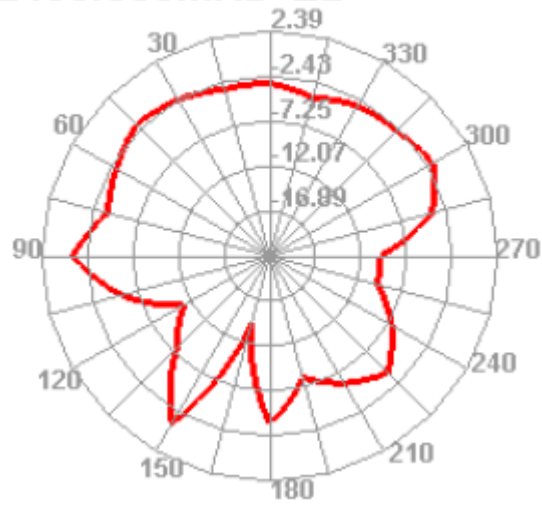

2500.000MHz H

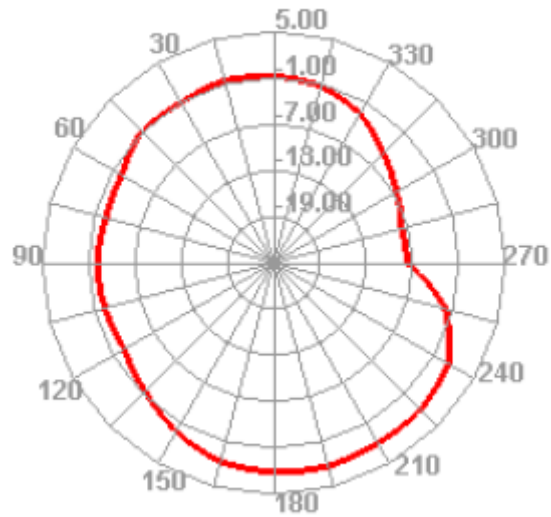

2500.000MHz E1

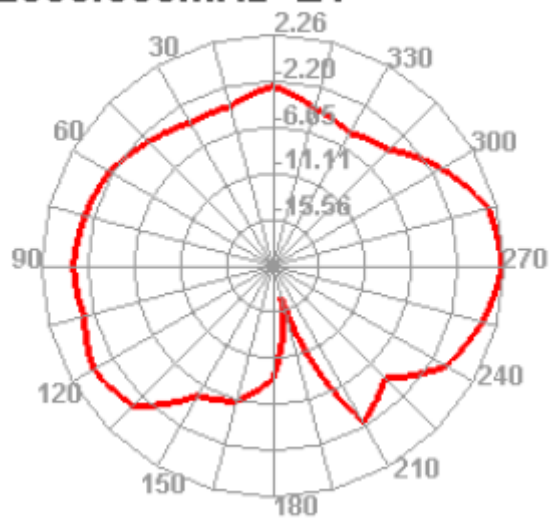

2500.000MHz E2

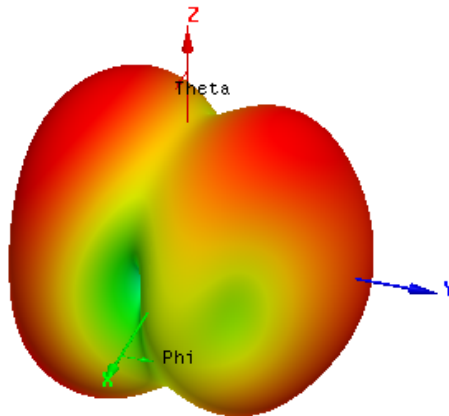
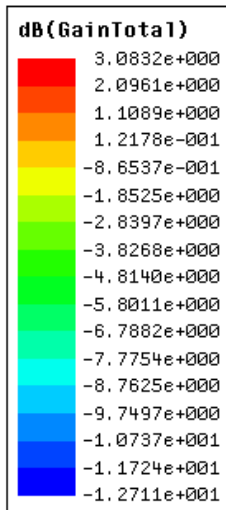
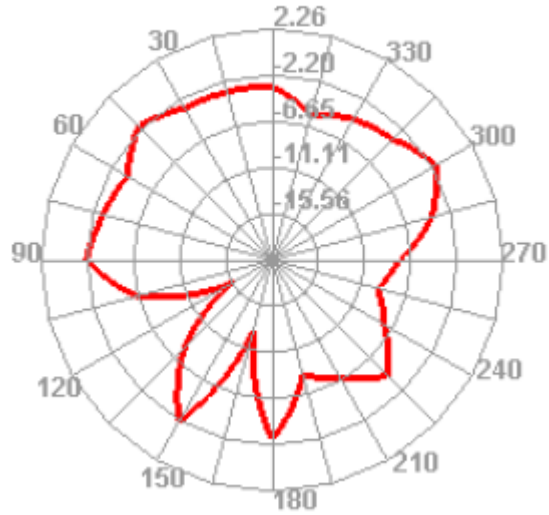

Frequency (MHz)	Gain(dB)		
	Max	Min	Avg
2400	0.589	-12.50	-7.44
2450	2.54	-13.88	-8.93
2500	2.59	-5.19	0.89

Manufacture: ZHUHAI JIELI TECHNOLOGY CO., LTD
 Address: ONE OF B SECTION, 3/F OF BUILDING A, NO. 9 PINGGONG WEST ROAD, NANPING TECHNOLOGY INDUSTRIAL PARK, ZHUHAI, CHINA