

RF TEST REPORT

For

Shenzhen Ugoos Technology Co., Ltd

Product Name: android tv box

Model(s): am8

Report Reference No. : POCE230819320HFR

FCC ID : 2AL8Y-AM8

Applicant's Name : Shenzhen Ugoos Technology Co., Ltd

Address : Room 6A, 6th Floor, Building A, Bao'an Square, Sun'gang Road, Luohu District, Shenzhen 518020, China

Testing Laboratory : Shenzhen POCE Technology Co., Ltd.

Address : 102 Building H1 & 1/F., Building H, Hongfa Science & Technology Park, Tangtou, Shiyan, Bao'an District, Shenzhen, Guangdong, China

Test Specification Standard : 47 CFR Part 15.247

Date of Receipt : August 17, 2023

Date of Test : August 17, 2023 to September 13, 2023

Data of Issue : September 13, 2023

Result : **Pass**

Note: This report shall not be reproduced except in full, without the written approval of Shenzhen POCE Technology Co., Ltd. This document may be altered or revised by Shenzhen POCE Technology Co., Ltd. personnel only, and shall be noted in the revision section of the document. The test results in the report only apply to the tested sample

Revision History Of Report

Version	Description	REPORT No.	Issue Date
V1.0	Original	POCE230819320HFR	September 13, 2023

NOTE1:

The manufacturer should ensure that all products in series production are in conformity with the product sample detailed in this report. If the product in this report is used in any configuration other than that detailed in the report, the manufacturer must ensure the new system complies with all relevant standards.

Compiled by:

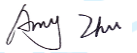

Amy Zhu / File administrators

Supervised by:

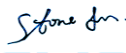

Stone Yin / Technique principal

Approved by:

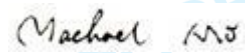

Machael Mo / Manager

CONTENTS

1 TEST SUMMARY	5
1.1 TEST STANDARDS.....	5
1.2 SUMMARY OF TEST RESULT	5
2 GENERAL INFORMATION	6
2.1 CLIENT INFORMATION.....	6
2.2 DESCRIPTION OF DEVICE (EUT)	6
2.3 DESCRIPTION OF TEST MODES	7
2.4 DESCRIPTION OF SUPPORT UNITS	7
2.5 EQUIPMENTS USED DURING THE TEST	8
2.6 STATEMENT OF THE MEASUREMENT UNCERTAINTY.....	10
2.7 IDENTIFICATION OF TESTING LABORATORY.....	10
2.8 ANNOUNCEMENT	10
3 EVALUATION RESULTS (EVALUATION).....	11
3.1 ANTENNA REQUIREMENT	11
4 RADIO SPECTRUM MATTER TEST RESULTS (RF).....	12
4.1 CONDUCTED EMISSION AT AC POWER LINE.....	12
4.1.1 E.U.T. Operation:.....	12
4.1.2 Test Setup Diagram:.....	12
4.1.3 Test Data:	13
4.2 OCCUPIED BANDWIDTH.....	15
4.2.1 E.U.T. Operation:.....	15
4.2.2 Test Setup Diagram:.....	16
4.2.3 Test Data:	16
4.3 MAXIMUM CONDUCTED OUTPUT POWER.....	17
4.3.1 E.U.T. Operation:.....	17
4.3.2 Test Setup Diagram:.....	17
4.3.3 Test Data:	17
4.4 CHANNEL SEPARATION	18
4.4.1 E.U.T. Operation:.....	18
4.4.2 Test Setup Diagram:.....	18
4.4.3 Test Data:	18
4.5 NUMBER OF HOPPING FREQUENCIES.....	19
4.5.1 E.U.T. Operation:.....	19
4.5.2 Test Setup Diagram:.....	19
4.5.3 Test Data:	19
4.6 DWELL TIME.....	21
4.6.1 E.U.T. Operation:.....	21
4.6.2 Test Setup Diagram:.....	22
4.6.3 Test Data:	22
4.7 EMISSIONS IN NON-RESTRICTED FREQUENCY BANDS.....	23
4.7.1 E.U.T. Operation:.....	23
4.7.2 Test Setup Diagram:.....	23
4.7.3 Test Data:	23
4.8 BAND EDGE EMISSIONS (RADIATED).....	24
4.8.1 E.U.T. Operation:.....	24
4.8.2 Test Setup Diagram:.....	24
4.8.3 Test Data:	25
4.9 EMISSIONS IN FREQUENCY BANDS (BELOW 1GHZ)	26
4.9.1 E.U.T. Operation:.....	26

4.9.2 Test Data:	27
4.10 EMISSIONS IN FREQUENCY BANDS (ABOVE 1GHz)	29
4.10.1 E.U.T. Operation:.....	29
4.10.2 Test Setup Diagram:.....	29
4.10.3 Test Data:	30
5 TEST SETUP PHOTOS	32
6 PHOTOS OF THE EUT	32
APPENDIX	33
1. -20dB BANDWIDTH	34
2. PEAK OUTPUT POWER	39
3. SPURIOUS EMISSIONS	44
4. BANDEDGE	53
5. CARRIER FREQUENCIES SEPARATION (HOPPING)	59
6. NUMBER OF HOPPING CHANNEL (HOPPING)	61
7. DWELL TIME (HOPPING)	63

1 TEST SUMMARY

1.1 Test Standards

The tests were performed according to following standards:

47 CFR Part 15.247: Operation within the bands 902-928 MHz, 2400-2483.5 MHz, and 5725-5850 MHz

1.2 Summary of Test Result

Item	Standard	Method	Requirement	Result
Antenna requirement	47 CFR Part 15.247		47 CFR 15.203	Pass
Conducted Emission at AC power line	47 CFR Part 15.247	ANSI C63.10-2013 section 6.2	47 CFR 15.207(a)	Pass
Occupied Bandwidth	47 CFR Part 15.247	ANSI C63.10-2013, section 7.8.7 KDB 558074 D01 15.247 Meas Guidance v05r02	47 CFR 15.215(c)	Pass
Maximum Conducted Output Power	47 CFR Part 15.247	ANSI C63.10-2013, section 7.8.5 KDB 558074 D01 15.247 Meas Guidance v05r02	47 CFR 15.247(b)(1)	Pass
Channel Separation	47 CFR Part 15.247	ANSI C63.10-2013, section 7.8.2 KDB 558074 D01 15.247 Meas Guidance v05r02	47 CFR 15.247(a)(1)	Pass
Number of Hopping Frequencies	47 CFR Part 15.247	ANSI C63.10-2013, section 7.8.3 KDB 558074 D01 15.247 Meas Guidance v05r02	47 CFR 15.247(a)(1)(iii)	Pass
Dwell Time	47 CFR Part 15.247	ANSI C63.10-2013, section 7.8.4 KDB 558074 D01 15.247 Meas Guidance v05r02	47 CFR 15.247(a)(1)(iii)	Pass
Emissions in non-restricted frequency bands	47 CFR Part 15.247	ANSI C63.10-2013 section 7.8.8 KDB 558074 D01 15.247 Meas Guidance v05r02	47 CFR 15.247(d)	Pass
Band edge emissions (Radiated)	47 CFR Part 15.247	ANSI C63.10-2013 section 6.10 KDB 558074 D01 15.247 Meas Guidance v05r02	47 CFR 15.247(d)	Pass
Emissions in frequency bands (below 1GHz)	47 CFR Part 15.247	ANSI C63.10-2013 section 6.6.4 KDB 558074 D01 15.247 Meas Guidance v05r02	47 CFR 15.247(d)	Pass
Emissions in frequency bands (above 1GHz)	47 CFR Part 15.247	ANSI C63.10-2013 section 6.6.4 KDB 558074 D01 15.247 Meas Guidance v05r02	47 CFR 15.247(d)	Pass

2 GENERAL INFORMATION

2.1 Client Information

Applicant's Name : Shenzhen Ugoos Technology Co., Ltd
Address : Room 6A, 6th Floor, Building A, Bao'an Square, Sun'gang Road, Luohu District, Shenzhen 518020, China

Manufacturer : Shenzhen Ugoos Technology Co., Ltd
Address : Room 6A, 6th Floor, Building A, Bao'an Square, Sun'gang Road, Luohu District, Shenzhen 518020, China

2.2 Description of Device (EUT)

Product Name:	android tv box
Model/Type reference:	am8
Series Model:	am8 pro,am8 plus,am8 max ,am8b plus,am8b pro
Model Difference:	The product has many models, only the model name is different, and the other parts such as the circuit principle, pcb and electrical structure are the same.
Trade Mark:	ugoos
Power Supply:	DC5V/3A;DC9.0V/2.22A;DC12.0/1.67A Power from Adapter
Power Adaptor:	MODEL:RPD20-01E INPOU:100-240V-50/60Hz 0.8A OUTPUT:DC5V/3A;DC9.0V/2.22A;DC12.0/1.67A 20.0W MAX
Operation Frequency:	2402MHz to 2480MHz
Number of Channels:	79
Modulation Type:	GFSK, $\pi/4$ DQPSK, 8DPSK
Antenna Type:	External
Antenna Gain:	3dBi
Hardware Version:	V1.0
Software Version:	V1.0

Operation Frequency each of channel							
Channel	Frequency	Channel	Frequency	Channel	Frequency	Channel	Frequency
1	2402MHz	21	2422MHz	41	2442MHz	61	2462MHz
2	2403MHz	22	2423MHz	42	2443MHz	62	2463MHz
3	2404MHz	23	2424MHz	43	2444MHz	63	2464MHz
4	2405MHz	24	2425MHz	44	2445MHz	64	2465MHz
5	2406MHz	25	2426MHz	45	2446MHz	65	2466MHz
6	2407MHz	26	2427MHz	46	2447MHz	66	2467MHz
7	2408MHz	27	2428MHz	47	2448MHz	67	2468MHz
8	2409MHz	28	2429MHz	48	2449MHz	68	2469MHz
9	2410MHz	29	2430MHz	49	2450MHz	69	2470MHz
10	2411MHz	30	2431MHz	50	2451MHz	70	2471MHz
11	2412MHz	31	2432MHz	51	2452MHz	71	2472MHz
12	2413MHz	32	2433MHz	52	2453MHz	72	2473MHz
13	2414MHz	33	2434MHz	53	2454MHz	73	2474MHz
14	2415MHz	34	2435MHz	54	2455MHz	74	2475MHz
15	2416MHz	35	2436MHz	55	2456MHz	75	2476MHz
16	2417MHz	36	2437MHz	56	2457MHz	76	2477MHz
17	2418MHz	37	2438MHz	57	2458MHz	77	2478MHz

18	2419MHz	38	2439MHz	58	2459MHz	78	2479MHz
19	2420MHz	39	2440MHz	59	2460MHz	79	2480MHz
20	2421MHz	40	2441MHz	60	2461MHz	61	2462MHz

Note:

In section 15.31(m), regards to the operating frequency range over 10 MHz, the Lowest frequency, the middle frequency, and the highest frequency of channel were selected to perform the test, and the selected channel see below:

Test channel	Frequency (MHz)
	BDR/EDR
Lowest channel	2402MHz
Middle channel	2441MHz
Highest channel	2480MHz

2.3 Description of Test Modes

No	Title	Description
TM1	TX-GFSK (Non-Hopping)	Keep the EUT in continuously transmitting mode (non-hopping) with GFSK modulation.
TM2	TX-Pi/4DQPSK (Non-Hopping)	Keep the EUT in continuously transmitting mode (non-hopping) with Pi/4DQPSK modulation.
TM3	TX-8DPSK (Non-Hopping)	Keep the EUT in continuously transmitting mode (non-hopping) with 8DPSK modulation.
TM4	TX-GFSK (Hopping)	Keep the EUT in continuously transmitting mode (hopping) with GFSK modulation.
TM5	TX-Pi/4DQPSK (Hopping)	Keep the EUT in continuously transmitting mode (hopping) with Pi/4DQPSK modulation.
TM6	TX-8DPSK (Hopping)	Keep the EUT in continuously transmitting mode (hopping) with 8DPSK modulation.

Remark: Only the data of the worst mode would be recorded in this report.

Title	Description
TX mode	Keep the EUT works in continuously transmitting mode with GFSK modulation.
	<input checked="" type="checkbox"/> Special software is used. <input type="checkbox"/> Through engineering command into the engineering mode. engineering command: <code>###3646633###</code> <input type="checkbox"/> Other method:
	Special software:

2.4 Description of Support Units

Title	Manufacturer	Model No.	Serial No.
PC	Lenovo	Air 14 Plus	
Display Screen			

2.5 Equipments Used During The Test

Conducted Emission at AC power line					
Equipment	Manufacturer	Model No	Inventory No	Cal Date	Cal Due Date
loop antenna	EVERFINE	LLA-2	80900L-C	2023-02-27	2024-02-26
Power absorbing clamp	SCHWARZ BECK	MESS-ELEKTRONIK	/	2023-02-28	2024-02-27
Electric Network	SCHWARZ BECK	CAT5 8158	CAT5 8158#207	/	/
Cable	SCHWARZ BECK	/	/	2022-12-27	2023-12-27
Pulse Limiter	SCHWARZ BECK	VTSD 9561-F Pulse limiter 10dB Ateennator	561-G071	2023-02-27	2024-02-26
50Ω Coaxial Switch	Anritsu	MP59B	M20531	/	/
Test Receiver	Rohde & Schwarz	ESPI TEST RECEIVER	ID:1164.6607K 03-102109-MH	2023-06-13	2024-06-12
L.I.S.N	R&S	ESH3-Z5	831.5518.52	2022-12-29	2023-12-28

Emissions in non-restricted frequency bands

Occupied Bandwidth

Maximum Conducted Output Power

Channel Separation

Number of Hopping Frequencies

Dwell Time

Equipment	Manufacturer	Model No	Inventory No	Cal Date	Cal Due Date
RF Test Software	TACHOY	RTS-01	V2.0.0.0	/	/
High Pass filter	ZHINAN	OQHPF1-M1.5-18G-224	6210075	/	/
Power divider	MIDWEST	PWD-2533	SMA-79	2023-05-11	2026-05-10
DC power	HP	66311B	38444359	/	/
RF Sensor Unit	Tachoy Information Technology (shenzhen) Co., Ltd.	TR1029-2	000001	/	/
Wideband radio communication tester	R&S	CMW500	113410	2023-06-13	2024-06-12
Vector signal generator	Keysight	N5181A	MY48180415	2022-12-10	2023-12-09
Signal generator	Keysight	N5182A	MY50143455	2022-12-29	2023-12-28
Spectrum Analyzer	Keysight	N9020A	MY53420323	2022-12-29	2023-12-28

Band edge emissions (Radiated)					
Emissions in frequency bands (below 1GHz)					
Emissions in frequency bands (above 1GHz)					
Equipment	Manufacturer	Model No	Inventory No	Cal Date	Cal Due Date
EMI Test software	Farad	EZ -EMC	V1.1.42	/	/
Positioning Controller	/	MF-7802	/	/	/
High Pass filter	ZHINAN	OQHPF1-M1.5-18G-224	6210075	/	/
Amplifier(18-40G)	COM-POWER	AH-1840	10100008-1	2022-04-05	2025-04-04
Horn antenna	COM-POWER	AH-1840 (18-40G)	10100008	2023-04-05	2025-04-04
Loop antenna	ZHINAN	ZN30900C	ZN30900C	2021-07-05	2024-07-04
Cable(LF)#2	Schwarzbeck	/	/	2023-02-27	2024-02-26
Cable(LF)#1	Schwarzbeck	/	/	2023-02-27	2024-02-26
Cable(HF)#2	Schwarzbeck	AK9515E	96250	2023-02-28	2024-02-27
Cable(HF)#1	Schwarzbeck	SYV-50-3-1	/	2023-02-27	2024-02-26
Power amplifier(LF)	Schwarzbeck	BBV9743	9743-151	2023-06-13	2024-06-12
Power amplifier(HF)	Schwarzbeck	BBV9718	9718-282	2023-06-13	2024-06-12
Wideband radio communication tester	R&S	CMW500	113410	2023-06-13	2024-06-12
Spectrum Analyzer	R&S	FSP30	1321.3008K40-101729-jR	2023-06-14	2024-06-13
Horn Antenna	Sunol Sciences	DRH-118	A091114	2023-05-13	2025-05-12
Broadband Antenna	Sunol Sciences	JB6 Antenna	A090414	2023-05-21	2025-05-20
Test Receiver	R&S	ESCI	102109	2023-06-13	2024-06-12

2.6 Statement Of The Measurement Uncertainty

Test Item	Measurement Uncertainty
Conducted Disturbance (0.15~30MHz)	±3.41dB
Occupied Bandwidth	±3.63%
RF power density	±0.234%
Radio Frequency	2×10 ⁻⁷
RF conducted power	±0.733dB
Duty cycle	±3.1%
Conducted Spurious emissions	±1.98dB
Radiated Emission (Above 1GHz)	±5.46dB
Radiated Emission (Below 1GHz)	±5.79dB
Note: (1) This uncertainty represents an expanded uncertainty expressed at approximately the 95% confidence level using a coverage factor of k=2.	

2.7 Identification of Testing Laboratory

Company Name:	Shenzhen POCE Technology Co., Ltd.
Address:	101-102 Building H5 & 1/F., Building H, Hongfa Science & Technology Park, Tangtou, Shiyan, Bao'an District, Shenzhen, Guangdong, China
Phone Number:	+86-13267178997
Fax Number:	86-755-29113252

Identification of the Responsible Testing Location

Company Name:	Shenzhen POCE Technology Co., Ltd.
Address:	101-102 Building H5 & 1/F., Building H, Hongfa Science & Technology Park, Tangtou, Shiyan, Bao'an District, Shenzhen, Guangdong, China
Phone Number:	+86-13267178997
Fax Number:	86-755-29113252
FCC Registration Number:	0032847402
Designation Number:	CN1342
Test Firm Registration No.:	778666
A2LA Certificate Number:	6270.01

2.8 Announcement

- (1) The test report reference to the report template version v0.
- (2) The test report is invalid if not marked with the signatures of the persons responsible for preparing, reviewing and approving the test report.
- (3) The test report is invalid if there is any evidence and/or falsification.
- (4) This document may not be altered or revised in any way unless done so by POCE and all revisions are duly noted in the revisions section.
- (5) Content of the test report, in part or in full, cannot be used for publicity and/or promotional purposes without prior written approval from the laboratory.
- (6) The laboratory is only responsible for the data released by the laboratory, except for the part provided by the applicant.

3 Evaluation Results (Evaluation)

3.1 Antenna requirement

Test Requirement:	Refer to 47 CFR Part 15.203, an intentional radiator shall be designed to ensure that no antenna other than that furnished by the responsible party shall be used with the device. The use of a permanently attached antenna or of an antenna that uses a unique coupling to the intentional radiator shall be considered sufficient to comply with the provisions of this section.
-------------------	-------------------------------------------------------------------------------------------------------------------------------------------------------------------------------------------------------------------------------------------------------------------------------------------------------------------------------------------------------------------------------------

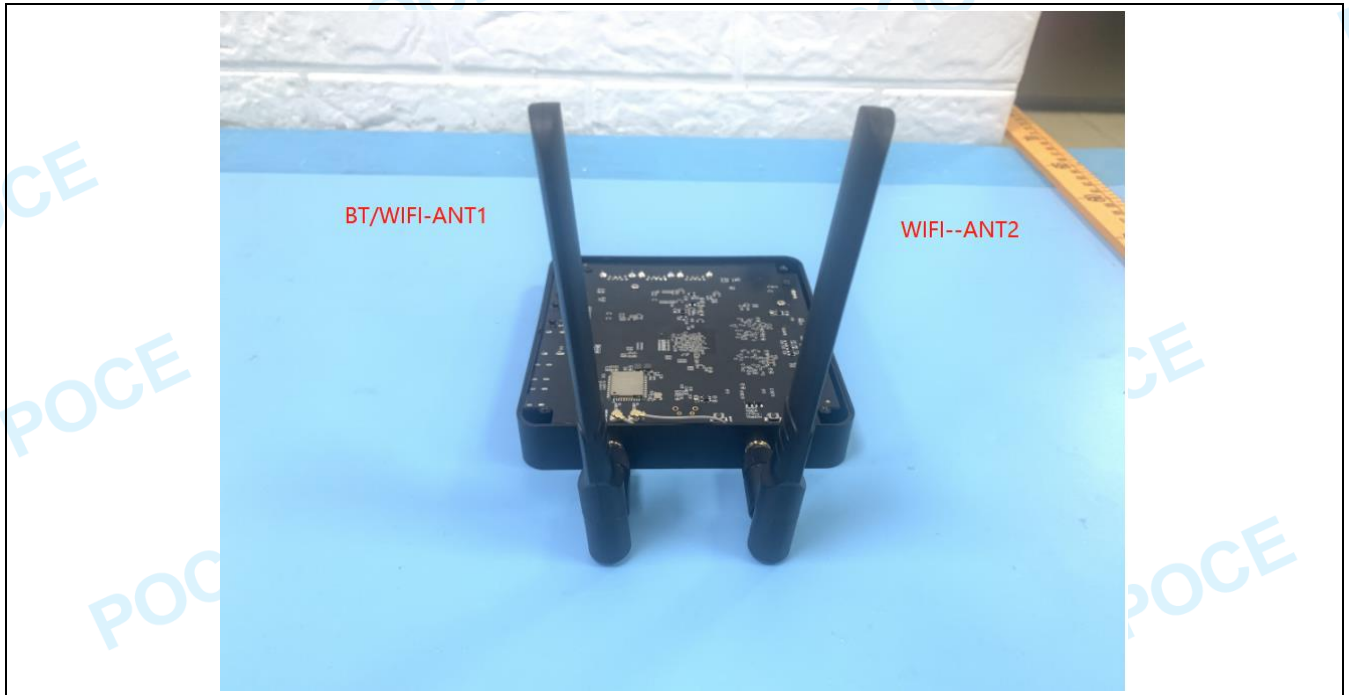

4 Radio Spectrum Matter Test Results (RF)

4.1 Conducted Emission at AC power line

Test Requirement:	Refer to 47 CFR 15.207(a), Except as shown in paragraphs (b) and (c) of this section, for an intentional radiator that is designed to be connected to the public utility (AC) power line, the radio frequency voltage that is conducted back onto the AC power line on any frequency or frequencies, within the band 150 kHz to 30 MHz, shall not exceed the limits in the following table, as measured using a 50 μ H/50 ohms line impedance stabilization network (LISN).		
Test Limit:	Frequency of emission (MHz)	Conducted limit (dB μ V)	
		Quasi-peak	Average
	0.15-0.5	66 to 56*	56 to 46*
	0.5-5	56	46
	5-30	60	50
*Decreases with the logarithm of the frequency.			
Test Method:	ANSI C63.10-2013 section 6.2		
Procedure:	Refer to ANSI C63.10-2013 section 6.2, standard test method for ac power-line conducted emissions from unlicensed wireless devices		

4.1.1 E.U.T. Operation:

Operating Environment:					
Temperature:	22.6 °C	Humidity:	53.6 %	Atmospheric Pressure:	102 kPa
Pre test mode:	TM1				
Final test mode:	TM1				

4.1.2 Test Setup Diagram:

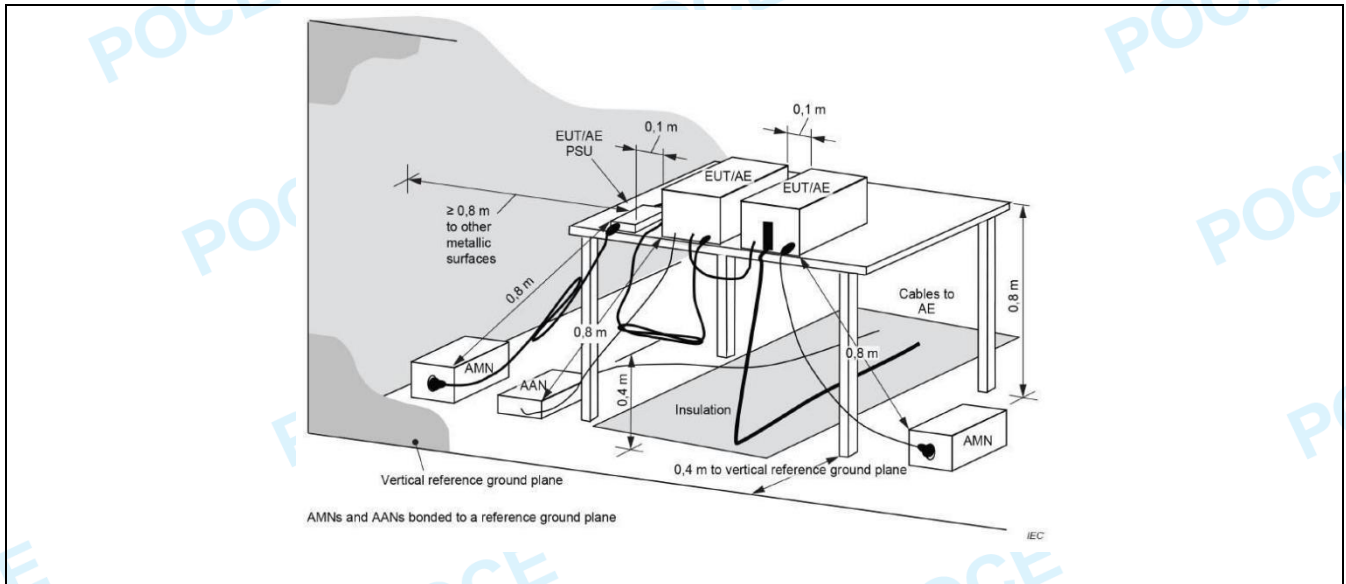

4.1.3 Test Data:

TM1 / Line: Line / Band: 2.4G / BW: 20 / CH: L

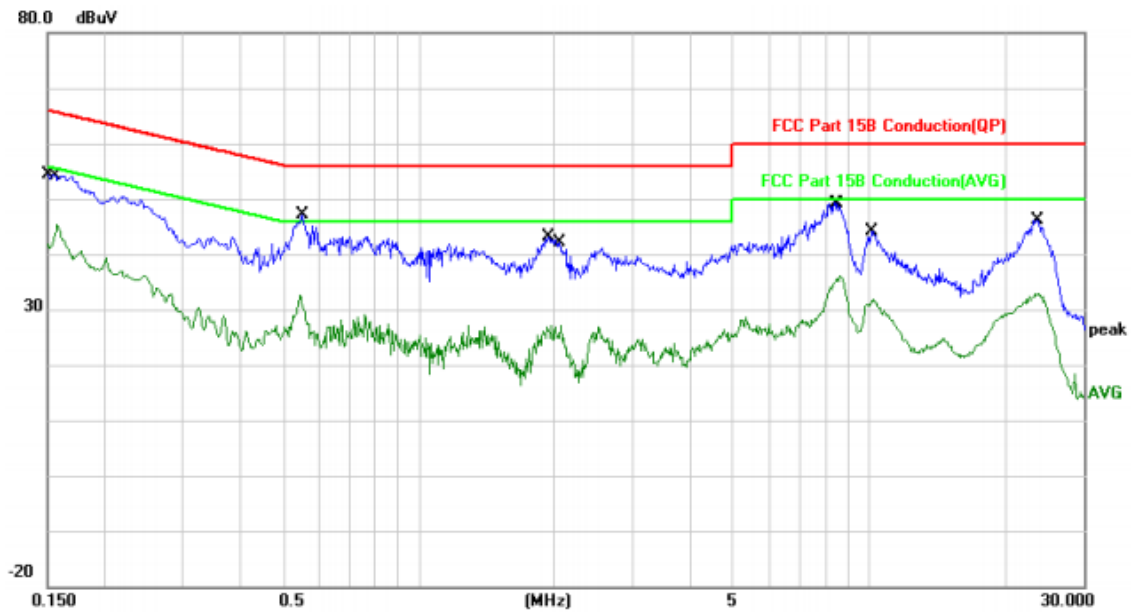

No. Mk.	Freq. MHz	Reading Level dBuV	Correct Factor dB	Measurement dBuV	Limit dBuV	Over dB	Detector	Comment
1	0.1507	44.21	10.20	54.41	65.96	-11.55	QP	
2	0.1580	35.10	10.19	45.29	55.56	-10.27	AVG	
3	0.5460	22.37	10.13	32.50	46.00	-13.50	AVG	
4 *	0.5540	36.98	10.13	47.11	56.00	-8.89	QP	
5	1.9460	33.05	10.09	43.14	56.00	-12.86	QP	
6	2.0700	16.98	10.11	27.09	46.00	-18.91	AVG	
7	8.5259	38.04	11.08	49.12	60.00	-10.88	QP	
8	8.6099	24.98	11.09	36.07	50.00	-13.93	AVG	
9	10.1618	32.81	11.37	44.18	60.00	-15.82	QP	
10	10.2219	20.54	11.38	31.92	50.00	-18.08	AVG	
11	23.7220	32.67	13.53	46.20	60.00	-13.80	QP	
12	23.9220	19.35	13.55	32.90	50.00	-17.10	AVG	

TM1 / Line: Line / Band: 2.4G / BW: 20 / CH: N

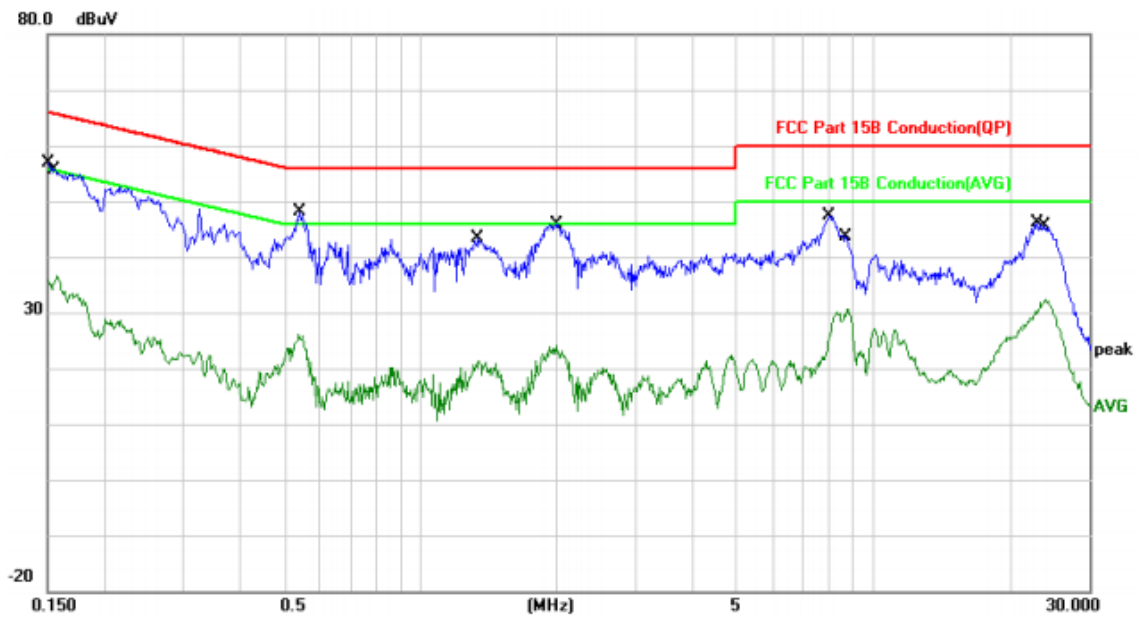

No.	Mk.	Freq. MHz	Reading Level dBuV	Correct Factor dB	Measure- ment dBuV	Limit dBuV	Over dB	Detector	Comment
1		0.1507	46.71	10.20	56.91	65.96	-9.05	QP	
2		0.1580	26.40	10.19	36.59	55.56	-18.97	AVG	
3		0.5380	15.91	10.13	26.04	46.00	-19.96	AVG	
4	*	0.5420	38.11	10.13	48.24	56.00	-7.76	QP	
5		1.3420	33.25	10.06	43.31	56.00	-12.69	QP	
6		1.3500	11.42	10.06	21.48	46.00	-24.52	AVG	
7		1.9940	14.07	10.09	24.16	46.00	-21.84	AVG	
8		2.0100	35.84	10.10	45.94	56.00	-10.06	QP	
9		8.0099	36.41	10.99	47.40	60.00	-12.60	QP	
10		8.7858	19.61	11.13	30.74	50.00	-19.26	AVG	
11		23.0220	32.74	13.45	46.19	60.00	-13.81	QP	
12		24.0860	18.77	13.57	32.34	50.00	-17.66	AVG	

1. An initial pre-scan was performed on the line and neutral lines with peak detector.
2. Quasi-Peak and Average measurement were performed at the frequencies with maximized peak emission.
3. Measurement Level = Reading level + Correct Factor, Over=Limit- Measurement

4.2 Occupied Bandwidth

Test Requirement:	47 CFR 15.215(c)
Test Limit:	Refer to 47 CFR 15.215(c), intentional radiators operating under the alternative provisions to the general emission limits, as contained in §§ 15.217 through 15.257 and in subpart E of this part, must be designed to ensure that the 20 dB bandwidth of the emission, or whatever bandwidth may otherwise be specified in the specific rule section under which the equipment operates, is contained within the frequency band designated in the rule section under which the equipment is operated.
Test Method:	ANSI C63.10-2013, section 7.8.7, For occupied bandwidth measurements, use the procedure in 6.9.2. KDB 558074 D01 15.247 Meas Guidance v05r02
Procedure:	<p>a) The spectrum analyzer center frequency is set to the nominal EUT channel center frequency. The span range for the EMI receiver or spectrum analyzer shall be between two times and five times the OBW.</p> <p>b) The nominal IF filter bandwidth (3 dB RBW) shall be in the range of 1% to 5% of the OBW and video bandwidth (VBW) shall be approximately three times RBW, unless otherwise specified by the applicable requirement.</p> <p>c) Set the reference level of the instrument as required, keeping the signal from exceeding the maximum input mixer level for linear operation. In general, the peak of the spectral envelope shall be more than $[10 \log (OBW/RBW)]$ below the reference level. Specific guidance is given in 4.1.5.2.</p> <p>d) Steps a) through c) might require iteration to adjust within the specified tolerances.</p> <p>e) The dynamic range of the instrument at the selected RBW shall be more than 10 dB below the target “-xx dB down” requirement; that is, if the requirement calls for measuring the -20 dB OBW, the instrument noise floor at the selected RBW shall be at least 30 dB below the reference value.</p> <p>f) Set detection mode to peak and trace mode to max hold.</p> <p>g) Determine the reference value: Set the EUT to transmit an unmodulated carrier or modulated signal, as applicable. Allow the trace to stabilize. Set the spectrum analyzer marker to the highest level of the displayed trace (this is the reference value).</p> <p>h) Determine the “-xx dB down amplitude” using $[(\text{reference value}) - xx]$. Alternatively, this calculation may be made by using the marker-delta function of the instrument.</p> <p>i) If the reference value is determined by an unmodulated carrier, then turn the EUT modulation ON, and either clear the existing trace or start a new trace on the spectrum analyzer and allow the new trace to stabilize. Otherwise, the trace from step g) shall be used for step j).</p> <p>j) Place two markers, one at the lowest frequency and the other at the highest frequency of the envelope of the spectral display, such that each marker is at or slightly below the “-xx dB down amplitude” determined in step h). If a marker is below this “-xx dB down amplitude” value, then it shall be as close as possible to this value. The occupied bandwidth is the frequency difference between the two markers. Alternatively, set a marker at the lowest frequency of the envelope of the spectral display, such that the marker is at or slightly below the “-xx dB down amplitude” determined in step h). Reset the marker-delta function and move the marker to the other side of the emission until the delta marker amplitude is at the same level as the reference marker amplitude. The marker-delta frequency reading at this point is the specified emission bandwidth.</p> <p>k) The occupied bandwidth shall be reported by providing plot(s) of the measuring instrument display; the plot axes and the scale units per division shall be clearly labeled. Tabular data may be reported in addition to the plot(s).</p>

4.2.1 E.U.T. Operation:

Operating Environment:					
Temperature:	22.6 °C	Humidity:	53.6 %	Atmospheric Pressure:	102 kPa

Pre test mode:	TM1, TM2, TM3
Final test mode:	TM1, TM2, TM3

4.2.2 Test Setup Diagram:

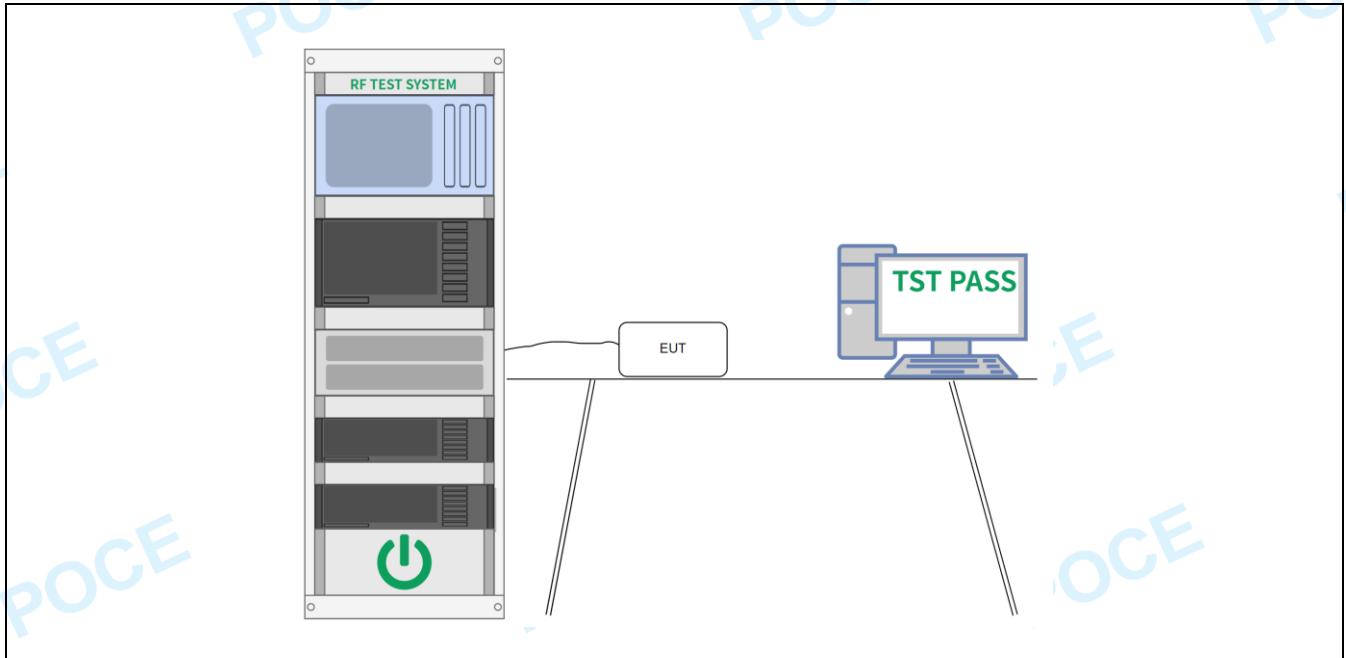

4.2.3 Test Data:

Please Refer to Appendix for Details.

4.3 Maximum Conducted Output Power

Test Requirement:	47 CFR 15.247(b)(1)
Test Limit:	Refer to 47 CFR 15.247(b)(1), For frequency hopping systems operating in the 2400-2483.5 MHz band employing at least 75 non-overlapping hopping channels, and all frequency hopping systems in the 5725-5850 MHz band: 1 watt. For all other frequency hopping systems in the 2400-2483.5 MHz band: 0.125 watts.
Test Method:	ANSI C63.10-2013, section 7.8.5 KDB 558074 D01 15.247 Meas Guidance v05r02
Procedure:	<p>This is an RF-conducted test to evaluate maximum peak output power. Use a direct connection between the antenna port of the unlicensed wireless device and the spectrum analyzer, through suitable attenuation. The hopping shall be disabled for this test:</p> <ol style="list-style-type: none"> a) Use the following spectrum analyzer settings: <ol style="list-style-type: none"> 1) Span: Approximately five times the 20 dB bandwidth, centered on a hopping channel. 2) RBW > 20 dB bandwidth of the emission being measured. 3) VBW >= RBW. 4) Sweep: Auto. 5) Detector function: Peak. 6) Trace: Max hold. b) Allow trace to stabilize. c) Use the marker-to-peak function to set the marker to the peak of the emission. d) The indicated level is the peak output power, after any corrections for external attenuators and cables. e) A plot of the test results and setup description shall be included in the test report. <p>NOTE—A peak responding power meter may be used, where the power meter and sensor system video bandwidth is greater than the occupied bandwidth of the unlicensed wireless device, rather than a spectrum analyzer.</p>

4.3.1 E.U.T. Operation:

Operating Environment:					
Temperature:	22.6 °C	Humidity:	53.6 %	Atmospheric Pressure:	102 kPa
Pre test mode:	TM1, TM2, TM3				
Final test mode:	TM1, TM2, TM3				

4.3.2 Test Setup Diagram:

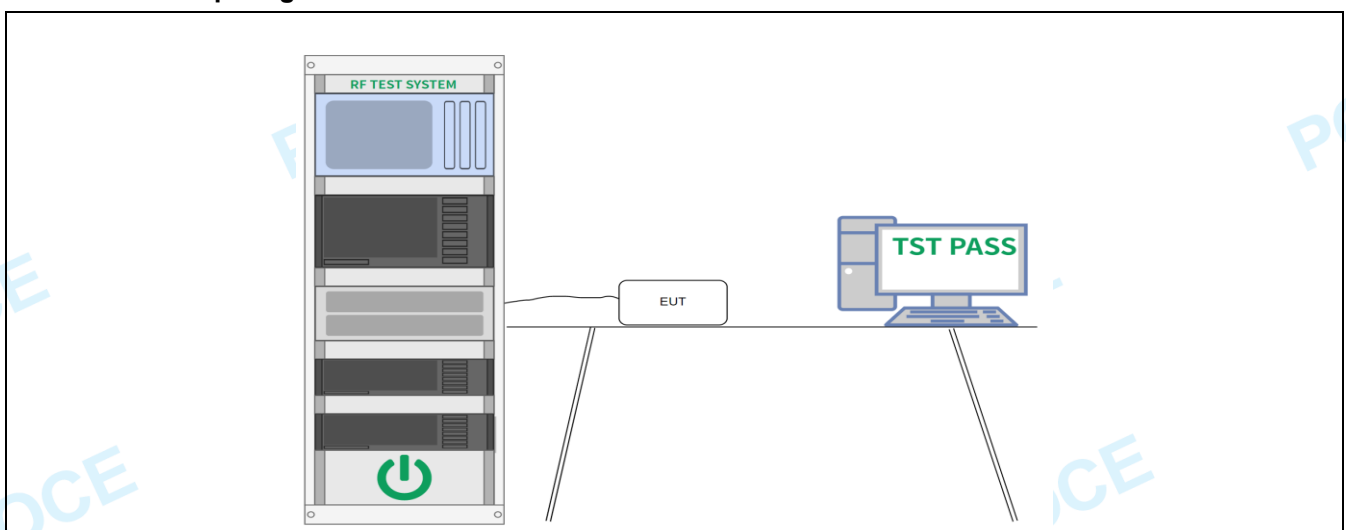

4.3.3 Test Data:

Please Refer to Appendix for Details.

4.4 Channel Separation

Test Requirement:	47 CFR 15.247(a)(1)
Test Limit:	Refer to 47 CFR 15.247(a)(1), Frequency hopping systems shall have hopping channel carrier frequencies separated by a minimum of 25 kHz or the 20 dB bandwidth of the hopping channel, whichever is greater. Alternatively, frequency hopping systems operating in the 2400-2483.5 MHz band may have hopping channel carrier frequencies that are separated by 25 kHz or two-thirds of the 20 dB bandwidth of the hopping channel, whichever is greater, provided the systems operate with an output power no greater than 125 mW.
Test Method:	ANSI C63.10-2013, section 7.8.2 KDB 558074 D01 15.247 Meas Guidance v05r02
Procedure:	The EUT shall have its hopping function enabled. Use the following spectrum analyzer settings: a) Span: Wide enough to capture the peaks of two adjacent channels. b) RBW: Start with the RBW set to approximately 30% of the channel spacing; adjust as necessary to best identify the center of each individual channel. c) Video (or average) bandwidth (VBW) ≥ RBW. d) Sweep: Auto. e) Detector function: Peak. f) Trace: Max hold. g) Allow the trace to stabilize. Use the marker-delta function to determine the separation between the peaks of the adjacent channels. Compliance of an EUT with the appropriate regulatory limit shall be determined. A plot of the data shall be included in the test report.

4.4.1 E.U.T. Operation:

Operating Environment:					
Temperature:	22.6 °C	Humidity:	53.6 %	Atmospheric Pressure:	102 kPa
Pre test mode:	TM4, TM5, TM6				
Final test mode:	TM4, TM5, TM6				

4.4.2 Test Setup Diagram:

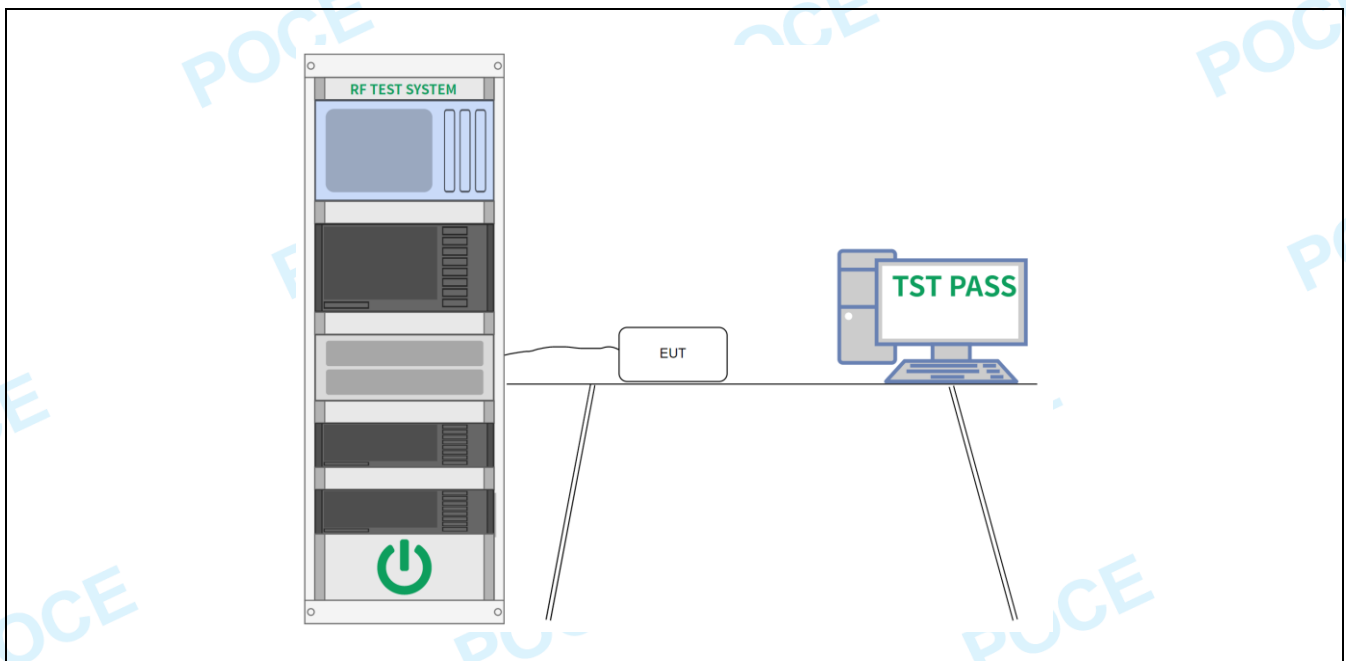

4.4.3 Test Data:

Please Refer to Appendix for Details.

4.5 Number of Hopping Frequencies

Test Requirement:	47 CFR 15.247(a)(1)(iii)
Test Limit:	Refer to 47 CFR 15.247(a)(1)(iii), Frequency hopping systems in the 2400-2483.5 MHz band shall use at least 15 channels. The average time of occupancy on any channel shall not be greater than 0.4 seconds within a period of 0.4 seconds multiplied by the number of hopping channels employed. Frequency hopping systems may avoid or suppress transmissions on a particular hopping frequency provided that a minimum of 15 channels are used.
Test Method:	ANSI C63.10-2013, section 7.8.3 KDB 558074 D01 15.247 Meas Guidance v05r02
Procedure:	The EUT shall have its hopping function enabled. Use the following spectrum analyzer settings: a) Span: The frequency band of operation. Depending on the number of channels the device supports, it may be necessary to divide the frequency range of operation across multiple spans, to allow the individual channels to be clearly seen. b) RBW: To identify clearly the individual channels, set the RBW to less than 30% of the channel spacing or the 20 dB bandwidth, whichever is smaller. c) VBW \geq RBW. d) Sweep: Auto. e) Detector function: Peak. f) Trace: Max hold. g) Allow the trace to stabilize. It might prove necessary to break the span up into subranges to show clearly all of the hopping frequencies. Compliance of an EUT with the appropriate regulatory limit shall be determined for the number of hopping channels. A plot of the data shall be included in the test report.

4.5.1 E.U.T. Operation:

Operating Environment:					
Temperature:	22.6 °C	Humidity:	53.6 %	Atmospheric Pressure:	102 kPa
Pre test mode:	TM4, TM5, TM6				
Final test mode:	TM4, TM5, TM6				

4.5.2 Test Setup Diagram:

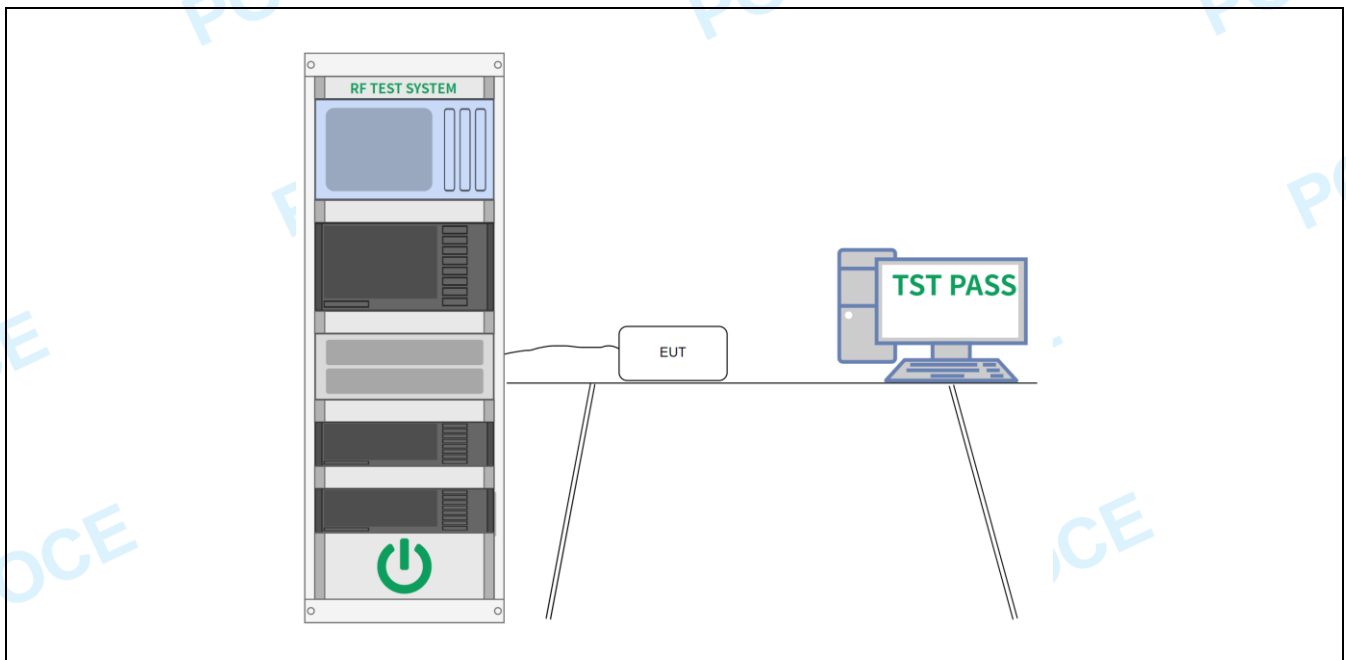

4.5.3 Test Data:

Please Refer to Appendix for Details.

4.6 Dwell Time

Test Requirement:	47 CFR 15.247(a)(1)(iii)
Test Limit:	Refer to 47 CFR 15.247(a)(1)(iii), Frequency hopping systems in the 2400-2483.5 MHz band shall use at least 15 channels. The average time of occupancy on any channel shall not be greater than 0.4 seconds within a period of 0.4 seconds multiplied by the number of hopping channels employed. Frequency hopping systems may avoid or suppress transmissions on a particular hopping frequency provided that a minimum of 15 channels are used.
Test Method:	ANSI C63.10-2013, section 7.8.4 KDB 558074 D01 15.247 Meas Guidance v05r02
Procedure:	<p>The EUT shall have its hopping function enabled. Use the following spectrum analyzer settings:</p> <ul style="list-style-type: none"> a) Span: Zero span, centered on a hopping channel. b) RBW shall be \leq channel spacing and where possible RBW should be set $\gg 1 / T$, where T is the expected dwell time per channel. c) Sweep: As necessary to capture the entire dwell time per hopping channel; where possible use a video trigger and trigger delay so that the transmitted signal starts a little to the right of the start of the plot. The trigger level might need slight adjustment to prevent triggering when the system hops on an adjacent channel; a second plot might be needed with a longer sweep time to show two successive hops on a channel. d) Detector function: Peak. e) Trace: Max hold. <p>Use the marker-delta function to determine the transmit time per hop. If this value varies with different modes of operation (data rate, modulation format, number of hopping channels, etc.), then repeat this test for each variation in transmit time.</p> <p>Repeat the measurement using a longer sweep time to determine the number of hops over the period specified in the requirements. The sweep time shall be equal to, or less than, the period specified in the requirements. Determine the number of hops over the sweep time and calculate the total number of hops in the period specified in the requirements, using the following equation:</p> $(\text{Number of hops in the period specified in the requirements}) = (\text{number of hops on spectrum analyzer}) \times (\text{period specified in the requirements} / \text{analyzer sweep time})$ <p>The average time of occupancy is calculated from the transmit time per hop multiplied by the number of hops in the period specified in the requirements. If the number of hops in a specific time varies with different modes of operation (data rate, modulation format, number of hopping channels, etc.), then repeat this test for each variation.</p> <p>The measured transmit time and time between hops shall be consistent with the values described in the operational description for the EUT.</p>

4.6.1 E.U.T. Operation:

Operating Environment:					
Temperature:	22.6 °C	Humidity:	53.6 %	Atmospheric Pressure:	102 kPa
Pre test mode:	TM4, TM5, TM6				
Final test mode:	TM4, TM5, TM6				

4.6.2 Test Setup Diagram:

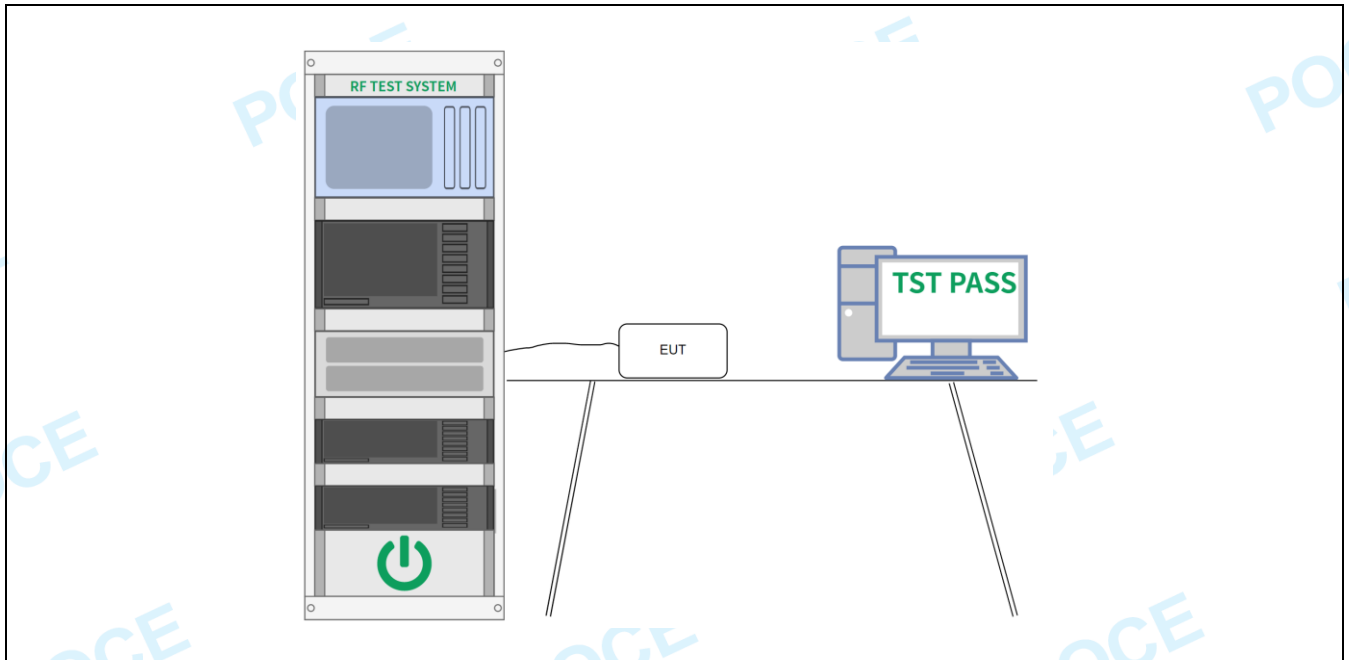

4.6.3 Test Data:

Please Refer to Appendix for Details.

4.7 Emissions in non-restricted frequency bands

Test Requirement:	47 CFR 15.247(d)
Test Limit:	Refer to 47 CFR 15.247(d), In any 100 kHz bandwidth outside the frequency band in which the spread spectrum or digitally modulated intentional radiator is operating, the radio frequency power that is produced by the intentional radiator shall be at least 20 dB below that in the 100 kHz bandwidth within the band that contains the highest level of the desired power, based on either an RF conducted or a radiated measurement, provided the transmitter demonstrates compliance with the peak conducted power limits. If the transmitter complies with the conducted power limits based on the use of RMS averaging over a time interval, as permitted under paragraph (b)(3) of this section, the attenuation required under this paragraph shall be 30 dB instead of 20 dB. Attenuation below the general limits specified in § 15.209(a) is not required.
Test Method:	ANSI C63.10-2013 section 7.8.8 KDB 558074 D01 15.247 Meas Guidance v05r02
Procedure:	Conducted spurious emissions shall be measured for the transmit frequency, per 5.5 and 5.6, and at the maximum transmit powers. Connect the primary antenna port through an attenuator to the spectrum analyzer input; in the results, account for all losses between the unlicensed wireless device output and the spectrum analyzer. The instrument shall span 30 MHz to 10 times the operating frequency in GHz, with a resolution bandwidth of 100 kHz, video bandwidth of 300 kHz, and a coupled sweep time with a peak detector. The band 30 MHz to the highest frequency may be split into smaller spans, as long as the entire spectrum is covered.

4.7.1 E.U.T. Operation:

Operating Environment:					
Temperature:	22.6 °C	Humidity:	53.6 %	Atmospheric Pressure:	102 kPa
Pre test mode:	TM1, TM2, TM3, TM4, TM5, TM6				
Final test mode:	TM1, TM2, TM3, TM4, TM5, TM6				

4.7.2 Test Setup Diagram:

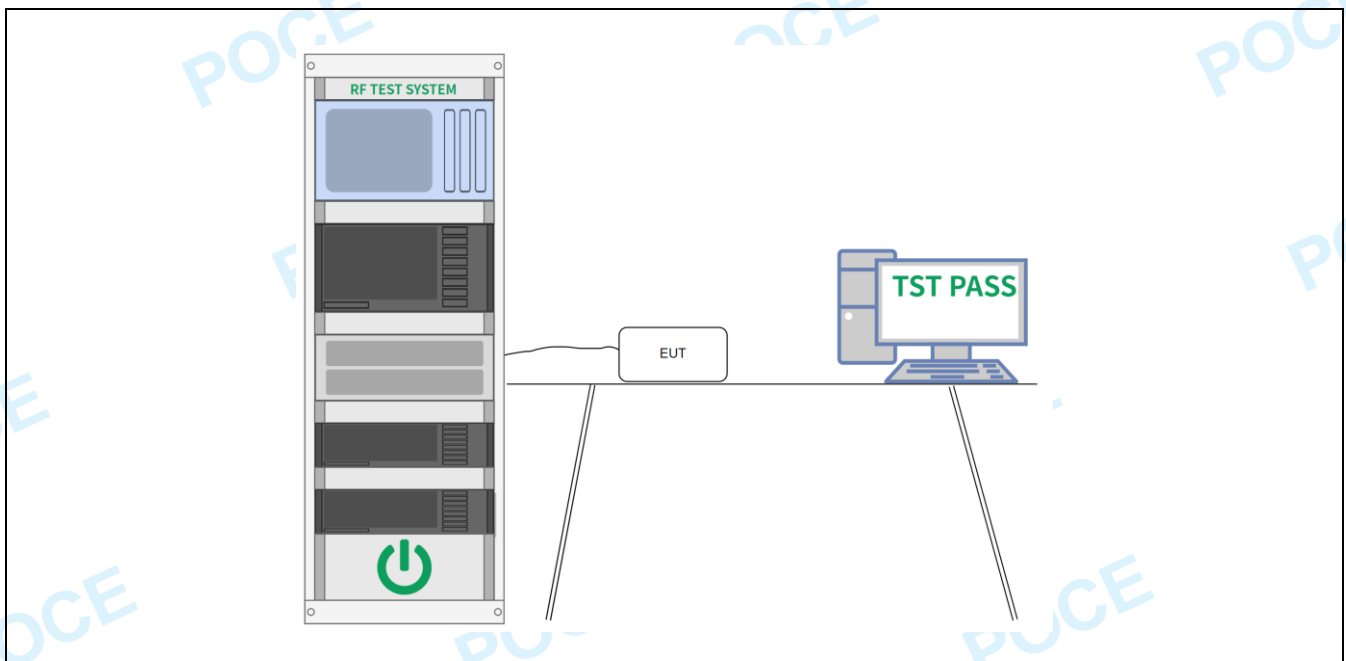

4.7.3 Test Data:

Please Refer to Appendix for Details.

4.8 Band edge emissions (Radiated)

Test Requirement:	Refer to 47 CFR 15.247(d), In addition, radiated emissions which fall in the restricted bands, as defined in § 15.205(a), must also comply with the radiated emission limits specified in § 15.209(a)(see § 15.205(c)).		
Test Limit:	Frequency (MHz)	Field strength (microvolts/meter)	Measurement distance (meters)
	0.009-0.490	2400/F(kHz)	300
	0.490-1.705	24000/F(kHz)	30
	1.705-30.0	30	30
	30-88	100 **	3
	88-216	150 **	3
	216-960	200 **	3
	Above 960	500	3
** Except as provided in paragraph (g), fundamental emissions from intentional radiators operating under this section shall not be located in the frequency bands 54-72 MHz, 76-88 MHz, 174-216 MHz or 470-806 MHz. However, operation within these frequency bands is permitted under other sections of this part, e.g., §§ 15.231 and 15.241.			
Test Method:	ANSI C63.10-2013 section 6.10 KDB 558074 D01 15.247 Meas Guidance v05r02		
Procedure:	ANSI C63.10-2013 section 6.10.5.2		

4.8.1 E.U.T. Operation:

Operating Environment:					
Temperature:	22.6 °C	Humidity:	53.6 %	Atmospheric Pressure:	102 kPa
Pre test mode:	TM1, TM2, TM3				
Final test mode:	TM1, TM2, TM3				

4.8.2 Test Setup Diagram:

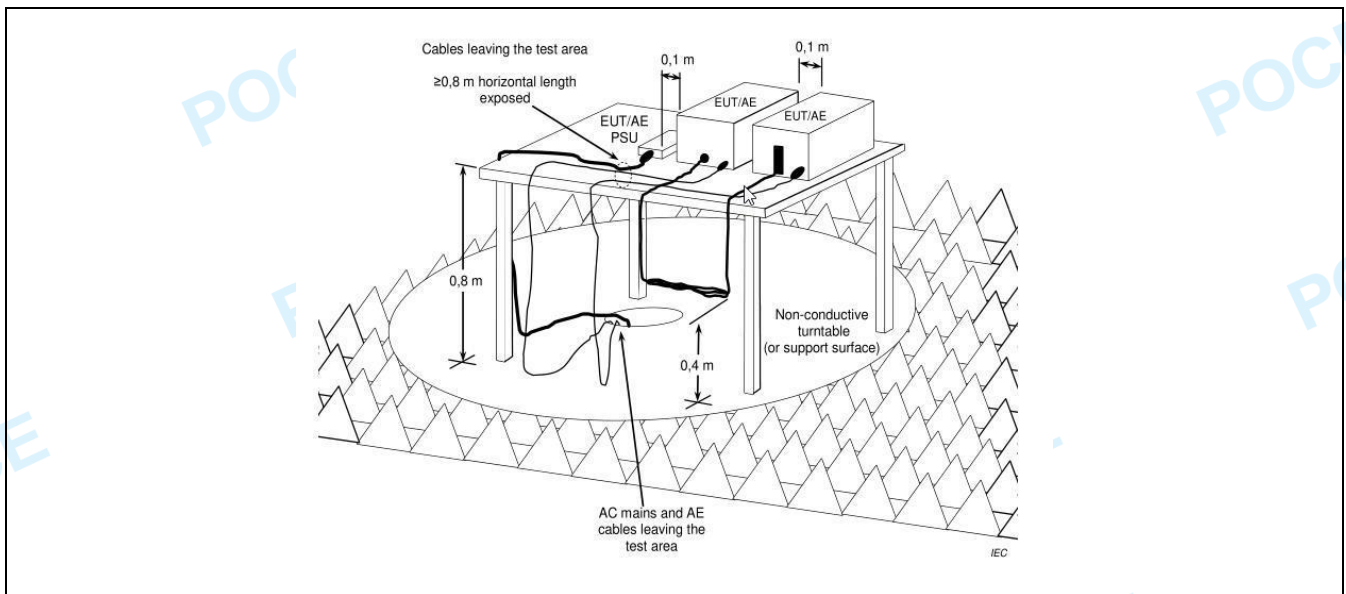

4.8.3 Test Data:

Frequency (MHz)	Meter Reading (dBμV)	Factor (dB)	Emission Level (dBμV/m)	Limits (dBμV/m)	Over (dB)	Detector Type	Ant. Pol. H/V
2310	58.38	-6.93	51.45	74	-22.55	peak	H
2310	45.87	-6.93	38.94	54	-15.06	AVG	H
2390	61.83	-6.72	55.11	74	-18.89	peak	H
2390	47.53	-6.72	40.81	54	-13.19	AVG	H
2310	58.05	-6.93	51.12	74	-22.88	peak	V
2310	45.46	-6.93	38.53	54	-15.47	AVG	V
2390	64.39	-6.72	57.67	74	-16.33	peak	V
2390	49.01	-6.72	42.29	54	-11.71	AVG	V

Frequency (MHz)	Meter Reading (dBμV)	Factor (dB)	Emission Level (dBμV/m)	Limits (dBμV/m)	Over (dB)	Detector Type	Ant. Pol. H/V
2483.5	59.11	-6.47	52.64	74	-21.36	peak	H
2483.5	44.57	-6.47	38.10	54	-15.90	AVG	H
2500	63.63	-6.43	57.20	74	-16.80	peak	H
2500	48.42	-6.43	41.99	54	-12.01	AVG	H
2483.5	57.25	-6.47	50.78	74	-23.22	peak	V
2483.5	45.73	-6.47	39.26	54	-14.74	AVG	V
2500	65.00	-6.43	58.57	74	-15.43	peak	V
2500	47.46	-6.43	41.03	54	-12.97	AVG	V

Remark:

- 1.Quasi-Peak and Average measurement were performed at the frequencies with maximized peak emission.
- 2.Measurement Level = Reading level + Correct Factor, Over=Limit- Measurement
Correction Factor= Antenna Factor + Cable loss – Pre-amplifier
- 3.The test data shows only the worst case(TX-GFSK (Non-Hopping))

4.9 Emissions in frequency bands (below 1GHz)

Test Requirement:	Refer to 47 CFR 15.247(d), In addition, radiated emissions which fall in the restricted bands, as defined in § 15.205(a), must also comply with the radiated emission limits specified in § 15.209(a)(see § 15.205(c)).		
Test Limit:	Frequency (MHz)	Field strength (microvolts/meter)	Measurement distance (meters)
	0.009-0.490	2400/F(kHz)	300
	0.490-1.705	24000/F(kHz)	30
	1.705-30.0	30	30
	30-88	100 **	3
	88-216	150 **	3
	216-960	200 **	3
	Above 960	500	3
** Except as provided in paragraph (g), fundamental emissions from intentional radiators operating under this section shall not be located in the frequency bands 54-72 MHz, 76-88 MHz, 174-216 MHz or 470-806 MHz. However, operation within these frequency bands is permitted under other sections of this part, e.g., §§ 15.231 and 15.241.			
Test Method:	ANSI C63.10-2013 section 6.6.4 KDB 558074 D01 15.247 Meas Guidance v05r02		
Procedure:	ANSI C63.10-2013 section 6.6.4		

4.9.1 E.U.T. Operation:

Operating Environment:					
Temperature:	22.6 °C	Humidity:	53.6 %	Atmospheric Pressure:	102 kPa
Pre test mode:	TM1				
Final test mode:	TM1				

4.9.2 Test Data:

Between 9KHz – 30MHz

The emission from 9 kHz to 30MHz was pre-tested and found the result was 20dB lower than the limit, and according to 15.31(o) & RSS-Gen 6.13, the test result no need to reported.

TM1 / Polarization: Horizontal / Band: 2.4G / BW: 1 / CH: L

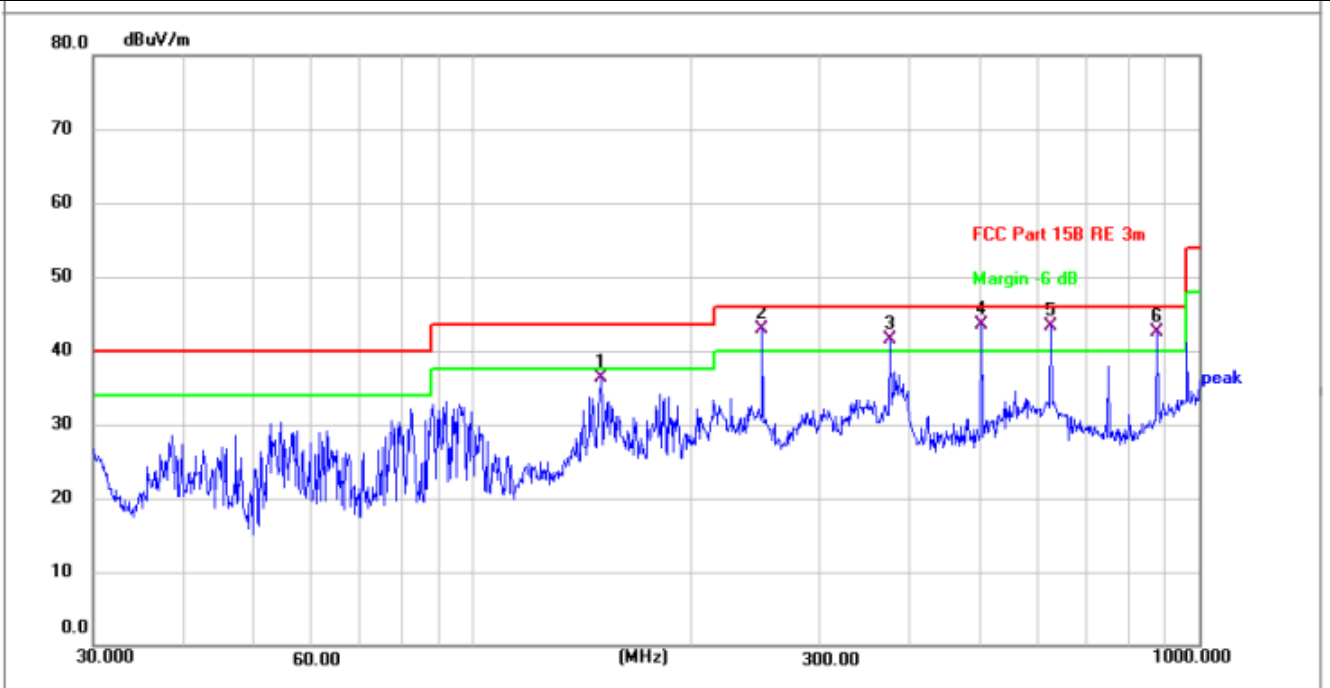

No.	Frequency (MHz)	Reading (dBuV)	Factor (dB/m)	Level (dBuV/m)	Limit (dBuV/m)	Margin (dB)	Detector	Height (cm)	Azimuth (deg.)	P/F	Remark
1	150.0108	39.95	-3.73	36.22	43.50	-7.28	QP	100	241	P	
2 !	250.3011	45.03	-2.11	42.92	46.00	-3.08	QP	100	360	P	
3 !	375.9385	40.36	1.08	41.44	46.00	-4.56	QP	100	259	P	
4 *	501.1790	41.51	1.91	43.42	46.00	-2.58	QP	100	351	P	
5 !	625.0780	38.80	4.43	43.23	46.00	-2.77	QP	100	58	P	
6 !	875.2470	35.51	7.00	42.51	46.00	-3.49	QP	100	127	P	

TM1 / Polarization: Vertical / Band: 2.4G / BW: 1 / CH: L

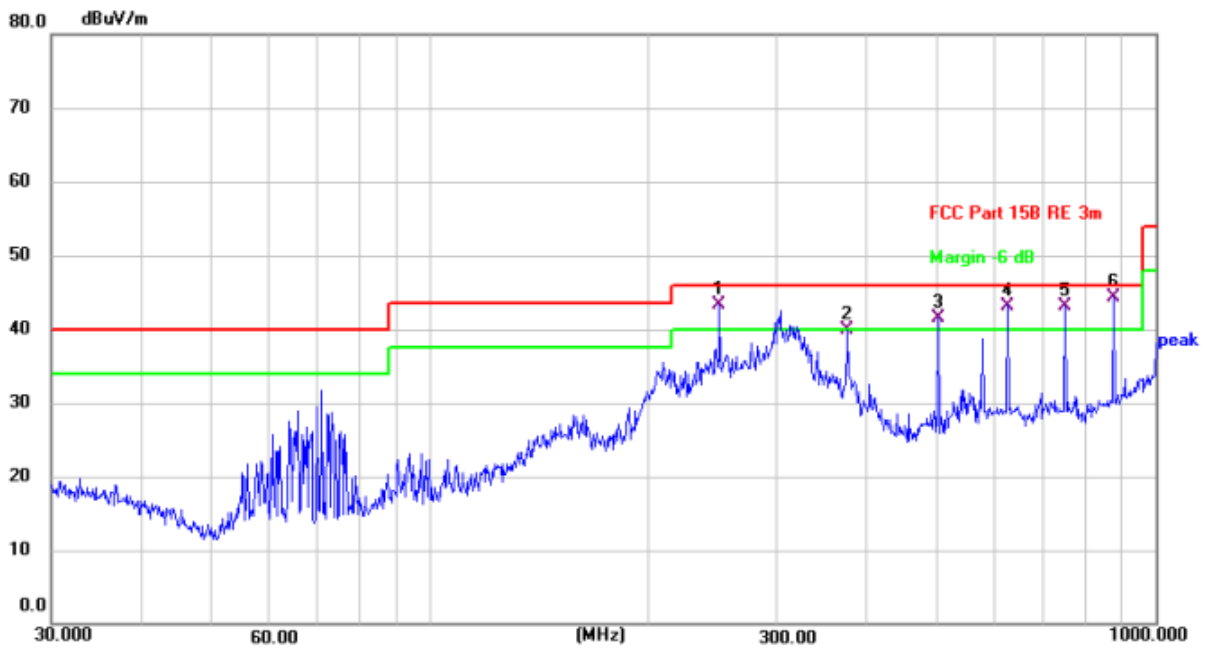

No.	Frequency (MHz)	Reading (dBuV)	Factor (dB/m)	Level (dBuV/m)	Limit (dBuV/m)	Margin (dB)	Detector	Height (cm)	Azimuth (deg.)	P/F	Remark
1 !	250.3011	45.40	-2.10	43.30	46.00	-2.70	QP	100	245	P	
2	375.9385	38.27	1.56	39.83	46.00	-6.17	QP	100	351	P	
3 !	501.1790	39.65	1.91	41.56	46.00	-4.44	QP	100	298	P	
4 !	625.0780	39.52	3.68	43.20	46.00	-2.80	QP	100	157	P	
5 !	750.1082	37.38	5.80	43.18	46.00	-2.82	QP	100	26	P	
6 *	875.2470	37.09	7.31	44.40	46.00	-1.60	QP	100	352	P	

Remark:

- 1.Quasi-Peak and Average measurement were performed at the frequencies with maximized peak emission.
- 2.Measurement Level = Reading level + Correct Factor, Over=Limit- Measurement
Correction Factor= Antenna Factor + Cable loss – Pre-amplifier
- 3.The test data shows only the worst case(TX-GFSK (Non-Hopping))

4.10 Emissions in frequency bands (above 1GHz)

Test Requirement:	In addition, radiated emissions which fall in the restricted bands, as defined in § 15.205(a), must also comply with the radiated emission limits specified in § 15.209(a)(see § 15.205(c)).		
Test Limit:	Frequency (MHz)	Field strength (microvolts/meter)	Measurement distance (meters)
	0.009-0.490	2400/F(kHz)	300
	0.490-1.705	24000/F(kHz)	30
	1.705-30.0	30	30
	30-88	100 **	3
	88-216	150 **	3
	216-960	200 **	3
	Above 960	500	3
** Except as provided in paragraph (g), fundamental emissions from intentional radiators operating under this section shall not be located in the frequency bands 54-72 MHz, 76-88 MHz, 174-216 MHz or 470-806 MHz. However, operation within these frequency bands is permitted under other sections of this part, e.g., §§ 15.231 and 15.241.			
Test Method:	ANSI C63.10-2013 section 6.6.4 KDB 558074 D01 15.247 Meas Guidance v05r02		
Procedure:	ANSI C63.10-2013 section 6.6.4		

4.10.1 E.U.T. Operation:

Operating Environment:					
Temperature:	22.6 °C	Humidity:	53.6 %	Atmospheric Pressure:	102 kPa
Pre test mode:	TM1, TM2, TM3				
Final test mode:	TM1, TM2, TM3				

4.10.2 Test Setup Diagram:

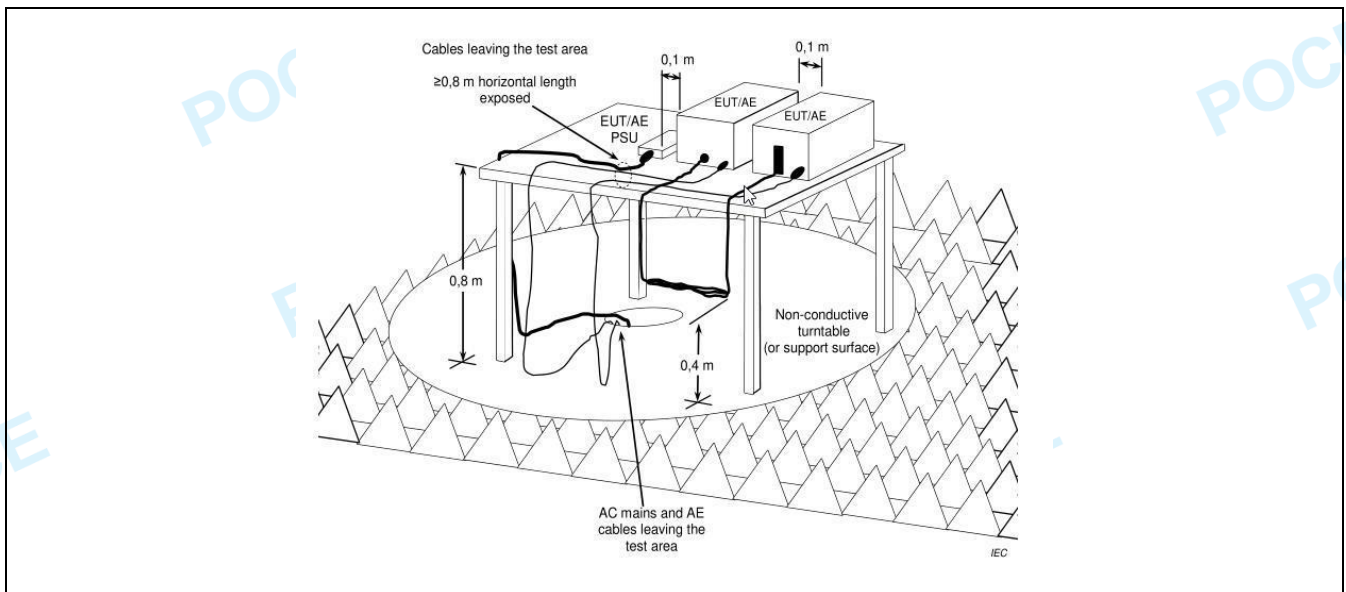

4.10.3 Test Data:

Frequency	Meter Reading	Factor	Emission Level	Limits	Over	Detector Type	Ant. Pol.
(MHz)	(dBμV)	(dB)	(dBμV/m)	(dBμV/m)	(dB)		H/V
4804	52.70	-0.9	51.80	74	-22.20	peak	H
4804	38.62	-0.9	37.72	54	-16.28	AVG	H
7206	54.51	4.13	58.64	74	-15.36	peak	H
7206	41.12	4.13	45.25	54	-8.75	AVG	H
9608	53.43	8.09	61.52	74	-12.48	peak	H
9608	42.49	8.09	50.58	54	-3.42	AVG	H
4804	52.66	-0.9	51.76	74	-22.24	peak	V
4804	39.24	-0.9	38.34	54	-15.66	AVG	V
7206	52.85	4.13	56.98	74	-17.02	peak	V
7206	39.68	4.13	43.81	54	-10.19	AVG	V
9608	54.22	8.09	62.31	74	-11.69	peak	V
9608	40.14	8.09	48.23	54	-5.77	AVG	V

Frequency	Meter Reading	Factor	Emission Level	Limits	Over	Detector Type	Ant. Pol.
(MHz)	(dBμV)	(dB)	(dBμV/m)	(dBμV/m)	(dB)		H/V
4882	52.39	-0.64	51.75	74	-22.25	peak	H
4882	38.11	-0.64	37.47	54	-16.53	AVG	H
7323	54.86	4.31	59.17	74	-14.83	peak	H
7323	40.35	4.31	44.66	54	-9.34	AVG	H
9764	53.14	8.09	61.23	74	-12.77	peak	H
9764	42.25	8.09	50.34	54	-3.66	AVG	H
4882	52.74	-0.64	52.10	74	-21.90	peak	V
4882	39.33	-0.64	38.69	54	-15.31	AVG	V
7323	53.07	4.31	57.38	74	-16.62	peak	V
7323	41.06	4.31	45.37	54	-8.63	AVG	V
9764	53.43	8.09	61.52	74	-12.48	peak	V
9764	42.26	8.09	50.35	54	-3.65	AVG	V

Frequency	Meter Reading	Factor	Emission Level	Limits	Over	Detector Type	Ant. Pol.
(MHz)	(dBμV)	(dB)	(dBμV/m)	(dBμV/m)	(dB)		H/V
4960	52.58	-0.37	52.21	74	-21.79	peak	H
4960	38.96	-0.37	38.59	54	-15.41	AVG	H
7440	55.43	4.49	59.92	74	-14.08	peak	H
7440	39.80	4.49	44.29	54	-9.71	AVG	H
9920	53.67	8.08	61.75	74	-12.25	peak	H
9920	42.53	8.08	50.61	54	-3.39	AVG	H
4960	52.96	-0.37	52.59	74	-21.41	peak	V
4960	38.12	-0.37	37.75	54	-16.25	AVG	V
7440	52.67	4.49	57.16	74	-16.84	peak	V
7440	39.22	4.49	43.71	54	-10.29	AVG	V

9920	53.00	8.08	61.08	74	-12.92	peak	V
9920	42.45	8.08	50.53	54	-3.47	AVG	V

Remark:

1. Quasi-Peak and Average measurement were performed at the frequencies with maximized peak emission.
2. Measurement Level = Reading level + Correct Factor, Over=Limit- Measurement
Correction Factor= Antenna Factor + Cable loss – Pre-amplifier
3. The test data shows only the worst case(802.11n(HT20) mode)

5 TEST SETUP PHOTOS

Refer to Appendix - Test Setup Photos

6 PHOTOS OF THE EUT

Refer to Appendix - EUT Photos

Appendix

1. -20dB Bandwidth

Condition	Antenna	Modulation	Frequency (MHz)	-20dB BW(MHz)	if larger than CFS
NVNT	ANT1	1-DH5	2402.00	0.948	No
NVNT	ANT1	1-DH5	2441.00	0.946	No
NVNT	ANT1	1-DH5	2480.00	0.945	No
NVNT	ANT1	2-DH5	2402.00	1.260	Yes
NVNT	ANT1	2-DH5	2441.00	1.228	Yes
NVNT	ANT1	2-DH5	2480.00	1.231	Yes
NVNT	ANT1	3-DH5	2402.00	1.278	Yes
NVNT	ANT1	3-DH5	2441.00	1.262	Yes
NVNT	ANT1	3-DH5	2480.00	1.262	Yes

-20dB Bandwidth_NVNT_ANT1_1-DH5_2402

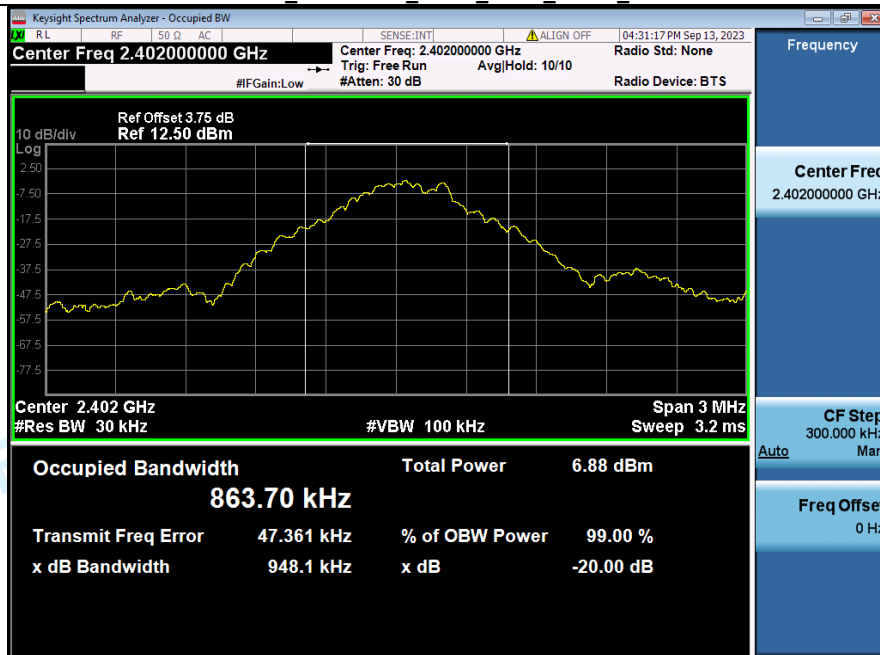

-20dB Bandwidth_NVNT_ANT1_1-DH5_2441

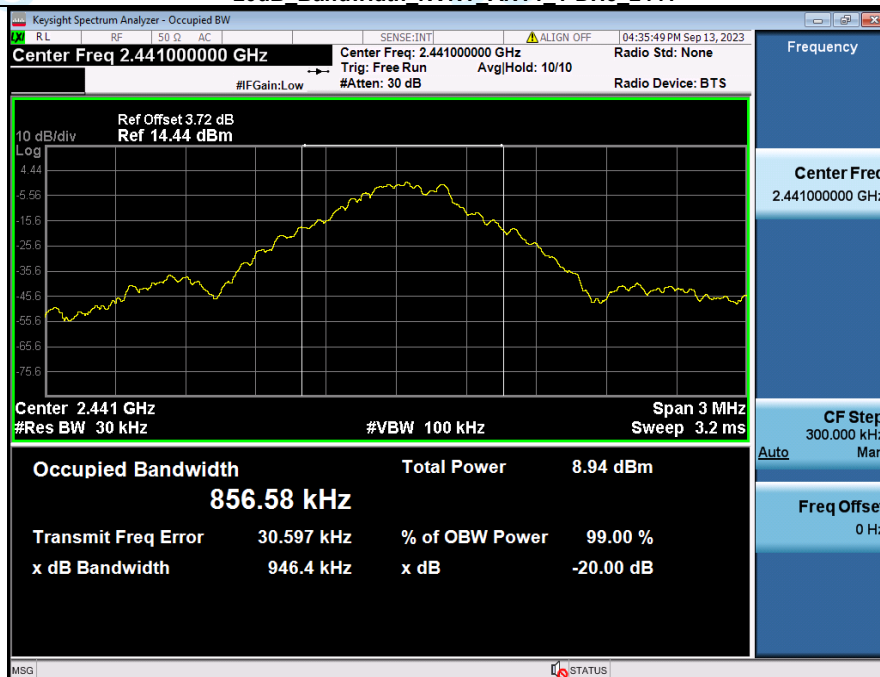

-20dB Bandwidth NVNT ANT1 1-DH5 2480

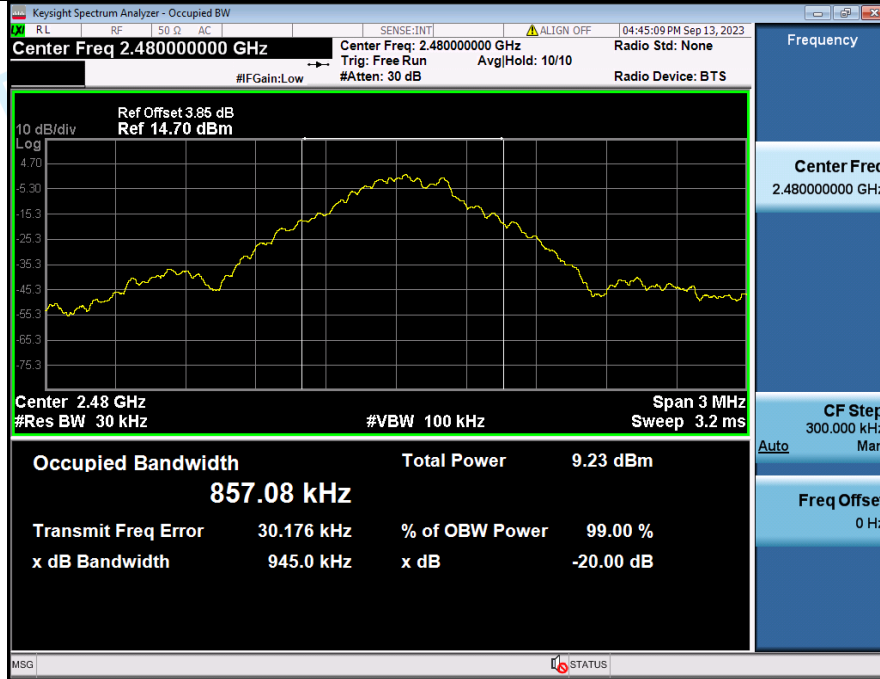

-20dB Bandwidth NVNT ANT1 2-DH5 2402

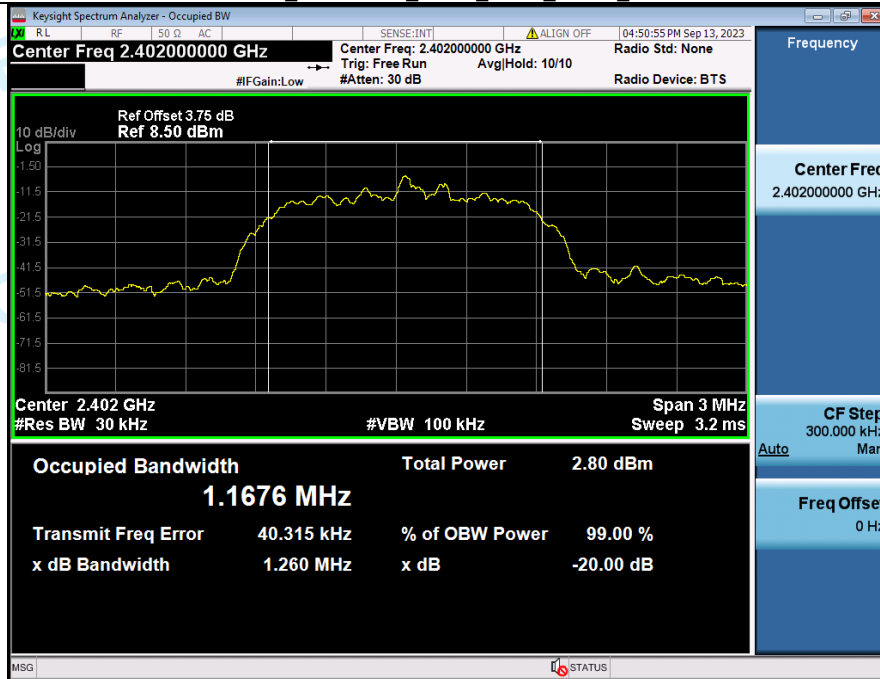

-20dB Bandwidth NVNT ANT1 2-DH5 2441



-20dB Bandwidth NVNT ANT1 2-DH5 2480

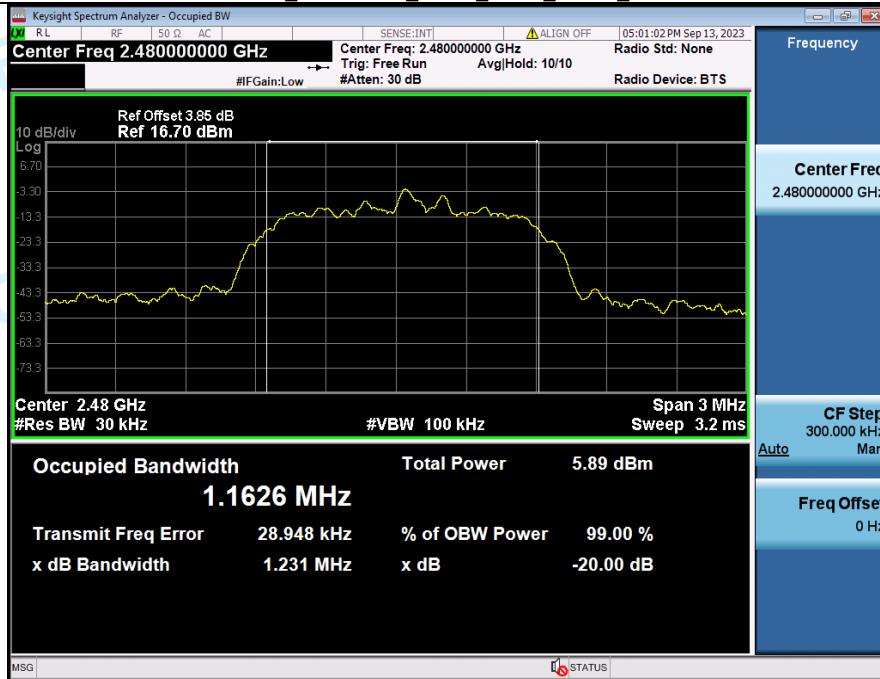

-20dB Bandwidth NVNT ANT1 3-DH5 2402

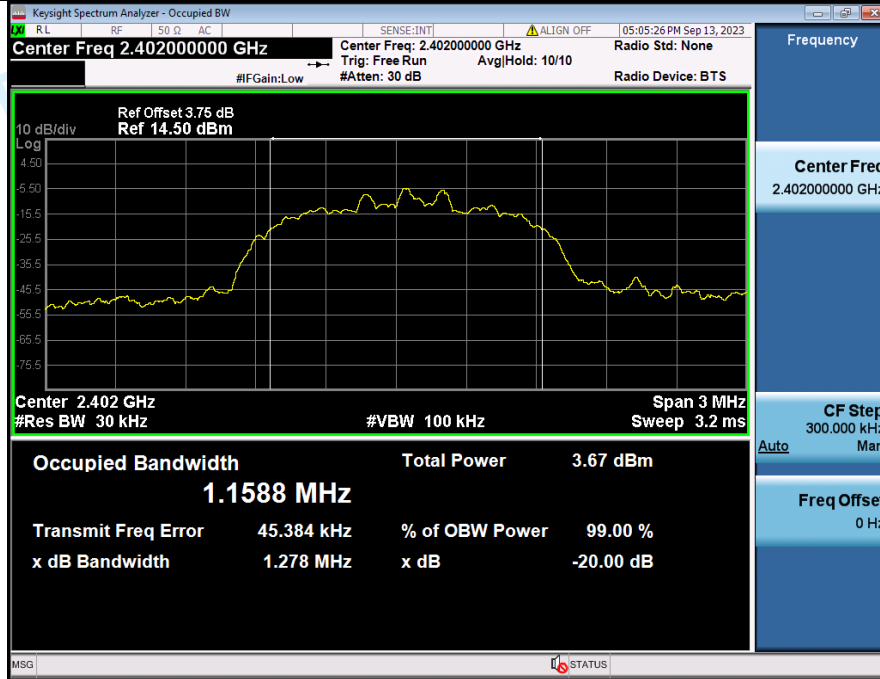

-20dB Bandwidth NVNT ANT1 3-DH5 2441

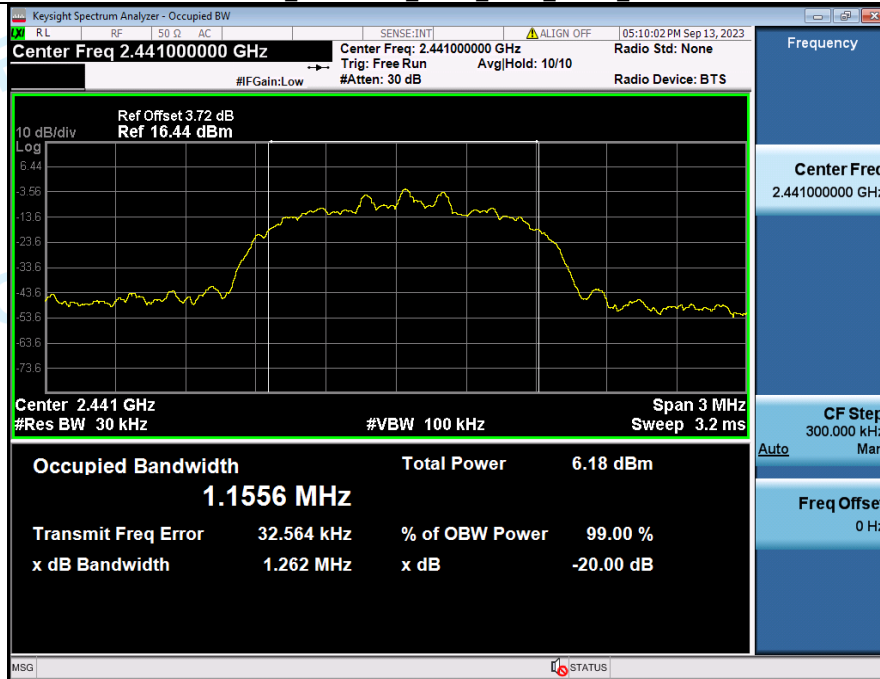

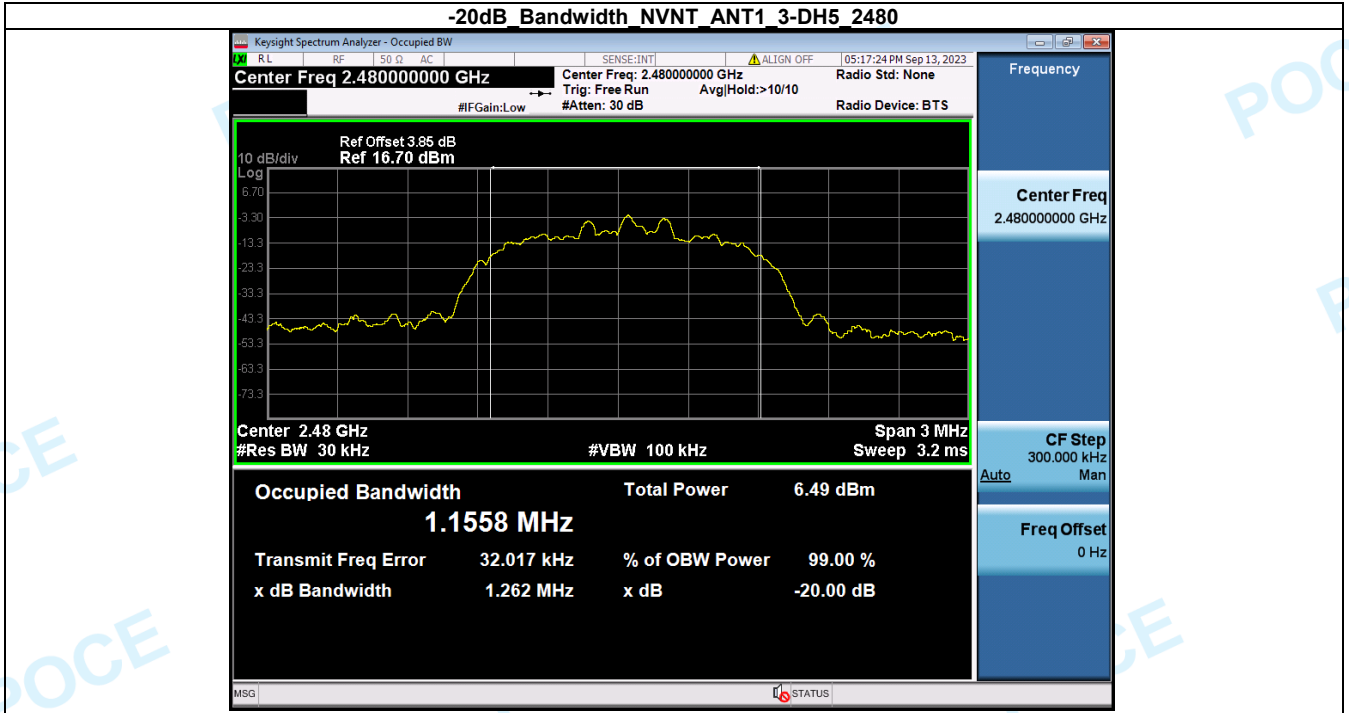

2. Peak Output Power

Condition	Antenna	Modulation	Frequency (MHz)	Max. Conducted Power(dBm)	Max. Conducted Power(mW)	Limit(mW)	Result
NVNT	ANT1	1-DH5	2402.00	-0.94	0.81	1000	Pass
NVNT	ANT1	1-DH5	2441.00	1.31	1.35	1000	Pass
NVNT	ANT1	1-DH5	2480.00	1.69	1.47	1000	Pass
NVNT	ANT1	2-DH5	2402.00	-3.04	0.50	125	Pass
NVNT	ANT1	2-DH5	2441.00	-0.55	0.88	125	Pass
NVNT	ANT1	2-DH5	2480.00	-0.10	0.98	125	Pass
NVNT	ANT1	3-DH5	2402.00	-2.69	0.54	125	Pass
NVNT	ANT1	3-DH5	2441.00	-0.09	0.98	125	Pass
NVNT	ANT1	3-DH5	2480.00	0.30	1.07	125	Pass

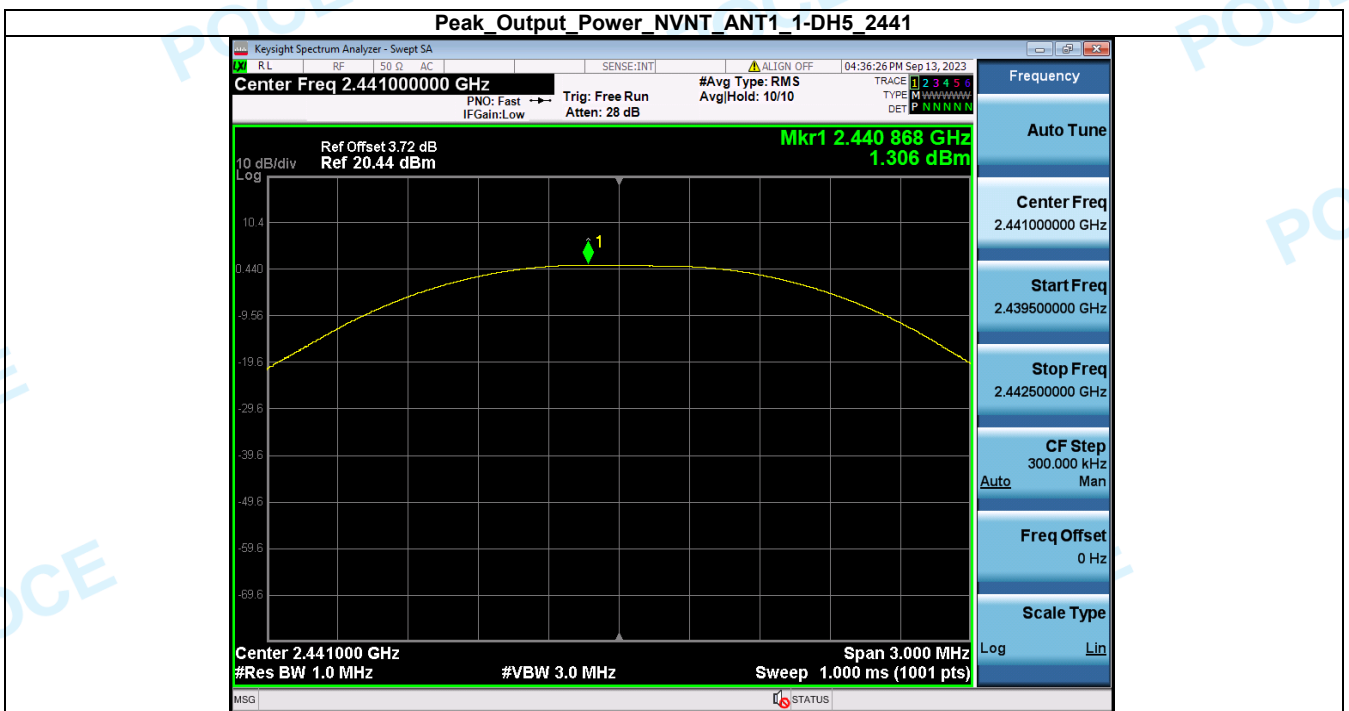
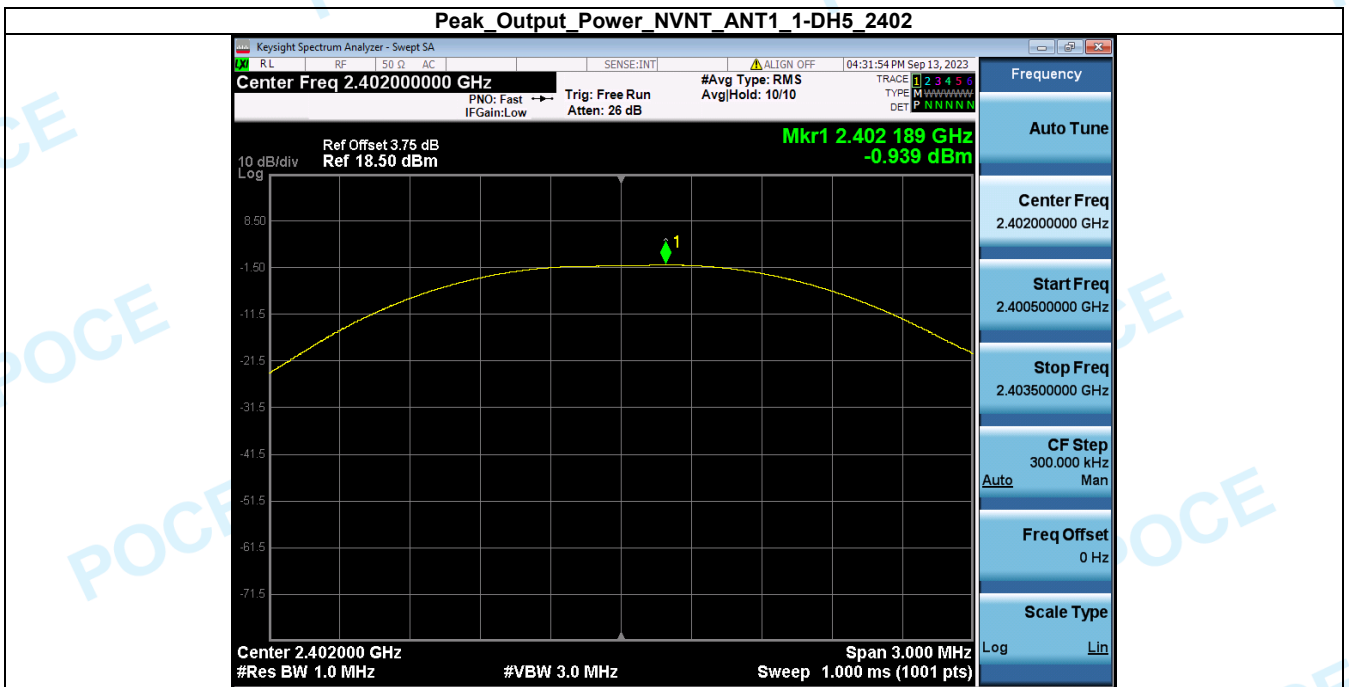

Peak Output Power_NVNT_ANT1_1-DH5_2480

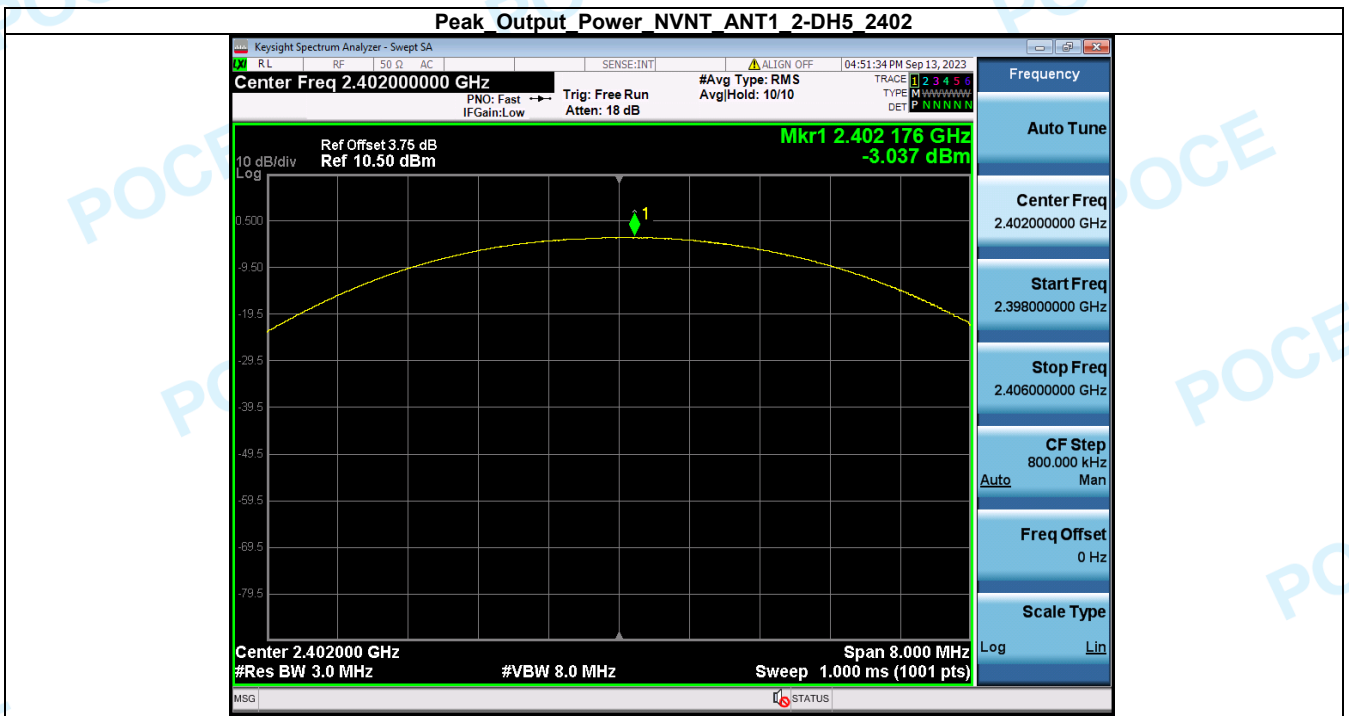
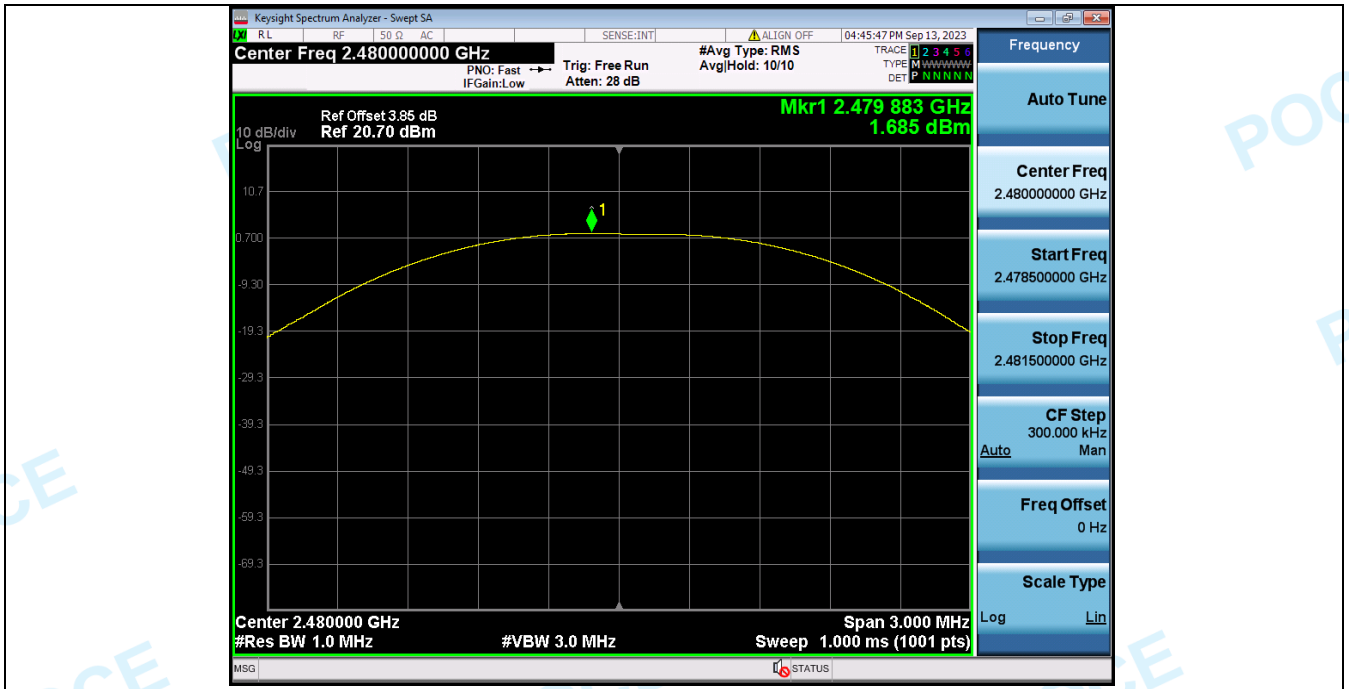

Peak Output Power NVNT ANT1 2-DH5 2441

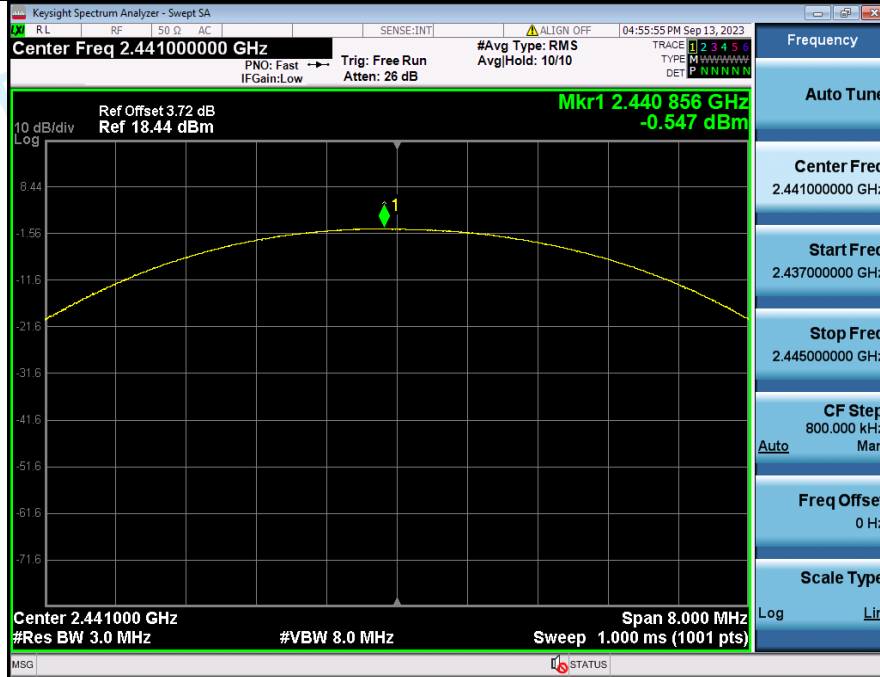

Peak Output Power NVNT ANT1 2-DH5 2480

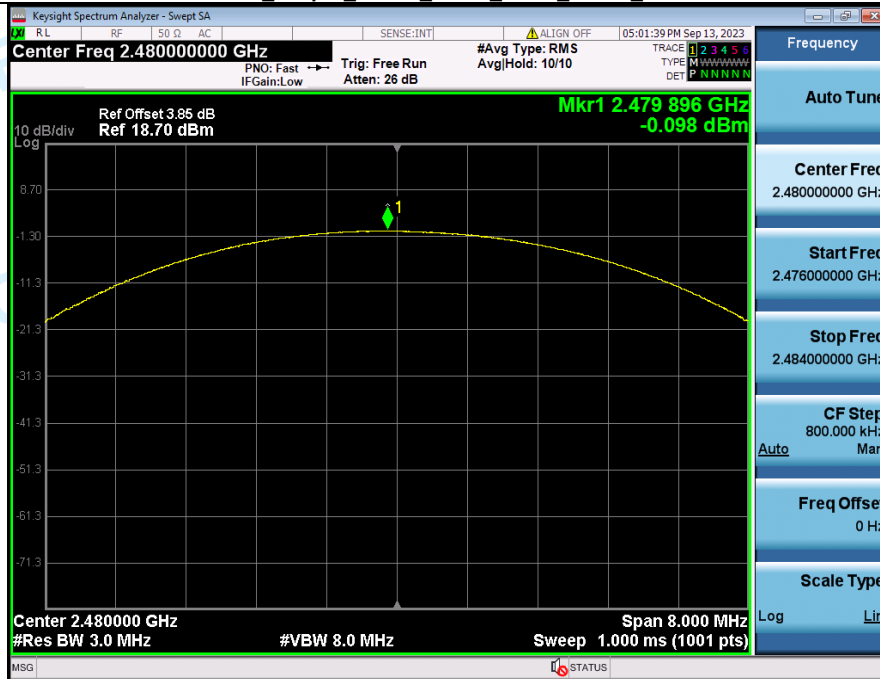

Peak Output Power NVNT ANT1 3-DH5 2402

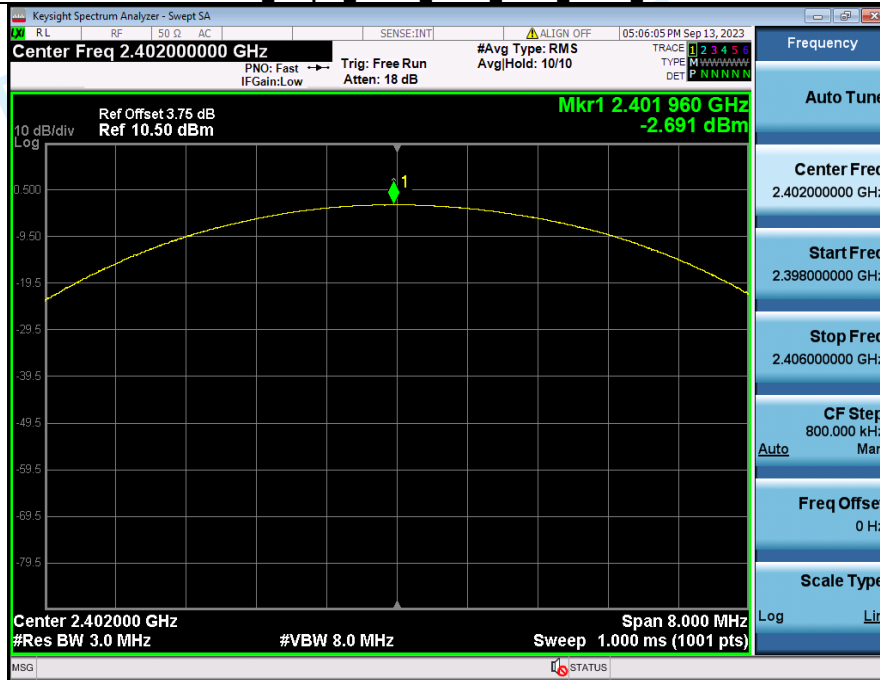

Peak Output Power NVNT ANT1 3-DH5 2441

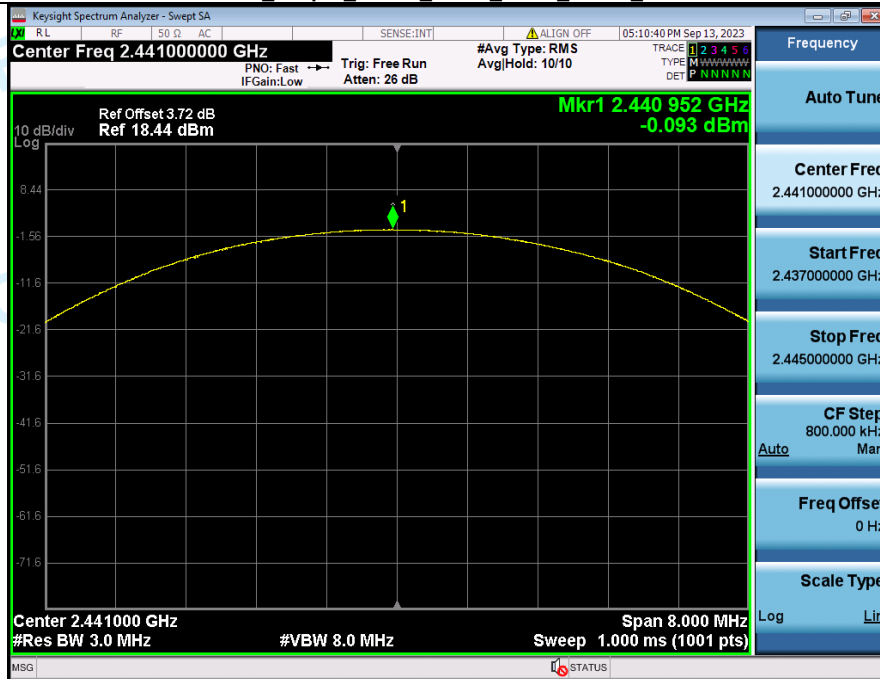

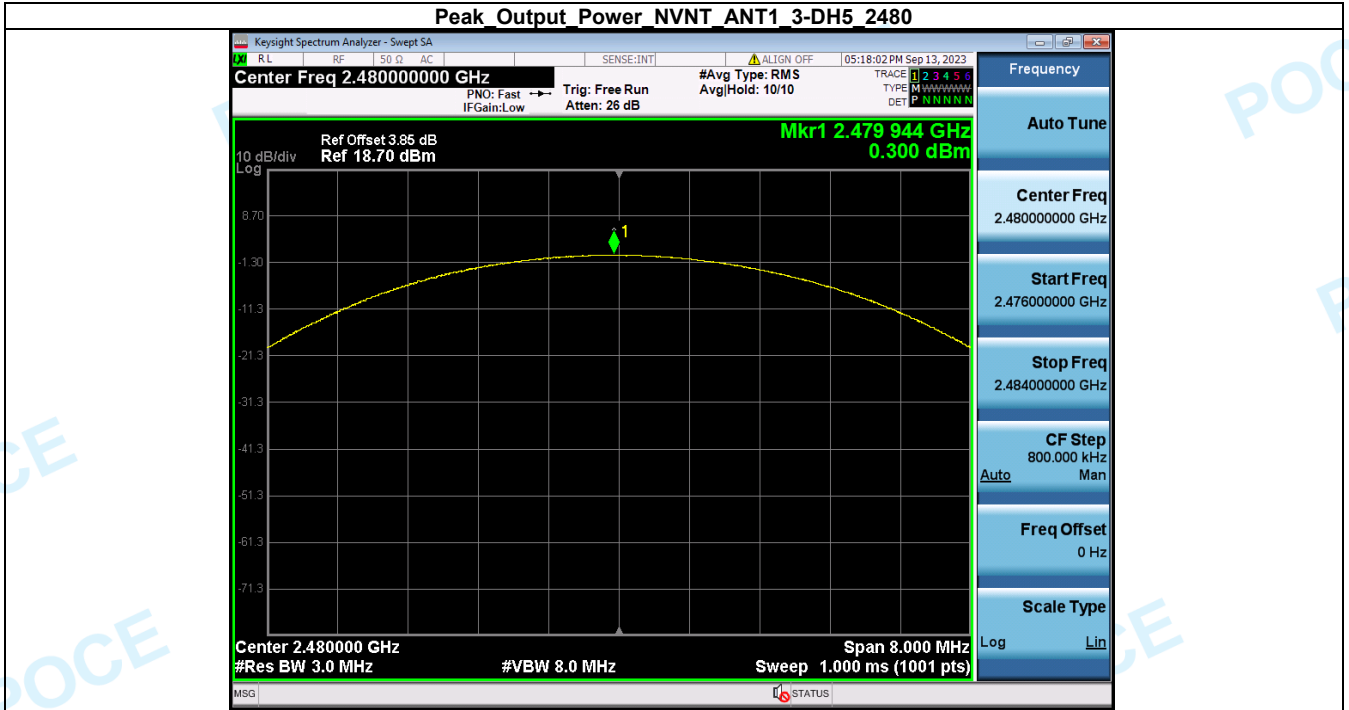

3. Spurious Emissions

Condition	Antenna	Modulation	TX Mode	Spurious MAX.Value(dBm)	Limit	Result
NVNT	ANT1	1-DH5	2402.00	-46.757	-21.052	Pass
NVNT	ANT1	1-DH5	2441.00	-46.623	-18.859	Pass
NVNT	ANT1	1-DH5	2480.00	-45.997	-18.477	Pass
NVNT	ANT1	2-DH5	2402.00	-52.747	-24.674	Pass
NVNT	ANT1	2-DH5	2441.00	-51.635	-22.065	Pass
NVNT	ANT1	2-DH5	2480.00	-47.768	-21.640	Pass
NVNT	ANT1	3-DH5	2402.00	-53.353	-24.509	Pass
NVNT	ANT1	3-DH5	2441.00	-49.993	-21.879	Pass
NVNT	ANT1	3-DH5	2480.00	-50.751	-21.691	Pass

1 Reference Level NVNT ANT1 1-DH5 2402



2 Spurious Emissions_NVNT_ANT1_1-DH5_2402

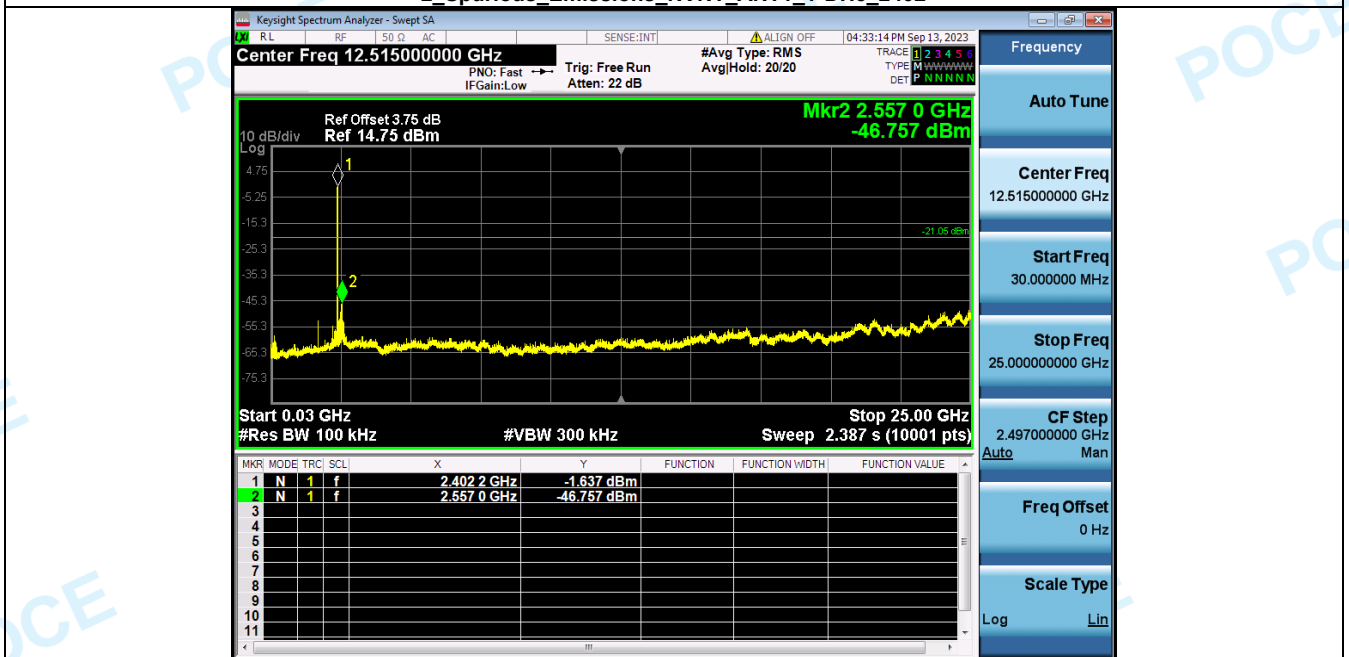

1 Reference Level NVNT ANT1 1-DH5 2441

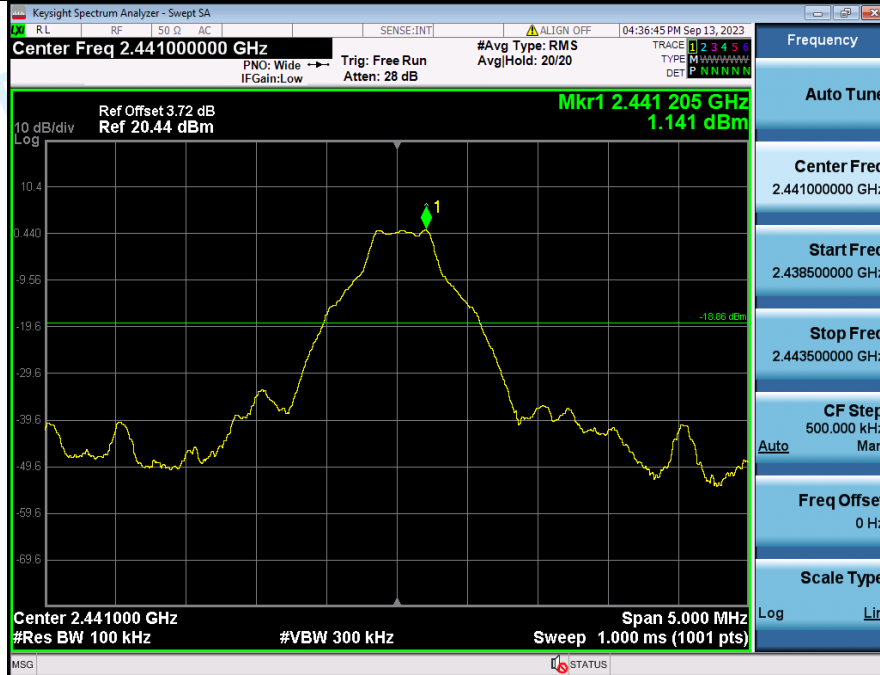

2 Spurious Emissions NVNT ANT1 1-DH5 2441

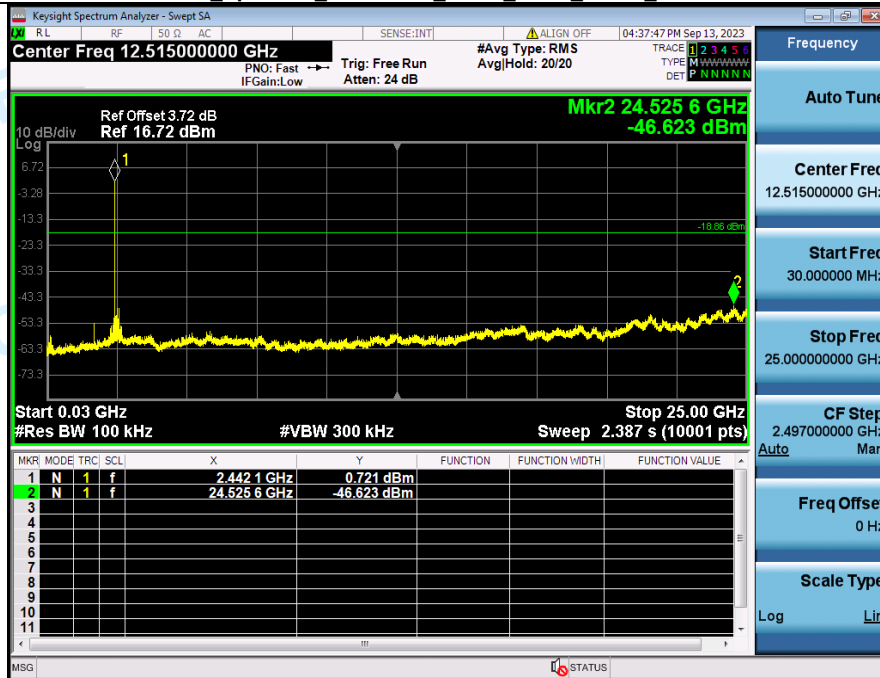

1 Reference Level NVNT ANT1 1-DH5 2480



2 Spurious Emissions NVNT ANT1 1-DH5 2480

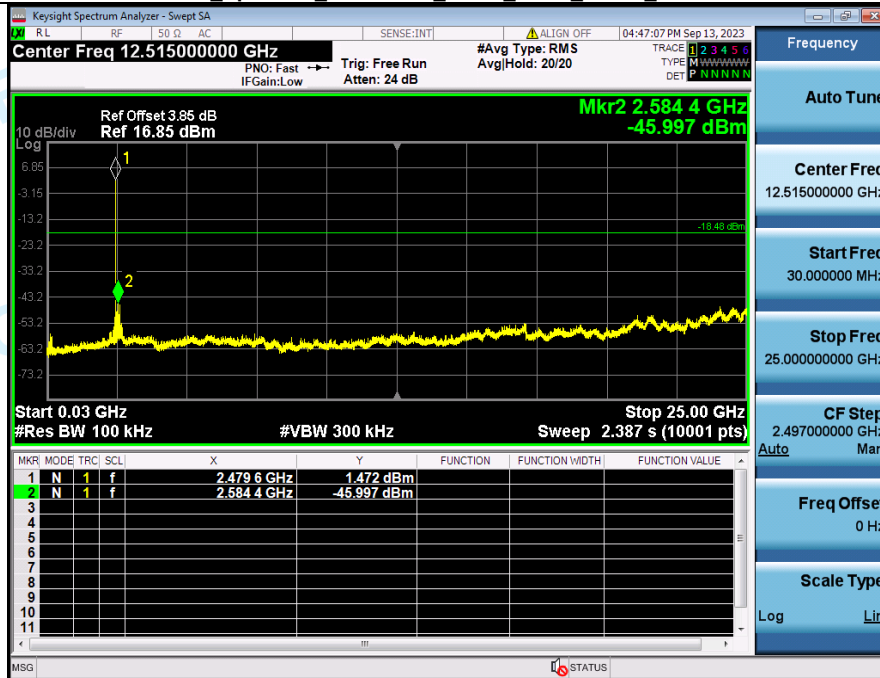

1 Reference Level NVNT ANT1 2-DH5 2402



2 Spurious Emissions NVNT ANT1 2-DH5 2402

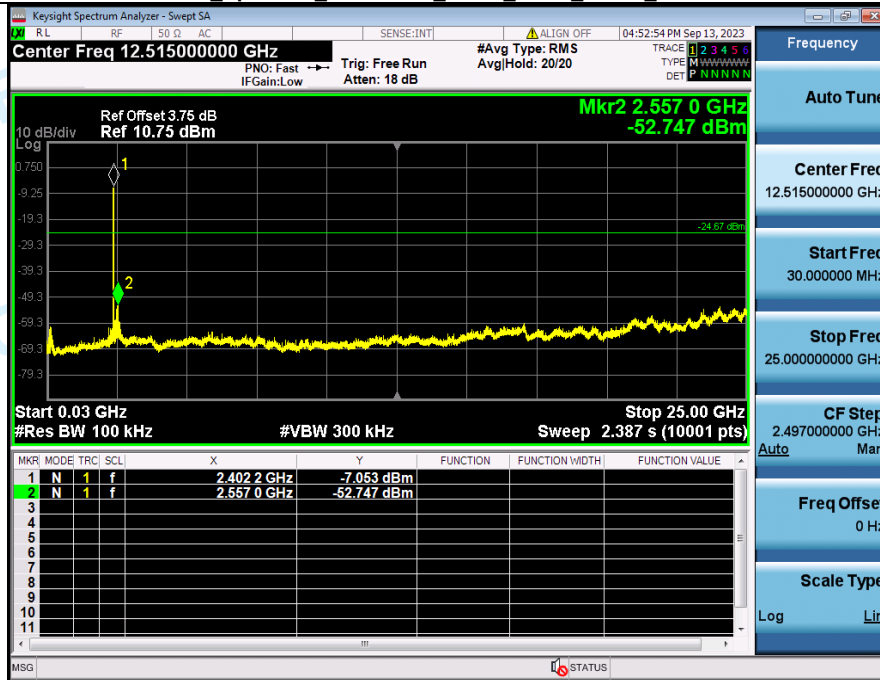

1 Reference Level NVNT ANT1 2-DH5 2441

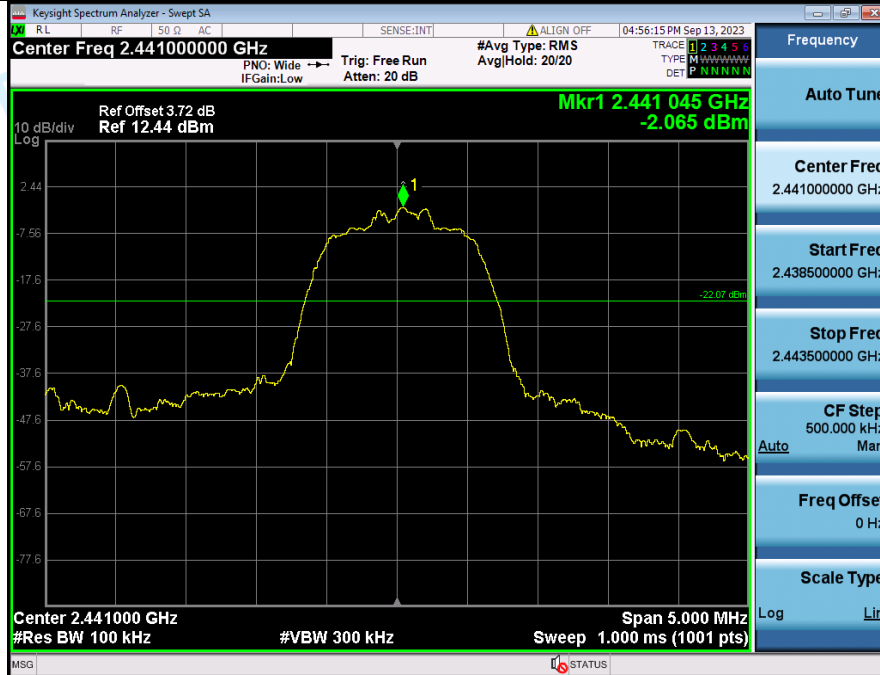

2 Spurious Emissions NVNT ANT1 2-DH5 2441

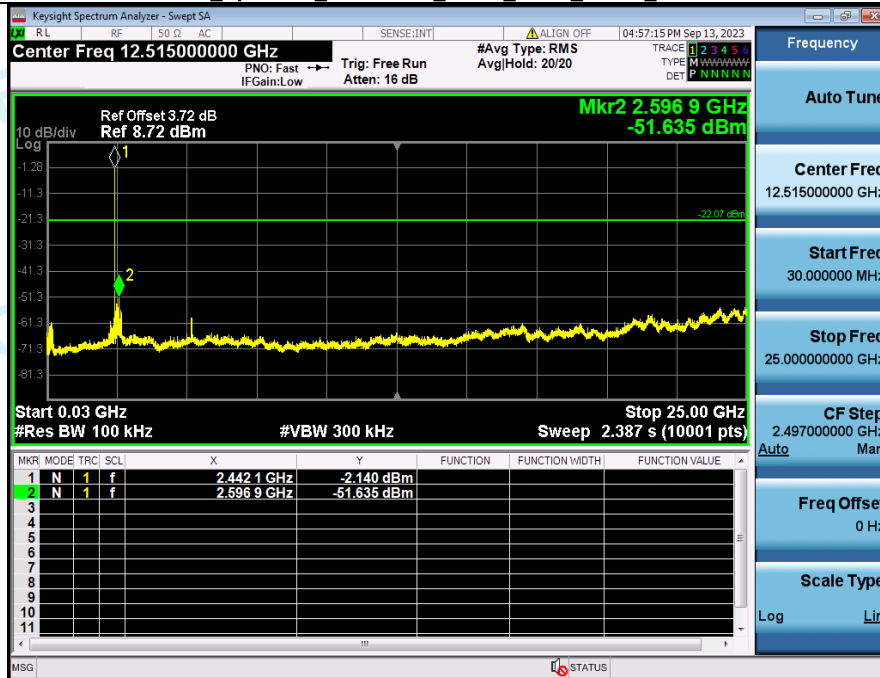

1 Reference Level NVNT ANT1 2-DH5 2480



2 Spurious Emissions NVNT ANT1 2-DH5 2480

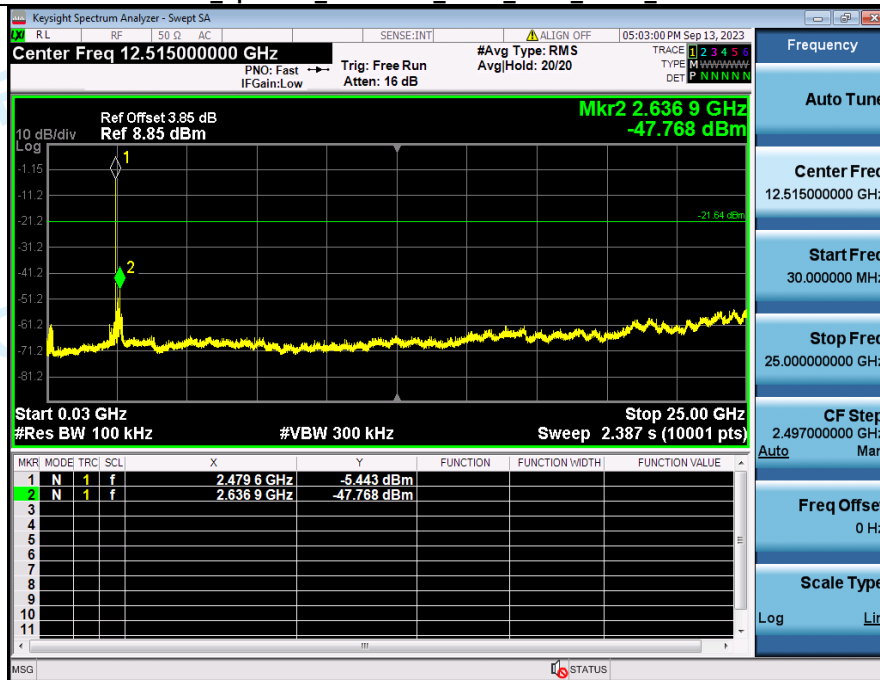

1 Reference Level NVNT ANT1 3-DH5 2402

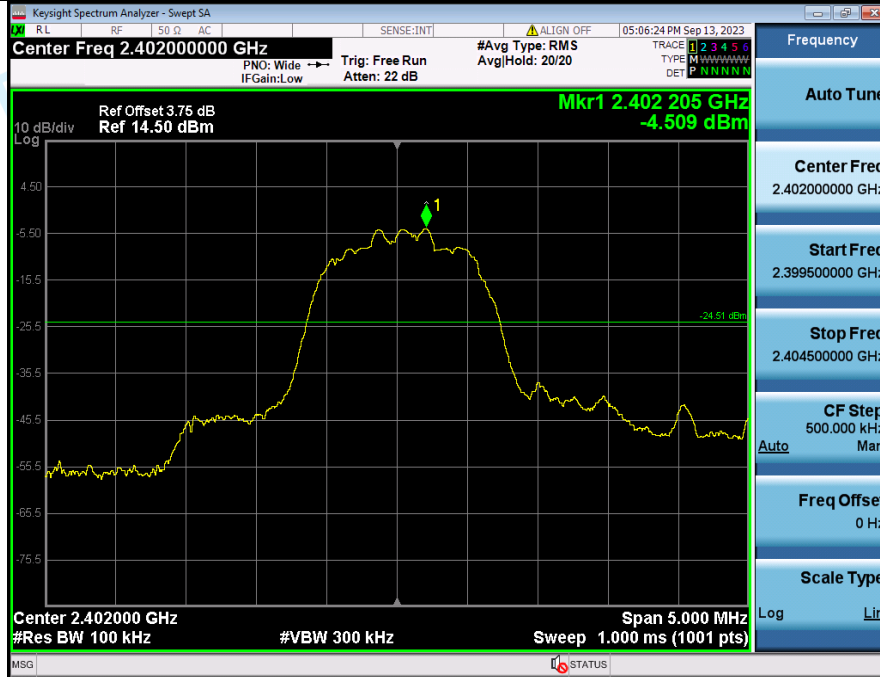

2 Spurious Emissions NVNT ANT1 3-DH5 2402

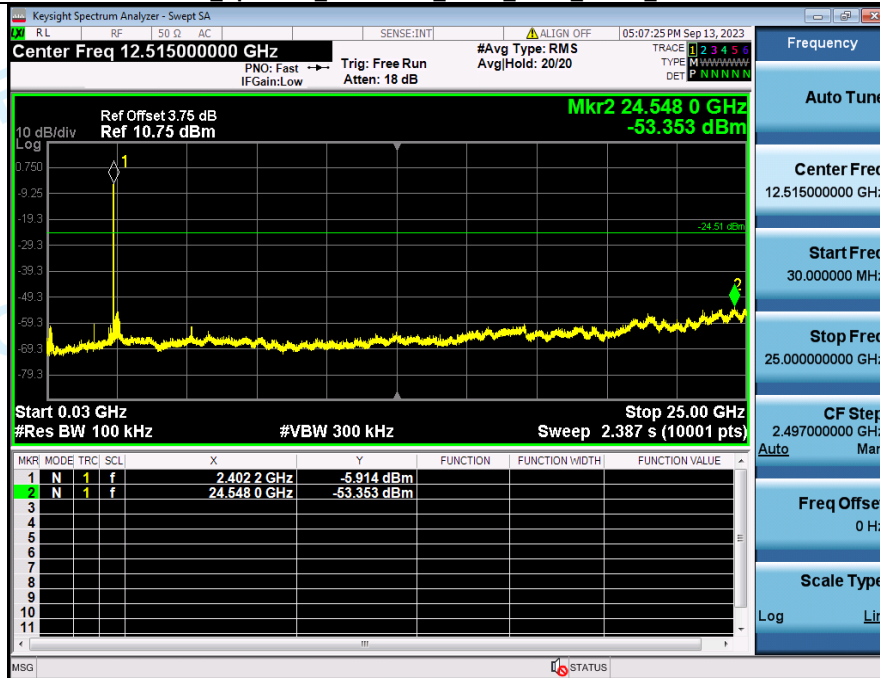

1 Reference Level NVNT ANT1 3-DH5 2441

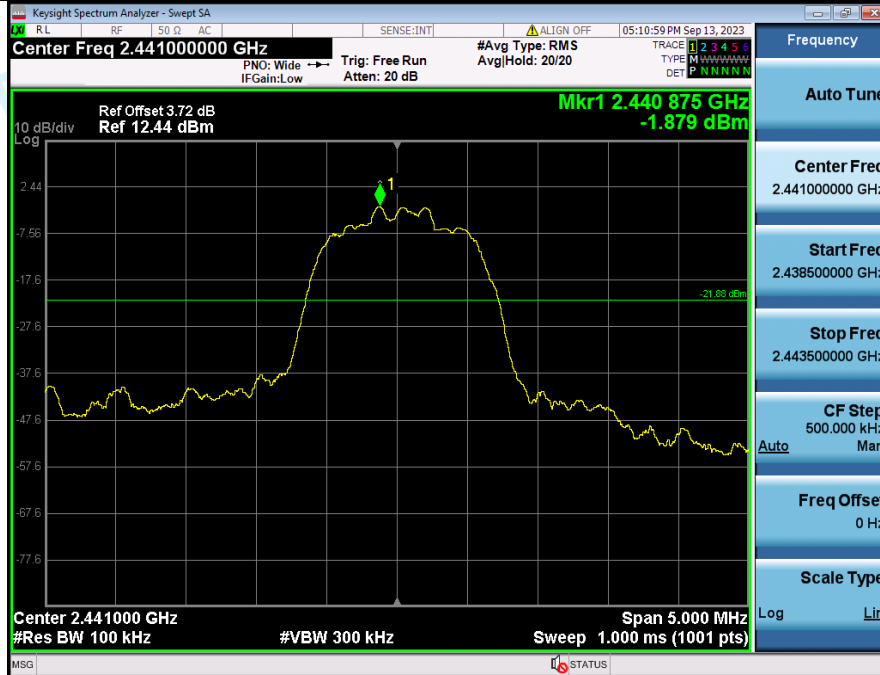

2 Spurious Emissions NVNT ANT1 3-DH5 2441

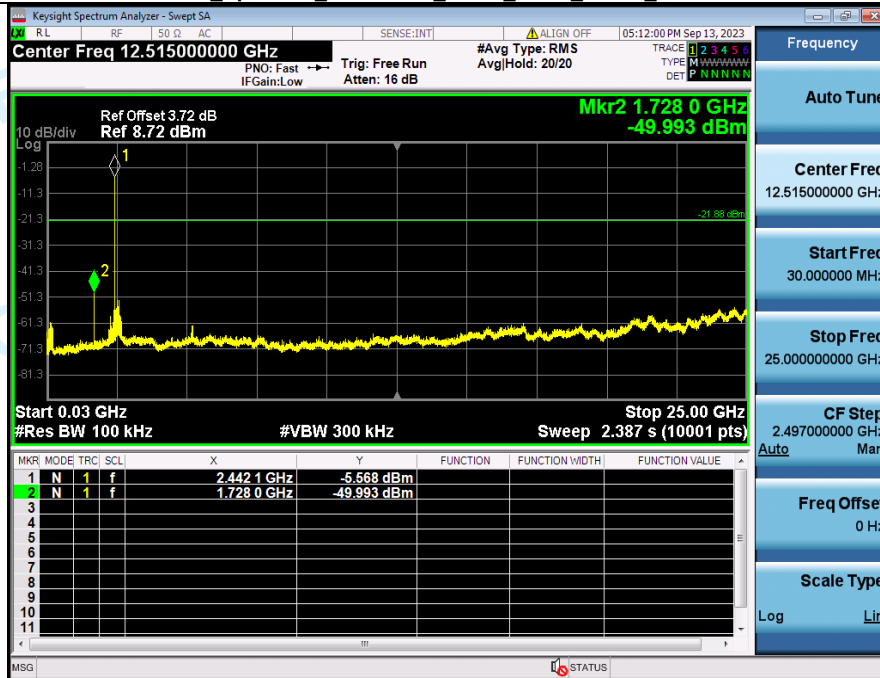

1 Reference Level NVNT ANT1 3-DH5 2480



2 Spurious Emissions NVNT ANT1 3-DH5 2480

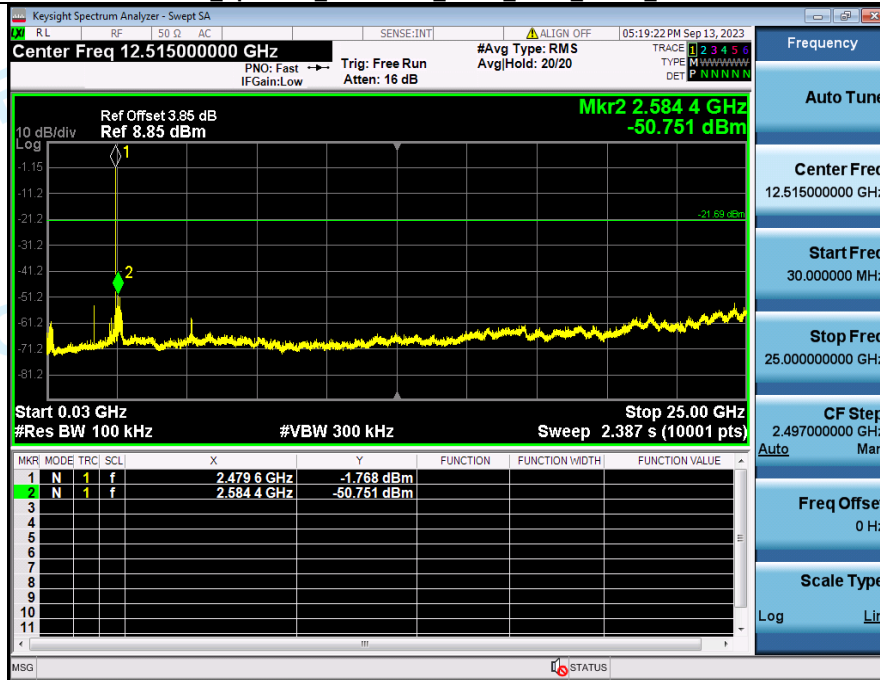

4. Bandedge

Condition	Antenna	Modulation	TX Mode	Bandedge MAX.Value	Limit	Result
NVNT	ANT1	1-DH5	Hopping_LCH	-50.838	-18.529	Pass
NVNT	ANT1	1-DH5	Hopping_HCH	-48.389	-18.347	Pass
NVNT	ANT1	2-DH5	Hopping_LCH	-57.861	-21.772	Pass
NVNT	ANT1	2-DH5	Hopping_HCH	-52.864	-21.788	Pass
NVNT	ANT1	3-DH5	Hopping_LCH	-56.770	-21.491	Pass
NVNT	ANT1	3-DH5	Hopping_HCH	-52.147	-21.700	Pass

1 Reference Level Hopping NVNT ANT1 1-DH5 Hopping

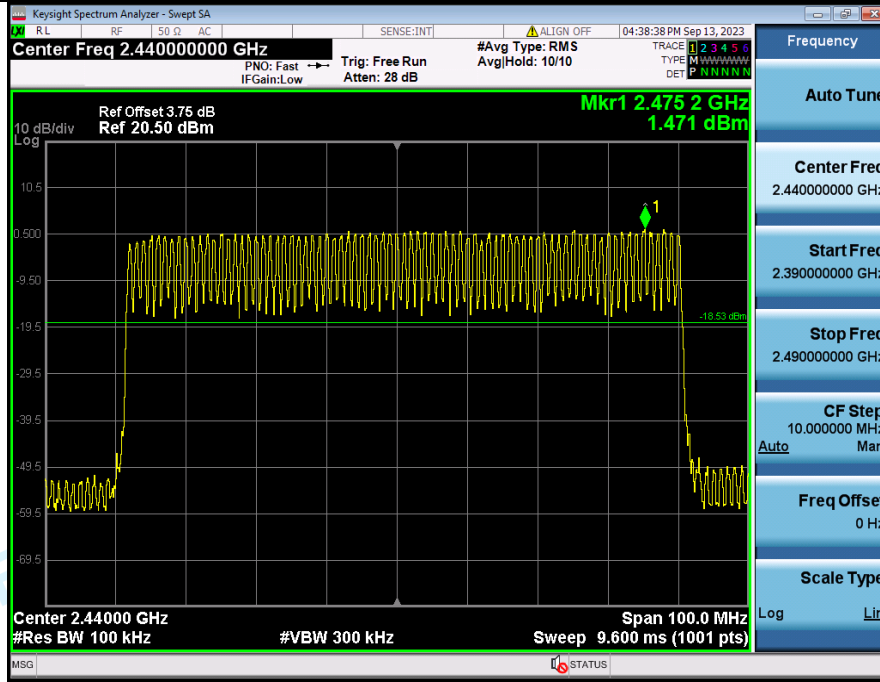

2 Band Edge (Hopping) NVNT ANT1 1-DH5 Hopping

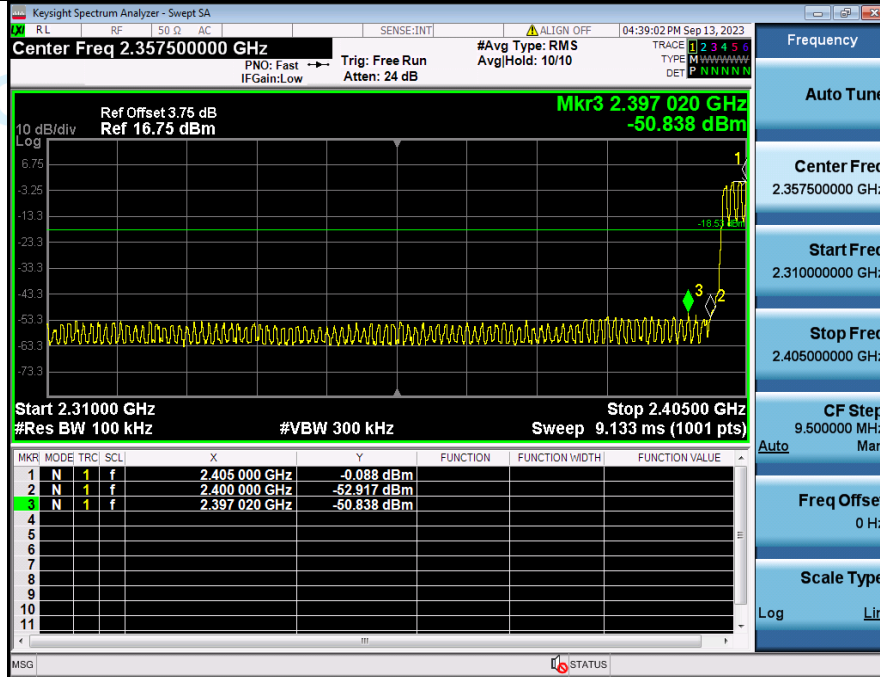

1 Reference Level Hopping NVNT ANT1 1-DH5 Hopping

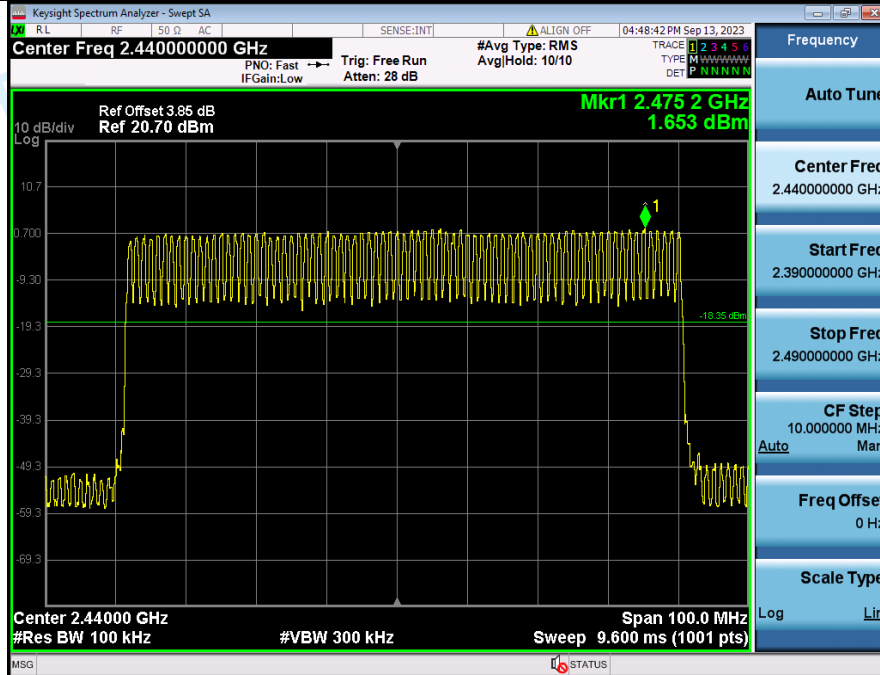

2 Band Edge (Hopping) NVNT ANT1 1-DH5 Hopping

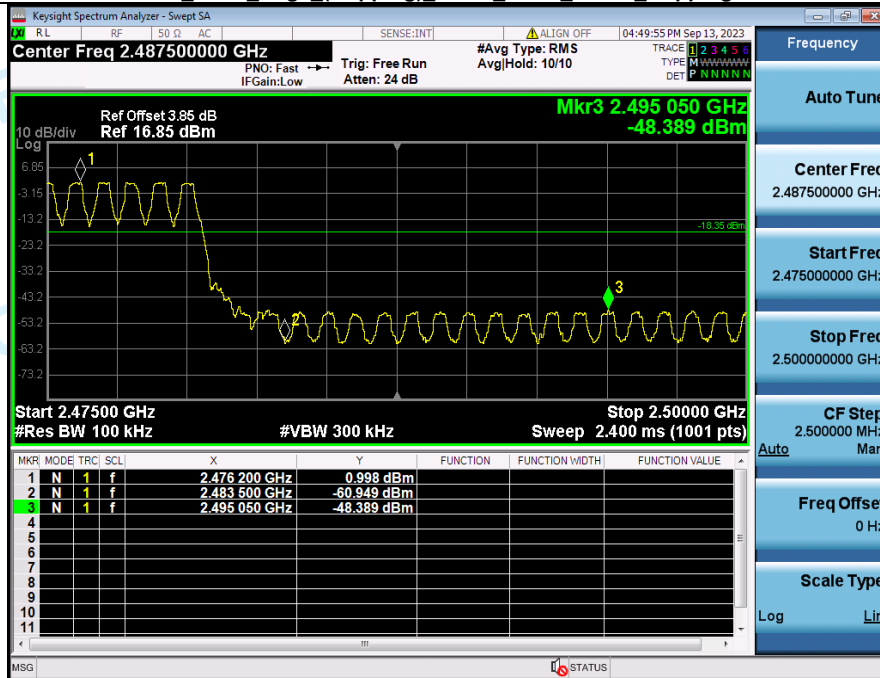

1 Reference Level Hopping NVNT ANT1 2-DH5 Hopping

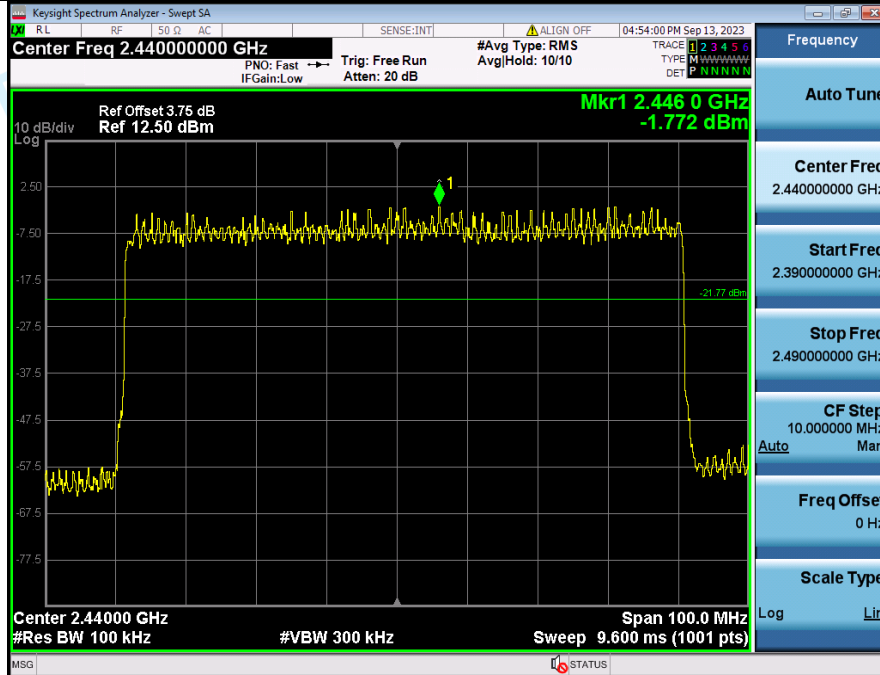

2 Band Edge (Hopping) NVNT ANT1 2-DH5 Hopping

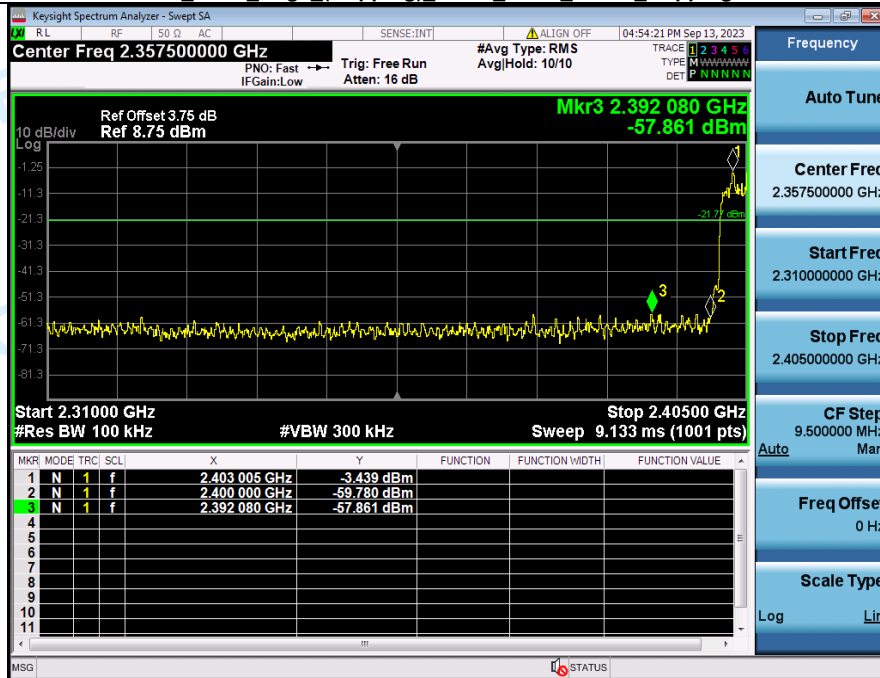

1 Reference Level Hopping NVNT ANT1 2-DH5 Hopping

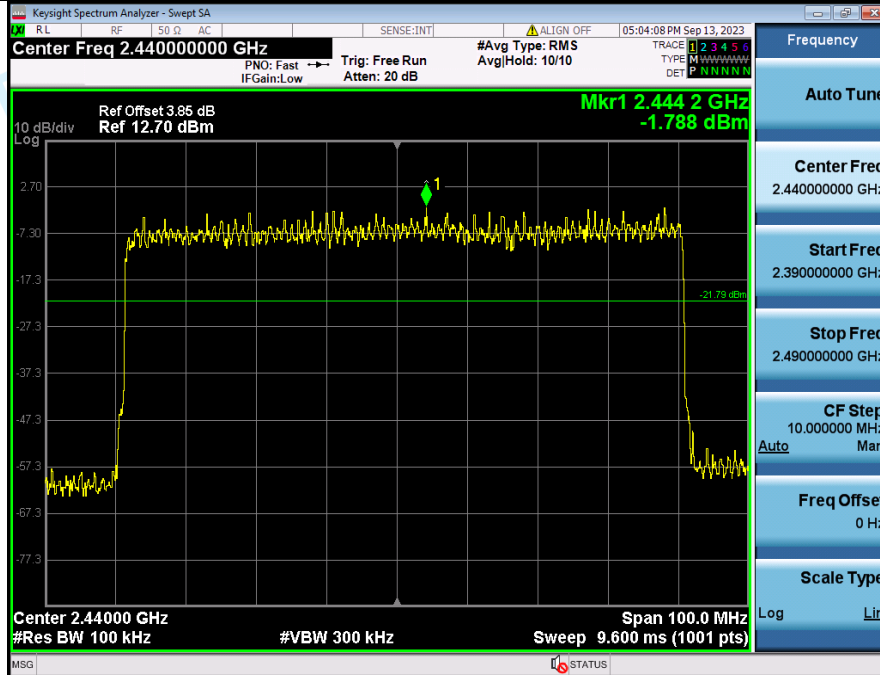

2 Band Edge (Hopping) NVNT ANT1 2-DH5 Hopping

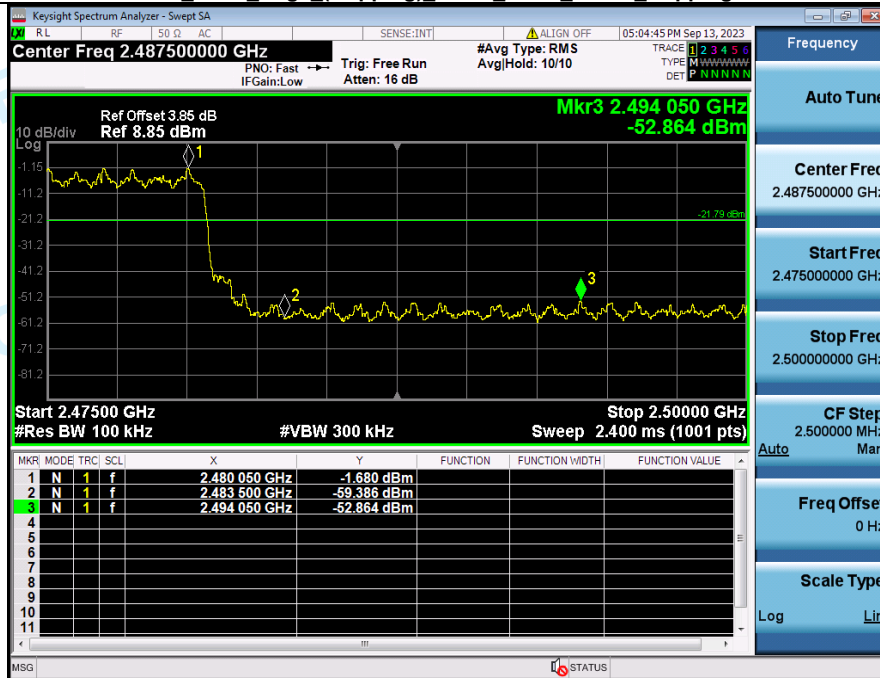

1 Reference Level Hopping NVNT ANT1 3-DH5 Hopping

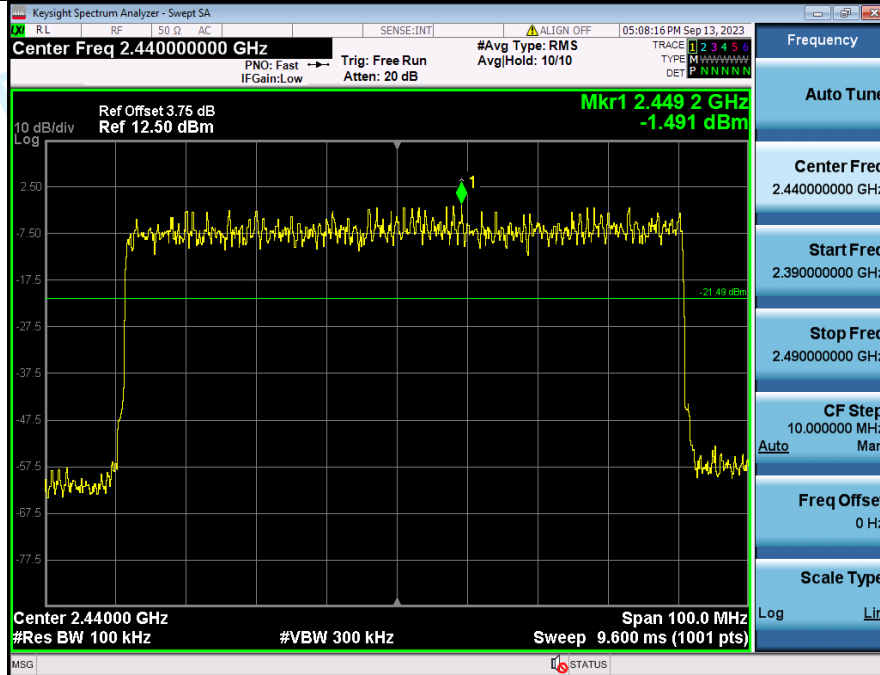

2 Band Edge (Hopping) NVNT ANT1 3-DH5 Hopping

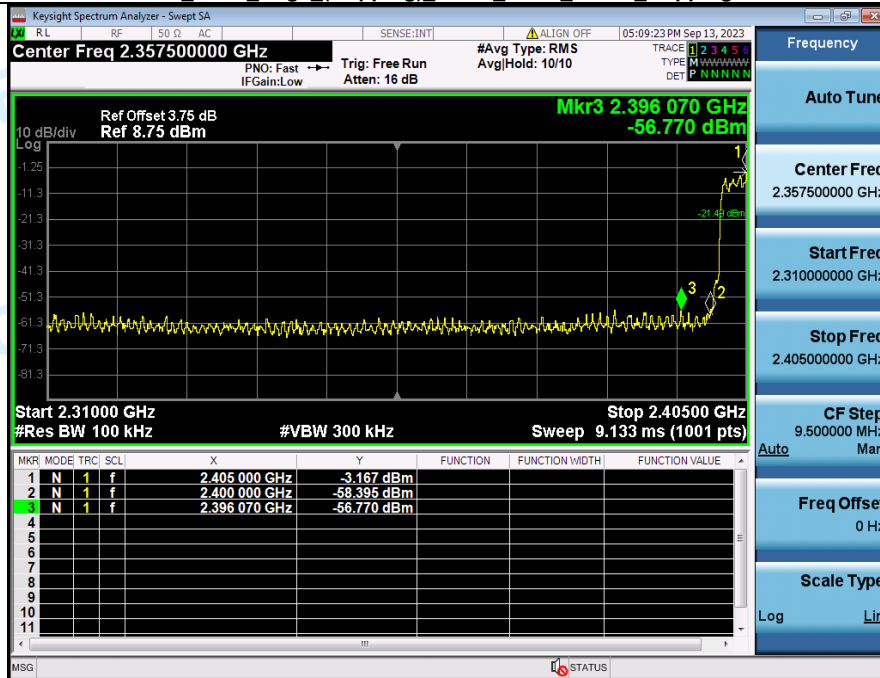

1 Reference Level Hopping NVNT ANT1 3-DH5 Hopping

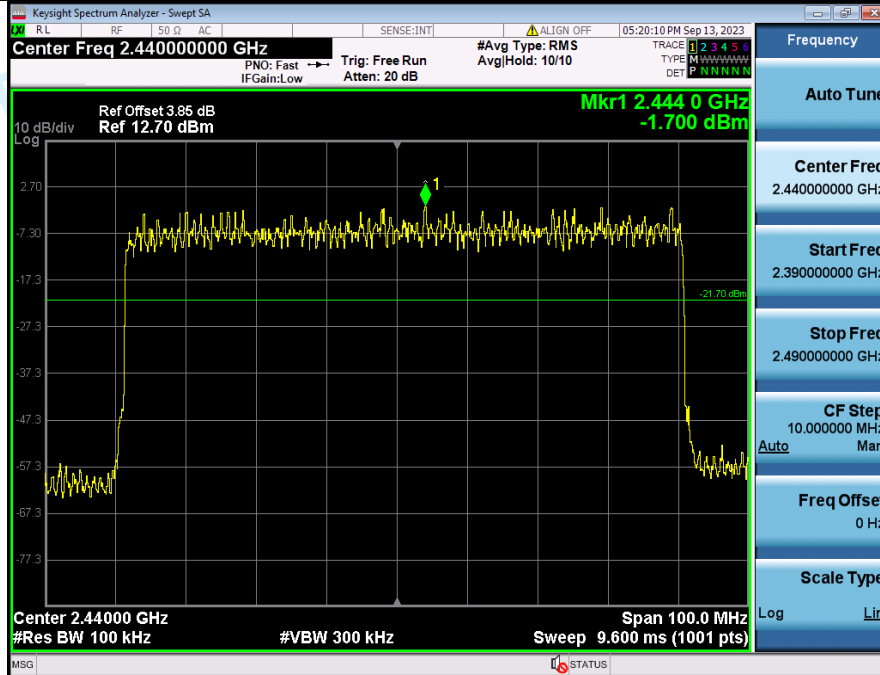

2 Band Edge (Hopping) NVNT ANT1 3-DH5 Hopping

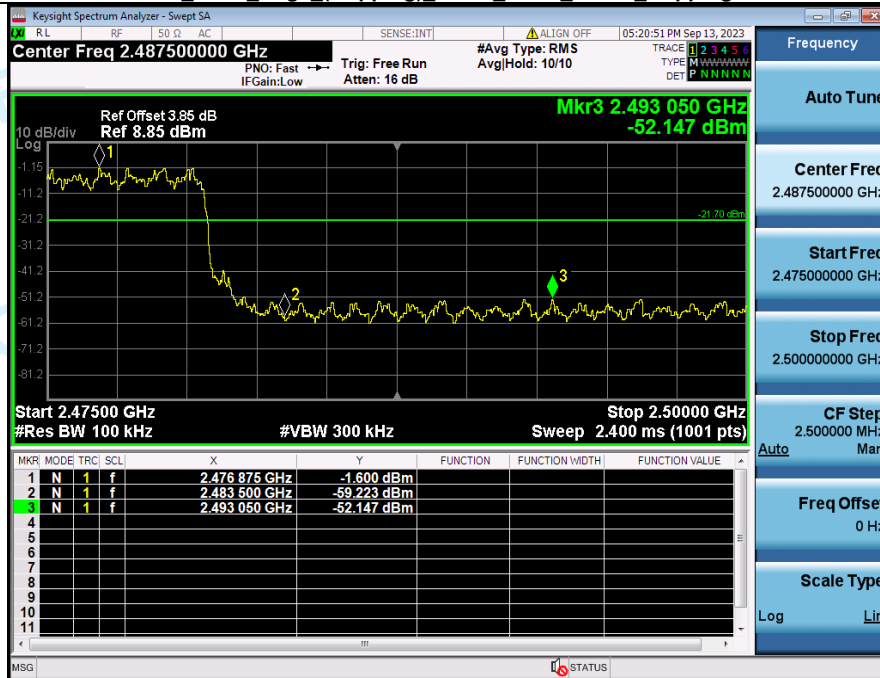

5. Carrier Frequencies Separation (Hopping)

Condition	Antenna	Modulation	Frequency(MHz)	Hopping NO.0 (MHz)	Hopping NO.1 (MHz)	Carrier Frequencies Separation(MHz)	Limit(MHz)	Result
NVNT	ANT1	1-DH5	2441.00	2440.996	2442.106	1.11	0.946	Pass
NVNT	ANT1	2-DH5	2441.00	2441.221	2442.040	0.908	0.819	Pass
NVNT	ANT1	3-DH5	2441.00	2441.206	2442.214	1.01	0.841	Pass

Carrier_Frequencies_Separation_(Hopping)_NVNT_ANT1_1-DH5_Hopping

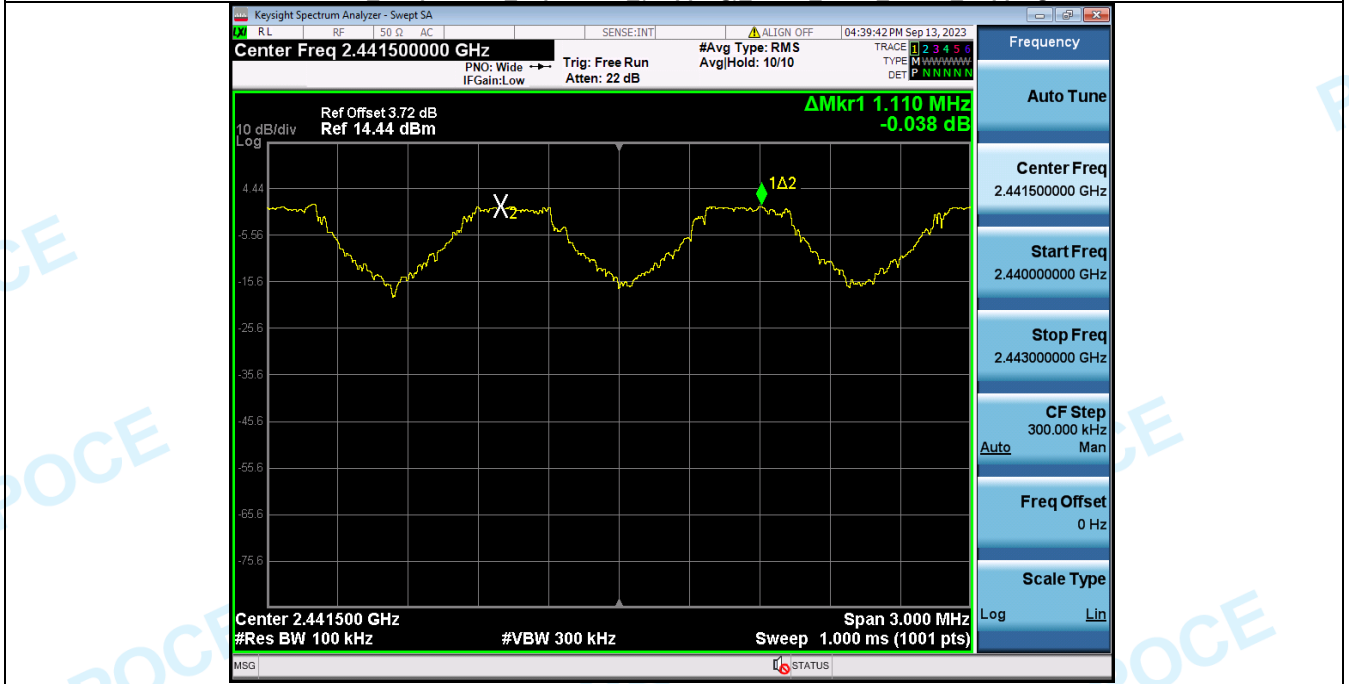

Carrier_Frequencies_Separation_(Hopping)_NVNT_ANT1_2-DH5_Hopping

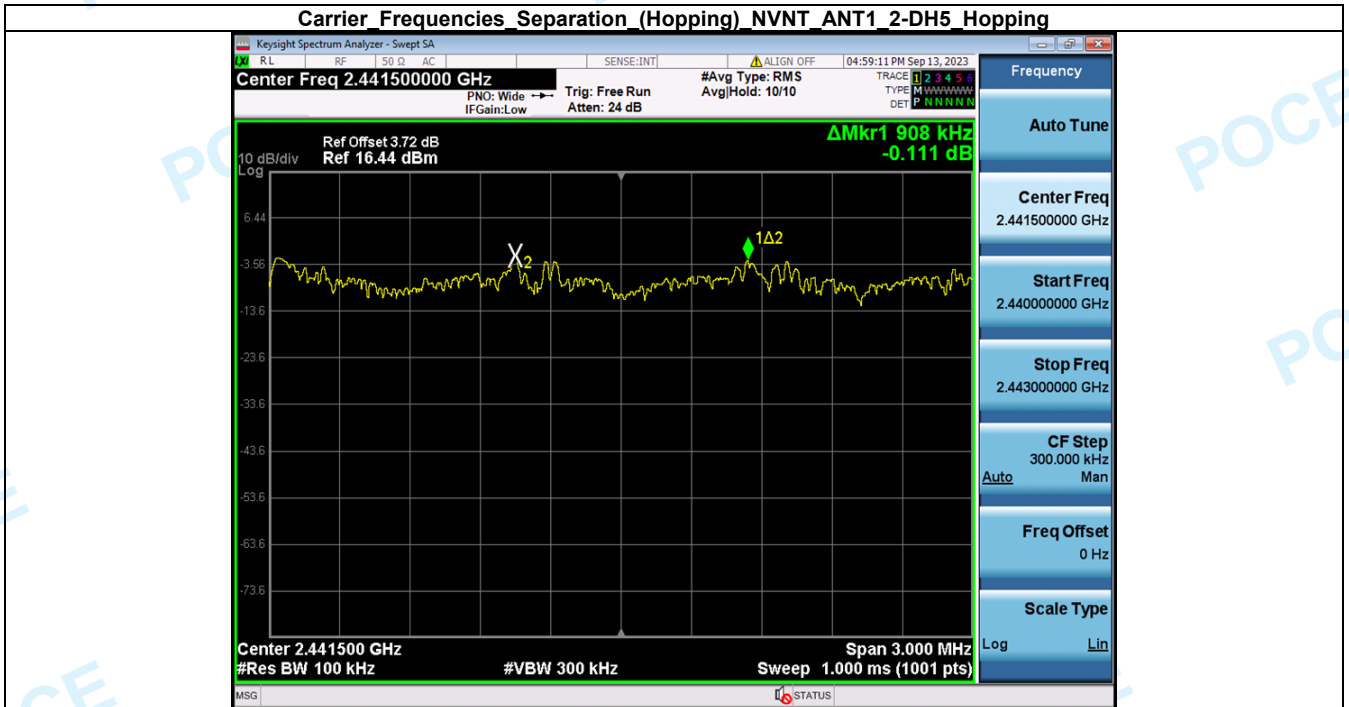

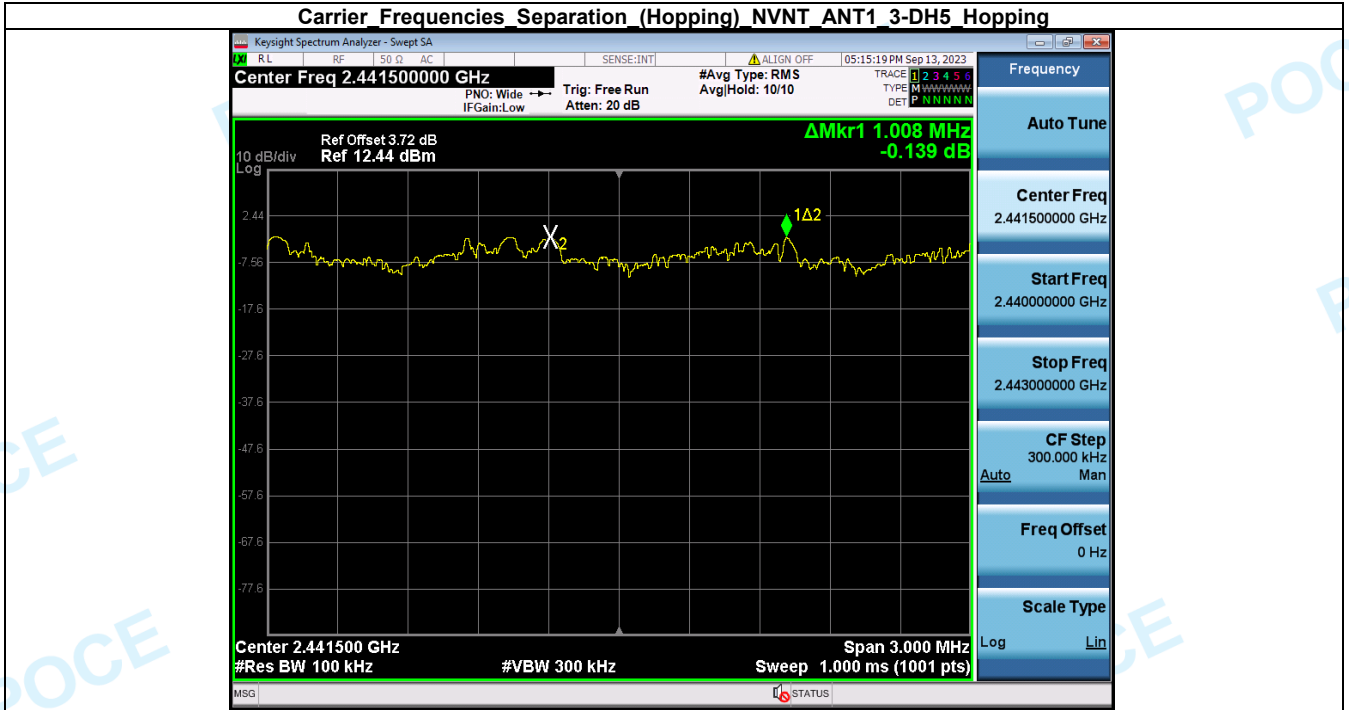

6. Number of Hopping Channel (Hopping)

Condition	Antenna	Modulation	Hopping Num	Limit	Result
NVNT	ANT1	1-DH5	79	15	Pass
NVNT	ANT1	2-DH5	79	15	Pass
NVNT	ANT1	3-DH5	79	15	Pass

Number of Hopping Channel (Hopping) NVNT ANT1 1-DH5 Hopping

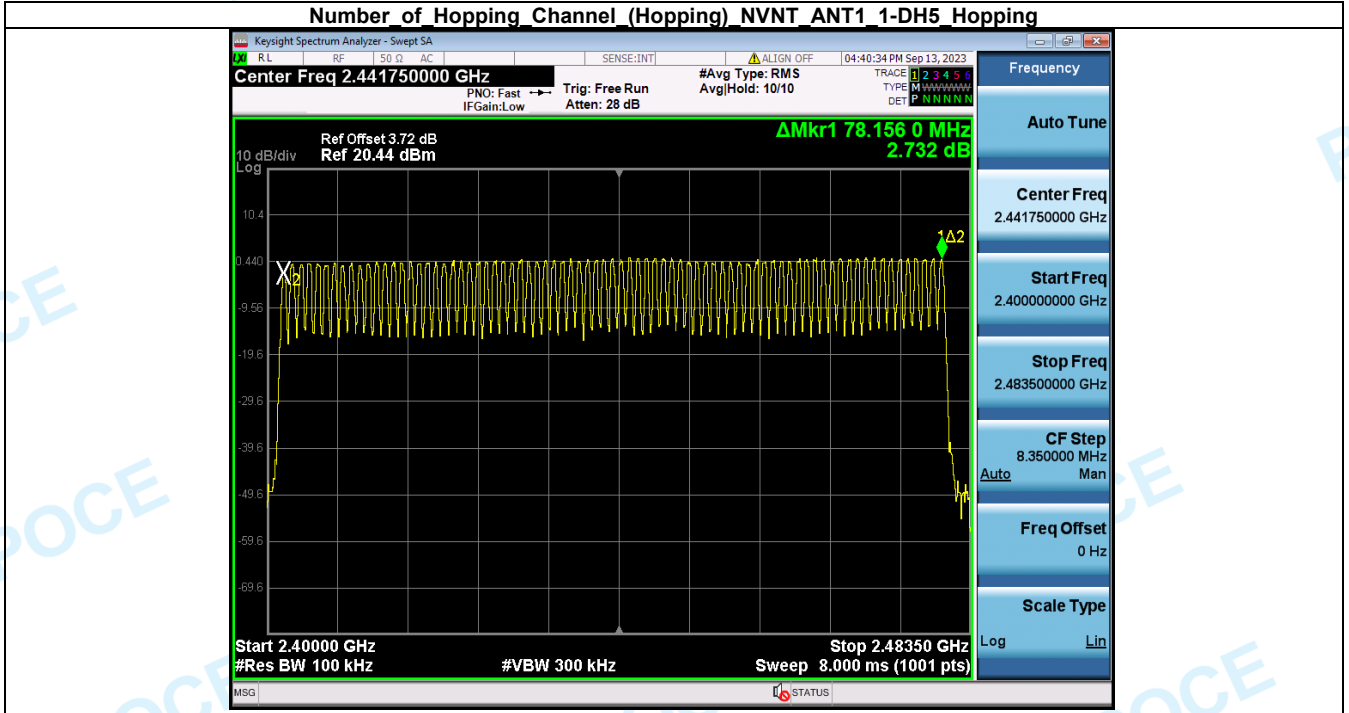

Number of Hopping Channel (Hopping) NVNT ANT1 2-DH5 Hopping

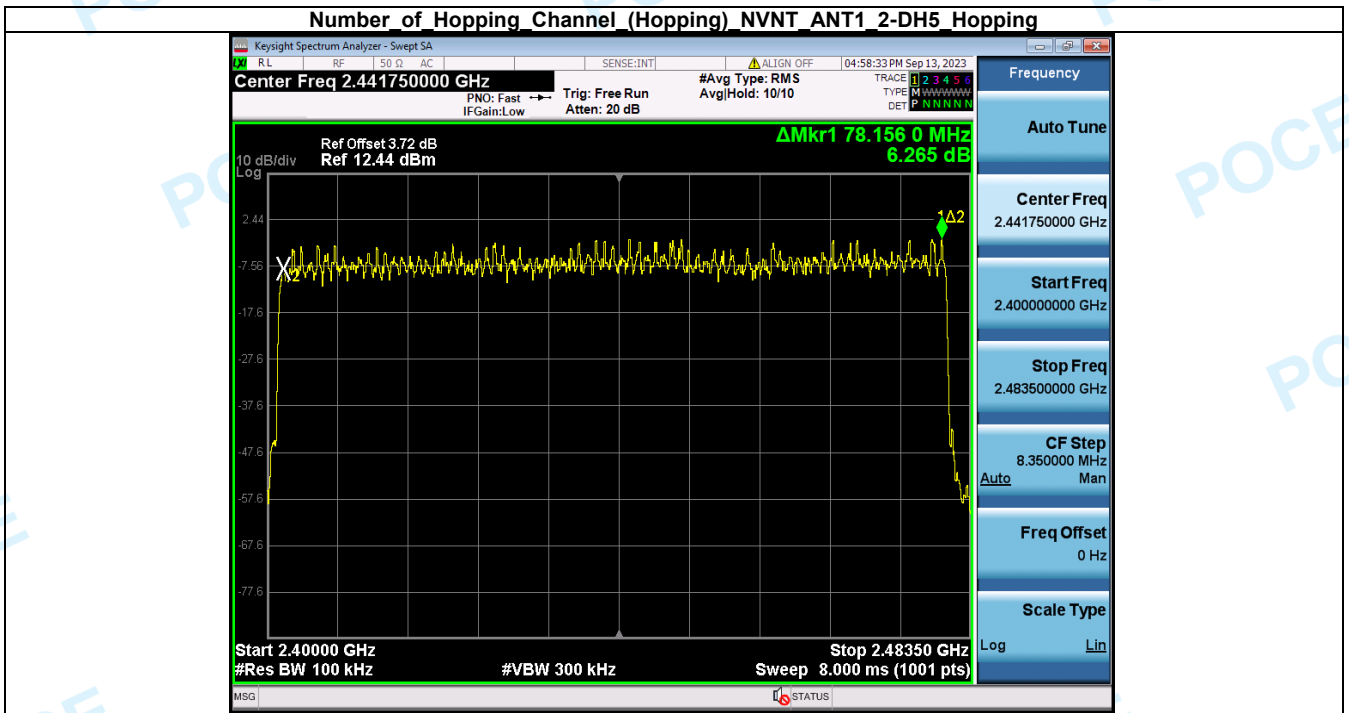

Number of Hopping Channel (Hopping) NVNT ANT1 3-DH5 Hopping

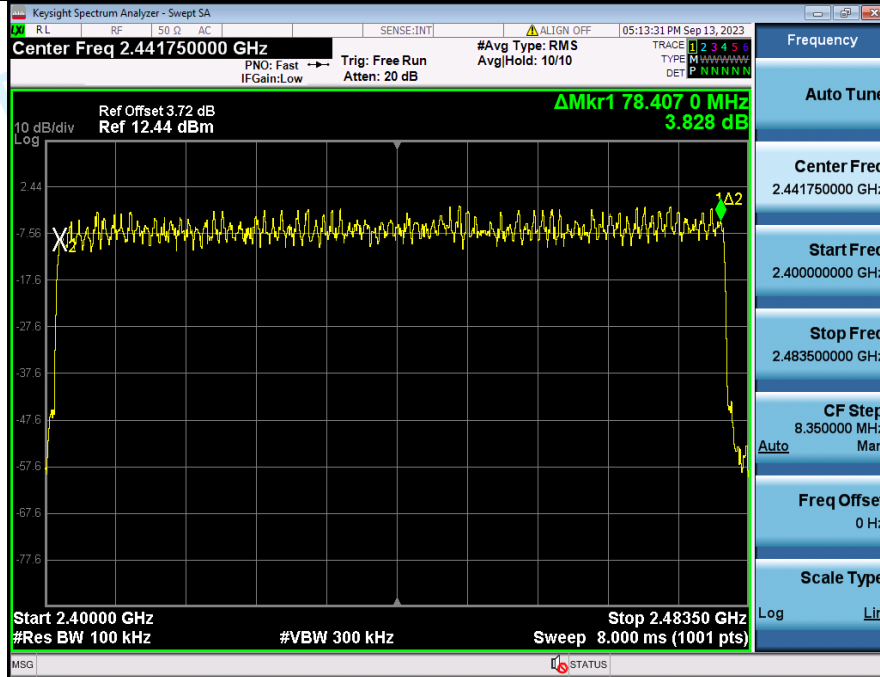

7. Dwell Time (Hopping)

Condition	Antenna	Packet Type	Pulse Time(ms)	Hops	Dwell Time(ms)	Limit(s)	Result
NVNT	ANT1	1-DH5	2.916	107.00	312.012	0.40	Pass
NVNT	ANT1	2-DH5	2.923	107.00	312.761	0.40	Pass
NVNT	ANT1	3-DH5	2.924	106.00	309.944	0.40	Pass
NVNT	ANT1	1-DH1	0.412	320.00	131.840	0.40	Pass
NVNT	ANT1	1-DH3	1.668	0.00	0.000	0.40	Pass
NVNT	ANT1	2-DH1	0.423	320.00	135.360	0.40	Pass
NVNT	ANT1	2-DH3	1.675	160.00	268.000	0.40	Pass
NVNT	ANT1	3-DH1	0.423	320.00	135.360	0.40	Pass
NVNT	ANT1	3-DH3	1.673	160.00	267.680	0.40	Pass

Dwell Time (Hopping) NVNT ANT1 1-DH5 2441 One Burst Time

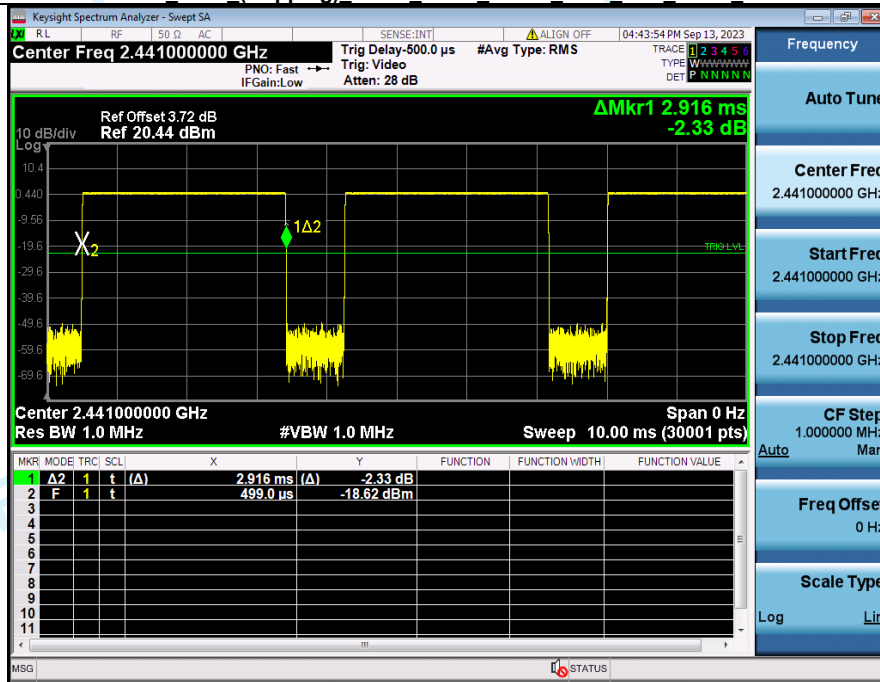

Dwell Time (Hopping) NVNT ANT1 1-DH5 2441 Accumulated

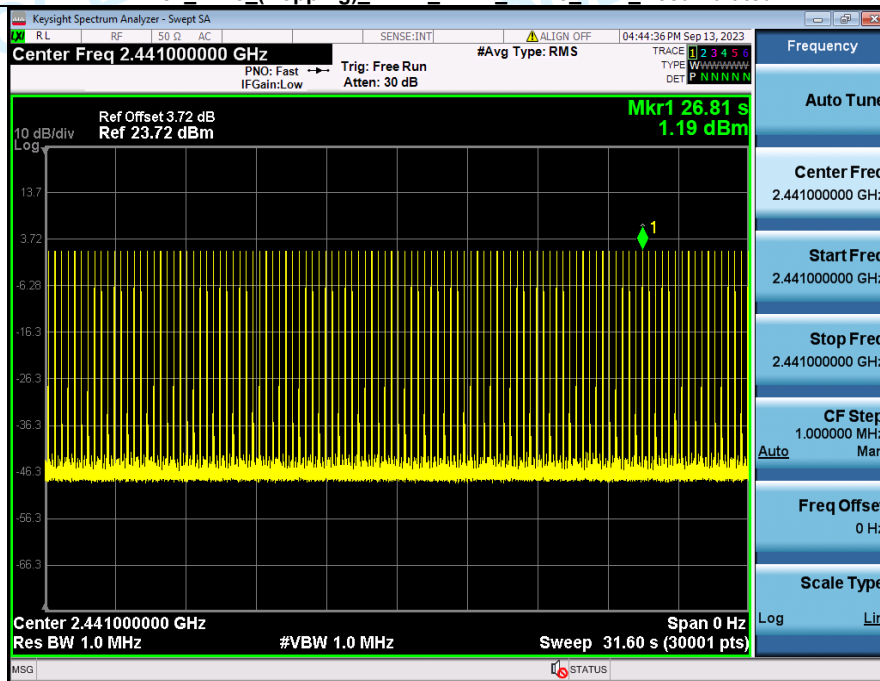

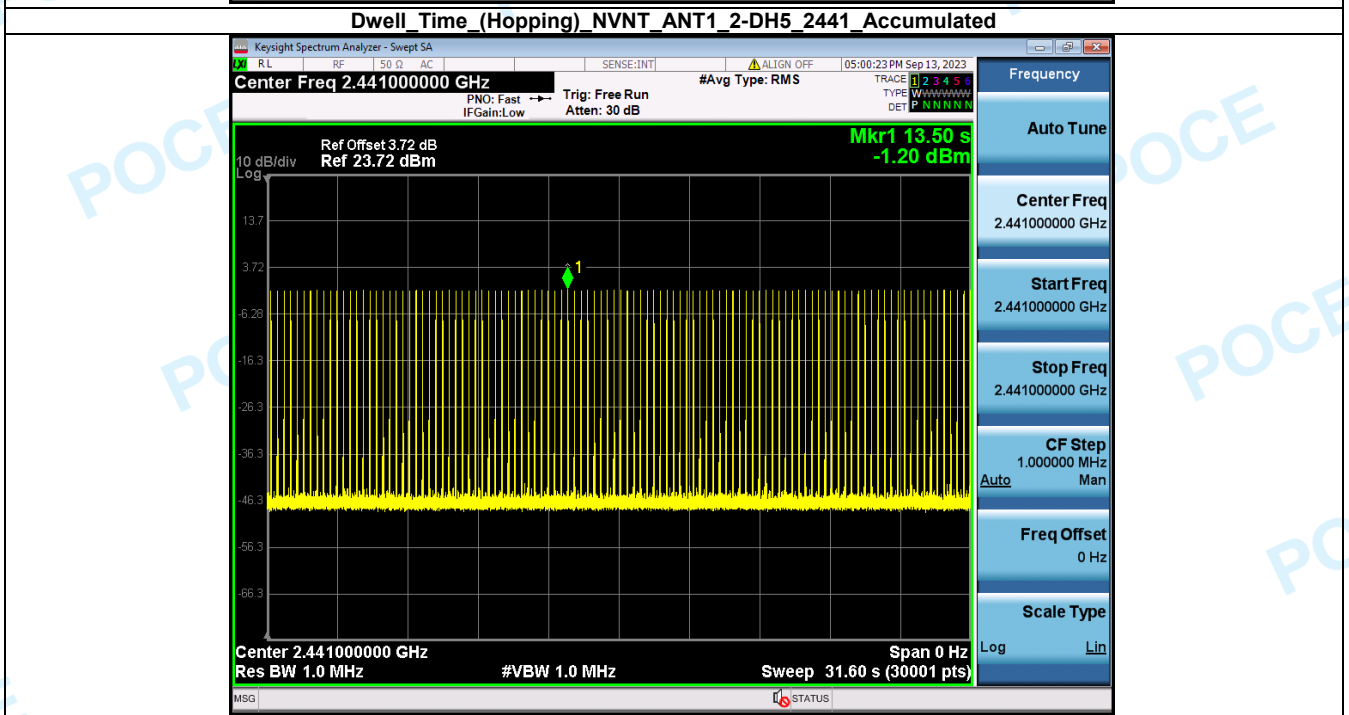
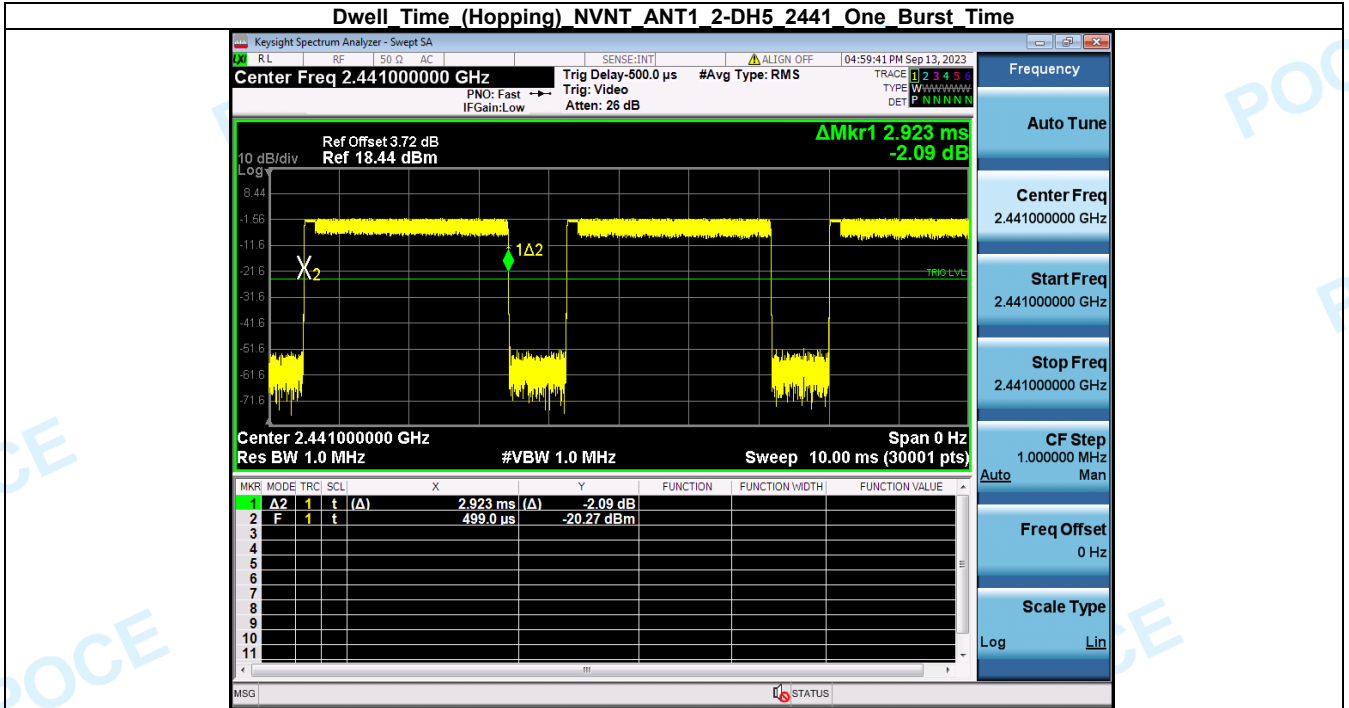

Dwell Time (Hopping) NVNT ANT1 3-DH5 2441 One Burst Time

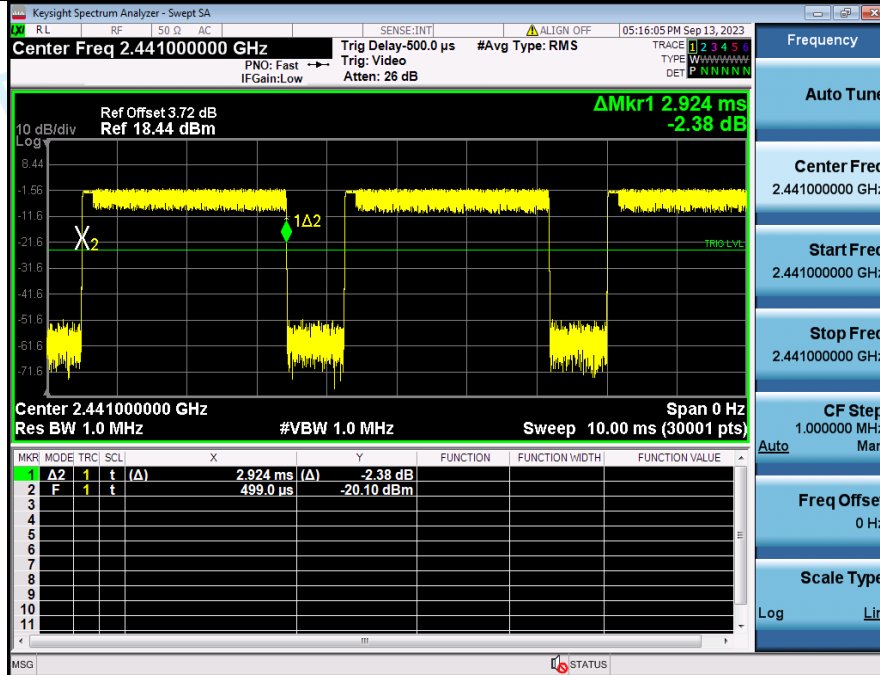

Dwell Time (Hopping) NVNT ANT1 3-DH5 2441 Accumulated

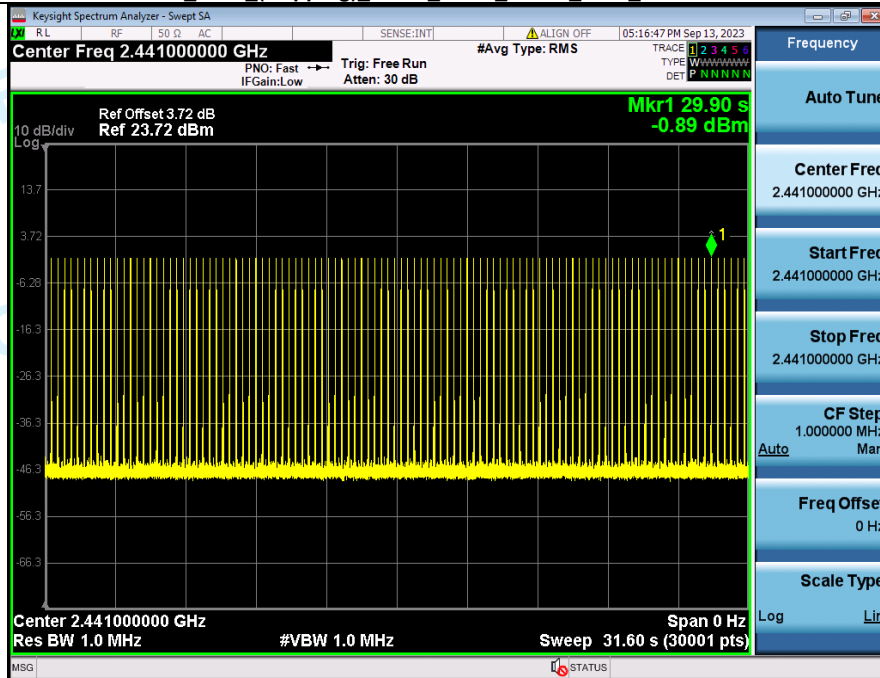

Dwell Time (Hopping) NVNT ANT1 1-DH1 2441 One Burst Time

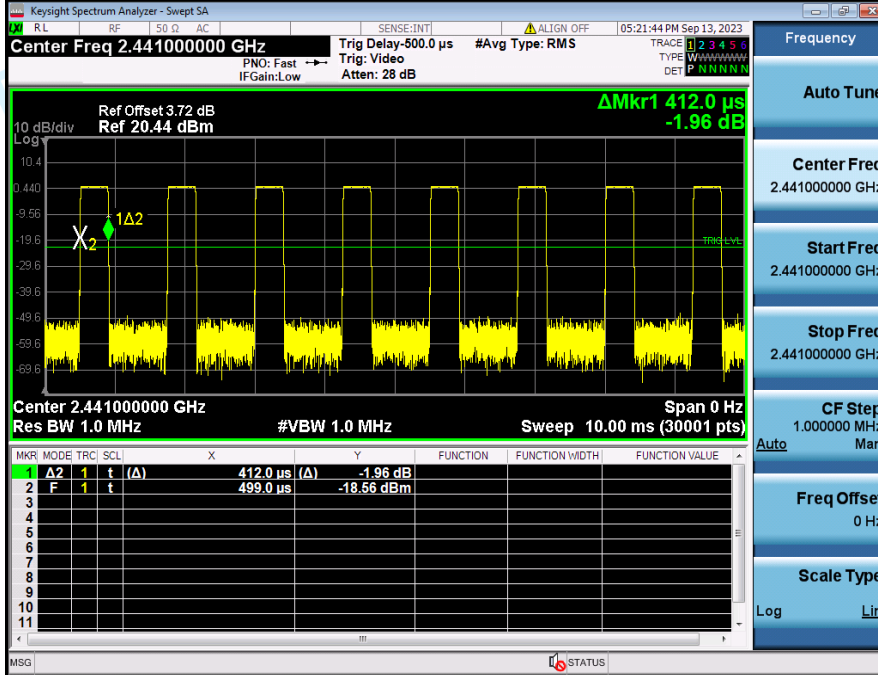

Dwell Time (Hopping) NVNT ANT1 1-DH1 2441 Accumulated

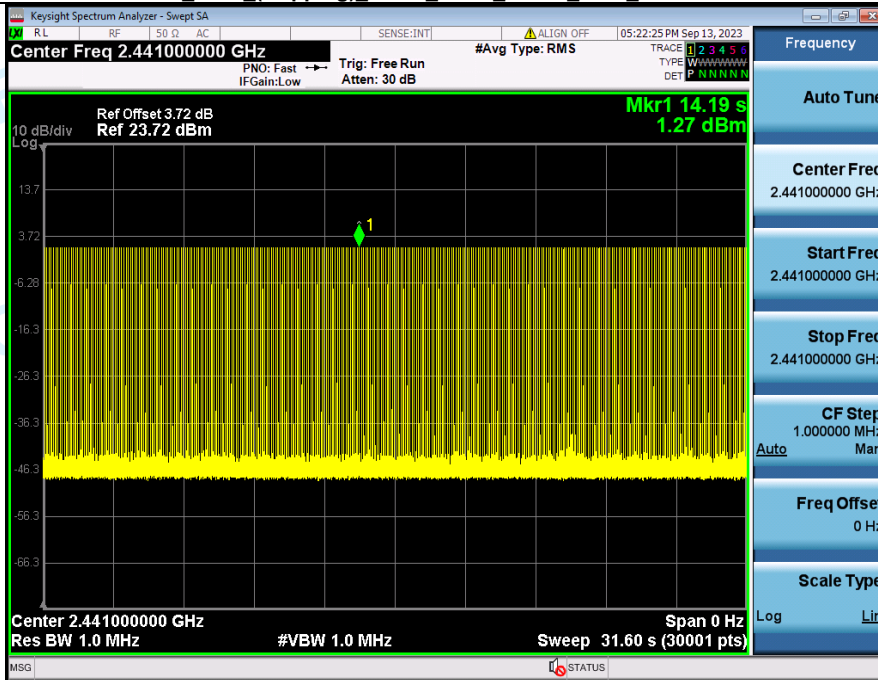

Dwell Time (Hopping) NVNT ANT1 1-DH3 2441 One Burst Time

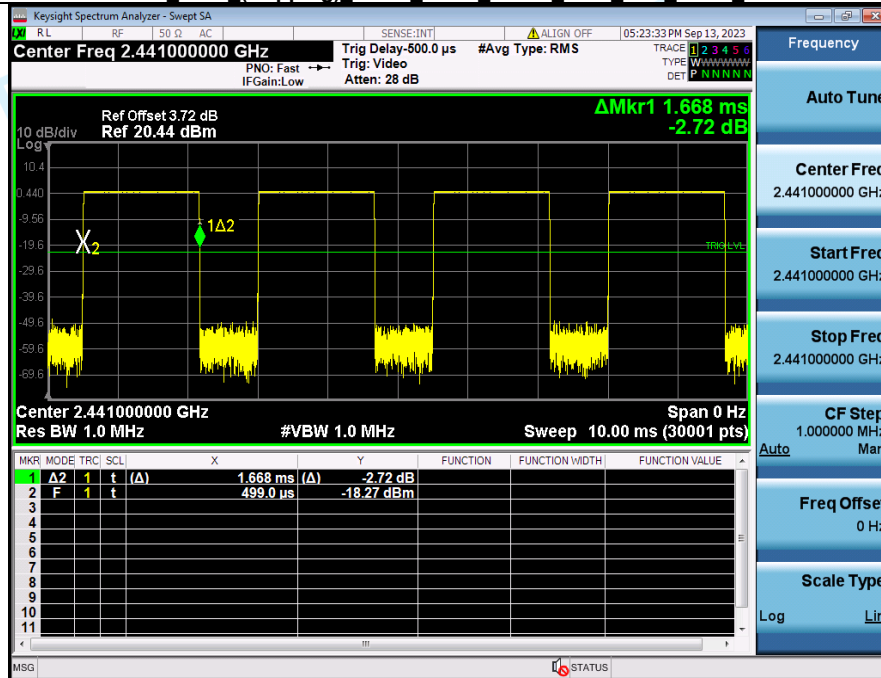

Dwell Time (Hopping) NVNT ANT1 1-DH3 2441 Accumulated

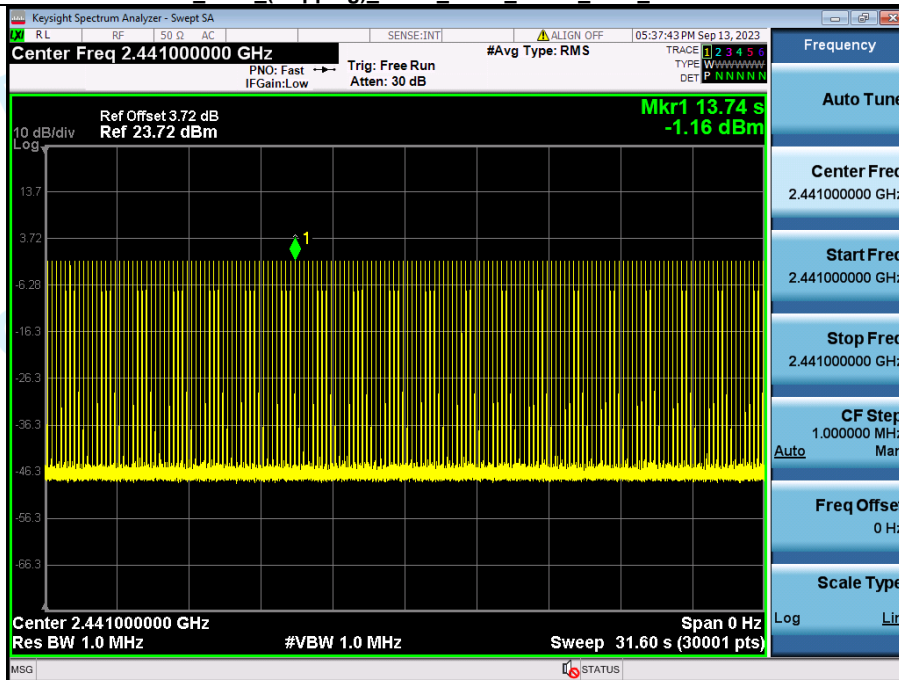

Dwell Time (Hopping) NVNT ANT1 2-DH1 2441 One Burst Time

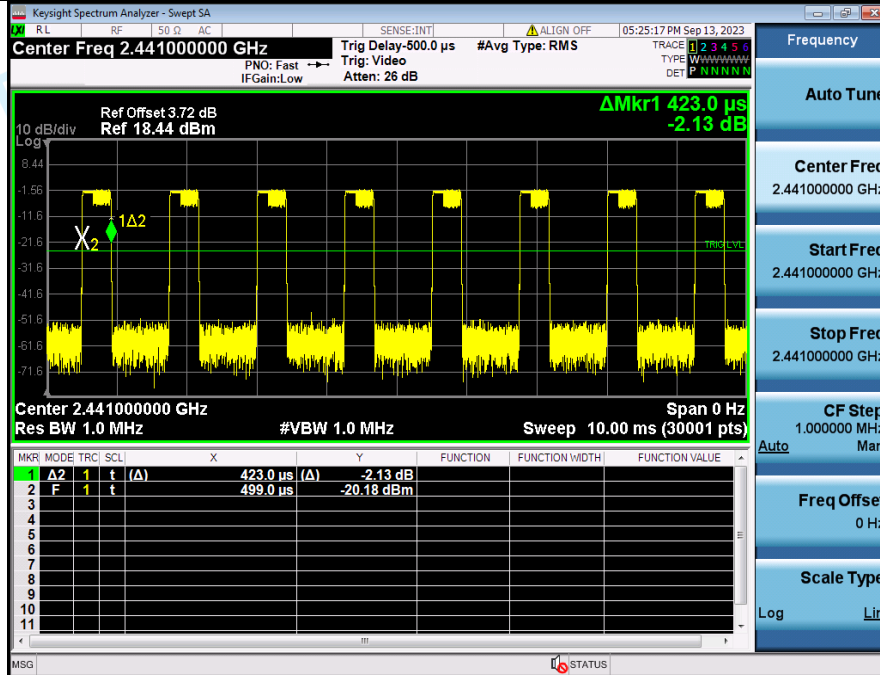

Dwell Time (Hopping) NVNT ANT1 2-DH1 2441 Accumulated

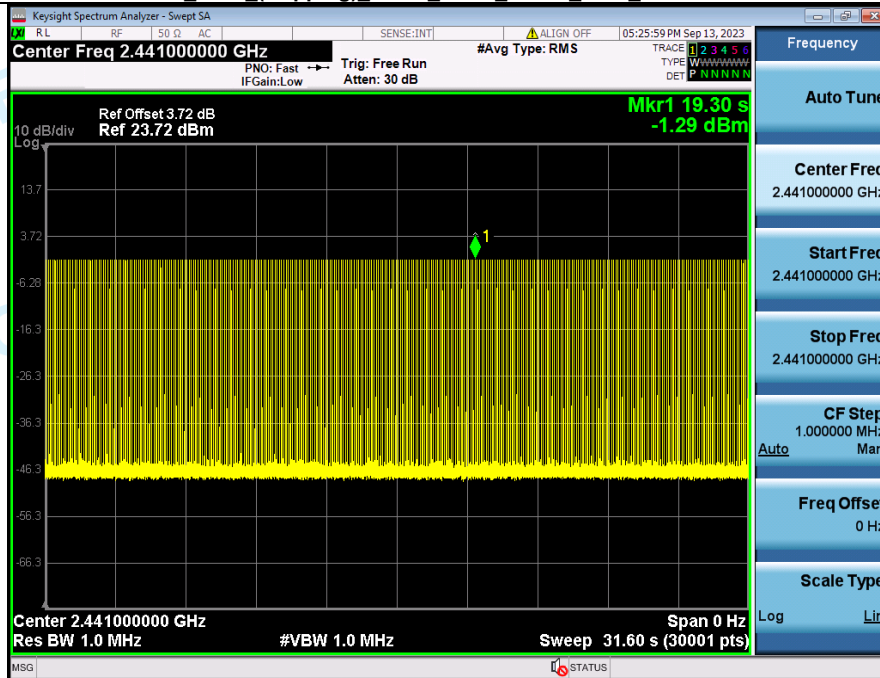

Dwell Time (Hopping) NVNT ANT1 2-DH3 2441 One Burst Time

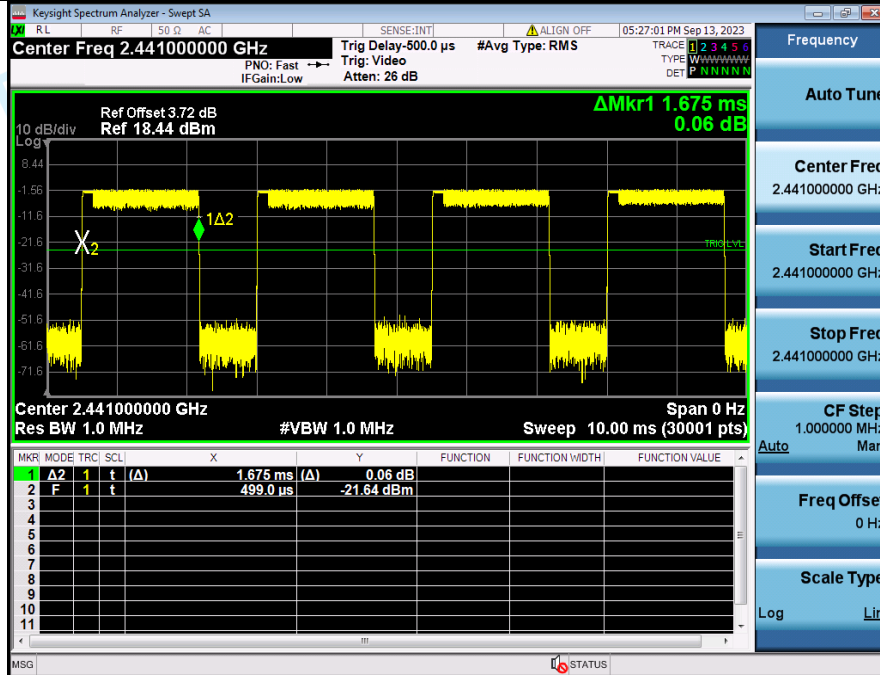

Dwell Time (Hopping) NVNT ANT1 2-DH3 2441 Accumulated

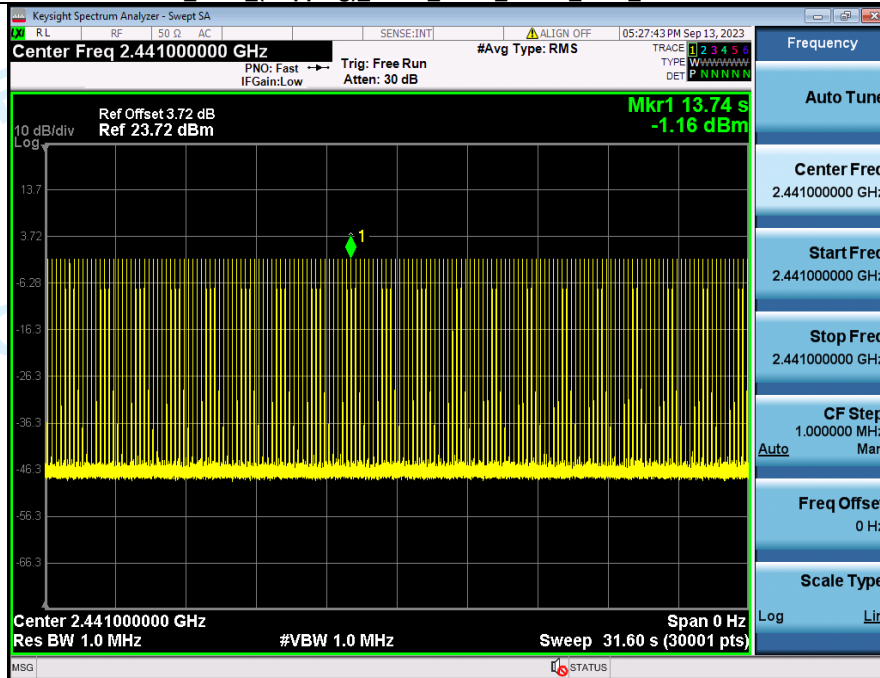

Dwell Time (Hopping) NVNT ANT1 3-DH1 2441 One Burst Time

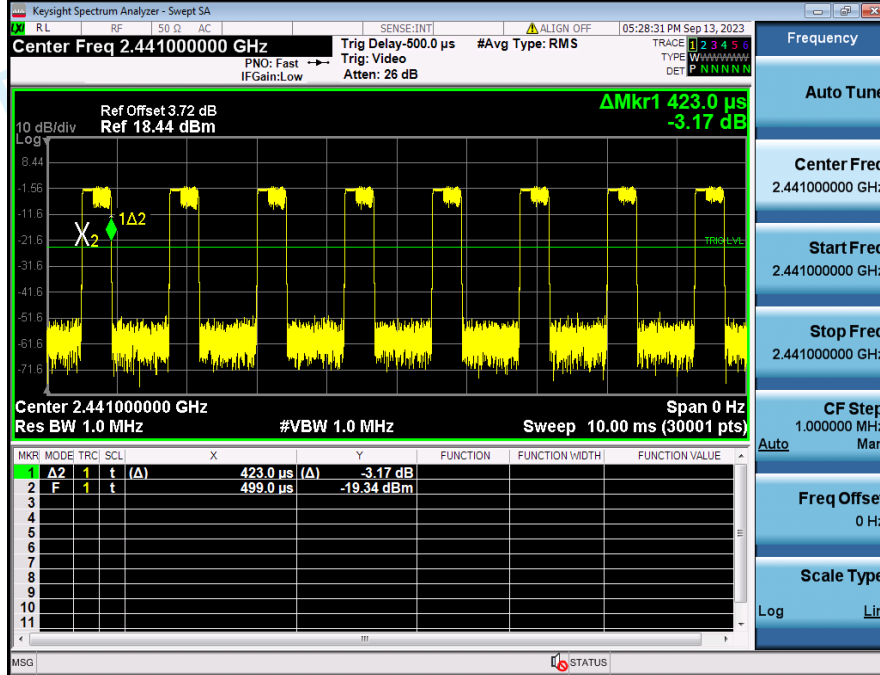

Dwell Time (Hopping) NVNT ANT1 3-DH1 2441 Accumulated

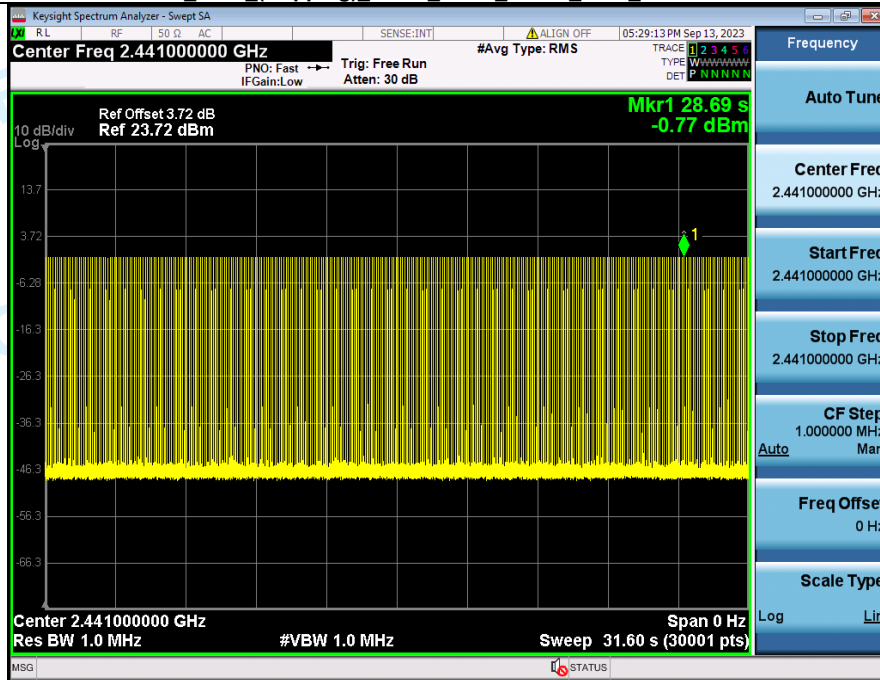

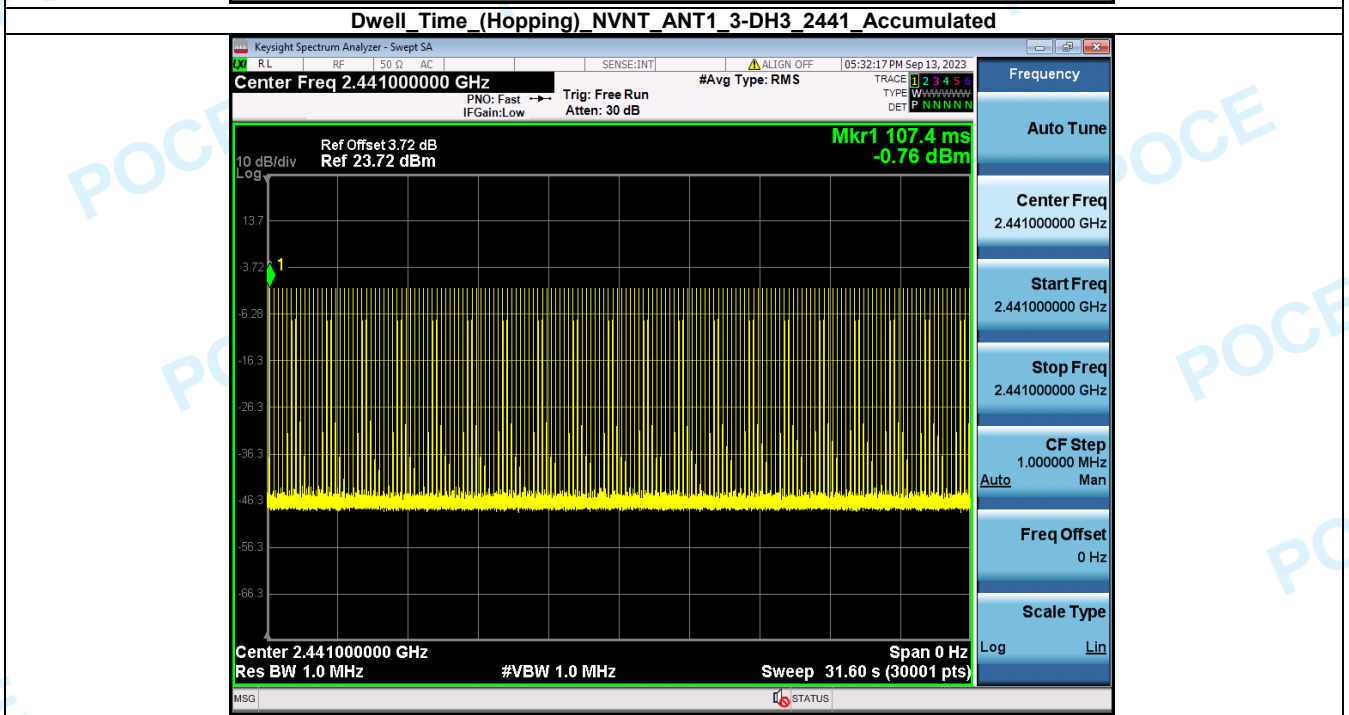
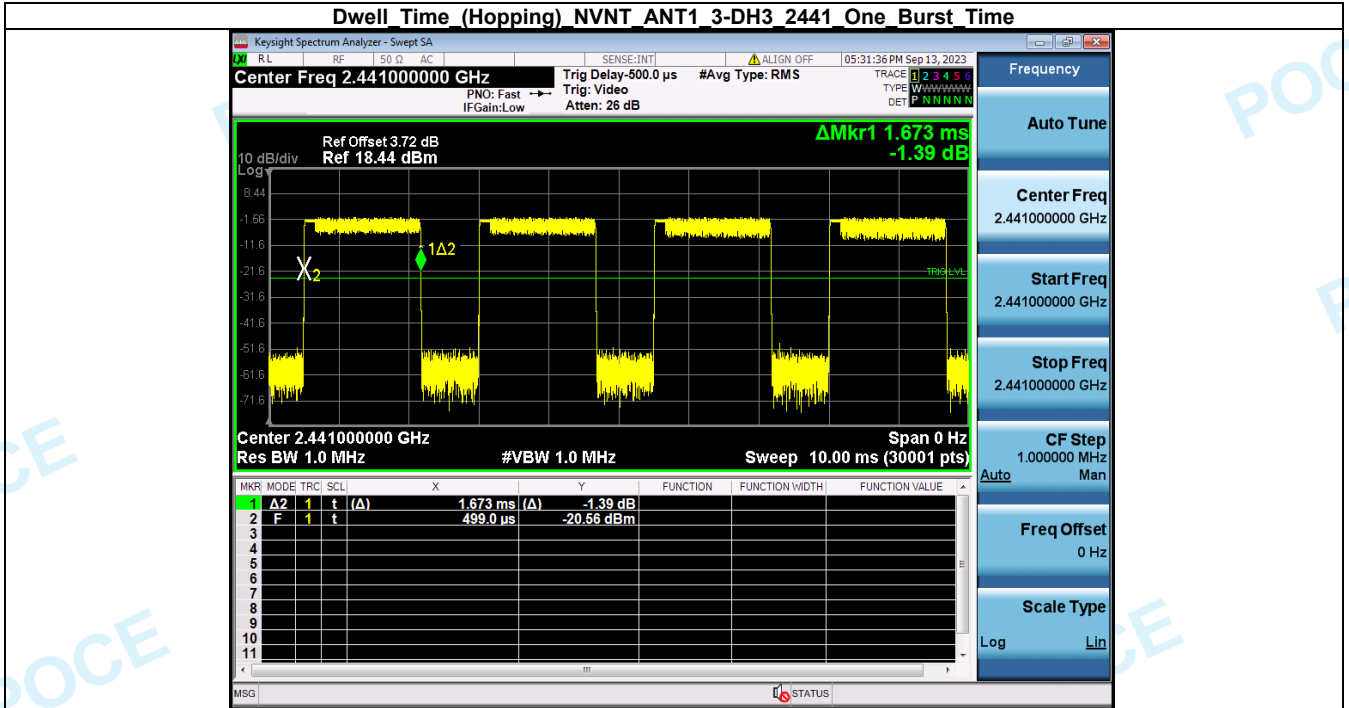

***** End of Report *****